

COMMUNICATIONS

\$1.00

INCLUDING "RADIO ENGINEERING" AND "TELEVISION ENGINEERING"



FEBRUARY

- ★ PLANNING AND CONSTRUCTING A 1-KW STUDIO-TRANSMITTER BUILDING
- ★ COMPLETE PROGRAM FOR 1947 IRE NATIONAL CONVENTION

1947

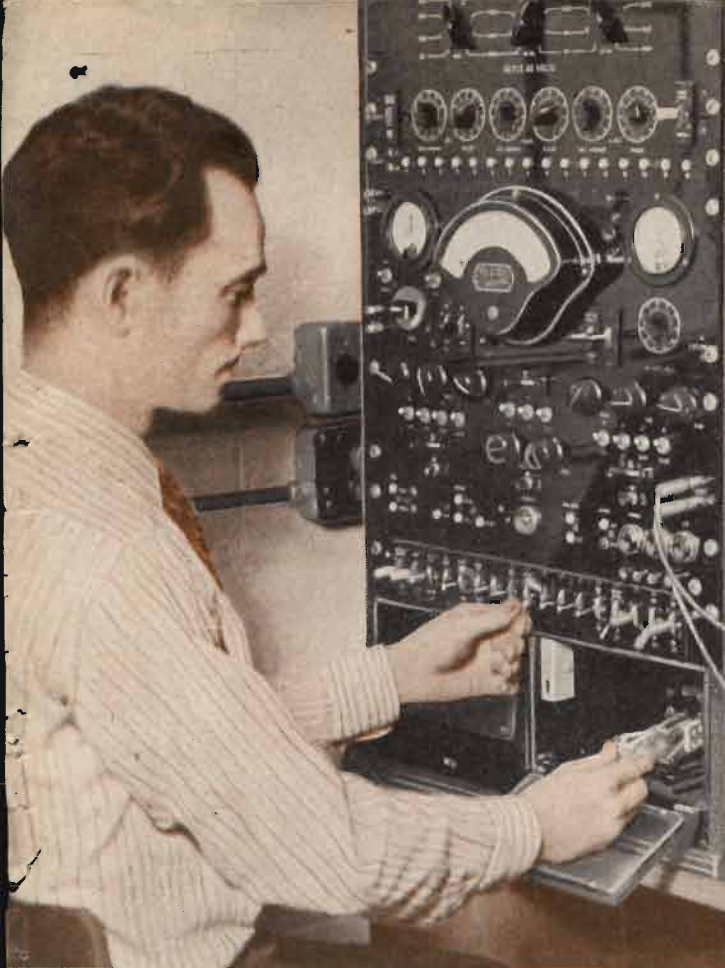

**Through This Machine
Pass The Most
Precisely Tested
Relays You Can Buy!**



● Designed and built by Clare to "stand in" for YOU, this machine automatically compares the Clare "Custom-Built" Relay you ordered with the one you will receive.

Clare ingenuity in economically producing a relay "custom-built" to your exact specifications is also demonstrated in this unique Test Set which checks coil windings, resistance, breakdown and desired current and voltage to meet the exact demands of your specifications.

Relays are our business. Clare engineering and manufacturing skills are entirely devoted to giving you the best built, most perfectly operating relay for the job you have. No precision methods of construction or testing which will assure this objective are overlooked. Clare reputation rides with the performance of every relay that bears our stamp.

That is why thousands of engineers in every branch of industry have learned to look to Clare "Custom-Built" Relays when new or unusual problems in the use of relays present themselves. They know Clare can give them a relay for their design . . . they never have to design to fit a stock relay.

Close at hand are Clare Sales Engineers ready to discuss such problems with you—to offer suggestions and set things moving for the design of a Clare "Custom-Built" Relay for YOUR application.

It will pay you to know all about Clare Relays. Our fine new Engineering Data Book will be mailed the day we receive your request. Drop a line today to: C. P. Clare & Company, 4719 West Sunnyside Avenue, Chicago 30, Illinois. Cable address: CLARELAY. *In Canada: Canadian Line Materials Limited.*

CLARE RELAYS

"Custom-Built" Multiple Contact Relays for Electrical and Industrial Use

New... **FERRANTI**

ELECTROSTATIC VOLTMETERS

FOR AC AND DC MEASUREMENTS

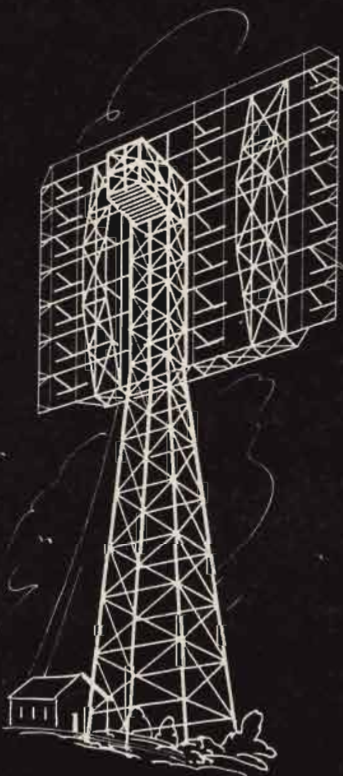

2 1/2" PORTABLE TYPE
Also made in FLUSH and
PROJECTING TYPES

- ZERO CURRENT CONSUMPTION
- READING FROM 20 to 25,000 VOLTS
- AC OR DC UP TO 3,500 VOLTS
- SELF-CONTAINED
- OVER-VOLTAGE PROTECTION
- 2 1/2 in. DIALS
- SINGLE, DUAL AND TRIPLE RANGES
- MAGNETIC DAMPING
- PRECISION BUILT, ACCURATE
- THOROUGHLY RELIABLE

A Product of over 65 years of Ferranti experience

FERRANTI ELECTRIC INC., 30 ROCKEFELLER PLAZA, NEW YORK 20, N. Y.

We See...

V-H-F TELEVISION ENGINEERING PROGRESS staged quite a show at the recent FCC demonstration hearings in New York and Princeton, N. J. On view were direct view and projection receivers with wide-angle screens and a brightness of from 75 to 500 foot lamberts, sufficient brilliance for viewing in sun-lit rooms. Gone too were the dozens of control knobs; only three or four controls were on the sets demonstrated.

V-h-f transmission coverage, also being probed, also proved its effectiveness with excellent reception recorded at points 40 to 50 miles from the transmitter, programs being of both studio and remote 6900-mc link type.

Noting the sound basis that the art has achieved, industry is planning a very substantial production program for 1947. According to James B. Sheridan of the FCC economic division, who testified at the cross-examination hearings in Washington, twenty-three companies have reported that they will be producing one or more models of black and white receivers during 1947. Over 400,000 sets are expected to come off the line. Many of the models will feature 7 or 10" direct-viewing tubes. Several are scheduled to use 15" and 20" tubes and several lines of projection models are also planned.

Television has hit a lively stride.

THAT 30-KC SEPARATION plan for a-m stations in the same area comes up again for discussion before the FCC in March, during the debate for broadcast standards that are to be set up for presentation to the NARBA Conference later this year. When the separation plan was proposed during the summer of 1946, the FCC disapproved the move stating that at least 40-kc separation is necessary since cross-modulation may result.

According to FCC, no station should be licensed for operation with a 30-kc separation from another station if the area enclosed by the 25 millivolt per meter ground-wave contours of the two stations overlap. Stations are required to send out a 25-millivolt signal over the main area in which they are located and thus the 30-kc plan could only be used for stations in adjacent cities, according to the FCC version.

There will be quite a few lively arguments on the subject when the FCC starts listening in March.

MARCH, APRIL AND MAY appear to have won acceptance again as engineering and industry conference months. In March, there will be the giant IRE Convention in New York. April 14th to 18th will see a Broadcast Engineering Conference in Atlanta, Georgia, co-sponsored by the Georgian Association of Broadcasters, Georgia Chapter of the IRE and the Georgia School of Technology. From April 28th to 30th, the RMA Engineering Department will hold its spring meeting in Syracuse, N. Y., and on May 17th, a New England Radio Engineering Meeting is scheduled for Cambridge, Mass.

We'll be telling you all about these sessions in COMMUNICATIONS.—L. W.

COMMUNICATIONS

Including Television Engineering, Radio Engineering, Communication & Broadcast Engineering, The Broadcast Engineer. Registered U. S. Patent Office.

FEBRUARY, 1947 VOLUME 27 NUMBER 2

COVER ILLUSTRATION

Processing and testing equipment designed in the engineering development laboratory at the Lancaster plant of the RCA tube department to measure and evaluate cathode emission of the electron gun in the neck of image orthicons. System permits testing of four tubes simultaneously, final readings being taken after an hour's operation

BROADCAST BUILDING CONSTRUCTION

Planning and Constructing a 1-kw Studio-Transmitter Building
 Hobart G. Stephenson, Jr. 9
Building Problems Overcome Through Use of Substitute Materials. Structure Features Isolated Studios, Office Facilities and Repair and Maintenance Shop.

F-M/TELEVISION RECEIVER DESIGN

Input Circuit Noise Calculations for F-M and Television Receivers
 William J. Stolze 12
Data Required to Design Efficient Input Stages of F-M and Television Receivers.

ENGINEERING CONFERENCE

Program for the 1947 IRE National Convention..... 18
 On View at the IRE National Convention..... 22

MEASUREMENTS

A 100-Kc Frequency Standard for Receivers.....James N. Whitaker 24
Miniature Unit Uses 100-kc Crystal Oscillator in Aperiodic Circuit Adjustable so That Harmonics Will Zero Beat With WWV.

RECORDING

Lateral RecordingW. H. Robinson 26
First of a Series of Recording Analyses Covering Groove Depths, Discs, vi Units, Cutters, Cutting Angles, etc.

TELEVISION ANTENNAS

Impedance Measurements with Transmission Lines of Television Antennas
 G. Edward Hamilton and Russell K. Olson 32
Analyses of actual measurement techniques.

MONTHLY FEATURES

Editorial (We See).....Lewis Winner 2
 The Industry Offers..... 22
 Veteran Wireless Operators' Association News..... 30
 News Briefs of the Month..... 50
 Advertising Index 52

Published monthly by Bryan Davis Publishing Co., Inc.
 52 Vanderbilt Avenue, New York 17, N. Y. Telephone MURray Hill 4-0170

Bryan S. Davis, President F. Walen, Secretary
 Paul S. Weil, Vice Pres.-Gen. Mgr. A. Goebel, Circulation Manager

Chicago Representative: Lawrence Wehrheim,
 5510 W. Lemoyne Ave., Chicago 51, Ill.; Telephone MEERimac 7919
 Cleveland Representative: James C. Munn,
 2650 E. 126th St., Cleveland 20, Ohio; Telephone OEdar 7783
 Pacific Coast Representative: Brand & Brand,
 1052 W. Sixth St., Los Angeles 14, Calif.; Telephone Michigan 1732
 1085 Monadnock Bldg., San Francisco 5, Calif.; Telephone Douglas 4475

Wellington, New Zealand: Te Aro Book Depot, Melbourne, Australia: McGil's Agency.
 Entire contents Copyright 1947, Bryan Davis Publishing Co., Inc.

Entered as second-class matter Oct. 1, 1937 at the Post Office at New York, N. Y., under the Act of March 3, 1879. Subscription price: \$2.00 per year in the United States of America and Canada; 25 cents per copy. \$3.00 per year in foreign countries; 35 cents per copy.



EVERY DE MORNAY-BUDD WAVE GUIDE is Electrically Tested, Calibrated and Tagged



Crystal Mount DB-453



Rotating Joint DB-446



90° Elbow (H Plane) DB-433



Pressurizing Unit DB-452



Mitered Elbow (H Plane) DB-439



Uni-directional Broad Band Coupler DB-424



Bulkhead Flange DB-451



Uni-directional Narrow Band Coupler DB-440



90° Twist DB-435

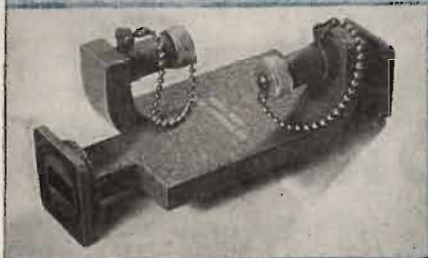

Bi-directional Narrow Band Coupler DB-441

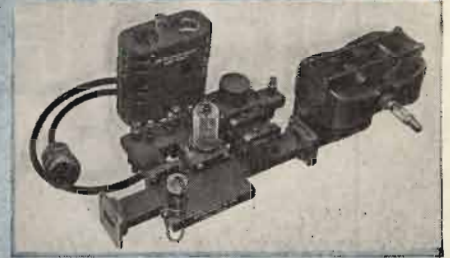
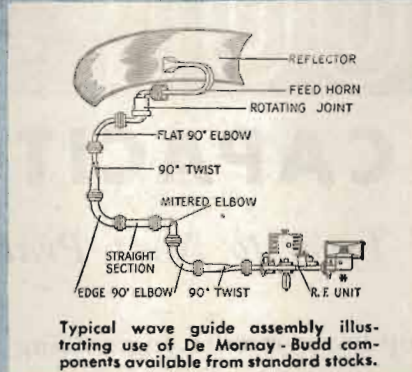

RF Radar Assembly DB-412

When you use any De Mornay-Budd wave guide assembly, you know exactly how each component will function electrically. You avoid possible losses in operating efficiency through impedance mismatches, or breakdown and arcing caused by a high standing wave ratio. (See chart below.)

De Mornay-Budd wave guides are manufactured from special precision tubing, and to the

most stringent mechanical specifications. Rigid inspection and quality control insure optimum performance.

NOTE: Write for complete catalog of De Mornay-Budd Standard Components and Standard Bench Test Equipment. Be sure to have a copy in your reference files. Write for it today.

The curve shows the manner in which the reflected power increases with an increase in the voltage standing wave ratio. The curve is calculated from the following equation:

$$\% \text{ Power Reflected} = \left(\frac{\left(\frac{V_{\max}}{V_{\min}} \right) - 1}{\left(\frac{V_{\max}}{V_{\min}} \right) + 1} \right)^2$$

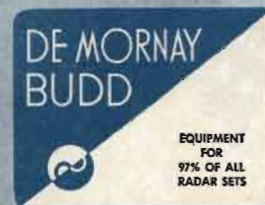
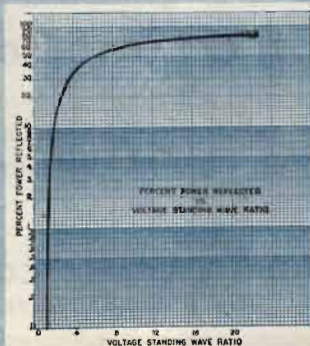

De Mornay-Budd, Inc., 475 Grand Concourse, New York 51, N. Y.



SPRAGUE

MICA CAPACITORS . . .

Standard and Special Types to Meet Practically Any Requirement

THE full advantages of up-to-the-minute engineering are incorporated in the war proven line of Sprague Mica Capacitors covering molded, molded-case potted and ceramic-case potted types for almost any need. If one of the many standard types does not meet your requirements Sprague engineers will welcome the opportunity to cooperate in the design of special types for out-of-the-ordinary uses.



WRITE FOR CATALOG 30

Contains data on all standard Sprague Mica Capacitors and outlines the many special types that can be engineered and produced as required.

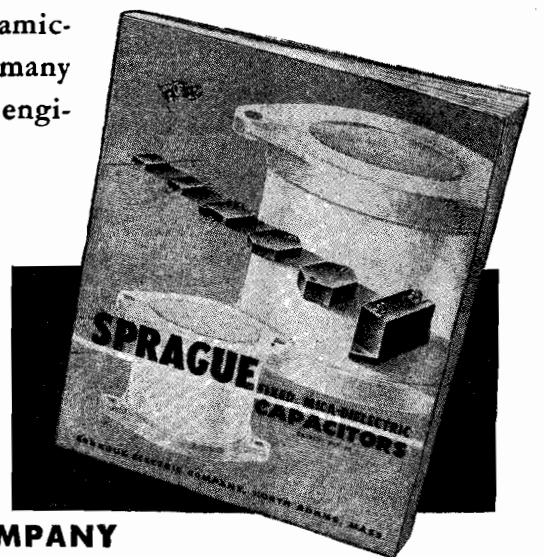

SPRAGUE ELECTRIC COMPANY
NORTH ADAMS, MASS.

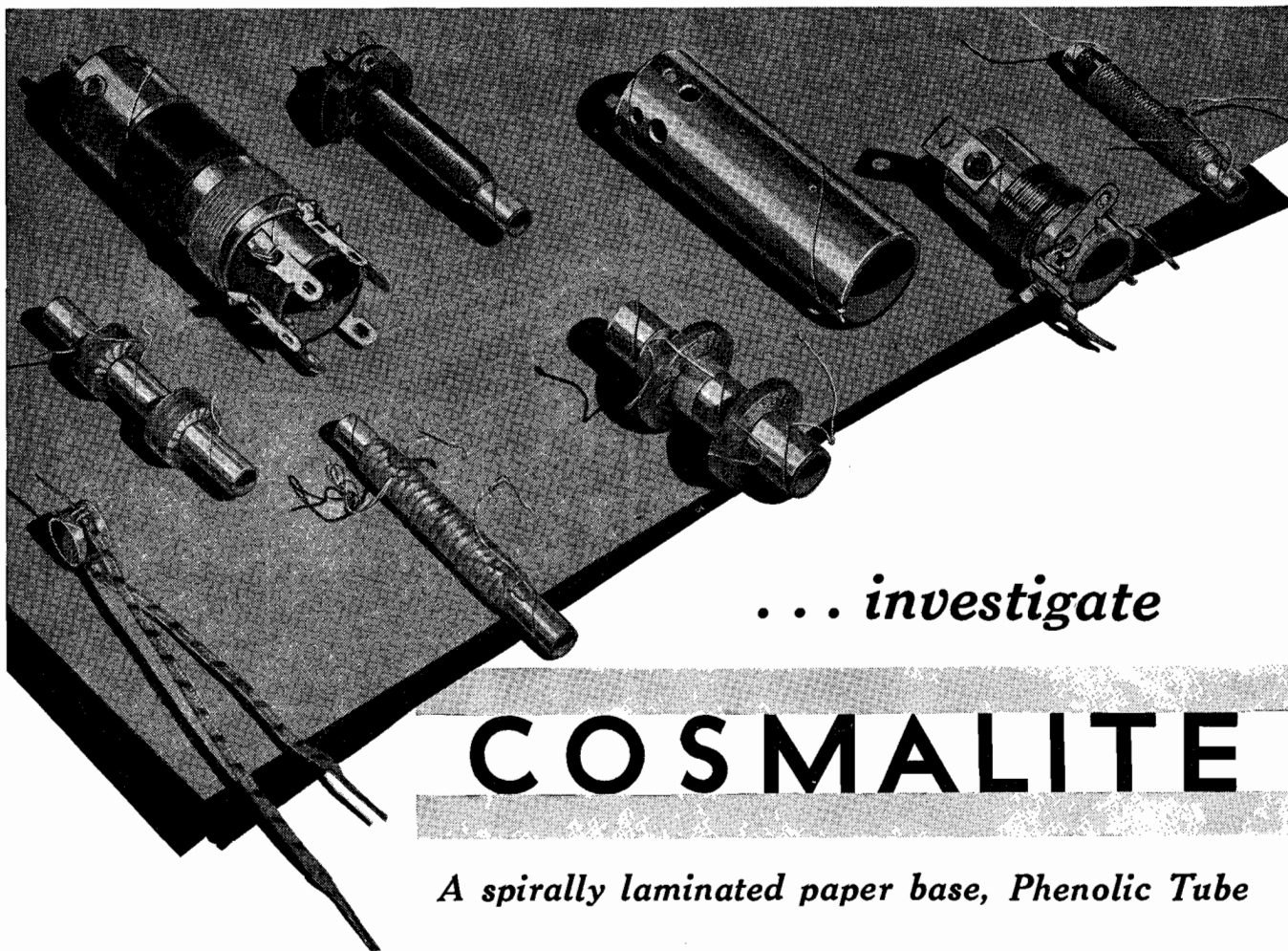

... investigate

COSMALITE

A spirally laminated paper base, Phenolic Tube

MADE IN TWO TYPES
 #96 COSMALITE is for coil forms in all standard broadcast receiving sets. Wall thicknesses from .010 up. Punching if desired.

SLF COSMALITE for Permeability Tuners available in wall thicknesses from .0065 to .0095.

See our Exhibit #421
 at the
I. R. E.
 Radio Engineering
 Show. Consult us
 for details.

COSMALITE* is the result of approximately seven years of research. You obtain the further advantage of *definitely lower costs!*

FAST DELIVERIES. Shipments are being made within four weeks.

Inquiries given specialized attention.



We also manufacture spirally wound kraft and fish paper Coil Forms and Condenser Tubes.

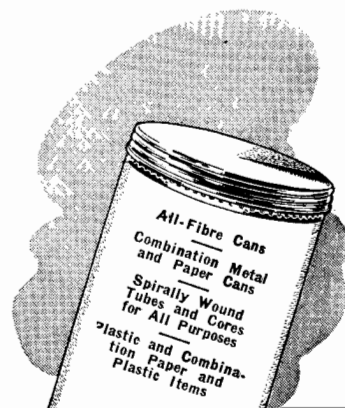

The **CLEVELAND CONTAINER Co.**
 6201 BARBERTON AVENUE CLEVELAND 2, OHIO

PRODUCTION PLANTS also at Plymouth, Wisc., Ogdensburg, N. Y., Chicago, Ill., Detroit, Mich., Jamesburg, N. J.
 PLASTICS DIVISIONS at Plymouth, Wisc., Ogdensburg, N. Y. • ABRASIVE DIVISION at Cleveland, Ohio
 New York Sales Office—1186 Broadway, Room 223

IN CANADA—The Cleveland Container Canada Ltd., Prescott, Ontario

*Trade Mark registered

Why this team is *Tops*



1915

The ocean, long a barrier to spoken communications, was conquered when Bell System engineers designed, built, and operated the transmitter which first sent the human voice across the Atlantic and Pacific.



1916

A Western Electric transmitter was used in one of the pioneer ship-to-shore radiotelephone experiments. Thirteen years later the first regular commercial service was established with Western Electric equipment.



1917

With the first airborne transmitter, Western Electric demonstrated two-way radiotelephony between a plane in flight and the ground. From this earliest experiment came commercial airline equipment in 1930.



1920

Western Electric radio became a part of the nation's telephone system when it was used to connect Catalina Island to the mainland. Seven years later, the Bell System offered commercial radio-telephone service to Europe.



1922

Western Electric manufactured and installed the first "high power" (500 Watt) commercial broadcast transmitter—for the Detroit News Station WWJ.



1930

Transmitter designed by Bell Laboratories first used for one-way contact with police cars. Police used Western Electric fixed station transmitters as early as 1922, and two-way mobile equipment from 1935.

From the basic developments pictured at the left, the team of Bell Laboratories and Western Electric continued to set the pace with the best in transmitting equipment. Among the later advances pioneered by this team were:

1928. The first 50 kw commercial broadcast transmitter, built by Western Electric, installed at WLW, Cincinnati, Ohio.

1935. A 50 kw Western Electric AM transmitter installed at WOR was the first to incorporate the Bell Laboratories-designed stabilized feedback circuit, since accepted as a broadcasting standard.

1937. The first single sideband transmitter was introduced for long distance, point-to-point communications. The world-wide military communications network used in the war came directly from this development.

1938. Flying tests of the first VHF aircraft transmitter showed relatively static-free communication at all times. Modifications of the original Bell Laboratories design were used for basic Army-Navy aircraft radiotelephony in World War II.

1940. The first Synchronized FM transmitter installed at WOR enabled broadcasters to put top-quality FM programs on the air and keep them on their assigned frequency.

1941. First FM transmitter to use grounded plate amplifier circuit was Western Electric 10 kw installed at WOR.

1941. Twelve talking channels adjacent to each other, available for the first time on a single radio frequency band, used to connect telephone lines on either side of Chesapeake Bay. Envelope feedback developed by Bell Telephone Laboratories and applied to the carrier technique in radio telephony made this possible.

—QUALITY COUNTS—

for Radio Transmitters!

The experience gained during the war, when the Bell Laboratories-Western Electric team was the largest supplier of communications equipment, added greatly to the skill and knowledge acquired through 30 years of transmitter development.

This background, plus unequalled research and manufacturing facilities, provides assurance that there are no finer transmitters than those designed by Bell Telephone Laboratories and built by Western Electric—whether for AM or FM broadcasting, point-to-point radiotelephony, or any type of communication or mobile service.

1943. The ARC-1, a crystal controlled ten frequency transceiver, used by the Navy's fighter planes during the war, has been accepted as standard VHF equipment by U.S. airlines. Provides nine plane-to-ground frequencies and one plane-to-plane frequency.



1947. The Western Electric 238-type mobile radiotelephone system is providing dependable Bell System service between vehicles and any wire telephone in a growing number of cities and along trunk highways.

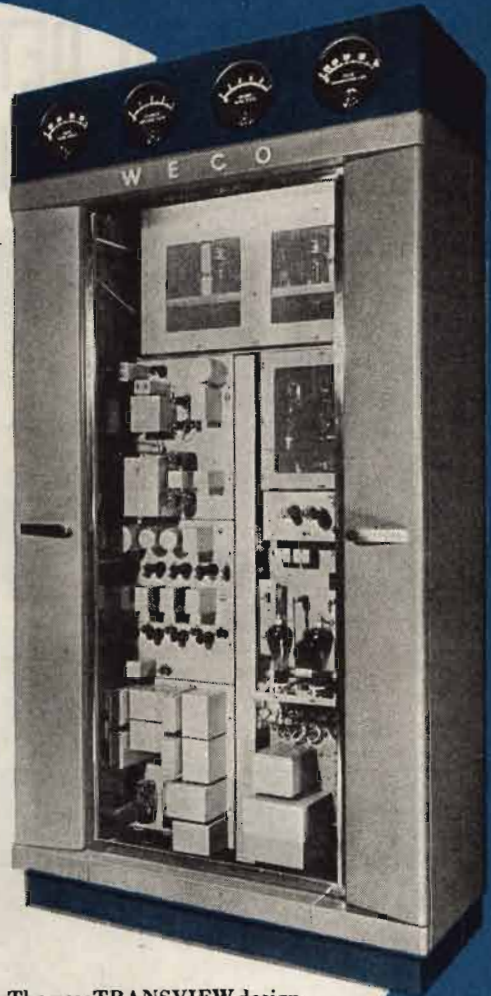

1947. The new TRANSVIEW design FM transmitter, being produced in 1, 3 and 10 kw units, for the first time provides the operator with an unobstructed view of all tubes while in operation. Incorporates Bell Laboratories-developed synchronized frequency control.

CITIZEN Distributed by
Graybar
OFFICES IN 95 PRINCIPAL CITIES



BELL TELEPHONE LABORATORIES

World's largest organization devoted exclusively to research and development in all phases of electrical communications.

Western Electric

Manufacturing unit of the Bell System and the nation's largest producer of communications equipment.

SYLVANIA NEWS

CIRCUIT ENGINEERING EDITION

FEB.

Prepared by SYLVANIA ELECTRIC PRODUCTS INC., Emporium, Pa.

1947

"ATTENTION TO DETAIL!" KEYNOTE OF SYLVANIA ELECTRIC RADIO TUBE PRODUCTION

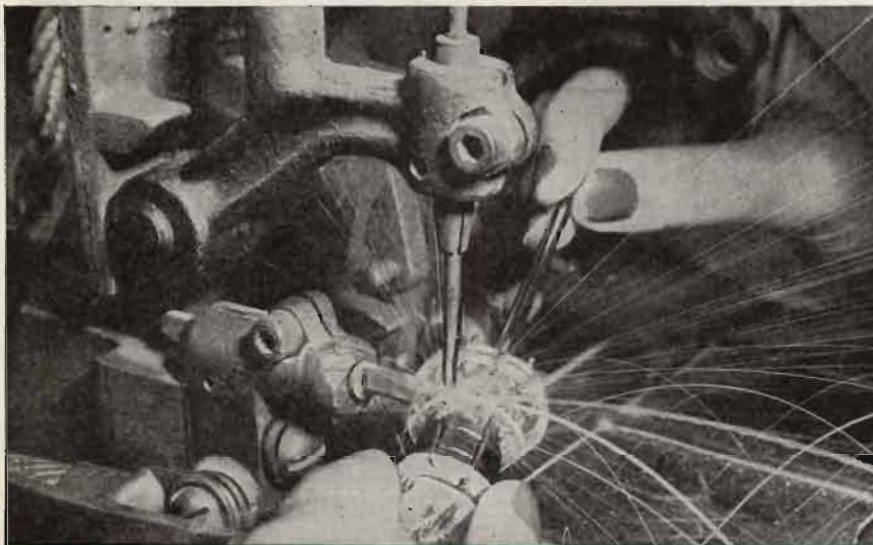

WELDING CONNECTIONS. All connections in the Lock-In Tube are welded for greater durability. Short, direct connections result in fewer joints and lower loss.



GLASS HEADERS. Small cylindrical cups of glass and metal pins are pressed into the low-loss glass base to which is joined the small glass exhaust tubing.

"Lock-In" Tube Manufacture Typical Of Plant Operation

Each Sylvania tube receives minute attention in every phase of production. Laboratory research achievements in developing and putting into production new alloys, new compounds, new engineering techniques, contribute fundamentally to the quality operation of Sylvania tubes.

An outstanding example of this controlled production is the famous Lock-In Tube. Note accompanying photographs.

LOCK-IN MOUNT AND GLASS HEADER

IMPROVED MOUNT . . . elements are ruggedly supported on all sides. Meticulous accuracy is required to fit and weld each part to the others to become the finished mount. There are few welded joints and no soldered joints—the elements can't warp or weave.

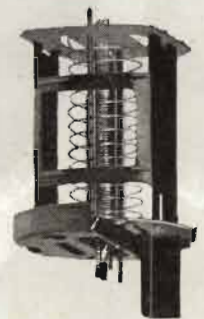

ALL-GLASS HEADER . . . through which element leads are directly brought—low-loss and better spacing of lead wires. These leads become the sturdy socket pins—effecting a much desired reduction in lead inductance and inter-element capacity.

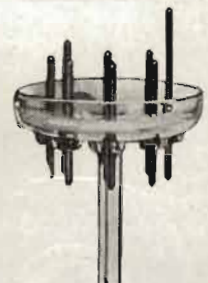

SYLVANIA ELECTRIC

Emporium, Pa.

MAKERS OF RADIO TUBES; CATHODE RAY TUBES; ELECTRONIC DEVICES; FLUORESCENT LAMPS, FIXTURES, WIRING DEVICES; ELECTRIC LIGHT BULBS

COMMUNICATIONS

LEWIS WINNER, Editor

* * FEBRUARY, 1947 * *

Planning And Constructing A 1-Kw STUDIO-TRANSMITTER BUILDING

Multi-Purpose Building Features Studios Isolated from External Noise, Streamlined Control Room, Deflection Baffles in Forced Ventilating System to Eliminate Extraneous Sounds, Soundproof Teletype Room, etc. Current Building Problems Overcome by Use of Variety of Substitute Materials. Design Applicable to Buildings Housing A-M or F-M Transmitters.

by **HOBART G. STEPHENSON, JR.**

Chief Engineer
WCNT, Centralia, Illinois

IN PLANNING THE CONSTRUCTION program for our rural station we found that a combination executive office-twin studio-transmitter building would provide the most effective business and technical setup.

Our plans provided for all controls to be handled by transmitter engineers, complete monitoring of programs throughout building and an inter-office signalling and communications system. We also decided to include a network outlet in the event that network operation become desirable. For local remotes provision was also made for a number of telephone loops.

In general, while not desiring to keep costs low at the expense of quality or efficiency, the costs were held within reason.

Our original plan centered around a small-sized modern unit of high effi-

ciency, constructed principally of wood. This would easily allow virtually complete isolation of the studios and control room from the office section of the building. A study of conditions of supply existing in the building trade and material market revealed that it would be necessary to revise the entire planning. Lumber was, and still is, virtually unobtainable in any quantity. And assortments of special acoustical materials were, and still are, not too readily obtainable.

This indicated a necessity to select the materials available and work from there. We believed that we would have to use prefabricated units, but we found masonry products were available. There were several that had suitable

¹Haydite, Hydraulic Press Brick Co., St. Louis, Missouri.

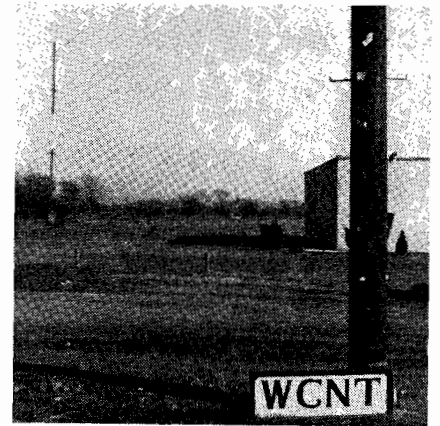

Figure 1a
Antenna and view of portion of office-studio-transmitter building.

acoustical qualities. Generally these products, composed of Portland cement and heat-treated and exploded products, are suitable in varying degrees, dependent on the amount and size of air bubbles formed during the treatment. As to structural strength they compare well with concrete blocks, weighing from 40% to 60% less, do not retain moisture, and may be nailed into under some conditions.

Blocks Selected

After a study of the various types of blocks, we selected a material composed of exploded shale.¹ These masonry blocks were available in a variety of types and sizes. Because of its convenience a 8" x 8" x 16" hollow block was chosen. This block worked well as it allowed reasonable dimensions

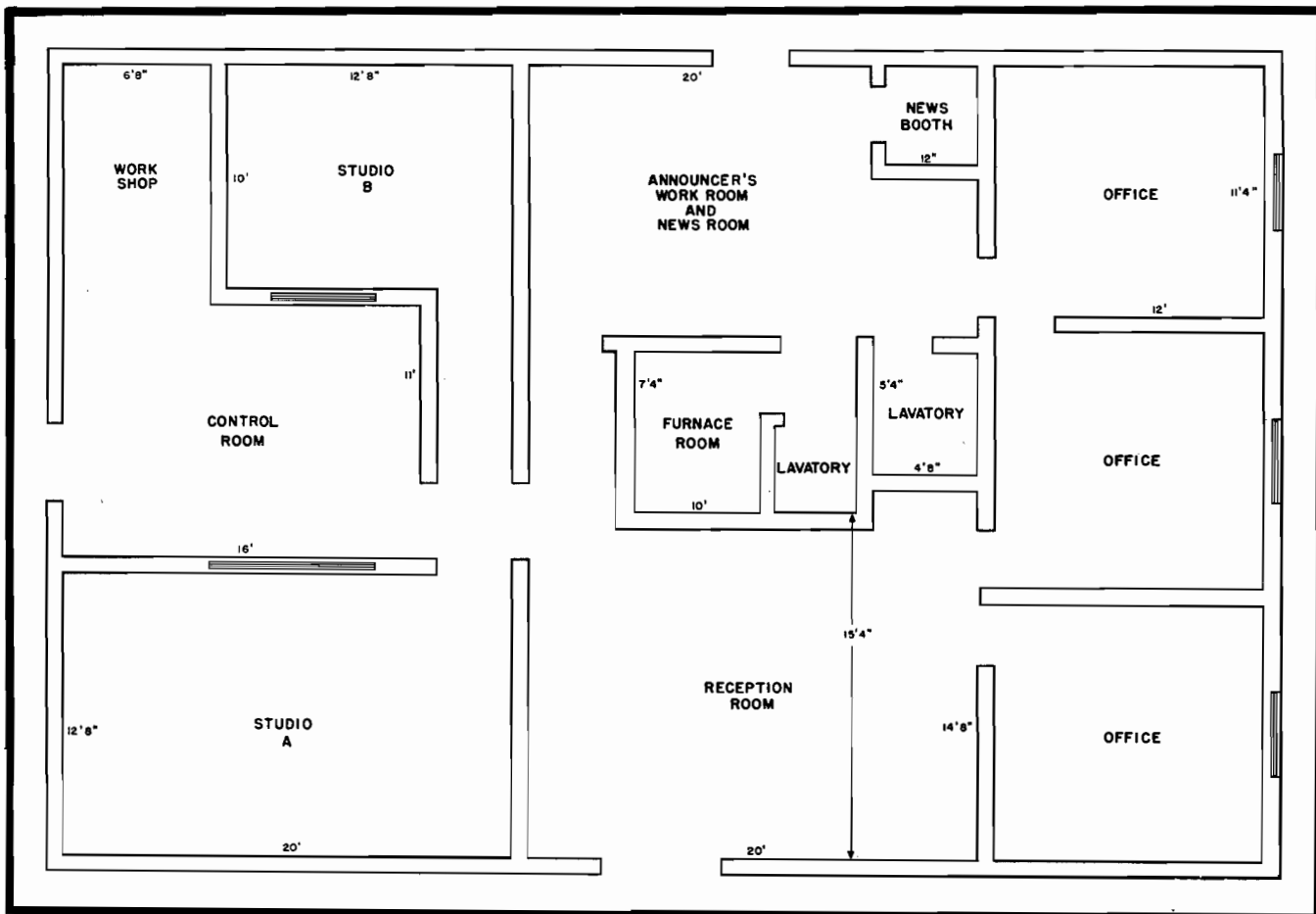

Figure 1

Layout of single floor which accommodates three offices, general work room, two studios and control room housing the transmitter equipment and work shop.

with a minimum of cutting. The center hollow was extremely desirable as it provided a convenient wiring channel. And fortunately these blocks also provided suitable acoustical qualities, having a sound transmission loss of 52 db which is quite adequate. The walls have a nominal sound absorption coefficient of .37, also adequate.

Since the blocks were rectangular in shape, it was felt advisable to retain rectangular lines throughout the structure. Our building plans called for a minimum of three offices, reception room, general work room, two studios and a control room large enough to contain the transmitting equipment and a workshop, bathroom facilities and a furnace room. The floor plan, shown in Figure 1, finally evolved, provided sufficient space, gave an efficient and unified layout, and completely isolated the studio section from the offices. Free, short and varied paths from any point to any other point were provided to facilitate office traffic. Studio traffic presents a problem and requires a cer-

tain caution and restraint against loud noise.

The Studio

Studio dimensions as developed by RCA² were used for our studios. The RCA design procedure applied is based upon an acoustical theory which holds that a certain desired resonance be introduced into a room rather than to risk random dissonant resonances. This is accomplished by maintaining the correct ratio between the three

Figure 2

Ceiling joist layout. To eliminate spurious noise through ceilings, joists and rafters are spaced. The joists are supported by masonry walls. There is no coupling or contact between joists over studio section (dashed-line section) and joists over office section.

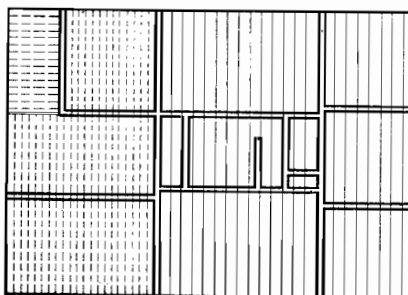

dimensions. Thus if the length and the width of the room stand in ratio to the height by a factor equal to the cube root of a power of two, i.e., ($\sqrt[3]{2}$, $\sqrt[3]{4}$, $\sqrt[3]{8}$, $\sqrt[3]{16}$, etc.) a resonance will be introduced. This tends to emphasize the major thirds of a tone or produces a condition which tends to emphasize those tones most pleasing to the ear. With this as a basic consideration we arrived at a suitable ceiling height, 8', which was retained throughout the building. With this height as a base, we set up one studio that was 12' 8" x 20' x 8', and another 12' 8" x 10' x 8'. This provided one moderate sized studio suitable for small musical groups, singers, discussions, etc., and a smaller studio from which the bulk of the routine announcing could be performed. For larger groups we arranged for the use of larger rooms in the city via a remote system.

Wall treatment for these studios was obtained by leaving the masonry blocks uncovered. This did provide a rather coarse appearance, but it was adequate from an acoustical point of view. This left two major problems, the floor and ceiling. The basic floor was of concrete throughout the building, covered

²J. E. Volkman, *RCA Broadcast News*: January 1945.

with asphalt tile. Had adequate ceiling material been available, this floor surface might conceivably have been left bare; however, no material of very good quality was immediately available and it was necessary to apply celotex wallboard to the ceiling. This dictated rugs and pads for the floor. In general it has been found that in small studios, under 3,000 cubic feet, that an average absorption coefficient over the entire room surface (walls, floor and ceiling) of .25 or above will give an acceptable reverberation time. Thus by applying rugs and pads to the floor we were able to use the celotex ceiling without any excessive reverberation in the studios.

Inasmuch as the building was to be located near a highway, we decided to omit outside windows in the room. Windows have been found to create sound transmission and absorption problems. Our problem was acute from both standpoints as we were operating close to the absorption margin and the traffic noise in such a low building was serious. This necessitated forced ventilation in the studios; however this would probably have been necessary in any event. In addition, omission of the outside windows permitted increasing of the observation glass size.

The other problem involved isolation of the studios from internal noise. The masonry block construction simplified this matter. Since a solid wall separates the studio section of the building completely, the only possibility of such transmission would be through the floor or ceiling. However, the floor of solid concrete, has comparatively poor transmission qualities, and is not prone to vibration. To eliminate spurious noise through ceiling joists and rafters they were spaced, Figure 2. Thus by placing a joist on either side of the wall and allowing no contact between the two, we eliminated the possibility of coupling between the joists, and the studio section is effectively in another building. Four inches of rock wool was placed between each joist. This cushioned any sound which might be transferred through the rafters and roof sheathing back to studio section. This has proved to be highly satisfactory, and no trouble has been experienced with this common source of extraneous noise.

Due to the lack of studio exterior windows, forced ventilation was necessary. This provides paths for extraneous sound transmission through the duct work of the ventilation system. To simplify this problem the return air pipes were placed in the concrete floor, which tended to deaden the pipes. Each pipe entrance was provided with deflection baffles (Figure 3) which

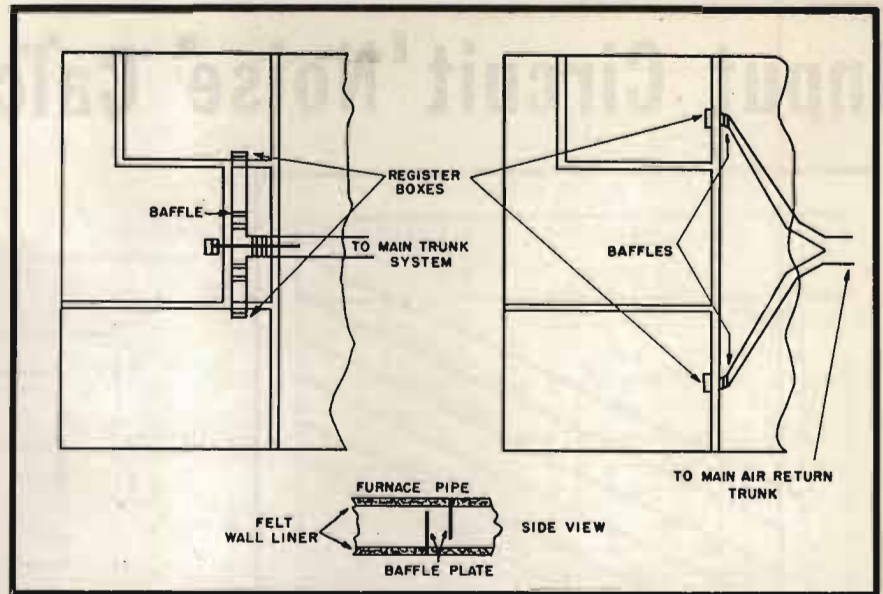

Figure 3

Ventilating duct system. The baffle plates are of celotex and are similar to the baffles in the exhaust muffler. Wall of pipe lined with felt to absorb disrupted sound. There is no air exhaust in the control-room floor. Exhaust in this room is provided by a fan which removes air from the transmitter and feeds out of doors.

forced the air against the pipe walls, these walls being lined for 2' at each end with highly absorbent felt. The warm air pipes were placed overhead and they were treated in a similar but

Figure 5

Control room and studios showing observation area; small studio window 32' x 52', large window 32' x 69', both 38' above floor.

different fashion. Again the idea was to disrupt the sound passages but not to overly impede the air-flow paths. The walls being absorptive in the areas

(Continued on page 42)

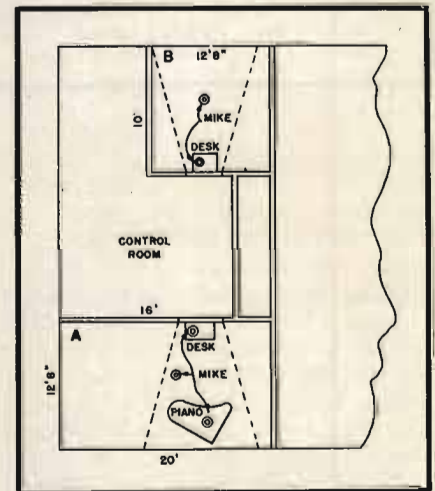
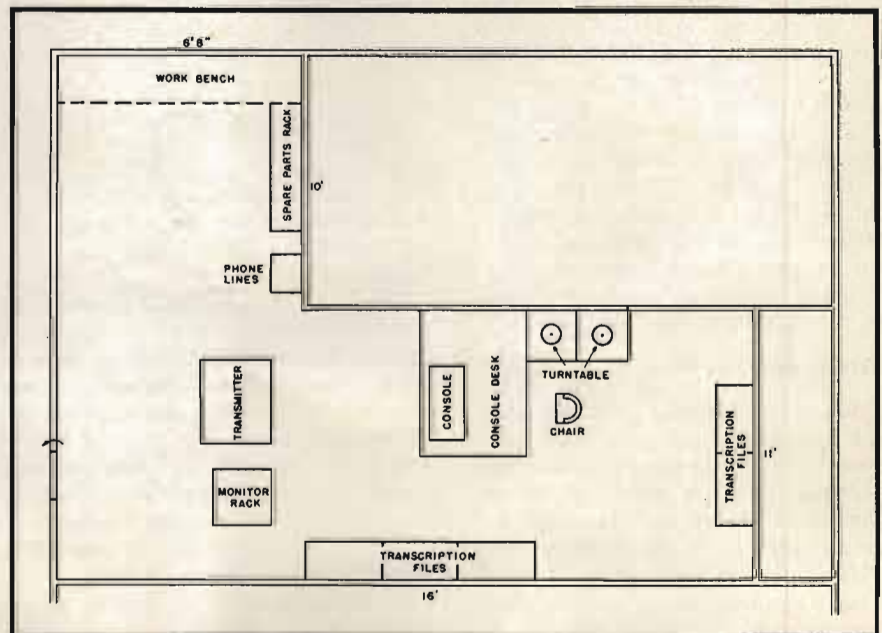

Figure 4

Control room that affords vision to either studio. Note workshop. In-line turntables conserve space and permit starting and stopping of tables by one man.



Input Circuit Noise Calculations for

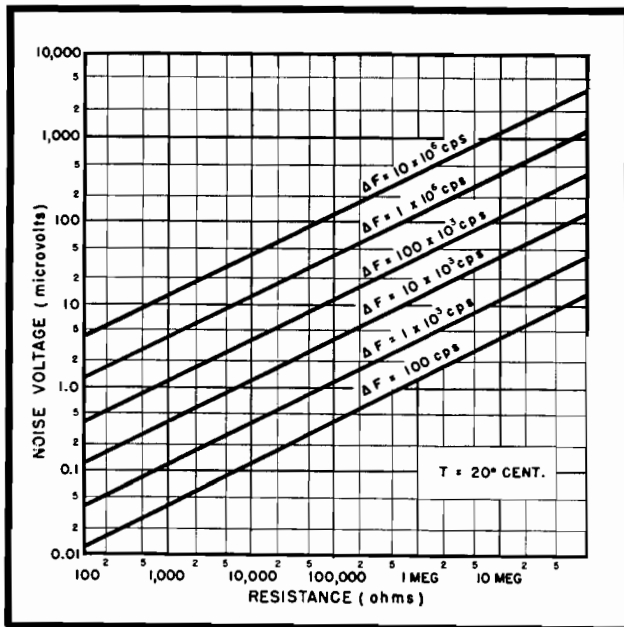

Figure 1 (below)
Sample thermal noise circuits: Frequency, 1000 kc; Q, 100; L, 300 microhenries.

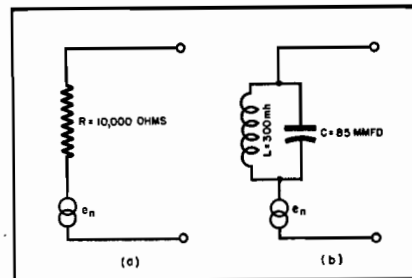

Figure 2
Thermal agitation noise voltage versus resistance and bandwidth.

MAXIMUM RECEIVER SENSITIVITY is not, in most cases, determined by the gain of the particular receiver but by the magnitude of the input circuit noise, which is generated by the antenna, the tuned input circuit, and the first tube. This is true of a-m, f-m, and television, except that in f-m and television the random noise effect assumes a far greater degree of importance than in the standard broadcast band. The reason for this is twofold:

(1) At the frequencies where these two services operate, 50 to 250 mc, the relative value of the several different noise sources assume entirely new proportions and the heretofore unimportant and little known *induced grid noise* becomes one of the predominant components of the total.

(2) Most random input and tube noise is proportional to the square root of the bandwidth. Both television, with a 4-mc band, and f-m, with a 200-kc band, occupy much wider sections of the frequency spectrum than anything previously encountered by the commercial receiver engineer.

Thermal Agitation Noise

When an alternating electric current flows through a conductor, electrons do not actually move along the conductor but they are displaced, an infinitesimal amount, first in one direction and then in the other. A voltage is built up across the conductor equal to the magnitude of the current times its resistance. Applying heat to the

conducting material agitates the molecules of the conductor and, consequently, varies the instantaneous position in space of the electrons. This random electron motion is, in a sense, a minute noise current flowing through the material and is known as *thermal agitation noise*. That is, the application of heat agitates the electron distribution of the substance thereby creating the noise.

The magnitude of the short-circuit noise current is given by

$$i_n^2 = \frac{4KT\Delta F}{R} \quad (1)$$

where:

i_n^2 = mean squared noise current (amperes²)

K = Boltzmann's Constant (joules per degree Kelvin), 1.37×10^{-23}

T = temperature (degrees Kelvin)

ΔF = bandwidth (cps)

R = resistance (ohms)

All noise currents and voltages are random fluctuations and occupy an infinite frequency band. Because of the random effect, the most convenient terminology to use in expressing their magnitude is average noise-power output. Mean-squared noise current or mean-squared noise voltage, either of which is proportional to average power, is generally used.

In the expression for various noise components the term ΔF refers to the

effective bandwidth of the circuit. This is determined from a curve of power output versus frequency by dividing the area under the curve by the amplitude of the power at the noise frequency in question. For most calculations, however, where only approximate values are desired, the bandwidth between half power points, or .707 voltage points, will give sufficient accuracy.

The equation below expresses thermal agitation noise as a voltage in series with a given resistor:

$$e_n^2 = 4KT\Delta FR \quad (2)$$

Both the above forms are true of all resistive circuit elements or combination of elements including parallel and series-tuned circuits.

Referring to Figure 1 (a), let us suppose a resistance of 10,000 ohms were connected to the input of an amplifier with a 5 kc bandwidth, i.e., 5 kc between half power points or an audio band of 2.5 kc. At room temperature, 20° C or 293° K, the terms $4KT$ in the expressions for noise simplifies to 1.6×10^{-20} , which may be used in most receiver calculations. The noise in Figure 1 (a) is therefore:

$$e_n^2 = 1.6 \times 10^{-20} \Delta FR$$

$$e_n = \sqrt{1.6 \times 10^{-20} \times 5000 \times 10,000}$$

$$e_n = 0.89 \text{ microvolt}$$

The noise bandwidth is generally determined by the narrowest element in the entire circuit under considera-

F-M And TELEVISION RECEIVERS

TRIODE AMPLIFIER	$R_{eq} = \frac{2.5}{g_m}$
PENTODE AMPLIFIER	$R_{eq} = \frac{1b}{1b + 1g_2} \left(\frac{2.5}{g_m} + \frac{201g_2}{g_m^2} \right)$
TRIODE MIXER	$R_{eq} = \frac{4}{g_c} g_c + \frac{g_m}{4}$
PENTODE MIXER	$R_{eq} = \frac{1b}{1b + 1g_2} \left(\frac{4}{g_c} + \frac{201g_2}{g_c^2} \right)$
MULTIGRID CONVERTER or MIXER	$R_{eq} = 20 \frac{1b(1k - 1b)}{1k g_c^2}$
R_{eq} = Equivalent Shot Noise Resistance g_m = Grid Plate Transconductance $1b$ = Average Plate Current $1g_2$ = Average Screen Current g_c = Conversion Transconductance $1k$ = Average Cathode Current	

Figure 3

Equivalent shot-noise resistance formulas.¹

tion. In the example for Figure 1 (b) the bandwidth of the amplifier is narrower than the tuned circuit and therefore its ΔF is used in the calculations.

Figure 1 (b) is a simple parallel-tuned circuit where the noise generating resistance is equal to the tuned circuit impedance. Again let us assume the bandwidth to be five kc per second.

$$R = Q(\omega L) = 100 \times 1900 = 190,000 \text{ ohms}$$

$$e_n^2 = 1.6 \times 10^{-20} \Delta F R$$

$$e_n = \sqrt{1.6 \times 10^{-20} \times 5,000 \times 190,000}$$

$$e_n = 3.9 \text{ microvolts}$$

Thermal agitation noise voltage may be calculated easily with equation (2) but by using the graph shown in Figure 2 the room temperature values may be found directly.

Shot Noise

Another important component of the total receiver noise is known as *shot noise*. This noise is generated inside the vacuum tube and is due to the random fluctuations in the plate current of the tube, or, to state it in another manner, random variations in the rate of arrival of electrons at the plate. When amplified, this noise sounds as if the plate were being bombarded with pebbles or as if a shower of shot were falling upon a metal surface, hence the name *shot noise*.

Although generated essentially in the plate circuit of the tube, which is

Efficient Design of Input Stages, a Critical Requisite in F-M and Television, Involves a Careful Consideration of Three Important Factors: Total Noise, Sensitivity and Signal-To-Noise Ratio. This Paper Discusses These Factors and Offers a Physical Concept of the Three Noise Components With Formulas and Data Necessary for Input-Circuit Calculations.

by WILLIAM J. STOLZE

Engineer, Industry Service Laboratory
R.C.A. Laboratories Division, R.C.A.

TUBE TYPE	APPLICATION	PLATE VOLTS*	SCREEN VOLTS	TRANSCONDUCTANCE MICROMHOS	EQUIVALENT NOISE RESISTANCE OHMS
6AC7	PENTODE AMPLIFIER	300	150	9,000	720
6AC7	PENTODE MIXER	300	150	2,200	2,800
6AG5	PENTODE AMPLIFIER	250	150	5,000	1,650
6AG5	PENTODE MIXER	250	150	1,250	6,600
6AG7	PENTODE AMPLIFIER	300	150	11,000	1,540
6AK5	PENTODE AMPLIFIER	180	120	5,100	1,880
6AK5	PENTODE MIXER	180	120	1,280	7,520
6AK6	PENTODE AMPLIFIER	180	180	2,300	8,800
6AT6	TRIODE AMPLIFIER	250	—	1,200	2,100
6AU6	PENTODE AMPLIFIER	250	150	5,200	2,660
6BA6	PENTODE AMPLIFIER	250	100	4,400	3,520
6BA6	PENTODE MIXER	250	100	1,100	14,080
6BE6	CONVERTER	250	100	475 [†]	190,000
6C4	TRIODE AMPLIFIER	100	—	3,100	810
6C4	TRIODE MIXER	100	—	770	3,240
6C5	TRIODE AMPLIFIER	250	—	2,000	1,250
6C5	TRIODE MIXER	250	—	500	5,000
6J5	TRIODE AMPLIFIER	250	—	2,600	960
6J5	TRIODE MIXER	250	—	650	3,840
½6J6	TRIODE AMPLIFIER	100	—	5,300	470
½6J6	TRIODE MIXER	100	—	1,320	1,880
6K8	CONVERTER	250	100	350 [†]	290,000
6SA7	CONVERTER	250	100	450 [†]	240,000
6S87-Y	CONVERTER	250	100	950 [†]	62,000
6SC7	TRIODE AMPLIFIER	250	—	1,325	1,890
6SG7	PENTODE AMPLIFIER	250	125	4,700	3,100
6SG7	PENTODE MIXER	250	125	1,180	12,400
6SJ7	PENTODE AMPLIFIER	250	100	1,650	6,100
6SK7	PENTODE AMPLIFIER	250	100	2,000	11,000
6SL7	TRIODE AMPLIFIER	250	—	1,600	1,560
6SQ7	TRIODE AMPLIFIER	250	—	1,100	2,300

(*) VALUES OF PLATE VOLTAGE AND CURRENT AND SCREEN VOLTAGE AND CURRENT ARE FOR TYPICAL OPERATING CONDITIONS.
(†) CONVERSION TRANSCONDUCTANCE - MICROMHOS

Figure 4

Approximate calculated equivalent noise resistance of various receiving-type tubes.



INFORMATION PLEASE!



Radio communication is as vital to the airways as rails are to the railroads. For high performance, dependability, and easy maintenance, WILCOX radio equipment has earned the confidence of airline personnel throughout the world. Solve your communication problems with Wilcox.

Check the Wilcox 2500 Watt 96C Transmitter For:

- 1. PERFORMANCE**—Transmitter units combine with modulator and rectifier to give either simultaneous transmission on a number of frequencies, or the selection of an individual frequency best suited to the immediate communication problem. Complete remote control.
- 2. DEPENDABILITY**—Research, engineering, and testing combined with highest quality materials result in a rugged product capable of sustained operation through all conditions of temperature, humidity, and weather.
- 3. MAINTENANCE**—All controls and components are completely accessible. Plugs and receptacles or clips make every major section readily removable. Fuses, power and telephone line terminals are located on convenient panels.
- 4. SAFETY**—The disconnect switch at base of transmitter cuts off all voltage and grounds components so unit can be serviced without affecting operation of adjacent channels.

A request on your letterhead will bring complete information

Wilcox Electric Company, Inc.
KANSAS CITY, MISSOURI



not a convenient reference point for sensitivity or signal-to-noise ratio calculations, the shot noise is nearly always referred to as a noise voltage in series with the grid. Since the following equation is true,

$$e_g = \frac{i_p}{g_m} \quad (3)$$

where
 e_g = a-c grid voltage,
 i_p = a-c plate current, and
 g_m = transconductance,

by simply dividing the noise current in the plate circuit by the transconductance of the tube the shot noise may be referred to the grid and expressed in terms of grid voltage.

Another step is taken, however, to simplify the noise nomenclature. Suppose a given tube has a shot noise equal to e_n microvolts in series with its grid. It is perfectly valid to imagine that this voltage could be replaced by a resistance whose thermal agitation noise is equal to e_n (the shot noise) and consider the tube to be free of noise. This imaginary resistance, which when placed in the grid of the

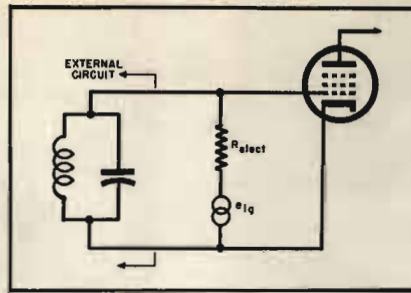

Figure 5
Position of induced grid noise in vacuum-tube circuit.

tube generates a voltage equal to the shot noise of the tube, is known as the shot noise equivalent resistance or just as the equivalent noise resistance of the tube. The advantage of this terminology is that when the equivalent noise resistance of the particular tube is known, the noise volts may be calculated directly for any given bandwidth by substituting values in the following formula:

$$e_n^2 = 4KT\Delta FR_{eq} \quad (4)$$

¹W. A. Harris, *Fluctuations in Vacuum Tube Amplifiers and Input Systems*, RCA Review; April 1941.

where R_{eq} = equivalent noise resistance or at room temperature

$$e_n^2 = 1.6 \times 10^{-20} \Delta F R_{eq} \quad (5)$$

If the noise were expressed as a voltage or current its value would be correct only for one particular bandwidth.

By knowing the R_{eq} of any two given tubes their relative shot noise merit is also known regardless of what bandwidth they are to operate at, while if the noise voltages were given alone the operating bandwidth at which the calculation was made would also have to be noted if the relative merits of the two tubes were to be defined.

Noise-equivalent resistance values for a number of different tube types (triodes, pentodes, and converters) and for various circuit applications (amplifiers and mixers) can be calculated by applying the expressions presented in the chart, Figure 3.¹

When the term converter is used it refers to a tube that is used for frequency conversion where the single

(Continued on page 44)

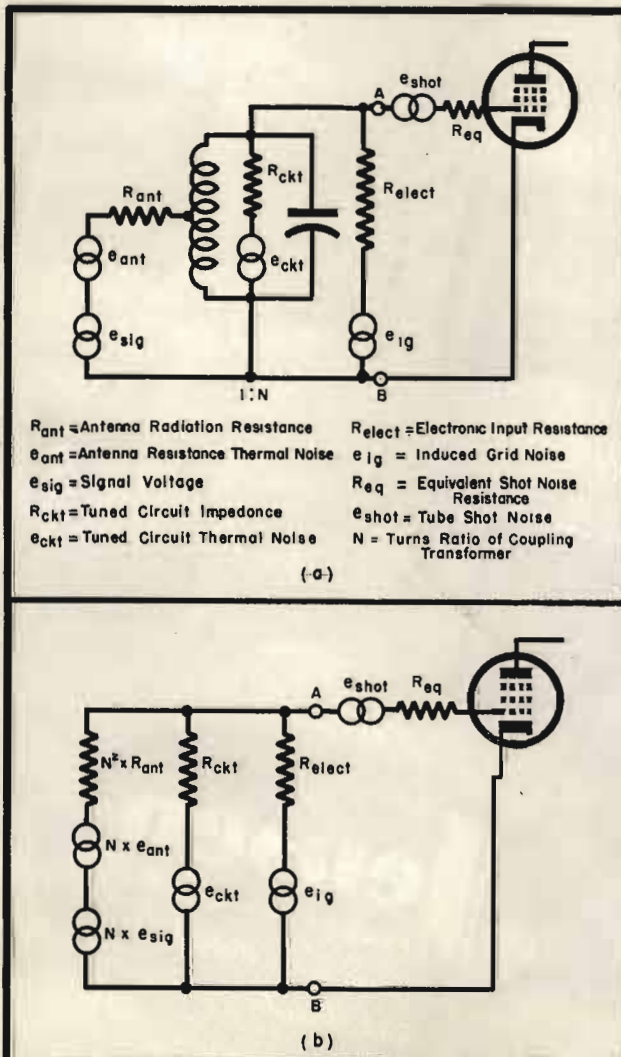

Figure 6 (below)
Approximate electronic input resistance versus frequency.

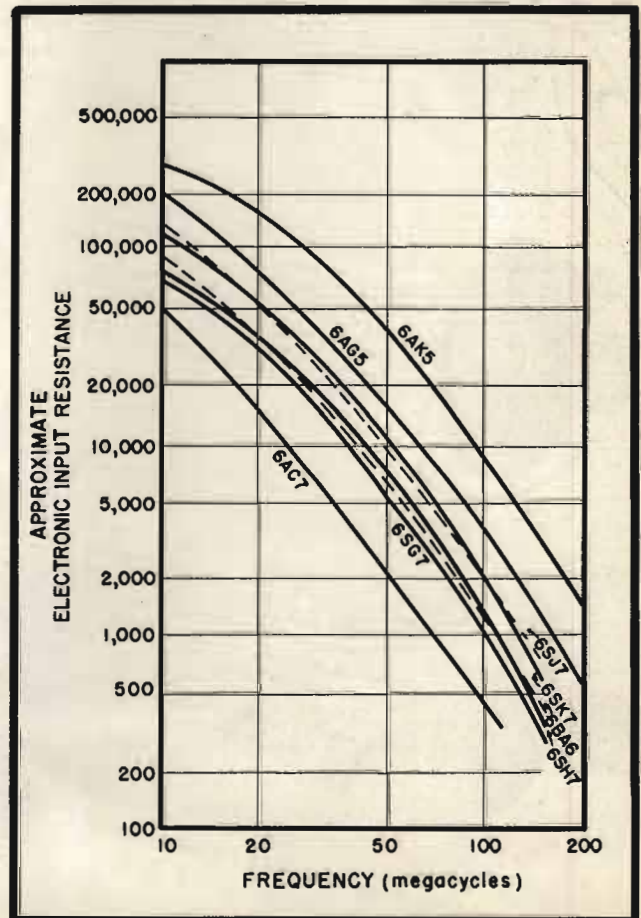

Figure 7
Position of various noise sources in input circuit.

Listen ... IT'S A Jensen SPEAKER!

4 COAXIAL SPEAKERS
8 REPRODUCERS
3 BASS REFLEX* CABINETS
REPRODUCERS

COAXIAL SPEAKERS



MODEL HNP-51 COAXIAL (ST-122). A 15-inch articulated Coaxial with cone-type h-f unit and horn-type h-f unit. Alnico 5 PM design throughout. Dividing network gives two-way performance. Wide-range response and excellent polar pattern. Ideal for FM receivers, high quality phonographs and similar applications. Including monitoring. In Bass Reflex cabinet, response ranges from 50 to 15,000 cps. H.F. Range Control lowers cut-off in four steps to suit program quality. Input impedance, 500-600 ohms. Maximum power rating in speech and music systems, 25 watts. List Price, \$125.00.



MODEL JAP-60 COAXIAL (ST-600). A 15-inch cone-type Coaxial with PM design. Furnished with H.F. Range Control. Nominal input impedance, 500-600 ohms. Maximum power handling capacity in speech and music systems, 20 watts. List Price, \$36.00.

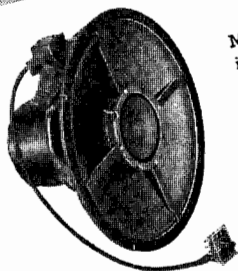

MODEL JHP-52 COAXIAL (ST-601). A 15-inch cone-type Coaxial like Model JAP-60 with efficiency approximately 4 db less. Furnished with H.F. Range Control. Input impedance, 500-600 ohms. Power handling capacity in speech and music systems, 15 watts. List Price, \$65.00.

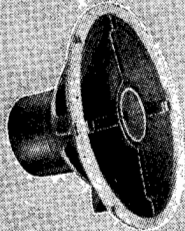

MODEL JCP-40 COAXIAL (ST-603). A 12-inch Coaxial at low cost. Ideal replacement and modernizing unit where 12-inch speaker is required. Simplified low-cost bridging network built-in. Terminals provided for addition of ST-606 Level Control. Nominal input impedance, 6-8 ohms. Power rating, 10 watts in speech and music systems. List Price, \$35.

UTILITY DESIGN (Brown Opaque Lacquer)

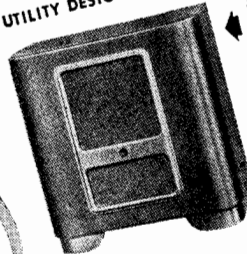

MODEL RA-151. Complete with Model HNP-51 Coaxial and H.F. Range Control installed. List Price, \$181.15.

MODEL RD-151. Complete with Model HNP-51 Coaxial and H.F. Range Control installed. List Price, \$201.00.

DELUXE DESIGN (Satin Finish Walnut)

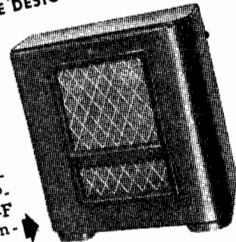

MODEL RA-153. Complete with Model JAP-60 Coaxial and H.F. Range Control installed. List Price, \$142.15.

MODEL RD-152. Complete with Model JAP-60 Coaxial and H.F. Range Control installed. List Price, \$162.00.

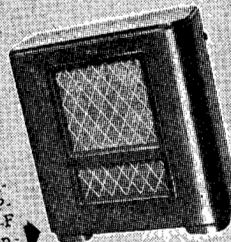

MODEL RA-154. Complete with Model JHP-52 Coaxial and H.F. Range Control installed. List Price, \$121.15.

MODEL RD-153. Complete with Model JHP-52 Coaxial and H.F. Range Control installed. List Price, \$141.00.

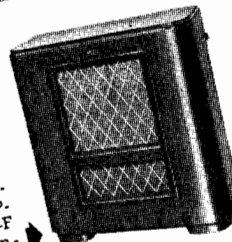

MODEL RA-124. Complete with Model JCP-40 Coaxial installed. List Price, \$94.15.

MODEL RD-122. Complete with Model JCP-40 Coaxial installed. List Price, \$114.00.

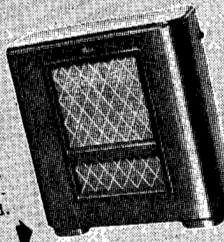

JENSEN MANUFACTURING COMPANY
 6603 S. Laramie Ave., Chicago 38, U. S. A.
 In Canada: Copper Wire Products, Ltd.,
 11 King St., W., Toronto, Ont.
 *TRADE MARK REGISTERED



Jensen
 SPEAKERS WITH **ALNICO 5**
 Designers and Manufacturers
 of Fine Acoustic Equipment

HUNDREDS OF CONTROL PROBLEMS SOLVED WITH STEPPING RELAYS

Design engineers are discovering new, efficient, money-saving applications daily for Guardian basic-type Stepping Relays. Typical applications include Automatic Sequence selection of circuits; Automatic Sequence cross connection of circuits; circuit control of Automatic Business Machines; control of Production Totalizing and Conveyor equipment; remote selection of records on Coin Operated Phonographs; Automatic Circuit Selection controlled from a pulsing dial; Automatic Wave Changing on short wave transmitters. This Guardian Stepping Relay is furnished for three basic types of A.C. and D.C. operation: Continuous Rotation—Electrical Reset—Add and Subtract. On each of these types the contact finger rotates in a counter-clockwise direction and all three types are designed to follow 10 pulses per second within the rated voltage range of the relay. Special construction prohibits skipping or improper indexing of the ratchet. Guardian Steppers may be furnished as separate units; in combination with relays, contact switches, solenoids, etc., completely assembled and wired to terminals; mounted on special bases or in enclosures. Any standard Guardian Stepping Relay can be modified to meet practically all "special" stepper control applications where quantities warrant special designing. For complete details write for Bulletin SR.

GUARDIAN  ELECTRIC
 1610-B W. WALNUT STREET CHICAGO 12, ILLINOIS
 A COMPLETE LINE OF RELAYS SERVING AMERICAN INDUSTRY

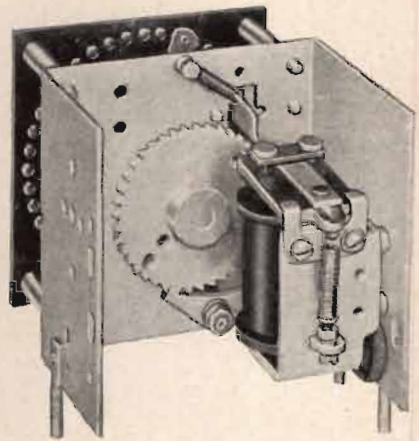

GUARDIAN SERIES R

1 Continuous Rotation

In this type the contact finger advances one step each time the circuit is made and broken. Weight approximately 20½ ozs.

2 Electrical Reset

Resets when a second coil is energized. Weight approximately 23 ounces.

3 Add and Subtract

Steps back one or more contacts at a time instead of resetting completely. Weight approximately 28½ ounces.

TYPICAL GUARDIAN UNITS AVAILABLE IN COMBINATION WITH GUARDIAN STEPPERS



Series 100
Snap-Action Relay



Guardian
Featherub Switch



Series 500
Midget Relay



Series I-A Solenoid

PROGRAM FOR THE 1947 IRE NATIONAL CONVENTION

	Hotel Commodore			Grand Central Palace	
	Main Ballroom	East Ballroom	West Ballroom	Auditorium A	Auditorium B
Monday, Mar. 3					
2:00 P. M.			<i>A Method of Determining and Monitoring Power and Impedance at High Frequencies;</i> J. F. Morrison, E. L. Younker, Bell Telephone Labs.	<i>Shipboard Radar Fire Control from the System Viewpoint;</i> Robt. M. Page, John B. Trevor, Jr., Naval Research Lab.	<i>FM Detector Systems;</i> B. D. Loughlin, Hazeltine Electronics Corp.
2:30 P. M.	<i>FM Cyclotron;</i> W. Salisbury, Collins Radio Co.		<i>Theory of Measurement of Dielectric Properties at 10,000 mc;</i> C. V. Larrick, G. E.	<i>System Considerations in the Design of VHF and SHF Communication Circuits;</i> E. Fubini, Airborne Instruments Lab.	<i>Broadband FM Detector for Multi-Channel Communication;</i> J. W. Albersheim, Bell Tel. Labs.
3:00 P. M.	<i>The Betatron;</i> T. M. Dickinson, G. E.		<i>A Coaxial-Line Noise Source for Ultra-High Frequency;</i> H. Johnson, RCA Labs.	<i>Portable Military Communication Set;</i> C. E. Sharp, Coles Signal Lab.	<i>Method for Measurement of Instantaneous Frequency of an FM Oscillator;</i> L. E. Hunt, Bell Tel. Labs.
3:30 P. M.	<i>A 70 MEV Synchrotron;</i> A. M. Gurewitsch, H. C. Pollock, R. V. Langmuir, F. R. Elder, J. R. Blewett, G. E.		<i>A New Reactance-Tube Distortion and Noise Meter;</i> C. W. Clapp, G. E.	<i>Carrier Current Dialing Over Long Distance Telephone Circuits;</i> I. Molnar, Automatic Electric Co.	<i>A Variable Phase-Shift Frequency-Modulated Oscillator;</i> O. E. DeLange, Bell Tel. Labs.
4:00 P. M.	<i>The Linear Accelerator;</i> J. C. Slater, M. I. T.		<i>Cathode Ray Presentation of Three-Dimensional Data;</i> O. H. Schmitt, Airborne Instruments Labs.		<i>Linearity in Tuned Transformer Frequency Discriminator;</i> H. R. Summerhayes, Jr., G. E.
4:30 P. M.				<i>Caesium Vapor Lamps in Infrared Communication;</i> M. C. Beese, Westinghouse Electric	
Tuesday, Mar. 4					
10:00 A. M.		<i>Relations Between Bandwidth, Speed of Indication, and Signal-to-Noise Ratio in Radio Navigation and Direction Finding;</i> H. Businies, and M. Dishal, Federal Telecommunication Labs.	<i>Nucleonics Instrumentation;</i> V. C. Wilson, G. E.	<i>Experimental Determination of Helical Wave Properties;</i> C. C. Cutler, Bell Tel. Labs.	<i>Synchro-lite For Television Film Projectors;</i> L. C. Downes and J. F. Wiggin, G. E.
10:30 A. M.		<i>Targets for Microwave Radar Navigation;</i> S. D. Robertson, Bell Tel. Labs.	<i>Proportional Counters and Geiger Counters;</i> S. Korff, NYU	<i>A Stabilized Magnetron for Beacon Service;</i> C. P. Vogel, J. S. Donal, Jr., B. B. Brown, C. L. Cuccia and W. J. Dodds, RCA	<i>Video-Frequency Negative-Feedback Amplifiers;</i> M. G. Hollobaugh and A. M. Levine, Federal Telecommunication Labs.
11:00 A. M.		<i>A Comparison of Interrogation by Search Radars and by Separate Interrogators in Pulse Transponder Systems;</i> F. A. Darwin, Hazeltine Electronics	<i>Cloud Chambers;</i> G. C. Baldwin, G. E.	<i>Coupled Circuits Used as Tunable Band-Pass Filters in the Ultra-High Frequency and Microwave Region;</i> R. O. Petrich, Airborne Instruments Labs.	<i>Radio-Frequency Performance of Some Receiving Tubes for Television;</i> R. Cohen, RCA Labs.
11:30 A. M.		<i>Low Frequency Loran;</i> V. S. Carson, S. Seton, M. Rothman, and M. Pomerantz, Watson Labs.	<i>Applications of the Vibrating Reed Electrometer;</i> W. P. Jesse, Argonne Nat'l Lab.	<i>Broad-Band Ultra-High Frequency Amplifiers;</i> A. M. Levine and M. G. Hollobaugh, Federal Telecommunication Labs.	<i>Theory of Multi-Stage Wide-Band Amplifier Design;</i> W. E. Bradley, Philco
12:00 Noon		<i>Elimination of Precipitation Static;</i> W. H. Bennett, Nat'l Bureau of Standards	<i>Counters and Pulse Amplifiers;</i> M. Sands, M.I.T.	<i>The Measurement of Delay Distortion in Microwave Repeaters;</i> D. H. Ring, Bell Tel. Labs.	<i>Recent Advances in the Design of Intermediate Frequency Amplifiers for Television Receivers;</i> C. Marsh, Allen B. DuMont Labs.
2:30 P. M.		<i>Cathode-Ray Tubes and Optical Systems;</i> H. Rinia, J. de Gier and P. M. Van Alphen, Philips	<i>The Electronic Digital Computers;</i> J. W. Forrester, Servomechanisms Lab., M. I. T.	<i>Screen Grid Transmitting Amplifier Tubes for Operation Up to 500 mc;</i> W. G. Wagener, Eitel-McCullough	<i>Phase and Amplitude Distortion in Linear Networks;</i> M. J. DiToro, Microwave Research Institute
3:00 P. M.		<i>High-Voltage Unit and Deflection Circuit;</i> H. Haantzes, G. J. Siezen, and F. Kerkhof, Philips	<i>Input Mechanisms for Electronic Digital Computers;</i> S. N. Alexander, National Bureau of Standards	<i>A New FM and Television Power Amplifier Tube and Its Associated Grounded Grid Cavity Circuit;</i> H. D. Wells and R. E. Reed, G. E.	<i>Correlation of Network Frequency Response and Square Wave Shape;</i> R. Lee, Westinghouse
3:30 P. M.		<i>Cathode-Ray Flying Spot Scanner for Television Signal Generation;</i> R. D. Kell and S. C. Sziklai, RCA Labs.	<i>Electronic Computing;</i> H. H. Goldstine, Institute for Advanced Study	<i>Frequency Modulation and Control by Electron Beams;</i> L. P. Smith, and C. Shulman, RCA Labs.	<i>Compensation of Phase Shift at Low Frequencies;</i> F. McGee, Federal Telecommunication Labs.
				<i>A Frequency-Modulated Magnetron for Super High Frequencies;</i> G. R. Kilgore, C. Shulman, and J. Kurshon, RCA Labs.	
				<i>A One-Kilowatt Frequency-Modulated Magnetron for 900 mc;</i> J. S. Donal, Jr., R. R. Bush, C. L. Cuccia, and H. R. Hegbar, RCA Labs.	
4:00 P. M.		<i>Gas-Discharge-Tube Television Deflection Systems;</i> K. R. Wendt, RCA Labs.	<i>A Tube for Selective Electrostatic Storage;</i> J. A. Rajchman, RCA Labs.		<i>Parabolic Loci of Coupled Circuits;</i> S. H. Chang, Watson Labs.
4:15 P. M.				<i>New Techniques in Glass to Metal Sealing;</i> J. A. Pask, Westinghouse	
4:30 P. M.		<i>An Improved Counter-Timer for Television;</i> C. E. Hallmark, Farnsworth	<i>Applications of Electronic Digital Computers;</i> P. Crawford, Office of Naval Research		<i>Reciprocity Failure in Crystal Networks;</i> L. Apker, E. Taft, and J. Dickey, G. E.
4:45 P. M.				<i>Determination of The Mutual Heating of Helical Filaments;</i> M. Youdin, Amperex	

PROGRAM FOR THE 1947 IRE NATIONAL CONVENTION

Wednesday, Mar. 5	Hotel Commodore			Grand Central Palace	
	Main Ballroom	East Ballroom	West Ballroom	Auditorium A	Auditorium B
10:00 A. M.	<i>The Function of Air Traffic Control</i> ; W. White, Airborne Instrument Lab.	<i>Electronic Control in Industry</i> ; G. M. Chute, G. E.		<i>Precision Measurements of Impedance Mismatches in Wave Guide</i> ; A. F. Pomeroy, Bell Tel. Labs.	<i>Propagation Characteristic of the UHF (480-920 mc) Television Band</i> ; W. B. Lodge, CBS
10:30 A. M.	<i>Trends in Air Navigation</i> ; H. Davis, Watson Labs.	<i>Variable Radio-Frequency Follower System</i> ; R. F. Wild, Brown Instrument Co. Div. Minneapolis-Honeywell		<i>A Coaxial-Line Support for 0-1000 mc</i> ; R. W. Cornes, Sperry Gyroscope	<i>Theoretical and Practical Aspects of FM Broadcast Antenna Design</i> ; P. H. Smith, Bell Tel. Labs.
11:00 A. M.	<i>Hazeltine Lanac System (Laminar Air Navigation Anti-Collision)</i> ; K. McIlwain, Hazeltine Electronics	<i>Continuous Recording Sensitive Magnetometer</i> ; R. F. Simmons, Airborne Instruments Lab.		<i>Power Leads at Very and Ultra-High Frequencies</i> ; A. G. Kandoian and R. A. Felsenfeld, Federal Telecommunication Labs.	<i>Monitoring Equipment for FM Broadcasting</i> ; M. Silver, Federal Telecommunication Labs.
11:30 A. M.	<i>First Tests on Navar System for Aerial Navigation and Air-Traffic Control</i> ; H. Busignies and P. R. Adams, Federal Telecommunication Labs.	<i>Three Dimensional Representation on Cathode Ray Tubes</i> ; C. Berkley, Allen B. DuMont Labs.		<i>Direct-Reading Wave meters</i> ; G. E. Feiker and H. R. Meahl, G. E.	<i>Ultra-High Frequency Multiplex Broadcasting System</i> ; A. G. Kandoian and A. M. Levine, Federal Telecommunication Labs.
12:00 Noon	<i>The Application of Microwaves to the Guidance and Control of Aircraft</i> ; J. Lyman and G. Litchford, Sperry Gyroscope	<i>New Electronic Wiring Techniques</i> ; C. Brunetti, Nat'l Bureau of Standards		<i>The Operational Behavior of a Magnetron Microwave Generator When Coupled to a Long Transmission</i> ; W. C. Brown, Raytheon	<i>Field Measurements on Magnetic Recording Heads</i> ; D. L. Clark and L. L. Merrill, Stromberg-Carlson Co.
Thursday, Mar. 6					
10:00 A. M.		<i>Limitations of The Super-regenerative Circuit</i> ; H. Stockman, Cambridge Field Station	<i>The Electronics Research Sponsored by the Office of Naval Research</i> ; E. R. Pierce, Office of Naval Research	<i>A Study of Tropospheric Reception at 42.8 mc and Meteorological Conditions</i> ; G. W. Pickard and H. T. Stetson, M. I. T.	<i>Consideration of Noon Relay Communications</i> ; H. Busignies and D. D. Grieg, Federal Telecommunication Labs.
10:30 A. M.			<i>Spherical Aberration of Compound Magnetic Lenses</i> ; L. Marton, Nat'l Bureau of Standards	<i>Results of Microwave Propagation Tests on a 40-Mile Overland Path</i> ; A. L. Durkee, Bell Tel. Labs.	<i>Experimental Studies of a Remodulating Repeater System</i> ; W. M. Goddall, Bell Tel. Labs.
10:40 A. M.		<i>Theory of Amplitude Stabilized Oscillators</i> ; P. R. Aigrain and E. M. Williams, Carnegie Institute of Technology			
11:00 A. M.			<i>Field Emission Arc as an Electron Source</i> ; C. M. Slack and D. C. Dickson, Westinghouse	<i>A Method of Rapid Continuous Measurement of Antenna Impedance Over a Wide Frequency Range</i> ; H. V. Cottony, Nat'l Bureau of Standards	<i>Experiences with Multipath Transmissions at VHF, UHF and SHF</i> ; P. P. Mort, Coles Signal Lab.
11:20 A. M.		<i>Synchronization of Oscillators</i> ; R. D. Huntoon and A. Weiss, Nat'l Bureau of Standards			
11:30 A. M.			<i>Response of a Thermionic Vacuum Tube to the Sudden Application of an External Voltage</i> ; E. H. Gamble, Polytechnic Institute of Brooklyn	<i>A Phase-Front Plotter for Centimeter Waves</i> ; H. Iams, RCA Labs.	<i>Multiplex Employing Pulse Time and Pulsed FM Modulation</i> ; H. Goldberg and C. C. Bath, Bendix Radio
12:00 Noon		<i>Operating Characteristics of Coupled-Circuit Oscillators</i> ; D. K. Cheng, Cambridge Field Station	<i>Noise-Suppression Characteristics of Pulse Modulation</i> ; S. Moskowitz and D. D. Grieg, Federal Telecommunication Labs.	<i>Aircraft Antenna Pattern Measuring System</i> ; O. H. Schmitt, Airborne Instruments Lab.	<i>Multiplex Microwave Radio Applied to Telephone Systems</i> ; T. H. Clark, Federal Telecommunication Labs.
2:30 P. M.		<i>Synchronous Detectors</i> ; J. G. Reid, Jr., Nat'l Bureau of Standards	<i>Beam-Deflection Control for Amplifiers and Mixers—Part I . . . High Transconductance Design Considerations</i> ; G. R. Kilgore, RCA Labs.	<i>Fundamental Limitations of Small Antennas</i> ; Helical Antenna for Circular Polarization; H. A. Wheeler	<i>An Adjustable Wave-Guide Phase Changer</i> ; A. G. Fox, Bell Tel. Labs.
			<i>Part II . . . Mixer Tubes for Ultra-High Frequency</i> ; E. W. Herold, C. W. Mueller and H. A. Finkle, RCA Labs.		
3:00 P. M.			<i>A New 100-Watt Triode for 1000 mc</i> ; W. R. Koye, C. E. Haller, E. A. Eschbach and W. P. Bennett, RCA Labs.	<i>The Directly-Fed Vertical Stabilizer as a Zero-Drift Broad-Band Aircraft Antenna for HF and VHF</i>	<i>Developments in Broadbanding of Microwave Plumbing Components</i> ; J. H. Vogelman, Watson Labs.
				<i>Antennas for Modern Transport Aircraft</i> ; R. S. Wehner, Airborne Instruments Lab.	
3:10 P. M.		<i>A Wide Band 550-mc Amplifier</i> ; R. O. Petrich, Airborne Instruments Lab.			
3:30 P. M.			<i>A Study of Microphonics in a Sub-Miniature Triode</i> ; V. W. Cohen and A. Bloom, Nat'l Bureau of Standards	<i>A Study of Networks Useful in Broad-Banding and Diplexing Turnstile Antennas for Television Transmission</i> ; G. H. Brown, J. Epstein, D. W. Peterson and O. M. Woolward, Jr., RCA Labs.	<i>A Consideration of Directivity in Wave-Guide Directional Couplers</i> ; S. Rosen and J. T. Bangees, Bell Tel. Labs.
3:50 P. M.		<i>A Compact Electro-Mechanical Filter for the 455-ke I-F Channel</i> ; R. Adler, Zenith Radio			
3:55 P. M.				<i>Radiation Patterns of Thick End-Fed Antennas</i> ; C. H. Page, R. D. Huntoon and P. R. Karr, Nat'l Bureau of Standards	

[Continued on page 40]

COMPACT VERSATILITY for 10 KW at 110 MC

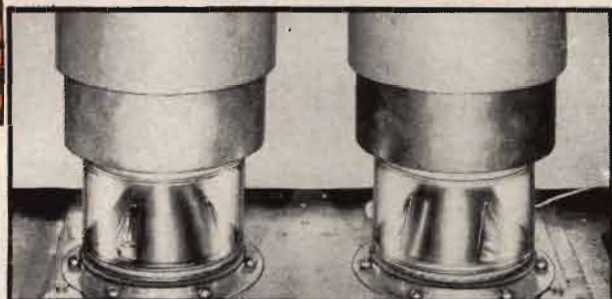
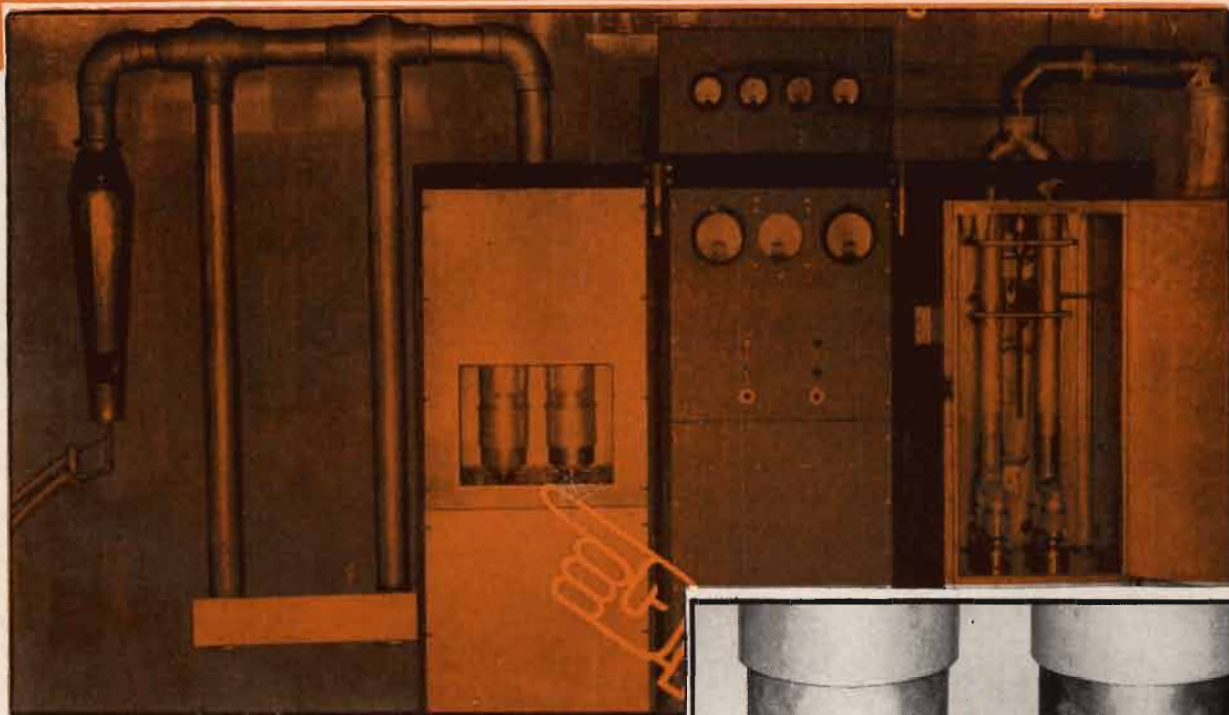

● Experimental 12½ kw 110 mc amplifier, above, and detail of Eimac 3X2500A3 triodes in final stage. Combination plate lines and air ducts simplify cooling.

Mounted in a 19-in. relay rack as illustrated above, two Eimac 3X2500A3 triodes are regularly pushing more than 10 kw of useful output power into a water-cooled load in the Eimac testing department. As measured, 12,500 watts is being delivered at 110 mc. The tubes are operating class C in a grounded-grid circuit, which requires no neutralizing and gives an apparent overall efficiency of 90 per cent. Circuit losses are reduced to a minimum by the use of low plate voltage. The 3X2500A3's deliver 12.5 kw at only 3500 plate volts.

So compact are the 3X2500A3 triodes (see inset closeup) that the entire final amplifier and driver can be housed in the equivalent space of two five-foot racks. The driver section, as shown at the right, provides 3 kw of driving power with four of Eimac's new 4X500A tetrodes in a push-pull parallel circuit. The low plate-voltage requirements of the 3X2500A3 also permit use of a common power supply for driver and amplifier.

Simple compact transmitter design is now made possible in the higher power brackets of the new f-m band. The Eimac 3X2500A3 offers a number of design advantages such as low driving power, low plate voltage, functional electrode terminations, and tool-less installation and removal. Write for full particulars.

EITEL-McCULLOUGH, INC., 1363F San Mateo Ave., San Bruno, Calif.
Export Agents: Frazar and Hansen, 301 Clay Street, San Francisco 11, Calif., U.S.A

Follow the Leaders to

Eimac
TUBES

POWER undistorted

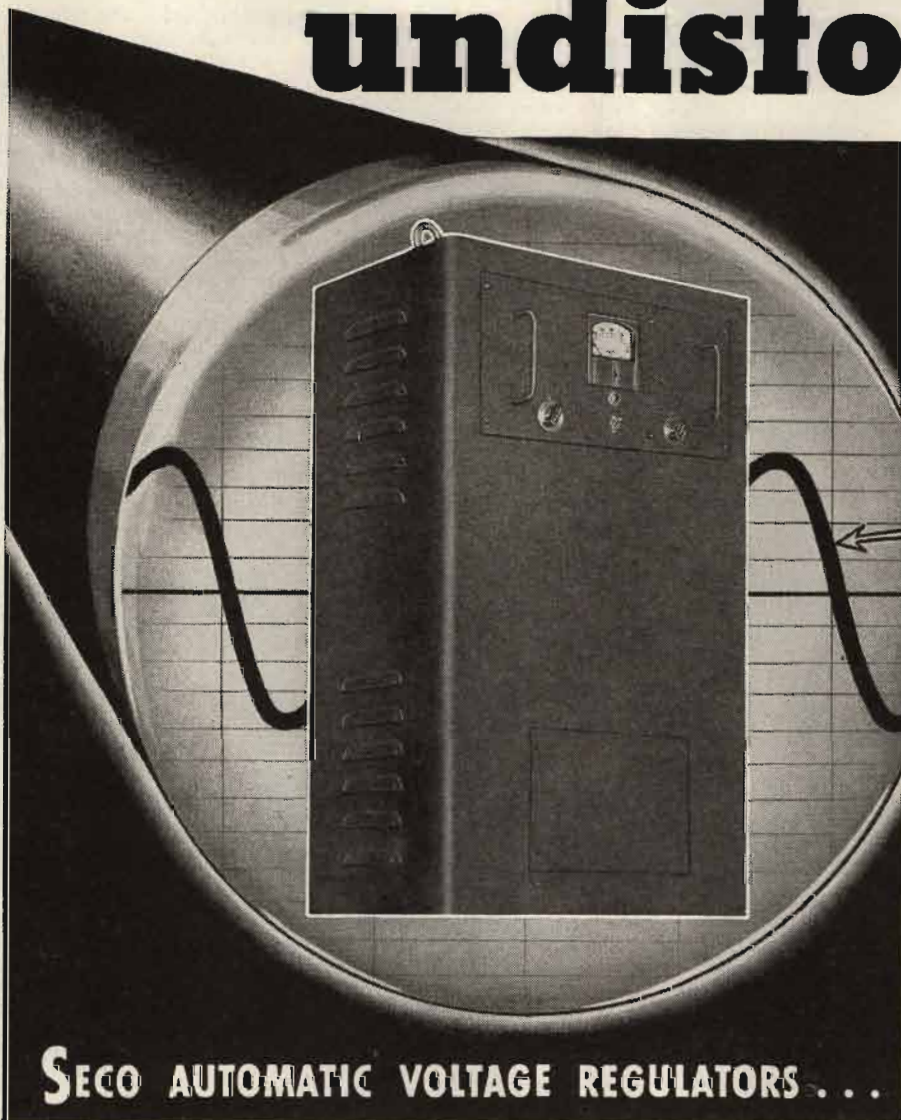

SECO AUTOMATIC VOLTAGE REGULATORS . . .

- **RAPID CORRECTION OF LINE VOLTAGE VARIATIONS**
- **NO CRITICAL MECHANICAL ADJUSTMENTS**
- **DOES NOT AFFECT POWER FACTOR of the SYSTEM**
- **NOT AFFECTED BY CHANGES in the POWER FACTOR OR MAGNITUDE of the LOAD**

Send for Bulletin 150 OC

The
Superior  **Electric**
Company

942 LAUREL STREET • BRISTOL, CONNECTICUT, U.S.A.

● ZERO WAVEFORM DISTORTION...a characteristic of all SECO Automatic Voltage Regulators... is not the most important but certainly a highly desirable feature in voltage regulating equipment. Please keep in mind —

**Seco Automatic
Voltage Regulators
produce zero
waveform distortion**

But...zero waveform distortion is just one of the many decided advantages of SECO Automatic Voltage Regulators. A few others are listed and a more comprehensive investigation would reveal such factors as low cost per KVA — easy installation — rugged mechanical construction.

Consider these combined advantages when in need of equipment to maintain CONSTANT VOLTAGE to electrical apparatus.

SECO Automatic Voltage Regulators offer more per dollar value whether the requirement involves 1 or 100 KVA.

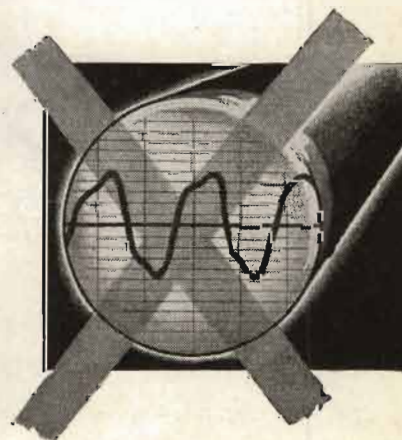

On View At the IRE National Convention

BOONTON 202-B F-M SIGNAL GENERATOR

Instrument covers the frequency range from 54 to 216 mc and is provided with two frequency deviation ranges, 0-80 kc, 0-240 kc for frequency modulation, as well as 30% and 50% calibrations for amplitude modulation. F-m distortion at 75 kc deviation is less than 2%. An internal audio oscillator having eight fixed frequencies between 50 cycles and 15 kilocycles may be conveniently switched for either frequency or amplitude modulation. By the use of an external a-f oscillator simultaneous a-m and f-m may be obtained for checking the performance of limiter stages and ratio detectors.

A monitoring meter is used to standardize the output level of generator to make the piston type r-f attenuator direct reading over the range from 0.1 micro-volt to 0.2 volt. The output impedance (with cable attached) is 26.5 ohms.

Self-contained, with power supply, and is designed for use on 115 volts, 60 cycles.

Boonton Radio Corp., Booton, N.J.

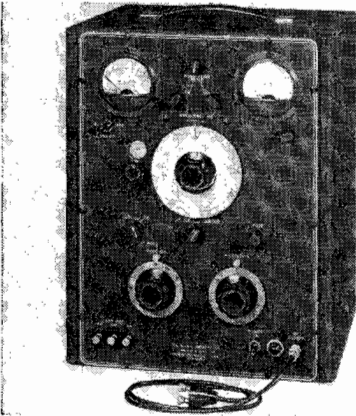

* * *

C-D TLA DYKANOL CAPACITORS

Filter capacitors for power supplies in portable v-h-f and u-h-f transmitters and transceivers, and high-fidelity p-a.

Capacitors have a high safety factor and long life at high temperatures due to impregnation with Dykanol.

Available with capacitor section either grounded (type TLA) or insulated (type TLAD).

Cornell-Dublier Electric Corporation, South Plainfield, N.J.

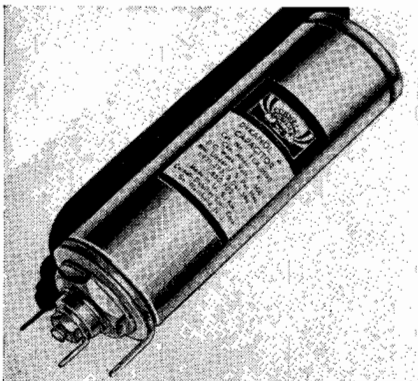

SOLA TYPE 21 CONSTANT-VOLTAGE TRANSFORMER

Output capacity, 25 to 50 va; 95 to 125 volts input; 6 to 6.3 volts output.

Structure provides for direct ventilation of the exposed core laminations and enclosure of the coils in end-bell housings. Capacitor is enclosed in the upper housing which is perforated to insure adequate ventilation. An insulating barrier prevents transmission of heat from the transformer to the capacitor compartment.

Provided with output terminals to facilitate its use as a "built-in" component of electrical equipment. Since the output terminals carry only low voltage they present no danger from shock.

Maintains output voltage constant to within $\pm 1\%$ for a total primary variation of 30%.

Sola Electric Co., 2525 Clybourn Ave., Chicago 14, Ill.

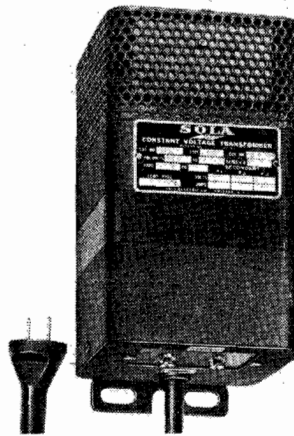

* * *

ASTATIC CONNEAUT 600-5 CRYSTAL MICROPHONE

Crystal microphone with relatively high output and wide frequency range. Overall frequency response 30 to 10,000 cps. Recommended load impedance, 5 megohms; output level below 1 volt/bar, -52 db. Supplied with on-off switch.

The Astatic Corporation, Conneaut, Ohio.

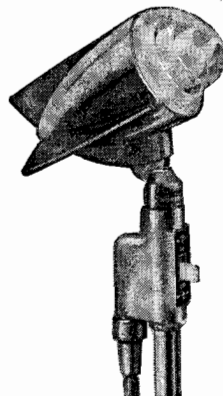

TECHNOLOGY INSTRUMENT 310-A Z-ANGLE METER

Instrument for electrical and electro-acoustic measurements; reads directly in impedance and phase angle.

Provides the complete $Z/\pm 0$ versus frequency information essential for studying or rating components or networks such as microphones, transmission lines, loudspeakers, filters, etc., which have wide variations in impedance with frequency because of electrical or mechanical resonances. It is direct reading in ohms impedance. Operation is independent of frequency. Provides phase angle readings over a range of $90^\circ (X_L)$ through $0^\circ (R)$ to $-90^\circ (X_C)$.

As a general purpose laboratory instrument its range in terms of resistance, inductance, capacitance, storage coefficient (Q) and dissipation factor (D) is: Resistance, 0.5 to 100,000 ohms; inductance, 5 microhenries to 500 henries; capacitance, 1000 mmfd to 10,000 mfd; Q , 0.1 to 10; and D , 10 to 0.1.

Technology Instrument Corporation, 1058 Main Street, Waltham, Mass.

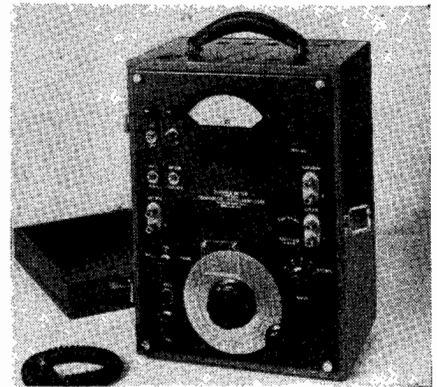

* * *

G. R. MONITOR FOR H-F SERVICES

Frequency monitor for a-m services above 1500 kc, consisting of a type 1175-A frequency monitor and a type 1176-A frequency meter.

Frequency-monitor is capable of monitoring four channels and one or more monitors can be used with a single frequency meter. The frequency meter contains clipping and limiting circuits to produce a constant waveform signal, and consequently the monitor is unaffected by amplitude modulation of the transmitter. Thus the monitor can operate directly from the transmitter output and need not be coupled to an unmodulated stage.

General Radio Company, Cambridge 39, Mass.

[Continued on page 41]

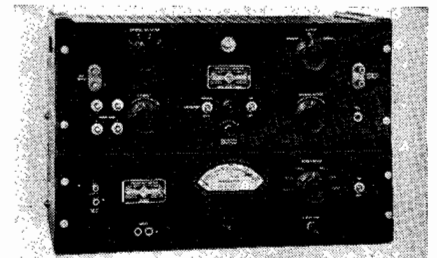

Save **SPACE, TIME** and **MONEY!**

with the **PYRAMID "TYNEE-DRY"**

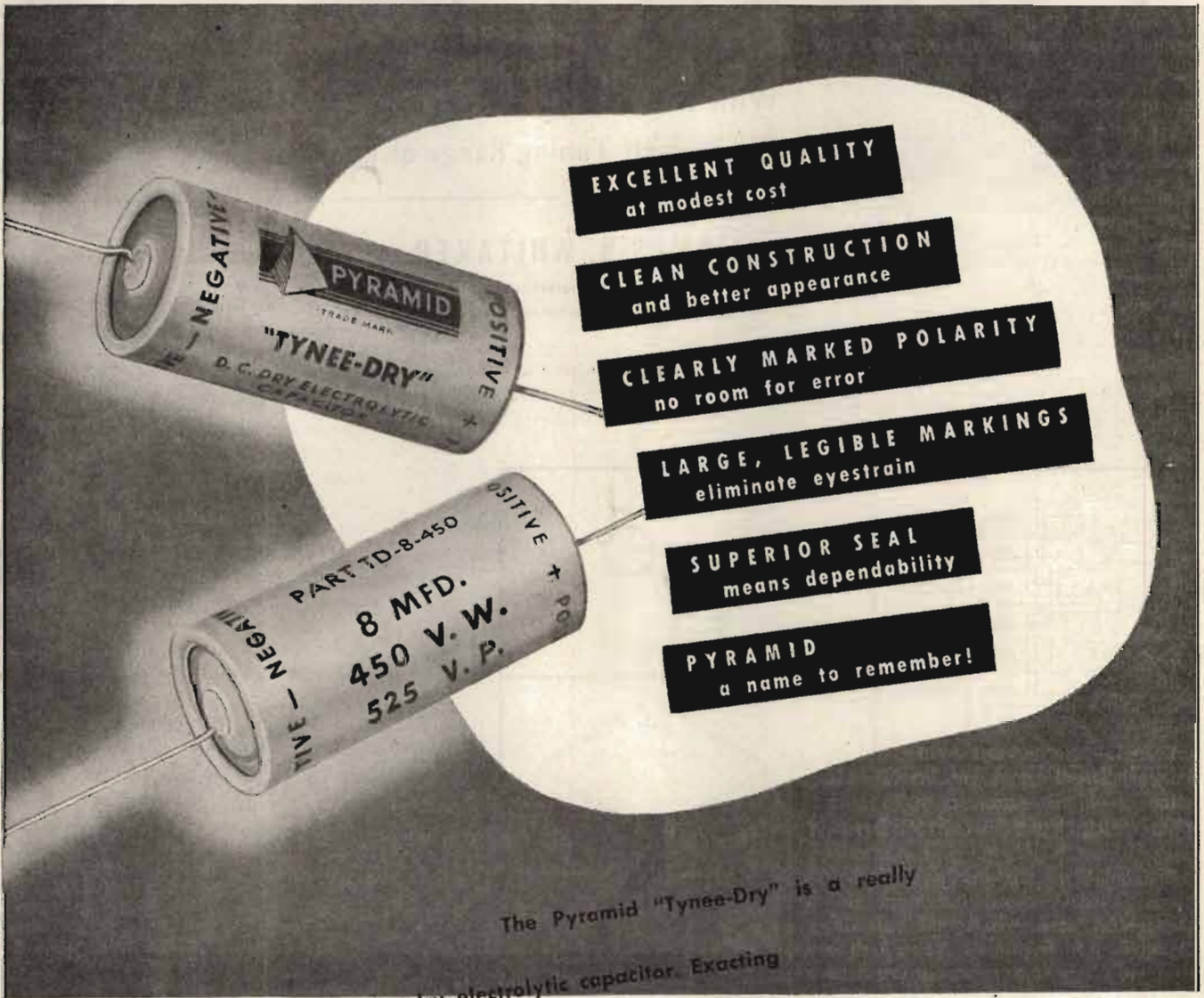

The Pyramid "Tynee-Dry" is a really tiny dry electrolytic capacitor. Exact engineering and production controls provide maximum quality within minimum space—and at modest cost! Write for literature.

PYRAMID ELECTRIC COMPANY
JERSEY CITY 6, N. J.

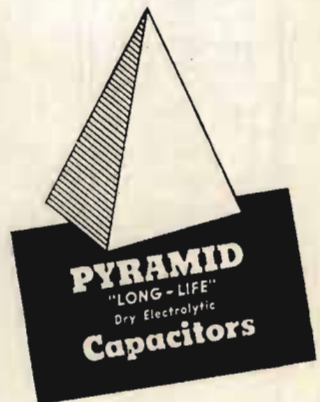

A 100-KC FREQUENCY STANDARD For Receivers

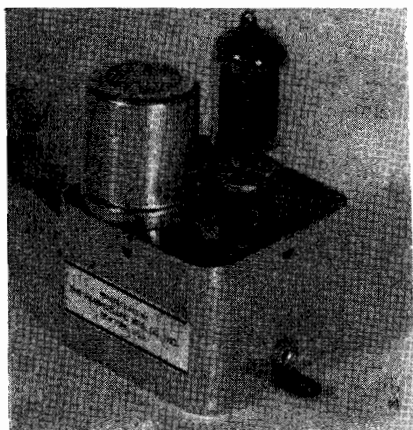

Figure 1
View of 100-kc standard.

Small Unit, Using 100-kc Crystal Oscillator in an Aperiodic Circuit, is Adjustable So That Harmonics Will Zero Beat With WWV. Marker Signals Can Be Heard 100-kc Apart Throughout Tuning Range of Receiver.

by JAMES N. WHITAKER

Engineering Department
Hammarlund Manufacturing Co., Inc.

Figure 2
Several methods of connecting frequency standard to receiver inputs; A and B, HQ129 and Super Pro inputs; C and E, typical tuned-circuit inputs.

A CONVENIENT MEANS FOR CHECKING the calibration of a receiver and accurately setting the band-spread dial of

a multi-range receiver is a very desirable facility, as any user of such a receiver well knows. In commercial operation, where it is desired to preset a receiver to the exact frequency of a transmitting station which is coming on the air at a predetermined time, the operator usually adjusts the receiver to the approximate frequency. He then waits for the signal to come on the air and then returns the receiver to the exact frequency.

If the operator has a reliable frequency standard available, he may accurately adjust the receiver to the desired frequency, and go about his other duties while awaiting the signal from the transmitter.

The use of a frequency standard generally involves physically moving a secondary standard to the location of the receiver, and may or may not involve making connection to the receiver.

Where a frequency standard is used for checking and adjusting all receivers in a large receiving station, the setup for the use of the signal from the standard usually involves switching or patching of the output of the standard to the desired receiver. In any event, there is some loss of time in making adjustments.

Frequency standards heretofore have been relatively costly and cumbersome to use, and thus have not been used to any great extent unless absolutely necessary.

There has been a need for a secondary frequency standard small enough to be incorporated in a receiver, and with a frequency capable of very accurate adjustment to a primary standard. Such a device must also require only a negligible amount of power so that it can be operated from the power supply of the receiver without ad-

(Continued on page 38)

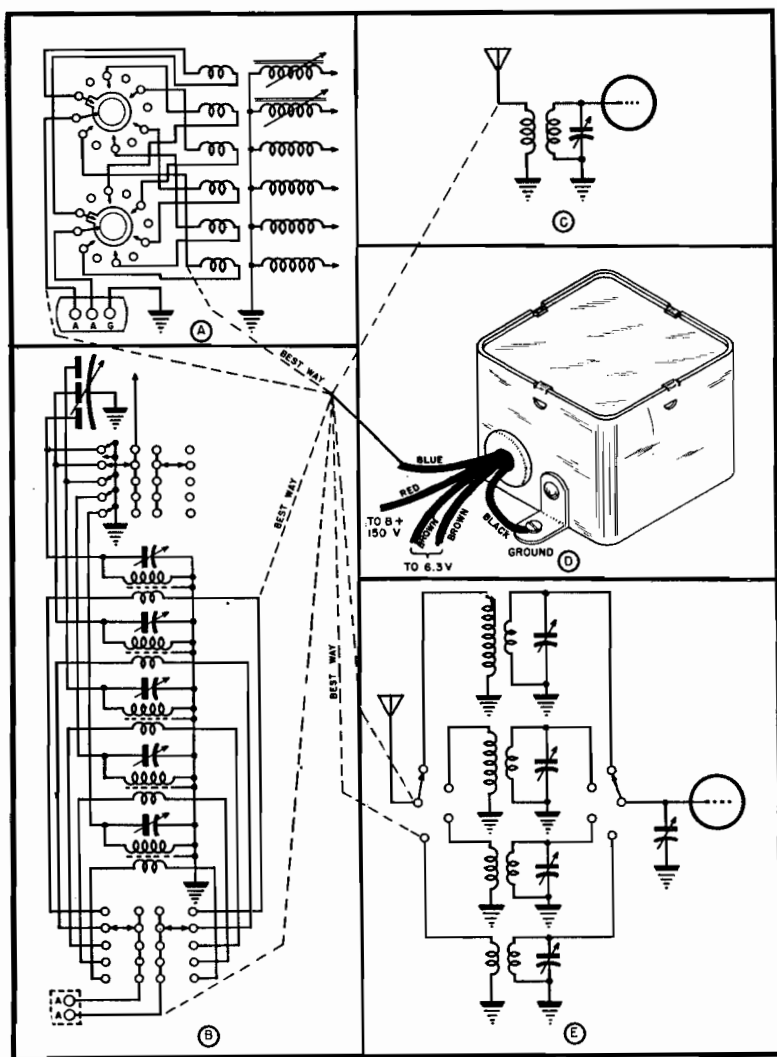

★ ANSONIA ★ Ankoseal

will not support Combustion

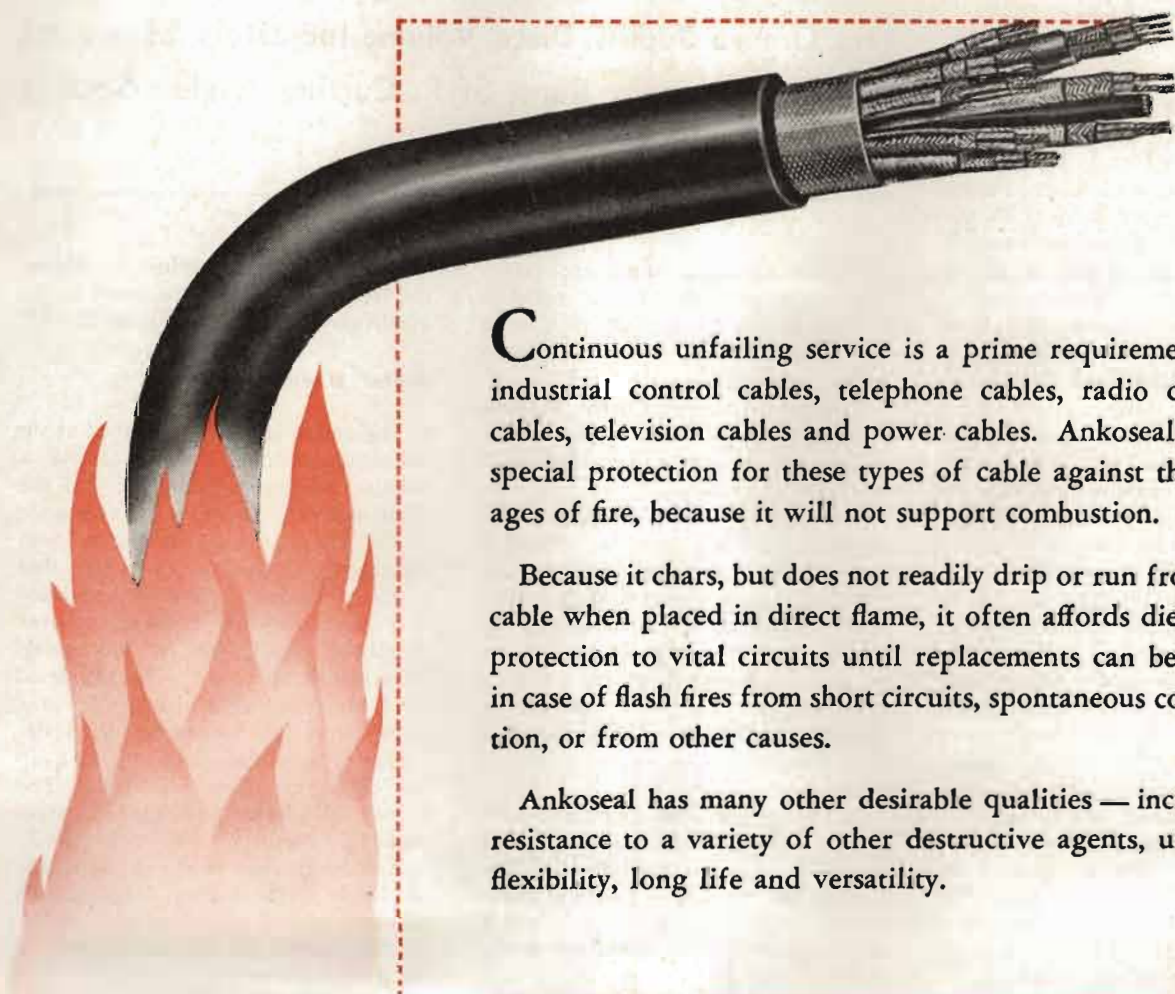

Continuous unfailing service is a prime requirement for industrial control cables, telephone cables, radio control cables, television cables and power cables. Ankoseal offers special protection for these types of cable against the ravages of fire, because it will not support combustion.

Because it chars, but does not readily drip or run from the cable when placed in direct flame, it often affords dielectric protection to vital circuits until replacements can be made in case of flash fires from short circuits, spontaneous combustion, or from other causes.

Ankoseal has many other desirable qualities — including resistance to a variety of other destructive agents, unusual flexibility, long life and versatility.

THE ANSONIA ELECTRICAL DIVISION
ANSONIA, CONNECTICUT *of*

NOMA ELECTRIC CORPORATION

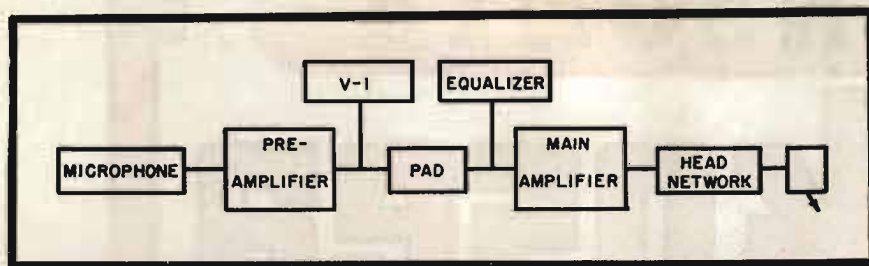

Figure 1
Block diagram of simple modern recording setup.

L A T E R A L R e c o r d i n g

by W. H. ROBINSON

Technical Advisor
Kasper-Gordon, Inc.

Discussion of Average Electromagnetic and Crystal Cutters, Groove Depths, Discs, Volume Indicators, Measuring Setups, Frequency Runs, Styli, Cutting Angles, Scratch Filters and Pickups.

PRESENT-DAY RECORDING TECHNIQUE has been developed over a period of time. Early arrangements were purely mechanical, and were subject to the limitations of any mechanical arrangement. Today we have two types of electric-type recorder heads; electro-magnetic and the piezoelectric. Both types are capable of doing high quality work, and both have their limitations and advantages.

A great many technicians assume that a well-designed magnetic cutter head will give constant amplitude of stylus vibration for a constant voltage applied to the cutter with varying frequency. This is far from true.

The cutter head must present to its amplifier a reasonably constant load at all frequencies which it is desired to record. This is admittedly difficult and is accomplished to some extent by the proper design of the component parts of the head, such as the armature, stylus chuck, cutter winding, and damping. The head, when supplied with a constant voltage across its terminals, is inherently a constant-velocity device. This means that the stylus point will travel with a constant maximum lateral velocity as it crosses the zero axis. This holds regardless of the frequency supplied to the head; the travel of the stylus of course is due to the signal voltage. Even with proper design the average cutting head will have considerable variation of impedance with frequency over its usable range. Usually a corrective network is placed in series with the cutter head across the amplifier output terminals. This network assists in correcting the effects of the variation of cutter impedance across the amplifier so that the amplifier may see a

reasonably constant output impedance. The characteristics of the network may be such as to correct, in a large degree, the deficiencies which show up in the cutter head.

Now let us consider what happens to the amplitude of the stylus movement as the frequency is changed from one value to another.

The velocity of the stylus point, it might be explained here, is constant if it constantly, from second to second, travels the same distance. With a constant velocity of stylus movement, as it traces the modulation in the groove, we would find that if we were able to straighten out the paths followed by the stylus at any two frequencies in a given length of time, the paths would be an equal length.

At 500 cps we cover a definite length of path with the stylus point as it cuts this frequency for one second. We have a definite velocity with a given voltage supplied to the circuit and a definite amplitude of signal cut in the groove; also, in one second we will have completed 1,000 complete alternations of the stylus point. Now, let us consider what happens when the frequency is doubled. At 1000 cycles we have 2000 complete alternations of the stylus point in one second, and the velocity remains the same as it was at 500 cycles. Thus, if we trace or cut twice as many alternations as before with the same velocity, we must have an amplitude of signal in the groove which is one half the amplitude at 500 cycles. Therefore, with

constant velocity of stylus, the higher the frequency we cut, the lower is the amplitude, as shown in Figure 2.

Cutter Modifications

The cutter is usually modified at the lower frequencies so that below a definite frequency the velocity of the stylus decreases, holding the amplitude of the modulation in the groove constant with decreasing frequency; that is, the stylus has a constant amplitude of movement below a given turnover frequency usually 500 or 300 cycles. This results because the amplitude of the modulation in the groove decreases with increasing frequency. This decrease in amplitude amounts to 6 db per octave on a velocity basis. The groove modulation amplitude is cut in half as the frequency doubles, Figure 3.

Assuming that we cut a usable amplitude at the highest frequency to be used, as the frequency is reduced, the amplitudes of the modulation in the groove increases. Thus at the frequency picked for the turnover frequency, the groove is fully modulated and any increase in the amplitude of the modulation will result in our cutting over into the next groove. However, if from this point down the velocity of the stylus movement is allowed to decrease, the amplitude of its swing will remain constant, and the width of the modulation in the groove will remain constant without overcutting, providing the voltage level fed to the head is not allowed to increase above

for **proved** performance
in **FM**



Specify These Federal Air Cooled Triodes
3,000 and 10,000 Watts per pair at 88 to 108 Megacycles

LEADING FM STATIONS all over the country report that these Federal triodes are not only living up to—but *far exceeding*—their exacting specifications, in day-after-day performance on the job.

To us at Federal, such service records are no surprise. Because long before these tubes were announced, they were subjected to the most rigorous and exhaustive development tests at the factory—for dependability, permanence of characteristics, overload capacity and long life. And in production, every tube is checked and double checked all along the line, from raw materials to finished product, to assure the utmost perfection of every detail. For complete information, write today to Dept. K 510.

DATA—TYPE 7C26		
Frequency, 88-108 Megacycles (Max. Output up to 150 Mc) Maximum plate dissipation 1000 watts Filament voltage 9.0 volts Filament current 28.0 amp Amplification factor 22 Mutual conductance 20,000 Umhos Cooling air requirements at maximum dissipation . . . 75 cfm		
DATA—TYPE 7C27		
Frequency, 88-108 Megacycles (Max. Output up to 110 Mc) Maximum plate dissipation 3000 watts Filament voltage 16.0 volts Filament current 29.0 amp Amplification factor 27 Mutual conductance 20,000 Umhos Cooling air requirements at maximum dissipation . . . 175 cfm		

Federal Telephone and Radio Corporation

In Canada:—Federal Electric Manufacturing Company, Ltd. Montreal.
Export Distributors:—International Standard Electric Corp. 67 Broad St., N. Y. C.



Newark 1,
New Jersey

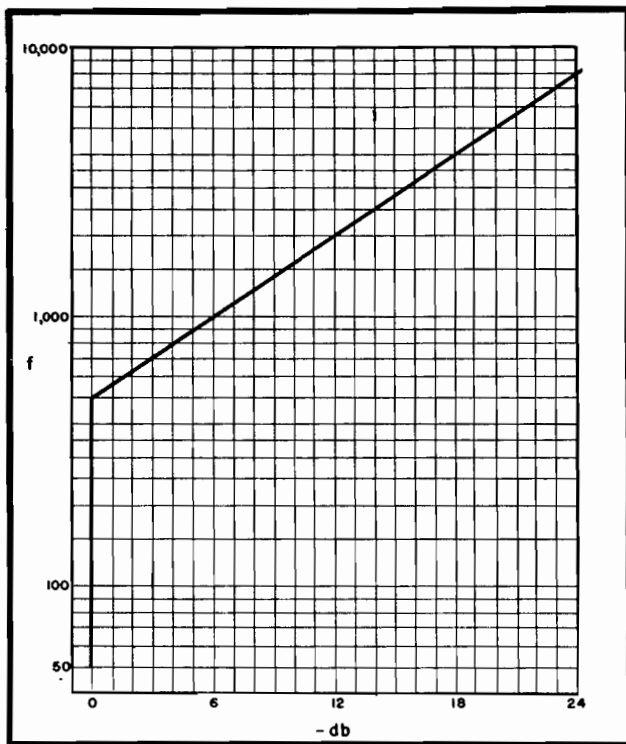

Figure 2

Idealized representation of the amplitude of modulation cut in the groove versus frequency, using constant amplitude and increasing stylus velocity from 50 to 500 cycles. Above 500 cycles the stylus velocity remains constant while the amplitude of the recorded signal in the groove decreases with increasing frequency as shown.

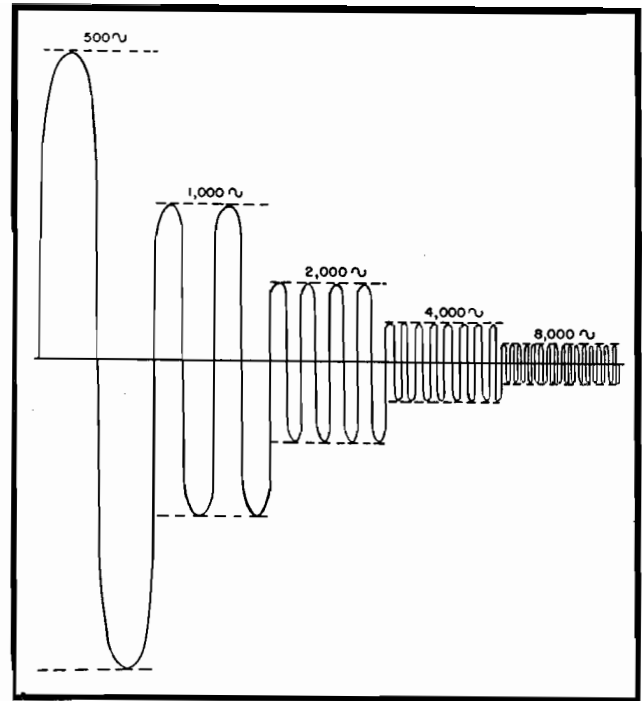

Figure 3

Relative amplitude of the octaves of modulation frequency, cut in the groove above a turnover point of 500 cycles, for the ideal case.

the amplitude which gives us this modulation amplitude in the groove.

Of course the magnetic playback unit inherently will supply a constant amplitude of output voltage for a constant velocity of needle movement for all frequencies above the turnover frequency. It is equalized or adjusted to give a constant amplitude of voltage for decreasing needle velocity for those frequencies below the turnover point.

We have certain points to remember then: (1)—Above the turnover point of our cutter head, usually 300 to 500 cycles, the cutter stylus moves with a constant velocity and decreasing amplitude; (2)—below the turnover point the stylus moves with decreasing velocity and constant amplitude.

Crystal Cutters

The crystal cutter, a capacitive device and capable of extremely good quality work, is a constant-amplitude device. This type of cutter can with a little time and thought be converted to cut a standard constant-amplitude, constant-velocity characteristic.

The average magnetic cutter usually deviates from the perfect constant-velocity device because it is designed to have its inherent constant-velocity

characteristics from the highest frequencies down to the region of the turnover point. From this point or region down it is deliberately designed to have a constant-amplitude characteristic. This variation from the true characteristics is accomplished at the factory. If the turnover point of the particular head in use is too high or too low proper, filters will alter the response it cuts so that the proper turnover point can be obtained. It must be remembered that the turnover point is not too sharply defined. However, it is well enough defined to be able to recognize it. With the standard constant amplitude, constant-velocity cut, the noise generated by imperfections in the groove may be great enough, and in fact often is great enough to mask the effects of the desired signal. To overcome this effect, new standards are being developed, namely the *orthocoustic*, and *NAB* cut; these will be discussed in subsequent installments.

Volume Indicators

It seems to be quite common practice to place the volume indicating device (for control of level in the recording system) across the amplifier output in parallel with the cutter itself. This procedure is not satisfactory because the cutter itself, without any corrective

equalizer, is not a constant impedance. Therefore the reading on the indicator shows nothing but the variation in cutter impedance with frequency. More effective results are possible if the meter is placed before the main amplifier, after adjusting the circuit for the proper recording level. This provides an accurate indication of what is actually happening to the level in the circuit. Another method used is the so-called constant-voltage feed to the cutter head, in which a resistor is placed in series with the cutter head. The meter is placed in shunt with this combination. The output impedance of the amplifier is set by the manufacturers' specifications for the cutter head impedance. The resistor value is equal to the lowest value of impedance that the cutter head assumes as the frequency is varied, minus the output impedance of the amplifier. The resistor is then usually bypassed by a capacitor whose total impedance, as seen by the amplifier, is constant over as wide a range as possible. This in many cases is the total cutter network. This capacitor also tends to resonate with the recorder head at the very high frequencies: its action is to keep the response of the head normal to as high a frequency as possible (normally at this stage 8,000 to 10,000 cycles.)

[To Be Continued]

BUILT FOR THE PRESENT
and **THE FUTURE**

Supreme

FM TRANSMITTERS

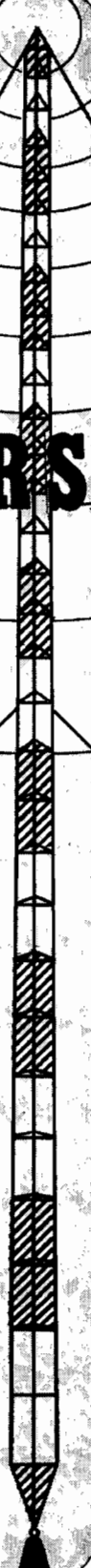

No obsolescence . . . no time lost on the air for changeover . . . no heavy depreciation charges! That's what a Supreme Transmitter means to you. For as your station grows, your Supreme Transmitter grows. Its output may be readily increased to 1, 3, 10 or 50 kilowatts by adding a suitable power amplifier or series of amplifiers.



*Typically
Supreme...*

Many "hams" are on the air with Supreme Model AF-100 desk-type 100-watt transmitter.

Here's a 6-band "rig" providing AM, FM, CW and ICW services! It's one of the most versatile "ham" jobs yet offered. For regardless what present or future frequency allocations may be, the AF-100 can be instantly set to operate. And it's highly efficient on all bands and for all types of transmission.

Operates in the 10, 11, 15, 20, 40 and 80 meter bands. Cuts through QRM and QRN like a razor in maintaining QSO contacts. Provides narrow, medium or wide-band FM transmission! Handsome panel and cabinet. Only 29 $\frac{1}{2}$ " w., 11 $\frac{1}{4}$ " h., 18 $\frac{1}{4}$ " d., 145 lbs. Only items required to "get on the air" are key, mike and (optionally) two crystals. Only \$450 complete, with tubes and coils. Typically "Supreme".



The basic unit is the Supreme Model FMB-250 Transmitter. Here's a high-quality low-power-output FM broadcast station. Simplest circuit design. Extreme operational ease. Maintenance at minimum. Equipment is complete—FM modulators, center frequency stabilization system and R.F. power output stage. Transmitter conforms in its entirety with F.C.C. standards of good engineering.



Built to last! Designed to last! Supreme Transmitters are for your PRESENT and your FUTURE. There's no sounder investment in broadcasting. Make us prove it!

GET THE FACTS...

Specifications, prices and delivery, sent on request. Let us collaborate on your FM and AM broadcast requirements, both for the present and the future.



Supreme

TRANSMITTER CORPORATION

Manufacturers of Communications Equipment
280 Ninth Avenue • New York City 1, N. Y. • Wisconsin 7-6413
Export Division: The Radelma Company, 53 Park Place, N. Y. C.



VETERAN WIRELESS OPERATORS ASSOCIATION NEWS

W. J. McGONIGLE, President

RCA BUILDING, 30 Rockefeller Plaza, New York, N. Y.

GEORGE H. CLARK, Secretary

Annual Meeting

AT THE ANNUAL VWOA MEETING held on January 21, 1947 a tabulation of votes indicated that W. J. McGonigle had been reelected president; A. J. Costigan, vice president; George H. Clark, secretary; and William C. Simon, treasurer and executive secretary. . . . Directors elected included William C. Simon, George H. Clark, A. J. Costigan, William J. McGonigle, Captain Fred Muller USNR, Arthur H. Lynch, J. R. Poppele and C. D. Guthrie who recently retired from the War Shipping Administration and in whose honor the meeting was tendered. CDG received numerous tributes applauding his forty-odd years of distinguished radio service.

AMONG THOSE AT THE MEETING were: Donald McNicol whose recent book "Radios Conquest of Space," an authentic history of radio and radio personalities, has been praised by the technical, trade and daily press; Arthur H. Lynch, New York manager of the National Company; Ludwig Arnson, life member and president of Radio Receptor; G. H. Clark, who recently returned to active service with RCA after a very brief retirement; William J. McGonigle; William C. Simon; Roscoe Kent, one of the earliest aides of Dr. Lee de Forest; A. F. Wallis, now engaged in promotional work but planning a Florida vacation very soon; Peter Podell, one of the founders of VWOA; Colonel Lamb; Sam Schneider, one of the earlier treasurers of our association and now in the retail radio trade in New York; H. L. Cornell, radio supervisor of the Standard Oil Company; Lt. Cmdr. B. Frank Borsody, USNR, planning to go to Japan on a War Department assignment; John A. Bossen, of Mackay Radio, one of our earliest members; R. H. Frey, radio supervisor of the Bull Steamship Lines and chairman of the reception committee at our annual affairs; Frank Orth, a charter member and supervisor at CBS; Fred McDermott, recently returned from several reassignments



VWOA president William J. McGonigle, Dr. Lee DeForest, honorary president of VWOA, and life member General David Sarnoff, president of RCA, at the recent AIEE annual convention during which Dr. DeForest received the Edison Medal of the Institute for his outstanding contributions to the communications art. The presentation was made by Gen. Sarnoff.

with the Navy; E. H. Price, vice president of Mackay Radio, with a group of his associates; A. F. Rehbein, radio supervisor of the American Hawaiian Steamship Company; R. J. Iversen, New York *Times* radio staff; Roger B. Lum, one of the earliest announcers on WJZ when it was located in Newark, N. J.; Henry T. Hayden, sales engineer of Ward Leonard; W. J. Gillule and J. Lohman of the N. Y. Mackay staff; Edward A. Carroll, WCAU in Philadelphia; E. L. Bisbee, radio department of the New York City Police Department; Fred E. Meinholtz, director of communications of the New York *Times*; Dave Carruthers, who succeeded "Jerry" Guthrie as radio supervisor of the War Shipping Administration; and George F. Duvall.

De Forest Dinner

VWOA TENDERED A DINNER to Dr. Lee de Forest at the Waldorf Astoria on January 28, 1947, in celebration of the fortieth anniversary of the audion tube . . . A congratulatory message from Frances Colt de Wolf of the State Department stated: "On the occasion of his designation as *Father of the Electronic Age* I wish to offer to Dr. Lee de Forest my congratulations and an expression of my admiration for the enormous contribution which he has made in the service of human-

ity in the field of electronics." . . . Congratulatory messages were also received from Governor Thomas E. Dewey; Admiral Stone, Chief of Naval Communications; W. R. G. Baker, IRE president; United States Coast Guard; Col. Mitchell, executive vice president of RCA Communications; Admiral Joseph R. Redman; Charles R. Denny, FCC chairman; Major General H. C. Ingles, chief signal officer of the Army; W. A. Ready, president of the National Company; George W. Bailey, president of the American Radio Relay League; and W. J. Halligan, president of Hallicrafters.

Personals

OUR GOOD WISHES TO FORMER CHAIRMAN of the Boston chapter, Charles C. Kolster, who has been named regional manager of FCC for the Northeastern zone with headquarters in New York. . . . Clarence A. McKee, veteran wirelessman, is president of the McKee Electric Company, distributors of Stromberg Carlson marine sound systems. CAM also conducts a consulting practice along general communications lines. . . . Veteran member George A. Sterling continues in his duties as assistant chief engineer of FCC in charge of the Field and Research Sections.



HRO-5A1

Wherever the choice of a communication receiver is based on proven performance, the HRO is a logical selection. For the HRO is cleanly designed for crack operators, free from superfluous tubes or details, yet including everything that can aid the user's skill. The HRO combines ease of operation with brilliant performance and superb reliability.



NATIONAL COMPANY, INC.
MALDEN, MASSACHUSETTS, U. S. A.

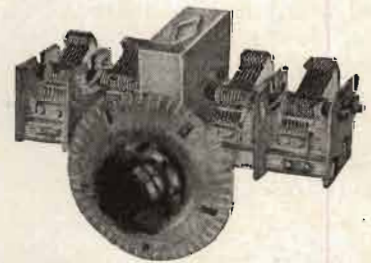

Four Section Precision Condenser. Micrometer dial for precise logging, preloaded worm drive for exact tuning, rigid construction for permanent calibration.



Ganged Plug-in Coils. Two stages of preselection for image suppression, weak signal response and high signal-to-noise ratio.

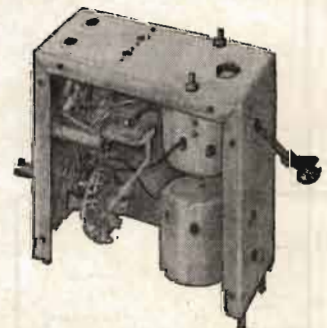

Wide Range Crystal Filter. Wide range selectivity and wide range phasing controls permit maximum attenuation of noise and heterodynes.

IMPEDANCE MEASUREMENTS

With Transmission Lines of Television Antennas

Second Installment of Series on Television-Antenna Design Covers an Analysis of Actual Measurement Techniques.

by G. EDWARD HAMILTON and RUSSELL K. OLSEN

Senior Engineers, Development Section
Allen B. Du Mont Laboratories

THE COMPLEX NATURE of an impedance may be determined by terminating a transmission line with the impedance, and measuring the standing wave ratio, ρ , shift in reference point, βd , and characteristic impedance, Z_0 .

In the previous installment² we showed that where d_{min} is the distance from the load to the nearest voltage minimum Z_r may be evaluated as follows:

$$Z_r = Z_0 \frac{1 - j\rho \tan \beta d_{min}}{\rho - j \tan \beta d_{min}}$$

Similar substitution, when V_{max} is used as a reference point, results in

$$Z_r = Z_0 \frac{\rho - j \tan \beta d_{max}}{1 - j\rho \tan \beta d_{max}}$$

Thus if three parameters are known, namely ρ , Z_0 , and βd , the fourth, Z_r , may be obtained.

To evaluate the angle βd , it is necessary to calibrate the line under conditions of open-circuit or short-circuit termination, the latter being the most satisfactory since balance of distribution may also be checked. (Balance on a line obtains when equal voltages appear on both lines.) The procedure for calibration, shown in Figure 4, is as follows:

- (1) Short circuit the line termination.

Figure 3a
General equation and solutions for a coaxial transmission line (left) and a two-wire balanced transmission line (right).

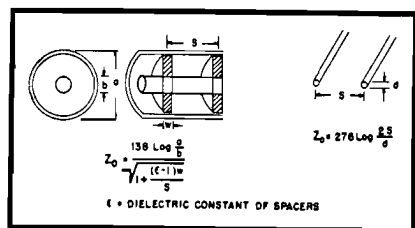

- (2) Adjust the signal generator to the correct frequency.
- (3) With a *standing-wave detector* determine the voltage minimum; this point gives a sharper indication than the voltage maximum.
- (4) Mark this position in reference to the applied frequency; position is approximately a half wave from the short circuit and toward the generator.
- (5) Determine the position of the next voltage minimum. The distance between these two minima is approximately a half wave. The deviation to the *space length* is due to the *velocity of propagation constant* of the transmission line and may be calculated as follows:

$$\lambda^n = \frac{300 \times 10^6}{f_{mc} \times 10^6} \times \frac{100}{2.54} = \frac{3 \times 10^4}{f_{mc} \times 2.54}$$

$$\frac{\lambda^n}{2} = \frac{5905}{f_{mc}} \text{ (Free Space Value)}$$

$$\text{Velocity of propagation constant} = \frac{\frac{\lambda^n}{2} \text{ (Measured)}}{\frac{\lambda^n}{2} \text{ (Free Space)}} \quad (28)$$

- (6) Repeat the foregoing steps for separate frequencies throughout the bandpass spectrum.

²January, 1947 COMMUNICATIONS.

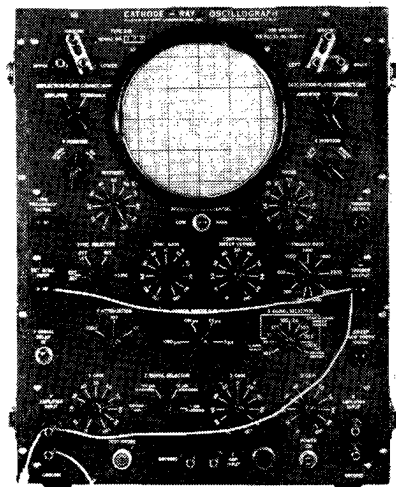

Figure 5a
Method of connecting an oscillograph for the measurement of transmission line Z_0 .

- (7) Connect the antenna to the measurement line and determine the standing-wave ratio and displacement of the reference point. (Reference point is any voltage minimum taken with respect to a short or open-circuited termination.)

The phase shift is indicated when the reference point on the transmission line is displaced toward or away from the termination depending upon whether the termination is inductive or capacitive. When the reference is with respect to a shorted termination, and the load is resistive but less than Z_0 , the reference point will remain unchanged. When Z_r is greater than Z_0 , and resistive, the V_{min} position will shift 90° . Where Z_r is greater than Z_0 , and capacitive, the nearest V_{min} position will be moved toward the generator. When Z_r is greater than Z_0 .

(Continued on page 34)

Figure 4
Procedure for calibrating line for phase-shift measurements.

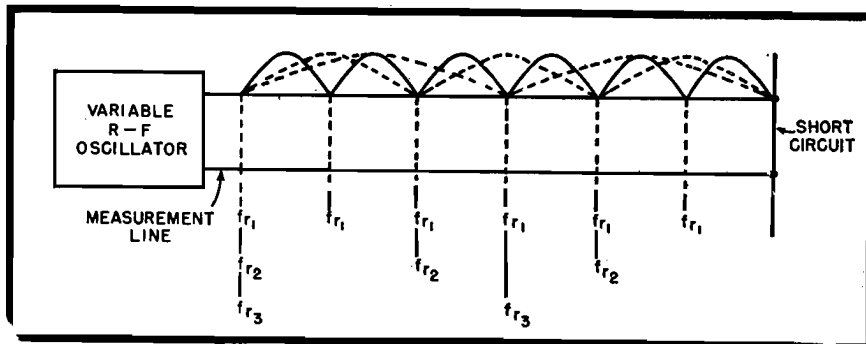

AIRCRAFT RADIO CORPORATION

Among the A.R.C. RADIO COMMUNICATION AND NAVIGATION SYSTEMS are

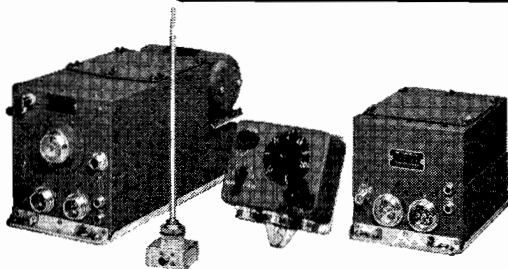

TYPE 11 SYSTEM
Range Receiver and VHF Transmitter.
or **TYPE 17 SYSTEM**
VHF Receiver and VHF Transmitter.

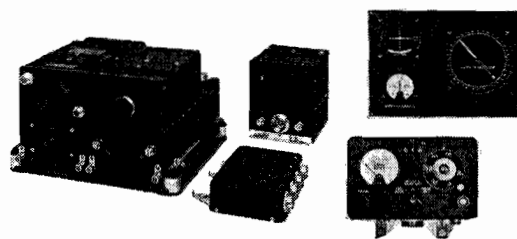

TYPE 15
VHF Omni-Directional
Range Receiving Equipment.

Among the A.R.C. ELECTRONIC COMPONENTS AND ACCESSORIES are

**"MUSIC-BOX" TYPE
SELECTOR SWITCHES**

For low-voltage control circuits.
Unusually positive detent action.
Lever-type control handle.

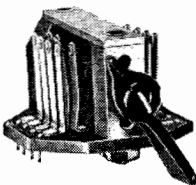

**CERAMIC-INSULATED PLUGS
AND RECEPTACLES**

- 24 combinations.
- 2 to 19 contacts.

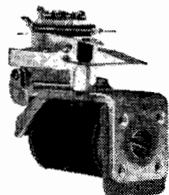
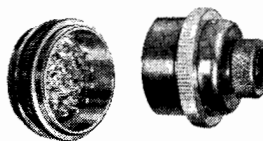

**CERAMIC-INSULATED
MINIATURE DC RELAYS**

1 1/4" long.
SPST, SPDT, DPST, SPST-SPDT,
and DPDT.

**DRY ELECTROLYTIC.
SEALED CONDENSERS**

Terminals mounted on mica.
No bakelite-rubber seals.

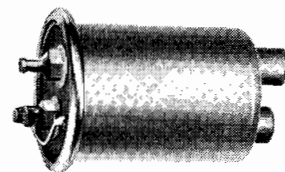

**MINIATURE PIN-PLUG
CONNECTORS**

Specially designed to
minimize spring fatigue.

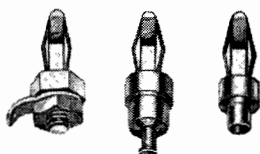

SNAPSLIDE FASTENERS

7/16" wide size, for heavy loads.
1/4" wide size, for light loads.



Among the A.R.C. MICROWAVE UNITS AND ACCESSORIES are

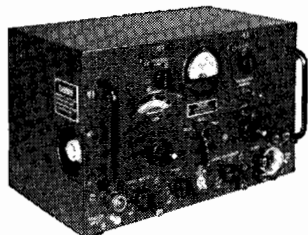

TYPE H-10 TEST SET

for the 1.2 cm band

and various assemblies for the 10 cm,
3.3 cm, and 1.2 cm bands.

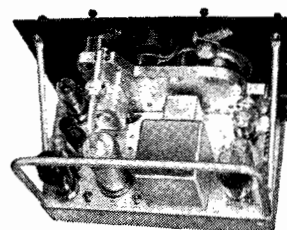

AIRCRAFT RADIO CORPORATION

DEPENDABLE COMMUNICATION AND NAVIGATION EQUIPMENT

Boonton, N. J.



for Important PUBLIC ADDRESS INSTALLATIONS

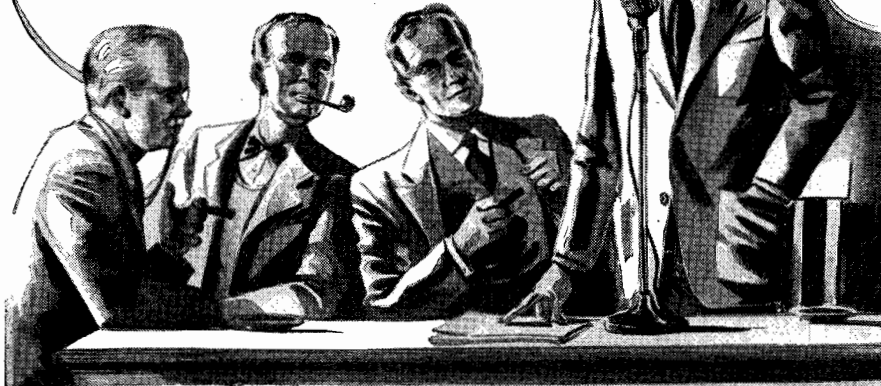

"The Globe"
multi-unit
CRYSTAL
Microphone

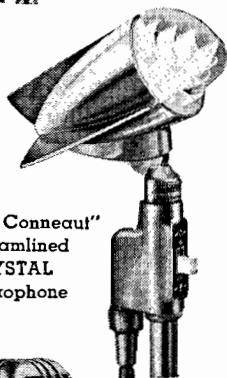

"The Conneaut"
Streamlined
CRYSTAL
Microphone



WR-Series
multi-unit
CRYSTAL
Microphone

THERE are few, if any, more important uses for microphones, than with public address equipment. Much depends upon faithful performance and reproduction. Well known speakers, famous dance bands, noted singers and musicians, leading actors and actresses, sport commentators and others . . . all are vitally concerned with the quality reproduction of their efforts. Astatic Microphones, beautifully designed and finished, expertly engineered and constructed, give the type performance that important public address installations merit.

See your Radio Parts Jobber
or write for new Catalog



TELEVISION ANTENNAS

(Continued from page 32)

and inductive, the nearest V_{min} will be moved toward the load. Where Z_r is less than Z_o , and inductive, the nearest V_{min} will be moved toward the load. Where Z_r is less than Z_o and capacitive, the nearest V_{min} position will be moved toward the generator.

Since the term $2\pi d/\lambda$ radians phase shift will always be between 0 and $\pm \pi/2$, or 0° and $\pm 90^\circ$, it is possible to convert the displacement in length units to degrees.

$$\frac{\lambda/4}{90^\circ} = \frac{\lambda/4 - d}{\phi^\circ}$$

$$\text{or } \phi^\circ = \frac{(\lambda/4 - d) \times 90^\circ}{\lambda/4} \quad (29)$$

Where: ϕ° = phase shift
 d = displacement in units of measurement
 $\lambda/4$ = measured length of a quarter wave; distance from V_{min} to V_{max} in units of measurement

The standing-wave ratio, ρ , may be determined by the use of a high-frequency vacuum-tube voltmeter for *slotted lines* or a special type of field-strength indicator moved along the line.

It is to be noted that most instruments within this classification are square-law devices and therefore the square root must be extracted in order to express the s-w-r. Care must be exercised in the choice of a metering circuit so that its impedance is high in comparison with the line impedance across which measurements are being made. There are commercially available high-impedance, high-frequency probes that are quite suitable for measurements up to 100 mc, especially where Z_o is below 150 ohms. Crystal probes have been used with considerable success. However their characteristics change over quite wide limits with respect to impedance, front to back ratios, capacity, etc. For u-h-f (200 mc up), however, the crystal probe and the bolometer are the most satisfactory devices to be used.

The characteristic impedance may be determined from the geometric and dielectric considerations for a specific transmission line. (Since coaxial lines and two wire systems are the most common, general equations for their solution are offered in Figure 3a).

Either of the two systems may be used for measurements. In the case of coaxial lines the outer conductor must

(Continued on page 37)

DIRECTIONAL ANTENNA EQUIPMENT FOR AM THE NEW "ISO-COUPLER" FOR FM

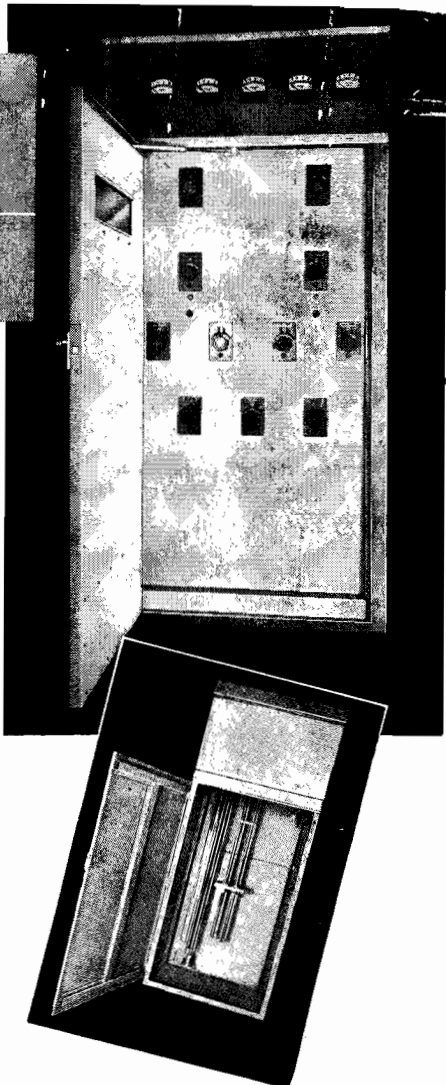

OTHER BROADCAST PRODUCTS

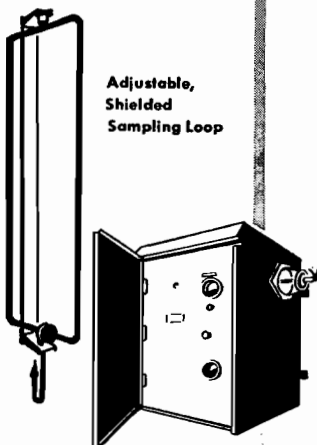

Adjustable,
Shielded
Sampling Loop

Coupling Unit

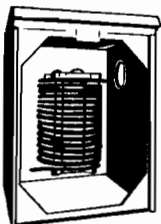

Isolation Filter



Tower Lighting Choke



Open Wire
Transmission
Line Support

Illustrated is a new phasing unit recently shipped to W G A C, Augusta, Georgia for use with their new 5 KW RCA transmitter. W G A C was the 60th station to choose JOHNSON for their directional system. This impressive total is growing at an accelerated clip—it's based on definite advantages. Your JOHNSON equipment will be more efficient because it is designed especially for your antenna system. Because it is not a "packaged" unit intended to solve everyone's problems there will be no unused components, nor will you have to add a few to meet your particular needs. JOHNSON-built cabinets will match the style and finish of your transmitter. Standardization is employed where it will not impair efficiency. For instance 90% of the major components are of standard design, and manufactured by JOHNSON. This permits an even flow of parts to your assembly job and careful control of their quality by JOHNSON engineers. No name of better reputation can appear on your phasing and antenna coupling units.

SAVE THE COST OF A SEPARATE FM TOWER!

If you are going to add FM to your existing AM facilities, quite likely you've looked at the price of a tower and wondered if the new antenna can go on top of an AM radiator. If the location is suitable and it's structurally possible, the answer is, it can and you'll never turn an easier several thousand dollars your way. The JOHNSON ISO-COUPLER announced in March of 1946 was the first commercial equipment offered to properly handle the two systems on one structure. It's designed for power up to and including 50 KW AM, and 10 KW FM. A heavy, weatherproof cabinet does away with the need of routine cleaning and uncertainties inherent in equipment exposed to the weather.

ONLY THE "ISO-COUPLER" OFFERS ALL OF THESE ADVANTAGES

1. Completely isolates AM and FM—no interaction possible.
2. Can be furnished with correcting network so that installation does not affect adjustment of present antenna coupling or directional equipment.
3. Easy to install and adjust.
4. Adjustments are efficient, broad, stable, and not affected by climatic changes.
5. Adjustments are possible at any time without disturbing coaxial lines.
6. Optimum impedance match possible for any FM frequency for 51.5 ohm line.
7. Standing wave ratio up to 2 caused by antenna can be eliminated between Iso-Coupler and transmitter.
8. Iso-Coupler can be used with any size and length of RMA standard FM line and any type of end terminal.
9. Coaxial line between Iso-Coupler and antenna can be fastened directly to AM tower, eliminating expensive line insulators and replacements.
10. Pressurizing maintenance independent of electrical adjustment.

The first ISO-COUPLER has already given many months of satisfactory service and we're in steady production.

Write to Department E for free Johnson literature today.



JOHNSON

a famous name in Radio

E. F. JOHNSON COMPANY • WASECA, MINNESOTA

COMMUNICATIONS FOR FEBRUARY 1947 • 35



FOR **SPECIAL TRANSFORMERS**

It is significant that, on the whole, difficult transformer jobs find their way to UTC. A few recent illustrations of accomplishment through engineering ingenuity are shown below.

This transformer was designed for laboratory apparatus requiring a frequency range previously unheard of . . . flat within 2 DB 2 cycles to 20,000 cycles, this unit handles 25 watts output.

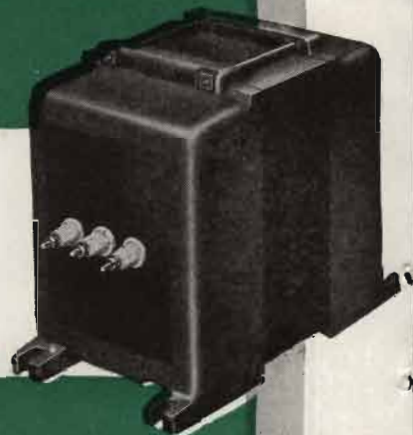

A manufacturer had the problem of changing his equipment from 400 cycle to 60 cycle power supply, but discovered that 60 cycle transformers are twice as large. UTC developed a unit, hermetically sealed, that fit his existing chassis, eliminating the need for a complete rebuilding of the equipment.

Narrow band filters are a common requirement for multiple channel tele-control purposes. To effect a maximum number of channels in the audio range, filters made by UTC employ toroid high Q coils of unique structure. A typical special filter with 1500 cycle pass band is down 40DB at 1400 and 1600 cycles.



Low power 115 volt appliances such as electric razors, fluorescent desk lamps, etc. are sometimes required to operate on 220 volts. For simplicity of installation in the application of one manufacturer, a 15 watt plug-in unit was developed incorporating both plug and receptacle.



The UTC engineering department is available for consultation on your design problem

United Transformer Corp.

150 VARICK STREET

NEW YORK 13, N. Y.

EXPORT DIVISION: 13 EAST 40th STREET, NEW YORK 16, N. Y.,

CABLES: "ARLAB"

TELEVISION ANTENNAS

(Continued from page 34)

be slotted for insertion of a probe. The slot width should be as small as possible so that the impedance will not be affected. The lines should be adjustable with respect to spacing in the open-wire line, and various sizes of inner conductors, for the coaxial line, to keep the ratio of Z_o/Z_r greater than 1 wherever possible, for better measurement accuracy.

The characteristic impedance of a transmission line may be measured in the megacycle region by use of a short-duration pulse generator (micro-second impulse) and a transient-response oscilloscope.³ The connections should be made as shown in Figure 5a. The negative trigger output is used to synchronize the 'scope driven sweep and also to supply the pulse to be observed. Negative trigger output is used so that a large pulse will merely cut off the first amplifier stage, and not drive the grid positive. As the pulse is fed to the transmission line at the vertical amplifier input terminal, and there is no external sending-end termination, the Y-axis amplifier input impedance is the sending and terminating impedance. R_L , the receiving end terminating impedance is selected so that the characteristic impedance of the transmission line is within its range.

In Figure 5b appears a photograph of the pattern produced when the receiving-end impedance is equal to the

(Continued on page 40)

³DuMont 248 c-r unit has been found satisfactory for supplying pulse, and measuring the incident and reflected waves.

Figures 5b (top), c (center) and d (bottom) The pattern obtained for $R_L = Z_o$ is shown in b. In c appears the pattern obtained for $R_L > Z_o$. The pattern obtained for $Z_o > R_L$ is shown in Figure 5d.

(E. A. Ossman, *Transmission Line Measurements*, DuMont Oscillographer; May-June 1945.)

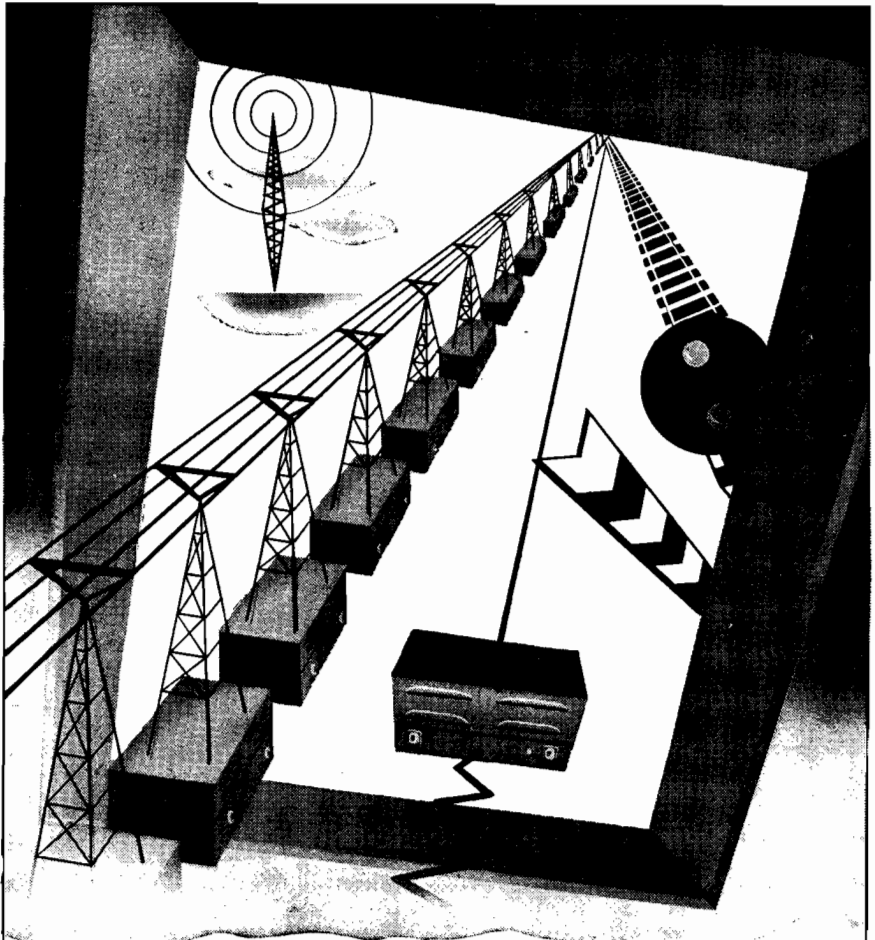
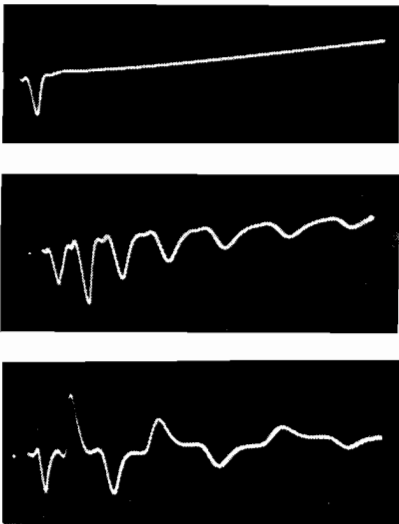

A MILLION MILES OF STRAIGHTENED VOLTAGES Without Moving a Muscle

Sorensen Voltage Regulators guarantee many miles of speed with safety by constantly and automatically stabilizing voltages that operate vital communications equipment on surface and air transportation lines.

Wire and radio contact systems depend upon quick, accurate response to even the smallest variation to attain peak performance. No moving parts in a voltage regulator means no time consuming adjustments, no wear and a minimum of maintenance.

These are just a few reasons why Sorensen Voltage Regulators are chosen as the perfect power guardian for the millions of miles of communications so essential to safe transportation.

Investigate the many advantages of Sorensen regulators applied to your unit. Write today for your copy of the new, complete Sorensen catalog M-C. It is filled with schematic drawings, performance curves, photos and contains in detail, "Principles of Operation."



SORENSEN & COMPANY, INC.
STAMFORD, CONNECTICUT

A LINE OF STANDARD REGULATORS FOR LOAD RANGES UP TO 30 KVA. SPECIAL UNITS DESIGNED TO FIT YOUR UNUSUAL APPLICATIONS.

For Better Jobs
 ...where SPACE is
 "AT A PREMIUM"



Hi-Q

CERAMIC CAPACITORS



C. N. TYPE



S. I. TYPE
Durez Coated

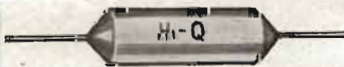

C. I. TYPE

Unusually high capacitance in relation to physical dimensions make Hi-Q ceramic capacitors the ideal components for use where space is extremely limited. Recognized stability insures dependable performance through years of service. Individually tested for accuracy of physical dimensions, temperature coefficient, power factor and dielectric strength. Available with axial leads (CI type); parallel leads (CN type); Durez coated (SI type). An experienced engineer will be glad to consult with you on your requirements.

OTHER Hi-Q COMPONENTS

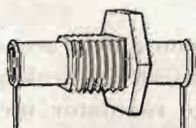

FEED THRU AND STAND-OFF CAPACITORS



WIRE WOUND RESISTORS



CHOKE COILS



ELECTRICAL REACTANCE
 CORPORATION
 FRANKLINVILLE, N. Y.

FREQUENCY STANDARD

(Continued from page 24)

versely affecting the operation of the receiver.

To fill this need there has been developed a small unit¹ which may be fitted into any receiver. It consists essentially of a 100-kc crystal oscillator in an aperiodic circuit. The unit is capable of slight frequency correction and may be easily adjusted so that one of the harmonics will zero beat with the U. S. Bureau of Standards transmitter WWV. When so adjusted, marker signals will be heard at frequencies precisely 100-kc apart throughout the tuning range of the receiver. The strength of these marker signals is increasingly lower as the higher frequencies are reached, but are still of satisfactory strength up to 40-mc and even higher.

Features of Unit

The device is enclosed in a drawn aluminum case 2" square and 1½" in height, with plug-in provisions at the top for tube and crystal.

Coupling is through a 25-mmf capacitor to the high-impedance plate circuit of the electron-coupled oscillator, and thus receiver sensitivity is not impaired by this connection to the antenna input circuit. It is not generally necessary to connect the oscillator lead to any but the high-frequency antenna coupling coil. Stray radiation and pickup will usually provide ample signal for all the low-frequency bands of the receiver.

The power required is approximately 1.25 milliamperes at 150 volts and .3 amperes at 6.3v when a 6AU6 is used. If power drain is of great importance, a 6AK5 tube may be used with equal satisfaction, and the power drain will then be reduced to approximately 0.75 milliampere at 150 volts and 0.175 ampere at 6.3 volts.

It is also possible to use a 6AG5 or a 6AK6 tube with this unit, and socket connections are arranged so that either of these types may be used if necessary.

The oscillator is silenced either by removing the crystal from its plug in socket or by opening the plate supply lead to the tube. For most commercial installations or any installation where the crystal oscillator is inaccessibly mounted, a switch on the front panel can be used to silence the oscillator.

Existing multi-position switches can be replaced with a switch having extra contacts to turn the oscillator on or off. For instance, in a receiver having a send-receive switch of the rotary type, the usual single pole two-

¹Model FS-35-C 100-kc Frequency Standard.

position switch could be replaced by a two pole three-position switch. The new switch would be arranged to have *transmit*, *receive*, and *calibrate* positions, with the *receive* and *calibrate* positions performing the functions of the original switch in the *receive* position. In the *calibrate* position, the plate supply circuit to the 100-kc oscillator would be closed by means of the corresponding contacts of the second pole.

It is also possible to use crystals of other frequencies in the unit. Crystals with frequencies up to 10 mc will operate satisfactorily in this circuit providing the holders are equipped with pins of the proper diameter and spacing. Some high frequency crystals, however, will not operate satisfactorily when the 6AK6 is used, but operate well with the other tubes mentioned.

The unit's ability to use other than 100-kc crystals suggest its use as a high-frequency oscillator in super-heterodyne receivers for fixed frequency operation, etc., and does permit some adjustment of the crystal frequency.

WTCN-FM 8-ELEMENT ANTENNA

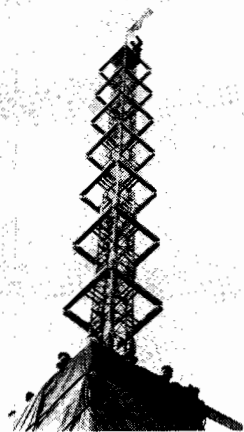

Above, 80' 8-element square-loop antenna, designed by FTR, recently installed by WTCN-FM in the 30-story Foshay Tower Building, Minneapolis. Below, workers placing fifth loop of f-m antenna in position just after section had been hoisted from basement 400' below. WTCN-FM operates on 97.1 mc and is at present using an FTR transmitter providing an effective radiated power in excess of 25 kw.

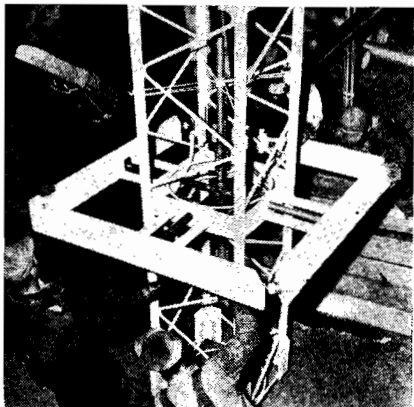

Andrew Co. begins its second decade of service to the industry



- Transmission lines for AM-FM-TV
- Directional antenna equipment
- Antenna tuning units
- Tower lighting equipment
- Consulting engineering service



WRITE FOR
COMPLETE CATALOG

ANDREW CO.

363 EAST 75th STREET • CHICAGO 19

*Pioneer Specialists
in the Manufacture
of a Complete Line of
Antenna Equipment*

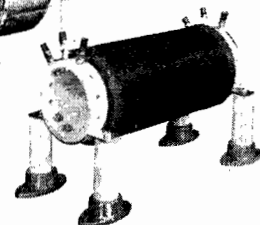
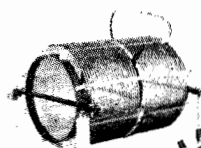
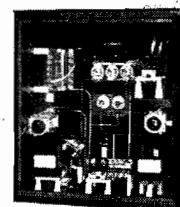
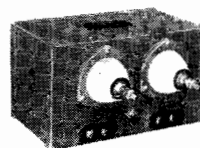
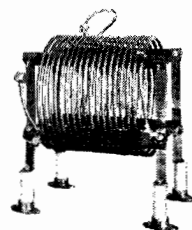
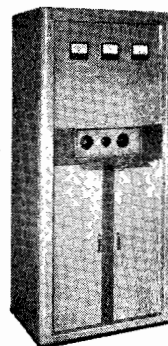
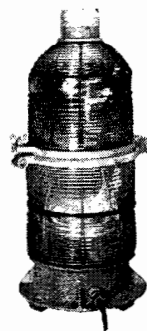
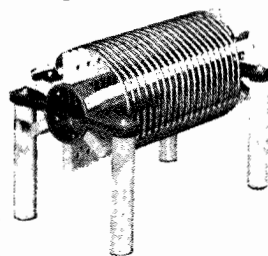
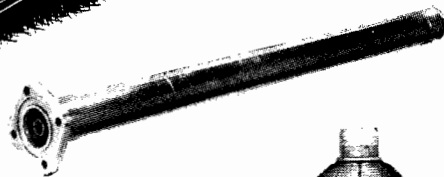
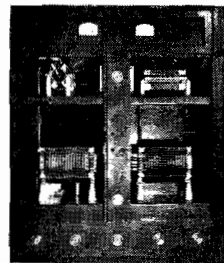

BURTON BROWNE ADVERTISING

Designed for



Application

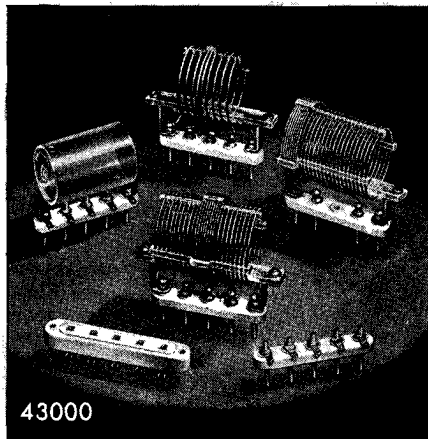

43000

**The No. 43000
AIR WOUND INDUCTORS
and ACCESSORIES**

Plug-in air wound inductors, coil forms, jack bars and sockets that have been "Designed for Application." The sockets are of the "straight line," type, facilitating symmetrical circuit arrangements and avoiding the undesirable bunching of leads, as when standard tube base socket-plug arrangements are used. Illustrated herewith are units from the small 75 watt or 43000 series. Two larger groups, the 44000 rated at 150 watts and the 42000 rated at 500 watts are also regularly available from your distributor of Millen radio products.

**JAMES MILLEN
MFG. CO., INC.**

MAIN OFFICE AND FACTORY
**MALDEN
MASSACHUSETTS**



TELEVISION ANTENNAS

(Continued from page 37)

characteristic impedance. It will be noted that only the original pulse is visible, since no reflections have taken place. To determine the unknown characteristic impedance of any transmission line it is merely necessary to connect the line, as shown in Figure 5a, and vary the receiving-end impedance until a pattern identical with Figure 5b is obtained. This adjustment is critical, since any slight variation from the characteristic impedance will produce a reflected pulse which will be visible on the oscillograph screen. Figures 5c and d illustrate patterns which result when the terminating impedance is not equal to the characteristic impedance. In the case of figure 5c, R_L is greater than Z_0 . In Figure 5d, Z_0 is greater than R_L . In both cases the terminating impedance at the sending end is the oscilloscope Y-axis amplifier input impedance, in parallel with the pulse-generator output impedance. The characteristic impedance of the line is approximately 50 ohms, making the sending-end impedance much larger than the characteristic impedance. It will be noted that the second pulse on both photographs is almost twice the amplitude of the first. This is a result of the terminating impedance at the sending end being much greater than the characteristic impedance.

[To Be Continued]

I R E PROGRAM

(Continued from page 19)

Thursday, March 6

4:00 P. M.
West Ballroom

Design of Gas-Filled Cold-Cathode Tubes; G. C. Rich, Sylvania Electric

Auditorium B

Electrical Measurements on Transmission Cavity Resonators at 3-cm.; M. S. Wheeler, Westinghouse

4:20 P. M.
Auditorium A

A New Type of Broad-Band Zero-Drag Aircraft Antenna; A. Dorne and J. Margolin, Airborne Instruments Lab.

4:30 P. M.
East Ballroom

Receiver Sensitivity at the Higher Frequencies; J. M. Pettit, Stanford University

West Ballroom

Recent Advances in High-Voltage Rectifiers for Television Receivers; G. Baker, Chatham Electronics

Auditorium B

Design of a Resonant Cavity for Frequency Reference in the 3-cm. Range; R. R. Reed, Westinghouse

4:45 P. M.
Auditorium A

Circularly Polarized Antennas; W. Sichak and S. Milazzo, Federal Telecommunication Labs.

**BOOKS
FOR THE
ENGINEER**

**UNDERSTANDING
MICROWAVES**

(Chapter Heads)

The Ultra High Frequency Concept Stationary Charge and its Field • Magnetostatics • Alternating Current and Lumped Constants • Transmission Lines Poynting's Vector and Maxwell's Equations • Waveguides • Resonant Cavities • Antennas • Microwave Oscillators • Radar and Communication • Section Two is devoted to descriptions of Microwave Terms, Ideas and Theorems. Index.

400 PAGES

PRICE \$6.00

**A-C CALCULATION
CHARTS**

Student engineers will find this book invaluable. Simplifies and speeds work. Covers all AC calculations from 10 cycles to 1000 megacycles.

160 PAGES

PRICE \$7.50

JOHN F. RIDER, Publisher, Inc.

404 FOURTH AVENUE, NEW YORK 16, N. Y.
EXPORT DIV. ROCKE-INTERNATIONAL ELEC. CORP.
13 E. 40TH STREET, NEW YORK CITY CABLE ARLAB

**HOPP Plastic
RADIO DIALS**

DIAL WINDOWS, NAME PLATES, GAUGES,
CALCULATORS, SCALES, CHARTS, ETC.

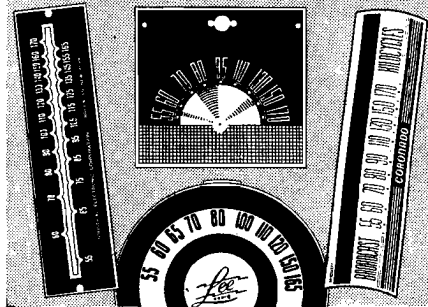

PLASTIC RADIO DIALS have endless possibilities in design, size, shape and color combination. Attractive and durable, our radio dials, windows and scales are preferred by many leading Radio manufacturers.

Not only for dials, but for numerous other electronic and electrical applications, Laminated Plastics are preferable.

Consult with our artists and engineers regarding applications for your particular purpose. Or send us your blue prints or samples for quotation.

THE HOPP PRESS, INC.
460 W. 34th STREET, NEW YORK 1, N. Y.
ESTABLISHED 1893

AT THE IRE CONVENTION

(Continued from page 22)

BROWNING LAB DD-20 CAPACITANCE RELAY

Unit permits changes in capacitance to control external devices or circuits. A panel meter indicates capacitance changes, from .01 mmfd, in addition to the relay operation. Relay operation can be obtained with changes of .05 mmfd or more. Sensitivity is variable to suit demands. Output provisions are made for supplying 115 volts a-c, closed circuit, or open circuit upon operation of relays. Self-contained power supply is regulated electronically for best stability and is designed to operate from 115-volt 60 cycle a-c source.

The unit is suitable for rack mounting and is supplied with 8 $\frac{3}{4}$ " rack panel and enclosing cabinet. Dimensions: 9" x 19" x 11".

Browning Laboratories, Inc., Winchester, Mass.

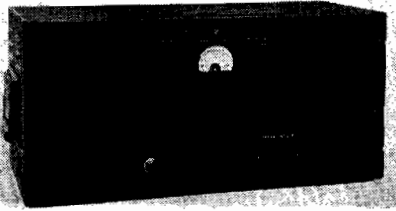

* * *

DeMORNAY-BUDD U-H-F COMPONENTS AND TEST EQUIPMENT

Component and test equipment for microwave transmission.

De Mornay-Budd, 475 Grand Concourse, N. Y. 51, N. Y.

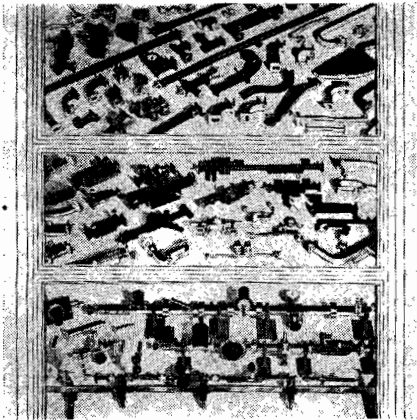

* * *

DuMONT 248-A OSCILLOGRAPH

Modification of 248 unit using a 5RP c-r tube. Improved model makes it possible to view and photograph high-speed transients and pulses, the rising or falling edges of which cannot be observed with normal equipment.

Allen B. DuMont Laboratories, Inc., Passaic, N. J.

NEW
TECH-LAB
DEVELOPMENT

For **RAPID**
MEASUREMENT
OF
AUDIO FREQUENCY
GAIN or LOSS

TYPE 1A TRANSMISSION MEASURING SET

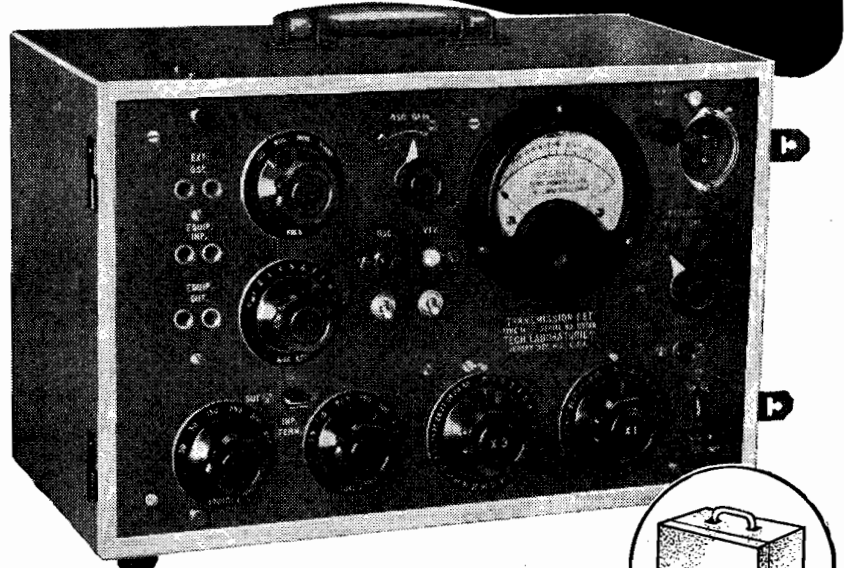

Completely Self-Contained

PORTABLE • AC OPERATED

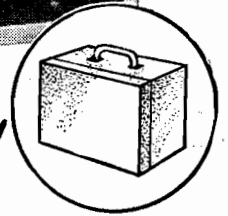

With this instrument it is possible to quickly and accurately analyze and service equipment in different locations without fuss in time consuming demounting and transportation of apparatus. It will thus pay for itself in a short time and no modern radio station can afford to be without it. It can also be used to good advantage in factory checking and inspection of audio equipment.

The set combines in a modern efficient manner an accurate vacuum tube voltmeter, an audio oscillator with four fixed frequencies and a precision attenuator all mounted in a handy cabinet easily carried by the operator.

SPECIFICATIONS

- GAIN: Up to 80 db.
- LOSS: 60 db. maximum.
- VACUUM TUBE VOLTMETER:
Range—40 to +40 db.
(1 mv. ref. level)
- AUDIO OSCILLATOR:
Freq. Range; 100 to
10,000.
- PRECISION ATTENUATOR:
Flat to 20 KC; 93 db.
in 1 db. steps.
- DIMENSIONS:
10 $\frac{1}{4}$ " x 16 $\frac{1}{4}$ " x 8 $\frac{3}{4}$ "
- WEIGHT: 30 lbs.
- INPUT: 115 Volts.
60 cycles, 70 watts.

TECH
LABORATORIES, INC.

Manufacturers of Precision Electrical Resistance Instruments
337 CENTRAL AVE. • JERSEY CITY 7, N. J.



**It's a
CLAROSTAT!**

That means a tough, dependable, longer-lasting composition-element potentiometer or control.

★

The exclusive Clarostat stabilized element has established brand new performance standards for composition-element controls. Extreme immunity to humidity, temperature, and other climatic conditions, as well as age.

★

Only 1 1/8" in dia. Body 9/16" deep or 7/8" with switch.

★

Rated at 1 watt. Resistance values of 500 ohms to 5 megohms. Choice of tapers and taps. With or without power switch. Choice of shafts.

★

Available in widest choice of standard values and listed in new No. 46 Catalog. Other values and types made to order. Write for literature.



CLAROSTAT MFG. CO., Inc. • 285-7 N. 6th St., Brooklyn, N. Y.

TRANSMITTER BUILDING

(Continued from page 11)

of sound disruption has worked to reduce sound transmission through this path to a negligible value.

Our studios do not feature one dead and one live end preferred by many engineers. However, this feature, while frequently desirable, is not always advantageous, and may under many conditions present very great problems. In larger installations, or in installations where a large number of live dramatic performances of a complicated production nature are envisaged, this dual quality is often convenient. However, the average small market station is in general in no position, from either a standpoint of talent or need, to enter into productions of this nature. For general-purpose use a studio of uniform quality, but not overly dead, has been found to be desirable. Such studios will produce a very natural quality in speaking voices, singers and small musical groups, and also prove quite satisfactory for choral singing. Dramatic work of high quality is possible, but certain qualities of voice or effects possible with the live-end studios are difficult to obtain without gimmicks. However, the need for such a studio is too slight to warrant

—MICO— ENGRAVER

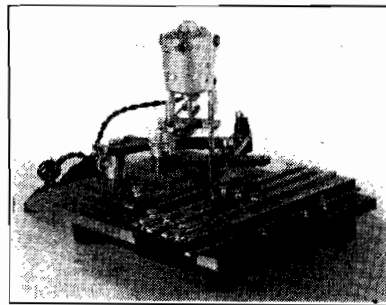

For lettering panels of steel, aluminum, brass, or bakelite, or for marking finished apparatus.

A sturdy machine for routine production as well as occasional engraving.

Attachments increase its versatility to include large work on flat or curved surfaces.

Excellent engraving can be produced by an inexperienced operator.

Prompt delivery. Catalogue on request.

Mico Instrument Co.
88 TROWBRIDGE STREET
CAMBRIDGE, MASS.



For dependable Antennas that will withstand corrosion and severe shocks, select the Premax

RADIO ANTENNA

*Standard for
Police, Fire
and All Mobile Units*

Solid steel "whip" types that can take abuse and still give perfect signals. Mountings that will meet every installation need.

Contact your radio jobber.

Premax Products

Division Chisholm-Ryder Co., Inc.

ELECTRONIC SUPPLIES PARTS—EQUIPMENT—BARGAINS

MASTER OSCILLATOR MI-19427-B

This unit was built for R.C.A. Add a final—becomes a complete transmitter with signal shifter. 2:20 mc—also FM—only a few cycles drift from cold start. Complete with regulated power supply and heavy duty deluxe rack. Illustrated flyer giving complete description, technical summary and specifications available upon request. Complete (less tubes)..... **\$225.00**

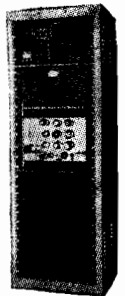

Thousands of "Hard-to-Get" parts, supplies and equipment at "rock-bottom" prices. Sensational clearance of complete stock of War Surplus Material.

Complete stock of tubes, transformers, test equipment, resistors, rectifiers, etc. All items for IMMEDIATE DELIVERY.

Mail convenient coupon below for your copy of Bargain Price List.

Niagara Radio Supply Corp.
160 Greenwich St.
New York City 6, N. Y.

Please send me illustrated folder on Master Oscillator and Price List C.

Name

Address

City

State

NIAGARA RADIO SUPPLY
160 Greenwich St., New York 6, N. Y.
Bowling Green 9-7993

4710 Highland Avenue, Niagara Falls, N. Y.

delay while seeking suitable material for such treatment. In our case it would have required a complete change in treatment, a treatment which was, incidentally, not available.

Control Room

The control room located between the two studios affords the control operator ample vision to either studio. The dimensions were set by the equipment chosen. The room 16' x 11' 4" x 8', opens into a maintenance shop 6' 8" x 10'; Figure 4. This contains sufficient space for tools, spare parts, and a workshop, and is extremely convenient.

The layout was planned carefully, with space allocated for possible expansion plans.

The turntable in-line arrangement, a departure from standard practice, has many virtues. It conserves space and it allows operator to always use the same hands and same procedure in starting transcriptions on either table. All record shows are handled from the small studio, so the turntable arrangement allows for constant visual contact, without neck strain, between operator and announcer. This consideration is important in placement of a control console to handle more than one studio.

The transmitter and monitor rack is located conveniently behind the console and close enough to allow meter readings to be made without the engineer rising to walk to the front of the transmitter.

An additional factor is the placement of the transcription libraries in the control room. This somewhat burdens the operator by forcing him to pull his own records. However, it has been found that it is very nearly as easy to pull records from the file as it is to pull them from a stack of records. Handling transcriptions directly also increases their life, since handling is minimized. Keeping the libraries in the control room has another great advantage in that it reduces control-room traffic, a distraction to the operator.

Observation Windows

The observation windows have, for reasons of sound reflection previously discussed, been kept as small as possible, commensurate with adequate vision and efficiency. The small studio window, 32" x 52", was placed about 38" above the floor. Because the engineer is placed more closely to this window, it is possible to keep its size quite small. The large studio glass, 32" x 68", was also placed 38" above the floor. This provides adequate vision of the vital portions of the studio,

(Continued on page 51)



VARIABLE ATTENUATORS

Quality-proved on the world's most exacting applications

Now . . . the foremost Attenuator line . . . Variaten . . . is being engineered and put into production by a national leader in precision electronic equipment . . . SHALLCROSS.

To a line already popular with broadcast, communication, recording and movie-sound equipment studios, has been added the complete facilities of this leading producer of fine electrical measuring instruments, selector switches and precision wire-wound resistors.

SHALLCROSS VARIATEN ATTENUATORS employ wire-wound resistors. Stone-lapped brush and contact surfaces assure complete overall contact for minimum noise level and lengthened service life. Types include ladder mixers, bridged and straight "T" attenuators, bridged and straight "H" attenuators, grid control potentiometers, loud speaker volume controls, turn-table faders, D.B. and V.U. meter range-extendors, and fixed pads for every purpose. Special designs available to specifications.

Shallcross Manufacturing Co.

DEPT. C-27, COLLINGDALE, PA.

Laboratory Standards

By
MEASUREMENTS CORPORATION

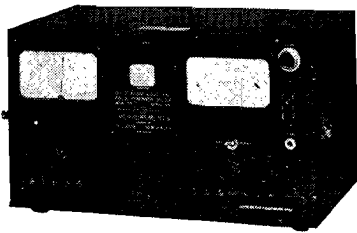

U. H. F. RADIO NOISE and FIELD STRENGTH METER
Model 58

FREQUENCY RANGE: 15 to 150 mc. Push-button switching for rapid, accurate measurement of noise levels or field strength.

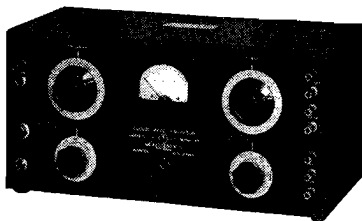

SQUARE WAVE GENERATOR Model 71

FREQUENCY RANGE: 5 to 100,000 cycles.
WAVE SHAPE: Rise time less than 0.2 microseconds.
OUTPUT VOLTAGE: 75, 50, 25, 15, 10, 5 peak volts fixed; 0-2.5 volts continuously variable.

- MANUFACTURERS OF
- Standard Signal Generators
 - Pulse Generators
 - FM Signal Generators
 - Square Wave Generators
 - Vacuum Tube Voltmeters
 - UHF Radio Noise & Field Strength Meters
 - Capacity Bridges
 - Megohm Meters
 - Phase Sequence Indicators
 - Television and FM Test Equipment

Catalog on request

MEASUREMENTS CORPORATION
BOONTON NEW JERSEY



F-M/TELEVISION RECEIVERS

(Continued from page 15)

tube acts as the local oscillator and the mixer (6SA7); the term mixer where two tubes are used, one as the mixer (6SG7), and one as the local oscillator (6C4).

After the equivalent noise resistance is known the value of rms noise voltage at the grid of this tube can be calculated by applying the same expression that is used for thermal agitation noise,

$$e_n^2 = 1.6 \times 10^{-20} \Delta F R \quad (2)$$

or by using the graph of Figure 2.

Figure 4 presents calculated equivalent noise resistance values for a number of commonly used tubes acting as various types of circuit elements. These are, of course, approximate figures.

It can be seen from Figures 3 and 4 that the noise resistance or voltage is at a minimum for a triode, increasing for the pentode and the multigrid tube, following in that order.

Shot noise is unique among the noise sources in the sense that the shot-noise voltage should be considered to exist in series with the grid inside the tube. The reason for this is that nothing can be done to the external grid circuit that will alter the magnitude of this component. Even though the shot noise must be tolerated, its effect can be minimized by designing the input circuit for maximum signal at the grid. This does not reduce the magnitude of the noise but does improve the signal-to-noise ratio of the receiver.

Induced Grid Noise

Also present in the receiving tube is a third source of noise which is generated internally in the tube but whose magnitude and effect are determined partially by the external input circuit. Known as *induced grid noise*, this minute current is induced in the grid wires of the tube by random fluctuations in the plate current. It is known that a varying electron beam will induce a current in any nearby conductor. Therefore, the fluctuating plate current which is in a sense a varying electron beam, will induce a noise current in the nearby grid conductors.

The input impedance of a vacuum tube has a reactive and a resistive component. At relatively low frequencies the resistive component is very high (below about 30 mc); as the frequency is increased the resistive com-

JONES 300 SERIES PLUGS and SOCKETS

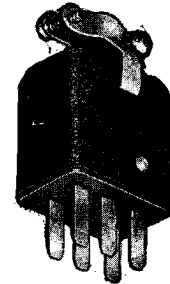

P-306-CCT

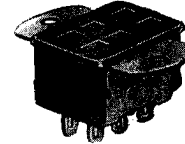

S-306-AB

A high quality line of small Plugs and Sockets adaptable to a thousand uses.

All Plugs and Sockets are Polarized. "Knife-switch" Socket contacts are of phosphor bronze, cadmium plated. Bar type Plug contacts are of brass, silver plated.

Insulation is of BM 120 molded Bakelite. Caps are of metal with formed fibre linings. Made in 2 to 33 contacts. Although designed for 45 volts at 5 amperes, these Plugs and Sockets can be used at higher ratings where circuit characteristics permit. 2 contact round, others rectangular. For additional information write today for catalog No. 14 showing complete line of Electrical Connecting Devices.

HOWARD B. JONES DIVISION
CINCH MFG. CORP.
2460 W. GEORGE ST. CHICAGO 18

JOBBER! QUANTITY BUYERS!
SAVE MONEY

with MID-AMERICA'S Sensational Values!

FREE MONTHLY BULLETINS

- RELAYS
- CONDENSERS
- TRANSFORMERS
- METERS • SWITCHES

Here's proof of the BIG BARGAINS in radio parts and electronic equipment MID-AMERICA offers EVERY MONTH to qualified quantity buyers through special bulletins and flyers. Check the outstanding buys listed here against what you've been paying—then get MID-AMERICA'S FREE CATALOG and the MONTHLY BARGAIN BULLETINS!

- 5" Dynamic Speaker, 450 ohm field, hum bucking coil, double shielded 50L6 transformer (lots of 20) \$2.95 ea. ELECTROLYTIC CONDENSERS with strap: 50/30 mfd—150 VDCW (lots of 100) 59c ea. 20 mfd—150 VDCW (lots of 100) 39c ea. 16 mfd—500 VDCW 1" Dia. Mallory FP (lots of 100) 79c ea.
- ALUMINUM CONDENSER: 4 mfd—600 VDCW oil filled paper, 4 1/2" high x 1 1/2" dia., equiv. to 8 mfd—600 VDCW electrolytic; (lots of 100) 79c ea.
- DPT ROTARY RADIO-PHONO or BAND SWITCH, 3/8" shank 1 1/2" shaft (lots of 100) 36c ea.
- ALLIANCE PHONO MOTOR, rim drive with 9" turntable (lots of 6) \$3.75 ea.
- ASTATIC HIGH FIDELITY PHONO PICKUP with Astatic L-72-A xtal (lots of 25) \$1.95 ea.
- 50L6 GT TUBES, std. brands (lots of 500) 70c ea.

For LOWER PRICES on LARGER QUANTITIES than those listed here write, wire MID-AMERICA'S store address, Dept. R-27.

MID-AMERICA CO. Inc.

STORE: 2412 S. MICHIGAN AVE. CHICAGO 16, ILL.
WAREHOUSE: 2307 S. ARCHER AVE. CHICAGO 16, ILL.

ponent decreases and its magnitude eventually becomes comparable to or even lower than the external grid circuit impedance. The resistive component is composed of two parts, the portion due to transit time effect, and the portion due to the inductance of the cathode lead.

An expression for induced-grid noise² for tubes with control grid adjacent to the cathode follows:

$$\bar{i}_{1,g.}^2 = 1.4 \times 4K T_k \Delta F g_{elect}$$

or when expressed in the form of a voltage generator,

$$\bar{e}_{1,g.}^2 = 1.4 \times 4K T_k \Delta F R_{elect} \quad (6)$$

where: T_k = cathode temperature (degrees Kelvin)

g_{elect} = electronic (transit time) component of input conductance

R_{elect} = electronic component of input resistance

From equation (6) it can be seen that the induced grid noise is proportional to the electronic or transit time component of the input resistance. Measurement of the total input resistance is a comparatively simple matter with the use of a high frequency Q meter, but the separation of the electronic and the cathode inductance components, which are essentially two resistances in parallel between the grid and ground, is a very difficult matter. Since most high-frequency tubes are constructed with either two cathode leads or one very short lead, assuming the total measured input resistance to be electronic would not introduce too great an error. Another factor in favor of this approximation is that it would be the case for maximum induced grid noise and any error introduced would more than likely be on the safe side.

Cathode temperature in most receiving tubes, which almost exclusively use oxide-coated cathodes, is approximately five times the normal room temperature in degrees K. Equation (6) can be rewritten therefore as

$$\bar{e}_{1,g.}^2 = 5 \times 4K T \Delta F R_{elect} \quad (7)$$

where: T = room temperature (degrees Kelvin), or when $T = 300$ degrees Kelvin

$$\bar{e}_{1,g.}^2 = 8 \times 10^{-20} \Delta F R_{elect} \quad (8)$$

In circuit calculations this noise is essentially in series with a resistance

(Continued on page 46)

²D. O. North, *Fluctuations Induced in Vacuum-Tube Grids at High Frequencies*, Proc. IRE; Feb. 1941.

Dependable MICROPHONE PLUGS by CANNON ELECTRIC



Judy Canova, radio star, broadcasting over NBC in Hollywood, with Hal Gerard and Joe Kearns. RCA microphone is equipped with Types "O" or "P". ALL RADIO NETWORKS USE CANNON MICROPHONE PLUGS.

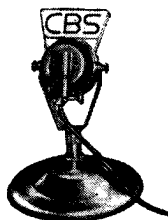

Left: Type "O3-42" Receptacle and "O3-11" Plug on Western Electric table type mike used by Columbia Broadcasting Co. Center and Right: Other large network mikes use type "O" for cable extension. The latchlock device prevents accidental disconnection resulting from jerks or strain on cord.

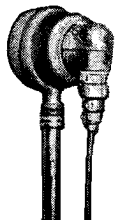

Left: Microphone with "P-42" Receptacle and P-CG-11 Plug used for platform public address. (Photo courtesy Reiss P. A. Systems, Detroit). Right: Mike used by CBS-Hollywood, with P-CG-12 plug shown in hand. As in the case of the above Type "O", two mating "P" plugs can be used conveniently for cable extension where receptacle is not an integral part of the microphone itself.

The New lightweight Type "XL" is standard equipment on the equally new RCA "Announce" Microphone which has a unique construction in the stem, allowing the plug to swing into the stem with a cover. Relief spring on XL-3-11 plug protects cord from sharp bends. Adapters are available to users of microphones such as the Turner (second to right) for those desiring to convert to Cannon "XL" Plugs.

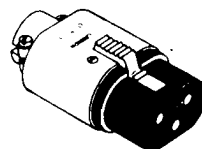
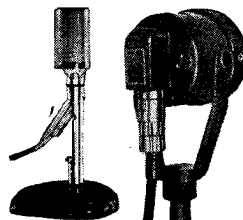

TYPE "O"

Two plugs and six receptacle styles available in this series. One oval insert arrangement with three 30-amp. contacts for No. 10 B&S stranded wire.

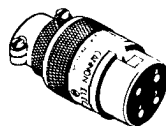

TYPE "P"

Five plugs and nine standard receptacle styles available in six insert arrangements; two to six 30-amp. contacts, one eight 15-amps. for No. 14 B&S stranded wire.

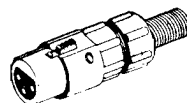

TYPE "XL"

Two small plugs and four receptacles with zinc shells carry three 15-amp. contacts for No. 14 B&S stranded wire. Equipped with compression gland and relief spring.

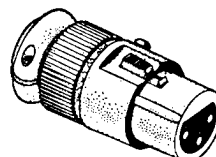

TYPE "XL"

Two steel shell XL plugs for rough, heavy-duty usage. Same insert arrangement as above. Integral clamp construction and leading XL features.

Write Dept. B-121 for C-46A Condensed Catalog, describing all above connectors and list prices. Available from jobbers everywhere.



CANNON ELECTRIC DEVELOPMENT COMPANY

3209 Humboldt Street, Los Angeles 31, California

Canada & British Empire — Cannon Electric Co., Ltd., Toronto, Ontario • World Export Agents (excepting British Empire) Frazer & Hansen, 301 Clay St., San Francisco 11, Calif.

E. H. Rietzke, President of CREI, invites You to Write for this

Free

Significant Analysis of Job Opportunities in Radio Electronics

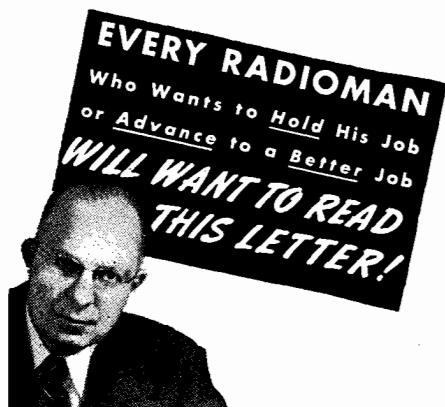

The Story Behind This Interesting Letter You Will Want to Read . . .

Our advertising agents, realizing that vital changes are taking place in the radio industry, asked me to give them a factual report of the unprecedented job opportunities created by the almost unbelievable expansion of the radio industry.

My letter to them contains some pertinent viewpoints on the subjects of COMPETITION — INDUSTRY EXPANSION — OPPORTUNITIES. These are first-hand observations based on my own experiences . . . a great deal of time spent in the field and constant contact with leaders in the radio industry.

The immediate reaction of our agency upon reading this letter was that it contained so much inspiration and information that it should be reproduced for thousands of radiomen to read. Therefore, this unusual advertisement to invite you to send for, and read, this letter.

It is doubtful if many radiomen realize the actual things that are happening. That is why I think you will want to read this letter. You are invited to send for your personal copy today.

E. H. Rietzke
President, CREI

CAPITOL RADIO ENGINEERING INSTITUTE
Washington 10, D. C.

MAIL COUPON FOR FREE COPY. NO OBLIGATION

Capitol Radio Engineering Institute
16th and Park Road, N. W., Dept. CO-2
Washington 10, D. C.

Gentlemen: Please send me FREE, Mr. E. H. Rietzke's Analysis of Job Opportunities in Radio-Electronics.

NAME

POSITION..... AGE.....

ADDRESS

CITY..... ZONE..... STATE.....

(Continued from page 45)

equal to R_{ref} located between the grid and ground; Figure 5.

The approximate input resistance for a number of common receiving tubes in the frequency range of f-m and television is given in Figure 6. This chart can be used to find approximate input resistance values for induced grid-noise calculations.

Total Noise Calculations

Calculations of total input noise are made by using the grid of the input tube as a reference point. There are many sources of noise and each must be calculated and referred to the grid reference point before a summation is made. Since noise is a random effect and calculated on a power basis, the separate components cannot be added directly but as the square root of the sum of the squares.

$$\text{Total Noise} = \sqrt{e_1^2 + e_2^2 + e_3^2 + \text{etc.}} \quad (9)$$

The various noise voltages that must be referred to the first grid are:

- (1) Thermal agitation noise of the antenna radiation resistance.
- (2) Thermal agitation noise of the tuned grid circuit.
- (3) Shot noise of the input tube.
- (4) Induced grid noise of the input tube.
- (5) Grid circuit noise of the following stages referred back to the first grid.

In Figure 7 (a) appears a diagram of a practical input circuit and the location of all the circuit parameters and noise voltages. Figure 7 (b) is essentially the same except that the antenna circuit is reflected through the transformer and considered to exist at the grid. This is the diagram that is most useful in calculating the total input circuit noise.

The steps necessary to find specific values for each of these factors are shown in Figure 8. Antenna radia-

(Continued on page 48)

Figure 8
Procedure for calculating various noise voltages.

(1) R_{ant} - Depends upon specific antenna

(2) $e_{\text{ant}} = \sqrt{1.6 \times 10^{-20} R_{\text{ant}} \Delta f}$ - or directly from Fig. 2

(3) $R_{\text{ckt}} = Q \omega L = \frac{Q}{\omega C}$

(4) $e_{\text{ckt}} = \sqrt{1.6 \times 10^{-20} R_{\text{ckt}} \Delta f}$ - or directly from Fig. 2

(5) R_{ref} - From accompanying chart, Fig. 6

(6) $e_{\text{ig}} = \sqrt{8 \times 10^{-20} R_{\text{ref}} \Delta f}$

(7) R_{eq} - From accompanying chart, Fig. 4

(8) $e_{\text{tot}} = \sqrt{1.6 \times 10^{-20} \Delta f R_{\text{eq}}}$ - or directly from Fig. 2

Just Out!

CONCORD
Bargain Catalog of
RADIO
Equipment
FOR
Immediate Shipment

CONCORD'S Outstanding 1947 RADIO VALUES

RADIO PARTS - SETS TESTERS

SPECIAL VALUES HAM GEAR AMPLIFIERS

FREE! MAIL COUPON BELOW!

RECORD CHANGERS PLAYERS

THOUSANDS OF ITEMS! OUTSTANDING VALUES!

Just off the press—48 exciting pages of radio parts, equipment, and supplies for dealers, servicemen, amateurs, maintenance, testing, building and experimenting—Thousands of items NOW **IN STOCK** and ready for **IMMEDIATE SHIPMENT!** Big feature sections of Radio Sets, Communications Receivers, Amplifiers, Replacement Parts, Ham Gear, Record Players and Portables, Record Changers and complete Sound Systems. Page after page of bargains in top-quality standard-make radio parts and electronic equipment.

Mail Coupon NOW for FREE COPY

Mail coupon below **TODAY** for your **FREE COPY** of this latest Concord Buying Guide and Bargain Catalog of Radio needs you can order for **SAME DAY SHIPMENT** from complete stocks in Chicago and Atlanta.

CONCORD

RADIO CORPORATION
LAFAYETTE RADIO CORPORATION
CHICAGO 7, ILL. ATLANTA 3, GA.
901 W. Jackson Blvd. 265 Peachtree St.

CONCORD RADIO CORP., Dept. R-27
901 W. Jackson Blvd., Chicago 7, Ill.
Yes, rush FREE COPY of the new Concord Bargain Catalog.

Name.....

Address.....

City..... State.....

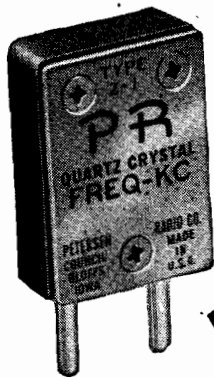

... For Dependable Commercial Service

Designed for the rigors of commercial service in all types of radio communication . . . broadcast, mobile, aircraft, police. Precision made for utmost in stability, dependability, trouble-free operation. Calibrated within .005 per cent of specified frequency . . . range 1.5 to 10.5 MC. Temp. coefficient less than 2 cycles per megacycle per degree centigrade. Weighs less than 3/4 ounce. Gasket sealed against contamination and moisture. Meets FCC requirements for all above services. See your jobber—Petersen Radio Company, Inc., 2800 W. Broadway, Council Bluffs, Iowa. (Telephone 2760.)



PR Precision CRYSTALS

WILLARD 2 VOLT

COMPACT RECHARGEABLE Spill-Proof STORAGE BATTERY

In an attractive Clear Plastic Case. Only 2 3/4" square and 6" overall height. About the size of the ordinary #6 Dry Cell. Rating 24 AH. Gangs nicely for other voltages in multiples of 2 volts. Ideal for many applications.

Shipped dry with electrolyte for each in separate container. (Cannot be shipped Parcel Post.)

CLOSE OUT PRICE While Our Stock Lasts. Every One BRAND NEW!

Stock No. 5A133, ONLY **\$2.95**

In Case Lots of 42. Each **\$2.50**

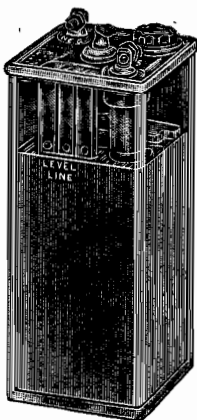

BURSTEIN-APPLEBEE CO.

1012-14 McGee, Kansas City 6, Mo.

WHEN YOU CHANGE YOUR ADDRESS

Be sure to notify the Subscription Department of COMMUNICATIONS, 52 Vanderbilt Avenue, New York 17, N. Y., giving the old as well as the new address, and do this at least four weeks in advance. The Post Office Department does not forward magazines unless you pay additional postage, and we cannot duplicate copies mailed to the old address. We ask your cooperation.

Electronic Research & Mfg. Corp.

A Service to INDUSTRY

Development and Construction of

Electronic Equipment for Any Application

1420 E. 25th St., Cleveland 14, O. - Ph.: SU. 1958

COMMUNICATIONS

NET PAID CIRCULATION IS NOW OVER

10,500 ABC

A vertical circulation of quality that combines specific reader interest with tremendous buying power.

Advertising in **COMMUNICATIONS** Pays Dividends

it revolves . . .
it's revolutionary

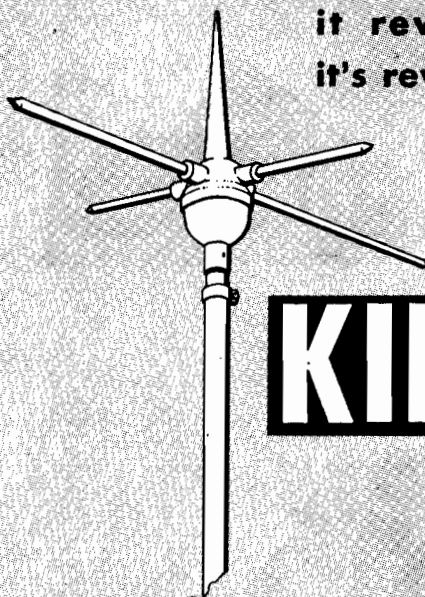

KINGS

roto beam antenna

FOR FM AND TELEVISION RECEPTION

A flip of the switch at the set

- ROTATES THE ANTENNA ARMS • TAPS THE PEAK OF THE TELEVISION AND FM CARRIER WAVES • ELIMINATES "GHOSTS" • BOOSTS WEAK STATIONS.

Be the first to feature this rotating, tunable, remote-controlled antenna. Now, at last, you can offer your FM and Video fans an antenna that can be tuned into the wanted station with a flip of the switch . . . at the set.

It's as simple as focussing a camera, yet it's efficiency PLUS. The **KINGS ROTO BEAM ANTENNA** eliminates "ghosts," boosts weak stations, and gives sharp, clear, unblurred reception.

There are plenty of other reasons why your customers will welcome this revolutionary antenna, so write today for the descriptive folder.

KINGS ROTO BEAM ANTENNA

List Price

\$115.

Matching transmission lines available.

Licensed under Farnsworth patents.



KINGS ELECTRONICS

372 CLASSON AVENUE, BROOKLYN 5, N. Y.

manufacturers of

- FM, TELEVISION AND HAM ANTENNAS • VARIABLE CONDENSERS • MICROPHONE PLUGS AND JACKS • CO-AXIAL CONNECTORS • WAVE GUIDES • WAVE TRAPS • RADAR ASSEMBLIES • SPECIAL ELECTRONIC EQUIPMENT

NEW!

ELECTRONIC DEVELOPMENT 5" OSCILLOSCOPE



For PRECISION OBSERVATION of Radio, Sound, Television and other Electronic Phenomena...

This new 5" Cathode Ray Oscilloscope is a precision instrument at an attractively low price, designed for practical application in laboratory research and production work. Sturdily built to stand up under continuous use, and ably engineered for accuracy, versatility and easy operation. Has wide frequency range, 10 cycles to 300 Kc. Deflection sensitivity, 1 volt RMS per inch. Sweep range, 10 cycles to 60 Kc. in four steps. For 110-120 volt, 50-60 cycle operation. In welded steel cabinet, with baked black wrinkle-finish; 8½" wide, 14½" high, 18½" deep. Instrument panel in black, with white designations; has removable calibrated plastic scale. Complete with tubes. No. 84-376. Net Only. \$99.50

STOCK NO. 84-376 ONLY **\$99.50**

Order from the Central Source for Everything in Radio and Electronics

ALLIED RADIO CORP.

833 W. Jackson Blvd., Dept. 31-B-7, Chicago 7, Illinois

Send for **ALLIED**

Catalog No. 111

SPECIALIZED

Skill in

METAL

PANELS · CHASSIS · RACKS
with Beautiful Chrome Trim

CABINETS

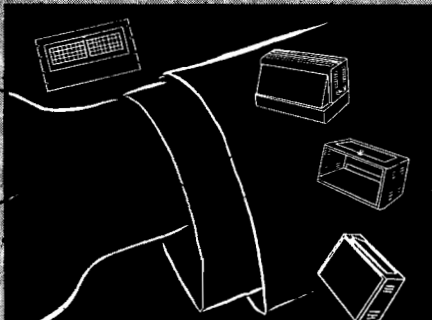
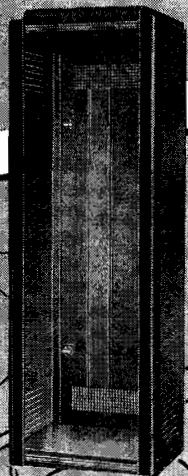

The time-tested Par-Metal line presents superior features of styling, design, and construction. True to policy, Par-Metal continues to specialize in Electronic Housings exclusively... and is therefore able to offer leadership in value. Compare! Write for Catalogue.

PAR-METAL PRODUCTS CORPORATION
32-62 - 49th STREET
LONG ISLAND CITY 3, NEW YORK
Export Dept.: Rocke International Corp.
13 East 40 Street, New York 16

(Continued from page 46)

tion resistance varies widely with the type of antenna chosen, but for f-m and television work it is generally in the order of 75 to 300 ohms. When the noise is known in terms of an equivalent resistance, as is the case here for the antenna, tuned circuit, and shot noise, the equivalent voltage can be either calculated or obtained directly from Figure 2.

In order to add the antenna, tuned circuit, and induced grid noise to the shot noise the effective voltage of these three components at the grid, or between the points *A* and *B*, must be known. Each must go through what is essentially a resistive divider and may be calculated as shown in Figure 9.

After knowing the magnitude of the separate sources that exist between *A-B*, the total noise voltage is

$$e_{total} = \sqrt{e_{shot}^2 + (e_{ant. at A-B})^2 + (e_{i-g, at A-B})^2 + (e_{ek, at A-B})^2} \quad (19)$$

One other factor may effect this total, however. If the total noise of the following stages, which is calculated similarly, ignoring the antenna of course, is appreciable it must be added to the constants of Figure 9. In

Figure 9

Circuit for reflecting various voltages to the grid.

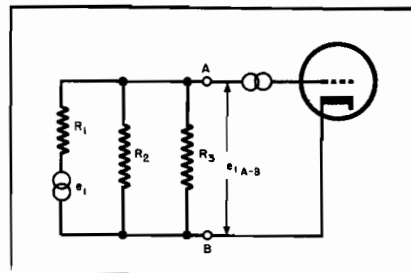

To find the effective voltage of the antenna, the tuned circuit, and the induced grid noise at the grid of the tube let R_1 equal one of the above noise resistances and e_1 its generated voltage. If R_2 and R_3 equal the other two noise resistances the effective voltage at the grid is

$$e_{A-B} = \frac{e_1}{R_1 + \frac{R_2 R_3}{R_2 + R_3}} \times \frac{R_2 R_3}{R_2 + R_3}$$

This calculation must be performed for the three components in turn.

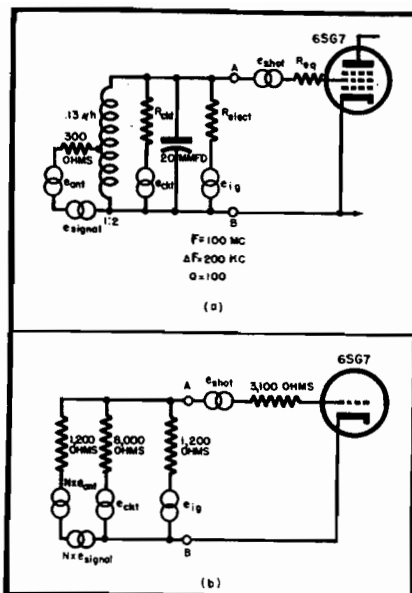

Figure 10
Typical f-m receiver input circuit.

reflecting it to the first grid the second stage noise should be divided by the gain of the first tube. When the gain is about ten or more this factor may usually be neglected.

Effective signal voltage across $A-B$ is calculated in the same way as the antenna noise in Figure 9. The signal-to-noise ratio is now also known.

Since the signal-to-noise ratio is determined by the signal strength and the total noise at the grid of the input tube, for a receiver that has a mixer, such as 6SK7, for the input tube, the signal-to-noise ratio may be considerably improved by the addition of an r-f tube, such as a 6SG7, which has considerably less total noise. By adding additional r-f tubes (6SG7s), however, since the total noise and signal at the grid will be the same, the signal-to-noise ratio will not be improved.

Sample Circuit Calculations

For a sample problem let us calculate the total noise at the grid of an f-m receiver r-f amplifier stage, assuming the circuit in Figure 10(a) to be under consideration.

As a simplification of procedure the steps in the calculation will be numbered.

- (1) $N^2 R_{ant} = 1200$ ohms (calculated)
- (2) $R_{elect} = 1200$ ohms (Figure 6)
- (3) $R_{ckt} = Q \omega L = 8000$ ohms (calculated)
- (4) $R_{eq} = 3100$ ohms (Figure 4)

At this point it will be convenient to redraw the circuit as shown in Figure 10(b).

- (5) $N e_{ant} = 2$ microvolts (Figure 2)

A MILLION Relays!

**Relays to Meet
Practically Any
Requirement**
— AT GREAT SAVINGS IN COST —

Our huge inventory of relays is, we believe, the largest and most complete in the country. These relays were made to exacting standards by America's leading manufacturers and are guaranteed in every respect. This equipment will meet your critical quality requirements and save you a large portion of the cost. Our new illustrated Relay Catalog is now ready and will be mailed upon request.

Consult Wells for Quality Radio Parts

We can make immediate delivery of a wide variety of radio components either singly or in quantity. Lists are available on the following items: Volume controls, condensers, resistors, phone jacks and plugs, wafer switches, Micro switches, transmitting tubes and Jones strips.

Army Walkie Talkies!

Here's a complete portable station for 28 to 52 Mc. operation. May be easily modified for 2 1/2 meter use. Crystal calibrator. Shipped complete with tubes, handset, telescope antenna and new battery — ready to operate — only \$45.00 edch.

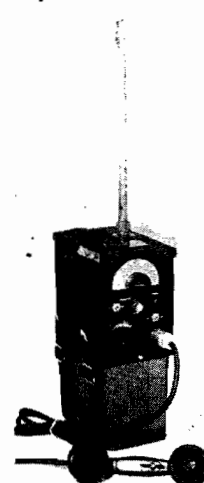

Extra batteries (80 hours continuous service) \$4.75 each.



Look for the Wells Display
At Your Jobbers

511 W. MADISON ST., DEPT M-2, CHICAGO 44, ILL.

$$(6) e_{i.g.} = \sqrt{\frac{8 \times 10^{-20} \times 200 \times 10^3}{\times 1200}} = 5 \text{ microvolts} \quad (\text{equation } (8))$$

- (7) $e_{ckt} = 6$ microvolts (Figure 2)
- (8) $e_{shot} = 3.5$ microvolts (Figure 2)

The next step is to find the effective voltage of each source between the grid and ground (or $A-B$) as shown in Figure 9.

$$(9) e_{ant} A-B = \frac{2}{1200 + 1040} \times 1040 = 0.93 \text{ microvolt}$$

$$(10) e_{i.g.} A-B = \frac{5}{1200 + 1040} \times 1040 = 2.3 \text{ microvolts}$$

$$(11) e_{ckt} A-B = \frac{6}{8000 + 600} \times 600 = 2.5 \text{ microvolts}$$

And the total noise is therefore

$$(12) e_{total} = \sqrt{3.5^2 + 0.93^2 + 2.3^2 + 2.5^2} = 4.9 \text{ microvolts} \quad (\text{equation } (10))$$

Conclusions

Selection of an input tube for a television or f-m receiver is dependent

(Continued on page 51)

Laboratory Standards

FM

MODEL 78
SIGNAL GENERATOR

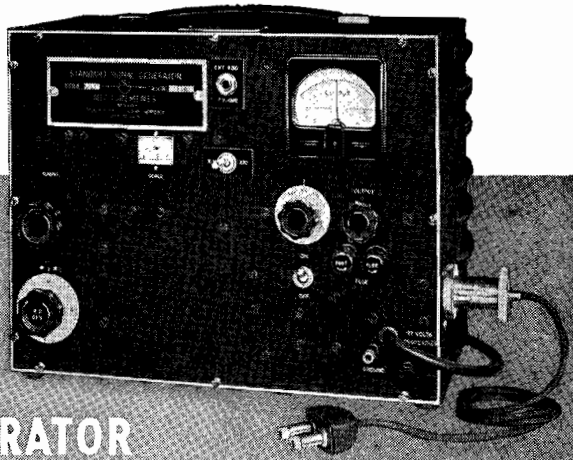

SPECIFICATIONS:

- CARRIER FREQUENCY RANGE:** 86 to 108 megacycles. Individually calibrated dial.
- OUTPUT SYSTEM:** 1 to 100,000 microvolts with negligible carrier leakage.
- OUTPUT IMPEDANCE:** Constant at 17 ohms.
- MODULATION:** 400 cycle internal audio oscillator. Deviation directly calibrated in two ranges: 0 to 30 kc. and 0 to 300 kc. Can be modulated from external audio source. Audio fidelity is flat within two db from d.c. to 15,000 cycles. Distortion is less than 1% at 75 kc. deviation.

PROMPT DELIVERY

MANUFACTURERS OF
Standard Signal Generators
Pulse Generators
FM Signal Generators
Square Wave Generators
Vacuum Tube Voltmeters
UHF Radio Noise & Field Strength Meters
Capacity Bridges
Megohm Meters
Phase Sequence Indicators
Television and FM Test Equipment

MEASUREMENTS CORPORATION
BOONTON NEW JERSEY

NEWS BRIEFS

MARX APPOINTED CHAIRMAN OF TBA AFFILIATES

Ernest A. Marx who heads the Du Mont television receiver division with headquarters at 515 Madison Ave., New York, has been appointed chairman of the Executive Committee on Affiliates by the Television Broadcasters Association. This committee will study activities of the affiliated industries and interests, such as telephone, motion pictures and film manufacturing, antenna designers and manufacturers, apartment house owners and operators.

FREKKO BECOMES CHIEF ENGINEER OF C-D ELECTROLYTIC DIVISION

Eugene Frekko has been appointed chief engineer of the electrolytic division of Cornell-Dubilier Electric Corp., South Plainfield, N. J. Mr. Frekko has been with C-D for ten years. He succeeds Paul McKnight Deeley, vice president, who has been promoted to manager of the South Plainfield plant.



GENERAL RADIO TO ENLARGE PLANT

Work has been started on a new four-story addition to the plant of the General Radio Company, 275 Massachusetts Avenue, Cambridge, Massachusetts.

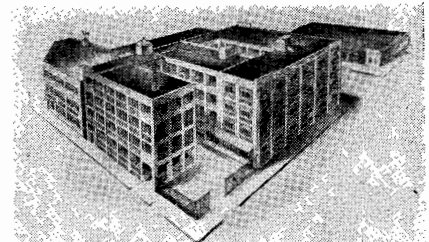

G. E. DELIVERS 100th F-M TRANSMITTER TO WPEN-FM

G. E. recently shipped its 100th f-m broadcast transmitter, a 3-kw unit, to the Philadelphia "Evening Bulletin's" station WPEN-FM.

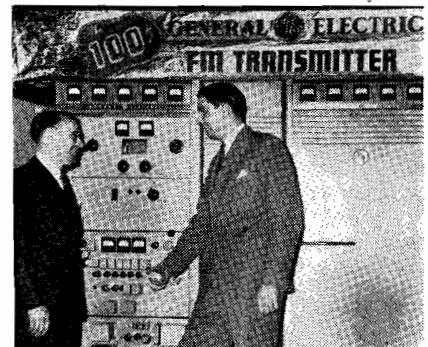

James D. McLean (right), G. E. manager of transmitter sales and R. D. Compton, WPEN-FM director of engineering.

BLAW-KNOX FOLDER

An 8-page folder discussing antenna tower products and plant facilities has been prepared by the Blaw-Knox Company, Farmers Bank Building, Pittsburgh 22, Pa.



Man, Here's Comfort for EARS!

That's right, mister. The Telex MONOSET replaces hot, headache-y, old-style headphones wherever comfortable hearing is needed. Worn under the chin, the MONOSET eliminates head and ear fatigue. So for *comfort* for ears (your own or your customers) specify Telex MONOSET. *Immediate delivery.*

Weighs only 1.3 oz. Fully adjustable to all head sizes. Rugged Tenite construction. Removable plastic ear tips. Frequency response: 50 to 3,000 c.p.s. Maximum sound pressure output: 300 to 400 dyns per sq. cent. Available in two impedances: 128 and 2,000 ohms.

Write to Department H for information and quotations.

"Hearing At Its Best"

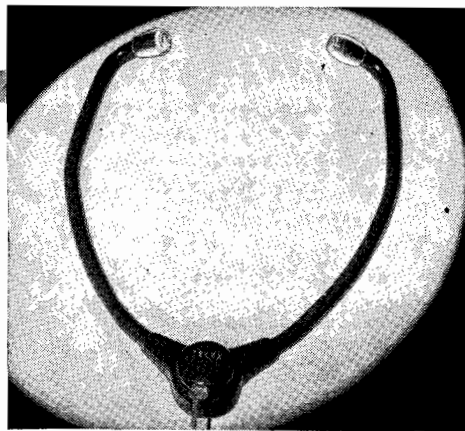

Complete with light plastic cord and standard phone plug.

USERS: Electrical transcribing machines. Program distribution systems. Commercial aircraft operations. RR inter-communication systems. Laboratory testing equipment. Wired music systems. Radio station operations. Radio "hams" and engineers.

TELEX INC.

ELECTRO-ACOUSTIC DIVISION
Minneapolis, Minn.

Canadian Distributors: Addison Industries, Ltd., Toronto

F-M/TELEVISION RECEIVERS

(Continued from page 49)

upon many varying circuit conditions and individual requirements. The choice of using balanced or unbalanced input, permeability or capacitor tuning, noisy pentodes or quiet triodes that possibly require neutralization, among others, lies entirely with the design engineer. Considering these reasons and various engineering and economic compromises, no particular tube can be chosen and defined as *the input tube*. Complete noise information about the circuits involved is necessary, however, as this is one of the determining factors for good sensitivity and signal-to-noise ratio.

TRANSMITTER BUILDING

(Continued from page 43)

though it does leave some blind spots. In practice this has not been found to be objectionable.

In the rear workroom a soundproof booth was constructed to house a United Press teletype. This has also been quite adequate, but is frequently a problem in small buildings where it is necessary to place teletype equipment close to studios. This booth is constructed of celotex walls with a dead-air space and a rock wool packing. It provides about a 40-db sound transmission loss.



THERMOSTATIC METAL TYPE DELAY RELAYS

PROVIDE DELAYS RANGING
FROM 1 TO 120 SECONDS

FEATURES:—Compensated for ambient temperature changes from -40° to 110° F... Hermetically sealed; not affected by altitude, moisture or other climate changes... Explosion-proof... Octal radio base... Compact, light, rugged, inexpensive... Circuits available: SPST Normally Open; SPST Normally Closed.

PROBLEM? Send for "Special Problem Sheet" and Bulletin.

AMPERITE REGULATORS

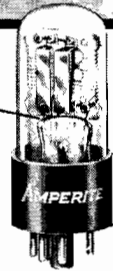
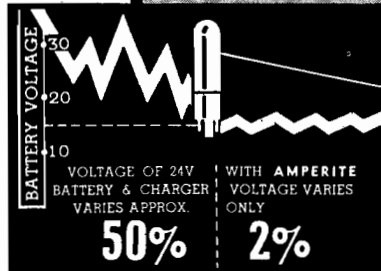

Amperite REGULATORS are the simplest, lightest, cheapest, and most compact method of obtaining current or voltage regulation... For currents of .060 to 8.0 Amps... Hermetically sealed; not affected by altitude, ambient temperature, humidity.

Write for 4-page Illustrated Bulletin.

AMPERITE CO., 561 Broadway, New York 12, N. Y.

In Canada: Atlas Radio Corp., Ltd., 560 King St., W. Toronto

HUGE STOCKS!

TRANSMITTING
AND SPECIAL
PURPOSE

TUBES

NEWARK NOW AGENTS OF WAR ASSETS ADMINISTRATION

Newark has been appointed agents of the War Assets Administration for transmitting and special purpose electronic tubes.

HUGE STOCKS! WIDE SELECTION!

This means that you can now get prompt Newark service on the previously hard-to-get tubes, priced at a fraction of their original cost. Make Newark your headquarters for tubes — whether it's for experimental work or production runs.

- ACTING AS AGENTS FOR WAR ASSETS ADMINISTRATION UNDER CONTRACT WAS(p) 7-167
- WRITE: 242-L W. 55th STREET, NEW YORK CITY

NEW YORK
Offices & Warehouse
242 W. 55th St., N.Y. 19

NEWARK TELEPHONE
Circle 6-4060
ELECTRIC COMPANY, INC.

New York City Stores: 115-17 W. 45th St. & 212 Fulton St.

WRITE FOR NEWARK'S LIST OF TUBES

Make Newark your source, too, for all needed radio and electronic parts. Brisk, competent service assures quick delivery.

- MAIL AND PHONE ORDERS FILLED PROMPTLY

WHAT IS THE
FREQUENCY OF YOUR
DOLLAR\$?



**SUPREME Model 576
Oscillator.**

SUPREME Oscillators cannot measure the wave length of your dollars, but they can increase the frequency by which they find themselves stopping in your cash register.



**SUPREME Model 561 A.F.
and R. F. Oscillator.**

See these and other SUPREME Testers at your Authorized SUPREME Distributor.



OR, write
for new catalogue
No. 446 for
complete details and
descriptions.

SUPREME

**SUPREME INSTRUMENTS CORP.
GREENWOOD, MISS., U.S.A.**

EXPORT DEPT:
The American Steel Export Co., Inc.,
374 Madison Ave., New York 17, N. Y.

ADVERTISERS IN THIS ISSUE

COMMUNICATIONS—FEBRUARY, 1947

AIRCRAFT RADIO CORP.....	33	KINGS ELECTRONICS CO.....	47
Agency: Burke Dowling Adams		Agency: Adair & Director	
ALLIED RADIO CORP.....	48	MEASUREMENTS CORPORATION.....	44, 50
Agency: George Brodsky, Advertising		Agency: Frederick Smith	
AMPERITE CO.....	51	MICO INSTRUMENT CO.....	42
Agency: H. J. Gold Co.		MID-AMERICA CO., INC.....	44
ANDREW CO.....	39	Agency: E. H. Brown Adv. Agency	
Agency: Burton Browne, Advertising		JAMES MILLEN MFG. CO., INC.....	40
THE ANSONIA ELECTRICAL DIV. NOMA ELECTRIC CORP.....	25	NATIONAL CO., INC.....	31
Agency: Albert Frank Guenther Law. Inc.		Agency: Graydon Smith Adv. Co.	
THE ASTATIC CORPORATION.....	34	NEWARK ELECTRIC CO.....	51
Agency: Wearstler Advertising, Inc.		Agency: The Charles Brunelle Co.	
BELL TELEPHONE LABORATORIES.....	6, 7	NIAGARA RADIO SUPPLY.....	42
Agency: Newell-Emmett Co.		Agency: Burke & Warburn Adv. Co.	
BURSTEIN-APPLEBEE CO.....	47	PAR-METAL PRODUCTS CORP.....	48
Agency: Frank E. Whalen Adv. Co.		Agency: H. J. Gold Co.	
CANNON ELECTRIC DEVELOPMENT CO.....	45	PETERSEN RADIO CO., INC.....	47
Agency: Dana Jones Co.		Agency: Bozell & Jacobs	
CAPITOL RADIO ENGINEERING INSTITUTE..	46	PREMAX PRODUCTS DIV. CHISHOLM-RYDER CO., INC.....	42
Agency: Henry J. Kaufman & Associates		Agency: Norton Adv. Service	
C. P. CLARE AND CO.....	Inside Front Cover	PYRAMID ELECTRIC CO.....	23
Agency: Hamilton Adv. Agency, Inc.		Agency: Arnold Coban Corp.	
CLAROSTAT MFG. CO., INC.....	42	JOHN F. RIDER PUBLISHER, INC.....	40
Agency: Austin C. Lescaurba & Staff		Agency: Lansford F. King, Advertising	
THE CLEVELAND CONTAINER CO.....	5	SHALLCROSS MFG. CO.....	43
Agency: The Nesbitt Service Co.		Agency: The Harry P. Bridge Co.	
COLLINS RADIO COMPANY.....	Back Cover	SORENSEN & CO., INC.....	37
Agency: McCann-Erickson, Inc.		Agency: Henry A. Stephens, Inc.	
CONCORD RADIO CORP.....	46	SPRAGUE ELECTRIC CO.....	4
Agency: E. H. Brown Adv. Agency		Agency: The Harry P. Bridge Co.	
DeMORNAY-BUDD, INC.....	3	THE SUPERIOR ELECTRIC CO.....	21
Agency: Federal Adv. Agency		Agency: Benson Adv. Service	
EITEL-McCULLOUGH, INC.....	20	SUPREME INSTRUMENTS CORP.....	52
Agency: L. C. Cole, Advertising		Agency: O'Callaghan Adv. Agency, Inc.	
ELECTRICAL REACTANCE CORP.....	38	SUPREME TRANSMITTER CORP.....	29
Agency: Scheel Adv. Agency		Agency: Austin C. Lescaurba & Staff	
ELECTRONIC RESEARCH & MFG. CORP.....	47	SYLVANIA ELECTRIC PRODUCTS INC.....	8
FEDERAL TELEPHONE & RADIO CORP.....	27	Agency: Newell-Emmett Co.	
Agency: Rirkard & Co.		TECH LABORATORIES.....	47
FERRANTI ELECTRIC, INC.....	1	Agency: Lewis Adv. Agency	
GENERAL RADIO CO.....	Inside Back Cover	TELEX PRODUCTS CO.....	50
GUARDIAN ELECTRIC CO.....	17	Agency: Campbell-Milthun, Inc.	
Agency: Kennedy & Co.		UNITED TRANSFORMER CORP.....	36
THE HOPP PRESS, INC.....	44	Agency: Shappe-Wilkes Inc.	
Agency: Gallard Adv. Agency		WELLS SALES, INC.....	49
JENSEN MFG. CO.....	16	Agency: Turner Adv. Agency	
Agency: Burton Browne, Advertising		WESTERN ELECTRIC CO.....	6, 7
E. F. JOHNSON CO.....	35	Agency: Newell-Emmett Co.	
Agency: David, Inc.		WILCOX ELECTRIC CO., INC.....	14
HOWARD B. JONES DIV. CINCH MFG. CORP..	44	Agency: Arthur G. Rippey & Co.	
Agency: Merrill Symonds, Advertising			

FOR ROUTINE MEASUREMENTS

of

- **INDUCTANCE**
- **CAPACITANCE**
- **RESISTANCE**



TYPE 650-A **Impedance Bridge** **\$220**

*(Plus 10% temporary price increase,
due to greatly increased costs)*



NO laboratory, in which any electrical equipment is used, is complete without this bridge. Completely self-contained, portable, and accurate enough for most routine measurements, the popular Type 650-A Impedance Bridge is always set up and ready to use. With it you can measure these basic quantities over these very wide ranges—**INDUCTANCE:** 1 microhenry to 100 henrys; **CAPACITANCE:** 1 micromicrofarad to 100 microfarads; **RESISTANCE:** 1 milliohm to 1 megohm. In addition it measures **DISSIPATION FACTOR (R/X)** from .002 to 1, and **STORAGE FACTOR (X/R or Q)** from .02 to 1,000.

The bridge includes built-in standards, batteries, a 1,000-cycle tone source for a-c measurements, a zero-center galvanometer null indicator for dc and terminals for a headset for 1,000-cycle null detection.

Provision is made for use of an external generator for measurements over a wide range from a few cycles to 10 kilocycles.

Direct-reading dials add greatly to the ease and rapidity with which measurements can be made with this universal bridge.

WRITE FOR COMPLETE INFORMATION



GENERAL RADIO COMPANY

90 West St., New York 6

920 S. Michigan Ave., Chicago 5

950 N. Highland Ave., Los Angeles 38

Cambridge 39,
Massachusetts

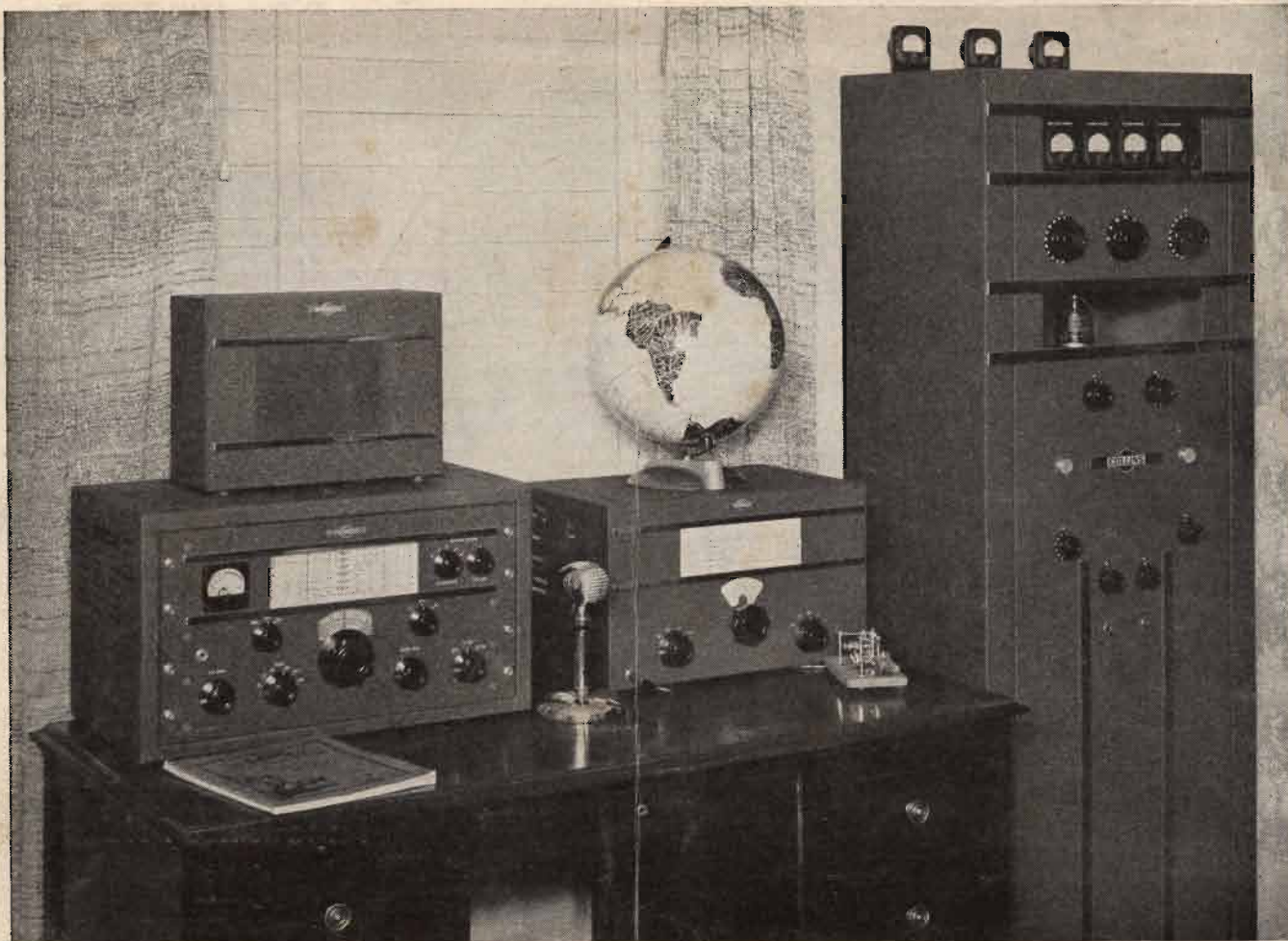

The world is at your fingertips



with Collins

Snap on the filaments, settle yourself at the controls, and enjoy a most satisfying world tour—by radio. Listen to the musical CQ from Latin America, the cheerful hello from Canada. Hear the eagerness in the voice of the American operating portable from Casablanca or Tinian. Maybe you're searching the DX bands for the G4—or was it an HB9—that you used to work every Saturday. Or perhaps your next door neighbor wants to send a message to his aunt in Phoenix.

Sharpen up the incoming signal you've selected on the Collins 75A receiver. You have a crystal filter that you can adjust with ease. The r-f gain control does not affect the pitch of a cw note. And the receiver is so stable that line voltage fluctuations—or the slam of a door—will not require frantic retuning to find the signal again.

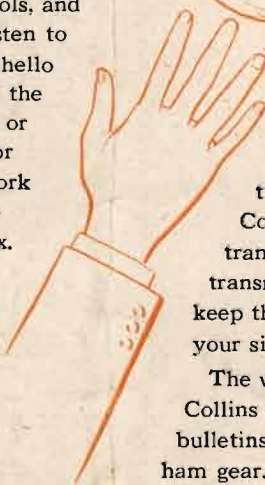

Even under adverse conditions your reception will be better with the 75A.

Then switch the Collins 30K transmitter to **the Operate** position and you're on the air. Use either fone or cw. You can change frequency quickly if you desire. The permeability tuned oscillator (PTO) controlled exciter—the Collins 310A—sits right on the operating desk. Both transmitter and exciter are bandswitching. The 30K transmitter has a speech clipper in the audio circuit to keep the modulation at a high level. Notice how it helps your signal, particularly in QRM or QRN.

The world is truly at your fingertips when you're using Collins equipment. Write for illustrated bulletins describing Collins ham gear.

FOR BEST RESULTS IN AMATEUR RADIO, IT'S . . .

COLLINS RADIO COMPANY, CEDAR RAPIDS, IOWA

11 West 42nd Street, New York 18, N. Y.

458 South Spring Street, Los Angeles 13, California

