

COMMUNICATIONS

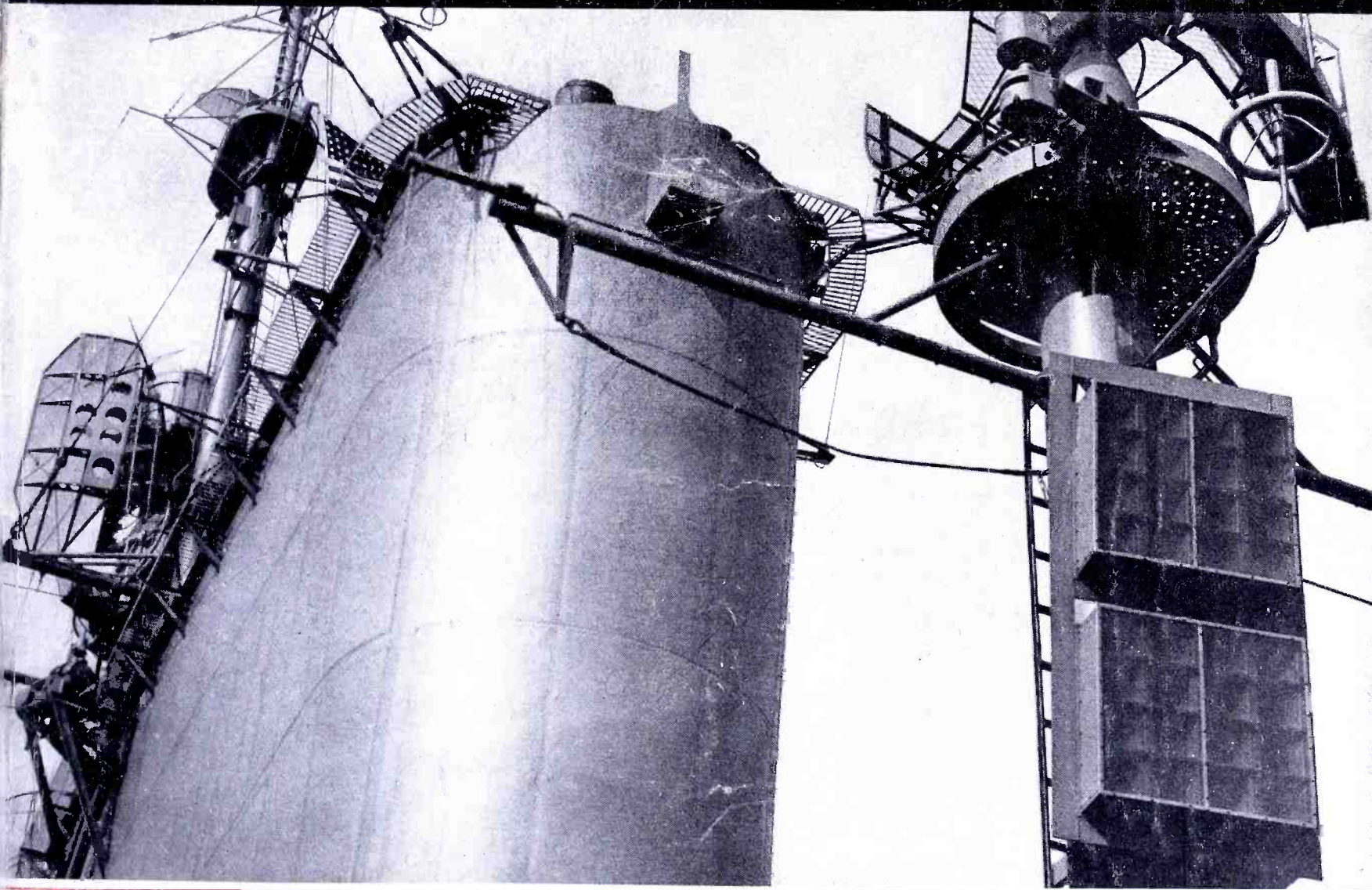

NOVEMBER

- ★ RADIO ENGINEERING
- ★ MINIATURE POCKET RECEIVER DESIGN
- ★ H-F TRANSMISSION LINE JACKETS
- ★ AERONAUTICAL COMMUNICATIONS
- ★ D-C VOLTAGE STABILIZERS
- ★ TELEVISION ENGINEERING
- ★ RANGE PREDICTION CHART FOR F-M STATIONS

1945

THE AMPEREXTRA FACTOR in SOUND TRANSMISSION

The Amperextra Factors of dependability and longevity represent important operational and replacement savings in the sound transmission field. Even in wartime, orders from essential civilian users were filled with fairly consistent regularity. Now, with nothing ahead but peace, the Amperextra Factor of service takes on an entirely new meaning for broadcasting stations, amateur radio operators and communications organizations. Your inquiries are invited.

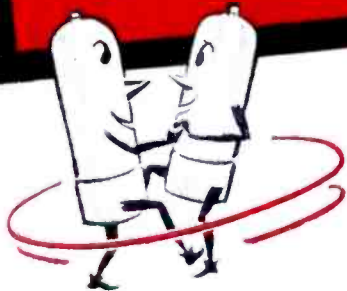

WHAT ONE USER SAYS...

... "the ease with which they can be driven to full output, the simplification of cooling arrangements, the relative immunity to heavy overloads, and the moderate plate voltages required result in a combination not easily surpassed."



AMPEREX INTERCHANGEABILITY

Amperex tubes will fit into all types of transmitters for which they are intended, and may be interchanged or used to replace tubes of other manufacture without need for circuit readjustment and without impairment of transmitter performance.

SPECIALLY PROCESSED GRAPHITE ANODES..

... in many of our exclusive designs make for more uniform temperature distribution, absence of change in characteristics with time, and a higher initial vacuum which keeps tubes harder and assures longer life.

AMPEREX

...THE HIGH PERFORMANCE TUBE

Many standard types of Amperex tubes are now available through leading radio equipment distributors. The Amperex Special Application Engineering Department will gladly work with you on the solution to your pressing problems.



Amperex Type 2B-120 Transmitting Tube. Filament voltage, 10-10.5 volts AC or DC. Filament current, 2 amperes. Amplification factor, 90. Grid-to-Plate Transconductance at 120 ma., 5000 micromhos. Direct Interelectrode Capacitances: grid-to-plate, 5.2 μf ; grid-to-filament, 5.3 μf ; plate-to-filament, 3.2 μf .



Amperex Type 11F-3000 Transmitting tube. Filament voltage, 21 to 22. Filament current, 40.5 amperes. Filament emission, 6 amperes. Amplification factor, 16. Grid-to-Plate Transconductance of plate current of 1 ampere, 6500 micromhos. Direct Interelectrode Capacitances: grid-to-plate, 10 μf ; grid-to-filament, 13 μf ; plate-to-filament, 4 μf .



Amperex Type S91-R Transmitting Tube. Filament, two-unit type for single-phase or two-phase AC or DC operation—voltage per unit, 11; current per unit, 60 amperes; amplification factor, 8. Grid-to-Plate Transconductance at a plate current of 0.75 ampere, 4000 micromhos. Direct Interelectrode Capacitances: grid-to-plate, 30 μf ; grid-to-filament, 16 μf ; plate-to-filament, 3 μf .



AMPEREX ELECTRONIC CORPORATION

25 Washington St., Brooklyn 1, N. Y., Export Division: 13 E. 40th St., New York 16, N. Y., Cables: "Arlab"
Canadian Distributor: Rogers Majestic Ltd. • 622 Fleet Street West, Toronto

108 SERIES Amplifiers

WITH MOUNTING ACCESSORIES

TYPE 108-B two-stage Amplifier provides transformer input impedances for either 30 or 250 ohms with nominal output impedance 500 or 8 ohms. Variable gain 65/105 db. with electronic volume control. Frequency response better than ± 1 db. 30/16,000 c.p.s. Power output +43 V.U. (20 watts) with less than 5% RMS harmonic content. Noise level full gain 56 db. below full output.

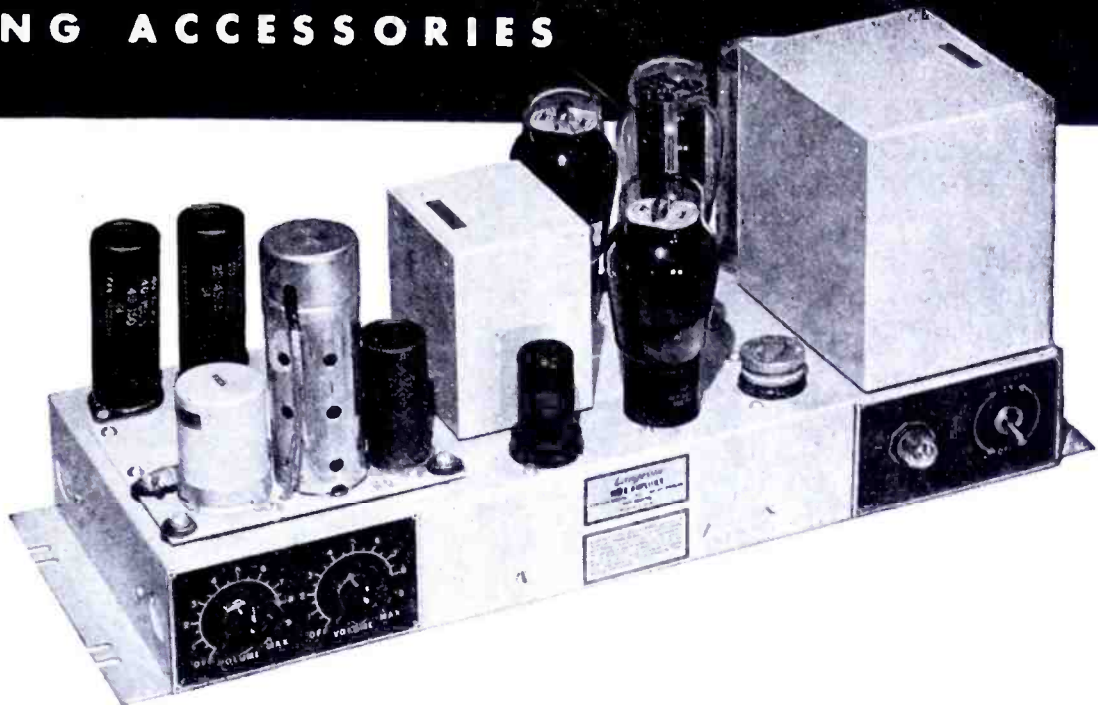

THE 108 SERIES consist of four different amplifiers available simply by changing one or two small input panels on the master chassis. Except for these input panels all amplifiers have the same transmission characteristics. Input impedance, gain and noise level depending on types listed below.

These units are designed for the highest type audio service having gain-frequency characteristics better than ± 1 db. 30/16,000 c.p.s. Power output +43 V.U. (20 watts) with less than 5% RMS harmonic content.

TYPE 108-A two-stage Amplifier provides transformer input for either 600 ohm or bridging. 600 ohm input fixed gain 61 db. Bridging input variable gain 6/46 db. Noise level 68 db. below full output.

Bridging input variable gain 2/42 db. Channel 2—high gain 30/250 ohm input variable gain 62/102 db. with electronic volume control. Noise level 56 db. below full output.

TYPE 108-B as illustrated and described above.

TYPE 108-C combines the input channels of the 108-A and 108-B Amplifiers. Channel 1—600 ohm input variable gain 20/60 db.

TYPE 108-D two-channel each 30/250 ohm input. Either channel variable gain 62/102 db. with electronic volume control. Noise level 56 db. below full output.

MOUNTING ACCESSORIES

TYPE 202-A Wall Mounting Cabinet permits universal installation of 108 Series Amplifiers to any flat surface. Well ventilated and designed for maximum accessibility, servicing and convenience of installation. Standard aluminum gray finish.

TYPE 9-A Modification Group permits 108 Series Amplifiers to mount on standard 19" telephone relay racks. Occupies 7" rack space. Allows servicing from front of rack. Standard aluminum gray finish.

The Langevin Company

INCORPORATED

SOUND REINFORCEMENT AND REPRODUCTION ENGINEERING

NEW YORK
37 W. 65 St., 23

SAN FRANCISCO
1050 Howard St., 3

LOS ANGELES
1000 N. Seward St., 38

www.americanradiohistory.com

LEWIS WINNER, Editor
 F. WALEN, Assistant Editor

COMMUNICATIONS

Including Television Engineering, Radio Engineering, Communication & Broadcast Engineering, The Broadcast Engineer. Registered U. S. Patent Office.
 Member of Audit Bureau of Circulations.

We See...

NOVEMBER, 1945

VOLUME 25 NUMBER 1

COVER ILLUSTRATION

Flight deck of the U. S. Navy's new 45,000-ton aircraft carrier, the Franklin D. Roosevelt, with an unusual assortment of radio, radar and sound equipment. The nine bull horns, at lower right, affording 5,000 watts of power, are used for flight instructions to pilots. (Courtesy Western Electric Co.)

ACCELERATED PROGRAMS TO EXTEND RADIO COMMUNICATIONS FACILITIES for airport traffic control may be adopted soon, according to reports from Washington. For months, a concerted campaign stressing the urgency of such facilities for our expanding airways system has been under way. But a variety of internal civil and military complications balked moves which would green-light the project. As yet the plans are not too complete, but the renewed vigorous interest of many authorities in several practical plans and systems, present a hopeful sign that it will not be too long before expansion begins.

The CAA has become extremely active in this expansion effort. They fully realize, they have said, that control of the anticipated 50,000 postwar aircraft without suitable radio facilities would be impossible. Under the present setup, using a limited instrument arrangement, it is only possible to traffic about 75 planes an hour between New York and Philadelphia. If the postwar aircraft increase becomes a reality, there'll be a minimum of several hundred planes an hour riding the New York-Philadelphia route. Only a well-planned radio-controlled airport traffic system would eliminate the probable confusion that would come with such heavy traffic.

The present CAA plans cover not only local control, but international control as well, and involves the study of both airborne and ground-landing systems. Omnidirectional v-h-f ranges will be the basic navigational method used. Loran may also be used for long-range navigation. Radar is also expected to play a major role in traffic control. Radar screens would permit the airport controller to visualize aircraft movement and thus regulate traffic with increased efficiency. The radar setup would also provide monitoring of aircraft.

Discussing radar's aircraft-control possibilities at the annual Rochester IRE Fall meeting, Dr. Lee DuBridge of the Radiation Labs said that monitoring via the screen could be the basis of a network system that could control aircraft travel from point to point. Central and intermediate points would be in constant touch with an en route plane with such a system, he said.

It appears as if 1946 may see some of the most striking innovations in aeronautical communications ever developed.

CONGRATULATIONS TO DR. FREDERICK B. LLEWELLYN on his election as IRE president for 1946. And a round of applause to Dr. William L. Everitt for his commendable record as IRE president during 1945.

THE GOOD NEWS THAT THE BROADCAST ENGINEERING CONFERENCE will be resumed in 1946 has reached our desk. The dates are March 18 to 23. The place is Ohio State University, Columbus, Ohio. Dr. W. L. Everitt, now head of the E.E. department at the University of Illinois, will continue to act as director. Professor E. M. Boone of Ohio State will be associate director. This conference will be one of the most important of the series, covering analyses of engineering activities of the past four years and the postwar era.

The industry is grateful to Dr. Everitt and Professor Boone for resuming this all-important conference.—L.W.

MINIATURE RECEIVER DEVELOPMENT

Miniature Pocket Receiver Design..... W. J. Brown 3

H-F PLASTICS

Jacketing Materials for H-F Transmission Lines..... A. J. Warner 3

F-M RECEIVER DESIGN

F-M Ratio Detectors..... Ralph G. Peters 4

VOLTAGE STABILIZERS

Voltage-Regulated Power Supplies..... G. Edward Hamilton and Theodore Maiman 4

S-H-F TRANSMISSION

Pulse-Time Modulation..... Donald Philips 4

MARINE RADAR

Shiphorne Radar..... G. E. M. Bertram 52

F-M BROADCASTING

Range Prediction Chart for F-M Stations..... Frederick C. Everett 57

RESISTIVE NETWORKS

Resistive Attenuators, Pads, Networks (Analysis of Their Application in Mixer and Fader Systems...Part X. Conclusion)..... Paul B. Wright 61

COMPONENT DESIGN

Received Loop Antenna Design Factors..... Edwin M. Kendell 62

COMPONENT MEASUREMENTS

Capacitance Measurement in Multi-Electrode Systems..... Wilson Pritchett 66

PIEZOELECTRIC CRYSTAL QUALITY CONTROL

Aging of Quartz Crystals..... Sidney X. Shore 70

MONTHLY FEATURES

Editorial (We See)..... Lewis Winner 2

News Briefs of the Month..... 88

Veteran Wireless Operators' Association News..... 96

The Industry Offers..... 100

Advertising Index..... 108

Published Monthly by the Bryan Davis Publishing Co., Inc.

BRYAN S. DAVIS, President

F. WALEN, Secretary

PAUL S. WEIL, Vice Pres.-Gen. Mgr.

A. GOEBEL, Circulation Mgr.

Advertising and Editorial offices, 52 Vanderbilt Ave., New York 17, N. Y. Telephone, MUrray Hill 4-0170. Cleveland 6, Ohio: James C. Munn, 10515 Wilbur Ave.; Telephone, SWEetbriar 0052. Pacific Coast Representative: Brand & Brand, 1052 W. Sixth St., Los Angeles 14, Calif.; Telephone, Michigan 1732. Wellington, New Zealand: Te Aro Book Depot. Melbourne, Australia: McGill's Agency. Entire Contents Copyright 1945, Bryan Davis Publishing Co., Inc. Entered as second-class matter Oct. 1, 1937, at the Post Office at New York, N. Y., under the act of March 3, 1879. Yearly subscription rate: \$2.00 in the United States and Canada; \$3.00 in foreign countries. Single copies, twenty-five cents in United States and Canada; thirty-five cents in foreign countries.

SYLVANIA NEWS

ELECTRONIC EQUIPMENT EDITION

NOV.

Published by SYLVANIA ELECTRIC PRODUCTS INC., Emporium, Pa.

1945

RADIO AND ELECTRONIC EQUIPMENT MAKERS GETTING SET FOR FULL-SCALE PRODUCTION

Will Receive Highest Quality Tubes From Sylvania Electric To Meet Pent-Up Demand



CATHODE RAY TUBES

With the period of reconversion taking active form and spreading over the nation, the radio industry is looking forward to what promises to be one of the most expansive developments in its history. Millions wait for radio sets of improved design and, consequently, of more complex construction. Industries will turn to greater use of electronic equipment.

Manufacturers are rapidly getting set for full-scale production to meet this pent-up demand. Of course, in radio here's the problem of obtaining an adequate supply of component parts.

However, as far as dependable, pre-

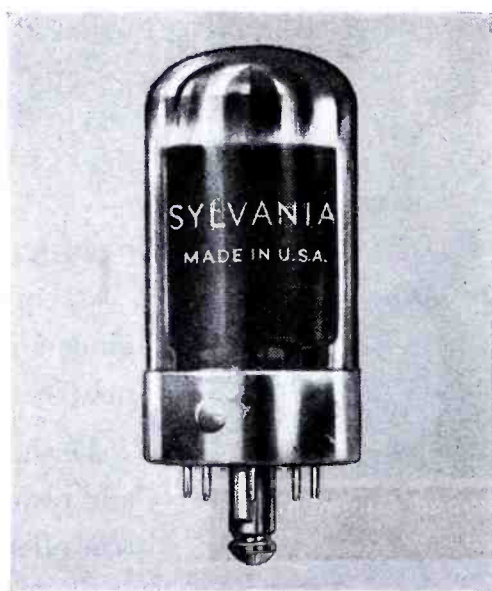

LOCK-IN RADIO TUBES

cision-built radio tubes are concerned, set makers are assured of receiving the benefits of Sylvania's more than 40 years' research experience and wide-scale production facilities. Note this list:

Television—experience in design and the production of untold thousands of Sylvania Cathode Ray Tubes for war requirements has contributed greatly to peace-time applications.

High frequency sets (FM, Television)—the Sylvania Lock-In Tube is so electrically and mechanically perfect in construction that it can handle



“GLASS” RADIO TUBES

ultra-high frequencies with ease. Besides, it is more than perfectly suitable for *all* types of radio sets.

Radio—manufacture and distribution of the famous high quality Sylvania lock-in “Glass” and miniature tubes will continue to satisfy the exacting circuit requirements of modern radio receivers.

Electronic devices—the same laboratory and manufacturing resources that served our government so well, are now available to the manufacturer of electronic devices of every description.

SYLVANIA ELECTRIC

Emporium, Pa.

MAKERS OF RADIO TUBES; CATHODE RAY TUBES; ELECTRONIC DEVICES; FLUORESCENT LAMPS, FIXTURES, WIRING DEVICES; ELECTRIC LIGHT BULBS
COMMUNICATIONS FOR NOVEMBER 1945 • 3

Out of Two Laboratories

comes a **NEW** railroad communication

Rock Island

SPERRY



● Sperry's Research Laboratory where Railroad Communications System was designed and developed

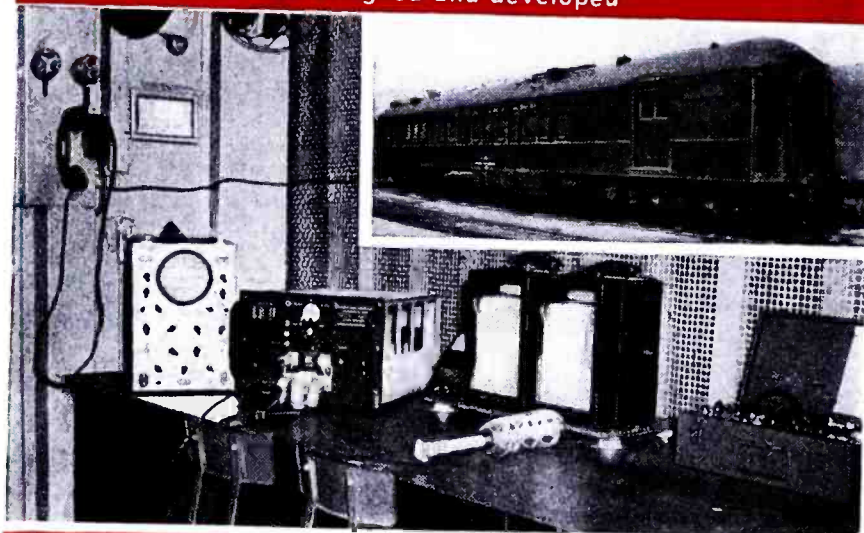

● Rock Island's Mobile Electronic Laboratory where equipment was put to rugged test

THE ENGINEERING STAFF of the Sperry Gyroscope Company, in collaboration with engineers of Rock Island Lines, has perfected a new system of railroad communications.

Designed especially for railroads by Sperry and tested extensively by Rock Island, this system offers to the railroad industry microwave applications, secret until now, which Sperry's vast engineering group developed during the war years in co-operation with the U. S. Navy. With the aid of Rock Island engineers working in their specially equipped Electronic Car the Sperry system has been completely tested and proved.

Sperry's Railroad Communications System makes possible for the first time clear, audible signals through tunnels, deep gorges, and the usual terrain and atmospheric conditions encountered in railroad service. No man-made

SPERRY GYROSCOPE COMPANY, INC.
Division of the Sperry Corporation

Leaders in the fields of . . . **GYROSCOPICS • ELECTRONICS**

system!



or atmospheric disturbance interferes with
tal business!

Automatic relay stations, employing hereto-
re-restricted radar components that can be
substituted for overhead land lines in treach-
erous storm areas, will link way stations and
headquarters, and provide a continuous en route
connection between trains and wayside points.

A specially designed antenna provides any
required degree of directional control.

Rock Island Lines, whose "sole purpose is
to provide the finest in transportation," is being
equipped with a Sperry Railroad Communi-
cations System.

If you would like our help in planning
a complete radio communications system to
expedite the handling of your freight and pas-
senger traffic, write our Industrial Department
for further information.

SPERRY RAILROAD COMMUNICATIONS SYSTEM

- **Microwave applications for the first time**
- **Designed especially for railroads**
- **Greater Range**
- **Increased Signal Strength**
- **FM Signal Audibility through any kind of interference**
- **Any degree of Directional Control**
- **Suitable for indoor and outdoor installations**
- **Available in both VHF and UHF**

GREAT NECK, N. Y. ★ LOS ANGELES • SAN FRANCISCO • SEATTLE • NEW ORLEANS • CLEVELAND • BROOKLYN • HONOLULU ★

RADAR • AUTOMATIC COMPUTATION • SERVO-MECHANISMS

Laboratory Standards

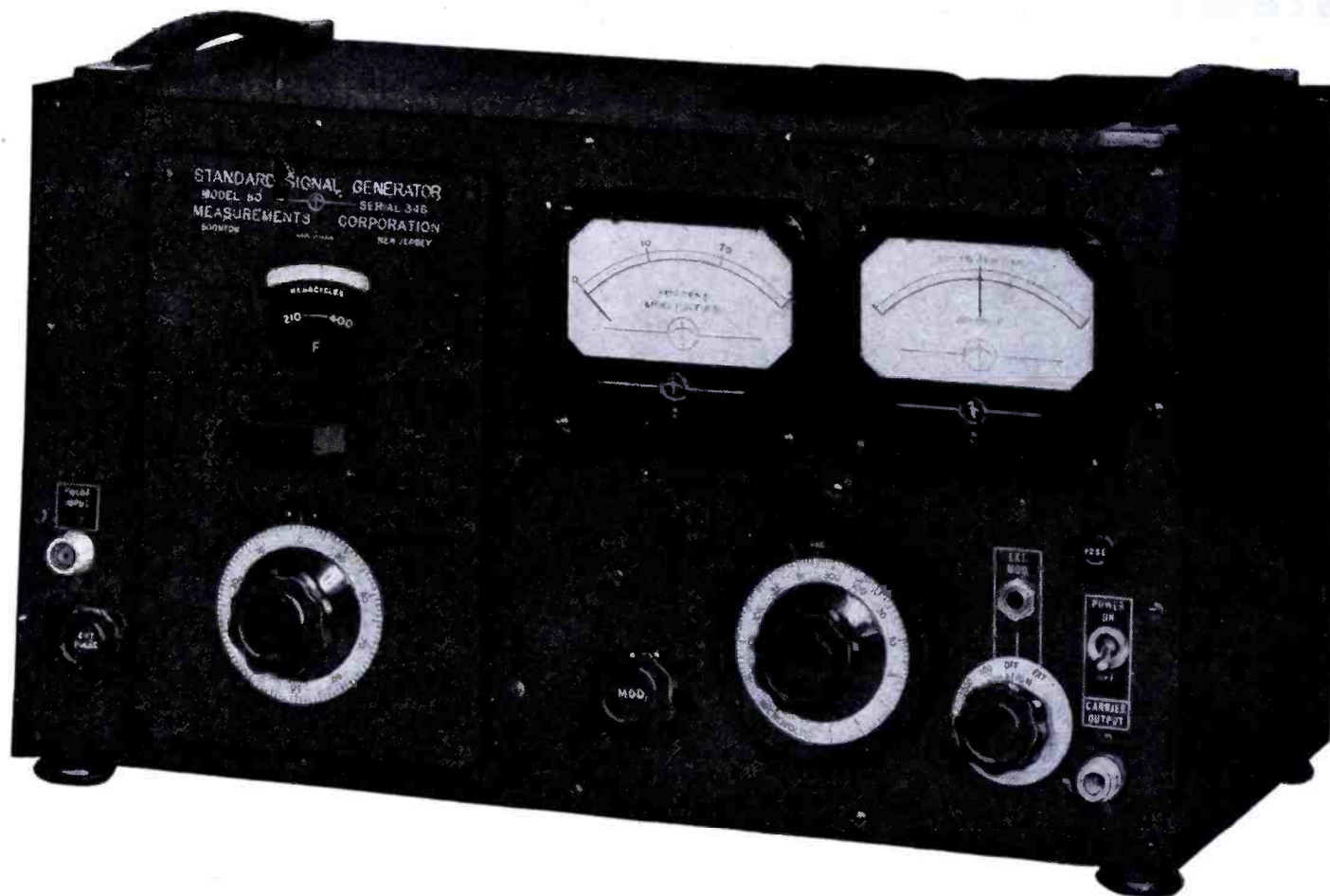

Model 80 STANDARD SIGNAL GENERATOR SPECIFICATIONS

CARRIER FREQUENCY RANGE:

2 to 400 megacycles. Individually calibrated dial with six overlapping bands. Automatic range indication eliminates error in selection of the correct frequency scale. Embodies a highly stable, low drift oscillator of thoroughly coordinated design.

OUTPUT SYSTEM:

Continuously variable from 0.1 to 100,000 microvolts. The output metering system incorporates a precision barretter bridge for continuous monitoring of the carrier oscillator. The carrier leakage is held to less than 0.1 microvolt.

OUTPUT IMPEDANCE:

Fixed at 50 ohms. Optional 6 db. external pads are available to reduce reflection errors from lines of uncertain characteristics.

MODULATION:

Amplitude Modulation from a self-contained modulator and oscillator providing 400 to 1,000 cycle. Provision for external audio modulation. Video Modulation jack is provided for connecting an external pulse generator (such as our 79-B) directly to the oscillator plate circuit. Pulses of one microsecond can be obtained at higher carrier frequencies.

DIMENSIONS:

Width 19", Height 10 $\frac{3}{4}$ ", Depth 9 $\frac{1}{2}$ ". Weight: Approximately 35 pounds. Power Supply: 117 volts, 50-60 cycle. Fuses: One type 8-AG-1 one ampere.

PROMPT DELIVERY

MEASUREMENTS CORPORATION
BOONTON  NEW JERSEY

NOW IN PRODUCTION FOR EARLY 1946 DELIVERY

Federal's Complete FM Broadcast Equipment

STUDIO EQUIPMENT • FM TRANSMITTERS • ANTENNAS AND TOWERS

With production now under way, Federal will deliver 1 and 3 KW FM Transmitters early in 1946...delivery of the 10 and 50 KW following shortly thereafter...featuring the latest in design, circuits, tubes and technique for unsurpassed operations in the new 88-108 mc. band.

Available with these transmitters will be complete associated equipment—from microphone to antenna—entire FM Broadcasting Systems...supplied by one experienced and dependable

source—Federal...for more than three decades a leading contributor to radio progress.

Federal engineers are ready to consult with you...help plan every step of your installation...and then stay with the job until your station is in completely satisfactory operation. And Federal assumes full responsibility for the performance of its equipment.

Call in Federal now...be among the first on the air with the finest in FM Broadcasting.

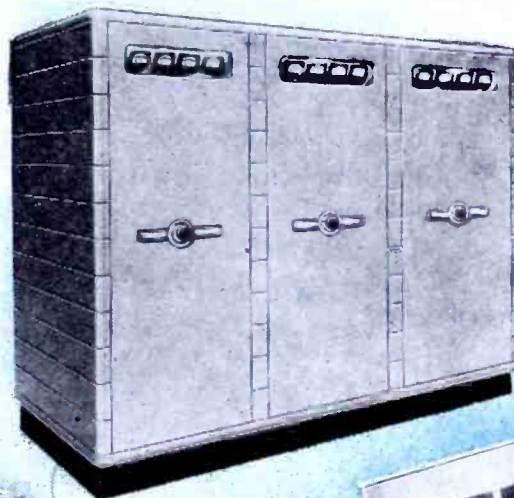

Write for brochure "Complete FM...by Federal" descriptive of Federal's complete FM Radio Broadcast Equipment from microphone to antenna.



Federal Telephone and Radio Corporation



Newark 1, N. J.



**"You can't argue with a
PRESTO RECORDING**

...because

Presto gives it to you straight!"

"There's nothing like a Presto Recording for honest criticism of your work," says Ray Bloch whose Orchestra and Chorus provide the musical portion of so many network shows. "Our programs are recorded on Presto equipment because we know we can depend on Presto's fine reproduction and fidelity to musical tones. When we play back the recording, we're practically hearing our own live performance!"

Major broadcasting stations feel the same way about Presto's high quality work—and add that Presto is rugged as well as efficient, remaining in perfect operating condition over long periods without adjustment. Schools, colleges and business organizations, too, prefer Presto equipment because it's so simple to operate. Write for complete information.



PRESTO

RECORDING CORPORATION

242 West 55th Street, New York 19, N. Y.

Walter P. Downs, Ltd., in Canada



WORLD'S LARGEST MANUFACTURER OF INSTANTANEOUS SOUND RECORDING EQUIPMENT AND DISCS

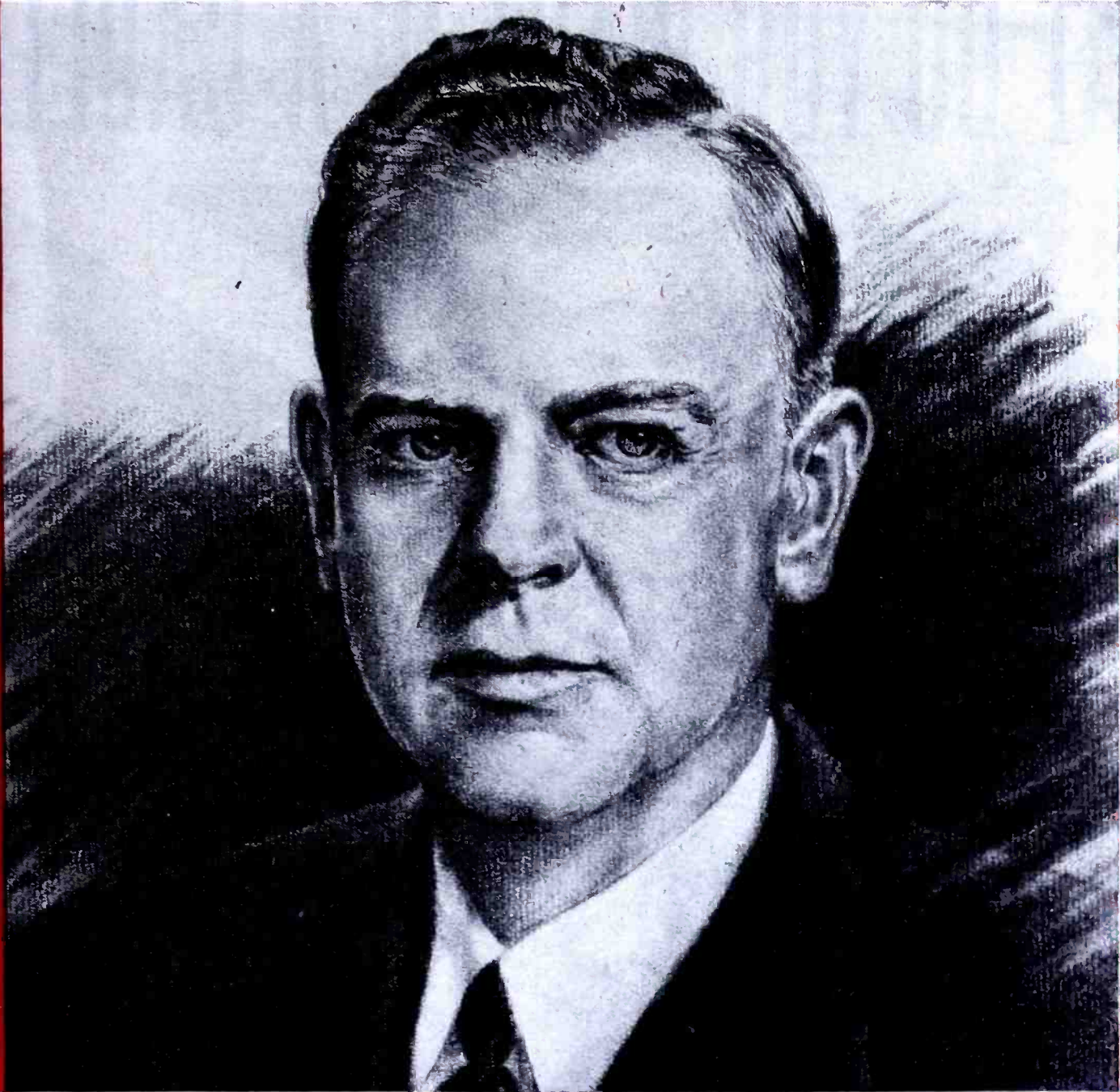

Portrait of Randolph C. Walker by John Carlton

Engineers of Victory

NOW SERVE MEN AT PEACE

The creative engineering which armed our fighting men for Victory has no less a responsibility in the years of peace ahead. Now that the war is won, we have the job of making this a better world.

AIREON produced huge quantities of communications and radar equipment and other machinery for waging war. Its achievements were equal to its heavy responsibilities, and its workers established an outstanding record of performance.

AIREON enters peacetime production with a notable engineering organization, highly skilled personnel and great confidence in the future. We have developed many products which will contribute to better living, for the manufacture of which all 15 AIREON plants will continue in production.

In order to extend our usefulness we recently estab-

lished an experimental laboratory in Greenwich. AIREON's creative engineering in radio communications, electronics, musonics and hydraulics will team with production proficiency in contributing devices for future service.

In peace, as in war, AIREON will stand for quality and performance.

Randolph C. Walker
PRESIDENT

Aireon
MANUFACTURING
CORPORATION

NEW YORK · GREENWICH · CHICAGO · KANSAS CITY · OKLAHOMA CITY · BURBANK · SAN FRANCISCO

WHAT DO YOU WANT IN A CABLE?

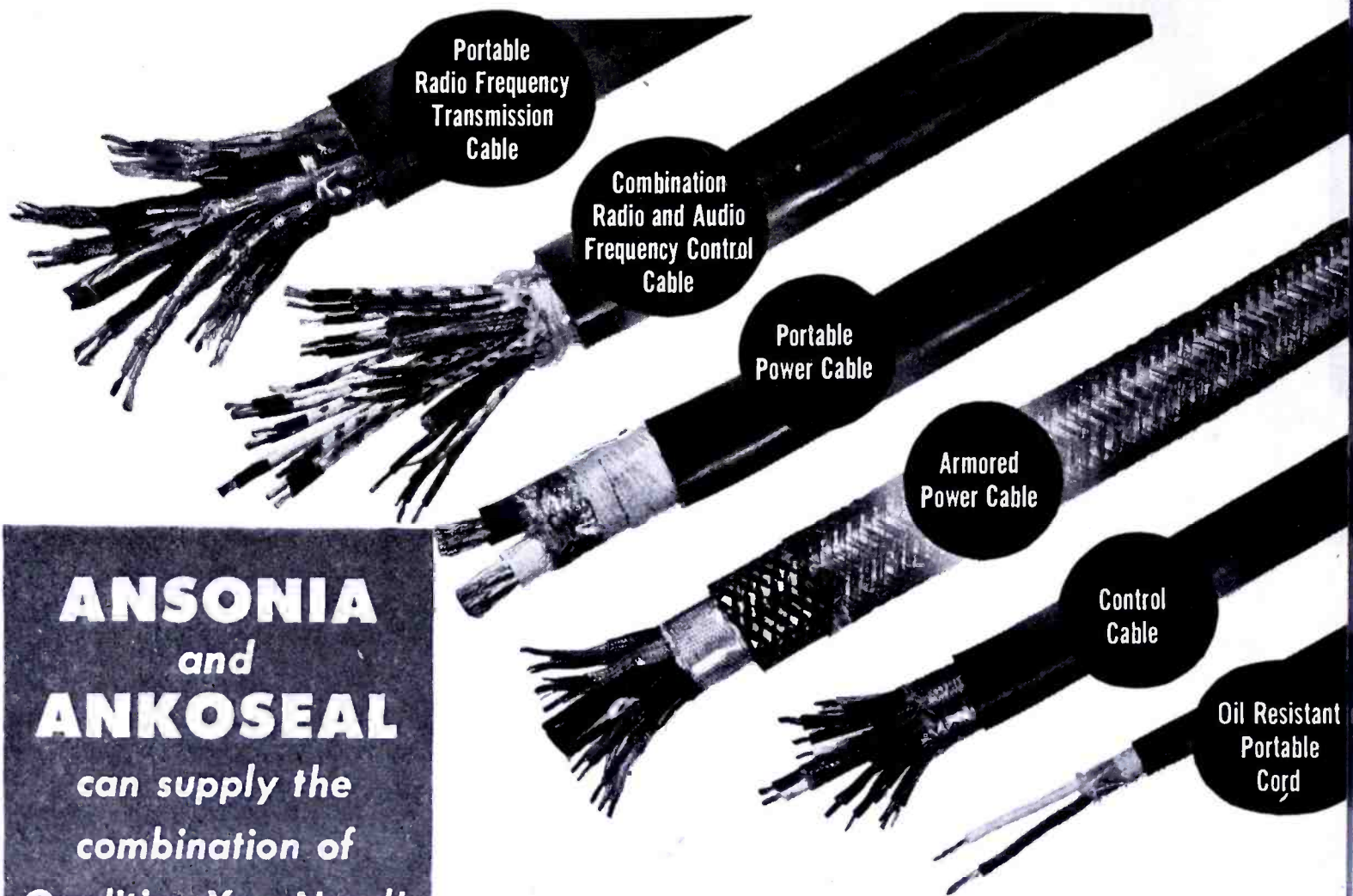

ANSONIA
and
ANKOSEAL
can supply the
combination of
Qualities You Need!

To do your job and do it right, you need cable with certain characteristics. Three or four or more factors—heat resistance, dielectric strength, flexibility and durability, for instance—must be satisfied in the *one* cable. You *can* settle for less—but when a cable fails, it's *your reputation* that suffers.

At Ansonia, electrical cable is engineered to meet *all* necessary requirements as far as that is possible. And,

thanks to ANKOSEAL, a remarkable thermoplastic insulation, our engineers are usually able to combine in one cable all the qualities you need.

Simply tell us what you *want* in a cable—we'll design and produce it. It won't be the cheapest cable—but *it will be right!* The difference will result in longer life and better performance.

We'll be glad to describe in detail what Ansonia can offer you in the form of *job-engineered* cable. Write now for fuller information.

Why ANKOSEAL
solves cable problems

Ankoseal, a thermoplastic insulation, can help solve many electrical engineering problems now and in the future. Polyvinyl Ankoseal possesses notable flame-retarding and oil resisting characteristics; is highly resistant to acids, alkalies, sunlight, moisture, and most solvents. Polyethylene Ankoseal is outstanding for its low dielectric loss in high-frequency transmission. Both have many uses, particularly in the radio and audio fields. Ankoseal cables are the result of extensive laboratory research at Ansonia—the same laboratories apply engineering technique in the solution of cable problems of all types.

THE ANSONIA ELECTRICAL COMPANY



Specializing in "Ankoseal" a Thermoplastic Insulation
ANSONIA • CONNECTICUT



A Wholly-Owned Subsidiary of

NOMA ELECTRIC CORPORATION

GENERAL OFFICES • NEW YORK, N. Y.

Makers of the famous Noma Lights—the greatest name in decorative lighting. Manufacturers of fixed mica dielectric capacitors and other radio, radar and electronic equipment.

MILITARY or COMMERCIAL

—they're BOTH Breeze Shielded

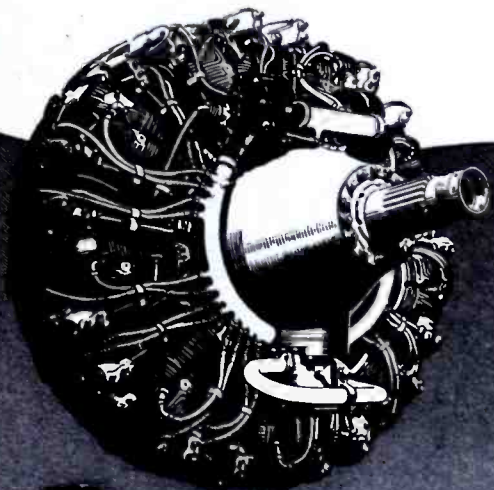

**BREEZE
MARK**

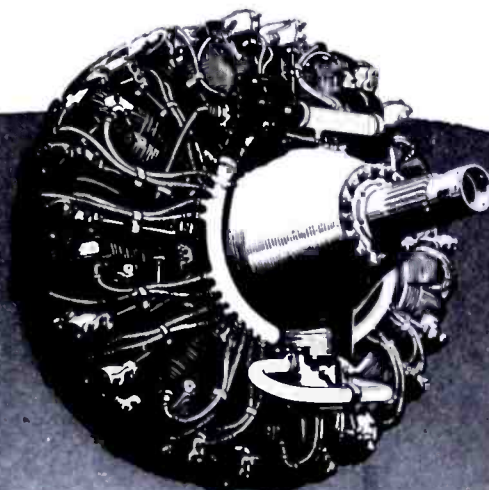

Four Breeze-Shielded Wright Cyclone 18's rated at 2200 HP powered the Boeing B-29 Superfortress in its smashing attacks against the Japanese homeland.

The 55-passenger Lockheed Constellation, whose trans-continental record of 6 hours, 58 minutes was powered by four Breeze-Shielded Wright Cyclone 18's.

● For many years Breeze has been recognized as the General Headquarters for Radio Ignition Shielding. The reputation which the products bearing the Breeze Mark of Quality built up on national and international airlines before the war has now been augmented by the service record of thousands of Breeze Shielding Assemblies for America's famous fighting aircraft, tank, marine and commercial engines. Now that final victory has been won, Breeze returns to production of Shielding for commercial applications without delay for reconversion. And the reservoir of Breeze Shielding experience so materially increased in maintaining dependable communication in war, once again is available to help pace progress in peace.

BREEZE

Corporations Inc.

NEWARK 7  NEW JERSEY

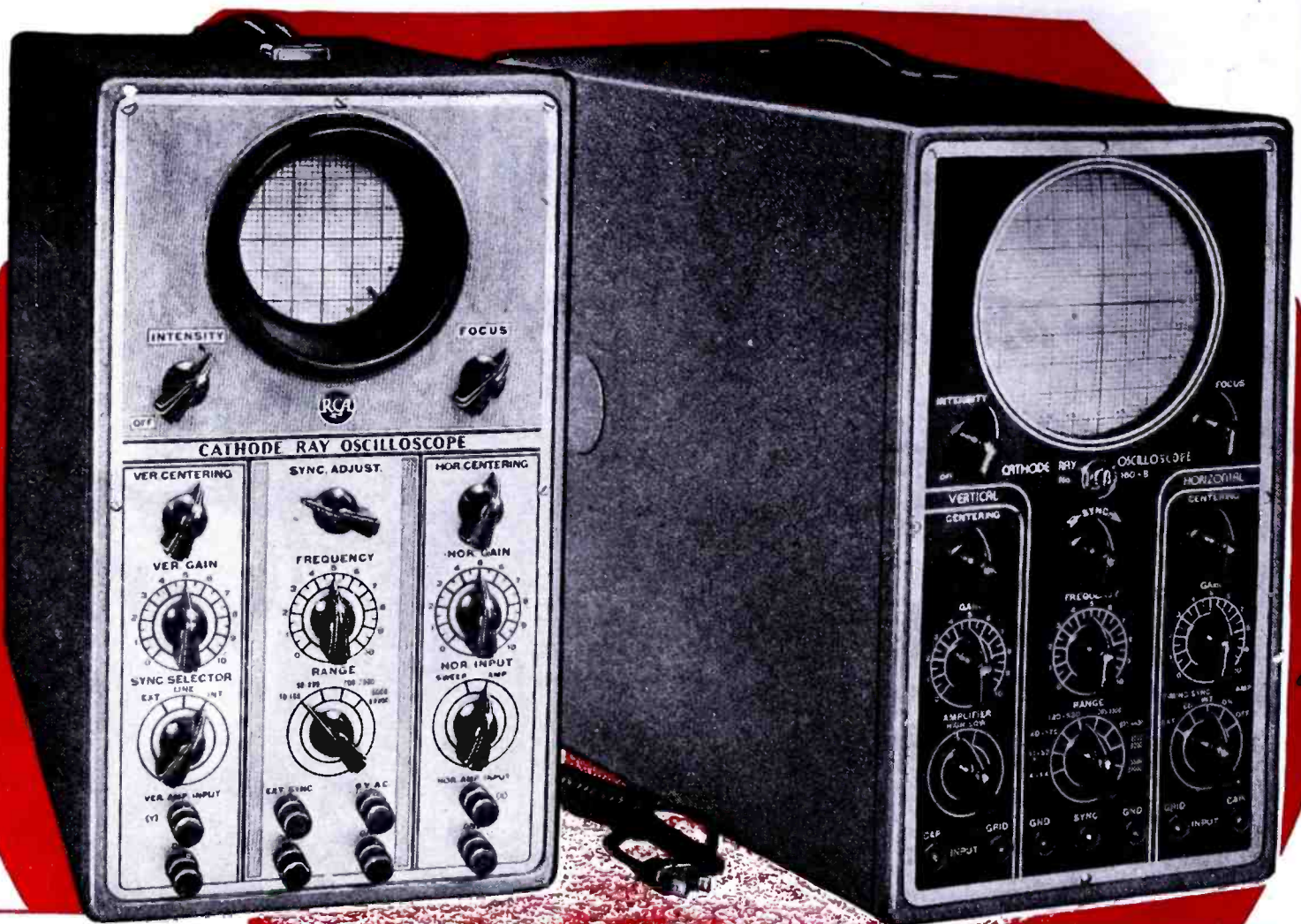

**RCA 155-C 3-INCH
OSCILLOSCOPE**

Easily portable. Adequate and convenient for field work, industrial testing, and most laboratory work. Special light-shield aids accurate observation at low intensity. High-fidelity amplifiers; improved, wide-range timing oscillator.

**RCA 160-B 5-INCH
OSCILLOSCOPE**

Entirely portable. Produces large, clear image on graduated viewing screen. Wide-range deflection amplifiers and low-frequency timing-axis oscillator provide unusual accuracy in measurements. Integral power-supply unit. All controls at front of cabinet.

*Not just your laboratory —
your shop, too,
needs Oscilloscopes!*

• Too many people imagine that cathode-ray oscilloscopes are purely laboratory instruments—not suitable for the shop, or for use by anyone except highly trained technicians. That is a mistake. A mistake that is costing many industrial companies money that could be saved. The RCA oscilloscopes shown above are especially made for practical men who want an instrument of this type, which can be used and maintained with

minimum difficulty and maximum satisfying results. Bear in mind that by using an oscilloscope many jobs can be easily and quickly handled that otherwise would be difficult, time-consuming, or impossible.



BUY BONDS

BUY BONDS

TEST AND MEASURING EQUIPMENT SECTION
RADIO CORPORATION OF AMERICA
Camden, N. J.

Please send me information about RCA Oscilloscopes.

Name.....

Street Address.....

City and State.....

140B

RADIO CORPORATION OF AMERICA

RCA VICTOR DIVISION • CAMDEN, N. J.

In Canada, RCA VICTOR COMPANY LIMITED, Montreal

21 STAR ★ FEATURES



21
NEW!

21
MODERN!

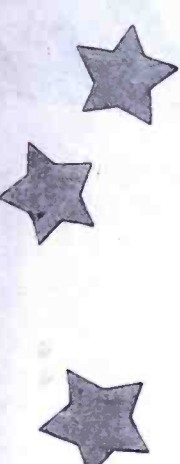

21
DIFFERENT!



Ready Now... the New 1946 EASTERN AMPLIFIERS

QUALITY performance is the keynote of the new 1946 21-Star-Feature series of Eastern Amplifiers. Each model contains the many built-in features exclusively listed as Eastern developments and innovations.

The 21 Star Features include the new Eastern's *AMPLITUDE, a unique circuit component, insuring constant operation under all conditions—Eastern's *UNICABLE construction, eliminating the troubles associated with old-fashioned "floating" com-

ponents—Eastern's *ROTO-VUE scale dials—Eastern's "Coded Cable Wiring Harness"—and many other Eastern contributions to "Soundest Sound" values. And back of this 1946 picture stands Eastern's well-known policy of "Ethical Engineering."

For complete information and price list—for the first edition of our 1946 Catalog—write today! Eastern Amplifier Corporation, 794 E. 140th St., New York 54, N. Y.—Dept. 11G.



EASTERN AMPLIFIERS

VITROHM RESISTORS AND RHEOSTATS

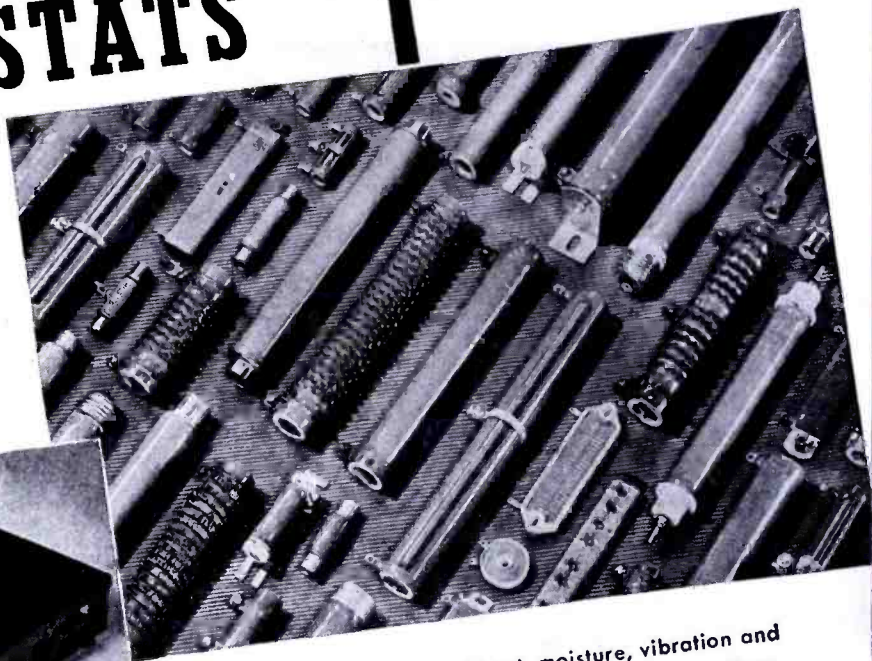

▲ RESISTORS that withstand heat, moisture, vibration and other adverse conditions. Wide range of types, ratings, terminals and enclosures.

◀ RHEOSTATS that include the widest range of sizes, types and current ratings from the tiny ring types for radio to huge power assemblies.

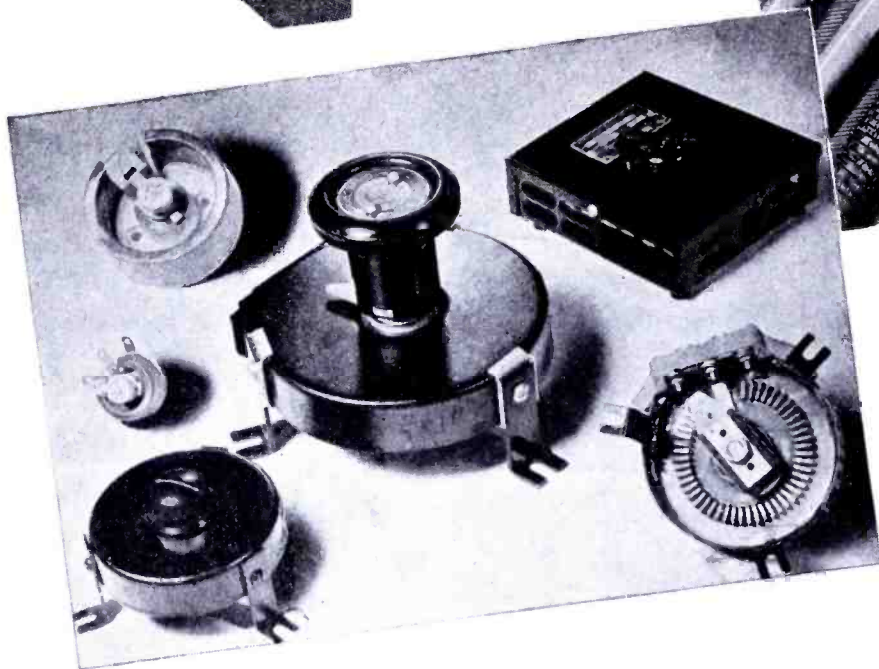

Ward Leonard Vitreous Enameled Wire-Wound Resistors and Rheostats are now available at radio parts distributors.

Better than ever before, because they

incorporate refinements and developments brought about through the war period.

Write for your copy of the Radio and Electronic Resistor Catalog.

WARD LEONARD ELECTRIC CO.

Radio and Electronic Distributor Division



53 WEST JACKSON BLVD., CHICAGO, ILL.



WARD LEONARD
ACCEPTED MEASURE OF QUALITY

RESISTORS
RHEOSTATS
RELAYS

distinguished cabinet member

on a secret mission . . .

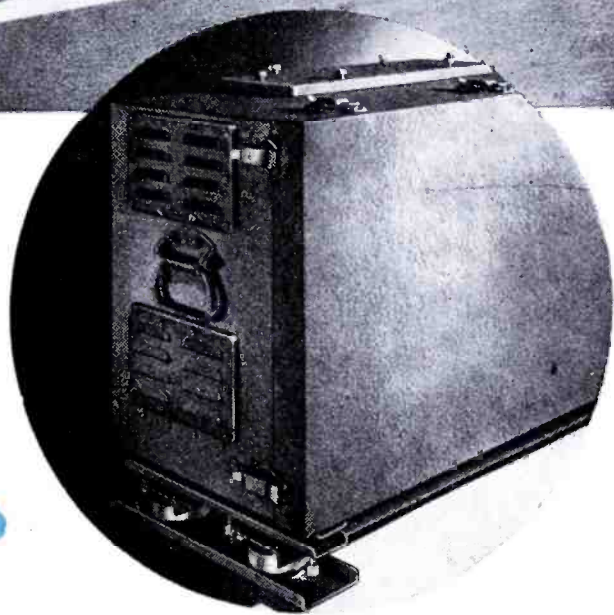
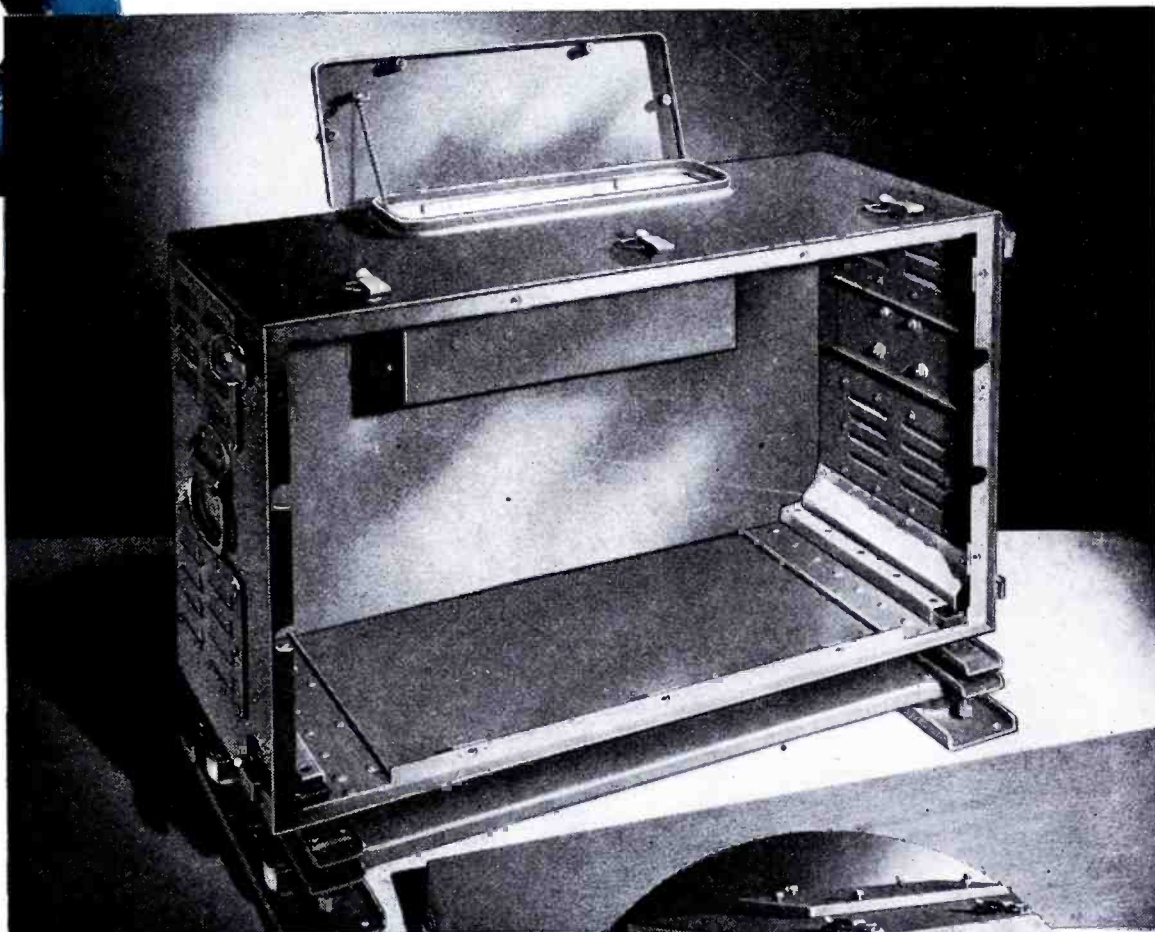

The actual use of this Karp-constructed cabinet assembly for electronic apparatus is a military secret.

We can, however, reveal the superior details of the all-welded aluminum construction. It is splash-proof, insect-proof—and at the same time ventilated. The assembly also includes a shock mount. Suspension slides permit the electronic apparatus to move in and out like a drawer.

If you require special-built housings, racks, panels, chassis or enclosures for electrical equipment, get the benefit of our 20 years of specialized experience in this field. Our hundreds of skilled craftsmen will save your time. Our complete facilities and numerous stock dies will save you money.

ANY METAL • ANY GAUGE • ANY SIZE • ANY FINISH

KARP

METAL PRODUCTS CO., INC.

Custom Craftsmen in Sheet Metal

127 -30th Street, Brooklyn 32, N. Y.



RADIO INTERFERENCE ?

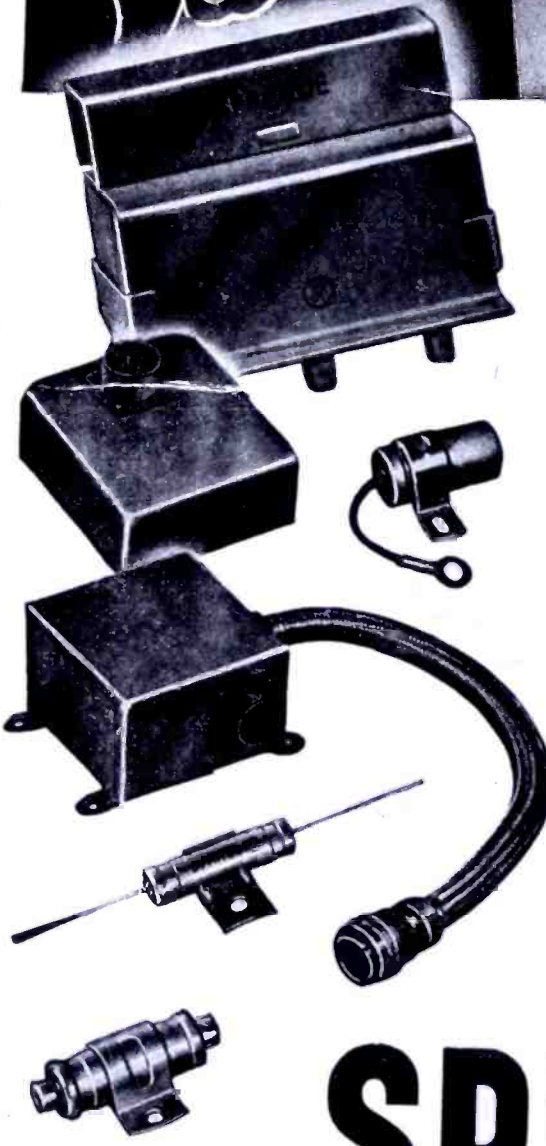
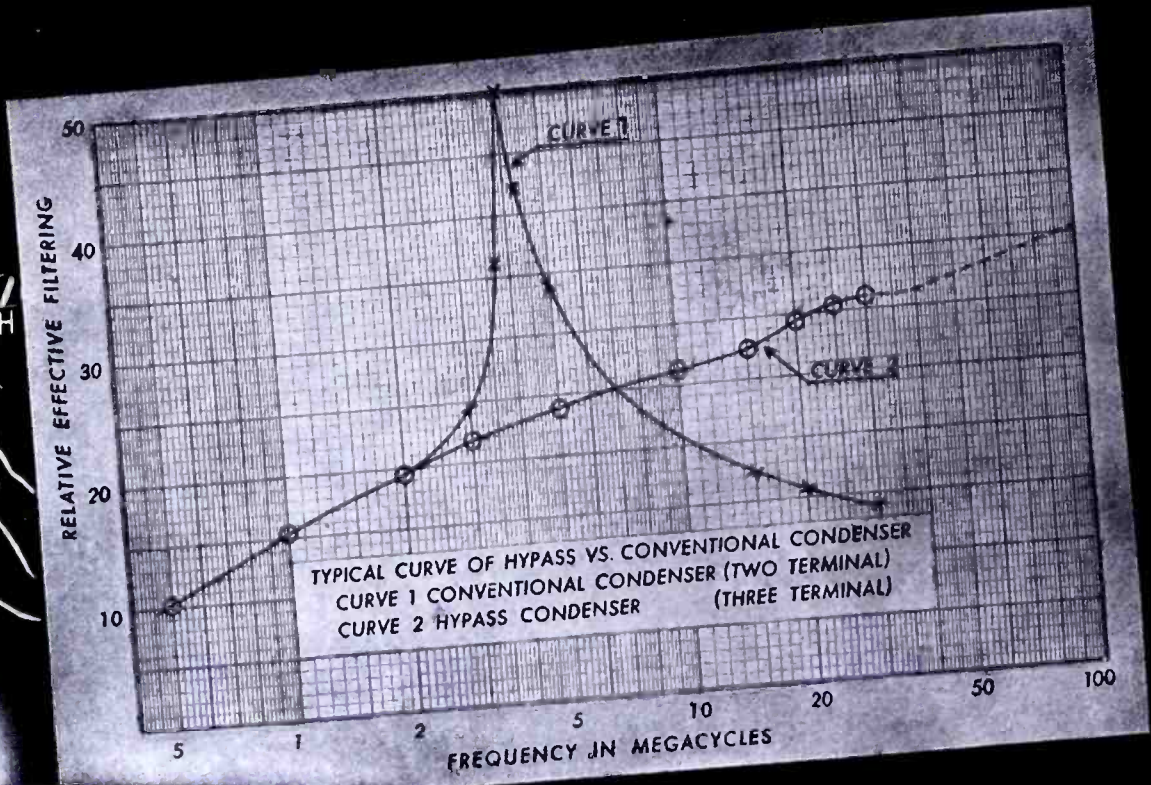

SPRAGUE HAS *the Answers!*

From inexpensive noise suppression capacitors for automotive use, to heavy-duty designs for service on power equipment, and for current ratings from 5 to 200 amperes capacity, Sprague produces modern filter units for practically any need. An unsurpassed background of engineering experience in dealing with all types of radio noise interference problems, is here at your disposal. Write for Sprague Capacitor Catalog 20.

ANTI-RESONANT FREQUENCY PROBLEMS SOLVED

Have you a vibrator "hash" problem that a conventional by-pass capacitor shunted by a mica capacitor only partially solves?

Write for details on Sprague *HYPASS Capacitors, the 3-terminal networks that do the job at 100 megacycles or more!

SPRAGUE ELECTRIC COMPANY
 North Adams, Mass.

*Trademark Reg.
 U. S. Pat. Off.

SPRAGUE

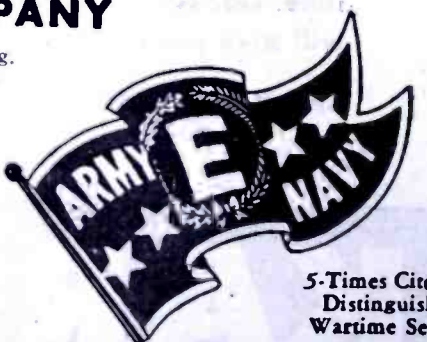

5-Times Cited for
 Distinguished
 Wartime Service

PIONEERS OF ELECTRIC-ELECTRONIC PROGRESS

RAYTHEON VOLTAGE STABILIZERS

- ★ **CONTROL OF OUTPUT VOLTAGE** to within $\pm 1/2\%$ of 115 V. or 230 V. This assures accurate operation of electrical equipment by stabilizing A.C. voltage from supply mains where input often varies as much as from 95 to 130 V. or from 190 to 260 V.
- ★ **QUICK RESPONSE.** Stabilizes varying input voltage within one twentieth of a second. Output variations cannot be detected on an ordinary voltmeter.
- ★ **STABILIZES** at any load within rated capacities from 95-130 V. and 190-260 V.
- ★ **ENTIRELY AUTOMATIC.** No adjustments. No moving parts. No maintenance. A magnetic unit assuring long, service-proof life.
- ★ **RAYTHEON VOLTAGE STABILIZERS** are improving performance of electrical equipment in a wide variety of applications.
- ★ **YOU'LL FIND** the complete story in Stabilizer Bulletin DL48-537. Write for your copy today.

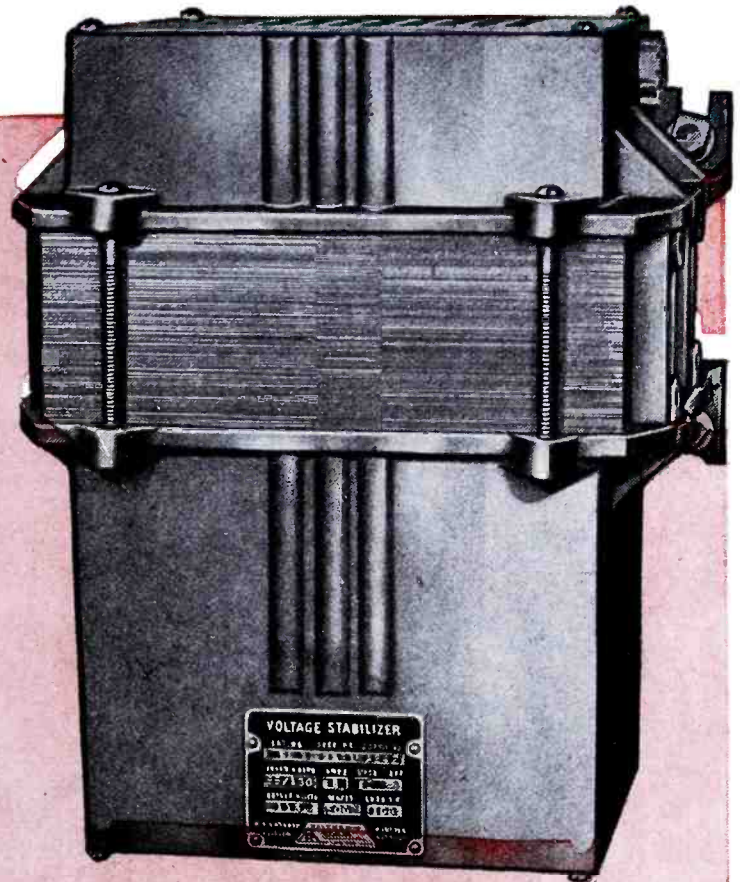

ENDBELL MODEL

Catalog Number	Cap'y in Watts	OVERALL			
		L		W	H
		50~	60~		
VR-5	500	13 1/8	12 1/2	9 5/8	8 1/2
VR-6	1000	14 5/8	14	14 3/4	11 1/4
VR-7	2000	17 1/2	16 3/8	14 3/4	11 1/4

CASED MODEL

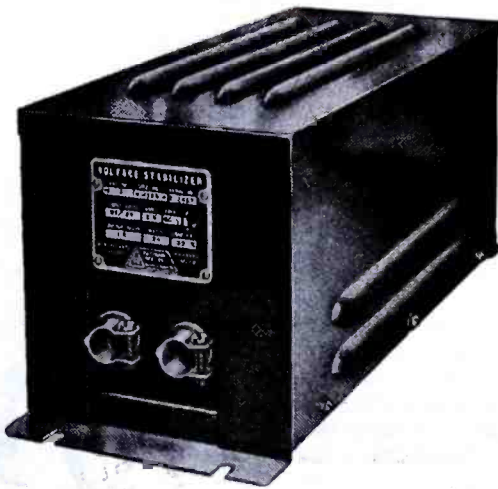

CASED MODEL DIMENSIONS IN INCHES					
Catalog Number	Cap'y in Watts	OVERALL			
		L	W	H	
VR-1	30	8 7/8	3 7/16	4 1/2	
VR-2	60	11 3/8	5 7/8	5 5/8	
VR-3	120	15	6	6 1/4	
VR-4	250	18 5/8	7	8 7/8	

APPLICATIONS:

- ★ Radio • Television
Communications • Radar
- ★ Motion Pictures
Sound Recording
- ★ Electronic Devices
- ★ Constant Speed Motors
Production Machinery
- ★ Signal Systems
- ★ X-ray Equipment
- ★ Testing and Laboratory
Equipment

UNCASED MODEL

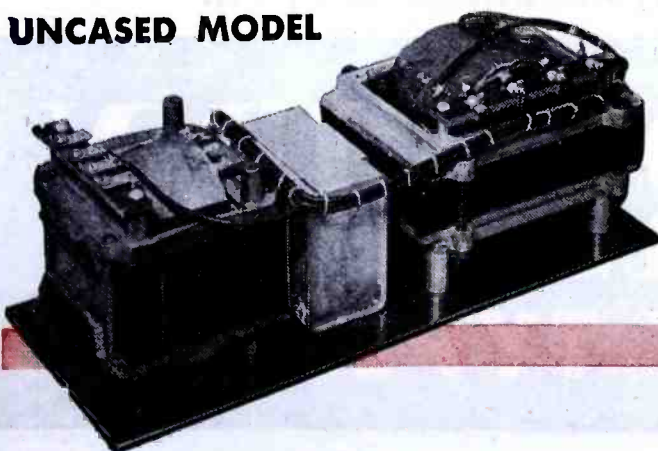

UNCASED MODEL DIMENSIONS IN INCHES					
Catalog Number	Cap'y in Watts	OVERALL			
		L	W	H Max.	
VR-1	30	7 9/16	3	3 5/8	
VR-2	60	7 7/8	5 11/16	5 3/16	
VR-3	120	12 7/32	5 11/16	5 3/8	
VR-4	250	15 9/16	6 3/4	7	

RAYTHEON

MANUFACTURING COMPANY
WALTHAM 54, MASS.

ELECTRICAL EQUIPMENT DIVISION
Excellence in Electronics

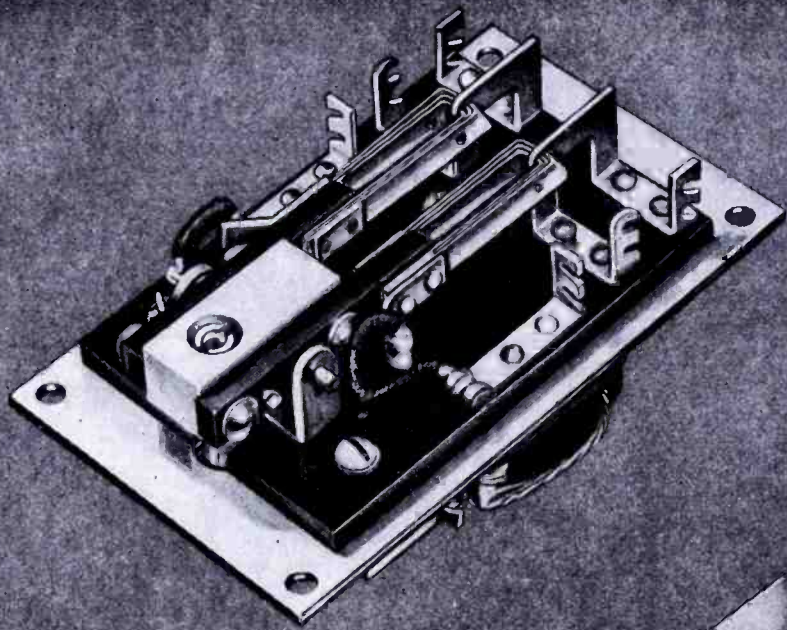

✓ **MAKE-BEFORE-BREAK CONTACT**
 Action eliminates transfer "click" interferences or circuit interruptions.

✓ **UNIQUE LAMINATED BRUSH TYPE CONTACTS**
 ... low and constant contact resistance.

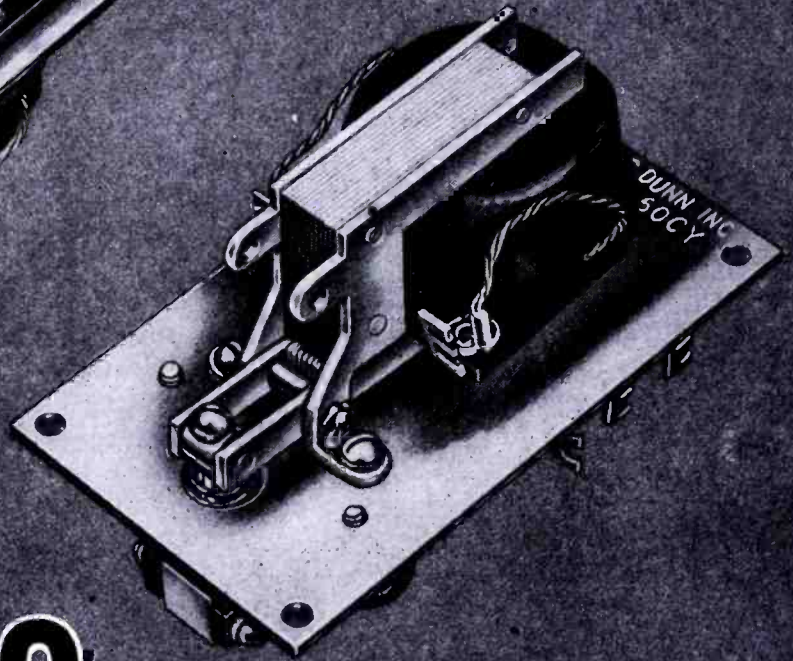

91XBX100 DESIGNED FOR MICROPHONE AND THERMO-COUPLE SWITCHING CIRCUITS . . . and other extremely low power control applications

The Struthers-Dunn a-c operated Type 91XBX100 Relay has double-pole double-throw, make-before-break contacts that are especially designed for handling milli-volt, milli-ampere, and milli-watt loads. Each moving contact consists of six laminations. The long sliding motion of the six contact surfaces results in extremely low and constant contact resistance, thus assuring electrically smooth performance—a "must" in audio frequency or recording instrument switching circuits.

The metal mounting plate acts as a shield, isolating the magnetic structure from the contacts, minimizing the possibility of induced a-c hum in the contact circuits.

Operating coils are available for use on standard voltages up to 230 volts a-c, 60 cycles.

**DISTRICT ENGINEERING OFFICES
 IN THESE CITIES TO SERVE YOU:**

ATLANTA • BALTIMORE • BOSTON •
 BUFFALO • CHICAGO • CINCINNATI •
 CLEVELAND • DALLAS • DENVER •
 DETROIT • HARTFORD • INDIANAPOLIS
 • LOS ANGELES • MINNEAPOLIS • MON-
 TREAL • NEW YORK • PITTSBURGH •
 ST. LOUIS • SAN FRANCISCO • SEATTLE
 SYRACUSE • TORONTO



STRUTHERS-DUNN, Inc., 1321 Arch Street, Philadelphia 7, Pa.

STRUTHERS-DUNN

5,312 RELAY TYPES

Here's the easiest way to get 10 WATTS OUTPUT at 156 Mc!

Build your Xmtr around HK-24G *Gammatrons*

JAN 3C24

Designing transmitters for the 152 to 162 megacycle region can be greatly simplified through the use of HK-24Gs. In the circuit below one of these tubes produces 10 watts at 156 Mc; more than ample to excite a pair of HK-257Bs in a 400 watt final.

These efficient Gammatrons, with low inter-electrode capacities and short plate and grid leads, are the answer for those who are engineering 1.9-meter equipment for railroads, police point-to-point, fire, press or broadcast relays, maritime, geophysical, urban telephone, and experimental use. They are also ideally suited for amateur transmitters on the 144-148 megacycle band, authorized as of November 15.

Not only will HK-24Gs do the job, but they will do it at low cost. Made with tantalum elements, without internal insulators, they can withstand heavy overloads and have a long operating life. And they are offered at a new low price made possible by improved production methods.

HK-24Gs are available now in quantity . . . and are one of Heintz and Kaufman's *standardized* types. Maximum plate dissipation 25 watts. Write today for data.

HEINTZ AND KAUFMAN LTD.

SOUTH SAN FRANCISCO • CALIFORNIA

EXPORT AGENTS: M. SIMON & SON CO., INC., 25 WARREN STREET, NEW YORK CITY, N. Y.



Now
ONLY \$ **6⁰⁰**

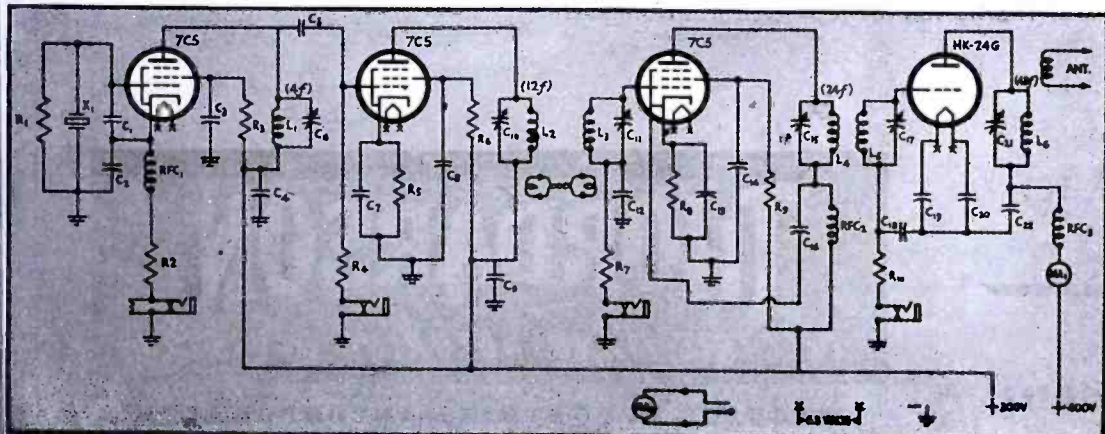

COMPONENT PARTS FOR WIRING DIAGRAM

- | | |
|--|---|
| C ₁ —35 mmfd. | R ₇ —100,000 ohms, ½ watt |
| C ₂ —250 mmfd. | R ₁₀ —15,000 ohms, 2 watts |
| C ₃ , C ₄ , C ₇ , C ₈ , C ₉ , C ₁₂ , C ₁₃ , | RFC ₁ —2.5 mh. |
| C ₁₄ —0.002 mfd. | RFC ₂ |
| C ₅ —50 mmfd. | RFC ₃ —Hf choke, approx. 50 |
| C ₆ —APC 100 | turns No. 32 on ¼" form. |
| C ₁₀ , C ₁₁ , C ₁₅ , C ₁₇ — | MA ₁ —0-100 ma. |
| APC 25 mmfd. | MA ₂ —0-25 ma. |
| C ₁₆ , C ₁₈ , C ₂₂ —100 mmfd. | X ₁ —3.5 Mc. crystal |
| C ₁₉ , C ₂₀ —250 mmfd. | L ₁ —19 turns No. 22 DCC ⅜" |
| C ₂₁ —15 mmfd. | form |
| R ₁ —100,000 ohms, ½ watt | L ₂ —7 turns No. 14 enamel, |
| R ₂ —200 ohms, 1 watt | ⅜" dia. Length ⅜" air, link |
| R ₃ —10,000 ohms, 1 watt | L ₃ coupled to L ₂ with one turn. |
| R ₄ —250,000 ohms, ½ watt | L ₄ —6 turns No. 14 enamel, dia. |
| R ₅ , R ₈ —500 ohms, 1 watt | ⅜", length 7/16" air, induc- |
| R ₆ , R ₉ —20,000 ohms, 1 watt | L ₅ tively coupled on same axis. |
| | L ₆ —4 turns No. 12 copper, dia. |
| | ⅜", length ⅜" |

Note: Grid and plate by-passes on driver and doubler final should be returned directly to tube cathode. All jacks are closed circuit jacks.



A background of Performance—over 50 years—is the *inside story* of the popularity that has brought leadership to *Thordarson* transformers. Performance over the years, after all, is the only true test of product quality.

Consumer acceptance will continue because *Thordarson* research and design engineers are never satisfied just keeping abreast of the times. These men are continually developing many transformer components which are instrumental in the production of new and better performing devices and equipment for the electronics industry.

This same pioneering spirit has been responsible for many new *Thordarson* transformer applications and developments during the war . . . all of which will be available shortly for civilian requirements.

Thordarson's well-tested methods of sales promotion and distribution will continue their joint task of making *Thordarson* Transformers, together with complete information on their applications and use, available to everyone in the field.

Always think of Thordarson for top-notch transformers!

500 WEST HURON ST., CHICAGO, ILL.



ORIGINATORS OF TRU-FIDELITY AMPLIFIERS.

THORDARSON
 ELECTRIC MANUFACTURING DIVISION
 MAGUIRE INDUSTRIES, INCORPORATED

California's mountains & valleys were **TOUGH**

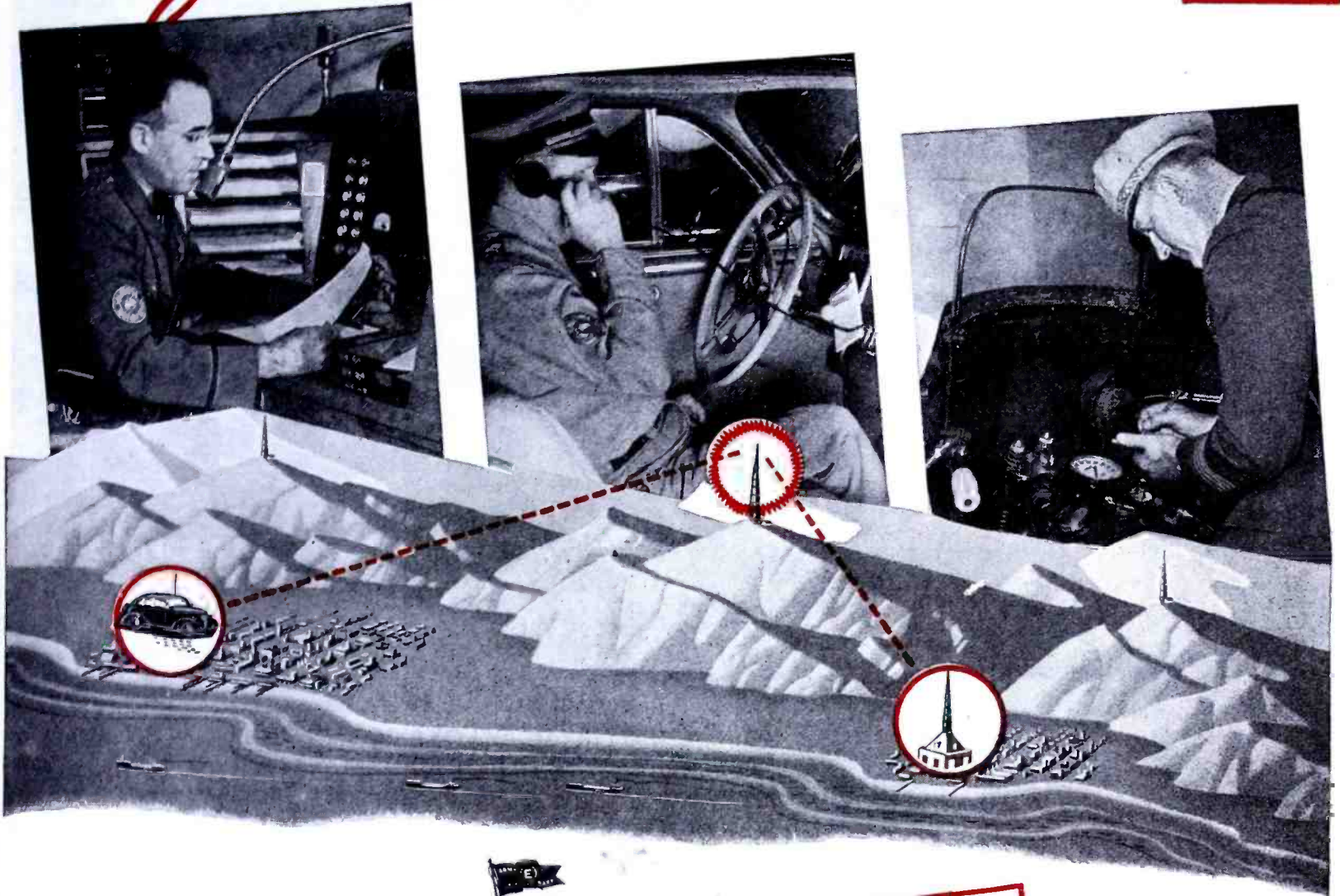

... but not for

Motorola **F-M** Radio

California's 158,693 square miles and 117,760 miles of roadways—with mountains like Mt. Whitney, 14,498 feet above sea level, and valleys like Death Valley, 300 feet below sea level—presented problems in state-wide coverage by radiotelephone that were super-tough.

Nevertheless, by the use of Motorola Radiotelephone F-M units and Motorola Radio automatic relay stations, the California State Highway Patrol has excellent radiotele-



phone communications with the 485 two-way patrol cars and the 377 one-way motorcycles patrolling California's 58 counties.

Your State, County, City or Community should take advantage of the skill and experience that Motorola Radio engineers have displayed in installing F-M 2- and 3-way Radiotelephone systems in 33 States and over 1,000 communities throughout the United States, the Canal Zone and Hawaiian Islands.

For Full Details, Write Today.

GALVIN MFG. CORPORATION • CHICAGO 51

F-M & A-M HOME RADIO • AUTO RADIO • AUTOMATIC PHONOGRAPHS • TELEVISION • F-M POLICE RADIO • RADAR • MILITARY RADIO

Compare the actual battery drain!*

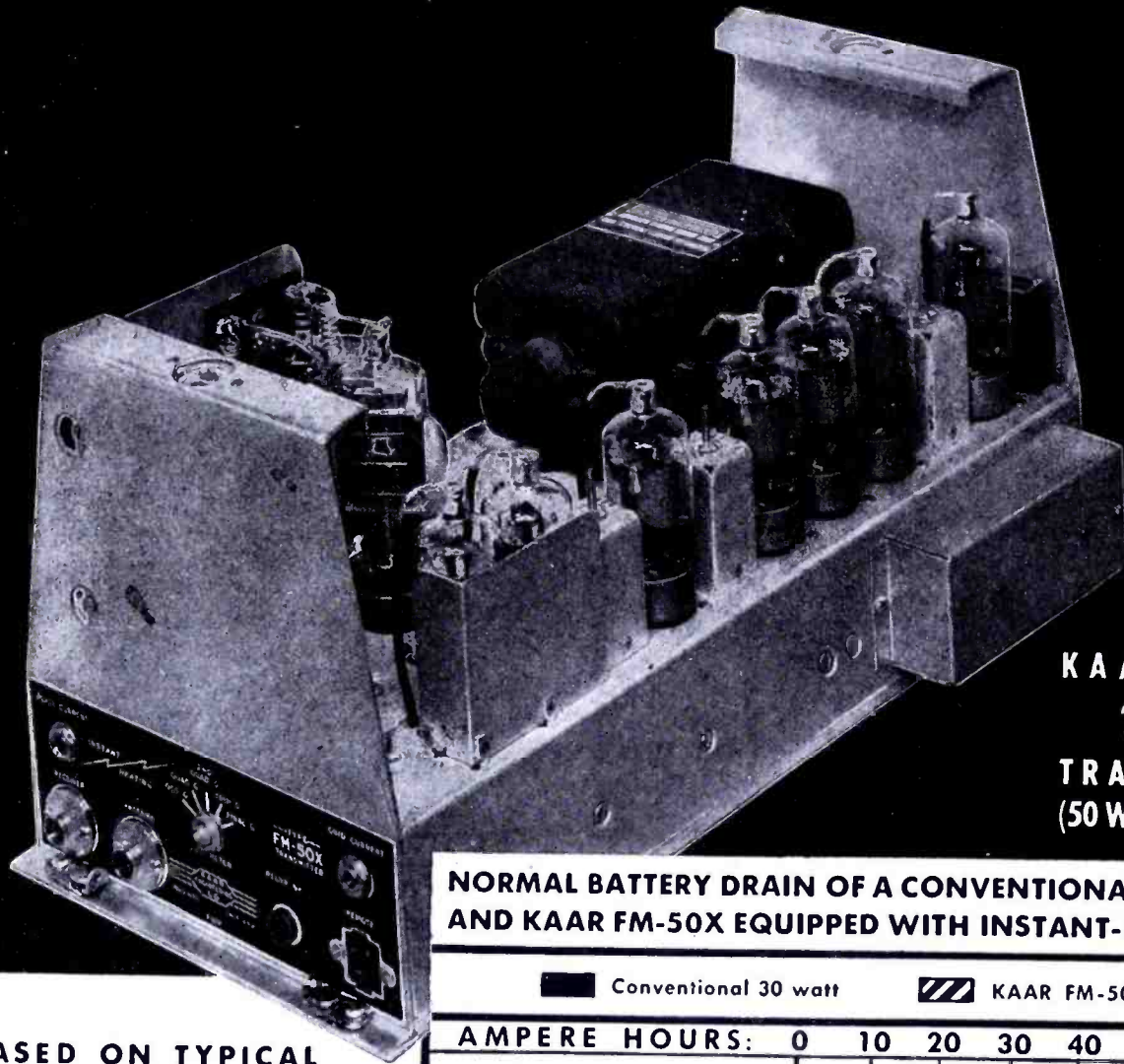

KAAR FM-50X
Mobile
TRANSMITTER
(50 WATTS OUTPUT)

NORMAL BATTERY DRAIN OF A CONVENTIONAL TRANSMITTER AND KAAR FM-50X EQUIPPED WITH INSTANT-HEATING TUBES

■ Conventional 30 watt ▨ KAAR FM-50X · 50 watt

AMPERE HOURS: 0 10 20 30 40 50 60 70

STANDBY DRAIN
24 HOUR PERIOD

55.2 AMPERE HOURS

0.0 AMP. HRS.—YET READY TO TALK INSTANTLY!

AVERAGE TOTAL
BATTERY DRAIN
24 HOUR PERIOD

56.8 AMPERE HOURS

2.2 AMPERE HOURS

* CHART BASED ON TYPICAL METROPOLITAN POLICE USE

(140 Radiotelephone-equipped cars operating three shifts in city of 600,000 population.)

MESSAGES ORIGINATED BY CARS	904
MESSAGES ACKNOWLEDGED BY CARS	932
TOTAL TRANSMISSIONS PER CAR	13
AVE. LENGTH OF TRANSMISSION	15 sec.
AVE. TRANSMITTING TIME 24 HOURS	3 min. 15 sec.

KAAR mobile FM-50X transmitter gives you 20 watts more output with only 1/25th usual battery drain!

KAAR engineers—who pioneered the instant-heating AM radiotelephone—have now, through the use of instant-heating tubes, made 50 and 100 watt mobile FM transmitters practical! Thus you gain greater power and range—along with a tremendous reduction in battery drain!

With instant-heating KAAR equipment standby-current is zero—yet the moment you press the button microphone you are on the air. Contrast this with conventional emergency transmitters, over 90% of which operate with the filaments "hot" during stand-by. Since sturdy instant-heating tubes eliminate this great waste of energy without slowing the handling of messages,

KAAR 50 and 100 watt transmitters can be operated from the standard ignition battery!

100 WATT MOBILE FM!

The KAAR FM-100X is identical to the FM-50X, except for the final amplifier. It puts 100 watts into a standard 34 ohm non-inductive load and is ideal for county and state police use. It requires no special batteries, wiring, or generator changes.

ADDITIONAL FEATURES

A new system of modulating the phase modulator tubes in KAAR FM transmitters provides excellent voice quality. Note that the equipment is highly accessible, and only two types of tubes are used. Frequency range: 30 to 44 megacycles.

Write today for free bulletin describing KAAR FM transmitters in detail. It's ready now!

KAAR ENGINEERING CO.

PALO ALTO

CALIFORNIA

Export Agents: FRAZAR AND HANSEN · 301 Clay St · San Francisco, Calif.

Must we go back?



The evolution of electronics will always remain a bright page in the history books of science. And the record has been significantly brilliant during the past four years when improvements and developments were advanced at a faster rate than normal. With the ending of the war, there may be a few who do not feel the urgency to progress at a similar pace . . . who will be willing to relax the rigid wartime standards. Or there may be those who do not too accurately gauge the temper of the consumer, now in a mood to anticipate only the best from an industry which has accomplished such miracles in the past few years.

Along with many other far-sighted producers, we here at Marion fully intend to maintain our wartime quality pattern, and to cooperate in every known way to provide even better products for a peaceful world. We endorse the postwar standardization program of the Army and Navy Electronics Standards Agency, and will continue to manufacture all Marion electrical indicating instruments in conformity with JAN specifications. Our customers have a right to expect nothing else.

It is important to note that continued adherence to the Electronics Standards Agency program need not result in increased costs, either to the manufacturer or the consumer . . . while it will definitely result in improved product performance wherever such standardized components are used.

We, the manufacturers, engineers, consumers of electronics, are part of a vital, daring, visionary industry. It is with this realization that we are faced with the responsibility of deciding, at this time, whether we can relax, or whether we shouldn't give as much to a world at peace as we gave to a world at war.

Your comments will be welcomed.



MARION ELECTRICAL INSTRUMENT CO.

MANCHESTER, NEW HAMPSHIRE

EXPORT DIVISION 458 BROADWAY • NEW YORK 13, N. Y., U. S. A.

CABLE ADDRESS: MORHANEX



CLAIM STAKING

Hallicrafters and Very High Frequency

Based on the facts in the case, Hallicrafters can stake out a very strong claim to leadership in the very high frequency field. The facts include such things as the Model S-37, FM-AM receiver for very high frequency work. The Model S-37 operates from 130 to 210 Mc.—the highest frequency range of any general coverage commercial type receiver.

Hallicrafters further supports its claim to domination in the high frequency field with the Model S-36A, FM-AM-CW receiver. The 36A operates from 27.8 to 143 Mc., covers both old and new FM bands and is the only commercially built receiver covering this range.

Further developments in this direction can soon be revealed—adding further support to Hallicrafters claim to continued supremacy in the high frequency field.

HALLICRAFTERS NEW \$600,000 HOME NOW UNDER CONSTRUCTION.



hallicrafters RADIO



THE HALLICRAFTERS CO., MANUFACTURERS OF RADIO AND ELECTRONIC EQUIPMENT • CHICAGO 16, U. S. A.

COPYRIGHT 1945 THE HALLICRAFTERS CO.

RADIART VIBRATOR GUIDE (Most Complete Published)

*Makes
Vibrator Servicing
Easy!*

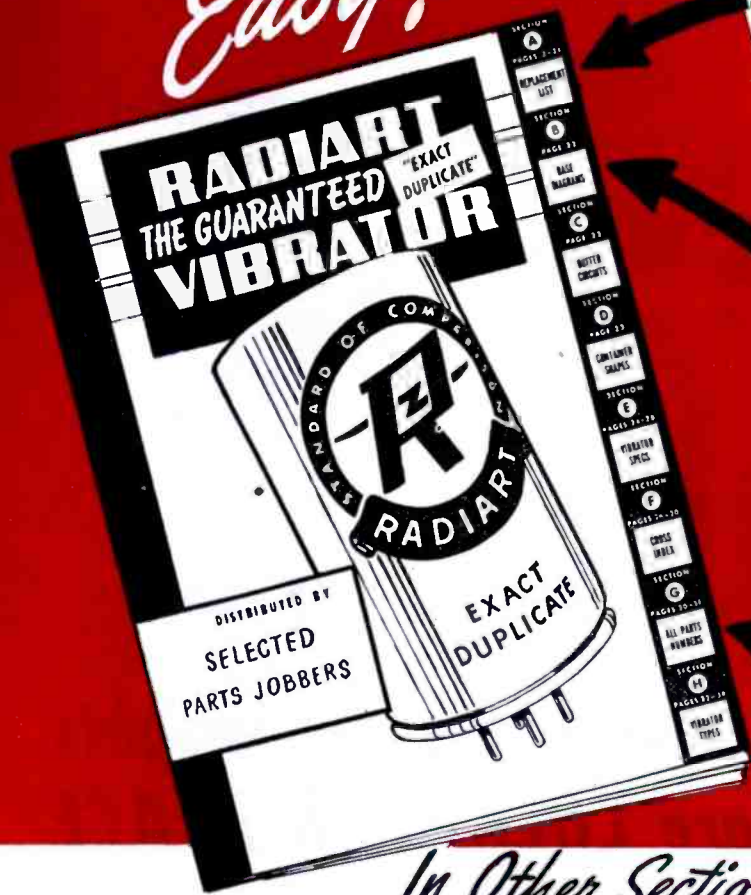

In Other Sections..

Section "C"—Buffer Condenser Values and Circuits.

Section "D"—Container Shapes permitting an easy method of "visual" identification.

Section "E"—Complete Vibrator Specifications arranged numerically by number. Contains necessary data not published in any other replacement guide.

Section "F"—Long a favorite with users of this guide. The only cross-index of all other manufacturers or merchandisers of vibrators, converting their type numbers to the Correct Radiart Replacement.

Section "H"—Numerical Listing of Radiart Vibrators. Furnishes complete information as to all models serviced by each unit. Also advises year each type was originated.

Auto Radio Service Dealers:

Obtain this Guide free of charge from your Radiart Distributor. Ask him to furnish you with a stock of the popular 12 types of Radiart Vibrators each of which is guaranteed to CORRECTLY service the applications listed for it in this guide. With these 12 types you can satisfy nearly all of the "Demand" types. But — RADIART is a complete line and your Radiart Distributor renders a complete service and can quickly furnish all of the necessary slower moving correct Radiart Replacement Vibrators as well.

Manufactured by the makers of RADIART Rust Proof Aerials.



Radiart Corporation

3571 W. 62nd STREET
Export Division
25 Warren St., New York 7, N.Y.

CLEVELAND 2, OHIO
Canadian Office
455 Craig St., W., Montreal, Canada

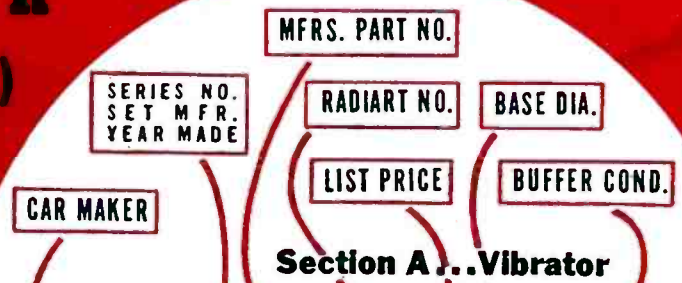

Section A...Vibrator

Name, Model No.	Mfrs. Part Number	Radiart Number	List Price	Base Dia.	Buffer Condenser
CHRYSLER					
C1808 (Elec. P. B.) (Philco—1941)...	83-0027	5326P	3.00	A	.005
25C6 (Wells-Gardner—1938)...	19A32	5437	5.95	AB	.018
600 (Mech. P.B.) (Colonial—1941)...	43697	5301	3.55	A	.004
601 (Colonial—1942)...	911545	5301	3.55	A	.004
800 (Philco—1941)...	83-0027	5326P	3.00	A	.005

Every model listed includes all available data. The correct Radiart Replacement number and other essential information is determined instantly.

SECTION "B"—Cross

Diagram Number	Shape	Voltage	Diam.	Ht.	Freq.	Identifying Characteristics	Max. Load Amps
B 3417	2 6	1 1/2	4 1/2	105			6
B 3815	9 6	1 1/2	4 1/2	105	Spec. Cup		6
C 5309	1 6	1 1/2	2 3/8	105			6
C 5331	1 6	1 1/2	3 1/4	105			6
D 4256	1 6	1 1/2	3 1/4	105			10
D 4256-12	1 12	1 1/2	3 1/4	105			6

In addition to conventional base diagram drawings this section is unique in that it groups all similar base types together indicating readily the differences between vibrators with the same base wiring. All characteristics are shown, including frequency and maximum load limit of each type.

SECTION "G"—Radiart and Original Equ.

Original Equipment Part No.	Radiart Nos.	Original Equipment Part No.	Radiart Nos.	Original Equipment Part No.
75	3283	1974	5301	8539
80-161	5421	2080	3417	8540
82B	5341M	2110	3417	8541
83-0017	5326P	2269	5413	8542
83-0025	5326P	2404	5340M	8601
83-0026	5326P	2501	5411	8602

Another Radiart Vibrator Guide EXCLUSIVE feature. When called upon to duplicate a vibrator and no information is available except the number on the old one, use this cross-index which shows the original manufacturer's number (as stamped on vibrator) and the CORRECT Radiart Replacement.

Because Accuracy Hangs in the Balance

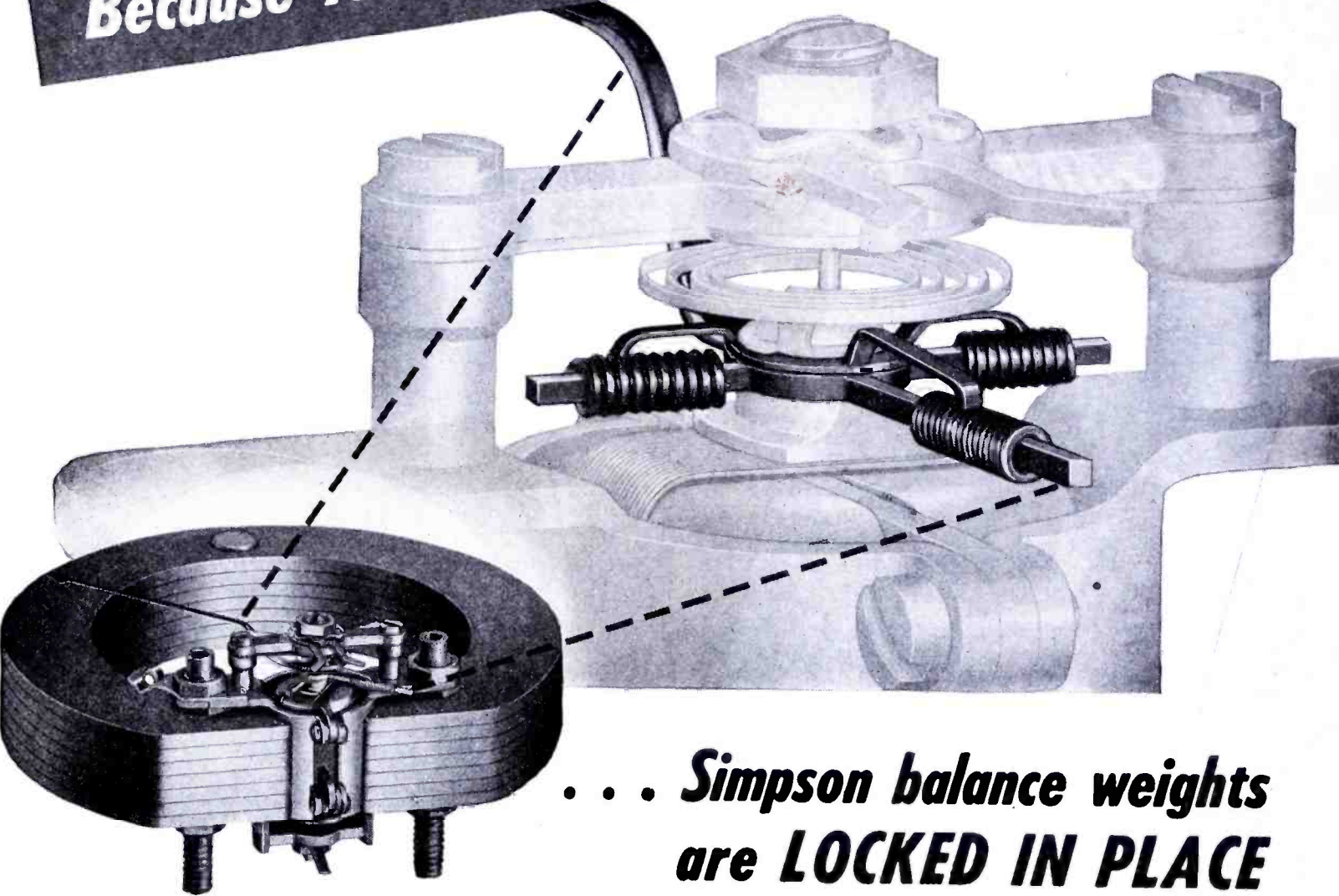

... Simpson balance weights are LOCKED IN PLACE

PERHAPS it's the smaller details, like these balance weights, that best illustrate the value of Simpson's 35 years of experience.

Though only tiny coils of wire, these balance weights have an important function—to offset the weight of the pointer so the moving assembly will swing in perfect balance. If the instrument is to stay accurate, they must stay in place.

So Simpson has devised a method of locking these balance weights in position. This construction not only defeats vibration and shock, it per-

mits even greater initial accuracy and makes possible faster, more efficient production.

Such refinements come from a greater knowledge of the problems of instrument manufacture, and a greater fund of practical experience which can be applied to their solution. This is the simple reason Simpson Instruments are writing such an outstanding service record in posts of vital responsibility. This, too, is your guarantee of the ablest translation of today's advances in tomorrow's instruments.

SIMPSON ELECTRIC COMPANY
5200-5218 Kinzie St., Chicago 44, Illinois

Simpson

INSTRUMENTS THAT STAY ACCURATE

Buy War Bonds and Stamps for Victory

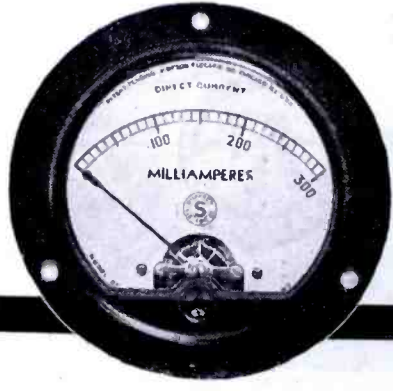

SYNTHETICS FOR ELECTRONICS

CONNECTORS

STEATITE SOCKETS

SYNTHETICS FOR ELECTRONICS

A-N FITTINGS

COAXIAL CABLES

The Line That Reaches 'Round the World



A-N CONNECTORS

CONNECTORS

PREFOCUSED LAMP RECEPTACLES

MICROPHONE CONNECTORS

With a proven background of honorable service on far-flung battlefronts around the world, Amphenol components—greatly improved by wartime experience and augmented in number, style and type—are now available to normal markets. Simplifying both buying and selling, this wider selection of high quality, tested items can be procured from one manufacturer. To know these popular Amphenol products better—write today for the new Condensed Catalog No. 72.

AMERICAN PHENOLIC CORPORATION
CHICAGO 50, ILLINOIS
In Canada • Amphenol Limited • Toronto

U.H.F. Cables and Connectors • Conduit • Cable Assemblies • Connectors (A-N, U.H.F., British) • Radio Parts • Plastics for Industry

**FOR LOW-COST
MANUFACTURE
OF YOUR ...**

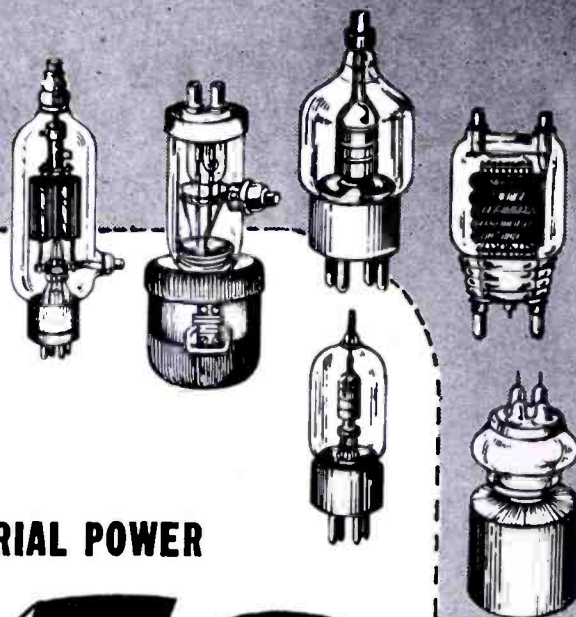

TRANSMITTING AND INDUSTRIAL POWER

TUBES

**LOOK TO *Lewis at Los Gatos* FOR THESE
IMPORTANT COMPETITIVE ADVANTAGES:**

1

LOW COSTS! You can look for important and immediate production savings when you place your tube manufacturing job in capable Lewis hands. This alert organization is cost-conscious. It always has been. It knows how to get costs down — and keep them there!

2

HIGH QUALITY! Every tube manufactured under your brand name in the Lewis plant will be a "top performer" . . . precision built and rigidly inspected, assuring a maximum long-life and efficiency you can depend upon!

3

WIDE EXPERIENCE! 20 years in the electronic engineering field has given this organization a wealth of practical knowledge and experience in every phase of tube design, re-design and manufacture. The full weight of this experience is ready to be applied to YOUR tube production problems!

4

UNENDING COOPERATION . . . from working out complex design problems right down the line to quantity deliveries made "on time." In more ways than one Lewis offers you important competitive advantages.

Write, wire or phone to have our representative personally call . .

Lewis ★ **ELECTRONICS**
LOS GATOS • CALIFORNIA

New!

Series 200

A RELAY BY GUARDIAN with Interchangeable Coils

BUILT IN TWO PARTS

★ Two basic parts—a coil assembly and a contact assembly—comprise this simple, yet versatile relay. The coil assembly consists of the coil and field piece. The contact assembly consists of switch blades, armature, return spring, and mounting bracket. The coil and contact assembly are easily aligned by two locator pins on the back end of the contact assembly which fit into two holes on the coil assembly. They are then rigidly held together with the two screws and lock washers. Assembly takes only a few seconds and requires no adjustment on factory built units.

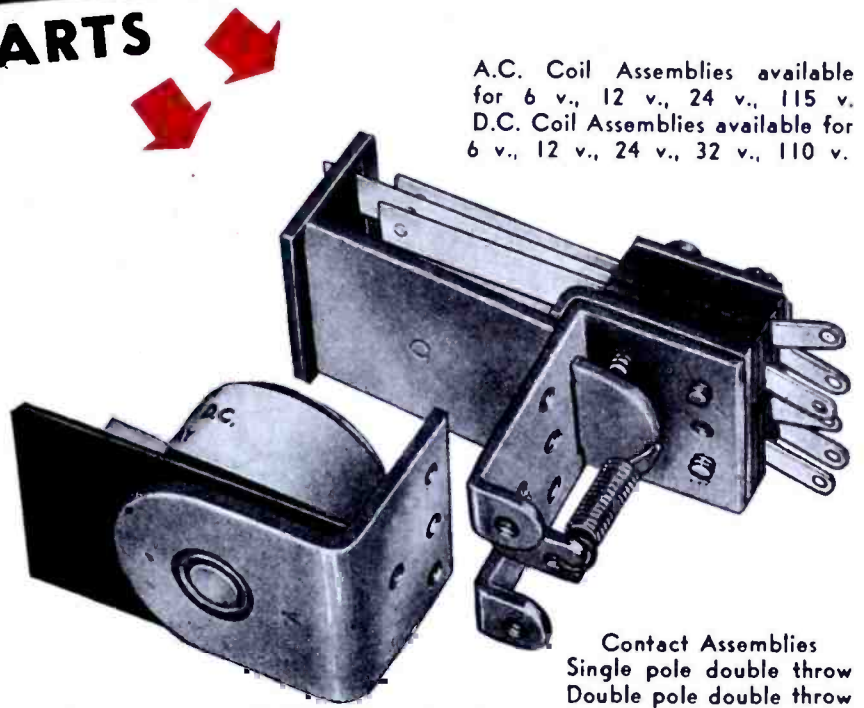

A.C. Coil Assemblies available for 6 v., 12 v., 24 v., 115 v.
D.C. Coil Assemblies available for 6 v., 12 v., 24 v., 32 v., 110 v.

Contact Assemblies
Single pole double throw
Double pole double throw

SERIES 200 RELAY

On Sale at Your Nearest Jobber NOW!

See it today! . . . this amazing new relay with interchangeable coils. See how you can operate it on any of nine different a-c or d-c voltages—simply by changing the coil. Ideal for experimenters, inventors, engineers.

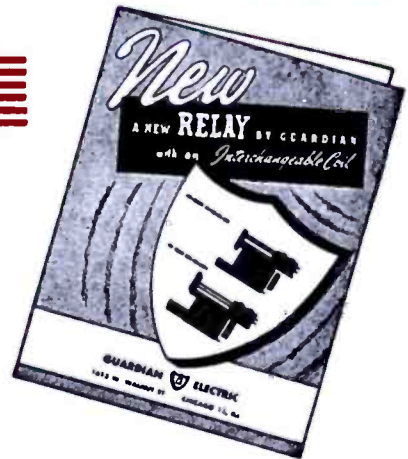

TWO CONTACT ASSEMBLIES

The Series 200 is available with a single pole double throw, or a double pole double throw contact assembly. In addition, a set of Series 200 Contact Switch Parts, which you can buy separately, enables you to build dozens of other combinations. Instructions in each box.

NINE COIL ASSEMBLIES

Four a-c coils and five d-c coils are available. Interchangeability of coils enables you to operate the Series 200 relay on one voltage or current and change it over to operate on another type simply by changing coils.

Your jobber has this sensational new relay on sale now. Ask him about it. Or write for descriptive bulletin.

GUARDIAN  **ELECTRIC**
1610-P W. WALNUT STREET CHICAGO 12, ILLINOIS
A COMPLETE LINE OF RELAYS SERVING AMERICAN INDUSTRY

Eimac
TUBES

THE COUNTERSIGN OF DEPENDABILITY IN ANY ELECTRONIC EQUIPMENT

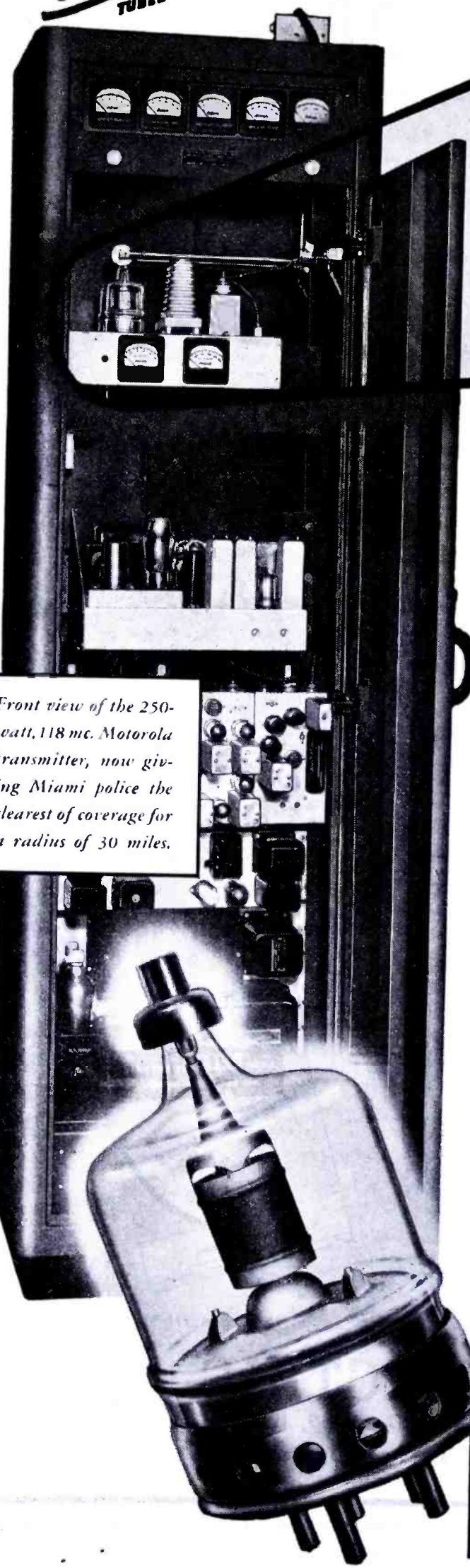

Front view of the 250-watt, 118 mc. Motorola transmitter, now giving Miami police the clearest of coverage for a radius of 30 miles.

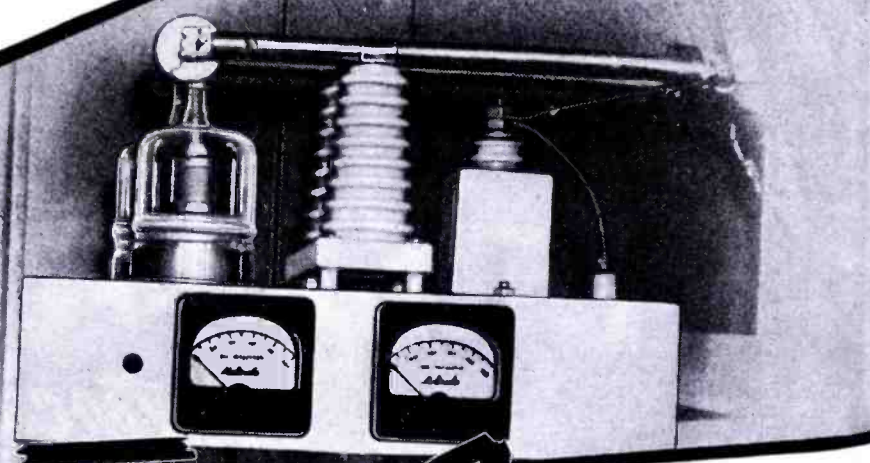

Top Spot

IN FM POLICE SYSTEMS



EIMAC TETRODE 4-125A

Top honors to Galvin Manufacturing Corporation for building it, and a salute to the police and fire departments of Miami, Florida, for putting it to work in spite of the skeptics! It's the first two-way police radiotelephone system in the United States on frequencies *above 100 mc.* Twenty-four hours a day, 12 patrol cars in Miami's busy area tune in on signals as solid as a dinner-table conversation from this Motorola 250 watt, 118 mc. FM transmitter.

From the earliest experimental stages of FM broadcasting, Eimac tubes have been lending a hand. Naturally, there are Eimac 4-125A tetrodes (pictured above) in the vital power output stage of Galvin's new Motorola success. Eimac 4-125A's were a logical choice for this transmitter because of their superlative high frequency performance capabilities and their low driving power requirements.

FOLLOW THE LEADERS TO

Eimac
TUBES



Ask for your copy of *Electronic Telesis*, the 64-page booklet giving the fundamentals of electronics. It will help electronic engineers explain the subject to laymen. Available in English and Spanish. No obligation, of course.

EITEL-McCULLOUGH, Inc., 1074 San Mateo Avenue, San Bruno, Calif.
Plants located at: San Bruno, California and Salt Lake City, Utah
Export Agents: Frazar & Hansen, 301 Clay St., San Francisco 11, Calif., U. S. A.

1074

ELECTRICAL CHARACTERISTICS - 4-125A TETRODE

Filament: Thoriated Tungsten	Direct Interelectrode Capacitances (Average)
Voltage 5.0 volts	Grid-Plate (Without shielding, base grounded) 0.03 μ fd.
Current 6.2 amperes	Input 10.3 μ fd.
Plate Dissipation (Maximum) 125 watts	Output 3.0 μ fd.
Transconductance ($i_b = 50$ ma., $E_b = 2500$ v., $E_{c2} = 400$ v.) . 2450 μ mhos	

New Westinghouse 6-volt input, 250-volt output dynamotor delivers 50 milliamperes. Adaptable for other ratings. Size 3.45 inch frame.

**power
on call**



where it's needed • • when it's needed

**OTHER WESTINGHOUSE EQUIPMENT
FOR COMMUNICATIONS**

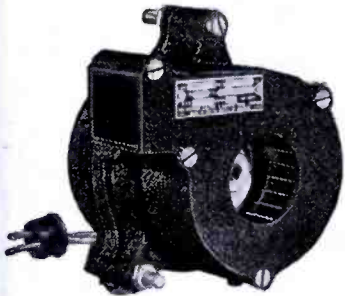

**LIGHTWEIGHT
MOTOR BLOWERS**

cool electronic equipment or keep temperature constant. Deliver 8 cfm free air at 60 cycles, single-phase and 25 cfm at 400 or 800 cycles, single-phase.

MOTORS

in a wide range of ratings—light in weight, compact, efficient for driving blowers or actuating controls.



This compact dynamotor for police communications equipment rates high on every count . . . for efficiency . . . light weight . . . dependable, long life . . . quiet operation . . . low ripple . . . excellent commutation. It provides the right power output where it's needed—in the way it's needed.

It's efficient as well, in conserving input power—important for low-voltage supply systems—operating, in effect, as a rotating direct-current transformer. Furthermore, its smooth functional design economizes on the small space allotted in a radio transmitter or receiver. Its ruggedness withstands the shock in moving vehicles as well as extreme climatic conditions. It is built to operate 2000 hours without servicing.

For further details on Westinghouse Dynamotors, see your nearest Westinghouse representative, or write Westinghouse Electric Corporation, P. O. Box 868, Pittsburgh 30, Pa.

J-03240

Westinghouse
PLANTS IN 25 CITIES . . . OFFICES EVERYWHERE

Communications Equipment

The PROFESSIONAL Receiver



New **HQ-129-X** \$129 AMATEUR NET
LESS SPEAKER

Price subject
to change
without notice.

WRITE TODAY FOR
TECHNICAL BOOKLET

There is a difference. The HQ-129-X receiver is designed purely from a professional point of view. The treatment of every detail is based on professional requirements. As soon as your dealer has the HQ-129-X in stock, go in and look it over and try it—you will see, hear and feel the difference.



HAMMARLUND

THE HAMMARLUND MFG. CO., INC., 460 W. 34TH ST., NEW YORK 1, N. Y.
MANUFACTURERS OF PRECISION COMMUNICATIONS EQUIPMENT

COMMUNICATIONS

LEWIS WINNER, Editor

NOVEMBER, 1945



Figure 1

W. J. Brown with miniature pocket receiver.

Figure 2
Miniature receiver and earphone. Receiver is 6" high x 2½" wide x 1 3/16" thick. Weighs 9½ ounces. Power, volume and tuning controls are at top of receiver. Entire broadcast coverage is provided.

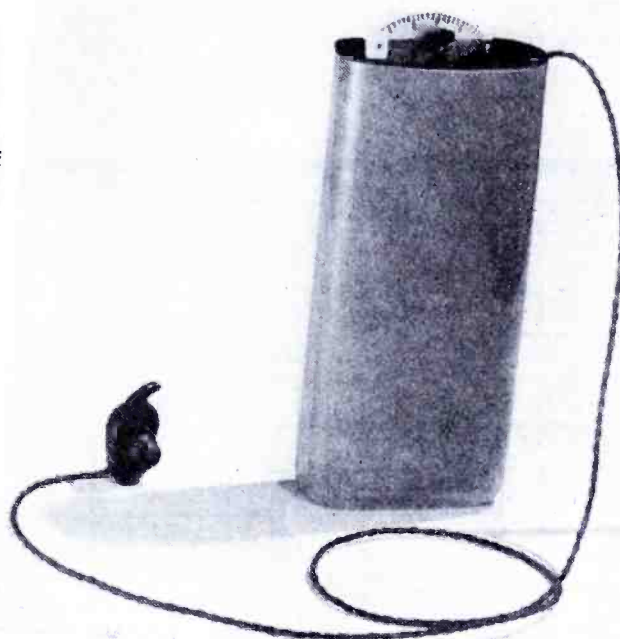

MINIATURE POCKET RECEIVER DESIGN

by W. J. BROWN

Consulting Engineer

Research Director, Electronic Research and Mfg. Corp.
Formerly Vice President, The Brush Development Co.

THIS paper describes a miniature receiver development initiated at the beginning of the war for the Brush Development Company. Security problems barred a detailed analysis at that time and throughout the course of the war. With the removal of wartime restrictions it is now possible to discuss many of the electrical and mechanical design features introduced in this unit.

In 1941, the vacuum-tube hearing aid had already been reduced in size so that it would fit comfortably in one pocket, with the batteries in another pocket; the technique of hearing-aid construction had been pressed much further in the direction of small size and weight than that of any known type of radio receiver. It became,

therefore, a matter of great interest to combine the technique of radio and hearing-aid design and to produce a receiver of much smaller size than the then existing *personal* radios.

The receiver which was finally developed met the essential requirements of a truly *wearable* or *pocket* receiver.

The receiver and all batteries were housed in a single casing 6" high x 2½" wide x 1 3/16" thick, having a total weight of 9½ ounces, including batteries.

The receiver fit snugly in the breast pocket or inside pocket of a man's

coat. Power, volume and tuning controls were included and projected from the top end of the casing. Thus the unit could be controlled while in the pocket. Incidentally the entire broadcast band was covered.

A miniature type of earphone with an insert fitting within the ear was used with the unit; thus no headband was required.

The miniature earphone was connected to the receiver with a 2' length of very thin tinsel cord which also acted as the antenna.

Reception up to about 25 miles was

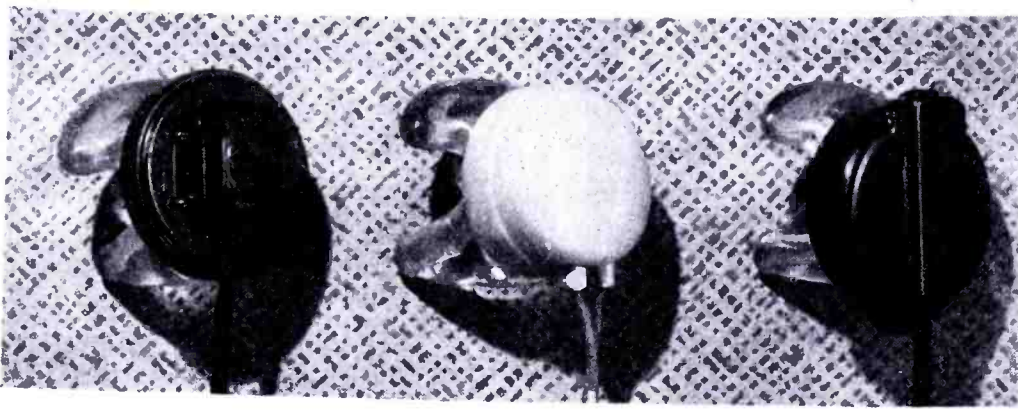

Figure 3
Typical insert-type earphones supplied with hearing aids. At left and right are crystal types, center, magnetic type.

possible. For long distance reception a supplementary antenna was used.

Design Problems

In applying hearing-aid technique to this new development, four factors had to be considered:

frequency response than a small loudspeaker. This result is possible because the earphone has to develop a given sound-pressure only in a very small volume of air (about 2 cubic centimeters) contained within the ear cavity; a loudspeaker has to

reaches the eardrum. Consequently the insert-type earphone may be driven from a very small output tube requiring a plate current of less than 0.2 milliamperes at 3 volts, as compared with the usual loudspeaker requirement of several milliamperes at 67½ volts.

Similarly, the insert-type earphone provides a perfect seal to the ear canal so that there is no loss of low-frequency response; in spite of its small size it has some of the advantages of a loudspeaker with an impossibly large infinite baffle.

In Figure 3 appears some typical insert-type earphones supplied with hearing aids (at left and right are crystal types, and in the center is a magnetic type) and molded plastic inserts which are supplied to fit these earphones to the ear canal. The latter are available in five different sizes, both for left and right ears. For the hard-of-hearing it is customary to make a special ear mold to fit the individual ear, but this is not necessary for radio reception by a normal listener.

Frequency-response curves obtained with typical insert-type earphones from a constant-voltage input are shown in Figure 4. When actually connected in the circuit the response of the crystal types of earphone is usually augmented in the neighborhood of 600 cycles due to the resonance of the crystal capacitance with the inductance of the output choke which is customarily used. This effect is shown approximately by the dotted curve in *a* of Figure 4.

2)—*Vacuum tube type choice.* The tubes available for hearing aids are much smaller in size and lower in current drain than any tubes previously used for receiver work, and at the same time they have a considerably higher impedance. By employing unusually high values of plate resistors and grid leaks they can be used as very effective voltage amplifiers. Because of the low power requirements of the miniature insert-type earphones they can also be used very satisfactorily in the output stage.

However, the tubes which were

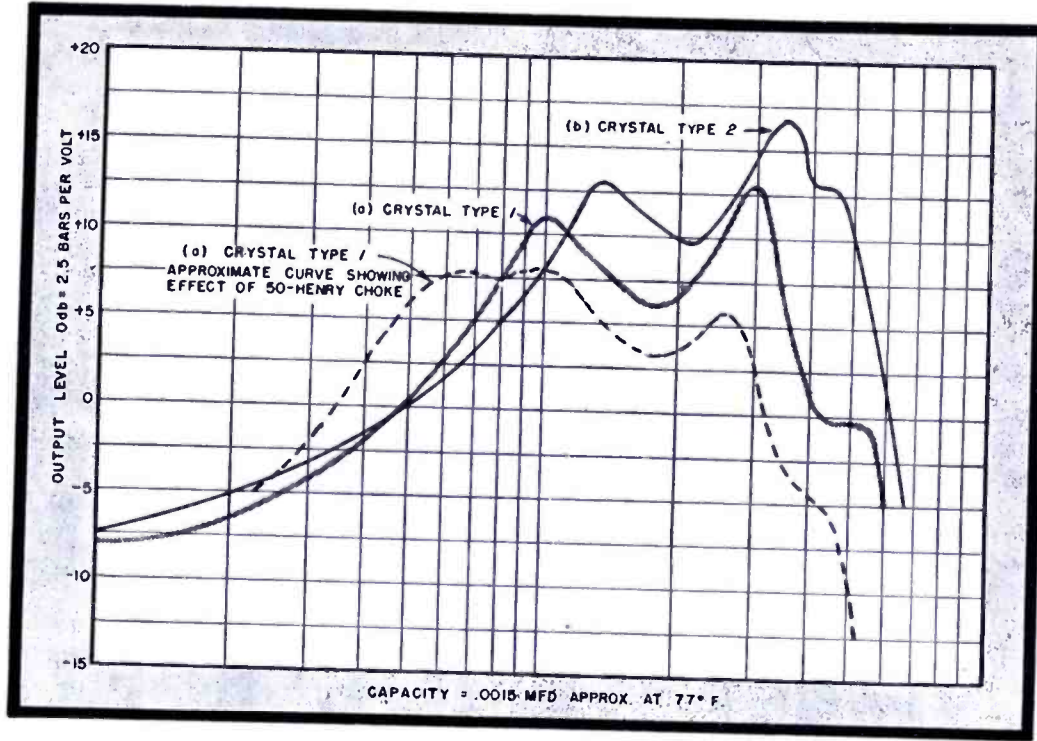

1)—*Selection of the miniature insert-type earphone.* This unit, customarily supplied with a hearing aid, requires far less power and is capable of giving appreciably better

develop the same pressure in tens of thousands of cubic centimeters of surrounding air, thus requiring a large amount of power of which only an infinitesimal fraction ever

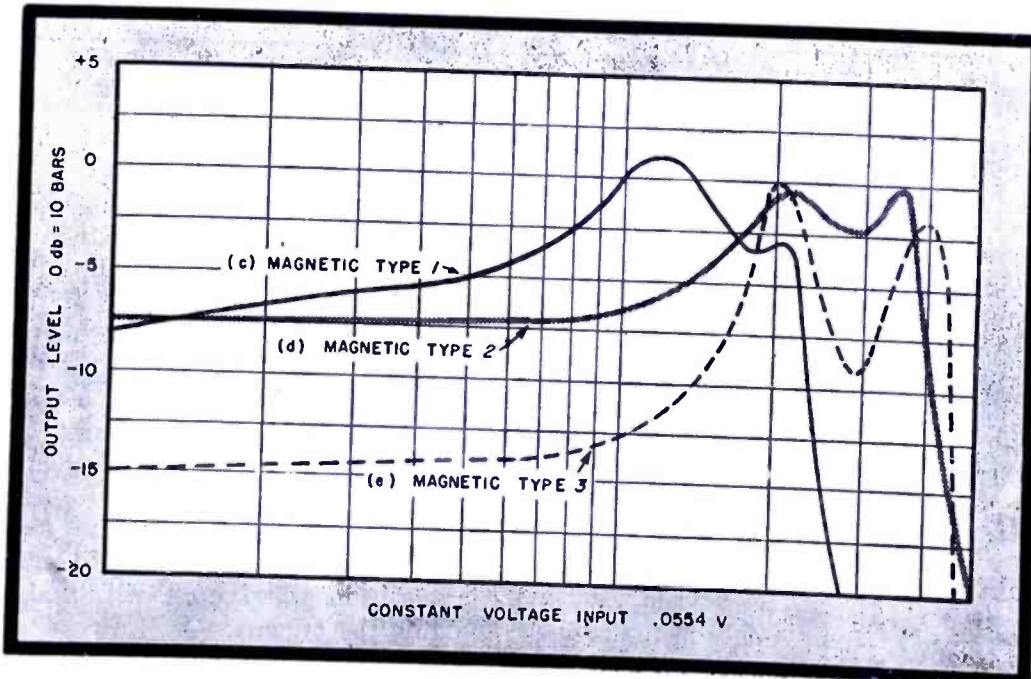

Figure 4
At center, left, and right are frequency-response curves obtained with insert-type earphones from a constant-voltage input. Abscissae, cps, 100 to 10,000 cps for center plot and 100 to 5,000 cps for plot at left.

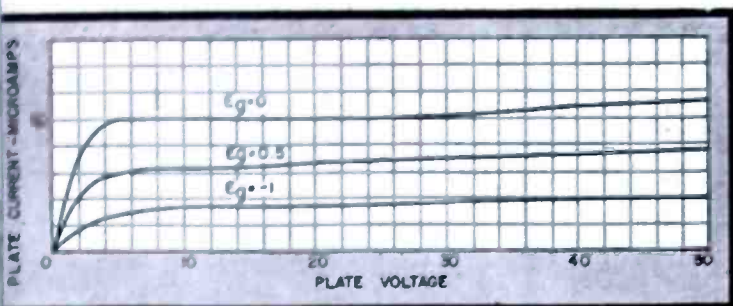
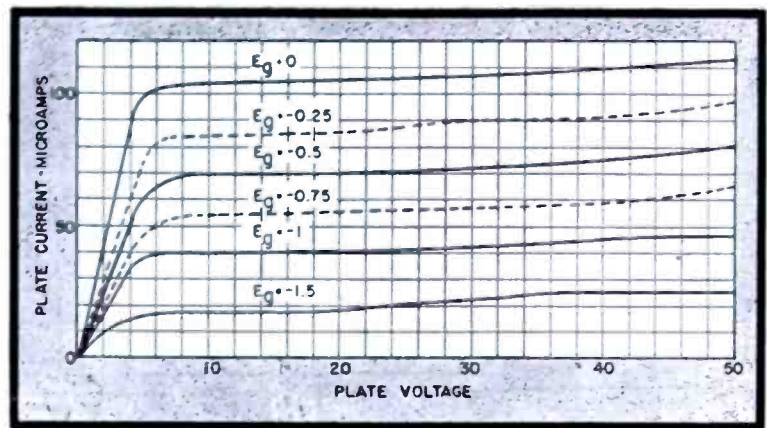

Figure 5 (a, right, and b, above) In a we have the characteristics of a 3401, 3402 tetrode voltage amplifier; screen voltage, 30. In b appears curves for tetrode with screen voltage of 22½.



were available several years ago when this pocket receiver was developed were useless for r-f or i-f amplification for two reasons. First, the mutual conductance was so low as to limit the r-f gain per stage to a low value unless tuned circuits of exceptionally high Q were employed. In the second place the hearing-aid tubes were ineffectively shielded, resulting in high grid-plate capacity which would result in instability in the event that good amplification were otherwise obtainable. (More recently, miniature tubes have been developed which are suitable for r-f amplification, frequency conversion and i-f amplification.)

The miniature tubes which were found most effective in the detector and RC-coupled audio amplifier and output stages were supplied by Edwin C. Ewing, formerly owner of Microtube Laboratories. These were tetrodes having the characteristics shown in Figure 5.

The tubes were 1⅛" long x .385" diameter (plus leads). The filament of types 3401 and 3402 operated on .625 volt at 20 milliamperes; type 3403 operated on .625 volt at 40 milliamperes.

The 3401 and 3402 types have similar characteristics, both being designed as voltage amplifiers. The only difference is that the 3401 was relatively non-microphonic for de-

detector or first-stage operation. The 3403 was designed as an output tube for crystal-type miniature earphones.

In initial audio amplifier tests employing the 3401 and 3402 as voltage amplifiers, the following power and component values were used: B-battery voltage, 30; grid bias, -625 v; plate resistor, 2 megohms; screen resistor, 2 megohms; grid leak, 5 megohms; plate current, .01 milliampere; and screen current, .005 milliampere.

Voltage gain per stage was found to be 40.

With the 3403 as an output tube, we used a B-battery voltage of 30; screen voltage, 30; grid bias, -2.5 volts; plate choke, 40 henries; crystal earphone load, .001 mfd; plate current, .2 milliampere; and screen current, .075 milliampere.

The maximum output was 16 volts rms, and the voltage gain 16.

3)—Battery choice. At the time of this development, the type 430 Ever-Ready 30-volt Minimax B battery had just been evolved; dimensions were 2¾" long by 1¼" wide by ⅞" thick. This battery was designed for a life of 150 hours with a 1 milliampere drain; such a low drain would be useless for the conventional personal radio having a loudspeaker but it was entirely suitable for the projected pocket unit with insert-type earphones. Samples of this battery were supplied

by L. M. Temple, then with the National Carbon Company.

4)—Component problems. Other components, such as paper and mica capacitors, resistors, and output chokes and transformers, were available from certain manufacturers in extremely small sizes, especially designed for hearing-aid use.

Design Details

In designing a miniature receiver, it is of course necessary to replace the hearing-aid microphone by the appropriate radio circuits. Since the receiver was to be used primarily for local station reception, the earphone had to have good frequency response up to 5,000 or 6,000 cycles.

Because of the very severe restrictions in size, it was decided to design, first, a t-r-f receiver with the object of determining what order of performance was obtainable with a receiver of this size, and surveying its general utility. It was realized during the first circuit studies, that the final model of a production-type receiver to meet general public acceptance would probably use the superheterodyne circuit.

In considering the circuit details, the antenna problem demanded close study. It was felt desirable that the receiver should operate satisfactorily without removing it from the pocket. This put a very serious limitation on the possibility of using a loop antenna, since this would not only be very small, but would be surrounded by batteries and

Figure 5 (c, right, and d, below) Characteristics of 3403 tetrode (output stage) with screen voltage of 40 and 40 ma filament, appear in c. In d we have the 3403 curves for a 22½-screen voltage.

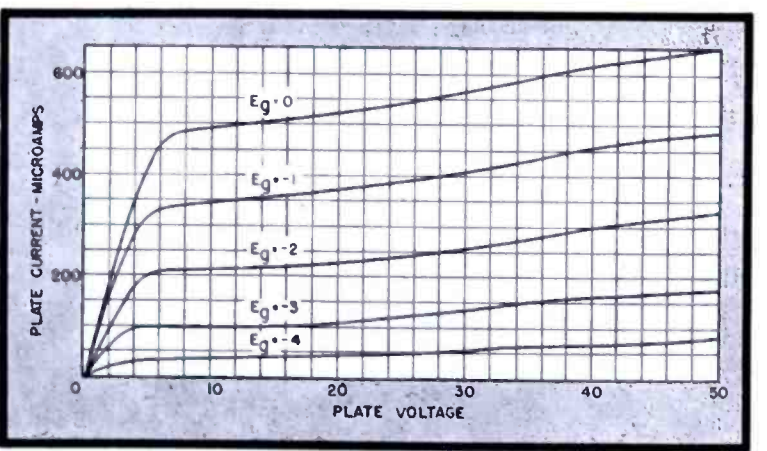
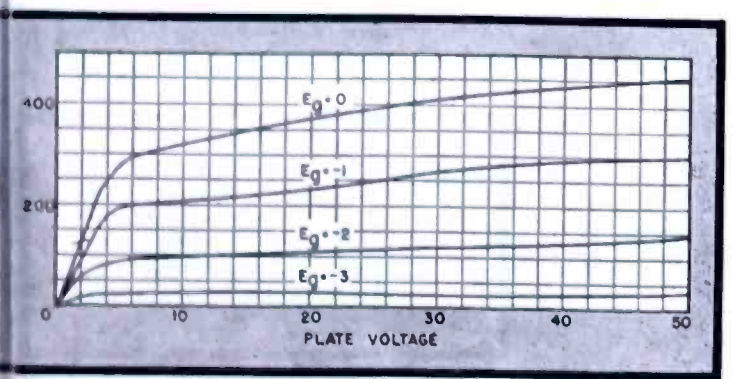

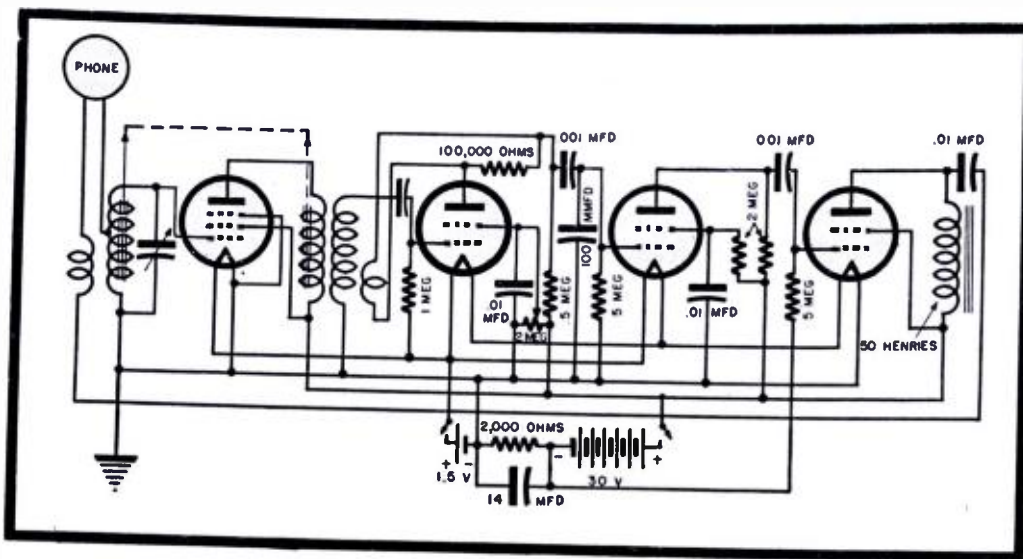

Figure 6
Circuit of the miniature pocket receiver using a 1T4 r-f stage, 3401 detector, 3402 a-f and 3403 output stage.

circuit components and would, therefore, be very inefficient.

An open-wire antenna seemed to be a much more promising solution. In view of the fact that a conductor was required to connect the earphones to the receiver, it was decided to attempt to use this conductor also as the antenna. Because of the high gain and compact nature of the receiver, it seemed essential to decouple the earphone cord from any r-f currents, which might appear in the output circuit, as completely as possible. This was accomplished by providing the antenna coil with a pair of windings which operated in parallel (through their mutual capacitance) for incoming r-f signals, but which served as *go-and-return* conductors for the audio output signal applied to the earphone. This arrangement is shown at the left of the circuit diagram in Figure 6.

Realizing the very small capacitance and effective height of such an antenna, it is obvious that the antenna tuning circuit must be designed to present the highest possible dynamic impedance at the grid terminal. Since the dynamic impedance at resonance is expressed by L/CR , where L and R are the induc-

tance and resistance of the coil and C the tuning capacitance, it is quite obvious that C must be kept to a bare minimum. This is readily achieved by using a permeability-tuned antenna coil and by resonating this with the stray capacitance of the tube, plus the wiring, without introducing additional tuning capacitance.

In practice it was found possible to cover the broadcast band in this way with a permeability tuned coil of the sliding core type.

In the final design the total stray capacitance, as calculated from the inductance and tuning range, was about 10 mmfd. The dynamic impedance, L/CR , was about 2 megohms at 550 kc and about $\frac{1}{2}$ megohm at 1,500 kc. This is much higher than would be obtained with a capacitor-tuning arrangement.

In Figure 7 appears one of the tuning coils and cores, as well as a group of other components, used in the receiver.

For maximum signal input to the

first grid, the earphone cord antenna should be connected to the grid end of the antenna-tuning coil. Unfortunately, such an arrangement is too sensitive to changes of antenna capacity, due to movements of the cord with respect to the body, and a more practical result was obtained by tapping the antenna about two-thirds of the way down the coil.

To obtain reasonably efficient detection with the very small signal input available from the short cord antenna, an r-f stage was employed ahead of the detector, using a 1T4 pentode. This relatively large tube was required for the r-f stage to obtain sufficiently high mutual conductance and sufficiently low grid-plate capacitance. The need for an r-f amplifier raised the difficult problem of eliminating mutual inductance and capacitance between the r-f plate tuning coil and the antenna coil, without increasing the size of the receiver. The normal procedure of completely shielding the coils was difficult on account of space limitations. It was, therefore, decided to locate the coils in such a relative position as to have substantially zero mutual inductance, and to lay out the receiver components so that the batteries act as an electrostatic shield between the plate and grid circuits of the r-f amplifier tube.

By using identical coils for the r-f plate and antenna circuits, it was found possible in a mechanical arrangement to be described later, to preserve substantially zero mutual inductance throughout the tuning range when the sliding cores are mechanically ganged together.

Two types of detector were tried: An anode-bend detector without feedback, and a grid-leak detector with feedback by inductive coupling from the detector plate circuit to the grid circuit.

The former arrangement was the easier to get into satisfactory operation, but it was found that by a suitable choice of tube types, the latter arrangement was also practicable resulting in a sensitivity increase of 6 to 10 db.

In the arrangement using anode-bend detection, control of the sensitivity and volume was obtained by varying the screen voltage of the r-f amplifier tube. In the grid-leak arrangement, volume control was obtained by varying the screen voltage of the de-

Figures 7 (left) and 8 (right below)

Figure 7. Tuning coil and core, and miniature components used in receiver. Figure 8. Mounting positions for batteries, r-f and detector coils, tubes and shield.

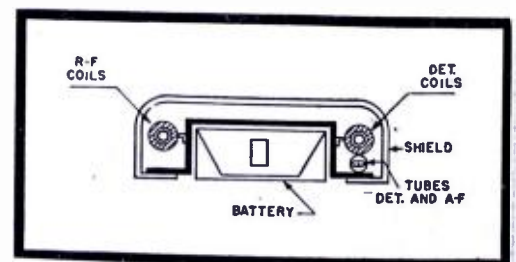
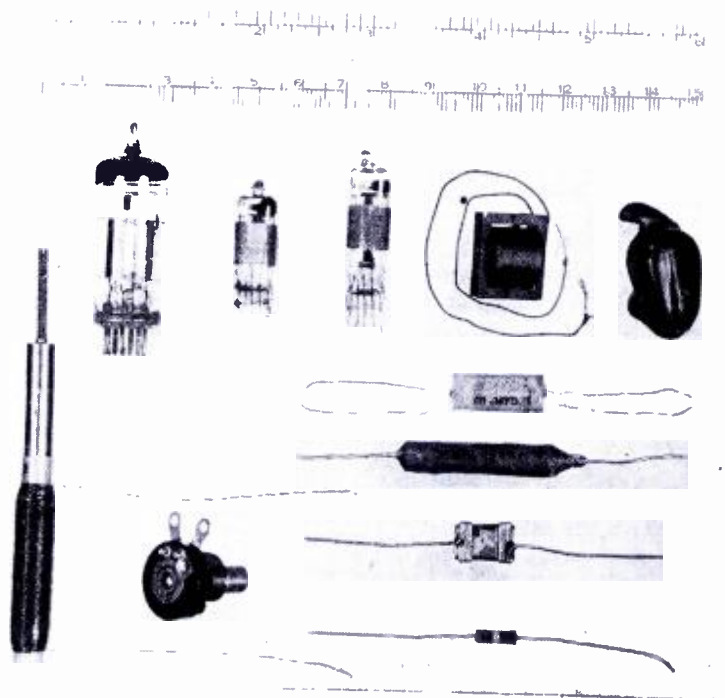

Figure 9

view of the miniature receiver showing 1T4 antenna coil along front edge. Metal foil in rear serves as mechanical and electrical shield.

ector tube; the degree of feedback was adjusted so as to cause oscillation when the detector screen voltage was raised to maximum but this oscillation was of a controllable type without excessive backlash. Thus high sensitivity was easily obtained without any great difficulty in adjustment.

The 3401 tetrode detector was resistance-capacity coupled to a 3402 tetrode audio amplifier, which in turn was resistance-capacity coupled to a 3403 output tube. Since the tube impedances were high, and the lowest possible plate currents were desired, the plate and grid resistors were unusually high in value. The voltage amplifier stages were operated at low screen voltages.

The 3403 output was designed for use in hearing aids with insert-type crystal earphones. The lower sensitivity of such insert-type earphones is exceedingly high, of the order of 1 dyne per sq. cm. per microwatt, and it was fortunate that by the use of a very simple output circuit, most of the available sensitivity could be realized in practice. As a result of this the plate current requirements of the output tube for persons of normal hearing need only be in the order of .1 to 0.2 milliamperes with a battery voltage of only 30.

The plate of the output tube was fed through a miniature choke coil of approximately 50 henries inductance. This high value of inductance was readily attainable within total cubic dimensions of $\frac{3}{4}$ " x $\frac{5}{8}$ " x $\frac{5}{8}$ " because of the low d-c value. The audio output to the earphone was taken through a capacitor to the low end of the double-tapped antenna coil and then from taps on the antenna coil to the earphone.

Performance

The performance of this circuit cannot be stated in terms of r-f sensitivity measured with a conventional dummy antenna, since the antenna has unusually low capacitance. It was found in practice that the useful daylight range of reception varied from 20 to 100 miles from a 50-kw broadcasting station, depending on local conditions. Daylight reception was obtained at 180 miles on one occasion.

The specified range of 20-100 miles

Figure 10

view of the miniature receiver showing hearing-aid, detector and a-f tubes beneath coil and core. At left is the 50-henry output choke.

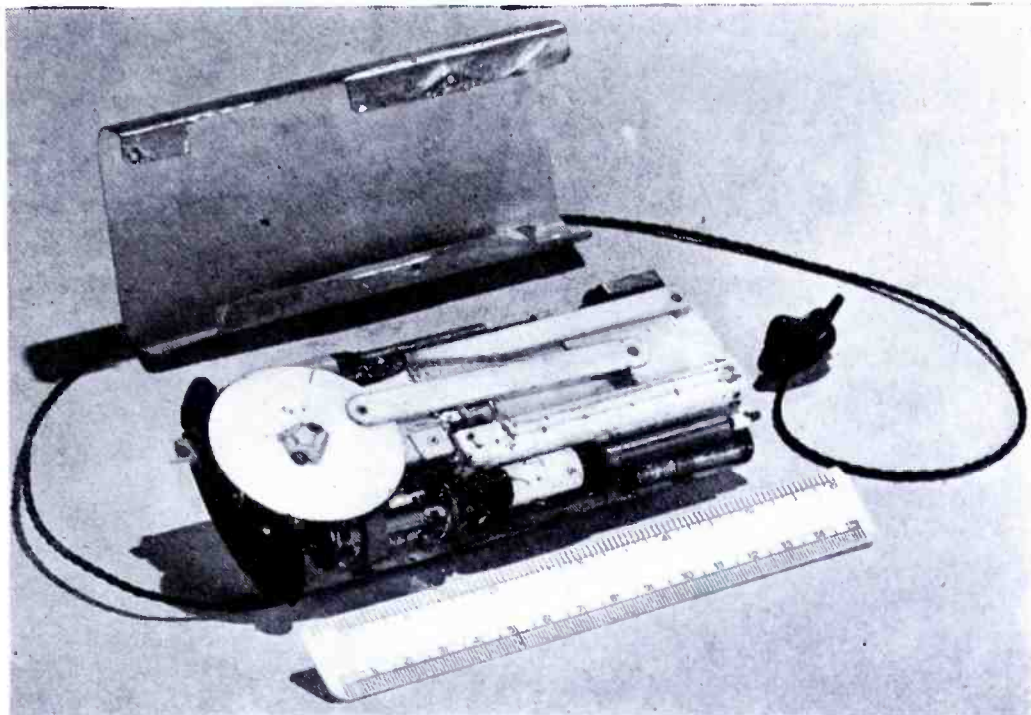

was obtained when walking outdoors or at home. When the receiver was used in a steel-framed building in which the field strength is low, a good range of reception was obtained by placing the receiver on or near a grounded object, such as a radiator, telephone, or table lamp; under these conditions WJR, Detroit, was regularly heard in Cleveland at a distance of 90 miles, day or night.

Mechanical Design

For lightness of weight, ease of correctly positioning the necessary components and simplicity of manufacture, it was decided to make the chassis of thermoplastic insulating material and to make the casing of similar material.

The chassis was made of plastic sheet hot formed to a modified U section.

The batteries were mounted inside the U section, as shown in Figure 8, while the tubes and components were

disposed along each side of the batteries outside the two wings of the U. The circuit components and tubes were electrostatically shielded by metal foil wrapped around the plastic chassis, and the complete chassis structure then fitted into a thermoplastic casing, as seen at the rear of Figure 10.

The advantage of this form of construction was that the batteries could easily be replaced by sliding the chassis out of the casing, while the metal foil shield protected the whole of the circuit assembly from damage during this operation.

In Figure 9 we see the chassis with the metal foil covering detached. The antenna coil and the 1T4 r-f tube are mounted along the front edge of the chassis in this view. The r-f plate tuning coil and the detector and audio tubes and circuits are mounted along the back edge of the chassis. The batteries and the metal foil covering together provide complete electrostatic

(Continued on page 54)

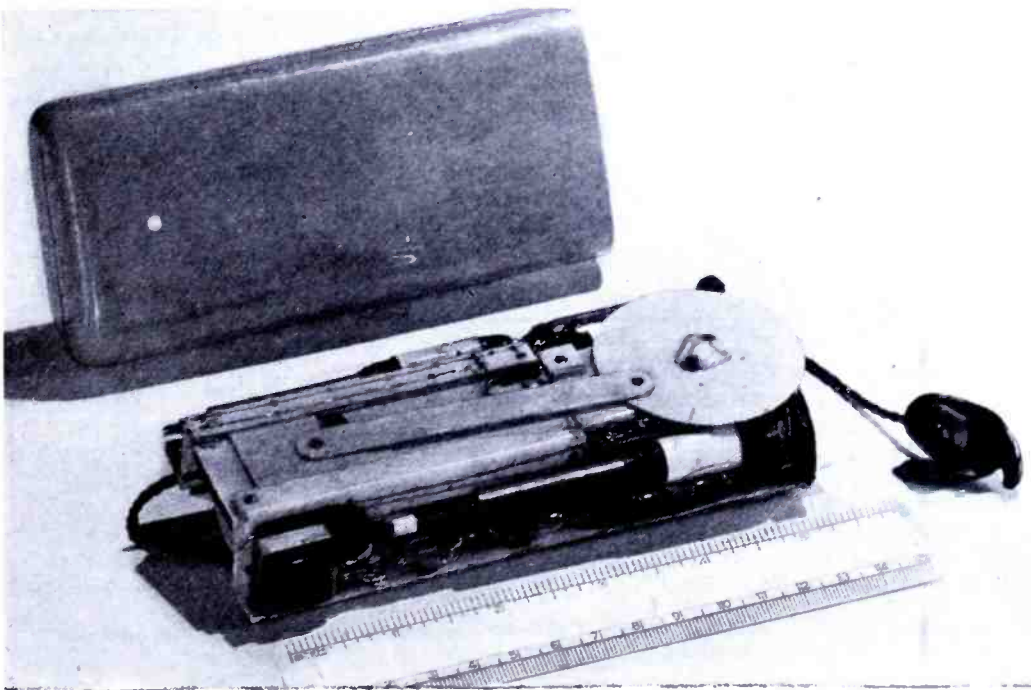

JACKETING MATERIALS

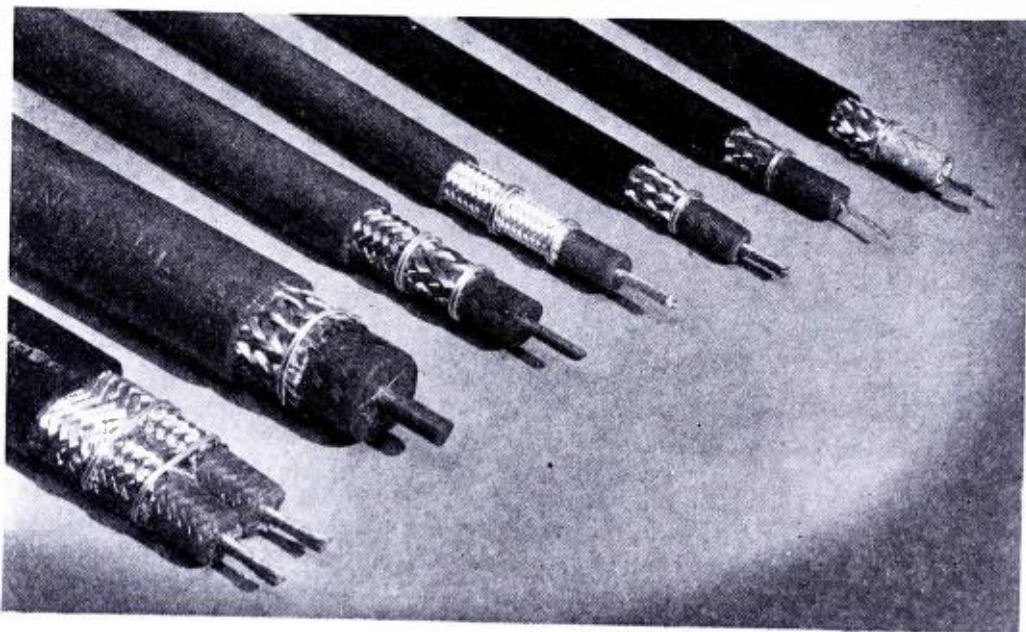

Figure 1
An assortment of h-f transmission lines using different types of jacketing materials.

THE outer protective covering, or jacket, of a transmission line was not considered to pose any major problems of engineering in the early days, since its purpose was believed to be only a mechanical protection for the transmission line itself. With the need to operate at higher and higher frequencies, and over wide ranges of temperature, however, it was found that the exact nature of the materials used in the jacket played a most important part in determining the limitations of the whole cable system.

Until very recently it was considered that the following characteristics determined the suitability of a specific material for use as a jacketing material for such high frequency transmission lines:

- (a)—Ability to withstand flexing at temperatures as low as -40°C , and at moderate radii of curvature, e.g. ten times the cable diameter.
- (b)—Ability to withstand temperatures as high as 80°C for prolonged periods, and as high as

120°C for short periods without excessive deformation.

- (c)—Resistance to water such that immersion of the cable in either fresh or salt water would not cause deterioration of the electrical properties of the cable dielectric or braid.
- (d)—Resistance to gasoline, particularly aromatic aviation gasoline.
- (e)—Ability to withstand the effects of hot lubricating oils and hydraulic brake fluids.
- (f)—Satisfactory abrasion resistance and toughness such that pulling into conduits or vehicles passing over the cable will not cause rupture of the jacket.
- (g)—Must be non-corrosive to the copper wires used as the electrostatic shield or braid.
- (h)—Must give a reasonably long service life without degradation of the above properties.
- (i)—Must be flame resistant or at least very flame retardant.

Apart from the above list of necessary

engineering characteristics, there were three other commercial aspects which were considered: Material capability of being processed on existing machinery or easily modified versions of the same, availability in quantities necessary, and reasonable pricing.

In the past two years it has been found that still another factor must be included in the extensive list of desired characteristics: Ingredients of the jacketing compound and their effects on the primary insulation. None of the jacketing compound ingredients should migrate into the transmission line primary insulation for this cause an increase in the power factor even though the whole cable should be held at temperatures as high as 85°C for long periods. The development of the compounds having all the characteristics above mentioned is not easy, and for practical considerations a compromise solution has to be adopted, since at the moment no material exists to meet all of the stated requirements.

Various materials have been used, or have been contemplated for use.

Elastomers of Polyvinyl Chloride

One type of plastics that has been quite popular as a jacketing material is polyvinyl chloride, vinylite QYNA or geon 101 (Koron 101).

This plastic is thermoplastic, flame resistant when suitably compounded, has good abrasion resistance, can be formulated to withstand low temperature flexing and high temperature deformation, is relatively cheap to produce and can be handled with moderate ease on existing plastic tubing ma-

Table 1
Physical properties of three jacketing materials that have satisfactory overall properties for many applications.

	Geon 6281	Geon 2095	Vinylite VE 5906
Hardness (Shore)	78	64	65
Elasticity (Shore)	17	32	29
Tensile strength (psi)	2300	1950	2400
Elongation (%)	250	400	325
Deformation at 120°C (%)	6	23	36
Brittle point ($^{\circ}\text{C}$)	-32	-57.5	-49
Gasoline penetration (hrs.)	32-50	15-23	7-8

Geon 6281 and Geon 2095 are polyvinyl chloride compounds while Vinylite VE 5906 is a polyvinyl chloracetate compound.

FOR H-F TRANSMISSION LINES

by A. J. WARNER

Intelin Research and Development Laboratories

Federal Telephone & Radio Corp.

hines. Together with the next class of materials, this material has formed the bulk of current jacketing materials, although with the exception of the special type of non-contaminating jacketing material to be described later, they cause undesirable power factor changes of the primary insulation on aging, particularly at elevated temperatures.

Elastomers of Polyvinyl Chloracetate

By copolymerizing vinyl chloride with a small percentage of vinyl acetate, we obtain another type of jacketing material somewhat different from the straight polyvinyl chlorides. A typical commercial product is sold under the trade name of vinylite VYNW.

The ultimate properties of both the straight chloride and the chloracetate materials are very dependent on the nature and amount of the plasticizers employed. In order to achieve the best results it is a common practice to use two, three or sometimes more, plasticizers in the final product. Vinylite VE-5906, for instance, the most common of existing jacketing materials using polyvinyl chloracetate, achieves low temperature flexibility without sacrificing its flame resisting properties by using as a plasticizer a mixture of dioctyl phthalate and tricresyl phosphate.

Table I shows the physical properties of three jacketing materials that have satisfactory overall properties for a large number of applications. The values of the brittle points given on this table are only an indication of the low-temperature flexing performance to be expected on transmission lines, or unfortunately, to date no direct correlation between brittle point and low temperature flexing has been obtained. All three of the materials have been extruded as jackets and withstood flexing at -40°C without cracking.

As already mentioned, the polyvinyl chloride and polyvinyl chloracetate jacketing materials form the bulk of the jackets made today.

None of the above compounds, however, meet the requirement of non-contamination of the primary in-

Figure 2
Recording tensile strength of jacketing compounds on a Scott testing unit.

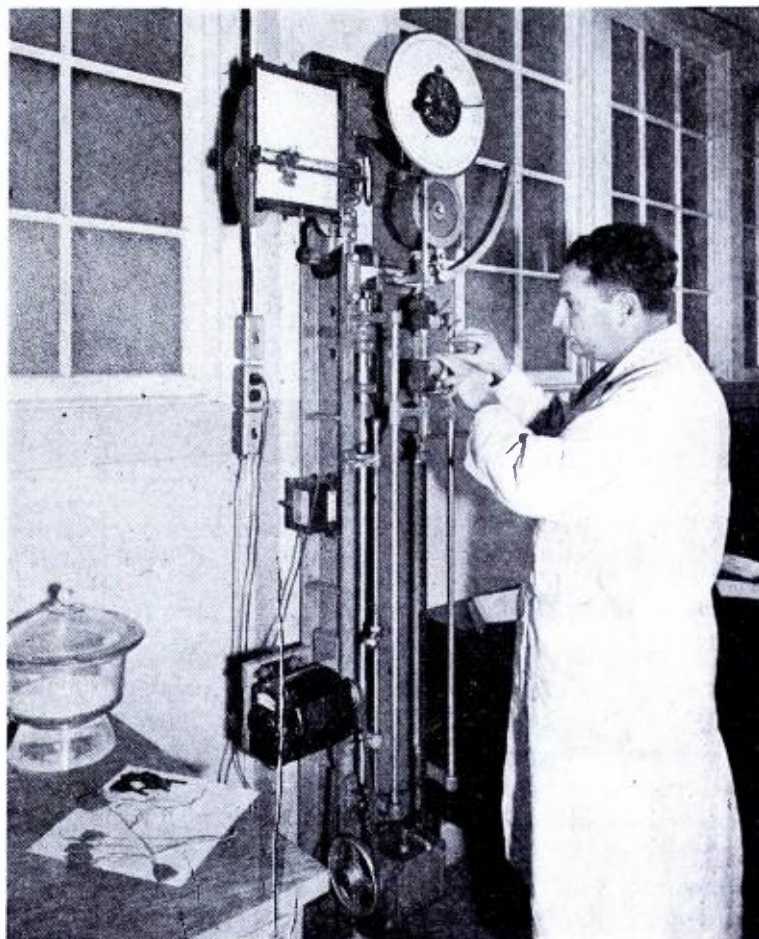

sulation with elevated temperatures, but this problem will be considered later in an analysis of *non-contaminating jackets*.

A number of other compounds have been suggested from time to time as jacketing materials, but they have not, in general, been used for high-frequency transmission lines, because of lack of one or another of the main characteristics heretofore enumerated.

Ethyl Cellulose as a Jacketing Compound

Ethyl cellulose is a relatively recent arrival to the plastics field, and its good impact strength at low temperatures was considered to make it attractive for use as a jacketing compound. However, it was found to have too low a heat deformation temperature for satisfactory use. It is also inflammable and has poor resistance to gasoline and moisture.

Cardolite

Another plastics composition tried for jacketing was Cardolite. This is a plastic composition based on cashew nut resins and ethyl cellulose with a chlorinated plasticizer, which when properly cured has good heat resis-

tance, is tough, substantially non-inflammable and not attacked by gasoline or oils. It proved unsuitable for use as a packaging material for high-frequency transmission lines because: (1)—It required a long and complicated cure cycle, (2)—the chlorinated material used as plasticizer and flame retarder was toxic, (3)—it had relatively poor low temperature characteristics, and (4)—it had a severe corrosive effect on the primary insulation and copper braid during cure.

Neoprene

Neoprene, an extremely good material for the outer covering of cables, has also been tried as a jacketing compound. Its excellent resistance to abrasion, oils and gasoline, coupled with its good low temperature characteristics and high temperature resistance appeared to make it ideal as a jacket. However, it was found that the compounding ingredients, necessary for satisfactory cure, caused undesirable effects on the electrical properties of a primary insulation such as polyethylene, and so it was not adaptable for high-frequency transmission lines. For pulse cables, however, neoprene jackets have been used,

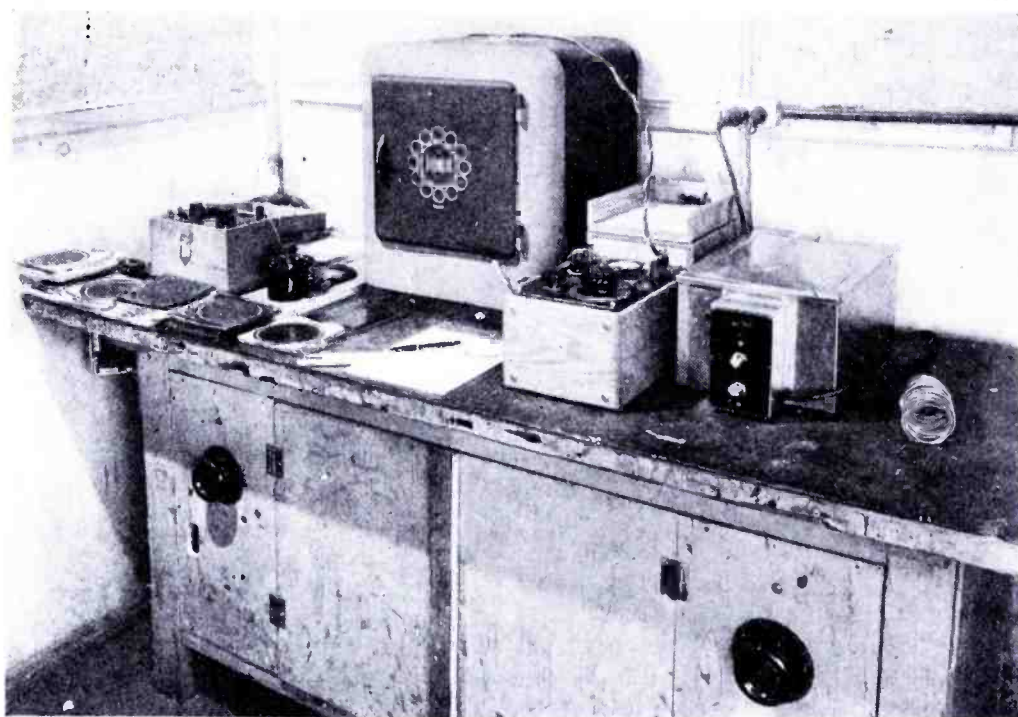

Figure 3
A setup used to measure the d-c volume resistivity of jacketing compounds.

the copper wires of the cable being protected by tinning.

GRS or Synthetic Rubber

Many cables for ordinary power frequencies have been jacketed with GRS, which has great flexibility but is relatively low in resistance to oil and gasoline, has a short life when exposed to ultraviolet light or ozone, and has poor flame resistance. Like Neoprene, GRS has to be vulcanized to develop its optimum properties and therefore does not lend itself favorably to use in transmission lines.

Styraloy 22

In an attempt to utilize the inherently good properties of polystyrene, a copolymer, Styraloy 22, exhibiting remarkably good low temperature flexibility and reasonably resistant to heat has been prepared. It has good abrasion resistance at ordinary temperatures, but when hot has a tendency to become *hot-short*, which gives the material poor tear resistance. It has reasonable resistance to organic solvents and oils. However, it is not flame resistant. Thus it has not been adaptable for high-frequency transmission lines.

Cotton Braid

For certain applications where the transmission lines are to be used inside of equipments or other locations where they are not exposed to either weather, gasoline and oil, or subject to mechanical abuse, it has been conventional to use a braided or knitted cotton outer covering which is usually impregnated with wax to provide waterproofing. It has been found in service, however, that the operating temperature of the lines is high enough to cause oxidation of the wax and im-

portant effect is an embrittlement of the material with a consequent loss of flexibility. At room temperature also, the effect of repeated flexings such a nylon jacket is to cause a *cold drawing* of the material which results in ridges being formed when the cable returns to its original state. Further drawbacks to the use of the material are the relatively high moisture absorption and transmission properties, the ease of attack by hydraulic brake fluids, and its inflammability. For these reasons, nylon has not been used other than experimentally on transmission lines, although for small wires such as radio hook-up wire there would seem to be possibilities which are currently being investigated.

gration of the oxidized wax into the primary insulation with a resultant deterioration of the electrical properties. Furthermore, the operation of soldering connectors and fittings to the lines melts the wax which dissolves in the polyethylene of the primary insulation giving poor mechanical performance. To overcome these difficulties, nylon and polyethylene thin walled jackets have been tried.

Linear Polyamides (Nylon)

By the use of a suitable die design and careful extrusion technique, linear polyamides can be extruded in thin sections over transmission lines. The secret of correct extrusion lies mainly in forming a tube at the die and subsequently drawing down this tube on the extruder to give a snug fit on the cable. Wall thicknesses as low as 3-5 mils can be successfully applied in this manner. It was believed that because nylon contains no plasticizer the material would be useful as a non-contaminating jacket, but test results indicate the material is not suitable in these applications mainly from a mechanical standpoint. Some small deterioration in electrical properties occurs when transmission lines jacketed with nylon are heated at elevated temperatures for a period of time, but the most im-

portant effect is an embrittlement of the material with a consequent loss of flexibility. At room temperature also, the effect of repeated flexings such a nylon jacket is to cause a *cold drawing* of the material which results in ridges being formed when the cable returns to its original state. Further drawbacks to the use of the material are the relatively high moisture absorption and transmission properties, the ease of attack by hydraulic brake fluids, and its inflammability. For these reasons, nylon has not been used other than experimentally on transmission lines, although for small wires such as radio hook-up wire there would seem to be possibilities which are currently being investigated.

Polyethylene

Polyethylene can fairly readily be extruded as a jacket material in thin walls, and is currently used for those applications where formerly a wax impregnated cotton braid was employed. Like nylon, the most successful way to apply the material is to tube it at the die and draw down on the cable passing through the machine. The drawbacks to the use of polyethylene are: (a)—Inflammability (b)—lack of resistance to oils and gasoline, (c)—rigidity, particularly at low temperatures, and (d)—sudden melting point in the vicinity of 110°C. It has also been recorded that polyethylene on exposure to weathering conditions undergoes some change resulting in a rise in brittle point, in some cases actually to above the freezing point of water.

By the addition of carbon black, polybutene and other materials, attempts have been made to prepare compositions of polyethylene suitable for use as jacketing materials, but to date no satisfactory compound is available. Therefore, polyethylene jackets have only very limited application in specialized problems.

Non-contaminating Jackets

Experience gained in the actual use of high-frequency transmission lines

(Continued on page 87)

Table 2

Average properties of jacketing materials using recently developed resinous polyester plasticizer (See page 87 for application data.)

	Tensile Strength (psi)	Elongation (%)	Hardness (Shore)	Elasticity (Shore)	Heat Deformation (%)	Brittle Point (°C)
IN-102	2400	350	72	29	23	-50
VE 3094	2700	350	80	19	10.5	-40
8070	2400	330	80	23	19.1	-28

DOES THE OUTPUT OF YOUR A. C. VOLTAGE REGULATOR LOOK LIKE THIS OR LIKE THIS

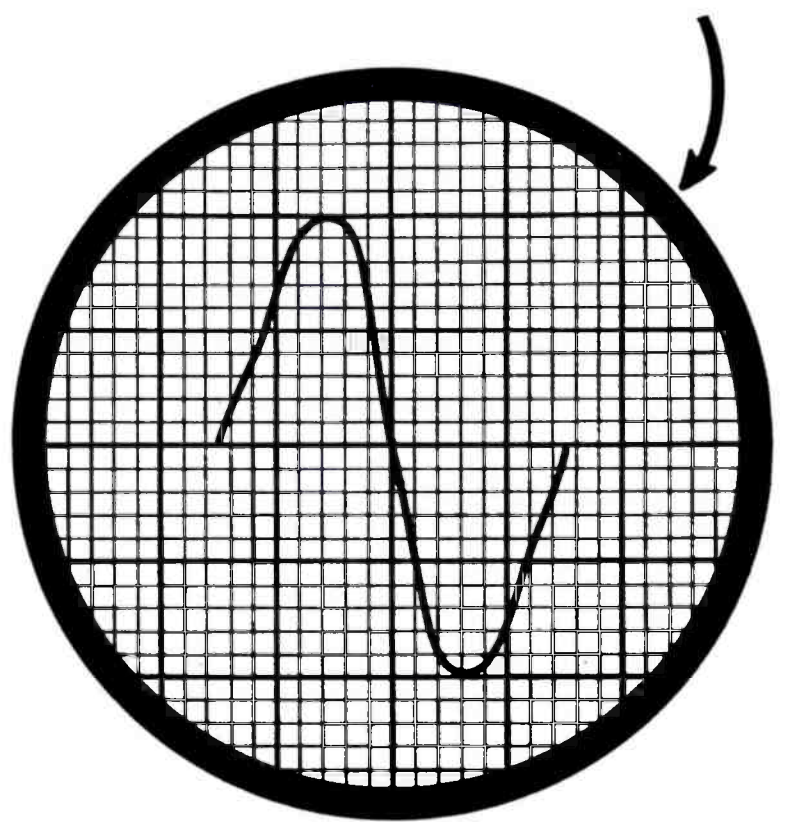
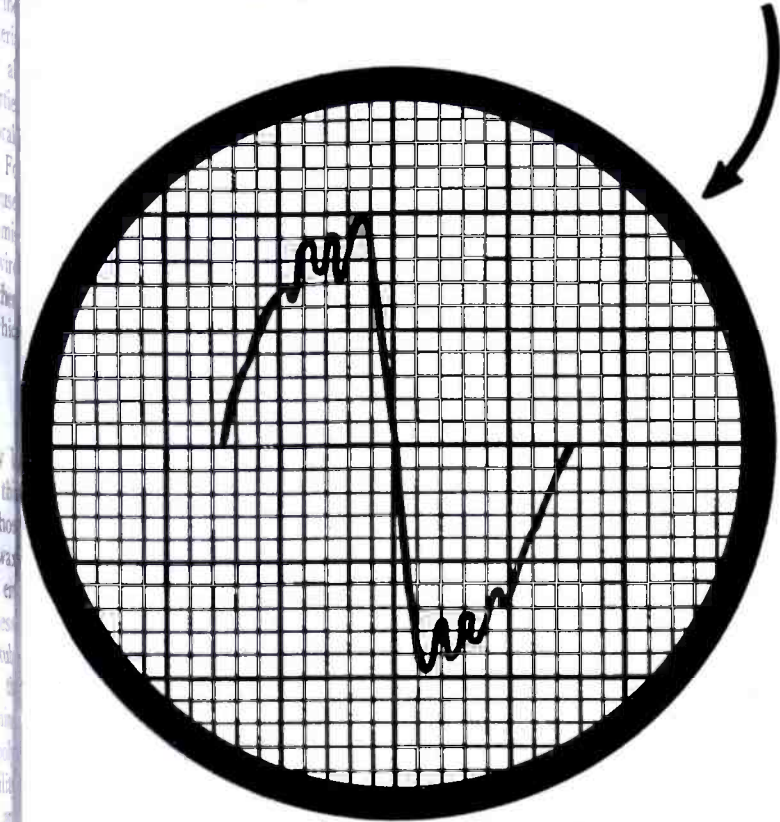

- SORENSON ELECTRONIC A. C. VOLTAGE REGULATOR WILL GIVE YOU GOOD WAVE FORM
- LESS THAN 5% DISTORTION (MODEL 1750)
- VOLTAGE REGULATION BETTER THAN .5%
- INPUT VOLTAGE CAN VARY FROM 95 TO 130 VOLTS
- POWER FACTOR CAN VARY FROM 30% TO 100%
- FREQUENCY CAN VARY $\pm 15\%$
- LOAD ON A SORENSON REGULATOR CAN VARY OVER THE ENTIRE RATED RANGE OF THE UNIT—OUTPUT VOLTAGE CONSTANT TO WITHIN 2/10%.
- CAN BE INCORPORATED IN OTHER EQUIPMENT—STANDARD 19 INCH PANEL CONSTRUCTION
- PRICES—NO MORE THAN OTHER UNITS OF COMPARABLE POWER HANDLING CAPACITY

IT'S THE **KNOW HOW** THAT MAKES THE DIFFERENCE

WRITE FOR MORE INFORMATION AND PRICES—ADDRESS DEPT. C

SOERENSEN & COMPANY, INC.

WILBORNE ELECTRONICS

STAMFORD, CONN.

Analysis of a Detector System Developed by S. W. Seeley of R C A Labs, Recently Discussed in an N. Y. IRE Paper

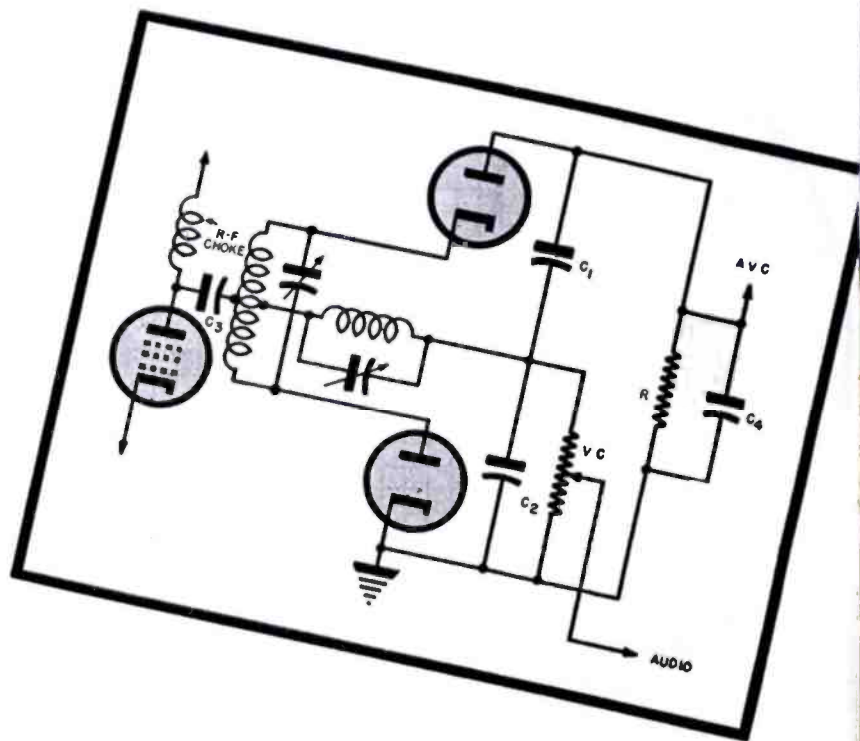
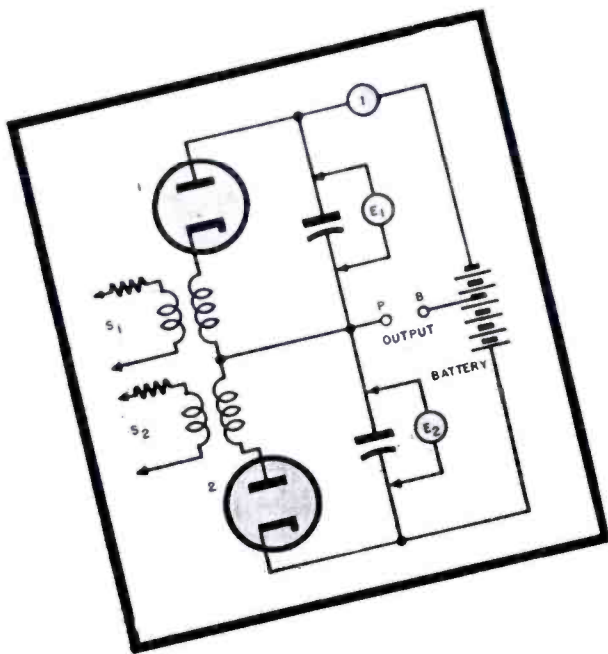

Figures 1 (above) and 2 (right) Figure 1 illustrates the basic elements of the ratio detector. In Figure 2 we have a typical ratio-detector circuit with representative values of components (described in text).

F-M RATIO DETECTORS

WITH the growing interest in f-m has come an accelerated f-m development program, with particular stress on improved detectors, discriminators and limiters. An IRE paper presented by S. W. Seeley offered a new detector design, a ratio detector, with which it was possible to build a f-m unit without a limiter. The receiver described used only one i-f and one r-f stage. Tuning was said to be very satisfactory since the side responses normally present in f-m sets were considerably subdued.

In his analysis of the new method, Mr. Seeley first discussed the conventional discriminator, pointing out that either an increase or decrease in the amplitude of the applied voltage gives rise to a difference in output which, therefore, makes the discriminator responsive to amplitude modulation. To eliminate this disadvantage in the discriminator, cascaded limiters are employed.

It would be a decided improvement to secure an output from the detector which is proportional only to the ratio of the two voltages in the discriminator instead of the difference in their

—by RALPH G. PETERS—

absolute values. Thus, in a normal discriminator, where the output of one diode is A , and the output of the other diode is B , the relationships are

$$\begin{aligned} A &= k(a + \Delta a) \\ B &= k(b + \Delta b) \end{aligned} \quad (1)$$

Here, the signal voltages which are applied to the diodes are a and b , and k is a proportionality factor. Δa and Δb are amplitude variations of the applied signal. This yields for the difference value

$$A - B = k(a + \Delta a - b - \Delta b) \quad (2)$$

It can be seen here that the resultant output voltage is not only proportional to $(a - b)$, but is also proportional to $(\Delta a - \Delta b)$.

In the ratio detector the output is proportional to R , where

$$R = (A/B) = \left(\frac{k(a + \Delta a)}{k(b + \Delta b)} \right) = (a/b) \quad (3)$$

The ratio between a and b will be the same as between Δa and Δb , so that R will be independent of the variation in amplitude. To obtain this result circuit may be set up wherein

$$A + B = K, \text{ a constant} \quad (4)$$

Suppose now that the output we take as the voltage A , under the condition of equation 4. Substituting equation 3 into equation 4, A becomes

$$A = \left(\frac{KR}{1 + R} \right) \quad (5)$$

Thus, the output voltage A is only proportional to a function of the ratio. It is thus necessary to show that if A is proportional to the frequency deviation, then under condition of equation 4, A is also proportional to the frequency deviation.

To analyze this proportionality characteristic we can cite the proportionality between the conventional discriminator output and the frequency deviation as

$$A - B = c \Delta f \quad (6)$$

where c is a proportionality factor and

(Continued on page 82)



The Tube that Makes Better Tubes

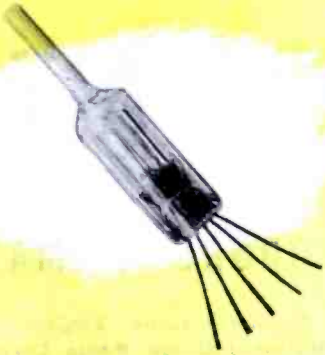

A NEW ACHIEVEMENT OF NATIONAL UNION RESEARCH LABORATORIES

IT was an important day in Vacuum Tube progress when engineers at National Union Research Laboratories perfected a new super-sensitive Ionization Gauge, capable of recording pressures well below a billionth of an atmosphere! With this precision instrument, new accuracy is possible in attaining uniform high vacuum in all N. U. Tubes. Especially advantageous in mass production are the simplicity of this streamlined electronic gauge and its low cost.

For two reasons this original N. U. development warrants careful consideration. First, it is an improved production tool

which makes all N. U. Vacuum Tubes better tubes. Second, it typifies the electronic "know-how" of N. U. Research engineers. So if electron tubes have a place in your post-war picture, make a note to count on National Union.

N. U. IONIZATION GAUGE

- Filament voltage 3.0 volts
 - Filament current 1.8 A.
 - Electron Collector voltage 200 volts
 - Electron Collector current 20 Ma.
 - Ion Collector voltage -13 volts
 - Sensitivity: Ten times the ion current in amperes equals the pressure in mms. of mercury.
- It is possible to expose the hot filament of this gauge to air at atmospheric pressure and later have it function efficiently under vacuum conditions.

RADIO AND ELECTRON TUBES

NATIONAL UNION RADIO CORPORATION • NEWARK 2, N. J.

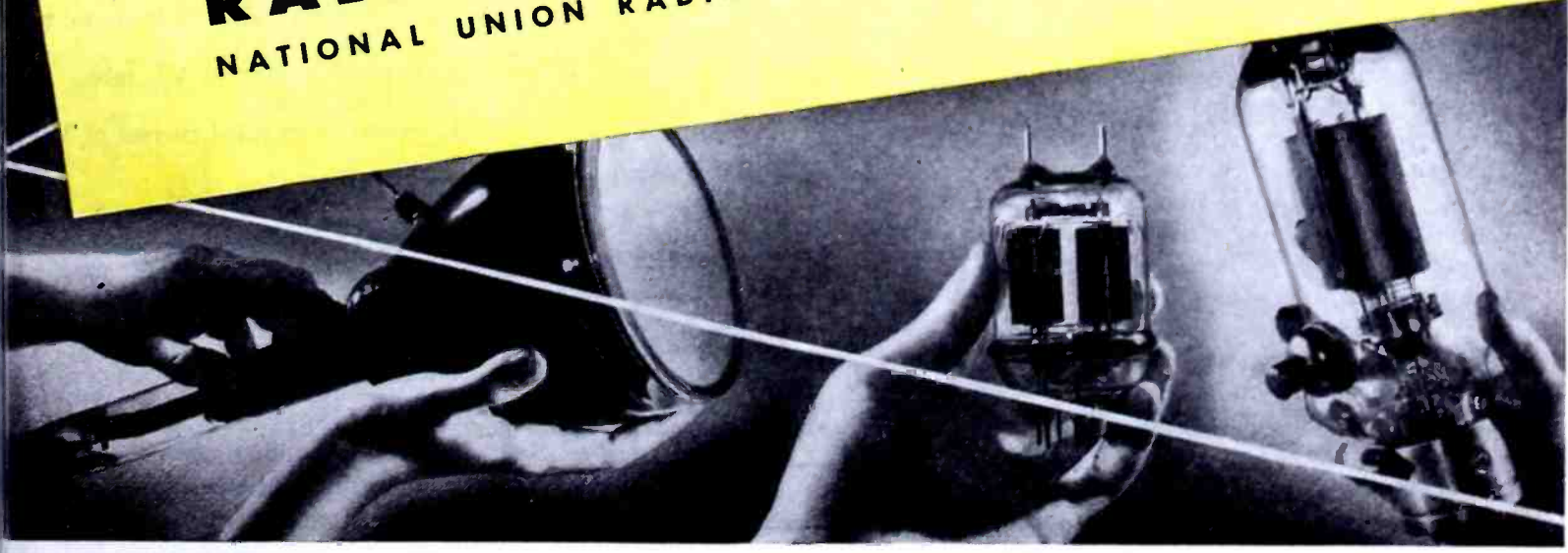

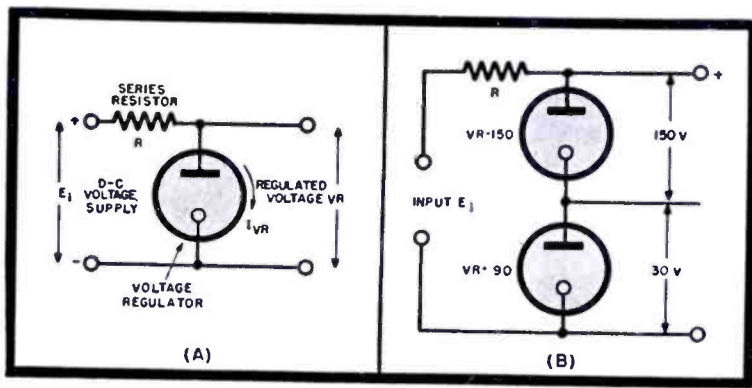
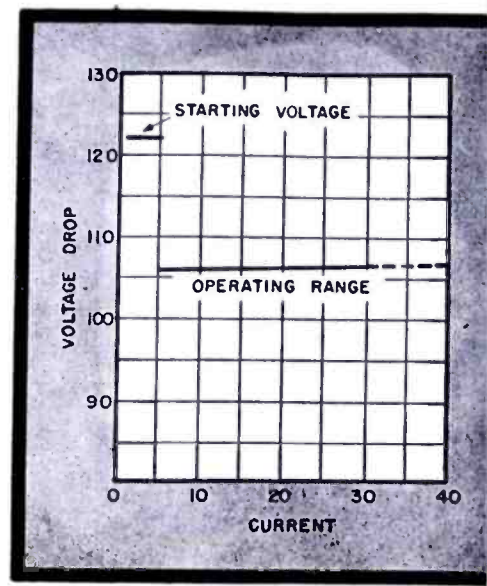

Figure 1

Typical gas-filled tube voltage-stabilizer circuits. In *b* we see how two or more tubes can be connected in series to regulate higher voltages than can be obtained with a single tube.

Figure 2 (right) Typical regulation characteristic for the VR-105-30. It will be noted that the starting voltage is considerably higher than the voltage drop across the tube for normal operating circuits.



VOLTAGE-REGULATED

by G. EDWARD HAMILTON and THEODORE MAIMAN

Senior Engineer
Test Equipment Division
National Union Radio Corp.

Formerly Junior Engineer
National Union Radio Corp.
Now with U. S. Navy

HIGH voltage sources that are independent of fluctuations of supply voltage and load, and with a minimum of output voltage ripple, have become a major requisite of a variety of instrument and communications equipment systems. Voltage stabilizers have provided the answer to most of these problems, affording direct voltages of almost any degree of magnitude and constancy.

Certain applications have used manual adjustment methods, and others have employed cold-cathode gaseous tubes in voltage stabilizers.

Cold Cathode Voltage Regulators

Certain cold-cathode gas-filled tubes may be used to provide, essentially, a constant voltage since their characteristics are such that the voltage drop across the tube remains almost constant over a wide range of current. Typical tubes in this category are: VR-75, VR-90, VR-105, VR-150, 874, 876 and certain neon lamps. The operating voltage of the VR series is indicated by the type number designations. In general the operating voltage of neon tubes is in the order of 55 volts. Figure 1 (*a* and *b*) shows typical circuits in which gas-filled tubes are used as voltage stabilizers. A typical regulation characteristic for the VR-105-30 appears in Figure 2. It

will be seen that the starting voltage is considerably higher than the voltage drop across the tube for normal operating circuits. It is therefore necessary that the input voltage be slightly higher than the starting voltage so that the tube will fire even though the line voltage is below normal. This voltage must be applied through a series resistor *R* so the maximum current drawn by the tube does not exceed its maximum rating. Generally the current minimum should not be allowed to fall below the rated value. However for certain applica-

tions the current may be as low as 10 microamperes.

Obtaining Higher Voltages

In Figure 1*b*, we see how two or more tubes may be connected in series to regulate higher voltages than can be obtained with a single unit. Voltage taps may be obtained by connecting to the series connections. The series resistance *R* may be determined by the expression

$$R = \frac{E_1 - V_r}{I_{vr} + I_L}$$

where:

- R* = series resistance.
- E*₁ = maximum input voltage to regulate circuit.
- V*_{*r*} = rated voltage of VR tube
- I*_{*L*} = load current
- I*_{*vr*} = maximum rated current of VR tube

Stable Voltage Control

Where an extremely stable voltage is required the VR-105 has been found to be the most satisfactory.

Transients

Transients on poorly-regulated power lines sometimes produce instantaneous fluctuations in the output of a supply, as high as 5 volts, in a well

Figure 3
Fundamental concept for a μ bridge-type voltage stabilizer. Primary function of this circuit is to compensate for changes in input voltage, the load remaining constant.

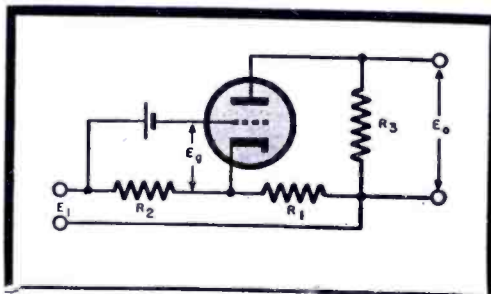

A Discussion of the Most Common Types of Voltage Stabilization Circuits And a Supply That is Capable of Electronic Control and Stabilization from Zero to Maximum Voltage Output

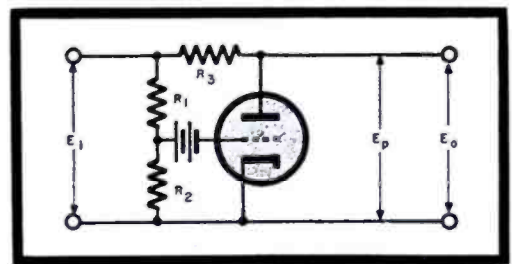

Figure 4
Voltage-output regulator circuit based on the transconductance-bridge principle. Battery in series with grid provides necessary bias.

POWER SUPPLIES

ered unit delivering 200 volts. With y VR tube, except the VR-105, these variations are reduced to about 60 millivolts. Type VR-105 reduces these variations to a value in the order of millivolts. This tube operates most satisfactorily when passing a current of about 15 milliamperes.

Bridge Voltage Stabilizers

In Figure 3 appears the fundamental circuit for a μ bridge-type voltage stabilizer. The primary function of this type circuit is to compensate for change in input voltage, the load remaining constant.

By definition $\mu = \frac{\partial E_p}{\partial E_g}$ where I_p remains constant. If the input voltage changes by ΔE_1 , then

$$\Delta E_g = \Delta E_1 \left(\frac{R_2}{R_1 + R_2} \right)$$

and E_p will change by

$$\Delta E_p = \Delta E_1 \left(\frac{R_1}{R_1 + R_2} \right)$$

For a constant I_p , the voltage drop across R_3 must be constant, and since

$$\frac{\partial E_p}{\partial E_g} = \frac{\Delta E_1 \left(\frac{R_1}{R_1 + R_2} \right)}{\Delta E_1 \left(\frac{R_2}{R_1 + R_2} \right)} = \frac{R_1}{R_2}$$

will remain constant when $\frac{R_1}{R_2} = \mu$

This result may also be shown by

setting up a loop equation, in reference to Figure 3.

$$\Delta E_1 = \Delta I_o R_3 + \Delta E_p^{(1)} + \Delta E_g$$

$$\Delta E_1 = \Delta I_o R_3 + r_p \Delta I_o$$

$$+ \mu \Delta E_g + \Delta E_g$$

$$\Delta E_1 = (R_3 + r_p) \Delta I_o + (\mu + 1) \Delta E_g$$

For regulation to obtain, $\Delta I_o = 0$, therefore

$$\Delta E_1 = (\mu + 1) \Delta E_g$$

then
$$\Delta E_g = \Delta E_1 \frac{R_2}{R_1 + R_2};$$

let

$$K = \frac{R_2}{R_1 + R_2}$$

$$\Delta E_1 = (\mu + 1) K \Delta E_1$$

$$1 = (\mu + 1) K$$

$$K = \frac{1}{1 + \mu} = \frac{R_2}{R_1 + R_2}$$

$$\therefore \mu = \frac{R_1}{R_2}$$

If $\frac{R_1}{R_2} = \mu$, the output voltage will

(1)

$$\Delta E_p = \left(\frac{\partial E_p}{\partial I_p} \right)_{E_g} \Delta I_o + \left(\frac{\partial E_p}{\partial E_g} \right)_{I_p} \Delta E_g$$

remain constant with changes in input voltage over the range in which μ is constant.

Tubes with high-amplification factors are recommended since a small voltage drop across R_2 is desirable from a standpoint of economy in rectifier components.

Transconductance Bridge-Type Stabilizers

Figure 4 shows a voltage-output regulator circuit based on the transconductance-bridge principle.

Transconductance is defined by the following relation:

$$G_m = \frac{\Delta I_p}{\Delta E_c} \text{ with } E_p = \text{constant}$$

Assuming that $E_p = E_o = \text{constant}$ and E_1 changes by ΔE_1 , we may state

$$\text{that } \Delta I_p = \frac{\Delta E_1}{R_3} \text{ and } \Delta E_c = \Delta E_1 \frac{R_2}{(R_2 + R_2)}$$

$$\text{but } G_m = \frac{\Delta I_p}{\Delta E_c} = \frac{\frac{\Delta E_1}{R_3}}{\frac{\Delta E_1}{R_2}} = \frac{R_1 + R_2}{R_2 R_3}$$

(Continued on page 78)

Figure 5
Degenerative voltage control system. This regulator compensates for changes in output voltages resulting from both changes of line voltage and varying load current.

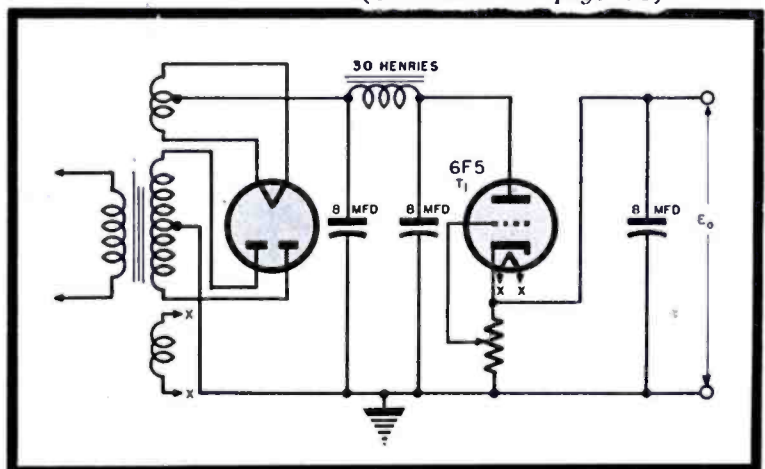

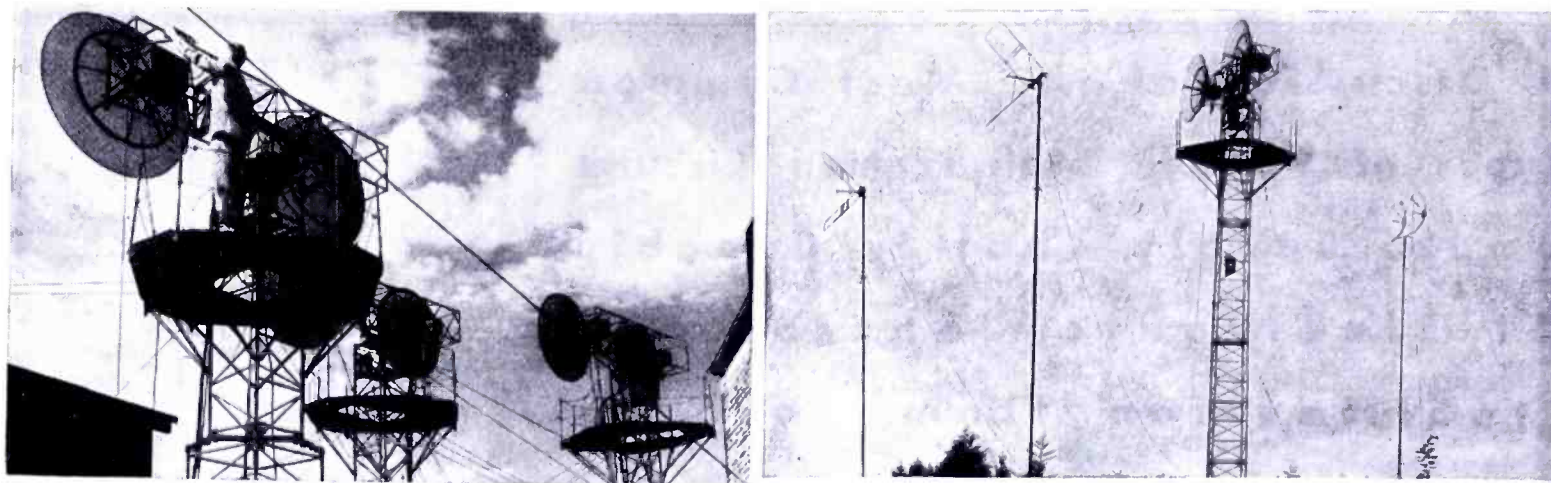

Above, left: Rear view of three of the microwave antennas, used for the AN/TR-6 pulse-modulation system, on the roof of the New York Telephone Company. Above, right: Radio relay terminal at Presidio, San Francisco, showing antennas for the AN/TRC-8, 6, 5 and 1 pulse system respectively. At right, page 47: Relay sites used for Signal Corps comparative tests from San Francisco to San Diego; dashed circles and lines indicate alternate relay points and routes.

P U L S E - T I M E

WITH the recent disclosures of the effective military uses of pulse-time modulation we have learned of another important wartime communications development that will play a major role in our postwar program. For this development represents a basic advance in the possibilities of multi-channel microwave relay chains, affording higher signal-to-noise ratio, less distortion per station, increased number of channels per carrier and greatly simplified terminal equipment. Theoretical and practical results of the new system have demonstrated that the quality of the speech channels is as good as that of the best wire telephone circuits.

In pulse-time (or position) modulation, the intelligence is based on a short

pulse of high-frequency carrier energy which is constant in width and amplitude and is emitted at a repetition rate several times higher than the highest audio-signal frequency to be transmitted. In the absence of modulation or signal voltage, the pulse repetition rate remains constant and the pulses remain evenly spaced. This is illustrated in Figure 1a. When modulation is applied, the repetition rate is varied at a rate equal to modulation frequency and to an extent proportional to modulation amplitude, so that the pulse is advanced or retarded in time. Figure 2b illustrates this condition for

sine-wave modulation. The emitted signal is demodulated by means of a detector capable of integrating the instantaneous pulse time-positions in terms of audio voltage varying at the original signal frequency.

Multi-Channel Operation

By proper choice of pulse width and basic repetition rate, in combination with high-speed gating or switching circuits, it is possible to transmit series or frame of pulses within each repetition or frame period, each pulse being separated in time and capable of being time-position modulated. If the

Figures 1 (left, below) and 2 (below)

Figure 1. In a appears an unmodulated pulse train: h , pulse amplitude (constant); t , pulse width (constant); T , pulse period (constant in absence of modulation). Figure 2. Individual signal pulse-time positions with modulation. A^1 , E^1 and I^1 represent pulse position when modulation amplitude is zero (at A , E and I). Dotted pulses represent pulse positions relative to zero modulation amplitude, for successive pulses during the modulation cycle. Figure 2. Pulse methods used in FTR (a), and RCA and WE AN/TRC 5 and 6 (b) units.

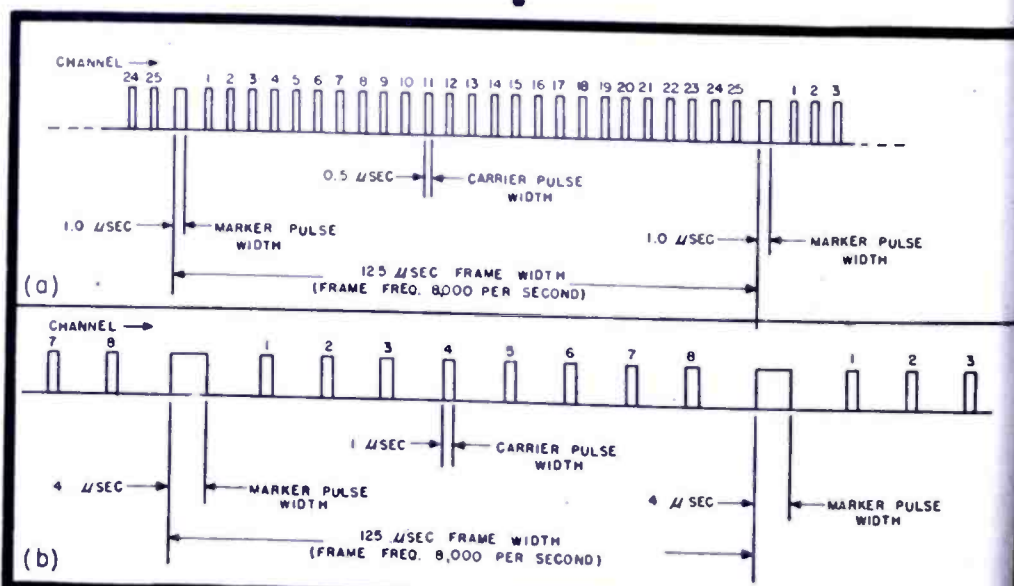
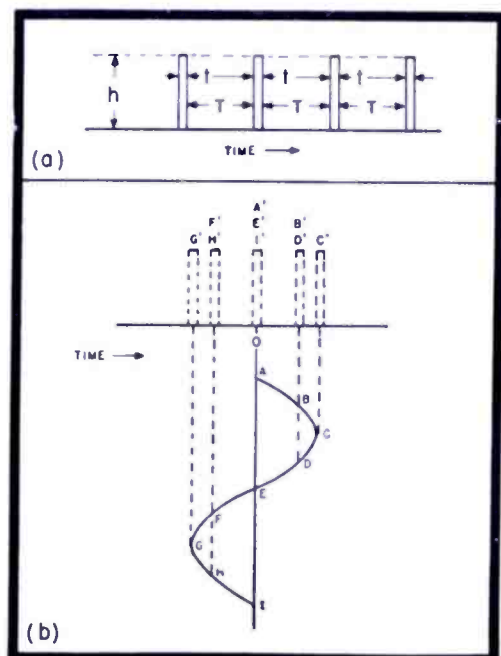

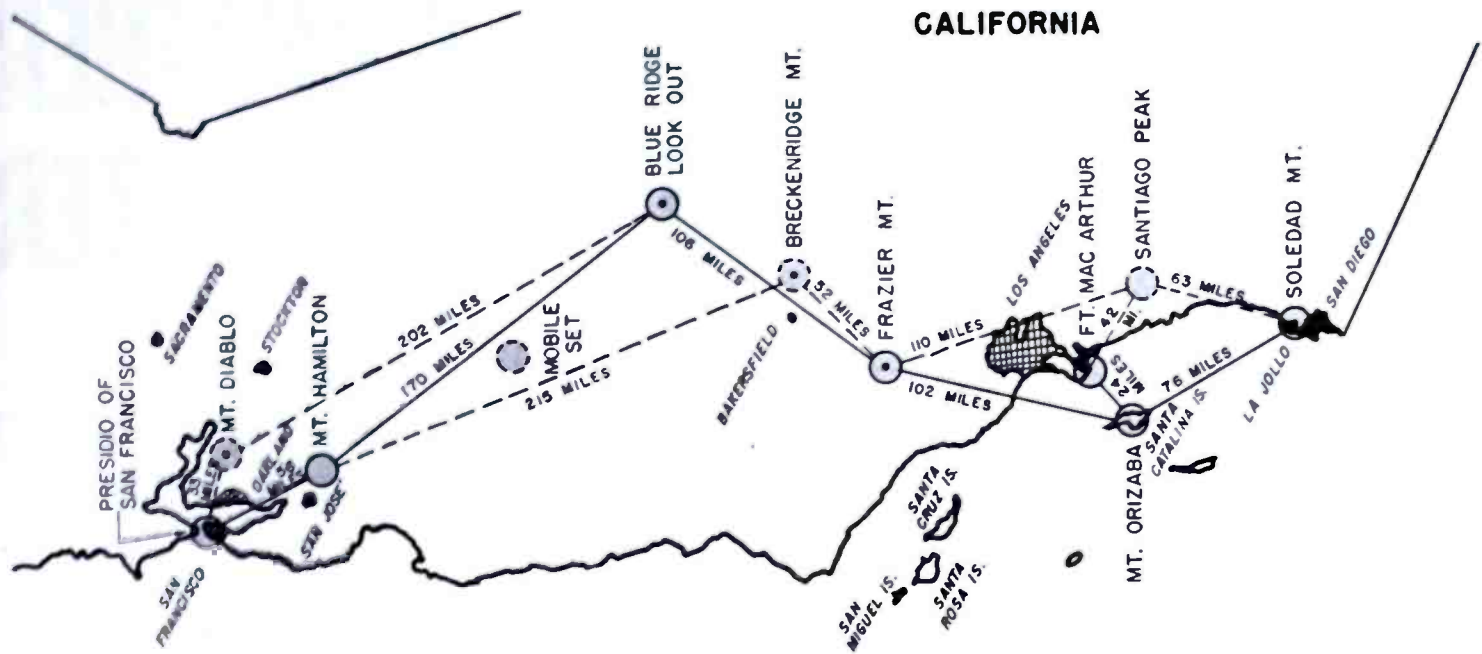

M O D U L A T I O N

Review of Some of the Features Disclosed in Recent New York and Los Angeles Demonstrations

by DONALD PHILIPS

Both of modulation is restricted to avoid overlap between the extreme possible time-position excursions of adjacent pulses, we then have multi-channel transmission by means of time-division rather than frequency-division as used in previous multi-channel transmission systems. The receiver must then possess similar gating circuits which are conveniently synchronized with the transmitter circuits by means of a marker or synchronizing pulse transmitted with each pulse frame, similar to television practice.

Recent Demonstrations

This method of pulse time-position modulation with time-division multiplexing served as the basis of the military and commercial systems disclosed recently in New York City and Los Angeles demonstrations.

Federal Telephone and Radio Corporation demonstrated an experimental 24-channel link between New York City and Nutley, N. J. (40 miles), while Bell Telephone Laboratories demonstrated a military set, AN/TRC-6, providing eight chan-

nels, between New York City and Neshanic, N. J. (40 miles). A similar military equipment manufactured by RCA, AN/TRC-5, was demonstrated by the Signal Corps on the West Coast.

While detailed engineering data on these systems are still restricted, it is possible to describe the pulse schemes used in each of the installations and some of the more obvious electrical and physical characteristics.

Figure 2a illustrates the pulse scheme used in the FTR equipment. The

Figure 3

Relationship between channels under modulation: T-S, time spectrum allotted each channel; G-B, guard band. Right: AN/TRAC-6 relay installation at Blue Ridge Lookout (elevation 5680' above sea level). Shown along each tent wall are the individual frames for each direction of transmission.

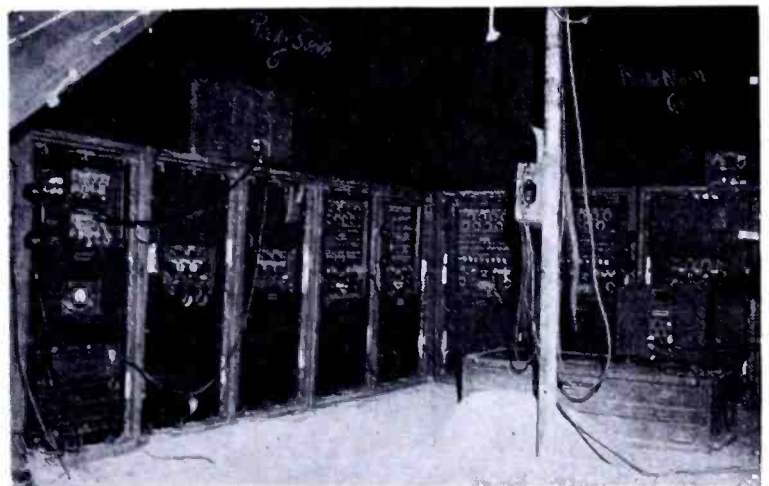
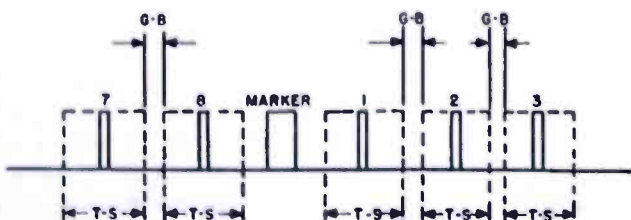

FRANKLIN ANNOUNCES ANOTHER TOWARD BETTER

***** *FLASH* *****

EXTRA



**IT'S NEW
NOTHING ELSE LIKE IT!**

**AUTOMATICALLY EMBOSSED ON
BACKBOARD TO SPECIFICATION**

**OPENS UP MANY AVENUES TO
BETTER RADIO SET DESIGNING**

THE *AIRLOOP*

AIR DIELECTRIC THROUGHOUT

ITS ENTIRE LENGTH

A radio engineers' dream come true . . . Flat sheets of copper die-stamped into perfect super-sensitive loops . . . The greatest development in loop antenna design and manufacture since 1920 . . . Being rectangular the Airloop has 27% more effective area . . . Better performance at lower cost . . . No set builder can afford to overlook the significance of the Airloop.

**INVESTIGATE
SPECIFY
FRANKLIN
AIRLOOPS**

- Optimum sensitivity
- High uniform "Q" over entire band
- Inductance to close tolerance without adjustable turn
- Low distributed capacity
- 27% greater effective loop area
- Electrical and mechanical stability
- Backboard and loop in one
- Lower cost
- Elimination of individual loop adjustment on assembly line
- Maximum space utilization (cabinet depth)

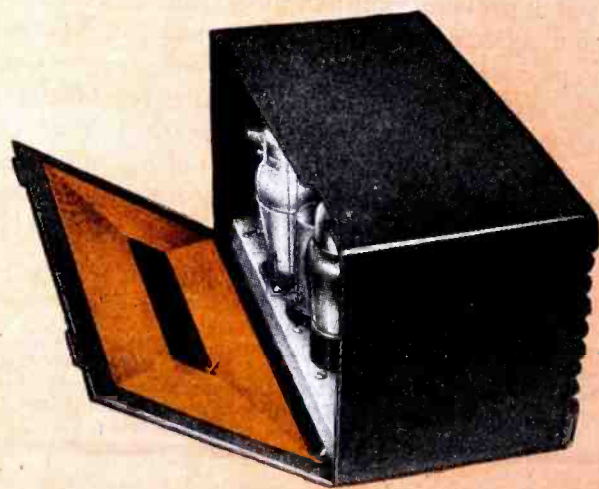

Illustrating the AIRLOOP as installed in a typical table model receiver; note that the AIRLOOP and backboard are one and placed as far away from the chassis as is possible to permit optimum sensitivity, easy access to tubes . . . and no Haywire.

*Patents pending in U.S.A. and Foreign Countries.

SENSATIONAL CONTRIBUTION RADIO RECEPTION!

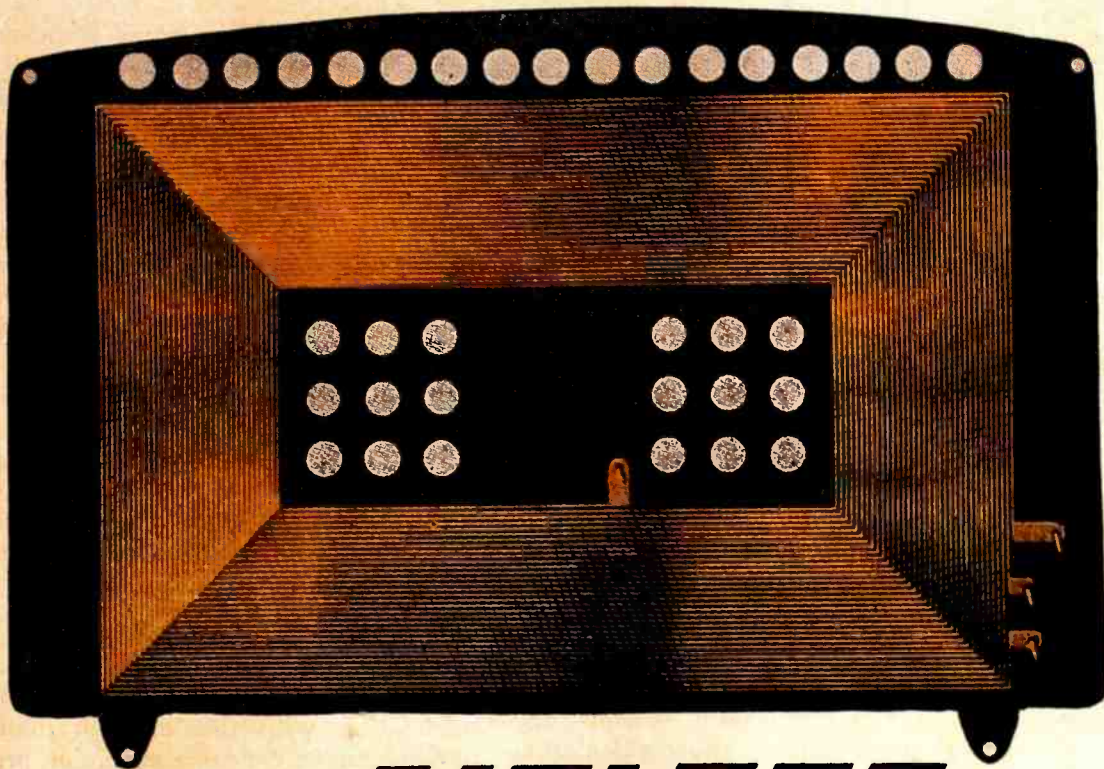

THE AIRLOOP

Illustrating the preciseness of AIR-LOOP manufacture; note that every turn has uniform air dielectric throughout, Die-embossed on automatic machines, each AIRLOOP is identical in every way...and is the backboard as well as the loop.

FEATURING AIRLOOP STABILITY...

AIRLOOPS have only 5% reduction in "Q" after being subjected to 100% humidity for 24 hours. Such mechanical stability is unequaled by any wound wire type of loop. Since AIRLOOPS require no wax for treatment against humidity, operation is stable at temperatures much higher than conventional wax treated loops can tolerate (wax usually melts at around 70° C.).

Inductance cannot be changed by rough handling in installation or in changing tubes.

FEATURING AIRLOOP LOW DISTRIBUTED CAPACITY...

By actual test, AIRLOOPS have 25% less distributed capacity than conventional loops of equivalent effective area. This means better frequency stability, permits use of smaller gang condenser resulting in lower costs and better performance (sensitivity) at high end of band since low distributed capacity does not lower the "Q" of the AIRLOOP as it does in conventional loops... also "Q" is more uniform over the entire band.

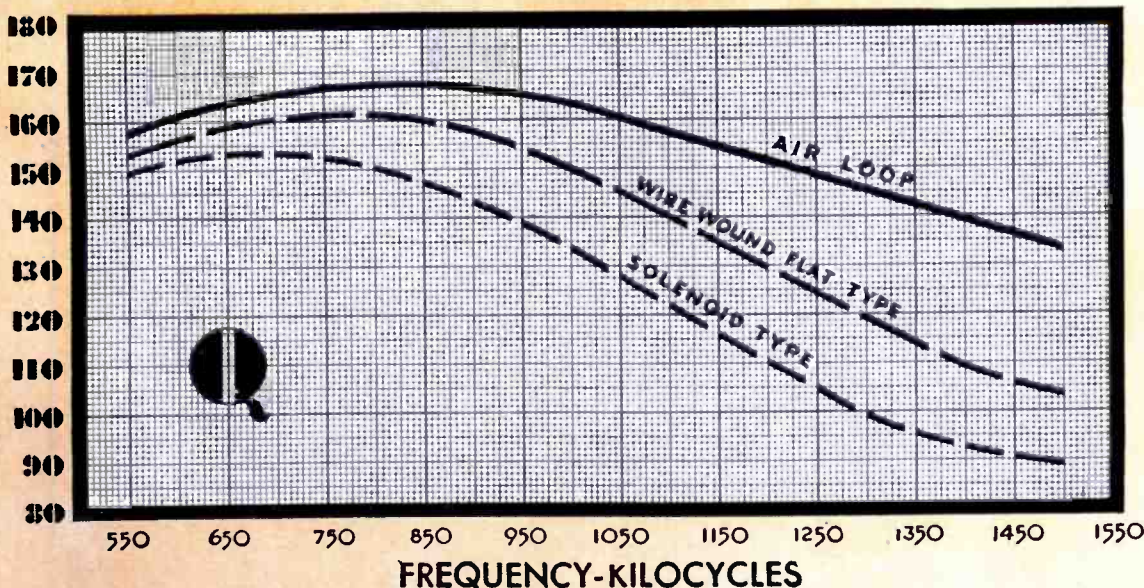

Investigate the AIRLOOP and you will specify them for your receivers.

Franklin **AIRLOOP** corp.
175 VARICK ST., NEW YORK 14, N. Y.

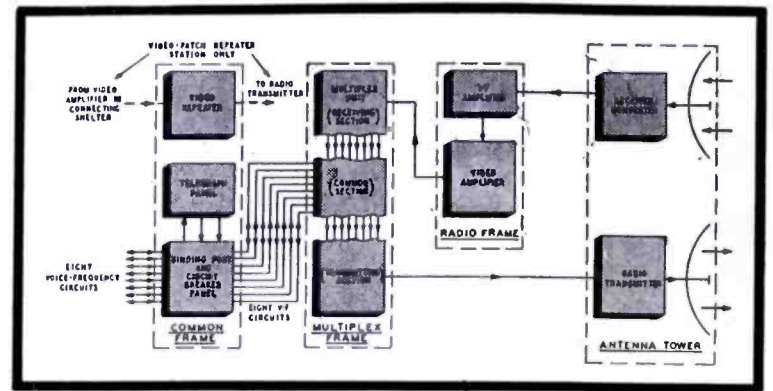
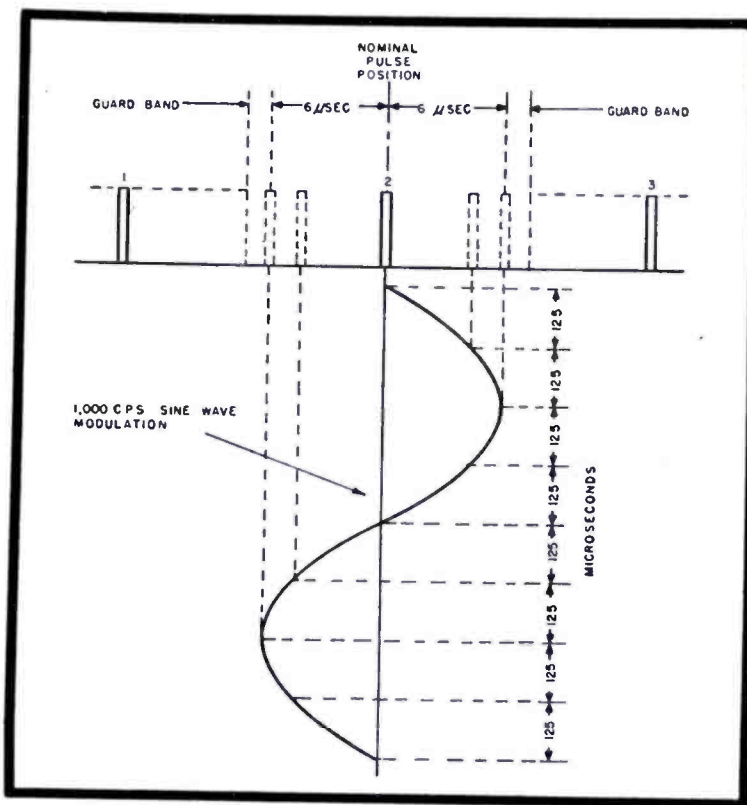

Figures 4 (left) and 5 (above)

Figure 4 shows a 1000-cycle sine-wave modulation on channel 2 of the AN/TRC-6. In Figure 5 we have a block diagram of the AN/TRC-6 system.

carrier pulse frequency in this example is 1,300 megacycles, the carrier pulse is 0.5 microsecond wide, the marker pulse is 1.0 microsecond wide and the frame frequency is 8,000 cps. Sharply focussed parabolas 8" in diameter are used for transmission and reception. The transmitting and receiving equipment is compact enough to be mounted in two standard relay racks.

The AN/TRC-5 and AN/TRC-6 models employ carrier pulse frequencies in the 1,350 to 1,450-mc and 4,200 to 4,900-mc range, respectively, while the pulse scheme is the same for both (Figure 2b): carrier pulse width, 1.0 microsecond; marker pulse width, 4.0 microseconds; and frame frequency, 8,000 cps. Parabolic reflector antennas of commensurate size are used for transmission and reception, while the entire equipment, including 50' antenna

masts, antennas, gas-generator power supplies and operating and spare transmitters and receivers, is housed in two 2½-ton trucks.

Analyzing the pulse sequences shown in Figure 2b, we note that the frame of nine pulses (i. e., marker pulse plus eight-channel pulses) is transmitted each 125 microseconds. Thus the speech intelligence or other modulation is chopped up or sampled 8,000 times per second. In proportion to the amplitude of the modulating signal, each channel pulse assumes a position in time before or after its nominal or unmodulated position. In the example given, the nominal pulse spacing is approximately 16 microseconds, so that the time-position modulation may extend ± 8 microseconds with respect to nominal. However, to prevent adjacent channel interference, the magnitude of the time excursions is limited to provide a guard band of several microseconds analogous to the frequency division gap used in conventional multiplex practice. An expanded section of Figure 2a is shown in Figure 3, with the foregoing facts represented. The dotted rectangle bracketing each channel pulse shows the time spectrum allotted to each channel for carrying the intelligence. For example, as shown in greater detail in Figure 4, suppose the time spectrum is

± 6 six seconds, the frame frequency again 8,000 cps and the modulation frequency 1,000 cps sinewave, with the peak modulation amplitude sufficient to use up the maximum time spectrum. The modulation signal is then sampled every 1/8,000 of a second or every 125 microseconds, so that, in the case of 1,000 cps modulation, one cycle of modulation signal is represented by eight pulses in space. In detecting the signal, the integrating capability of the demodulator is capable of producing a smooth tone out of the chopped-up segments, and the overall capabilities of the system are sufficient to render high-quality reproduction of speech tones up to 3,000 cps.

Comparative Advantages

While it may seem that pulse-time modulation with time-division multiplexing might consume an undue proportion of frequency spectrum, there are advantages which more than offset this. In such a system the number of channels, within broad limits, is essentially independent of bandwidth. The

(Continued on page 85)

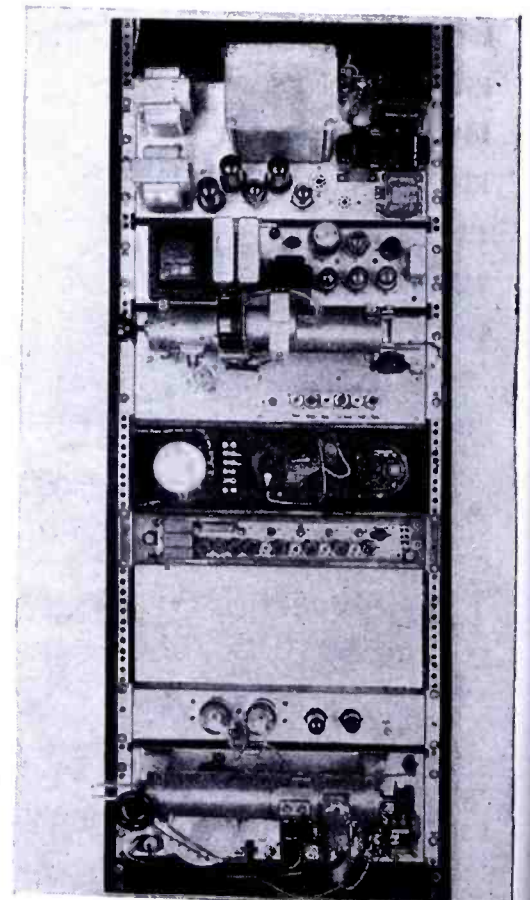
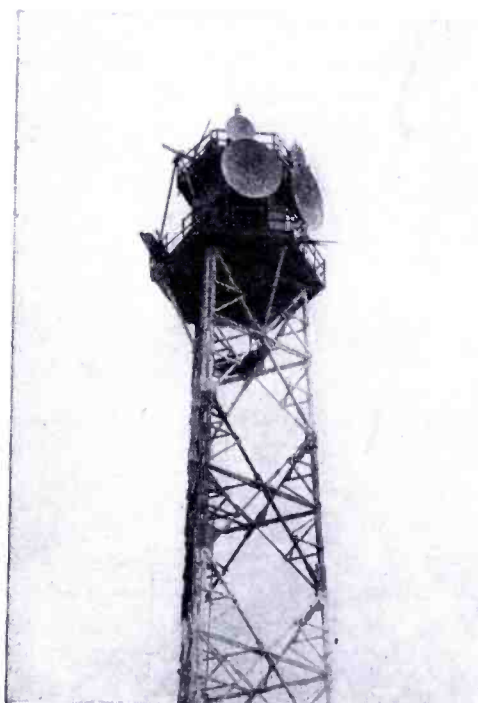

At left, FTR pulse-time modulation antenna towers at Nutley, N. J. Right, view of the FTR pulse-time multi-channel repeater assembly.



for every transformer application

FOR THE SET MANUFACTURER

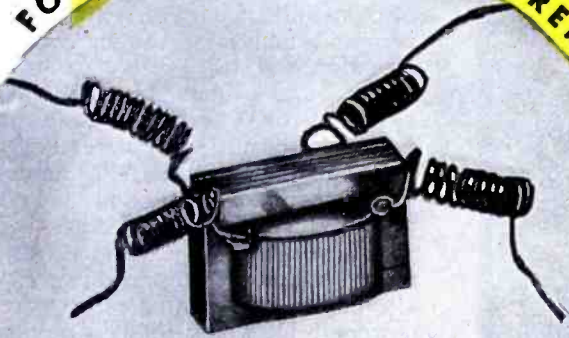

Miniature components to match the new "proximity fuse" miniature tubes. Output and input transformers, and reactors with dimensions 9/16" x 3/4" x 5/8".

FOR THE RESEARCH LABORATORY



Typical of the special units produced by UTC is this high gain, 100 cycle, matching transformer. Primary impedance 500 ohms, secondary impedance 37,500,000 ohms, shielding suitable for -160 DB signal level.

FOR THE RADIO AMATEUR

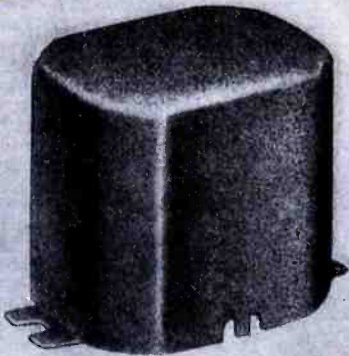

UTC Special Series components cover the entire range of amateur and low priced PA requirements . . . attractively cased . . . economically priced.

FOR THE BROADCAST STATION

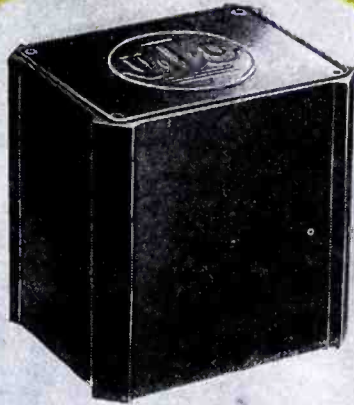

UTC linear standard transformers are the ultimate in high fidelity design . . . frequency response guaranteed ± 1.5 DB 20 to 20,000 cycles . . . Low wave form distortion . . . Extremely low hum pickup.



United Transformer Corp.

150 VARICK STREET NEW YORK 13, N. Y.
EXPORT DIVISION: 13 EAST 40th STREET, NEW YORK 16, N. Y., CABLES: "ARLAB"

SHIPBORNE RADAR

— by G. E. M. BERTRAM —

Chief Engineer

Radar Division

Raytheon Manufacturing Co.

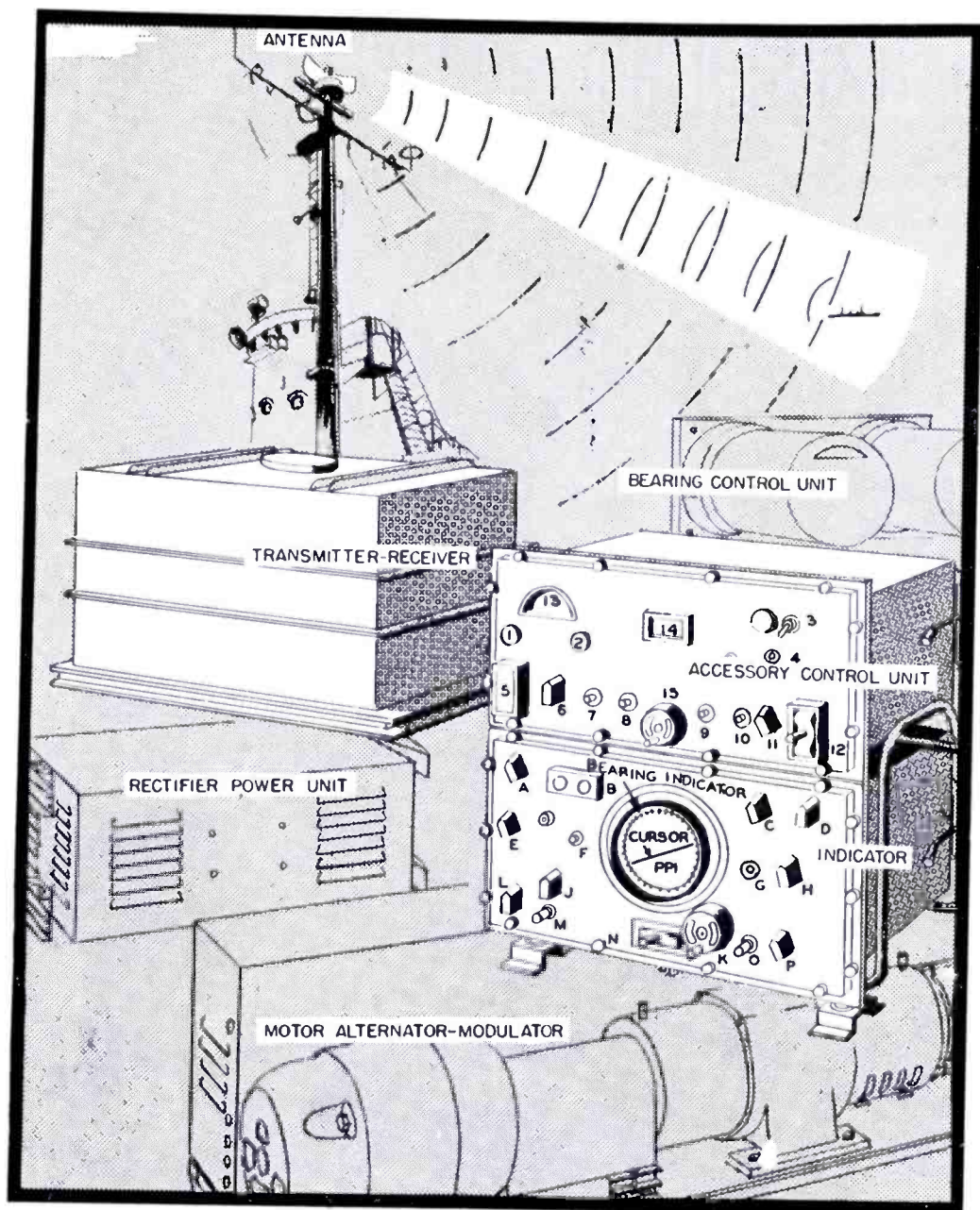

WHILE the basic design features of land and sea radar systems are similar, their special wartime applications demanded many unusual features. This was particularly true of shipborne radar, which actually is a fixed-mobile unit, with extreme sensitivity, and unusually rugged marine construction.

One of these units, the SO radar, consisted of five sections: Transmitter-receiver, indicator and accessory control units, rectifier power unit, motor alternator-modulator unit and the antenna.

The ship's 24-volt d-c system is used as a primary supply to operate a shunt-wound motor which, in turn, drives an alternator generating high-frequency power at 115 volts. This a-c output system serves to power the complete radar system.

In the alternator-modulator, the potential is stepped up to approximately 8 kv, half-wave rectified, and fed to a pulse line. The a-c voltage charging this pulse line has a frequency of approximately 400 cycles. A synchronized rotary spark gap is utilized to discharge the line. Thus for each cycle of a-c the line is charged,

(Continued on page 55)

Right, setup of shipborne radar equipment. Plan position indicator controls: A, off-on, main switch for equipment; B, stop-start, main switch for modulator (turned on after set has warmed up); C, gain, controls receiver gain; D, marks, controls marker intensity; E, N-E normal-emergency, controls transmitter plate voltage for emergency operation; F, sw-l (sweep length), adjusts sweep speed; G, tune set, controls receiver tuning (dual) by coarse adjustment of local circuits; H, tune, controls receiver tuning by vernier adjustment of plate voltage of local circuits; J, range, selects range 4-20-80 miles; K, bearing orank, adjusts bearing cursor; L, pilot, controls pilot light intensity; M, int, (intensity), controls PPI intensity; N, ccw-off-cw (counterclockwise-clockwise), controls direction of antenna rotation; O, focus, controls PPI focus, and P, center, adjusts PPI spot centering. Accessory control unit: 1, gain, controls echo box gain; 2, tune, tunes echo box, using meter resonance indicator; 3, ship heading flash, controls ship heading flash; 4, gain, special gain; 5, tune, switches meter from line voltage to echo box resonance indication; and 6, pilot, controls pilot light intensity.

Right, main frame of shipborne type SG radar. Below, closeup of SG radar, large type ship-search unit, used aboard capital ships.

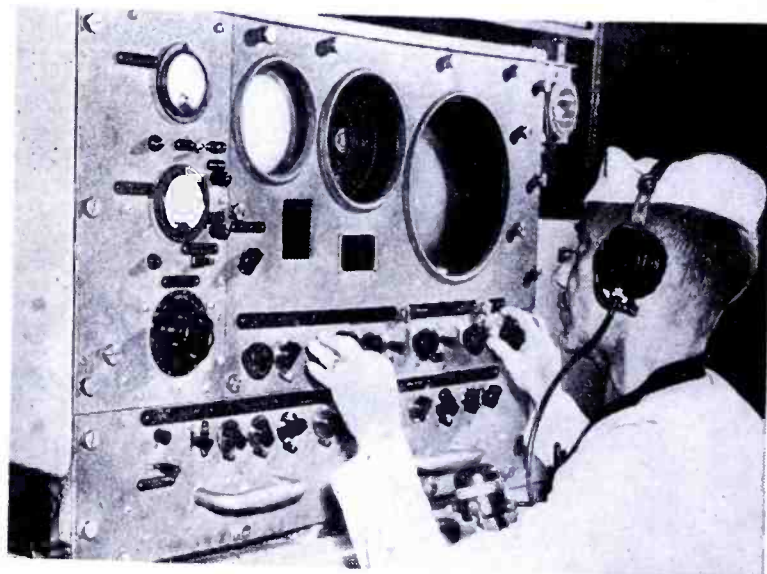
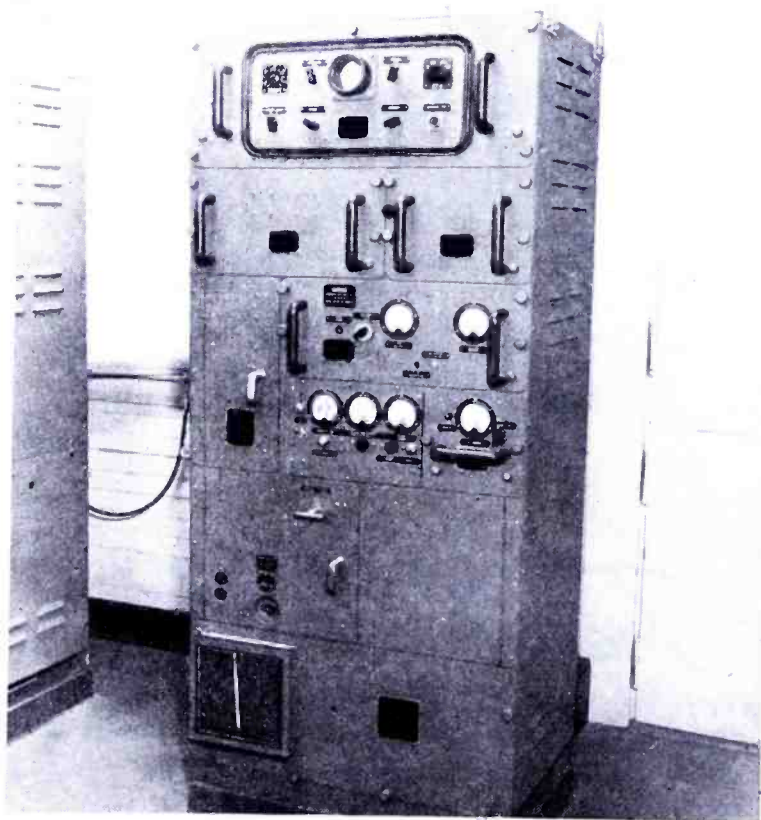

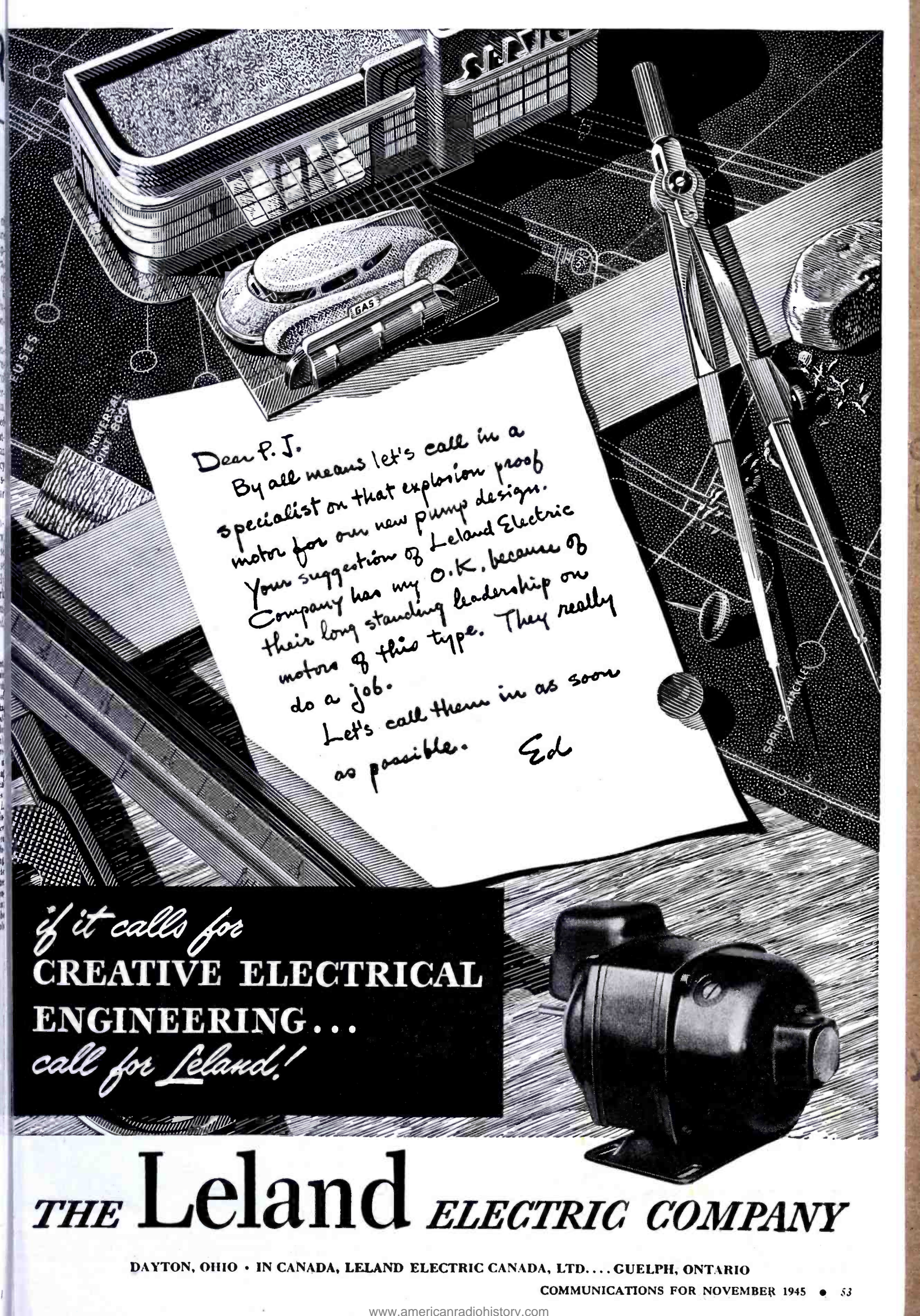

Dear P. J.

By all means let's call in a specialist on that explosion proof motor for our new pump design. Your suggestion of Leland Electric Company has my O.K. because of their long standing leadership on motors of this type. They really do a job.

Let's call them in as soon as possible. Ed

if it calls for
**CREATIVE ELECTRICAL
ENGINEERING...**
call for Leland!

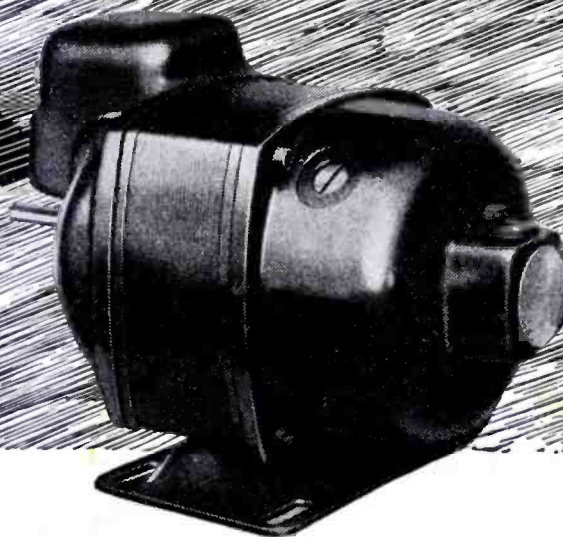

THE Leland ELECTRIC COMPANY

DAYTON, OHIO • IN CANADA, LELAND ELECTRIC CANADA, LTD. . . . GUELPH, ONTARIO

COMMUNICATIONS FOR NOVEMBER 1945 • 53

A NEW 104 db GAIN

Portable

AMPLIFIER—15 WATTS



The new Altec Lansing A-323 portable amplifier is specifically engineered to operate adequately from low level phonograph pick-ups, microphones or radio tuners. Up to its rated power, it reproduces high quality sound over the full frequency range without overload or distortion. It is a small, compact, 6-tube portable amplifier especially designed and manufactured to efficiently operate with the Duplex Speaker, public address systems, home radio receiving sets and other applications where high quality, low cost amplification is desired.

\$118⁰⁰

WITH INPUT TRANSFORMER
\$158⁰⁰

AT ALL LEADING DEALERS
OR SEND YOUR ORDER TO

ALTEC
LANSING CORPORATION

1210 TAFT BLDG., HOLLYWOOD 28, CALIF.
250 WEST 57 STREET, NEW YORK 19, N. Y.
IN CANADA: NORTHERN ELECTRIC CO.

MINIATURE POCKET RECEIVER

(Continued from page 37)

shielding between the grid and plate circuits of the r-f tube.

The coils are tuned by sliding cores attached to a *cross head* which slides along the chassis and which is driven by a connecting rod from a calibrated tuning dial which projects from the end of the chassis and can be operated by edgewise motion with the thumb. The tuning dial, connecting rod and crosshead can be seen at the top of the chassis in Figure 9. The volume control and battery switch are at the left, immediately under the tuning dial.

A screwdriver adjustment was provided for mechanical alignment of the cores in the coils. A small trimmer capacitor of a few mmfd is connected across the r-f grid circuit and this was found sufficient to align the antenna and r-f circuits electrically over the entire waveband, providing the cores were first aligned mechanically.

The opposite edge of the chassis appears in Figure 10. At the right hand of the front edge is the r-f plate coil. The three hearing-aid miniature type tubes can be seen lying flat under the coil and its core; these are the detector and the two audio amplifier tubes. At the left hand end is the 50-henry output choke.

Besides their small size, the miniature tubes offered the advantage of very low battery drain. The total *A* drain was 90 milliamperes at 1½ volts of which 50 ma was for the 1T4 r-f tube, and only 40 ma total, for the other three tubes. The total *B* drain was about 1.5 ma at 30 volts; the last three tubes dissipated only 0.3 ma, and the 1T4 r-f the remainder.

This resulted in a life of approximately 10 hours for the *A* battery and 100 hours for the *B* battery.

To realize these very small battery currents in practice, it was of course essential to use an earphone of high sensitivity; it would not be possible to obtain anything like this degree of battery economy when using a small loud-speaker.

When using a crystal earphone, a plate choke had to be used for feeding the plate of the output tube. The lower cutoff frequency was determined by the inductance of the choke. The lower peak in the overall frequency characteristic, shown in dotted lines in Figure 4a, is due to resonance between the inductance of the choke and the capacity of the crystal earphone. This resonance is useful inasmuch as it increases the dynamic impedance of the output circuit to several hundred thousand ohms and makes it possible to obtain an unusually high-voltage gain in

the output tube when this is a pentode or tetrode. When using a magnetic earphone a miniature output transformer must be used.

In the receiver described, the voltage gain of the output tetrode was about 16 times. At the same time, the power sensitivity of the earphone was such as to give a good loud signal with 5 volts across its terminals, corresponding to a total power in the output circuit of only 250 microwatts. Consequently, the output tube plate current may be as low as 200 microamperes, thus permitting the use of exceptionally small batteries.

Several types of earphone are available at the present time, both of the crystal and the magnetic type. In general the crystal type is lighter in weight, while the magnetic type is slightly heavier, but is more rugged, and usually lower in cost. These earphones are available with various ranges of frequency response. For instance there are crystal units with frequency ranges from 300-4,000 cps, 300-6,000 cps, and 200-7,000 cps. Magnetic types are available in ranges from 100-2,300 cps, 100-4,000 cps, and 100-4,500 cps.

Fortunately, all these earphones are standardized insofar as the earmold attachments are concerned. In other words, the same standard sizes of earmold (five for left and five for right ear) will fit any one of the various types of earphone listed above.

For reception of the finest quality, a pair of earphones may be worn, both in the left and the right ears. The apparent fidelity of reproduction, even with the pocket radio set just described, is then as good as that of the average radio console model.



Miniature pocket receiver recently developed by Belmont Radio Corp.; 3" wide, ¼" thick, 6¼" high. Weighs 10 ounces including batteries.

(Continued from page 52)

When discharged by the fringing of the gap, resulting in one-microsecond 8-kv pulses being fed through a coaxial cable, from the modulator unit to the transmitter.

A small amount of the high-frequency one-microsecond pulse voltage is also fed to the indicator. This synchronizes the radial sweep of the PPI with the transmitted pulse. It also serves to trigger the accessory control unit and to operate a PPI unblinking circuit.

In the transmitter, the one microsecond high-voltage pulses are applied to a half oscillator at a power input of approximately 250 kw and a repetition rate of 400 cps. Once each repetition cycle, microwave energy is generated for a period of one microsecond and fed to the antenna via a waveguide and radiated into space. The antenna reflector concentrates and reradiates the energy in a narrow beam.

Energy reflected back to the antenna from targets, enters the receiver via a TR box (duplexing cavity). This unit is merely an electronic switching arrangement which effectively changes the antenna from the transmitter to the receiver while the transmitter is off.

The receiver comprises a wide-band superheterodyne, detector and video amplifier. The output is delivered through a coaxial cable to the indicator as a rectified video signal. Here, the video signal is again amplified and fed to the control grid of the PPI, finally appearing on the screen as a small bright spot.

As the antenna rotates through 360° the radial sweep on the PPI does likewise and in exact synchronization with the antenna. This means that the outer dial on the tube may be calibrated in degrees and will, therefore, give precise bearing data.

Because of the synchronization of the radial sweep to the transmitted pulse, the distance of the target echo from the center of the screen is directly proportional to the distance of the target from the antenna. Calibrated markers can be superimposed on the face of the PPI which will generate marker rings. From these concentric rings approximate ranges can be derived. The accessory control unit generates an accurate range mark which also appears on the PPI screen. When the range crank on this unit is rotated, this range mark moves out along the trace and when the mark coincides with the echo to be ranged, accurate range may be read directly from a dial mechanism which is coupled to the range crank.

It is a normal procedure to tune the equipment for optimum reception of surrounding targets. However, an echo box (resonance chamber) is supplied with each installation and may be used for tuning in the absence of targets.

The echo box is a resonant chamber which can be tuned to resonate at the transmitted frequency. The unit itself provides a high-Q tuned circuit in which oscillations persist for some time after the transmitted pulse stops. These oscillations are fed back into the waveguide, through the duplexing cavity into the receiver, thus simulating echoes received from an actual target.

Operation of SO radar is not compli-

(Continued on page 56)

Willor

For *Precision Accuracy*

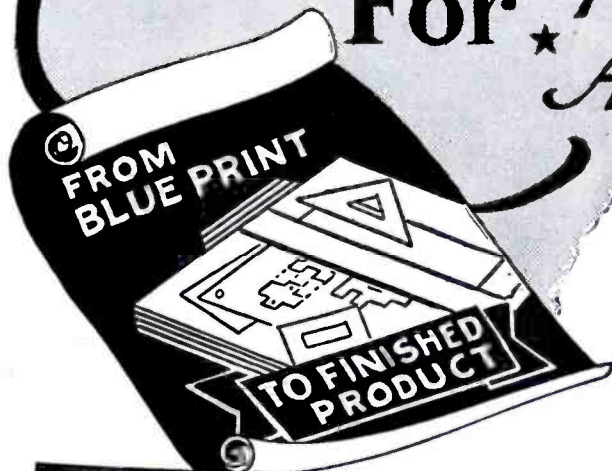

WILLOR STAMPINGS

A modern plant, including designing, Tool and Die making — automatic stamping — machining — welding — assembling — spraying — large or small production runs — special custom built products, at low cost.

A Service . . .
Complete from Design to Finished Product

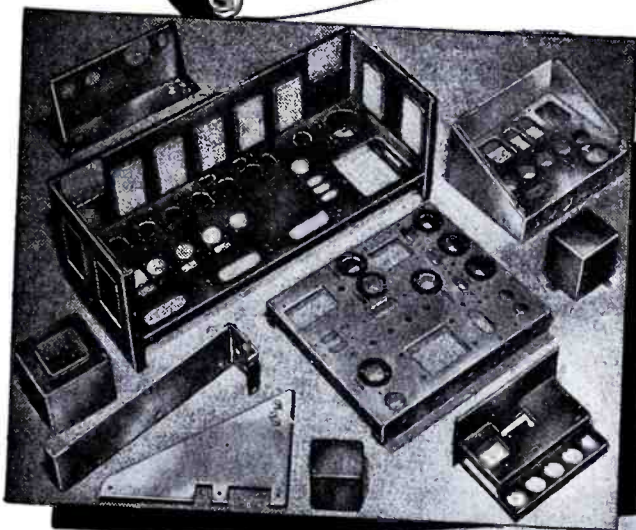

WILLOR

is your definite assurance of **SKILL** and **ACCURACY** for **PERFORMANCE**.

If your product is in the development stage or finished blueprint, write WILLOR for quotations. You will find our plant is prepared to produce to meet your needs.

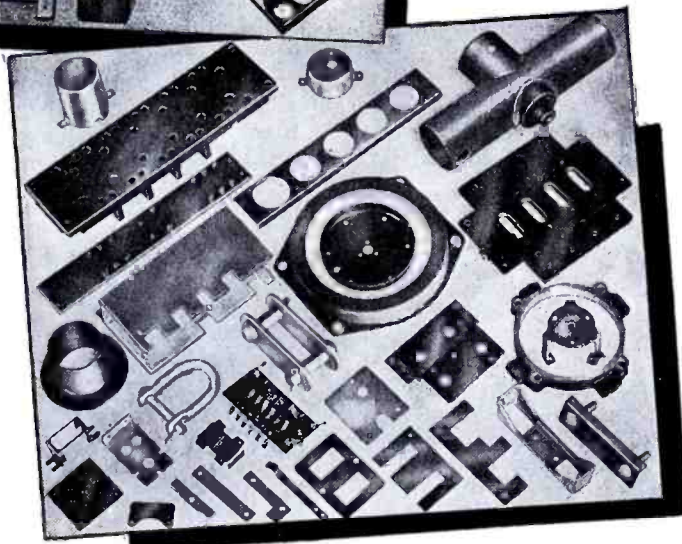

Our large assortment of stock dies may fit your requirements and result in real savings for you.



WILLOR

manufacturing Corp.

794 C EAST 140th STREET, NEW YORK 54, N. Y.
MELROSE 5-6085

OVER 40 YEARS OF EXPERIENCE

SHIPBORNE RADAR

(Continued from page 55)

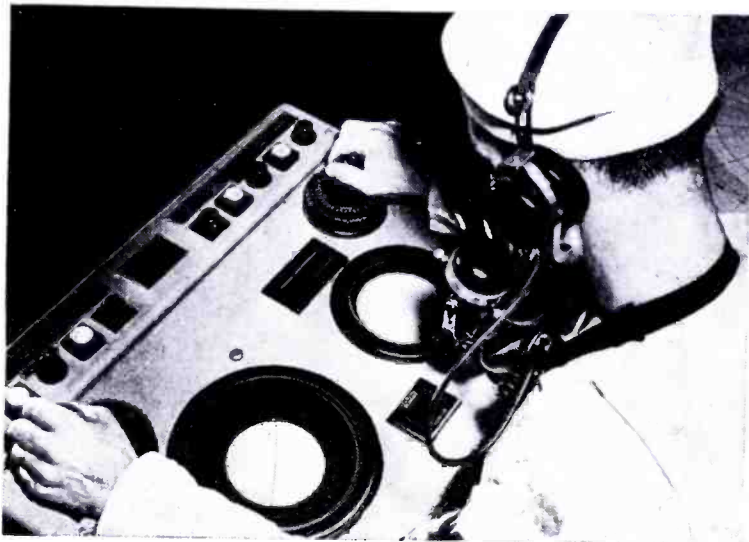

Left: Radar repeater. On right is a *sweep*, which is a rectangular plot, with range and bearings on the co-ordinates. In this *sweep* the target is enlarged. Below, left: Enlargement of segment of target viewed on radar unit. Below, right: Scope view. Concentric circles are the ranging marker, which is cranked across the PPI until it lies directly over target.

cated, despite the large number of controls. After the set is turned on and permitted a normal warmup period, a start button is pressed. To avoid this delay a *normal-emergency* switch is provided.

Assuming the various semi-permanent and range adjustments to be in order, the intensity control is set for moderate brilliance of a spot appearing at the centerpoint of the PPI.

The gain control may be advanced to full for maximum output from the receiver. The receiver-tune knob is set to approximately mid-scale. The *marks* control is turned up until marker dots of moderate brilliance appear along the trace on the PPI. The space between each dot represents a specific distance depending on which one of the range settings is used.

When one particular target is to be observed, the antenna is brought to bear on it, using the antenna motor switch which has a clockwise and counter-clockwise position. The tune control is adjusted for maximum brilliance of the signal appearing on the PPI. If the target is at close range, the center control is used. Adjustment of this control regulates the

starting point of the PPI trace, and prevents the centerpoint spot from overlapping and blocking out any signals from the nearby target. It does not affect the distance between range marks.

The sweep-length control is used to contract or expand the PPI sweep. Assuming we desire to closely follow a selected area, expanding the sweep length permits emphasis of details. It does not, however, change the range distance represented between the marker circles (the circles created by the marker dots rotating around the face of the PPI).

To determine the bearing of an obstacle, a bearing crank is used. Rotating the crank, moves the hairline around the PPI. By setting the hairline on the target and reading the azimuth scale around the PPI, the bearing may be read directly in degrees.

If the ship is equipped with a flux-gate or similar compass, the radar may be equipped with a true-relative bearing indicator. Selection of the desired reading will cause a *flash* trace to indicate either true or relative heading, of the antenna. The trace flashes once each revolution, only when the *flash* switch is turned on. On installations not equipped

with special compasses, when turned on the flash will always occur at zero degrees.

The range crank controls the ranging marker on the PPI. When the marker control is turned up, the ranging marker appears, forming a circle as it rotates around the face of the PPI. If the antenna is not rotating, it will of course merely appear as a spot. The position of this marker is made to coincide with the target. The cranking of the range control automatically changes the range readings on the dial, and when lined up will give the range in yards. Practice in handling the equipment permits the entire sequence of steps in less than a minute. It is important to avoid confusion over the two different markers on the PPI. One set of four, forms the fixed distance markers. The other, a single marker which may be varied, is used to range on the object being scanned.

Since shipborne radar also has postwar commercial navigation applications, active development was initiated many months ago. As a result a simplified navigational radar design was completed recently. This comprises three units . . . antenna, transmitter-receiver, and indicator . . . the first two of which may be combined when the antenna is not mounted on the mast-head. The weatherproof indicator unit is but little larger than the over-all dimensions of the PPI. It has a binnacle-type mounting that permits installation at any convenient position and at any angle.

Available accessories include repeaters (remote indicators), the attachment for obtaining true-bearing readings in addition to the standard relative-bearing readings, and an echo box. Provision is also made for the reception of radar beacon signals.

The commercial model is designed to operate from shipboard 115-volt power source and has a power consumption not exceeding 2 kva. The expected maximum range is 15-20 miles for large surface objects such as ships, or 4-6 miles for small objects such as bell buoys. The minimum range is 100 yards from the antenna. Four range scales will be provided, 1½, 5, 15, and 50 miles. Range marks will permit ranges to be read with an accuracy of about 2%. Bearing accuracy will be within 2°.

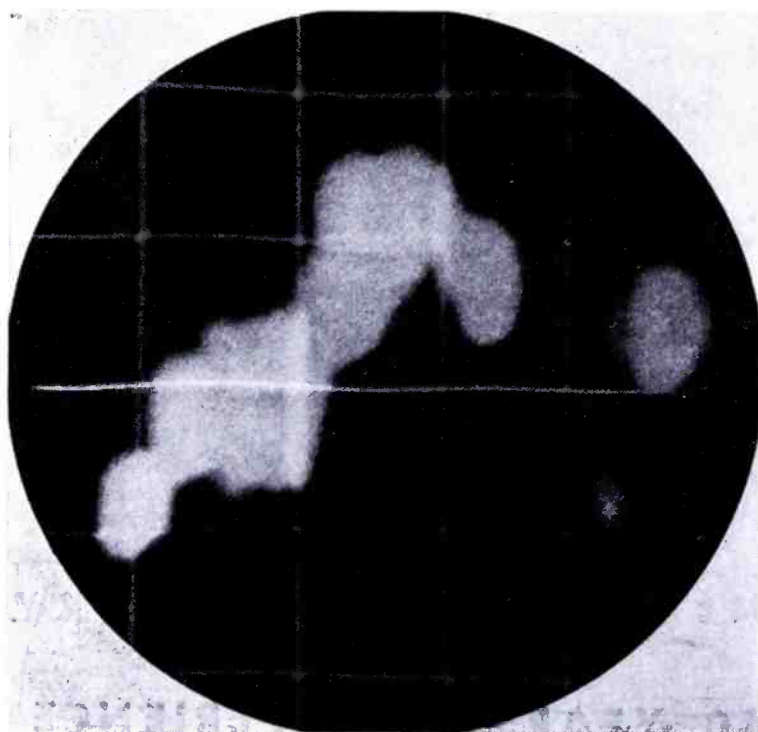

GOOD NEWS FOR BROADCASTERS

REL 88-108 Megacycle Band

FM

Broadcasting Equipment in Assembly . . .

PLACE YOUR ORDER NOW

This REL broadcasting equipment can now be ordered . . . to meet or exceed present FCC requirements.* Entirely new . . . with important design advancements.

Transmitters

With the new Armstrong Modulator . . . providing simple, stable . . . even more efficient performance than ever before!

Power Output	Cat. No.
250 watt	549A-DL
1000 watt	518A-DL
3000 watt	519A-DL
10,000 watt	520A-DL

Speech Equipment

- Cat.
603—Studio Speech Console, Table type, 6 Position
604—Station Speech Console, Table type, combined with Cat. 600 Monitor and transmitter desk control

Monitoring Equipment

- Cat.
600—FM Station Frequency and Modulation Monitor

Wire or write today for technical data, prices and delivery . . . or better yet . . . do as other broadcasters have already done—send your order, subject to later confirmation, thus assuring early delivery.

**REL FM equipment guaranteed to meet or better the FCC standards of good engineering practice for FM Broadcast stations.*



SALES REPRESENTATIVES

MICHIGAN
M. N. DUFFY & CO., Inc.
2040 Grand River Ave., W.
Detroit, Mich.

MIDWEST
REL EQUIPMENT SALES, Inc.
612 N. Michigan Blvd.
Chicago, Ill.

PACIFIC COAST
NORMAN B. NEELY ENTERPRISES
7422 Melrose Avenue, Hollywood 46, Calif.
PIONEER MANUFACTURERS OF FM TRANSMITTERS EMPLOYING ARMSTRONG
PHASE-SHIFT MODULATION

RADIO ENGINEERING LABS., INC.
Long Island City, N.Y.

SHIPBORNE RADAR

(Continued from page 55)

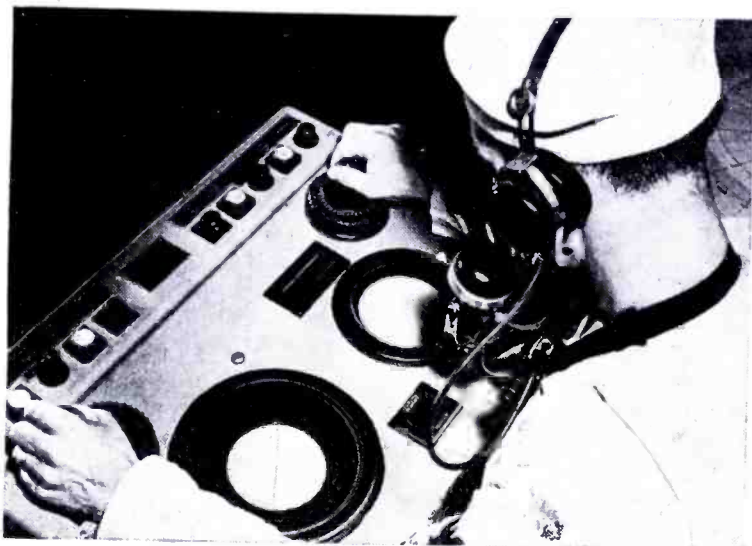

Left: Radar repeater. On right is a *sweep*, which is a rectangular plot, with range and bearings on the co-ordinates. In this *sweep* the target is enlarged. Below, left: Enlargement of segment of target viewed on radar unit. Below, right: Scope view. Concentric circles are the ranging marker, which is cranked across the PPI until it lies directly over target.

cated, despite the large number of controls. After the set is turned on and permitted a normal warmup period, a start button is pressed. To avoid this delay a *normal-emergency* switch is provided.

Assuming the various semi-permanent and range adjustments to be in order, the intensity control is set for moderate brilliance of a spot appearing at the centerpoint of the PPI.

The gain control may be advanced to full for maximum output from the receiver. The receiver-tune knob is set to approximately mid-scale. The *marks* control is turned up until marker dots of moderate brilliance appear along the trace on the PPI. The space between each dot represents a specific distance depending on which one of the range settings is used.

When one particular target is to be observed, the antenna is brought to bear on it, using the antenna motor switch which has a clockwise and counter-clockwise position. The tune control is adjusted for maximum brilliance of the signal appearing on the PPI. If the target is at close range, the center control is used. Adjustment of this control regulates the

starting point of the PPI trace, and prevents the centerpoint spot from overlapping and blocking out any signals from the nearby target. It does not affect the distance between range marks.

The sweep-length control is used to contract or expand the PPI sweep. Assuming we desire to closely follow a selected area, expanding the sweep length permits emphasis of details. It does not, however, change the range distance represented between the marker circles (the circles created by the marker dots rotating around the face of the PPI).

To determine the bearing of an obstacle, a bearing crank is used. Rotating the crank, moves the hairline around the PPI. By setting the hairline on the target and reading the azimuth scale around the PPI, the bearing may be read directly in degrees.

If the ship is equipped with a flux-gate or similar compass, the radar may be equipped with a true-relative bearing indicator. Selection of the desired reading will cause a *flash* trace to indicate either true or relative heading, of the antenna. The trace flashes once each revolution, only when the *flash* switch is turned on. On installations not equipped

with special compasses, when turned on the flash will always occur at zero degrees.

The range crank controls the ranging marker on the PPI. When the marker control is turned up, the ranging marker appears, forming a circle as it rotates around the face of the PPI. If the antenna is not rotating, it will of course merely appear as a spot. The position of this marker is made to coincide with the target. The cranking of the range control automatically changes the range readings on the dial, and when lined up will give the range in yards. Practice in handling the equipment permits the entire sequence of steps in less than a minute. It is important to avoid confusion over the two different markers on the PPI. One set of four, forms the fixed distance markers. The other, a single marker which may be varied, is used to range on the object being scanned.

Since shipborne radar also has postwar commercial navigation applications, active development was initiated many months ago. As a result a simplified navigational radar design was completed recently. This comprises three units . . . antenna, transmitter-receiver, and indicator . . . the first two of which may be combined when the antenna is not mounted on the mast-head. The weatherproof indicator unit is but little larger than the over-all dimensions of the PPI. It has a binnacle-type mounting that permits installation at any convenient position and at any angle.

Available accessories include repeaters (remote indicators), the attachment for obtaining true-bearing readings in addition to the standard relative-bearing readings, and an echo box. Provision is also made for the reception of radar beacon signals.

The commercial model is designed to operate from shipboard 115-volt power source and has a power consumption not exceeding 2 kva. The expected maximum range is 15-20 miles for large surface objects such as ships, or 4-6 miles for small objects such as bell buoys. The minimum range is 100 yards from the antenna. Four range scales will be provided, 1½, 5, 15, and 50 miles. Range marks will permit ranges to be read with an accuracy of about 2%. Bearing accuracy will be within 2°.

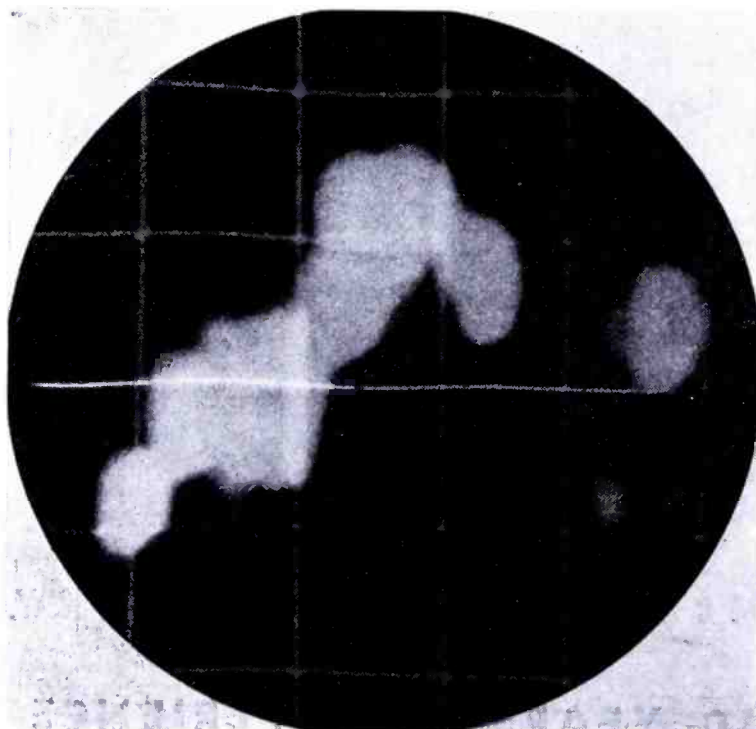

RANGE PREDICTION CHART FOR F-M STATIONS

by **FREDERICK C. EVERETT**

Engineer, Radio Facilities Group, NBC

WITH the assignment of the 88 to 106-mc channels to f-m (106 to 108 mc in the Northeastern area), it has become necessary to analyze many transmission factors such as station ranges. The prediction of these ranges can be simplified by a chart,¹ as we have at the right. With this chart it is possible to determine the signals that can be expected with various powers, antenna heights and distances.

The heights indicated in the chart are those of the transmitting antenna over the average terrain to the point in question and a receiving antenna height of 30'. This average height is ordinarily obtained by plotting a ground contour profile between the transmitter and the indicated point. Since such effects as shadows, reflection and diffraction will be important the values obtained can be taken as median values of intensity to be expected.

Examples

To illustrate the use of the chart, two examples are offered; one for a Northeastern metropolitan station and another for a transmitter site 1,000' high with a 50-microvolt signal 70 miles away.

The range of a Northeastern metropolitan station is predicated on the range provided by 20 kw radiated at an antenna height of 500' to 1-millivolt contour.

In example 1 we have a dotted line drawn between 20 kw and the 1 millivolt/meter field intensity. We note that this line intersects the microvolt plot for 1 kw at 224 microvolts. Drawing a solid line between this point and the 500' transmitting antenna height plot indicates a distance of 32 miles. Thus we find that a station with an antenna height of 500' over the average ground, and radiating 20 kw will give a 1 millivolt-per-meter signal at 32 miles. According to the FCC plan of allocation, metropolitan stations with higher antennas will be assigned powers such that the 1-millivolt signal will be at the same distance away.

In example 2 we have the case of a transmitter site, 1,000' high and the need for a 50-microvolt (0.05 millivolt) signal 70 miles away. The dotted line connecting 70 miles and 1,000' indicates that a 1-kw station operating at this height would radiate 21.5 microvolts at 70 miles. If we draw a solid line between this point, the 0.05-millivolt point and the power scale, we find that a power of 5.5 kw would be required to produce the desired 50 microvolts at the 70-mile distance with a 1,000' antenna height.

¹Chart has been prepared from data supplied by the FCC in their "Standards of Good Engineering Practice"; with 98 mc, horizontal polarization, used as a basis of computation.

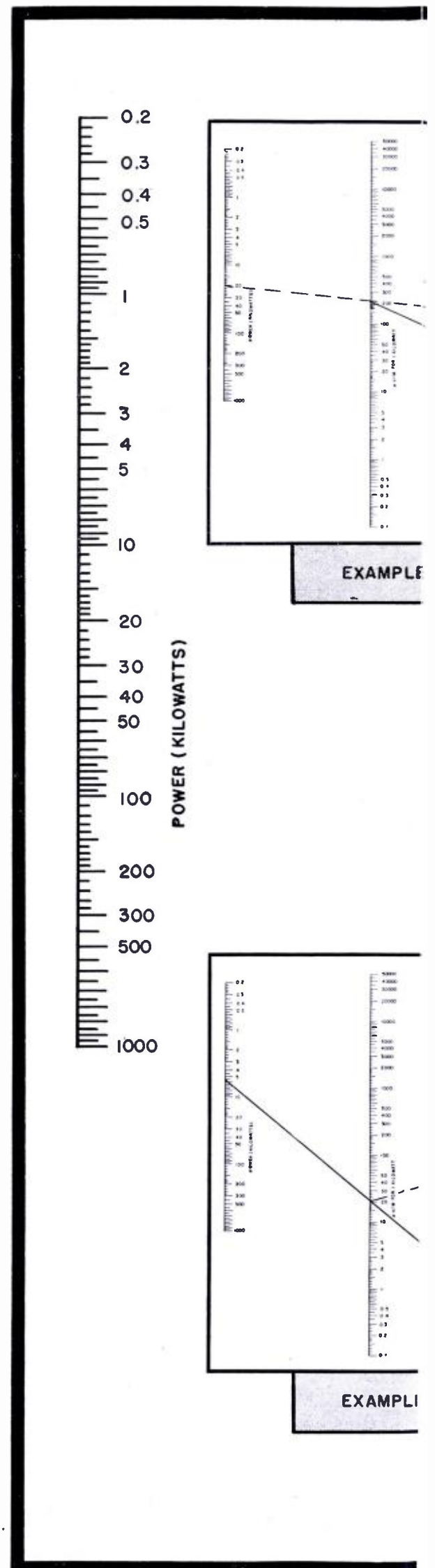

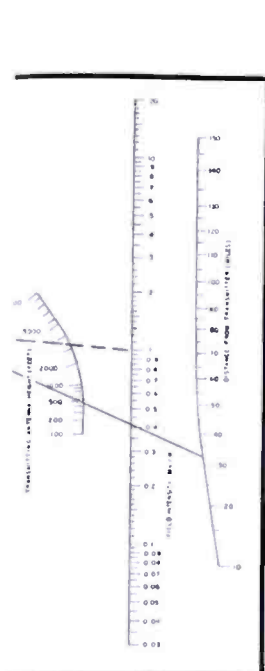

ONE

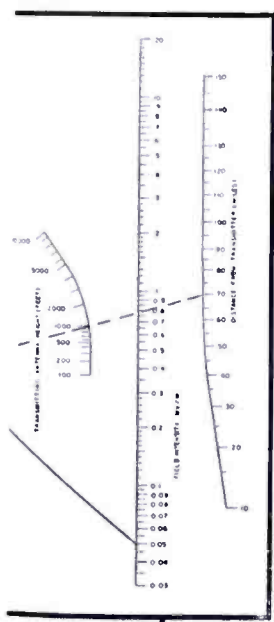

TWO

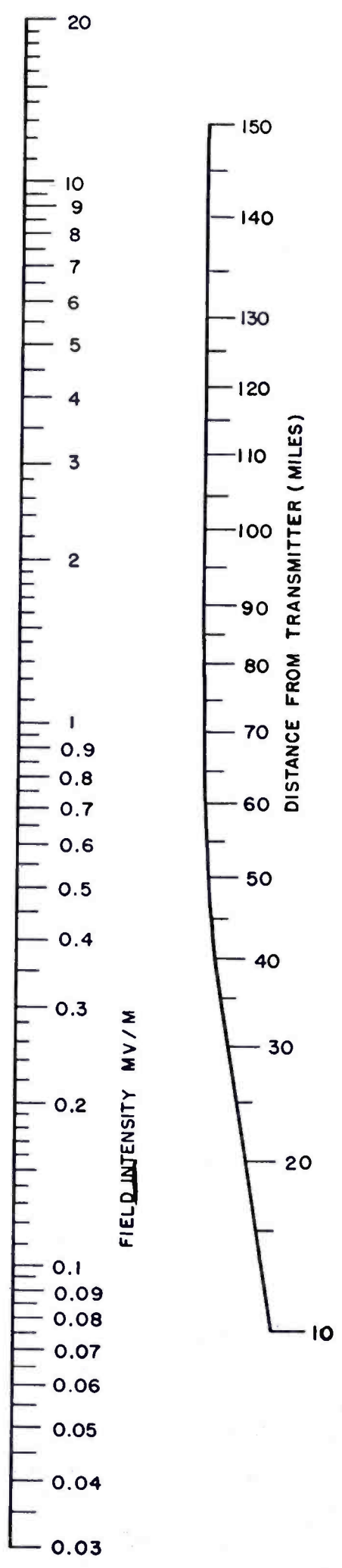
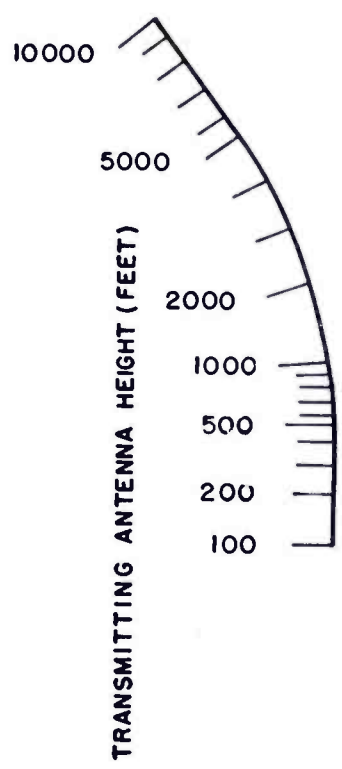
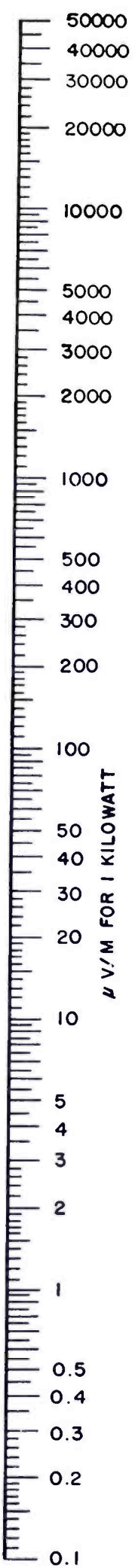

RESISTIVE ATTENUATORS, PADS AND NETWORKS

An Analysis of Their Applications in Mixer and Fader Systems

[Part Ten; Concluding Installment]

by **PAUL B. WRIGHT**

Communications Research Engineer

A 4-CHANNEL series-parallel mixer and fader system is shown in Figure 1. The design equations for this system appeared in the tables of Part 8 (September). The values of the functions which would normally be obtained by interpolation as required from the second and third sets of tables of hyperbolic functions were tabulated in more manageable form there and is believed that the functions tabulated for specific use there, in conjunction with the figures accompanying them, are adequate for design purposes.

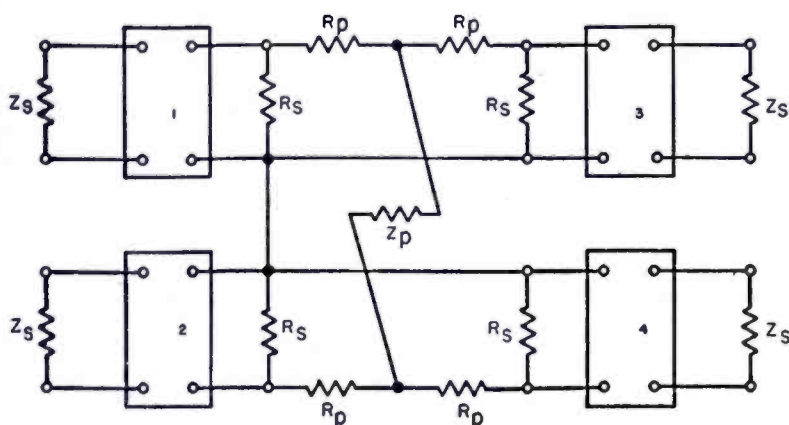

Figures 1 (above) and 2 (below)

Figure 1. A 4-channel series-parallel mixer and fader system. Jumpers are usually used on lower terminals of Faders 1 and 3; jumpers also are used on upper terminals of Faders 2 and 4. Figure 2. Values of the compensating resistances required to provide proper impedance matching at all junctions of the series or the parallel fader and mixer systems. The insertion losses are also given and shown to be identical for either system.

SERIES MIXER										Network Element and Impedance Termination	Requirements and Definitions
No. of Channels											
2	3	4	5	6	7	8	9	10		$R = cz$ $R = 2gZ$ $Z = Ez$ $z = eZ$ n = No. of Channels	$c = \coth \theta = \frac{n}{n-1}$ z = Input fader impedance $2g = 2 \operatorname{csch} 2\theta = \frac{2n-1}{n(-1)}$ Z = Output mixer impedance $E = \cosh^2 \theta = \frac{2n-1}{n^2}$ $e = \operatorname{sech}^2 \theta = \frac{2n-1}{n^2}$ $\operatorname{db} = 10 \operatorname{Log}_{10} (2n-1)$ $\theta = 0.115129 \times \operatorname{No.} (\operatorname{db}) / (n-1)$ $C = \tanh \theta = \frac{n}{n(n-1)}$ Z = Input fader impedance $G/2 = \frac{1}{2} \sinh 2\theta = \frac{2n-1}{2n-1}$ z = Output mixer impedance $E = \cosh^2 \theta = \frac{2n-1}{n^2}$ $e = \operatorname{sech}^2 \theta = \frac{2n-1}{n^2}$ $\operatorname{db} = 10 \operatorname{Log}_{10} (2n-1)$ $\theta = 0.115129 \times \operatorname{No.} (\operatorname{db}) / (n-1)$
2.00000	1.50000	1.33333	1.25000	1.20000	1.16667	1.14286	1.12500	1.11111			
2g											
1.50000	.83333	.58333	.45000	.36667	.30952	.26786	.23611	.21111			
E											
1.33333	1.80000	2.28576	2.77778	3.27273	3.76923	4.26667	4.76470	5.26316			
e											
.75000	.55555	.43749	.36000	.30555	.26531	.23437	.20988	.19000			
No. (db) Insertion Loss											
4.77	6.99	8.45	9.54	10.41	11.14	11.76	12.30	12.79			
PARALLEL MIXER										$R = CZ$ $R = \frac{G}{2} z$ $Z = Ez$ $z = eZ$ n = No. of Channels	(Same as Series Mixer table)
C											
.50000	.66667	.75000	.80000	.83333	.85716	.87500	.88889	.90000			
G/2											
.66667	1.2000	1.71428	2.2222	2.72727	3.23077	3.73333	4.23529	4.73684			
E											
1.33333	1.80000	2.28576	2.77778	3.27273	3.76923	4.26667	4.76470	5.26316			
e											
.75000	.55555	.43749	.36000	.30555	.26531	.23437	.20988	.19000			
No. (db) Insertion Loss											
4.77	6.99	8.45	9.54	10.41	11.14	11.76	12.30	12.79			



What Happens Inside an -hp- Model 500A Frequency Meter

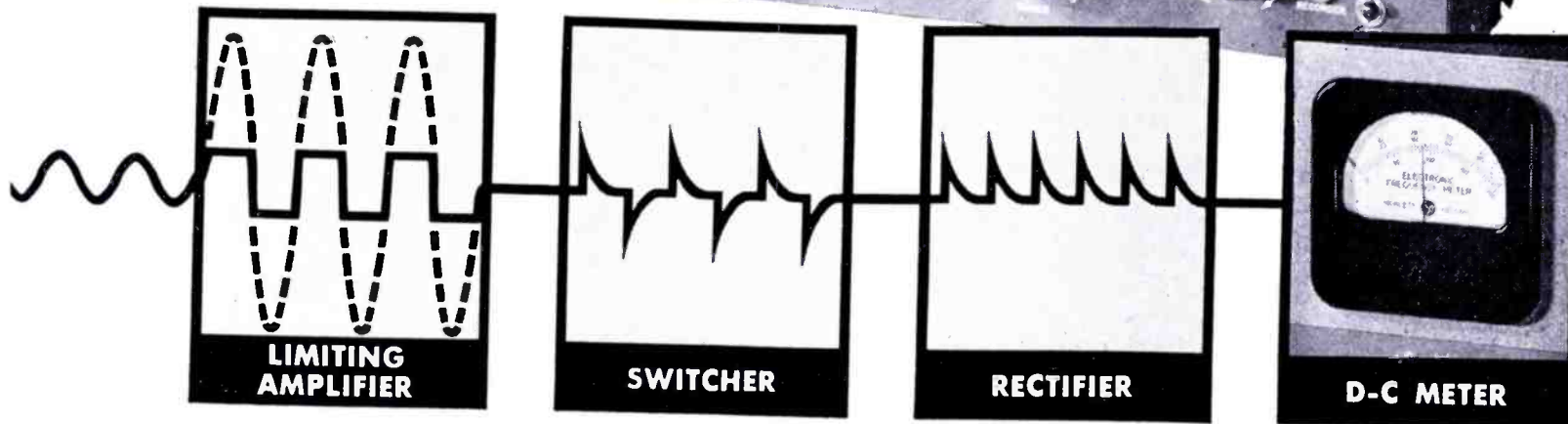

This Instrument Counts Cycles of an Unknown Frequency

The above diagram shows how the -hp- 500A analyzes an unknown frequency so that cycles per second will accurately register on the specially calibrated d-c meter.

The unknown frequency is introduced to a limiting amplifier which generates a square wave output. The square wave voltages are applied to two switching tubes which become alternately conducting on opposite half cycles. From a constant current supply, the two switching tubes deliver a current to load resistors. Each load resistor causes the charge on a pair of capacitors to vary in accordance with the switched current pulses. Thus a current flows from the combination to the rectifier. The rectified pulses are delivered to the d-c meter. Each pulse is of the same size and independent of other factors. The meter integrates these pulses and gives a deflection which is proportional to the number of

pulses per second. Thus the meter reading is directly related to the unknown frequency.

The instrument is easy to use and requires but a small amount of power. It has good sensitivity and a wide range of usable voltages. The input range is from 0.5 to 200 volts—input impedance is 50,000 ohms. A switch on the panel selects one of ten ranges which are read directly on the meter.

Accuracy of the instrument is $\pm 2\%$ —independent of line voltages, vacuum tube characteristics and magnitude and wave form of applied voltage—because the meter reading is dependent only upon the constant current supply and the RC combination.

The uses for this meter become readily apparent. Of special interest is its use as a high speed tachometer. (See column at right.) Write for more detailed information today. -hp- engineers are at your service.

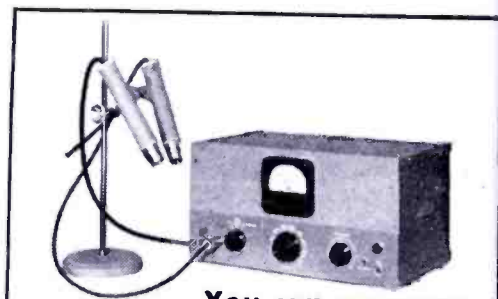

You can measure
**3,000,000 r.p.m. with this
-hp- Electronic Tachometer**

Using a photo electric cell pickup in conjunction with an -hp- Model 500A Frequency Meter provides an Electronic Tachometer capable of accurately measuring incredible speeds. This method places no load on the device being clocked.

Two special models of -hp- frequency meters, complete with light source and pickup, are available for this purpose. One model (505A) is calibrated in r.p.m. from 600 to 3,000,000 r.p.m.; the other model (505B) is calibrated in r.p.s. from 50 to 50,000 r.p.s. (10 r.p.s.) are conveniently measured directly, while still slower speeds can be measured by a simple expedient. Ask for special technical bulletin on -hp- Models 505A and 505B.

1073

HEWLETT-PACKARD COMPANY

BOX 1073E • STATION A • PALO ALTO, CALIFORNIA

- | | | |
|--------------------------------|---------------------|------------------------|
| Audio Frequency Oscillators | Signal Generators | Vacuum Tube Voltmeters |
| Noise and Distortion Analyzers | Wave Analyzers | Frequency Meters |
| Square Wave Generators | Frequency Standards | Attenuators |
| | | Electronic Tachometers |

RESISTIVE ATTENUATORS, PADS AND NETWORKS

An Analysis of Their Applications in Mixer and Fader Systems

[Part Ten; Concluding Installment]

by **PAUL B. WRIGHT**

Communications Research Engineer

A 4-CHANNEL series-parallel mixer and fader system is shown in Figure 1. The design equations for this system appeared in the tables of Part 8 (September). The values of the functions which would normally be obtained by interpolation as required from the second and third sets of tables of hyperbolic functions were tabulated in more manageable form there and is believed that the functions tabulated for specific use there, in conjunction with the figures accompanying them, are adequate for design purposes.

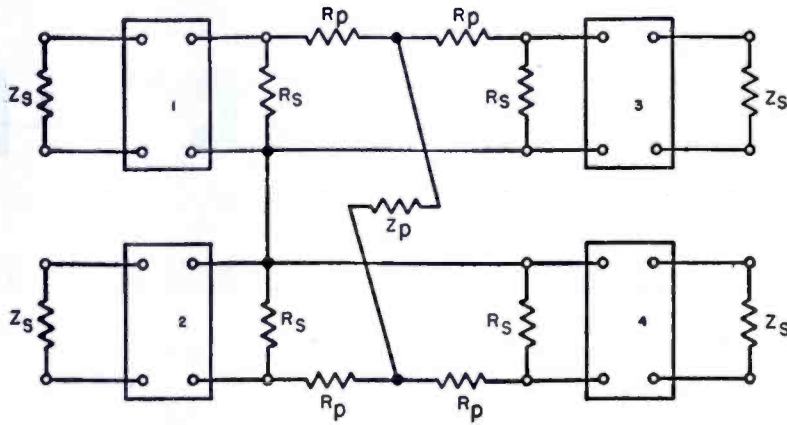

Figures 1 (above) and 2 (below)

Figure 1. A 4-channel series-parallel mixer and fader system. Jumpers are usually used on lower terminals of Paders 1 and 3; jumpers also are used on upper terminals of Paders 2 and 4. Figure 2. Values of the compensating resistances required to provide proper impedance matching at all junctions of the series or the parallel fader and mixer systems. The insertion losses are also given and shown to be identical for either system.

SERIES MIXER										Network Element and Impedance Termination	Requirements and Definitions
No. of Channels											
2	3	4	5	6	7	8	9	10		$R = cz$ $R = 2gZ$ $Z = Ez$ $z = eZ$ n = No. of Channels	$c = \coth \theta = \frac{n}{n-1}$ z = Input fader impedance $2g = 2 \operatorname{csch} 2\theta = \frac{1}{n(n-1)}$ Z = Output mixer impedance $E = \cosh^2 \theta = \frac{2n-1}{n^2}$ $e = \operatorname{sech}^2 \theta = \frac{2n-1}{n^2}$ db = $10 \log_{10} (2n-1)$ $\theta = 0.115129 \times \text{No. (db)}$ $C = \tanh \theta = \frac{n}{n(n-1)}$ Z = Input fader impedance $G/2 = \frac{1}{2} \sinh 2\theta = \frac{1}{2n-1}$ z = Output mixer impedance $E = \cosh^2 \theta = \frac{2n-1}{n^2}$ $e = \operatorname{sech}^2 \theta = \frac{2n-1}{n^2}$ db = $10 \log_{10} (2n-1)$ $\theta = 0.115129 \times \text{No. (db)}$
2.00000	1.50000	1.33333	1.25000	1.20000	1.16667	1.14286	1.12500	1.11111			
c											
1.50000	.83333	.58333	.45000	.36667	.30952	.26786	.23611	.21111			
2g											
1.33333	1.80000	2.28576	2.77778	3.27273	3.76923	4.26667	4.76470	5.26316			
E											
.75000	.55555	.43749	.36000	.30555	.26531	.23437	.20988	.19000			
e											
No. (db) Insertion Loss											
4.77	6.99	8.45	9.54	10.41	11.14	11.76	12.30	12.79			
PARALLEL MIXER											
C											
.50000	.66667	.75000	.80000	.83333	.85716	.87500	.88889	.90000			
G/2											
.66667	1.2000	1.71428	2.2222	2.72727	3.23077	3.73333	4.23529	4.73684			
E											
1.33333	1.80000	2.28576	2.77778	3.27273	3.76923	4.26667	4.76470	5.26316			
e											
.75000	.55555	.43749	.36000	.30555	.26531	.23437	.20988	.19000			
No. (db) Insertion Loss											
4.77	6.99	8.45	9.54	10.41	11.14	11.76	12.30	12.79			

RECEIVER LOOP ANTENNA

DESIGN FACTORS

—by EDWIN M. KENDELL—

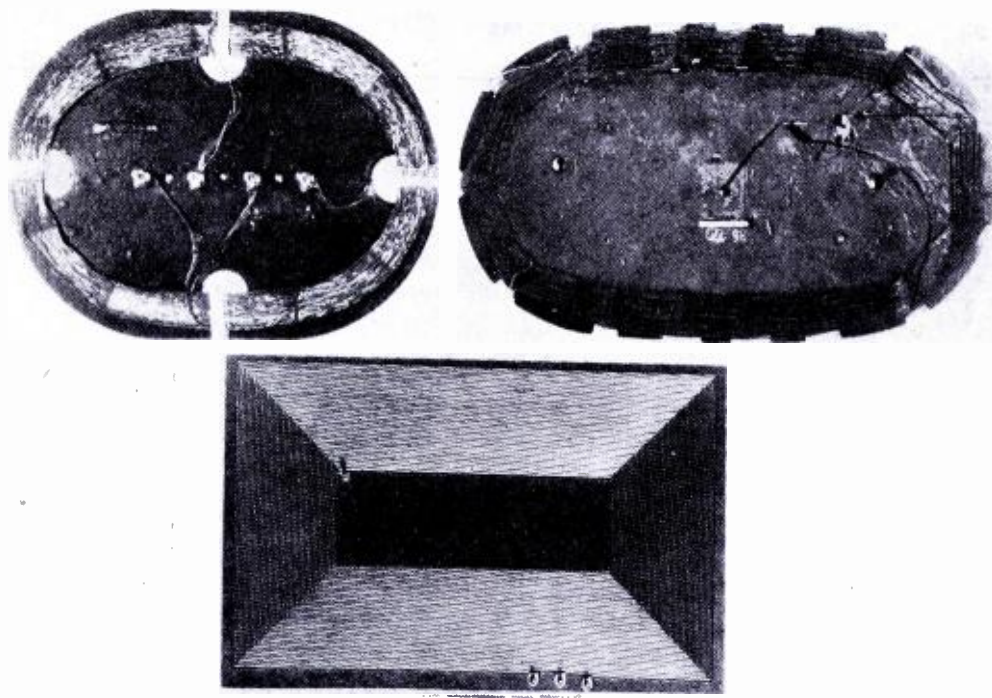

Three types of loop antennas analyzed in paper solenoid (top left), basket weave (top right) and embossed type (bottom center).

THE increased use of portable, table and midget receivers has accelerated interest in the development of loop antennas. While these small loops are quite simple in appearance, their design involves many careful considerations.

In determining loop efficiency it is necessary to evaluate both electrical and mechanical factors or size and pickup characteristics. Specifically included among these electrical-mechanical factors are base dimensions, conductor and base materials, mountings and loop designs.

In studying the influence of these factors upon the efficiency of the loops,

several types of tests are usually conducted. One of these provides for the relative Q s of loops in space. In Figure 1 appears the result of such a test for several types of loops.

Curve *A* is for an 8" loop, basket-weave type, and is typical of the Q obtained with loops of this type, in this price range. A solenoid-type loop Q appears in curve *B*. Curve *C* is for a basket-weave loop, of standard construction, with a more uniform weave than the loop of curve *A*. On curve *D*, we have the Q for a new type of loop, using embossing, and known as the *Air-loop*. The general shape of a loop antenna is observed, but the loop con-

ductor is applied differently; it is stamped out of a sheet of copper onto a composition or plastic base. Curve *E* is for the same loop as curve *D*, using however lucite as the mounting base. All of these antennas have approximately the same inductance, and the same shape. That is they are longer than they are wide, and average about 8" in length.

Relative Q s of Loop Antennas

The relative Q s of loop antennas, as measured in space, bear only a moderate influence on their efficiency. The Q drops sharply, for instance, when loops are installed in their normal position in a receiver. Therefore it is necessary to run tests to check these factors. In Figure 2 appear the results of such a test. Curves *A* and *B* are for representative loops of the basket-weave and embossed types, respectively. Their Q in space is shown for comparison. For curves *A* and *B*, the loops were mounted at a distance of $\frac{1}{8}$ " from the chassis. Curves *A'* and *B'* show how the Q increased when these loops were mounted $1\frac{1}{2}$ " from

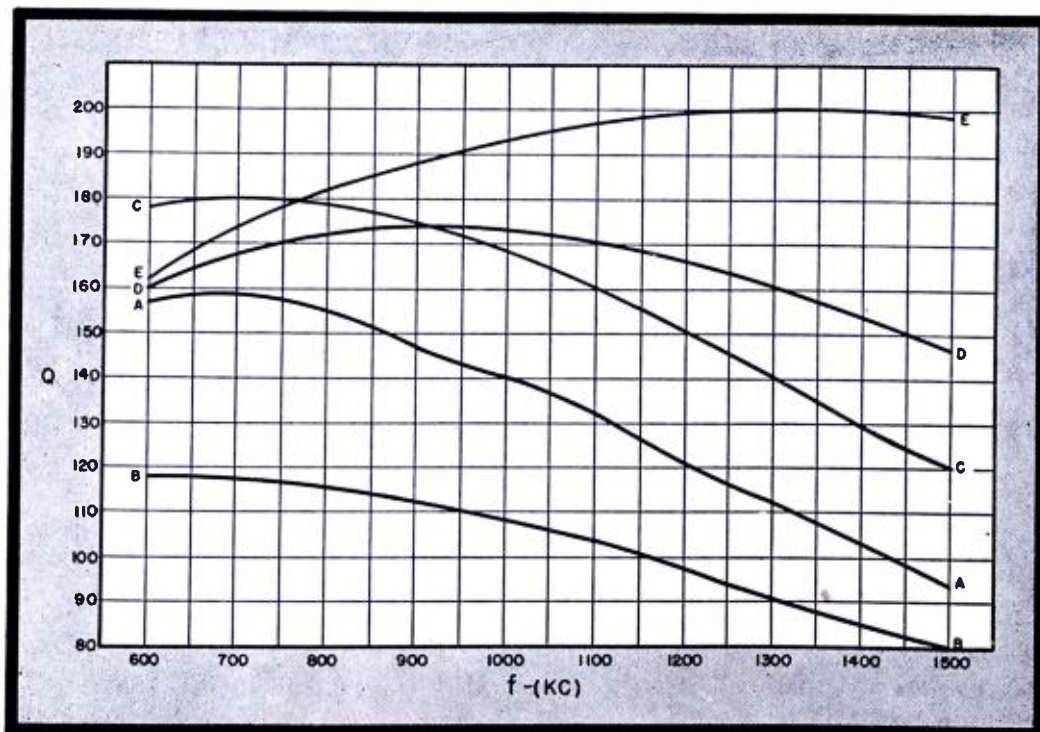
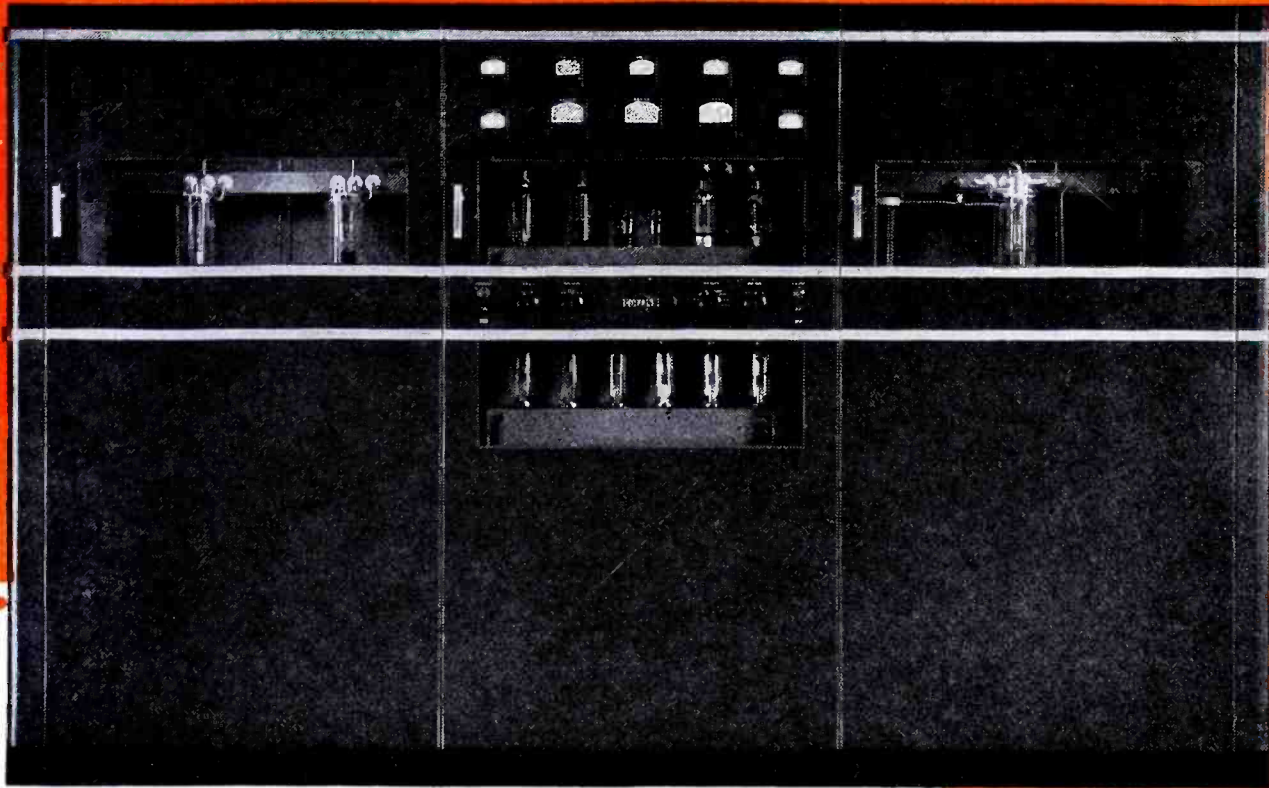

Figure 1

Comparative Q of three types of loop antennas as measured in space; curve *A*, 8" loop, basket-weave type; curve *B*, solenoid type; curve *C*, basketweave type of more uniform weave than curve *A*; curve *D*, embossed type of loop; curve *E*, embossed type mounted on lucite. All these have equal inductance and approximately the same dimensions.

The New Collins 21A, 5 kw Broadcast Transmitter



Fulfilling the Tradition of Collins Quality Leadership

The 21A is a thoroughly developed 5 kw AM broadcast transmitter, and an excellent example of characteristically superior Collins engineering and construction.

Based on sound, well-proved principles of design, the 21A has been completely modernized within recent months. New components of improved design, with longer life and higher safety factors than were previously available, assure reliable continuous operation.

The response curve is flat, within $\pm 1/2$ db. from 30 to 10,000 cycles. Reduced power to 1 kw is obtained by instantaneous lowering of plate voltages, permitting uninterrupted program transmission.

We will be glad to send you detailed information regarding the 21A, other Collins transmitters, the 12Y remote amplifier, the 12Z four channel remote amplifier and Collins high quality studio equipment. Collins Radio Company, Cedar Rapids, Iowa; 11 West 42nd Street, New York 18, N. Y.



FOR BROADCAST QUALITY, IT'S . . .

COLLINS EQUIPMENT IS SOLD IN CANADA
BY COLLINS-FISHER, LTD., MONTREAL.



The Collins 12Y Remote Amplifier

A one channel remote amplifier for unattended operation from a 115 volt a.c. power source, the 12Y provides the advantages of quick set-up, small size, light weight, high fidelity, simple operation, utmost reliability and low cost. It is practically hum free due to the removal of the isolation transformer, which is in the power cable.

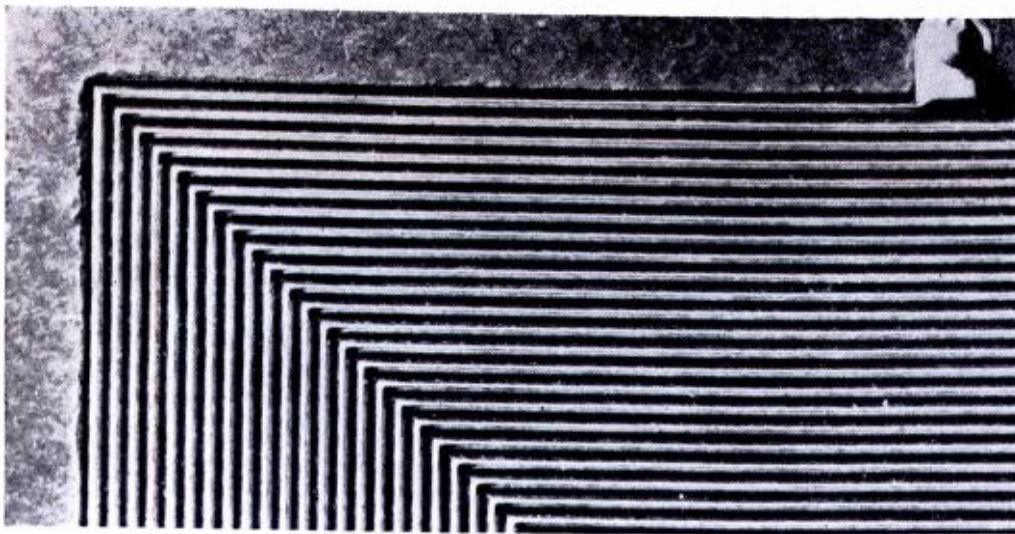

Closeup of windings of embossed type loops

the chassis. In addition, it was found that if the loop were mounted so that the lower portion of the loop was above the chassis, the Q increased materially. Therefore, the initial Q , which is reduced by $\frac{2}{3}$ when the loop is mounted on the chassis, actually does not exert the influence on loop performance that would be expected.

Studying the use of a primary on the loop, so that an external antenna may be used, it has been found that it reduces the Q of the loop by approximately 3%. The effect on receiver performance is negligible.

In analyzing the voltages induced in a loop by a wave polarized in the plane of the loop¹ we apply the expression:

$$E_L = 2 \pi e \frac{N A}{\lambda} \cos \theta$$

where:

E_L = voltage induced in the loop

N = number of turns

e = field strength in volts per meter

A = area of loop in square meters

θ = angle with respect to plane.

From this expression we see that an increase in the number of turns or the area of the loop increases the developed voltage. However, the form factor of the loop is also important, as well as wire size, dielectric constant of the loop form, etc. Any factor which affects the Q of a coil will have a similar effect on the Q of a loop. Since an increase in turns also increases the distributed capacity (depending on the type of winding) which in turn decreases the Q , it is necessary to use winding ratios which increase the Q more rapidly than the inductance. It is therefore possible to have loops with less turns which display a higher Q than loops with a greater number of turns.

Since the width of the loop designed for table model receivers is limited, a longer loop gives better results. This was proved in a series of field tests with seven different types of loops.

A typical table receiver was used for

the test. The avc system was grounded and a v-t voltmeter was connected across the avc feeder resistor.

Station WQXR (1560 kc) was tuned in using the various loops. The loops were mounted in the same position, and the receiver was rotated for maximum indication on the voltmeter. The trimmers on the tuning condenser were then adjusted for maximum output. For loops of equal inductance, those with higher Q gave greater output. For loops of equal length, the longer loops gave greater output. However, the greater influence was the length of the loop.

A second test involved the comparative pickups of basket-weave and embossed-type loops. Three stations were used in this test: WMCA (530 kc), WHN (1010 kc), and WQXR (1560 kc). While the results were identical for WMCA and WHN, the embossed type of loop showed a much higher gain for WQXR.

Tests of loops mounted in cabinets were also conducted. Here the embossed-type loop was found to perform better than the other types because of a mechanical superiority.

From Figure 2 we note that the Q increases rapidly as the loop is moved away from the chassis. This improvement in Q results in much higher antenna stage gains. Where high antenna gains cannot be used because of regeneration problems, the increased distance from the chassis not only improves the Q , but also permits the use of higher Q loops.

The IRE standard test provides another method for determining loop efficiencies. Applying this test format, results were found to be similar to those obtained with the station signal. The latter method was found preferable for checking loop performance. No shielded room is necessary, and body effects, which proved quite annoying in trying to line up the receiver, were not as evident. The distance from the transmitting loop to the receiving loop was also found to be critical. Since adequate space must be provided between the receiving and transmitting loops and the walls of the shielded room, it was quite difficult to remove the receiver any great distance from the signal generator. However, the IRE test should be used in determining overall receiver performance.

¹Terman, *Radio Engineering*, page 813.

Figure 2

Comparative Q s of the basketweave and embossed types of loop when mounted on a receiver. Curve A is for a basketweave loop mounted 9/16" from the chassis. Curve A' is for the same loop mounted 1 1/2" from the chassis. Curves B and B' are for an embossed type under the same conditions. AA and BB are the curves of the two loops in air and are shown for comparison.

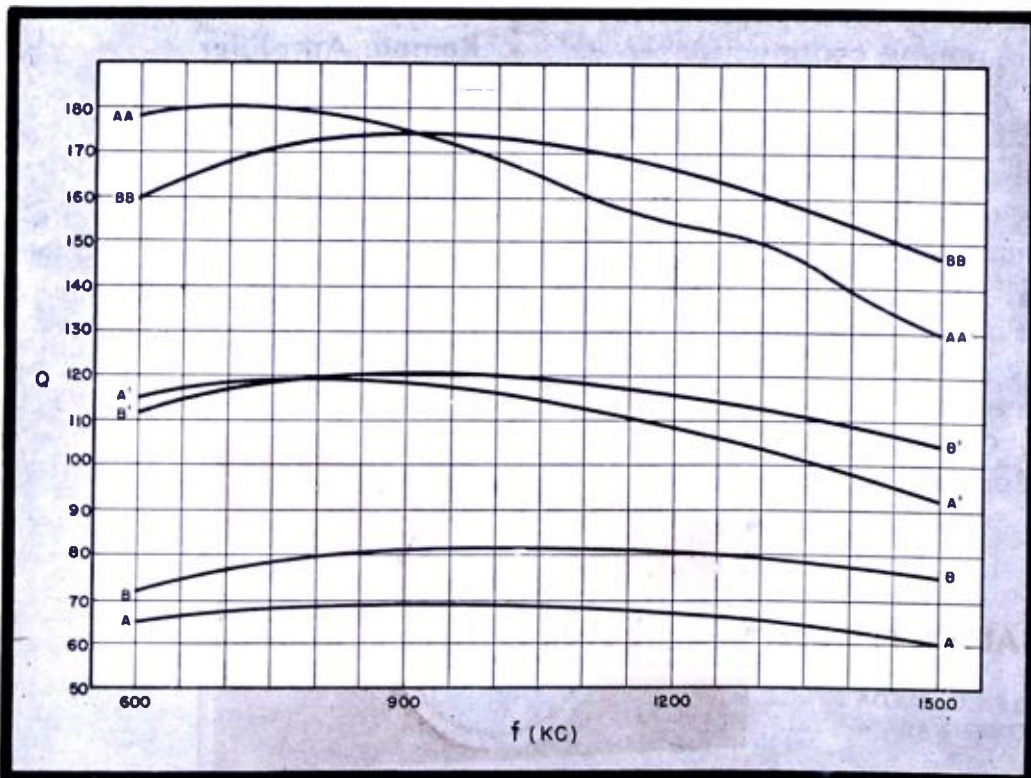



Switches

Shown above are a few of the many types of micro-switches, toggle switches, knife switches, rotary switches, band switches, etc., now available through the Hallicrafters Co., Chicago, agent for the Reconstruction Finance Corporation under contract SIA-3-24.

Other radio and electronic components such as resistors and condensers are also available in large quantities. Send the coupon for further details.

hallicrafters RADIO

THE HALLICRAFTERS CO., AGENT FOR RFC UNDER CONTRACT SIA-3-24
MANUFACTURERS OF RADIO AND ELECTRONIC EQUIPMENT

THESE VALUABLE ITEMS *Available Now*
or very soon. Write, wire or phone for further information.

- head phones • test equipment • component parts •
- marine transmitters and receivers • code practice equipment • sound detecting equipment • vehicular operation police and command sets • radio beacons and airborne landing equipment.

CLIP THIS COUPON NOW

RFC DEPARTMENT 314, HALLICRAFTERS
5025 West 65th Street • Chicago 38, Illinois

Send further details and price on Switches and component parts

Send listings of other available items

Especially interested in _____

NAME _____

ADDRESS _____

CITY _____ ZONE _____

STATE _____

C A P A C I T A N C E

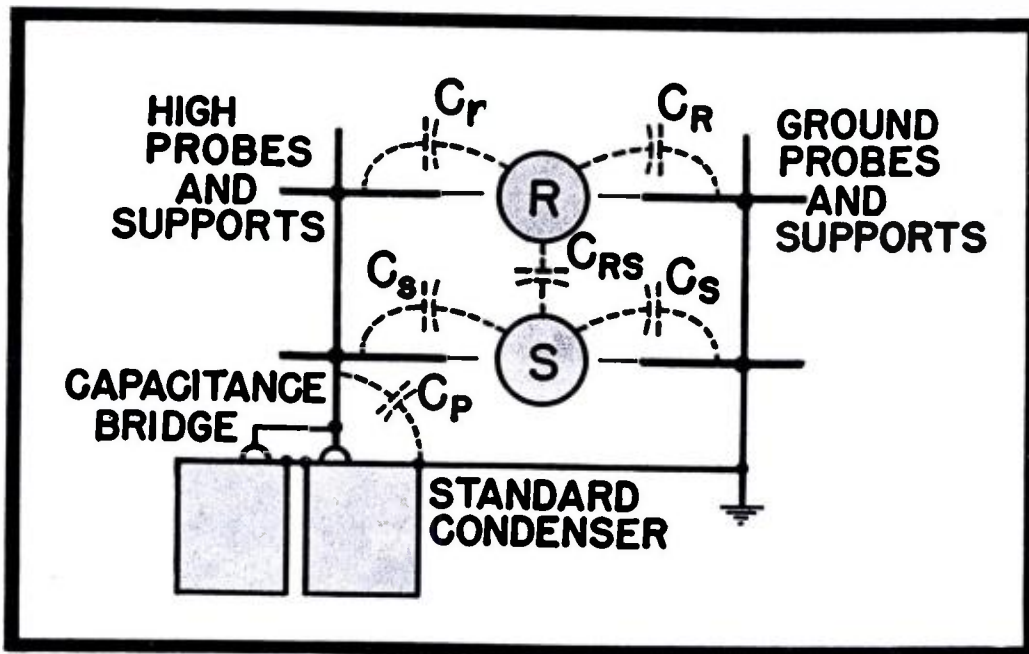

Figure 1

Setup of instruments and probes for capacitance measurement in a multi-electrode system. In this arrangement the parallel substitution method is used; only the standard capacitor is adjusted after an initial balance.

IN this method a system of probes is used and connected to the high terminal of a bridge and ground. These probes introduce some approximations which will be discussed, together with a means for making the errors small.

Two-Electrode System

Any multi-electrode system of the type under consideration must be reduced first to a two-electrode system by grounding all but any pair of the electrodes. All possible combinations taken two at a time may then be measured and the individual direct and total stray capacitances evaluated for each pair in turn. Finally, subtraction of the appropriate direct capacitances from any total stray capacitance yields the individual stray capacitance to ground.

Parallel-Substitution Method

The parallel substitution method, in which only the standard capacitor is adjusted after an initial balance, is shown in Figure 1. The formulas are derived from this circuit, but the resulting equations can be used with data taken by direct measurement on a capacitance bridge. Rugged construction must be used in mounting the probe supports on the grounded table top and on the high terminal of the bridge and standard capacitor. (One high probe and one ground probe are supplied for each electrode in the multi-electrode system.) All probes must remain as nearly undisturbed as

possible throughout the measurements and connected to the corresponding electrode either by slight translation or by extending a very slender stiff wire from inside the end of the probe to the electrode.

The frequency of the measuring voltage must be made sufficiently low so that the inductances and resistances of the probes and their supports produce negligible error up to the largest capacitance where this method is of advantage.

Approximations

The presence of the ground probes increases the capacitance to ground of the electrodes at the expense of direct capacitance over that which exists in the absence of the probes. The amount of the increase is in the same order of magnitude, if not practically the same, as the capacitance of the electrode to the high probe. This capacitance can be determined and an approximate correction made if desired or necessary.

Probe and Electrode-Position Effects

Translation of the probes or extension of the wire inside the probe to its electrode is assumed to change the capacitance of the probe neither to ground nor to any other electrode. The maximum effect of extending the probe can be measured in the absence of an electrode by simply measuring the change in the setting of the standard capacitor for the two conditions. In the presence of an electrode the in-

crease in capacitance may be much less due to the shielding effect of the electrode.

The positions of the electrodes with respect to each other and to ground and the type of their insulating supports influences the direct and stray capacitances. Therefore, the degree to which the desired arrangement can be secured at the measuring position before the bridge determines the degree to which the measurement data represent actual desired conditions.

Measurement Equations

Let us now refer to Figure 1. To make the measurement equations valid all electrodes except any pair such as R and S must be grounded. The notations to be used are:

- C_{RS} , the direct capacitance between any electrode R and any other electrode S .
- C_r , the direct capacitance between the entire probe support and all high probes to any electrode R .
- C_R , the capacitance to ground of any electrode R plus its direct capacitance to all other electrodes which are grounded in the system except electrode S , the other one under consideration at the moment.
- C_p , the capacitance of the probe to ground plus its direct capacitance to all other electrodes in the system except the two, R and S , under consideration.
- C , the largest setting of the standard capacitor for balance, obtained with all probes retracted as in Figure 1.

MEASUREMENT IN MULTI-ELECTRODE SYSTEMS

by WILSON PRITCHETT

Radio Engineer
E. F. Johnson Company

the capacitance setting of the capacitance bridge. C^r , C^s , C^R , C^{RS} , C^B , C^{rB} and C^{Bs} , all possible settings of the standard capacitor for balance under the respective conditions in which the capital superscripts indicate connections of ground probes to the electrodes and the lower case superscripts indicate connections of high probes to the electrodes. The above superscripts correspond to the subscripts of Figure 1.

Another setting of the standard capacitor in addition to the nine referred to so far for balance may be made by short circuiting the electrodes and re-actating all probes. This measurement is omitted because it is not practicable with widely spaced electrodes and is not needed in the analysis.

Equations

The needed measurement equations are:

$$C_s = C_p + C^r + C_R + \frac{C_s(C_{RS} + C_s)}{C_s + C_{RS} + C_s} \quad (1)$$

$$C_s = C_p + C^B + C_r + \frac{C_s(C_{RS} + C_s)}{C_s + C_{RS} + C_s} \quad (2)$$

$$C_s = C_p + C^s + C_s + \frac{C_R(C_{RS} + C_r)}{C_R + C_{RS} + C_r} \quad (3)$$

$$C_s = C_p + C^B + C_s + \frac{C_r(C_{RS} + C_R)}{C_r + C_{RS} + C_R} \quad (4)$$

$$= C_p + C^r + C_R + C_s \quad (5)$$

$$= C_p + C^{RS} + C_r + C_s \quad (6)$$

$$= C_p + C^{rB} + C_{RS} + C_R + C_s \quad (7)$$

$$= C_p + C^{Bs} + C_{RS} + C_r + C_s \quad (8)$$

Evaluating Capacitances

The equation for the condition of the probes shown in Figure 1 is not needed, but it follows readily from transforming the T circuit made up of the direct capacitance and either the upper or the lower pair of capacitances into the corresponding π circuit and applying the simple rules for combining capacitors in series and parallel as done above.

These equations can now be used to evaluate each of the capacitances in the system represented in Figure 1 and defined above.

From 1, 5, and 7:

$$C_s = (C^r - C^{rB}) + \sqrt{(C^r - C^{rB})(C^r - C^{rB})} \quad (9)$$

From 3, 5 and 8:

$$C_R = (C^s - C^{rB}) + \sqrt{(C^s - C^{rB})(C^s - C^{rB})} \quad (10)$$

From 5, 6, 7, and 8:

$$C_{RS} = \frac{(C^{rB} - C^{rB}) + (C^{RS} - C^{rB})}{2} \quad (11)$$

From 2, 6, and 8:

$$C_s = (C^r - C^{rB}) + \sqrt{(C^r - C^{rB})(C^r - C^{rB})} \quad (12)$$

And from 4, 6, and 7:

$$C_r = (C^B - C^{rB}) + \sqrt{(C^B - C^{rB})(C^B - C^{rB})} \quad (13)$$

Four-Electrode System

The general procedure outlined can now be applied to the specific case of a four-electrode system and ground. The essential parts of the arrangement are shown in Figure 2. Assuming that all electrodes are different, the probe capacitances are not wanted, and a check on the measurements and computations made is desired, the following data will be adequate:

Ground C and D	Ground A and D
*(a) C^{AB}	*(k) C^{bc}
*(b) C^{AB}	
*(c) C^a	Ground A and B
*(d) C^{ab}	(l) C^c
*(e) C^b	(m) C^{cd}
*(f) C^{Ab}	(n) C^d
	*(o) C^{cd}
Ground B and D	
(g) C^a	Ground A and C
*(h) C^{ac}	(p) C^b
(i) C^c	*(q) C^{bd}
*(j) C^{Ac}	*(r) C^d
	Ground B and C
	(s) C^{ad}

The capacitances of the four-electrode system in terms of the mea-

This paper offers an analysis of a method for measuring the direct capacitances between electrodes and the individual stray capacitances to ground in any multi-electrode system of reasonable size. This method is most useful in measuring capacitances in the 1 to 100-mmfd range where the stray capacitances to ground of any electrodes are significant or are of the same order of magnitude as the direct capacitances between electrodes. The technique was developed especially for measuring neutralizing and other small value capacitors.¹ Some resemblance may be found to a method given for determining the influence of shielding on the interelectrode capacitance of vacuum tubes.² A feature of the method is that the capacitances between the electrodes and the high lead from the bridge are eliminated from the results.³

¹Role of the Neutralizing Capacitor in Tuned Power Amplifiers, COMMUNICATIONS; October, 1945.
²Pockman, Leonard T., The Dependence of Inter-Electrode Capacitance on Shielding, Proc. IRE; Nov. 1944.
³A device for eliminating the lead capacitance in the measurement of shielded capacitors having a single high terminal has been developed. This was described by Mr. F. Field in a paper on Connection Errors in Capacitance Measurement, General Radio Experimenter; Jan. 1938. Other methods for measuring direct capacitance have also been published in the G. R. Experimenter. These were described by Mr. Field and I. G. Aston. The Field paper covered Direct Capacitance and Its Measurement; Nov. 1933. Mr. Aston's paper described A Method for Measuring Small Direct Capacitance; September 1944.

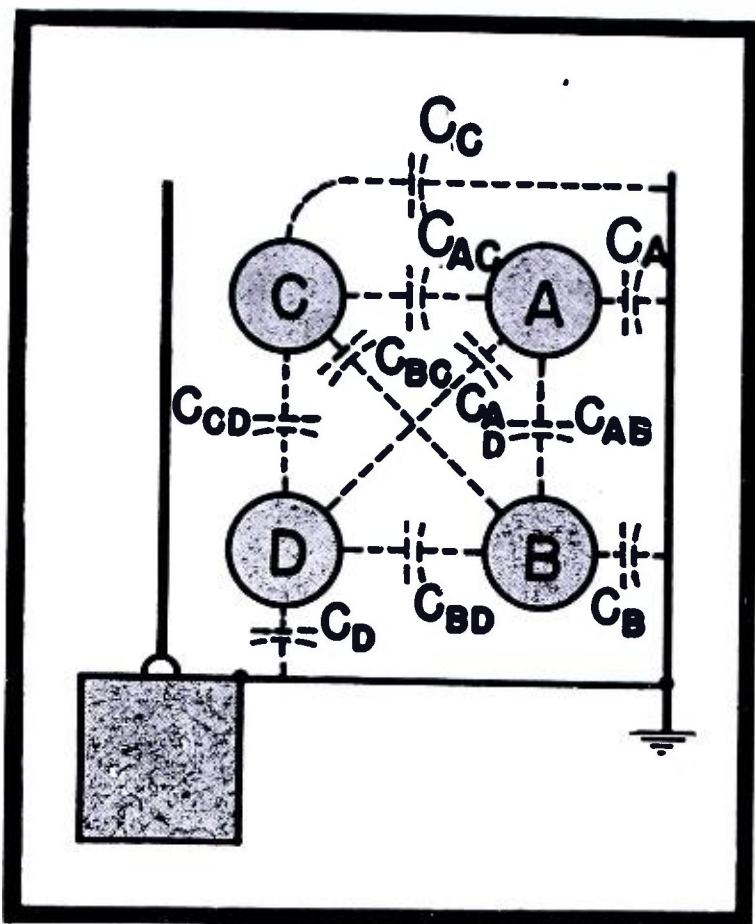

Figure 2

A four-electrode system and ground arrangement, showing direct capacitance between electrodes and stray capacitances to ground. An analysis of this specific case is offered in this discussion. Equations presented in analysis provided results consistent within .1 mmfd.

Measurement data tabulated are:

$$C_{AB} = \frac{(d-f) + (a-b)}{2} \quad *(14)$$

$$C_{OD} = \frac{(m-o) + (a-j)}{2} \quad (15)$$

$$(C_B + C_{BD} + C_{BC}) = \frac{(c-d) + \sqrt{(c-d)(c-b)}}{2} \quad *(16)$$

$$(C_D + C_{BD} + C_{AD}) = \frac{(l-m) + \sqrt{(l-m)(l-o)}}{2} \quad (17)$$

$$(C_A + C_{AC} + C_{BC}) = \frac{(e-d) + \sqrt{(e-d)(e-f)}}{2} \quad *(18)$$

$$(C_C + C_{AC} + C_{AD}) = \frac{(n-m) + \sqrt{(n-m)(n-o)}}{2} \quad (19)$$

$$C_{AO} = \frac{(h-j) + (a-b)}{2} \quad *(20)$$

$$C_{BD} = \frac{(q-o) + (a-f)}{2} \quad *(21)$$

$$(C_A + C_{AB} + C_{AD}) = \frac{(i-h) + \sqrt{(i-h)(i-j)}}{2} \quad (22)$$

$$(C_C + C_{CD} + C_{BO}) = \frac{(g-h) + \sqrt{(g-h)(g-b)}}{2} \quad (23)$$

$$(C_B + C_{AB} + C_{BC}) = \frac{(r-q) + \sqrt{(r-q)(r-o)}}{2} \quad *(24)$$

$$(C_D + C_{OD} + C_{AD}) = \frac{(p-q) + \sqrt{(p-q)(p-f)}}{2} \quad (25)$$

$$C_{BC} = \frac{(k-f) + (a-j)}{2} \quad *(26)$$

$$C_{AD} = \frac{(s-o) + (a-b)}{2} \quad (27)$$

Individual Stray Capacitances

Separation of the direct capacitances from the total stray capacitances by subtraction yields the individual stray

capacitances to ground.

For the special case in which *A* is like *C* and *B* like *D* and the pairs arranged symmetrically with respect to ground as two identical neutralizing capacitors, only the data and formulas marked with the asterisk (*) are needed to give the desired capacitances and afford a check on the work.

Measurements

Results of the method applied to two neutralizing capacitors appeared in the October discussion. The probes were made from phosphor bronze wire of two sizes, then silver plated; the larger (0.081) mounted in the holder and held in place with a set screw was moved $\frac{1}{8}$ " to cause the smaller (0.025) which extended beyond and from the end of the larger to make contact with the electrode. Care was used in withdrawing the probe from the electrode to establish as nearly as possible the same position each time. The equations shown gave results consistent within 0.1 mmfd from the data. It has been found, however, that sensitivity and accuracy in measuring the capacitance change from setting to setting should be within 0.01 mmfd.

Direct Bridge Measurements

All of the equations presented for the direct and total stray capacitances may be used with data taken by direct measurement, using the capacitance bridge, by changing the algebraic sign of each difference written within the parentheses.

NEW RAYTHEON SUB-MINIATURE TUBES for Pocket Receivers

Since 1938 Raytheon has pioneered in the design, development and production of small, low drain, long life tubes. These have helped to make possible the modern

extremely compact hearing aid.

Now for Radio Receivers—Now Raytheon announces a physically similar kit of that style, sub-miniature tubes for radio receiver applications. Included is a shielded RF-pentode amplifier, a triode-heptode converter, a diode-pentode detector-amplifier and an output pentode for earphone operation.

Much Smaller Radios Possible—These tubes make it possible to construct radios a fraction the size of prewar "personals," with sensitivity rivaling much larger sets.

The ratio of performance to battery drain is maintained very high, thus assuring the maximum possible operating life from the small size batteries now available.

The line consists of tubes approximately 1 1/16" long x 0.3" x 0.4" in cross section. Each type is available with pins for use with small commercially available sockets as illustrated, or may be had with long flexible leads for wiring the tube directly into the circuit.

No progressive radio manufacturer will overlook the tremendous possibilities inherent in the small pocket receiver—built around the new Raytheon sub-miniature tubes. But call on Raytheon for every tube need—large or small—for the finest in engineering, production and performance.

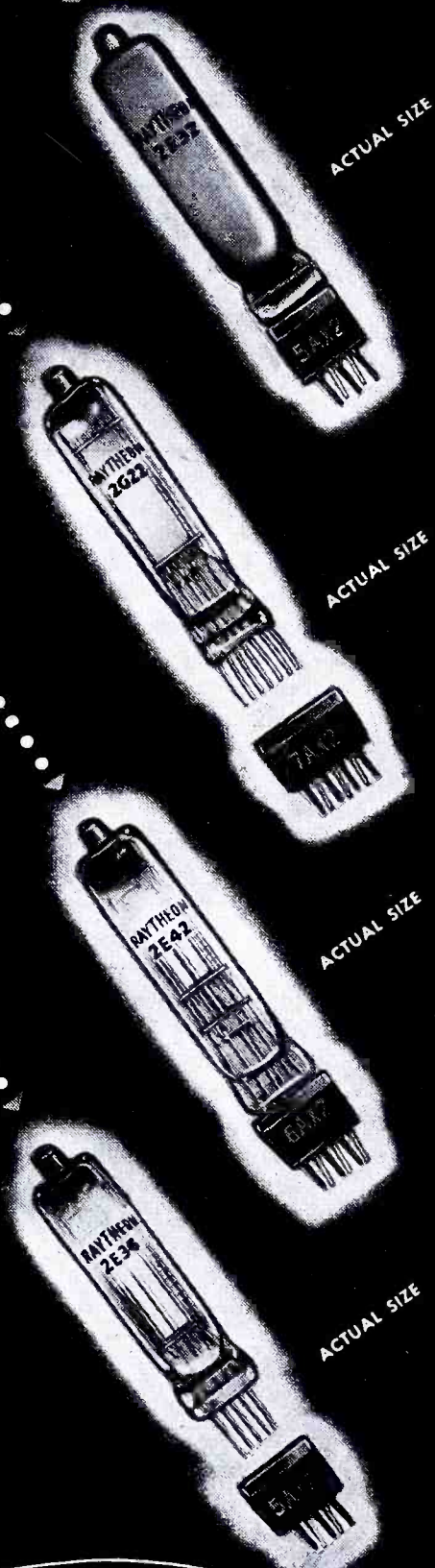

ELECTRICAL CHARACTERISTICS

	2E31† 2E32# Shielded RF Pentode	2G21† 2G22# Triode- Heptode	2E41† 2E42# Diode- Pentode	2E35† 2E36# Output Pentode
Filament Voltage	1.25 V	1.25 V	1.25 V	1.25 V
Filament Current	50 ma	50 ma	30 ma	30 ma
Max. Grid-Plate Capacitance	0.018 μf	0.065 μf†	0.10 μf	0.2 μf
Plate Voltage**	22.5 V	22.5 V	22.5 V	22.5 V
Screen Voltage	22.5 V	22.5 V	22.5 V	22.5 V
Control Grid Voltage*	0	0	0	0
Osc. Plate Voltage	—	22.5 V	—	—
Plate Current	0.35 ma	0.2 ma	0.4 ma	0.27 ma
Screen Current	0.3 ma	0.3 ma	0.15 ma	0.07 ma
Osc. Plate Current	—	1.0 ma	—	—
Transconductance	500 μmhos	60 μmhos (Gc)	400 μmhos	385 μmhos
Plate Resistance	0.35 meg	0.5 meg##	0.25 meg	0.22 meg

*With 5 megohm grid resistance connected to F—
**Higher voltage operation is possible as shown
on engineering characteristics sheet available by
request.

†Flexible Lead Types.
#Plug-In Types.
##Approximate conversion Rp.
‡Signal grid to mixer plate Capacitance

RAYTHEON

MANUFACTURING COMPANY

Radio Receiving Tube Division

NEWTON, MASSACHUSETTS • LOS ANGELES
NEW YORK • CHICAGO • ATLANTA

EXCELLENCE IN ELECTRONICS
COMMUNICATIONS FOR NOVEMBER 1945 • 69

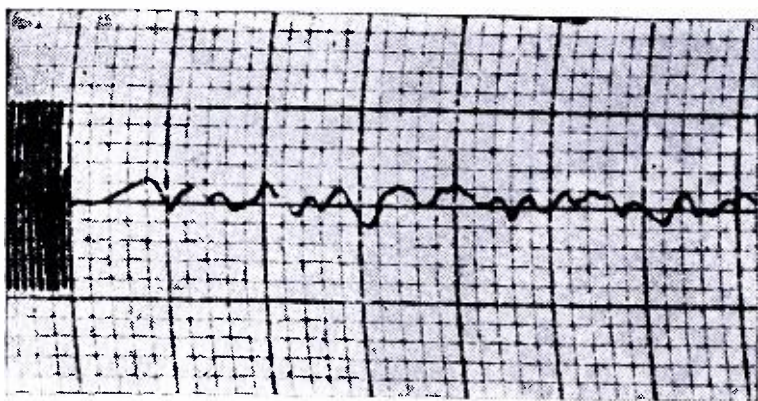

Figure 1

Surface of rough-cut AT blank. Vertical magnification, 1 small division = 100 microinches; horizontal magnification, 1 small division = 500 microinches. RMS roughness varies from 30 to 70 microinches.

A Study of the Surfaces of Crystals in Various Stages of Manufacture

by **SIDNEY X. SHORE**

Consulting Engineer

[Part Four of a Series]

THE aging of quartz crystals has always been of significant interest to both manufactureres and users, because of its end-use effects . . . the increase in resonant frequency and decrease in activity as time progresses.

Before the war, crystals destined for use in frequency standards or broadcast transmitters, where constant frequency was necessary over long periods of time, were artificially aged prior to final calibration and shipment. This accelerated aging process at the factory was necessary to prevent crystal failures in the field. It consisted largely of a series of heat cycles.

With the first rush of war contracts for crystals this factor of aging was somehow neglected. The unfortunate consequences were that vast numbers, several millions, of previously approved crystals were totally inoperative or unusable when they were finally taken from the shelves of the storage depots months after delivery.

The usual procedure for crystal manufacture included several machine lapping stages with successively finer

grits of abrasive. The final lapping operation was usually completed by hand, the crystal surfaces being rubbed against a glass plate sprinkled with very fine abrasive and water or kerosene. This operation brought the crystal to its final frequency. Some companies used a dip in dilute hydrofluoric acid as the final frequency adjustment step. In general the acid dip was found to have deleterious effects on activity and was avoided.

Crystals finished to a final frequency solely by the abrasive-lapping method were found to age quite a bit. Suppose the frequency of such a crystal were 8,000 kc at the time of completion, and its activity in a particular oscillator were represented as 1.0 ma of rectified grid current. At the end of 6 months the frequency of this crystal, which had been lying around on a shelf and subject to ambient room temperatures, might be 8,000.600 kc and activity 0.85 ma. At the end of a year the fre-

quency might jump to 8,000.100 kc and activity drop to 0.25 ma. If this crystal were now to be removed from its casing an examination of its surface would show the existence of a slight powdery deposit. With a good scrubbing the surface could be cleaned and upon recasing the frequency might be 8,000.750 kc and the activity 1.0 ma once again.

The surface of any material, after being subjected to abrasion, will be stressed and unstable. If the material is crystalline quartz the surface stresses existing at any one temperature will be enormously increased with changes in temperature. The reason is that crystalline quartz has a large average temperature coefficient of expansion and, especially, a different t-c of expansion in different directions.

If we visualize a surface with multitudinous sharp irregularities and discontinuities that usually exist on a quartz crystal after successive mechanical abrading steps, we can realize the temperature change problems that might exist. For temperature changes

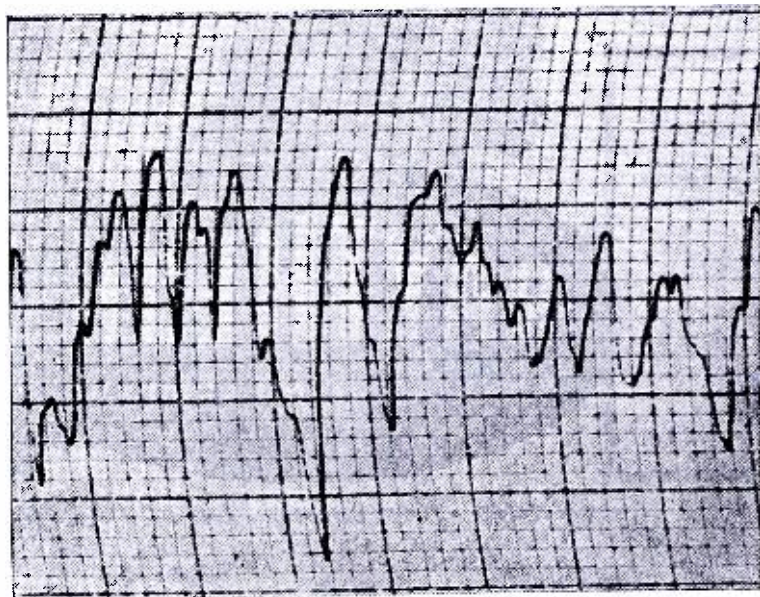

Figures 2 (left) and 2a (below)
Figure 2. Surface of rough-lapped AT blank (320 grit silicon carbide). Vertical magnification, 1 small division = 10 microinches; horizontal magnification, 1 small division = 500 microinches. RMS roughness varies from 26 to 46 microinches. Figure 2a. Three small horizontal divisions at center of Figure 2 plotted to uniform magnification of 4000 X in each direction. A region of large surface height variation was chosen. [Each small division in Figure 2 is equal to 1 millimeter.]

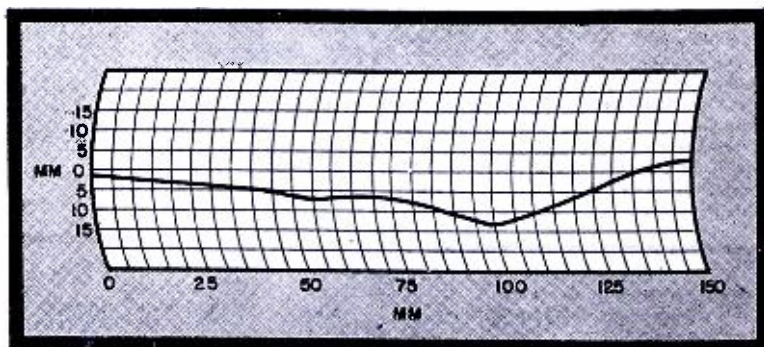

OF QUARTZ CRYSTALS

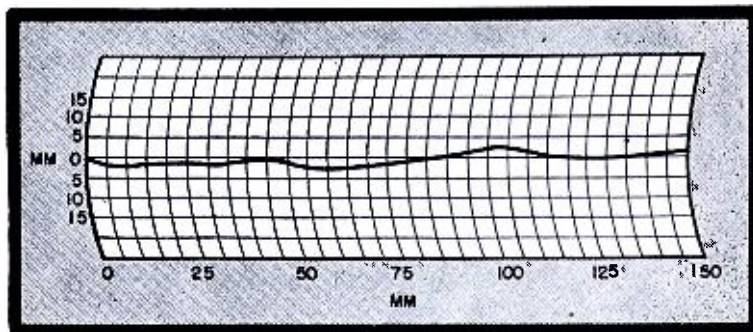
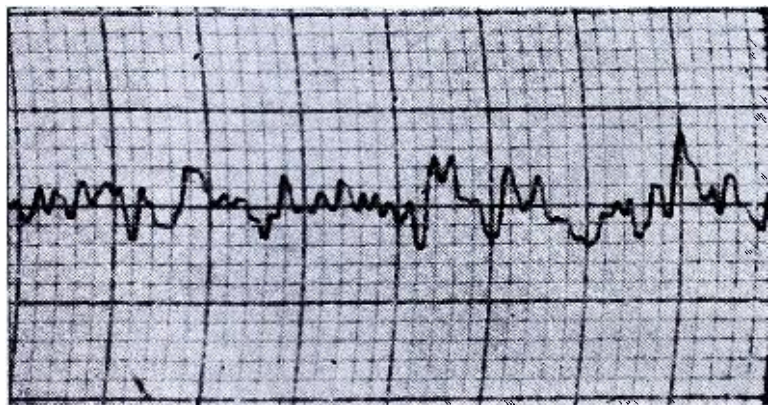

may set up such large stresses in sections of this irregular surface that the strains would exceed the elastic limit of the surface and chipping and fragmentation occur.

It is also believed that the water vapor trapped in the microscopic crevices may develop high vapor pressures with ambient temperatures, to chip and crack the fragile surfaces. Local surface areas are believed sometimes to convert to unstable silicon dioxide and water compounds. The unstable compounds break down with temperature and humidity changes. Perhaps, the cause for most aging is the unstable physically stressed surface which cannot withstand strains induced by temperature changes.

The breakdown of the surface results in increased frequency by virtue of the decrease in effective mass and thickness. The activity is decreased because the detached particles on the surfaces load the crystal and increase surface friction, thereby decreasing the Q .

In a survey of deteriorated crystal stocks at depots it was noted that only a few of the bad crystals bore the names of the companies which etched their crystals in the final frequency calibration operation. Hydrofluoric acid and certain fluoride salts such as ammonium and sodium bifluoride were used as the etching agents, dissolving the surfaces of the crystals, thereby raising their frequency.

In 1943 the crystal procurement program of the armed forces was seriously affected because of the failures of crystals stored at depots. As a result an unofficial campaign was conducted among manufacturers requesting the

•
 *Figures 3 (above left) and 3a (above right) Surface of finish-lapped AT blank (1500 grit silicon carbide). Vertical magnification, 1 small division = 10 microinches; horizontal magnification, 1 small division = 500 microinches. RMS roughness varies from $6\frac{1}{2}$ to $9\frac{1}{2}$ microinches. Figure 3a. Three small horizontal divisions at center of Figure 3, plotted to uniform magnification of 4000 X in each direction. A region of large surface height variation was chosen.

etching of all crystals to final frequency, instead of abrading them. By early 1944 a minimum etch of 1 micron of overall thickness for AT and BT thickness-shear oscillator plates was made mandatory. Also, by that time virtually all manufacturers had set up some kind of semi-automatic etching equipment.

It was found that an overall average thickness reduction of 1 micron or 39.4 microinches, by solution, of the surface layers of quartz in fluoride solvents removed all traces of surface stresses and instability. This is the equivalent of approximately 20 microinches average depth per major surface. The term, average depth, is used

because the final surfaces may have hills and valleys with peak displacements of 85 microinches or more; see Figure 5.

To further analyze aging, surface conditions studies were initiated, using x-ray diffraction methods and the electron microscope. After a series of tests with these instruments, it was decided to try another procedure using the Brush surface analyzer. In 1944 the Bausch and Lomb Optical Company agreed to make several preliminary surface analyses of quartz crystals in various stages of manufacture. These analyses served as a stimulus to make more complete tests and a few weeks ago such tests were completed at the Brush Development Company laboratories in Cleveland using their laboratory standard calibrating surface analyzer. In Figures 1 to 12 appear unretouched photographs of some of the surface test runs made.

Both AT and BT crystals were checked. The BTs were from a regular production run and the ATs were specially prepared for these tests. Figures 1 through 6 are graphs of the surface contours of AT crystals from the rough art stage through the etched stage. In all, the above charts except

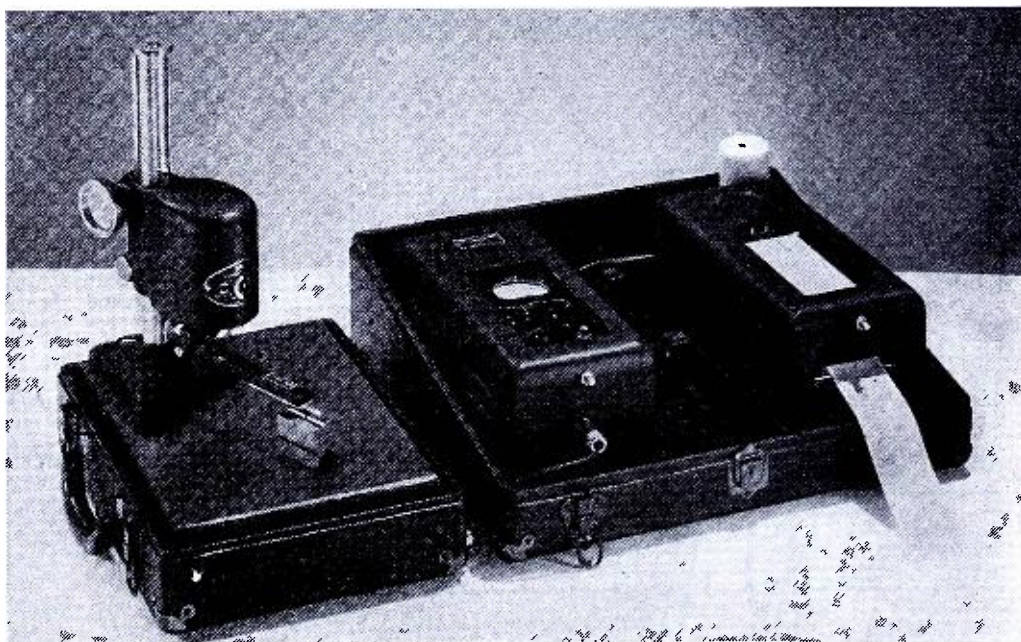

•
 Brush laboratory standard calibrating surface analyzer used in preparing quartz crystal surface plots discussed in this paper.

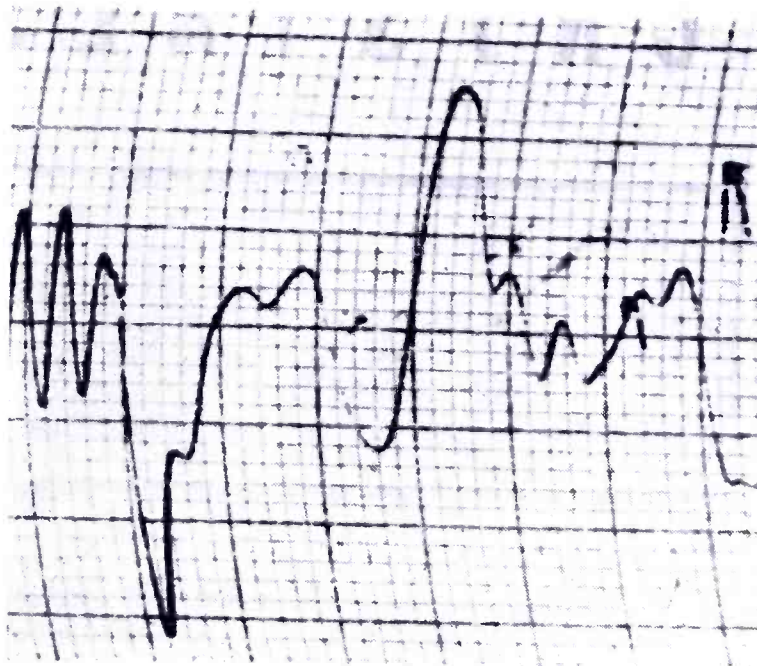

Figure 4
Surface of finish-lapped AT blank shown in Figure 3 where in the vertical magnification: 1 small division = 1 microinch; horizontal magnification, 1 small division = 100 microinches.

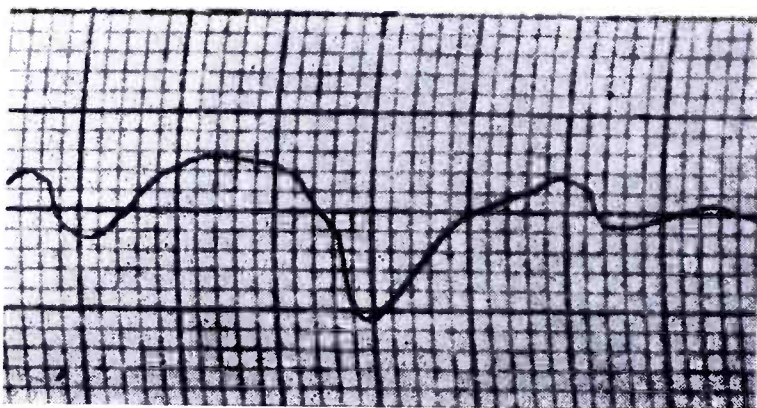

Figure 5
Surface of the same AT crystal blank used in plotting Figure 3 after etching it in an ammonium - bifluoride solution to decrease its average thickness by 580 microinches. Vertical magnification is 1 small division = 10 microinches; horizontal magnification, 1 small division = 500 microinches. RMS roughness varies from 5 to 15 microinches. Although the peak-to-valley surface displacement is larger here than in Figure 3, because quartz dissolves with different rates in different directions, the surface is much more stable. The slopes of the undulations are more gradual and the peaks are smoothed out while the frequency of undulations is tremendously reduced.

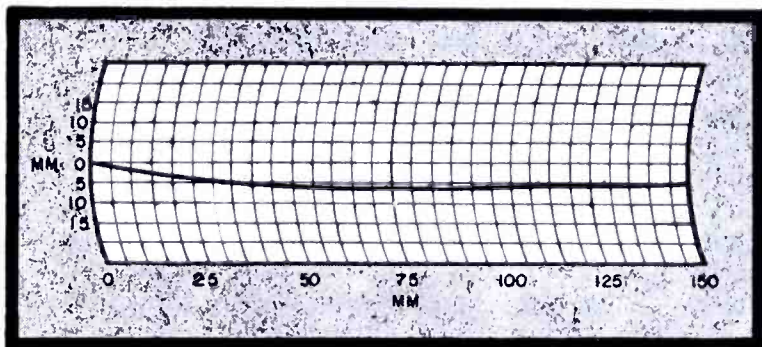

Figure 5a
Three small horizontal divisions at center of Figure 5 plotted to uniform magnification of 4000 X in each direction. A region of large surface height variation was chosen.

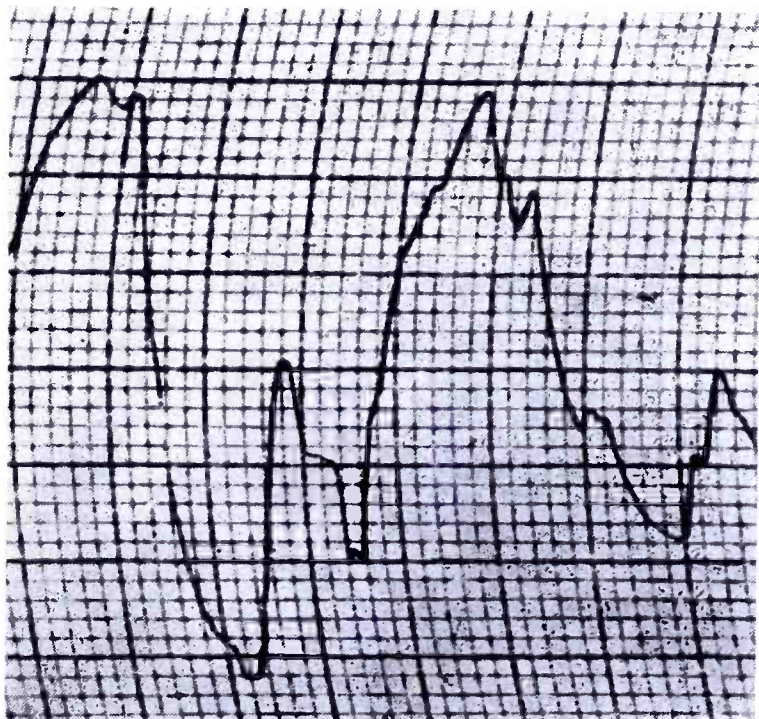

Figure 6
Surface etched AT blank of Figure 5 over a region where markedly deep local etch pits were noted. Magnification is same as in Figure 5. RMS roughness varies from 18 to 54 microinches. Note that even this region, with a roughness greater than the rough-lapped blank, is stable. Surface contours here are also rounded, slope gradually, and undulate less frequently than those of a plain-lapped surface. This crystal blank oscillated quite well in this condition.

Figure 1, the vertical magnification is approximately 4,000 times. Each small division horizontally and vertically is 1 mm in the original chart. In Figure 1 the vertical magnification is 400 times. In all these charts except Figure 4 the horizontal magnification is approximately 80 times; in Figure 4, the magnification is 400 times.

It will be noted that the charts therefore are not anastigmatic overall magnifications. In order to illustrate the actual uniformly magnified surface as derived from Figures 2, 3 and 5, we have redrawn a horizontal length of chart of 3 mm to a scale of 4,000 times magnification, horizontally as well as vertically. These appear in Figures 2a, 3a and 5a, respectively.

A limitation of this method of surface analysis is that subsurface cracks and surface valleys smaller than the exploring stylus are not accurately indicated. However, the nature of each surface is clearly shown and the manner in which the surface becomes more and more stable may be seen. The slopes of the microscopic mountains and valleys become less with each finer lapping operation and still less with the etching. It will be noted that the peak displacement between highest and lowest points in Figure 3 is 60 microinches and the rms roughness is 8-11 microinches. The peak displacement of high and low points in Figure 5 is 85 microinches and the rms roughness is 5-15 microinches. Figure 3 represents a crystal lapped finally with 1500-grit carborundum. Figure 5 shows the same crystal after an average thickness of 580 microinches has been dissolved. From the 8-mc crystal experience we know that the crystal of Figure 3 would change frequency about 3,000 cycles over a 12-month period, whereas the crystal of Figure 5 would change frequency no more than 10 to 25 cycles in the same period.

Figure 6 illustrates a trace of the surface of the crystal in Figure 5 over some local deeply-etched spots. Although the overall displacement is about 310 microinches and the rms roughness is 18-54 microinches, we note that the surface has many less undulations per unit length than the crystal of Figure 3.

Figure 7 shows the same crystal explored across a scratch on the surface. Here we note that although the overall displacement at the scratch is 320 microinches its slopes are well rounded.^{1,2}

Figure 8 shows the same crystal etched further to decrease average thickness by a total of 710 microinches. The overall displacement has increased to 155 microinches and the rms roughness is 8-36 microinches.

Figures 9 to 12 show the surfaces of

*Enduring Accuracy
in Vital R.F. Applications*



OHMITE RESISTORS & CHOKES

The unique characteristics of these Ohmite units have made them especially suitable for many r.f. applications. Proved by use before war came . . . they are performing vital functions today in the production and operation of critical equipment. Tomorrow—they will be more popular than ever!

GLASS-SEALED NON-INDUCTIVE DUMMY ANTENNA RESISTORS—for testing and measuring power output accurately. 100-watt and 250-watt sizes in variety of resistances.

R. F. PLATE CHOKES—single-layer wound on low power factor steatite cores, with moisture-proof coating. Built to carry 1000 M.A. 5 stock sizes from 2½ meters to 160 meters.

PARASITIC SUPPRESSOR—small, light, compact non-inductive resistor and choke, designed to prevent u.h.f. parasitic oscillations.

NON-INDUCTIVE VITREOUS ENAMELED POWER-SIZE RESISTORS—Useful in wide variety of radio frequency applications. 50-watt, 100-watt and 160-watt stock sizes in many resistances.

Ohmite Engineers are glad to assist you on any resistance-control problem.

OHMITE MANUFACTURING CO.
4870 FLOURNOY STREET • CHICAGO 44, U. S. A.

Be Right with

OHMITE

RHEOSTATS • RESISTORS • TAP SWITCHES

COMMUNICATIONS FOR NOVEMBER 1945 • 73

SEND FOR CATALOG No. 40
Write on company letterhead for helpful Catalog and Engineering Manual No. 40. Address Ohmite Mfg. Co., 4870 Flournoy Street, Chicago 44, Illinois.

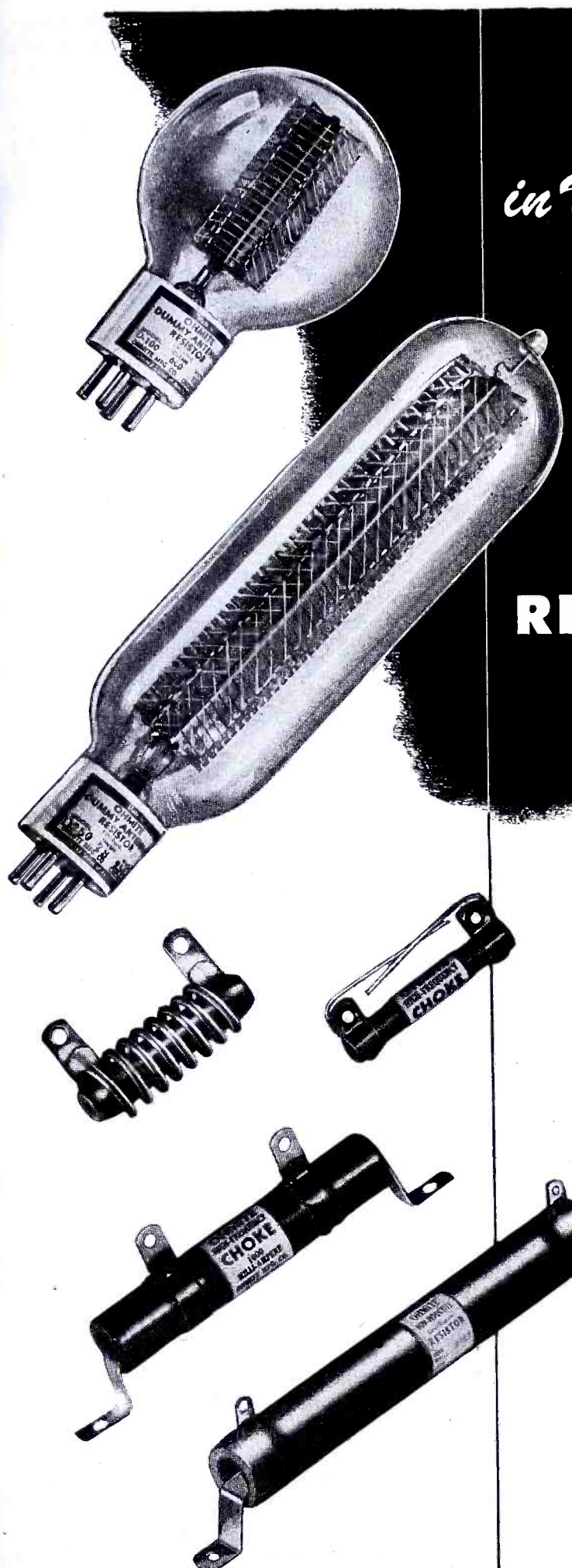



Figure 7

Surface of the same etched AT blank used in plotting Figure 5, where the exploring probe was moved across a scratch in the surface. The scratch occurred during final lapping. Magnification is same as in Figure 5. Note the rounded and smooth slopes and edges of the scratch. The surface here is mechanically stable.

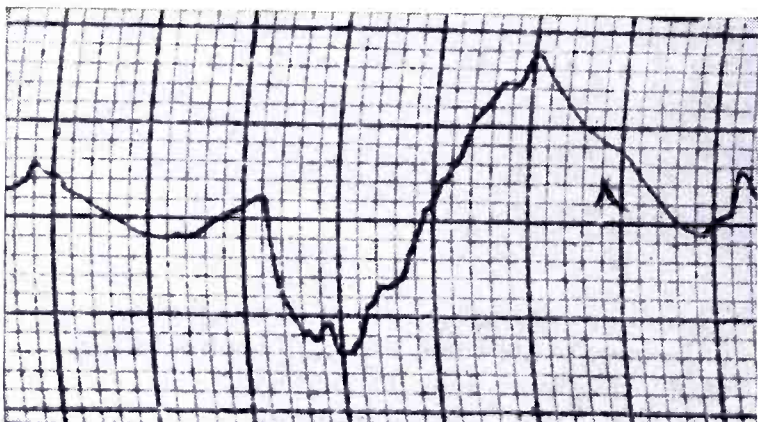

Figure 8

Surface of the same AT-crystal blank used in plotting Figures 3 and 5 after a total thickness reduction of 710 microinches, by solution in ammonium bifluoride. Magnification is same as in Figures 3 and 5. RMS roughness has increased from 8 to 36 microinches. Note that rounded contours, typical of the etched surfaces, are retained. This crystal oscillated well.

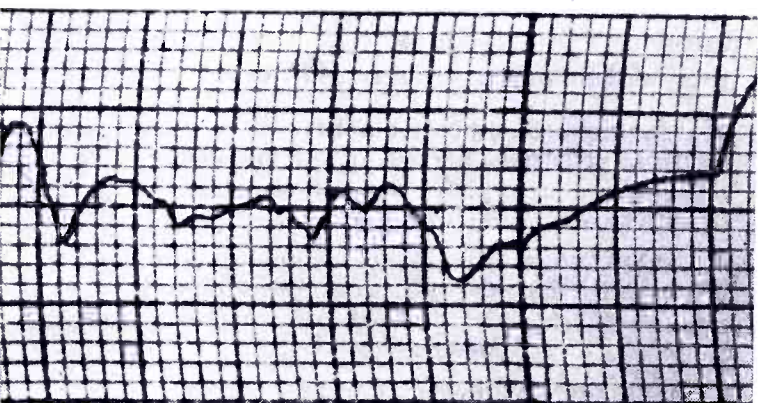

Figure 9

Surface of rough-cut BT blank from regular production run, where diamond wafering saw is driven through the mother quartz at a slightly excessive rate. Magnification is same as in Figure 1 for the rough-cut AT blank. In comparing the two surfaces, we note increased roughness where the cutting rate is too high. RMS roughness varies from 70 to 240 microinches.



Figure 10

Surface of rough-lapped BT blank (320 grit silicon carbide). Vertical magnification, 1 small division = 100 microinches; horizontal magnification, 1 small division = 500 microinches. RMS roughness varies from 40 to 80 microinches. This plot should be compared with Figure 2.

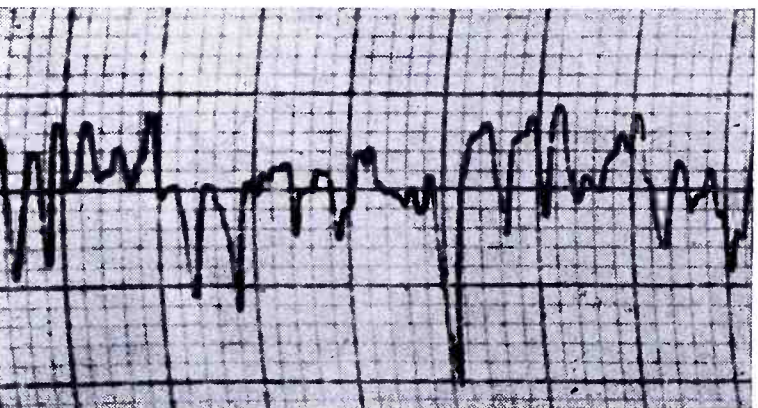

Figure 11

Surface of semi-finished lapped BT blank (600 grit silicon carbide). Vertical magnification, 1 small division = 10 microinches; horizontal magnification, 1 small division = 500 microinches. RMS roughness varies from 14 to 27 microinches.

four different BT crystals from a regular production run. We note that the vertical scale is magnified 400 times in Figure 9, as in Figure 1. The surface roughness of Figure 9 is 70-240 microinches rms, as compared with 30-74 microinches rms, for Figure 1. Both are rough-cut blanks, directly from the quartz wafering saw. But the BT blank of Figure 9 was cut much faster than the AT blank of Figure 1. Hence its surface is much rougher and will be more difficult to lap smooth.

Comparing Figure 10, the rough lapped BT, vertical scale 400 times magnification, and its rms roughness of 40-80 microinches with Figure 2 for the rough lapped AT, vertical scale 4,000 times magnification, and its rms roughness of 26-46 microinches, we see that the relative roughness of the rough cut is carried through at least part of the lapping operation, all other factors being equal. Rough lapping was done with an abrasive grit having an average diameter of 35-40 microns. Final lapping used an average diameter of abrasive of 10 to 15 microns.

It is believed that these charts show graphically the mechanism involved in etching the surfaces of quartz crystals and the reasons for the inhibition of aging.

While, with the North American Philips Company, in the latter part of 1943, several interesting aging analyses were made.

With crystals abraded to final frequency, the A-grade temperature test cycle of -50°C to $+90^{\circ}$ resulted in a rise in room temperature frequency of an 8-mc crystal of up to 800 cycles after only one heat cycle. Crystals abraded to within 10 kc of final frequency and etched the remainder of the distance showed increases in frequency of under 30 cycles after one heat cycle.

When universal etching to final frequency of a minimum of 10 kc was introduced in production an interesting chart was compiled. The crystals were supplied to final finishing operators about 20 to 50 kc below final frequency. The instructions were to abrade the crystals with 303½ grit

¹An optical viewing and projection system for straightening out the arcuate coordinate of a coordinate system, such as this one, is being developed.

²With charts where the vertical coordinate is curved, as these are, we find that the right sides of the peaks and the left sides of the valleys show up steeper than they actually are. The left sides of the peaks and the right sides of the valleys show up with less steepness than what we have actually.



HOME for them!

**and the
HOME STRETCH
for YOU!**

You still have time! In December, your employees' allotments to the Victory Loan through your company's Payroll Savings Plan offer a final chance to help speed the proud homecoming of our fighting men—and do all in medical power for our hospitalized heroes!

Make December a plantwide TOP-THE-QUOTA drive! Now's the time to spotlight your Payroll Savings Plan—and "brief" your Bond-selling organization for fast, last minute action!

**Resolicit every employee to buy
the New F.D.R. Memorial \$200 Bond**

The new Franklin Delano Roosevelt \$200 Bond—better than actual cash because it earns interest—is a strong building stone toward the secure future of every employee-purchaser!

From now 'til the New Year—with plant rallies, interdepartmental contests and resolicitation—keep Payroll Savings Plan Bond-buying at a new Victory Loan high! Buying a Victory Bond is the best way of saying "Welcome Home" to our returning veterans! Also an active aid in assuring prosperity to your nation, your employees—and your own industry!



The Treasury Department acknowledges with appreciation the publication of this message by

COMMUNICATIONS

This is an official U.S. Treasury advertisement prepared under the auspices of the Treasury Department and War Advertising Council

COMMUNICATIONS FOR NOVEMBER 1945 • 75

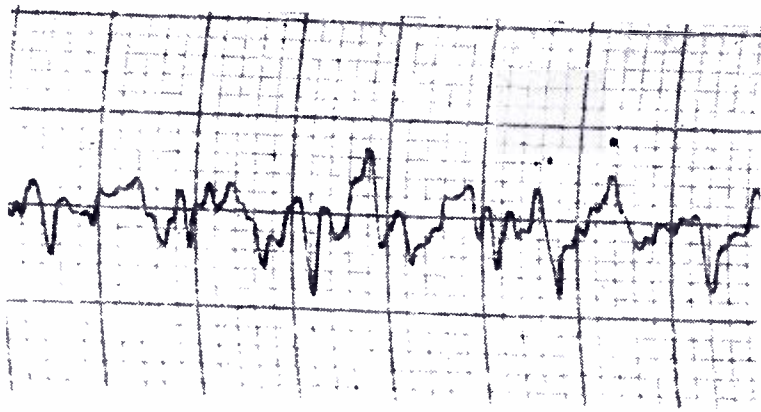

Figure 12

Surface of finish-lapped BT blank (1500 grit silicon carbide). Same magnification as Figure 3. RMS roughness varies from 10 to 16 microinches.

Crystal	Frequency Check (kc) 12/29/43	Δf (cps) 12/30/43	Δf (cps) 12/31/43	Δf (cps) 1/1/44	Frequency Check (kc) 1/1/44	Overall Frequency Deviation (cps) 12/29/43 to 1/1/44
1.....	8258.954	+ 33	- 68	+ 10	8258.929	- 25
2.....	8258.998	+ 96	+ 69	+ 51	8259.214	+ 216*
3.....	8258.783	- 13	- 25	- 37	8258.710	- 73
4.....	8258.757	+ 93	- 8	- 25	8258.817	+ 60
5.....	8258.861	- 4	- 51	- 12	8258.794	- 67
6.....	8258.990	- 55	- 15	+ 20	8258.940	- 50
7.....	8258.965	+ 27	- 11	+ 37	8259.018	+ 53
8.....	8258.766	+551	+173	+116	8259.606	+ 840*
9.....	8258.772	+792	+175	+161	8259.900	+1128*
10.....	8258.947	+799	+155	+159	8260.060	+1113*
11.....	8258.954	+ 51	- 12	+ 26	8259.019	+ 65
12.....	8258.831	+748	+139	+177	8259.895	+1064*
13.....	8258.747	+353	+ 25	+ 54	8259.179	+ 432*
14.....	8258.955	+ 22	+ 25	+ 3	8259.005	+ 50
15.....	8259.141	+677	+172	+297	8260.287	+1146*
16.....	8258.997	+107	- 44	- 12	8259.048	+ 51
17.....	8258.902	- 62	- 5	- 3	8258.832	- 70
18.....	8258.904	+ 47	00	+ 23	8258.974	+ 70
19.....	8258.794	+168	- 15	+ 13	8258.960	+ 166*
20.....	8259.071	+470	+ 75	+ 92	8259.708	+ 637*
21.....	8258.939	+ 6	- 16	+ 2	8258.931	- 8
22.....	8258.978	+ 63	+ 18	+ 14	8259.073	+ 95
23.....	8258.850	+ 45	+ 10	+ 30	8258.935	+ 85
24.....	8259.036	+758	+109	+107	8260.010	+ 974*
25.....	8259.077	+ 90	- 60	+ 9	8259.116	+ 33
26.....	8259.047	+ 33	- 38	- 4	8259.038	- 9
27.....	8258.956	- 45	- 21	- 9	8258.881	- 75
28.....	8259.105	- 27	- 11	- 7	8259.060	- 45
29.....	8259.200	+ 56	- 44	+ 15	8259.227	+ 27
30.....	8259.145	+ 7	- 45	+ 12	8259.119	- 26
31.....	8258.942	+ 43	- 21	- 12	8259.952	+ 10
32.....	8258.986	+ 46	- 44	+ 7	8259.995	+ 9

emery moistened on a glass plate until the frequency was 10 kc below the final desired frequency. Then each crystal was to be etched in ammonium bifluoride solution to final frequency. Any crystals abraded too far were to be discarded and used for the next higher frequency channel.

Check on Operators

This chart, Figure 13, allowed us to determine exactly which operators were conscientious and careful and which operators disobeyed the instructions just outlined. For example, operator 4 was the control, etching all crystals 10 kc because she had no abrasive and was given her crystals 10 kc from final frequency. Operators 1, 2 and 3 were not advised of the impending statistical survey. Three temperature cycles of -50°C to

Figures 13 (left, top) and 14 (left, bottom)

Figure 13. Chart showing the results of the work of three production finishers with instructions to hand-lap crystals only to within 10 kc of final frequency and then to etch them the remainder of the way. Crystals 1 to 8 were the work of the first finisher, 9 to 16 the second, and 17 to 24 the third. A fourth finisher acted as the control and was not permitted to hand-lap her crystals. These crystals were all 10 kc from final frequency; crystals 25 to 32 were etched to final frequency. The chart shows the variation in frequency between successive room-temperature measurements after three repeated A-grade heat cycles of -50°C to $+90^{\circ}\text{C}$. In the last column appears the overall frequency shift. Shifts over 100 cycles are shown with asterisks. All three finishers slipped up in rejecting those blanks which were hand-lapped too close to final frequency, although finisher two was the worst offender. It will be noted that the asterisk crystals aged excessively in this accelerated aging test. Downward frequency shifts were partially due to electrode or spring shifts during heat cycles, or slightly different room temperatures each day.

Figure 14. Production chart of twelve BT-cut crystals each etched 22 kc two days after final lapping with 303½ grit aluminum oxide. Seven A-grade heat cycles were executed with room temperature frequency measured after each cycle. After heat cycle 5, crystals 4 through 9 were uncased and thoroughly washed, and then returned to the test. We note that there was no significant frequency change due to this washing, indicating stable surfaces. Frequency changes between successive A-grade cycles are indicated in the last column, showing the overall frequency change. The final frequency measurement was made 10 months after the last heat cycle, the crystals resting on a shelf during the interim.

Crystal	Frequency Check (kc) 12/15/43	Δf (cps) 12/16/43	Δf (cps) 12/17/43	Δf (cps) 12/18/43	Δf (cps) 12/19/43	Δf (cps) 12/20/43	Δf (cps) 12/21/43	Δf (cps) 12/28/43	Δf (cps) 10/26/44	Frequency Check (kc) Resting From 12/28/43 to 10/26/44	Overall Frequency Deviation (cps) 12/15/43 to 10/26/44
1	8259.069	-11	+69	-27	+44	-19	+26	-31	-20	8259.100	+31
2	8258.725	+56	-11	-44	+14	-30	+ 6	-12	+31	8258.735	+10
3	8259.053	-70	+92	-85	-22	+11	+16	-35	+55	8259.015	-38
4	8259.061	-37	+17	-69	+12	+24	+ 1	-20	+41	8259.030	-31
5	8259.119	+13	-20	+12	-28	+12	+ 7	-25	+37	8259.127	+ 8
6	8259.118	-54	+59	-93	-30	+11	- 1	-37	+62	8259.035	+83
7	8258.827	+36	+32	-82	- 1	+30	-17	+ 5	+70	8258.900	+73
8	8258.800	-18	+35	-78	-27	+28	-25	+17	+48	8258.780	-20
9	8258.888	-43	+61	-95	+16	+ 6	+17	-20	+25	8258.855	-33
10	8259.061	-22	+69	-32	-20	-29	+22	-16	+39	8259.072	+11
11	8258.660	+98	+95	-72	-35	-16	+27	-32	00	8258.725	+65
12	8258.946	+94	+10	-61	-18	+ 9	-28	+11	+ 2	8258.965	+19

90°C were made on all crystals. Their frequencies and activities were measured at room temperature before and after each heat cycle. The test proceeded for a 48-hour period. The activity changes in all crystals here were negligible. The frequencies changed as shown in the figure.

Chart Analysis

Analyzing this chart we note that Operator 1 slipped up on two crystals and one suffered a total frequency loss of 840 cycles, whereas the other lost 216 cycles. Operator 2 was the worst offender with five out of eight crystals rising in frequency quite a few hundred cycles. Operator 3 had three out of eight which showed lack of adequate etching. We note too that all of the crystals etched as a control by operator 4 rose less than 100 cycles after 3 heat cycles. As an epilogue to this experiment, it may be stated that operators 1, 2 and 3 at first denied the infraction of the rules of procedure, but finally admitted their carelessness and were completely justified at the method used to find their neglect.

Ten-Month Test

Figure 14 shows the work of the second of the three operators when the abrasive plates were removed from the finishing room, and these crystals were etched from 55 to 70 kc to final frequency. We note that 7 temperature cycles were made over a period of thirteen days, and crystals 4 to 9 were uncased and scrubbed after the fourth temperature cycle, and then run through the remaining tests with the rest. All twelve crystals were set aside for ten months and then frequency checked again. The overall frequency changes were remarkably small. Some frequencies were, in fact, lower than originally checked. This may be attributed to the setting of the springs or electrodes or perhaps to the loading of the crystal by precipitation of vapors from the gaskets or plastic holder walls during and after the heat cycles. Activities didn't change over 5% overall.

Credits

The writer is indebted to W. L. Snowlton of Bausch and Lomb and to I. P. Odell and E. Hensley of Brush Development for their cooperation in making the surface analysis charts possible.

CUSTOM-BUILT ELECTRONIC ASSEMBLIES

Need electronic assemblies engineered, designed and produced to match your requirements *exactly*? B & W offers unsurpassed facilities in this respect—for anything from a special transmitter or high-voltage equipment to test equipment, tuning units, high—and ultra-high frequency assemblies and dozens of others.

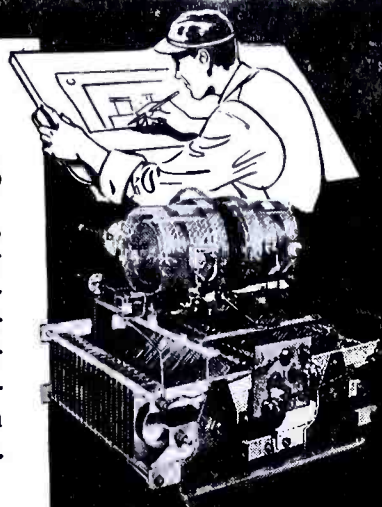

- ✓ Built-in Neutralization
- ✓ Perfect Design Symmetry
- ✓ Heavy-Duty Construction

Half the length of conventional dual units, designed for built-in neutralization, and thus having perfect design symmetry, B & W Heavy-Duty Variable Condensers assure a remarkable improvement in the performance of any equipment from a transmitter to a dielectric heating assembly. Write for Bulletin 75-C.

CYCLOMETER COUNTERS

Count shaft rotations—facilitate making pre-determined settings

B & W Cyclometer Counter assemblies are useful wherever a shaft must be turned a pre-determined number of times, or set at any exact pre-determined position. Exact settings to tenths of a turn are automatically recorded. Write for Cyclometer Bulletin.

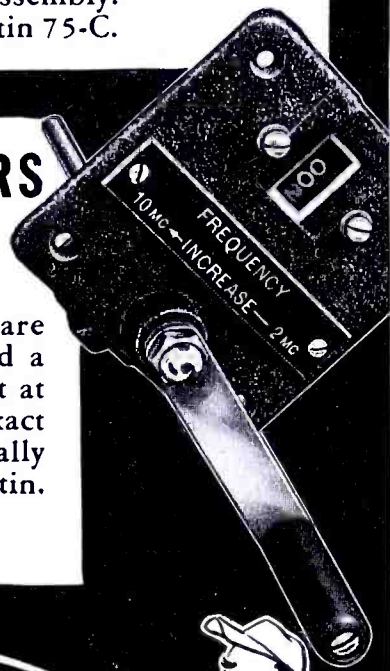

BARKER & WILLIAMSON

DEPT. C-115 235 FAIRFIELD AVE., UPPER DARBY, PA.

Export: LINDETEVES, INC., 10 Rockefeller Plaza, New York, N.Y., U.S.A.

VOLTAGE-REGULATED POWER SUPPLIES

(Continued from page 45)

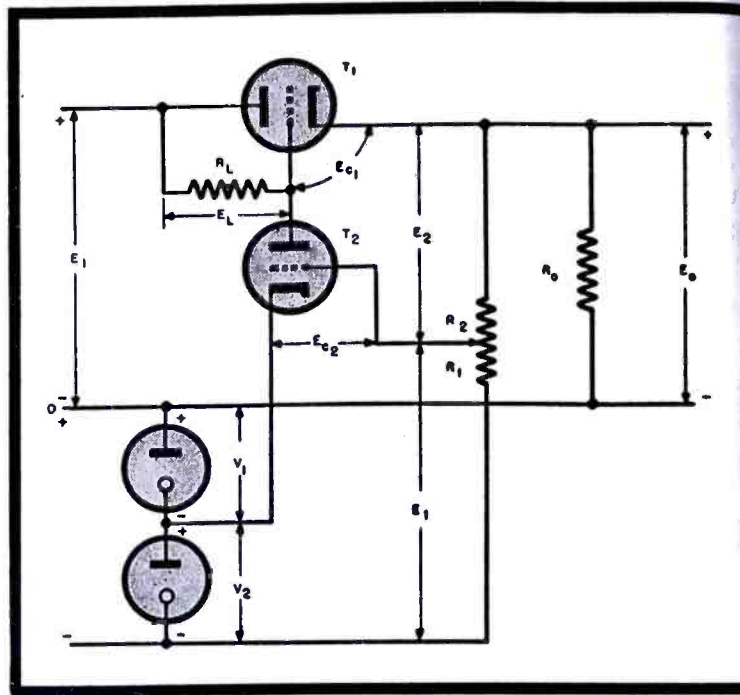
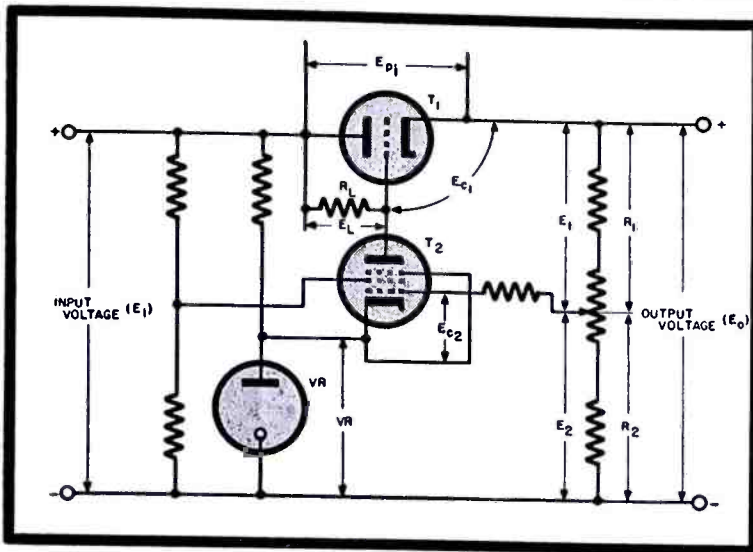

Figures 6 (above) and 7 (right)

Figure 6 illustrates a circuit that provides compensation for both changes of input voltage and load current. It also has a low internal impedance between its output terminals. Figure 7 shows an elementary full-range voltage-regulated supply.

Therefore for proper operation and design of this type regulator the following general equation may be used:

$$R_3 = \frac{R_1 + R_2}{R_2 G_m}$$

$R_1 + R_2$ should be chosen so that approximately 15% of the rated output current will flow through this bleeder circuit resulting in better input regulation. R_2 should be chosen so that with the maximum change in E_1 , the grid voltage (E_2) will not become positive. Tubes having a high transconductance are most satisfactory for this application since a minimum voltage drop is desirable across R_3 .

Neither the μ bridge nor the transconductance bridge compensates for

changes in load current. That is, they are high impedance devices, and are therefore of little value when used with a changing load. The degenerative type stabilizer will compensate for both line and load changes.

Degenerative Regulators

A degenerative regulator compensates for changes in output voltage resulting from both changes of line voltage, and varying load current. In Figure 5 we have a degenerative amplifier of this classification, which is the most elementary of this group. An increase of output voltage, E_0 , as a result of decreasing load current or increasing input voltage, increases the current through R resulting in a higher bias voltage on T_1 and a corre-

sponding decrease of plate current. This action tends to return the output voltage, E_0 , to its original value. For best regulation, tubes with a high amplification factor are recommended but this requirement limits the plate current of T_1 , since tubes with high amplification factors, in general, have low plate current. Where a simple method of manual voltage control is required with not too rigid regulation, 2A3, 6B4 or 6L6 tubes may be employed.

Resistance R in Figure 5 may be replaced by an amplifier having a high μ so that in addition to manual voltage control a high degree of regulation may be had. Figure 6 shows a circuit that provides compensation for both changes of input voltage and of load current, and has a low internal impedance between its output terminals. Regulation is accomplished in the following manner: Let us assume that the value of load resistance increases. The normal result of this action is for the load current to decrease. Due to the internal impedance of the source, the output voltage will increase. However in this case, the increase in output voltage causes E_2 to increase in direct proportion to the change in output voltage (ΔE_0). This increase in E_2 results in a decrease in bias voltage on T_2 (causes the negative bias for T_2 to become more positive) which causes an increase in plate current of T_2 . [See note 1 on page 8]

To show that E_0 cannot equal zero

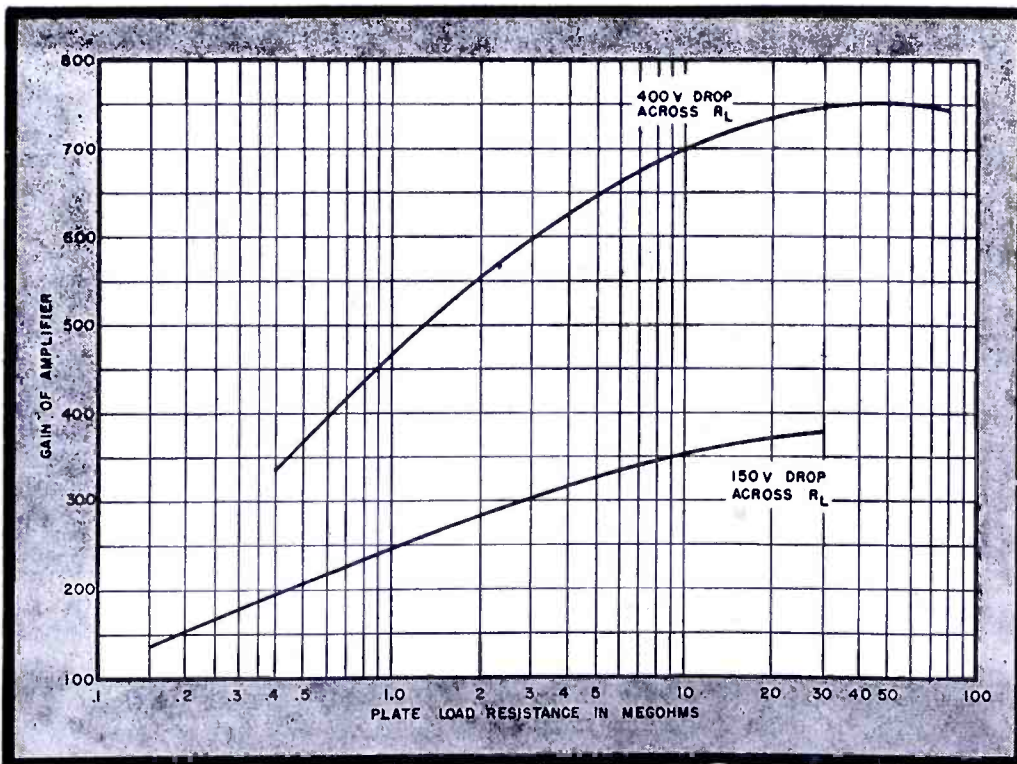

Figure 8

Plot showing variation of amplifier gain versus plate-load resistance in megohms.

op equation may be set up around control and passing tubes:

$$E_o - V_r - E_{p2} - |E_{c1}| = 0$$

$$E_o = V_r + E_{p2} + |E_{c1}|$$

Symbol Notations

- = Input voltage to the regulator.
- = Regulator output voltage.
- = Voltage drop across a single VR tube.
- = Absolute bias voltage on the passing tube (grid-cathode).
- = Actual plate-cathode potential across passing tube.
- = Actual plate-cathode potential across the amplifier or regulator tube (6SJ7).
- = Absolute bias voltage on the regulator tube (6SJ7).
- = Amplification factor of passing tube.
- = Plate load for the voltage regulator
- V_b = Bias supply of full range voltage regulated system, Figure 7.
- E_b = Sum of regulated output and bias supply voltages, Figure 7.
- = Control supply voltage = $E_1 - VR$.

f E_o is assumed equal to zero then $+E_{p2} + |E_{c1}| = 0$ or $-|E_{c1}| = VR + E_{p2}$, but since VR is constant at some positive value, it may be seen from the equations that $|E_{c1}|$ will be a positive voltage which is an impossible condition of operation. The lowest voltage to which this supply can be reduced is somewhat in excess of the VR volt-

The minimum voltage output from a regulated supply such as shown in Figure 6 may be determined in the following way: T_2 must not be allowed to draw grid current; therefore $E_{c2} = 0$ as a limit, $E_{bb2} = E_1 - VR$. Suppose we construct a load for T_2 with $E_{bb2} = E_1 - VR$. The phase angle with the voltage axis is

$\frac{1}{R_L}$. We can then determine

at the intersection of the zero bias line and load line the value of E_{p2} .

$$E_1 = E_{p1} + E_o$$

$$E_o = V_r + E_{p2} + |E_{c1}|$$

as an approximation let $-|E_{c1}| = \mu_1 E_{p1}$, where $|E_{c1}|$ is the cut-off

$$E_o = V_r + E_{p2} + \frac{E_{p1}}{\mu_1}$$

(Continued on page 80)

PLUGS and JACKS

for every known application!

Built in accordance with latest Signal Corps and Navy specifications, Amalgamated Plugs and Jacks are tropicalized to make them fungus resistant, waterproof and moistureproof when called for. Insulators of these components are designed to withstand extremes of temperatures for -67°F to $+167^\circ\text{F}$, at humidities up to 100%. We also specialize in producing Plugs which will bear up under the high heat met in rubber molding cord sets.



NOTE: Amalgamated Engineers will gladly consult with you on the design and development of Plugs and Jacks for special applications—present or postwar.



PLUG PL-55 and N.A.F. 1136-1

Long sleeve, two-conductor plug, mate to Jack JK-34-A. Withstands minimum of 500 cycles AC, potential of 500 volts effective, applied between any two terminals for not less than two seconds. Meets minimum insulation value of 2000 megohms between conductors at 68°F at humidities up to 100%.



PLUG, STYLE "A"

Two-conductor, special type plug for use with Neoprene or Buna S molded cords. Same specifications as PL-55.



PLUG, STYLE "D"

Two-Conductor, special type plug for use with Neoprene or Buna S molded cords. Same specifications as PL-55.



PLUG PL-204

Hand set. A special plug wherein both a modified plug, PL-55 and PL-68, are held in place by a phenolic case. Same specifications as PL-55 and PL-68.



JACK JK-26, N.A.F. 215284-2

Two-conductor Jack, mate to PL-54. Tropicalized. Withstands 60 cycle AC potential of 500 volts effective, applied between any two terminals for not less than two seconds. Meets minimum insulation value of 2000 megohms between conductors at 68°F , at humidities up to 100%.



JACK JK-48

Light duty, two-conductor Jack, mate to Plug PL-291 and Plug 291-A.



PLUG PL-54, PL-540, PL-354, N.A.F. 215285-2

Short sleeve, two-conductor plug, mate to Jack JK-26. Same specifications as PL-55.

AMALGAMATED RADIO TELEVISION CORP.

476 BROADWAY • NEW YORK 13, N. Y.

Designed for

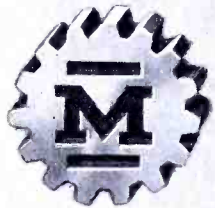

Application



THE NO. 80075 BEZEL FOR 5" CATHODE RAY TUBE

Another item in the Millen line of "Designed for Application" components. Bezel of cast aluminum with black wrinkle finish. Complete with neoprene cushion, green lucite filter scale and four "behind the panel" thumb screws for quick detachment from panel when inserting tube. Mounts in 5" diameter panel hole.

JAMES MILLEN MFG. CO., INC.

MAIN OFFICE AND FACTORY
MALDEN MASSACHUSETTS

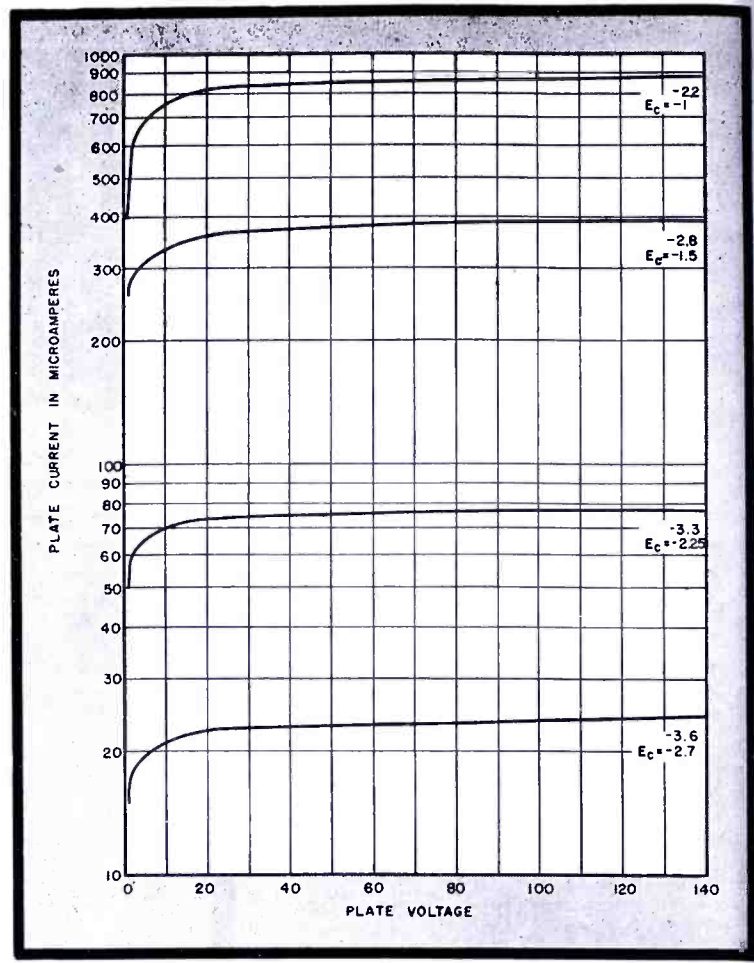

Figure 9
Plate family characteristics of 6SJ7 at low values of plate current; $E_s = 100$ v, $E_s = 50$ v.

VOLTAGE-REGULATED POWER SUPPLIES

(Continued from page 79)

$$E_o = V_r + E_{p2} + \frac{(E_1 - E_o)}{\mu_1}$$

$$\mu_1 E_o = \mu_1 (V_r + E_{p2}) + E_1 - E_o$$

$$E_o = \frac{\mu_1 (V_r + E_{p2}) + E_1}{\mu_1 + 1}$$

The approximation $E_{c1} = \frac{E_{p1}}{\mu}$ introduces an error, but since E_{c1} is small compared to $V_r + E_{p2}$, it will be negligible, especially when we consider that operation near the minimum output voltage is unstable.

Full Range Regulated Power Supply

Frequently, electronic - regulated power supplies, variable from zero to maximum output voltage and well regulated over the entire range, are required. Such a circuit is shown in Figure 7. Two separate supplies are needed; one for the actual output voltage, and one to supply a bias voltage below ground to the passing tube. Fundamentally the preceding analysis can also be applied for this type of full range supply.

In designing a voltage-stabilized supply capable of control from zero to the maximum output voltage, the following procedure can be applied:

Suppose E_o and I_o are the output

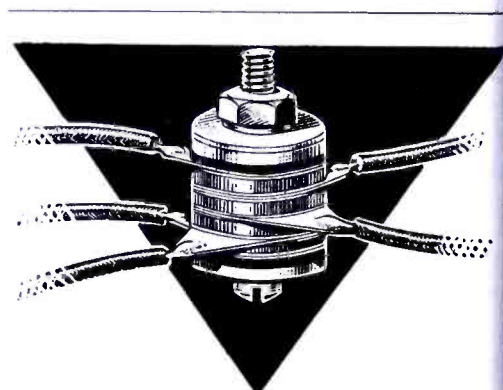

ELECTROX Low-Capacity RECTIFIERS

Full-wave and half-wave copper-oxide rectifiers for instruments, test-sets and similar applications. Supplied, since 1930, to leading manufacturers.



Write for illustrated Bulletin 446.

SCHAUER MACHINE COMPANY

2075 READING RD., CINCINNATI 2, O.

requirements. We have to determine the voltage across the passing tube, E_{p1} . (It has been found that a minimum voltage drop of approximately 100 volts across T_1 , when operating at maximum output voltage, is satisfactory.)

$$E_{p1} = E_1 - E_c$$

We then must determine E_{c1} to find the required potential drop across T_1 and T_2 . E_{c1} may be found from plate family of curves for T_1 .

Calculating Maximum Gain

The required voltage drop across T_1 (E_{c1}) is equal to $E_{p1} + |E_{c2}|$. To realize the maximum gain from T_1 it is necessary to choose the optimum value of R_L . This may be done by plotting a curve of amplifier gain versus load resistance (R_L), as shown in Figure 8, for the 6SJ7.

Having obtained R_L from the curve it is now necessary to determine I_{p1} (plate current through control tube).

$$I_{p1} = \frac{E_c}{R_L}$$

Operation of the control tube is over a flat portion of the plate voltage-plate current curves, and since the plate resistance is high, due to the low value of plate current, it is not necessary to know the value of plate voltage drop across the tube, since wide voltage variation produces little change in plate current. However, the grid voltage (E_{c2}) required to meet the initial specifications may be found from a family of plate characteristics plotted for low values of plate current, as shown in Figure 9 for the 6SJ7.

Solving for Ratio of R_1/R_2

Having obtained E_{c2} from the curve of Figure 9 we may solve for the ratio of R_1/R_2 after determining E_{c1} and E_{c2} .

$$E_c + E_{c2} = E_c + V_1 + V_2 \quad (1)$$

$$E_c = E_c + |E_{c2}| \quad \text{or} \quad E_c = V_2 - |E_{c2}| \quad (2)$$

Substituting 2 in 1

$$E_c = E_c + V_1 + |E_{c2}|$$

Having solved for E_{c2} , this value may be substituted in equation 1 and solve for E_{c1} :

$$E_c = E_c + V_1 + V_2 - E_{c2}$$

$$\frac{E_c + V_1 + V_2 - E_{c2}}{E_c + V_1 + E_{c2}} = \frac{E_1}{E_2} = \frac{R_1}{R_2}$$

[Further analysis data will appear in the coming installment in December, when design information will also be presented.]

FLAT Contacts

reduce noise, prolong service life



VARIATEN #1218

"T" Circuit—1½ db per step; 30 to 600 ohms impedance. Price, F.O.B. \$17.50

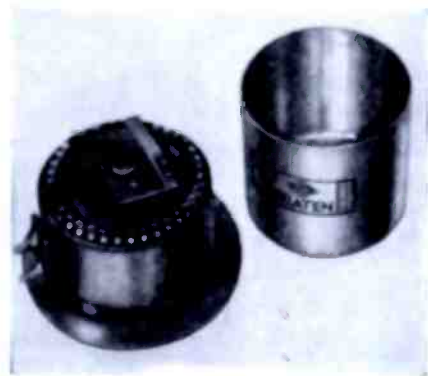

VARIATEN #1156

Ladder Circuit—1½ db per step; 30 to 600 ohms impedance. Price, F.O.B. \$12.50

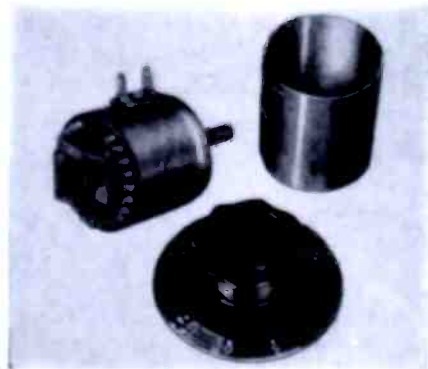

VARIATEN #1384

Ladder Circuit—2½ db per step; 30 to 600 ohms impedance. Price, F.O.B. \$7.50

VARIATEN contacts and brush surfaces make contact over their entire area because the contacts are ground flat and the brushes stone-lapped, *not* buffed. Buffing produces rounded surfaces and therefore a "point" contact highly susceptible to noise. Variaten brushes move from one contact to the next without rocking motion. The resulting perpendicular spring pressure at all positions allows us to take advantage of the natural resiliency of metals to provide a completely flat contact over the entire brush surface at all times and so reduce noise and lengthen service life.

No carbon resistors are used in any Variaten Mixer...

All are of stable, wire-wound construction. Most are step type. Where quiet operation is the major consideration, we recommend ladder type mixers because the circuit requires only one contact brush operation on the input side of the circuit and any possible brush noise is therefore attenuated along with the signal.

By all means compare circuits, construction and features of these mixers. From the hundreds of Variaten attenuators you may select the attenuators best adapted to your specific needs. Write for the Variaten Catalog today.



CINEMA ENGINEERING CO.
Established 1935 • Burbank • California

RADIO PARTS

ELECTRONIC

EQUIPMENT



FREE! CONCORD Victory Clearance Flyer

Ready now! 32 Bargain-packed pages listing thousands of standard-make, top-quality radio parts and electronic supplies—now available without priority at low VICTORY CLEARANCE prices. The values listed below are typical of the important savings offered in Meters, Condensers, Transformers, Resistors, Controls, Relays, Switches, Test Equipment, Generators, Microphones, Tools, and hundreds of Repair, Replacement, and Accessory Parts:

D.C. Milliammeters



2 1/2" flange mtg. type. Metal case dull black finish. G. E. 0-200 M.A. C10650 Specially Priced, \$4.95

Output Transformer



Hermetically sealed. Six studs. 1, 2, and 3 are pri. 4, 5, and 6 the sec. Pri. ind. at 5 V. 1000 cy. .20 H. Ratio: sec. to pri. 3.02:1. Size: 3 1/4 x 2 1/4 x 1/4" 5B5045 Your cost, \$1.95

Immediate Shipment from CHICAGO or ATLANTA

Huge stocks in two convenient warehouses—one in CHICAGO and one in ATLANTA—are ready to supply you quickly with needed parts of dependable nationally-known quality—and at VICTORY CLEARANCE prices that mean real savings. Mail the coupon below NOW for your FREE copy of CONCORD'S VICTORY CLEARANCE Flyer.

CONCORD RADIO CORPORATION

Lafayette Radio Corporation

CHICAGO 7, ILL. ATLANTA 3, GA.
901 W. Jackson Blvd. 265 Peachtree Street

CONCORD RADIO CORPORATION
901 W. Jackson Blvd.
Dept. R-115, Chicago 7, Ill.
Please RUSH FREE copy of
CONCORD'S new 32-page VICTORY
CLEARANCE Flyer.



Name.....
Address.....
City..... State.....

F-M RATIO DETECTORS

(Continued from page 42)

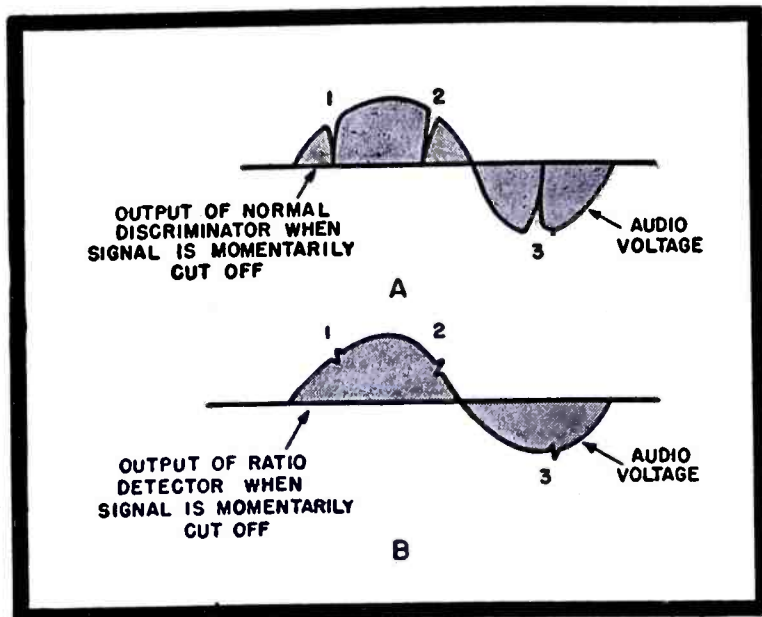

Figure 3
Oscillograms illustrating output of conventional discriminator, A, and ratio detector, B, under action of a momentary discontinuity in the input r-f signal.

Δf is the frequency deviation. Substituting equation 4 into equation 6, and rearranging terms, we get

$$A = \left(\frac{c \Delta f + K}{2} \right) \quad (7)$$

Since K is a constant, equation 7 shows that the a-c component of A is proportional to Δf under the condition of equation 4.

In Figure 1 we have the basic elements of the ratio detector. S_1 and S_2 are applied signals corresponding to the voltages a and b previously discussed. The output is taken between P and B . The battery fixes the value of the total voltage represented by $E_1 + E_2$, so that dependent on the conduction of diode 1 and diode 2 under the action of the instantaneous signal amplitudes, the proportionality between E_1 and E_2 will vary. The voltage E_2 corresponds to the voltage A discussed in the foregoing equations.

A typical ratio detector circuit where the output is taken out across the volume control, VC , appears in Figure 2. The voltage across the resistance R (shunted by C_4 , a high value electrolytic) is used to operate the avc in the receiver. C_4 tends to keep the voltage across R constant with variation in signal, thus serving as a battery to establish the value of the constant, K .

In Figure 3 appear oscillograms of the output voltage of a normal discriminator when the signal is momentarily cut off at the points 1, 2 and 3, compared to that of a ratio detector. In the normal discriminator the output voltage drops to zero, whereas in the ratio detector, only a small discontinuity in voltage takes place. Mr. Seeley said that this difference actually is not as noticeable to the ear as it is in the oscillograms.

Seventy-five microseconds of de-em-

phasis is obtained in the ratio detector by proper proportioning of the values of C_1 , C_2 and C_3 in conjunction with the dynamic impedances of the associated resonant circuits and diodes.

A discussion by Mr. Hutchinson of Columbia University disclosed that the de-emphasis will change with signal level. However Mr. Seeley pointed out that this was not noticeable in practice

PLASTIC RADIO DIALS combine the beauty of radiant color with the utility of perfect light transmission.

The possibilities of design, size, shape and color combination are limitless.

Whether your problem is dials, or any of hundreds of allied applications, let Hopp artists and engineers "sit in" on your designing problem.

Send us your blueprints or samples for quotation.

THE HOPP PRESS, INC.

PRINTING — FABRICATING — FORMING

460 W. 34th STREET, N. Y. C.

ESTABLISHED 1893

since the AVC is effective in keeping the signal level substantially constant.

It was necessary in the course of development of the ratio detector to obtain curves of variation in output versus amplitude modulation. A set of such curves appears in Figure 4.

These curves were obtained in the following way:

(1). The solid curves were obtained with a-f modulation on the signal, so that when the diodes stop conducting, the condensers C_1 and C_2 keep the output level constant, preventing the momentary discontinuity in the region where the signal voltage becomes too low to cause current to flow in diodes against the fixed applied bias. (2) Dotted curves were obtained by static measurements. It can be seen that even with zero frequency deviation, curvature of the characteristic took place resulting in residual amplitude modulation in the output. It should also be noted that for high levels of signal, all the curves tend to converge. It was found that the distortion of the amplitude curves, especially the zero curve, was caused by harmonic distortion being introduced by the i-f amplifiers. This was removed by degenerating the second harmonic in the cathode circuit of the last i-f stage. Although this reduced the zero-deviation-curve to a straight line, it was found that the high amplitude signals still caused all of the output curves to converge.

Eliminating Harmonic Distortion

A circuit wherein full wave detection was applied for both sides of the detector network is shown in Figure 5. This eliminated the effect of harmonic distortion and straightened out all of the curves of Figure 4. However, it was still found that at high signal levels, the curves converged. To eliminate this defect, the regulation of the voltage network $R-C_4$ (controlling the sum of the diode voltages) was decreased by the insertion of a small resistance in series with C_4 . This allowed compensating currents to flow through the diodes, causing a step-up in the recti-

(Continued on page 84)

Figure 4

Curves of output voltage variation versus input signal level for ratio detector.

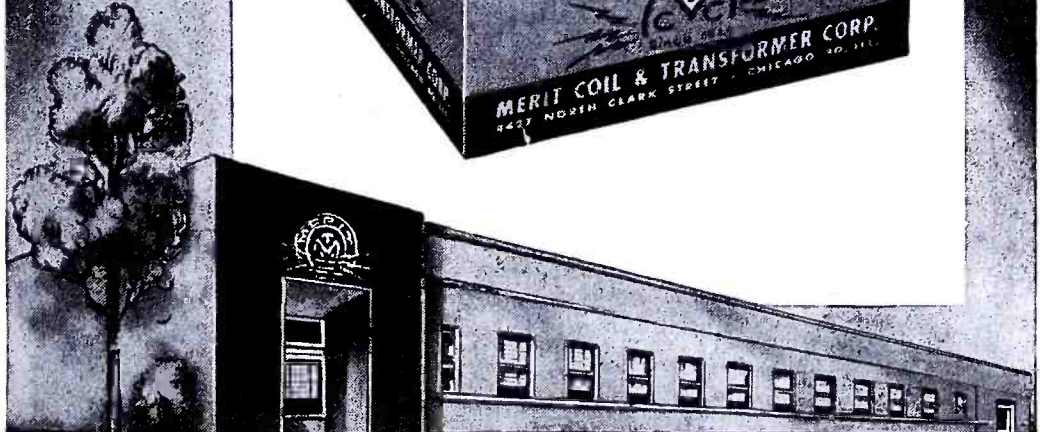
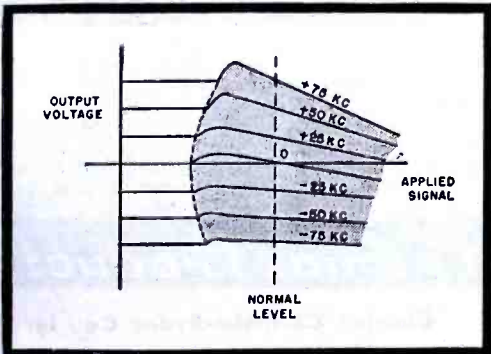

MERIT COIL & TRANSFORMER CORP.

4427 North Clark St. Telephone Long Beach 6311 CHICAGO 40, ILL.

DC
means
SC

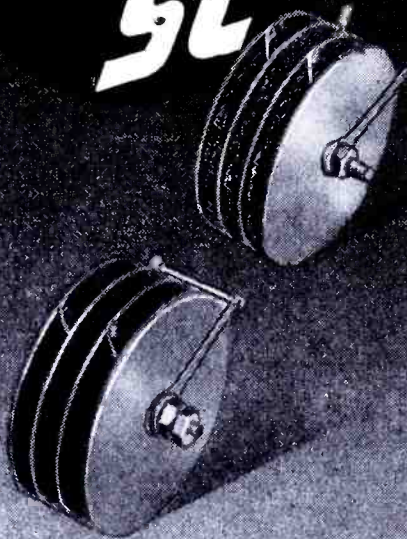

DC means SC... Selenium Conversion and Selenium Control. SC Type "K" Selenium Rectifier is especially designed to pass the 100-hour salt spray test at 50° Centigrade. Again proving that DC means SC...Selenium Conversion and Selenium Control. If you use DC ... get the facts on SC.

SEND FOR BULLETIN

SELENIUM CORPORATION of AMERICA



1719 WEST PICO BOULEVARD
LOS ANGELES 15, CALIFORNIA

EXPORT DIVISION: FRAZAR & HANSEN
301 CLAY STREET, SAN FRANCISCO, CALIFORNIA

IN CANADA: BURLUC LTD., TORONTO 13, ONTARIO, CANADA

F-M RATIO DETECTORS

(Continued from page 83)

fied output when the signal amplitude was high, and thus straightening the amplitude variation curves.

Mr. Seeley disclosed that in the receiver using this system the primary to secondary coupling of the transformer was made very tight, and the effective operating Q s were low because of the loading contributed by the diodes. He also pointed out that good circuit balance is necessary, since the circuit cannot be balanced by peaking the amplitude response curves as in the case of the normal discriminator. Mr. Seeley also indicated that the ratio detector is somewhat harder to align for linear conversion.

Figure 5

Full-wave detection system that eliminated the effect of harmonic distortion.

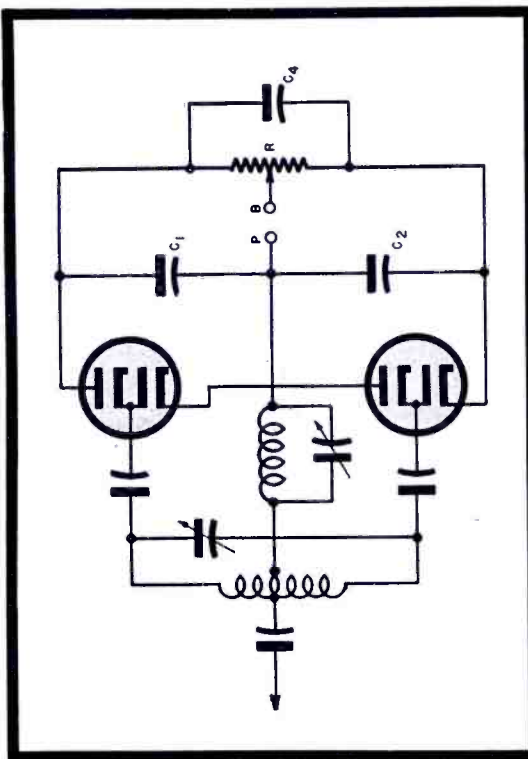

LONG-LIFE RADAR TUBE

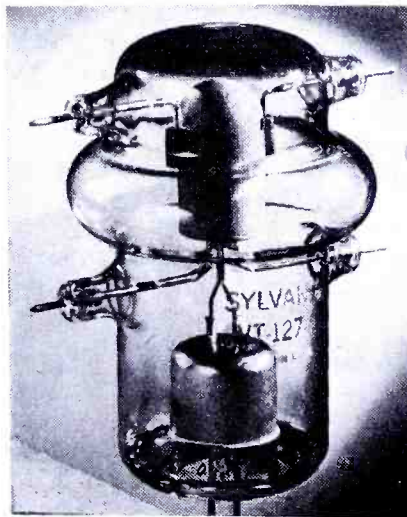

The VT-127-A radar tube produced by Sylvania that is said to have a 10,000-hour life.



WAXES AND COMPOUNDS

FOR INSULATING and WATERPROOFING of ELECTRICAL and RADIO COMPONENTS

Also for CONTAINERS and PAPER IMPREGNATION

FUNGUS RESISTANT WAXES

ZOPHAR WAXES and COMPOUNDS MEET ALL ARMY AND NAVY SPECIFICATIONS
Inquiries Invited

ZOPHAR MILLS, INC.
(FOUNDED 1846)
120 - 26th ST., BROOKLYN, N. Y.



ANTENNAS

For Police and other Mobile Units



If you have an Antenna job on a mobile unit... one that requires a sturdy "whip" type or a vertical antenna... Premax can help you.

Premax Antennas have been developed and proven in the armed services and meet ready acceptance by municipalities, emergency and public utility units. Write for details, or consult your jobber.

Premax Products

Division Chisholm-Ryder Co., Inc.
4610 Highland Avenue, Niagara Falls, N. Y.

PULSE-TIME MODULATION

(Continued from page 50)

bandwidth is primarily determined by the build-up time of the pulses and not by the number of pulses used. For example, if the r-f bandwidth is assumed to be 3 mc, then the number of channels may be anything from 1 to 150 for signal frequencies up to 3,000 cps. It is true that for the same 3-mc bandwidth, in consideration of certain reasonable assumptions, the number of possible amplitude modulation and frequency-modulation channels would be 750 and 350 respectively,¹ but no economic or technical reasons exist for such intensive channel division. Utilizing frequency division as required for a-m or f-m multiplexing requires complicated filters and other components in the terminal equipment, whereas pulse-time modulation with time-division multiplexing accomplishes the same thing with less equipment (and hence the possibility of more channels on a more economical basis) and with equipment inherently simpler and more reliable.

With regard to signal-to-noise ratio and system linearity, it should be pointed out that the only kind of disturbance capable of producing noise or non-linearity in this system is a disturbance which tends to distort the time phase pattern of the emitted pulses. Thus a noise pulse slightly preceding or following the channel pulse effects a disturbance not because of any change in the pulse amplitude but because it may alter the time phase of the front or tail of the channel pulse. This effect can be greatly minimized in reception by limiting both top and bottom of the transmitted pulse in the receiver, resulting in signal-to-noise

(Continued on page 86)

View of microwave pulse-time antennas atop New York Telephone Building.



¹E. M. Deloraine & E. Labin, *Pulse Time Modulation*, Electrical Communication: Volume 12, No. 2.



FIRST AWARD . . . JUNE 23, 1944

FIRST RENEWAL WITH STAR . . . DEC. 16, 1944

SECOND RENEWAL WITH STAR . . . MAY 26, 1945

IMMEDIATE DELIVERY

METAL CHASSIS, CABINETS
TERMINAL BOARDS
AND STAMPINGS

To Your Specifications

A complete, expertly-manned tool and die shop enables Insuline to give almost immediate delivery on anything a manufacturer might require... from a lug to a gigantic transmitting cabinet... in quantities and to specifications.

The rest of the Insuline plant is equally well equipped to serve the nation's manufacturers. Batteries of high-production machinery are available to turn out such items as chassis, metal boxes, cabinets, terminal boards, and special stampings of all kinds.

Moreover Insuline can produce the item you require from beginning to end, all within the walls of the Insuline plant.

If you have a production problem, an Insuline Engineer will be glad to discuss it with you. If you prefer, send your specifications and we will send an accurate estimate by return mail.



insuline

CORPORATION OF AMERICA

QUALITY PRODUCTS SINCE 1921

INSULINE BUILDING • LONG ISLAND CITY, N. Y.

POSTWAR RADIO TRANSFORMERS

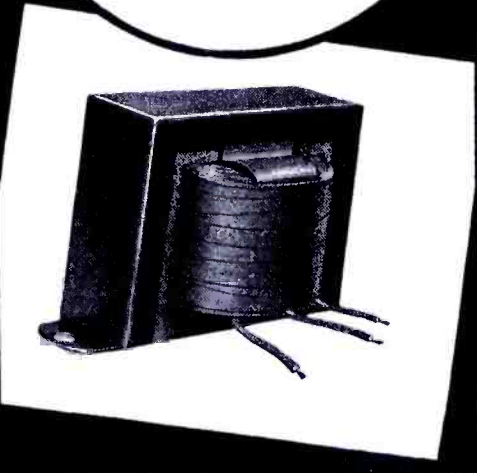
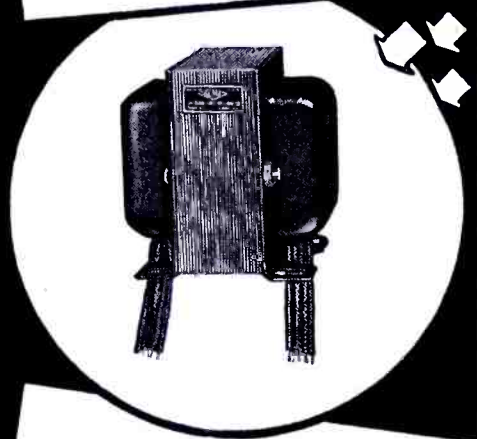
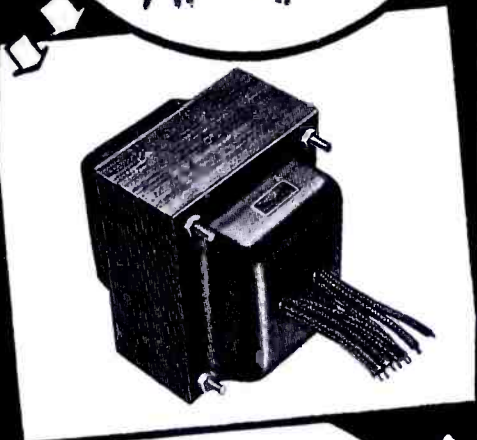
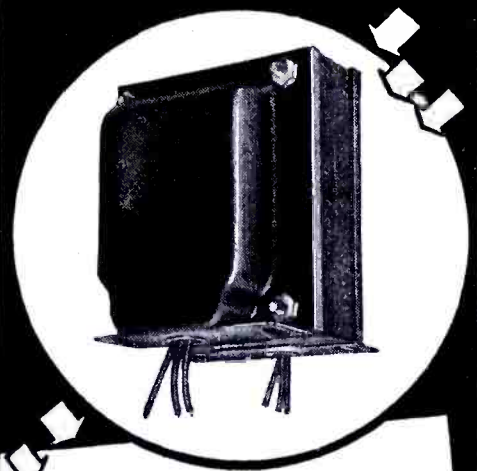

THE ACME ELECTRIC & MFG. CO.
CUBA, N. Y.

Acme  Electric

PULSE-TIME MODULATION

(Continued from page 85)

relationships similar to those obtained for f-m.

The requirement of bandwidths of the order of several megacycles naturally demands that the carrier frequencies be in the very high or superhigh frequency regions. At the same time the requirement of highly directional, but physically simple antenna structures for relay station chains, again demands high carrier frequencies. It is interesting to note, therefore, that this development makes many points of contact with the concepts and techniques of both radar and television.

Bell Telephone Demonstration

The New York City demonstration of Bell Telephone Labs using the AN/TRC-6 revealed the numerous service facilities available with a pulse-time system. In the tests the sets were used in pairs, with the antennas seeing each other over a line-of-sight path. In the first part of the demonstration, one pair of sets was used, the terminals being New York City and Neshanic, N. J., some 40 miles away. Six of the available channels were used for telephone conversations between twelve guests, six at each end. Of the remaining two channels, one carried a daily weather map by Army facsimile and the other carried eighteen simultaneous teletype messages. Two more pairs of sets were then operated with the receiver of the first patched to the transmitter of the second and the receiver of the second patched to the transmitter of third, so that eight channels were provided over an equivalent distance of 200 miles. Then seven receive-transmit channels were cross-patched in the three pairs of sets, providing a single two-way channel over an equivalent path of 1,400 miles. Finally the two-way channel was itself cross-patched to provide a one-way circuit originating and ending in New York City over an equivalent path of 2,800 miles. The speech quality and noise observed in the latter demonstrations seemed equal to or better than local landline conditions.

Microwave pulse-time relay tower of the wartime Wiesbaden-Augsburg circuit.

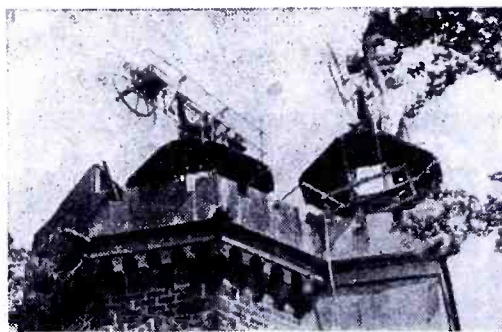

Receiving and transmitting antennas for 1200-mc pulse system atop I. T. & T. Building in New York City.

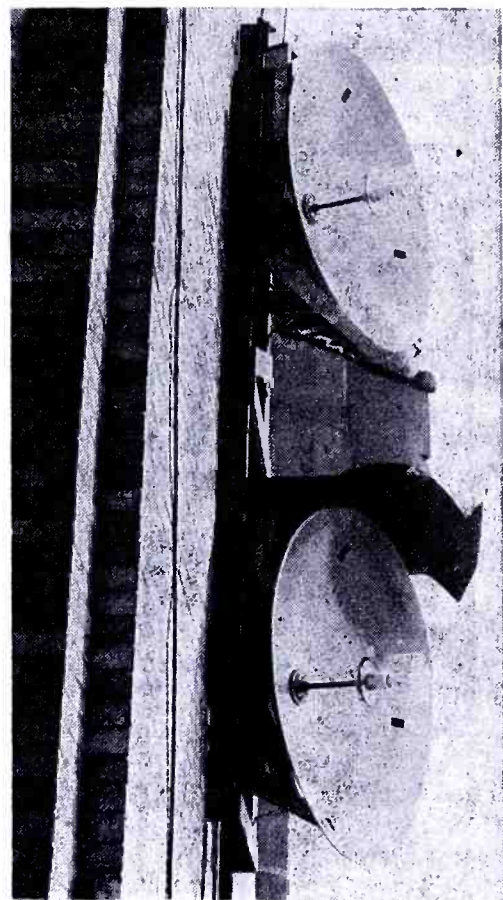

Permanent MAGNETS

By

Thomas & Skinner

ALL SHAPES... ALL SIZES
Cobalt • Chrome • Tungsten
Stamped, Formed or Cast.

ALNICO

(Cast or Sintered)

Also: LAMINATIONS for output transformers of highest permeability. Standard stocks in a wide range of sizes for Audio, Choke, Output and Power Transformers. Write for dimension sheet. . . . TOOLS DIES STAMPINGS HEAT TREATING.
44 YEARS' SPECIALIZED EXPERIENCE

Thomas & Skinner

STEEL PRODUCTS CO.

1113 E. 23rd St., Indianapolis 5, Ind.

H-F JACKETING MATERIALS

(Continued from page 40)

revealed that the lines were not stable with age, particularly when heated at elevated temperatures (85°C and above). The electrical properties, especially attenuation, deteriorated. Investigation of this phenomenon revealed that contamination of the polyethylene primary insulation was occurring due to the migration of the plasticizers from the vinyl jackets, causing a marked rise in power factor. To obtain a non-contaminating jacket material it was necessary to investigate several scores of plasticizers and it was found that for one reason or another all except one of the materials tried were unsatisfactory.

The plasticizer which has exhibited the most favorable characteristics is a resinous polyester developed by the Resinous Products Corporation of Philadelphia. This material differs from the usual run of plasticizers for vinyl chloride or vinyl chloracetate in that it is not a solvent-type material and requires very careful handling during manufacture of the jacket compound if the best properties are to be developed.

New Jacketing Materials

Commercially available jacketing materials containing this new plasticizer have been produced by our company as IN-102, Bakelite Corporation (VE 3004), B. F. Goodrich (8070) and General Electric. Table II shows the average properties of such compounds and indicates that they have good overall mechanical properties. At the present moment, however, the low temperature flexing properties are not as good as might be desired. However, cables jacketed with this material, when properly manufactured and extruded, can be flexed at -30°C to -35°C using the standard Navy test. Tests run at our laboratories revealed that despite heating at 100°C for periods up to 1440 hours, this jacket had no effect on the power factor of the polyethylene. A cable jacketed with this material, heated and flexed for a period totaling 927 hours with the attenuation measured after each test, showed that the transmission line maintained an almost constant attenuation.

The development of this new jacketing composition makes possible transmission lines having electrical stability hitherto impossible to attain.



No. 5 of a Series

MODERN COIL WINDINGS

Partial View of Assembly Department

For many months, COTO-COIL facilities have been employed in producing wartime essentials. Now, as we have so long hoped, our entire plant can be devoted to peacetime industry.

Our 28 years of experience are at your service to help you with modern coil design and construction.

COTO-COIL CO., INC.

COIL SPECIALISTS SINCE 1917

65 PAVILION AVE.

PROVIDENCE 5, R. I.

HARVEY

now has for delivery
long awaited

PRESTO PRODUCTS

As the supply situation relaxes, HARVEY can supply more and more famous radio and electronic components and equipment, such as the dependable Presto recorder and transcription playback described below. Avail yourself of our rapidly growing stocks, our fast, efficient service, our technical know-how! Get the equipment you need now by placing your order promptly.

PRESTO Model "K" RECORDER

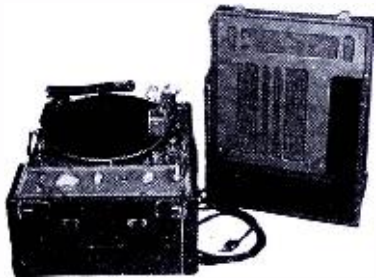

A portable sound recorder, record player and public address system. Complete in a single carrying case.

The Model "K" records 15 minutes continuously at 33 1/3 RPM on side of 13 1/4" disc. It also makes 6, 8, 10, and 12 inch records, and plays all makes of phonograph records. With its many exclusive features found in no other low priced recorder, the user is able to make high quality recordings consistently, reducing spoilage cost of discs and needles. As a voice amplifying system, it serves audiences of about 500 persons.

PRESTO Model "L" TRANSCRIPTION PLAYBACK



For those who demand "something better" in portable reproducing equipment. Small, light weight, easy to operate.

Its extreme simplicity and remarkably clear, wide range reproduction have made the Model "L" a favorite of radio stations, advertising agencies and program producers. It consists of a 12" dual speed rim-driven recording turntable, a 16" pickup on a swivel mounting which folds into the case when not in use, a 4 1/2 watt amplifier and an 8" loudspeaker, mounted in a single case. The speaker mounted in the case cover is equipped with a 20' extension cable. Semi-permanent needle supplied as initial equipment.

Telephone Orders to LO 3-1800

NEWS BRIEFS

FCC ENG. DEPT. TO HAVE LAB. DIV.

A laboratory division has been incorporated within the FCC engineering department to study the civilian uses of radar as they affect frequency allocations. The division will also conduct wave propagation and allocation studies, develop monitoring equipment, test all types of transmitters for type approval, and test diathermy and industrial heating equipment.

Charles A. Ellert will be chief of the new section. He was formerly technical supervisor of the radio intelligence division (RID). William K. Roberts, engineer-in-charge of the Laurel (Md.) laboratory of the field division of the engineering department, will be assistant chief.

Need for the new section became evident during the recent f-m hearings when all forms of wave propagation data were required to determine allocations.

* * *

RAYTHEON, BENDIX, YELLOW CAB, HIGHWAY RADIO AND INTERCITY BUS RECEIVE MOBILE SERVICE PERMITS

Class II experimental service construction permits to develop radio communication systems in the proposed general mobile radio service have been granted to Raytheon, Bendix, Yellow Cab Co. of Cleveland, Highway Radio, and Intercity Bus Radio.

Raytheon Manufacturing Company was granted 10 applications for experimental stations, to be located in New York City, N. Y., Boston, Mass., Chicago, Ill., and Los Angeles, Calif., with one portable-mobile unit to be used in conjunction with each land station. Experiments with stations operating in both the proposed highway mobile and urban mobile services will be undertaken in New York City. In the other locations experiments will be confined to proposed urban mobile service. Three types of communications (narrow channel selective-code paging and indicating signal systems; two-way voice transmission; and record transmission by facsimile or printer) are to be investigated.

Bendix Aviation Corp., Pacific division, was granted temporary authority to construct 12 portable and portable mobile experimental stations to be installed at various locations, to be determined by test, between Los Angeles and Fresno, Calif., or on trucks or buses operating in this region. Systems for highway transportation companies will be studied.

The Yellow Cab Company of Cleveland, Inc., was granted construction permits for one land station and 10 portable mobile units. The land station is to be located in Cleveland and the portable mobile units are to be installed in taxicabs operating in that city.

Highway Radio, Inc., has been granted permission to construct one land station and 100 portable mobile units to develop a radio communication system in the proposed highway mobile service. The land station will be located in Chicago, Ill., and the portable mobile units will be installed on trucks operating in the vicinity of the Chicago area.

Intercity Bus Radio, Inc., has also been granted permission to build one land station and 100 portable mobile units to develop a

AT RADIO PIONEER'S PARTY



Louis G. Pacent (left), general chairman of the Radio Pioneer's Party, recently held in N. Y. City, and Dr. William L. Everitt, president of the IRE, who acted as master of ceremonies.

highway mobile service. The land station will be located in Chicago, Ill., and the portable mobile units are to be installed on passenger carrying buses operating in the vicinity of Chicago, Ill.

* * *

TWENTY-TWO COMPANIES JOIN RMA

Twenty-two more companies have been admitted to RMA membership, bringing the membership to a new high of 273.

The new RMA members include: American Transformer Co., Newark, N. J.; De Mornay-Budd, Inc., New York, N. Y.; Eastern Electronics Corp., New Haven, Conn.; Franklin Photographic Industries, Chicago, Ill.; Hartford Industries, Inc., Jackson Heights, N. Y. C. N. Y.; Hazeltine Electronics Corp., New York, N. Y.; Industrial Electronic Corp., Brooklyn, N. Y.; Lewis Electronics, Los Gatos, Calif.; Modern Electronic Co., Inc., New York, N. Y.; National Design Service, New York, N. Y.; National Moldite Co., Hillside, N. J.; Noma Electric Corp., New York, N. Y.; Peerless Electrical Products Co., Los Angeles, Calif.; Radio Receptor Co., Inc., New York, N. Y.; Rayenergy Radio & Television Corp., New York, N. Y.; Regal Electronics Corp., New York, N. Y.; Stamford Electric Products, Inc., Stamford, Conn.; Symphonic Radio & Electronic Corp., Cambridge, Mass.; United States Trunk Co., Inc., Fall River, Mass.; Waters Conley Co., Rochester, Minn.; Wilmak Corp., Benton Harbor, Mich.; and The Workshop Associates, Newton Highlands, Mass.

* * *

NELSON CASE BECOMES HALLICRAFTERS RECEIVER CHIEF ENGINEER

Nelson P. Case, former engineering director of Hamilton Radio, has been named chief en-

STATEMENT OF THE OWNERSHIP, MANAGEMENT, CIRCULATION, ETC., REQUIRED BY THE ACTS OF CONGRESS OF AUGUST 24, 1912, AND MARCH 3, 1933, OF COMMUNICATIONS

Published monthly at New York, N. Y., for October 1, 1945.

State of New York } ss.:
County of New York }

Before me, a Notary Public, in and for the State and county aforesaid, personally appeared B. S. Davis, who, having been duly sworn according to law, deposes and says that he is the Business Manager of COMMUNICATIONS, and that the following is, to the best of his knowledge and belief, a true statement of the ownership, management, etc., of the aforesaid publication for the date shown in the above caption, required by the Act of August 24, 1912, as amended by the Act of March 3, 1933, embodied in section 537, Postal Laws and Regulations, to wit: 1. That the names and addresses of the publisher, editor, managing editor, and business manager are: Publisher, Bryan Davis Publishing Co., Inc., 52 Vanderbilt Avenue, New York 17, N. Y.; Editor, Lewis Winner, New York, N. Y.; Managing Editor, None; Business Manager, B. S. Davis, Ghent, N. Y.; 2. That the owners are: Bryan Davis Publishing Co., Inc., 52 Vanderbilt Avenue, New York 17, N. Y.; B. S. Davis, Ghent, N. Y.; J. C. Munn, Union City, Pa.; A. B. Goodenough, Port Chester, N. Y.; P. S. Weil, Great Neck, N. Y.; F. Walen, Union City, N. J.; G. Weil, Great Neck, N. Y.; L. Winner, New York, N. Y. 3. That the known bondholders, mortgagees, and other security holders owning or holding 1 per cent or more of total amount of bonds, mortgages, or other securities, are: None. 4. That the two paragraphs next above, giving the names of the owners, stockholders and security holders, if any, contain not only the list of stockholders and security holders as they appear upon the books of the company, but also, in cases where the stockholder or security holder appears upon the books of the company as trustee or in any other fiduciary relation, the name of the person or corporation for whom such trustee is acting is given; also that the said two paragraphs contain statements embracing affiant's full knowledge and belief as to the circumstances and conditions under which stockholders and security holders who do not appear upon the books of the company as trustees, hold stock, and securities in a capacity other than that of a bona fide owner; and this affiant has no reason to believe that any other person, association, or corporation has any interest direct or indirect in the said stock, bonds, or other securities than as so stated by him.

(Signed) B. S. DAVIS, Business Manager.

Sworn to and subscribed before me, this 27th day of September, 1945.

(Seal) FRANKLIN B. GOULD, Notary Public.
Commission expires March, 1948.

Telephone Orders to LO 3-1800

HARVEY
RADIO COMPANY
HARVEY

103 WEST 43rd ST., NEW YORK 18, N. Y.

...ineer of the receiver division of the Halli-
crafters Company, Chicago.
Mr. Case will also participate in the engi-
neering activities of the Echophone home-
radio division of Hallicrafters.



**DOUGLAS, BENNETT AND CUTLER
JOIN HOFFMAN RADIO**

Walter D. Douglas, II, has been appointed
vice president in charge of procurement and
material control of Hoffman Radio Corp., Los
Angeles. He was formerly a lieutenant com-
mander, U.S.N.R.
Aubert E. Bennett, former Signal Corps
senior radio engineer has become a Hoffman
radio section engineer.
Stanley Cutler, formerly assistant chief en-
gineer of Air Associates, Inc., is now a radio
project engineer for Hoffman.

**RCA AND NEW ENGLAND TELEPHONE
COMPANY RECEIVE RELAY AND
MOBILE STATION PERMITS**

Eight class II experimental fixed station con-
struction permits to permit research and de-
velopment of practical automatic unattended
microwave radio relay lines of communica-
tion, have been granted to RCA Communica-
tions, Inc., by the FCC. Stations will be lo-
cated in New York City and Washington,
D. C., with intermediate points at New Brun-
swick, N. J., Arney's Mount, N. J., Philadel-
phia, Pa., Wilmington, Del., Havre de Grace,
Md., and Baltimore, Md.

The New York station will be located in the
Continental Bank Building, 30 Broad Street,
Philadelphia, at 1335 Walnut Street.

RCA composite type experimental equipment
will be used; 25 watts power; unlimited hours
of operation.

The New England Telephone and Telegraph
Company have also received class II experi-
mental construction permits for one land sta-
tion and 55 portable-mobile stations to study
urban mobile services. The applicant will de-
termine the extent to which a general public
message telephone and signalling type of ser-
vice for motor vehicles operating in Boston,
Mass. and vicinity can be developed, the ser-
vice requirements of various classes of users,
and technical factors involved in the provision
of such a service. Studies of coverage, suit-
ability of equipment, location of transmitter,
number and location of receivers required, and
other factors will be included in this experi-
ment.

The telephone company has indicated that
the proposed service should provide an effec-
tive means for assisting in the maintenance
and operation of its telephone network by pr-

(Continued on page 90)

RCA MICROWAVE RELAY TOWER

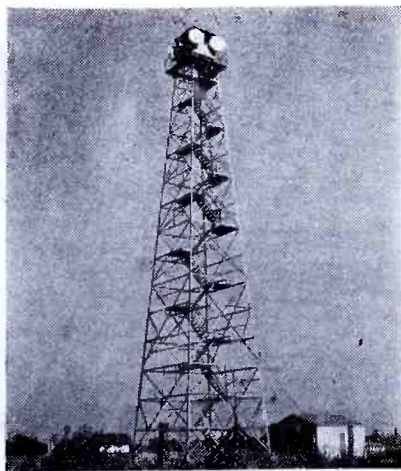

One of the 100' steel towers with reflector an-
tennas used by RCA in a microwave relay link
that Western Union proposes to adopt for their
system. A test circuit between Camden and New
York is now in operation on the 3900 to 4500-
mc band.



Which for You—
**SCREWDRIVER
or SLIDE RULE?**



Face the Facts:

**You Must Train Now to Step Ahead of Competition
Into A Good-Paying Job in Radio-Electronics**

*— or be left behind because you lack the
understanding of new electronic techniques*

*CREI home-study courses are for professional radio-
men only and this CREI message is for those who are
not afraid to face the facts! The bars are down on
radio-electronics progress! You are facing a completely
new era in the radio-electronics world. The war-
restricted curtains of secrecy have been pulled aside,
revealing each day momentous, revolutionary applica-
tions of new radio-electronic principles and theories,
and their complicated circuits, equipment, individual
parts, etc.*

*No matter what your past radio-electronics experi-
ence has been, no matter what your training, you must
start anew to add to your store of radio-electronics
knowledge. You must keep pace with the new de-
velopments and ahead of competition if you expect to
get ahead in this new world of radio-electronics—or
even maintain your present position in the field.*

*How much do you know about U.H.F. Circuits,
Cavity Resonators, Wave Guides, Klystron, Magnetron
and other tubes? All these revolve largely around
U.H.F. applications. And here is where CREI train-
ing can help you. In our proved home study course,
you learn not only how . . . but why! Easy-to-read-
and-understand lessons are provided well in advance,
and each student has his personal instructor who cor-
rects, criticizes and offers suggestions on each lesson
examination.*

*Let CREI train you now and trade that "screw-
driver" for a slide rule. Do something about increasing
your technical ability and advance to the better-paying
radio jobs that offer security and opportunity. The
facts are in the free booklet. Send for it today.*

**WRITE FOR
FREE 36-PAGE
BOOKLET**
*"Your
Opportunity in
the New World of
Electronics"*

If you have had pro-
fessional or amateur
radio experience and
want to make more
money, let us prove to
you we have something
you need to qualify for
a better radio job. To
help us intelligently
answer your inquiry—
PLEASE STATE
BRIEFLY YOUR
BACKGROUND OF
EXPERIENCE,
EDUCATION AND
PRESENT POSI-
TION.

CAPITOL RADIO ENGINEERING INSTITUTE

HOME STUDY COURSES IN PRACTICAL RADIO-ELECTRONICS
ENGINEERING FOR PROFESSIONAL SELF-IMPROVEMENT

Dept. CO-11, 3224—16th Street, N. W., Washington 10, D. C.

Contractors to U. S. Navy — U. S. Coast Guard — Canadian Broadcasting Corp.
Producers of Well-trained Technical Radiomen for Industry.

MEMBER: NATIONAL COUNCIL OF TECHNICAL SCHOOLS



THERMOSTATIC METAL TYPE
DELAY RELAYS
 PROVIDE DELAYS RANGING
 FROM 1 TO 120 SECONDS

Other important features include:—

1. Compensated for ambient temperature changes from -40° to 110° F.
2. Contact ratings up to 115V-10a AC.
3. Hermetically sealed — not affected by altitude, moisture or other climate changes . . . Explosion-proof.
4. Octal radio base for easy replacement.
5. Compact, light, rugged, inexpensive.
6. Circuits available: SPST Normally Open; SPST Normally Closed.

WHAT'S YOUR PROBLEM? Send for "Special Problem Sheet" and Descriptive Bulletin.

AMPERITE CO. 561 BROADWAY
 NEW YORK 12, N. Y.
 In Canada: Atlas Radio Corp., Ltd.
 560 King St. W., Toronto

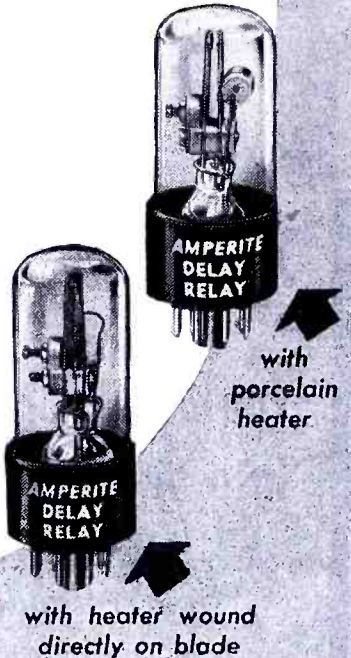

NEWS BRIEFS

(Continued from page 89)

viding direct communications between repair men or construction crews and the supervisor forces at all times. The service will also be available to ships operating the Boston Harbor, Massachusetts Bay, Cape Cod Bay and nearby portions of the Atlantic Ocean, supplementing present service available through coastal harbor stations.

A 250-watt land station will be located at 6 Bowdoin Square, Boston, and will be operated on 156.53 mc on a temporary basis. Special authority was granted to operate by remote control with the licensed operator located at 125 Milk Street, one-half mile from the transmitter. The portable-mobile station, 15 watts, were assigned 157.43 mc on a temporary basis, and will be located on land vehicles and harbor craft in the vicinity of Boston.

R. L. TRIPLETT BECOMES V. P. OF J-B-

R. L. Triplett, president of the Triplett Electrical Instrument Co., has been elected first vice president of J-B-T Instruments, Inc., 4 Chapel St., New Haven 8, Conn. Phillip Stevens has been named vice president, in charge of sales and public relations, and Ericson has become assistant treasurer. Mr. Triplett is also a member of the J-B board of directors.



R. L. Triplett . . . P. Stevens

RAYTHEON OFFICERS NAMED

Laurence K. Marshall, president of Raytheon Manufacturing Co., has been elected president of Raytheon's subsidiary, Belmont Radio Corp. Harold C. Mattes, one of the founders and chief executives of Belmont, has been named executive vice president, in charge of all phases of the subsidiary's activities. Three new vice presidents were elected: Charles M. Hofman in charge of sales, advanced from contract sales manager, replacing Sigmund Freshman who for the past 15 years has served as director and general sales manager of Belmont and who is retiring from active business January 1, 1946; Carl J. Hollatz, formerly general manager of the Ken-Rad tube division of G. I. in charge of receiving tube division; and William L. Dunn, in charge of engineering and research.

The board of directors of Belmont is composed of Laurence K. Marshall, William Gammell, Jr., Ralph D. Booth and David

BUS COMMUNICATIONS SYSTEM

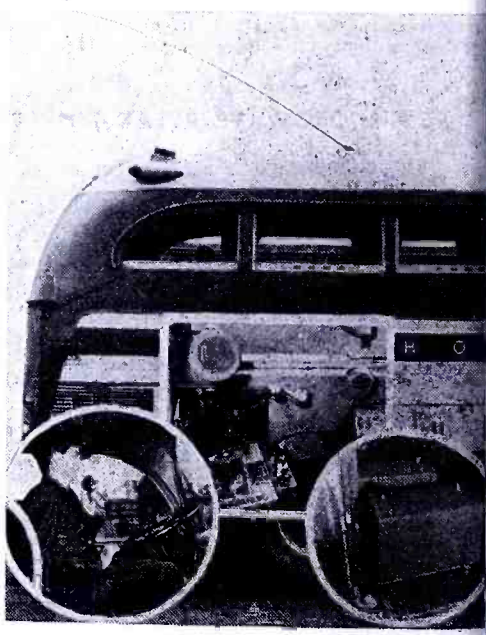

Bus of Greyhound Bus Lines, Chicago, with recently installed radio system. In the center is the complete installation in the driver's compartment, with the microphone hung on a clip attached to the side of the car.

(Courtesy Motorola)

Specialists in Special Crystals



100 KC FREQUENCY STANDARD CRYSTAL

... Designed to withstand severe shock and vibration. A crystal so precisely finished that it has less than 15 cycles drift from -50° C to $+85^{\circ}$ C*. (If oscillator or circuit is furnished, an accuracy of 3-5 cycles can be obtained)

A special solder bead supports a tensile load of 9,000 lbs. per square inch. Crystalab engineered to meet the most rigid operating requirements.

*Also available in frequencies from 80.86 to 200 KC.

Write Dept. R.M. for comprehensive catalogue "Selectronic Crystals" and facilities booklet "Crystalab Solves a Problem"



Yankee Ingenuity makes us

SPECIALISTS IN SPECIAL CRYSTALS

CRYSTAL RESEARCH LABORATORIES

INCORPORATED
 LABORATORIES AND MAIN OFFICE: 29 ALLYN STREET, HARTFORD 3, CONN
 New York Office: 15 E. 26th Street, New York 10, N. Y. Phone MU 5 2952

ultz of Raytheon's executive committee, in addition, Harold C. Mattes and Charles Hofman. Arnel S. Billings, former president of Bell, has retired as president and director of Bell and as director of Raytheon.

MAGUIRE INDUSTRIES BUY RADIART

Radiart Corporation, Cleveland, has been bought by Maguire Industries, Inc. All common and preferred stock has been purchased from Leslie K. Wildberg and William H. Lamar, and the corporation will be operated as a wholly owned Maguire subsidiary.

SYLVANIA PLANTS WIN THIRD "E" STARS

Three Massachusetts plants of Sylvania Electric Products, Inc., at Boston Street and Irving Street in Salem and at Danvers, were recently awarded a third star for their Army "E" flags.

C. SPOOR APPOINTED EICOR REGIONAL DIRECTOR

C. Spoor has been appointed director of operations of Eicor, Inc., Chicago, Ill. Mr. Spoor was formerly in the small motor division of G. E. in charge of sales policy.



W. BENNETT JOINS SHAPPE-WILKES

W. Bennett has joined the staff of Shappe-Wilkes, Inc., 215 Fourth Avenue, New York City. He will serve as technical adviser on geographic and radio subjects and will prepare articles.

FCC TO ISSUE RADAR NAVIGATIONAL LICENSES

A limited number of experimental licenses for the operation of radar navigational devices are to be issued by the FCC, under a new policy recently issued. Authorization will be made only for experimental class II stations. Radar station licenses have been issued as of late except for certain experimental licenses under which these devices were developed in conjunction with wartime activities of the Government. In the final FCC report concerning the allocation of frequencies above 25,000 kc, several bands were designated as available for radio navigation. These bands are subject to change or modification as may subsequently be made to conform to any frequency allocation as the result of the next World Communications Conference. In view of the present status of the available bands and

(Continued on page 92)

20-YEAR SERVICE AWARD



B. Macartney (left), vice president in charge of sales of the Hammarlund Manufacturing Co., receiving the Hammarlund 20-year gold award from Lloyd A. Hammarlund, president of the company.



New FOLDED UNIPOLE ANTENNA

Another Example of ANDREW Ingenuity in Engineering

Concentrating on electrical performance, Andrew engineers have designed a unique Folded Unipole Antenna which—according to comparative tests—easily outperforms other antennas at several times the price.

Used for transmitting and receiving at frequencies from 30 to 40 MC and for powers up to 5,000 watts, this antenna has proved so successful that similar models for higher frequencies are now being designed.

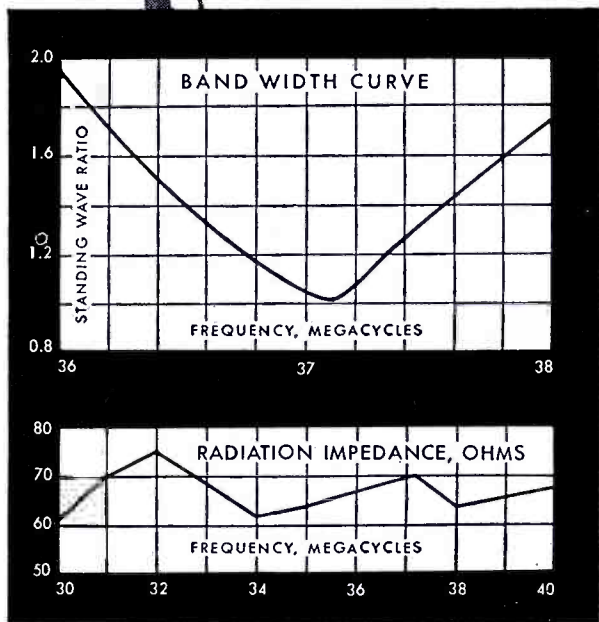

FEATURES:

- Light weight — only 15 pounds — simplifies installation.
- Lightning hazard minimized by grounded vertical element.
- "Slide trombone" calibration permits exact adjustment for any frequency between 30 and 40 MC, using only a wrench. Optimum performance for that frequency is guaranteed without "cut and try" methods.
- Proper termination of coaxial transmission line. Unlike other "70-ohm" antennas, the Folded Unipole actually provides a non-reactive impedance with a resistive component varying between 62 and 75 ohms (see lower curve).
- Excellent band width, ideal for FM (see upper curve).

Andrew Co. specializes in the solution of antenna problems. For designing, engineering and building of antenna equipment, consult Andrew Co.

ANDREW CO.
 363 EAST 75th ST., CHICAGO 19, ILL.
 WRITE FOR FULL INFORMATION

Check the Quality Features of the Drake No. 500 Series

- ✓ Time tested—Millions have been used since March 1940!
- ✓ Available in any quantity with any type of bracket.
- ✓ Sturdy Bakelite Molded insulating casting shields socket from outside contact.
- ✓ Center contact lead wire mechanically secured before soldering.
- ✓ Both lead wires withstand over 25 lbs. tension.
- ✓ Rounded eyelet edges prevent cut or frayed lead wire insulation.
- ✓ 1000 volts minimum breakdown voltage between contacts and to ground.
- ✓ Casting mechanically secured to bracket—can't turn.
- ✓ Socket mechanically secured within casting—can't turn or be pulled out.
- ✓ Center contact secured within socket—contact won't protrude when lamp is removed.

Consider this better underwriters' approved DRAKE dial light assembly for your production requirements. Lead wire 2 3/4 in. to 4 ft. Prompt shipment in any quantity assured. May we send samples or our newest catalog.



SOCKET AND JEWEL LIGHT ASSEMBLIES

DRAKE MANUFACTURING CO.

1713 WEST HUBBARD ST., CHICAGO 22, U.S.A.

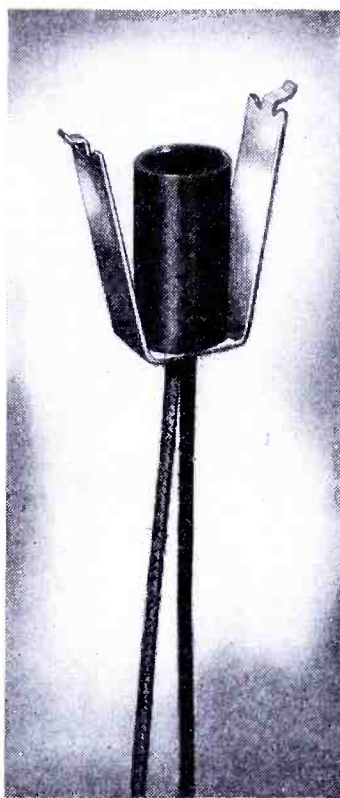

The NO. 527F TYPE

NEWS BRIEFS

(Continued from page 91)

the limited information available no channels have been specifically allocated for radar stations. Nor have rules and regulations yet been promulgated for the installation, operation and licensing of such stations.

MAJOR M. H. WORK SUCCEEDS COL. T. H. A. LEWIS AT AFRS

Colonel Thomas H. A. Lewis, commandant of the Armed Forces Radio Service, a combined operation of the War and Navy departments, is being relieved from active duty. He will be succeeded by Major Martin H. Work.

Major Work has served as AFRS executive officer. The AFRS offices are at 6011 Santa Monica Boulevard, Los Angeles 38, California.

AIREON NAMES NEW OFFICERS

Kenneth D. Halleck, Washington sales representative (1108 16th Street, N.W.) the past two years for the Aireon Manufacturing corporation has been elected to the board of directors.

A. E. Welch, formerly vice president and treasurer, has been appointed executive vice president and treasurer of the corporation and of its wholly owned subsidiaries.

Jack Kaufman who recently was named head of the San Francisco office, has been elected a vice president of Aireon.

R. R. Greenbaum has been elected an Aireon vice president and will be in charge of the automatic phonograph division.

HOWARD DOOLITTLE JOINS MACHLETT

Dr. Howard Doolittle, formerly of Radiation Laboratories, has joined the engineering staff of Machlett Laboratories, Springdale and Norwalk, Connecticut. Dr. Doolittle will be in charge of high-frequency research and development.



DU MONT TELEVISION TUBE BULLETIN

A bulletin, *DuMont Cathode-Ray Tubes for Television*, has been issued by Allen B. DuMont Laboratories, Inc., Passaic, N. J. Illustrated and described are 5", 7", 10", 12" and 20" tubes of both the electrostatic and the magnetic deflection designs.

B. G. TWYMAN BECOMES ELECTRONIC LABS. REPRESENTATIVE

B. G. Twyman and Associates have been appointed distributors for Illinois and eastern Missouri, outside of the metropolitan districts

GERMAN COPY OF HRO

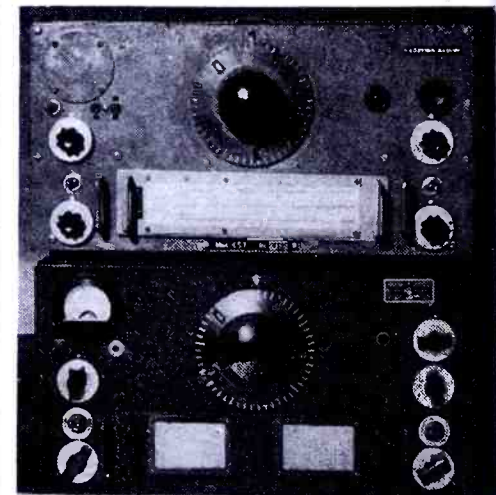

Recently captured German communications receiver (top) whose electrical and physical features were found to be practically identical to those of the National Company HRO receiver. The German model, made by Korting-Radio, used three sets of coils for 3 to 24 mc.

of Chicago and St. Louis by Electronic Laboratories, Inc., Indianapolis, Indiana. The territory of A. E. Rodman, west coast representative, has been increased to include Nevada and Oregon.

BENDIX RECEIVES ARMOUR WIRE RECORDER LICENSE

Bendix Aviation Corporation has received an Armour magnetic wire sound recorder license for receiver and commercial applications.

Bendix is planning to produce wire-record business dictating machines; adaptor units for use with existing home radios; portable, self-contained recorders (including pocket models); recorders for installation on railroad trains, ships and planes for entertainment purposes, etc.

COSGROVE NOW VICE PRESIDENT OF AVIATION CORP.

R. C. Cosgrove, vice president and general manager of the manufacturing division of Crosley, which was recently purchased by The Aviation Corporation, has been elected vice president in charge of sales for Aviation Corp.

H. G. ARCADIUS BECOMES MEISSNER DISTRICT MANAGER

Herbert G. Arcadius has been appointed district manager of radio phonograph sales for the Meissner manufacturing division of Maguire Industries, Inc.

Mr. Arcadius will be located in the Chicago sales headquarters of Meissner. He will cover the middle western area. He was formerly associated with Lyon & Healy, Chicago.



R. L. FREEMAN JOINS LEWYT

Dr. Robert Lee Freeman has been named chief electronics engineer of Lewyt Corporation, Brooklyn, New York.

Dr. Freeman will be in charge of the electronics and radio divisions.

Before joining Lewyt, Dr. Freeman was senior and consulting engineer for Hazeltine Corporation and previously served in an engineering capacity for Farnsworth Television, Inc., and Crosley Radio Corp.



CARTER AND ZIMMER PROMOTED BY SYLVANIA

E. Finley Carter and H. Ward Zimmer have been elected vice presidents of Sylvania Electric Products, Inc.

Mr. Carter will be in charge of industrial relations. Mr. Zimmer, who was general manager of operations of the radio division since 1943, will now be in charge of the radio tube division.



H. W. Zimmer

E. M. JOHNSON JOINS MBS

Earl Minor Johnson, radio wave and antenna (Continued on page 94)

ANTENNAS

EST.



1906

For every radio purpose

BRACH ANTENNAS

since the beginning of radio broadcasting have been pace-makers in their field

IN WAR



IN PEACE



BRACH Antennas, tested and perfected to meet Army and Navy standards, have done their part for victory on land, on sea, and in the air.

And now, BRACH Puratone* Antennas will again resume their established leadership for Home and Auto Radios, Television, Marine, F.M. and other services.

TODAY AND IN THE FUTURE

... FOR *antennas* REMEMBER

*Reg. Patent Trade Mark



World's Oldest and Largest Manufacturers of Radio Antennas and Accessories

RCA IMAGE ORTHICON

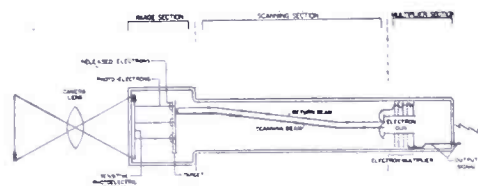
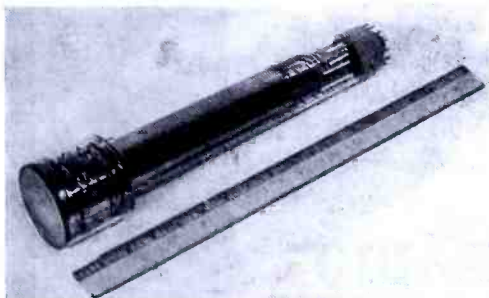

Simplified functional drawing of the image orthicon. Light image from the subject (arrow at extreme left) is picked up by the camera lens and focused on the light-sensitive face of the tube, releasing electrons from each of thousands of tiny cells in proportion to the intensity of the light striking it. These electrons are directed on parallel courses from the back of the tube-face to the target, from which each striking electron liberates several more, leaving a pattern of proportionate positive charges on the front of the target.

The image orthicon television tube recently demonstrated by RCA. It was developed by Dr. Albert Rose, Dr. Paul K. Weimer and Dr. Harold B. Law of the RCA Research Staff.

**PERFECT YOUR
POST-WAR
PRODUCTS
WITH DIALCO**

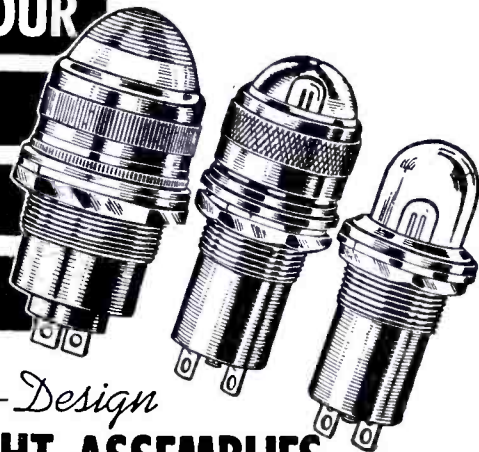

Functional-Design
PILOT LIGHT ASSEMBLIES

HOUSING NEON OR MAZDA LAMPS

GREATER emphasis on functional design is the trend in post-war engineering of Electrical-Electronic Products. Mindful of this fact, Dialco has produced a line of Pilot Lights calculated to meet readily all post-war requirements. Comprising Warning-and-Signal Pilot Lights, Panel Lights, Jewel Assemblies, and Socket Assemblies, the Dialco line offers unlimited variations in functional design, size, shape, electrical characteristics, color, finish, etc. Special emphasis on applications of NEON Glow Lamps.



Let our Engineering Dept. help you select the Pilot Light best suited to the functional design of your post-war product.

PLUS LAMPS: To help speed production, we offer Pilot Lights completely assembled with the required General Electric or Westinghouse Lamps.

WRITE FOR NEW ILLUSTRATED BROCHURE

DIAL LIGHT CO. of America, Inc.

900 BROADWAY • NEW YORK 3, N. Y.

Telephone: ALgonquin 4-5180-1-2-3

NEWS BRIEFS

(Continued from page 93)

development specialist, until recently with the War Department, has joined the engineering department of MBS.

TAYLOR TUBES ANNOUNCES AMATEUR TRANSMITTER CONTEST

An amateur transmitter contest has been inaugurated by Taylor Tubes, Inc., Chicago, Illinois, and co-sponsored by nine radio-component manufacturers.

Prizes consist of two transmitters, designed by the contestants, complete from microphone to antenna post, plus \$1125 in Victory Bonds, furnished by the participating manufacturers. The two prizes will include a transmitter with final power input classification up to 250 watts, and another with power input classification of from 250 to 1,000 watts.

The participating manufacturers are: Aero-vox Corp., New Bedford, Mass.; American Phenolic Corp., Chicago, Ill.; Barker & Williamson, Upper Darby, Pa.; Bliley Electric Co., Erie, Pa.; Gothard Mfg. Co., Springfield, Ill.; International Resistance Co., Philadelphia, Pa.; E. F. Johnson Co., Waseka, Minn.; Solar Mfg. Corp., New York, N. Y.; and United Transformer Corp., New York, N. Y.

Official entry blanks, which must accompany every entry, are available from radio parts jobbers or distributors. The contest opened November 1, 1945, and will close February 15, 1946.

A. O. SEEHAFFER BECOMES G. S. M. AT RUSSELL ELECTRIC

A. O. Seehaffer has been appointed general sales manager of Russell Electric Co., Chicago. He has been with Russell Electric since 1944.



McMULLEN OF W. E. NOW RMA AVIATION SECTION CHAIRMAN

F. C. McMullen, in charge of aviation radio sales for Western Electric, has been appointed chairman of the aviation section of the RMA transmitter division. Mr. McMullen succeeds J. W. Hammond of Bendix Radio, Baltimore, Maryland.

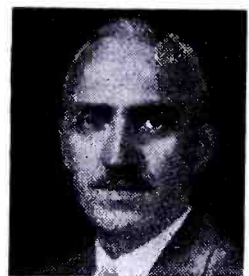

MACHLETT LABORATORIES EXPANDING

Machlett Laboratories, Inc., of Springdale and Norwalk, Connecticut, is expanding its Spring-

EASTERN AMPLIFIER "E" AWARD



At the recent "E" award ceremonies in N. Y. City: Left to right: Lt. Col. Harold L. Lister, Lt. Cmdr. William J. Warburton, Harry Friedlander and Leonard Meyerson of Eastern Amplifier, and Major Meredith J. Roberts.

There's no substitute for
ACCURACY

B. R. C. instruments are designed and manufactured to give accurate and precise direct reading measurements with simplicity of operation.

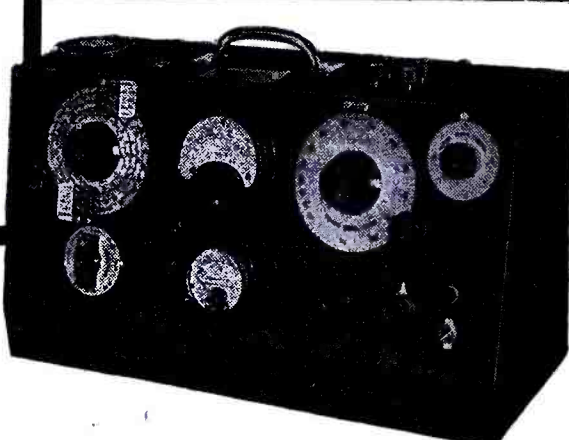

Q-METER

TYPE 160-A

A Standard for "Q" Measurements with a reputation for accurate and dependable service. Has a Frequency Range of 50 kc to 75 mc which may be extended with external oscillator down to 1 kc.



BOONTON RADIO

BOONTON, N. J.

Corporation



DESIGNERS AND MANUFACTURERS OF THE "Q" METER . . . QX-CHECKER . . . FREQUENCY MODULATED SIGNAL GENERATOR . . . BEAT FREQUENCY GENERATOR . . . AND OTHER DIRECT READING TEST INSTRUMENTS

dale plant. A building program, that will approximately double the size of the plant, is now under way.

C-D CAPACITOR COLOR CARD AND CHART

A mica-capacitor color code card and wall chart using the RMA standards for the six dot color code and the three dot color code, as well as the Army and Navy standards has been released by the Cornell-Dubilier Electric Corporation, New Bedford, Mass.

DU MONT EXPANDS TELEVISION EQUIPMENT PRODUCTION FACILITIES

Allen B. DuMont Laboratories, Inc., has leased additional space at 330 Highland Avenue, Passaic, N. J., for building television transmitters, cameras, receivers and studio equipment.

Ernest A. Marx has been named general manager of the DuMont television division.

GEORGE BALSAM NOW AEROVOX AD MAN

George Balsam has been appointed advertising manager and director of sales promotion of Aerovox Corporation, New Bedford, Mass.

CARDWELL SOLD TO GRENBYS MFG. CO.

The Grenby Mfg. Co., Plainville, Conn., has acquired full control of The Allen D. Cardwell Mfg. Corp., 81 Prospect St., Brooklyn, N. Y.

Carl A. Gray, president of The Grenby Mfg. Co., has been elected chairman of the board of Cardwell.

Both the sales and development engineering departments will continue to operate from Brooklyn.

Ralph H. Soby, vice president and director of Grenby, has been elected president of Cardwell following the retirement of Mr. Cardwell. Joseph K. Fabel, formerly assistant district manager, New York section of the Army-Navy Electronics Production Agency, will continue to serve as vice president and sales manager of the development and engineering division. Ray L. Morehouse will continue as sales manager of the commercial products division.



Carl A. Gray

GIMBELS-PHILA. INSTALLING INTRA-STORE RCA TELEVISION SYSTEM

An intra-store television system is being installed in Gimbel's-Philadelphia by the RCA Victor Division of RCA.

Gimbel's auditorium will house both studio and control facilities. An audience of about 500 people will be able to view television production in action at each show. Shows will be produced every half hour for ten minute periods with emphasis on dramatic presentations of the store's merchandise supplemented by entertainment features.

Two television cameras will be used in the store's studio.

RCA Victor has made available approximately 20 TRK receivers and laboratory models of the large-screen projection receivers.

The viewing locations will be known as telesites. Each floor will have at least two telesites with four floors having three or more.

R. A. NIELSEN PLACED IN CHARGE OF WESTINGHOUSE WESTERN H-F LAB.

Dr. Russell A. Nielsen, formerly research engineer for Westinghouse at East Pittsburgh, Pa., will direct the new Pacific coast Westinghouse h-f laboratory.

TECHNICAL APPLIANCE CONSOLIDATES PLANTS

Technical Appliance Corporation is consolidating its wartime New York City and Flushing plants and will be located at 41-06 De Long St., Flushing, N. Y.

The postwar Taco line will include antenna



Revolutionary!

1000 uufds.
HIGH VOLTAGE VACUUM CAPACITORS
 ANOTHER FIRST BY
Jennings RADIO
 VACUUM ELECTRONIC COMPONENTS

TENTATIVE CHARACTERISTICS
 Peak Voltage, 10 KV (increased voltage ratings may be obtained upon request)
 Peak Current, 100 amps. Capacity, 001 uufds.
 Overall Length approximately 7 1/2"
 Maximum Diameter at center 4"

This new Jennings unit is required for heavy industrial needs where induction heating and other electronic uses call for the unusual in capacities, size and performance. Also for Broadcast Studios and Experimental Laboratories where rugged mechanical construction in a vacuum capacitor of this capacity is essential

We welcome your inquiry and the opportunity to serve you.
 WATCH JENNINGS FOR NEW DEVELOPMENTS IN THE FIELD OF SPECIALIZED VACUUM ELECTRONIC COMPONENTS. WRITE FOR CATALOG C

JENNINGS RADIO MANUFACTURING COMPANY • 1098 E. WILLIAM ST. • SAN JOSE 12, CALIFORNIA

Patent applied for

systems and kits for broadcast reception and also for i-m and television.

NEVILLE MILLER OPENS LAW OFFICE

Neville Miller, recently special assistant to Army-Navy Liquidation Commissioner and former president of the National Association of Broadcasters, and Arthur H. Schroeder, recently Lieutenant Colonel, Army of the United States, have formed a law partnership. Offices are in the Munsey Building, Washington, D. C.

FRISCH RETURNS TO RADIO WIRE TELEVISION, INC.

Irving Frisch, formerly member of the technical staff of Bell Telephone Laboratories, has rejoined Radio Wire Television, Inc., as advertising director.

VAN DER VEER NOW AT TUNG-SOL

John D. Van der Veer has been named west-
 (Continued on page 98)

POSTWAR RECEIVER



Radio of the future displayed by Hallicrafters at a preview of new equipment in Chicago recently.



VETERAN WIRELESS OPERATORS ASSOCIATION NEWS

W. J. McGONIGLE, President

RCA BUILDING, 30 Rockefeller Plaza, New York, N. Y.

GEORGE H. CLARK, Secretary

Personals

COMMANDER Fred Muller, U.S.N.R., formerly secretary, president, vice president and director of VWOA is now Electronics Officer, Reserve Fleet, United States Atlantic Fleet, Fleet Operating Base, Norfolk, Va. Commander Muller is in charge of an electronics reserve group. He has had quite a diversified Naval career. A member of the regular Navy in 1908 he terminated his four-year enlistment as a Senior Wireless Operator under Admiral Usher. Then he went with the United Fruit Company where he subsequently headed all communications—radio, cable, mail, telegraph and telephone. He returned to the Navy during World War I and was commissioned a Chief Gunner in 1918. Progressively advanced in the Naval Reserve he was commissioned a Lieutenant, Senior Grade, in 1926 and a Lieut. Comdr. in 1937, with which rank he resumed active duty in December 1940. Advanced to the rank of Commander in 1942, he has had such important assignments as Radio Materiel Officer at the Brooklyn Navy Yard, at Third Naval District Headquarters and then to Puerto Rico.

A note from F. M. says, in part, "Sorry to be unable to join in VWOA festivities, but keep informed by the VWOA news page in COMMUNICATIONS."

Well, we're glad to have you back in the U. S. and hope to see you soon, F. M.

IT was good to hear from "Bill" Ehmer, formerly a Tropical Radio operator and for many years in the flying business. While stationed in China, some years ago as a co-pilot, "Bill" had both ankles broken when his plane failed to clear a mountain top in the interior of China. He is now in charge of the *Link* training program of American Airlines and serves as Commander of his local post of the Veterans of Foreign Wars. . . . Roscoe Kent is up and about again. Hope you can make it to our next affair R. K. . . . Welcome to a new



Commander Fred Muller, U.S.N.R., former VWOA director, who is now stationed at the Fleet Operating Base, Norfolk, Va., as Electronics Officer, Reserve Fleet, U. S. Atlantic Fleet.

member, Don Harris, Globe Wireless manager in New York. Don was in the Naval Reserve in 1922 and then in the Navy in '24 and '25. He was in commercial operating for a while. Later he took on assignments at broadcasting stations. He has been with Globe since 1933 when he started at Muscle Rock, San Francisco, except for an assignment with the Army in 1943. Good luck Don, and welcome to New York. . . . One of our real oldtime members, R. S. Palmer, secretary back in '33, continues active in VWOA affairs at Bothell, Washington. . . . Lt. Bark, United States Navy, is now stationed aboard the U. S. S. San Francisco. . . . Tony Tambourino is still with the Navy as a civilian electronics specialist. . . . Ken Richardson, formerly of Brooklyn, and one of the genuinely early pioneers going back to the early 1900's, has moved to Long Island. . . . F. E. Meinholtz, formerly VWOA secretary and member of the board of directors, has renewed his membership in the Association. Fred is still active as Superintendent of Communications for the *New York Times*. . . . John C. Mead, formerly with the FCC Monitoring Service, recently sailed aboard the S.S. Frostburg Victory. . . . Harvey Butt, now in Washington with Radiomarine, started his radio career with the Mar-

coni Company in 1917 serving aboard various ships and for many years held various shore assignments with RCA. Harvey served for several years as a director of VWOA. . . . Otis P. Angell was a professional operator with the Marconi Company from 1914 to 1930. He joined the U. S. Navy and later served with the Tropical Radio Telegraph Company. . . . Julian C. Arenburg reversed the usual procedure. Starting in radio in the Army in 1929, he has been in marine radio since 1935. . . . Edward A. Banek, now a Chief Radioman in the Navy, started in commercial radio in 1939 aboard the S.S. Catherine. . . . We've received a V mail note from Lt. George Bonadio. Sorry we can't tell where he is, since he has an FPO address. . . . Peter R. Cuda is now serving with RCA Communications at Rocky Point, L. I.

Nominations

AT a meeting of the board of directors of VWOA on October 9, the following nominations were made: President, William J. McGonigle; vice president, Arthur J. Costigan and Arthur H. Lynch; secretary, George H. Clark; treasurer and executive secretary, William C. Simon. . . . Nominations to the board of directors were: Ludwig Arnsion, Radio Receptor Company; A. Barbalate, RCAC; A. J. Costigan, Radiomarine Corporation of America; C. B. Cooper, Cooper-Di Blasi; George H. Clark, RCA; G. F. Duvall; C. D. Guthrie, War Shipping Administration; Raymond F. Guy, NBC; H. T. Hayden, Ward Leonard Electric; Arthur H. Lynch, New York Manager, National Company; William J. McGonigle, New York Telephone Company; Comdr. Fred Muller, U. S. N. R.; Frank Orth, CBS; Peter Podell, Podell Motor Sales; J. R. Poppele, WOR-Mutual; O. W. Penney, WMCA; Haraden Pratt, Mackay Radio and Telegraph Company; A. H. Rehbein, American Hawaiian Steamship Company; William C. Simon, Tropical Radio Telegraph Company; and H. A. Steinberg, Blair-Steinberg

PRODUCERS of:

- Variable Resistors
- Selector Switches
- Ceramic Capacitors, Fixed and Variable
- Steatite Insulators
- Silver Mica Capacitors
- Button Type



Centralab

Division of GLOBE-UNION INC., Milwaukee

Remler Appointed as Agent for R.F.C.

... to handle and sell government owned electronic equipment released for civilian use.

Write for Bulletin Z-1 listing a wide variety of equipment covering entire electronic field.

Remler Co., Ltd. :: 2101 Bryant Street, San Francisco 11, Calif.

REMLER SINCE 1918

Radio o Communications o Electronics

CRYSTALS EXCLUSIVELY



SINCE 1934

PETERSEN RADIO CO., Council Bluffs, Iowa

FREE CATALOG

Radio parts, test equipment, P.A. accessories, amateur supplies, technical books. Send today for your free copy to Dept. A-2.

RADIONIC EQUIPMENT CO.

"Chancellor Radio"

170 NASSAU STREET, NEW YORK 7, N. Y.

Ted McElroy

World's Largest Manufacturer of Wireless Telegraphic Apparatus

COMPLETE CENTRAL OFFICE EQUIPMENT

McElroy Manufacturing Corp.

82 Brookline Avenue • Boston, Massachusetts

WHEN YOU CHANGE YOUR ADDRESS

Be sure to notify the Subscription Department of COMMUNICATIONS, 52 Vanderbilt Avenue, New York 17, N. Y., giving the old as well as the new address, and do this at least four weeks in advance. The Post Office Department does not forward magazines unless you pay additional postage, and we cannot duplicate copies mailed to the old address. We ask your cooperation.

Origin of a hurricane

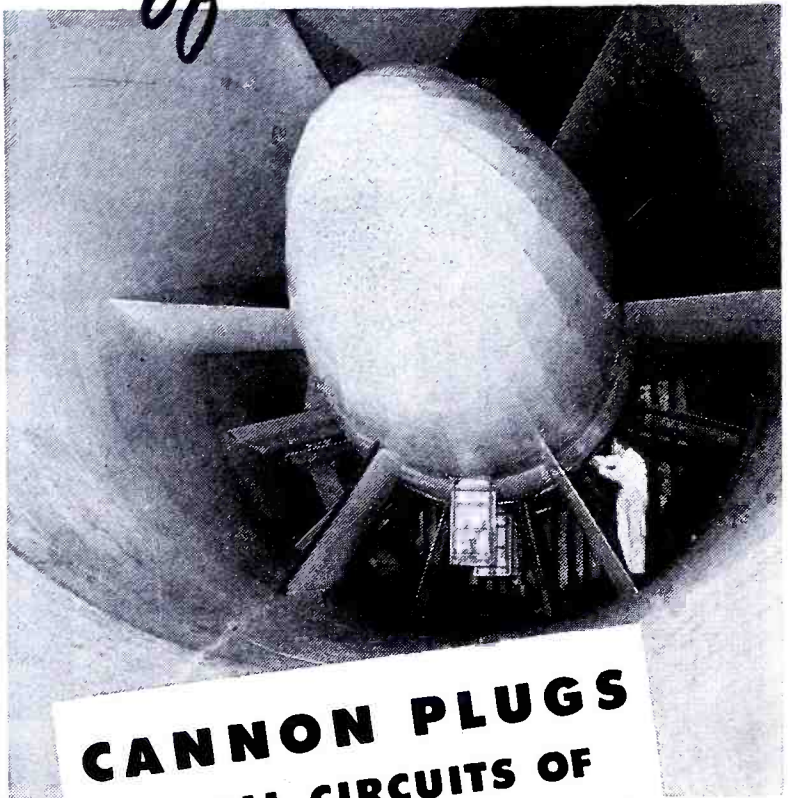

CANNON PLUGS IN ALL CIRCUITS OF THIS NEW WIND TUNNEL

One of the fans in the Cooperative Wind Tunnel—owned by Consolidated Vultee, Douglas, Lockheed, and North American—operated by the California Institute of Technology.

Two fans, each 21 feet 9½ inches in diameter, with a main drive of 12,000 hp. maximum, develop an air speed of over 700 m. p. h. in this new aircraft testing machine. Models are tested under air pressures ranging from one-quarter atmosphere to four atmospheres. Aerodynamic forces and moments are measured accurately, readings automatically recorded.

More than a thousand Cannon Connectors are employed in the electric circuits of the installation. Their use makes possible the quick and easy interchange of equipment, eliminates the duplication of costly instruments, increases the accuracy of the records taken.

Cannon Connectors, available in many thousands of standard capacities, sizes and types, may serve well in the circuits of the instruments you use or the products you manufacture. Write for a Condensed Catalog. Cannon Electric Development Co., Dept. A-121, 3209 Humboldt St., Los Angeles 31, Calif.



Special Cannon Receptacle for portable control and recording unit of the Cooperative Wind Tunnel.



CANNON ELECTRIC

Cannon Electric Development Co. Los Angeles 31, Calif.

Canadian Factory and Engineering Office:

Cannon Electric Co., Ltd., Toronto, Canada

Representatives in Principal Cities — Consult Your Local Telephone Book

**STOP VIBRATION
GREMLINS WITH
BIRTCHER
STAINLESS STEEL - LOCKING TYPE
TUBE
CLAMPS**



Where vibration is a problem, Birtcher Locking TUBE CLAMPS offer a foolproof, practical solution. For ALL types of tubes and similar plug-in components.

83 VARIATIONS

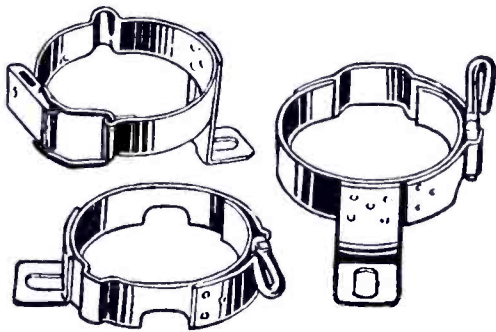

OVER TWO MILLION IN USE
Send for our standard catalog and samples of corrosion-proof Birtcher Tube Clamps.



THE BIRTCHER CORPORATION
Manufacturers of AIRCRAFT
and RADIO PARTS

5087 HUNTINGTON DR. LOS ANGELES 32

NEWS BRIEFS

(Continued from page 95)

ern manager of the Tung-Sol Lamp Works, Inc., Newark, N. J., for equipment sales of tubes. He will be located in Chicago.

Mr. Van der Veer was formerly a Captain, U. S. Army Signal Corps.



ROY D. JORDAN NAMED G. E. TRANSMITTER DIVISION ADV. AND SALES PROMOTION MANAGER

Roy D. Jordan, formerly Major, U. S. Signal Corps and Assistant Chief of the Publications Branch, Personnel and Training Service, Office of the Chief Signal Officer, has been appointed advertising and sales promotion manager of the transmitter division of G.E..



ELECTRONIC MECHANICS CELEBRATES 10th ANNIVERSARY

Electronic Mechanics, Inc., 84 Clifton Blvd., Clifton, New Jersey, is now celebrating its tenth anniversary.

R. E. Replogle is founder and president of Electronic Mechanics.



R. E. Replogle

BURGESS BATTERY REPLACEMENT GUIDE

A 6-page guide with a listing of the correct replacement batteries for approximately 1000 portables and farm receivers has been released by the Burgess Battery Company, Freeport, Illinois. The guide also includes a listing of private brand portables. Also available is a numerical and alphabetical listing of all Burgess Battery products.

Free copies are available from department RG.

H. E. HARRIS PROMOTED BY BELL SOUND

Harry E. Harris, previously sales engineer

MICROWAVE RADAR LAB

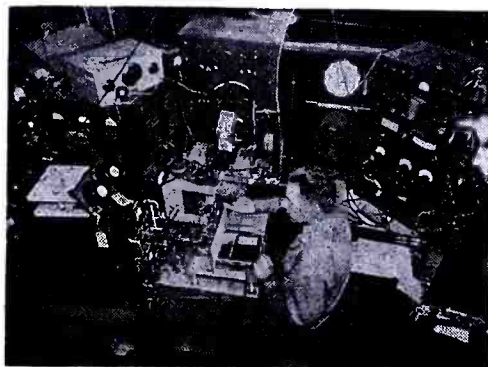

Recent microwave radar lab setup at MIT Radiation Laboratory in Cambridge, Mass.

PROMPT DELIVERY
All styles of
**BIRTCHER TUBE
CLAMPS**

Genuine Birtcher, Locking-style Tube Clamps, manufactured from type 302 Stainless Steel, have proven their worth in over THREE MILLION APPLICATIONS.

Let us assist you with your clamping problems. Our experienced engineers are at your service.

Write, Wire or Phone for speedy Courteous Service.



THE GEORGE S. THOMPSON CORPORATION

5420 HUNTINGTON DR.
LOS ANGELES 32, CALIF.

ELECTRONICS
to your order!

Veterans of pre-war and wartime electronics, we serve aviation, marine and related companies to C. A. A. and F. C. C. standards. Ask us ...

To DESIGN, DEVELOP
and MANUFACTURE ...

Radio Receivers and Transmitters
Industrial Electronic Equipment
Airport Radio Control Equipment
Marine Radio Telephone Equipment

Your inquiries will receive immediate action

ISLIP RADIO MFG. CORPORATION

ISLIP, L. I., NEW YORK

the Bell Sound Systems, Inc., Columbus, Ohio, has been appointed as general sales manager of the manufacturers and jobbers division.

**AWARDED TO ROBESONIA
PLANT OF NATIONAL UNION**

Army-Navy "E" was recently awarded to National Union Radio Corp. at Robesonia.

MUTER BUYS ROLA COMPANY

Muter Company, 1255 South Michigan Avenue, Chicago, Ill., has acquired all the total stock of The Rola Co., Inc., Cleveland, its subsidiary, The Rola Company. Harry King, formerly associated with Opera- will be president and general manager of a which will now be operated as a division of Muter.

Ben Engholm, former president and principal stockholder of Rola, died recently.



**PHENOL EXPANDS PLASTICS
FACILITIES**

Three-story building to house expanding plastics facilities has been announced by the American Phenolic Corporation, 1830 South Avenue, Chicago 50.

PLASTICS BOOKLET

44-page catalog, describing a variety of thermoplastic and thermosetting material ducts, molding methods, cure rates and stresses, has been issued by The Waterman Manufacturing Company, Echo Lake Road, Westtown, Connecticut.

**First to Power
100 Watt Mobile
Transmitter**

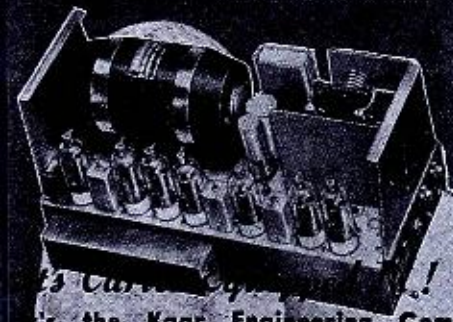

is the Kaar Engineering Company's recently developed 100 Watt Mobile Transmitter.

ARTER Rotary Products provide unequalled performance and dependability for all types of mobile communication equipment.

test catalog and trade bulletin at upon request.

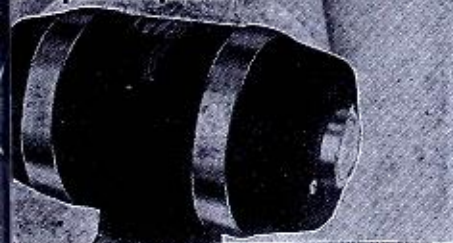

Carter Motor Co.

MILWAUKEE AVE. CABLE: GENEMOTOR
TER, a well known name in radio for over 20 years.

CANNON BULLETIN

A revised 64-page edition of the Cannon Electric type K bulletin on electric connectors has been issued by the Cannon Electric Development Company, 3209 Humboldt St., Los Angeles 31, California.

Data presented cover receptacles, dust caps, junction shells, stowage receptacles for aircraft, instruments, radio, motor, geophysical equipment, and general electrical applications.

COUNTING DEVICE DATA

An 8-page catalog, describing stroke and revolution counters, electric counters, coil winding counters and predetermined electric counters, has been released by the Production Instrument Company, 708-12 W. Jackson Blvd., Chicago 6, Illinois.

Application data are also offered.

**ED. GREEN AND IRVING GERBER
JOIN GERBER SALES**

Ed Breen, who during the war was at the M.I.T. Radiation Lab. is now with the Gerber Sales Company at 94 Portland Street, Boston. Irving Gerber, son of Harry Gerber, owner of Gerber Sales, has also joined the organization. He is a Worcester Polytechnic Institute graduate.

ARNOLD ENGINEERING P-M DATA

A 24-page bulletin offering an analysis of p-m materials has been released by the Arnold Engineering Company, 147 E. Ontario Street, Chicago, Ill.

Data covers: Magnetic properties, design considerations, applications of Alnico, resistance comparisons, magnetic measurements, demagnetization and energy curves, etc.

**H. G. BAKER NAMED SALES MANAGER
OF RCA VICTOR HOME INST. DIV.**

Henry G. Baker has been appointed general sales manager of the home instrument division of RCA Victor. Prior to this assignment, Mr. Baker had been general purchasing director for RCA Victor.

**JACK BEEBE NOW WITH
SWAIN NELSON**

Jack Beebe has joined the transformer division of the Swain Nelson Company of Glenview, Illinois, where he will be in charge of the manufacturing and distributing of J-N-C transformers.

Mr. Beebe was formerly general sales manager of Thordarson Electric Manufacturing Company.

JENSEN PROMOTES T. L. PIERCE

Thomas L. Pierce has become factory superintendent in charge of the manufacturing division of Jensen Radio Mfg. Company, Chicago, Ill. He has been with Jensen for sixteen years.



SYLVANIA COLD-CATHODE RECORDER

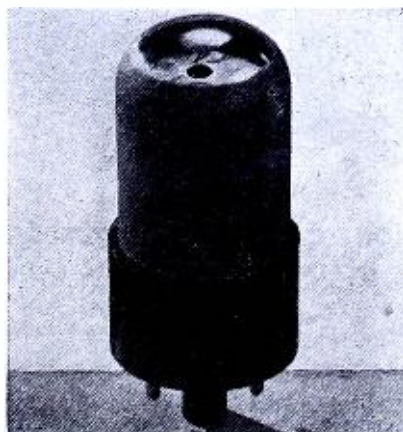

A modulator glow tube of the crater type usually operated by the single-ended output stage of a push-pull amplifier, to provide a modulated, high intensity point-of-light source, developed by the Industrial Electronics Division of Sylvania Electric Products, Inc., Boston, Mass.

**Long and
Satisfying
Service**



IT'S
ENGINEERED WITH
Hi-Q
COMPONENTS

Ask any service man with years of radio set repair experience and he'll tell you most sets "go bad" because of the failure of some insignificant component. That's why it's important to give more than ordinary consideration to the selection of capacitors. Engineer a unit with Hi-Q components and you have strengthened every link in the chain of satisfying performance. Hi-Q ceramic capacitors are individually tested at every step of their manufacture. They'll stand up under the severest conditions of temperature, humidity, vibration and shock. Send for samples and complete data.



CERAMIC CAPACITORS

CN type with parallel leads
CI type with axial leads



WIRE WOUND RESISTORS

Sizes and quantities available promptly to required specifications.



CHOKE COILS

Uniform in quality — rugged construction tested for performance.

**ELECTRICAL REACTANCE
CORPORATION**
FRANKLINVILLE, N. Y.

**THE
VIBRATION-PROOF
SHOCK-PROOF**

**EBY
MINIATURE
TUBE
SOCKET**



**The ideal miniature socket for
RAILWAY • AIRCRAFT
AUTOMOTIVE
and other commercial radio
and electronics equipment**

Now available for commercial use — the famous Eby miniature tube socket, the only socket meeting specification JAN-S-28 for military aircraft use.

Developed to meet the most rigorous service conditions of constant vibration and shock, the peace-time applications of this socket are readily apparent.

The use of the Eby miniature tube socket with special beryllium copper contacts assures minimum tube breakage and maximum uninterrupted operation of equipment.

Can be supplied with shock shield and protective cover or saddle type.

(Also available with phosphor bronze contacts for home radio receivers.)

Write today for
Samples and Prices
of the Eby Vibration-
proof, shock - proof
miniature tube
socket.

**HUGH H.
EBY
INCORPORATED
18 W. CHELTEN AVE.
PHILA. 44, PENNA.**

THE INDUSTRY OFFERS . . .

**JENNINGS RADIO HIGH-VOLTAGE
VACUUM CAPACITORS**

Vacuum-capacitors with a peak voltage of 10 kv, peak current of 100 amp and capacity of .001 mfd, have been announced by Jennings Radio Manufacturing Company, 1098 E. Williams St., San Jose, Calif.

Overall length approximately, 7 $\frac{7}{8}$ "; maximum diameter at center, 4 $\frac{3}{4}$ ".



RADIO SPECIALTIES TEST CLIPS

Test clips, produced in pairs, rights and lefts, have been announced by the Rapid Specialties Company, 327 W. Huron St., Chicago 10, Ill.

Base, 3 $\frac{1}{8}$ " x 1 $\frac{1}{2}$ "; height, 1 $\frac{1}{2}$ ". Made of .051 polished brass. Tension, .016; phosphor bronze spring. Base is drilled to take holding screws and terminals.

COLLINS REMOTE AMPLIFIER

A 4-channel high-fidelity remote amplifier, 12Z, has been announced by the Collins Radio Company, Cedar Rapids, Iowa.

Features include front-access attenuators (patented), a master control in addition to the individual control for each channel, and meter calibrated in vu for volume level and to measure operating voltages. Monitoring facilities are also included.

Input impedance, 30/50 ohms; output said to be 50 milliwatts at less than 1% distortion into a 600-ohm load; frequency response said to be 30-12,000 cps, ± 1.0 db; overall gain, approximately 95 db.

Weights about 35 pounds. Has self-contained power supplies, both a-c and d-c, the latter in the form of batteries. If the a-c voltage source fails, the batteries are automatically switched into the circuit.

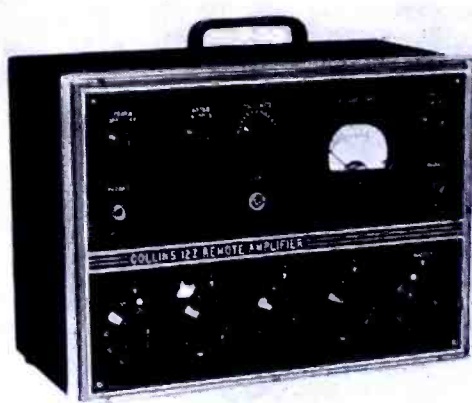

DU MONT C-R TELEVISION TUBES

Cathode-ray tubes in electrostatic and magnetic deflection and focusing types, and in the 5", 7", 10", 12" and 20" sizes are now available from the Allen B. DuMont Laboratories, Inc., Passaic, N. J.

Picture areas of the 5" tube are 3 x 4"; 7" tube, 4 x 5 $\frac{5}{8}$ "; 10" tube, 6 x 8"; 12" tube, 6 $\frac{5}{8}$ x 8 $\frac{3}{8}$ "; and 20" tube, 12 x 16".

Relatively flat faces are used in all of these types; 5" and 7" tubes have 24" radius screens, 10" tube has a 42" radius, 20" tube has a 30" radius.

The operating voltages range from 1500 for the 5" tubes without intensifier feature, to 15,000 volts for the 20" tube with intensifier.

**ANDREW REMOTE ANTENNA
AMMETER**

A remotely-located d-c microammeter actuated by a current transformer feeding a diode-rectifier tube located at the antenna, has been developed by Andrew Co., 363 E. 75th St., Chicago 19.



BLILEY V-H-F CRYSTAL UNIT

A crystal unit for v-h-f, type ART, has been announced by Bliley Electric Company, Erie, Pennsylvania. This new unit, a temperature-controlled crystal assembly, is available for frequencies from 3,500 to 11,000 kc. Temperature range said to be from -55°C to +75°C. A built-in heater operating on 6.3 volts at 1 ampere is said to provide temperature control within $\pm 2^\circ\text{C}$, permitting an overall frequency tolerance of $\pm .005\%$.

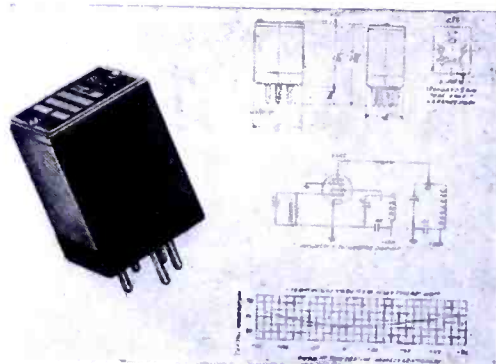

UTAH WIRE RECORDER

A portable wire recorder, *Magicwire*, has been

**PROTECT YOUR HOME FROM
TUBERCULOSIS**



BUY CHRISTMAS SEALS

Portable POWER CLEANER

For Cleaning
Electrical Equipment,
Wiring, etc.

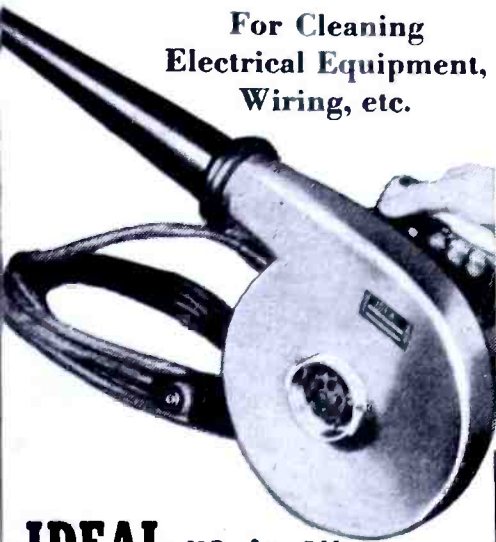

IDEAL "3-in-1" Electrical BLOWER

BLOWS • VACUUMS • SPRAYS

Super-powered, Heavy Duty, full 1 H.P. motor. Gently but effectively blows or vacuums dry air at low pressure; won't harm electrical insulation or wire connections, etc.; completely removes dust, dirt, etc. in all types of general cleaning, from floors and furniture to the most delicate mechanism. Easy to reach out-of-the-way places because of extreme portability. Wide selection of attachments available.

PROMPT DELIVERY

Write for Detailed Literature

IDEAL COMMUTATOR DRESSER CO.
4025 Park Ave. Sycamore, Ill.
Sales offices in all Principal Cities

1407

IDEAL

Sycamore

supply power for rotation at a time. The operation of either pulley is controlled by a motor switch.

Over-all dimensions are 13 1/4" x 11 1/2" x 9"; total weight, together with carrying shield, 37 3/4 pounds.



STEPHENS COAXIAL SPEAKERS

A coaxial speaker, *tru-sonic*, consisting of a low-frequency paper cone, and high-frequency diaphragm operating into a multicellular horn and a dividing network, mounted on a cast aluminum frame 15 7/8" in diameter and 9 1/2" in depth, has been produced by the Stephens Manufacturing Company, 10416 National Boulevard, Los Angeles 34, Calif.

Multicellular horn is said to allow a vertical sound distribution of 40° and a horizontal distribution of 80°.

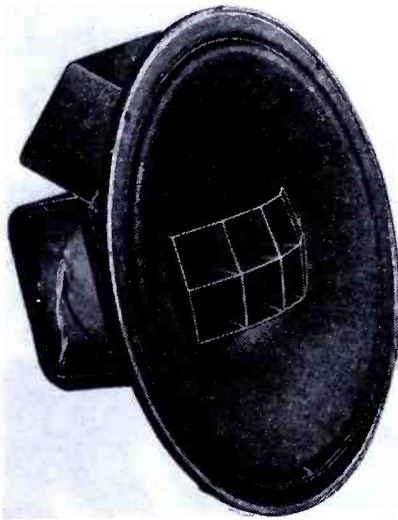

NE-O-LITE TESTER

A test unit, Ne-O-Lite Test-Lite, for locating blown fuses, testing a-c lines, polarity, tracing ground lines, r-f indication, etc., has been developed by Ne-O-Lite Mfg. Co., Rockford, Illinois.

Tests voltages from 60 volts a-c to 550 volts a-c or d-c by variable light intensity, using a neon lamp.

Has clear plastic tip and shell and insulated test points.

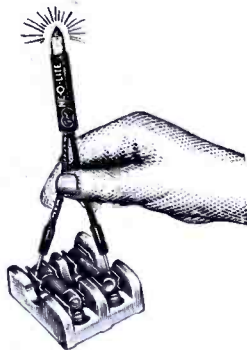

OHMITE PRECISION RESISTORS

A series of resistors, Riteohm types 844A, 844B, and 842A, that can be mounted by means of a through-bolt and equipped with a radial lug at each end, has been announced by the Ohmite Manufacturing Company, 4835 Flournoy St., Chicago 44, Ill.

The units are pie-wound and available in 3 sizes—9/16" diameter x 9/16" long, 9/16" diameter x 7/8" long, and 3/4" diameter x 1 3/16" long. The smallest is a 2-pie while the other two are 4-pie units. The minimum resistance is 1.0 ohm for the 2-pie unit and small 4-pie unit, and .10 ohm for the large 4-pie unit. The maximum resistance is 200.

(Continued on page 102)



Widest range
of tracer code
identification
... plus maximum
insulation resistance

Spiralon, the newly developed Surco plastic insulated wire, embodies many decided improvements for tracer code identified wire, particularly reduction in weight and space, and smaller sizes of O. D. Spiralon's coding combinations are unlimited with colored spiral stripes, easily and immediately seen. Because the spiraling does not add color pigments to the primary covering, Spiralon retains increased insulating resistance and allowance for greater voltage.

Covered with a nylon jacket, Spiralon also proves highly resistant to fungi and abrasion, eliminates voids, reduces creepage when terminals are being soldered, and injury to insulation when in contact with a hot soldering iron. In fact, all insulating and protective qualities are greatly increased with this thin nylon jacket, which is resistant to high heat and low temperatures, and which raises the rupture point far above that of the average lacquer coating on braid. Send for complete specifications.

- SHIELDED WIRE
- HIGH FREQUENCY WIRE and CABLE
- VINYL RESIN SHEETING
- INSULATING TUBING
- INSULATING TAPE

Address Dept. L

Surprenant
ELECTRICAL INSULATION CO.
84 Purchase St., Boston 10, Mass.

ATTENUATORS by TECH LABS

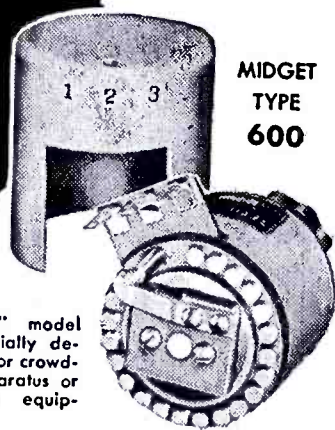

MIDGET
TYPE
600

"Midget" model is especially designed for crowded apparatus or portable equipment.

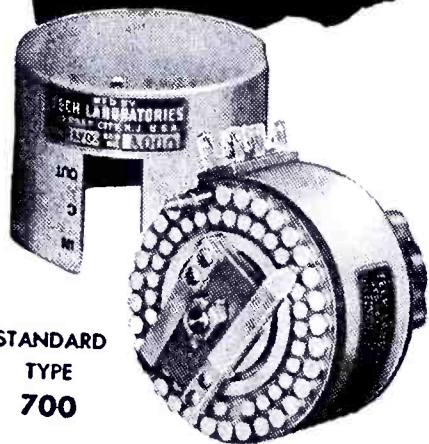

STANDARD
TYPE
700

- Solid silver contacts and stainless silver alloy wiper arms.
- Rotor hub pinned to shaft prevents unauthorized tampering and keeps wiper arms in perfect adjustment.
- Can be furnished in any practical impedance and db. loss per step upon request.
- TECH LABS can furnish a unit for every purpose.
- Write for bulletin No. 431.



Manufacturers of Precision Electrical Resistance Instruments
337 CENTRAL AVE. • JERSEY CITY 7, N. J.

Toroids.. by DX

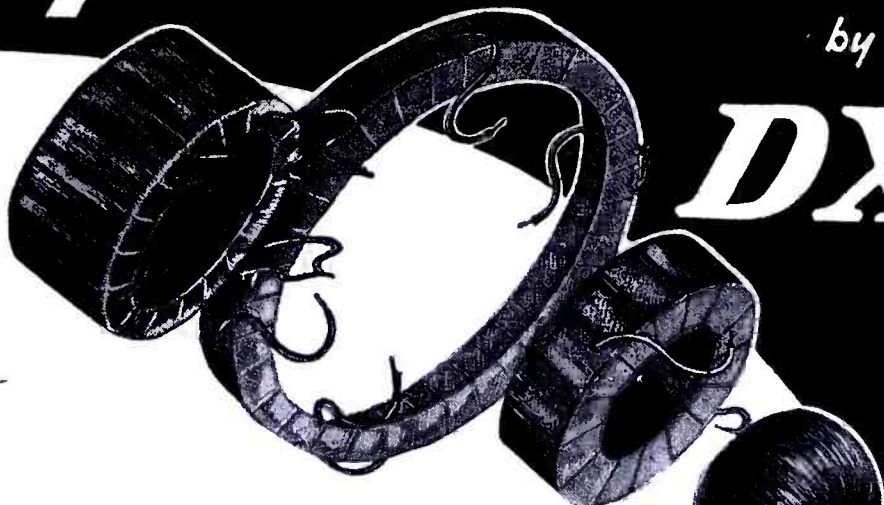

Doughnut Coils for electronic and telephone purposes. High Permeability Cores are hydrogen annealed and heat treated by a special process developed by DX engineers. Send us your "specs" today—ample production facilities for immediate delivery.

DX RADIO PRODUCTS CO.

GENERAL OFFICES 1200 N. CLAREMONT AVE., CHICAGO 22, ILL., U.S.A.



"the heart of a good receiver"

THE INDUSTRY OFFERS...

(Continued from page 101)

000 ohms for the 2-pie, 400,000 ohms for the small 4-pie, and 1.5 megohms for the large 4-pie unit.

The resistors have non-inductive winding of enameled alloy resistance wire on a non-hygroscopic ceramic bobbin which has a hole through the center for a No. 6 screw. Lug type terminals are fastened to the bobbin. After being wound, the unit is vacuum impregnated with a special varnish to provide additional insulation and protect the winding against humidity. The resistor can be supplied with a varnish coating containing a fungicidal agent.



HICKOK CHARGICATOR

A Chargicator to indicate electrically the equivalent gravity of any lead-acid storage battery, regardless of size or voltage, has been developed by the Hickok Electrical Instrument Company, 10529 Dupont Avenue, Cleveland 8, Ohio. Said to place no load on the battery.

The probe type, illustrated, is said to give instantaneous measurement of battery condition. It shows what charging rate to use, either for trickle charging or for a safe, high-rate charge. It indicates the percentage of charge and charging danger and warns of destructive overcharging.

Has a large four-color scale dial. All models are sealed within molded, acid-proof bakelite cases.



BRADLEY LABS. COPPER-OXIDE RECTIFIERS

A full-wave, copper-oxide rectifier, rated at either 12 volts a-c and 50 milliamperes d-c, or 6 volts a-c and 100 milliamperes d-c, has been developed by Bradley Laboratories, Inc., 82 Meadow Street, New Haven 10, Conn.

This unit is said to be a double unit of Bradley's model CX-4D4-F23, redesigned to handle greater capacity than the original version. The single unit is now rated at 6 volts a-c and 50 milliamperes d-c continuous. It mounts on a single screw, is fully enclosed and sealed with a plastic compound. Pre-soldered lead wires said to prevent overheating during assembly.

U-M-C CONSTANT VELOCITY RECORDS

Constant velocity frequency records, type D-61, for use in checking frequency response of phonograph pickups and recording components, have been prepared by the Universal Microphone Co., Inglewood, Cal.

The record is 12", lateral recorded, for use on 78 rpm. Record covers the following ranges

B-L METALLIC ELECTRICAL RECTIFIERS

offer you these advantages:

They are **COMPACT**
SILENT
DEPENDABLE
TROUBLE-FREE
RUGGED and
They are **ADAPTABLE**
for power outputs
from **Milliwatts** to
Kilowatts.

any rectifier applications, heretofore considered impractical, have been devised by B-L engineers. It is more than likely that they can be of assistance in solving your problems of converting AC current to DC... Write for Bulletin R38-e.



COPPER SULPHIDE

BENWOOD-LINZE COMPANY
LOCUST ST. • ST. LOUIS 3, MO.
Long distance telephone Central 5830



constant velocity; 50 to 100 cps at + 7 db; to 500 cps at + 14 db; 500 to 10,000 cps at + 21 db; 1000 cps, 2 db steps from + 8 to + 18 db; and 400 cps at + 18 db. Record material is said to be unbreakable.

BETTER HIGH-SPEED COUNTER

Two-decade electronic high-speed counter has been announced by Potter Instrument Company, 136-56 Roosevelt Avenue, Flushing, N. Y. The unit is said to be particularly applicable to counts exceeding 10 cycles per second. Used as a two-decade instrument, the maximum count capacity of the electronic counter is 100. A tube-operated relay is provided for counts where the quantity to be counted exceeds 100. The relay has a single-pole, double-throw contact. When operation of the relay and an external mechanical counter are not involved, the counter may be used alone, at counting rates up to 20,000 per second. The instrument comprises an input section,

suitable for any of the four types of input circuits:

Contact closure, pulse signals, sine-wave signals, square-wave signals.

There are also two standard counter-decades, designated respectively as the units decade and the tens decade, an output relay stage, and a power supply.

Width, 13 1/2"; height, 8 7/8"; depth, 10"; weight, 26 pounds.



RADIATION PRODUCTS MARINE SYSTEMS

Marine radiotelephone units, Radiaphone 25, providing instantaneous push-to-talk operations for ship-to-ship, ship-to-shore, and ship-to-Coast Guard, have been announced by Radiation Products, Inc., Los Angeles. Operates from 6- to 12-volt batteries.

TAYLOR TUBES U-H-F TRIODES

An u-h-f triode, type TUF-20, that is said to operate at full ratings up to 250 mc, has been released by Taylor Tubes, Inc., 2312 Wabansia Avenue, Chicago, Illinois.

Has a thoriated filament and tantalum plate. Grid to plate capacitance, 3.6 mmfd; grid to filament capacitance, 1.8 mmfd; plate to filament capacitance, .095 mmfd; amplification factor, 10; filament 6.3 volts a-c or d-c at 2.75 amperes; maximum plate power, 750 volts at .075 ampere; plate dissipation, 20 watts.

Typical operation: Plate volts, 750; plate current, 75 ma; grid voltage, -150; maximum d-c grid current, 20 ma; approximate driving power, 1.5 to 2.5 watts; approximate carrier output, 40 watts (at 115 mc).

Size, 3 3/4" overall height x 1 1/2" maximum diameter.

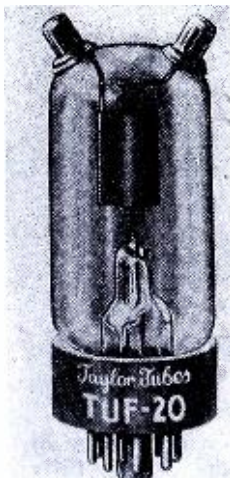

SYLVANIA H-F I-F AMPLIFIERS

High-frequency i-f amplifiers for center frequencies between 30 and 70 mc, with any bandwidth from 2 to 10 mc, have been announced by Sylvania Electric Products, Inc., industrial electronics division, Boston, Mass.

A typical amplifier is said to have an overall gain of 100 db with a center frequency of 60 mc and a half-power bandwidth of 9.0 mc. Unless otherwise specified, a standard 500-ohm input impedance is supplied. The output stages are cathode followers designed to operate into impedances of 75 to 100 ohms with voltages ranging from 0.5 to 2.0 volts, negative or positive.

Amplifiers are said to be able to pass a square top pulse having a duration of 0.15 microsecond or greater without appreciable frequency or phase distortion.

Either single ended or balanced input circuits are supplied. Balanced input circuits are designed for use with dual input systems and will distinguish between in-phase and out-of-phase signals from two channels. In one such unit the discrimination is said to be 33 db.

Power supply for a typical amplifier includes + 105 volts d-c at 90 ma, + 300 volts d-c at (Continued on page 104)

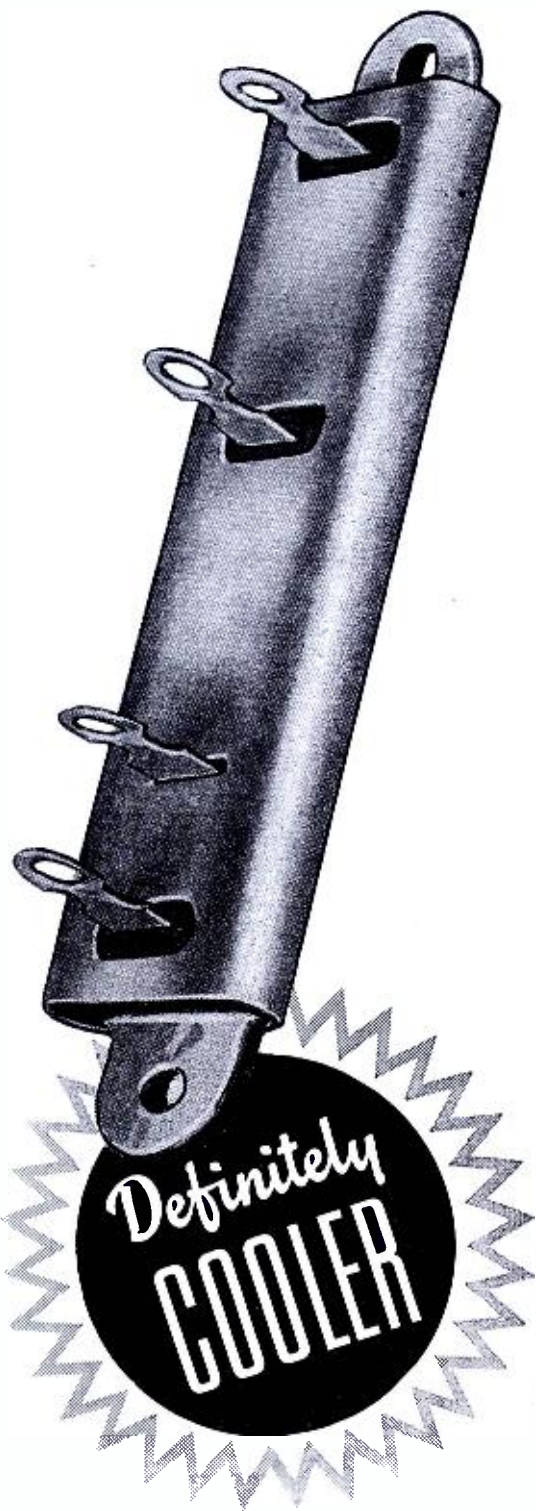

★ Here's where we go on record: Clarostat Series MMR bakelite-insulated metal-clad resistors are definitely **COOLER** than any other similar types, **SIZE FOR SIZE**; or putting it another way, these resistors will **DISSIPATE MORE POWER** for the same temperature rise, **SIZE FOR SIZE**. ★ That's our statement. We invite your own tests. ★ Sample on request if you write on business letterhead. Also detailed literature.



CLAROSTAT MFG. CO., Inc. • 285-7 N. 6th St., Brooklyn, N. Y.

*Ready...
Willing...
Able...*

Ready to take on any transformer production job... our complete new manufacturing facilities are second to none in the industry.

Willing to handle any transformer design or development job in elaborate new laboratories staffed with engineers of unusual experience.

Able to ship, quickly, "one million or one" of any transformer you order. Write, wire or phone us for fast efficient service.

SPECIALIZED

Transformer

ENGINEERS

3223-9 WEST ARMITAGE AVENUE · CHICAGO 47, ILLINOIS

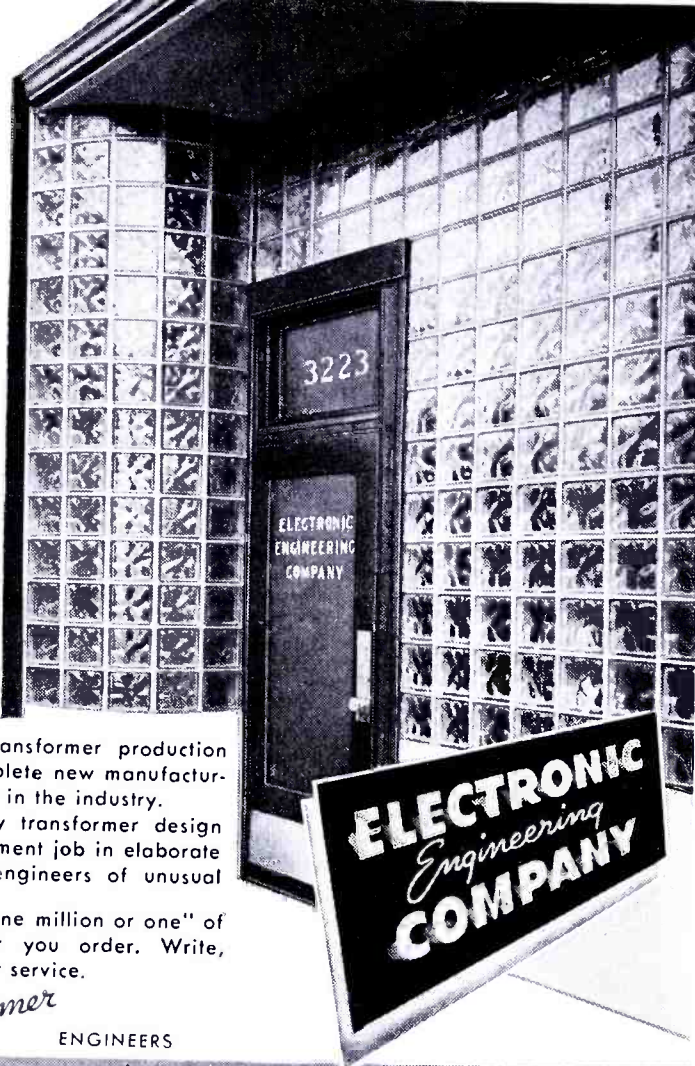

Draftsman Wanted

Also

Designer, Detailer, Tracer and Engineer

We are one of the largest manufacturers of a wide variety of communication and electronic equipment in the world, fully prepared and ready to go ahead with a very ambitious, expansion program as quickly as we are permitted. There will be unlimited possibilities for creative, ambitious men to advance to key positions both in research development and production field.

Good Starting Salaries

Exceptionally fine working conditions

Apply: Personnel Office, 8 A. M. to 5 P. M.

Federal Telephone & Radio Corp.

the Mfg. unit of the International Tel. & Tel. Corp.

591 BROAD ST., NEWARK, N. J.

W M C Rules Observed

THE INDUSTRY OFFERS . . .

(Continued from page 103)

20 ma, and 6.3 volts a-c or d-c at 1.7 amperes. External gain control requires 0 to -12.5 volts d-c at 1.5 ma.

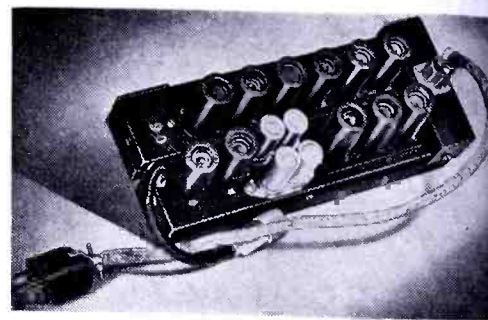

STACKPOLE SCREW-TYPE IRON CORES

Screw-type molded-iron cores are now available from the Stackpole Carbon Company, St. Marys, Penna. Cores are threaded; no brass core screw is necessary for adjustment.

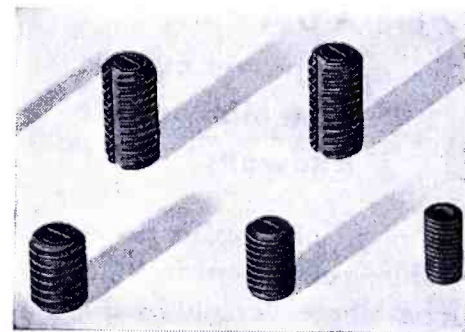

RADIART MIDGET VIBRATORS

Midget vibrators, VR-2, 2 1/8" high x 1 1/8" in diameter, have been designed by the Radiart Corporation, 3571 W. 62nd St., Cleveland 2, Ohio. Designed for operation from 6-volt storage battery.

Vibrator frequency, 185 cps ± 10%; input voltage (nominal), 6; input voltage range, 4.5 to 7.5; input current, 1.5 amperes maximum, at 6.0 v; output voltage, 200 v d-c maximum; potential difference between primary reed and secondary reed, 25 v maximum.



FAIRCHILD SPOTTING AND REPEATING RECORD PLAYER

A combination word spotter-record player, the *Language Master*, has been produced by the Fairchild Camera & Instrument Corp., Jamaica, N. Y.

Unit is supplied complete with synchronous motor driving the turntable at 78 rpm, standard crystal pickup, spotting mechanism, three-tube amplifier, and five-inch p-m dynamic speaker.

The spotting arm is directly beneath the turntable panel. In playing position, the spot-

JONES 300 SERIES PLUGS and SOCKETS



P-306-CCT



S-306-AB

A high quality line of small Plugs and Sockets adaptable to a thousand uses.

All Plugs and Sockets are Polarized. "Knife-switch" Socket contacts are of phosphor bronze, cadmium plated. Bar type Plug contacts are of brass, silver plated.

Insulation is of BM 120 molded Bakelite. Caps are of metal with formed fibre linings. Made in 2 to 33 contacts. Although designed for 45 volts at 5 amperes, these Plugs and Sockets can be used at higher ratings where circuit characteristics permit. 2 contact round, others rectangular. For additional information write today for catalog No. 14 showing complete line of Electrical Connecting Devices.

HOWARD B. JONES COMPANY
2460 W. GEORGE ST. CHICAGO 18



PREFERRED BY ENGINEERS

BURGESS BATTERIES

RECOGNIZED BY THEIR STRIPES - REMEMBERED BY THEIR SERVICE

ting arm rests free. To repeat a word or sentence a lever is depressed; this actuates the arm, and the pickup is instantly lifted clear of the record. With the lever still depressed, the spotting arm can be moved and the pickup can be repositioned. This is said to be possible within one groove on the record. An illuminated position-indicator shows the pickup's exact location on the record as it travels across it. A scale of 0-100 on the position-indicator showing number of grooves on the record, is expanded by the use of five consecutive points to allow for coverage of disks up to 12".

Weights about 20 pounds. For use on 110-volt, 50-60 cycles a-c.

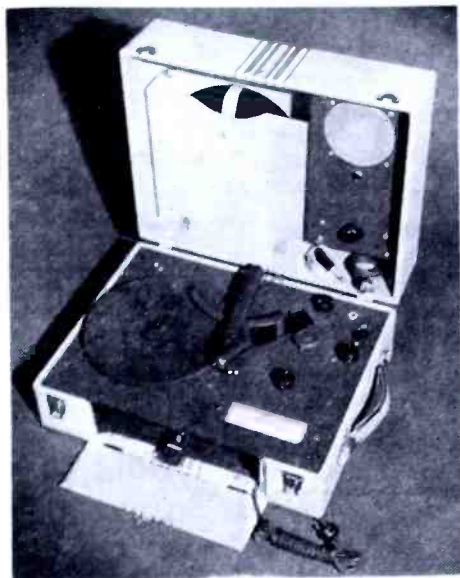

SHALLCROSS AXIAL LEAD RESISTORS

Fixed wire-wound 1-megohm/1-watt resistors, type 188, with 3" axial leads, have been announced by the Shallcross Manufacturing Co., Jackson & Pusey Avenues, Collingdale, Pa. Unit is 1 3/16" long x 3/8" diameter. Standard tolerance is $\pm 1\%$, although higher accuracy up to $\pm 0.1\%$ is said to be available on order.



AVIOMETER HAND MICROPHONES

A hand-type carbon microphone that is said to provide an 8-milliwatt output for an input of 100 dynes per square centimeter (normal close-speaking voice) has been announced by the Aviometer Corporation, 370 W. 35th St., New York.

Has a recessed finger grip. Equipped with flexible rubber retract cord which extends 40".



HAMMARLUND COMMUNICATIONS RECEIVER

An 11-tube amateur type communications receiver, the HQ-129-X, for the .54- to 31-mc range has been announced by the Hammarlund Mfg. Co., Inc., 460 W. 34th St., N. Y. 1, N. Y.

Features include: Band spread, 4 calibrated ham bands and one arbitrary scale; variable selectivity crystal filter for phone as well as code reception; low-drift beat oscillator for

(Continued on page 106)

**YOU NAME IT,
WE'LL SUPPLY IT**



EVERYTHING IN RADIO AND ELECTRONICS

R. W. T., world's oldest and largest Radio Supply House is ready again with tremendous stocks of sets, parts and equipment. You can depend on our quarter-century reputation for quality, sound values and super-speed service. Orders shipped out same day received. All standard lines already here or on the way, including: National, Hammarlund, R. C. A., Hallicrafters, Bud, Cardwell, Bliley and all the others you know so well.

Originators and Marketers of the Famous *Lafayette Radio*

Radio Wire Television Inc.

100 Avenue of the Americas, New York 13
(Formerly Sixth Avenue)
Boston, Mass • Newark, N. J.

"No supplier anywhere has a bigger stock of Radio and Electronic equipment. Test equipment, Public Address equipment, Communications equipment. If your engineering problem requires special equipment, we'll make it. Write today. Dept. FL-5."

THE INDUSTRY OFFERS . . . —

(Continued from page 105)

code and locating stations; antenna compensator for image rejection; voltage regulation;

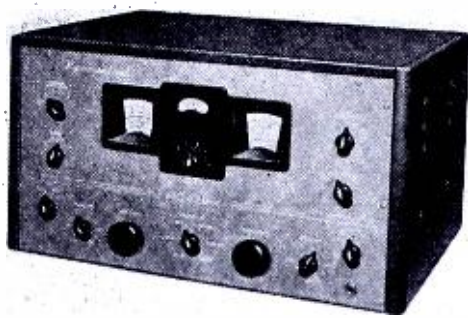

AMP SINGLE AND MULTIPLE SOLDERLESS CONNECTORS

Connector strips with knife-switch disconnect terminal design, have been produced by Aircraft-Marine Products, Inc., 1591 F North Fourth Street, Harrisburg, Pa. Permanent disconnect member of the splice has an extended tongue which fits into connector strip.

Two types are available: (1) Single-width strip adapted to use with the AMP pre-insulated splicing terminal which requires no insulation sleeving. The knife-switch part of the permanent member extends outside the strip and connection and disconnection are

made without removing the cover of the assembly; (2) Double-width strip in which the disconnect ends are enclosed, locked and insulated by the cover, one-half of which is independent of the other half. Disconnection is made by unscrewing one half of the cover to expose the connections.

SPRAGUE 1-, 2- AND 3-WATT BOBBIN-TYPE RESISTORS

Three wire-bound bobbin-type resistors rated at 1, 2 and 3 watts at 80° C ambient, wound with ceramic-insulated resistance wire on molded, high-temperature plastic forms, have been announced by Sprague Electric Co., Resistor Division, North Adams, Mass.

Resistance tolerance said to be available from ±½% to ±5%. Maximum permissible temperature, ambient plus rise, is said to be 150° C.

Type RX3, 9/16" diameter x 15/32" long, carries a maximum resistance value of 100,000

FREE TO YOU COLOR CODE AND OHMS LAW CALCULATOR

A great convenience. Easy to work. Solves many problems. Attach coupon to your letterhead. Free to radio men, engineers, etc.

BURSTEIN-APPLEBEE COMPANY
1012 McGee, Kansas City 6, Mo

Send me FREE Color Code and Ohms Law Calculator along with latest catalog.

I am _____
STATE CONNECTION IN INDUSTRY _____
NAME _____
ADDRESS _____
TOWN _____ STATE _____

BURSTEIN-APPLEBEE COMPANY
1012 McGee St.
Kansas City 6, Mo.

Mail Coupon Now

EFFECTIVE

JANUARY 1946—

TRIM SIZE OF COMMUNICATIONS
WILL BE INCREASED TO 8 7/8" x 11 3/4"
BLEED PLATES SHOULD BE 9" x 12"

CIRCULATION OVER 8000 ABC

AGAIN AVAILABLE—

COMMUNICATIONS

(12 Big Issues—\$1)

Group Subscription Plan

Saves Fifty Per Cent of the Subscription Price if Four or More Orders, Including Your Own, Are Properly Entered on This Form

To COMMUNICATIONS:

52 VANDERBILT AVE., NEW YORK 17, N. Y.

Please enter annual subscriptions (12 issues) for each of the undersigned for which payment is enclosed at the rate of \$1.00 each. (This rate applies only on 4 or more subscriptions when occupations are given.)

Name
Address
City-State
Occupation
Employed by
Nature of Business
(State if Manufacturer, Broadcast Station, etc.)
Product

Name
Address
City-State
Occupation
Employed by
Nature of Business
(State if Manufacturer, Broadcast Station, etc.)
Product

Name
Address
City-State
Occupation
Employed by
Nature of Business
(State if Manufacturer, Broadcast Station, etc.)
Product

Name
Address
City-State
Occupation
Employed by
Nature of Business
(State if Manufacturer, Broadcast Station, etc.)
Product

ohms when wound with 1.5 mil ceramic-insulated wire or 25,000 ohms with 2.5 mil wire. Type RX4, 3/4" diameter x 3/4" long, has a maximum of 300,000 ohms with 1.5 mil wire and 75,000 ohms with 2.5 mil wire. Type RX5, 3/4" diameter x 1" long, has a 500,000-ohm value with 1.5 mil wire, or a maximum of 125,000 ohms with 2.5 mil wire.

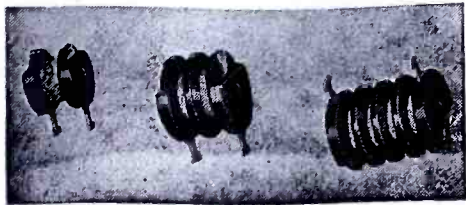

PLYTUBE MASTS

Fifty-foot plytube masts designed for u-h-f and v-h-f have been developed by the Plymold Corporation of Lawrence, Massachusetts.

The mast is made up of four sections which telescope and nest into a 14' 3" long section. With each mast, two sets of guy wires, a base plate with four base spikes and four anchors are supplied. An erection kit, consisting of a boom, one boom cylinder, boom top collars and rope vangs, one block and tackle, and a boom anchor is also included. Weight of the mast without the fittings is 29 pounds net; weight of the fittings is 41 pounds net, and the weight of the erection kit is 15 pounds.

BRAND EXTRUDED INSULATED WIRES

Thermoplastic insulated wire, Turbotherm, that is said to be resistant to the effects of oil, inorganic solvents, acids, alkalis, sunlight, ozone, and oxidation, has been announced by William Brand & Company, 276 Fourth Ave., New York 10, N. Y.

The wire is also said to have high dielectric properties, by virtue of its polyvinyl insulation values, in excess of 1000 voltage-breakdown strength, per thousandth of an inch.

Available in fine stranded and solid conductor construction, gages 24 to 30.

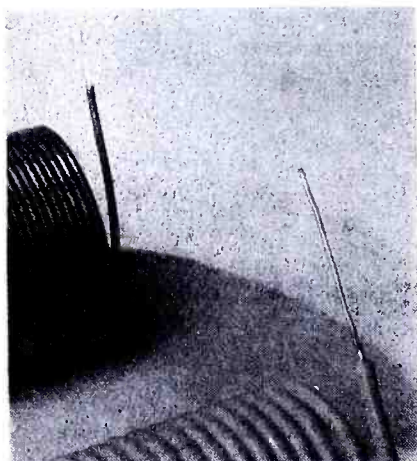

CML MEGOHM METER

A range of 400,000 ohms to 100,000 megohms in five ranges on a single scale 4" meter, is featured in a megohm meter, type 1500, developed by the meter division, Communication Measurements Laboratory, 120 Greenwich Street, New York 6, N. Y.

Single zero reset adjustment is provided for all ranges. Accuracy said to be better than 5% on all ranges at all points on scale. Weighs 8 pounds.

Line voltage, 115 volts, 60 cycles.

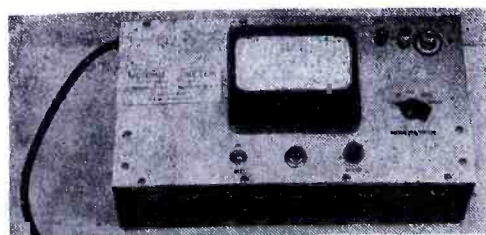

TENNEY ATMOSPHERIC CONTROL

An insulated variable temperature and humidity chamber for the simulation and control of atmospheric conditions has been announced by

Tenney Engineering, Inc., 26 Avenue B, Newark 5, N. J.

Dry bulb temperature of the air can be set from room temperature to any desired point.

Control of up to 90% relative humidity said to be possible; atmosphere will not vary over $\pm \frac{1}{2}^{\circ}\text{C}$ from the wet bulb of the humidity required.

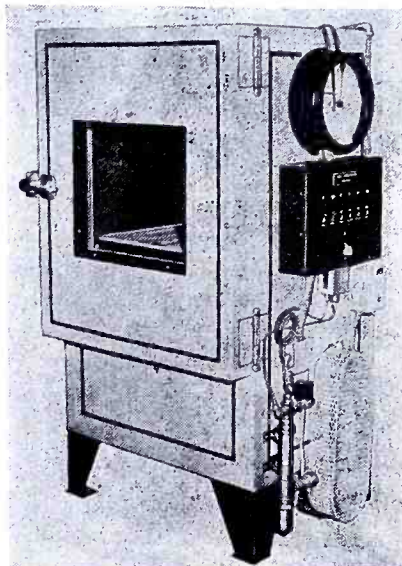

STEVENS-ARNOLD ULTRA-HIGH SPEED RELAYS

Hermetically sealed sensitive relays, Millise relays, that are said to be capable of speeds up to 1000 operations per second, have been produced by Stevens-Arnold Co., Inc., 22 Elkins Street, South Boston, Massachusetts.

Sensitivities down to 1/2 milliwatt are said to be possible. Ratings up to 5 amperes can be obtained. Closing time can be less than one millisecond. Outside dimensions of the 115-volt a-c 1-ampere rating unit are 3" high, 1 1/2" base diameter.

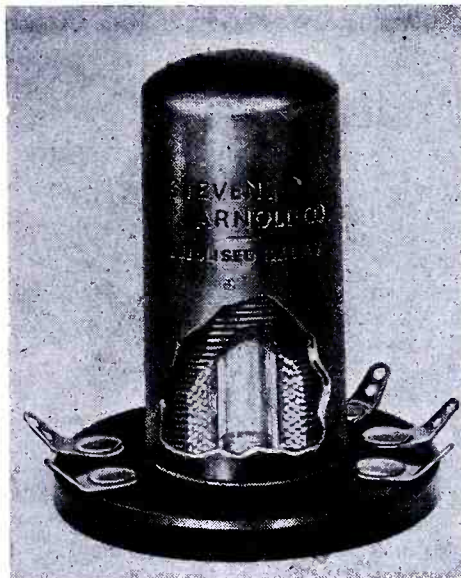

EASTERN ENG'G HEAT DISSIPATOR

Heat dissipating units that will dissipate up to 1200 watts with a constant controlled temperature, irrespective of surrounding temperature, within a close heat control range of 2° C, has been developed by the Eastern Engineering Company, New Haven, Connecticut. Size of this unit is 16" x 7 1/2" x 7 1/2"; available in steel, bronze or aluminum.

Models can be built to dissipate up to 5000 watts.

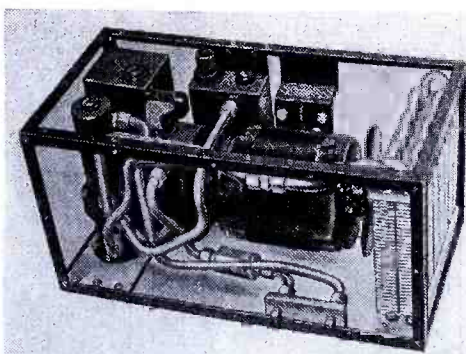

AERVOX PATENTED IN U.S. & FOREIGN COUNTRIES M.F.O. 458 922 MADE IN U.S.A.

ARMY NAVY

HEAVY-DUTY Electrolytics

● Now that V-J Day has come and gone, those heavy-duty metal-can electrolytics are once again becoming available for civilian use. Once again the Aerovox electrolytic line is providing that outstanding choice of types for the better jobs you are out to do, in this post-war radio and electronic world.

For your very best maintenance work where equipment must be kept going day in and day out; for those power packs that have to keep delivering properly filtered voltages hour after hour; for those radio sets that "must stay put" — you can depend on these Aerovox metal-can heavy-duty electrolytics.

● Ask Our Jobber...

Ask him about the Aerovox heavy-duty electrolytics that are now starting to come through for civilian use. Ask about the other types in the outstanding choice of Aerovox capacitors. Ask for a catalog—or write us direct.

AERVOX Capacitors
INDIVIDUALLY TESTED

AERVOX CORP., NEW BEDFORD, MASS., U. S. A.
In Canada: AERVOX CANADA LTD., HAMILTON, ONT.
Export: 13 E. 40 St., New York 16, N. Y. Cable: 'ARLAB'

AUDAX

RELAYED-FLUX
Microdyne

The Importance of SPECIALIZATION

Aside from outstanding and long-acknowledged technical skill — our "Specialization Formula" is probably as fully responsible for the world-renowned AUDAX quality as any other single factor.

We proudly concentrate all our energies and resources upon producing the FINEST pick-ups and cutters. Because we are specialists in this field, much more is expected of us. Because the production of fine instruments like MICRODYNE is a full time job, it stands to reason that we could not afford to jeopardize our reputation—EVER—by making pick-ups a side-line.

Now that Victory is ours, you may expect AUDAX improvements, refinements . . . master-touches to heighten the marvelous *fac-simile* realism of AUDAX reproduction.

AUDAK COMPANY

500-C Fifth Ave., New York 18, N. Y.

Creators of Fine Electro-Acoustical Apparatus Since 1915

Send for complimentary copy of our informative "PICK-UP FACTS"

★ BUY
WAR BONDS

"The Standard by Which Others
Are Judged and Valued"

ADVERTISERS IN THIS ISSUE

COMMUNICATIONS — NOVEMBER, 1945

ACME ELECTRIC MFG. CO. 86	IDEAL COMMUTATOR DRESSER CO. 101
Agency: Scheel Adv. Agency	Agency: VanAukon-Ragland, Inc.
AEROVOX CORPORATION 107	INSULINE CORPORATION OF AMERICA 85
Agency: Austin C. Lescarboura & Staff	Agency: S. R. Leon & Co.
AIREON MFG. CO. 9	ISLIP RADIO MFG. CORP. 98
Agency: Craven & Hedrick	Agency: The Kotula Co.
ALTEC LANSING CORPORATION 54	JENNINGS RADIO MFG. CO. 95
Agency: Honig-Cooper Co.	Agency: L. H. Waldron Adv. Agency
AMALGAMATED RADIO & TELEVISION CORP. 79	HOWARD B. JONES CO. 105
Agency: Shappe-Wilkes Inc.	Agency: Merrill Symonds, Advertising
AMERICAN CONDENSER CO. 92	KAAR ENGINEERING CO. 22
Agency: A. L. Addison	Agency: The Conner Co.
AMERICAN PHENOLIC CORP. 27	KARP METAL PRODUCTS CO. 15
Agency: Evans Associates, Inc.	Agency: Rose-Martini, Inc.
AMPEREX ELECTRONIC CORP. Inside Front Cover	THE LANGEVIN CO. 1
Agency: Shappe-Wilkes Inc.	Agency: Terrill Belknap Marsh Associates
AMPERITE CO. 90	THE LELAND ELECTRIC CO. 53
Agency: H. J. Gold Co.	Agency: Weiss & Geller
ANDREW CO. 91	LEWIS ELECTRONICS 28
Agency: Burton Browne, Advertising	Agency: Wank and Wank
THE ANSONIA ELECTRICAL CO. 10	McELROY MFG. CORP. 97
Agency: Albert Frank Guenther Law, Inc.	Agency: Shappe-Wilkes Inc.
THE AUDAK CO. 108	MARION ELECTRICAL INSTRUMENT CO. 23
Agency: Hart Lehman, Advertising	Agency: Shappe-Wilkes Inc.
BARKER & WILLIAMSON 77	MEASUREMENTS CORP. 6
Agency: The Harry P. Bridge Co.	Agency: Frederick Smith
BIRTCHEER CORPORATION 98	MERIT COIL & TRANSFORMER CORP. 83
Agency: Robert F. Dennis, Inc.	Agency: Merrill Symonds, Advertising
BENWOOD-LINZE CO. 103	JAMES MILLEN MFG. CO., INC. 80
Agency: Major Adv. Agency	NATIONAL UNION RADIO CORP. 43
BOONTON RADIO CORP. 94	Agency: Hutchins Adv. Co., Inc.
Agency: Frederick Smith	OHMITE MFG. CO. 73
L. S. BRACH MFG. CORP. 93	Agency: Henry H. Teplitz, Advertising
Agency: United Adv. Agency	PETERSEN RADIO CO. 97
BREEZE CORPORATIONS INC. 11	PREMAX PRODUCTS DIV. CHISHOLM-RYDER CO., INC. 84
Agency: Burke Dowling Adams	Agency: Norton Adv. Service
BURGESS BATTERY CO. 105	PRESTO RECORDING CORP. 8
Agency: Howard H. Monk & Associates	Agency: M. H. Hackett Co.
BURSTEIN-APPLEBEE CO. 106	Agency: M. H. Hackett Co.
Agency: Frank E. Whalen Adv. Co.	RADIART CORPORATION 25
CANNON ELECTRIC DEVELOPMENT CO. 97	Agency: Kenneth H. Kolpien
Agency: Dana Jones Co.	RADIO CORPORATION OF AMERICA 12
CAPITOL RADIO ENGINEERING INSTITUTE. 89	Agency: Kenyon & Eckhardt, Inc.
Agency: Henry J. Kaufman & Associates	RADIO ENGINEERING LABS., INC. 59
CARTER MOTOR CO. 99	Agency: Van Dolan, Givaudan & Masecek, Inc.
Agency: Advertising Engineers Corp.	RADIONIC EQUIPMENT CO. 97
CENTRALAB 97	RADIO WIRE TELEVISION, INC. 105
Agency: Gustav Marx Adv. Agency	Agency: S. T. Seldman & Co.
CINEMA ENGINEERING CO. 81	RAYTHEON MFG. CO. 17
Agency: The McCarty Co.	Agency: J. M. Mathes, Inc.
CLAROSTAT MFG. CO., INC. 103	RAYTHEON MFG. CO. 67
Agency: Austin C. Lescarboura & Staff	Agency: Burton Browne, Advertising
COLLINS RADIO CO. 63	REMLER CO., LTD. 97
Agency: McCann-Erickson, Inc.	Agency: Albert A. Drennan
CONCORD RADIO CORP. 82	SCHAUER MACHINE CO. 80
Agency: E. H. Brown Adv. Agency	Agency: Rudolph Krebs
COTO-COIL CO., INC. 87	SELENIUM CORPORATION OF AMERICA 84
Agency: Frank E. Dodge & Co., Inc.	Agency: Honig-Cooper Co.
CRYSTAL RESEARCH LABS., INC. 90	SIMPSON ELECTRIC CO. 26
Agency: Post & Johnson, Inc.	Agency: Kreleker & Meloan, Inc.
D-X RADIO PRODUCTS CO. 102	SORENSEN & CO. 41
Agency: Michael F. Mayger	SPERRY GYROSCOPE CO., INC. 4, 5
DIAL LIGHT COMPANY OF AMERICA INC. 94	Agency: Young & Rubicam
Agency: H. J. Gold Co.	SPRAGUE ELECTRIC CO. 16
DRAKE MFG. CO. 92	Agency: The Harry P. Bridge Co.
Agency: The Vanden Co.	STRUTHERS-DUNN, INC. 18
EASTERN AMPLIFIER CORP. 13	Agency: The Harry P. Bridge Co.
Agency: Roberts & Riemers, Inc.	SURPRENANT ELECTRICAL INSULATION CO. 101
HUGH H. EBY, INC. 100	Agency: C. Jerry Spaulding, Inc.
Agency: Renner Advertisers	SYLVANIA ELECTRIC PRODUCTS INC. 3
EITEL-McCULLOUGH, INC. 60	Agency: Newell-Emmett Co.
Agency: L. C. Cole, Advertising	TECH LABORATORIES 102
ELECTRICAL REACTANCE CORP. 99	Agency: Lewis Adv. Agency
Agency: Scheel Adv. Agency	THOMAS & SKINNER STEEL PRODUCTS CO. 86
ELECTRONIC ENGINEERING CO. 104	Agency: The Caldwell-Baker Co.
Agency: Burton Browne, Advertising	GEORGE S. THOMPSON CORP. 98
FEDERAL TELEPHONE & RADIO CORP. 104	Agency: Robert F. Dennis, Inc.
Agency: Commerce Agency, Inc.	THORDARSON ELECTRIC MFG. DIV. MAGUIRE INDUSTRIES, INC. 20
FEDERAL TELEPHONE & RADIO CORP. 7	Agency: Park City Adv. Agency, Inc.
Agency: Marshalk & Pratt	UNITED TRANSFORMER CORP. 51
FRANKLIN AIRLOOP CORP. 48, 49	Agency: Shappe-Wilkes Inc.
Agency: Sam J. Gallay	WARD LEONARD ELECTRIC CO. 14
GALVIN MFG. CORP. 21	Agency: E. M. Freystadt Associates, Inc.
Agency: Gourfain-Cobb Adv. Agency	WESTINGHOUSE ELECTRIC CORP. 31, Back Cover
GENERAL RADIO CO. Inside Back Cover	Agency: Fuller & Smith & Ross, Inc.
GUARDIAN ELECTRIC 29	WILLOR MFG. CO. 55
Agency: Kennedy & Co.	Agency: Sternfield-Godley, Inc.
HALLICRAFTERS CO. 24, 65	ZOPHAR MILLS, INC. 84
Agency: Burton Browne, Advertising	Agency: Copp Adv. Agency
HAMMARLUND MFG. CO., INC. 32	
Agency: Roeding & Arnold, Inc.	
HARVEY RADIO CO. 88	
Agency: Shappe-Wilkes Inc.	
HEINTZ & KAUFMAN LTD. 19	
Agency: The Conner Co.	
HEWLETT-PACKARD CO. 60	
Agency: L. C. Cole, Advertising	
THE HOPP PRESS, INC. 82	
Agency: Gallard Adv. Agency	



TYPE 566-A
0.5 — 150 Mc
Accuracy: 2—3%
\$45



TYPE 758-A
55 — 400 Mc
Accuracy:
2%, \$28

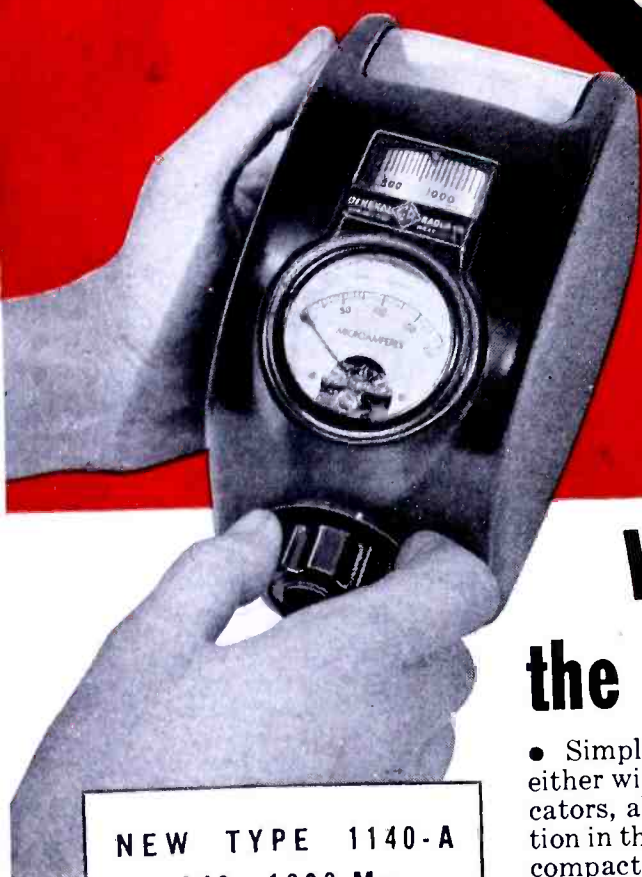

NEW TYPE 1140-A
240—1200 Mc

This is the latest addition to the G-R wavemeter line, with a butterfly-type tuned circuit in which the capacitive and inductive elements are built integrally and tuning is effected by simultaneously varying both. The rectifier is a sensitive and rugged silicon crystal detector with a microammeter for resonance indication. The scale on the frequency indicator drum is 9 inches long. The tuning unit and indicating meter are mounted in a plastic housing which can be held conveniently in one hand. The instrument is accurate to 2% of the indicated frequency. Price: \$65



TYPE 724-A 0.016 — 50 Mc
Accuracy: 0.25—1%, \$190

WAVEMETERS for the ENTIRE COMMUNICATIONS SPECTRUM

• Simple, tuned-circuit wavemeters, either with or without resonance indicators, always will find wide application in the laboratory. Direct reading, compact, lightweight, rugged, easy to use, and with accuracy more than ample for many uses, these meters effectively supplement the highly accurate heterodyne frequency meter for many types of measurement.

Wavemeters will always be useful for approximate measurements of coil ranges, oscillator spans, preliminary lining up of transmitters, locating and naming harmonics in either the receiver or the transmitter, and for general experimental work.

For almost thirty years General Radio Company has pioneered in the design and manufacture of accurate wavemeters. General Radio's frequency measurement program, which

has resulted in the finest primary standard of frequency to be obtained anywhere, has always had as a concurrent project the development of a line of wavemeters to cover as much of the useful radio spectrum as the art required.

The four instruments depicted cover the entire frequency range from 16 kc to 1,200 Mc. All of these meters are calibrated in our Calibration Laboratory in terms of the G-R Primary Standard of Frequency. All are built to the same standard of G-R quality as is found in the most precise frequency measuring assembly we manufacture.

G-R wavemeters are correctly designed, skillfully engineered, carefully manufactured and accurately calibrated. Write for detailed information.

GENERAL RADIO COMPANY

**Cambridge 39,
Massachusetts**

90 West St., New York 6

920 S. Michigan Ave., Chicago 5

1000 N. Seward St., Los Angeles 38

Swift

dependable take-offs begin here

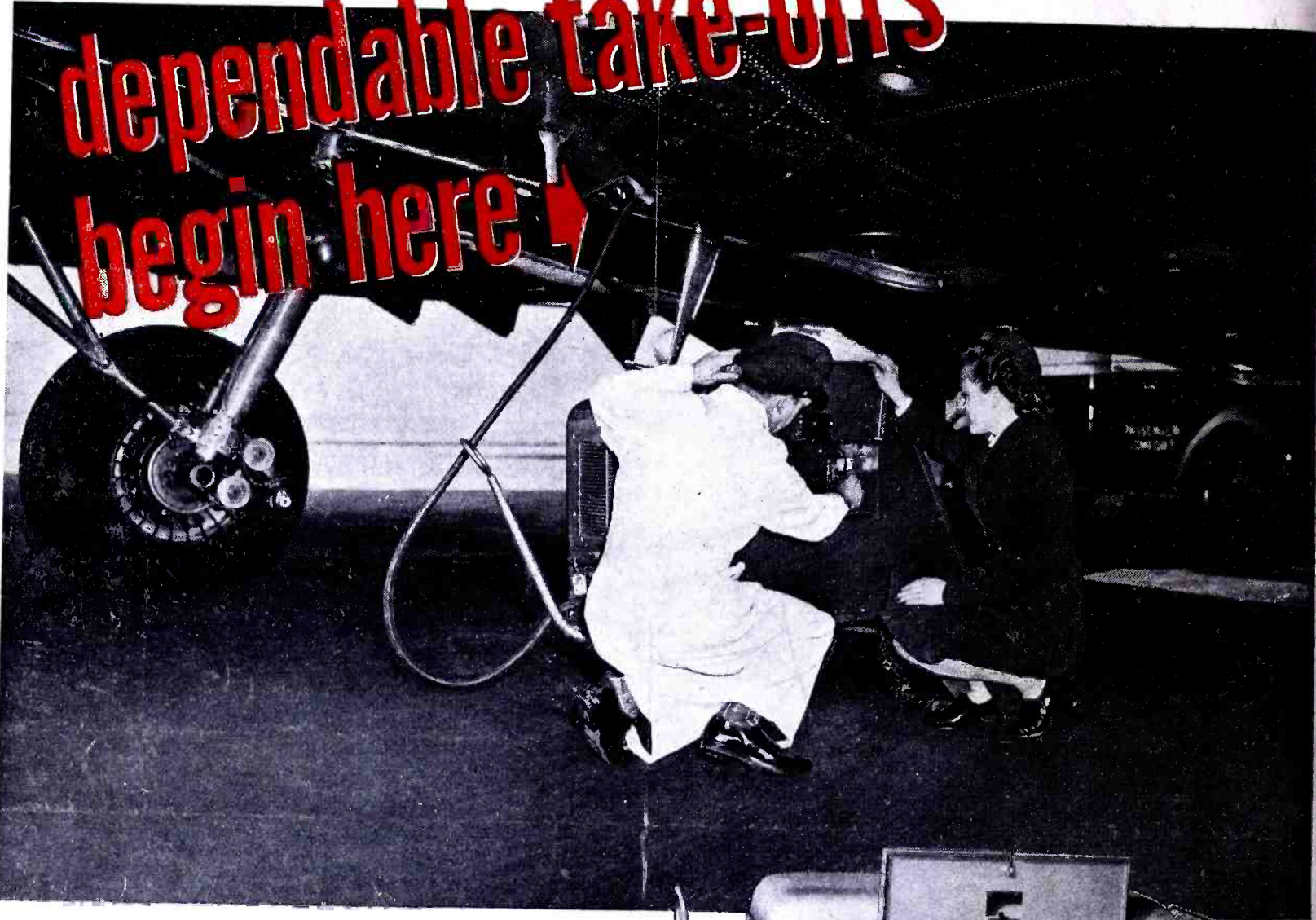

You can speed engine starting—and save your aircraft batteries—with effective, easy-to-use Rectox Engine Starters.

These portable Rectox units maintain high efficiency over a wide load range, and deliver full output *instantly*. They can be moved quickly into position on the rubber-tired wheels and they're protected by a weatherproof steel cabinet. Maintenance is low . . . no moving parts except ventilating fan.

Rectox Starters are available in 230 and 460-volt ratings for a-c input, single or 3-phase, 50/60 cycle. Each unit supplies d-c at either 12 or 24 volts.

The benefits of Rectox Aircraft Engine Starters are backed by actual performance in leading airports and aircraft engine plants. Ask your nearest Westinghouse office for all the facts. Westinghouse Electric Corporation, P.O. Box 868, Pittsburgh 30, Pennsylvania.

J-21359

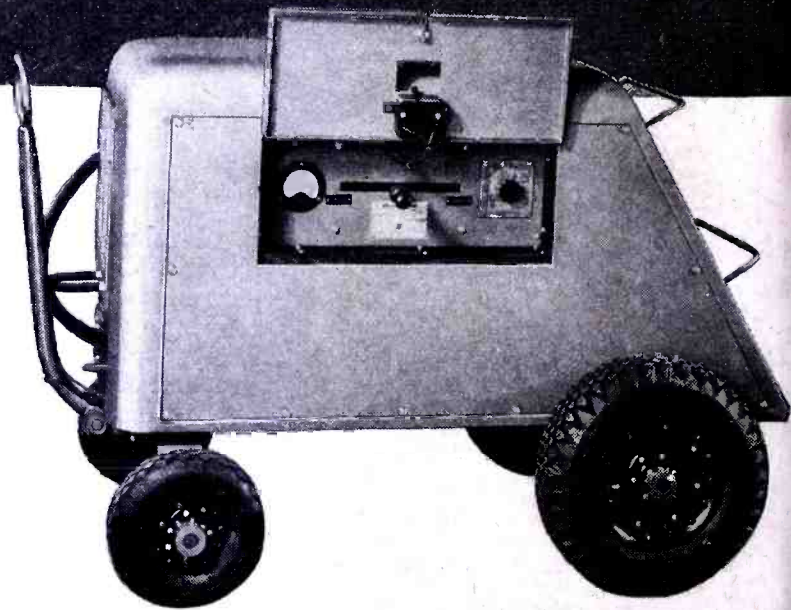

Controls shown on this Rectox Engine Starter include, left to right, ammeter, transformer and selector switches. Low center of gravity prevents tipping, improves safety. No radio interference.

Westinghouse

RECTOX AIRCRAFT ENGINE STARTERS

