

COMMUNICATIONS

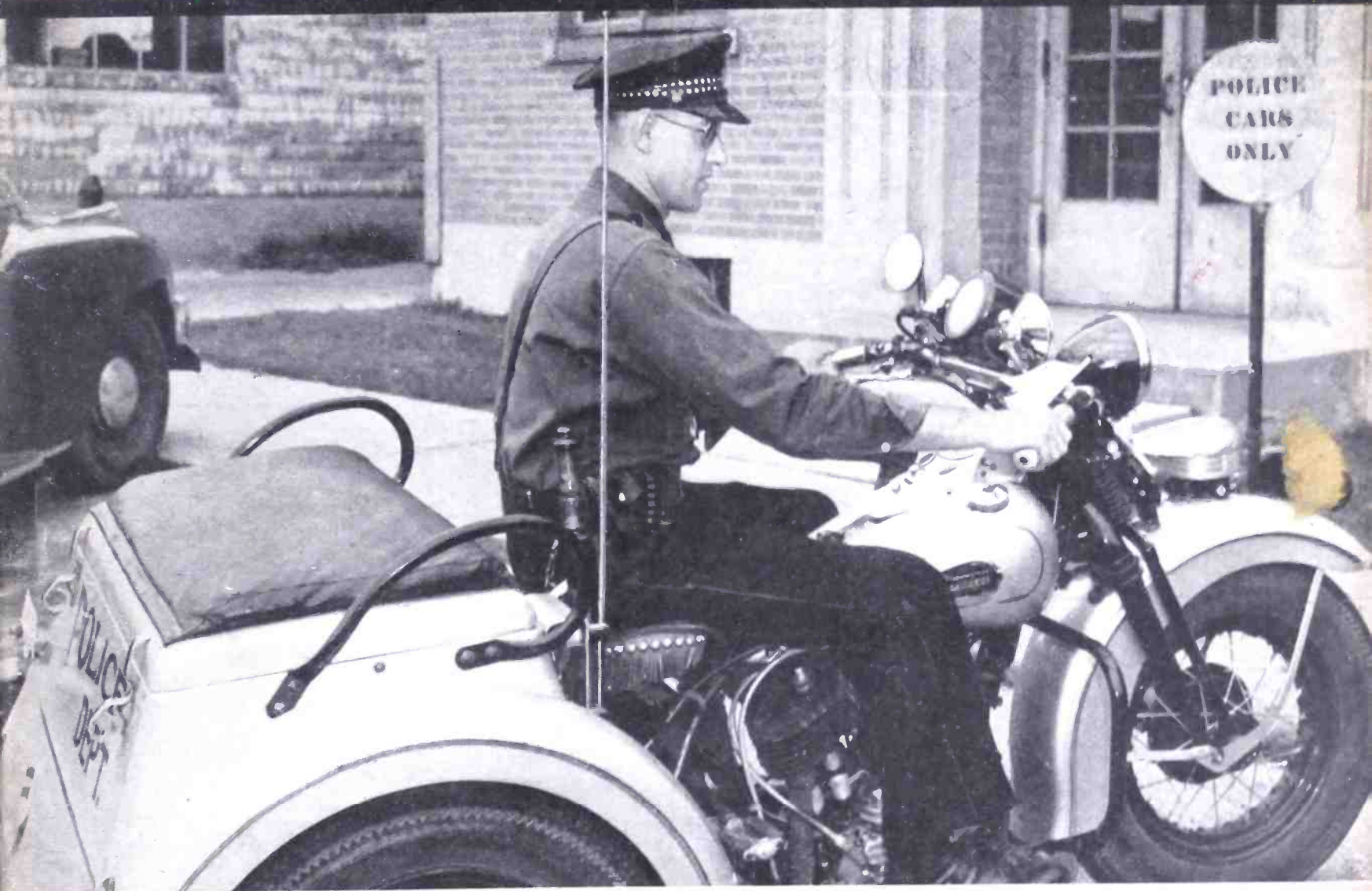

MARCH

- ★ RADIO ENGINEERING
- ★ RAF RADIO EQUIPMENT
- ★ COAXIAL CABLE LOSS AT U-H-F

- ★ NEGATIVE CAPACITANCE
- ★ HIGH Q AUDIO REACTORS
- ★ AIRCRAFT COMMUNICATIONS

1944



Special purpose

CERAMIC TUBULAR CAPACITORS

In addition to our standard type tubular capacitors Centralab is prepared to furnish **SPECIAL PURPOSE** Capacitors for radio frequencies (high and ultra-high frequencies) for both transmitter and receiver circuits.

Our extensive laboratory and engineering facilities make possible the production of special types some of which are illustrated here . . . to meet the need of our standard tubular capacitors.

We invite correspondence where special capacitors are indicated.

Send for
Bulletin No. 721
for specific
details



Centralab



Division of GLOBE-UNION INC., Milwaukee

Producers of Variable Resistors • Selector Switches
• Ceramic Capacitors, Fixed and Variable •
Steatite Insulators.

INSPECTION

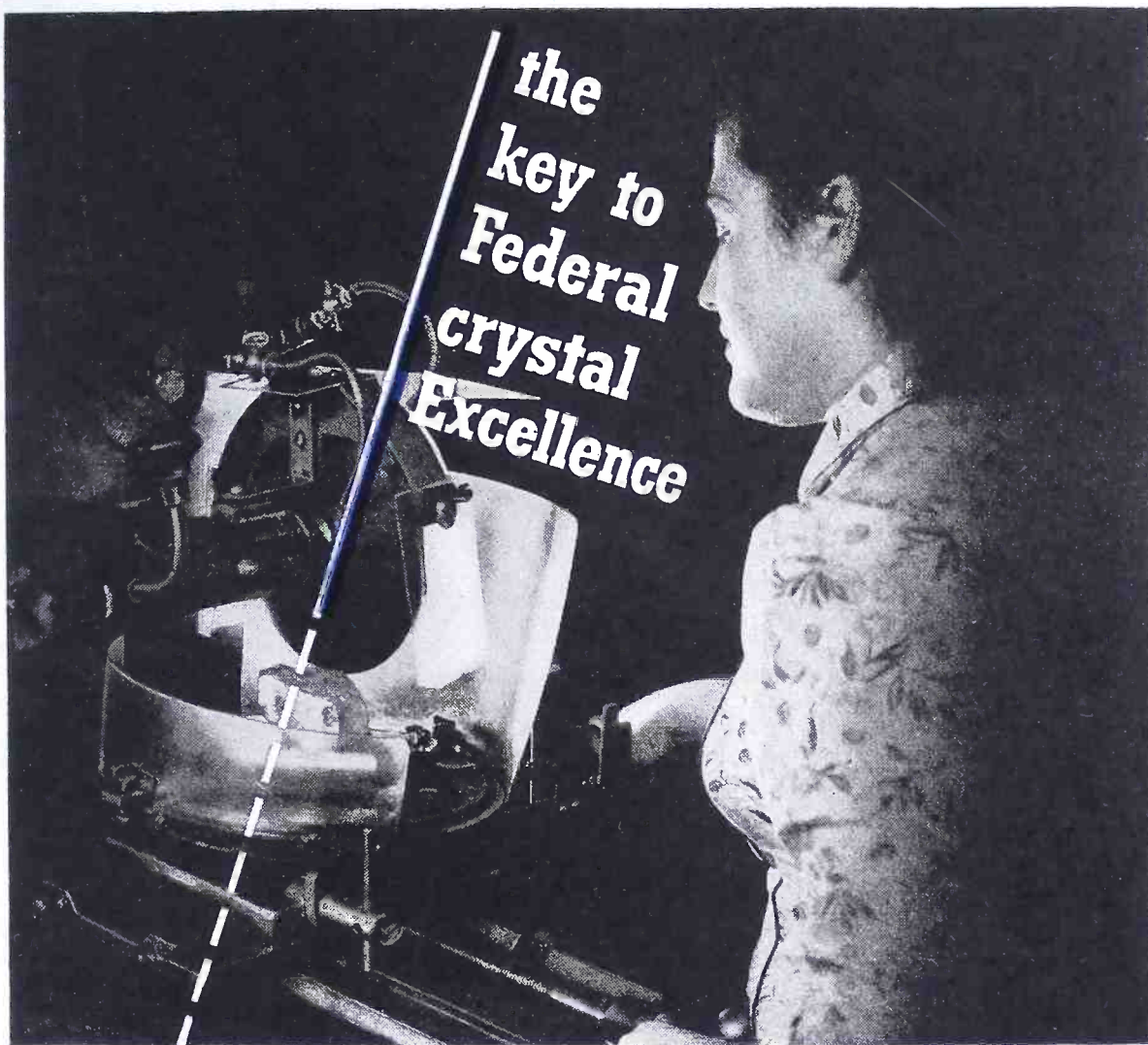

the
key to
Federal
crystal
Excellence

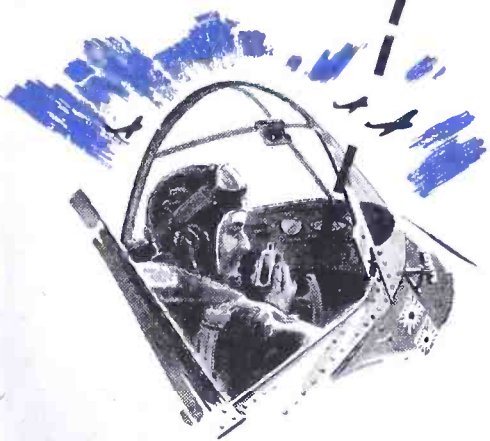

★ ★ ★

Federal is a leading manufacturer of aerial navigation, broadcast and general communications equipment. Its outstanding contributions through the years have made the name Federal synonymous with radio development and progress.

Key to the excellence of Federal Crystals is intensive, step-by-step inspection, geared to strict production tolerances.

And behind this painstaking process are world famous engineers, skilled technicians, highly developed precision machinery.

As a result, Federal has earned a reputation for crystals of the highest standard — crystals which are today filling a vital role in wartime radio.

Remember, Federal's comprehensive facilities can fill any crystal need . . . from the lowest frequency bar to the highest oscillator plate.

And with every crystal goes the Federal stamp of approval, an assurance of uniform performance under the most difficult operational conditions.

When it's crystals you want—call Federal.

Federal Telephone and Radio Corporation



Newark, N. J.

Brush Crystal

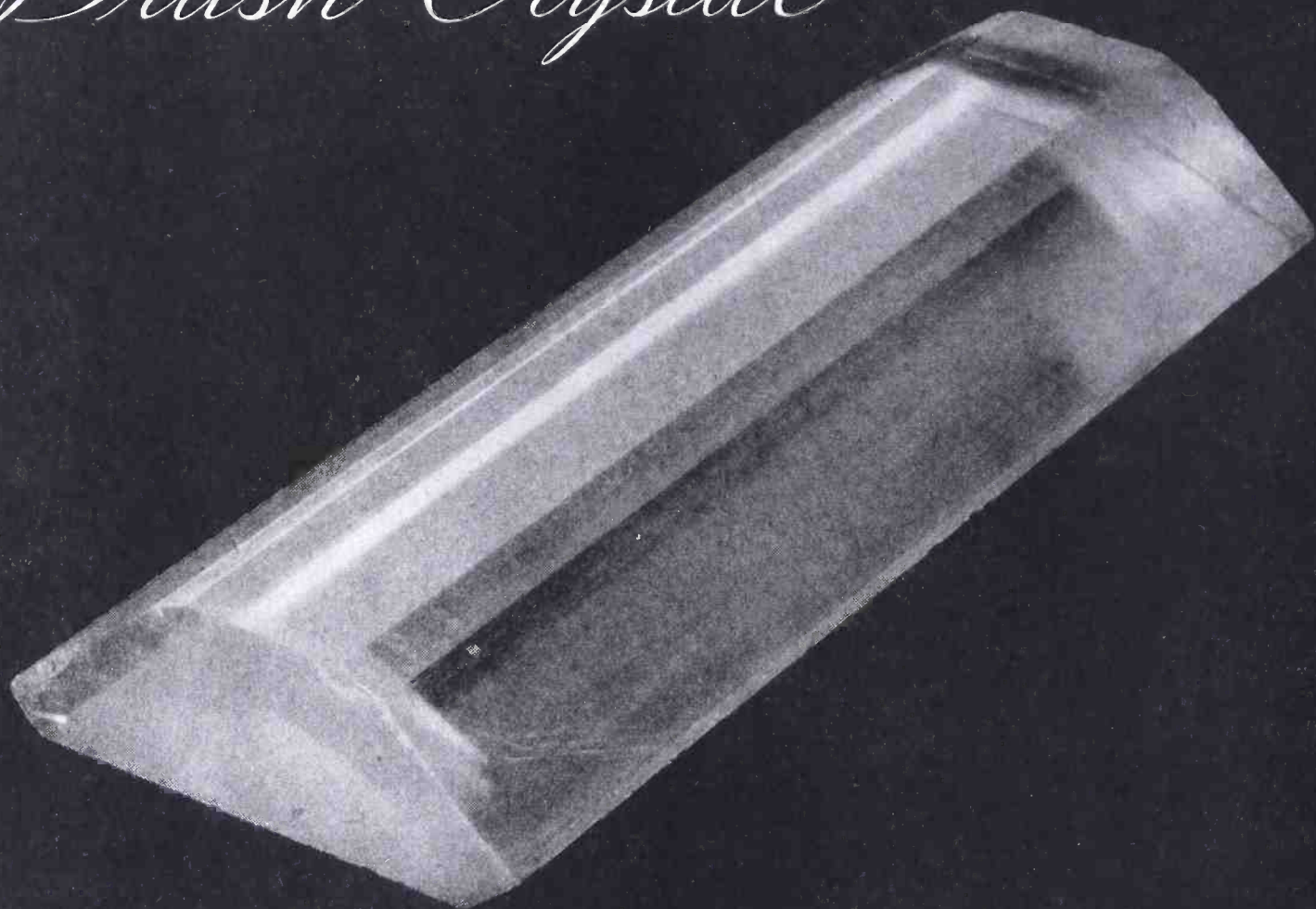

Piezo-electric products—born of Brush Crystal—are working for Victory. Soon we hope, these products and others to come will be building greater progress for you in the postwar world.

Yours for Postwar

THE BRUSH DEVELOPMENT CO.

3315 PERKINS AVENUE

CLEVELAND, OHIO

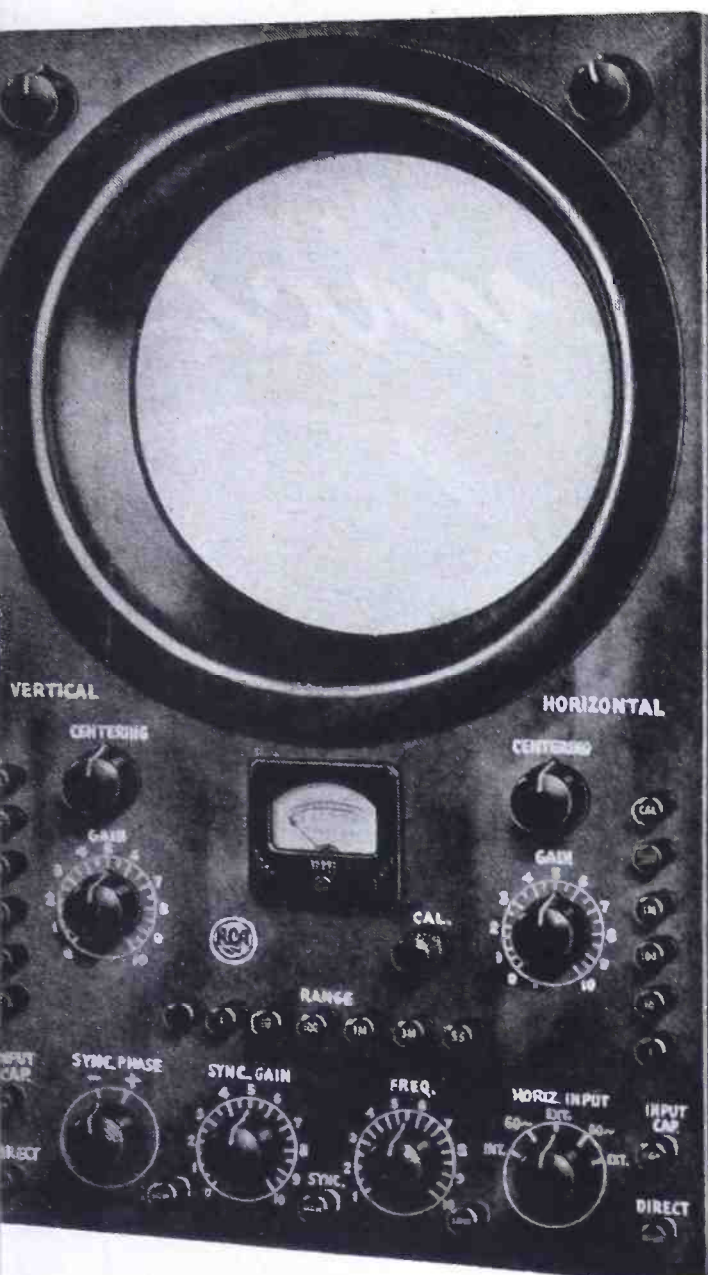

Here's an Oscilloscope
that ranges from
100 kilocycles down
to zero cycles!

RCA Type 327-A D. C. Oscilloscope

THAT'S why it's called a D.C. Oscilloscope: because it uses direct coupled amplifiers having a low frequency characteristic that holds good all the way down to no frequency—in other words, direct current.

- Equipped with 9" tube—RCA 914 high vacuum type.*
- Identical horizontal and vertical amplifiers.*
- Direct connection (capacity coupling) may be made to either pair of deflecting plates.*
- Vacuum tube (non-gaseous) timing axis oscillator operates down to 1 cycle per second. Special feature for converting normal timing axis to a single sweep circuit for study of transient phenomena.*
- Ideal for photographic work: combined blanking circuit provides increased intensity and illumination only during sweep.*
- Fitted with push button switches for fast manipulation.*

AMPLIFIER CHARACTERISTICS	
FREQUENCY RANGE 0 to 100,000 cycles per second.	MAXIMUM INPUT AC—800 volts for 8" deflection.* DC—240 volts for 4" deflection.*
DEFLECTION SENSITIVITY DC—.06 volts per inch.* AC—.02 volts RMS per inch.* AC direct to deflecting plates —52 ^{1/2} volts RMS per inch.	ATTENUATOR RANGES 4 steps of 10 to 1 each, with fine control over each range.
* Approximate	

NOTE: Deliveries as scheduled under General Scheduling Order M-293 of WPB. Please address inquiries to Test and Measuring Equipment Section, Radio Corporation of America, Camden, New Jersey.



Test & Measuring Equipment
RADIO CORPORATION OF AMERICA

GUTHMAN Inductronics*

INDUCTORS AND ELECTRONICS

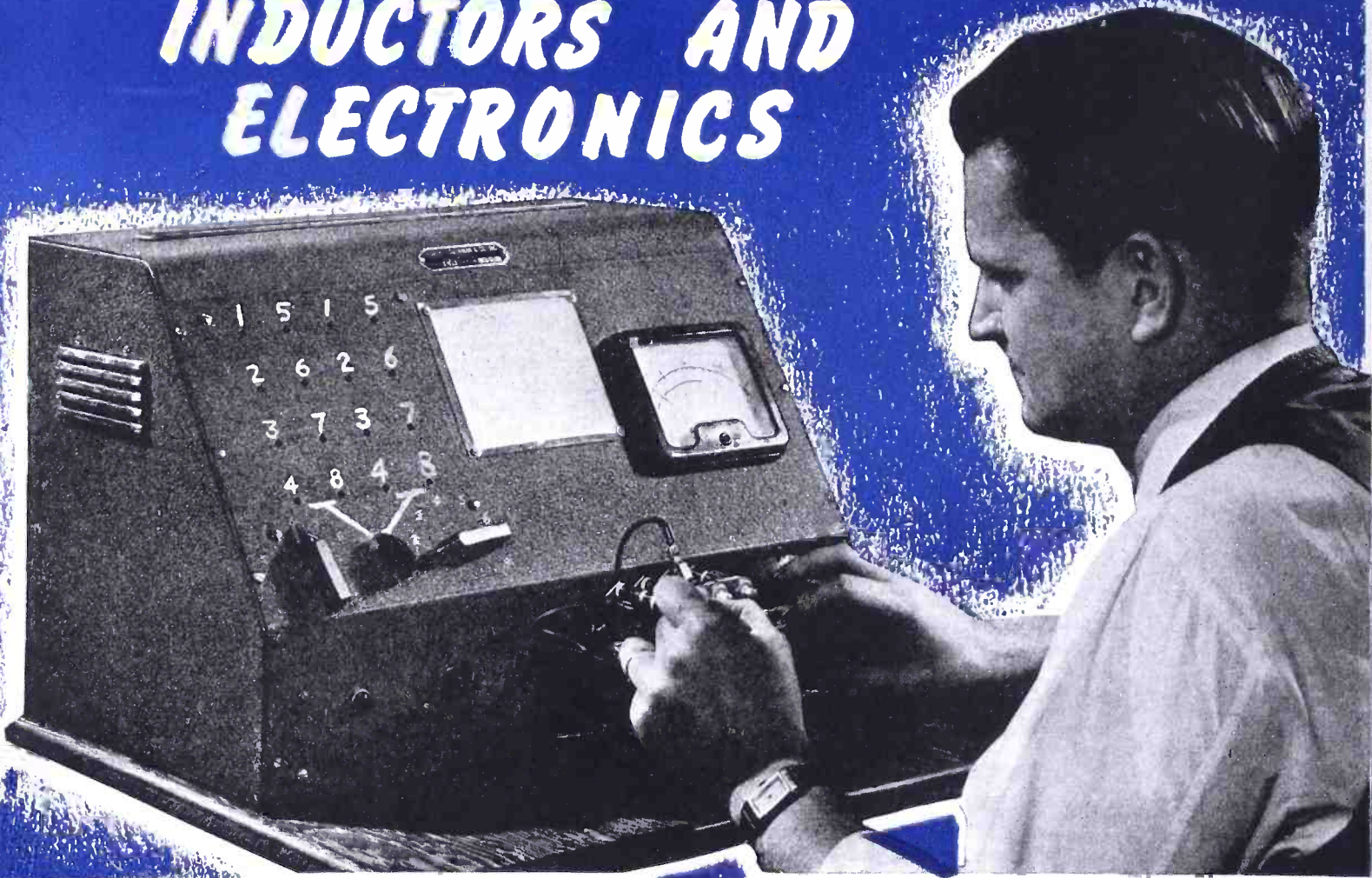

Typical in precision measuring of R. F. Inductors to rigid war production tolerances, the "Dynamic Inspection Analyzer" is representative of the ingenuity of Guthman "INDUCTRONIC" research. Employing a highly stabilized circuit of our own design this 24-frequency inspection device, used in the manufacture of an Ant. R. F. and Osc. assembly, can analyze the individual coils for band coverage, inductance, and Q. at their operating frequencies. Uniformity of electrical characteristics in the manufacture of Guthman super-improved coils makes...

*Guthman... "Leader in Inductronics"**

* Copyright: Edwin I. Guthman & Co., Inc. 1943



EDWIN I. GUTHMAN & CO. INC.

15 SOUTH THROOP STREET · CHICAGO

PRECISION MANUFACTURERS AND ENGINEERS OF RADIO AND ELECTRICAL EQUIPMENT

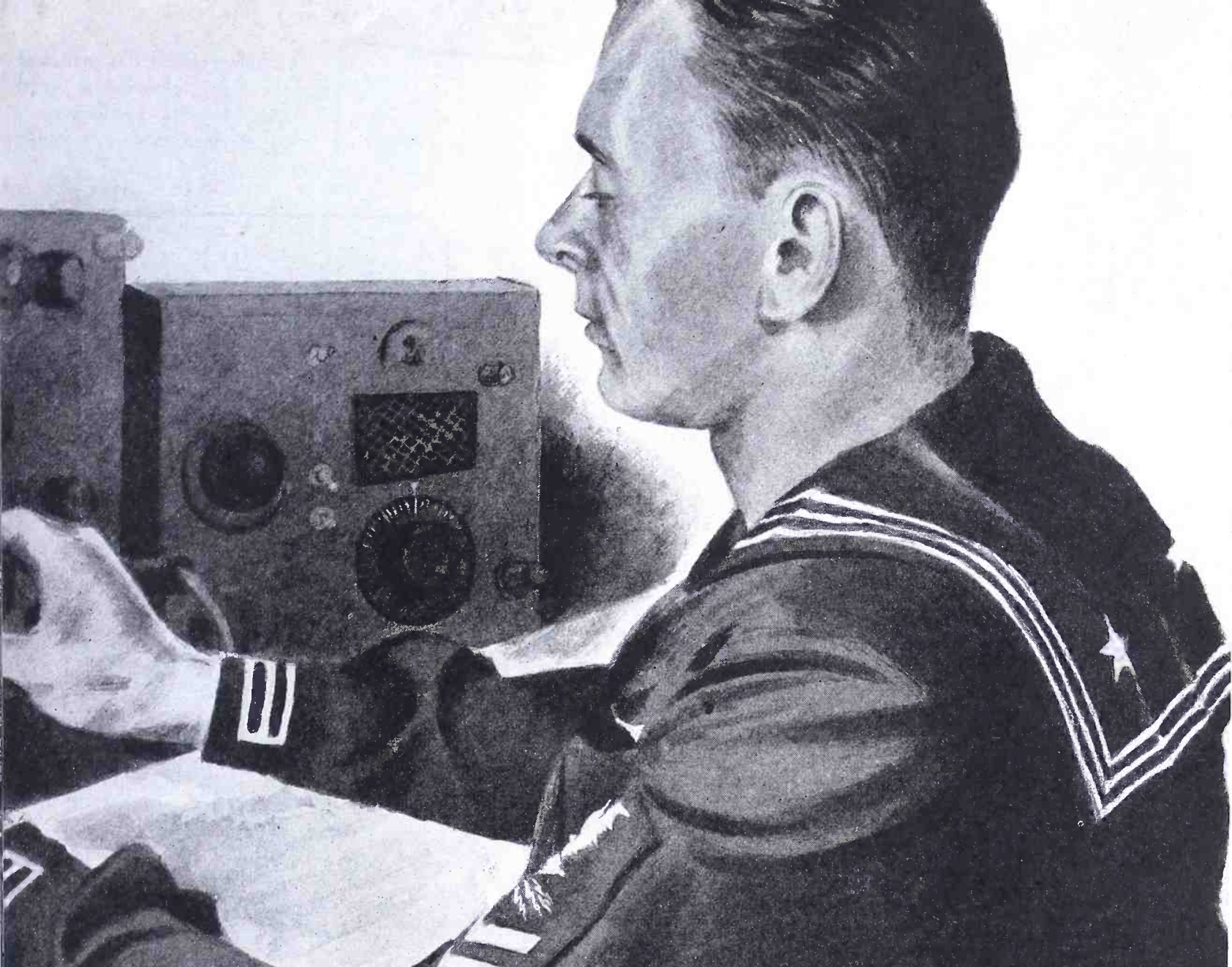

The amateur is still in radio...

No other industry has had the benefit of such an eager and proficient group of supporters as the radio amateur.

By his own experimentations and inventions, and because of the extreme demands he made upon radio equipment, the radio amateur has been the driving force behind many of the major developments in radio. Out of the amateur testing grounds have come advanced techniques and vastly superior equipment of which Eimac tubes are an outstanding example.

Eimac tubes created and developed with the help of radio amateurs, possess superior performance characteristics and great stamina. They will stand momentary overloads of as much as 600% and they are unconditionally guaranteed against premature failure due to gas released internally. These are good reasons why Eimac tubes are first choice among leading electronic engineers throughout the world.

Follow the leaders to

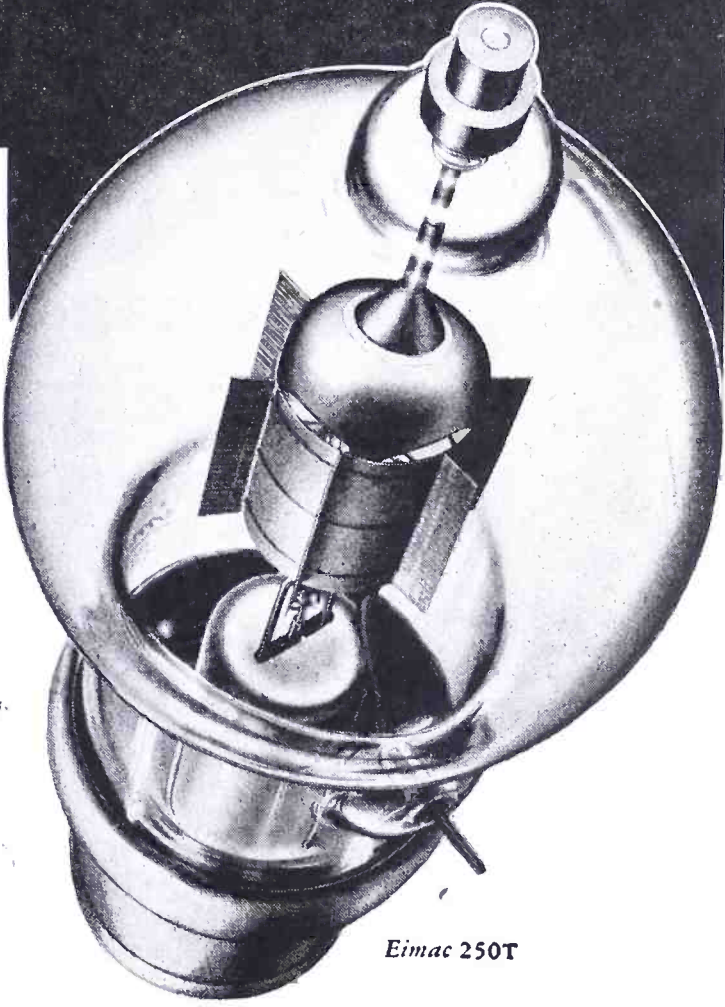

Eimac 250T

EITEL-McCULLOUGH, Inc., SAN BRUNO, CALIF.

Plants at: Salt Lake City, Utah and San Bruno, California

Export Agents: **FRAZAR & HANSEN, 301 Clay Street, San Francisco, California, U. S. A.**



RATING DATA

Voltage and Wattage Ratings:—

Resistance Value
Up to 1.9 megohms
2.0 to 10 megohms
Above 10 megohms

Resistance Value
Up to 3.9 megohms
4.0 to 20 megohms
Above 20 megohms

Temperature Rating:—
Maximum recommended hot spot temperature for continuous operation: 130°C (Ambient plus rise).
Maximum recommended ambient temperature for full wattage ratings: 70°C.

Temperature Coefficient:—
Approximately .04% per degree C between 20°C and 130°C.

TYPE 1
Maximum Wattage Rating
12 watts
9 watts
based on voltage

TYPE 2
Maximum Wattage Rating
22 watts
15 watts
based on voltage

R.M.S. Voltage Rating
based on wattage
9 kv. max.
10 kv. max.

R.M.S. Voltage Rating
based on wattage
15 kv. max.
20 kv. max.

Resistance Tolerance:—
Minimum acceptable tolerance $\pm 10\%$.

Construction:—
(a) Hermetically-sealed to withstand salt water immersion tests.
(b) Designed to withstand aircraft vibration and 10g acceleration tests.

A problem solved, designed, and produced in ninety days—and made possible by longstanding research and experience.

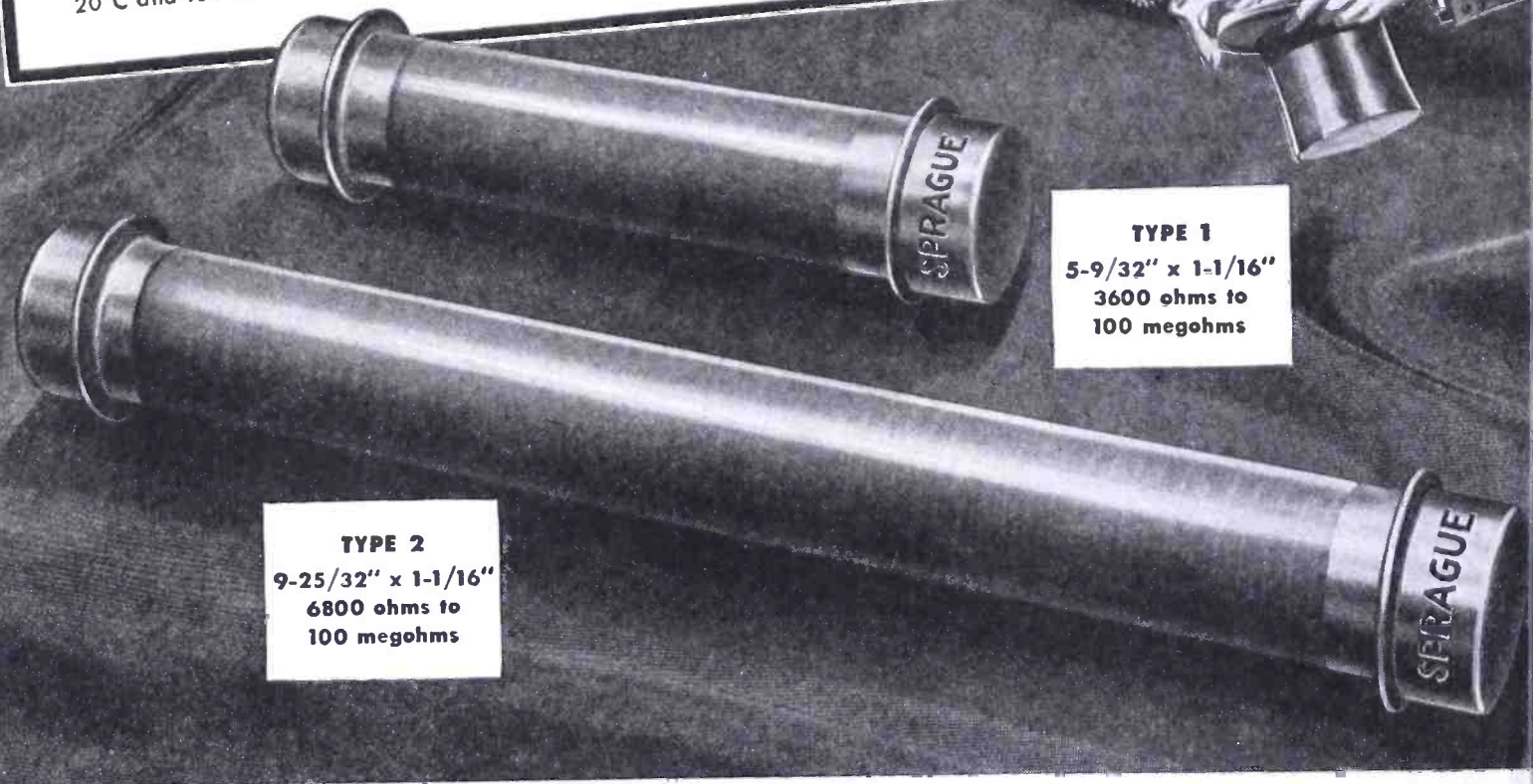

TYPE 1
5-9/32" x 1-1/16"
3600 ohms to
100 megohms

TYPE 2
9-25/32" x 1-1/16"
6800 ohms to
100 megohms

SPRAGUE MEG-O-MAX

HIGH-RESISTANCE, HIGH-VOLTAGE RESISTORS

Less than 3 months from the presentation to Sprague Koolohm Resistor engineers of the problem of designing high-resistance value units capable of dissipating power at voltages up to 20 kv. and at high ambient temperatures, the first Sprague Meg-O-Max Resistors were on the job! Moreover, they used practically no critical materials, were of smaller physical size, and presented a degree of resistance stability and mechanical ruggedness not available in other units, exclusive of costly wire-wound meter multiplier types!

Entirely unique in construction, Meg-O-Max Resistors are formed of a series of molded segments. These are joined non-inductively, and the assembly is then encased in a hermetically-sealed, rugged glass envelope provided with ferrule terminals to withstand aircraft

vibration tests, salt water immersion tests, and test for mechanical shock produced by rapid acceleration.

In addition to use as a high-voltage bleeder and as broad accuracy meter multiplier for a voltage indicator, Meg-O-Max Resistors find many applications in measuring instruments, rectifier systems, high-voltage dividers, and as broad accuracy meter multipliers. Specify Meg-O-Max for High-Resistance—High-Voltage requirements.

Data sheets gladly sent upon request. Samples sent only on firm's request, giving details of application.

SPRAGUE SPECIALTIES COMPANY
Resistor Division • North Adams, Mass.

A NEW DEVELOPMENT BY THE MAKERS OF

KOOLOHM

TRADEMARK REGISTERED

INSULATED WIRE-WOUND RESISTORS



Not just one test—
but **90!**

Longer life and superior performance are distinguished characteristics of NORELCO Cathode Ray Tubes. These qualities are achieved by advanced production techniques—assured by perfect scores in 90 exacting tests of raw materials, parts, sub-assemblies, assemblies and performance.

One of the 90, the torsion test, which follows the immersion test, is illustrated above.

It is this precision, this relentless pursuit of perfection which has made North American Philips one of the leading producers of Cathode Ray Tubes. NORELCO power, transmitting and special-purpose tubes, quartz oscillator plates and communications equipment are doing wartime duty on land, on sea and in the air. And for those who carry this equipment on to Victory, every okeh on our inspection line is vital.

Tomorrow, these skills, the heritage of long years of world-wide experience in electrical applications, will be available for the development of peacetime industries.

For our war industries we now make Searchray

(X-ray) apparatus for industrial and research applications; X-ray Diffraction Apparatus; Electronic Temperature Indicators; Direct Reading Frequency Meters; Electronic Measuring Instruments; High Frequency Heating Equipment; Tungsten and Molybdenum in powder, rod, wire and sheet form; Tungsten Alloys; Fine Wire of practically all drawable metals and alloys: bare, plated and enameled; Diamond Dies.

And for Victory we say: Buy More War Bonds.

Norelco

ELECTRONIC PRODUCTS by

NORTH AMERICAN PHILIPS COMPANY, INC.

Executive Offices: 100 East 42nd Street, New York 17, New York
Factories in Dobbs Ferry, New York; Mount Vernon, New York
(Metalix Division); Lewiston, Maine (Elmet Division)

COMMUNICATIONS FOR MARCH 1944 • 11

AAC Quartz CRYSTALS

help keep the communications



Today..and Tomorrow

Illustrated at right is a typical crystal manufactured by Aircraft Accessories Corporation and used in both ground and plane radio installations by America's commercial airlines. Many other types of AAC crystal units are being supplied various branches of the armed service and other government agencies.

Today, practically all AAC facilities are devoted to war production. Tomorrow, advanced AAC electronic developments will be available for the post-war world.

AAC

Products

AIRCRAFT

Manufacturers of PRECISION
Burbank, Calif. Kans. City

Systems of the World's Greatest Airlines Working Efficiently!

REALIZING the extreme importance placed by the airlines upon the proper maintenance of their communications facilities, Aircraft Accessories Corporation has set aside a special division of its crystal laboratories to provide rapid delivery to airlines and associated communications services of a variety of standard crystals. Deliveries in limited quantities can be made within a few days after receipt of purchase order with adequate priority.

In the manufacture of quartz crystals, AAC development and production engineers employ the experience gained as one of America's largest producers of transmitters and other precision radio equipment. AAC crystal units will meet the most exacting requirements under severe operating conditions. Address all crystal orders and inquiries to Electronics Division, Kansas City, Kansas.

The services of our Engineering Department in designing special equipment are available to you without obligation.

Products of

ELECTRONICS DIVISION

TRANSMITTERS • AIRCRAFT AND TANK ANTENNAS
QUARTZ CRYSTALS • RADIO
TEST EQUIPMENT

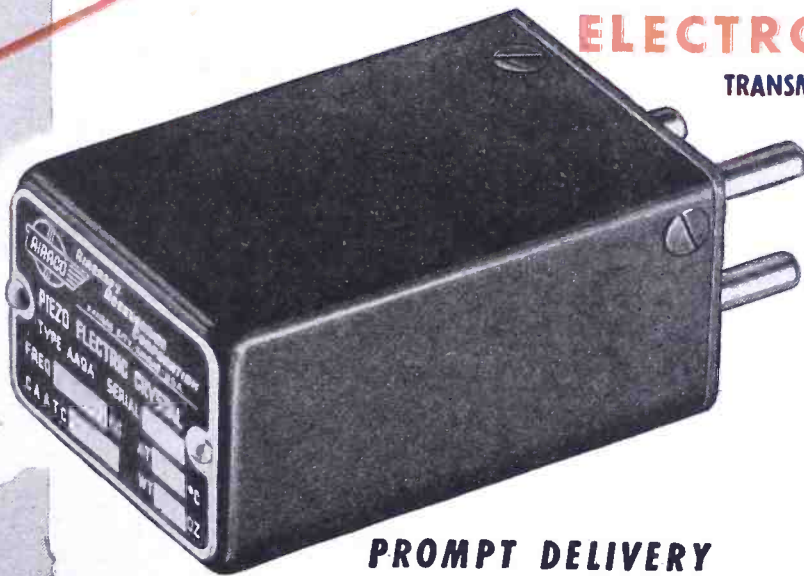

PROMPT DELIVERY

◀ Type AA9 Crystal, 2.5 parts/million temperature coefficient, accuracy of carrier frequency .01%. Made in three models—A, G and E, covering total fundamental frequency range of 200 to 10,000 kc. Internal adjustment screw permits small amount of frequency control in the single crystal units, AA9A and AA9G.

AIRCRAFT ACCESSORIES CORPORATION

AIRCRAFT EQUIPMENT • HYDRAULICS • ELECTRONICS

City, Kans.

New York, N. Y.

Cable Address: AACPRO



“Landing According to Plan”

IN the planning . . . and the execution . . . of landing operations Communications are playing a vital part. That's why in the forefront of every landing party there usually is to be seen the man with the Pack Set strapped to his back. Light and compact, yet powerful and sturdy, this adaptation of the walkie-talkie provides the *instant communication* by which our intricate military operations are planned . . . and carried out.

In the Pack Set, as in many other audio communication instruments, Transformers by Rola are living up to a reputation gained through 25 years of leadership in Sound Reproduction. That, no doubt, is the reason why so many of the largest producers of communication equipment are looking to Rola for Transformers, Headsets, Coils and other Electronic Parts . . . why others are saying, "Let's discuss our problem with Rola".

THE ROLA COMPANY, INC., 2530 SUPERIOR AVENUE, CLEVELAND 14, OHIO

ROLA

Let's do more



in forty-four!

MAKERS OF THE FINEST IN SOUND REPRODUCING AND ELECTRONIC EQUIPMENT



JACK GRAND
Burlingame Associates
10 Murray St., N. Y. C.



CHAS. E. SARGEANT
Burlingame Associates
10 Murray St., N. Y. C.



J. D. RYERSON
Burlingame Associates
10 Murray St., N. Y. C.



ALFRED CROSSLEY
549 W. Randolph Street
Chicago, Illinois



HARRY HALINTON
Alfred Crossley
549 W. Randolph Street
Chicago, Illinois



NORMAN B. NEELY
5334 Hollywood Blvd.
Hollywood, California



D. LOU HARRIS
Atlas Radio Corporation
560 King St. West
Toronto 2, Canada

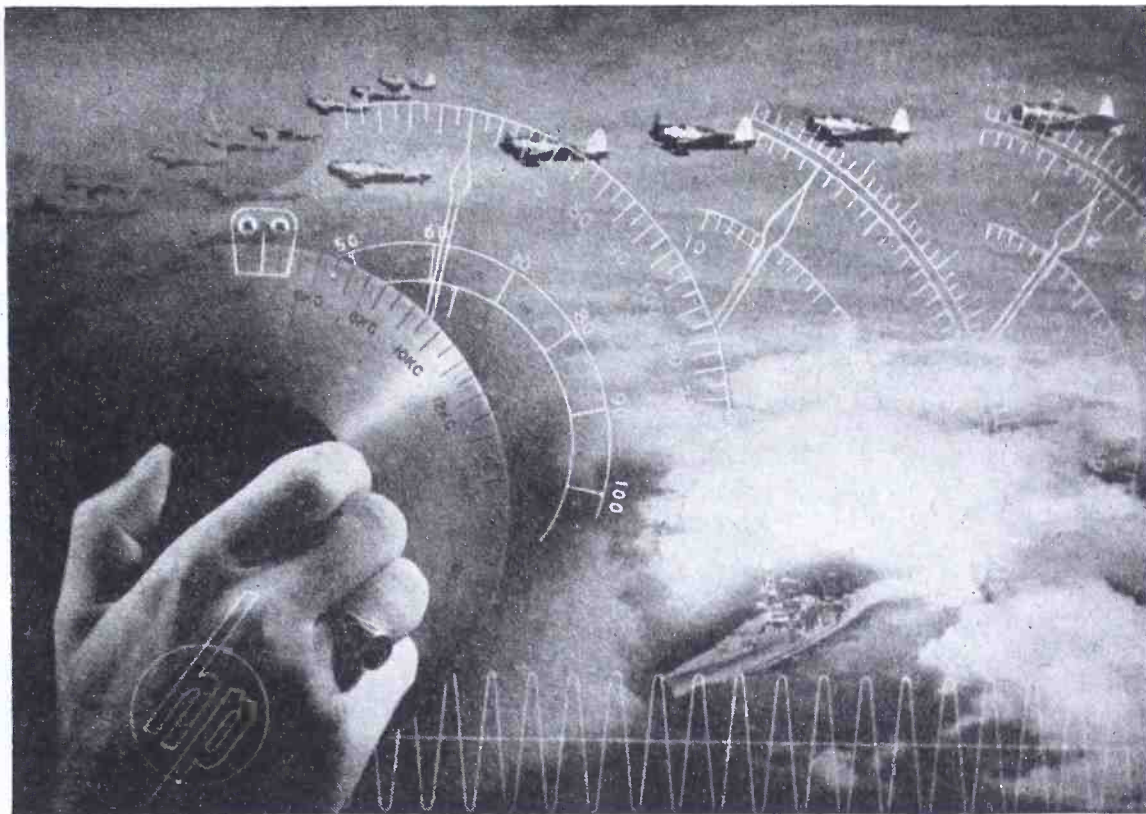

THESE ARE -HP- MEN YOU SHOULD KNOW



One of the fundamentals of *-hp-* equipment is the speed with which tests and measurements can be made. Accuracy, of course, is never slighted in gaining this end. This same fundamental permeates the entire organization from the engineers who design the instruments to the men in the field who contact you personally. Today, more than ever, time is an important factor. The men whose pictures are shown here are at your service... fully prepared to demonstrate the speed and accuracy of *-hp-* instruments as well as the speed and accuracy of *-hp-* service to you. We urge you to contact the man who is located nearest your office.

HEWLETT - PACKARD COMPANY

Laboratory Instruments for Speed and Accuracy

PALO ALTO, CALIFORNIA
BOX 676F, STATION A

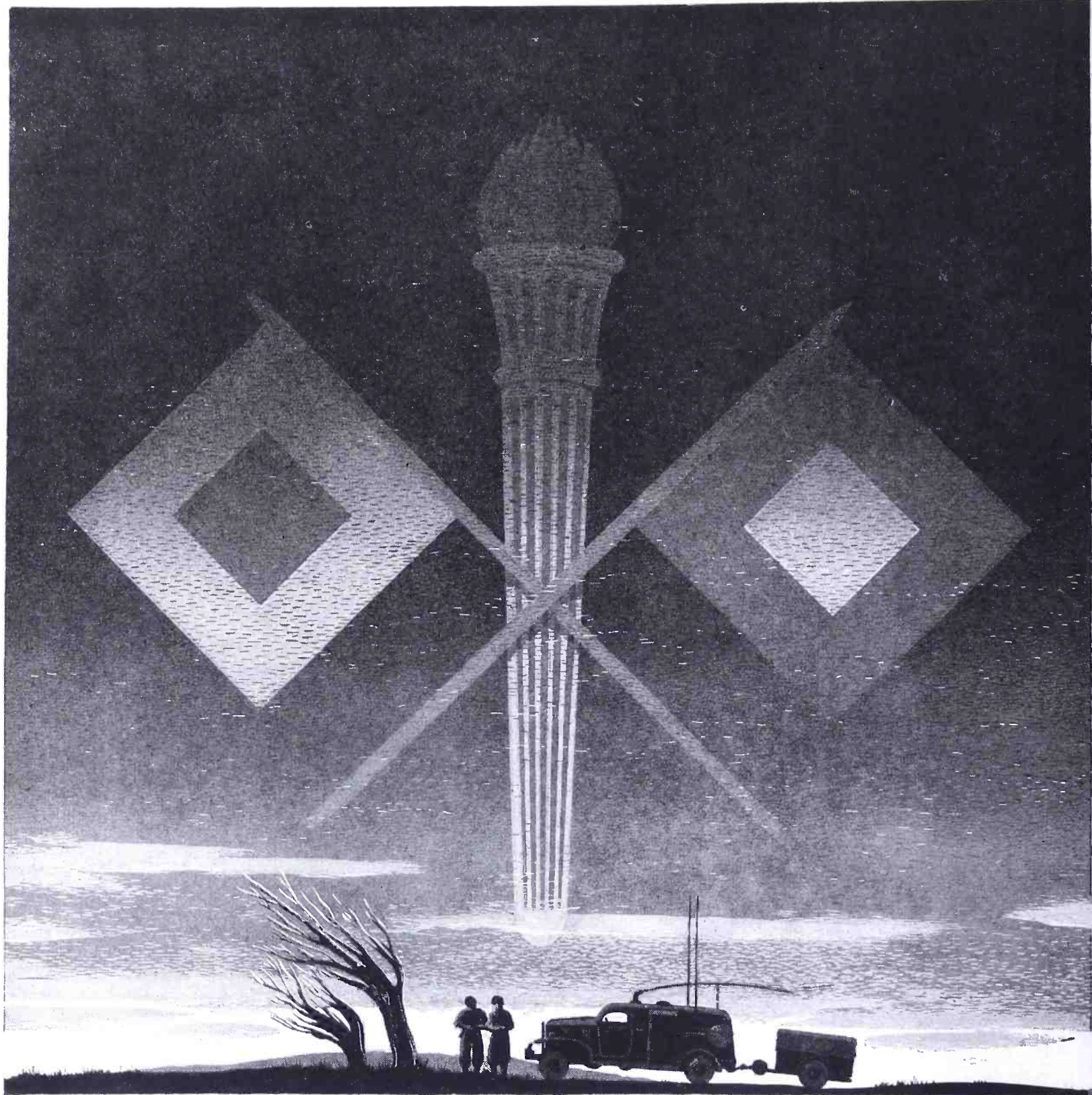

A TRIBUTE to the members of the Signal Corps, United States Army, for their great achievements in the field of military communications. On every front, from the development laboratory to the most remote outpost, they are doing their job superbly well.

Hallicrafters employees are proud of the part they are privileged to take in the design and production of radio equipment for the Signal Corps.



BUY MORE BONDS!

hallicrafters RADIO

THE HALLICRAFTERS CO., MANUFACTURERS OF RADIO AND ELECTRONIC EQUIPMENT, CHICAGO 16, U. S. A.
16 • COMMUNICATIONS FOR MARCH 1944



**THE IMPORTANCE
OF CRYSTALS IN**
Modern Warfare

Success in modern warfare depends greatly upon accurate and dependable coordination between all combat units. Precision crystals by **Crystal Products Company** are providing sharp selectivity on planes, tanks, ships, in every climate and under the most rigorous battle conditions.

 *Crystal*

PRODUCTS COMPANY

1519 MCGEE ST., KANSAS CITY 8, MO.

Producers of Approved Precision Crystals for Radio Frequency Control

OHMITE RHEOSTATS

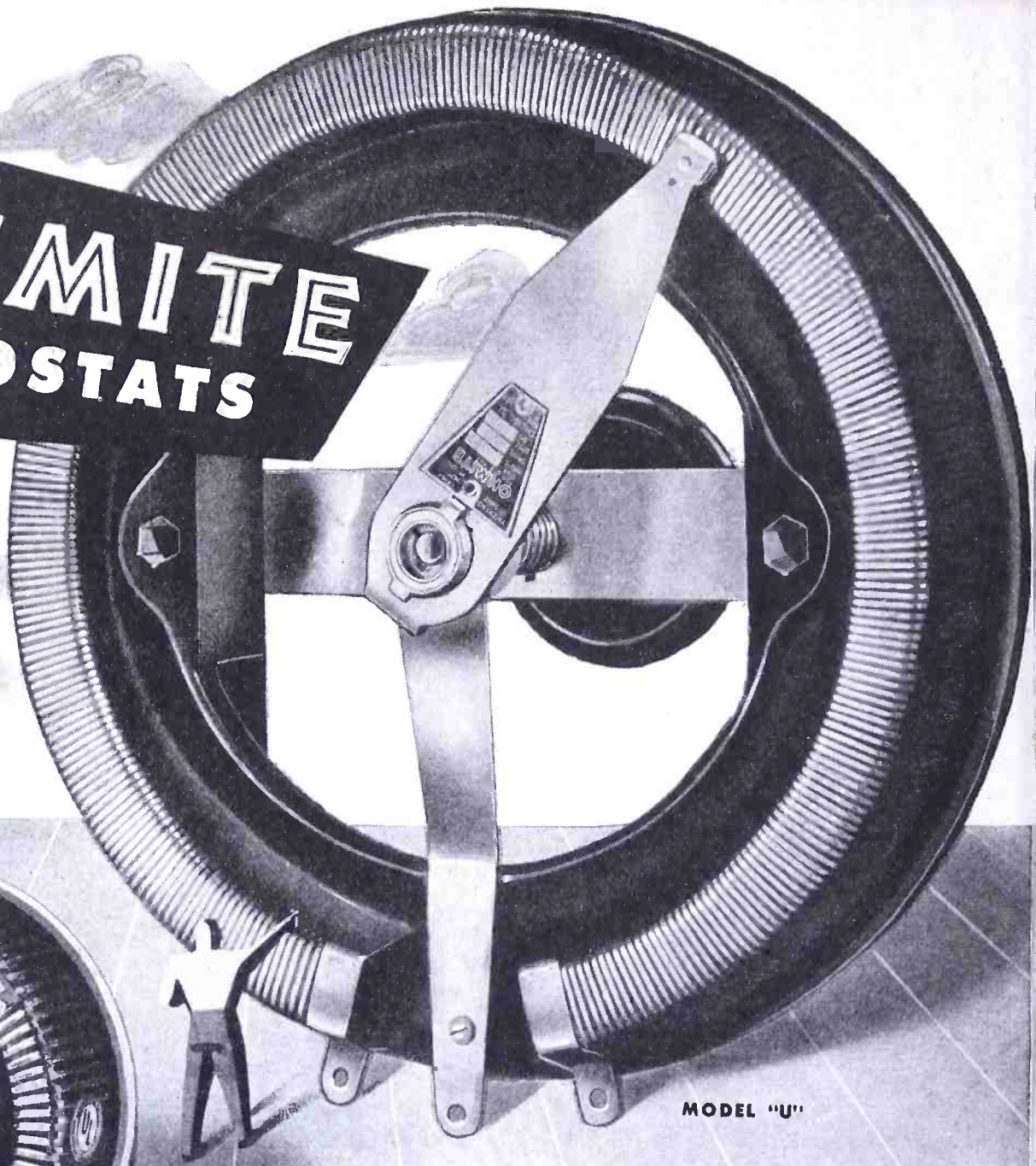

MODEL "U"

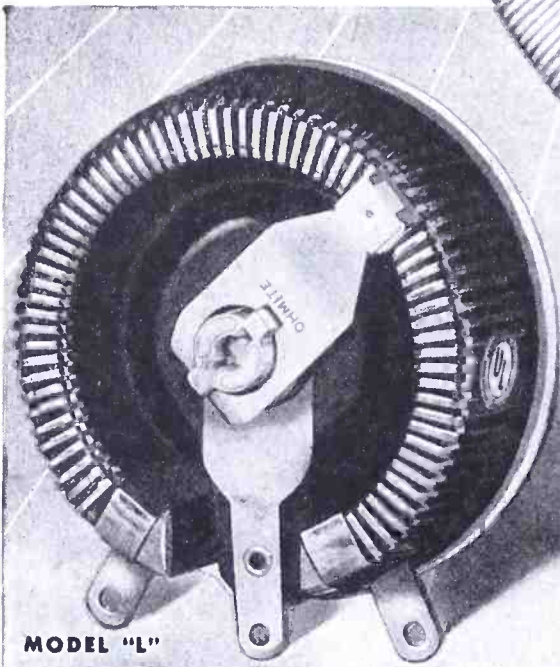

MODEL "L"

BIG Sizes for BIG Jobs

The Model "U" shown above is 12" in diameter and rated at 1000 watts. The Model "L" is 4" in diameter and rated at 150 watts. Other models in this series of larger units are 10", 8", 6" and 5" in diameter and rated at 750, 500, 300 and 225 watts respectively. These rheostats handle tough applications with ease. They provide permanently smooth, close, trouble-free control on big jobs. Made in single or tandem assemblies, in straight or tapered winding, from 25 watts to 1000 watts.

Your "Answer Book" to Resistance Problems
Write on company letterhead for 96-page Industrial Catalog and Engineering Manual No. 40.

OHMITE MANUFACTURING CO., 4870 Flourney St., Chicago 44, Ill.



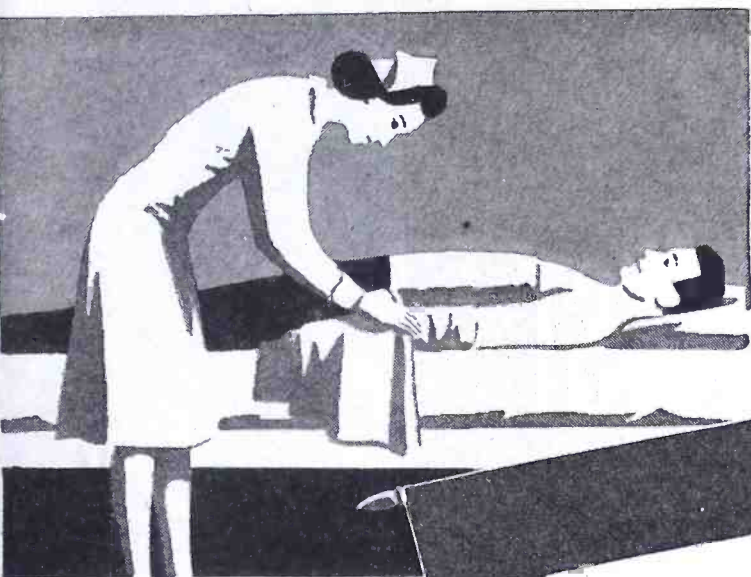

BLOOD DONATIONS by the hundreds have been made by Breeze workers to the Red Cross Blood Bank.

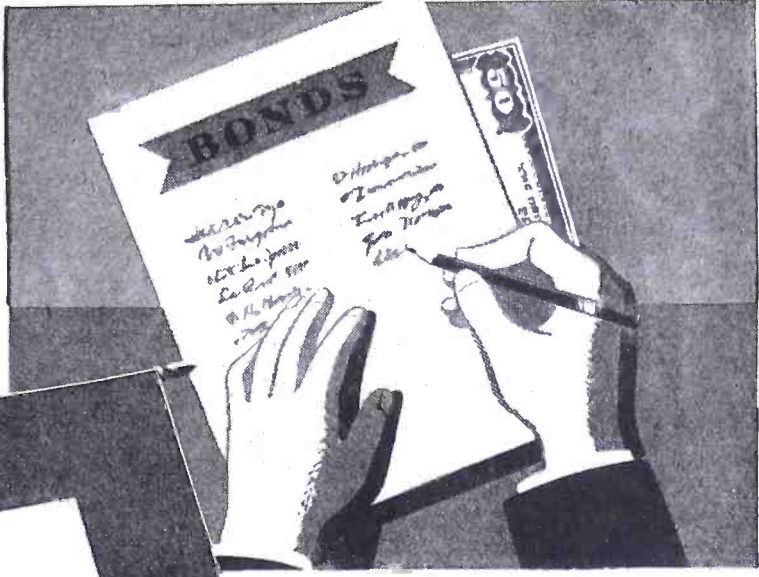

WAR BOND DRIVES have been enthusiastically supported in addition to payroll deduction purchases.

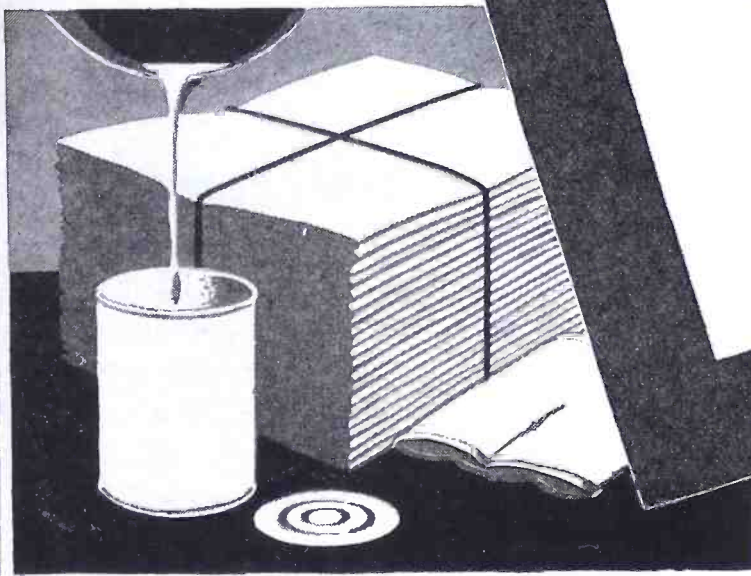

SALVAGE CAMPAIGNS both at home and at their work are aided by the efforts of Breeze men and women.

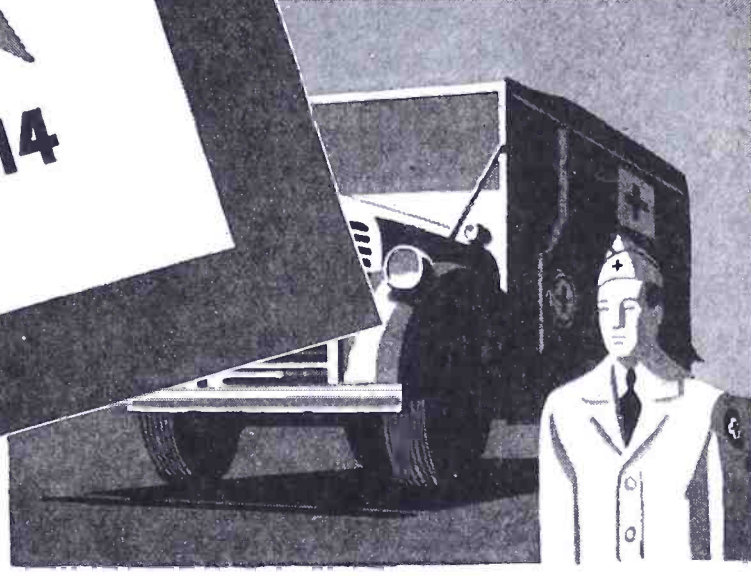

RED CROSS ambulance, station wagon and special car donated by management of Breeze to Motor Corps.

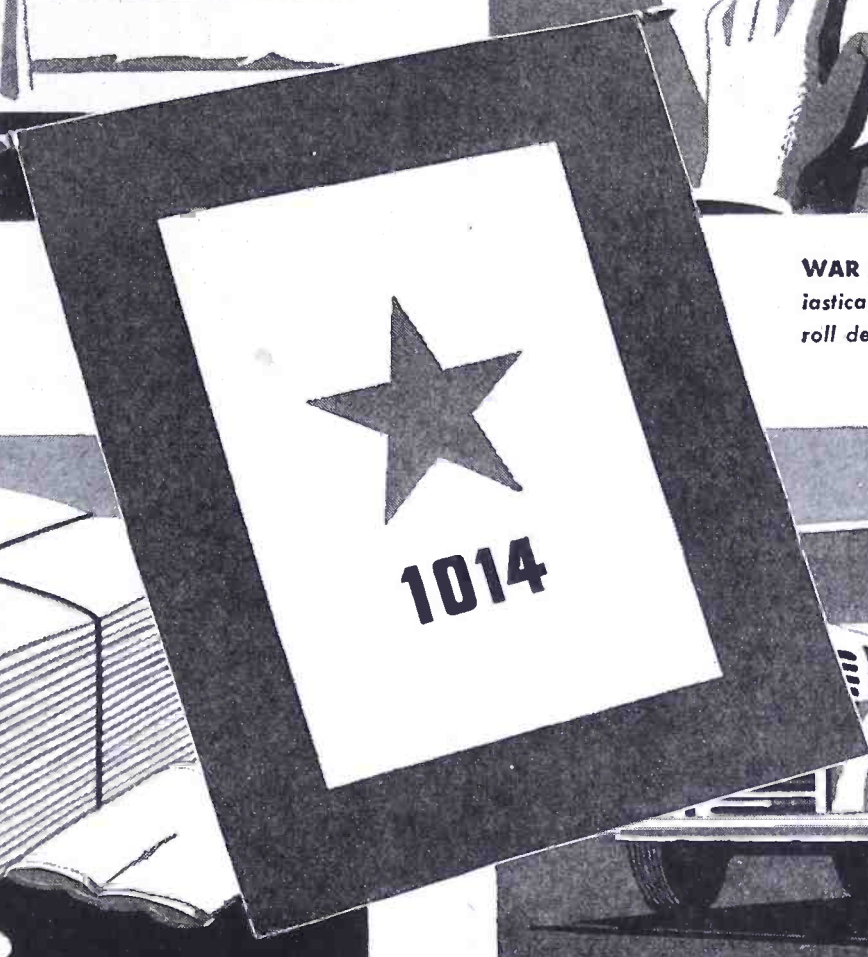

Our Third Front

VICTORY DEPENDS ON WHAT WE DO AT HOME AS WELL

THERE IS a Third Front, here at home, on which the men and women of Breeze are fighting. Putting 10% and more of their pay in war bonds, giving blood regularly to the Red Cross Blood Bank, cooperating to the fullest extent in civilian defense activities and government war campaigns, Breeze workers are a part of the great team that is backing up the boys at the front.

Without this teamwork, the efforts of our fighting men might well be wasted.

And in addition to their outside work, the men and women of Breeze are on the job day and night, turning out in tremendous quantities the well-known Breeze products which are serving America today on fighting fronts the world over.

Breeze 
CORPORATIONS, INC.
 NEWARK, NEW JERSEY

PRODUCTION FOR VICTORY • PRODUCTS FOR PEACE

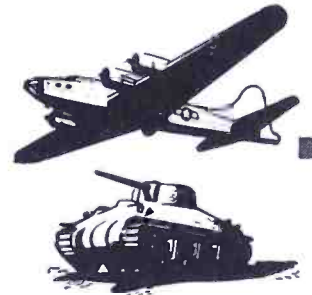

A Few of the Many Breeze Products in the Nation's Service

- Radio Ignition and Auxiliary Shielding • Multiple Circuit Electrical Connectors • Flexible Shielding Conduit and Fittings • Cartridge Engine Starters • Internal Tie Rods • Elevator and Rudder Tab Controls • Flexible Shaft and Case Assemblies • Aircraft Armor Plate

Serving THE WORLD'S GREATEST AIRLINE —

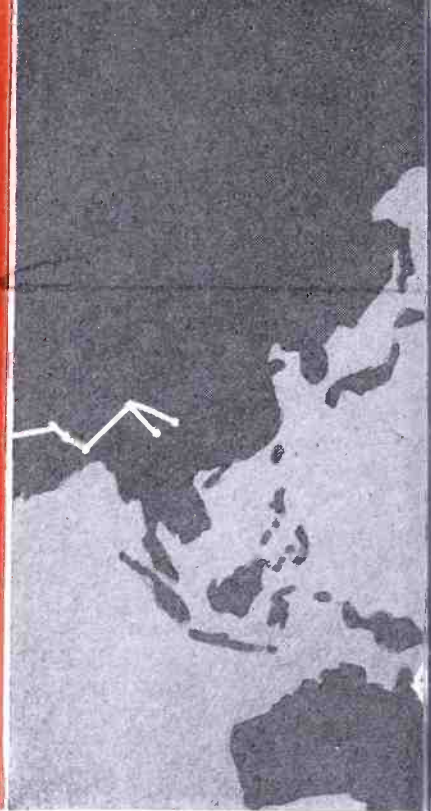

Signal Corps Photo

Our Proudest Achievement

A gigantic network of air routes—more than 100,000 miles of communications, landing fields and supply depots, stretching across six continents and four oceans—*that's the Army Air Forces Airways.* RADIO RECEPTOR'S contribution to the equipment of the radio life-line of these airways is its proudest achievement.

Developed in pre-war days . . . refined and simplified in the crucible of conflict, RADIO RECEPTOR airway and airdrome radio equipment will be ready, when Victory comes, to doff its war paint and resume its civilian dress. It is our hope that the men of the Army Airways Communications System Wing, now operating and maintaining RADIO RECEPTOR airdrome controls, radio ranges, markers, etc., in foreign lands, will soon be on the job at home to meet the expanding needs of peacetime flight.

◀ *Airdrome traffic control tower somewhere along the lines of the Army Air Forces. Operated by the Army Airways Communications System Wing. Maintains two-way communication between airfield and aircraft.*



RADIO RECEPTOR CO., INC.

Engineers and Manufacturers of Airway and Airport Radio Equipment

SINCE 1922 IN RADIO AND ELECTRONICS

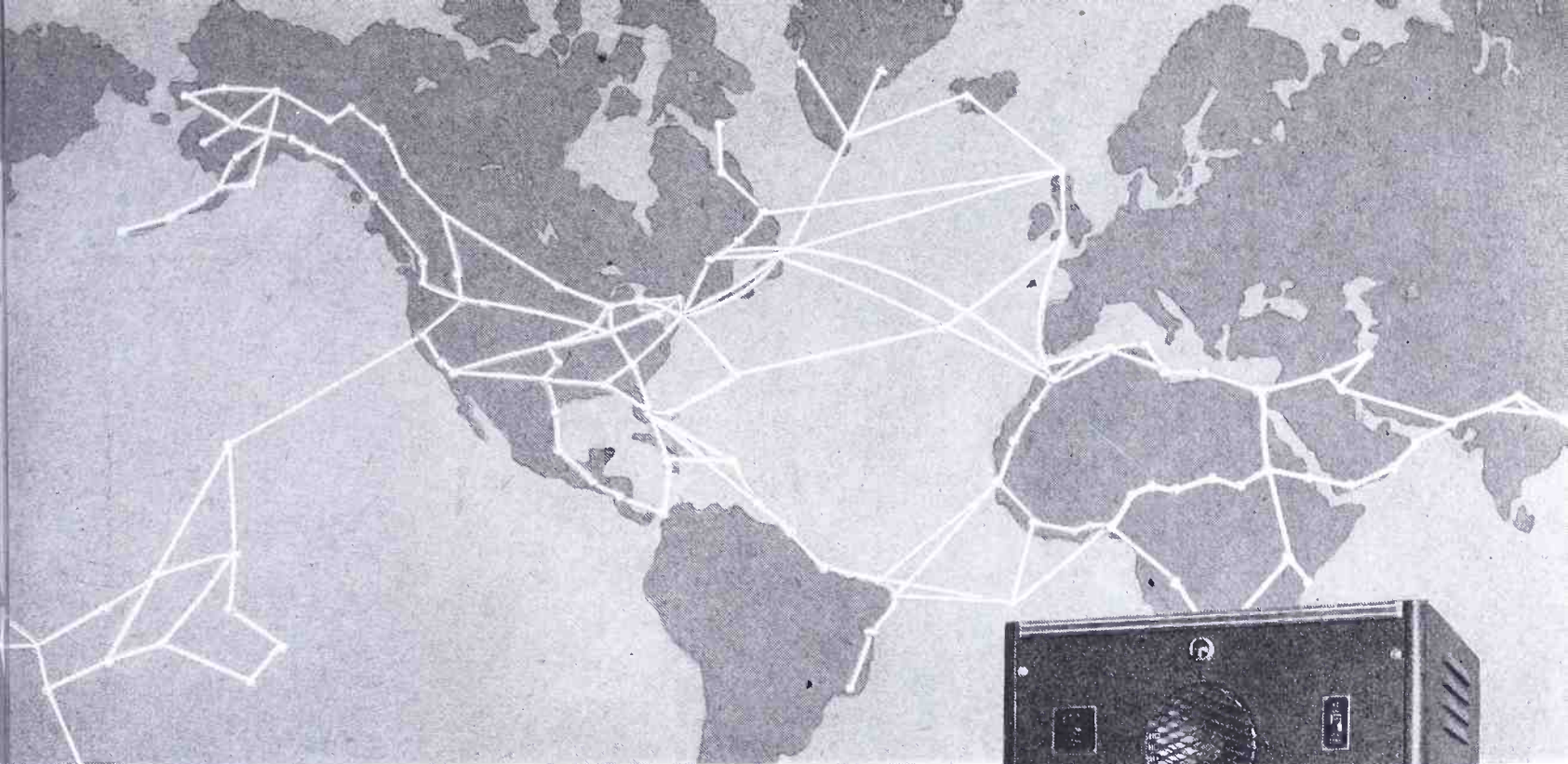

Routes of the World's Largest Airline . . . the Army Air Forces Airways

Plan now for Victory

Although the entire production of RADIO RECEIVER equipment now goes to the Army Air Forces, the Signal Corps and other war agencies, our engineers will be glad to confer with you on your plans for peace. The 6,000 new airports, estimated by the CAA as needed by the country, will require virtually the same type of equipment which is now being supplied to the military services.

To the thousands of municipalities planning the expansion of existing airports, or the construction of new ones, we offer our experience. Plan now so that production will not be interrupted . . . so that men and machines may continue at work when Victory comes. We shall be glad to confer with you. No obligation.

Airports are more than bricks and mortar. Our non-technical booklet, "Highways of the Air," explains the importance of radio to aviation. Write for your free copy . . . Desk R-3



*For Meritorious Service
on the Production Front*

**SPEED THE DAY OF VICTORY
BUY MORE WAR BONDS**

**251 WEST 19th STREET
NEW YORK 11, N. Y.**

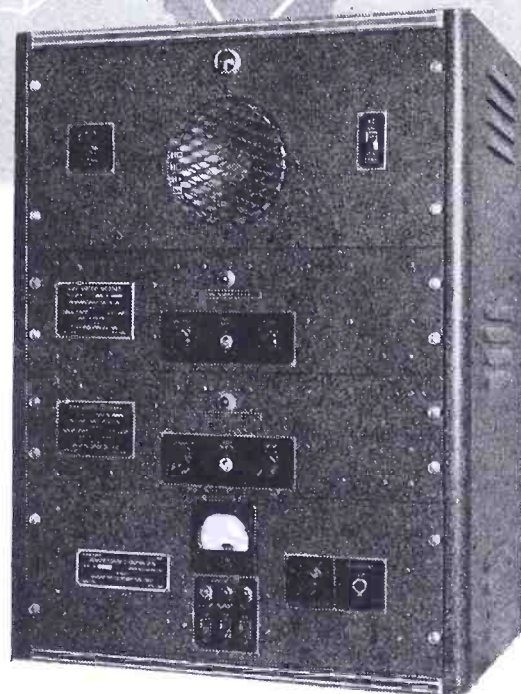

Control Cabinet Assembly. Consists of transmitter remote control unit, loud speaker and two fixed frequency airport receivers.

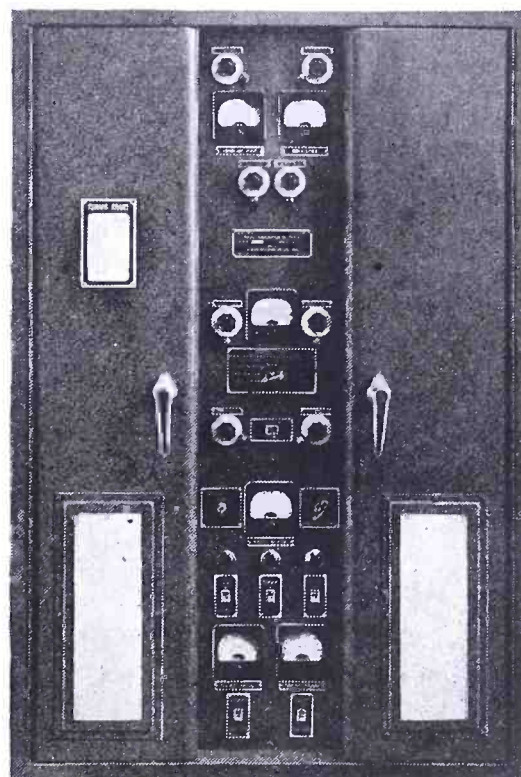

Transmitter for Airport Traffic Control. Output rating 50 watts, Frequency range 116 to 126.25 megacycles.



Congratulations

ON A FINE JOB, WELL DONE!



THE Treasury "Star" Flag—the bond-buying counterpart of the Army-Navy "E"—marks plants with at least 90% of personnel participating in the Payroll Savings Plan to at least 10% of gross payroll, and also having reached, or topped, a War Loan Drive quota!

The successful close of the 4th War Loan Drive finds many more "Star" Flags than ever before flying over the industrial plants of America. To all these, go the heartiest thanks of the nation, and the deep appreciation of the Treasury Department for a great job! And to those who may not quite have qualified for the "Star," go equally sincere thanks—and the confidence that soon they, too, will join the ranks of the "Star" fliers.

One thought that many concerns have

found helpful in stepping up the intake from their Payroll Savings Plans is this. In many cases the Treasury Representative in a plant has been able to point out the fact that during *Loan Drive periods* the employees have found it possible to spare much more than they had counted on when setting up their original subscription, and that—*when properly approached*—a very substantial fraction of such employees will decide they can well afford a distinct increase in their current Payroll Savings Plan.

Talk this over with your Treasury Representative—it offers important possibilities when correctly handled. And again accept the Treasury Department's congratulations for your fine work in helping to put over the 4th War Loan.

The Treasury Department acknowledges with appreciation the publication of this message by

**LET'S ALL KEEP
BACKING THE ATTACK
WITH WAR BONDS**

COMMUNICATIONS

This is an official U. S. Treasury advertisement—prepared under auspices of Treasury Department and War Advertising Council.

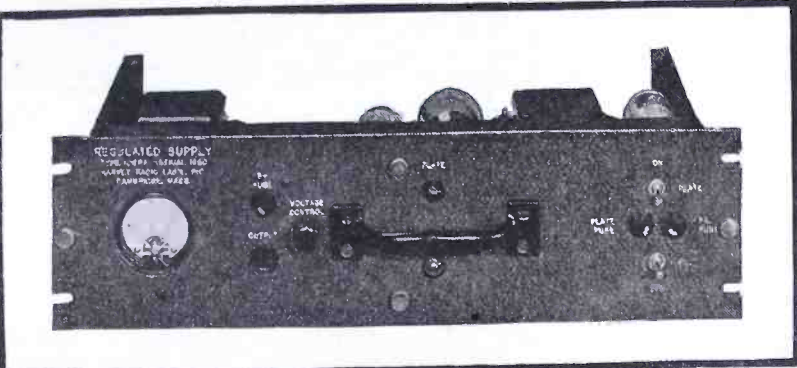

LOOK INTO THIS HARVEY REGULATED POWER SUPPLY

For a dependable, controllable source of laboratory D.C. power, you'll find the HARVEY 106 PA just what the doctor ordered. Designed to operate from 115 volts A.C. it has a D.C. output variable from 200 to 300 volts, and is capable of regulation *to within one per cent.*

There are separate fuses on each transformer primary as well as the D.C. output fuses; pilot lights on each switch; a D.C. volt-meter for measuring output voltage; a handy two-prong plug or binding posts for the power output. All in all this is a precision instrument that is a model of efficiency and operating convenience.

Years of specialization in the development and building of radio and electronics apparatus such as this Power Supply, I-F and Audio "Ampli-Strips", Radio Transmitters, Police and Marine Telephone Units qualify us to assist you in the development and production of technical knowledge and facilities. Whenever you have a problem of this character it will pay you to get in touch with

HARVEY RADIO LABORATORIES, INC.
445 CONCORD AVE., CAMBRIDGE 38, MASS.

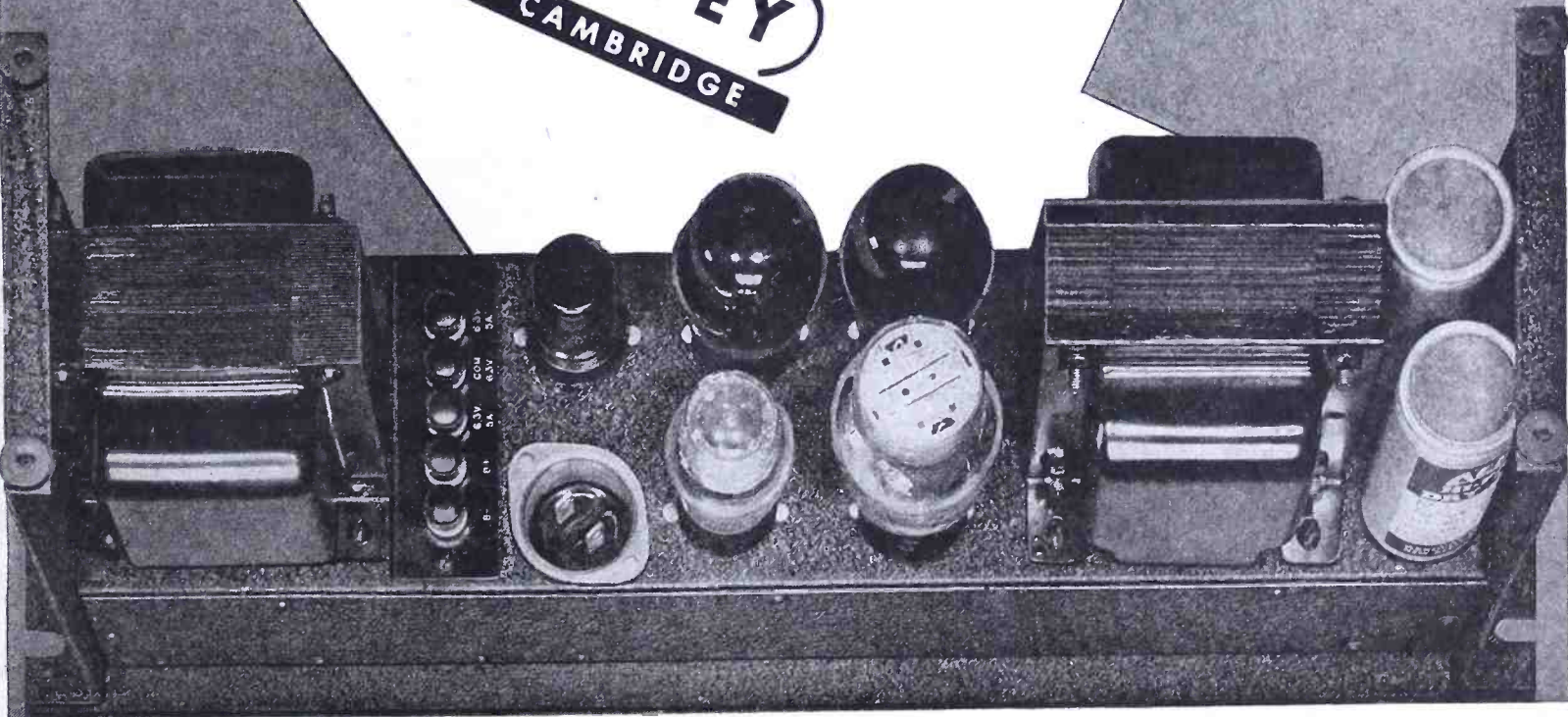

HAMMARLUND **RADIO**

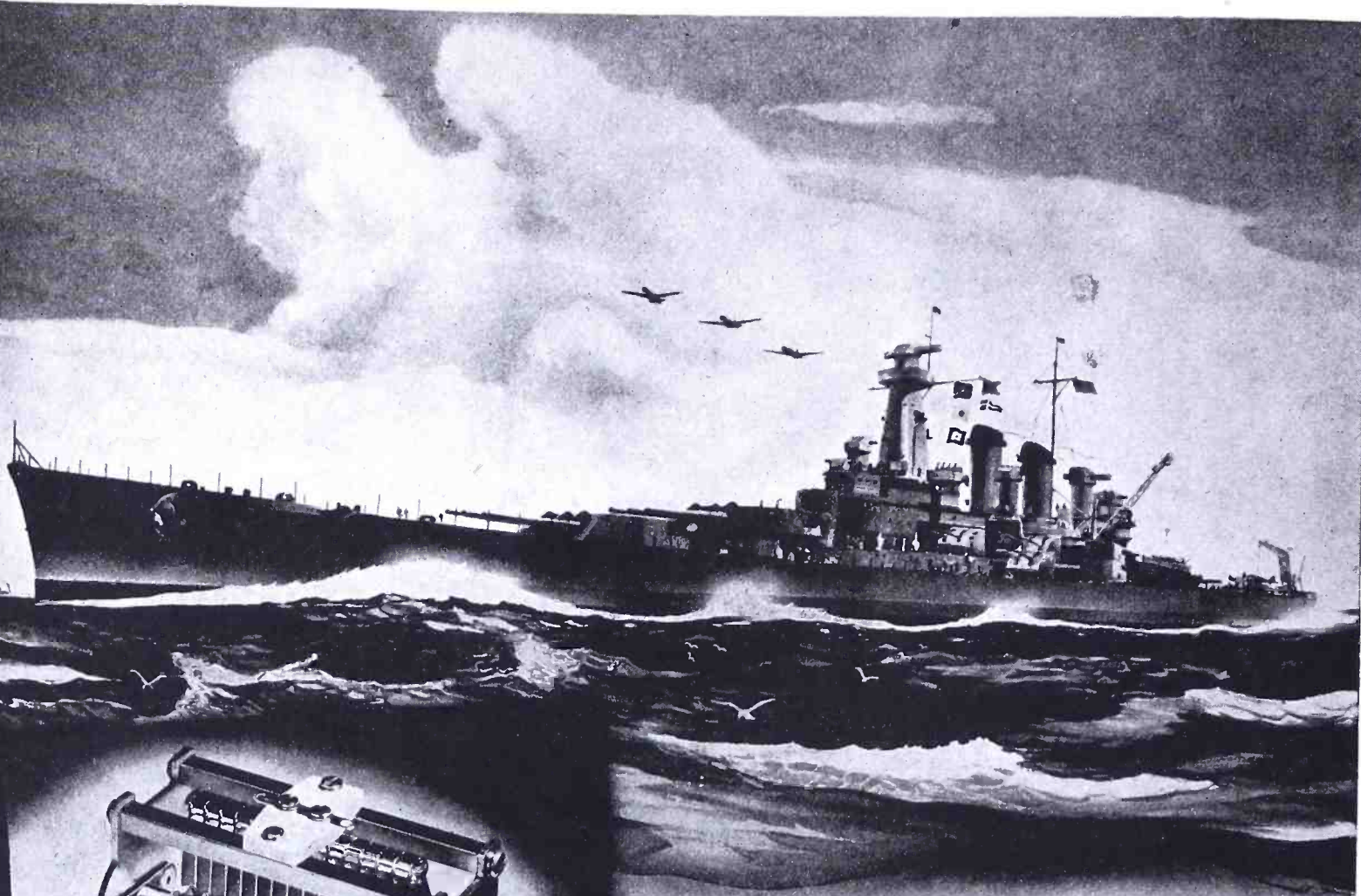

Official U. S. Navy Photo

EYES AND EARS OF THE NAVY

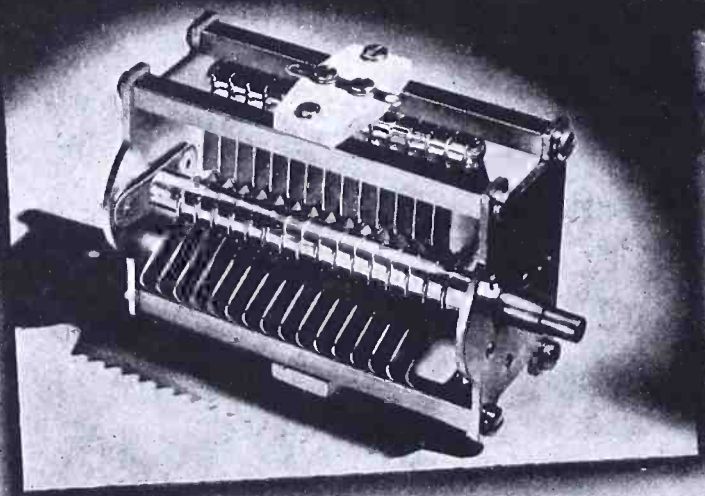

As our Navy prowls the seas, searching out and destroying the enemy, Hammarlund Radio products help guide our great ships to certain victory. In commercial type marine equipment too, you'll find Hammarlund products are outstanding for their record of service.



THE HAMMARLUND MANUFACTURING CO., INC.

460 WEST 34th ST., NEW YORK, N. Y.

Established 1910

COMMUNICATIONS

LEWIS WINNER, Editor

* * MARCH, 1944 * *

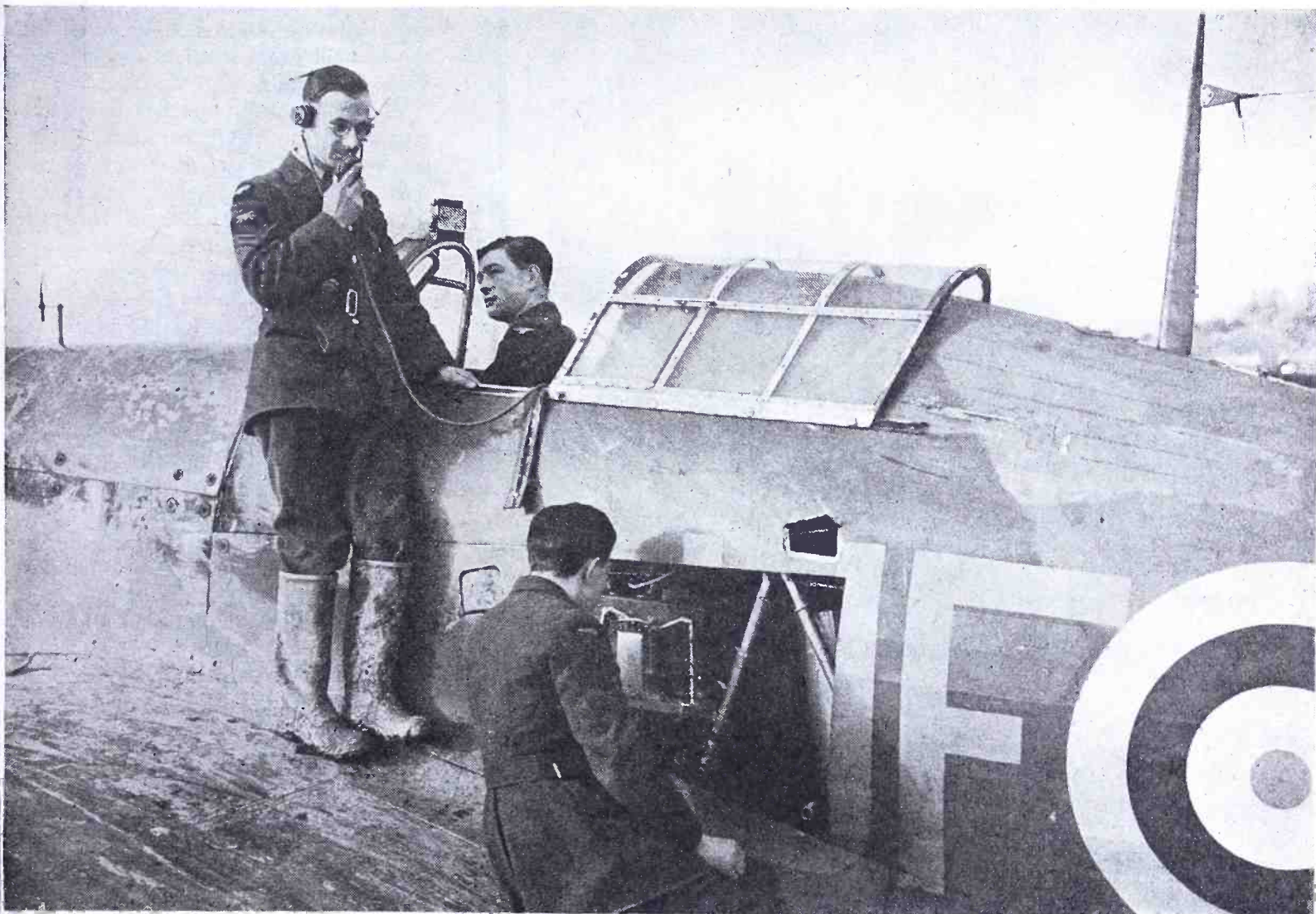

RAF COMMUNICATIONS

by ROY NORRIS

Editor, Electrical Trading and Radio Marketing, London

IN Britain the Royal Air Force and Army are two separate organizations. The RAF, therefore, has its own world-wide radio network for administrative and operative communication. Traffic runs in several million words daily and it has to be handled with the greatest reliability and accuracy as a whole campaign may, at some point, hang on a single vital message.

For communications between London headquarters and the Overseas Commands, and between the Commands themselves, a high-speed code system is used, the equipment being

Figure 1 (above)

Installing communications equipment in a RAF fighter.

basically similar to that of big commercial communication networks.

All smaller radio gear within this main communication framework is portable—mobility being an outstanding feature of Royal Air Force radio. The *secondary* links between the headquarters of Commands and their Groups and Wings are provided by manually-operated code transmitters, which can be truck-mounted.

This apparatus works mainly in the 3-20 mc band. It is rugged, accessible, simple to operate and is suitable for all extremes of climate. The transmitter is

RECEIVER

AMPLIFIER

MODULATOR

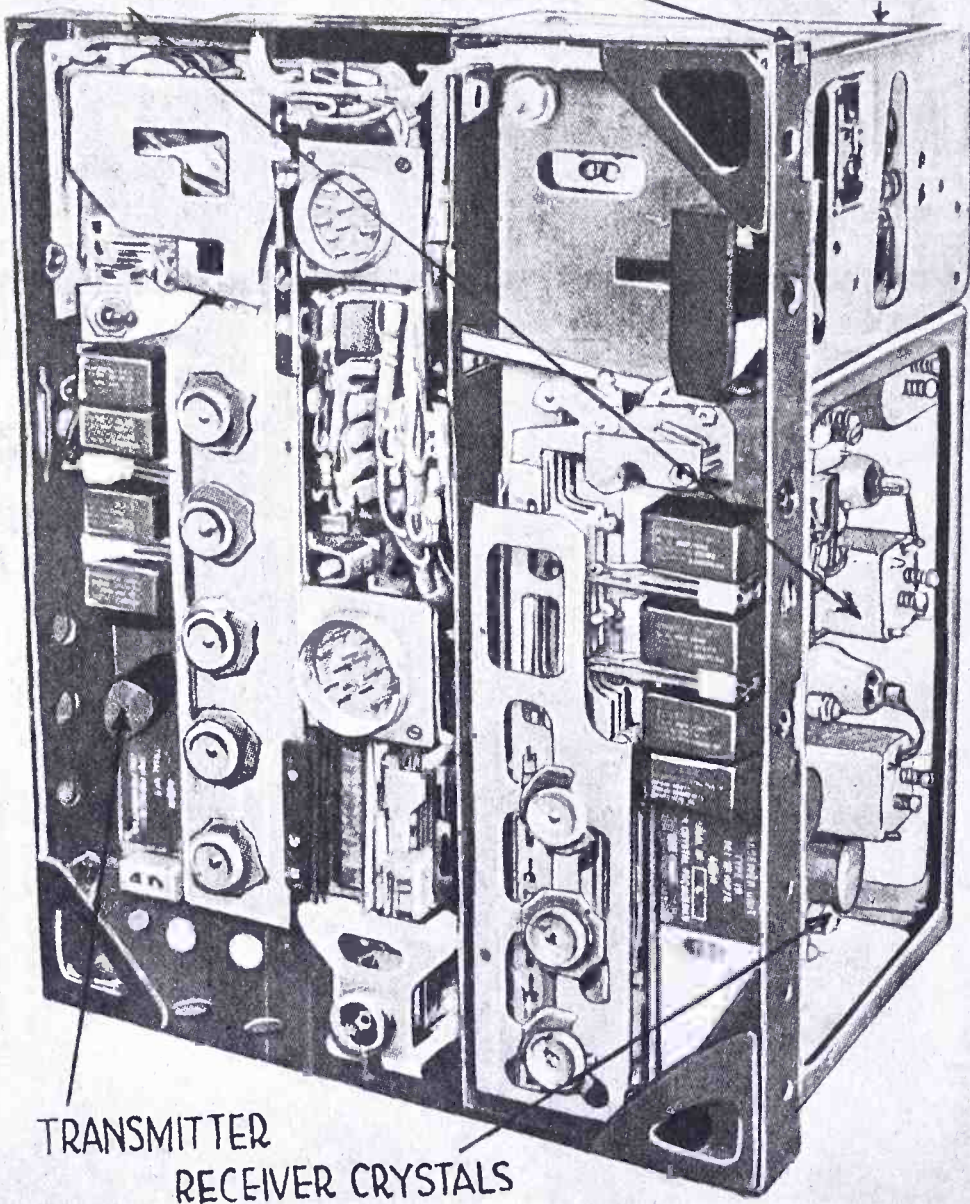

Figures 2 (left) and 3 (below)
Figure 2, standard v-h-f fighter communications unit. Figure 3, a receiver used in RAF bombers for long distance code reception.

applicable for both crystal and master oscillator drive, and normally runs from Britain's standard supply of 230 volts, 50 cycles, 3-phase. Receivers work from either the power lines or batteries.

Mobile equipments are available for high-speed automatic code transmission powers of 10 and 5 kilowatts. All the airfield radio services can be provided *on wheels*.

A familiar sight in Britain's countryside is the RAF *pack set*. This can be carried short distances by two men and it gives reliable communications of up to 100 miles without the erection of a tuned aerial array.

Apart from medium frequencies, the RAF uses two bands; h-f and v-h-f. Broadly speaking the h-f band is 3 to 8 mc and the v-h-f band is from 100 to 124 mc.

At an airfield, the radio system provides: (1)—h-f code transmission on medium power for signalling to aircraft at long range, (2) h-f direction-finding station, (3)—several h-f channels for instructing aircraft coming in to land, (4)—several v-h-f channels for the same duties, (5)—a v-h-f direction-finding station, and (6)—a beam approach system for assisting aircraft to approach and land in poor visibility.

On the larger type of aircraft the radio installation includes a general purpose code set manipulated by the radio man; a pilot-operated h-f telephony set; a beam-approach receiver used by the pilot; a direction-finding loop operated by the radio man; and an intercom amplifier linking up the crew.

With this equipment an aircraft can communicate by Morse with its base and can talk by phone to other aircraft in the formation, escort fighters or to control-tower when coming in to land. It can *home* on any medium band transmission or obtain a *fix* from the high or medium frequency ground organizations. It can come in and land almost *blind*.

Standardization of sets has been carried a long way to speed production and simplify maintenance. A standard high frequency code set is made in great quantities to use in Britain and overseas for all bomber, general reconnaissance and training aircraft.

For telephony there are two main
(Continued on page 75)

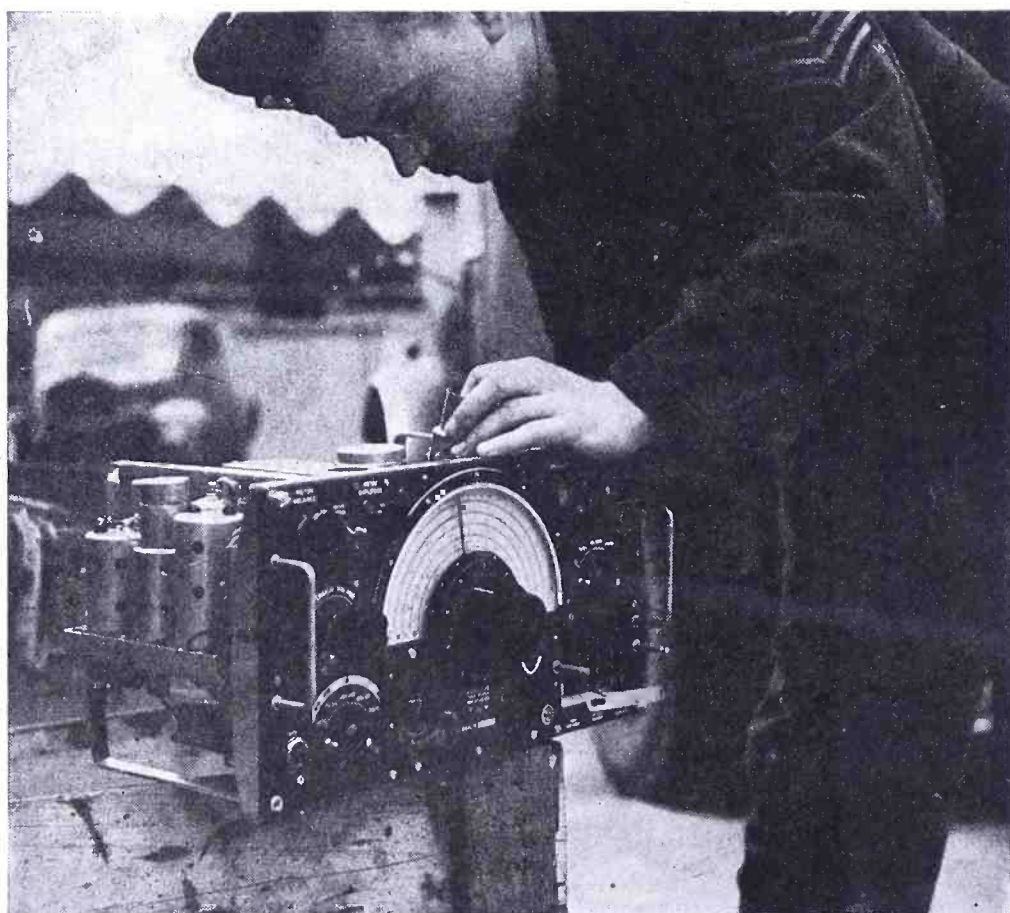

Diameter	Temper	K_1	K_2	Maximum recommended frequency in megacycles
1/4"	Soft	1.59	.014	1200
0.286"	Soft	1.23	.012	1000
3/8"	Soft	0.95	.0084	740
5/8"	Soft	0.53	.0095	430
0.643"	Soft	0.51	.0095	430
7/8"	Soft	0.36	.0056	340
7/8"	Hard	0.35	.0024	120
7/8"	Hard	0.37	.0073	450
1 3/8"	Hard	0.21	.0024	70
1 5/8"	Hard	0.18	.0024	60
2 1/8"	Soft	0.15	.0085	155
2 1/8"	Hard	0.13	.0020	48
2 5/8"	Hard	0.11	.0026	47
4 1/8"	Hard	0.07	.0026	47

LOSS IN COAXIAL CABLES AT U - H - F

by DR. VICTOR J. ANDREW

Andrew Company

THESE losses are based on termination of the cable in a pure resistance equal to the characteristic impedance of the cable. Moderate mismatches increase the loss only slightly.

The frequency range on the large

diameter cables can be extended by using smaller bead spacings.

Loss in decibels per 1,000 feet = loss in conductors plus loss in insulation

$$\text{db/1,000 ft.} = K_1\sqrt{f} + K_2 f$$

where f = frequency in megacycles.

Example: To determine loss in 350' of 2 1/8" hard temper cable at 46 mc:
Loss = 350/1,000 (.13√46 + .002 × 46) = 0.34 db = 7.5% of power into line.

NEGATIVE

by CLEDO BRUNETTI

Senior Radio Physicist, National Bureau of Standards,
Washington, D. C.
Formerly Assistant Professor of Electrical Engineering,
Lehigh University

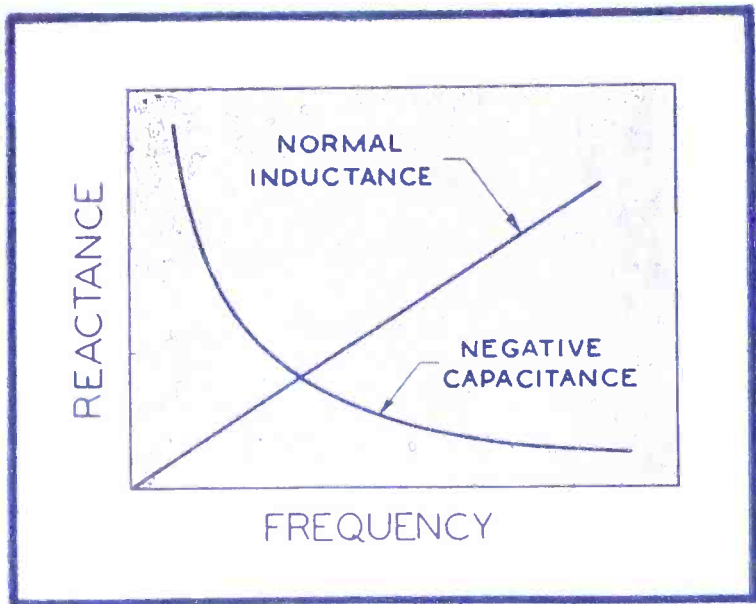

Figure 1
Comparison of negative capacitance with normal inductance.

WHEN the output of an ordinary two-stage amplifier is coupled back to the input through a condenser, it is possible, by proper adjustment of the amplification, to secure an input impedance that behaves as a negative capacitance¹. A negative capacitance is a reactive circuit element whose reactance varies inversely as the frequency, but is positive in sign (Figure 1). At any given frequency a negative capacitance will present the same type of reactance as an inductance. However, if the frequency is increased, the reactance of the inductance will increase in value while that of the negative capacitance will decrease.

Negative Capacitance Uses

A practical negative capacitance will be found useful in improving the frequency response of amplifiers by neutralizing tube input and output capacitances, in improving the Q of tuned circuits by neutralizing shunting capacitances, in extending the range of measurement of Q meters and in many similar applications. Other uses are to

This paper is based on work carried on by the authors at Lehigh University.

be found in special networks such as filters and corrective networks, in transmission line problems², and in obtaining impedances proportional to the N th power of the frequency where N may be any positive or negative integer³.

A negative capacitance obtained in the manner described above can be made to be substantially independent of amplifier tube and supply voltage variations and of frequency by employing inverse feedback in the amplifier.

In Figure 2 is shown an amplifier with an impedance Z_{pf} connected between input and output terminals, 1 and 3 respectively, of the two-stage amplifier. The equivalent circuit, assuming the impedance of the grid circuit of the first stage of the amplifier

¹C. Brunetti and L. Greenough, *Some Characteristics of a Stable Negative Resistance*, Proc. IRE, vol. 30, pp. 542-546; Dec., 1942.

²H. Mouradian, *Long Distance Transmission Problems*, Jour. Frank. Inst., vol. 207, No. 2; Feb., 1929.

³L. C. Verman, *Negative Circuit Constants*, Proc., IRE, Vol. 19, pp. 676-681; April, 1931.

Figure 2 (right) and 3 (below). In Figure 2 appears a method of obtaining negative capacitance. Figure 3 is a circuit equivalent of Figure 2.

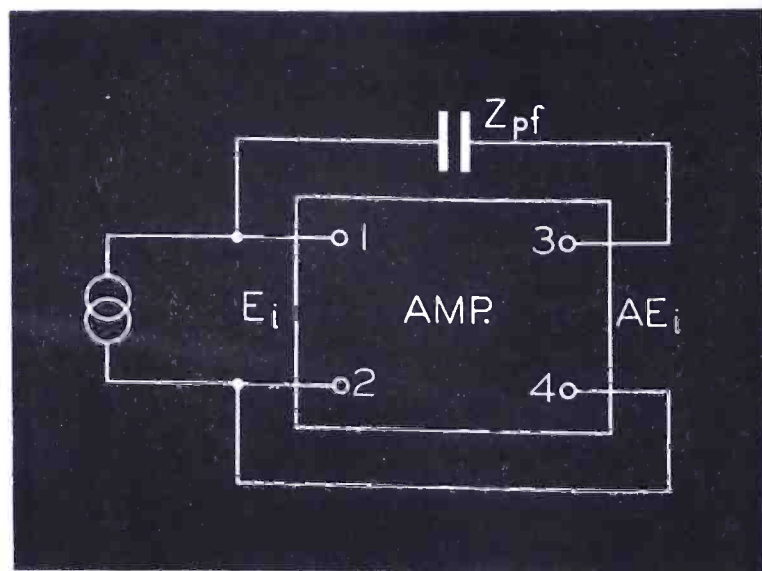
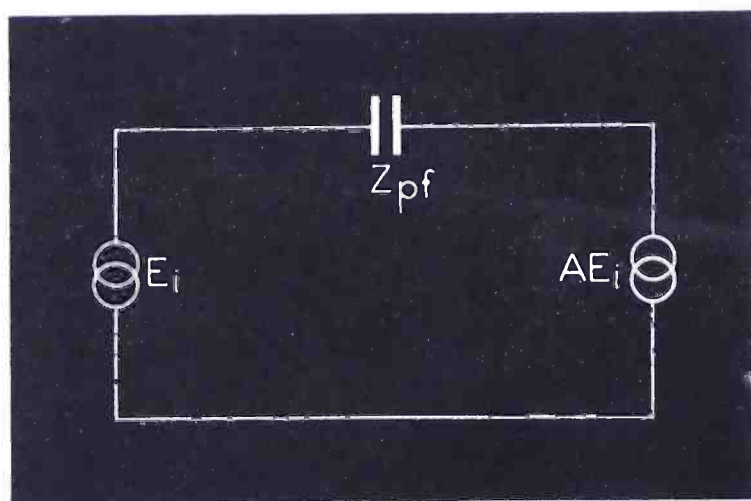

to be infinitely large, is shown in Figure 3. The input current is found to be

$$I_i = \frac{E_i - AE_i}{Z_{pf}} \quad (1)$$

Where A is the amplification and E_i is the input voltage, the input impedance is

$$Z_n = \frac{E_i}{I_i} = Z_{pf} \frac{1}{1 - A} \quad (2)$$

Equation 2 shows that if A is real (i.e. has no phase shift) and greater than unity, Z_n will be a negative multiple of Z_{pf} . If Z_{pf} is a condenser of value C , equation 2 yields

$$Z_n = \frac{1}{j\omega C_{pr}(1 - A)} = \frac{1}{j\omega C_n} \quad (3)$$

where $C_n = C_{pr}(1 - A)$.

The input impedance is that of a capacitance of value $C_{pr}(1 - A)$ which, for A greater than unity and real in value, is negative.

Inverse Feedback

In the equivalent circuit of Figure 3 it was assumed that effective internal impedance in the amplifier output circuit was negligible in comparison with Z_{pf} . When this is not so, the internal

CAPACITANCE

and LEIGHTON GREENOUGH

Research Engineer, RCA Mfg. Co., Princeton, N. J.

Impedance must be added to Z_{pf} and introduces what is often an undesirable negative resistive component in series with the negative capacitance. Employment of inverse feedback helps materially to reduce the amplifier output impedance and to yield a negative capacitance with a very low power factor, as will be illustrated later.

Negative Capacitance Circuits

A practical circuit for obtaining negative capacitance is shown in Figure 4. It is a slight modification of a circuit used to obtain negative resistance. Some performance characteristics of this type of circuit have already been reported by the authors¹. Figure 5 shows the typical relation of negative capacitive reactance, as a function of frequency, obtained from the circuit of Figure 4. For negative capacitances up to -0.5 mfd, the maximum deviation in capacitance from a fixed value was 0.2% over the range 250 to 1,500 cps.

The method employed to measure the negative capacitance is somewhat the same as that used previously by the authors for other negative elements.¹ A positive impedance is connected in parallel with the unknown to bring the real part of the impedance of the combination into the positive region where it can be measured by ordinary means. The technique of carrying out the measurements, however, requires careful attention. A satisfactory circuit for the measurement is shown in Figure 6. It is a modified Maxwell substitution bridge with a Wagner ground and a headphone detector.

Obtaining Balance

The procedure recommended in obtaining a balance is as follows:

(1)—With the negative capacitance

Figure 5

Negative capacitive reactance as a function of frequency.

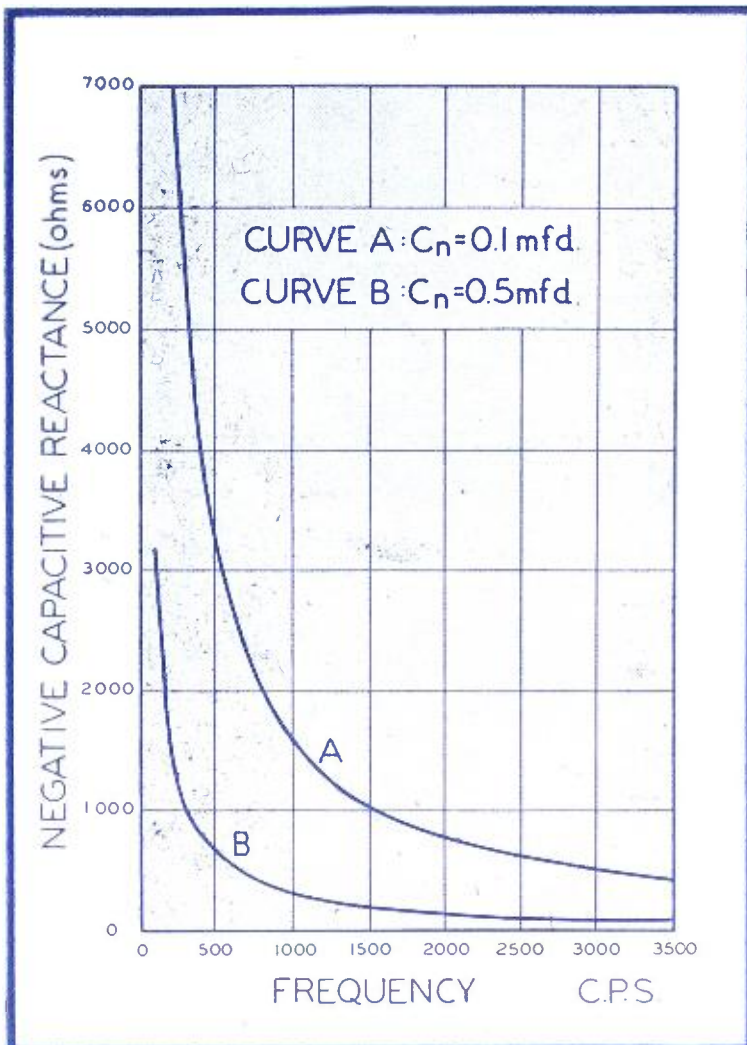

in the circuit, the bridge is first balanced by varying only R_p and C_p . Rough adjustment is provided by L_s and R_1 or R_2 . The Wagner ground is then balanced. C_{p1} and R_{p1} are recorded. The subscript 1 indicates the first reading.

(2)—The negative capacitance is removed from the circuit and the bridge again balanced. C_{p2} and R_{p2} are read.

The equations for finding C_e and R_e , the equivalent parallel negative capacitance and resistance respectively, are

$$C_e = -(C_{p1} - C_{p2})$$

$$R_e = \frac{-R_{p1} R_{p2}}{R_{p2} - R_{p1}}$$

The equivalent series negative capacitance is given by

$$C_s = C_e \frac{1 + R_e^2 \omega^2 C_e^2}{R_e^2 \omega^2 C_e^2}$$

$$R_s = \frac{R_e}{1 + R_e^2 \omega^2 C_e^2}$$

Figure 4

Circuit for obtaining negative capacitance.

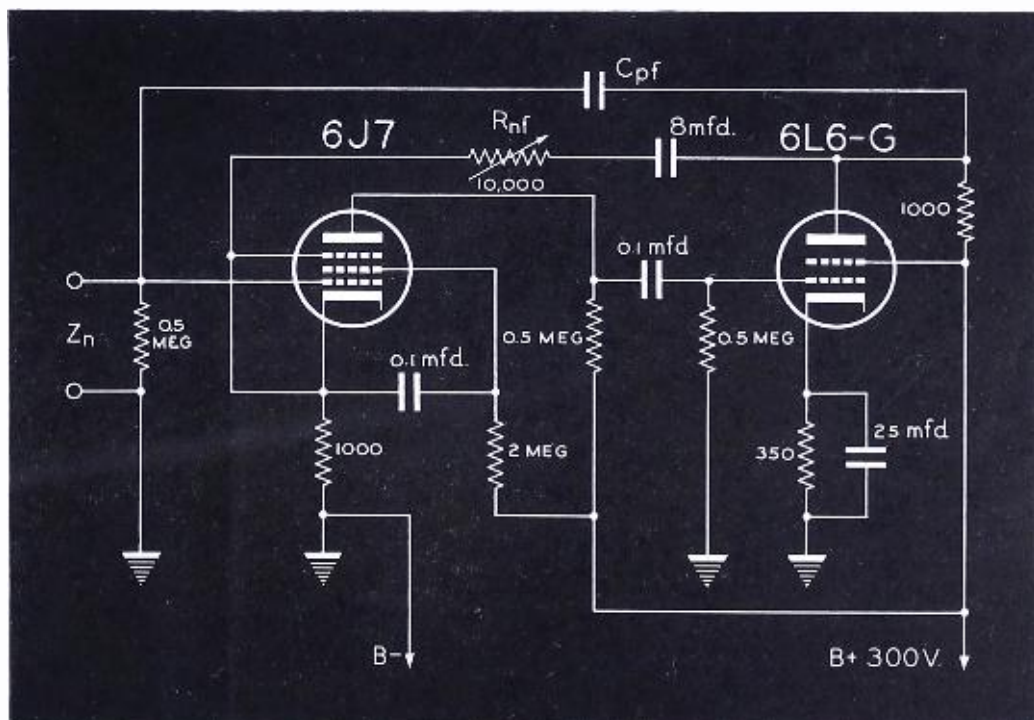

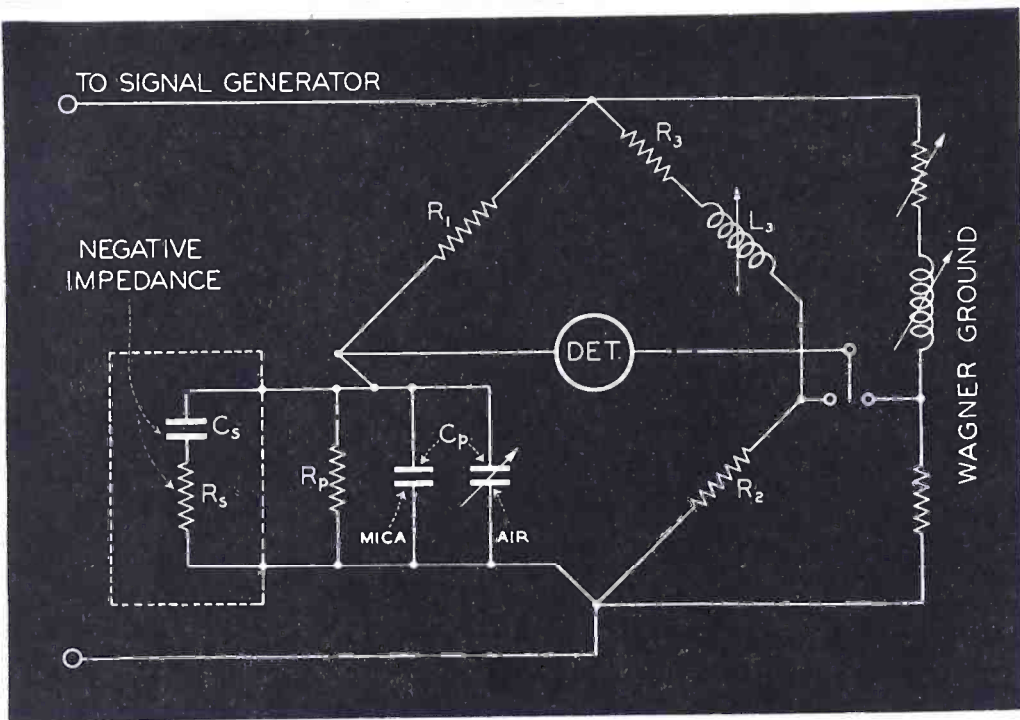

Figure 6 (above)

Bridge used to measure negative impedance. This is a modified Maxwell substitution bridge with a Wagner ground and a headphone detector. In operation a positive impedance is connected with the unknown to bring the real part of the impedance of the combination into the positive region where it can be measured by standard means.

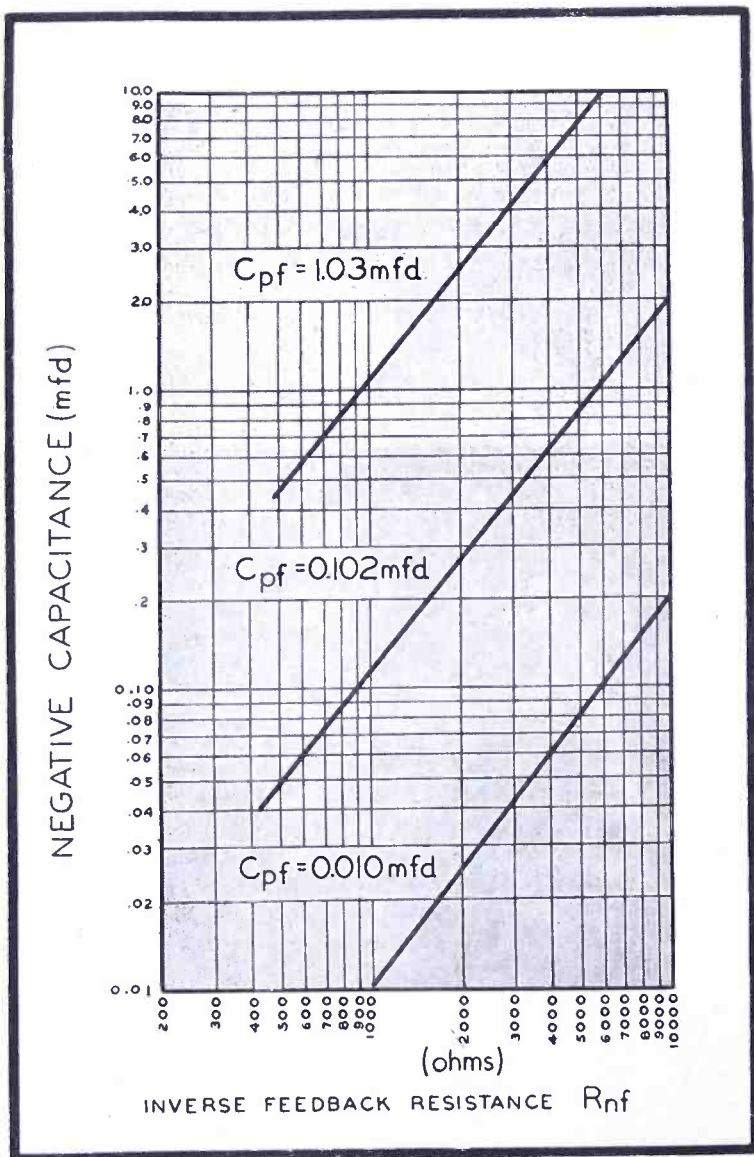

Figure 7

Negative capacitance as a function of the inverse feedback resistance R_{nf} . The range of negative capacitance shown here was obtained from the circuit of Figure 4. These values were measured at 1000 cps. It will be noted that the relation between R_{nf} and the negative capacitance is linear.

This method was found to be the most satisfactory of a large number tried. One of its chief advantages is that the difference quantity ($R_{p2} - R_{p1}$) does not depend upon two calculated values based on measurements of other components in the bridge. Such a difference would be subject to considerable error if slight inaccuracies were to occur in the calibration of R_1 and R_2 . In the above method R_p may first be set at R_{p1} and the variation in this quantity provided by means of another low range decade resistance box in series with R_p . Such a step is necessary because a setting of as close as 0.2 ohm in 5,000 may be required

Range of Negative Capacitance

Figure 7 shows the range of negative capacitance obtained from the circuit of Figure 4 for various values of C_{pf} as the amount of inverse feedback was varied by means of R_{nf} . These values were measured at a frequency of 1,000 cps. The relation between R_{nf} and the negative capacitance is seen to be linear. Figure 8 shows the relationship between amplification A and inverse feedback resistance R_{nf} . As the amplification is, within reasonable limits, a linear function of R_{nf} over the range shown in the Figure, the linearity of the graphs of Figure 7 would be expected.

Power Factor Considerations

In general the impedance is not a pure negative capacitance but may contain a small negative resistance component. The power factor is therefore negative. If a value of C_{pf} of 0.01 mfd or less is used, the absolute magnitude of the power factor is less than 0.5%; if C_{pf} is in the range 0.01 mfd to 0.10 mfd, the negative power factor increases to approximately 1%. For larger values of C_{pf} the absolute magnitude of the power factor increase somewhat proportionally; also the losses in C_{pf} contribute materially to the power factor. If paper capacitors are used, care should be exercised to select those with low losses. The use of mica capacitors is recommended.

Negative Capacitance Stability

The negative capacitance is practically independent of small variations in supply voltage. The stability in this respect is comparable to that of the negative resistance obtainable from the same amplifier.¹

Applications

The negative capacitance described

erein has proven useful in extending the frequency response range of amplifiers by a factor of as much as 5 to 10 times. As pointed out earlier, this performance is obtained simply by neutralizing the input, interstage or output capacitance of the amplifier with a negative capacitance.

Uses in V-T Voltmeters

Another useful application is in reducing the input capacitance of vacuum tube voltmeters or other instruments fed by long cables with high capacity to ground. Insertion of the negative capacitance at the input or output terminals of the cable makes it possible to neutralize the shunting effect of the cable and raise its input impedance at high frequencies appreciably.

H-F Transformer Application

The high-frequency response of audio-frequency transformers is limited by the distributed capacity of the windings. This response may be improved materially by means of negative capacitance. For example, a negative capacitance connected across the secondary of a transformer, whose normal output voltage with constant input was down to 85% of maximum at 2,000 cps, increased the range of operation for the same output voltage performance to 12,000 cps.

Applications in Q Meters

Q meters, as a rule, are limited in range of measurement by the residual capacitance of the instrument. Figure 8 shows a typical Q-meter circuit. The unknown inductance L_x is measured in terms of the magnitude of the standard capacitance C_s required to series-resonate it. The minimum value of Q obtainable is limited by the residual capacitance of the instrument. Introduction of a negative capacitance in parallel with C_s , as shown by the dotted lines, removes this limitation and extends the range of measurement.

Brief consideration of the possibilities will lead to other applications of similar or varied nature.

In using negative capacitance to cancel or neutralize the positive capacitance of a circuit, care should be exercised to see that too much cancellation is not attempted. As mentioned above, the source of negative capacitance may contain a negative resistance component and complete cancellation of the capacitance across the output terminals will present a circuit in which oscillations may be sustained. These unwanted oscillations may

Figure 8

The relationship between amplification and the inverse feedback resistance is shown in this graph. We note that the amplification is within reasonable limits a linear function of R_{nf} .

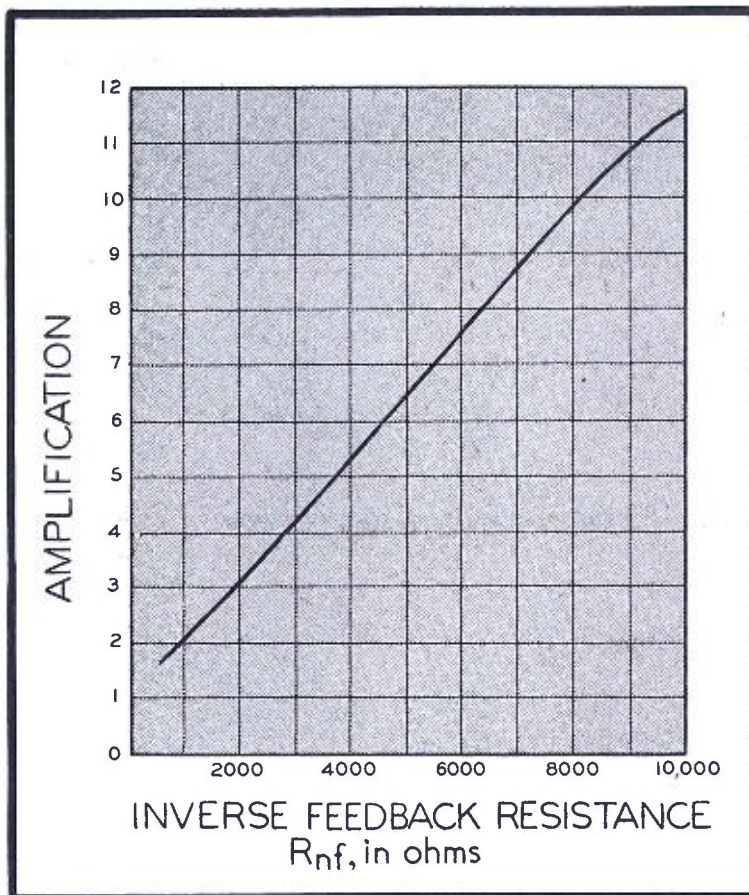

make the use of the negative capacitance impractical unless they should occur at frequencies well beyond the working range for which the device is intended and provided they do not produce undesirable secondary effects.

Cancellation of the capacity across a tuned parallel circuit was attempted by connecting a negative capacitance across the terminals. The tuned circuit consisted of a coil having an inductance of 0.153 henry and an 0.09-microfarad capacitor. The normal frequency of resonance of this circuit was approximately 1400 cycles per second. By means of the negative capacitance it was possible to raise the resonance frequency to 10,000 cycles per second without introducing oscillations. The resulting equivalent capacitance was approximately 1.66×10^{-8} microfarad. This represents a reduction of fifty-four to one in capacitance. Reductions of ten to one may be obtained with very stable performance.

The major factor contributing to the

input capacitance of a triode amplifier usually is the grid-plate capacitance. A large current flows through this capacitance as the latter appears at the input terminals magnified by an amount $1 + A \cos \phi$ where A is the voltage amplification and ϕ is the phase angle of the load impedance in the plate circuit. For large amplification this capacitance is approximately proportional to the amplification and is much greater than the interelectrode capacities themselves. With screen-grid and pentode tubes the grid-plate capacitance may be negligible and the input capacitance is principally the sum of the grid-screen and grid-cathode capacitances.

Capacitance neutralization in amplifiers may be obtained in a variety of methods other than with the use of negative capacitance. Typical of such methods are the Hazeltine neutrodyne and Rice systems of neutralization, the inverted neutrodyne and the bridge circuits of Ballantine and Hull.

Figure 9

A typical Q-meter circuit wherein the unknown inductance L_x is measured in terms of the magnitude of the standard capacitance C_s required to series-resonate it.

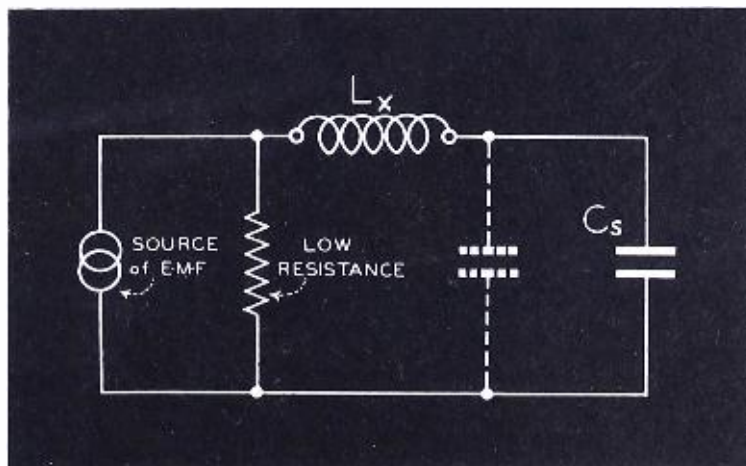

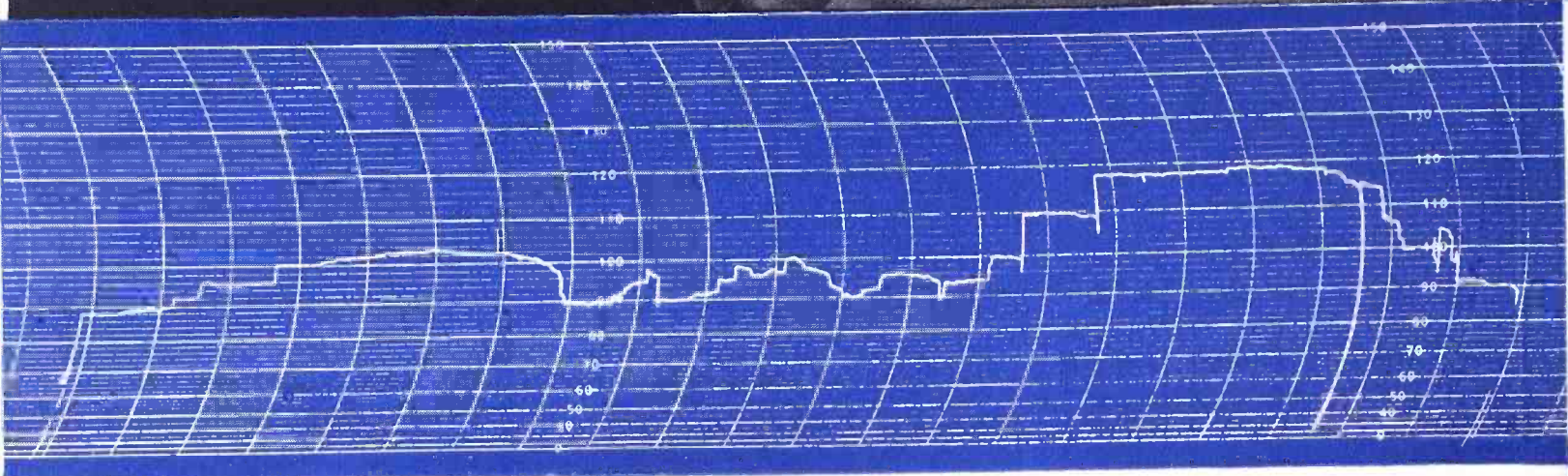

RATED VOLTAGE is always available to equipment protected with built-in **CONSTANT VOLTAGE**

"Operate at 115 volts" on the label of electrically operated precision equipment is not simply informative — it's a warning!

A warning that the device is too sensitive to tolerate the voltage fluctuations that may be met on America's power lines, and still perform with efficiency. A warning that sensitive tubes and other delicate mechanisms may be irreparably damaged by line surges and that costly replacements, with consequent loss of time and efficiency, lie ahead.

The design engineer who assumes that the precisely controlled voltages of the research laboratory will be duplicated in the field is heading his product toward trouble. Nominal

line voltage ratings can no longer be used as single, stable reference points for design considerations. Commercial power lines are too heavily loaded and unpredictable.

"Operate at 115 volts" is no longer sufficient on a label. A guarantee that the "115 volts" will always be available, in spite of the unpredictable fluctuations of commercial power, is a prime requisite if the device is to perform with unflinching efficiency and precision.

The place to provide voltage control is within the equipment. With a Constant Voltage Transformer as a component part, the device is provided with a dependable source of voltage and unflinching protection

against performance interference and construction damage.

SOLA Constant Voltage Transformers are available in sizes and capacities to meet design requirements of any electrically operated equipment or electronic device. Items so protected will deliver as efficiently in the field as under the most ideal laboratory conditions.

SOLA Constant Voltage Transformers have no moving parts to get out of order. There are no manual adjustments to be made. They perform instantly and automatically maintaining output constant to within $\pm 1\%$ of the rated voltage, regardless of line fluctuations as great as 30%.

Constant Voltage Transformers

SOLA

To Manufacturers:

Built-in voltage control guarantees the voltage called for on your label. Consult our engineers on details of design specifications.

Ask for Bulletin ECV-74

Transformers for: Constant Voltage • Cold Cathode Lighting • Mercury Lamps • Series Lighting • Fluorescent Lighting • X-Ray Equipment • Luminous Tube Sign
Oil Burner Ignition • Radio • Power • Controls • Signal Systems • Door Bells and Chimes • etc. SOLA ELECTRIC CO., 2525 Clybourn Ave., Chicago 14, Ill

HIGH-Q AUDIO REACTOR

Design and Production

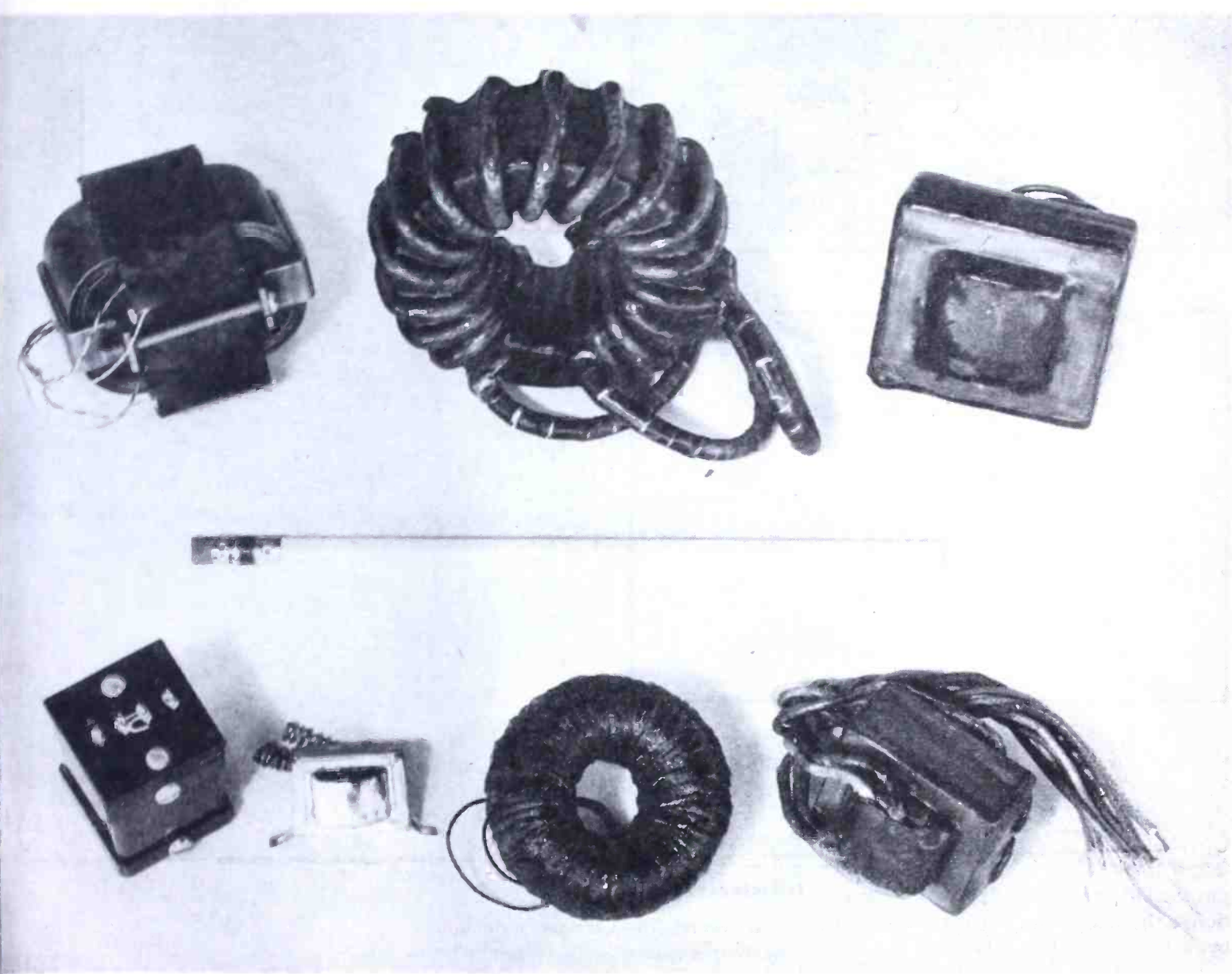

by COLIN A. CAMPBELL

Plant Engineer

Attec-Lansing Corporation

THE introduction of a magnetic core into a coil is not as innocent as it might seem for it exacts a certain toll or compensation for the benefits derived. The purpose of this paper is to, first, analyze the effect of the magnetic core, and second, show commercial practice of inductance manufacture.

A commercial power transformer might be considered as a special case of an inductor or reactor. The heat dissipated in the core is quite evident;

Top row, at extreme left, a hipersil core: $f_{(\max Q)} = 1400$ cycles, $L = 2$ henrys, $Q_{\max} = 80$; used for tank circuit, 400-cycle oscillator. Center, top, a powdered core: $f_{(\max Q)} = 10,000$ cycles, $L = 33$ microhenrys, $Q_{\max} = 40$; used to damp a light valve. Right, top, an E-I core: $f_{(\max Q)} = 1000$ cycles, $L = 3.3$ millihenrys, $Q_{\max} = 35$; used in dividing network for two-way horn system. In the bottom row we have, at extreme left, a dust core: $f_{(\max Q)} = 10,000$ cycles, $L = 2$ henrys, $Q_{\max} = 12$; used in 10-kc filter of radio tuner. Center, at left in bottom row, is an F core: $f_{(\max Q)} = 1000$ cycles, $L = 16$ henrys, $Q_{\max} = 16$; for equalizing low level sound circuits. At right center, bottom, is a powdered core: $f_{(\max Q)} =$ very broad, $L = 100$ millihenrys, $Q_{\max} = 22$; used where constant Q is necessary. At extreme right, bottom, we have an E-I core: $f_{(\max Q)} = 50$, $L = 880$ henrys with taps; $Q_{\max} = 12$; used in geophysical circuits.

this is commonly called *core loss*. This loss has two components called hyste-

resis loss and eddy current loss. Hysteresis loss is determined by the chemical and physical structure of the core itself. The loss is usually expressed by the formula

$$\text{Watts loss} = k f (\beta_{\max})^n, \text{ where}$$

- k = a constant for the particular material.
- f = frequency in cycles per second.
- β_{\max} = maximum instantaneous flux density.
- n = Steinmetz exponent, usually slightly less than 2.

This formula may be interpreted in the following way. If the flux density is kept constant, the loss will vary in proportion to the frequency, or if the terminal voltage is kept constant and the frequency is varied, the loss will vary approximately inversely to the frequency.

The other principal core loss is due

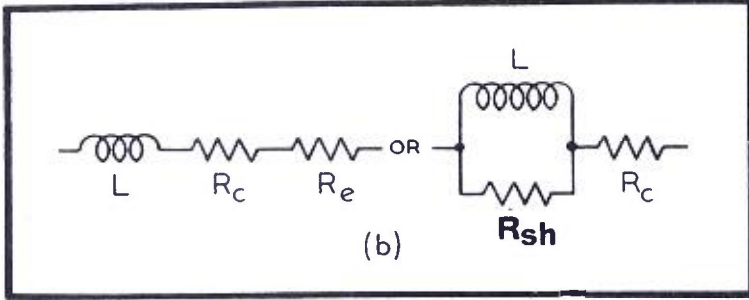
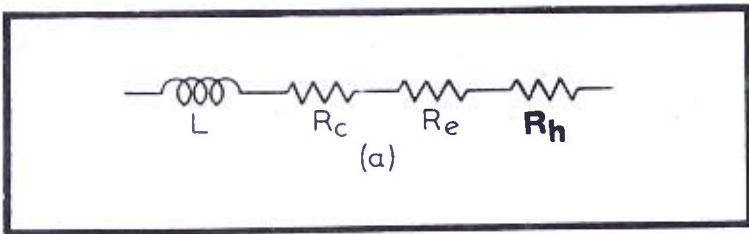

LOW FREQUENCY	Q MAX	HIGH FREQUENCY
EDDY CURRENT LOSS		
<p>SHUNTING EFFECT LOW</p>		<p>SHUNTING EFFECT HIGH</p>
COPPER LOSS		
<p>Rc DOMINANT</p>	<p>Q MAX</p>	<p>Rc NEGLIGIBLE</p>

to eddy currents and is expressed as

$$\text{Watts loss} = k_2 f^2 (\beta_{\max})^2 t^2$$

Obviously, the loss is independent of frequency. The symbol t represents the thickness of the individual laminations; the loss is very greatly reduced by using thin laminations.

In considering an inductance for audio frequencies, it is confusing to think of *loss* in terms of *watts*—rather it is more convenient to visualize a resistor as representing a loss.

In Figure 1a appears a circuit which represents the losses in an inductance. In this circuit L = pure inductance; R_c = winding resistance (ohmic), that is, copper loss not affected by frequency; R_e = eddy current loss; R_h = hysteresis loss.

In order to simplify the analysis the voltage applied to the inductance will be assumed to be very low so that the hysteresis loss will be low compared with the eddy current loss. With this restriction the circuit may be represented as follows:

In Figure 1b, R_c is the winding resistance and R_e the eddy current loss resistance, which should be thought of as being in *shunt* with the resistance. That is, we should think of a transformer which has a secondary winding

terminated with a resistance. Resistance is independent of frequency, but its effect is not independent of frequency.

Inductance Qualities

The merit of various inductances may be compared on a common basis known as Q .

$$Q = \frac{2\pi f L}{R}$$

For the purpose of circuit analysis the shunt resistance, R_{sh} , may be equated to a series resistance by the following manipulation. The impedance of the inductance and resistances in parallel, may be expressed algebraically as

$$Z = \frac{j R_e \omega L}{R_c + j \omega L}$$

Conforming to the general rule of parallel impedances

$$(1) Z_o = \frac{Z_1 Z_2}{Z_1 + Z_2} = \frac{R_c j \omega L}{R_c + j \omega L}$$

$$(2) \text{ Multiplying each term by } R_c - j \omega L$$

$$(3) Z = \frac{R_c j \omega L (R_c - j \omega L)}{R_c + j \omega L (R_c - j \omega L)}$$

$$= \frac{R_c (\omega L)^2 + j (R_c)^2 \omega L}{(R_c)^2 + (\omega L)^2}$$

(4) Separating real and imaginary terms

$$\frac{R_c (\omega L)^2}{(R_c)^2 + (\omega L)^2} + \frac{j (R_c)^2 \omega L}{(R_c)^2 + (\omega L)^2}$$

(5) And considering only the real term

$$\frac{R_c (\omega L)^2}{(R_c)^2 + (\omega L)^2}$$

(6) Then factoring the denominator

$$\frac{R_c (\omega L)^2}{(R_c)^2 \left[1 + \left(\frac{\omega L}{R_c} \right)^2 \right]}$$

(7) If $\frac{\omega L}{R_c}$ is small compared with 1

the expression becomes $\frac{(\omega L)^2}{R_c}$ which

being a series resistance may be added directly to R_c making the total loss

$$R = R_c + \frac{(\omega L)^2}{R_c}$$

which gives for Q

$$Q = \frac{\omega L}{R}$$

R = total resistance of circuit

Simplifying

$$Q = \frac{\omega L}{R_c + \frac{(\omega L)^2}{R_c}} = \frac{1}{\frac{R_c}{\omega L} + \frac{\omega L}{R_c}}$$

$$= \frac{1}{\frac{R_c \omega L}{R_c \omega L + (\omega L)^2} + \frac{R_c \omega L}{R_c \omega L + (\omega L)^2}}$$

Now, to find when Q is a maximum we have only to differentiate Q with respect to f .

R_c , R_e and $2\pi f$ are to be considered constants. Applying the formula for the differentiation of a quotient: let $a = R_c$
 $b = R_e$
 $c = 2\pi f$

wherever a tube is used...

for example - INDUCTION HEATING

Electronic heaters with inductor coils connected to terminals of Oscillator Type Tubes, are used for brazing, soldering, hardening, and bonding of small diameter parts, thin sections and low resistance materials.

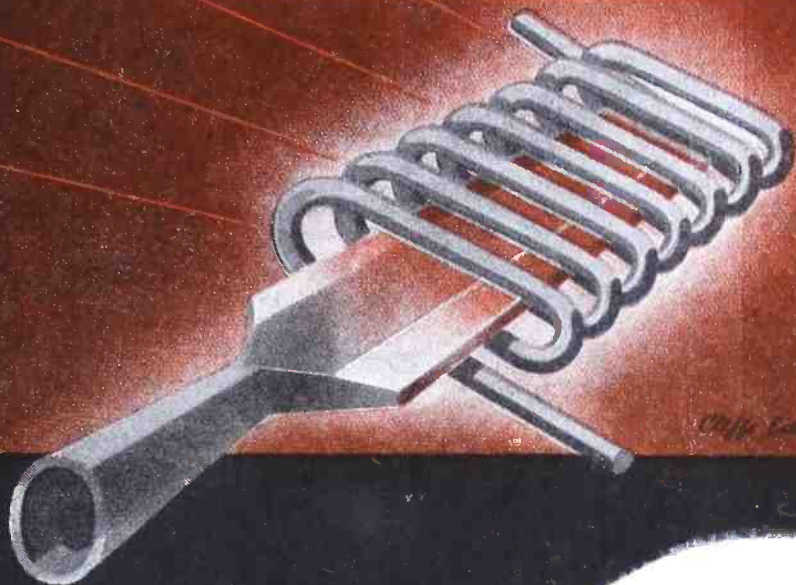

THERE'S A JOB FOR

Relays BY GUARDIAN

Induction heating costs less, is more dependable and easier by the electronic method. Safer, too, even with inexperienced hands, when protected from improper operation by quality relays such as the Guardian Series 90 Interlock Relay and the Series L-500 Overload Relay.

Series 90 Interlock Relay locks mechanically from an electrical impulse and unlatches or resets from another such impulse. Combinations up to DPDT available with $12\frac{1}{2}$ amp. contacts rated at 110 v., 60 cycles, non-inductive load. Coil resistances up to 10,000 ohms. For AC or DC operation.

Series L-500 Overload Relay, manual reset, protects DC circuits against abnormal current surges where current conditions are constant. Contacts can take severe overloads undamaged, cannot be reset during overload. Rated for 1500 watts on 110 v., 60 cycle, non-inductive AC.

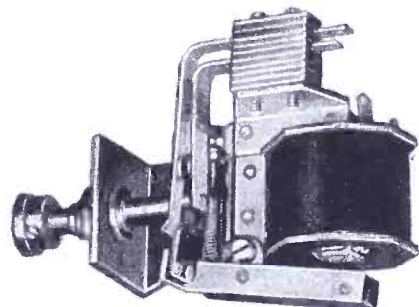

Series L-500—Overload Relay
Ask for Bulletin R-5

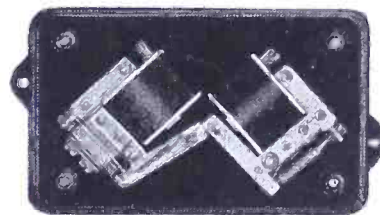

Series 90—Interlock Relay
Ask for Bulletin 21

Consult Guardian wherever a tube is used—however—Relays by Guardian are NOT limited to tube applications but may be used wherever automatic control is desired for making, breaking, or changing the characteristics of electrical circuits.

GUARDIAN ELECTRIC

1623-C W. WALNUT STREET

CHICAGO 12, ILLINOIS

A COMPLETE LINE OF RELAYS SERVING AMERICAN WAR INDUSTRY

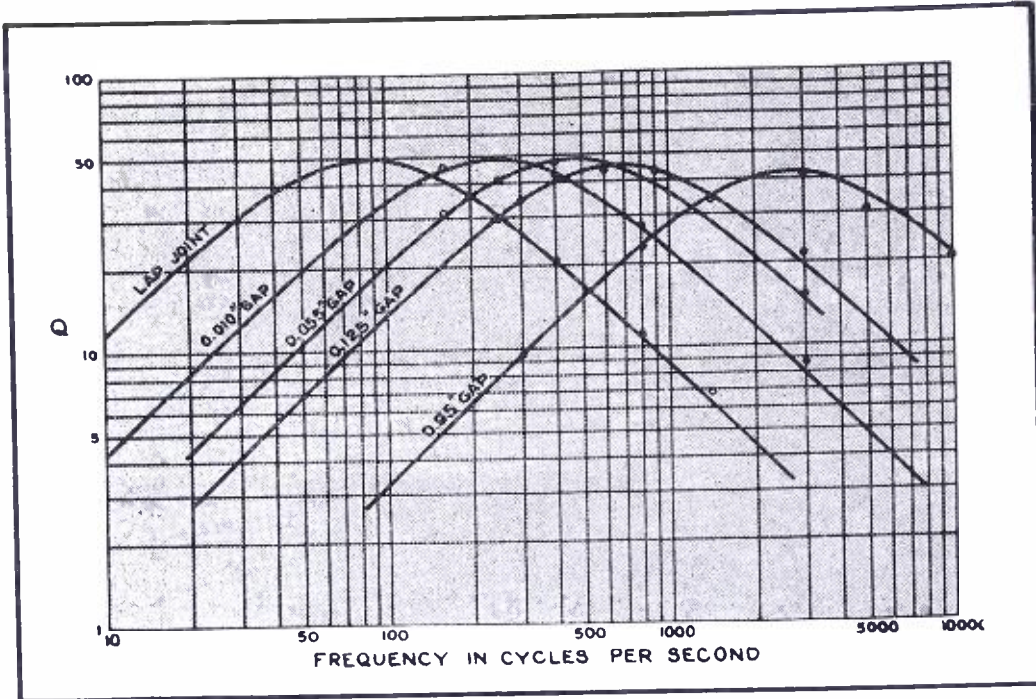

Figure 2

A graphical explanation of how and why Q changes with frequency, and why it goes through a maximum. (Courtesy General Radio Experimenter)

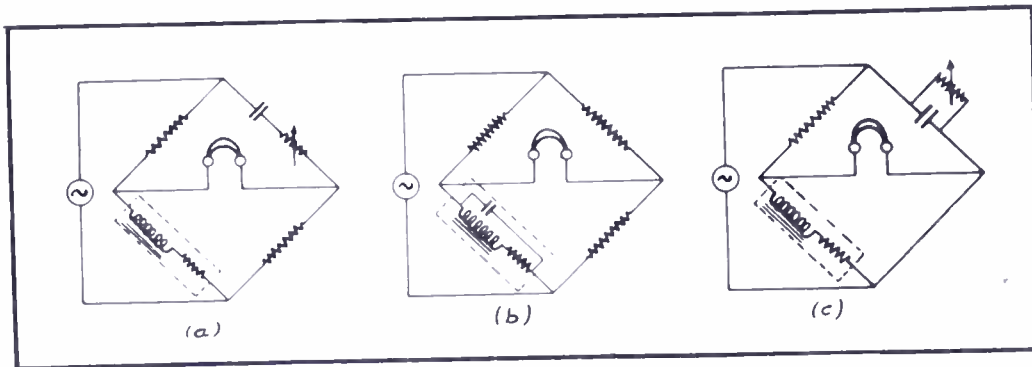

Figure 3

Bridge circuits for measurements of Q . At (a) appears a Hay bridge; at (b), a resistance bridge operated at resonant frequency of tuned circuit; at (c), Maxwell bridge.

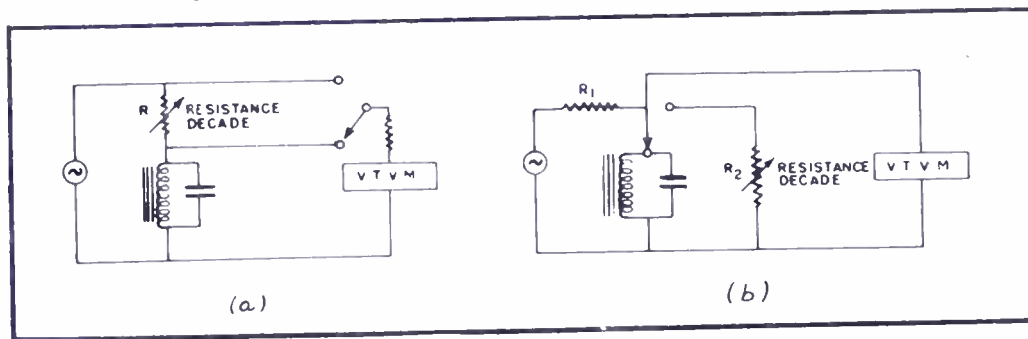

Figure 4

Methods of measuring Q . At (a) is a 6-db drop method, and at (b) appears a resistance substitution method. In (a), $Q = \omega L/R$ when 6-db voltage difference exists across switch. In (b), R_1 is selected so that small changes in Z of tuned circuit can be observed on V.T.V.M.

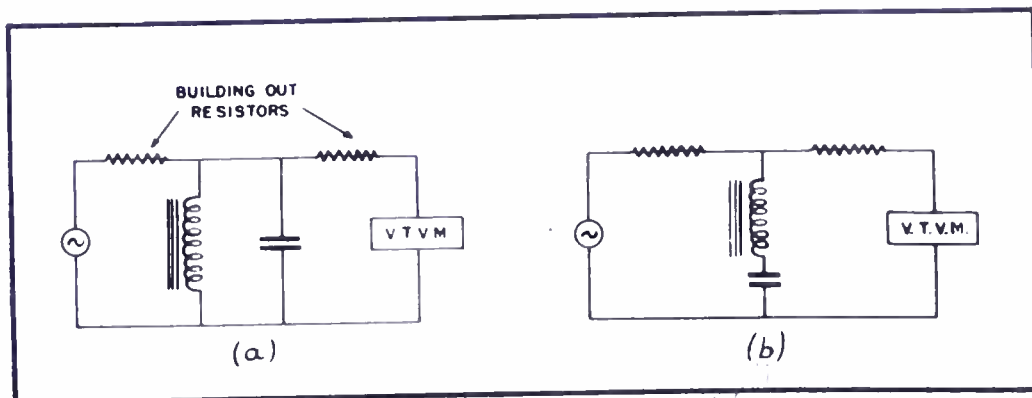

Figure 5

In (a) and (b) appear frequency variation methods. Similar methods can be used with series-resonant circuits.

$$\frac{dQ}{df} = \frac{[ab + (cf)^2]bc - [0 + 2ef] \times c^2bf}{(ab + c^2f^2)^2}$$

$$= \frac{ab^2c + c^3bf^2 - 2c^3f^2b - ab^2c - bf^2c^3}{(ab + c^2f^2)^2}$$

$$= \frac{cb(ab - f^2c^2)}{ab + c^2f^2}$$

(each term can be set equal to zero)

$$ab - f^2c^2 = 0$$

$$f = \frac{ab}{c^2} \quad f = \frac{\sqrt{ab}}{c} = \frac{\sqrt{R_c R_c}}{2\pi L}$$

Similar equations are solved to give the following expressions

$$Q_{\max} = \frac{\pi f_{\text{of max } Q} L}{R_c}$$

$$Q_{\max} = \frac{1}{2} \sqrt{\frac{R_c}{R_c}}$$

A graphical analysis is helpful in showing how and why Q changes with frequency and why it goes through a maximum (Figure 2).

A typical air core coil has only copper loss, so the Q is expressed

$$Q = \frac{\omega L}{R_c}$$

A graph of Q plotted against frequency is a straight line starting at the origin, with a positive slope of 1 . Now, the effect of a shunt resistance is just the opposite; a line with a slope of -1 . The frequency of intersection of these two lines is the frequency of maximum Q . The sum of the two lines at any frequency is the Q for that frequency. (The sum in this case is not the arithmetical sum but rather the reciprocal of the sum of the reciprocals; think of D , dissipation factor!)

An air core coil of 1 henry with 50 ohms of resistance would have the following Q :

100 cycles	1.256
1,000 cycles	12.56
10,000 cycles	125.6

Now let us visualize a shunt resistance of $80,000$ ohms to represent eddy current losses. ωL at 100 cycles 628 ohms, so $80,000$ ohms in shunt would have a very small effect. At 1 kc, $\omega L = 62,800$, so $80,000$ ohms shunt would have a pronounced effect. The frequency at which Q is a maximum is

$$f_{\max} = \frac{\sqrt{R_c R_c}}{2\pi L}$$

$$= \frac{\sqrt{500 \times 80,000}}{(6.28)(1)} = 1,000 \text{ cyc}$$

The actual Q would be

$$Q_{max} = \frac{1}{2} \sqrt{\frac{80,000}{500}}$$

$$= \frac{1}{2} \sqrt{160} = \frac{12.6}{2} = 6.3$$

In all the above expressions L is varied by adjusting the air gap of the magnetic structure.

For the foregoing discussion the flux density has been considered as being very small, so small that the hysteresis loss is negligible. The question might be raised: "What good is such an analysis since it does not represent working conditions?" Since the Steinmetz exponent is somewhat less than 2, it follows that hysteresis loss is almost constant with frequency, decreasing slowly as the frequency is increased, provided a constant voltage is maintained at the inductance terminals. As the voltage is increased the hysteresis loss increases very rapidly, masking, at high voltage, the effect of R_e and R_c in determining the frequency of Q_{max} . However, since this loss resistance varies so slowly with frequency, it may be considered as being independent of frequency. The most important thing about the analysis is that it provides the engineer with explanatory data.

In order that an inductance have high Q the three losses, R_e , R_c and R_h must be low.

R_c is kept low by using a magnetic structure that has a large winding

Figure 6
The sharpness of resonance of a circuit indicated in Figure 5 is divided by the change in frequency necessary to produce a certain change in current in the tuned circuit, as we see in this table.

(Courtesy Terman's Radio Engineers Handbook, McGraw-Hill Book Co.)

FRACTIONAL DETUNING (= CYCLES OFF RESISTANCE RESONANT FREQUENCY)	ACTUAL CURRENT CURRENT AT RESONANCE
$\frac{1}{6Q} = \frac{1}{3} \times \frac{1}{2Q}$	0.95
$\frac{1}{4Q} = \frac{1}{2} \times \frac{1}{2Q}$	0.90
$\frac{1}{2Q} = 1 \times \frac{1}{2Q}$	0.707
$\frac{1}{Q} = 2 \times \frac{1}{2Q}$	0.447
$\frac{2}{Q} = 4 \times \frac{1}{2Q}$	0.242
$\frac{4}{Q} = 8 \times \frac{1}{2Q}$	0.124

space and by filling this space as nearly as possible with copper wire.

Eddy current loss may be kept low by: (a) using thin laminations; (b) using laminations which have a high specific resistance; (c) keeping the leakage flux from metallic objects, especially iron; (d) preventing eddy currents from flowing from sheet to sheet of the laminations, and (e) op-

erating the core at low flux density.

R_h may be kept low by operating at low flux density and by using low loss core material.

How to Measure Q

The simplest methods of measuring Q is to use an impedance bridge such as a GR 650A. After the balance is obtained, the Q may be read directly from the DQ or Q dial. Bridges may be made from laboratory parts. The Hay bridge is most convenient if the inductance under test has a high Q ;

Figure 7
60-cycle incremental permeability characteristics of Allegheny audio transformer "A" sheet steel (No. 29 U. S. Gauge).
(Courtesy Allegheny Steel Company)

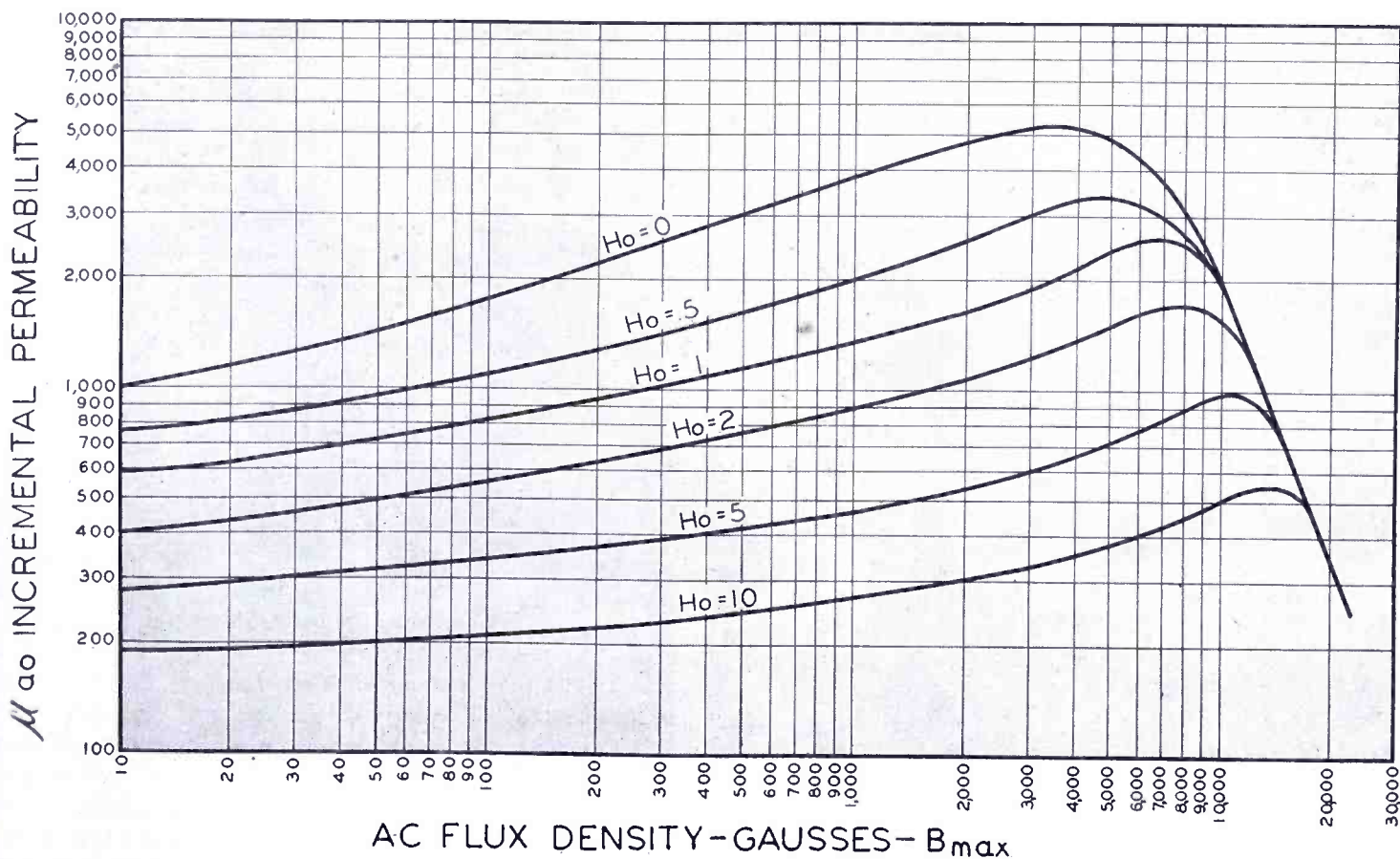

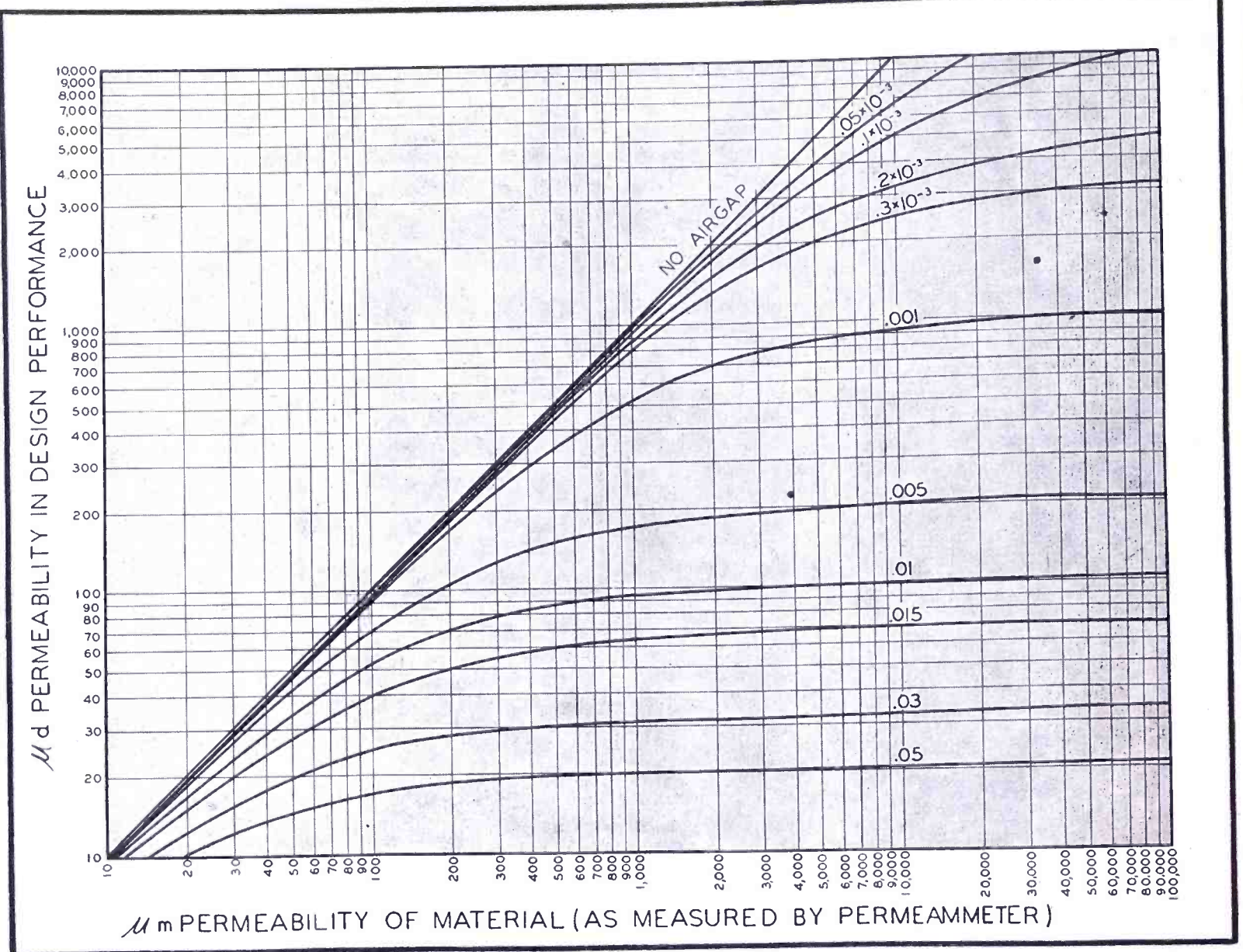

Figure 8
Permeability of design (μ_d) resulting from known permeability values (μ_m), corresponding to various ratios of airgap to total length of magnetic path (a/l).

the Maxwell bridge is most convenient for low Q .

A different method is to tune the inductance to resonance by use of a suitable condenser, and then measure the impedance of the tuned circuit by any of several different methods, (Figures 3 and 4).

For parallel resonance the impedance (for $Q = 10$ or more) is $Z = \omega L \times Q$.

$$Z = R = \omega L Q$$

$$Q = \frac{R}{\omega L}$$

The formula in Figure 4 is not correct for parallel resonance, but is correct for series resonance.

A still different method is the *frequency variation method*, (Figure 5). Here the sharpness of resonance is indicated by the change in frequency necessary to produce a certain change in current in the tuned circuit. (Figure 6).

Manufacturing Practices for High Q Inductances

The conventional transformer, such as an output transformer, or a microphone transformer, has characteristics

which are not at all suitable for inductances. To begin with, a transformer usually shows a very poor Q , that is, if each winding is considered as an inductance.

A conventional transformer has another poor characteristic, that is, the inductance of a given winding does not remain constant. A graph which shows the relationship between a-c permeability and flux density shows clearly that if the applied voltage is increased from a small value, the a-c permeability increases. This results in an increase in inductance (Figure 7). The flux density is proportional to the applied voltage.

For example, silicon steel laminations which are 100% interleaved, show a 4 to 1 increase in inductance when the flux density changes from 10 gauss to 1000 gauss corresponding to a 100 to 1 voltage increase. If this applied voltage is still

further increased, the inductance will also increase up to a critical value, at which point the core material is said to exhibit its maximum permeability. This is around 4,000 to 5,000 gauss. If the applied voltage is still increased, the inductance decreases very rapidly as the core material approaches saturation. The curve mentioned above, up to the point of maximum permeability, will show a positive slope. At maximum permeability the slope is zero, and at a still higher value of flux density the slope is negative.

This fact can be more easily observed by using an inductance bridge such as the GR 650-A, and instead of using the source of voltage within the bridge, an audio oscillator with an attenuator can be used, so that widely different voltages can be applied to the bridge. The highest voltage would be determined by the maximum allowable voltage which the bridge could withstand without damage, and the lowest voltage by the amount of amplification available for determining the null point of the bridge. Using this method, voltages through a range of 1,000 to 1 can be applied to the coil under test, noting

(Continued on page 87)



Inductors - to specifications

From the small 100 watt tube socket types to the large 100KW types using copper tubing, Johnson inductors are designed to rigid specifications. They are more than coils. Into each of Johnson's inductors go more than 20 years of "know how"—familiarity with materials—skill in mechanical design—knowledge of circuits—and experience in electrical design for greatest efficiency in the particular application. Tapped inductors, fixed and variable coupling coils, variable inductors, and clips are all features Johnson can furnish. Copper tubing, wire, edgewise wound copper strip, or flat copper strip are available. Insulation materials used are steatite, Mycalex, Bakelite, and porcelain. Write for suggestions on YOUR inductor problem. Quotations furnished on the basis of either mechanical specifications or performance specifications.

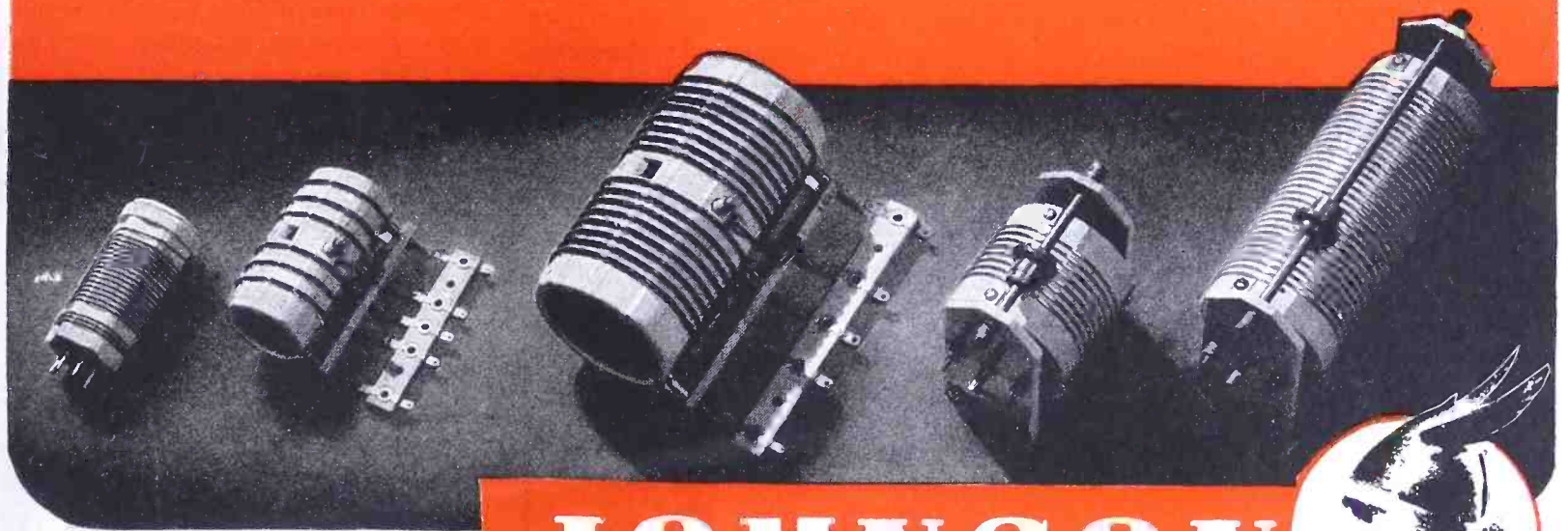

Write for New
JOHNSON CATALOG
968E

JOHNSON

a famous name in Radio



E. F. JOHNSON COMPANY • WASECA • MINNESOTA

COMMUNICATIONS FOR MARCH 1944 • 39

IMPEDANCE TRANSFORMATION

(PART TWO OF A TWO-PART PAPER)

by PAUL J. SELGIN

Instructor, Electrical Engineering, Polytechnic Institute of Brooklyn

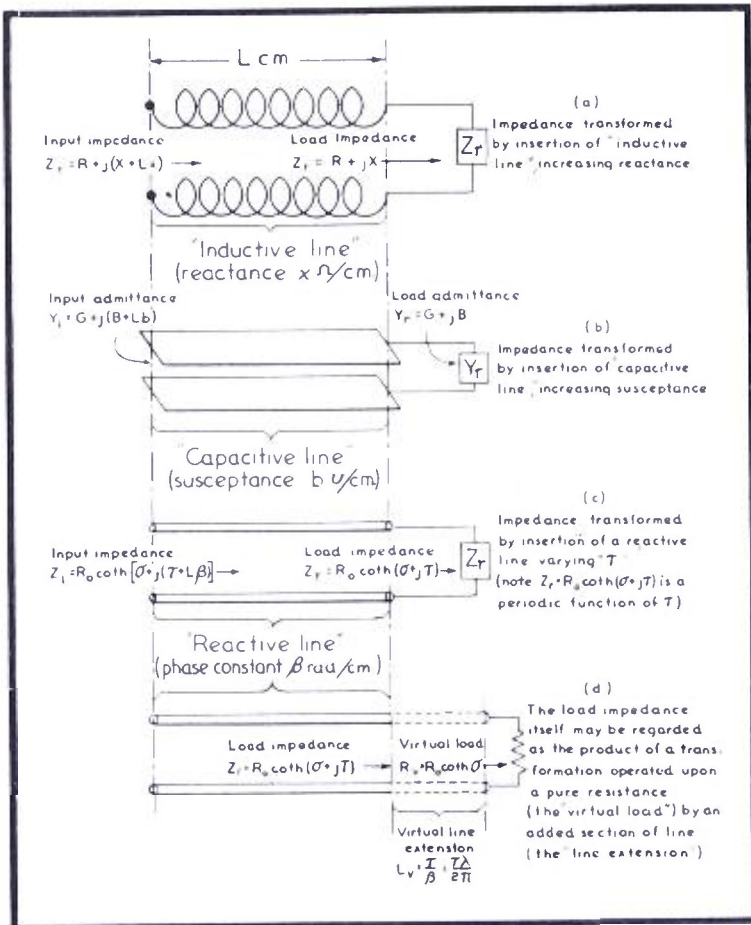

Figure 6

Illustrating the impedance transforming action of a reactive line.

IN the first part of this paper, the principle of impedance transformation was considered in general; impedance transformation by means of the addition of series and parallel branches, and its geometric representation, were taken up in greater detail. It appeared that every single-frequency impedance transformation problem could be solved, *on paper*, by the use of *two-element* networks, comprising a perfect coil and a perfect condenser (except two coils or two condensers).

Unfortunately, however, this solu-

tion can be used only up to a value of frequency which cannot be set once for all, but depends on the values of load and generator impedance and the allowable dissipation.

Deviation of Coil Reactance

As the frequency is increased, the true reactance of a coil deviates more and more from the *theoretical* value based on the *inductance* of the coil (a parameter which, strictly speaking, has a meaning only at d-c). The device of linking the same current many times with the same magnetic path, used so

successfully at low frequency, must be discarded when the displacement current between turns grows to high values. At very high frequencies, there must be some relationship between the voltage and the distance between two points.

These and other considerations point to transmission lines as the answer. The operation of transmission lines in contrast to that of coils, becomes more straightforward as the frequency increases (up to the point where the wavelength is comparable to the lateral dimensions).

Let us consider the input impedance of a section of transmission line (Figure 6 (c)) when the load impedance (output impedance) has some value Z_r . We cannot conveniently think of the line as a combination of series and parallel branches, which would transform the load impedance by successive additions similar to those considered in the first portion of this paper. We can, however, think of the line as a single *symmetrical network*. As a matter of fact, the transmission line, at sufficiently high values of the frequency, is an exceptionally simple network. Its *characteristic impedance* is a pure resistance, of value

$$R_0 = \sqrt{l/c} \quad (1)$$

where l is the distributed inductance, c the distributed capacity. Its transfer constant is an imaginary, of value

$$\theta L = j \frac{2\pi L}{\lambda} \quad (2)$$

where L is the length of the line in meters, λ the wavelength. The number $\frac{2\pi}{\lambda}$ is also called the *phase constant*

of the line, and $\frac{2\pi L}{\lambda}$ is often

called the *line angle*.

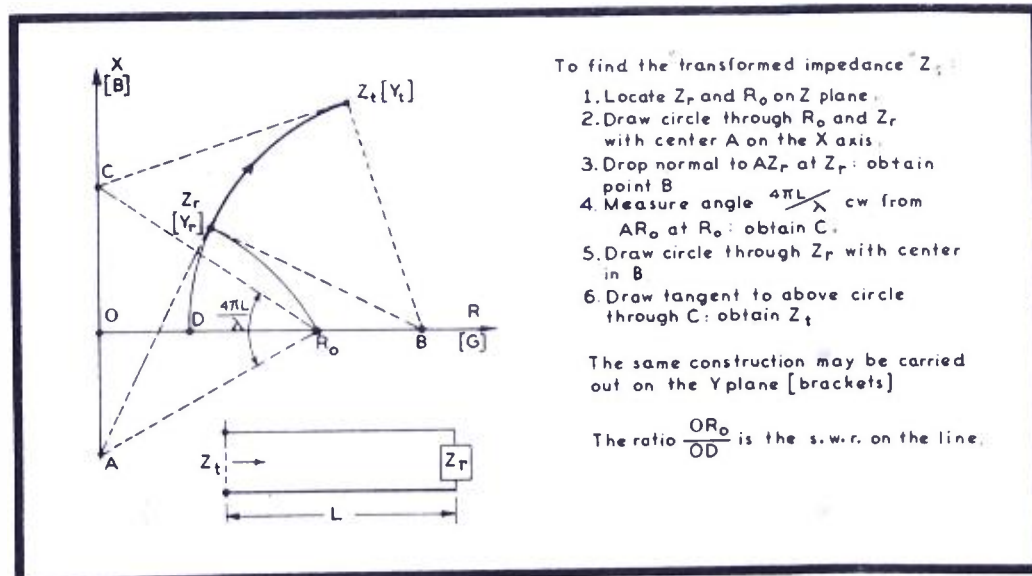

Figure 7

Impedance transformation by a reactive line.

Graphical Methods of U-H-F Transmission Line Analysis

The problem of determining the impedance transforming action of a line of this type (which we will call *reactive line*), reduces to the following:

(1)—Given the load impedance, find the corresponding reflection factor ρ . This may be done analytically, by expanding the equation

$$Z_L = R_0 \coth \rho \quad (3)$$

expressing the general relation between load impedance and reflection factor. Since R_0 is known (equation 1), the above may be solved for ρ , which will appear, in general to be complex. It is often more convenient to find ρ by chart methods or by construction. The hyperbolic tangent map (see the first part of this paper) may be used; or we may use constructions and charts discussed in 2 and 3.

(2)—Given ρ , add to this number the transfer constant of the line, given by 2. Thus we find the complex number:

$$\rho' = \rho + j \frac{2\pi L}{\lambda} \quad (4)$$

(3)—Repeating step (1) in the opposite direction, find:

$$Z_L = R_0 \coth \rho'$$

which is the required transformed impedance. Whatever method has been used in step (1) may be used here again, of course.

Figure 6 illustrates the analogy between an inductive line (two long solenoids with negligible mutual and inter-turn capacitances), a capacitive line (two flat parallel strips with negligible inductance) and an ordinary transmission line with appreciable values of both l and c . The three lines add imaginary terms to the values of Z , Y and ρ respectively, in proportion to their length. The concepts of *virtual load* and *virtual line extension* are also illustrated.

Determining Line Performance by Ruler and Compass

Constructions using only a ruler and a compass are very desirable, as they are infinitely less laborious than the corre-

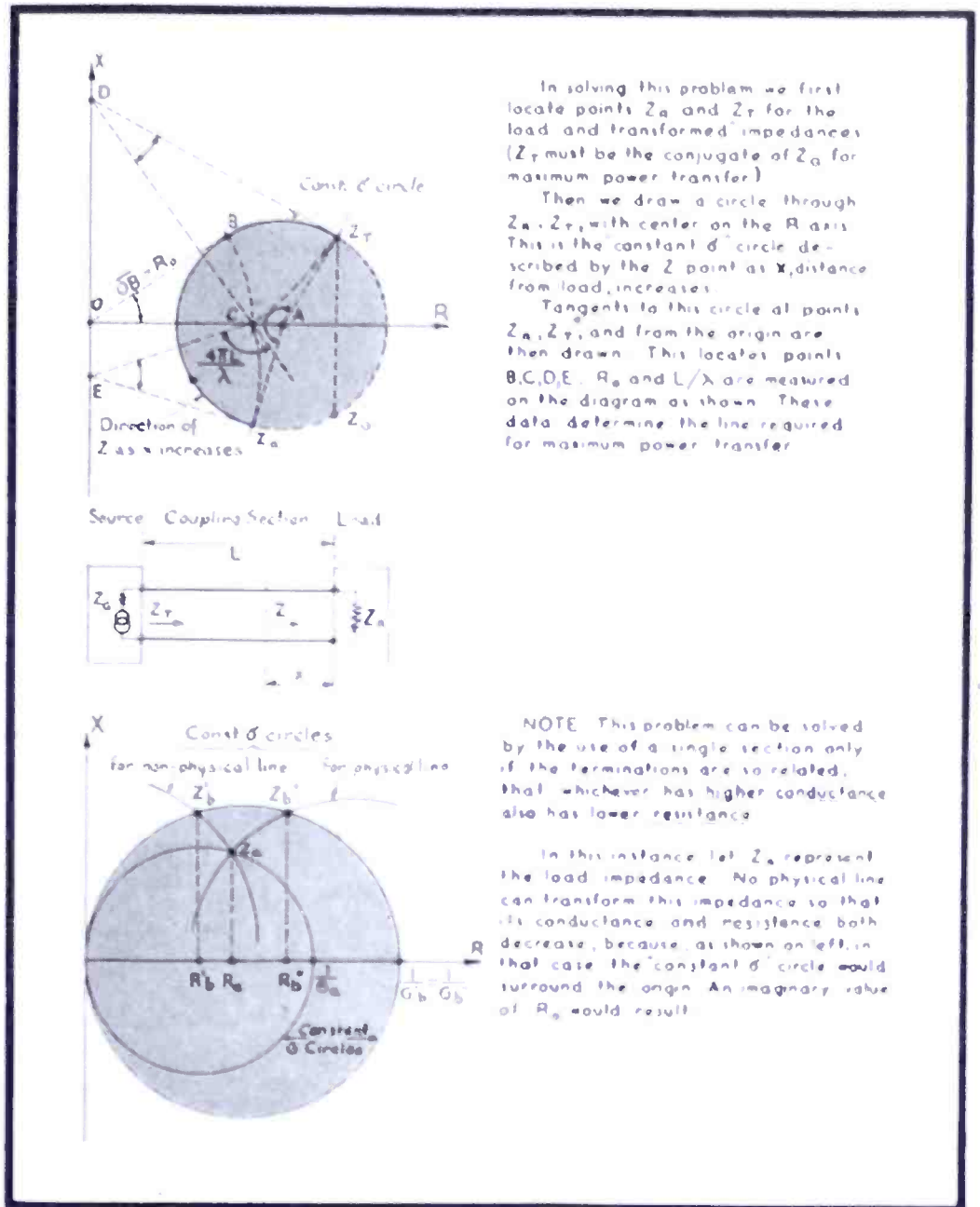
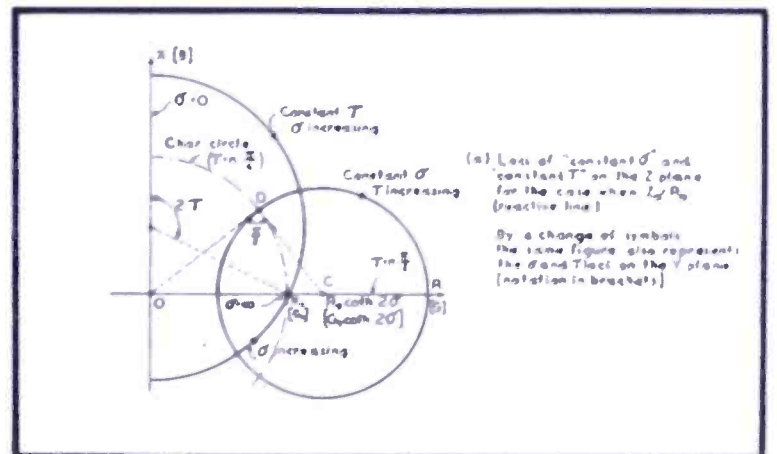

Figure 9

Solution of the coupling problem by means of a section of reactive line.

Figure 8
Impedance transformation by a network insertion.



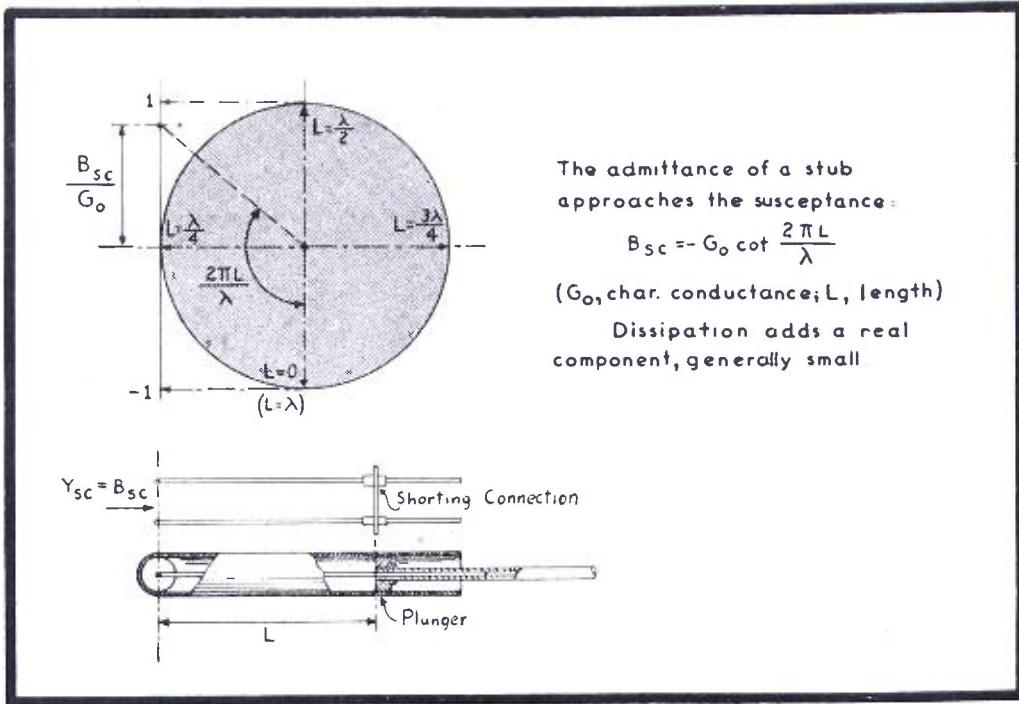

Figure 10
Short circuited line section (stub). Upper left shows construction for B_{sc} . Lower left shows parallel and coaxial stubs.

The admittance of a stub approaches the susceptance:

$$B_{sc} = -G_0 \cot \frac{2\pi L}{\lambda}$$

(G_0 , char. conductance; L , length)
Dissipation adds a real component, generally small

axial line, with concentric conductors of which the outer one is tubular.]

Line Couplings and Use of Stubs

Returning to the construction of Figure 7, the inverse construction is also evidently possible. That is, if we are given the two end points of the impedance transformation, Z_r and Z_i , we may by construction determine the parameters of a reactive line capable of effecting the transformation. Figure 9 shows this construction in detail. If we carry it out in a number of cases, we find that a solution is not always possible. The required value of R_0 may turn out to be negative, which of course is not true of any physical line. The problem may be solved only if that termination for which the conductance is higher, also has the lower value of resistance.

For this reason, it is often necessary to use couplings which include, in addition to the coupling section of line, one or two parallel susceptances shunting this line at the ends or at an intermediate point. These susceptances are supplied by added sections of transmission line, connected across the coupling section at one end, while the other end is shorted (Figure 10). These additional dead-end line sections are called stubs. An example of coupling including two stubs, and the corresponding Y plane diagram, is shown in Figure 11.

An important reason for using stubs (aside from the impossibility of obtaining a conjugate match with a simple line coupling in particular cases) is that the susceptance of stubs can easily be adjusted, simply by moving the shorting connection. Such adjustments are very necessary in practice, not only when the transmitted frequency is varied, but also because the terminal impedances Z_r and Z_i are never accurately known. The setting of the stubs which permits maximum power flow is usually found by tuning for maximum power, as in the case of a tuned amplifier. Because two separate conditions must be met for maximum power transfer, and one condition is required for maximum voltage, coupling systems in general must have two adjustments and cannot be tuned

sponding computations, and more accurate and flexible than most chart methods. The problem of finding the input impedance of a reactive line, and hence any other data pertaining to the line in question, is solved by the construction of Figure 7.

Essentially, this construction locates the point corresponding to the required input impedance on the impedance plane, by tracing out the path described by this point, as an increasing length of line is inserted between the load and the input terminals. This path must correspond to a variation of the imaginary part of the reflection factor, as we have seen. Writing this factor in the form

$$\rho = \sigma + j\tau \quad (5)$$

the path in question may be considered as a locus of constant σ , because a

variation of τ does not change σ , or vice versa (just as a variation of reactance does not affect resistance).

The loci of constant σ on the Z plane, and also on the Y plane, are circles, as shown in Figure 8. The loci of constant τ are also circles, intersecting the former at right angles. This double family of circles is a map of the function

$$\rho = \sigma + j\tau$$

on the Z plane. σ and τ are sometimes called bipolar coordinates because, oddly enough, the identical family of circles also represents the magnetic and electric flux lines in a bipolar system of two parallel cylindrical conductors, which is one of the two types of transmission line systems in common use. [The other is the co-

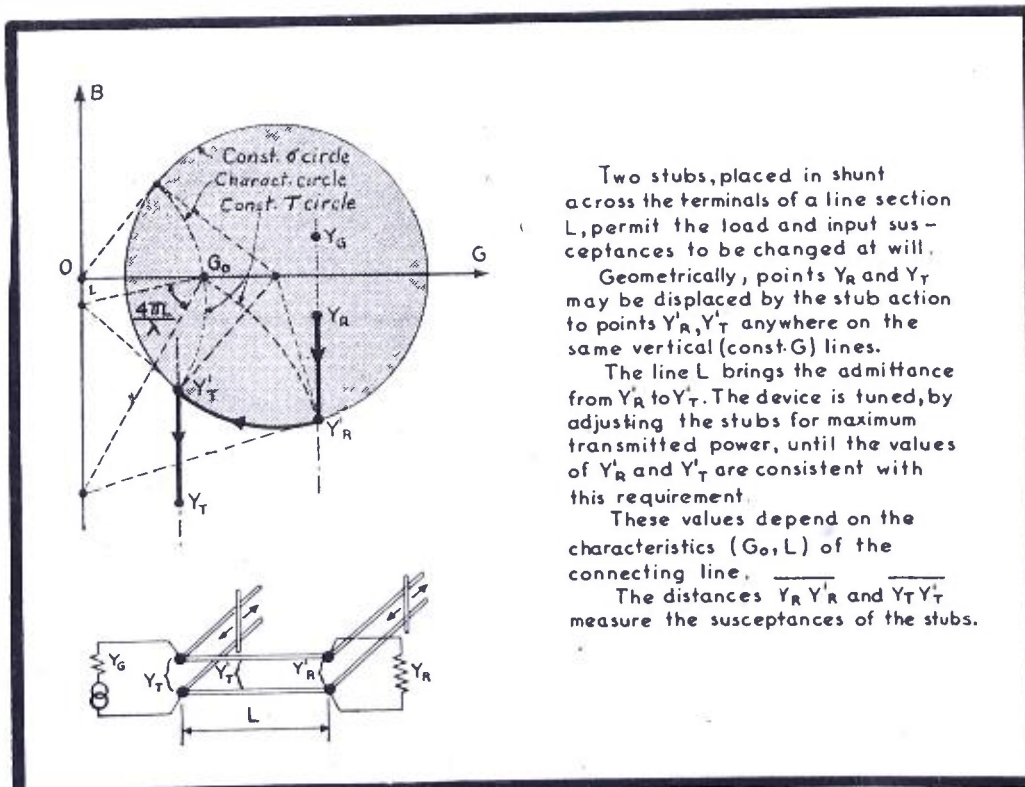

Figure 11
A double shunt tuner.



ART AND SCIENCE...BOTH



Little wonder that tube making is often referred to as an *art*. For much of the work is by hand. To fashion these complex assemblies of filaments, grids, plates and wires; to position the parts within such close space limitations—parts, mind you, that often are so fragile, flimsy and elusive, *tweezers* are required to handle them—calls for a high degree of skill, a steady hand and an eye for accuracy. Art is right!

Yet, today, guiding every move of every N. U. production worker's hands is the "know how" of many scientists and engineers. Here are

chemists, physicists, metallurgists, and men high in the sciences of electronics and mechanics—all teamed up in a scientific tube development and production program recognized as a model throughout this industry.

It takes a lot of *both* science and art to make the advanced-design, high performance N. U. tubes now being produced for combat service. It is such superior tubes that will do your electronic jobs better, after the war. *Count on National Union.*

NATIONAL UNION RADIO CORPORATION, NEWARK, N. J.
Factories: Newark and Maplewood, N. J., Lansdale and Robeson, Pa.



NATIONAL UNION RADIO AND ELECTRONIC TUBES

Transmitting, Cathode Ray, Receiving, Special Purpose Tubes • Condensers • Volume Controls • Photo Electric Cells • Panel Lamps • Flashlight Bulbs

Figure 12

Map of the y function on the k plane
 $(y = k - 1/k + 1)$.

as readily as an amplifier, which has only one.

Relative Advantages of Transmission Line Charts

It was pointed out that the charts used in transmission line computations (at power, telephone or ultrahigh frequencies) are, essentially, tools for obtaining the function ρ from Z (or Y) and vice versa. A number of schemes may be used for this purpose. In all of them a *map* of either function is drawn on the *plane* of the other function. Each map has its particular field of usefulness. The *hyperbolic tangent* map, which appeared in the first part of this paper, is particularly useful for power lines and long telephone lines and cables. On this map, the *point of operation* describes a straight path as the length of the transmission line is varied. The presence of attenuation merely changes the slope of the path. If characteristics of the line or cable are known, it is possible to tell, in case of fault, how far along the line the fault has occurred, and whether it is an *open* or a *short*, simply by measuring the impedance at the *near end* and drawing a straight line with the proper slope on the hyperbolic tangent map.

When attenuation is negligible, as in short lengths of u-h-f line, the map of " ρ " on the Z (or Y) plane, made up of circles like those of Figure 8, has definite advantages. However, in the opinion of the writer it is better not to have the map drawn at all and to draw the required arc of circle by construction (Figure 7). In this way, problems involving successive sections of line with different characteristic

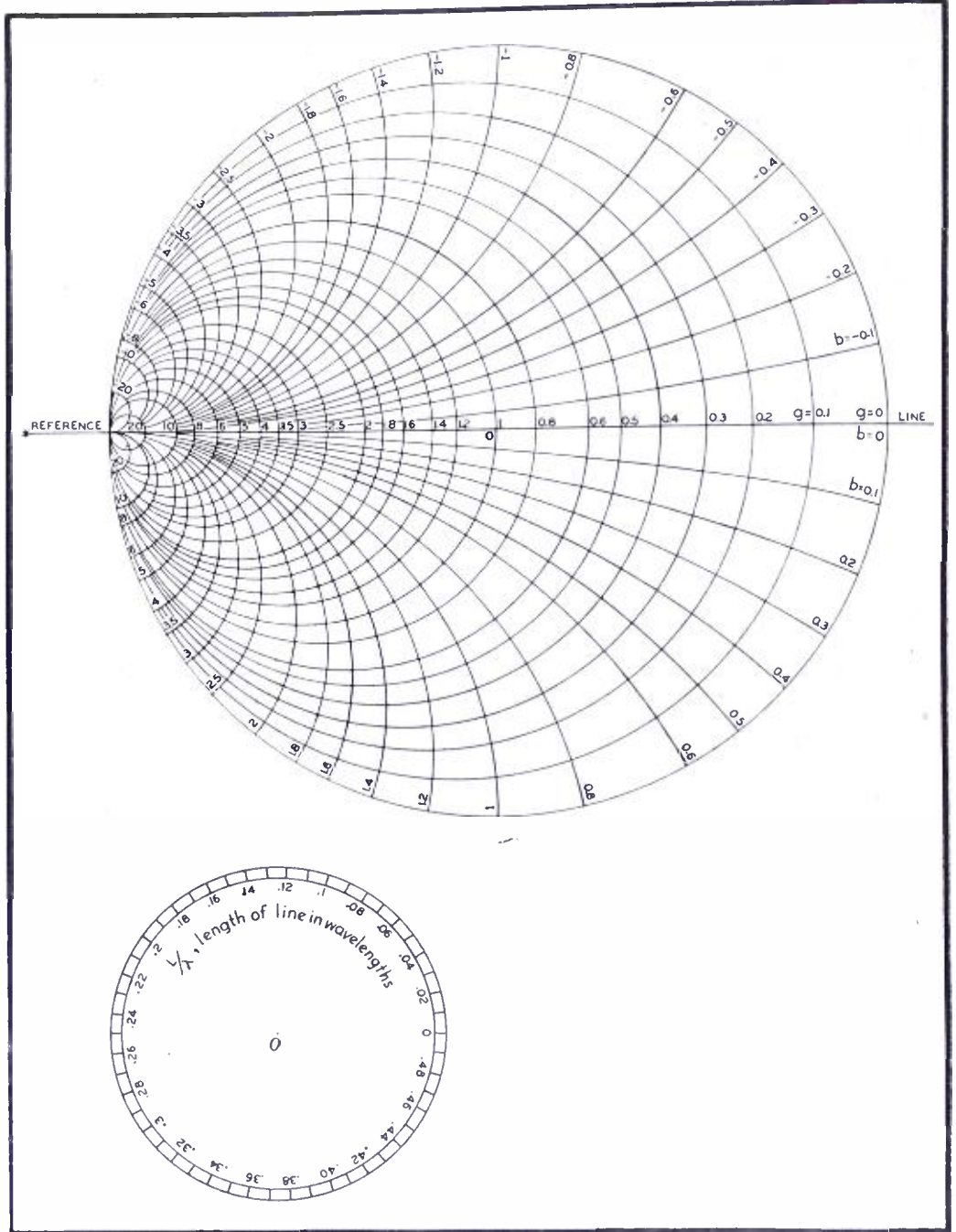

impedance values may be solved by repeating the construction, with R_0 in a new position for each section. This would be manifestly impossible if the map were pre-drawn.

There is a third type of chart, also extensively used, and possessing defi-

nite advantages. It is obtained when we map the impedance (or admittance) function on the plane whose points represent the following function

$$k = e^{-2\rho} = \frac{Z - Z_0}{Z + Z_0} \quad (6)$$

Considering k as a vector, it will be noted that the *angle* of this vector is equal to 2τ (from equation 5). Hence an increase in τ corresponds to a movement of the k point on a circle concentric with the origin.

Line Calculator

By following the directions of Figure 12, a useful line calculator may be assembled. Such calculators have
(Continued on page 87)

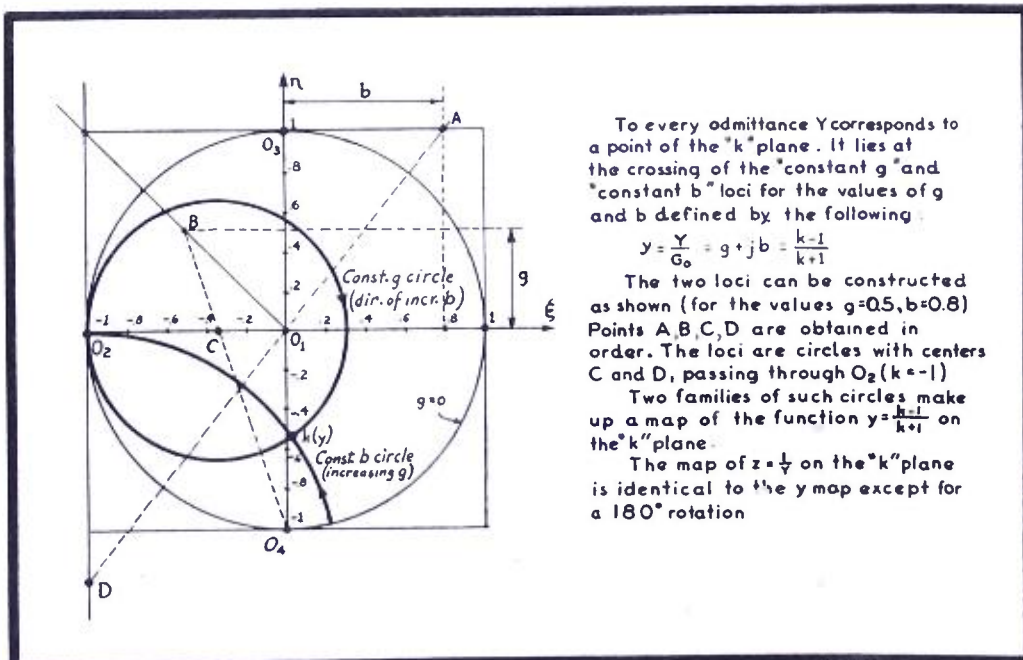

To every admittance Y corresponds to a point of the " k " plane. It lies at the crossing of the "constant g " and "constant b " loci for the values of g and b defined by the following:

$$y = \frac{Y}{G_0} = g + jb = \frac{k-1}{k+1}$$

The two loci can be constructed as shown (for the values $g=0.5, b=0.8$) Points A, B, C, D are obtained in order. The loci are circles with centers C and D, passing through O_2 ($k=-1$)

Two families of such circles make up a map of the function $y = \frac{k-1}{k+1}$ on the " k " plane.

The map of $z = \frac{1}{y}$ on the " k " plane is identical to the y map except for a 180° rotation

Figure 12(a)

Loci of constant g and constant b on the k plane.

"THEN I'LL PUT IT THIS WAY—THE
JEEP AND YOUR **ECHOPHONE EC-1**
ARE BOTH REMARKABLE!"

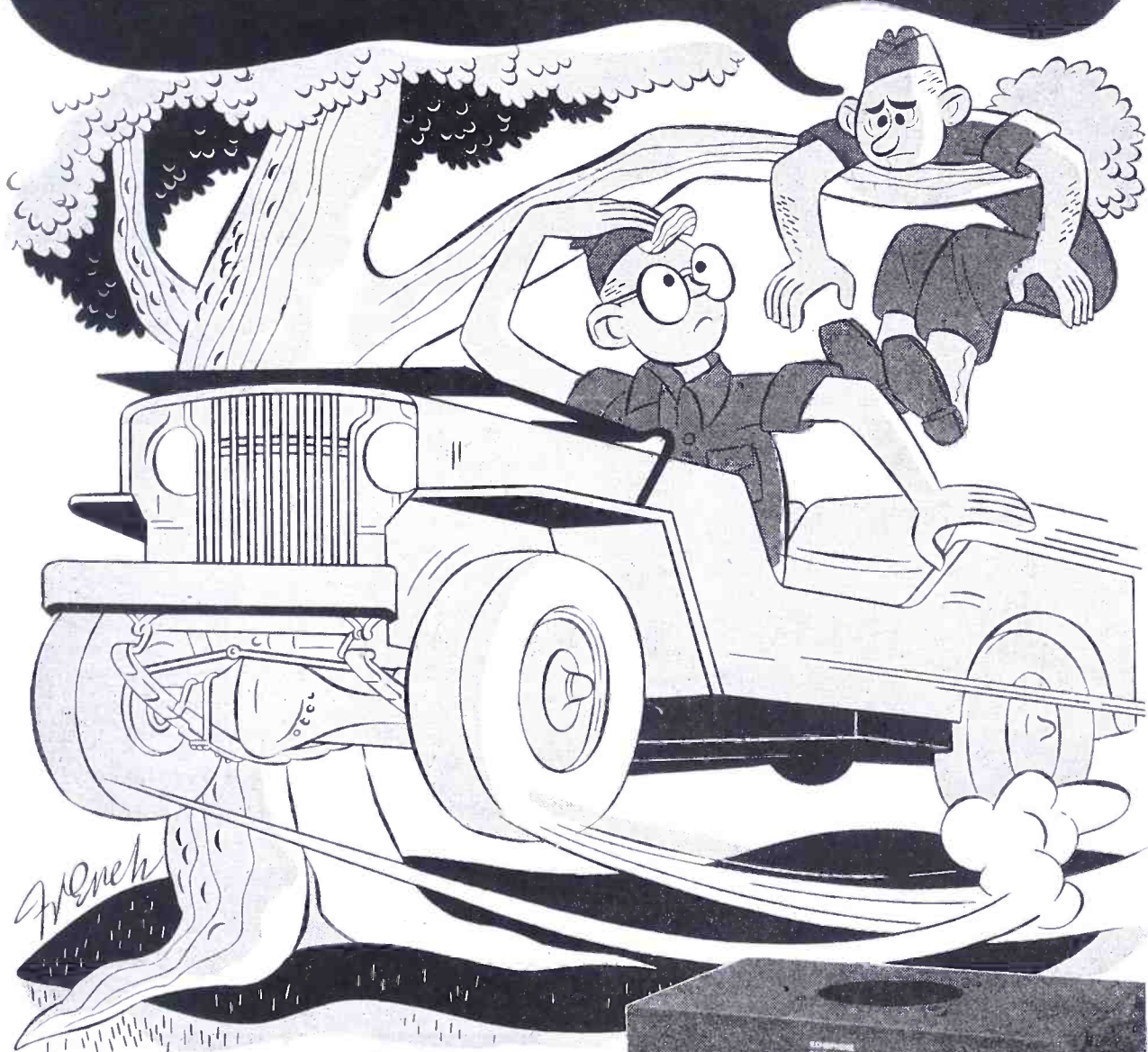

Echophone Model EC-1

(Illustrated) a compact communications receiver with every necessary feature for good reception. Covers from 550 kc. to 30 mc. on three bands. Electrical band-spread on all bands. Beat frequency oscillator. Six tubes. Self-contained speaker. Operates on 115-125 volts AC or DC.



Echophone Radio Co., 540 N. Michigan Ave., Chicago 11, Illinois

WHEATSTONE BRIDGE

And Its Applications

(PART THREE OF A THREE-PART PAPER)

by PAUL B. WRIGHT

Communications Research Engineer

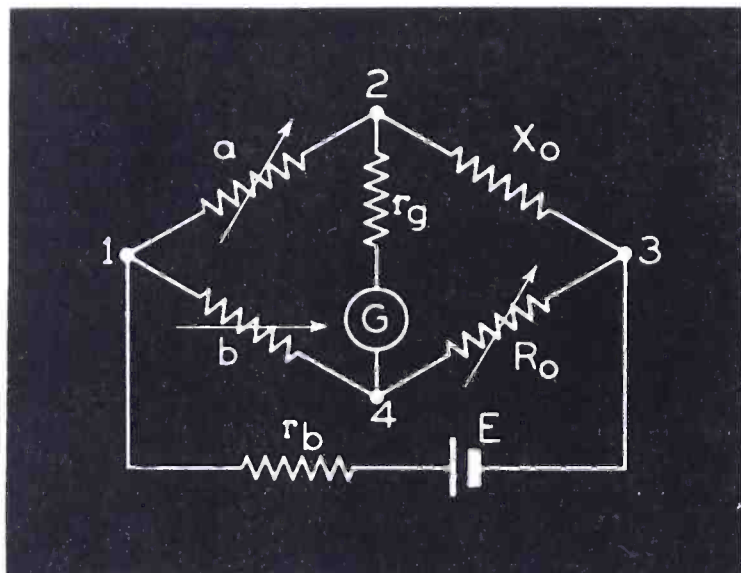

To facilitate reading of this concluding installment, these four illustrations are repeated from previous installments. Figure 3, at upper left, shows a conventional schematic of the Wheatstone bridge circuit. In Figure 6, at left, we have a simple loop measurement of a pair of wires. Figure 7, below left, illustrates a grounded Varley measurement. Figure 10, below right, illustrates a corrected Varley method.

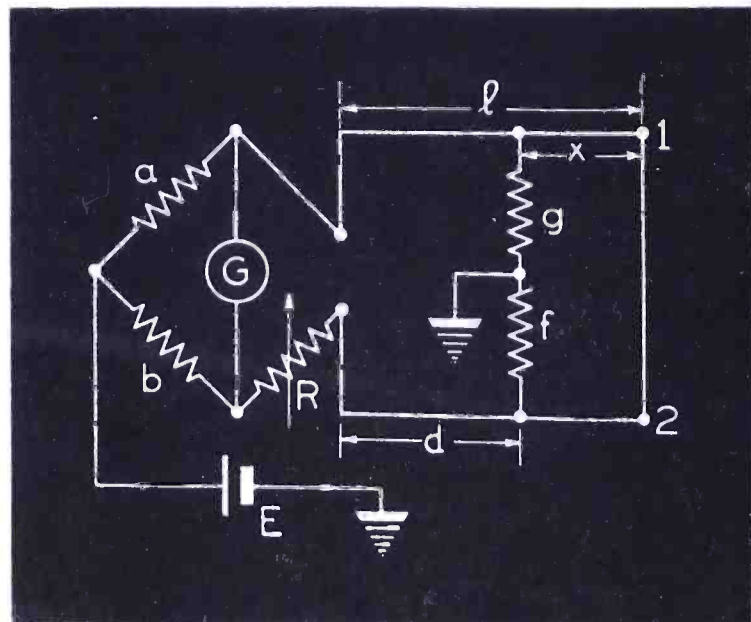
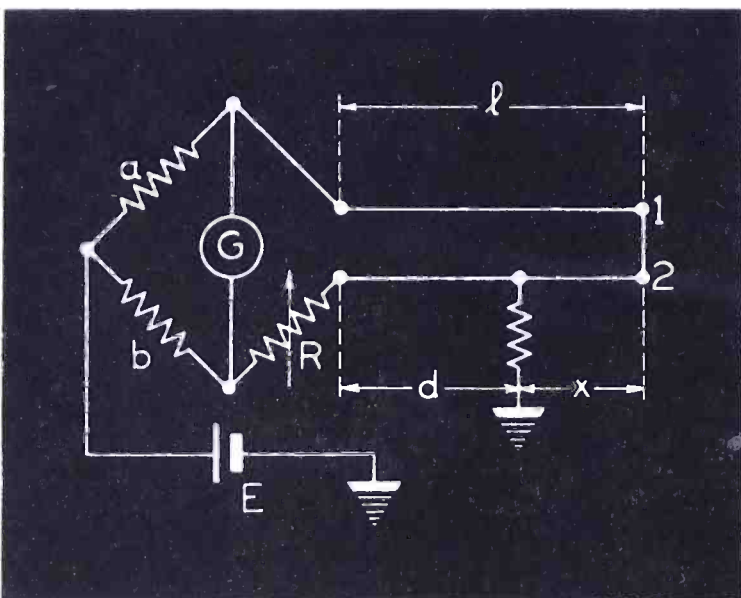
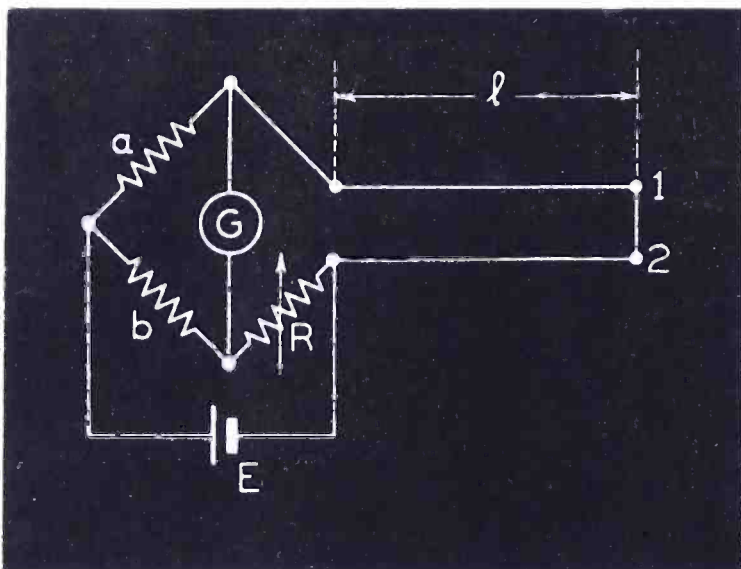

PART I analyzed and considered some of the general aspects of the Wheatstone bridge circuit with respect to accuracy and sensitivity with variations in the element values of the bridge arms. Part II presented an introduction to the theory and application of the bridge for the purpose of locating faults on lines and cables. Formulae and methods of operation were given for a number of the basic applications in fault location work. These were: the simple resistance, line loop resistance, grounded Varley, metallic Varley, corrected Varley, Varley-Fisher or three-wire Varley, Murray loop, and one method of straight resistance measurement. In this, the concluding installment, additional methods of measurement of faults are shown with applications for open location types of measurement by modification of the bridge circuit. Methods of making insulation measurements by means of an auxiliary high resistance voltmeter are also shown. In conclusion, a number of practical considerations are pointed out to assist in evaluating the results obtained.

Straight Resistance

Method 2. This method assumes the same conditions as Method 1 and is subject to the same limitations, but permits measurements to be made from one end only. It thus possesses the advantage of requiring only one bridge. This method may also be used to deter-



History of Communications Number Three of a Series

PRIMITIVE COMMUNICATIONS

An early communications instrument was the Tom-Tom—to prove its efficiency, it is still used by the natives of Africa. Tom-Tom signals are “Beat out” along jungle lined rivers, but even then distance is a handicap, and “repeater” stations are many.

Like all means of communications, other than voice communication, translation of coded signals must take place in which additional skill is required, and another chance of error is presented. As in the case of the Tom-Tom beater: knowledge of the Tom-Tom code was restricted to a special family within the tribe, and was handed down from generation to generation.

Today, Universal Microphones in the hands of the fighting men of the Allied Armed Forces are performing a simple but vital need in electronic voice communications where their quality and efficiency are bringing us one step closer to victory.

< Model T-30-S, illustrated at left, is but one of several military type microphones now available to priority users through local radio jobbers.

UNIVERSAL MICROPHONE CO., LTD
INGLEWOOD, CALIFORNIA

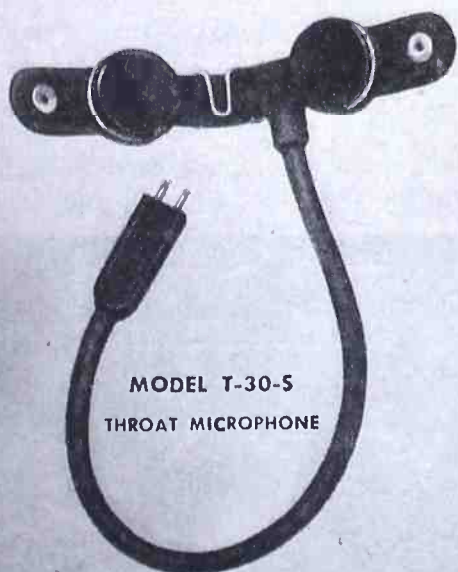

MODEL T-30-S
THROAT MICROPHONE

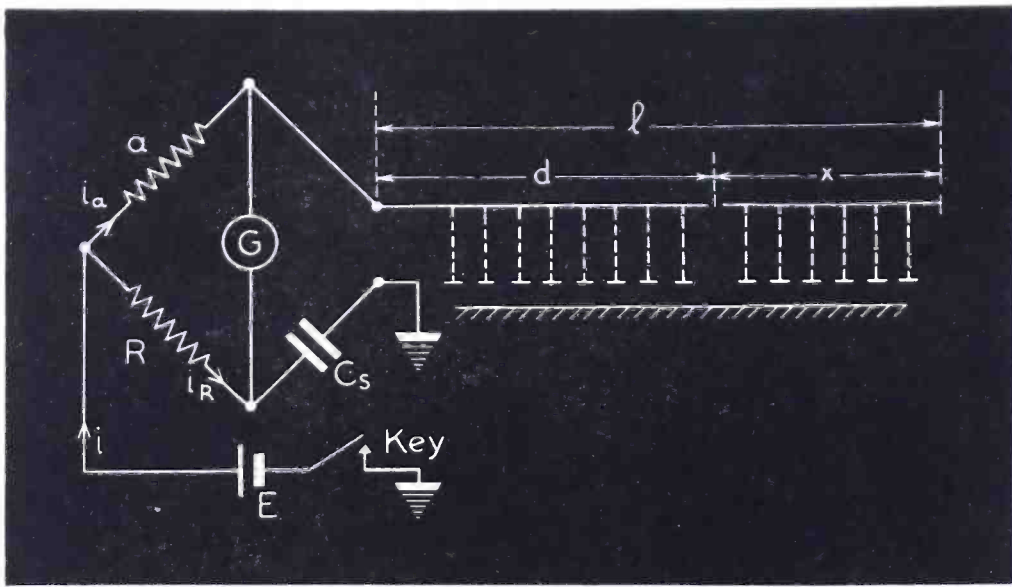

Figure 13a
Measurement of an open fault on a line by deflection balance.

mine the value of a high resistance to low resistance cross when a suitable ground connection is not available at the far end. When such ground connections are available, it is much more satisfactory and reliable to use the regular grounded or metallic Varley type of measurement. A simple loop measurement is taken, connected as in Figure 6 with a resistance of unknown value as in Figure 15, or with wires grounded through f and g ohms as in Figure 10. Letting

h = resistance of unknown cross, or sum of the wire resistances to ground.

$L = 2 l$, total loop resistance, obtained from records, or calculated from known wire constants and temperature.

$2d = L - 2x$ = loop resistance of conductors to the fault.

For the far end open, let $M = 2d + h$ (86)

For the far end short circuited, let $N = 2d + \frac{h(2x)}{h+2x}$ (87)

Solving 86 and 87 for h , equating the results, and solving for the resistance from the measuring end to the trouble in terms of M , N and L , noting that $2x = L - 2d$,

$(2d)^2 - 2N(2d) + (MN - ML + NL) = 0$ (88) which is a quadratic equation in $2d$. By the quadratic formula,

$2d = N \pm \sqrt{(N-L)(N-M)}$ ohms (89)

From 87, $N \geq 2d$, also $L > N$ and $M > N$, hence 89 becomes,

$2d = N - \sqrt{(L-N)(M-N)}$ ohms (90)

Using 90 in 86, the resistance of the short or cross may be ascertained, giving,

$h = (M-N) + \sqrt{(L-N)(M-N)}$ ohms (91)

These equations must each be divided by the resistance per loop foot in the

Figure 13b (below)
Measurement of an open fault by means of a modified bridge circuit.

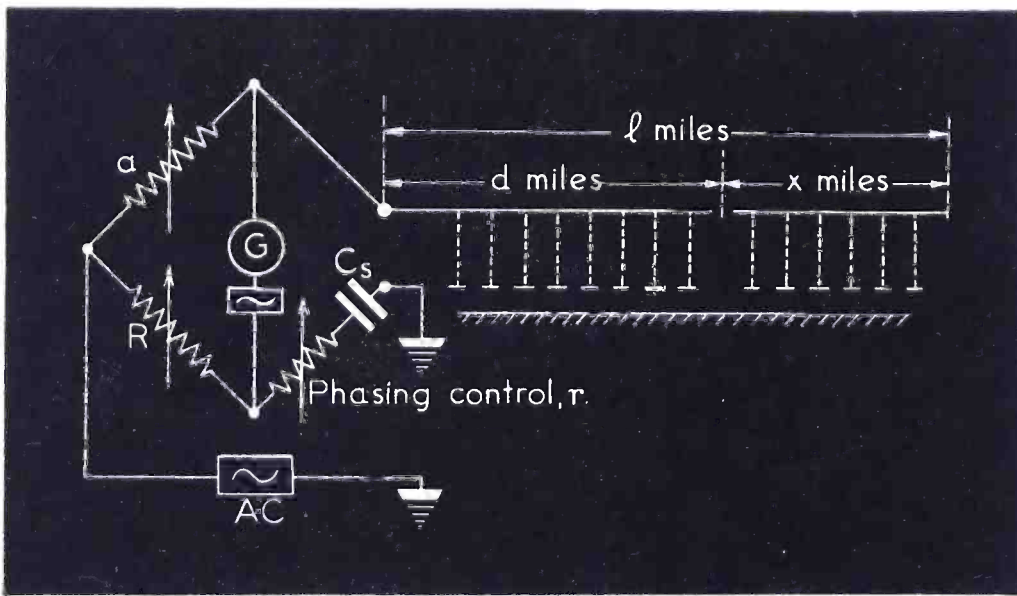

Figures 14 (below, left) and 15 (below, right)

Figure 14, measurement of unknown condenser capacity. Figure 15, a Varley measurement of the resistance in a fault crossing a pair of wires.

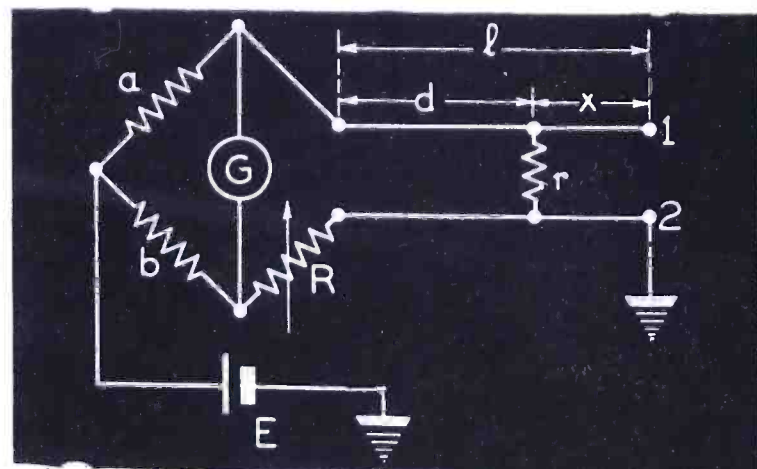
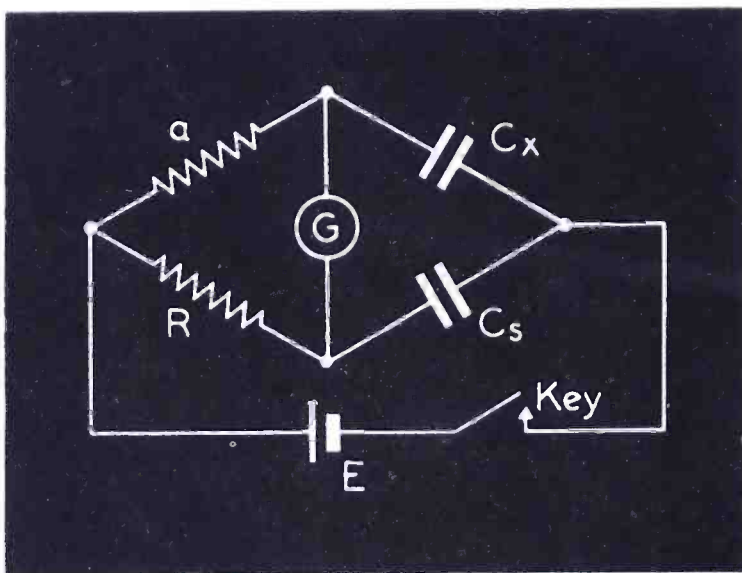

Here is a Frequency Meter that drives a Recorder without need for Auxiliary Amplifiers

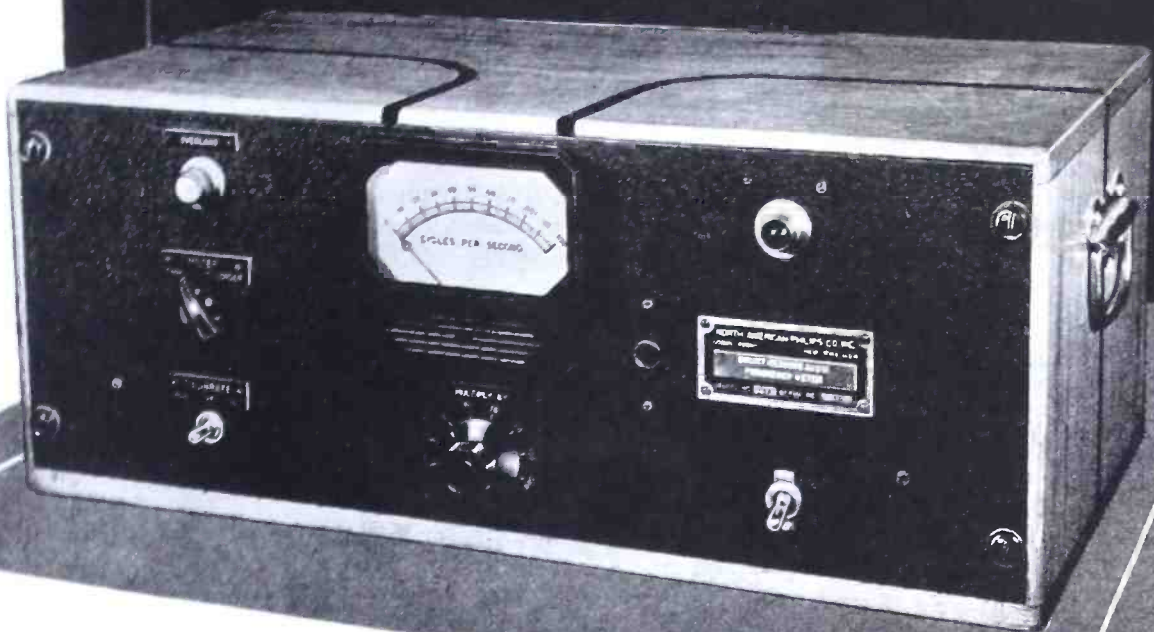

The *Norelco* Direct Reading Frequency Meter 8 Ranges: 0 to 50,000 Cycles

This new NORELCO instrument is an accurate, sensitive and versatile tool for laboratory or factory, adaptable to many regular or special uses and capable of directly driving standard 5 milli-ampere recorders.

Both the meter and recorder (when one is in use) are protected against overload by a sensitive relay which operates instantly in case a frequency higher than maximum reading of range in use is applied to input.

Write for complete information on this new meter, so that you may be able to decide for yourself its true value in your own plant.

For Army and Navy communications we make Quartz Oscillator Plates; Amplifier, Transmitting, Rectifier and Cathode Ray Tubes. For war industries we make Searchray (X-ray) apparatus, X-ray Diffraction Apparatus; Electronic Measuring Instruments; Direct Reading Frequency Meters; High Frequency Heating Equipment; Tungsten and Molybdenum products; Fine Wire in many metals and various finishes; Diamond Dies.

And for Victory we say: Buy More War Bonds!

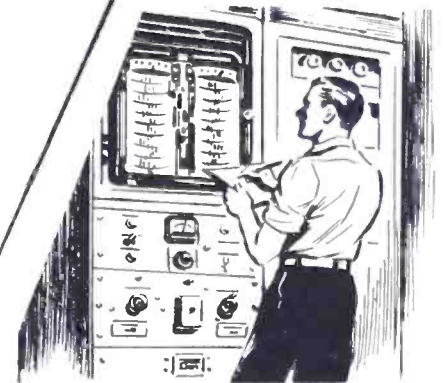

Easy to Use—The new NORELCO meter is supplied in either sturdy oak cabinet (main illustration) or for standard rack mounting and can be used with standard 5MA recorders.

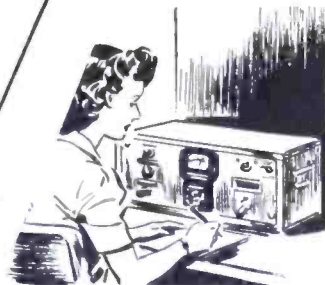

Easy to Read—The direct reading feature throughout the eight ranges, from 0 to 50,000 cycles facilitates measurements, particularly by unskilled operators.

Norelco

**ELECTRONIC PRODUCTS by
NORTH AMERICAN PHILIPS COMPANY, INC.**

Executive Offices: 100 East 42nd Street, New York 17, New York
Factories in Dobbs Ferry, New York; Mount Vernon, New York
(Metalix Division); Lewiston, Maine (Elmet Division)
Represented in Canada by Electrical Trading Co., Ltd., Montreal

Check These

ALTEC-LANSING ACHIEVEMENTS



1. Duplex Loud Speakers for highest quality monitoring.
2. Hermetically Sealed Transformers.
3. Shielded Audio Transformers.
4. High Q Chokes for Equalizers.
5. 250 Watt P. A. Amplifiers.
6. Limiting Amplifiers.
7. Intermodulation Signal Generators and Analyzers.
8. Multi-cellular P. A. Horns.

Nationally recognized engineering staffs... years of practical experience in sound research, application and perfection... selection, manufacture and assembly of only the highest quality materials and components guarantee these Altec-Lansing achievements as "new highs" in quality, performance and dependability.

SEND FOR BULLETINS

ALTEC

LANSING CORP.

1210 TAFT BLDG., HOLLYWOOD 28, CALIF.

case of cable fault location work, or by the resistance per loop mile for open wire fault location. This gives the distance to the trouble in feet for cable and miles for open wire in equations 89 and 90, and equivalent distance in equation 91. If bridges should be available at both ends, the same method applied at both ends should give for each the same value of h , the resistance of the cross. This acts as a useful check upon the method and checks the accuracy of the final measurements. This method should never be used if it is possible to use either the grounded or metallic Varley methods however, since the frequent variation of contact resistance causes h to vary quite widely at times, decreasing its reliability and consequent utility.

Resistance of a Cross or Short

This is a variation of the grounded Varley of Figure 7 and is shown in Figure 15, with one wire grounded at the far end. A Varley measurement is then taken as shown. Since for this method it is assumed that the line wires are balanced, the only unbalance existing is that caused by the unknown short or cross, r . This must be balanced by the resistance R , for ordinarily, $a = b$, and we have immediately,

$$R = V = r \text{ ohms.} \quad (92)$$

or the value of the resistance causing the fault is obtained by simply reading the value of R giving the Varley balance. Since R is generally between ten and twelve-thousand ohms, a can in practically all cases be made equal to b . When this cannot be done, the lowest ratio that can be used and is available with a particular bridge should be applied so that the sensitivity of the system will not be impaired unnecessarily. When this is the case, the resistance may be found by apply-

ing the previous theory to Figure 15. This gives

$$r = \frac{a}{b} (R + d) - d \quad (93)$$

where the distance represented by d must be obtained by one of the methods given previously and converted to ohms. This illustrates strikingly the need for using the ratio arms equal to each other if complications are to be avoided in even the simplest Varley measurements in some cases.

The additional Figures of various applications shown by 16, 17, 18 and 19 are specific uses to which the ordinary Varley measurement may be put. In each case, the amount of unbalance is read directly from the value of the adjustable resistance, R , with the ratio arms equal to each other.

Other specific methods of locating series resistance unbalances by bridge measurements and alternating current impedance runs are given by the two papers referred to, in references 6 and 7. These papers should be consulted by the interested reader who wishes to go further into the subject than is given here.

Open measurements are made upon lines by a modification of the Wheatstone bridge circuit. The ratio arm b is replaced by R , and the location of R in the circuit is replaced by a condenser capacity, usually on the order of 1 microfarad. This is a standard condenser of good quality, and is used for the purpose of comparing the capacity of a line to that of the condenser. This method of locating open faults is quite good when the lines are short and the insulation high. The accuracy goes down with longer lines and poor insulation to ground. This is because the line behaves less like a pure capacity under these conditions and therefore has both a resistive and a reactive component which would

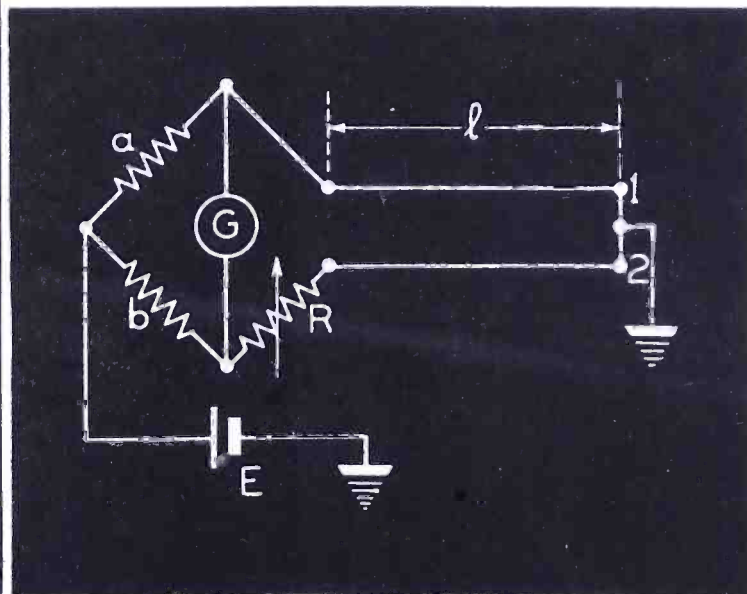
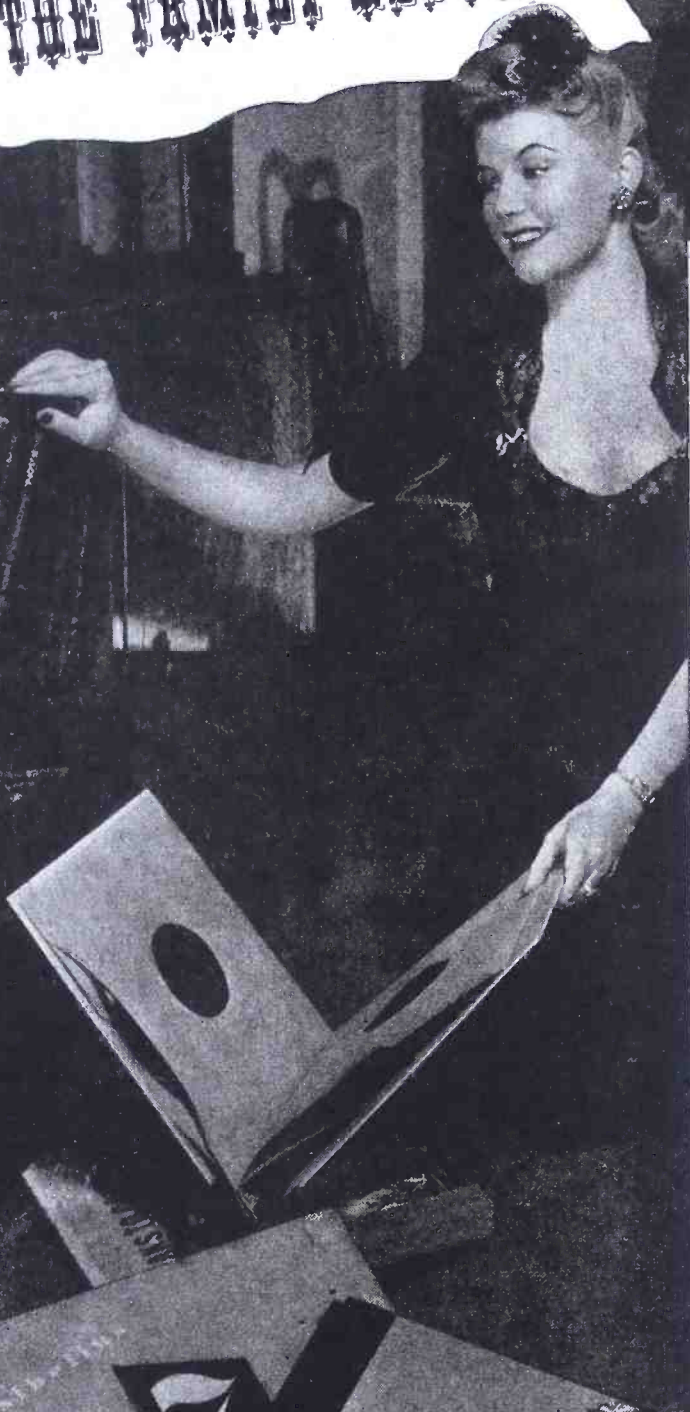

Figure 16
A Varley measurement to determine the unbalance between the wires of a pair.

THE FAMILY ALBUM



TODAY'S FAMILY ALBUM is no longer a pictorial record, but rather that treasured collection of the world's favorite music and musicians—"Bix" Beiderbecke—Toscanini—Tibbett and Sinatra—Beethoven's Fifth and Fats Waller.

So important have these albums become that the first postwar demand of these record devotees will be a perfected, simple to operate, precision-performance record changer. We envision a device that not merely plays in sequence, but acts as a magical, mechanical master-of-ceremonies, performing for uninterrupted hours, selecting at the owner's whim, executing request numbers, rendering encores, manipulating the records in any arrangement.

We at G. I. are anticipating this demand. In the postwar era a still greater portion of our activities will be devoted to the mass production of Automatic Record Changers with innovations and improvements of great significance.



General Instrument Corp.
The first in our industry to be so honored

 829 NEWARK AVENUE, ELIZABETH 3, N. J.

PHONOGRAPH RECORD CHANGERS—HOME PHONOGRAPH RECORDERS—VARIABLE TUNING CONDENSERS—PUSH-BUTTON TUNING UNITS AND ACTUATORS

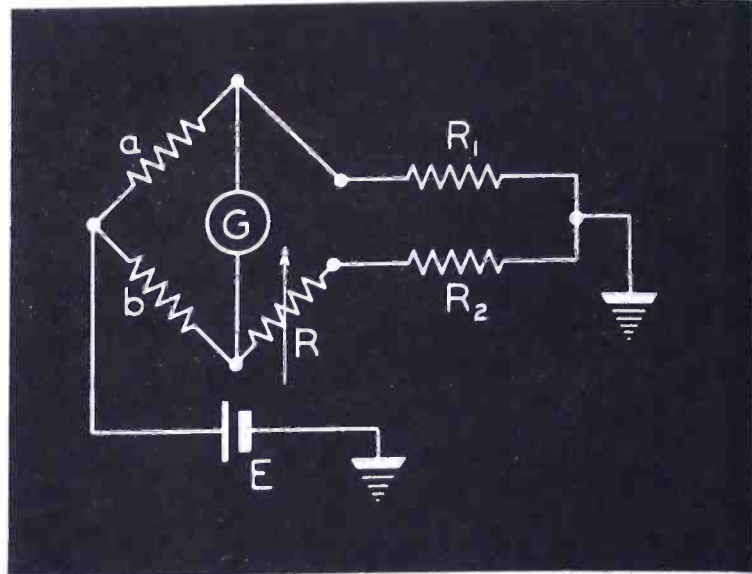
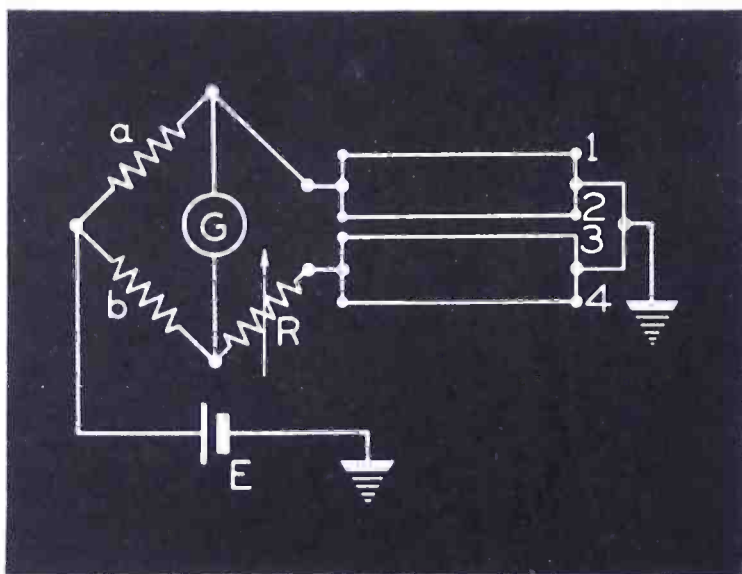

have to be balanced for accuracy. Many of the more modern types of bridges do take the resistive component into account, however, by means of a phasing control, which is simply a variable resistance in series with the standard condenser, c_s , as shown by Figure 13(b).

The line may be charged up as shown by the simplified diagram in Figure 11 using a key in the battery lead to ground while adjusting the resistance, R , to give zero deflection on the galvanometer. This very simplified method is not a very accurate one to use because the average throws or deflections on the meter are not zero for the charge and discharge of the line. And when measuring on lines having very short time constants, the discharge takes place so rapidly that the tendency is to attempt to balance the bridge by unbalancing it. Hence, in practice, it is more customary to use an alternating current of very low frequency from 4 to 20 cycles per second, and a reversing relay or commutation device for the galvanometer so that the galvanometer is always connected in the proper direction. Since the unequal charge and discharge currents through the galvanometer are equal for each poling of the alternating current, the average is zero for the separate charges and discharges of the line.

The necessary conditions of balance for Figures 13(a) and 14 are found by direct application of the previously developed theory, where the capacity of the line is considered as C_x , and the capacity of the standard condenser as C_s . Here, $R_o = 1/j \omega C_s$, and $X_o = 1/j \omega C_x$, then

$$a \cdot \frac{1}{j \omega C_s} = R \cdot \frac{1}{j \omega C_x} \quad (94)$$

$$\text{or} \quad C_x = R C_s / a \quad (95)$$

The value of a is most frequently set at 1,000 ohms, although any of the Murray bridge ratios can be used. With C_s at 1 mfd and a at 1,000 ohms,

Figures 17 (top, left) and 18 (top, right) Figure 17, a Varley measurement is used to determine the unbalance existing between the side circuits of a phantom group. Figure 18, resistance unbalance between selected resistors may readily be determined by the Varley method.

equation 95 becomes

$$C_x = R \times 10^{-3} \text{ microfarads} \quad (96)$$

When $R = 1,000$ ohms, the value of the unknown capacity is equal to that of the standard. The reading of R at any value required to obtain a balance is frequently spoken of as having that many *spills*. The methods used to obtain the distance are based upon the proportional part of the number of spills obtained on the faulty wire to the number obtained on a good wire, preferably its mate. This ratio taken, times the total distance then gives the distance to the trouble. With bridges of the older types using 20-cycle reversals, the accuracy of measurement is not as great as with those of the more modern type mentioned above, since these bridges do not have a phasing control to take into account the variable resistance component of the line with variable physical and weather conditions. For average weather conditions with 20-cycle reversals open

wire measurements will give about 15 spills per mile and decreases in value as the insulation resistance of the line goes down. In average cables the approximate value of resistance obtained gives about 90 spills per mile, and since the insulation of cables of all kinds is quite high, being better than 500 megohms per mile, the accuracy of results compared to open wire measurements is much greater.

Although the accuracy of open fault location measurements do not nearly approach in general that obtained by the grounded and metallic Varley measurements using direct conducting paths, it has been found in practice to be one of the indispensable types of tests.

No hard or fast rules can be outlined for all of the conditions which may be encountered in fault location work, but a thorough knowledge of the theory of operation of the Wheatstone bridge circuit will assist in learning the methods of operation through practical experience.

In determining the best method to use to locate a fault, we must learn as exactly as possible the nature of the fault condition. Faults may be classified into many special and specific

(Continued on page 70)

Figure 19 The d-c resistance of mid-tapped transformers in pushpull systems is easily obtained by application of the Varley method.

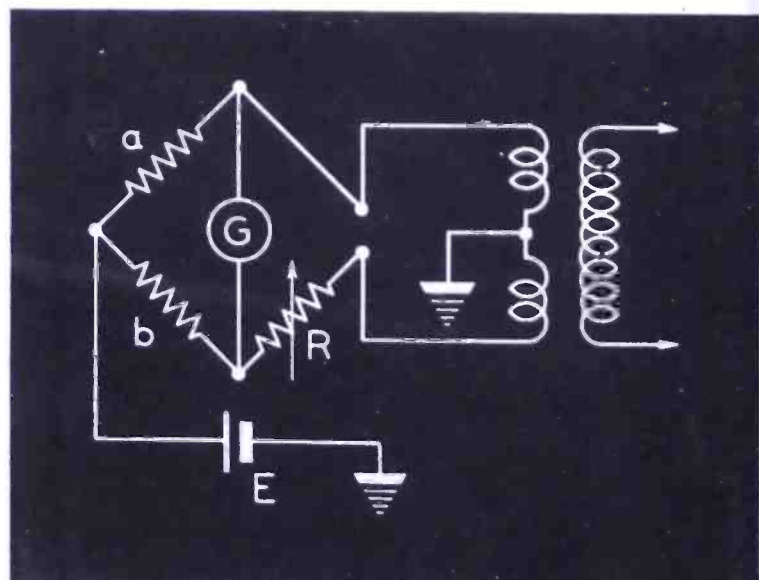

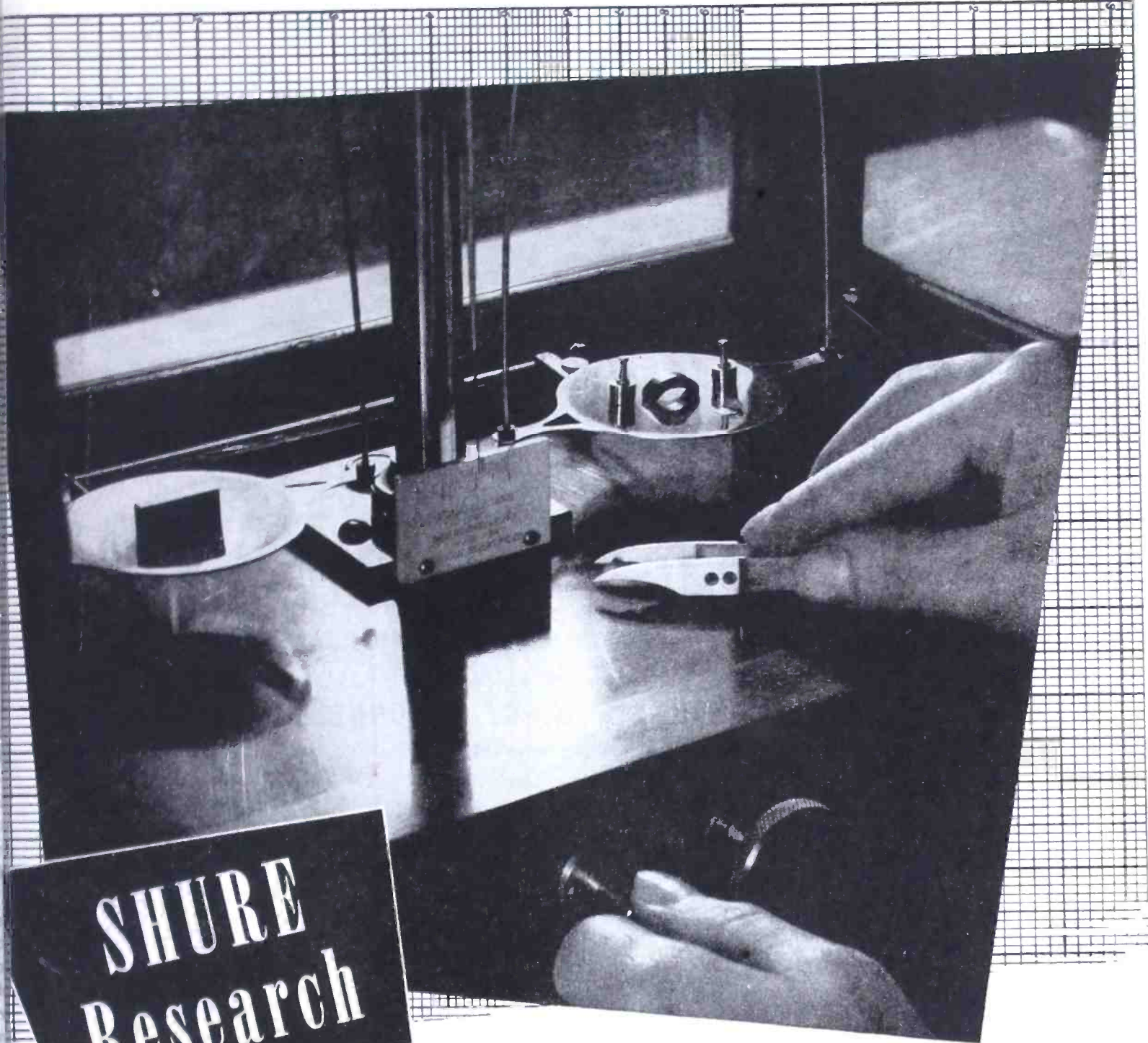

**SHURE
Research**

...in Magnetic Structures

By the time we finish our present contract for headphones, Shure Engineers will have effected a 3½ ton saving in critical magnetic alloys. Redesign of the magnetic structure effected a saving of three-quarters—so that, today, the magnetic material generally required for one headphone is now enough for four headphones. This has been accomplished with full maintenance of the operating characteristics with the added advantage of decrease in weight. Shure Engineering continues to lead the way to better microphones and headphones for your postwar needs.

SHURE BROTHERS, 225 West Huron Street, Chicago
Designers and Manufacturers of Microphones and Acoustic Devices



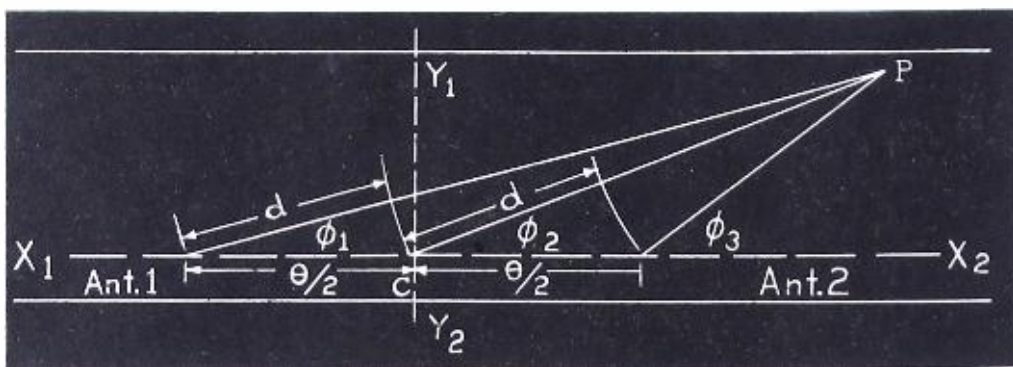

Figure 16

This plot reveals that the difference in paths varies as the point P moves about the station. Assuming that P is at a great distance from the station, its bearing from the two antennas and from the point C will be equal for all practical purposes.

DESIGN AND OPERATION OF RADIO RANGE BEACONS

(PART TWO OF A TWO-PART PAPER)

by CAPTAIN W. G. McCONNELL

Army Airways Communications System

Theory, Adjustment and Maintenance

Appendix A

Field Pattern of Two Adjacent Antennas Excited 180° Out of Phase

The radiated field of an antenna can be expressed in the conventional form:

$$E_1 = E_m \sin wt$$

in which case the field of the second antenna will have the form:

$$E_2 = -E_m \sin wt$$

since it is 180° out of phase with the first antenna. The sum of the two voltages

$$E_{1-2} = E_m \sin wt - E_m \sin wt = 0$$

if the signal from both antennas reaches the receiving point simultaneously. This is the case on a line perpendicular to the axis of the antennas and passing midway between them.

At all other points, however, the distances from any point P to each of the antennas are not equal, and the difference in distance produces a phase shift so that the voltages do not cancel completely. The residual field is then a function of the electrical spacing of the antennas θ , and the angle ϕ that the point P bears to the axis $X_1 - X_2$ of the antennas.

In order to analyze the resulting field it is convenient to consider the phase of the voltage secured with respect to C, the midpoint between the two antennas.

If the spacing in electrical degrees between the antennas is θ , then for a point along the axis of the antennas the field will be

$$E_{1-2} = E_m \sin (wt + \theta)$$

$$- E_m \sin (wt - \theta)$$

which will no longer equal zero.

By examining Figure 16 it is obvious that the difference in the two paths varies as the point P moves about the station. If we assume that P is at a great distance from the station its bearing from the two antennas, and from the point C, will be equal for all practical purposes. Therefore ϕ_1 , ϕ_2 and ϕ_3 will be equal, and the difference will be the distance d . Since we have assumed that ϕ_1 , ϕ_2 and ϕ_3 are equal, the small triangles will be, for all practical purposes, right triangles and the distance d will be equal to

$$\theta/2 \cos \phi$$

The complete expression for the field at any point P then becomes

$$E_{1-2} = E_m \sin \left(wt + \frac{\theta}{2} \cos \phi \right)$$

$$- E_m \sin \left(wt - \frac{\theta}{2} \cos \phi \right)$$

The terms of this expression have the form

$$\sin (A \pm B)$$

which can be expanded to

$$\sin A \cos B \pm \cos A \sin B$$

Making this expansion we secure

$$E_{1-2} = E_m \sin wt \cos \left(\frac{\theta}{2} \cos \phi \right)$$

$$+ E_m \cos wt \sin \left(\frac{\theta}{2} \cos \phi \right)$$

$$- E_m \sin wt \cos \left(\frac{\theta}{2} \cos \phi \right)$$

$$+ E_m \cos wt \sin \left(\frac{\theta}{2} \cos \phi \right)$$

$$= [2 E_m \cos wt] \left[\sin \left(\frac{\theta}{2} \cos \phi \right) \right]$$

The first part of this expression

$$2 E_m \cos wt$$

determines the magnitude and inst

AIRCRAFT COMMUNICATIONS

Can YOU use this



VARIABLE INDUCTOR

Culminating a number of years of research, the UTC Variable inductor is an ideal tunable device for peaked amplifiers, filters, etc. This sealed unit measures 1 1/4" x 1 7/16" x 1 7/16". Available in inductance value from 10 Mhy. to 10 Hys.

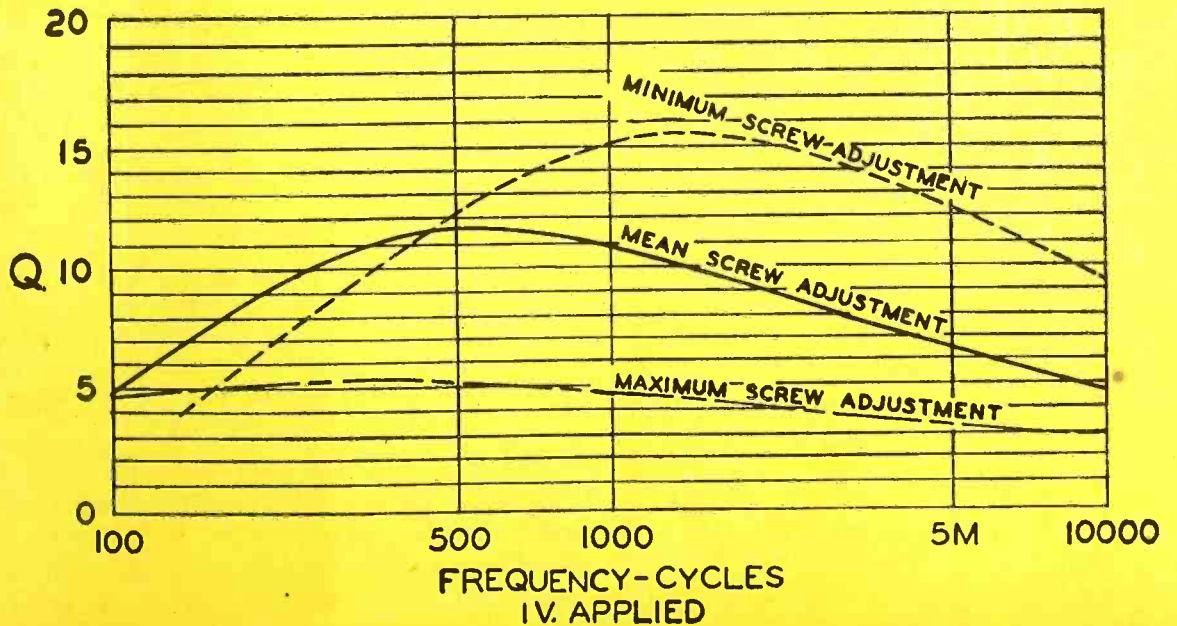
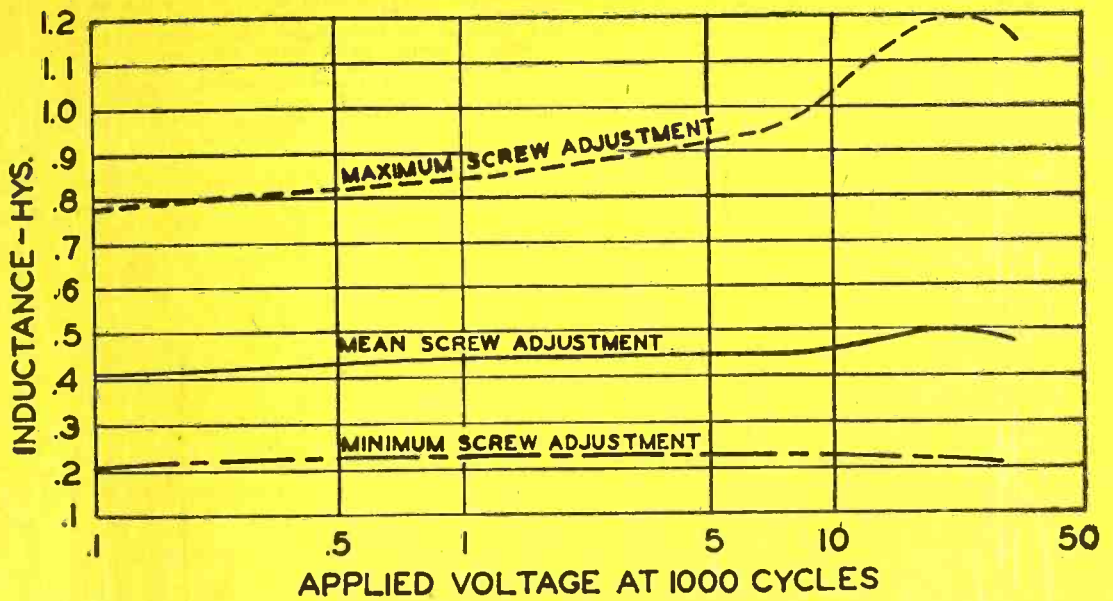

United Transformer Co.

150 VARICK STREET

NEW YORK 13, N. Y.

EXPORT DIVISION: 13 EAST 40th STREET, NEW YORK 16, N. Y., CABLES: "ARLAB"

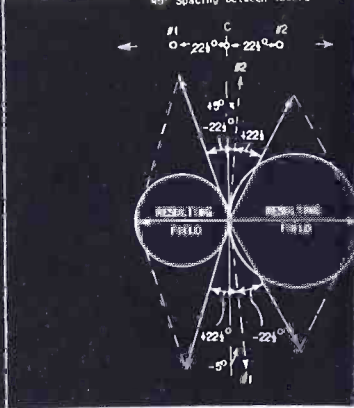
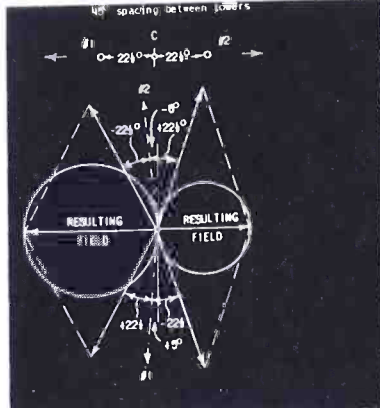
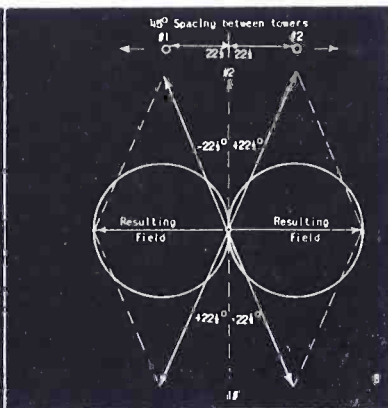
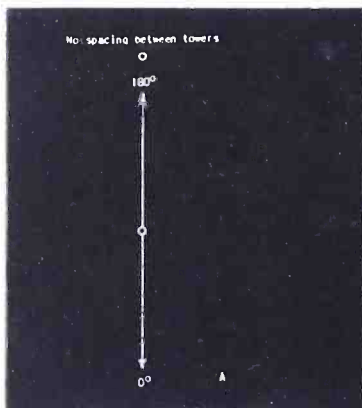

taneous voltage of the field, and is independent of the spacing and the bearing of the point *P*. It is interesting to note that the phase of the radio frequency voltage has shifted 90°, which would be expected since the maximum voltage would occur when the field of one antenna passes through zero.

The second half of the expression

$$\text{sine} \left(\frac{\theta}{2} \cos \phi \right)$$

determines the field pattern.

Along the axis of the antennas $\cos \phi = 1$, so that the voltage at this point will equal

$$(2 E_m \cos wt) \left(\text{sine} \frac{\theta}{2} \right)$$

For the spacing of 180°

$$\text{sine} \frac{\theta}{2} = \text{sine} \frac{180^\circ}{2} = \text{sine} 90^\circ = 1$$

So that the resulting field is equal to

$$2 E_m \cos wt$$

or twice the voltage due to one antenna with a phase shift of 90°.

For a spacing of 90°, which occurs at 400 kc for a tower spacing of 600 feet

$$\text{sine} \frac{\theta}{2} = \text{sine} \frac{90^\circ}{2} = \text{sine} 45^\circ = .707$$

and the field is

$$E_{r_{1-2}} = 2 E_m \cos wt \times .707 = 1.4 E_m \cos wt$$

If the point *P* is on the line $Y_1 - Y_2$, which is perpendicular to $X_1 - X_2$, and which passes through *C*

$$\cos \phi = \cos 90^\circ = 0$$

and the field strength

$$E_{r_{1-2}} = 2 E_m \cos wt \text{ sine} \left(\frac{\theta}{2} \cos \phi \right) = 0$$

Figures 13 (left, above) and 13a (right, above)

Figure 13, effect of tower spacing in establishing pattern. In A, towers 180° out of phase; vectors cancel, no field. In B, tower 180° out of phase. Tower 1 advanced 22½° in direction of 1; retarded 22½° in direction of 2. Tower 2 retarded 22½° in direction of 1; advanced 22½° in direction of 2. Pattern is symmetrical. Figure 13a, effect of adding variation of transmission line length to tower to distort pattern. In C, towers 170° out of phase. 1 advanced 5°; 2 retarded 5°. Pattern increased in direction of 1; decreased in direction of 2. In D, towers 170° out of phase. 1 retarded 5°; 2 advanced 5°. Pattern increased in the direction of 2; decreased in direction of 1.

as we stated before. Thus no signal will be received regardless of the spacing θ .

The form $\text{sine} \left(\frac{\theta}{2} \cos \phi \right)$ is not

a true figure-of-eight. The lobes tend to bulge at the sides and the larger θ becomes the greater they differ from true circles; until, when $\theta = 360^\circ$ the radiation along the axis becomes zero, and each lobe splits in two with a major axis bearing approximately 45° to the axis $X_1 - X_2$.

If $\theta/2$ is small, however, we can assume that

$$\text{sine} \frac{\theta}{2} \cos \phi = \frac{\theta}{2} \cos \phi^*$$

in which case the equation for the field pattern becomes

$$E_{r_{1-2}} = 2 E_m \frac{\theta}{2} \cos \phi^*$$

which is a figure-of-eight with the lobes true circles. Practically, the figure-of-eight diagram can be assumed as a pair of circles up to spacings of 90°.

Appendix B

Course Bending of SRA Stations

Figure 13 illustrates the manner in which the figure-of-eight patterns are distorted by means of vector diagrams.

*In these equations $\frac{\theta}{2}$ must be expressed in radians.

The vectors show the amplitude the pattern along the axis of the antenna only. In the notation of Appendix A, ϕ is assumed to be zero, and $\cos \phi$ is unity. *A* indicates the cancellation of the vectors when θ is zero. Thus $\theta/2$ is zero and

$$E_m \text{ sine } wt - E_m \text{ sine } wt = 0$$

The two vectors cancel and there is no field.

B indicates the value of the field vector when θ equals 45°. In this case we have (see Appendix A)

$$E_{r_{1-2}} = E_m \text{ sine} \left(wt + \frac{\theta}{2} \right) - E_m \text{ sine} \left(wt - \frac{\theta}{2} \right)$$

which becomes

$$[2 E_m \cos wt] [\text{sine} \theta/2]$$

$\cos \phi$ being equal to 1.

$E_m \cos wt$ is the length of vector.

Therefore, the resulting field is

$$F_{1-2} = (V) 2 \text{ sine} \frac{\theta}{2}$$

or

$$F_{1-2} = (V) 2 \text{ sine} 22\frac{1}{2}^\circ$$

and the resulting field is equal to .77 V.

The vector diagram illustrates the manner in which the phase of one antenna is retarded for radiation in one direction and advanced for radiation in the other direction. For radiation to the left of the figure, the vector of tower 1 is rotated clockwise (advanced) 22½°; the vector of tower 2 is rotated counter-clockwise (retarded) 22½°. The resulting field is secured by completing the parallelogram. For radiation to the right, tower 1 is retarded and tower 2 is advanced. Thus the resulting field is equal and the pattern is symmetrical.

C indicates the effect when the phase of the radiation of the two towers is no longer 180° apart. In this case, the phase of tower 1 is

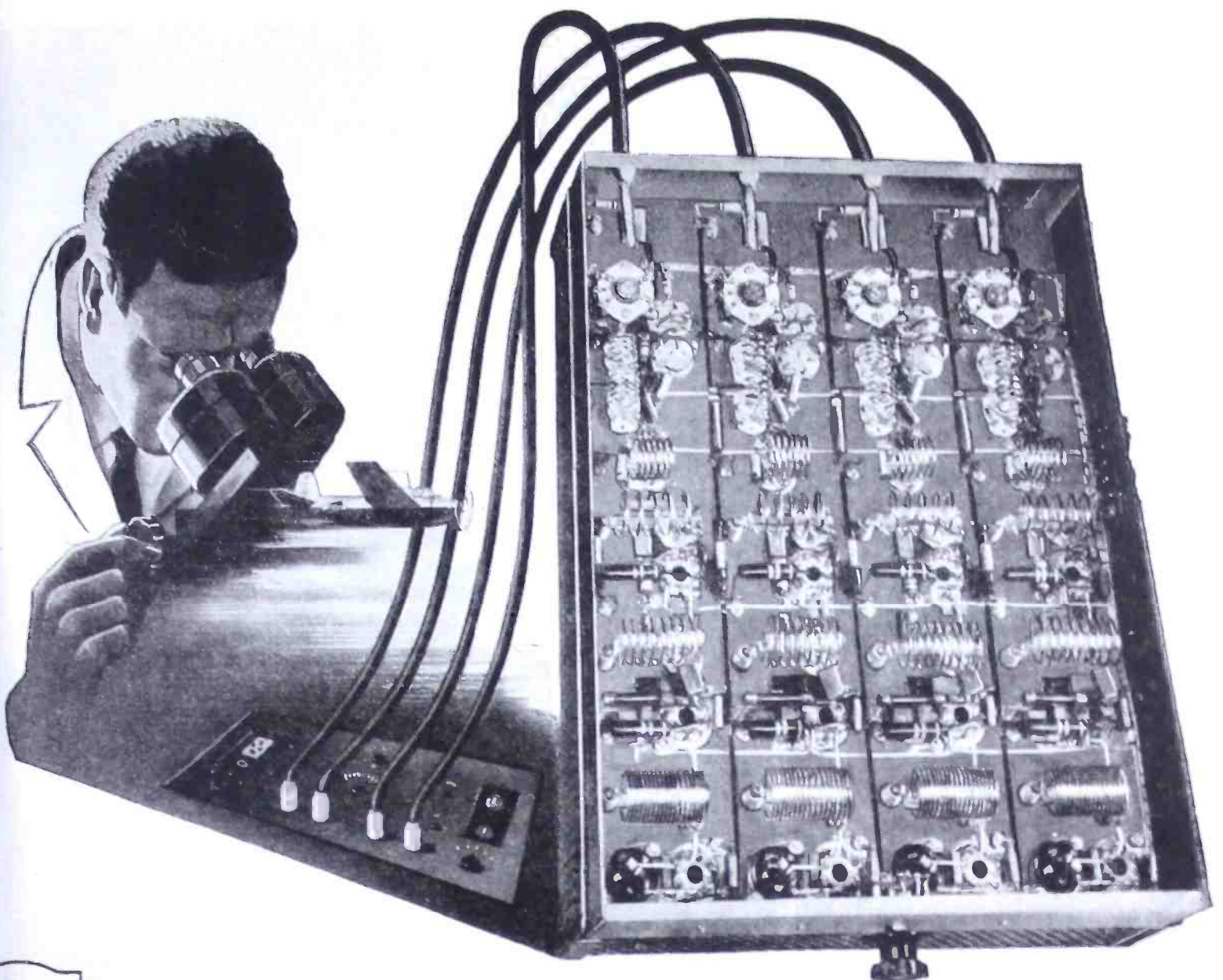

EXACTING laboratory standards

The reason for our successful interpretation of specialized production problems is an open secret. ECA has an invaluable supplement to sound experience and versatile facilities. This is the competitive spirit in our ranks fostered by both management and labor. Such a challenge to individual effort results in greater efficiency, greater economy, and a deeper insight into the assignment at hand.

The ECA Laboratory Frequency Standard is an excellent example of our work. This unit is used in our production department for testing and calibrating equipment. It is a frequency standard providing checking of ultra-high frequencies with an accuracy of one hundredth of one percent. It is composed of crystals and a series of frequency multipliers which multiply each crystal frequency 64 times. This unit was built in the ECA laboratory since there is no commercial equipment available that will guarantee the required accuracy at certain ultra-high frequencies. It has made possible the delivery of specially needed equipment for the war agencies.

100%
IN WAR WORK . . .
OCCASIONALLY,
HOWEVER,
PRODUCTION
SCHEDULES
PERMIT US
TO ACCEPT
ADDITIONAL
ASSIGNMENTS

FIGHT HARD WITH WAR BONDS . . . BUY ALL YOU CAN, AND MORE

ELECTRONIC CORP. OF AMERICA

45 WEST 18th STREET • NEW YORK 11, N. Y. • WATKINS 9-1870

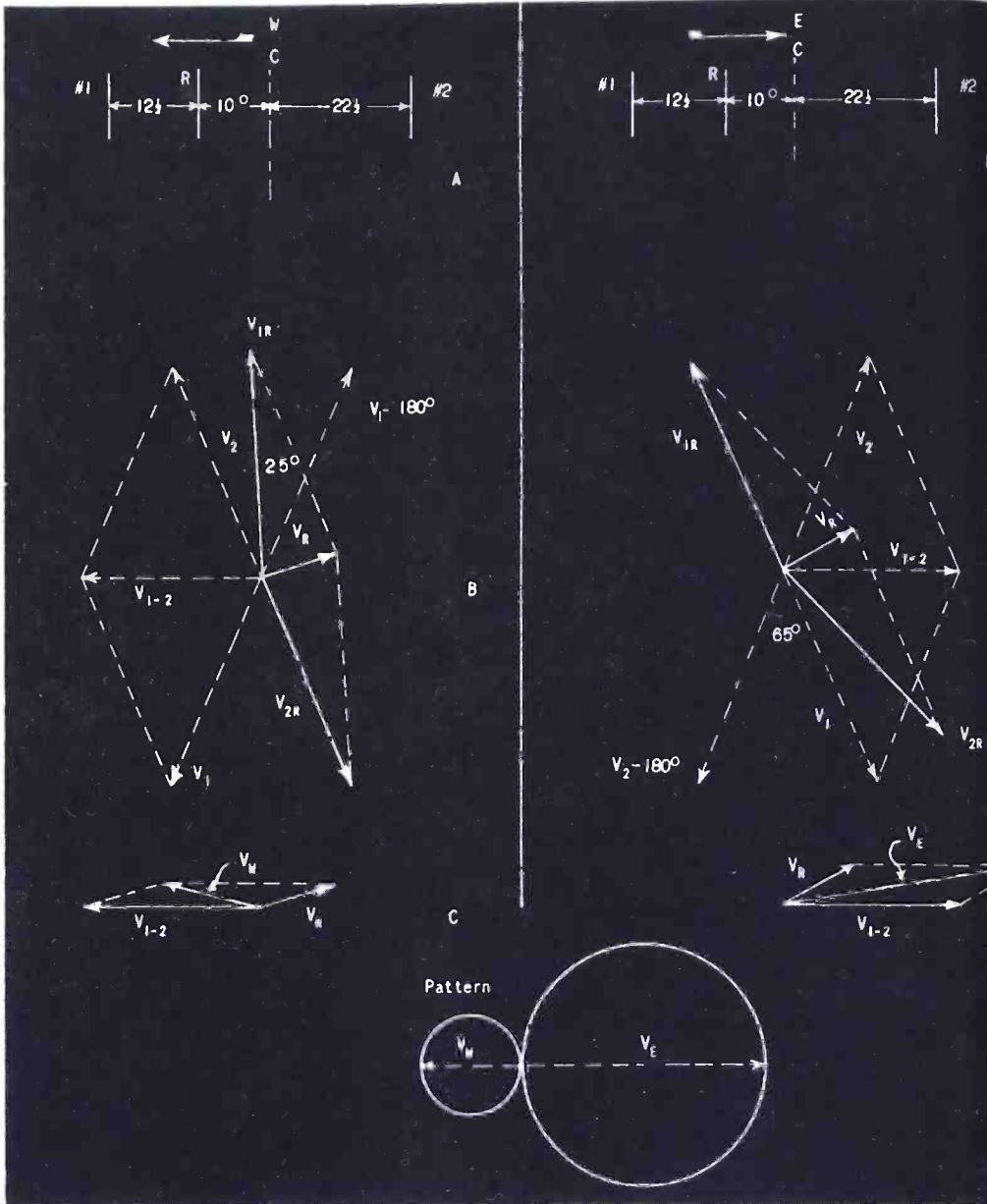
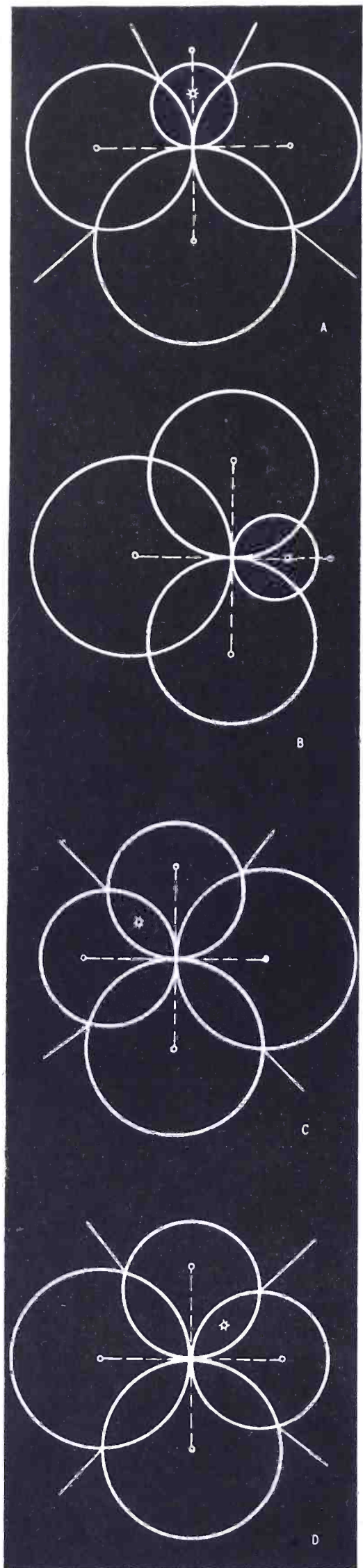

Figures 14 (top) and 15 (left)

Figure 14, effect of course bending antenna (reflector). Figure 15 shows patterns secured due to presence of course bending antenna (reflector). Dashes between small circles indicate loop; asterisks are course bending antenna.

been advanced 5° and the phase of tower 2 has been retarded 5° by transmission line changes.

For radiation to the left of the paper, the phase of tower 1 is advanced 5° by its original phase difference. To this is added the $22\frac{1}{2}^\circ$ due to the tower spacing, so that this vector is advanced a total of $27\frac{1}{2}^\circ$ from the original position of A. Tower 2 is retarded 5° due to its original phase difference, and retarded $22\frac{1}{2}^\circ$ by the tower spacing. Its vector, therefore, is retarded a total of $27\frac{1}{2}^\circ$. This produces the resultant field to the left, which is greater than the symmetrical fields of B. The actual field becomes

$$F_{1-2} = (V) 2 \text{ sine } 27\frac{1}{2}^\circ = .92 V$$

For radiation to the right the

phase of tower 1 is advanced 5° its original phase difference and tarded $22\frac{1}{2}^\circ$ by the tower spacing, a net retardation of $17\frac{1}{2}^\circ$. The radiation of tower 2 is retarded 5° by original phase difference and advanced $22\frac{1}{2}^\circ$ by the tower spacing, a net advance of $17\frac{1}{2}^\circ$. This produces the resultant field to the right which is smaller than the symmetrical field of B. The actual value becomes

$$F_{1-2} = (V) 2 \text{ sine } 17\frac{1}{2}^\circ = .6 (V)$$

and the resultant figure-of-eight is longer symmetrical.

D illustrates the effect when original phase displacement is reversed. In this case the field reverses. The larger lobe is always in the direction of the tower which has been advanced in phase.

Appendix C

Course Bending of MRL Stations

Figures 14 and 15 illustrate the effect of the course bending antenna at MRL stations.

Figure 14 is a vector diagram showing the fields due to the vertical section

(Continued on page 74)



TOO GOOD

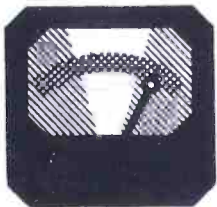

JUST RIGHT



NOT SO GOOD

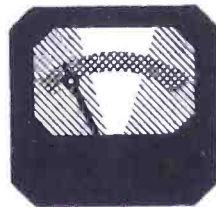

Admit it. Like any enlightened gentleman, you too are a connoisseur when it comes to women. You can pick 'em; and no fooling. Feminine desirability we leave to you, but we do pride ourselves upon fashioning tubes "just right" for your electronic equipment.

As you know, ideal production would yield only tubes with the exact characteristics required. In practice, Hytron sets close tolerances for all characteristics, and then painstakingly controls production to hit uniformly the centers of those tolerances.

Does it seem strange that Hytron rejects not only tubes "not so good" but also "too good"? Consider a simple example. Mutual conductance is a figure of merit normally desired high. Once your circuit constants have been fixed for a standard tube, however, too great transconductance may give unstable performance.

Hytron strives, therefore, to produce for you tubes which are standardized; uniform tubes which — as originals or spares — will always be *just right* for the war-time radio and electronic applications you design.



OLDEST EXCLUSIVE MANUFACTURER OF RADIO RECEIVING TUBES

HYTRON
CORPORATION ELECTRONIC AND RADIO TUBES

SALEM AND NEWBURYPORT, MASS.



**BUY
ANOTHER
WAR BOND**

NEWS BRIEFS OF THE MONTH . . .

COPPER AND STEEL SUPPLY IMPROVES

The War Production Board conservation division states in its recent report on the *material substitutions and supply list*, that the supply of copper and steel is improving. The report emphasizes, however, that *casings* applies rather to the raw materials than to facilities or manpower for fabricating them.

According to the report, tin continues to be short in supply, an exception to the general improvement in the supply of nonferrous materials. It is recommended that tin be used as little as possible in bronzes and plating.

As groups, chemicals and plastics are somewhat tighter than on the previous listings, while textiles and fibres remain about the same.

Copies of Issue No. 11 of the *material substitutions and supply list* may be obtained by applying in person at any Regional Office of War Production Board, or by writing on official letterhead to the Editor, Conservation Division, Room 2616, Tempo "D", Washington 25, D. C.

* * *

ARMY-NAVY ISSUES NEW PREFERRED TUBE LIST

A preferred list of tubes, that supersedes the Army-Navy preferred list of vacuum tubes dated March 1, 1943, has just been issued.

* * *

DELORAINÉ ELECTED TO I. T. & T. BOARD

Edmond M. Delorainé, general director of the laboratories division of Federal Telephone and Radio Corporation, was recently elected to serve as a director on the I. T. & T. board of directors.

Mr. Delorainé has specialized in h-f and u-h-f development. Under his direction in 1931 the first demonstrations of single sideband short-wave radiotelephony were carried out between Buenos Aires and Madrid, and between Madrid and Paris. In 1931 and 1933 he established telephone and printer communications across the English Channel on approximately 1,700 megacycles, using very sharp beams, and in 1936 and 1937 made possible the first multi-channel u-h-f telephone link. Later he used ultrahigh frequency in connection with television transmission, including the construction of the station at the Eiffel Tower, providing the highest power ever used.



Edmond M. Delorainé

ASA AIRCRAFT CRYSTAL STANDARDS

A new standard for quartz crystals (C75, 11-1944) used for control of frequency in aircraft radio equipment has just been approved by the American Standards Association.

This standard, for the first time, coordinates British, Canadian, and American practice in the manufacture of aircraft crystal units.

* * *

RADIO CLUB SEES ELECTRON MICROSCOPE DEMONSTRATION

The electronic microscope was demonstrated and described by Dr. C. H. Bachman of G. E. at a recent meeting of the Radio Club of America, at Columbia University.

* * *

TEST INSTRUMENT ADVISORY COMMITTEE FORMED

The War Production Board has announced the formation of a test instrument industry advisory committee.

Committee members include A. H. Hotopp, Jr., Technical Device Corp., Bloomfield, New Jersey; David Newman, Daven Company, Newark, New Jersey; Paul Jackson, Jackson Elec. Instru. Corp., Dayton, Ohio; E. G. Perkins, Supreme Instrument, Greenwood, Mississippi; V. E. Jenkins, Weston Electrical Instru. Corp., Newark, New Jersey; Milton Reiner, Radio City Products Company, New York, New York; J. J. McCarthy, Triumph Mfg. Company, Chicago, Illinois; and A. J. Lush, Rawson Electrical Instru. Co., Cambridge, Mass.

* * *

BONFIG JOINS ZENITH

Henry C. Bonfig has resigned as commercial vice president of the Radio Corporation of America to join Zenith Radio Corporation, as vice president in charge of the household radio sales division.

* * *

WHITE STAR TO UNITED ELECTRONICS

The United Electronics Co., Newark, N. J., has been awarded a white star for their Army-Navy "E" flag.

* * *

DR. DUFFENDACK JOINS N. A. PHILIPS

Dr. Ora Stanley Duffendack, professor of physics at the University of Michigan, has been appointed director of research of North American Philips Company, Inc. Dr. Duffendack will direct a new research laboratory located in the *Richmond Hill* mansion at Irvington, N. Y.

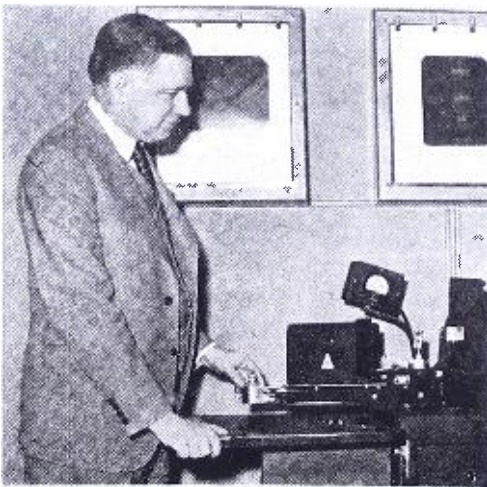

Dr. O. S. Duffendack

RADIOMARINE COASTAL STATIONS RESUME SERVICE

Two coastal radiotelegraph stations, Radiomarine Corporation of America, WNY, New York and WOE, Florida, have resumed operation with ships at the authority of the FCC.

* * *

GENERAL RADIO ANNOUNCES NEW OFFICERS

Errol H. Locke has been elected president of General Radio Company to succeed Melville Eastham, who however will continue as chief engineer in charge of research and development. Harold Richmond was named chairman of the board and chairman of the management committee. Henry S. Shaw, former chairman of the board, continues as director of the company, along with Melville Eastham, Mr. Locke, and Mr. Richmond. Frank L. Tucker, formerly comptroller, was elected treasurer and secretary, well as a member of the board of directors. Arthur E. Thiessen, formerly commercial engineering manager, was named vice president in charge of sales; a Charles C. Carey, formerly superintendent, was named vice president in charge of manufacturing. C. E. Hills Jr. was appointed assistant secretary-treasurer. He will also retain his post as commercial manager.

* * *

LAMME MEDAL AWARDED KEHOE

The 1943 Lamme Medal of the AIEE has been awarded to Arthur H. Kehoe, vice president of Consolidated Edison Company of New York Inc., "for pioneer work in the development of alternating current networks and associated apparatus for power distribution."

* * *

PFOHL TO MUTER COMPANY

Paul J. Pfohl, western manager of RCA tube division since 1931, has become sales manager of the Muter Company, Chicago, Ill.

* * *

ANDERSON PROMOTED BY FRANKLIN TRANSFORMER

R. L. Anderson has been appointed chief engineer of the Franklin Transformer Company, Minneapolis, Minn. Mr. Anderson was previously associated with the Rockefeller Foundation at University

(Continued on page 64)



R. L. Anderson

Engineers and Technical Men—

Real Opportunities for the Future While Promoting the War Effort

Here are positions, not for the duration only, but offering excellent opportunity for permanent advancement with a successful and growing organization for those particularly skilled in the latest electronic techniques.

Gilfillan Bros. Inc. of Los Angeles offers these positions for qualified men:

Electronic and radio engineers (both transmitters and receivers) to design electronic and navigational equipment.

Mechanical Engineering graduates with five to ten years' experience in design and layout of light mechanical devices plus shop experience or equivalent.

Men of engineering grade for extensive electronic production and field test operations.

Technical men with ability to write technical material for instruction books and to handle complicated parts lists.

These positions are in essential war work and availability certificates are required.

Write stating qualifications, experience and personal data.

IMPORTANT—INTERVIEWS FOR SUCCESSFUL APPLICANTS WILL BE CONVENIENTLY ARRANGED.

In Reply—Refer to: R112 - CFW

GILFILLAN BROS. INC.

1815 VENICE BOULEVARD

LOS ANGELES 6, CALIFORNIA



W. J. McGONIGLE, President

RCA BUILDING, 30 Rockefeller Plaza, New York, N. Y.

GEORGE H. CLARK, Secretary

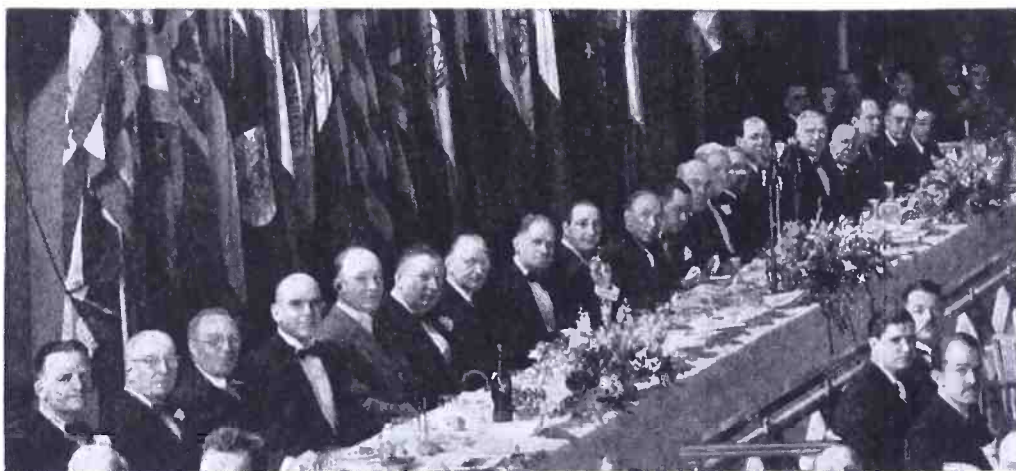

At the nineteenth annual dinner-cruise in the Hotel Astor, New York City, left to right: J. R. Poppele, George H. Clark, J. V. L. Hogan, George W. Bailey, J. McWilliams Stone, T. R. McElroy, E. A. Nicholas, Ludwig Arnson, William J. Halligan, Brig. Gen. H. M. McClelland, William J. McGonigle, Rear Adm. Joseph F. Farley, A. J. Costigan, Comdr. Charles W. Horn, Hon. James L. Fly, Major Gen. Joseph O. Mauborgne (USA Ret.), E. H. Rietzke, Lieut. Col. Thomas Mitchell, and Lieut. Comdr. James Flood.

THE nineteenth annual dinner-cruise at the Hotel Astor in New York City, on February 12th, 1944, saw a record attendance. Consular representatives of many of the United Nations and communications specialists from industry and government were present.

Brig. General H. M. McClelland, Air Forces Communications Officer, was present to personally represent General Henry Harley Arnold, Commanding General of Army Air Forces, who received the VWOA Marconi Memorial Commemorative Medal. General Arnold in acknowledging the award, wrote: "The honor bestowed upon me by the awards committee of the Veteran Wireless Operators Association in naming me as the recipient of the Marconi Memorial Commemorative Medal is deeply appreciated. Please convey to your associates that I am most honored that they voted to have the medal struck in my name and that I only regret that I cannot personally express my appreciation to them."

The Marconi Memorial Medal of Achievement was given to T. R. McElroy, president of McElroy Manufacturing Corporation; E. A. Nicholas,

president of Farnsworth Television and Radio Corporation; Ludwig Arnson, president of Radio Receptor Company; and William J. Halligan, president of Hallicrafters. Medal presentation ceremonies were broadcast over the NBC network.

Veteran radio men from National Company, Radiomarine, Tropical Radio, Mackay Radio, Hallicrafters, McElroy, Radio Corporation of America, Radio Receptor, Farnsworth, Harvey Radio, Bryan Davis Publishing Company, FCC, WOR-Mutual, National Broadcasting Company, Columbia Broadcasting System, and many others were at the dinner.

Among the pioneers present were: Ben Beckerman of Old Dominion Line fame; E. N. Pickerill, long chief radio officer of the Leviathan and now with RCAC; George McEwen of RCAC; Henry Hayden of Ward Leonard; Sam Schneider, one of our first treasurers and now with the OWI; C. S. Anderson, now retired from Radiomarine, who did so much work on many VWOA Year Books; Ed Content, assistant chief engineer of WOR; Raymond F. Guy, radio facilities engineer of the National Broadcasting Company who was made a VWOA

life member; Bill Simon, our very energetic treasurer, who also became a life member; Bryan Davis and Lewis Winner of COMMUNICATIONS; F. P. Guthrie, chairman of our Washington chapter; C. D. Guthrie, supervisor of radio for the Maritime Commission; Haraden Pratt, vice-president and chief engineer of Mackay Radio, who became a life member of VWOA; W. A. Ready, president of the National Company and Arthur Lynch, also of National, who became a life member of VWOA; Guy Entwistle and Walter Butterworth of the Boston chapter of VWOA; John Varian and V. P. Villandre of Radiomarine; Frank Rigby, personnel director of RCA Communications; Lt. Cmdr. A. F. Wallis of the Maritime Service; Charles Maps, wire chief in the New York Telephone Company; Don McNicol, one of the earliest presidents of the IRE; E. H. Price and J. A. Bossen of Mackay Radio; and Frank Orth, technical supervisor of the Columbia Broadcasting System, who became a life member of VWOA; and many, many others.

Music was supplied by a band composed of workers in the McElroy plant.

Year Book

COPIES of the 1944 VWOA Year Book are available from headquarters at fifty cents per copy, to cover cost of packaging and mailing. It is the largest issue in our long history and contains some very interesting biographies on the men who received the honors at the dinner-cruise. Interesting facts about pioneers and charter VWOA members also appear. The issue is well worth having and we urge you to get your copy now, while the supply lasts.

VWOA Spring Meeting in New York

ON April 27th members of the VWOA will gather at the 77th Division Club, 28 East 39th Street, New York City, to hear George Clark talk on his famous collection of hieroglyphics.

IMPROVED radiotelegraph communications from

SHIP to SHIP
SHIP to SHORE
POINT to POINT

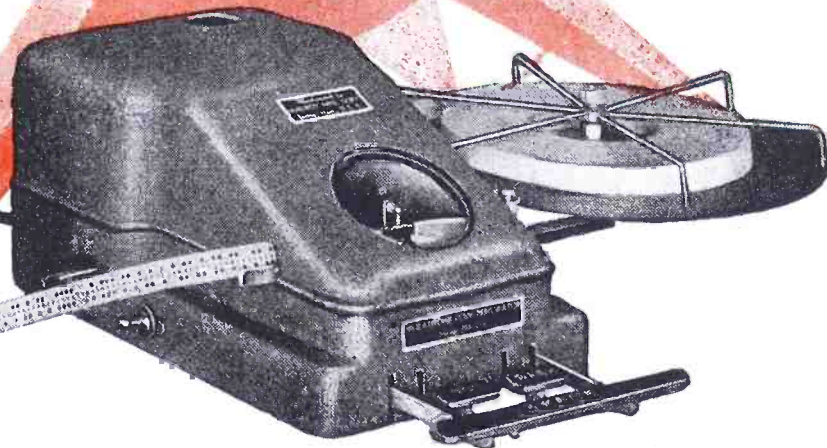

NEW McELROY ELECTRONIC CODE TAPE PERFORATOR PFR-443-A

Every ship and every marine station should and probably will, eventually, be equipped with perforator and transmitter.

Marine radiotelegraph communications were given a substantial boost in efficiency when Ted McElroy perfected the McElroy Code Tape Perforator PFR-443. This new model . . . the PFR-443-A...represents an even greater advancement in reducing the human margin of error. Entirely mechanical, the PFR-443-A comprises two units: The Keying Unit which is made up of an assembly of two keys, the space bar and punching mechanism; plus the Electronic Unit which relieves the keying contacts of high current and voltage, and provides for utmost ease in operation.

Operation of the PFR-443-A is similar to a semi-automatic ("bug") key excepting that the transmission of dots and dashes is automatic. A light touch actuates the punching mechanism for as long as either the key or space bar is depressed. Experienced operators can maintain, with ease, an accurate speed of more than 40 words per minute . . . in all Morse combinations assigned to the Russian, Turkish, Greek, Arabic and Japanese alphabets and languages, which are not found on the keyboards of standard perforators manufactured in the United States and Great Britain. *Write for additional information.*

McElroy engineers never imitate...never copy
We CREATE...DESIGN...BUILD



MANUFACTURING
CORPORATION

82 BROOKLINE AVENUE
BOSTON, MASS.

KEEP IT UP...BUY MORE
AND MORE WAR BONDS

**NEW
IMPROVED**

"T-PAD"

**ATTENUATORS
BY TECH LAB**

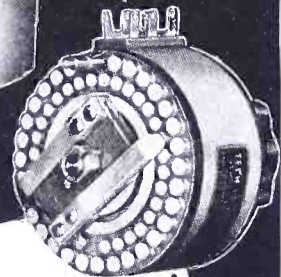

- Stainless Silver Alloy contacts and wiper arms.
- Rotor hub pinned to shaft prevents unauthorized tampering and keeps wiper arms in perfect adjustment.
- Can be furnished in any practical impedance and db. loss per step upon request.
- Write for our Bulletin No. 431.

**TECH
LAB MICROHMMETER**



Direct and instantaneous resistance readings down to 5 microhms and up to 1,000,000 megohms. Write for Bulletin No. 432.



1 LINCOLN STREET
JERSEY CITY 7, N. J.

NEWS BRIEFS

(Continued from page 60)

Minnesota, and with CBS in Minneapolis as research specialist on ultrashort-wave experiments.

* * *

**MRS. KINZIE NOW ASS'T
RTPB SECRETARY**

Mrs. Martha Kinzie, in radio since the pioneering days of 1920, has been elected assistant secretary of the Radio Technical Planning Board. Mrs. Kinzie has been Dr. W. R. G. Baker's secretary for many years, and is at present working with him in G. E.'s electronics department at Bridgeport, Connecticut.

* * *

EIGHT NEW I. T. & T. OFFICERS

Four vice presidents and four second vice presidents have been appointed by the board of directors of International Telephone and Telegraph Corporation. The new vice presidents are: H. C. Roemer, vice president and comptroller of Federal Telephone and Radio Corporation; W. H. Freng, assistant general attorney, who has also been appointed solicitor; Charles D. Hilles, secretary of the corporation; and Francis White, vice president of International Standard Electric Corporation. The second vice presidents appointed are: F. F. Davis, H. H. Buttner, G. A. Ogilvie, and Leonard Jacob II.

* * *

SYLVANIA SHIFTS EMPORIUM PLANT

Sylvania Electric Products' industrial apparatus plant at Emporium, Pennsylvania, has been transferred to plant two at Williamsport, Pennsylvania. Virgil M. Graham will continue as manager.

* * *

**RADIO CLUB HEARS
WHITE ON V-H-F**

S. Young White, consulting engineer with the General Communication Company of Boston, spoke recently on v-h-f tuning systems before the Radio Club of America meeting at Columbia University. His paper covered theory and economics of tuning by parallel and concentric lines, cups, sliding contact, coils, core tuning, etc.

* * *

WILSON NOW AAC VICE PRESIDENT

Ira Stuart Wilson has been elected vice president in charge of finance of Aircraft Accessories Corporation. Mr. Wilson will maintain his headquarters at the electronics division of AAC in Kansas City, Kansas.



* * *

ZENITH OPENS N. Y. SUBSIDIARY

Formation of the Zenith Radionics Corporation of New York, a subsidiary of the Zenith Radio Corporation, with offices



ALL THIS
AND RAPID DELIVERIES, TOO

**Radio and
Electronic
Components!**

**From
America's Leading
Manufacturers!**

**Thousands of
Desirable
Items!**

**Trained
Expeditors!**

**Technical
and Priority
Advisers!**

**17 Years
of Solid
Experiences!**

Harvey does the work for you. Shortages of critical parts can be solved... either from our stocks... or located for you by our ever-vigilant scouts. Whatever your needs... whatever your problems... we can help.

◆ **WRITE, WIRE OR TELEPHONE** ◆
**Orders Accepted for Any Quantities,
from Any Part of the Country**
Telephone Orders to BRyant 9-1946

HARVEY
RADIO COMPANY
HARVEY
103 WEST 43rd ST., NEW YORK 18, N. Y.

in the Empire State Building, was recently announced.

H. J. Wines, for the last 17 years general sales manager of the New York and Chicago branches of the Frigidaire division of General Motors Corporation, has been appointed general manager and a director of the New York corporation. E. F. McDonald, Jr., president of Zenith Radio Corporation, will also head the new corporation. Toni Strassman has been appointed sales manager of the Zenith Radionic hearing aid division of the subsidiary.

Ray Hoeffler, for the last two years New York regional manager for Zenith, has been promoted to manager of the Zenith Radio Distributing Corporation, wholesale distributor of Zenith products in the Chicago area.

* * *

BRYANT ELECTRIC WINS "E"

In a dual ceremony at Bridgeport, Conn., two divisions of the Bryant Electric Company were awarded Army-Navy "E" flags.

The wiring device division received its flag from Capt. Carl H. Bushnell, USN; the plastic division was presented with a flag by Col. Arthur H. Rogow, USA.

* * *

AMP SOLDERLESS WIRING DEVICE CATALOG

A 72-page sectionalized catalog of AMP solderless wiring devices, SD-I, has just been published by Aircraft-Marine Products Inc., 1591F North Fourth Street, Harrisburg, Pa.

This manual includes illustrated data on solderless insulation support terminals, standard and flag type terminals, connectors, lighting contacts, cable lugs, wiring plugs, standard and quick disconnect bonding jumpers, splicing terminals, grid clips, etc.

Hand tools and installation presses are also described and illustrated, and complete working instructions for setting up crimping dies are included.

Data, specification and dimensional charts, and Army-Navy and commercial wire sizes are also supplied.

* * *

C. L. PUGH NOW UTAH REPRESENTATIVE

C. L. Pugh has been appointed Utah's wholesale and sound divisions representative in the states of Ohio, West Virginia, and western Pennsylvania. His offices are at 2009 Elmwood, Columbus 8, Ohio. Mr. Pugh was formerly connected with Hughes Peters, Inc., RCA, and the Standard Transformer Company.



* * *

AERO NEEDLE ENLARGES

Aero Needle Company has announced (Continued on page 66)

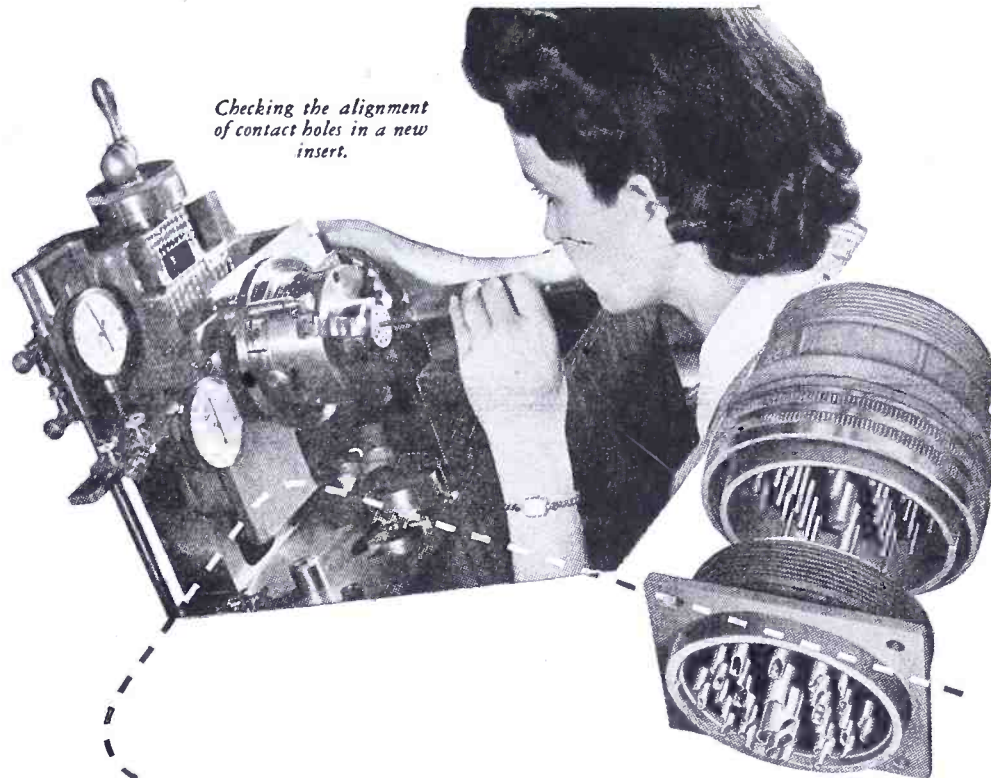

Checking the alignment of contact holes in a new insert.

Cannon Quality Control
colossus of little things

To our customers Cannon Quality Control means *one thing* only — the absolute dependability of Cannon Connectors.

To Cannon men and women, however, quality control means *a thousand things* — the constant vigilance to innumerable details — the continuous betterment of design — the alert scrutiny of materials — the steady improvement of machines, tools and methods — the checking, testing and checking again of all the parts as well as the completed product.

It means following the product into use to measure it against the demands of service. And so Cannon Quality Control results in what you know and appreciate — the uniformity of excellence throughout the multi-millions of Cannon Plugs in service today.

New Training Film on Soldering

An important training aid "Soldering Tips," a 25 minute slide film with sound, giving step-by-step procedure in soldering contacts... a companion film for "The Quick Disconnect," available on request. Contact your Cannon Representative or write direct to the Cannon Factory, Dept. A-121.

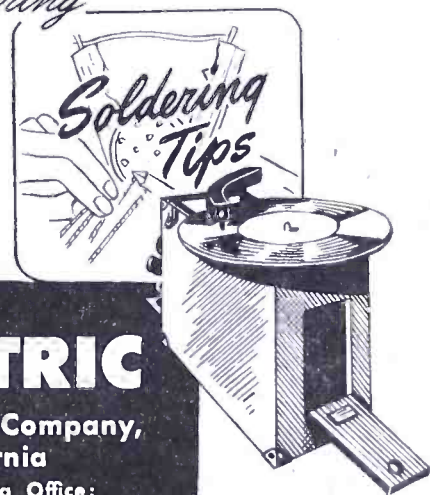

CANNON ELECTRIC

Cannon Electric Development Company,
Los Angeles 31, California

Canadian Factory and Engineering Office:
Cannon Electric Company, Limited, Toronto



Representatives in principal cities — Consult your local telephone book

AVAILABLE IMMEDIATELY!

Gould-Moody "Black Seal"

GLASS BASE
INSTANTANEOUS
RECORDING
BLANKS

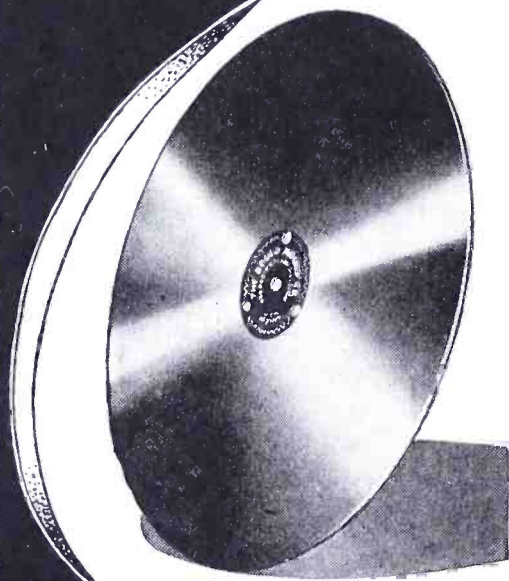

Broadcasting stations!
Recording studios!
Schools! "Black Seal"
Recording Blanks may
be obtained without de-
lay on an AA-2X rating
which is automatically
available to you.

Send us your priority
rating, and we'll ship
these famous, better-
sounding, longer-wear-
ing, more satisfying
blanks immediately. Two
weights — thin, flexible,
interchangeable with
aluminum, or medium
weight. Four holes. Cen-
ter-flow thread action.
Won't age, harden, dry
out or deteriorate.

Old Aluminum Blanks Recoated with
"Black Seal" Formula in Short Notice

the
GOULD-MOODY
company



Recording Blank Division
395 Broadway
New York 13, N. Y.

NEWS BRIEFS

(Continued from page 65)

the completion of their new and larger
quarters at 208 East Erie Street, Chi-
cago, Ill.

O'BRINE JOINS RCA INFORMATION STAFF

Jack O'Brine has joined the RCA in-
formation department. Mr. O'Brine was
formerly associated with Popular Science
Monthly, the New York Herald Tribune,
and NBC.

KELLEY-KOETT'S COVINGTON PLANT ENLARGED

An addition to the Kelley-Koett Manu-
facturing Company's plant at Covington,
Kentucky, has been completed.

A new sales and service office has been
opened at 1109 Traction Building, Cin-
cinnati, Ohio. This office will serve as
headquarters for Ted Tierney, represen-
tative for the Cincinnati area; Floyd
Tracht, representative for southern Ohio;
and Wayne Kruse, service representative.

HILLIARD NOW G-M OF BENDIX RADIO

W. P. Hilliard has been named general
manager of the radio division of Bendix
Aviation Corporation, Baltimore, Mary-
land and Red Bank, New Jersey. Mr.
Hilliard, who has been director of sales
and engineering of the radio division
since its inception in 1936, succeeds Hugh
Benet who will assume other Bendix
duties.

WILLIAM PURVIS TO CBS

William Purvis, who received an honor-
able discharge from the Navy recently,
has joined CBS as a short-wave trans-
mitter technician at the Wayne, New
Jersey plant. Mr. Purvis was previously
connected with the CAA, WBAX in
Wilkes-Barre, Pennsylvania, the Amer-
ican Airlines, and the Radiomarine
Corporation of America.

SENNOTT NEW DETROLA CONTROLLER

John Harmon Sennott, supervising ac-
countant for Ernst & Ernst, Chicago,
since 1932, has been appointed controller
of the Detrola Radio Division, Detroit.

KLINGENSCHMITT ELECTED PRESI- DENT OF RADIO CLUB OF AMERICA

F. L. Klingenschmitt has been elected
president of the Radio Club of America.
O. James Morelock was elected vice presi-
dent; J. J. Stantley is the new treasurer;
newly elected corresponding secretary is

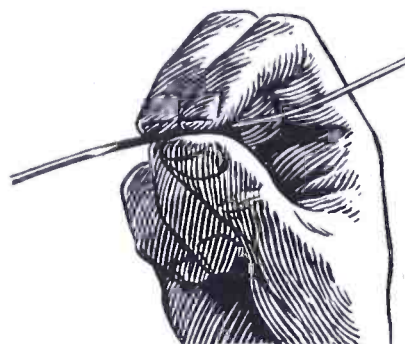

"SURCO-AMERICAN"
means PRETESTED
under all conditions

"Surco-American" high quality
flexible plastic tubings and insu-
lated wire are pretested to stand
up under a wide range of tempera-
tures and under the most severe
conditions because they are spe-
cially formulated to meet the most
exacting requirements. Tubings are
available in inside diameters from
.005" to 2". Dielectric strength
averages 1500 volts per mil. thick-
ness. "Surco-American" flexi-
ble plastic insulated wire is avail-
able in all lengths and colors in
wire sizes #12 to #48 A.W.G. solid
or stranded, shielded, tinned or
silver plated copper wire and cable.
Technical bulletins and sam-
ples on request.

Address Dept. L

Surprenant
ELECTRICAL INSULATION CO.
84 Purchase St. Boston, Mass.

A STEADY SOURCE OF ALL
ELECTRONIC
EQUIPMENT

TERMINAL RADIO CORP.
Telephone: WOrth 2-4416
85 CORTLAND ST., NEW YORK, N. Y.

TO: *Your Plant*
FOR ACTION
PHONE! WIRE! WRITE
BULLETINS AND CATALOGS ON REQUEST

THE TUBES YOU CAN
DEPEND UPON

CETRON

Rectifiers - Phototubes - Electronic Tubes

Prompt deliveries on most types

SEND FOR CATALOG

CONTINENTAL ELECTRIC COMPANY

CHICAGO OFFICE
303 MERCHANDISE MART

GENEVA, ILL.

NEW YORK OFFICE
765 W. 14th ST.

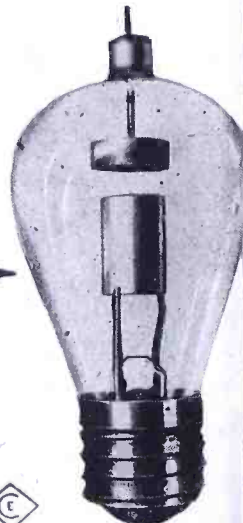

M. B. Sleeper; and J. H. Bose is now recording secretary.

* * *

CLARK OF FORMICA ON NACA WOOD-PLASTICS SUBCOMMITTEE

George H. Clark, vice president of Formica Insulation Company, Cincinnati, has been appointed to the Subcommittee on Wood and Plastics for Aircraft of the National Advisory Committee for Aeronautics for 1944.

The NACA was established by Congress as an independent research and fact-finding agency associated with the development of aircraft in this country.

Chairman of the Wood and Plastics Subcommittee is Dr. Gordon M. Kline, National Bureau of Standards, Washington, D. C. Other appointments to this committee for 1944 are: Captain R. M. Houghton, USA, Materials Laboratory, Wright Field; Lieut. Commander S. L. Chisholm, USN, Bureau of Aeronautics; Henry Sang, Aircraft Materials Laboratory, Naval Air Experimental Station, Philadelphia; Paul C. Speiss, CAA, Washington; L. J. Markwardt, Forest Products Laboratory, Madison, Wisconsin; Evan H. Schuette, Lumber Manufacturers Association Laboratories; C. W. Armstrong, Marco Chemicals Inc., Sewaren, New Jersey; and Dr. Harry C. Engel, assistant design engineer, Glenn L. Martin Company, Middle River, Maryland.



George H. Clark

* * *

ARHCO PLANT NOW IN MT. VERNON

A new American Radio Hardware Company plant has been opened at 152 MacQuesten Parkway, South Mount Vernon, New York.

* * *

J. KELLY JOHNSON JOINS HAMMARLUND

J. Kelly Johnson, former production section chief of the Electronics Division, Office of Procurement and Material, Navy Department, Washington D.C., has been appointed executive engineer in charge of all engineering activities at Hammarlund Manufacturing Company Inc., 460 West 34 Street, New York City.

Prior to his Washington post, Mr. Johnson was assistant chief engineer of Silver-Marshall & Company, Chicago; development engineer at Hazeltine Service Corporation, New York; and chief engineer for Wells Gardner & Company, Chicago.

* * *

UNIVERSAL MICROPHONE CO. LTD. NOW A PARTNERSHIP

The Universal Microphone Company Ltd., of Inglewood, California, has dissolved its

(Continued on page 68)

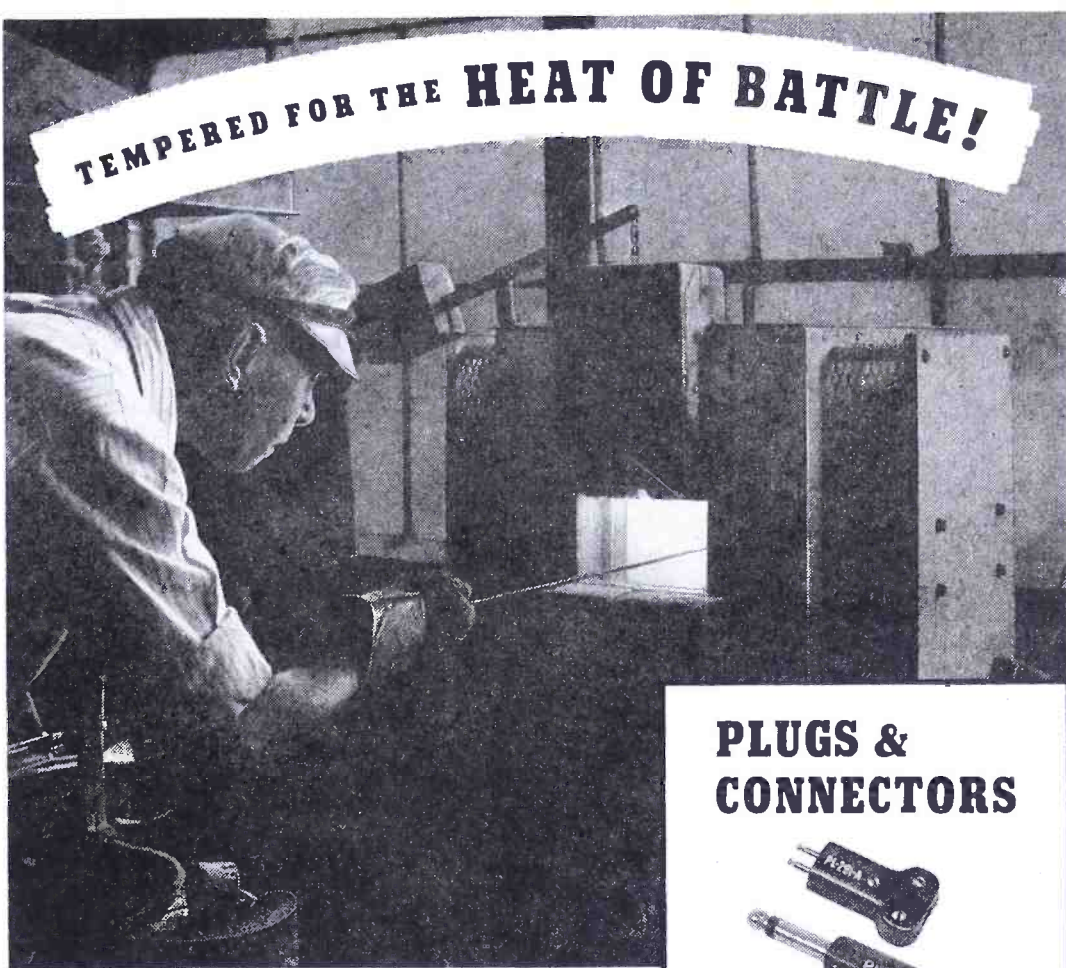

Remler craftsman heat treats welding and cutting dies and tools for automatic screw machines.

ELECTRONIC TOOLS OF WAR...

in quantity and on time! There are no delays because Remler has the facilities and experience to do the job from design to finished product—plus the know-how to cut production time which frequently permits quotations at lower prices. This organization of skilled specialists manufactures components and complete electronic equipment for our armed forces and components for your application. Inquiries invited.

Wire or telephone if we can be of assistance

REMLER COMPANY, LTD.

2101 Bryant St. • San Francisco, 10, California

PLUGS & CONNECTORS



Signal Corps and Navy Specifications

Types:		PL		
50-A	61	74	114	150
54	62	76	119	159
55	63	77	120	160
56	64	104	124	291-A
58	65	108	125	354
59	67	109	127	
60	68	112	149	

PLP		PLQ		PLS	
56	65	56	65	56	64
59	67	59	67	59	65
60	74	60	74	60	74
61	76	61	76	61	76
62	77	62	77	62	77
63	104	63	104	63	104
64		64			

NAF

1136-1

No. 212938-1

Other Designs to Order

REMLER

SINCE 1918

Announcing & Communication Equipment

Designed for



Application

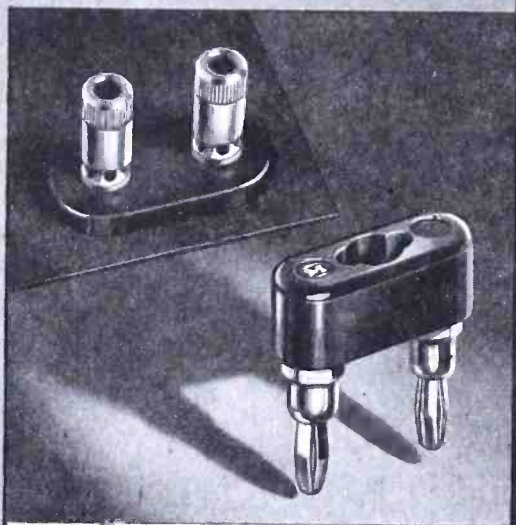

THE 37212 PLUG

Designed for Application! Compact, easy to use. Made in black and red regular bakelite as well as low loss brown mica filled bakelite for R.F. uses. Small circular depression on top for "color coding" or polarity indication. Designed primarily for use with our No. 37222 captive head posts and No. 37202 plates.

(Standard 3/4" spacing)

**JAMES MILLEN
MFG. CO., INC.**

MAIN OFFICE AND FACTORY
**MALDEN
MASSACHUSETTS**



NEWS BRIEFS

(Continued from page 67)

corporation and hereafter will be known as the Universal Microphone Company.

James L. Fouch and Cecil L. Sly, president and vice president of the former corporation, have re-organized the company as a partnership.

* * *

CROWLEY RECEIVES WHITE STAR

A white star for the "E" flag has been awarded to Henry L. Crowley & Company, Inc., West Orange, N. J.

* * *

WEBSTER PRODUCTS EXPANDS

Additional floor space will soon be added to the plant of Webster Products, 3825 W. Armitage Ave., Chicago 47, Ill.

* * *

BURNDY CONNECTOR CATALOG

A 64-page catalog, 6050, of indent type electrical connectors has been published by the Burndy Engineering Co., Inc., 107 Eastern Boulevard, New York 54, N. Y.

* * *

CANNON BATTERY CONNECTORS BULLETIN

A 24-page bulletin illustrating and describing battery connectors used with battery carts for engine starting, for the quick disconnect of large storage batteries, general service batteries, and rack battery installations, has been issued by Cannon Electric Development Company, 3209 Humboldt Street, Los Angeles 31, Calif. Application photos and condensed data sheets are also included.

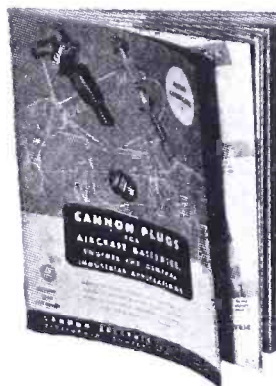

* * *

ALTEC-LANSING TO DISTRIBUTE FOR HANOVA

The Altec-Lansing Corporation of Hollywood, California, has been appointed exclusive western, Chicago and Detroit distributor of Hanovia Chemical and Manufacturing Company's products.

* * *

"E" AWARDED TO ERCO

The Army-Navy "E" was awarded recently to the Erco Radio Laboratories, Inc., Hempstead, New York. Commander S. J. Singer, USNR, executive officer, Industrial Incentive Division, presented the "E" flag to Edward Ruth, III, secretary-treasurer of Erco.

* * *

DU MONT FIVE-YEAR CLUB INAUGURAL

A dinner-dance was held recently to inaugurate the DuMont Five-Year Club of employees of the Allen B. DuMont Laboratories, Inc., Passaic, New Jersey. Allen B. DuMont, president of the company, awarded five-year pins to all employees with his organization for five or more years.

Ten-year gold pins were presented to A. J. Hinck, Stanley J. Koch, and Harry Gawler, the three men who worked with Mr. DuMont in the latter's home base-

**ELECTRONIC
TUBE PARTS
and
SHIELDS**



GOAT

METAL STAMPINGS, Inc.
Division Of THE FRED GOAT CO., INC.
Machinery Specialists since 1893
320 DEAN STREET, BROOKLYN, N. Y.

ment in 1932 on the first DuMont tubes. And Mr. DuMont himself received a ten-year pin. Toastmaster for the gathering was Leonard F. Cramer, vice president and general sales manager.

* * *

PHILCO PROMOTES HARDY

Larry F. Hardy has been elected vice president in charge of the home radio division of Philco Corporation. Mr. Hardy, who has been with Philco since 1932, was formerly with Landers, Frary and Clark. He was also New York City manager of motor appliances for GE and mid-western division manager for Ceco Manufacturing Company.

* * *

FORMICA PLASTICS FILM SHOWN IN N. Y.

A sound film in color prepared by The Formica Insulation Company, Cincinnati, Ohio, depicting the history of the laminated plastics industry, had its premier showing in New York recently.

The film, entitled *The Formica Story*, reviewed the development, design and application of laminated plastics, during the past fifty years.

The sound film on 16mm is available for meetings of engineers, executives, employee organizations, and for plastic classes in colleges.

* * *

BALTIN APPOINTED TO TBA

Will Baltin, former program manager of the DuMont television station W2 XWV, has been appointed secretary-treasurer of Television Broadcaster Association. Mr. Baltin will handle the business affairs of the association, and coordinate the activities of member television companies for the advancement of

television during wartime and in the post-war period.

* * *

CONTINENTAL ELECTRIC ELECTRONIC TUBE CATALOG

A catalog, RS, with data on phototubes, rectifier tubes, and grid control tubes (thyratrons) has been published by Continental Electric Company, Geneva, Illinois.

* * *

OCCUPATIONS IN ELECTRONICS" OLDER

A 6-page folder on *Occupations in Electronics* by Forrest H. Kirkpatrick of Bethany College, and John E. Crawford of RCA, has been published by Occupational Index, Inc., New York University, New York 3, New York. The folder describes the job opportunities in postwar electronics. Single copies are 25c.

* * *

PRAGUE ISSUES "FOR IMMEDIATE DELIVERY" PAMPHLET

A listing of *immediate delivery* items is included in a 4-page pamphlet being distributed by Sprague Products Company of North Adams, Massachusetts. Included in the listings are bathtub type metal rectangular units in single and dual capacities and in voltages from 50 to 1750 volts d-c (tolerance is said to be minus 20%, plus 30%); oil-filled, oil-impregnated can type units range in capacities from 1.0 to 17 mfd and in a variety of a-c/d-c voltages. Mica condensers available for immediate delivery include units in d-c test voltage range of 1000, 500, and 5000.

* * *

ABRASION TEST FOLDER

A repeated-scrape abrasion tester for comparing the toughness of insulation on film-coated magnet wires is described in G. E. folder, GEA-4166.

* * *

SOLAR EMPLOYEE JOURNAL

A journal covering activities of employees is now being published monthly by the Solar Manufacturing Corporation. Sylvan A. Wolin is editor.

F-M TURNSTILE ANTENNA

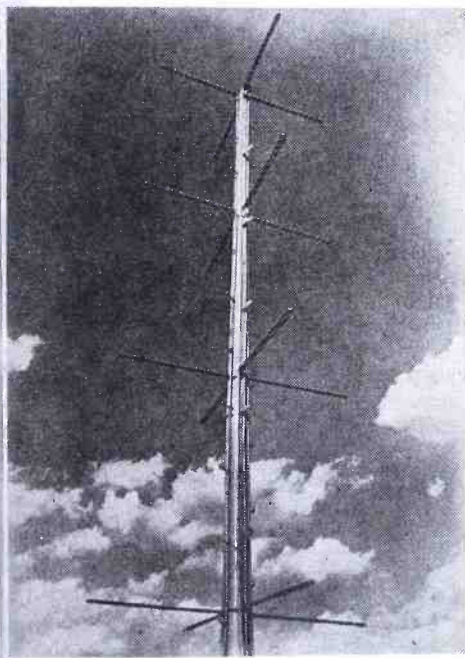

(Courtesy Andrew Company)

A recent installation in the Zenith F-M station WWZR atop the Field Building in Chicago. Feeding the four bays of the turnstile antenna are eight 1 3/8" diameter coaxial cables. These lines as well as the 4 1/8" diameter cables feeding power from the transmitter, are used in a "back-to-back" connection to provide a balanced 140-ohm transmission line.

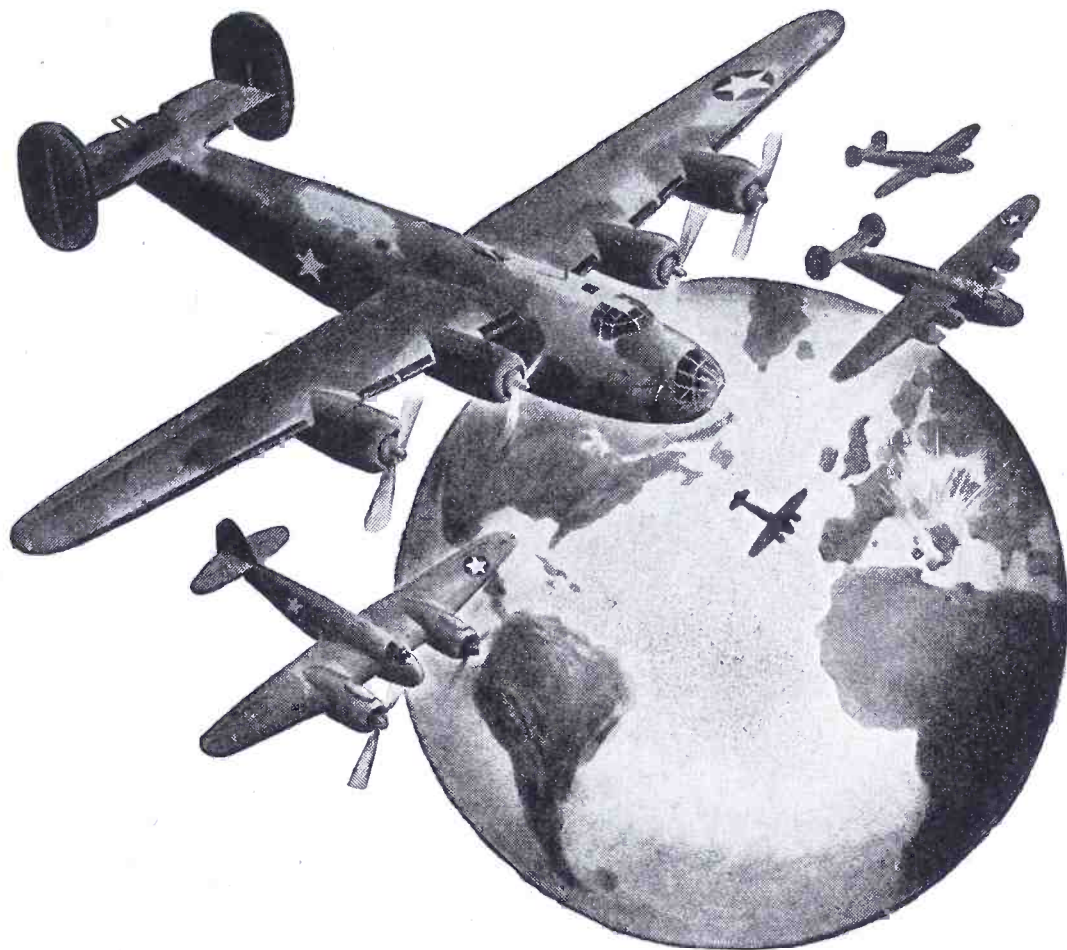

How tiny Piezo Crystals

do their part to make this

a brighter, better world!

When those big, long range raiders strike deep behind enemy lines, crystals ride along—doing their small, but mighty important job, of keeping alive the line of communications from plane to plane, and from raider force to home base.

To fulfill this responsibility, crystals must be perfect. Here at Scientific Radio Products Company we're proud to be engaged in the important work of making perfect crystals for the allied nations. That's where the big share of our output goes—but our facilities are such that we may be able to serve you, too, in your efforts to bring destruction to the enemy — and make this world a better place to live. Write us.

Scientific Radio Products Company

738 W. BROADWAY, COUNCIL BLUFFS, IA



LEO MEYERSON W9GFQ
E. M. SHIDELER W9IFI

MANUFACTURERS OF PIEZO ELECTRIC CRYSTALS AND ASSOCIATED EQUIPMENT



KEY TO Laboratory Standards

- Standard Signal Generators
-
- Square Wave Generators
-
- Vacuum Tube Voltmeters
-
- U. H. F. Noisemeters
-
- Pulse Generators
-
- Moisture Meters
-

**MEASUREMENTS
CORPORATION**
BOONTON, NEW JERSEY

WHEATSTONE BRIDGE

(Continued from page 52)

kinds, but come under only a few general classifications. These are:

- (1)—Grounds of one or more wires, which may be of high, low or intermediate value.
- (2)—Shorts or crosses of one or more wires of a pair, crossed or shorted to one or more wires of a line or cable.
- (3)—Opens, which may affect one or more wires of a pair, quad or an entire line or cable.
- (4)—Combinations of grounds, crosses or opens, which may affect one or more wires of a line or cable.

For a solid short condition, a loop measurement is indicated. This cannot be relied upon until it has been verified by measurement from both ends into the trouble, and by comparison with a spare or another pair of like gauge, that the trouble is solid and free from variation caused by contact resistance. The grounded Varley or the metallic Varley may also be used where possible to check the resistance in the short, if any exists. If none exists, the Varley measurement will indicate zero.

For a variable short circuit condition, the best method to use is the metallic Varley using a split pair. This places the variable resistance in the battery branch of the circuit, thus removing it from the balancing arms. The accuracy of location will suffer to a greater and greater degree as the resistance of the fault increases since under this condition, the sensitivity of the bridge circuit goes down. This would necessitate using a higher voltage battery which is not desirable for two reasons. One is that the hazards of ruining either the galvanometer or the resistances or both are too great in the event that the high resistance suddenly changes to a low resistance. The other is that whenever the high resistance is caused by poor contact at the fault, the excess current may cause the trouble to suddenly disappear only to reappear with the removal of the battery. In all cases of a high resistance contact such as may be caused by very fine wire or very rusty or corroded wire, etc., a low battery potential should be used to avoid the burning out of the contact.

Open measurements should be made using the bridge set up for Murray loop measurements and preferably using a very low a-c frequency of 4 to 20 cycles per second as previously outlined. It is important that the insulation of the faulty wire be good, but if an appreciable leak is found, less

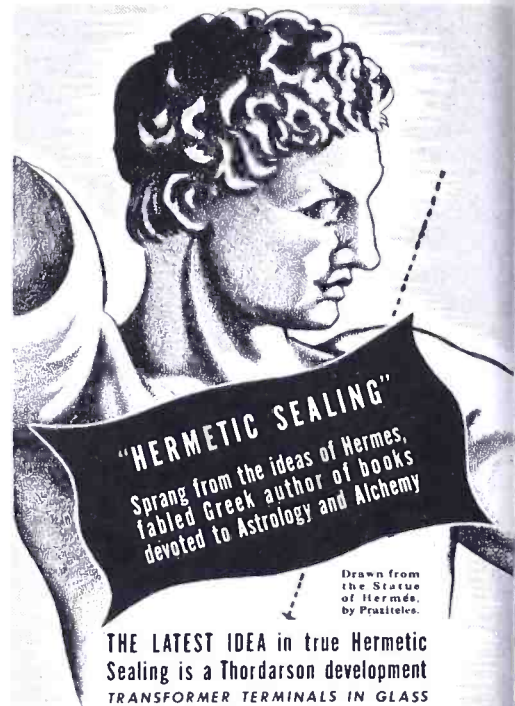

"HERMETIC SEALING"
Sprang from the ideas of Hermes, fabled Greek author of books devoted to Astrology and Alchemy

Drawn from the Statue of Hermes, by Praxiteles.

THE LATEST IDEA in true Hermetic Sealing is a Thordarson development
TRANSFORMER TERMINALS IN GLASS



The above types are suitable for use anywhere in the world, regardless of climatic conditions.



THORDARSON

TRANSFORMER DIVISION
THORDARSON ELECTRIC MFG. CO.
300 WEST HURON STREET, CHICAGO, ILL.

Transformer Specialists Since 1895
ORIGINATORS OF TRU-FIDELITY AMPLIFIERS

**TOOLS • DIES
STAMPINGS
HEAT
TREATING**

LAMINATIONS

For
Output
Transformers
of highest
permeability

Standard
Sizes for
Audio, Choke,
Output and Power
Transformers in
Stock.

Write for
dimension
sheets.

**PERMANENT
MAGNETS**

Alnico
(cast or sintered)
Cobalt, Chrome or
Tungsten, cast, formed
or stamped. Engineering co-
operation backed by 40 years ex-
perience insures quality, dependability
and service.

Thomas & Skinner
Steel Products Co.

1113 E. 23rd St. Indianapolis, Ind

accurate results are only to be expected. In all of the cases that have been analyzed and discussed, it has been tacitly assumed throughout that the effect of intermediate connecting cable, open wire, and equipment with their accompanying variations in resistance with changes in weather and temperature have been taken into account. The theoretical resistances and distances apply to the conductors only. For example, a circuit is composed of 100 feet of 22-gauge cable from the location of the measuring bridge, 800 feet of 19-gauge cable from the office cable terminal, 27 miles of 104 copper, 5 miles of 16-gauge cable at the far end of the open wire to the other terminating office, 200 feet of 20-gauge cable and finally terminating into a transformer or repeating coil, account must be taken of each length of copper paired cable and equipment. The type of measurement may in this case be a loop followed by a Varley if one wire of the open wire pair is grounded. From the total loop measurement of the bridge, the excess amounts of equipment and cable resistance must be deducted. This gives the actual resistance of the open wire pair which would be approximately 270 ohms. A Varley measurement made from the same office or near end would include the loop resistance of the open wire plus the total loop resistance of cable, connecting wire, and repeating coil windings at the far end. The difference of the loop and Varley measurements would cancel out the excess cable and equipment resistance at the far end, leaving only the near end to be accounted for. This difference obtained would have deducted from it the excess cable and bridge lead resistance giving the actual resistance to the trouble in ohms. The quotient of the loop minus the Varley, and the loop corrected as outlined will give the fractional part of the total distance to the trouble from the measuring or near end. This when multiplied by the total length of the open wire will give the actual miles to the trouble from the junction of the open wire with the near end cable. If the total length of the open wire is not known, the temperature coefficient in ohms per loop mile may be used. In this instance, the quotient of the corrected loop minus Varley and the ohms per loop mile will give the distance to the trouble.

Insulation Resistance by the Voltmeter Method

Although this type of testing is not directly allied with the Wheatstone bridge circuit, it is so closely tied up

(Continued on page 72)

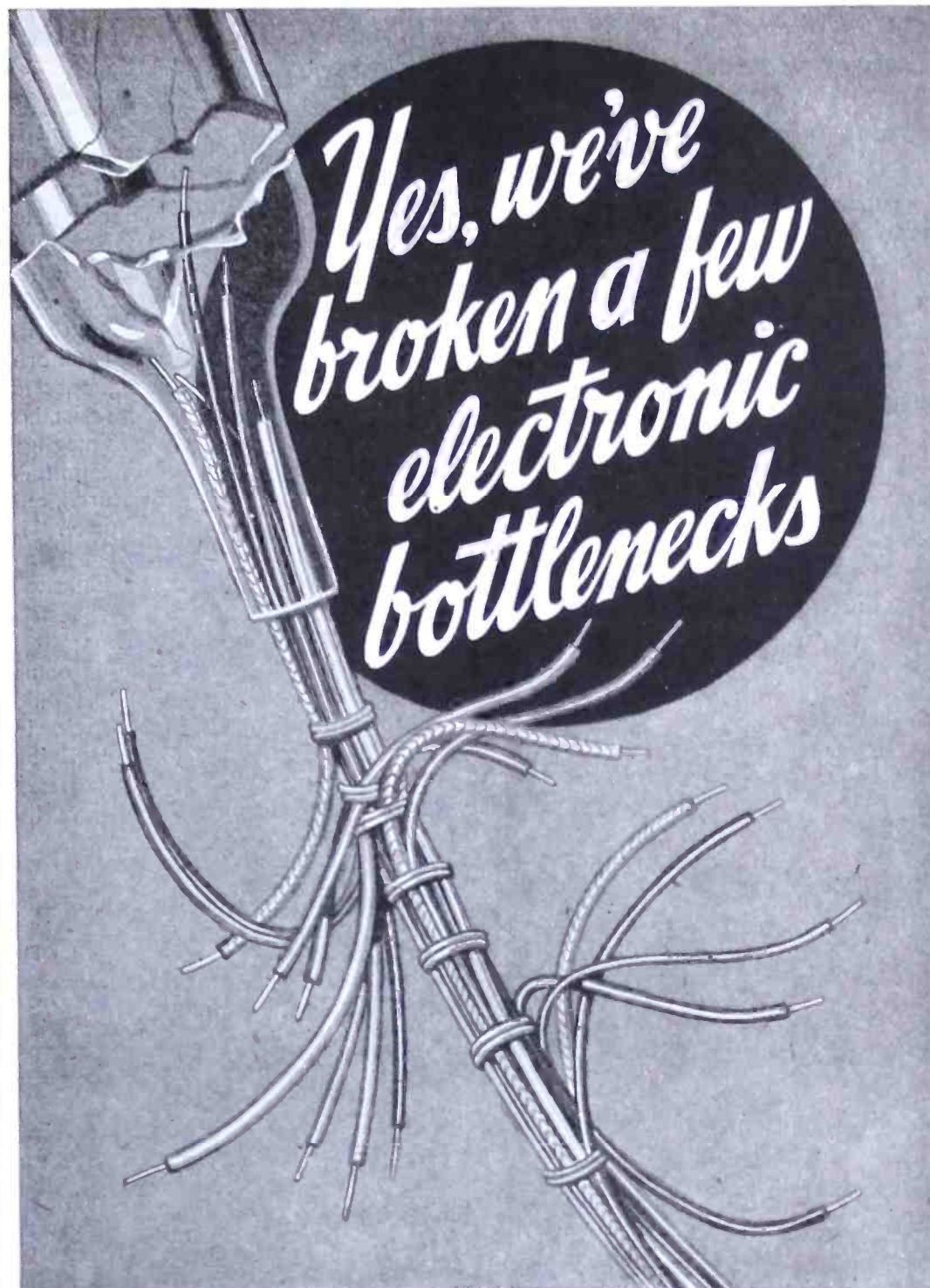

Yes, we've broken a few electronic bottlenecks

Harnesses — made to your toughest "specs" — that's one of our big dishes. Several internationally known radio manufacturers can tell you that Wallace methods help them get the production they want. Of course, it's all in winning the war but it's fine training for competitive peacetime operation, too. Perhaps we can use this experience to help you get the jump on competition once peace is declared.



Wm. T. WALLACE MFG. Co.
General Offices: PERU, INDIANA
Cable Assembly Division: ROCHESTER, INDIANA

**ENGINEERING
EXPERIENCE
and
Manufacturing
Facilities for**

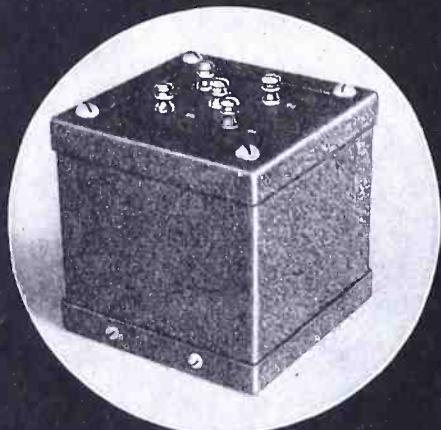

FILAMENT TRANSFORMERS

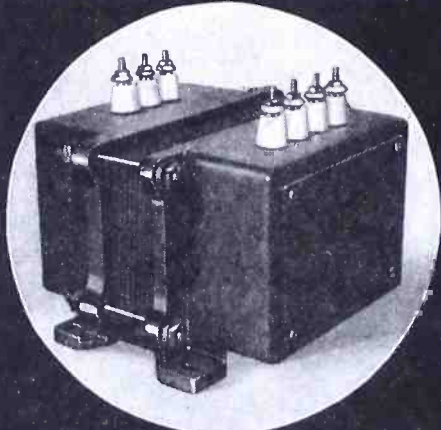

MODULATION TRANSFORMERS

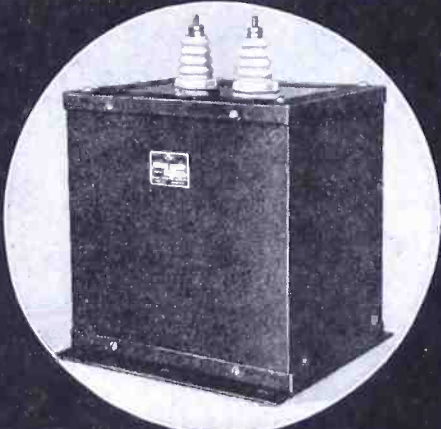

REACTORS

**SEND PRINTS AND
SPECIFICATIONS IN
CONFIDENCE FOR
ESTIMATE**

THE ACME ELECTRIC & MFG. CO.
CUBA, NEW YORK • CLYDE, NEW YORK

Acme Electric
TRANSFORMERS

WHEATSTONE BRIDGE

(Continued from page 71)

with the applications of that circuit in practically all of the measurements described, that it is included here for the sake of continuity and completeness.

Let us consider Figure 12, in which a battery and a high resistance voltmeter are connected in series to a wire n miles long, having assumed uniform leakage to ground throughout its length. If we let internal resistance of the battery be assumed as negligible, in comparison with the magnitude of the resistances being measured, and R = resistance of the voltmeter, in ohms,

D = deflection of the meter indicator, in volts, and

X = total line leakage, in ohms;

$x = nX$ = leakage per mile, in ohms, or $nX/10^6$ megohms per mile.

The series resistance of the wire itself is also considered to be negligible in comparison with the leakage resistance. By Kirchoff's second law, the equation of voltage equilibrium is $E = R i + n X i = i (R + n X)$ (97)

Since the deflection of the meter is proportional to the potential across the meter, or $D = R i$, each side of 97 may be multiplied by R , from which we get,

$$E R = R i (R + n X) = D (R + n X) \quad (98)$$

and since, the insulation resistance per mile, $x = n X$, we may solve for x in 98 using this substitution, or

$$x = n R \left(\frac{E}{D} - 1 \right) \text{ ohms per mile} \quad (99)$$

which may be converted to the more common form of

$$x = \frac{n R \left(\frac{E}{D} - 1 \right)}{10^6} \text{ megohms per mile} \quad (100)$$

If a limit of M -megohms per mile is set as the allowable limit below which the insulation shall not be permitted to fall, then with $x = M$, and 100, the deflection maximum is

$$D = \frac{10^{-6} n E R}{M + 10^{-6} n R} \text{ volts} \quad (101)$$

If the minimum insulation resistance is set at 25-megohms per mile and a meter having 100,000 ohms is used with a battery of 100 volts, the deflec-

Figure 12

Insulation resistance measurement using a high resistance voltmeter.

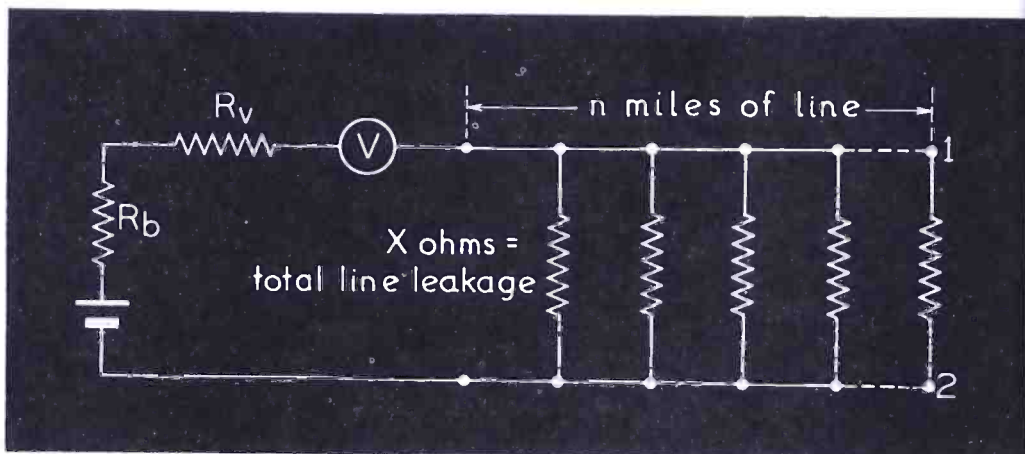

**JONES 500 SERIES
PLUGS AND SOCKETS**

Designed for 5,000 volts and 25 amperes. All sizes polarized to prevent incorrect connections, no matter how many sizes used on a single installation. Fulfill every electrical and mechanical requirement. Easy to wire and instantly accessible for inspection. Sizes: 2, 4, 6, 8, 10, and 12 contacts. Send for a copy of Bulletin 500 for complete information. Write today.

HOWARD B. JONES

2460 W. GEORGE STREET
CHICAGO 18, ILL.

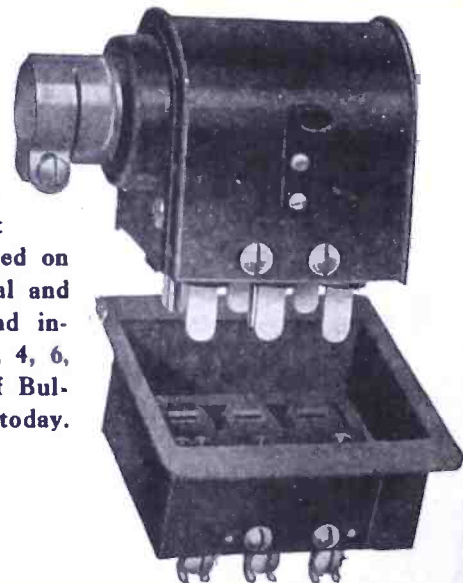

ion obtained will be

$$D = \frac{10 n}{25 + 0.1 n} \text{ volts} \quad (102)$$

For example if a wire 50 miles long were tested, the highest reading that could be allowed without exceeding the limits required for a satisfactory commercial line would be 16.7 volts, while a 100-mile line should not give a reading in excess of 28.6 volts.

Since the sensitivity of these high resistance voltmeters is fairly good, they may be used to check for crosses, shorts and grounds on cables and lines. The Wheatstone bridge circuit would then be used for the actual location as outlined in the preceding theory. The exact application which would have to be used in any particular case would be determined largely by the nature of the trouble as revealed by the voltmeter. Of course, if the voltmeter is absent, a listening test may reveal that trouble exists, but it is most frequently a poor criterion. The best procedure in this instance would be to go ahead with loop and Varley tests. The loop may then be either longer or shorter than expected, or the Varley may read either zero or some definite value. If the loop is longer than expected, a series unbalance or an open condition in which both wires have made contact with a ground path is indicated. If the Varley reads zero, then either a ground at the far end with a short, or a short alone, or contact with a foreign wire which causes a capacity unbalance without a direct ground path is indicated. If a loop indicates shorter than expected, a shorted pair is most certainly indicated, the nature of which has to be determined by one of the methods outlined. The short may be solid, intermittent solid, greater than zero and solid, or greater than zero and intermittent or variable, or both. Thus from a few considerations of the simplest of the conditions which might be met with in practice, it can be appreciated that the better knowledge of theory of the bridge circuit that one possesses, the more accurate may be the location of a fault consistent with speed and expediency.

There is no substitute for experience in dealing with the multitude of possible arrangements and faults that may develop when many circuits are in close proximity. The general headings of the causes of trouble run into the hundreds, while the specific causes multiply this figure by several times. The author has had practical field experience in locating line faults and thus has a deep appreciation of the difficulties which beset those upon whom the responsibility for clearance and maintenance of the lines of communications rest.

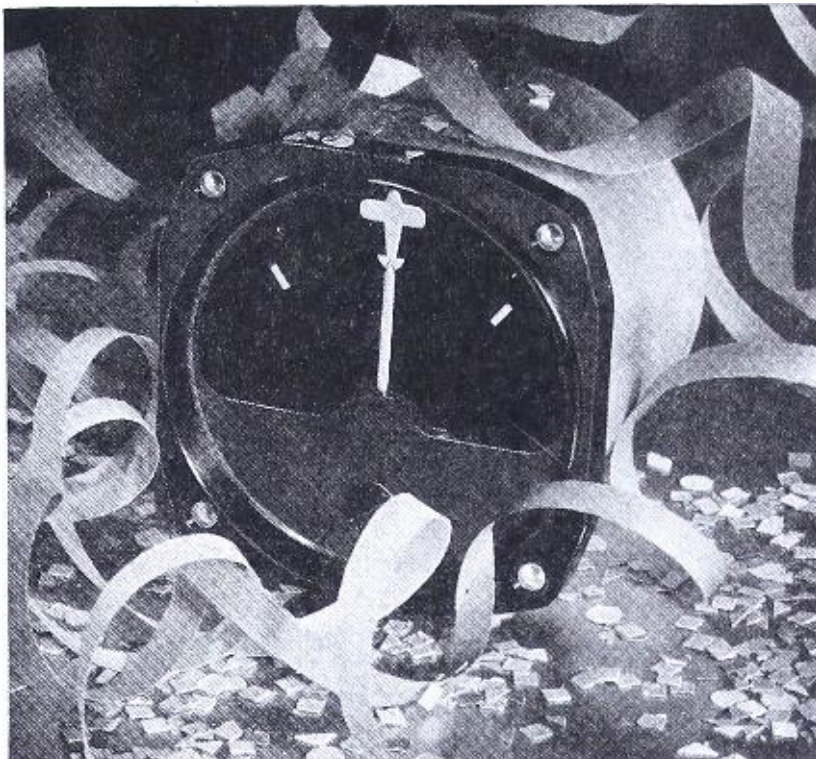

Unsung Hero!

ONE of these days the confetti will fly and we'll welcome home the millions of our heroes to enjoy the peace they've won. That's the way it should be.

But there are other heroes, too—among them the staunch instruments that helped to give our planes, our ships, our guns their incredible power and precision. These instruments are saving lives, are shortening the war, are hastening the defeat of our enemies.

When the war is won, there will be other jobs for them to do—in the professions, in the sciences, in industry. High among these servants of the peace will be the instruments made by Boes. In peace, as in war, the *sustained accuracy** of Boes-made instruments will be prized by all who use them.

* **SUSTAINED ACCURACY** is not an easy quality to achieve. It must take into account all factors of use—must then employ the design, the alloys, the construction that infallibly protect an instrument against all threats to its reliable performance. Such instruments, obviously, must be built with performance—not price—in mind. We invite the inquiries of those who are interested in such standards.

Boes instruments

for Measuring, Metering & Testing Equipment

THE W. W. BOES COMPANY, DAYTON, OHIO



Stepping up to
10 MILLION VOLTS

● Charged in parallel, discharged in series, these capacitors provide for voltages up to 10,000,000 and over. Individual units are rated from 50,000 to 150,000 volts D.C. Choice of capacitances, from .001 to .1 mfd.

Originally designed for certain deep penetration X-ray and impulse generator applications, Aerovox Type '26 capacitors may be used for radio and electronic applications requiring exceptionally high operating voltages. Multi-layer paper sections; oil-impregnated, oil-filled; housed in sturdy tubular bakelite cases. Choice of metal cap terminals facilitate stack mounting and connections. Sections of matched capacitance insuring uniform voltage gradient throughout length of capacitor.

● DATA . . .

New catalog, listing an outstanding line of heavy-duty capacitors for radio, electronic and industrial functions, sent on request to engineers and others engaged in radio and electronic work. Write on business stationery.



AEROVOX CORP., NEW BEDFORD, MASS., U. S. A.
In Canada: AEROVOX CANADA LTD., HAMILTON, ONT.
Export: 13 E. 40 ST., NEW YORK 16, N. Y. Cable: 'ARLAB'

RADIO RANGE BEACONS

(Continued from page 58)

of the loop (indicated as antennas 1 and 2) and the course bending antenna *R*. In this example it is assumed that the electrical spacing between the vertical sections of the loop is 45° , and that the reflector (course bending antenna) is spaced 10° to the left of the center of the loop.

The vertical antennas 1 and 2 have a resultant field V_{1-2} to the left (see Appendix B). In addition each antenna energizes the reflector 180° out of phase with its own field.

As the energy due to antenna 2 passes toward the left it energizes the reflector which, in turn, produces a field 180° out of phase with the field which energized it. Therefore, V_{2R} , the reflector field due to antenna 2, is drawn in 180° out of phase with V_2 , the vector of antenna 2.

The energy due to antenna 1, however, must travel to the reflector, is reversed 180° , and travels back to antenna 1 before it can regain the field which energizes it. In this time the net phase difference becomes $180^\circ - 25^\circ$. The 25° represents the time taken for the energy to travel to the reflector and back. V_{1-2} is therefore drawn in, reversed 180° from V_1 and retarded an additional 25° .

By completing the parallelogram, V_R , the net reflector voltage is secured. The sum of V_R and V_{1-2} produces V_w , the resulting field to the left (or west). This is shown in C so as not to confuse B.

The radiation to the right is analyzed in a similar manner. In this case the reflector field (V_{1R}) due to antenna 1 is 180° out of phase with the field that produces it (V_1). The field due to antenna 2 is 180° out of phase, with an additional retardation of 65° , the time the energy takes to travel from antenna 2 to the reflector and back again. The resulting field to the right (or east) is V_E .

The resulting pattern for the case in point indicates that the smaller lobe of the non-symmetrical figure-of-eight is in the direction of the reflector.

Figure 15 illustrates various field combinations for various locations of the reflector.

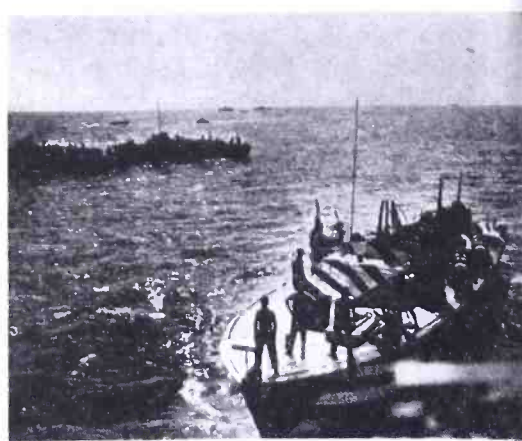

U. S. Navy Photo

RADIO ANTENNAS

Developed and manufactured by Premax in standard and special designs, are proving themselves every day on land and sea.

For the important task of maintaining communications under most adverse conditions, Premax Antennas are outstanding.

Send for details of standard models.

Premax Products

Division Chisholm-Ryder Co., Inc.
4401 Highland Avenue, Niagara Falls, N. Y.

PRESS WIRELESS, INC.

Has several openings for radio communication engineers and technicians with research or manufacturing experience.

APPLY PERSONNEL DIVISION

230 W. 41st Street
NEW YORK, N. Y.

or

435 N. Michigan Avenue
CHICAGO, ILLINOIS



AF COMMUNICATIONS

(Continued from page 26)

s, both giving push-button selection of four channels. One works on the v-f band and the other is a v-h-f job used to all fighters and close-support aircraft.

This fighter set, model TR1143, has a compact box-like chassis consisting of four sections which plug together. These sections include the receiver, transmitter, audio amplifier and channel-selector mechanism. It weighs 15 pounds and is both easy to install and service.

Tubes are the familiar 6 volt, 3 ampere octal-based types. Their sequence in the receiver is . . . radio frequency amplifier, crystal-controlled oscillator working in the 6-mc band, 10 times multiplier, cathode-injection mixer, three intermediate frequency stages operating at about 9 mc, and a double-diode-triode for demodulation, automatic volume control, and first low frequency amplification.

The transmitter uses a 6-mc crystal-controlled oscillator followed by two push-pull stages and a doubler stage. A push-pull power amplifier stage gives 10 watts r-f output.

The amplifier-modulator unit contains a low frequency output pentode and a push-pull modulator circuit for the transmitter. An impulse-type motor is employed in the push-button channel selector mechanism.

Power is drawn from a rotary converter run from the *floating* aircraft battery. Heater current as well as plate and bias supplies are taken from separate generators. Ample filtering systems are provided.

With this transmitter the range is 100 miles from 10,000 feet, but greater distances are covered, particularly from higher altitudes. The range is *optical* and rests very largely on the location of the aerial and the height of the aircraft.

Royal Air Force sets are built to withstand temperatures between -30° and $+60^{\circ}$ C and are tested in low pressure chambers and in heavy atmospheric humidity. They are proof against dust and sand.

With light weight they combine strength and reliability. In one month of 1943, code transmitting unit failures

Britain's Bomber Command were less than .1 per cent of sorties flown.

PAPER IS VICTORY POWER! CONSERVE IT. DON'T WASTE IT!

SMALL and MEDIUM TRANSFORMERS for QUICK delivery

If you have the proper priority rating, Consolidated Radio can now make deliveries in a few weeks instead of many months!

Consolidated Radio Products Company has recently greatly expanded its production facilities on a wide range of small and medium transformers including Pulse Transformers, Solenoid Coils, Search Coils. Other products include Range Filters, Headsets.

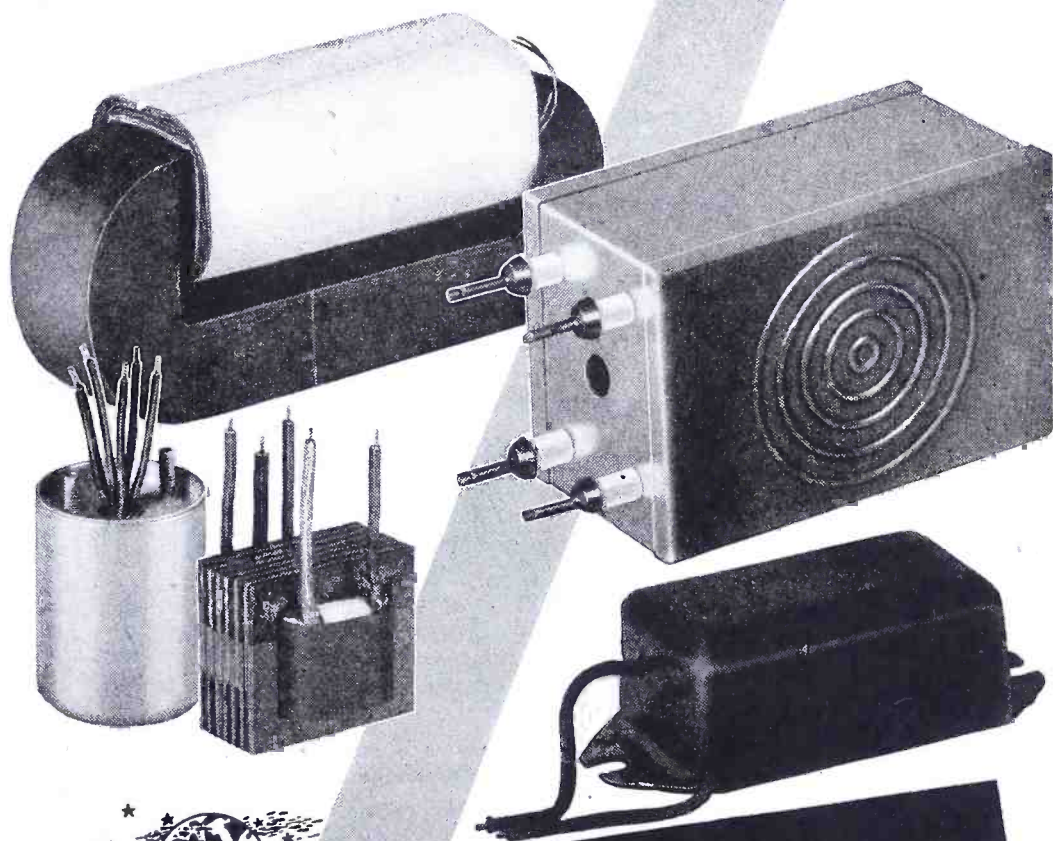

Electronic and Magnetic Devices
CONSOLIDATED RADIO
Products Company
350 W. ERIE ST., CHICAGO, ILL.

ICA

GET THIS NEW CATALOG NOW!

Stepped-up PRODUCTION OF RADIO-ELECTRONIC PRODUCTS!

As reflected in our new 48-page Catalog, the expanded Insuline plant is producing an enlarged line of high-quality Radio, Sound, and Electronic Products. These include:—

- Metal Cabinets, Chassis, Panels •
- Plugs and Jacks • Clips • Tools •
- Metal Stampings • Screw-Machine Products • Antennas • Hardware and Essentials.

Send specifications for estimates. Write for your copy of our Catalog—now!

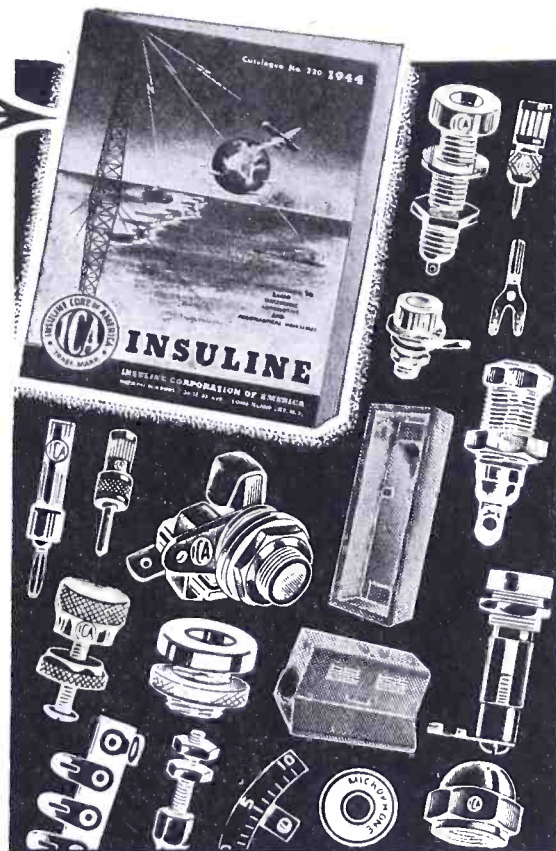
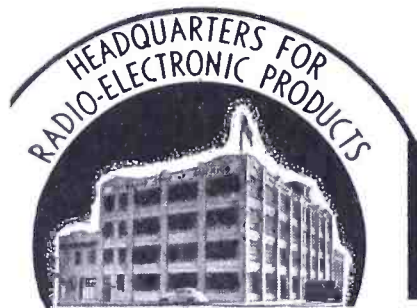

INSULINE

CORPORATION OF AMERICA

INSULINE BUILDING • LONG ISLAND CITY, N.Y.

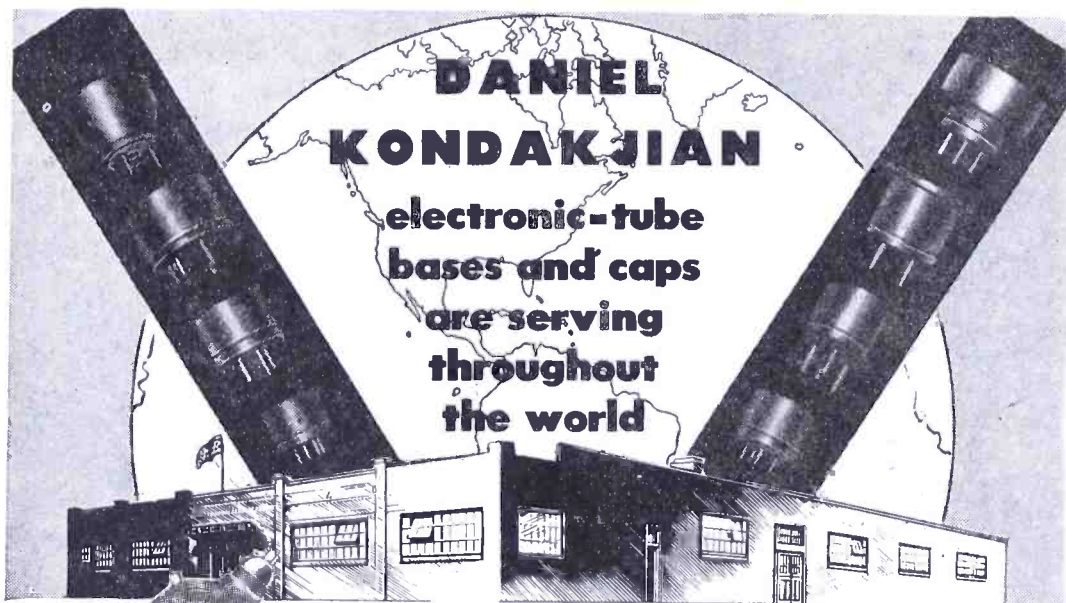

DANIEL KONDAKJIAN
 electronic-tube
 bases and caps
 are serving
 throughout
 the world

...designed to bring Victory closer now.. and better, more healthful living tomorrow!

The wonders of electronics are slowly being unfolded—guns accurately aimed through cloud banks and darkness of night, continuous indication of aircraft's position relative to the earth's surface, making visible U-boats far down in the ocean's depths—these are a few of the strides as applicable to a military world. But tomorrow . . . even the most hopeful guess will probably be surpassed in the

progress to come in the post-war era. The field is limitless.

DANIEL KONDAKJIAN electronic components will assume an important role in tomorrow's world, too. Engineers and manufacturers with projects or problems pertinent to future plannings, and suitable to our capabilities, are invited to send inquiries. Our complete collaboration, in strictest confidence, is assured; write today.

THE ENGINEERING CO., 27 WRIGHT ST., NEWARK, N. J.

TUNGSTEN LEADS DANIEL KONDAKJIAN BASES AND CAPS

BOOK TALK . . .

RADIO MATERIEL GUIDE

By Lieut. Francis E. Almstead, USNR U.S. Naval Training School, Norotor Heights, Connecticut, and Comdr. F. R. L. Tuthill, USNR, Eastern Sea Frontier Command . . . 242 pp. . . New York: McGraw-Hill Book Company, Inc. . . . \$2.00.

A condensation of fundamentals so effective in rapid training techniques serves as the basis of this compact volume. The treatment and data presented closely parallels that offered in the courses of study of Army and Navy radio schools.

The text opens with a review of mathematics needed in elementary radio, such as frequency determination impedance, power factor, etc. Other chapters cover the nature and control of electrical energy, measuring instruments, sonic wave behavior, circuits and their calculation, radio parts and their care. More than one-hundred and fifty illustrations accompany the text.

The book is recommended as a reference manual for practicing radio operators, as well as prospective operators and men preparing for the armed services.—J. M. L.

• • •

MAINTENANCE AND SERVICING OF ELECTRICAL INSTRUMENTS

By James Spencer, Director, Instrument and Relay Department, Meter Division, Westinghouse Electric & Manufacturing Company, Newark, New Jersey; Edited by Major M. F. Behar, Editor, Instruments . . . 256 pp. . . Pittsburgh, Pennsylvania: Instruments Publishing Company . . . \$2.00.

The material contained in this study is a reprint of a serial published in *Instruments* in 1941, and was originally developed from class notes which the author used in teaching the subject to trade schools and to new personnel of an instrument manufacturer.

Chapters list general type of instruments in common use, with simple explanations of their principle of operation and detailed instructions on maintenance and repair. The repair of parts and the making of new parts is not dealt with, except for a chapter on pivot and bearing troubles.

Covered are direct-current instruments, a-c ammeters and voltmeters a-c wattmeters, frequency meters, instrument transformers, synchroscopes power factor and rva meters, reactive

factor meters, and others, with 274 charts, diagrams and photographs.—
O. R.

• • •

THE RADIO AMATEUR'S HANDBOOK

By The Headquarters Staff of the American Radio Relay League . . . 664 pages . . . West Hartford, Connecticut: The American Radio Relay League, Inc. . . . \$1.00 (paper cover).

In this 1944 edition appears an expansion and revision of the chapters on fundamental principles and design.

The construction and data section of the book closely follows the pattern of recent editions, except for the addition of a chapter on Carrier-Current Communication. The War Emergency Radio Service chapter has been completely rewritten and considerably expanded.

Also revised are the classified vacuum-tube tables, which this year include some fifty new tubes. A supplementary cross-index of tubes by type numbers has been added.—
J. M. L.

• • •

MATHEMATICS OF RADIO COMMUNICATIONS

By T. J. Wang, Ph.D., Instructor in Electrical Engineering, Ohio State University . . . 371 pp. . . . New York: D. Van Nostrand Company, Inc. . . . \$3.00.

For the student or engineer who wishes to study communications, but cannot devote the time necessary to the study of all the associated mathematics, this book will prove quite useful. Only those parts of algebra, trigonometry, calculus, etc., necessary for understanding fundamental electric and radio theory are stressed.

There are 15 chapters covering laboratory work with graphical representations and practical computations, elementary direct current theory and circuits, and elementary alternating current theory and circuits.

The mathematical coverage includes simple equations, algebra, quadratic and simultaneous equations, exponents, square root, trigonometry, radian measure of angles, vectors and vector forms, logarithms, differential and integral calculus and Fourier series.

While intended primarily for students, this book is an excellent review for the radio engineer who wants to brush up on his mathematics.

Answers to the exercises are not included, but the chapters contain numerous examples of mathematical operations for the branches covered.—
A. M.

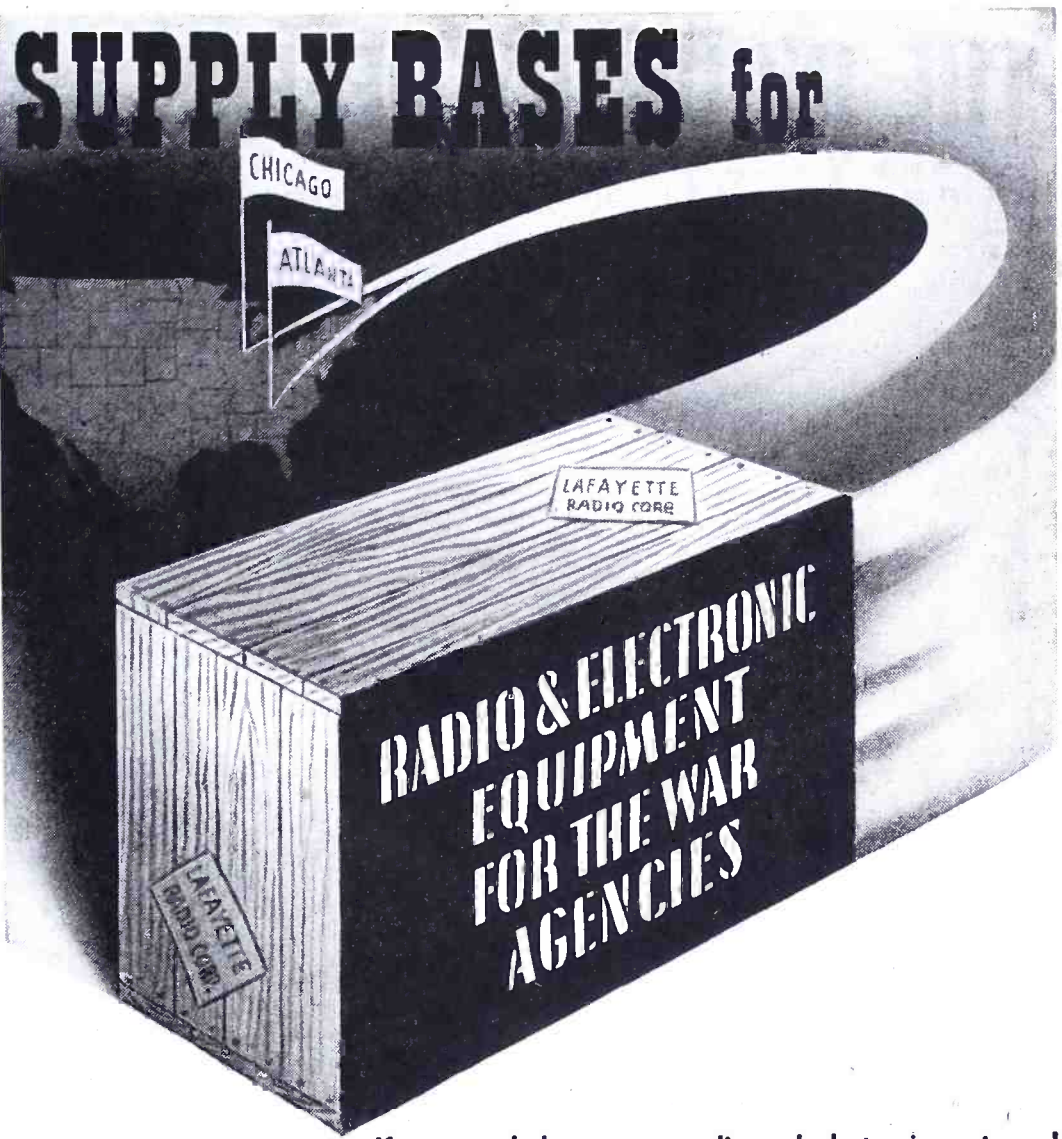

If you need the newest radio and electronic parts and equipment, etc., your requirements can be adequately met by Lafayette Radio Corporation. Our "supply bases" in Chicago and Atlanta are on 24-hour call. We make every effort to provide same-day service. A separate super-speed division is devoted to wartime industry and the Armed Forces. One of our most desirable specialties is the procurement of equipment for laboratory and experimental projects.

For non-critical consumer applications, Lafayette Radio Corporation carries a supply of all standard radio replacement parts plus a wide variety of useful parts and equipment.

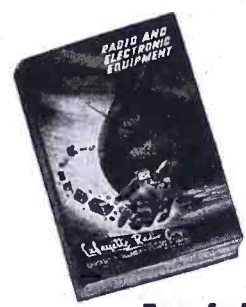

Free! AMERICA'S NO. 1 CATALOG RADIO AND ELECTRONIC COMPONENTS AND EQUIPMENT.

Recently published. A powerful volume, filled from cover-to-cover with listings and descriptions of thousands of needed items . . . plus valuable information concerning delivery and priority problems. MAIL COUPON TODAY!

LAFAYETTE RADIO CORP.
901 W. Jackson Blvd., Chicago 7, Ill., Dept. R-3
Please send me a free copy of the new Lafayette Radio Corporation Catalog No. 94.

NAME _____
ADDRESS _____
CITY _____ STATE _____

YOUR BLOOD IS NEEDED ON THE BATTLEFIELD . . . GIVE TODAY!

Lafayette Radio Corp.

901 W. Jackson Blvd., Chicago 7, Illinois ★ 265 Peachtree Street, Atlanta 3, Georgia

THE INDUSTRY OFFERS

G. E. FLUXMETER

A light-beam instrument, the fluxmeter, for measuring either flux density or the total magnetic flux in magnetic circuits has been announced by G. E.

The instrument, applicable wherever permanent magnets or d-c electromagnets are used, is similar to a light-beam galvanometer and has a suspension-type element. Different sensitivities are available by utilizing galvanometers of various characteristics. These galvanometers are interchangeable. The instrument has a scale of 50-0-250 millimeters.

The control box, which contains a dry cell, resistors, rheostat, push button, and a switch, provides a means of introducing a voltage into the electric circuit to compensate for small but undesirable spurious voltages that may otherwise cause errors in high-sensitivity instruments of this type. The control box provides a means of returning the spotlight index to the zero position after a measurement has been made.

A direct current, moving-coil galvanometer of the compensated type is used. In this design, the restoring torque of the suspension is, for all practical purposes, eliminated. After a flux change has been indicated, the light beam index remains at the point, giving ample time for accurate readings.



IDEAL COMBINATION ETCHER AND DEMAGNETIZER

A new tool that is ready for instant use as either an etcher or demagnetizer has been announced by The Ideal Commutator Dresser Company, 4025 Park Avenue, Sycamore, Illinois.

Fourteen heats are provided: lo-90, 150, 200, 250, 350, 450, 600; hi-300, 400, 500, 650, 850, 1100, 1350 watts. This wide range is useful for marking all iron, steel and their alloys from small delicate parts up to large smooth castings.

Overall dimensions are 8 1/4" x 11 1/2" x 8 5/8". Size of work-plate, 8 3/4" x 7 3/4". Includes 5' primary cord and plug, heat-resisting etching tool with 5' lead, extra point, ground clamp and 4' lead. Weight, 39 lbs.

OXFORD-TARTAK CABLE CLAMP

A compression type cable clamp, O-T, has been announced by Oxford-Tartak Radio Corporation, 3911 South Michigan Avenue, Chicago 15, Illinois.



EBY MINIATURE TUBE SOCKETS

A miniature tube socket with micro-processed beryllium copper silver-plated contacts has been developed by Hugh H. Eby, Inc., 18 West Chelton Avenue, Philadelphia 44, Pa.

The socket is available in two types. One is a low loss type with Navy grade G steatite casting, having loss factor of .016 or less when tested in accordance with ASTM D 150-42T. Its capacity is said to be 1.5 mmfd or less at 10 mc. The second type is a general purpose unit with mica filled plastic casting having a loss factor of .05 or less when tested in accordance with ASTM D 150-42T. Its capacity is said to be 5 mmfd or less at 10 mc.

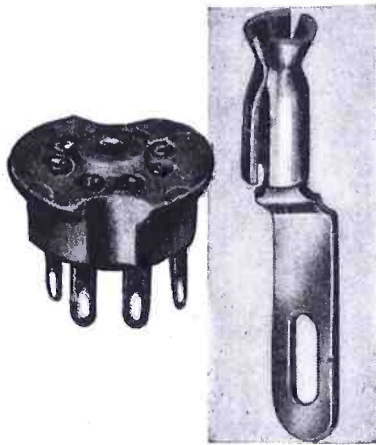

G-M LAB SENSITIVE POWER RELAYS

Relays for circuits requiring small multi-pole relays have been developed by G-M Laboratories. Known as the type 27 sensitive relays, they are available in 1, 2, and 3-pole sizes, approximately 1 3/8" x 1 11/16" x 2" high. Five-pole relays are also available. These are approximately 2" x 2 1/2" x 2 1/8" high. Weight, 4 1/2 to 6 1/2 ounces; vibration and acceleration: 10 g.; contact capacity, up to 10 amperes, depending on available power and on coil and circuit characteristics; contact pressure, 30 to 50 grams; temperature, humidity, elevation and salt spray test to usual aircraft specifications.

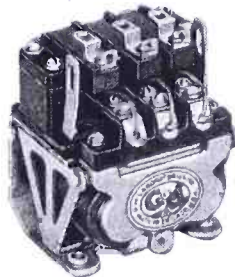

KIRKLAND RECESSED-LAMP INDICATING LIGHT

A pilot light for either panel or switchplate mounting with a recessed bulb has been developed by the H. R. Kirkland Company, Morristown, N. J.

According to the manufacturers, this unit, S11, provides such exterior ventilation to the lamp bulb that a much greater lamp-life is to be expected. It is available in all colors.



INTERELECTRODE CAPACITY INSTRUMENT

A meter that provides measurement of vacuum tube interelectrode capacities on a production basis has been announced by the Technical Apparatus Company, 1171 Tremont Street, Boston 20, Massachusetts. The instrument identified as model 37 interelectrode capacity meter has a range from .001 to 100.0 mmfd. Accuracy is said to be 5% or better on all the five steps in which this range is provided. On the lowest range, increments as low as .00001 mmfd may be used. Measurement is made at radio frequency in a crystal-controlled circuit having both primary and secondary voltages automatically regulated for maximum operating stability.

The connector base accepts adapters for tubes up to 8-pin and provides for connection of coaxial cables to any pair of elements whose capacity is to be measured. A universal shield is furnished with the instrument to accommodate tubes up to 2 5/8" in diameter and 4 1/4" high; standard RMA shields, as specified for various tube types, may also be used. Special shields for various tube types can be supplied when required.

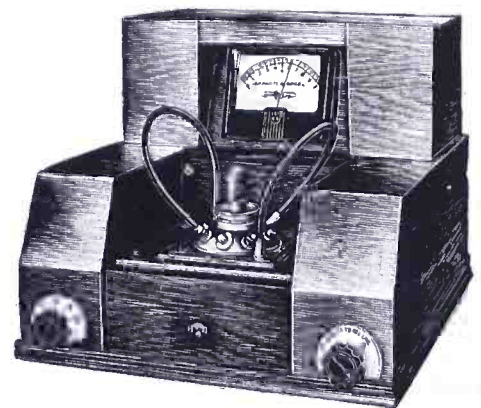

FAIRCHILD AMPLIFIERS AND RECORDERS

A portable recorder and a portable amplifier-equalizer are now being produced by the Fairchild Camera and Instrument Corporation, 88-06 Van Wyck Boulevard, Jamaica 1, N. Y. The unit now in production has a new magnetic cutter head replacing the old crystal cutter head; a low-pressure pickup with a choice of crystal or dynamic type; and the weight of the machine has been lightened to 70 pounds.

According to George Rattray, assistant vice president in charge of engineering, and Theodore Lindenberg, sound equipment project engineer, the general vibration level of the recorder has been reduced by 5 to 8 decibels.

The recorder is designed for portable field service, for lateral recording and use of 78 rpm or 33.3 rpm discs up to 16".

The recorder mechanism has a selection of four cutting pitches; either from the inside of the record to the outside or from the outside in, without the necessity of changing feed screws. The turntable speed is changed from 78 rpm to 33.3 rpm by shifting a push rod on the center pivot of the turntable. For operation on a 115 volt/60 cycle power line. Power consumption, 70 watts.

On the recording head carriage mechanism an octagonal scale reading in minutes is mounted directly back of the carriage mechanism. This scale is calibrated to meet all sixteen conditions of pitch, direction and speed by simply rotating the scale until the calibration that matches the conditions of the recording appears on top. In addition, this scale shows the minutes of recording completed.

(Continued on page 80)

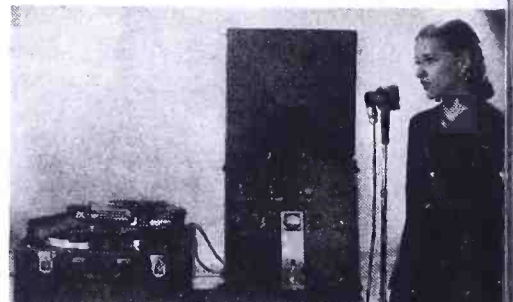

"R-9" Quartz Crystals

for
Frequency Control
and
Special Applications

are

Accurate, and Dependable

We are equipped to handle any type or size order. May we quote you on your future requirements? Immediate delivery.

R9 Crystal Company, Inc.

907-909 Penn Ave.

Pittsburgh, Penna.

RADIO AND ELECTRONIC DEVICES



BURSTEIN-APPLEBEE CO.

1012-1014 McGee St. Kansas City, Missouri

SPECIAL SOLDERING FLUXES

- FAST ACTING
- EASY-TO-USE
- NO HARMFUL FUMES

Manufactured to government specifications, Rubyfluid products are economical and efficient. Try Rubyfluid Liquid or Paste Flux for general use and Ruby's Stainless Steel Flux for that metal. Ask your jobber or write direct to—

RUBY CHEMICAL CO.

65 McDOWELL ST. COLUMBUS, OHIO

Rubyfluid



STUDY

the Rolling Spring

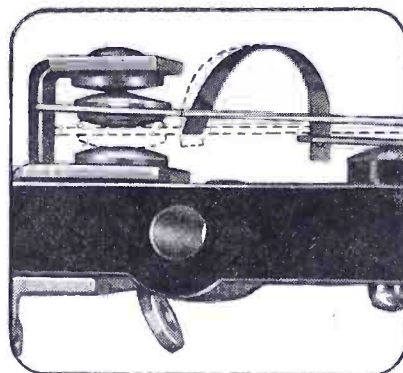

Acro-Snap

Acro-Snap

THE GREATEST THING IN SNAP ACTION SWITCHES

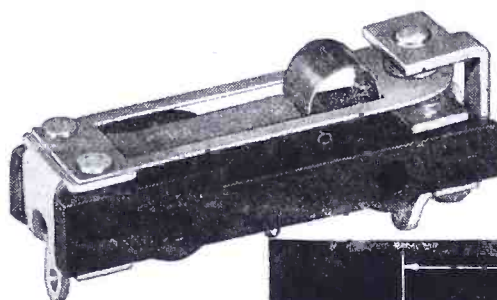

Midget Switch illustrated one-fourth larger than actual size.

• The rapidly rising preference for ACRO-SNAP SWITCHES is due to the rolling

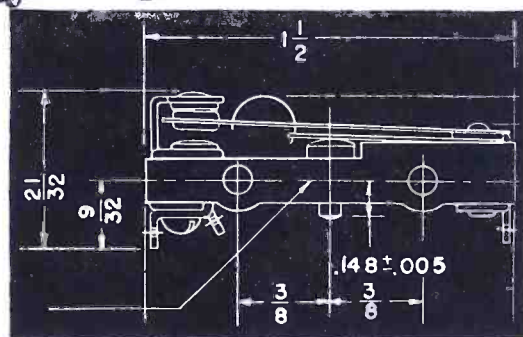

spring principle of actuation. Two beryllium springs are locked together in a manner which compels one spring to "Trigger" the other. The contact break is more nearly instantaneous than with a conventional type snap-action switch. Friction is eliminated, and firmer contact pressure maintained. When built into relays, smaller coils may be used as less operating pressure is required. ACRO SWITCHES have been approved by the U. S. Army Air Forces after Winterization tests and adopted by both prime, and sub-contractors on all types of war equipment.

Write for special bulletin on Model G Midget.

ACRO ELECTRIC COMPANY

1319 SUPERIOR AVENUE, CLEVELAND 14, OHIO

NEW YORK, CHICAGO, BUFFALO, DETROIT, DALLAS, OMAHA, ST. PAUL, KANSAS CITY, MEMPHIS, TAMPA, BALTIMORE, NEW ORLEANS, PHEONIX, LOS ANGELES, DAYTON, TORONTO, CANADA.

COMMUNICATIONS FOR MARCH 1944 • 79

THE INDUSTRY OFFERS . . . —

(Continued from page 78)

and the minutes of blank disc remaining to be recorded.

Pitches of 98, 141, and 161 lines per inch are selected by snapping into place any one of four standard spur gears supplied.

The 33.3 rpm speed is obtained by a 54 to 1 gear and worm reduction of the 1800 rpm synchronous motor speed.

The 78 rpm speed is secured from a friction step-up device from 33.3 to 78 rpm. This consists of a group of balls riding between two conical shaped races held together under spring pressure. The speed shift pin, when in the up position, interposes this step-up mechanism between the 33.3 drive and the turntable, driving the turntable at 78 rpm.

The portable recorder is equipped with 110-125 volt, 60 cycle synchronous motor which is dynamically balanced and selected for quiet operation.

The equalization element of the amplifier-equalizer is provided to permit a boost of the extremes to compensate for falling off of high or low frequencies. At any frequency from 20 to 100 cycles, a boost of from 0 to 20 db is said to be available; and at any frequency from 4,000 to 10,000 cycles, the manufacturer states that 0 to 20 db may be added. There is a negligible interaction between the controls and they can be pre-set at any time to provide known amounts of equalization for any particular purpose.

This unit is provided with receptacles for instantaneous hookup on the rear of the chassis for the accommodation of amphenol input plugs for a microphone of 50 or 250 ohms impedance, two crystal pickups of 10,000 ohms impedance and both a **T** unbalanced and an **H** balanced 500-ohm impedance for radio tuner or line from an external mixer. Outputs are connections provided for two portable recorders as well as for a **T** unbalanced and an **H** balanced 500-ohm output line.

The amplifier, speaker and control panel are mounted in a metal trunk with an overall width of 17" and height of 18 1/4". The greatest depth is 11".

There are 11 tubes in the circuit: 2-1620's, 1-6J7, 4-6J5's, 2-6L6G's, 1-6H6, and 1-5U4G.

Maximum undistorted output is said to be 12.51 watts from the 500-ohm winding of the **T** or **H** position on the output. The noise level below zero level of .006 watts at full gain of amplifier with bass and high controls off is said to be minus 22 decibels, and the hum level is said to be minus 40 decibels. The microphone input positions are said to have a gain of 107 decibels. Both pickup positions are said to have a gain of 61 decibels, and both line input positions a gain of 67 db.

If the dynamic pickups are used, the pickup inputs will be wired for 50-ohm impedance at 170 db gain.

The master gain control is provided with a logarithmic taper.

A phone monitor jack is provided on the panel so signals may be monitored with headphones instead of the loud speaker. This jack is a separate 8-ohm output winding.

BERYLLIUM COPPER SPRING GRADE WIRE

A spring grade beryllium copper wire with a new type of silver coating is now being produced by Little Falls Alloys, Inc., 189 Caldwell Ave., Paterson, New Jersey. Wire is available in sizes .064" to .007". This wire, known as Silvercote, is said to have a guaranteed minimum tensile strength of 185,000 pounds after hardening.

SHEFFIELD TORSIOMETER

An instrument that measures the torsion of small spiral springs has been produced by the Sheffield Corporation, Dayton, Ohio, as a result of collaboration with the Gruen Watch Company and the Manross Division of the Associated Spring Corporation. A direct reading of the torsion measurement of the spring being checked can be made in millimeter grams on a graduated Manross scale. This permits the identifying and classifying of springs as to torsion before assembling in instruments.

The torsionmeter will accommodate springs up to 2 7/8" in diameter with a maximum torsion measurement of 49.5 millimeter grams.

In operation, the inner end of the spiral spring to be checked is attached to the center post. The outer end is grasped by the suspended tweezers. The outer marker is set at 120 on the scale which represents the zero point. The dial is then turned one complete revolution. The point at which the indicator

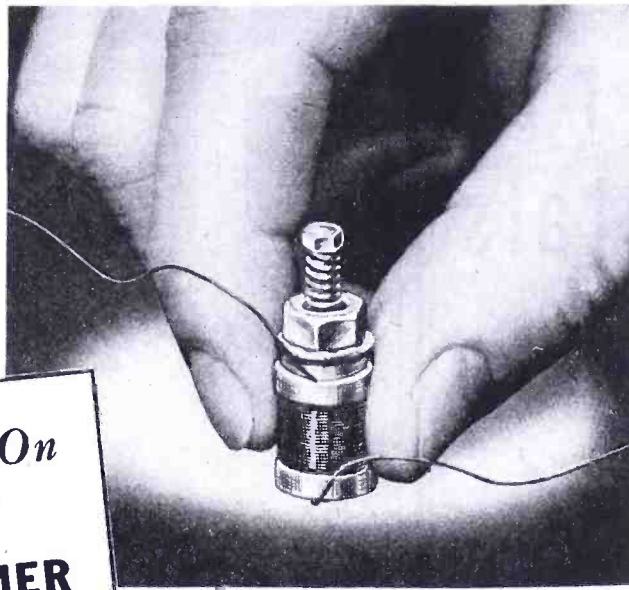

The LS-1 shown above is actual size.

Get The Story On
This
I-F TRANSFORMER

It may prove mighty useful to you. This small, precision built, permeability-tuned I-F Transformer was developed, proved and is being used with outstanding success on a variety of vital war applications. Now available for more general use, it may be just what the doctor ordered for some of your present or projected components. Better have the complete facts on this simple precise transformer readily available. Ask us about the LS-1 transformer.

CAMBRIDGE Thermionic CORPORATION

445 Concord Avenue

Cambridge 38, Massachusetts

CABINETS
PANELS

CHASSIS
RACKS

Skill in *Metal*

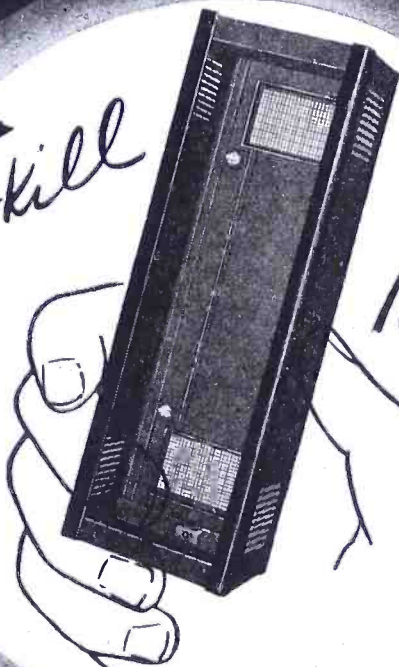

Serving the
Electronics
Field
Exclusively

Write for
Catalogue
No. 41-A

Though manufactured by modern high-speed methods, Par-Metal products have a definite quality of craftsmanship — that "hand-made" quality which is born of years of specialization.

PAR-METAL PRODUCTS CORPORATION

32-62—49th STREET . . . LONG ISLAND CITY, N. Y.

Export Dept. 100 Varick St., N. Y. C.

rests on the scale represents the torsion classification of the spring.

The indicator spindle rides on a jewel bearing and has a resistance of nearly zero. The pointer is made of non-magnetic material and the pointer assembly is statically balanced.

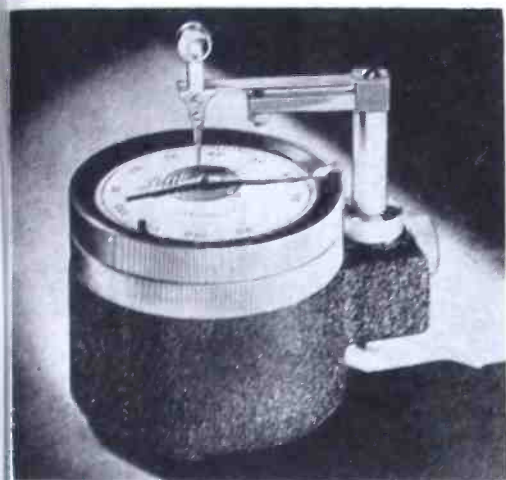

ALLIED CONTROL DUAL-COIL RELAY

A dual-coil power relay with a semibalanced armature has been developed by the Allied Control Company, Inc., 2 East End Avenue, New York City 21, N. Y.

The double coil construction is said to make this type of unit suitable for use in plate circuit applications where the limited amount of current is insufficient to operate a single coil power relay directly.

The two coils of the relay, known as BOY, may be connected in series for operation at one voltage and in parallel for a second voltage; or one coil can be used for operation while the other is used for holding. The coils are cellulose acetate sealed.

Dimensions are 1 5/8" x 1 7/8" x 1 1/2"; weight, five ounces.

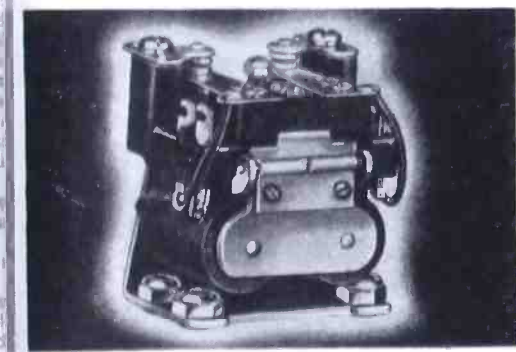

REINER 5" OSCILLOSCOPE

A 5" oscilloscope, model 550-A, for square wave analysis has been produced by Reiner Electronics Company, 152 West 25th St., New York 1, N. Y. The instrument is said to afford reproduction of square-wave signals from 40 cycles per second to 50 kc per second. A vertical amplifier has a sine wave frequency response of 500 kc per second, ± 1 db. The voltage gain is said to be 625.

The oscilloscope is equipped with a detachable coaxial cable with input capacity of 8 mmfd. A compensated 4-step attenuator permits observation of voltages up to 175 volts, with a variable gain control on the second stage providing continuous variation of gain.

CML VOLTAGE REGULATED SUPPLIES

Two power supplies, model 1100 table model and model 1110 rack mounting, using the series regulator circuit, have been announced by the Communication Measurements Laboratory, 116 Greenwich Street, N. Y. City, N. Y.

Two stage control circuit is used. The high voltage output can be shifted through a range of 225 to 325 volts by means of a potentiometer control on the front panel. The maximum current drain is 200 milliamperes from 225 to 300 volts and 180 milliamperes from 300 to 325 volts. Under these conditions the sum of all a-c components present in the output is said to be less than 5 millivolts. The change in voltage output from no load to

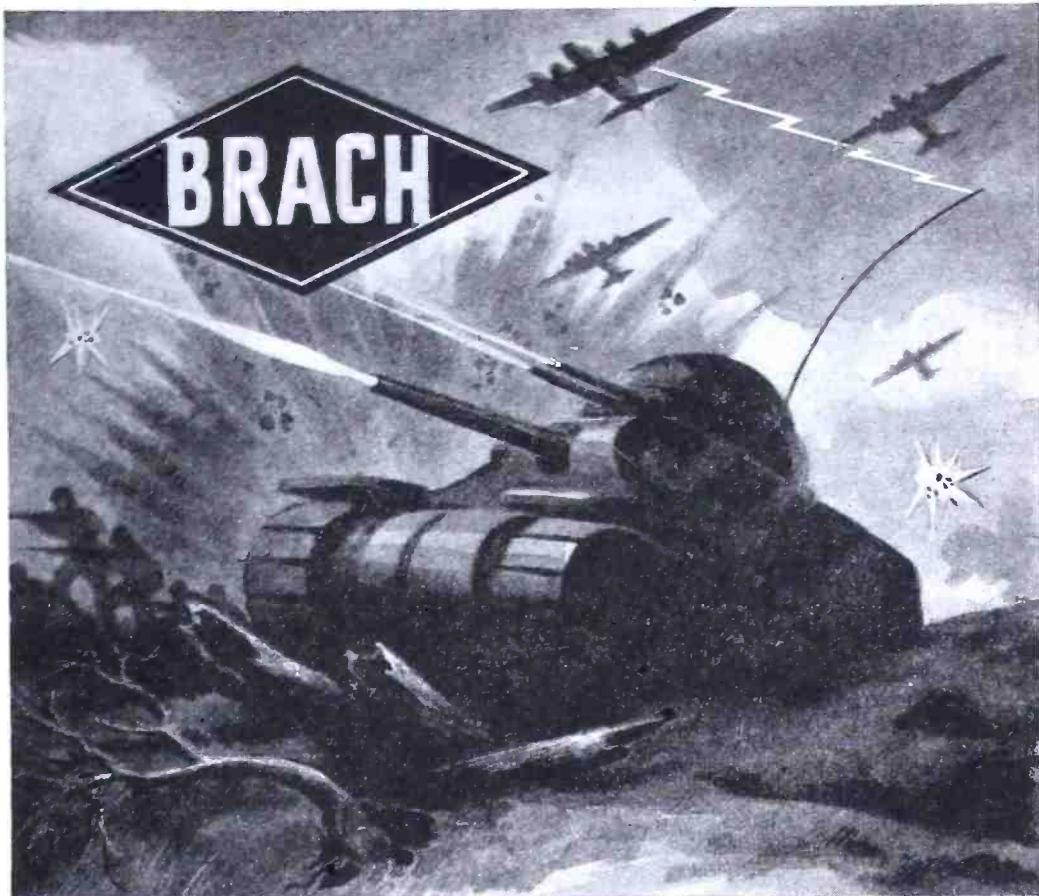

BRACH Radio Antennas

... in war Today ... as in peace Tomorrow
DEPENDABLE PERFORMANCE - - Always

BRACH Antennas and other radio and electrical products are rendering a distinguished service on fighting fronts everywhere. But when the war is over, they'll be back where they belong ... in your store, making sales.

L. S. BRACH MFG. CORP.

World's Oldest and Largest Manufacturers of Radio Antennas and Accessories
55-65 DICKERSON STREET • NEWARK N. J.

full load is said to be less than one volt.

The primary of the power transformer is tapped for use at 105, 115 and 125 volts on a 50-60 cycle source. An unregulated heater supply winding of 6.3 volts at 5 amperes is furnished.

ALLIANCE AIRCRAFT D-C MOTOR

An aircraft type d-c series motor is now being produced by the Alliance Mfg. Company, Lake Park Blvd., Alliance, Ohio.

Primarily designed to operate blowers for cooling purposes in aircraft equipment, the unit operates on a 28 volt d-c source at 0.75 ampere delivering a 1/80 h-p at 8000 rpm. Totally enclosed with ball bearing construction. Measures overall, less the 1/4" diameter shaft extension, 3" in length by 1 1/8" diameter. Weighs 17 ounces. Said to have low temperature rise permitting operation under high ambient temperatures.

Basic design can readily be modified to meet other volume applications with either shunt or series winding for desired voltage, current

drain and horsepower output up to 1/50 consistent with speed and duty cycle.

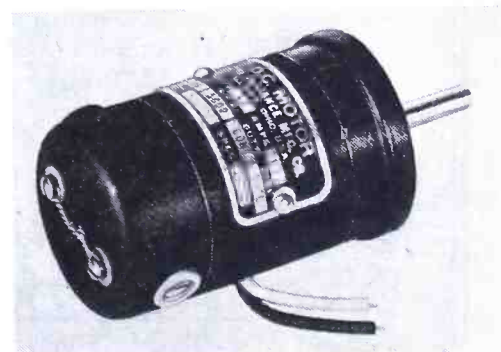

BRADLEY LAB C-O RECTIFIERS

A group of copper oxide rectifiers, coprox, has
(Continued on page 82)

FIRST AND LAST

THE FIRST WORD IN
CRYSTALS ...

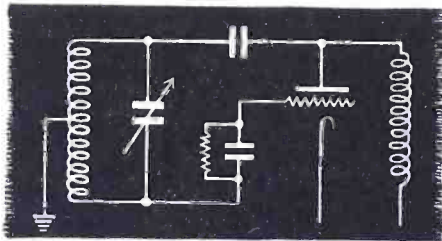

Remember This?

THE LAST WORD IN
CRYSTALS ...

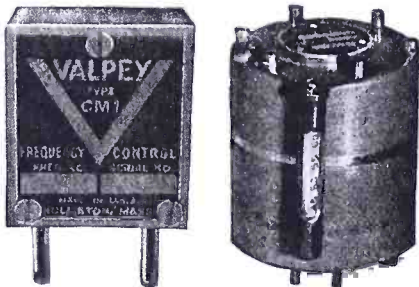

Do You Use These?

The first word in fundamental design — VALPEY
The last word in precision craftsmanship — VALPEY

We, Valpey, esteem it a privilege to devote our entire production to the service of our country in war.

We shall consider it an equal privilege to serve society in peace when we resume our place as the leader in our field of custom-made crystals for all frequency control applications, for mountings, temperature control ovens and all other expedient uses.

NEW XLS



Special low frequency unit developed primarily for use in vital war equipment.

For Information On
QUARTZ PRISMS, LENSES AND
SPECIAL OPTICAL PIECES



HOLLISTON, MASS.
"Craftsmanship in Crystals"

THE INDUSTRY OFFERS ...

(Continued from page 81)

been announced by Bradley Laboratories, Inc., 82 Meadow Street, New Haven 10, Conn. Features of the rectifiers are said to be gold contacts on the copper oxide pellets, and pre-soldered lead wires.

Among the types available is the BX-100, a center tap full-wave rectifier completely enclosed in bakelite. It has been designed for use in special circuits up to 8 megacycles. Another type produced, BX-22.5, is a single half-wave rectifier. A full wave, BX-22.2, and a double half-wave type, BX-22.4, are also produced.



BX-22.3



BX-100



BX-22.4

... ..

KELLOGG FIELD PHONE GENERATOR

A portable generator, GN-38-B, designed by the Kellogg Switchboard and Supply Company, Chicago, is now being used in the EE-8 portable field telephone of the Signal Corps.



... ..

TAB-TYPE WIRE MARKERS

A tab or apron type of electrical conductor identification marker for very fine or small diameter conductors, such as sizes smaller than No. 10, is now available from William Brand & Co., 276 Fourth Avenue, New York, N. Y.

... ..

PEERLESS TRANSFORMER

A hermetically sealed transformer, type S, has been developed by Peerless Electrical Products Co., 6920 McKinley Ave., Los Angeles 1, Calif. The new transformer is enclosed in a cold drawn copper cadmium plated steel case.

PLASTIC NAME PLATES

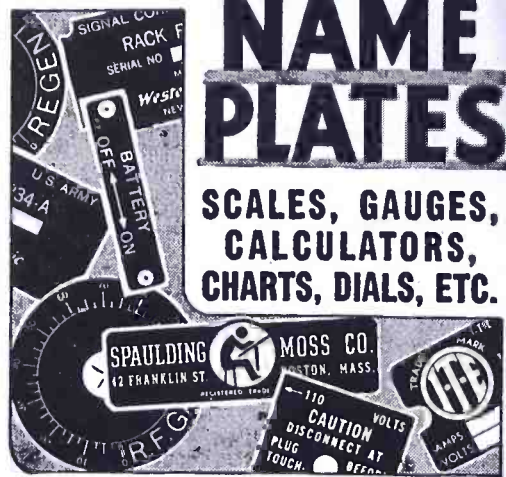

SCALES, GAUGES,
CALCULATORS,
CHARTS, DIALS, ETC.

- Impervious to moisture, grease, oils, acids, alkalis.
- Printing guaranteed not to wash or rub off.
- Non-inflammable, non-corrosive plastic.
- Printed and laminated vinylite and cellulose acetate.

SAMPLES AND ESTIMATES GLADLY SUPPLIED ON REQUEST
WRITE DEPARTMENT C.

THE HOPP PRESS, INC.
PRINTING — FABRICATING — FORMING
460 W. 34th STREET, N. Y. C.
ESTABLISHED 1893

Terminal is molded into a plastic block which has a metal flange molded into its periphery. This flange is then soldered into the case.

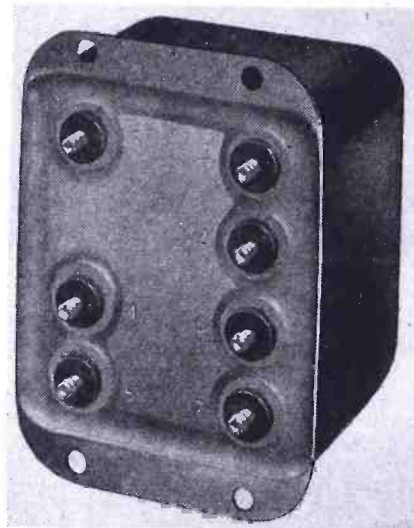

... ..

G. E. THYRATRON WELDING CONTROL

A thyatron welding control for low-capacity spot welders has been announced by the industrial control division of G. E. Coupled with a suitable welding transformer, this control can be used with either welding tongs or a small bench welder. It is said to be particularly suitable for the spot-welding of vacuum tube parts.

Other applications for which the control, in combination with the proper welding transformer, is desirable, include the welding of solid or stranded wires to terminals of copper, brass, bronze, steel, or ferrous alloys; joining two tinned-copper, steel, or alloy wires; and spot-welding thin pieces of various alloys.

... ..

RADIOTONE PLANT SOUND UNIT

A portable sound system with recording,

receiving, phonograph and p-a features has been produced by the Radiotone division of The Robinson Houchin Optical Company, 79 Thurman Avenue, Columbus, Ohio.



...

INDUSTRIAL SPECIALTY ELECTRON MICROSCOPE CAPACITOR

A .01-mfd, 40,000 volt, d-c capacitor has been built for use in a special application of the electron microscope by the Industrial Specialty Company, 1725 West North Avenue, Chicago 22, Illinois. This capacitor is said to be capable of continuous operation at 80°C.

The case is welded steel 4 11/16" x 5 3/4" x 7", with a stand-off insulator 8 1/2" high. This insulator is the Westinghouse solder seal type, soldered directly to the case.



...

KAAR VARIABLE CONDENSERS

A new line of variable condensers with capacities of from 12 to 140 mmfd are now being offered by Kaar Engineering Company, Palo Alto, California.

Condensers feature shafts slotted for screw-driver adjustment. Tapered lock nuts and split bushings are also used.

Special types with double rotors and stators, high maximum capacities, or special mounting brackets are also available.

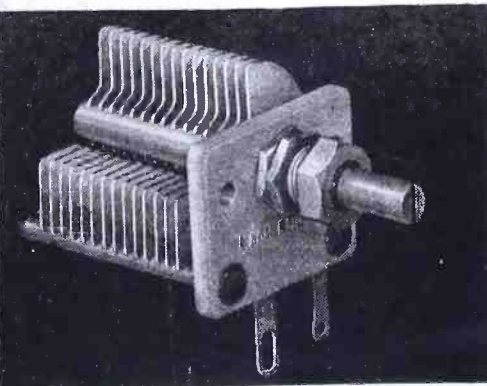

...

AERCO MULTI-GRIP CHUCK

A hydraulic multi-grip milling machine chuck has been announced by Aerco Corporation, Hollydale, California. The chuck has two rows of five collets. Both rows of parts may be milled simultaneously, according to the manu-
(Continued on page 84)

PROMPT DELIVERY

Interphone Equipment and Component Parts

JACK JK-48

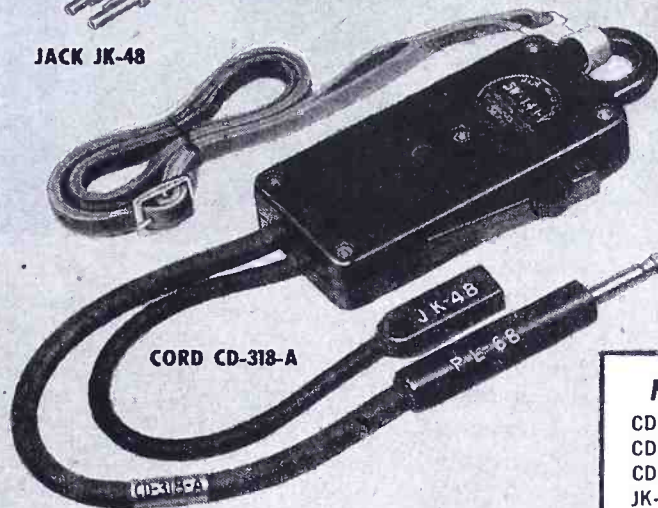

CORD CD-318-A

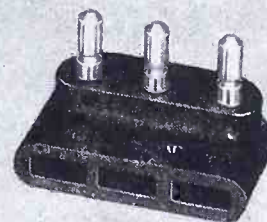

PLUG PL-58

NOW IN PRODUCTION

CD-318-A	JK-48	PL-68
CD-307-A	PL-47	"A" Plug
CD-874	PL-54	BC-366
JK-26	PL-55	BC-347-C
PE-86	SW-141	
JB-47	TD-3	



TRAVLER KARENOLA

RADIO AND TELEVISION CORPORATION
1038 W. VAN BUREN ST., CHICAGO 7, ILL.

Products of "MERIT" means Fine Radio Parts

... PARTS manufactured exactly to the most precise specifications.

Long manufacturers of component radio parts, MERIT entered the war program as a complete, co-ordinated manufacturing unit of skilled radio engineers, experienced precision workmen and skilled operators with the most modern equipment.

MERIT quickly established its ability to understand difficult requirements, quote intelligently and produce in quantity to the most exacting specifications.

Transformers—Coils—Reactors—Electrical Windings of All Types for the Radio and Radar Trade and other Electronic Applications.



Since 1924

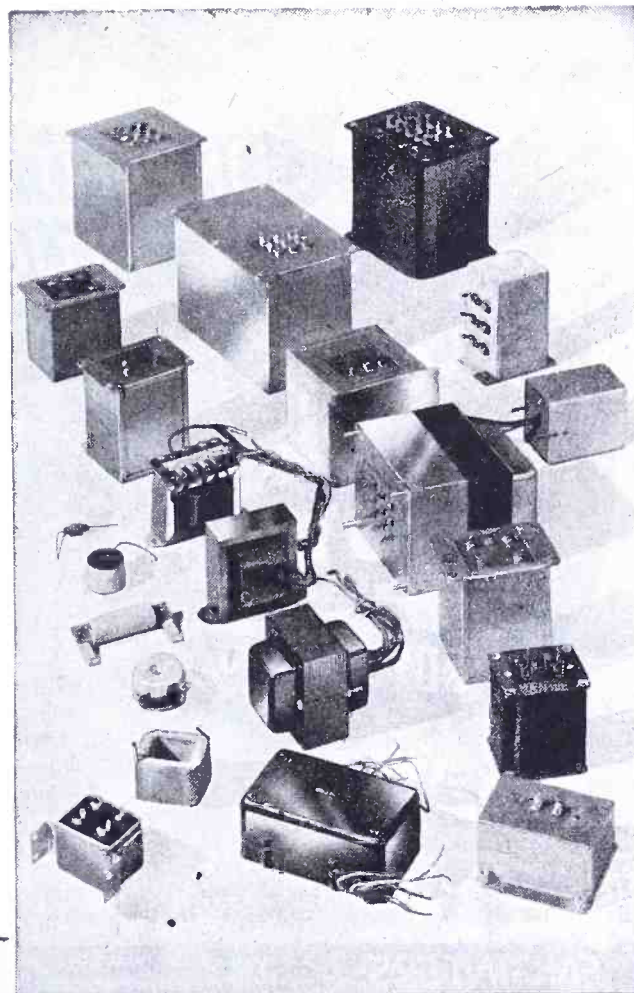

MERIT COIL & TRANSFORMER CORP.

311 North Desplaines St. CHICAGO 6, ILL.

X-RAYED!

TO INSURE PERFECT JOINT

Note elimination of junction boxes in right angle bends, designed and engineered by Andrew to meet exacting requirements of this special application.

Inner conductor is bent, not spliced. Outer conductor is mitered and silver soldered. X-ray insures no silver solder penetration into cable, eliminating danger of short circuit. Sealing and pressurizing transmission lines before plating prevents possible corrosion.

For your problems in radio antenna equipment, consult Andrew. The Andrew Co. is a pioneer in the manufacture and engineering of coaxial cables and accessories. Free catalog on request. Write today.

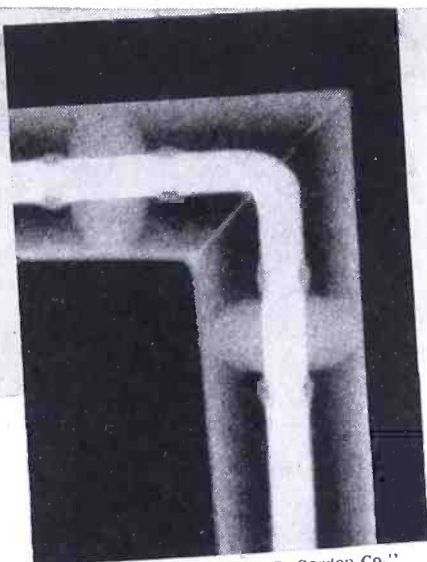

"Photo by G. A. Russ, Claud S. Gordon Co."

X-ray illustrates Andrew right angle coaxial cable assembly, part of a Fan Marker Beacon Transmitter made for CAA by Farnsworth Television and Radio Corporation. Pilots' lives depend on the 100% reliability of this equipment. Andrew is proud of the use of its coaxial cable in this installation.



363 EAST 75TH ST.,
CHICAGO 19, ILLINOIS

COAXIAL CABLES

THE INDUSTRY OFFERS . . .

(Continued from page 83)

facturer. A hydraulic hand pump supplies the necessary pressure for closing all collets simultaneously.

Self-centering aligning collets are said to insure perfect on-center milling. An automatic safety stop prevents damage to collets should all stations not be filled. The collets themselves operate on a double taper, one at each end. An adjustable depth stop is provided for each collet.

The new chuck comes in two models. The pump, valves, pressure gauge, depth gauge and collet assemblies are all incorporated in the main body of the chuck. Model 10-B measures 14 1/4" x 4 1/2" x 4 1/2" with a collet capacity of from 1/8" to 1/2". Model 10-E measures 21" x 6 3/4" x 6 3/4". Its collet capacity is from 1/2" to 1 1/4".

Round, square and hexagon collets are available for both chuck models.



VOLTAGE REGULATED POWER SUPPLY

A voltage regulated power unit, model 1218, supplying d-c loads up to 40 watts at 200 to 400 volts, with voltage variation of less than 1% from zero to full load, has been developed by the Technical Apparatus Company, 1171 Tremont Street, Boston 20, Massachusetts.

Current may be drawn up to 100 milliamperes at 400 volts and increasing to 200 milliamperes at 200 volts.

A built-in voltmeter and milliammeter permit direct reading of output delivered at a safety jack located on the front panel. A second output jack affording 4 amperes a-c at 6.3 volts (unregulated) is also provided. Both the d-c output and the a-c input are fused for protection against overload.

The power supply is housed in a ventilated steel cabinet 13" wide, 9" high, and 9" deep.



BARBER TUBE VOLTMETER

A wide range vacuum tube voltmeter with a h-f probe is being made by Alfred W. Barber Laboratories, 34-02 Francis Lewis Blvd., Flushing, N. Y. This probe is cone shaped with the high terminal in its nose. The probe is molded from low-loss material.

The voltmeter, model VM-27E, is said to measure voltages from 0.1 to 100 volts at d-c, a-c and r-f frequencies to over 100 megacycles.

PAPER PACKS A WAR PUNCH FIGHT WASTE!

CURRENT and VOLTAGE FLUCTUATION REDUCED

WITH

AMPERITE REGULATORS

Features:

1. Amperites cut battery voltage fluctuation from approximately 50% to 2%.
2. Hermetically sealed — not affected by altitude, ambient temperature, humidity.
3. Compact, light, and inexpensive.

Used by U.S. Army, Navy, and Air Corps.

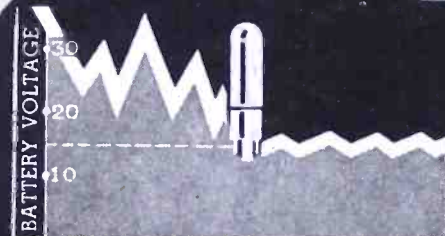

VOLTAGE OF 24V BATTERY & CHARGER VARIES APPROX

50%

WITH AMPERITE VOLTAGE VARIES ONLY

2%

DELAY RELAYS: For delays from 1 to 100 seconds. Hermetically sealed. Unaffected by altitude. . . . Send for catalogue sheet.

ENGINEERS: This 4-page folder will help you solve Current and Voltage Problems; contains much valuable data in practical form — Write for your copy now.

AMPERITE CO., 561 Broadway, New York (12), N. Y.
In Canada: Atlas Radio Corp., Ltd., 560 King St., W. Toronto



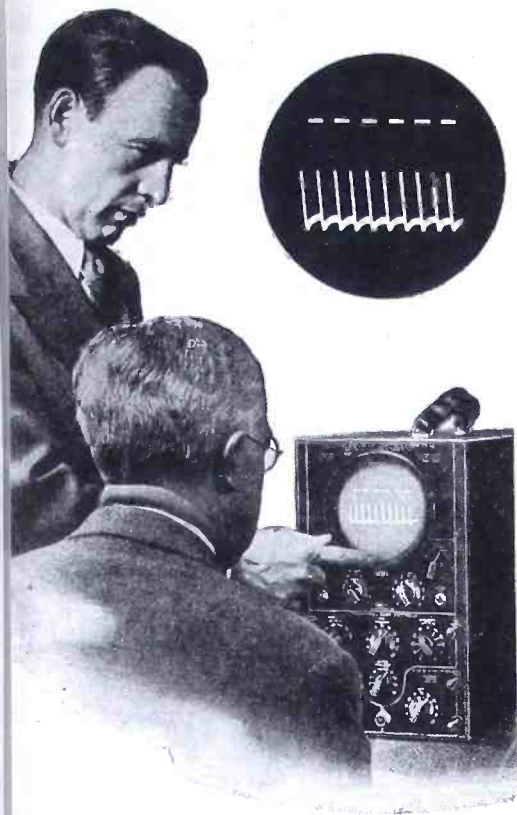

PUT IT IN

Electronic
WRITING...

Your report on electronic, radio, electrical and most technological functions should be put in *electronic writing* to save time, to be really explicit, to facilitate proper consideration and decision.

As an oscillogram vividly traced on the Du Mont cathode-ray tube screen, your presentation permits either a quick grasp of the situation, or a highly intricate study if the finer intricacies of the wave form receive due consideration. A photograph of the oscillogram provides a permanent record.

Yes, it pays to put such matters in *electronic writing* these days. More and more presentations, explanations, discussions, are being handled that way, with Du Mont oscillographs.

• Write for Literature . . .

DU MONT
ALLEN B. DU MONT LABORATORIES, INC.
Passaic, New Jersey

able Address: **Wespexlin, New York**

HIGHLIGHTS OF DR. ROTERS' AIEE PAPER ON D-C ELECTROMAGNET DESIGN CONSIDERATIONS

FOR an intelligent application of magnetic circuits to instruments, motors and control apparatus, a working knowledge of the fundamental properties of electromagnets is essential. Graphical solutions to magnetic design problems as a substitute for cut-and-try programs, or just plain guesswork were offered by Dr. Herbert C. Roters, Director of Research, Fairchild Aviation Corporation, in his paper.

The magnetization curve was presented to provide an analysis (useful flux in the operating air gap versus NI, the ampere-turns) for all the iron parts of the magnet and the air gap which is used to determine the optimum operating point.

In tractive magnets, the useful work done equals the *force* at the start of the stroke times the *stroke*. In designing a magnet it was shown that it is first necessary to calculate its index number which is $= \sqrt{F/S}$ where $F = \text{force}$ and $S = \text{stroke}$. It is then necessary to pick the general type of solenoid which operates most efficiently for that index number. A long, thin magnet called the *solenoid* and *plunger* type (or *leakage flux* type) has the lowest index number; hence is most suitable for long stroke and small force. A tapered plunger design comes next. A cone-faced plunger has an intermediate value. A flat-faced plunger magnet has a high index number, being suitable for developing high forces at short strokes, while a flat-faced armature type of lifting magnet has the highest force and smallest stroke. The common horseshoe magnet was shown to be impractical for any single job but, when large pole pieces are attached, it can provide satisfactory results for a wide range of operating points.

The following expression was presented in the discussion of force:

$$\text{Average force} = \frac{B^2 S}{2\mu} = \frac{B^2 r^2}{11.45} \text{ lbs. for}$$

$$\text{lifting magnet, and } \frac{B^2 r^2}{22.9} \text{ for the flat-}$$

faced plunger magnet, where

$r = \text{radius of core in inches}$

$B = \text{kilomaxwells per square inch}$

Particular attention was given to relays which are usually limited in

'till
VICTORY
and Beyond

You can count on Wincharger Antenna Towers. They combine strong efficient coverage with built to last qualities that insure you years of service.

Add to these advantages their strikingly attractive appearance plus a sensationally low initial cost and it's easy to see why an ever increasing number of Wincharger Antenna Towers are being used for:

**Commercial Broadcasting
Police Work
Signal Corps Air Lines
Ordnance Plants**

To be sure for years ahead
—be sure to specify Wincharger Antenna Towers.

WINCHARGER VERTICAL RADIATOR
WINCHARGER CORPORATION SIOUX CITY, IOWA

VICTORY...in the Making

Here, at Doolittle, we are coordinating every effort and skill to help provide the communications equipment so essential for Victory. This will mean better peace-time communications after our battles are won.



To Assure Victory
Buy More U. S. War
Bonds and Stamps

Doolittle

RADIO, INC.

Builders of Precision Radio Communications Equipment
7421 S. Loomis Blvd., Chicago, U. S. A.

Remember THE ISOSO-LOOP?



This was the highest "Q" loop known. It went into vast numbers of pre-war receivers. For the present, all of our efforts are devoted to making DX Xtals but when Peace comes, we hope to be, once again, the World's Largest Loop-Aerial Manufacturers.

May we help you with your post war plans?

DX CRYSTAL CO.

GENERAL OFFICES: 1841 W. CARROLL AVE., CHICAGO, ILL., U.S.A.

DX
XTALS

'the heart of a good transmitter'

TRADE MARK

power consumption. For high speed action, according to Dr. Roters, inductance must be held to a minimum, making a high permeance and current necessary. It is also desirable to laminate or slot the core to decrease the lag due to eddy currents. The advantages of Permalloy were stressed, including the low residual which permitted the omission of the usual non-magnetic spacer to prevent sticking. This in turn, permitted a shorter stroke, less leakage, less NI, a smaller coil . . . etc., offering a cumulative advantage.

Coil Design Problems

Dr. Roters also brought out many interesting facts about coil design. Where power can be neglected (as in many aircraft applications) a considerable reduction in size is possible when the coil is wound with Formex or Formvar vinyl-acetal-insulated magnet wire. These coils seem to stand 150° C indefinitely and, in some cases, even 160°. This allows a temperature rise of at least 80° C over an ambient of 70° C, a favorite present high limit. Because this type of insulation does not become brittle as does standard enamelled wire, the paper used between layers may often be eliminated, further reducing the coil size.

It is obvious that a smaller coil permits a smaller magnetic circuit. But it does more, according to Dr. Roters. When the length is decreased, the NI and leakage coefficient are decreased. This permits a smaller core, which further reduces the coil size, etc., again offering a cumulative effect. As the unit decreases in bulk, the inductance also decreases, making faster operation possible. Similarly, increasing the flux density by the use of special alloys (where price will permit) results in a series of cumulative benefits which reduces the magnet size considerably. The Ferrocobalts are particularly good. Dr. Roters gave as an example a solenoid of about 1 cubic inch wound with Formex which withstood 250 watts for intermittent periods of a second or so in regular operation.

In the discussion which followed the paper, coil construction, special alloys, comparison of core materials and the advantages of annealing the core in low NI applications were all given consideration. The speaker also referred to his book, *Electromagnetic Devices*, published by John Wiley, which, incidentally is an outstanding work.—(E. G.)

IMPEDANCE TRANSFORMATION

(Continued from page 44)

appeared from time to time, but are not generally available.

Knowing the admittance $Y = G + jB$ of the receiver, the two numbers

$$g = GR_0 \quad b = BR_0$$

may be obtained from R_0 , the characteristic impedance of the line.

The two corresponding circles of the z -plane map will be found to intersect at some point. This intersection should be marked on the map. Then the rotating dial (Figure 12) which we imagine to have been enlarged and placed in position, should be set to read zero on the dial, (the dial is read at the point $g = 0, b = 0$ of the chart).

In the next operation we make a point mark on the dial sheet opposite the intersection previously determined; after which the dial is rotated, until the dial reading is equal to L/λ , the length of the line in wavelengths. The point mark which we have made on the dial sheet will have moved on an arc of a circle, and its new position will determine a new intersection, hence two new values of b and g , from which the input admittance of the line may easily be determined (dividing by R_0).

The chart of Figure 12 may be redrawn to any desired accuracy by using the construction of Figure 12a.

AUDIO REACTORS

(Continued from page 38)

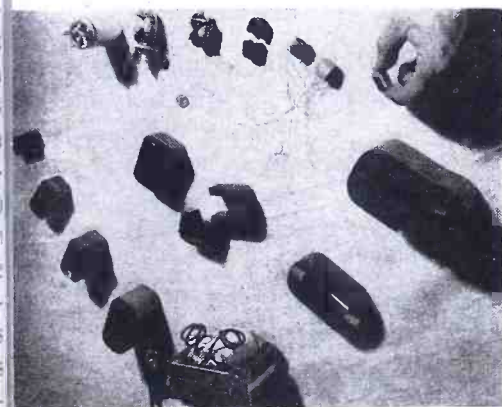

(Courtesy Westinghouse)

Hipersil ribbon-wound cores.

the change in inductance and also the change in Q .

If the inductance is properly designed, the inductance (in henrys) will not change perceptibly even with this large range in voltage, but of course, the Q will change.

From this it follows that if the Q or inductance of a coil is to be expressed, the applied voltage and frequency must also be stated.

This non-linear response will produce waveform distortion and inter-

(Continued on page 88)

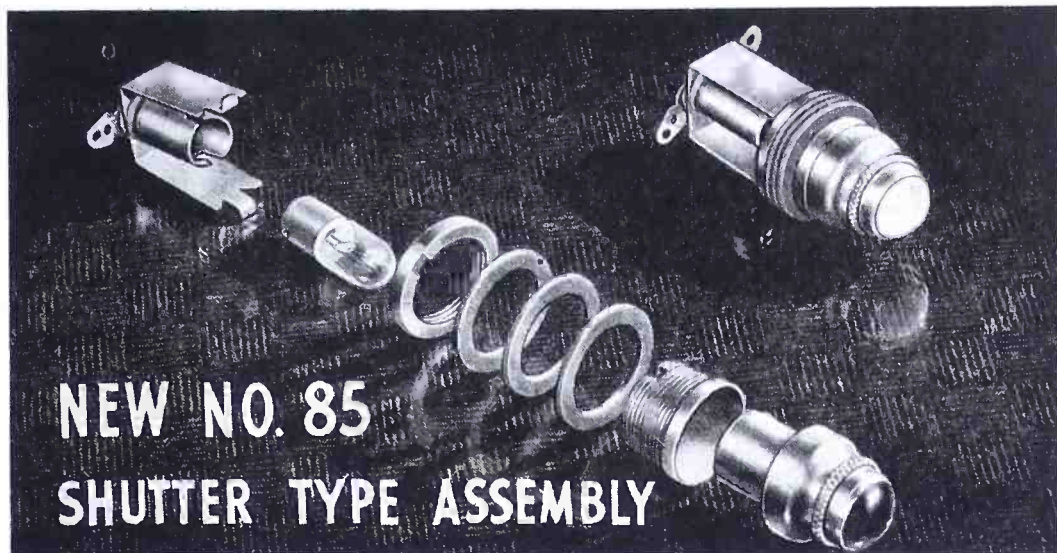

NEW NO. 85 SHUTTER TYPE ASSEMBLY

A LOCKING SLIP-FIT BEZEL

is one of the big features of this new and better DRAKE Shutter Type Assembly. It permits instant lamp replacement from front of panel, without tools! Other improvements are complete, uniform illumination over entire surface of Jewel, and complete blackout

with a quarter (90°) turn to right. Three fibre washers compensate for varying panel thicknesses. This patented Drake Assembly is only one of the many standard and special types we make. As the world's largest exclusive manufacturer, quick deliveries in any quantities are assured. Is our latest catalog where you can reach it instantly?



PILOT LIGHT ASSEMBLIES

DRAKE MANUFACTURING CO.

1713 WEST HUBBARD ST., CHICAGO 22, U. S. A.



Pointing the way....

WITH UNERRING ACCURACY

Today, as a result of American engineering skill ingeniously applying amplification principles to highly specialized instruments, thousands of amplifiers by "Eastern" help to guide our army and navy bombers with unerring accuracy in success-

fully completing their vital missions.

Our engineering staff invites your inquiry—large and small production runs, even single units, receive our usual prompt attention.

Write for Bulletin 98C

BACK THE ATTACK ★
BUY WAR BONDS ★

EASTERN AMPLIFIER CORP.
794 E. 140th St., New York 54, N.Y.

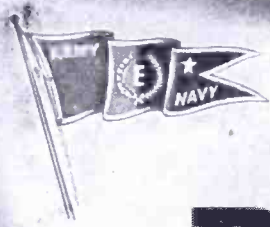

RUGGED

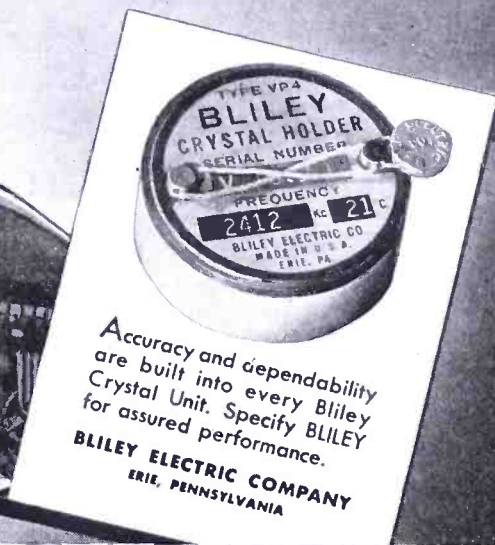
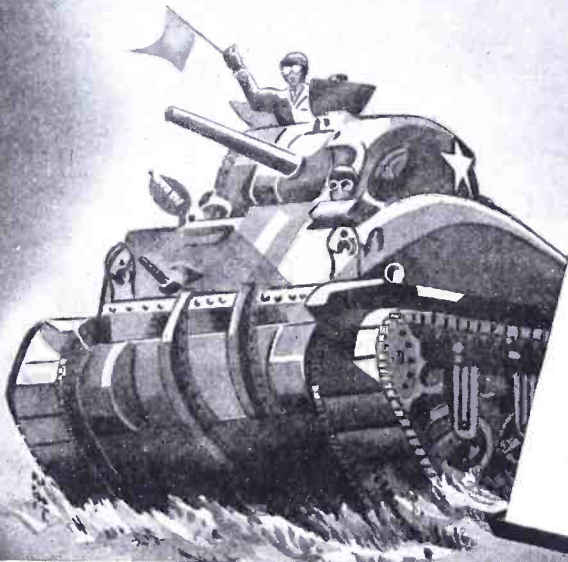

Accuracy and dependability are built into every Bliley Crystal Unit. Specify BLILEY for assured performance.

BLILEY ELECTRIC COMPANY
ERIE, PENNSYLVANIA

Bliley Crystals

Purchasing Agents!
Engineers!

JUST OUT!



NEW 1944 EDITION FREE!

800 Page Buying Guide

RADIO PARTS

RADIO TUBES and INDUSTRIAL ELECTRONIC EQUIPMENT - IN A HURRY

FROM OUR LARGE STOCK!

★ ★ ★

SEND FOR FREE CATALOG! New 1944 Edition - Just Out!

Write today on your company letterhead for this massive 800 page, bound volume containing everything in radio and electronic equipment. Address Box CM.

— Telephone BARclay 7-1840 —

SUN RADIO & ELECTRONICS CO.

212 Fulton Street, New York 7, N. Y.



WAXES AND COMPOUNDS

FOR INSULATION and WATERPROOFING

of ELECTRICAL and RADIO COMPONENTS

● such as transformers, coils, power packs, pot heads, sockets, wiring devices, wet and dry batteries, etc. Also WAX SATURATORS for braided wire and tape and WAXES for radio parts. The facilities of our laboratories are at your disposal to help solve your problems.

ZOPHAR MILLS, INC.

(FOUNDED 1846)

120 - 26th ST., BROOKLYN, N. Y.

AUDIO REACTORS

(Continued from page 87)

modulation, especially if the operating range is through a high value of flux density. If the device is operated much above its maximum permeability, the distortion is horrible, showing itself chiefly as third harmonic. Swing chokes and voltage regulating transformers operate on the negative slope of this permeability curve. To make an inductance stable and suitable for equalizers or filters, all of the characteristics mentioned above must be suppressed. This is done chiefly by introducing reluctance into the magnetic circuit. This reduces the effective permeability of the magnetic circuit, but more important, makes the apparent permeability constant for different values of applied voltage. The loss in permeability is generally a very large factor, in most cases will probably be greater than 10.

Now in terms of transformer design this would be a very great loss, but in terms of inductances, the permeability, even though reduced by this large amount, is still very much greater than with no core. A design might call for a permeability of 50, even though a permeability of 1,000 was possible with the same laminations interleaved. The loss of inductance would be 20 to 1. However, the inductance in henries would be 50 times as great as if no core was used. Obviously, if you have a permeability of 50, the amount of winding for a given inductance can be materially reduced, resulting in smaller size or increased Q or both.

The effect of the introduction of an air gap (called magnetic resistance or reluctance) in reducing the non-linear distortion is comparable to the introduction of resistance into the plate circuit of a vacuum tube amplifier. The tube is basically not free from distortion since the plate current varies as the 3/2 power of the applied plate voltage, and can only approach freedom from distortion when resistance is introduced.

The apparent loss of permeability is expressed as

$$\mu = \frac{\mu_{AC}}{1 + [(a/e) \mu_{AC}]}$$

where μ = permeability of finished inductance, and μ_{AC} = permeability of core material. a/l is the ratio of air gap to the length of the magnetic path. A graph showing this curve appears in Figure 8. The precise control of inductance, accomplished by varying the air gap, may be used to maintain production (of a typical 1,000-cycle Q_{max}

inductance) to within 1% of specifications.

The practical application of iron core inductances requires an air gap in the magnetic circuit for the purpose of adjusting the inductance as well as stabilizing. A design for Q_{max} to occur at low frequencies such as 50 cycles will probably have a very small air gap, a few thousandths of an inch at most. It is quite obvious that if this air gap changes even slightly, the inductance will change greatly, so the mechanical problem of maintaining an accurate air gap under these circumstances is acute. There is a solution which is quite unique; an F-shaped lamination was chosen which had the center leg cut at 45°. The two half sections of F laminations were held butted up with a clamp, as shown in Figure 9, and the inductance was regulated by sliding the F pieces, which open up the air gap, at the 45° cut of the lamination. The particular virtue of this design lies in the location of the air gap which falls in the center of the winding, and also in that there is a minimum of leakage flux to intercept the clamp, there being an intimate contact where the two F -sections butt.

At medium audio frequencies, air gaps, by necessity, assume a/l ratios of .001 to .005, so the matter of precise air gap spacing is very much less critical. A design might be illustrated by an $E-I$ core structure using a bakelite spacer of .050 with the E and I pieces held by a hard fiber frame. The screws are brass in order to reduce the hysteresis loss caused by steel screws.

Typical power filter reactors are examples of how not to build high- Q inductances. To begin with, the core material is usually several grades poorer than *audio* grades, and is thick. This makes eddy current loss and hysteresis loss high. The shape will invariably be E and I which will result in leakage flux. In order to clamp the I pieces together, keepers are used along with some kind of a shell or bracket made of cold-rolled steel.

The presence of a keeper or iron clamp at a point of leakage flux will distort the magnetic field due to the permeability of the keeper being many times that of air, (Figure 9). The lines of force which are supposed to travel from the E to I crowd into the keeper, which produces a very high flux density in the keeper, resulting in the generation of spurious frequencies which may be difficult to filter. To demonstrate this point, one has only

(Continued on page 90)

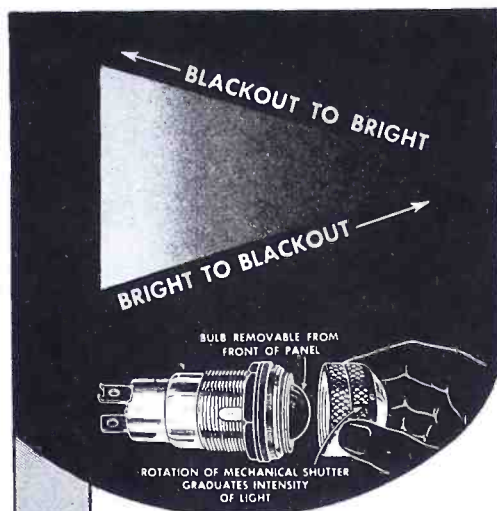

NEW.. "ONE-INCH" VARIABLE DIMMING PILOT LIGHT ASSEMBLIES by DIALCO

To regulate the intensity of light, this new Dialco unit has a superior mechanical shutter built into the knurled head. This Vari-Dim Jewel Head assembly can also be readily applied to any of the CS series of Pilot Lights listed in our 24-page Catalogue No. 43. Write for a copy.



Plus LAMPS...

To help speed production, Dialco offers Pilot Lights completely assembled with G.E. or Westinghouse Lamps—any type or voltage. Samples submitted on request.



DIAL LIGHT CO. of America, Inc.

900 BROADWAY • NEW YORK 3, N. Y.

Telephone: ALgonquin 4-5180-1-2-3

CINAUDAGRAPH SPEAKERS

*Engineered for Today's
Big, Precision Job!*

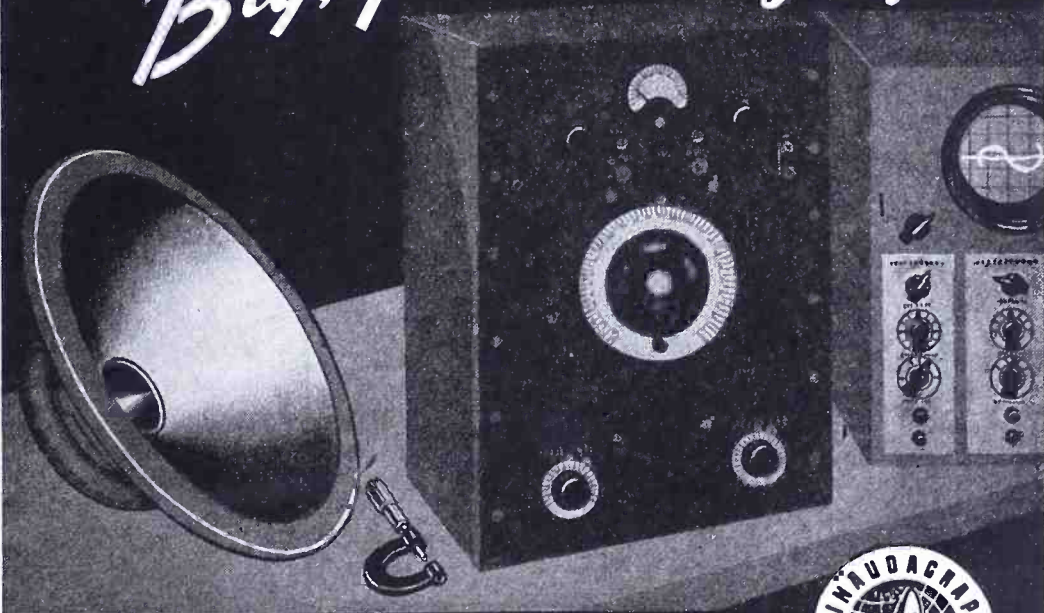

Cinaudagraph Speakers, Inc.

3911 S. Michigan Ave., Chicago

"No Finer Speaker Made in all the World"



ELECTRICITY

For Any Job—Anywhere

For a dependable source of electricity on projects remote from commercial power, Onan Electric Plants are proven leaders in the field. More than half of the armed forces' total requirements for Power Plants are built by Onan.

Gasoline-driven. . . . Single-unit, compact design.
 . . . Sturdy construction. . . . Sound engineering. . . .
 Suitable for mobile, stationary or emergency service.

Over 65 models, ranging in sizes from 350 to 35,000 watts. 50 to 800 cycles, 110 to 660 volts, A.C.—6 to 4000 volts, D.C.—Also dual A.C.-D.C. output types.

Descriptive literature sent promptly on request.

D. W. ONAN & SONS
 1266 Royalston Ave.
 Minneapolis, Minn.

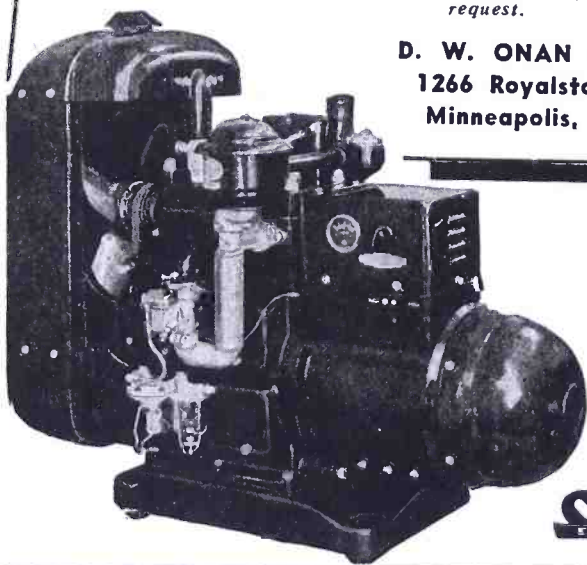

The Army-Navy "E" has been awarded to each of Onan's four manufacturing plants.

ONAN
 ELECTRIC PLANTS



CRYSTALS

CRYSTALS FOR THE CRITICAL

For years, The James Knights Company has specialized in quantity production of an exceptionally wide variety of Quartz Crystals. Recent patents on new precision cuts and improved mechanical processes have increased still further the accuracy and volume output of James Knights Crystals. We make samples nearly every day for some new customer so that he can design his equipment to fit a crystal that is now a standard of comparison. Why not let us help you?

The JAMES KNIGHTS Co.
 SANDWICH, ILLINOIS

WANTED:

1 Farnsworth 6 Stage or 11 Stage Infra Red Sensitive Photo Multiplier Tube for important war research work.

Reply should be sent to:

Att: E. E. Ruckbrod, Ansco, Binghamton, New York.

CRYSTALS
 EXCLUSIVELY



SINCE
 1934

ORDERS SUBJECT TO PRIORITY

PETERSEN RADIO CO., Council Bluffs, Iowa

(Continued from page 89)

to tune the filter choke to parallel resonance at 120 cycles and then connect a high gain amplifier to the power supply. The noise generated by the choke will be quite noticeable. However, if the choke is constructed along the idea of a high- Q audio reactor, the tuned filter system will be effective in reducing hum.

Reactors which must exhibit high Q

at high frequencies require magnetic structures which have very low eddy current losses. This in turn calls for thinner and thinner laminations, and, at the same time, a large air gap. The search for thinner and thinner laminations ends with powdered core. The air gap in this case is the binder and insulating material, and of course is uniformly distributed throughout the length of the magnetic circuit. The

usual design employs the classic ring core; however, the powdered core is not as ideal as might be expected since the permeability is so low that the core is not altogether effective in confining the flux. Powdered cores for audio frequencies have much more active material; they are more dense than the familiar radio frequency cores. Permeabilities range around 25 and 50; the permeability for radio frequency cores is usually from 2 to 5.

Most inductances for equalizers and wave filters, etc., use conventional transformer cores and transformer type windings. As the requirements for Q become more severe, special high efficiency shapes are used along with certain peculiar devices.

A recent transformer core development of the Westinghouse Company, hipersil, has been used effectively in high- Q inductance, (Figure 10). The material is made in ribbon form and so heat treated and processed that it has very low losses. This is accomplished chiefly by the pronounced development of grain structure. It is layer wound on a mandrel, annealed at high temperature, baked with a binding material, then cut into two halves, U-shaped. The layers are so well bound together that they appear to be solid. The cut surfaces are

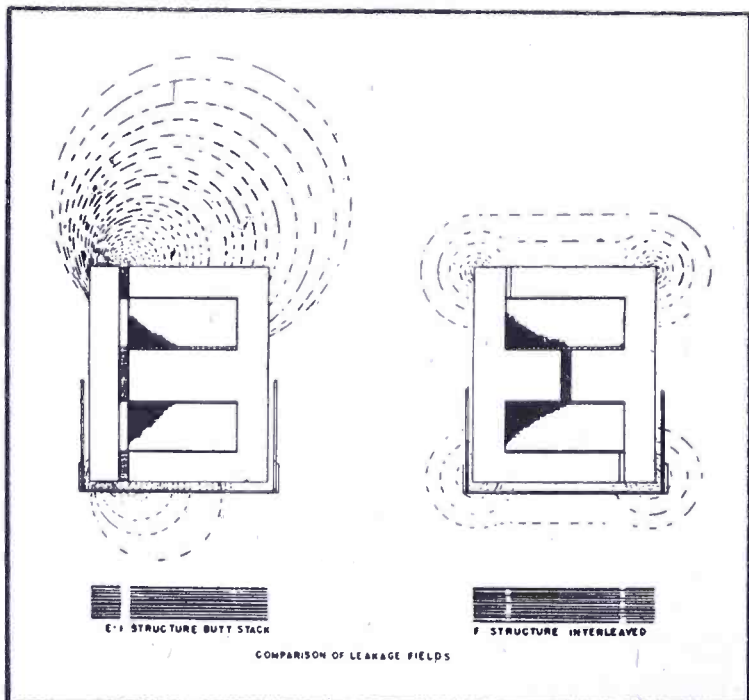

Figure 9

Here we see how the presence of a keeper or iron clamp at a point of leakage flux will distort the magnetic field due to the permeability of the keeper being many times that of air.

"DIE-LESS" DUPLICATING SAVES MAN HOURS AND DELAYS

"DIE-LESS" DUPLICATING
The DI-ACRO System of METAL DUPLICATING Without Dies

DIE ACCURACY WITHOUT DIES

Send for Catalog

DI-ACRO PRECISION MACHINES
DIE-LESS DUPLICATING

O'NEIL-IRWIN MFG. CO.
322 EIGHTH AVE. SO., MINNEAPOLIS 15, MINN.

CRYSTALS by HIPOWER

Thousands of vital transmitting installations rely on the accuracy and dependability of Hipower Precision Crystal units. With recently enlarged facilities, Hipower is maintaining greatly increased production for all important services. When essential demand begins to return to normal, Hipower will be glad to help with your crystal needs.

HIPOWER CRYSTAL CO.
Sales Division—205 W. Wacker Drive, Chicago
Factory—2025 Charleston Street, Chicago, Ill.

HEAD

CUSTOM BUILT AMPLIFIERS, OSCILLOSCOPES INDUSTRIAL CONTROLS

INDUSTRIAL ELECTRONICS, INC.
21 HENRY DETROIT 1, MICH.

Gothard

VIBRATION RESISTING Shutter Type PILOT LIGHT

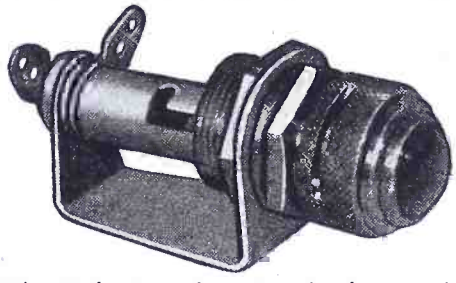

DIMOUT OR TOTAL BLACKOUT

Gothard No. 431 Pilot Light is used in aircraft, ships, tanks, signal and similar applications where vibration is an important factor. Precision, snug fitting jewel and lens holder maintains set position. 90° rotation of shutter provides gradation of light from bright, thru intermediate glows, to dim glow, or total dark. Faceted or plain jewels. Also available with polarized lens. Red, green, amber, blue or opal lens.

Write for complete information.

Gothard

MANUFACTURING COMPANY
1335 No. Ninth Street, Springfield, Ill.

round flat so that when the core is reassembled into a transformer the air gap at the butt will be a minimum. There are three outstanding advantages in this type of core. First, it has unusually low losses; second, it is readily adaptable to an astatically balanced winding; and third, it may be securely clamped to maintain the air gap without loss in Q .

Summary

- (1) All iron core inductances should have an air gap for stability and distortion-free operation unless they operate at extremely low flux density.
- (2) The formulas for $f(Q_{max})$ etc., hold only for low values of flux density, where the hysteresis loss is small compared with the eddy current loss. Furthermore, if the operating flux density is high, the $f(Q_{max})$ will be somewhat lower than the formulas indicate, since the increased hysteresis loss is effectively a shunt resistance across the inductance in parallel with the eddy current loss.
- (3) In order that Q be a maximum:
 - (a) The core area should be large;
 - (b) the copper space should be large and the length of the turn short;
 - (c) the length of the magnetic circuit should be short;
 - (d) the electrical re-

sistance of the core material should be high; (e) the lamination of the core material should be thin; (f) the flux density should be low; and (g) there should be a minimum of leakage flux.

(4) For high Q at low frequency, all of the above, but most important, the effective permeability of the magnetic circuit should be large, and the air gap should be small.

Conclusion

Iron core inductances can account

- for the following improvements over air core inductances at audio frequencies.
- (1) Smaller physical space.
 - (2) Higher Q .
 - (3) A means of adjusting or trimming the inductance to exactly the right value.
 - (4) A reduction in the external field.
 - (5) An inductance which can be conveniently shielded both electrostatically and electromagnetically.

Figure 10
Characteristics of hipersil, with a comparison of the leakage fields.

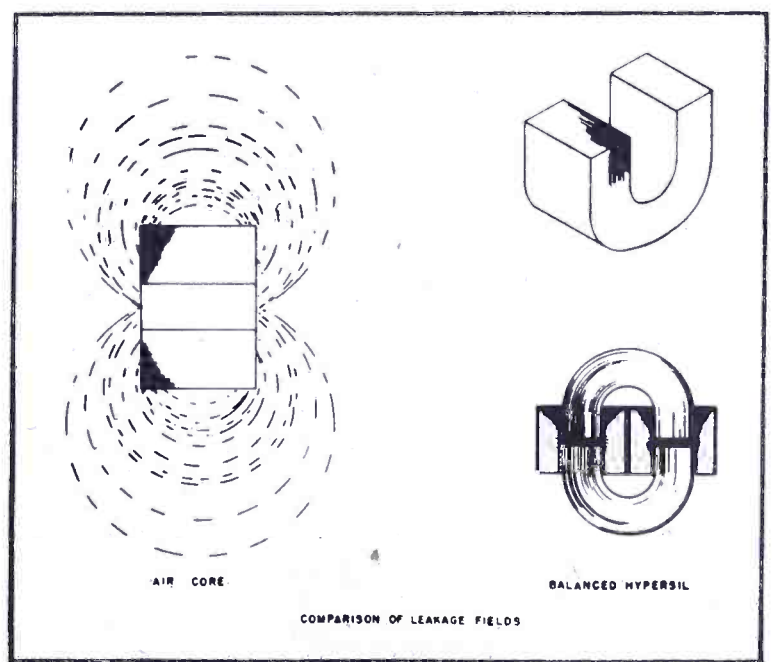

New *Littelfuse* Protection

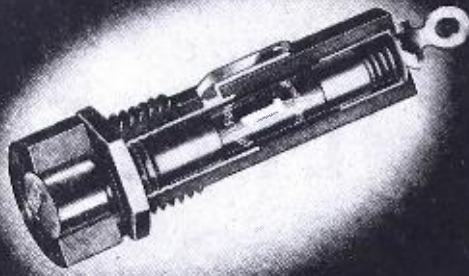

Advances include electric welding of side terminals

Cutaway of Littelfuse Extractor Post No. 1075 exemplifies new construction with side terminals electrically welded.



EXTRACTOR POSTS

Better conductivity and strength for maximum resistance to heat and severe vibration insured by electric welding, making terminals integral with inside of shell. Strong body molded black bakelite for insulation, and prevention of corrosion and shorts, positive Fuse Grip permitting full visual shock-proof inspection, knob that pulls and holds fuse, Special Grip preventing fuse from dropping out are other Littelfuse factors.

EXTRACTOR POSTS FOR WIDEST RANGE OF MOUNTINGS

Illustrated at top No. 1075 for 3 AG fuses for radio and other currents. Screw-driver operated (Underwriters' spec.); also finger-operated. No. 1087 similar type for 8 AG fuses. Aircraft Littelfuse types at right.

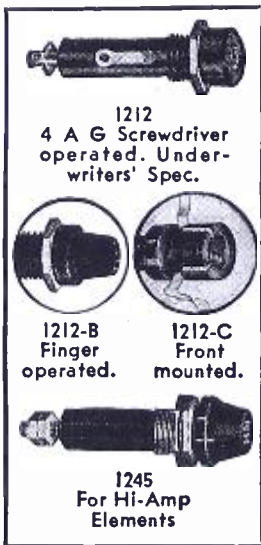

Send for B/P and Engineering Data
Ask for samples for your applications.
Write

LITTELFUSE Inc.

263 Ong St., El Monte, California
4793 Ravenswood Ave., Chicago 40, Ill.

ADVERTISERS IN THIS ISSUE*

COMMUNICATIONS—MARCH, 1944

THE ACME ELECTRIC & MFG. CO.....	72	INDUSTRIAL ELECTRONICS, INC.....	91
Agency—Scheel Adv. Agency		INSULINE CORPORATION OF AMERICA.....	76
ACRO ELECTRIC CO.....	79	Agency—H. J. Gold Co.	
Agency—The White Adv. Co.		E. F. JOHNSON CO.....	39
AEROVOX CORP.....	74	Agency—David, Inc.	
Agency—Austin C. Lescarbourea & Staff		HOWARD B. JONES.....	72
AIRCRAFT ACCESSORIES CORP.....	12, 13	Agency—Merrill Symonds, Advertising	
Agency—Potts-Turnbull Co.		THE JAMES KNIGHTS CO.....	90
ALTEC-LANSING CORP.....	50	Agency—Turner Adv. Agency	
Agency—Davis and Beaven		LAFAYETTE RADIO CORP.....	77
AMERICAN RADIO HARDWARE CO.....	1	Agency—Shappe-Wilkes Inc.	
Agency—Shappe-Wilkes Inc.		LITTELFUSE, INC.....	92
AMPEREX ELECTRONIC PRODUCTS		Agency—Merrill Symonds, Advertising	
Agency—Shappe-Wilkes Inc.		McELROY MFG. CORP.....	63
AMPERITE CO.....	84	Agency—Shappe-Wilkes Inc.	
Agency—H. J. Gold Co.		MEASUREMENTS CORP.....	70
ANDREW CO.....	84	Agency—Frederick Smith	
Agency—Burton Browne, Advertising		MERIT COIL & TRANSFORMER CORP.....	83
ANSCO.....	90	Agency—Ross Llewelly, Inc.	
BLILEY ELECTRIC CO.....	88	JAMES MILLEN MFG. CO.....	68
Agency—W. S. Hill Co.		NATIONAL UNION RADIO CORP.....	43
THE W. W. BOES CO.....	73	NORTH AMERICAN PHILIPS CO., INC.....	II, 49
Agency—Kircher, Lytle, Helton & Collett		Agency—Erwin, Wasey & Co., Inc.	
L. S. BRACH MFG. CORP.....	81	OHMITE MFG. CO.....	18
Agency—United Adv. Agency		Agency—Henry H. Teplitz, Advertising	
THE BREEZE CORPORATIONS INC.....	19	D. W. ONAN & SONS.....	90
Agency—Burke Dowling Adams		Agency—Pioneer Advertising	
THE BRUSH DEVELOPMENT CO.....	6	O'NEIL-IRWIN MFG. CO.....	91
Agency—Gregory Adv. Agency		Agency—Foulke Agency	
BURSTEIN-APPLEBEE CO.....	79	PAR-METAL PRODUCTS CORP.....	80
Agency—Frank E. Whalen Adv. Co.		Agency—H. J. Gold Co.	
CAMBRIDGE THERMIONIC CORP.....	80	PETERSON RADIO CO.....	90
Agency—Walter B. Snow & Staff		PREMAX PRODUCTS DIV. CHISHOLM-RYDER	
CANNON ELECTRIC DEVELOPMENT CO.....	65	CO., INC.	74
Agency—Dana Jones Co.		Agency—Norton Advertising Service	
CENTRALAB.....	4	PRESS WIRELESS.....	74
Agency—Gustav Marx Adv. Agency		R9 CRYSTAL CO., INC.....	79
CINAUDAGRAPH SPEAKERS, INC.....	89	RADIO CORPORATION OF AMERICA.....	7
Agency—Michael F. Mayger		Agency—Kenyon & Eckhardt, Inc.	
CONSOLIDATED RADIO PRODUCTS CO.....	75	RADIO RECEPTOR CO., INC.....	20, 21
Agency—Burton Browne, Advertising		Agency—Shappe-Wilkes Inc.	
CONTINENTAL ELECTRIC CO.....	66	REMLER CO., LTD.....	67
Agency—Duane Wanamaker, Advertising		Agency—Albert A. Drennan	
CRYSTAL PRODUCTS CO.....	17	THE ROLA CO.....	14
D-X CRYSTAL CO.....	86	Agency—Foster & Davies, Inc.	
Agency—Michael F. Mayger		RUBY CHEMICAL CO.....	79
DIAL LIGHT COMPANY OF AMERICA, INC....	89	Agency—Harry M. Miller, Inc.	
Agency—H. J. Gold Co.		SCIENTIFIC RADIO PRODUCTS CO.....	69
DOOLITTLE RADIO, INC.....	86	Agency—Allen & Reynolds	
Agency—Henry H. Teplitz, Advertising		SHURE BROTHERS.....	53
DRAKE MFG. CO.....	87	Agency—Henry H. Teplitz, Advertising	
Agency—The Vanden Co.		SOLA ELECTRIC CO.....	32
ALLEN B. DuMONT LABORATORIES, INC.....	85	Agency—Hardy Advertising	
Agency—Austin C. Lescarbourea & Staff		SPRAGUE SPECIALTIES CO.....	10
EASTERN AMPLIFIER CORP.....	87	Agency—The Harry P. Bridge Co.	
Agency—Sternfield-Godley, Inc.		SUN RADIO & ELECTRONICS CO.....	88
ECHOPHONE RADIO CO.....	45	SURPRENANT ELECTRICAL INSULATION CO.....	66
Agency—Burton Browne, Advertising		Agency—Franklin Adv. Service	
EITEL-McCULLOUGH, INC.....	9	SYLVANIA ELECTRIC PRODUCTS, INC.....	3
Agency—L. C. Cole, Advertising		Agency—Arthur Kudner, Inc.	
ELECTRONIC CORP. OF AMERICA.....	57	TECH LABORATORIES.....	64
Agency—Shappe-Wilkes Inc.		Agency—Lewis Adv. Agency	
THE ENGINEERING CO.....	76	TERMINAL RADIO CORP.....	66
Agency—George Homer Martin		Agency—Charles Brunelle	
FEDERAL TELEPHONE AND RADIO CORP....	5	THOMAS & SKINNER STEEL PRODUCTS CO.....	70
Agency—Marschalk & Pratt		Agency—The Caldwell-Baker Co.	
GENERAL INSTRUMENT CORP.....	51	THORDARSON ELECTRIC MFG. CO.....	70
Agency—H. W. Fairfax Agency, Inc.		Agency—Duane Wanamaker	
GENERAL RADIO CO.....	Inside Back Cover	TRAV-LER KARENOLA RADIO & TELEVISION	
GILFILLAN BROTHERS.....	61	CORP.....	83
Agency—Smith & Drum, Inc.		Agency—Jones Frankel Co.	
GOAT METAL STAMPINGS, INC.....	68	U. S. TREASURY DEPT.....	22
Agency—Lewis Adv. Agency		UNITED TRANSFORMER CO.....	55
GOTHARD MFG. CO.....	91	Agency—Shappe-Wilkes Inc.	
Agency—Merchandising Advertisers		UNIVERSAL MICROPHONE CO., LTD.....	47
THE GOULD-MOODY CO.....	66	Agency—Ralph L. Power Agency	
Agency—Shappe-Wilkes Inc.		VALPEY CRYSTAL CORP.....	82
GUARDIAN ELECTRIC.....	35	Agency—Cory Snow, Inc.	
Agency—Kennedy & Co.		WM. T. WALLACE MFG. CO.....	71
EDWIN I. GUTHMAN & CO., INC.....	8	Agency—Michael F. Mayger	
Agency—Sydney S. Lovitt		WESTINGHOUSE ELECTRIC & MFG. CO.....	Back Cover
HALLICRAFTERS CO.....	16	Agency—Fuller & Smith & Ross, Inc.	
Agency—Burton Browne, Advertising		WINCHARGER CORP.....	85
HAMMARLUND MFG. Co.....	24	Agency—Critchfield & Co.	
Agency—Roeding & Arnold, Inc.		ZOPHAR MILLS, INC.....	88
HARVEY RADIO CO.....	64	Agency—J. G. Proctor Co., Inc.	
Agency—Shappe-Wilkes Inc.			
HARVEY RADIO LABS., INC.....	23		
Agency—Walter B. Snow & Staff			
HEWLETT-PACKARD CO.....	15		
Agency—L. C. Cole, Advertising			
HIPOWER CRYSTAL CO.....	91		
Agency—Turner Adv. Agency			
THE HOPP PRESS, INC.....	82		
HYTRON CORP.....	59		
Agency—Henry A. Loudon, Advertising			

*Due to paper restrictions several advertising pages had to be omitted from this issue.

USE VARIACS*

for Efficient Voltage Control

Hundreds of thousands of Variacs are used to control motor speed, heat, light and power, and to compensate for under-voltage or over-voltage lines.

- LOW LOSSES
- GOOD REGULATION
- SMALL SIZE
- LINEAR VOLTAGE ADJUSTMENT

These features, plus General Radio quality construction are the reasons for the wide acceptance of the Variac wherever variable a-c voltage is required.

Variacs are more efficient, more economical, and more convenient to use than resistive controls.

The Variac is an autotransformer with a toroidally shaped winding. As the control dial is rotated, a carbon brush traverses the winding, turn by turn. The brush position at any setting determines the output voltage, which is read directly from the dial.

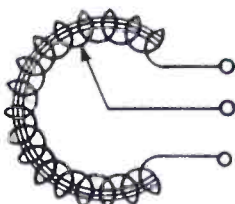

Bulletin No. 865 describes current models of the Variac. Write for your copy today.

Variacs are available for 60-cycle service in 9 models ranging from 170 va to 7 kva. They can be assembled in gangs for 3-phase operation in power ratings up to 25 kva for line voltages up to 460.

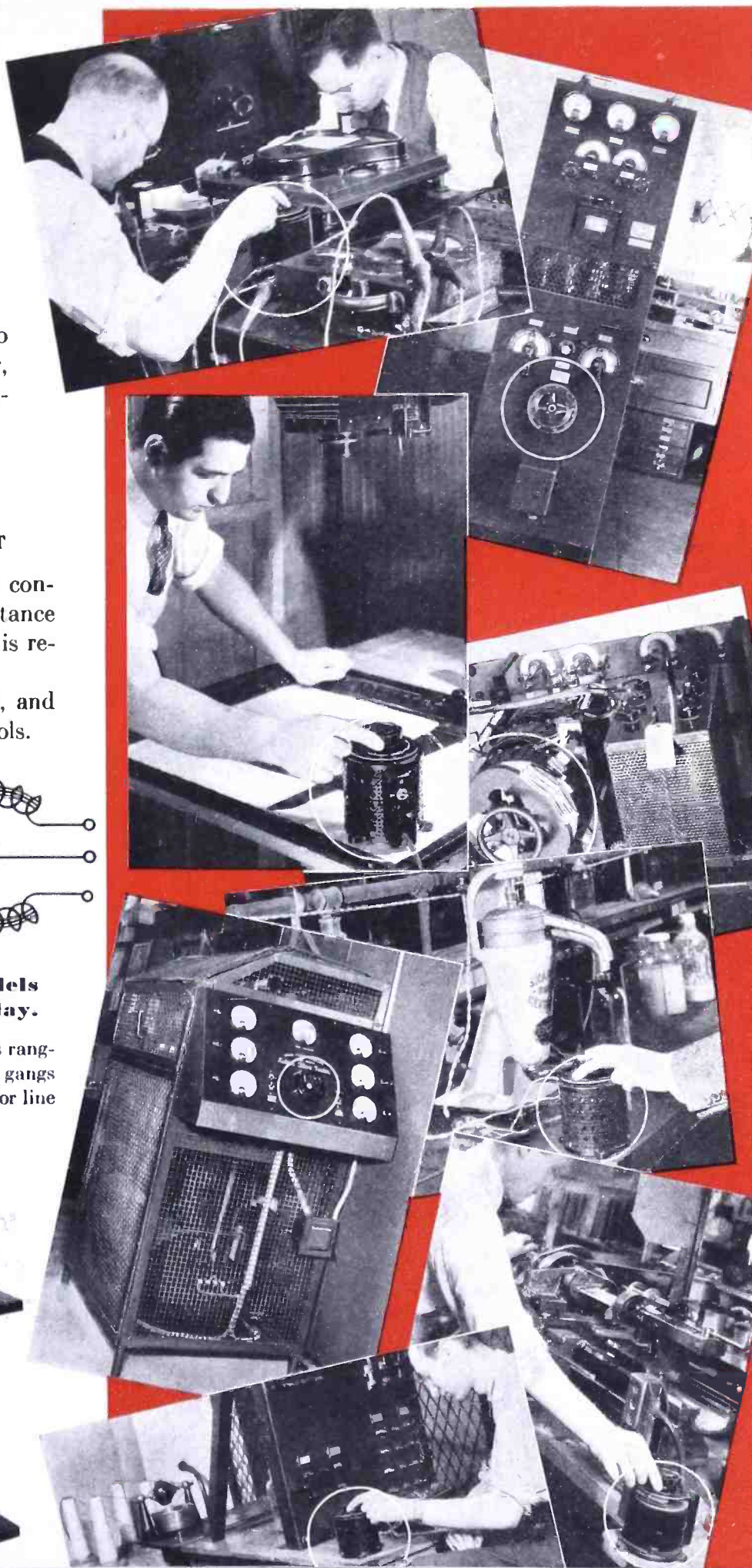
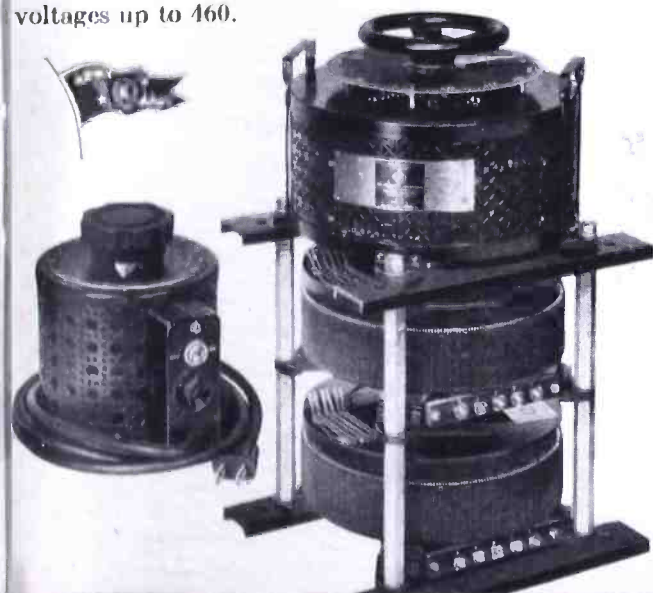

GENERAL RADIO COMPANY

Cambridge 39, Massachusetts
NEW YORK CHICAGO LOS ANGELES

*The name Variac is a registered trade mark of the General Radio Company. The Variac is manufactured and sold under U. S. Patent No. 2,009,013.

Ready

LATEST... MOST COMPLETE DATA ON INERTEEN CAPACITORS FOR D-C CIRCUITS IN ELECTRONIC EQUIPMENT

Every engineer, designer and technical man concerned with developing high-performance electronic equipment for war or postwar use should have this booklet handy. It's packed with fresh facts and data on Westinghouse D-C Inerteen Capacitors and their application. Essentially, it is a guide to the selection and use of capacitors for any D-C applications in communications, electronics or related fields.

It will bring you up to date on capacitor advancements, and provide dimension data for designing of equipment.

Includes ratings from 400 volts to 250,000 volts D-C.

To make sure that a copy reaches your desk without delay, use the coupon to reserve your copy. Westinghouse Electric & Manufacturing Co., East Pittsburgh, Pa., Dept. 7-N.



WESTINGHOUSE

Inerteen Capacitors

400 TO 250,000 VOLTS D-C
FOR D-C SERVICE IN
• COMMUNICATIONS EQUIPMENT
• ELECTRONIC EQUIPMENT
• GENERAL D-C APPLICATIONS

WESTINGHOUSE
WESTINGHOUSE ELECTRIC & MANUFACTURING CO.
EAST PITTSBURGH PENNSYLVANIA

CAPACITOR CONSTRUCTION—its effect on performance.

FEATURES that improve performance and reliability.

SPECIFICATION DATA—covers working temperature ranges, capacitance and voltage tolerances on both intermittent and continuous service.

DATA on dimensions, weights, and capacities.

APPLICATION DATA for each type of Inerteen Capacitor.

CHECK LIST for application data.

ASK FOR A COPY... NOW

Westinghouse Electric & Mfg. Co.,
East Pittsburgh, Pa., Dept. 7-N.

Please send me a copy of your new book on
Inerteen Capacitors.

Name _____
Position _____
Company _____
Address _____
City _____ State _____

Westinghouse

PLANTS IN 25 CITIES . . . OFFICES EVERYWHERE

INERTEEN CAPACITORS

