

# COMMUNICATIONS

**IRON-CORED CHOKE  
MEASUREMENTS**

**REVIEW OF PAPERS  
AT FALL I R E MEETING**

**NATIONAL  
DEFENSE**

**NOVEMBER  
1941**







## In a world at war



So that our next generation will not be born to a world of violence, shortages, rationing and sacrifice . . . a world wherein advancements are distorted into mechanics of destruction . . . a world in which peacetime economies are harnessed to the maintenance of colossal war machines . . . we pledge ourselves and our facilities.

Our nation is engaged in a great task of preparedness for our defense, and our products, transmitting and rectifying tubes, are employed in the establishment and maintenance of vital communications lines. These same tubes, which serve in our broadcasting stations to bring us laughter, music and culture; in research—and in electro-medical apparatus to alleviate suffering and disease; and in many industrial applications; must *NOW* serve in the protection of our shores. To this end, we cooperate willingly.

We must therefore ask your cooperation in anticipating essential, normal requirements so that we may continue to serve both you and our country to the best of our ability.

**AMPEREX ELECTRONIC PRODUCTS**  
79 WASHINGTON STREET • BROOKLYN, NEW YORK



# ISOLANTITE UNDERTAKES EXPANSION PROGRAM TO RAISE ITS CERAMIC OUTPUT TO TEN TIMES THE VOLUME OF A YEAR AGO

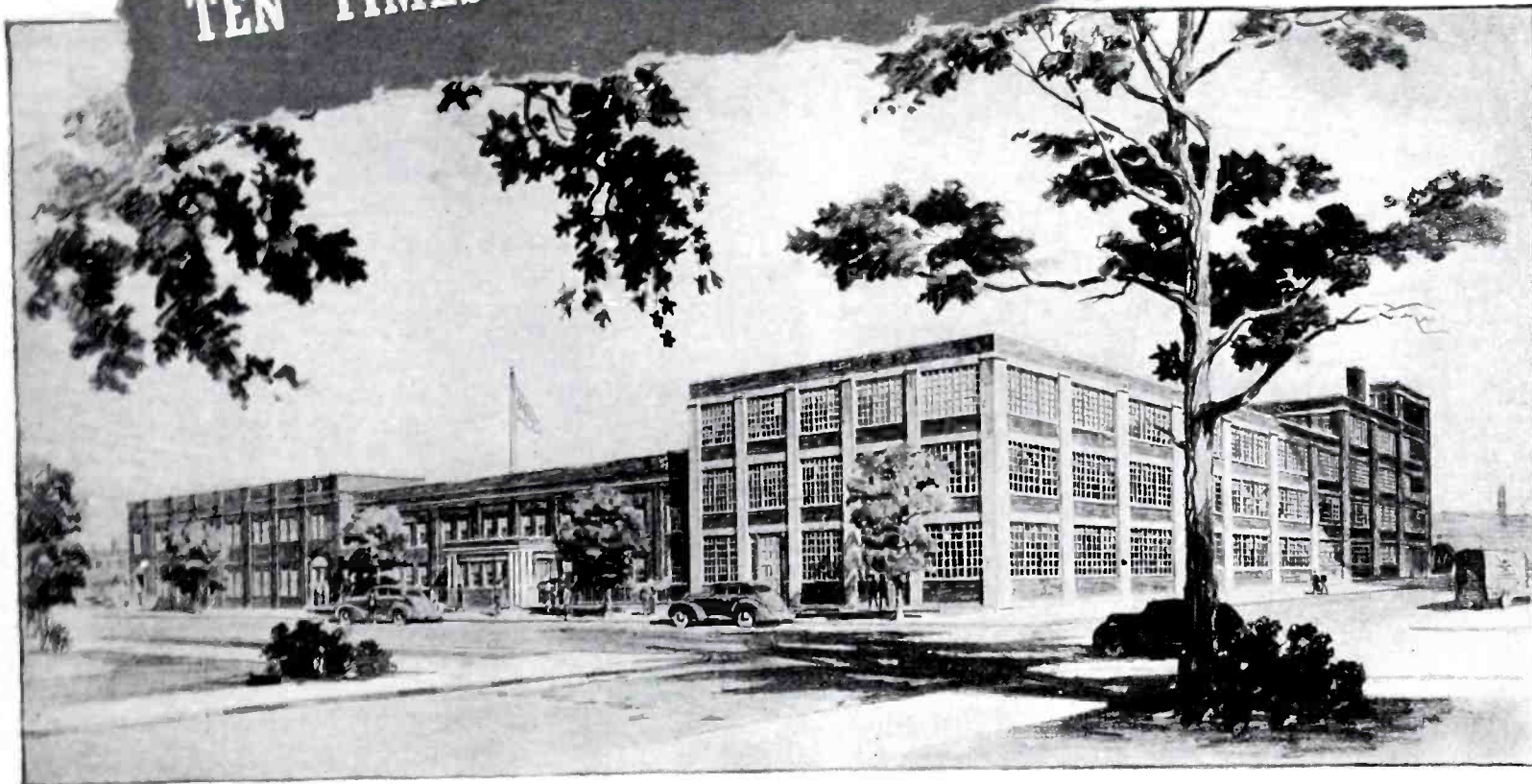

**I**SOLANTITE, INC. has, within the past year, increased its production of high-quality precision ceramic parts to five times the former output, in order to keep pace with the constantly increasing demand for its products in urgent defense work.

This exceptional increase in output has been made possible by purchase of new equipment which utilizes existing plant facilities to the full, by increasing operations to a twenty-four-hour basis and by effecting every possible economy in manufacturing time.

Large as this increase is, Isolantite recognizes that a still further expansion in output is necessary to anticipate the needs of industry for quality ceramic parts. With this end in view, Isolantite has initiated a program of plant construction and improvement that will double present capacity—raising Isolantite's output to ten times the level of a year ago.

Construction of a new three-story building that will add 80,000 square feet to existing productive areas is a major phase of Isolantite's expansion program. The new building will be provided with machinery of the most modern type, and production lines will be planned to maximum capacity. Rearranged facilities in existing buildings will contribute to the increased flow of Isolantite products.

Isolantite, Inc. is also concentrating its efforts towards new and improved manufacturing methods. Modern facilities and engineering research will maintain present high quality standards for which Isolantite has been the

leader. New bodies are now in the course of development which will offer to the electronic industry improvements in both electrical and mechanical properties. Personnel is being expanded to meet the demands of these new and broadened facilities.

The recently created "Radio Specialties Division" is constantly developing new items involving metal parts in combination with Isolantite for transmission line, antenna and other important radio and allied products.

Work has already begun on this expansion program. With its completion in the early spring, Isolantite will be ready to render more efficient service in meeting the demand for its ever-growing list of new products.

\*Registered trade-name for the products of Isolantite, Inc.

## ISOLANTITE

### CERAMIC INSULATORS

ISOLANTITE, INC. FACTORY: BELLEVILLE, NEW JERSEY  
SALES OFFICE: 233 BROADWAY, NEW YORK, N. Y.





## We See...

A POPULAR COLUMNIST writing in one of New York's largest selling newspapers, said on November 17, "Radios, it has been decided, are necessary to public morale, so production of sets won't be curtailed after all." Judging by the care with which this factfinder always selects his data, it may be assumed that his statement has more than just some foundation. Cognizant of the trend in Washington, it probably is, but not without reservations that natural problems will prompt. With materials and equipment being taxed to the hilt by defense needs, it's going to be pretty tough to just "go-ahead", unless we have some re-allocation of present methods of design, development and production, with "conservation" being the main theme. In that direction we have the plan outlined by Dorman Israel at the recent IRE convention and reviewed on pages 18 and 21 of this issue. It represents one of the most plausible solutions we have ever seen. His method is a thorough one of vital import to every engineer.

THAT DREADED WORD "Blackout" receives a cold, but clear analysis in a new book just issued by the United States Office of Civilian Defense and prepared by the War Department. Tersely, succinctly and deliberately, the cards are placed squarely on the table for everyone, particularly we in the Communications industry. What "blackout" will mean to Communications does not require an exposition. you'd better send for it now. A note If you haven't received your copy, to the Superintendent of Documents, Washington, D. C., with twenty-five cents enclosed, will do the trick. —L. W.

NOVEMBER, 1941

VOLUME 21 NUMBER 11

### COVER ILLUSTRATION

Radio-equipped scout car of the 102nd horse mechanized cavalry on manoeuvres.

(Photo by U. S. Army Signal Corps)

### COMPONENT DESIGN AND APPLICATION

The Measurement of Iron-Cored Choke Inductance... E. H. Meier and D. L. Waidelich 5

### TRANSMITTER DEVELOPMENT

Columbia Island (Part 2) ..... Donald Phillips 9-13

### ENGINEERING CONVENTION REVIEW

A Report on the IRE Rochester Meeting..... Lewis Winner  
Shepard's Audio System ..... 14  
Selvidge's Solid Dielectric Flexible RF Transmission Line..... 18  
Dorman Israel's Receiver Production Plan for '42..... 18  
New Magnetic Materials ..... 21  
A 400 MC Generator ..... 24  
Plastics Today ..... 25  
An F-M Signal Generator..... 27  
Tube Noises ..... 28

### NATIONAL DEFENSE

Dorman Israel's Receiver Production Plan for '42..... 18  
New Magnetic Materials ..... 21  
Plastics Today ..... 25

### MONTHLY FEATURES

Veteran Wireless Operators Association News..... 16  
The Industry Offers..... 30  
News Briefs ..... 33  
Advertising Index..... 36

Published Monthly by the Bryan Davis Publishing Co., Inc.

BRYAN S. DAVIS, President

PAUL S. WEIL, Advertising Director

JAMES A. WALKER, Secretary

A. GOEBEL, Circulation Manager

Advertising and Editorial offices, 19 East 47th Street, New York City, Telephone PLaza 3-0483. Chicago office, 608 South Dearborn Street, Chicago, Ill., Telephone Wabash 1903. Wellington, New Zealand, Te Aro Book Department. Melbourne, Australia, McGill's Agency. Entire Contents Copyright 1941, Bryan Davis Publishing Co., Inc. Entered as second-class matter October 1, 1937, at the Post Office at New York, N. Y., under the act of March 3, 1879. Yearly subscription rate: \$2.00 in the United States and Canada, \$3.00 in foreign countries. Single copies; twenty-five cents in United States and Canada, thirty-five cents in foreign countries.



# I n the considered judgment of leading engineers...

When important decisions are made about vacuum tubes it is not uncommon for an Eimac tube to win the honors. *Reason:* the designers of Eimac tubes have consistently held as their objective the anticipation of the future requirements of the radio industry. Efforts have not been confined to the production of a tube for yesterday's requirements.

This policy has kept Eimac tubes ahead of the industry... a factor that is logical because the efficiency and progress of radio depends almost entirely upon the development of new ideas... new improvements in vacuum tube performance. Take the Eimac 250T, for example, which now possesses the most recently developed refinements. Check these features illustrated below and then check the performance of Eimac tubes in your transmitter. You'll see why Eimac tubes are found in most of the important new developments in radio.

Follow the leaders to

**Eimac**  
**TUBES**

Eitel-McCullough, Inc.  
San Bruno, Calif.

Note the solid tungsten plate lead. No sharp edges on exterior of bulb to cause corona.

Note sturdy joint of plate hood to plate lead and then absence of complicated plate stem seal. Tube is mechanically rugged.

Improved thoriated tungsten filament for long life.

Sparklingly clean bulb attests the hard vacuum and absence of contaminating gas. All Eimac tubes are unconditionally guaranteed against premature failures caused by gas released internally.

Tungsten bar grid lead straight through bulb.

## EIMAC REPRESENTATIVES

California, Nevada  
HERB BECKER, 1530 W.  
104th St., Los Angeles, Cal.  
N. Y., N. J., Penn., Md., Del.,  
Dist. of Col., Maine, N. H.,  
R. I., Conn., Mass.  
ADOLPH SCHWARTZ, 262  
Grayson Place, Teaneck, New  
Jersey.

Wash., Ore., Idaho, Mont.  
GENERAL SALES CO.,  
Verner O. Jensen, 2605-07  
Second Ave., Seattle, Wash.

Colo., Wyo., New Mexico,  
Arizona, Utah  
RICHARD A. HYDE, 4253  
Quitman St., Denver, Colo.

Chicago, Illinois, Wisconsin  
G. G. RYAN, 549 W.  
Washington Blvd., Chicago,  
Ill.

N. Caro., S. Caro., Georgia,  
Tenn., Flor., Ala., Miss.  
JAMES MILLAR, 316 Ninth  
St. N. E., Atlanta, Georgia.

Texas, La., Okla., Ark.  
J. EARL SMITH, 2821 Live  
Oak St., Dallas, Texas.

Ohio, Mich., Ky., Ind., Minn.,  
Mo., Kan., Neb., Iowa  
PEEL SALES ENGINEER-  
ING CO., E. R. Peel, 154  
E. Erie St., Chicago, Ill.

Export Agents: Frazar & Co., Ltd., 301 Clay Street, San Francisco



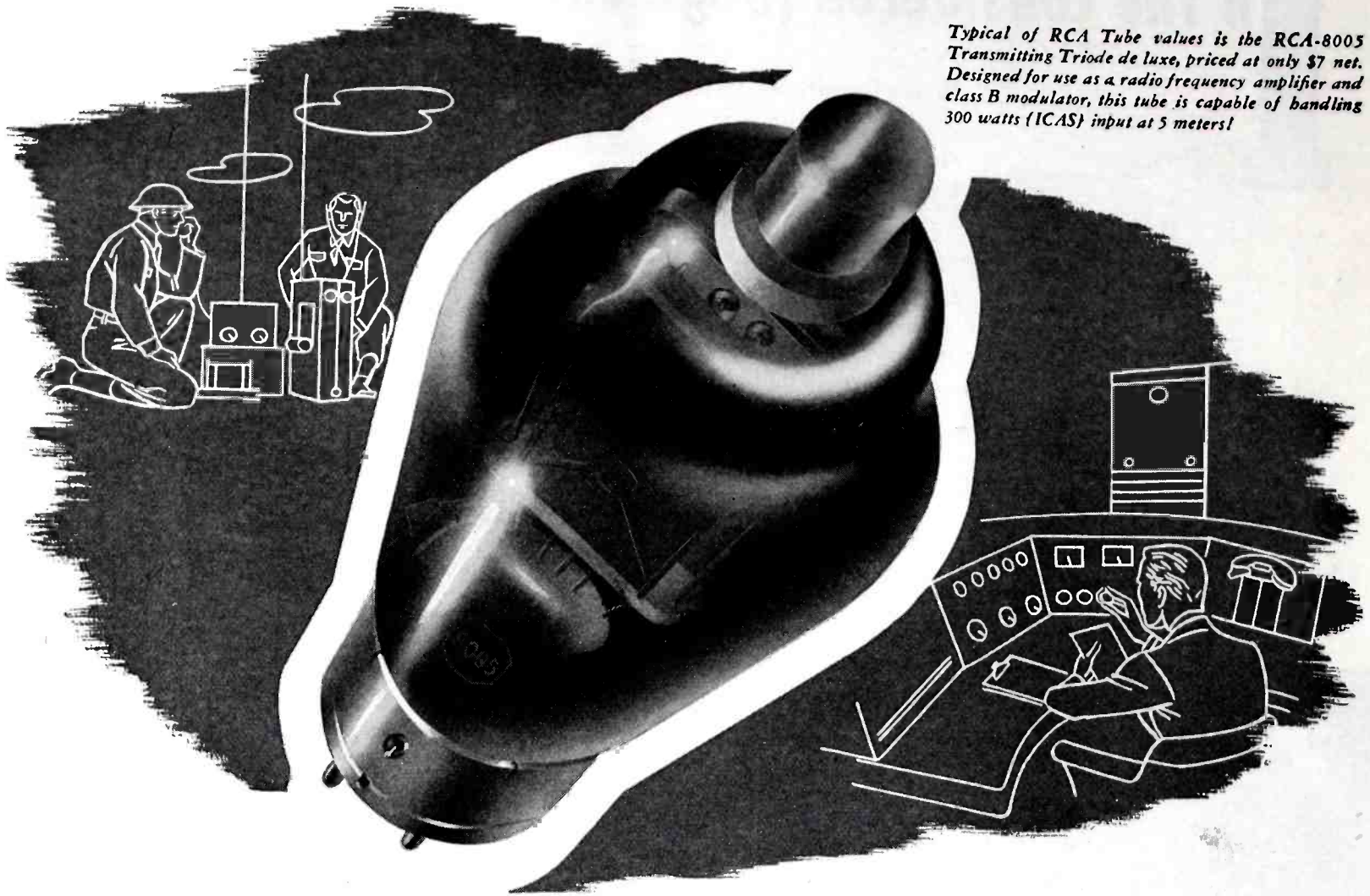

*Typical of RCA Tube values is the RCA-8005 Transmitting Triode de luxe, priced at only \$7 net. Designed for use as a radio frequency amplifier and class B modulator, this tube is capable of handling 300 watts (ICAS) input at 5 meters!*

# **PRODUCTION FOR DEFENSE ... COOPERATION FOR ALL!**

Defense production with RCA gets first call—and always will. Suffice to say that a tremendous quantity of RCA Transmitting Tubes is being supplied for a wide variety of defense needs. Meanwhile, although the 1941 total of RCA Transmitting Tubes supplied through our regular distribution channels will exceed that of last year, there is a scarcity of certain types. We know you will understand that this is unavoidable. We know, too, that we can count on your cooperation during these trying times—just as we want our countless friends in all branches of Radio to know that they can count on ours.

RCA Transmitting Tube quality is being rigidly maintained. RCA publications will be kept up-to-date. Ham Tips for amateurs will be continued. New data and construction material will be supplied. Inquiries about RCA Tubes and their applications will be answered promptly. Above all, research and development work is continuing as never before.

Thus, although it may not always be possible to supply the tubes you want during the National Emergency, RCA is still on the job to help wherever and whenever it can!



## **TRANSMITTING TUBES**

**RCA MANUFACTURING CO., Inc., Camden, N. J.**

**A Service of The Radio Corporation of America • For Canadian prices write to RCA Victor Company Limited, Montreal**

## The Measurement of IRON-CORED CHOKE INDUCTANCE\*

THE DESIGN of rectifier filters requires a knowledge of the inductance of the chokes used in the circuits under actual working conditions. These chokes carry currents which have both d-c and a-c components, and the inductance of the chokes under these conditions may be quite different from that measured by the usual methods. The purpose of this paper is to present a method of measuring the choke inductance under conditions simulating those of actual use. This method may be applied also to inductance measurements of the audio transformers and reactors of radio receivers and transmitters.

The choke current of rectifier filter circuits consists of a d-c component, and a-c fundamental and harmonic components. In most applications these a-c harmonic components are negligible as compared to the fundamental component, and a combination of a d-c voltage and a sinusoidal a-c voltage may be used for testing the chokes. The inductance of an iron-cored choke coil when tested under these conditions will depend upon the magnitude of the alternating component of current, and the previous history of the magnetic material of the core. Most inductance coils have an appreciable amount of interwinding capacitance; hence, the effective inductance will also depend upon the frequency of the superimposed alternating current. For consistent results the core of the choke should be completely demagnetized before any tests are made.

A number of methods for measuring the inductance which an iron-cored coil offers to an alternating current superimposed upon a direct current have been developed. Terman has given a method whereby a modification of the Hay bridge is used to measure the inductance.<sup>1</sup> The alternating component of current carried by the inductance is varied in the process of

“In-action” bridge method expounded. Application eliminates questionable results in development and design.

by E. H. MEIER and D. L. WAIDELICH

General Electric Company

University of Missouri

attaining a balance for this bridge and the magnitude of this component of

current is not readily obtained. In addition, the balance equations depend on the frequency for the Hay bridge.

Bridge arrangements which employ standard inductances have also been used.<sup>2</sup> For such arrangements, however, the amount of direct current which can be made to flow in the coil which is under test is limited by the current-carrying capacity of the standard inductance. For the measurement of large inductances by this method the standard inductance must also be large to get accurate results.

The voltmeter-ammeter method<sup>3</sup> of measuring inductance may also be used, and is probably the most popular method. Several disadvantages are the shunting effect of the d-c source, the wave form error, and the neglect of the a-c resistance of the choke to be tested.

A modification of the Owen bridge<sup>4</sup> was used in determining the apparent inductance of an iron-cored coil carrying an alternating current superimposed upon a direct current. The essential circuit of the standard Owen bridge is shown in Figure 1. The resistances  $R_1$  and  $R_2$  are fixed, non-inductive, standard resistances; and  $C_3$  is a fixed, standard capacitance. The capacitance  $C_4$  is a standard capacitance which can be varied by small amounts and  $R_4$  is a standard resistance which is also variable. The inductance under test is  $L$  and the apparent series resistance of this inductance is  $R_L$ . A standard Owen bridge has the complex balance equation

$$\frac{Z_1}{Z_2} = \frac{Z_3}{Z_4}$$

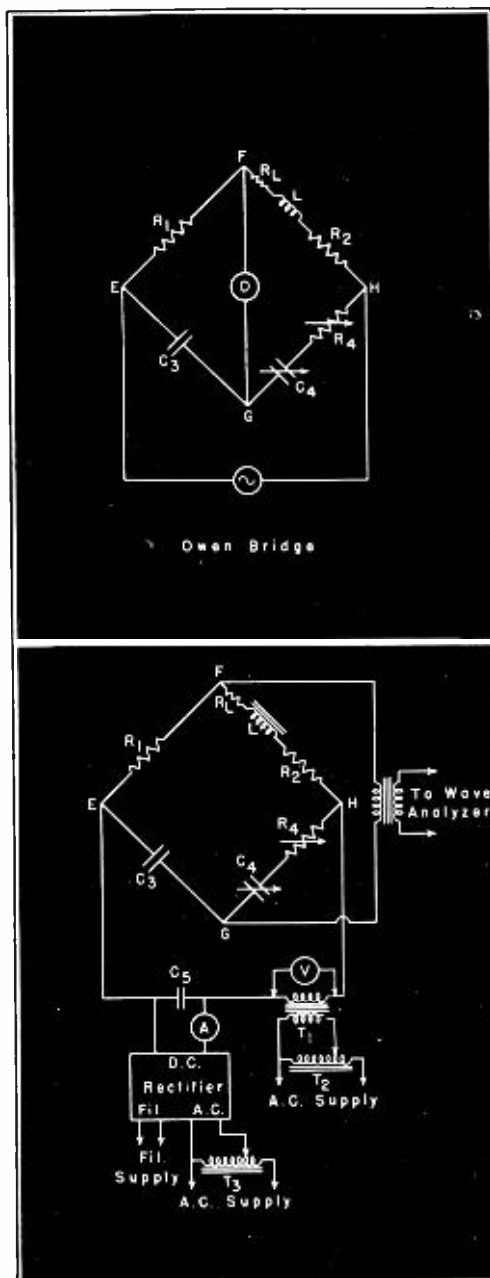

Figure 1 (top)—Figure 2 (bottom).

\*This paper constitutes a report on a project of the Engineering Experiment Station, University of Missouri.



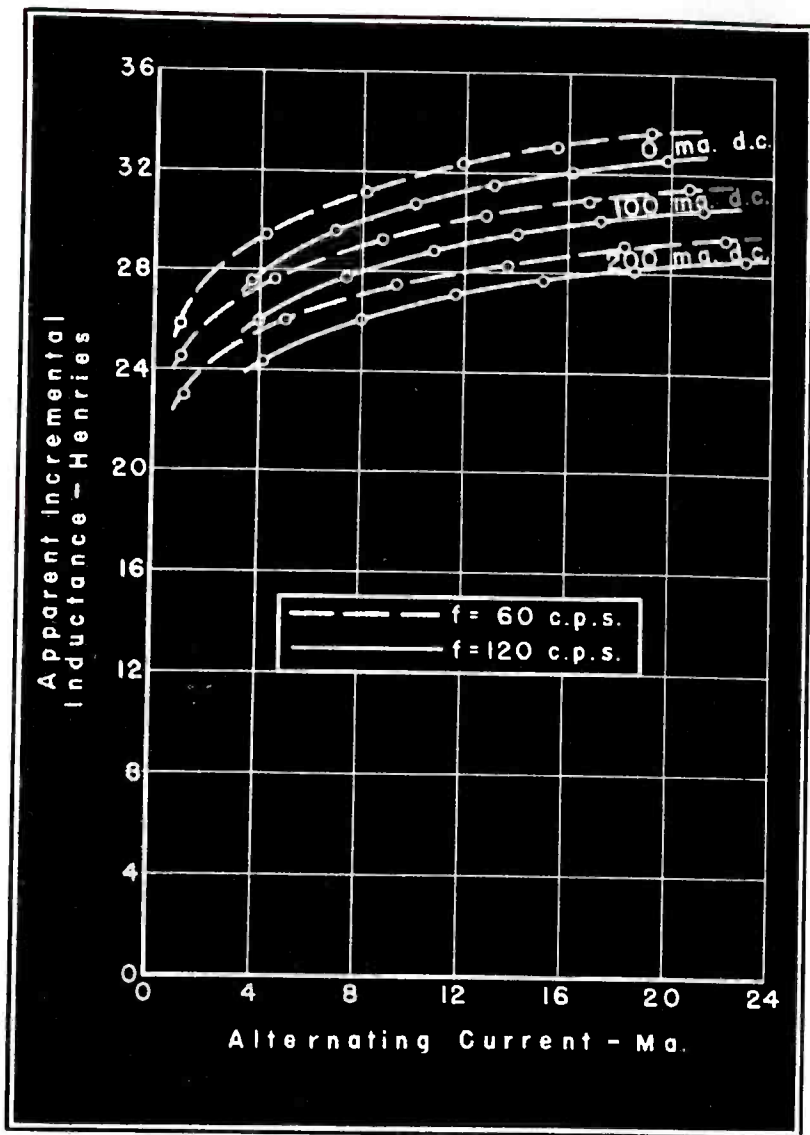

Figure 3  
Inductance as against the size of the alternating component of current for an iron-cored coil in the magnetic circuit are plotted in this curve. With the increased inductance, the magnitude of a-c increases, but the magnitude of d-c decreases.

nating voltage-drop across the capacitance  $C_s$  and the direct voltage-drop across the transformer  $T_1$  are small, the voltage measured by the voltmeter  $V$  can be assumed to be equal to the alternating component of voltage across  $E$  and  $H$ . The alternating component of current in the inductance is, therefore, given by

$$I_{AC} = \frac{V_{AC}}{\sqrt{(R_1 + R_2 + R_L)^2 + (\omega L)^2}}$$

The resistances  $R_1$  and  $R_2$  are usually small compared to  $\omega L$  so that most of the a-c voltage is across the choke.

The sensitivity of the Owen bridge is maximum when the resistances and reactances of the arms of the bridge and of the detecting instrument are approximately equal.<sup>4</sup> It is desirable, however, to make the value of the resistance  $R_2$  small in order that the apparent resistance of the coil may be accurately determined. The value of  $R_2$ , therefore, is made just large enough to cause the sensitivity of the bridge to be sufficient. If the apparent resistance of the coil is large the value of the resistance  $R_2$  can often be made zero. A wave analyzer was used as a detecting instrument and proved to be a very sensitive device for securing a balance.

The results obtained by using this modification of the Owen bridge to determine the inductance which an iron-cored choke offers to an alternating current superimposed upon a direct current are shown by the data and curves herein. For reasons heretofore explained the core of the inductance was completely demagnetized before the direct-current component of current was increased to the desired value. With the frequency and the direct component of current held constant, the bridge was balanced for different values of the alternating component of current; thereby determining the inductance. This procedure was repeated for other values of direct current and frequency, and typical results for a commercial choke are given in Table I where  $I_{dc}$  is the choke direct current. Curves of the inductance versus the magnitude of the alternating component of current for an iron-cored coil with no airgap in the magnetic circuit are plotted in Figure 3. It should be noted that the inductance increased with increasing magnitude of alternating current and with decreasing magnitude of direct current. For this particular coil the apparent inductance decreased with increasing frequency over the range of frequencies and currents which were used. The values of apparent resistance corresponding to the values of inductance determined for this coil are plotted in Figure 4.

The Owen bridge adapts itself readily

Substitution for the parameters of the bridge gives the complex relation

$$\frac{R_1}{(R_2 + R_L) + j\omega L} = \frac{-j/\omega C_s}{R_1 - j/\omega C_4}$$

where  $\omega/2\pi$  is the impressed a-c frequency. Cross-multiplying and equating real and imaginary terms give the following balance equations:

$$\frac{R_1}{C_4} = \frac{R_2 + R_L}{C_s}$$

and

$$R_1 R_4 = \frac{L}{C_s}$$

The expressions for  $L$  and  $R_1$  obtained from these equations are

$$R_L = \frac{R_1 C_s}{C_4} - R_2$$

and

$$L = R_1 R_4 C_s$$

It should be noted that the balance equations are independent of frequency and that the adjustment required for the balance of one equation does not disturb the balance of the second equation since the variable  $C_4$  appears in only one equation and the variable  $R_4$  appears in only the other.

The circuit shown in Figure 2 was

used to determine the inductance which an iron-cored coil offered to an alternating current superimposed upon a direct current. An alternating voltage and direct voltage were applied in series across the points  $E$  and  $H$ . The magnitude of the direct current which the inductance carries depends upon the magnitude of the direct voltage. This voltage was varied by changing the input voltage to the rectifier circuit by use of the variable auto-transformer  $T_3$ . Since the branches  $EG$  and  $GH$  contain series capacitances, no direct current can flow in these arms or the detector circuit. Therefore, the direct current carried by the inductance was measured by the milliammeter  $A$ .

The magnitude of the alternating component of current carried by the coil depends upon the output voltage of the transformer  $T_1$ . This voltage was varied by changing the input voltage to transformer  $T_1$  by use of the variable auto-transformer  $T_2$ .  $T_1$  was large enough so that the wave form of the a-c voltage was not appreciably affected by the direct current flowing in the secondary. In order to isolate the direct-current supply from the alternating current flowing in this series arrangement, a large capacitance,  $C_s$ , was connected across the direct current voltage output and the meter  $A$ . Since the alter-



to the measurement of the inductance of a coil carrying direct current. The direct current can be made to flow through the inductance without disturbing the alternating-current balance of the bridge because of the series capacitances in two of the branches. Since the parameters which are varied to secure a balance are in one of the arms containing series capacitance, the direct current which the inductance carries is not varied in the process of securing a balance. The two conditions of balance may be secured without mutual interference and the end point may be rapidly attained. The balance is independent of frequency and, therefore, is not affected by the wave form of the alternating voltage applied. The wave form of the alternating voltage applied to the bridge must be nearly sinusoidal, however, in order that the alternating component of current carried by the inductance can be determined accurately. The rating of the transformer, therefore, must be large enough to keep the wave form of the output-voltage from being seriously affected by saturation of the iron core of the transformer caused by the direct component of current carried by the transformer. If a tuned vacuum-tube voltmeter is used as a detector the sensitivity of the bridge is very high. The standard resistances  $R_1$  and  $R_2$  carry the same current as the inductance under test and, therefore, must have rather large current-carrying capacities.

For many applications of iron-cored coils no undesirable effects are caused by the variation in the inductance of

Figure 4  
The values of apparent resistance corresponding to the values of inductance determined for the coil under test are plotted in this chart.

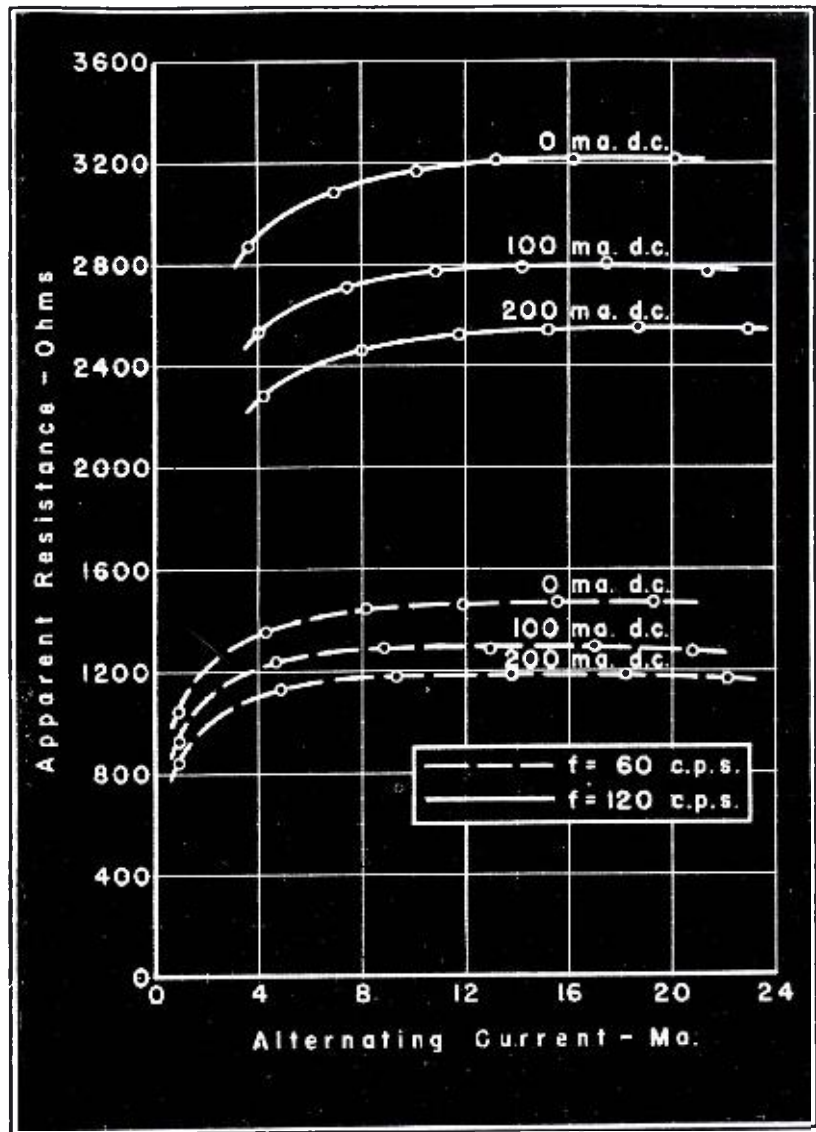

the coils. For the careful analysis and design of filter circuits containing such inductances, however, it becomes increasingly important to be able to assign definite values of inductance to

the coils when used under specified conditions. To state that an iron-cored coil has a certain inductance is meaningless unless the conditions under  
(Concluded on page 29)

Table I  
Apparent Inductance and Resistance of a Commercial Choke

D-C Resistance = 52.5 ohms

$R_1 = 500$  ohms     $R_2 = 0$  ohm     $C_3 = 1$  mfd.

Frequency $\omega/2\pi$ c.p.s.	Meter Readings		Bridge Adjustments		Calculated Values		
	$I_{dc}$ Ma.	$V_{ac}$ volts	$R_1$ ohms	$C_1$ mfd.	$L$ henrys	$R_L$ ohms	$I_{AC}$ ma.
60	0	10	51,800	0.477	25.90	1,048	1.01
60	0	250	67,280	0.339	33.65	1,475	19.31
60	200	10	46,010	0.582	23.00	859	1.14
60	200	250	58,810	0.422	29.40	1,185	22.30
120	0	80	55,540	0.173	27.75	2,890	3.77
120	0	500	65,270	0.155	32.60	3,225	20.10
120	200	80	48,840	0.218	24.42	2,290	4.29
120	200	500	56,960	0.195	28.48	2,560	21.70



# COLUMBIA ISLAND

In this, the 2nd and concluding article on the new 50 kw WABC "salt-water" station, a detailed description of the transmitter and associated equipment is presented for the first time.

by DONALD PHILLIPS

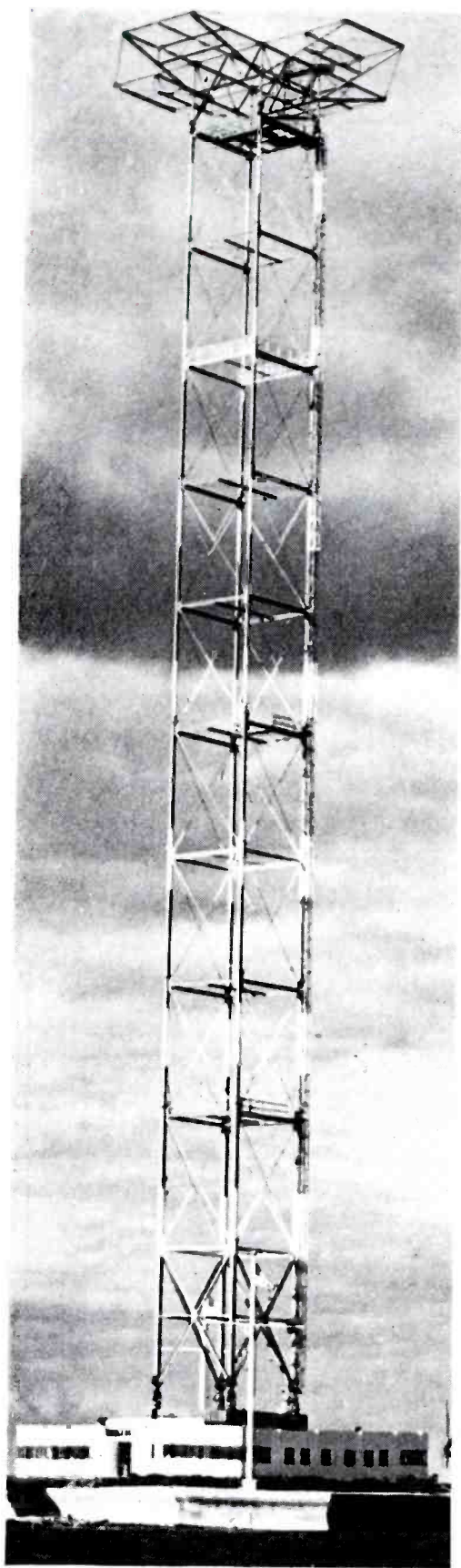

Figure 1

All steel 180 ton antenna tower, with its 85 foot steel "top-hat."

FUNDAMENTALLY each of the two complete and independent Columbia Island transmitters capable of delivering 50 kw and 5 kw (auxiliary unit), consist of a crystal controlled oscillator followed by four radio frequency amplifiers, the last of which is modulated by a high level class AB1 modulator, driven by three push-pull audio stages. The oscillator and the first buffer RF amplifier is installed in duplicate and each assembly has its own plate rectifier. Similarly the first two audio stages are installed in duplicate and each of these has its own plate rectifier.

The front panel units consist of the exciter modulator and power amplifier. They are positioned behind a separate "false front" panel with electrically locked doors preventing access to the equipment when high voltages are on.

Each of these units has its control and meter panel located approximately 42 inches above the floor and mounted on a 45 degree angle for convenience in reading meters and operating controls. In the power amplifier unit the most important meters are large scale, 6" x 6" size, and located so that they are visible from the control console. Smaller meters used for making adjustments and the controls are located under hinged covers. In the modulator and exciter units, meters and controls are located also under hinged covers.

In the 5 kw unit a two stage push-pull resistance coupled amplifier is in-

stalled in duplicate in the modulator unit, with a plate rectifier using two Type 816 tubes delivering approximately 1000 volts for the plates of the amplifier tubes.

Two identical oscillator-buffer trays mount in this unit on slides, on which they may be withdrawn and removed for servicing. The tray is designed to operate on 115 volts so that it may be operated for test and checking on the house service. Individual power switches, located on the exciter control panel are provided for the trays which are electrically locked in place, so that a tray may not be removed until its power switch is "off" and the power switch for the other tray is "on." Connections are made by a plug-in arrangement so that it is unnecessary to remove any wires to withdraw a tray. A transfer switch permits selection of the radio frequency output of either tray from the exciter control panel.

#### Temperature Controlled Oscillator

Each tray has its temperature-controlled crystal oscillator using a type 807 tube and an 807 buffer stage, and its individual power supply, which uses a type 5Z3 rectifier tube. Four meters on each tray read plate voltage, oscillator cathode current, oscillator grid current and buffer cathode current.

The output of the tray drives the grids of two type 813 tubes operated in parallel as the RF driver for the final



power amplifier. These tubes have their filaments supplied with alternating current.

A 1500 volt .75 ampere plate rectifier is located in this unit supplying plate voltage for the two 813 tubes and for the two 845 tubes in the third audio amplifier located in the modulator unit.

There is also in this unit a 1200 volt bias rectifier which supplies bias for two F-891-R tubes in the modulator stage.

#### Unique Meter Installation

Meters are installed on the sloping panel of this unit to read plate current for the first 813 tube and plate current for the second 813 tube, as well as 1500 volt rectifier voltage, the total 813 grid current and oscillator grid current. The latter meter reads the individual grid current of whichever oscillator is turned on, or the sum of the grid currents of the two oscillators if both are turned on.

Up to 4 kilowatts of audio energy is provided by the modulator unit for plate modulation of the F-891-R tube in the final power amplifier.

Two identical type audio amplifier trays are also located in this unit mounted on slides on which they also may be withdrawn and removed for servicing. This, too, is designed to operate on 115 volts so that it may be operated for test and checking, etc. Power contacts for this unit operate in the same fashion as for the oscillator-buffer trays.

#### Push-Pull Audio

The audio tray comprises a two stage push-pull audio amplifier, the first stage using two type 1603 tubes, resistance coupled to the second stage which uses two type 802 tubes. The internal power supply uses a Type 5Z3 rectifier tube. Meters on the tray read plate voltage

and cathode current for each of the amplifier tubes.

The balanced audio output of the tray is carried by two concentric transmission lines to the grids of the push-pull 3rd audio amplifier in which two 845 tubes are used. These are cathode biased and have their plate voltage supplied by a 1500 volt rectifier in the exciter unit. The audio output of this stage is transformer coupled to the grids of the two F-891-R modulator tubes.

Grid bias for the modulator stage is supplied by a 1200 volt .5 ampere rectifier located in the exciter unit. This bias is individually adjustable for each F-891-R tube by potentiometers operated by the modulator control panel.

The 5 kw transmitter control system allows "standby" with rectifier filaments at half voltage and provides for cutting in either directly to the antenna or

to act as a driver for the 50 kilowatt amplifier of the main transmitter.

The Exciter Unit in the 50 kw unit furnishes radio frequency energy to drive the grids of two F-124-A tubes in the final power amplifier.

Two identical oscillator-buffer trays (same as in the 5 kw unit) mount in this unit and are removable as heretofore described.

Each tray here also has its temperature-controlled crystal oscillator using a type 807 tube and 807 buffer stage, with its individual plate power supply and a type 5Z3 rectifier tube. The output of this tray drives the grid of an 813 beam power tube radio frequency amplifier which supplies excitation for the grids of the F-128-A tubes in the output stage of the driver. Variable condensers are used in tuning the output tank circuits of these two stages and the 128A stage is inductively neutral-

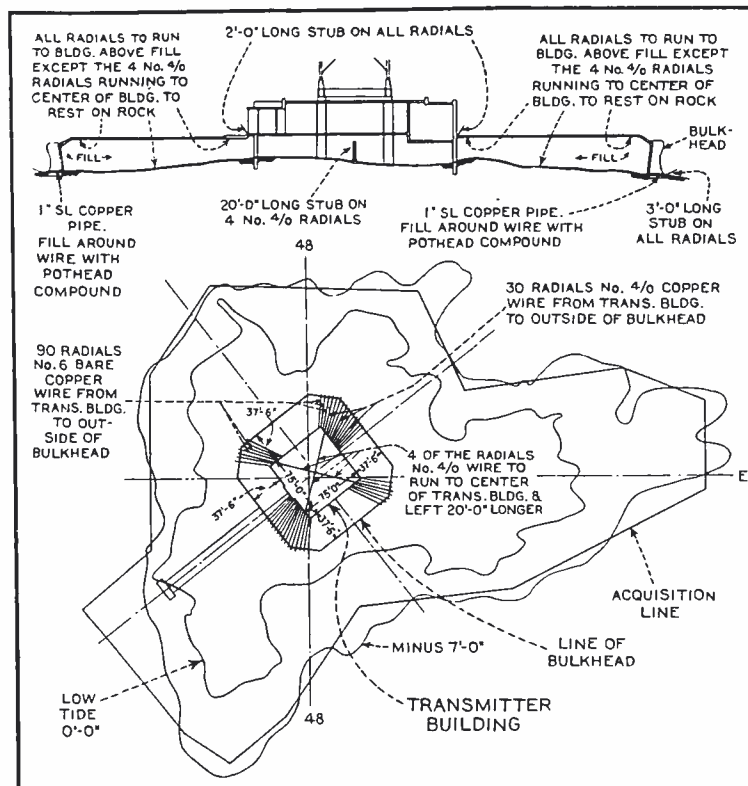

Figure 2  
Diagrammatic illustration of the ground radial system on Columbia Island. These radials, 300 feet out, serve to form an exceedingly effective method of grounding.

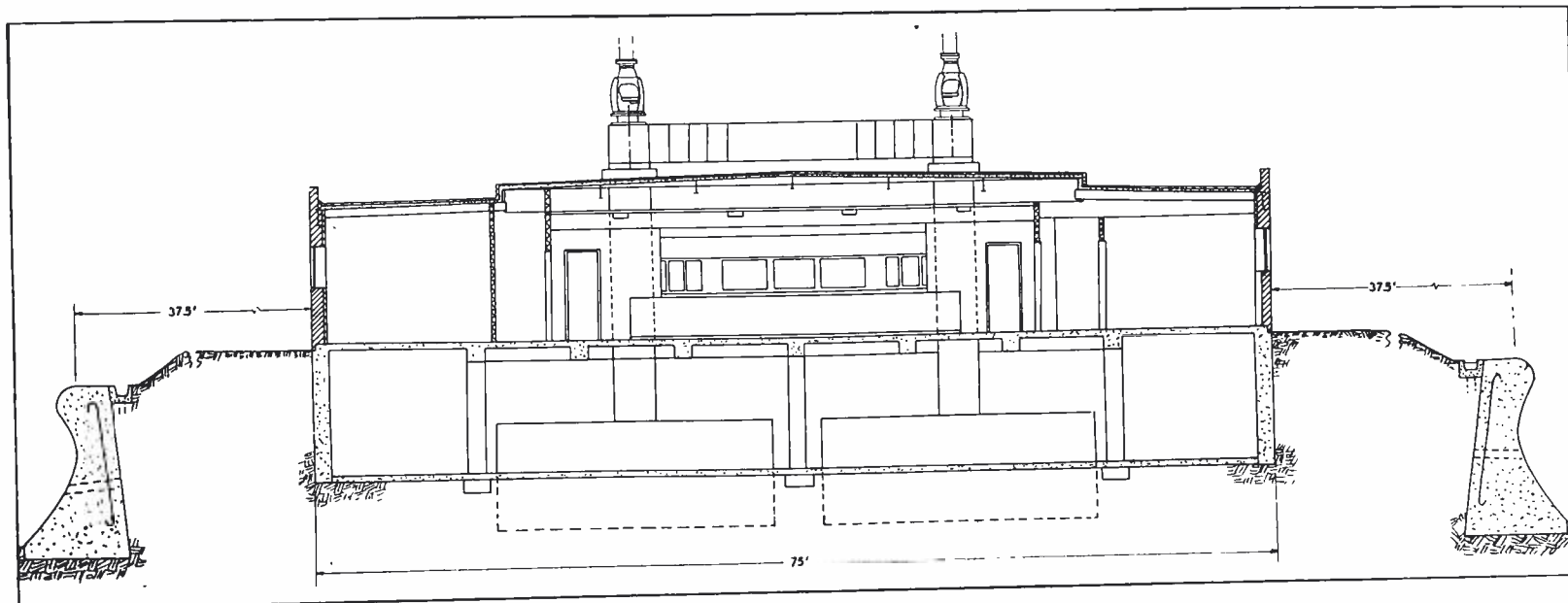

Figure 3  
A cross sectional view of the island. Note the concrete antenna pillars that extend through the building.



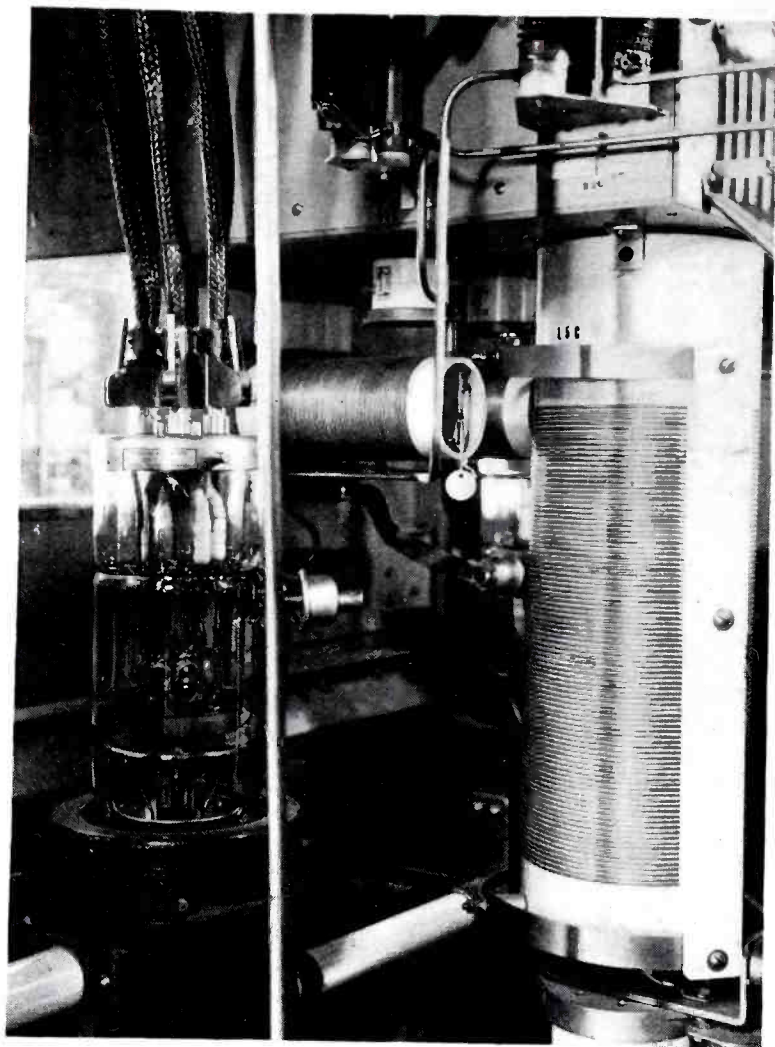

Figure 4  
The right side view of the 50 kw. power amplifier, showing the F-124-A output tubes, grid chokes and neutralizing coil.

ized with a condenser for vernier adjustment of the neutralization. This can be checked on a thermocouple meter cut into the circuit by a switch which at the same time removes the 128A plate voltage.

All tubes in the exciter have their filaments supplied by a-c transformers.

A 3000 volt 1.5 ampere plate rectifier is located in this unit supplying plate voltage for the 813 and F-128-A tubes, this rectifier also supplying the plates of the 3rd audio amplifier in the modulator unit.

#### Identical Audio Trays

Two identical audio amplifier trays are located in this unit, mounted on slides which may be easily withdrawn and removed for servicing. A transfer switch on this tray permits selection of the audio output of either tray from the modulator control panel. This switch also transfers the audio input to the tray of the feedback circuit from the modulator output. This audio tray comprises a two stage push-pull audio amplifier, the first stage using two type 1603 tubes resistance coupled to the second stage using two type 802 tubes. The integral power supply uses two type 816 rectifier tubes. Meters on the tray read rectifier plate voltage and cathode current for each of the four amplifier tubes.

The balanced audio output of the tray

is carried by two concentric transmission lines to the grids of the push-pull 3rd audio amplifier in which two F-132A tubes are used. These are cathode biased and have their plate voltage supplied by a 3,000 volt rectifier in the exciter unit. The audio output of this stage is transformer coupled to the grids of two F-125-A push-pull modulator tubes.

Grid bias for the modulator stage is supplied by a 3,400 volt 1.4 ampere rectifier located in the control unit. This is individually adjustable for each F-125-A tube by potentiometers operated from the modulator control panel.

The third audio amplifier driver stage uses two type 132-A tubes with a plate voltage of 3,000 volts. In the modulator stage two F-125-A tubes are used in push-pull with their filaments lighted by six phase a-c.

#### Thermostat Control

A thermostat mounted on one of the filament leads of a 125-A tube operates when the filament lead becomes warm. This thermostat when operated holds the control circuit to the distilled water pump on, after the auxiliary supply switch on the cathode has been broken, so that water flow will continue for a few minutes after the transmitter has been shut down.

The power amplifier unit with two F-124-A tubes comprises the modulated

amplifier together with output tank circuit and matching network components.

A 3,400 volt modulator bias rectifier and two 400 volt power amplifier bias rectifiers are located in the control unit, which also contains a 24 volt copper oxide rectifier that serves relays and circuit breakers.

#### Pi Antenna Network

The antenna coupling unit consists essentially of a Pi network for matching the 75 ohm output of the T network in the power amplifier to the antenna. In addition there is a loading inductance to tune out the negative reactance of the antenna. The shunt elements of the network are air insulated aluminum plate condensers.

#### 50 Kw. Rectifiers

The rectifier unit for this 50 kilowatt assembly, installed in the rear enclosure of the transmitter, consists of seven F-357 mercury vapor tubes with six being used in a conventional 3 phase full wave circuit. The seventh is available for immediate cut in by transfer of a "plug bar." All power to the transmitter passes through a motor operated 460 volt three pole main station circuit breaker which is equipped with both instantaneous and inverse time delay tripping. From the output of this main breaker, power is distributed through individual circuit breakers and magnetic

Type	Function
F-124-A	Final Power Amplifier
F-128-A	R-F Driver Amplifier
813	Int. R-F Amplifier
807	Buffer Amplifier (Duplicate Oscillator Buffer Trays)
807	Crystal Oscillator (Duplicate Oscillator Buffer Trays)
F-125-A	Modulator
F-132-A	A-F Driver
802	A-F Amplifier (Duplicate Amplifier trays)
1603	A-F Amplifier (Duplicate Amplifier trays)
F-357-A	12,000 volt Plate Rectifier (1 standby tube)
F353-A	3000 volt Plate Rectifier
866	400 volt Bias Rectifier
F-353-A	3400 volt Bias Rectifier
816	4 - 450 volt Plate Rectifiers
84	Carrier Rectifier
84	Monitor Rectifier
84	Feedback Rectifier
84	Carrier Cutoff Circuit Rectifier

Figure 5  
The tube complement for the 50 kw transmitter.



contactors to the auxiliary circuits of the transmitter.

### Cooling System

The cooling system circulates and cools distilled water used to cool the plates of the modulator and power amplifier tubes and also to carry off the heat from the water cooled dummy or artificial antenna. Motor operated centrifugal pumps are used to circulate distilled water through the system and an evaporative cooler is used for cooling the water. This cooler is equipped with a blower and a raw water circulating pump which sprays raw water over the tubes of the cooler, the make-up water for the raw water system being drawn from the house water supply. Distilled water tanks are provided for the distilled water. To insure constancy of flow, the coolers, distilled water tanks, and distilled water pumps are supplied in duplicate.

The cooling system is provided with interlocking in the form of flow relays which operate to remove filament and plate power from the water cooled tubes in case of insufficient flow. A thermostat serves to ring an alarm bell in the control unit, in case the water temperature rises above a predetermined value. This thermostat may be adjusted to any value between 100 and 200 degrees F. Under normal circumstances this is usually set at 135 degrees. Another thermostat operates to remove plate and filament power from the transmitter in case the water temperature arrives at a predetermined value. This thermostat may also be set between 100 and 200

Figure 6  
Rear view of the 5 kw. modulator section. Note the simplicity of layout and wiring. Where name plates do not appear on the components, identifying marks have been stamped directly on the panel beside each part.

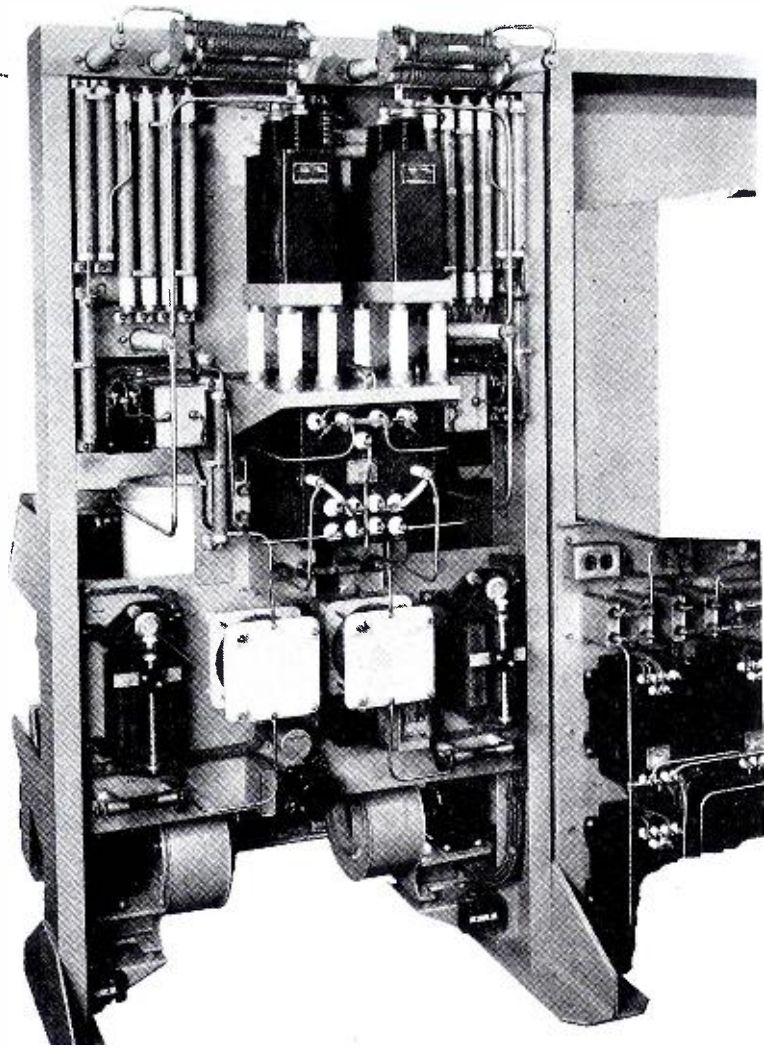

degrees F., and ordinarily 155 degree temperature is used. Thus the thermostat first described gives a warning period allowing the operator to investigate the cause of the hot water before the transmitter is cut off the air by the latter thermostat described. Thermometers are also provided for reading inlet and outlet water temperatures on the modulator and PA cooling systems as well as for the dummy antenna system. The remote reading thermometer reads the inlet and outlet temperature of the entire system for the cooling of the transmitting tubes. A flow relay prevents application of radio frequency power to the dummy antenna unless sufficient water is flowing therein, while a meter in the power amplifier keeps checks on any water leakage current in this circuit.

### Constant Voltage Transformers

Twelve constant voltage transformers provide constant voltage within one per cent for the filaments of the two power amplifier and two modulator tubes. In addition, these constant voltage transformers provide current limitation on starting so that the cold filament will not draw dangerous currents when voltage is applied. These twelve regulators are wired in four groups providing 3 phase power for each of these tubes.

The exciter unit furnishing radio fre-

quency energy to drive the grids of the F-892-R tube in the final power amplifier, contains two RF oscillator buffer trays each with its integral plate rectifier, the second radio frequency amplifier using a type 813 tube and the radio frequency driver amplifier using two type F-128-A tubes. A 3,000 volt plate rectifier using three type F-353-A mercury tubes is a part of this unit. The F-128-A tube in the RF driver amplifier are neutralized by means of inductance neutralization, using an inductor in series with a condenser which in turn is used for vernier adjustment of the neutralization.

Since the plate current drawn by the F-128-A tubes is approximately sixty per cent of the total load on a 3000 volt rectifier no individual plate current overload relay is provided for the F-128-A stage. Overloads in this stage as well as any other d-c overload on the 3,000 volt rectifier operate a relay which is shunted across a resistance in a negative lead of the 3,000 volt rectifier which has a calibrating resistor.

### 3000 Volt Rectifier

The 3,000 volt rectifier is a conventional 3 phase half-wave inter-connected "wye" using plate transformers and filament transformers. The positive lead of the rectifier is brought to a mechanically operated relay which is

Type	Function
F-892-R	Final Power Amplifier
813	R-F Driver Amplifier
807	Buffer Amplifier
807	Crystal Oscillator (Duplicate Oscillator-Buffer Trays for items No. 3 and No. 4)
F-891-R	Modulator
845	A-F Driver
807	A-F Amplifier (Duplicate A-F Amplifier Trays)
1603	A-F Amplifier (Duplicate A-F Amplifier Trays)
F-353-A	8000 volt Plate Rectifier (1 standby tube)
866-A	1500 volt Plate Rectifier
866-A	1250 volt Bias Rectifier
83	4 - 450 volt Plate Rectifiers
84	Monitor Rectifier

Figure 7  
The tube complement for the 5 kw transmitter.



closed by the upper front door of the unit and from there to another relay which removes plate voltages from the 128-A and 813 stages when the 5 kilowatt auxiliary transmitter is used as a driver for the 50 kilowatt power amplifier.

The 3,000 volt rectifier of this unit also supplies plate voltage for the third audio amplifier located in the modulator unit. When this unit is replaced by the 5 kilowatt transmitter as a driver for the power amplifier, this rectifier is still active. The tubes of this rectifier are available through a door in the shelf, made accessible by opening the upper front door of the unit. However, the shelf door is separately interlocked and may not be entered during the condition when the 5 kilowatt is driving the 50 kilowatt. The interlock for this rectifier shelf door consists of a lock and a door switch.

The modulator unit of this 50 kilowatt transmitter provides up to 40 kilowatts of audio energy for plate modulation of the two F-124-A tubes in the final power amplifier.

#### 50 Kw. Power Amplifier

The 50 kilowatt plate modulated power amplifier uses two type 124-A water cooled tubes with their filaments operated on 6 phase a-c supply. The filament voltages for these tubes are adjustable individually by the third phase commutator type voltage regulators. The output of the three r-f amplifiers of the exciter unit is connected to the input of the power amplifier by means of a concentric transmission line which is brought to the contacts of a transfer contactor. This contactor connects the power amplifier grid circuit to the output of the 5 kilowatt auxiliary transmitter when this unit is used as a driver for the 50 kilowatt power amplifier. Individual grid blocking condensers are provided for each of the power amplifier tubes. These are shunted by a resistance and condenser arrangement for prevention of oscillation at low frequency.

#### Thyrte Protectors

Thyrte protectors are used so that in case of a plate voltage arc-over plate to grid the bias rectifier will not be damaged. Plate parasitic traps are provided for each of the power amplifier tubes. Lapp compressed gas tank condensers are used in the power amplifier. Pressure here is maintained at 200 pounds. Gassing the condenser is accomplished by connecting a pressure regulator to a cylinder of oil pumped nitrogen and adjusting the diaphragm

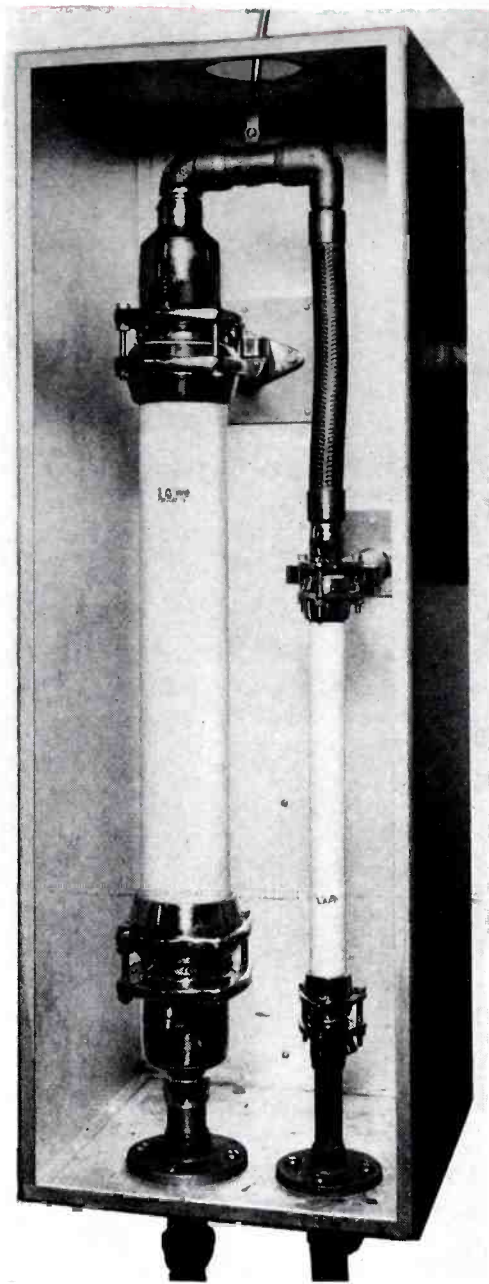

Figure 8

The water cooled dummy antenna that is connected to the "off-air" transmitter.

of the regulator until the output pressure gauge reads 200 pounds. An air hose on the opposite side of the regulator is then connected to the valve on the Lapp condenser and the gas in the hose is allowed to equalize with that in the condenser so as to give a reading of 200 pounds on the gauge of the condenser.

The tank condenser for the 5 kilowatt transmitter is also a Lapp gas filled unit, gassed to a pressure of 200 pounds in the same manner as for the 50 kilowatt transmitter.

#### Third Audio Amplifier

The third audio amplifier or driver stage of the 5 kw unit uses two type 845 tubes in a push-pull circuit. The 5 kilowatt modulator stage uses two 891-R tubes with its filaments operated on a single phase 60 cycle a-c.

In case of failure of the air supply,

air relays remove filament-plate power from the 891-R tube.

The control console is of an unusual design. It contains audio facilities and control switches for starting the transmitter with individual control of the 12 kv rectifier plate voltage.

A complete set of indicating lamps on the console shows where overloads occur and the sequence of operation of the control circuits. In usual operation the transmitter may be started and stopped from this console.

The 12 kv breaker has magnetic instantaneous and thermal inverse time limit a-c tripping action. This a-c tripping operates on back fires in the F-357 rectifier tubes or on any other a-c overload. There are other instantaneous d-c overload relays which trip the 12 kv breaker, one for each 124-A tube, one for each 125-A tube and one in the rectifier d-c negative lead. The operation of all of these relays is identical.

#### Under Voltage Release Coil

A 24 volt rectifier supplies voltage to the under voltage release coil of the 12 kv breaker through a resistor which drops the voltage to 12 volts across the coil which is its normal operating voltage. These overload relays operate to short circuit the under voltage release coil, tripping the breaker. Thus, this latter resistor momentarily has 24 volts across its terminals thereby preventing shorting of the rectifier.

A back contact on each overload relay connects to the holding contact on a lamp relay for that position, so that operation of the overload relay puts out an indicator lamp associated with that circuit. The lamp relays have a second coil which is energized through a lamp reset push button so that all lamps may be reset at once.

#### Antenna Protective Circuit

A protective circuit is provided for the antenna coupling unit and associated equipment so that in case of an arc-over due to lightning the radio frequency carrier will be momentarily interrupted and a sustained destructive arc will not result.

When the carrier is interrupted for any reason the final amplifier plate current is reduced, raising the impedance as seen by the modulator to a high value. It is undesirable to modulate the transmitter under such a condition so the audio cut-off relay is provided which operates on the rectified r-f current from the monitor rectifier tube. When this audio cut-off relay is operated, audio input is supplied to the transmitter and



when it releases, the audio line is shorted and opened. Thus when no r-f output is present the audio is removed.

The control console is divided into two independent sections, the left-hand section contains indicating lamps and switches associated with the control of the 50 kilowatt transmitter. The right-hand section contains indicating lamps and switches associated with the control of the 5 kilowatt transmitter and with the transfer of the 5 kilowatt transmitter to the antenna as an emergency transmitter in place of the 50 kilowatt regular transmitter, or in transferring the 5 kilowatt transmitter as a driver for the 50 kilowatt power amplifier in place of the regular 50 kilowatt driver.

The control of the plate breaker is designed for recycling in case of interruption but this recycling can occur only once each eight seconds; but if the plate breaker switch is closed and immediately opened, the plate breaker will not close again until the breaker reset button is pressed. In normal operation with the plate breaker closed if an interruption occurs such as an overload in one of the large tubes which opens the plate breaker, it will immediately reclose. If on reclosing an overload still exists, the plate breaker will open and remain open until the reset button is pressed manually closing it.

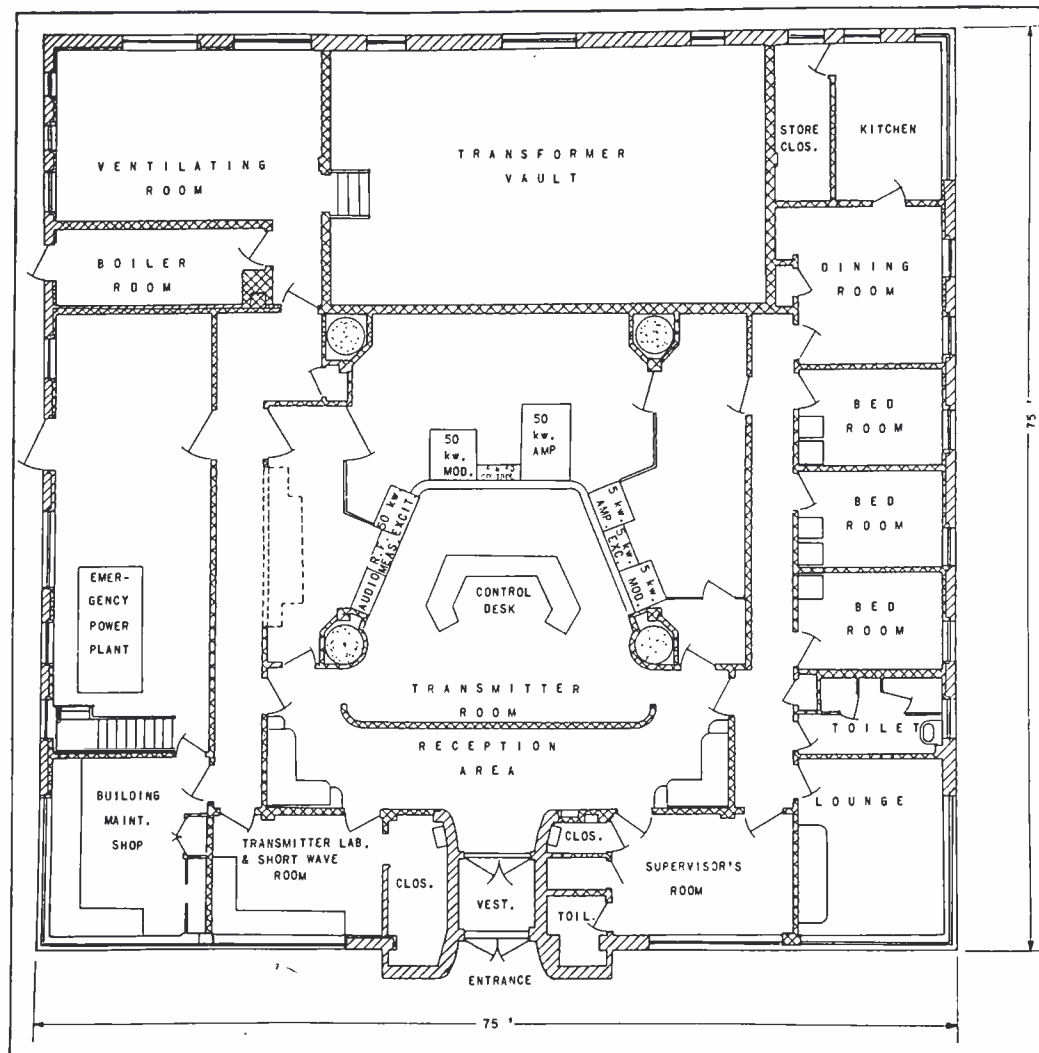

Figure 9

The complete plan of the main floor at Columbia Island.

### Indicating Lamps

The indicating lamps on the control board are installed primarily to show the function of the control circuits rather than to indicate the proper operation of the radio and audio circuits of the transmitter or rectifier output voltages, etc. In the case of the bias rectifiers, the lamps operate from marginal release relays and actually indicate that bias is present on the grids of the tubes. However, in the case of a 450 volt tray plate rectifier and in the case of a 3,000 volt plate rectifier, as well as a 12 kilo-

volt plate rectifier, these lamps indicate that the contactors controlling power to these rectifiers have closed but do not necessarily indicate that d-c output voltage is available from them. For example, it may be possible that the 3 kilovolt plate rectifier lamp is lighted by the 3 kv plate supplier contractor being closed, yet the circuit breaker on the power distribution panel supplying power to this circuit may be opened and

no plate voltage will be available. In this manner the lamp indications are a guide to the operation of the control circuit rather than the actual operating condition of the equipment which may be determined by the meters installed for that purpose.

### Efficiency Characteristics

The modulation capability of the 50 and 5 kw transmitters is 100%. The frequency response on both is from 40 to 10,000 cycles and within plus or minus .5 db, while the frequency response from 30 to 15,000 cycles is within plus or minus 2 db. The total rms harmonic distortion in these transmitters at 50 and 400 cycles is 1½% or less; at 5,000 cycles it is 3% or less, and at 7,500 cycles it is 5% or less. The carrier shift up to 100% modulation is less than 3%. The noise level (total rms unweighted) is at least 60 db below 100% modulation from 100 to 5,000 cycles, while above 5,000 cycles and below 100 cycles, it is at least 50 db below 100% modulation. The frequency stability is within plus or minus 5 cycles.

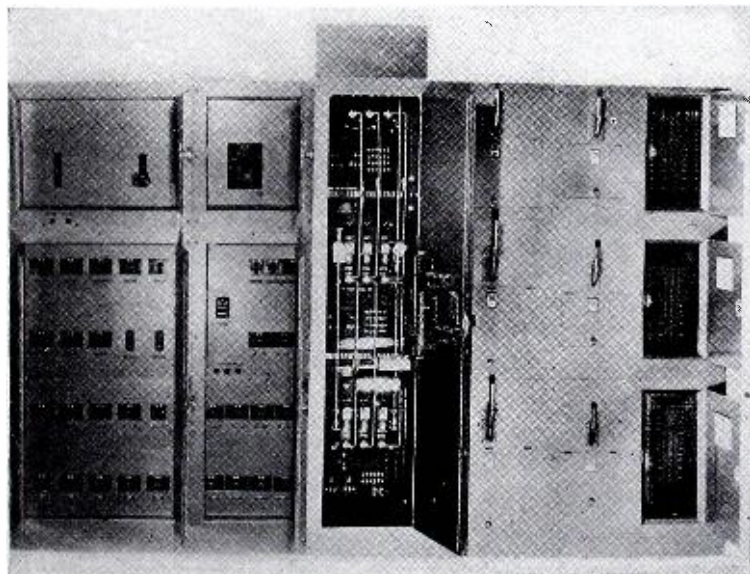

Figure 10

Front view of the switch board controlling power for the transmitter and the building as well. Novel swinging doors have been incorporated to facilitate repair and maintenance.



## A Report on the

# IRE ROCHESTER MEETING

by LEWIS WINNER

Editor

### SHEPARD'S AUDIO SYSTEM

THE hearing mechanism of the human ear has been found by research workers to have a non-linear characteristic. That is, the input-output response of the ear is such that the sensitivity of the ear is great for small amplitude signals and greatly reduced for high amplitude signals. This non-linear characteristic also causes the generation of harmonics. In addition, the non-linearity of the ear is different at different sound intensity levels. In this way the ear corrects for sound absorption effects in nature to keep the timbre of sound generated at various distances, or nearly constant as heard by the brain. (See Fig. 1—Stevens and Neuman curve.)

The fact that the ear is in itself non-linear in varying amounts permits the introduction of the proper type of non-linearity into an amplifier system. This permits the handling of increased amplitude ranges and at the same time gives the illusion (because of harmonics generated by the non-linearity) that certain frequencies that it is impossible to radiate, are present. By introducing a certain definite type of distortion similar to that of the human ear into the

audio circuit of an amplifier as in a small receiver or p-a system, Frank Shepard, Jr., chief engineer of Revelation Patent Holding Corporation, showed how he has been able to compress the signal level and obtain synthetic reproduction of certain frequencies, particularly those frequencies to which the listener may be deaf or which the reproducing system will not handle.

The distortion characteristic varies with the frequency and the amplitude of the signal as we can see from the composite set of characteristic curves in Fig. 2. When the level of the signal is high, the frequency characteristic falls off towards the low frequencies. This characteristic may be obtained in the conventional manner by using an output transformer having limited inductance and by using a small coupling condenser between the driver and output tube.

The distortion of the human ear at any particular frequency, said Mr. Shepard, is roughly a power function; that is the output raised to a power is a direct function of the input.

Thus in actual practice, in small radio receivers the plate load of the driver is

limited in value so that the driver has little more than enough output voltage to drive the output tube. In this way, a high degree of non-linearity is introduced even before regeneration is added. The ideal condition is never actually met in practice, because it is necessary to make the amplifier depart from the proper type of non-linearity just before maximum output is reached. This is done to produce a raucous type of distortion to give the illusion that the set has a high power output. While the set is never operated at this level in actual use, it is difficult to sell a set that does not overload raucously at maximum output.

It is desirable to have the exponent rise in value, as the frequency varies from 200 cycles to 80 or 90 cycles per second. The values of the feedback filter resistors and condenser are adjusted to form a low pass filter arrangement to obtain this characteristic. This characteristic just mentioned is the reciprocal of the frequency characteristic of the ear and is correct for all systems which radiate sound of varying inten-

(Continued on page 18)

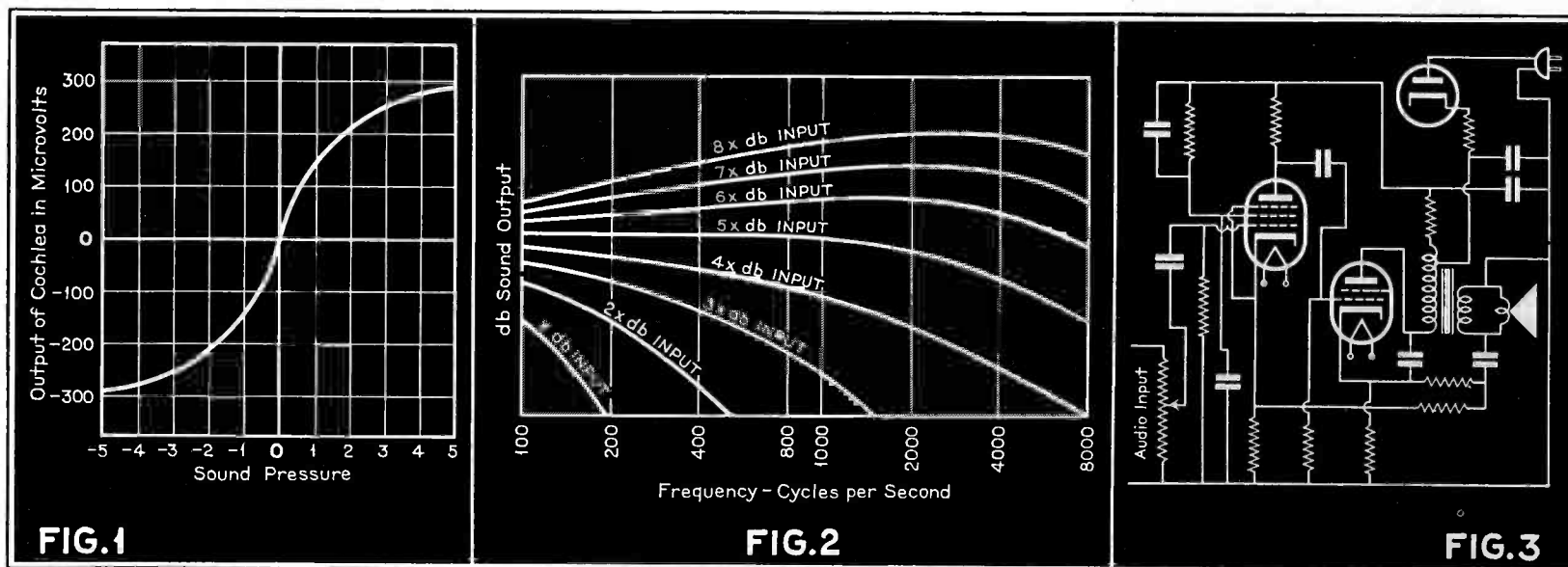



# HOW TO START A STATION

# Right!

**Here's the RCA Transmitter chosen by  
84 American Broadcasting Stations!**

Starting a *new* station—? Whether your construction permit has already been granted, or your application is still to be filed, choose the transmitter that is America's *first* choice by an impressive margin—the RCA Type 250-K, for efficient, economical, dependable operation at 100/250 watts.

84 stations, built or being built, have purchased this outstanding broadcast transmitter. Foreign purchasers account for nine more. Yet the 250-K has been on the market less than two years!

The *reasons* for such unequalled acceptance are inherent in the 250-K itself. Flat within

1½ db. from 30 to 10,000 cycles, it delivers program-quality difficult to match even at a higher price. High-level Class B Modulation, and efficient RCA-engineered circuits, keep operating costs low. It draws only 1625 watts from your power-line while operating at average program modulation on a 250-watt carrier. Installation is simple and inexpensive; operation is simplicity itself.

And—a thought for the future—the 250-K is easily adapted to 1,000-watt operation at any time, by the simple addition of the RCA amplifier unit, Type MI-7185 and suitable power-supply. Write for complete data today.

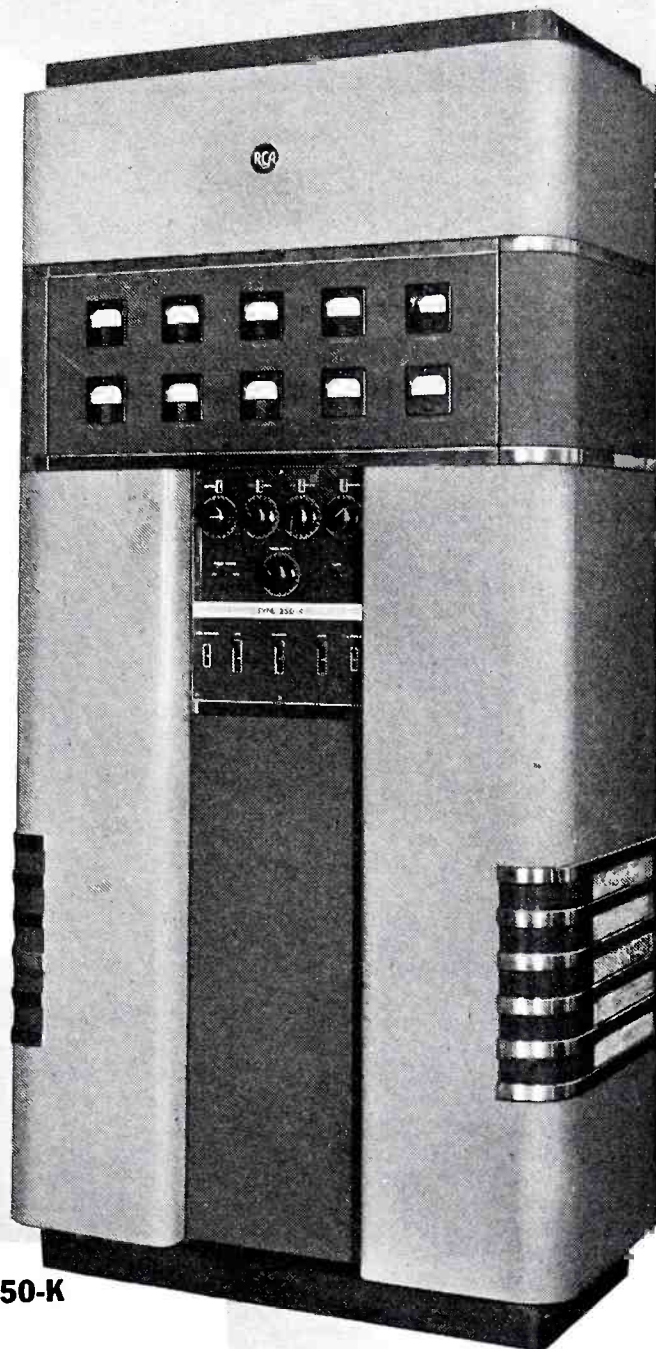

## American Broadcasting Stations Equipped with the 250-K

including 1,000-watt stations using it as a 250-watt exciter unit

KANA	KBIX	KBWD	KBUR	KFBG	KFIZ	KGLO	KFMB	KFIO	KFPW
KFXM	KHAS	KHON	KLS	KLUF	KRJF	KROD	KSKY	KSRO	KUJ
KVFD	KVOE	KWIL	KWRC	KYCA	KYOS	WAJR	WARM	WATN	WBIR
WBTA	WCED	WBOC	WDAS	WDEF	WCBI	WCRS	WDAK	WDFD	WHKY
WFIG	WGTC	WHBQ	WGOV	WISR	WHUB	WFPG	WINX	WIZE	WHYN
WGAC	WLBJ	WKIP	WKMO	WKWK	WKPA	WLAV	WLOK	WMJM	WMRN
WMOB	WMOG	WOSH	WORD	WSAV	WSGN	WSOO	WSRR	WSLB	WSOC
WTHT	WTMA	WTJS	WWNY						

... plus still others to foreign countries, American police installations, and for stations now under construction!

**RCA 250-WATT  
TYPE 250-K**



# Broadcast Equipment

RCA Manufacturing Company, Inc., Camden, N. J. • A Service of the Radio Corporation of America  
In Canada: RCA Victor Co., Ltd., Montreal



New York: 411 Fifth Ave. Chicago: 589 E. Illinois St. Atlanta: 530 Citizens & Southern Bank Bldg. Dallas: Santa Fe Bldg. San Francisco: 170 Ninth St. Hollywood: 1016 N. Sycamore Ave.





## VETERAN WIRELESS OPERATORS ASSOCIATION NEWS

W. J. McGONIGLE, President

RCA BUILDING, 30 Rockefeller Plaza, New York, N. Y.

GEORGE H. CLARK, Secretary

OUR ASSOCIATION, in cooperation with the American Signal Corps Association, tendered a Testimonial Dinner to Major General Joseph O. Mauborgne, who retired as Chief Signal Officer of the Army on September 30, 1941 after a distinguished career covering forty years. During this period he rose from enlisted man to the top office in his chosen field of Army communications.

A portion of the evening's program was broadcast over the NBC blue network during which our president, William J. McGonigle paid tribute to the outstanding accomplishments of the guest of honor and introduced General Mauborgne. General Mauborgne spoke of the need of planning for the reconstruction of world-wide communications after the present conflict is ended and told of his own early pioneering efforts in the use of radio communication in Army maneuvers. He was followed by Brig. General Follett Bradley, Commanding General of the Third Bomber Command, who flew up from Drew Field, Fla., to be present. General Bradley was the operator on the plane, in November, 1912, when radio was first used by General Mauborgne in aviation for artillery spotting.

Our prexy then introduced George H. Clark, Association secretary who read several messages among which were the following:

From David Sarnoff, president of the Radio Corporation of America: "It is altogether fitting that the Veteran Wireless Operators Association should extend to you the highest honor and recognition within their power to bestow. They see in you a pioneer, practitioner and friend of the radio art, whose vision and wisdom have greatly served our country by increasing the usefulness of radio to national defense. Your early experiments in the control of artillery fire by means of radio communication from observation airplanes marked a new epoch in military history. Your administration as Chief Signal Officer of the United States Army has been one of progress and accomplishment. I take great pleasure in joining your host of friends tonight in congratulating you upon a distinguished record of achievement, and wishing you many more years of good health and happiness."

From Hon. James Lawrence Fly, chairman of the Federal Communications Commission and the Defense Communications Board: "Mr. William J. McGonigle, president, V.W.O.A., I can think of nothing more fitting than the Testimonial Dinner by your Association in honor of General Mauborgne and I regret exceedingly that I cannot be present. It was my privilege and pleasure to work with General Mauborgne on the Defense Communications Board and I can well attest that he merits the honor you are bestowing upon him. With all best regards to General Mauborgne, to yourself and to your splendid Association".

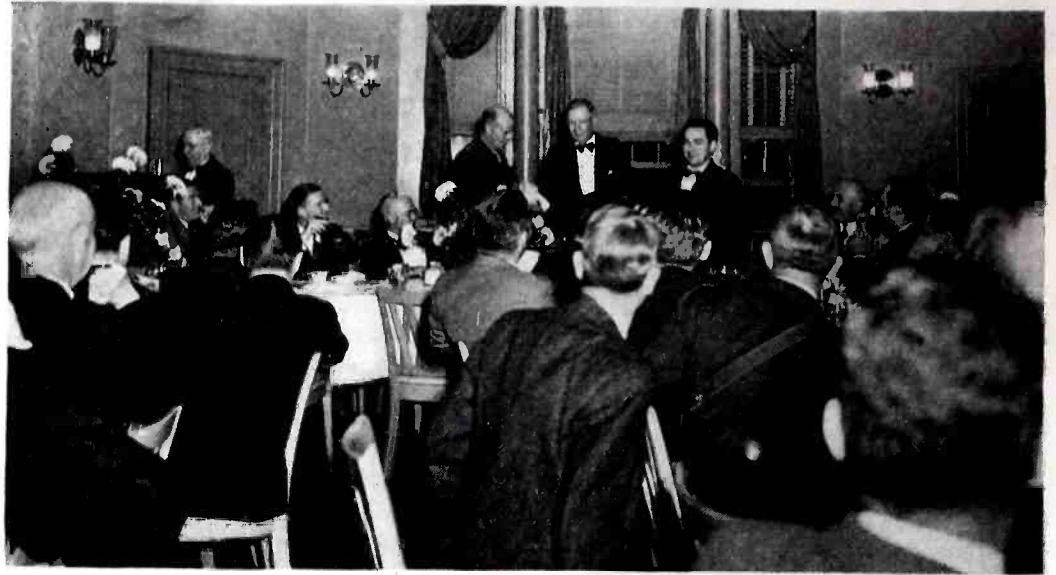

Standing at rear, left to right, Brig. Gen. F. Bradley, Commanding General 3rd Bomber Command, Tampa, Fla.; Major Gen. Joseph O. Mauborgne and William J. McGonigle.

From Major General Herbert A. Dargue, Commanding General First Air Force, Mitchell Field, N. Y. "I thank you for your cordial invitation to join you in doing honor to my old friend Joe Mauborgne. It is with deep regret that I cannot be present."

There were many more telegrams of greetings—too many, unfortunately, to reproduce here. Included were messages from General Arnold, Chief of the United States Army Air Corps; General Olmstead, Acting Chief Signal Officer of the Army, Col. Eastman, Signal Corps, United States Army.

Among those present at the Dinner were: Colonel Albright, Signal Officer Second Corps Area; Colonel Bickelhaupt, Signal Corps Reserve, assistant vice-president A. T. & T.; Haraden Pratt, vice-president and chief engineer of Mackay Radio; George Lewis, executive of the I. T. & T. Co.; Allen B. Dumont, television pioneer; Charles W. Horn, Director of development and research NBC; groups from WOR, CBS, NBC, and RCA; many reserve officers, members of the American Signal Corps Association; Wm. C. Simon, our treasurer; John Cose, superintendent of RCA Institutes; Gerald Morris, superintendent of communications New York City Police Department; A. J. Costigan, vice-president and director of our Association; Herbert J. Schroll assistant vice-president New York Telephone Company; 'Dick' Nebel, Radio Aide Second Corps Area and a group of Army amateurs; Major Armstrong of frequency-modulation fame; Frank Butler, one of the earliest assistants of Doc de Forest's; Ludwig Arnson, president of Radio Receptor Company; Captain Berhalter, secretary of the American Signal Corps Association, who was of inestimable assistance in arranging the details of the Dinner; Arthur Lynch, chairman of our Ways and Means Committee and representative of the National Company of

Malden, Mass.; a group from RCA Communications; Fred Meinholtz, Director of Communications of the New York Times; Lewis Winner, editor of COMMUNICATIONS; William Priess, pioneer wireless inventor; and many others.

### Congratulations

Robert Hilton Frey, Chairman of our Reception Committee, on the eleventh of October wed Dorothy Elvira Wilmot of Dunnellen, N. J.

### Anniversary

Our Association will celebrate its seventeenth Anniversary with a Dinner-Cruise at the Hotel Astor, New York City and our Chapters will join in the celebration in various cities throughout the nation on Saturday, February 21, 1942. Keep the date in mind—and don't say we didn't tell you in time.

### Boston

The "Yankee Chapter" V.W.O.A. held their first meeting of the season on Saturday evening, October 4, 1941. The group met at the Hotel Manger, Boston, Mass., at 7:30 p.m. A report was read by the secretary regarding the status of the local chapter. Following this, Chairman Stockllburg made a short address terminated by the presenting of a V.W.O.A. pin, a gift from the local chapter, to Brother Guy Entwistle in appreciation of his loyal and never-ending efforts toward keeping V.W.O.A. activities alive and in the foreground in the Boston district.

A brief meeting of the Yankee Chapter, V.W.O.A., was held Saturday evening, October 18, 1941, at the Hotel Bradford. The main issue of the meeting was the nomination of officers for the ensuing year. This gathering was in conjunction with the A.R.R.L. Amateur Convention.

Francis C. W. Lazenby, Secy.-Treas.,  
Yankee Chapter, V.W.O.A.



# GL-880

**A MIDGET IN SIZE—A GIANT IN OUTPUT**



*Three-fifths  
actual size*

**FOR HIGH-POWER  
FM  
AND TELEVISION**

## **To Get the Most from Your Tube Dollar Be Sure to Specify GL-880's**

GL-880 is the largest of the G-E developed tubes for high-frequency (FM and television) services. Its background is more than 28 years of G-E tube experience.

GL-880's ingenious "folded" anode reduces internal lead lengths by 10 inches without sacrificing cooling surface. High efficiency is obtained even at high frequencies.

Dual grid leads for separation of excitation and neutralization minimize neutralizing problems.

### **Easy to Drive**

With only 1500 watts driving power at the grids, two GL-880's will deliver an easy 50 kw of FM at 50 mc.

### **Here's Real Versatility**

Primarily for FM and Television, yes, but GL-880's have unusual efficiency at international and standard broadcast frequencies, and as modulators. A pair will give a 50-kw plate-modulated carrier at 25 mc!

**Be sure to** ask your nearby G-E representative for full information on the complete line of G-E transmitting tubes for all services. There are G-E offices in 80 principal cities. General Electric, Schenectady, New York.

*G-E 50,000-watt  
FM broadcast  
transmitter*



**GENERAL  ELECTRIC**

161-18



(Continued from page 14)

sity from a point source. However, when sound is picked up at a point from points varying in distance and amplified, a characteristic similar to the ear (having maximum distortion towards the high frequencies) should be used.

It is extremely important that the tubes be operated at the center of their characteristics (normally biased at the point of maximum mutual conductance). A practical way of arriving at this point, said Mr. Shepard, is to adjust the feedback in the circuit, Fig. 3, until the circuit just oscillates. Then adjust the series screen resistor and self-bias resistor of the driver until maximum intensity of oscillation is attained. It may be necessary to reduce the amount of feedback from time to time while making this adjustment. Before making this adjustment on the driver, the load and bias of the output tube should be adjusted by observing the input-output characteristic on the cathode ray oscillograph, to insure operation at the center of the dynamic characteristics of the tube. These adjustments should be made before the frequency adjustments are made.

Since this type of circuit makes low frequency hum voltages in the power supply audible in the output, and since the apparent gain of the amplifier for these low frequencies is high, it is imperative that means be taken to eliminate these currents and voltages from the output. This can be done by greatly increasing the size of the power supply filter or it can be more economically done by a hum eliminating circuit consisting of a condenser divider which sets the hum potentials of the screen at the correct hum level between B plus and B minus to effectively neutralize the effects of B supplied hum potential variations.

While this type of circuit, in effect, exerts a powerful damping influence on the speaker and will suppress to a large extent bad speaker resonance in an inefficient speaker, when it occurs in the region of the frequency spectrum where the regeneration is effective, it is sometimes desirable to use degeneration to help damp undesirable speaker effects that may occur at higher frequencies. Degeneration, in effect, lowers the output impedance of the circuit; hence current variations due to speaker and cabinet resonances, etc., are more efficiently reflected in that part of the circuit from which regeneration is derived. This enables the positive feedback to be effective in damping speaker and cabinet resonances. A very convenient method of obtaining degeneration, according to Mr. Shepard, is to place the voice coil in series with the screen bypass condenser of the driver tube to the ground.

	Power Factor at 1 MC.
Polystyrene	.0002
Polybutene	.0006
Polyethylene	.0008

Figure 4

A comparison of the power factor of three of the best synthetic materials suitable for cable dielectric. These materials are suitable from a loss standpoint; the polystyrene is too hard and brittle for a flexible cable. Polybutene is too soft to be used alone as a dielectric material. Polyethylene is satisfactory from a mechanical standpoint but is unavailable in this country at this time although it is used in England.

Material	Power Factor at 1 MC.	Dielectric Constant
Copolene B	.0006	2.6
Polyethylene	.0008	2.6
Copolene S	.0010	2.8

Figure 5

Power factor and dielectric constants of Copolene and Polyethylene.

Since the regeneration is so effective in controlling the resonance of the speaker it is possible and desirable to place the resonant point of the speaker at a frequency lower than is considered good common practice in normal circuits. In fact it has been found that the resonance of the speaker should be placed just above the frequency of maximum circuit regeneration.

#### SELVIDGE'S SOLID

##### DIELECTRIC FLEXIBLE R-F

##### TRANSMISSION LINE

**F**LEXIBLE insulations for covering wires have been known for many years, but it has always been a problem to secure those cables which had low losses in the high frequency regions. For many applications, a solution was found in the cables using polystyrene interlocking beads. However, even these beaded cables were found to have some mechanical disadvantages, and thus were not always entirely satisfactory for all uses. To insure efficiency at high frequency, it was recognized that it was necessary to have a cable in which air spaces were absent so that moisture filled air could not gather and condense at low temperatures. And it was also imperative that with such a cable at these low temperatures, voltage breakdown must not occur. A low loss transmission line, using solid dielectric material, and conforming to the foregoing strict requisites

was discussed by Dr. Harner Selvidge, consulting engineer for the American Phenolic Corporation.

In these new cables, said Dr. Selvidge, the solid material also prevents the outside shield from collapsing when the line is bent on a short radius. The line insulation being a homogeneous mass, which will not absorb moisture, thus voids the cumbersome method of gas filling to keep the line dry, according to Dr. Selvidge.

The new cables, made in several sizes of coaxial and balanced twin conductor lines, is named Copolene, since copolymer resins are used. At the present time, two types of Copolene are made, Copolene S and Copolene B. Copolene S is a copolymer resin of styrene which produces a very firm material which can be used safely at temperatures to 300° F., depending upon the physical load the cable must carry. Losses are slightly greater than those of Copolene "B" cables, therefore Copolene "S" will be used where firmness or ability to withstand high temperatures are required.

Copolene B is a copolymer resin of butene which has somewhat lower losses than Copolene S, is softer and more flexible and will withstand temperatures to 200°-250° F.

Polybutene, whose power factor is shown in Figure 4, may be modified to give it the necessary stiffness so that it results in Copolene B, whose dielectric properties are shown in Fig. 5. Up to the present time it has not been possible to modify the polystyrene without some deterioration of its electric properties. The material, Copolene S, is shown in Figure 5 compared with Copolene B and polyethylene.

A novel connector designed to fit the solid dielectric cables was also described. This connector is so designed that a continuity of impedance is provided through the connector so that no discontinuities are encountered in ultra high frequency use.

#### DORMAN ISRAEL'S RECEIVER

##### PRODUCTION PLAN FOR '42

**D**URING the past months radio manufacturers have received an assortment of data covering percentages of receiver curtailment for this year and next. Production schedules have accordingly been affected and during the coming months new lows in production may become quite evident. To offset this dangerous move, a unique plan was outlined by Dorman D. Israel, chief engineer of Emerson Radio and Phonograph Corporation, who spoke on "Civilian Receiver Design, 1942." Mr.

(Continued on page 21)



**MEMO TO:**

*Radio and Electrical Engineers*

In these busy times - when you are facing more vital problems in a day than you formerly met in a month - competent assistance is more than welcome. We are offering to help lighten your burden by extending the services and facilities of our engineering department.

These facilities are at your disposal for the selection of the right wire for the job. We understand how important to your equipment the matter of Insulated Wire can be and are prepared to make a thorough study of your requirements and make honest recommendations out of our findings and experience.

Frequently a type of insulation that had not been under consideration will best serve the purpose electrically, mechanically and more economically.

It has been our experience that the most outstanding service obtained from Lenz Insulated Wire has been in such cases where we were favored with the complete confidence of the Designing Engineer and together solved his wire problems.

Lenz makes a complete line of Insulated Wire for Radio Transmitters, Receivers, Aviation Instruments, and Aeronautical Army-Navy Wire. Call on us for consultation - such service and wire samples are without charge.

*Ray G. Zender*

Chief Engineer



**LENZ ELECTRIC MFG. CO.**

1759 North Western Avenue  
CHICAGO, ILL., U. S. A.

**ENJOYING ITS 36TH YEAR OF SUCCESSFUL BUSINESS**



Why doesn't somebody  
tell me these things?



*is an ideal source for  
transformers to specifications*

With improvements in materials, structural design, and production methods, UTC is producing, today, transformers which even a year ago would have been considered impossible.

As a typical example of such development is a transformer recently supplied to a customer for *one cycle operation* having the following characteristics:

- Primary impedance 10 ohms.
- Secondary inductance 250,000 Hys.
- Impedance ratio 75,000:1.
- Self-resonant point above 7 cycles.
- Weight under 8 pounds.

In addition to these difficult characteristics, this unit operates at  $-160$  DB signal level and hum shielding was developed to provide negligible hum pick-up to signal ratio.

**MAY WE ASSIST YOU IN YOUR PROBLEM?**

The same design experience and engineering ingenuity shown in the above example can be applied to your application.

May we have an opportunity to cooperate?

**UNITED TRANSFORMER CORP.**

150 VARICK STREET



NEW YORK, N. Y.

EXPORT DIVISION: 100 VARICK STREET NEW YORK, N. Y. CABLES: "ARLAB"



DECREASE OF INCREASE	TOTAL	REMAINDER and X	CABINET and KNOBS	CONTROLS	SOCKETS	PAPER CONDENSERS and RESISTORS	ELECTRO- LYTICS	HOO-K-UP WIRE and LINE CORD	OTHER COILS	I.F. TRANS- FORMERS	BRACKETS and HARDWARE	CHASSIS	LOOP ANTENNA	VARIABLE CONDENSER or P. TUNER	LOUD SPEAKER		
	2.85	.02	X	.21	-		X			.03	.24	.82		.38	1.15	1940	IRON and STEEL
.39	2.46	.02	X	.26	.03		X			.04	.15	X		.68	1.28	1942 A	
.68	2.17	.02	X	.26	.03		X			.04	.15	X		.39	1.28	1942 B	
	.53	.01		.05	.03	.04	X	.06	X	.03			.08	X	.24	1940	BRASS, COPPER and BRONZE
	.11	.01		X	-	.04	X	.06	-	-			-	X	X	1942 A	
	.11	.01		X	-	.04	X	.06	-	-			-	X	X	1942 B	
	.19	-				.026	.014			.05				.10	-	1940	ALUMINUM
.14	.05	-				-	.03			0				-	.02	1942 A	
.14	.05	-				-	.03			0				-	.02	1942 B	
	.06	.06				X		X		X				X		1940	TIN
0	.06	.06				X		X		X				X		1942 A	
0	.06	.06				X		X		X				X		1942 B	
	.04	.04				X		X		X	-			X		1940	LEAD
.35	.39	.04				.12		X		.03	.20			X		1942 A	
.38	.42	.07				.12		X		.03	.20			X		1942 B	
	.003	.003								X					-	1940	NICKEL
.04	.043	.003								X					.04	1942 A	
.04	.043	.003								X					.04	1942 B	
	-														-	1940	COBALT
.01	.01														.01	1942 A	
.01	.01														.01	1942 B	
	2.0	.2	1.8		X					X				X		1940	BAKELITE
1.8	.2	.2	-		X					X				X		1942 A	
1.8	.2	.2	-		X					X				X		1942 B	
	-								-	-			-			1940	SILVER
.11	.11								.01	.02			.08			1942 A	
.05	.05								.03	.02			-			1942 B	

Figure 6

Israel pointed out that if engineers received an allotment of all essential materials, it would be possible to adapt these materials in such form as to permit production of as many receivers as their ingenuity would afford. This could not only be done by substituting, but also by redesigning any portion of the receiver in which material shortages may occur. To prove his point, a special chart was shown.

From this chart reproduced above we learn that in 1940 receivers used steel chassis weighing .82 pounds. An aluminum-plate variable condenser was also used. The 1942A chassis is similar but uses all steel plates in the gang condenser. If aluminum rotor and end plates are necessary, then a slight amount must be added, but since the total rotor and stator plate weight was .1 pound on 1940, the two or four plates won't amount to much if needed. The 1942B chassis differs in the tuner and circuit. Permeability tuning is planned and along with it will be the elimination of the loop antenna. A lead foil capacity plate will be substituted and an antenna coil used.

Both the A and B receiver will use something other than a steel chassis. Perhaps it will be ceramic, which already has been tried by many. In some instances, porcelain 1/2" thick with sockets as a part of the base, have been placed into models. Pressed board or heavy mache have also been tried. Lead foil or spray will be used for shielding

within the chassis.

Under present conditions, it is the belief that aluminum, nickel and cobalt will be allotted to permit the elimination of the electromagnetic field using .25 pound of copper in 1940. If Alnico V will be made available a .2 pound magnet will work admirably, and use but .02 pound of aluminum; .01 pound of nickel, and .01 pound of cobalt. Additional filter condensers using .016 pound of aluminum foil may have to be used, but the net saving of aluminum in the receiver will be .14 pound out of a total of .19 pound, used in 1940, or about a 75% reduction.

If Alnico V is used, the steel used in the speaker will decline abruptly with redesign of the magnetic circuit. This, however, has not been allowed as a saving on the chart. On the contrary the amount of steel in the speaker rises in 1942 in the chart, because of the iron content of the magnet. Notwithstanding, other chassis savings bring the net amount of the steel down for the entire receiver.

Having eliminated .24 pound of copper in the 1940 receiver electro-dynamic speaker field, a substantial saving of this vital metal has been affected. Now let us look at the silver picture. Silver wire is twelve times the cost of copper wire. A condenser tuned radio uses .08 pound of copper in the loop antenna. By using iron cup IF cores, it is possible to design two transformers that will use .02 pound of wire. This totals

.10 pound. If silver is used, the cost increases about 30¢ per set. But in the same way, .05 pound or 15¢ of silver wire could be used in the permeability tuned set. This method of allocating and adapting, affords a saving of .42 pound out of a 1940 usage of .52 pound of copper or about an 80% reduction.

The chart was based on a standard receiver using a bakelite cabinet, that already has been eliminated in 1942 in favor of wood. There is no doubt that this is an expensive substitution, but in view of the small allocation of bakelite, its use in cabinets would not be justified, said Mr. Israel.

#### NEW MAGNETIC MATERIALS

IN the parade of metals vital to communications today few have become so important as those having effective magnetic properties. In speakers, transformers and other applications, the choice of suitable magnetic materials has steadily grown to become a major factor in development and design. And with national defense requirements exerting tense demands, effective applications in both civilian and defense channels have become problems of interest to every engineer.

Many combinations of magnetic materials, once accepted as standards, have thus been reshuffled to provide for instance, new forms of alnico, according to William E. Ruder, head of the



metallurgical and magnetic section of the General Electric Laboratories, who spoke on "New Magnetic Materials."

It was the foresight of engineers years ago that prompted the development of magnetic materials that centered around low losses and high permeability at relatively high densities. For they were concerned with increased efficiency and a corresponding decrease in size of equipment, as we are today. It was thus that silicon-iron alloys were developed to a high degree and losses have been reduced from 1.20 to .35 watt per pound, 60 cycles, 10,000 B, through a careful control of composition, structure and heat treatment. It is interesting to note that although many other materials have been tried, no completely satisfactory substitute for silicon as an alloying element has been found.

Until about 1930, said Mr. Ruder, permanent magnets were made of alloy carbon steel. Then the alloys free from carbon, now known as alnico were developed. The latest alnico, an alloy generally consisting of iron, aluminum and cobalt, he stated, was first proposed by a laboratory in Holland, and developed by the General Electric Laboratory. This may contain a small amount of copper as well. With magnetic cooling, its maximum energy is about five times that of the best alnico alloys of a few years ago. The new alnico contains a higher percentage of cobalt than the old, making the cost per pound relatively high, but the high energy content, with the corresponding saving in size, brings the cost per unit of available energy on a basis comparable to other alnico compositions.

During the past ten years, said Mr. Ruder, many advances in the p-m alloy development have provided us with alnico I to V with varying degrees of

$H_c$  from 440 to 730; varying degrees of  $B_r$  from 7,300 to 12,500 and external energy ( $B_r H_a \text{ max.} \times 10^6$ ) ranges from 1.40 to 4.5. The new "KS" material has an  $H_c$  of 785, a  $B_r$  of 7150 and an external energy of 2.03. These alloys are grouped into a classification known as "Dispersion Hardening." Other classifications in this group are "Quench Hardening," in which we find such materials as 1% C Steel, 6% W Steel, and 36% Co, 4% W, 5% Cr; "Oxide Magnets" have such compositions as 16  $C_2O$ , 34  $Fe_2O_3$ , 50  $Fe_3O_4$ ; "Cold Worked" contain such compositions as 60% Cu, 20% Ni, 20% Fe and still another classification known as "Super-Lattice" with such materials as 76.7% Pt, 23.3% Co or 86% Ag, 9% Mn, 5% Al.

Any good magnetic material should have a hysteresis loop of large area, according to Mr. Ruder. The area of this loop is largely determined by the value of the residual ( $B_r$ ) and the coercive

force ( $H_c$ ). However, the shape of the demagnetization curve is also important, since it determines the density at which a permanent magnet can be used with greatest efficiency. To designate the quality of the magnet, it has become customary to refer to it in terms of its maximum external energy or  $BH_{\text{max}}$  value. By subjecting a Ni-Al-Co-Cu permanent magnet alloy to a strong magnetic field at high temperature, two specialists, Oliver and Shedden improved the  $B_r$  and  $BH_{\text{max}}$  at least 20%. Other substantial increases were made by research workers by using a higher cobalt content and in some cases small copper and titanium, cited Mr. Ruder.

In the British patent specification No. 522,731, explained Mr. Ruder, details of processes and composition of important permanent magnet alloys are supplied. A compilation of these data are shown in Figure 8.

High initial permeability, high resistivity, constant permeability, low loss at very high frequencies and combinations of these are legion, in magnetic alloys, said Mr. Ruder.

Silicon, used in the manufacturing of high grade transformer sheet, has the effect of increasing resistivity and reducing the solubility of the alloy for carbon, thereby increasing the magnetic quality at medium and low density. However, it also has the limiting effect of reducing the saturation induction. Thus, the highest quality that has been obtained in commercial silicon alloys, according to Mr. Ruder is in a 6¼% silicon sheet, where high permeability and low loss (under .35 watt per pound 60 cycles, 10,000 B) result from the use of an alloy having practically zero magnetostriction. In Figure 7 we see curves illustrating these properties. Although developments in magnetic materials will call for some radical changes in applications for full justification of their value, material

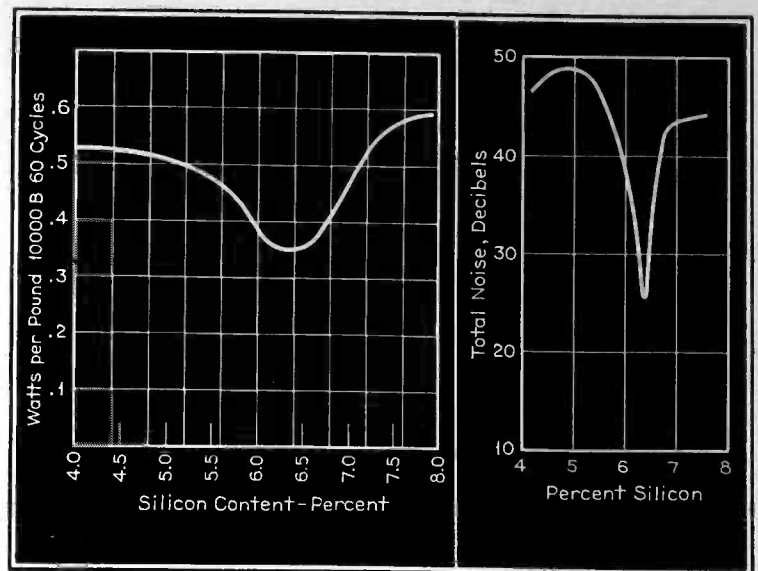

Figure 7

Curves depicting characteristics of high grade Silicon Sheet (6¼%). This high permeability and low loss results from the use of an alloy having practically zero magnetostriction.

Composition in % Ni Al Co Cu Ti	Usual thermal treatment			Same treatment but cooled in a magnetic field			Cooling rate 1200°-600° C °C/sec.
	BH max. $\times 10^6$	$H_c$	$B_r$	BH max. $\times 10^6$	$H_c$	$B_r$	
16 8.5 23 .. ..	1.22	348	9050	3.45	492	126500	1
13.5 8.0 24 1.5 ..	1.32	370	9450	3.77	505	13100	2.6
13.5 8.0 24 3.0 ..	1.68	535	8300	4.78	600	13350	1.8
16 7.8 25 .. 2.8	1.60	604	7600	3.06	640	10000	4
14 7.1 24 3.0 2.4	1.72	594	7900	3.78	660	11050	4
14 7.5 20 6.5 1.8	1.65	620	7350	3.25	676	9825	4.3
16.5 8.1 20 1.1 2.3	1.82	640	8150	3.12	685	10200	4

Figure 8.



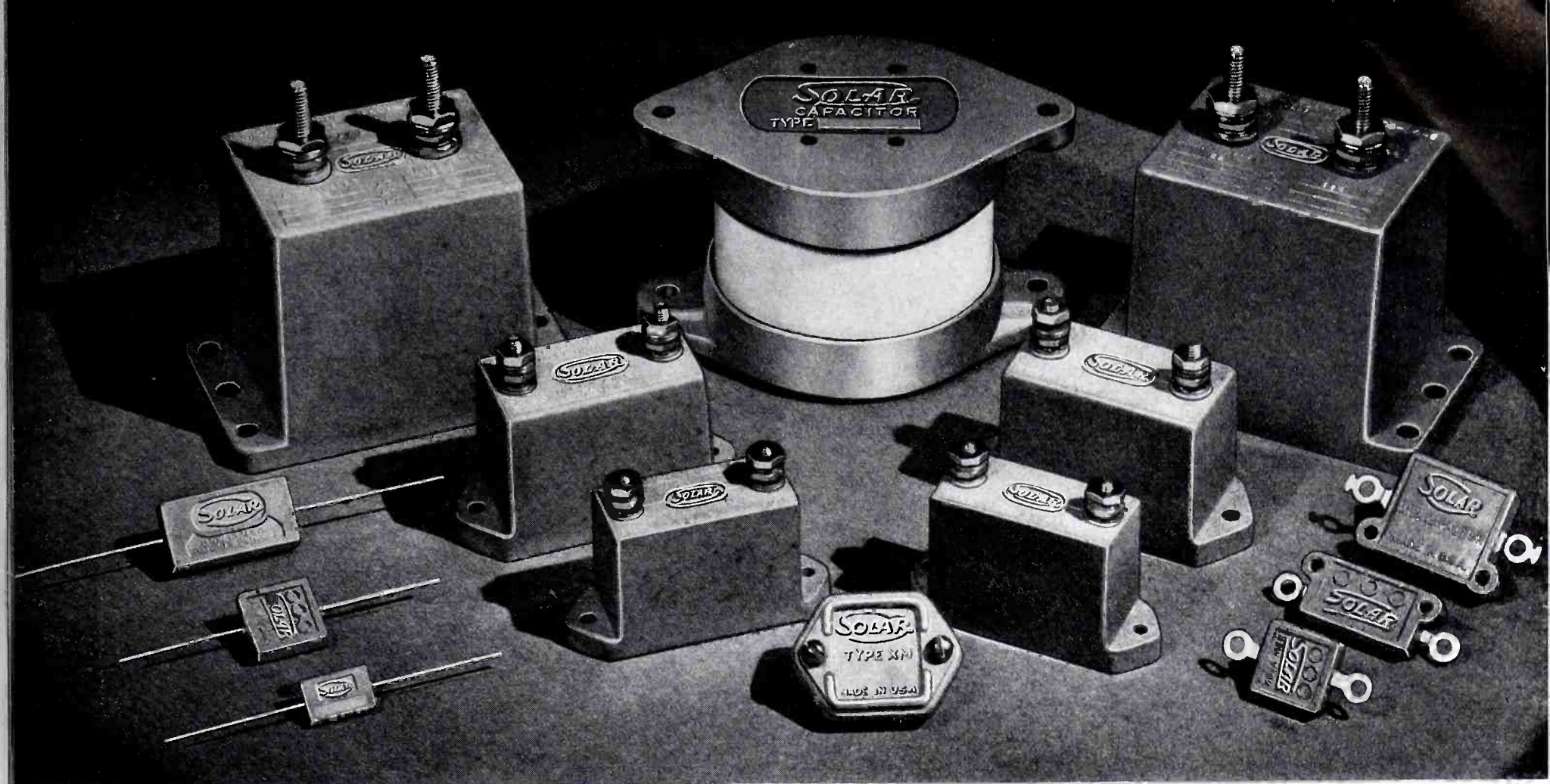

## MICA CAPACITORS

**Solar Mica Capacitors add vital dependability to radio and communications equipment for the Armed Service Branches of the Government.**

**The "Quality Above All" incorporated in these units is evolved from a wealth of experience.**

**If Mica Capacitors are part of your present problems, consult Solar for a ready solution.**

*Ask for Catalog 12-E*

**SOLAR MFG. CORP., BAYONNE, N. J.**



savings and physical reductions so essential today, will be among the rewards of adoption.

#### A 400 MC GENERATOR

**I**N ultra high frequency development research, the 50 to 400 megacycle range has become more and more vital to many forms of communications. Critical studies of operating characteristics and efficiency standards have thus become necessary. But because of the innate characteristics of these extremely high frequencies, it has been difficult to secure all of the instruments to complete this survey. Cognizant of this problem, development engineers have been constantly at work, and have succeeded in producing, lately, several ingenious devices, the most recent of which was described by John M. Van Buren of Measurements Corporation.

This new instrument is a generator capable of generating from 50 to 400 megacycles, with an output voltage of from 1 microvolt to at least 100,000 microvolts.

Among the many new features of this instrument is the attenuator, which is the resistance type. It is a six step 120 db balanced type, affording a constant output impedance over the whole frequency and output range. The variable output voltage is measured directly by a special high frequency diode voltmeter. The selection of attenuator steps was accomplished by short sections of transmission line arranged in a drum fashion.

The choice of the resistance attenuator was based on the fact that since the ideal voltage source has zero impedance, the lower the output impedance, the better. This thought was maintained even though a great deal of work is done on a 72 ohm transmission line, for it is extremely useful to be able to feed the output of the generator into the grid of a tube or other capacitive device. Thus, said Mr. Van Buren, in the event that the output impedance of the generator is 70 ohms or more, the capacitive reactance of the grid is often low enough at high frequencies to upset seriously the termination of the output line. Therefore since a low impedance output can be used perfectly easily into a 70 ohm line, it was believed that the low impedance was the most practical.

A parallel rod or balanced line type of resonator is another of the features. This method was chosen, for the oscillator can be easily loaded with capacity to reach a reasonably low frequency,

Figure 9

Oscillator assembly of the 400 mc. signal generator, with one side plate removed. The rotor unit rotates on its axle, while the main shorting contact which controls the length of the line is held stationary.

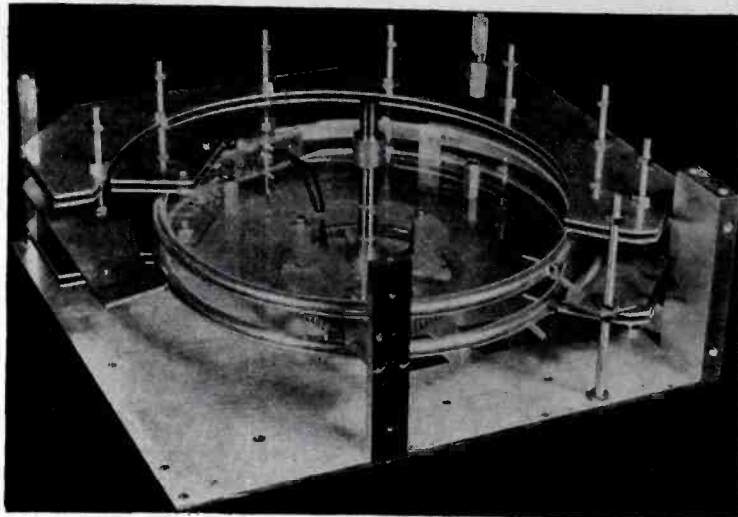

while keeping physical size well within bounds. A pair of rods about 18" long with approximately 50 mmfd. would give a low limit somewhere around 50 megacycles, according to Mr. Van Buren. Thus, in order to cover the complete range of 50 to 400 megacycles, either several ranges of capacity would have to be employed or a variable condenser would have to be used. In order to maintain a fairly constant output and avoid difficulties in range changing, a variable condenser plus a variable length line to cover the whole frequency range without switching was chosen. In Figure 9 we see the complete oscillator assembly, with one side plate removed. In this unit, the rotor unit rotates on its axle, and the main shorting contact which controls the length of the line is held stationary. Consequently, as the rotor revolves, the length of the line is varied. And, as the length of the line increases, the condenser plates attached to the rotor mesh with the stator plates which are held on a series of studs. These stator plates are so shaped that as the length of the line increases, the rotor plates mesh deeper and deeper with them, thus adding considerable capacity loading. If the rotor is rotated counter clock-wise, the active length of the line decreases and the inactive length increases. Since the inactive portion tends to resonate as a closed half wave length of the line at the higher frequencies, it is necessary to short it at frequent intervals to prevent dead spots. Clips spaced along the line perform this function by shorting on a stationary strip at the proper time.

These clips continue to slide along the stationary shorting strip and thus keep the inactive portion broken up into short sections preventing resonances in the working range. In this way the three operations of varying the length of the line, varying the capacity loading and shorting the unused portion of the line are all completed with the single movement of the rotor.

To avoid excessive frequency reaction, when the fine output control was

varied, a relatively constant load would have to be presented into the oscillating circuit. To achieve this, a simple variable coupling loop was found to work very well, said Mr. Van Buren. This coupling loop is mounted at the end of a T branch of a hollow copper tube. From this loop leads are run inside the tube, spaced by polystyrene beads to form a balanced transmission line of approximately 150 ohms surge impedance. The beads are slightly smaller than the inside diameter of the copper tube and the wires forming the transmission line are flexible so that the line can twist freely inside the tube. This tube is supported by mounting blocks which causes the pickup coil to approach or move away from the main shorting contact, this being the point of maximum current. In this way the coupling is varied and the voltage at the end of the line is varied with a minimum of complexity. Since at the high frequencies, the coupling between the tank circuit and the loop increases greatly, it was found necessary to supply a small copper shield for the loop to retire into. The absence of this shield was found to decrease the maximum to minimum voltage to three to one.

The drum switch used in the attenuator has its six sections of balanced transmission line of different lengths arranged in cylindrical forms with the sections of the line running parallel to the axis of the cylinder. One end of all of the sections of the line lie in a plane at the bottom of the drum and connect in turn to the output cable system. The upper ends of the sections lie at various points along the drum, and by rotating the drum parallel to the attenuator, the various lengths of the line are switched in between the output cable



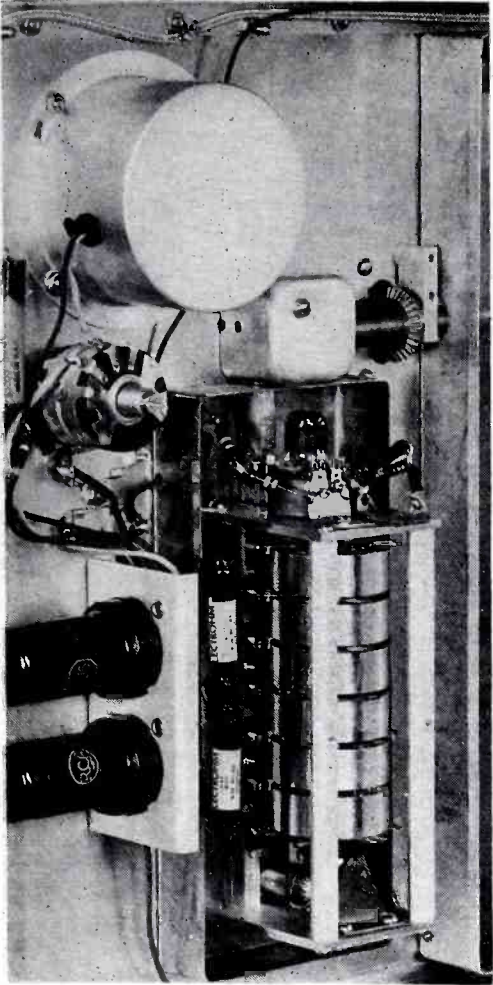

Figure 10

contact and the desired attenuator step contact. In this way, the voltage is transferred from each attenuator step in turn to the output cable in a properly terminated line. Upon leaving the attenuator, the output voltage enters a pair of 3" flexible transmission lines. At the outer end of these lines is a terminal box containing the proper terminating resistors to avoid reflections in the output cable. As the entire attenuator and output system is of balanced design, both mechanically and electrically, the ground currents which are often a serious source of trouble in single ended attenuators, cancel.

The calibration accuracy of this new generator, according to Mr. Van Buren, can be maintained to better than 1/2% over long periods, because of the stability of the oscillator. The output voltage is continuously variable from 0.2 microvolt to 0.2 microvolt, balanced to ground while the leakage below 200 megacycles is not measurable on a sensitive receiver. Modulation is continuously variable to 50% from 400 and 1000 cycle internal oscillator from an external source.

#### PLASTICS TODAY

**F**EW materials have received as severe a jostling in production plans as plastics. Originally believed to be the answer to every prob-

*(Continued on page 26)*

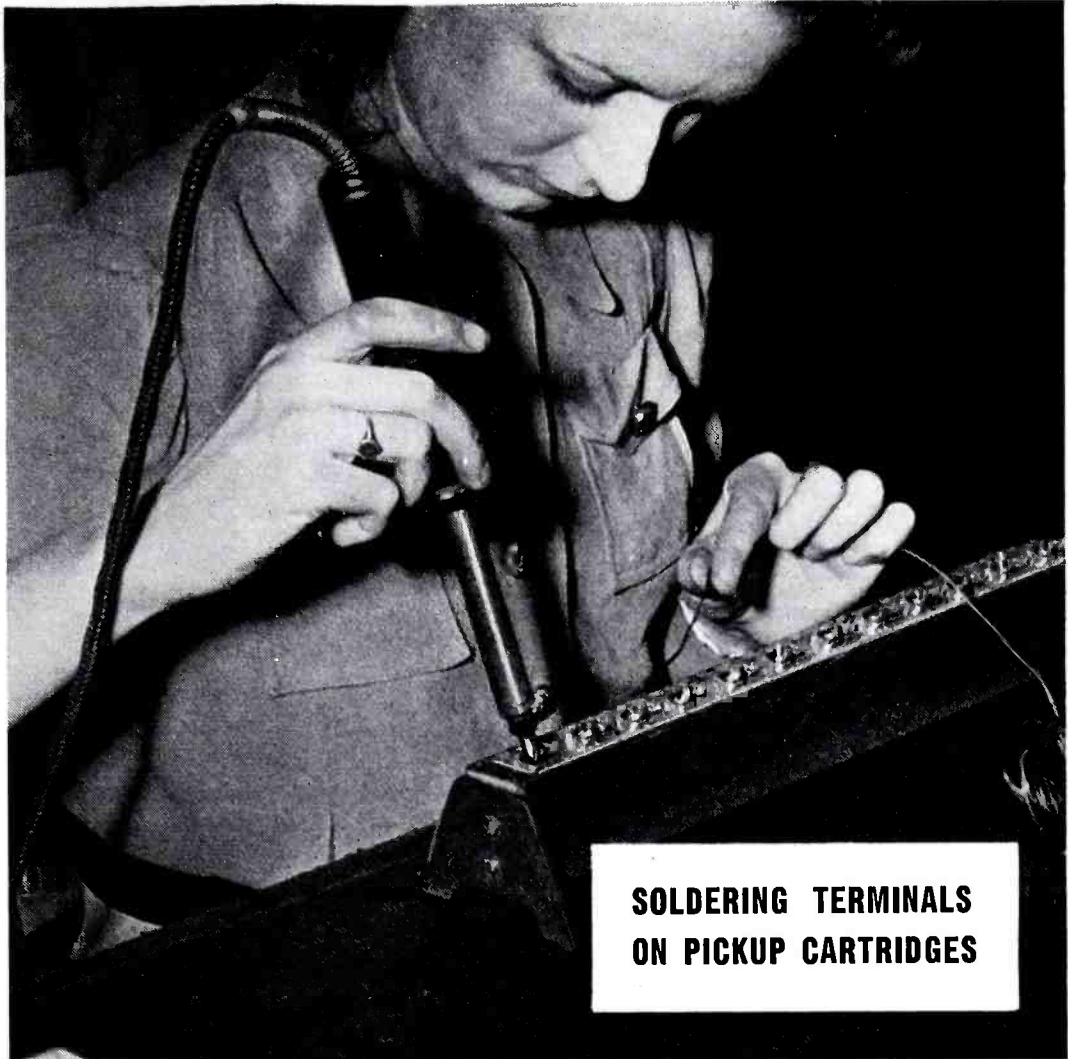

**SOLDERING TERMINALS  
ON PICKUP CARTRIDGES**

## 3000 BUSY FINGERS Trained in Precision Workmanship

● Because of the many exceedingly small and fragile parts required in the manufacturing of crystal microphones, pickups, cartridges and recording heads, much of this work must be done by hand. Astatic employees, long experienced in the assembling of these products, show amazing skill and accuracy in these operations. Constant supervision and testing provide an additional guarantee of accuracy. No Astatic Crystal Microphone, Pickup or other product ever leaves Astatic's shipping rooms before it has been tested and approved to meet the exacting standards of performance for which it was intended. Careful design, engineering and assembly assure the long and satisfactory service of Astatic Crystal Microphones, Pickups, Cartridges and Recording Heads. Your Radio Parts Jobber will be pleased to demonstrate their efficiency.

**ASTATIC**

**THE ASTATIC CORPORATION**

YOUNGSTOWN, OHIO

Licensed Under Brush  
Development Co. Patents

In Canada:  
Canadian Astatic Ltd.  
Toronto, Ontario



(Continued from page 25)

*Mighty Widgets*  
FOR AVIATION AND MARINE RADIO



No. 1312  
I. F. TRANSFORMERS  
1 1/8" SQ. x 2" HIGH



No. 320 R. F. COILS 1 1/8" SQ. x 2" HIGH

- BROADCAST BAND COILS
- LONG WAVE BAND COILS (AIRCRAFT)
- SHORT WAVE COILS (MARINE & AIRCRAFT)
- PERMEABILITY TUNED TRANSFORMERS
- FIXED-TUNED PLUG-IN COILS



No. 761 R. F. COILS  
1 1/8" DIA. x 2 1/4" HIGH

**J. W. MILLER CO.**

Send for Catalog 5917 SOUTH MAIN ST. LOS ANGELES, CALIF.

lem, then catapulted to the stormy quarters of national defense, and back again to civilian objectives, plastics today finds itself in a peculiarly variable state. This is because there are plastic ingredients not on the critical or "must" listing that are suitable for plastic structure, effectively in some instances, and in others "good-enough" for ordinary applications.

In radio as in other associated industries, the application governs the type of plastics chosen. For instance, according to Paul B. Leverette of the General Electric plastics department, there are those plastics which use plastics for their electrical insulating properties combined with their structural strength and economy of fabrication, and then there are those plastics which are primarily structural or decorative. Phenol formaldehyde appears to be the basis of resin structure for most plastics used primarily for insulation. In some of these applications, the resins consist of phenol, aniline and formaldehyde to afford high dielectric strength and low dielectric losses. For other insulating purposes, the woodflour filled phenol formaldehyde resin compounds are used.

Other widely used plastics for insulating purposes are the thermoplastics, the most popular of which is polystyrene which has extremely low losses at high frequencies and is unaffected by changes in atmospheric humidity. However, its uses have been limited because of its softening properties below boiling water temperatures, or around 70 to 80 degrees centigrade. This softening is also characteristic of some of the other thermoplastics.

Unfortunately because of national defense demands for phenol, which is the basis of picric acid explosives and also in antiseptics such as carbolic acid, it is not possible to continue ordinary plastic production with this particular type of resin. Formaldehyde, the other important ingredient in this combination is also on the difficult list, since the high pressure equipment ordinarily used for the manufacture of methanol, the basis of formaldehyde, is now used for the production of ammonia for use in nitric acid for explosives.

However, vinyl acetal resins, used in enamel wire, have not been restricted, except perhaps by some of the coal tar resins and solvents used with them. According to the General Electric specialist, the shortage of copper will be more responsible for the shortage of enameled wire, than the insulation covering it.

Such cellulose plastics as cellulose acetate or acetobutyrate, have not been affected by the supply of cellulose or

*Congratulations! WABC*

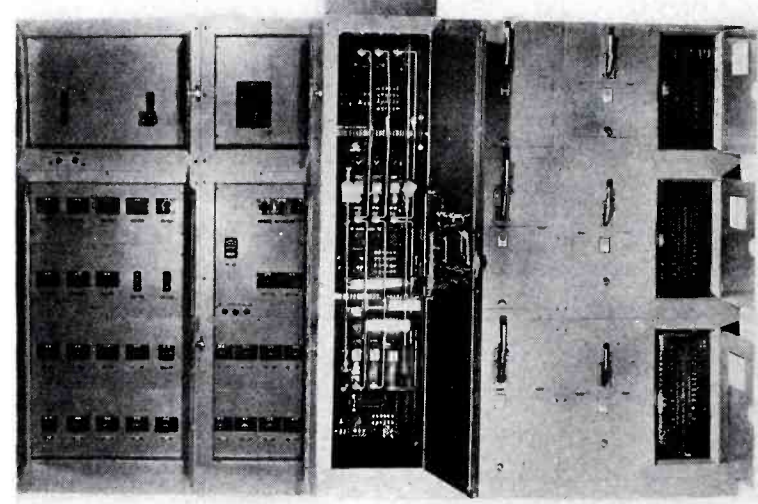

The Square D Company compliments the Columbia Broadcasting System on another of its new stations. We are proud to have again supplied a main switchboard and the panels, and to have had a part in this modern installation.

**SQUARE D COMPANY**  
ELECTRICAL EQUIPMENT  
SWITCH AND PANEL DIVISION  
5060 RIVARD ST., DETROIT, MICH.



chemicals used in treating them, but rather by the shortage of the plasticizer tricresyl phosphate due to the scarcity of cresylic acid as well as the demands for tricresyl phosphates for defense work.

Used in large quantities in powder plants are such chemicals as acetone and methanol, which also serve to make up the acrylic resins. In addition, these resins, which also use sodium cyanide, in addition to the acetone and methanol, are being used to make up windshields and turret housings in aircraft.

The one form of plastics that is not seriously affected is polystyrene, since it uses no plasticizer, being manufactured from basic raw materials, ethylene and benzene, of which there is no shortage at present. The increased use of this plastics will depend upon how quickly equipment to produce it, is manufactured and installed.

Mr. Leverette expressed the hope that there would be a sufficient supply of such plastics fundamentally necessary in the construction of radio receivers to keep up with the rate of production as it is limited by other factors.

But cabinet and decorative uses, Mr. Leverette said, account for by far the larger volume of phenolic and urea plastics now essential to national defense. Thus, at present, he said, there is no alternative in these plastics which is not just as short in supply, and therefore the only answer for cabinets and control knobs during the shortage seems to be a return to wood.

#### AN FM SIGNAL GENERATOR

**I**NCREASED development and production in frequency modulation has propelled the demand for laboratory devices that will not only keep an orderly check on production, but offer a reliable means of gauging unit efficiency and manufacturing progress.

Among the instruments necessary for this work is the signal generator. In this type of signal generator, the amplitude of an emitted carrier wave is not varied. Instead the instantaneous frequency is varied in accordance with the modulating signal. This is quite difficult and consequently requires a great deal of equipment if assurances of a high degree of fidelity to the audio control signal is to be available. In amplitude modulation signal generator design, it is possible to get suitable performance by using two tubes in the radio frequency generating unit. It is only necessary to vary the plate supply voltage of the output amplifier to insure modu-

(Continued on page 28)

# Specify DAVEN ATTENUATORS



**To INSURE PRECISE QUALITY  
and RUGGED DEPENDABILITY  
in your SPEECH INPUT EQUIPMENT**

Substitutes, whose only merit can be a claim that they are "just-as-good", are **NEVER** the equal of the original. When ordering new speech input equipment, insist upon **DAVEN ATTENUATORS**, particularly when these precision components **COST YOU NO MORE**. **DAVEN** leadership in the field is clearly indicated not only by the caliber but also the number of organizations who are satisfied users.

Our catalog lists the most complete line of precision attenuators in the world. However, due to the specialized nature of high fidelity audio equipment, a large number of requirements are encountered where stock units may not be suitable. If you have such a problem, write to our engineering department.

**THE DAVEN COMPANY**  
158 SUMMIT STREET • NEWARK, NEW JERSEY



**U.S.A., 1941** - First domestic production of high grade iron powder, specifically designed for the needs of the radio, electronics and communications fields, receives enthusiastic reception.



**BIGGER News THAN EVER FOR 1942**

*.. will be*  
**G.A.W. CARBONYL IRON POWDER**

*.. and its use in many original and startling developments of the high frequency radio field.*

FOR INFORMATION ADDRESS THE MANUFACTURER

**GENERAL ANILINE WORKS**  
435 Hudson Street, N.Y.C.

OR THE DISTRIBUTOR

**ADVANCE SOLVENTS & CHEMICAL CORPORATION**  
245 Fifth Avenue, N. Y. C.

(Continued from page 27)

lation. In F-M design this simplicity is not so prevalent, said C. J. Franks of the Boonton Radio Corporation, who spoke on the "Design of a F-M Signal Generator."

Because of the involved nature of the phase-shift Armstrong system, said Mr. Franks, it is difficult to construct a laboratory instrument using this system. The high degree of multiplication which is an integral part of the system, calls for a number of tubes which are far in excess of that practically suitable for laboratory instruments. Accordingly, said Mr. Franks, the reactance tube system was used in this F-M signal generator design. Only two tubes are required for actual generation of the frequency modulated carrier at a single mean carrier frequency.

One of the important conclusions reached in the study of modulators, according to Mr. Franks, is that it is highly desirable to operate the F-M generating system at but a single fixed mean carrier frequency. A variation of the mean carrier frequency is not all out of question but the difficulties are great enough to avoid the plan, particularly if it is desired to go to low carrier frequencies for work in i-f systems.

The amplifier in this generator is of the broad band type which can be made to transmit a band nine megacycles wide, with sufficient flatness. The amplifier circuit in the I.F. range is a wide range low pass amplifier that is customarily used in television work with low frequency compensating networks being omitted. In this system the net plate load is 500 ohms, and to shift the pass band to the carrier frequency range small fixed-tune circuits are switched in parallel with the plate load resistors which shunt them and thus produce the desired broad pass band.

**TUBE NOISES**

**S**HARP impulse noises produced by radio tubes are the result of intermittent contact between conducting surfaces within the tubes. Noises of this sort may be caused by intermittent short circuits directly between electrodes. In other instances the intermittent short circuits are from one electrode through unintentional metallic or carbonaceous deposits upon insulating spacer numbers to another electrode.

The most common and most troublesome source of intermittent short circuits however is carbonized fibers of lint said W. L. Krahl, of Hygrade Sylvania Corporation. If tiny fibers of cotton, wool, linen, silk or other animal

You and your associates can obtain a year's subscription to **COMMUNICATIONS (12 issues)** for only \$1.00 each by using the Group Subscription Plan.

A regular yearly subscription to **COMMUNICATIONS** costs \$2.00 — but when four or more men sign up at one time, each one is entitled to the half-price rate. (Foreign subscribers on the "G-S-P" only pay \$2.00 each).

**COMMUNICATIONS**  
19 E. 47th St., N. Y. C.

Please enter annual subscriptions (12 issues) for each of the undersigned for which payment is enclosed at the rate of \$1.00 each. (This rate applies only on 4 or more subscriptions when occupations are given.) Foreign Subscriptions are \$2.00 each.

Name .....

Street .....

City-State .....

Occupation or title .....

Employed by .....

Nature of business .....

(State if Manufacturer, Broadcast Station, etc.)

Product .....

Name .....

Street .....

City-State .....

Occupation or title .....

Employed by .....

Nature of business .....

(State if Manufacturer, Broadcast Station, etc.)

Product .....

Name .....

Street .....

City-State .....

Occupation or title .....

Employed by .....

Nature of business .....

(State if Manufacturer, Broadcast Station, etc.)

Product .....

Name .....

Street .....

City-State .....

Occupation or title .....

Employed by .....

Nature of business .....

(State if Manufacturer, Broadcast Station, etc.)

Product .....



or vegetable fibres deposit upon tube parts they have a tendency to adhere tenaciously to them through high temperature firing in reducing atmospheres and finally become reduced to carbon filaments when the tubes are evacuated and heated to high temperatures during exhaust and aging. If one of these tiny filaments comes in contact with the two electrodes a loud noise results.

Another classification of sharp impulse noises, he said, are those that result from intermittent open circuits of current carrying tube conductors. A closely allied source of such disturbances is intermittent contact of tube elements or metal parts connected to the electrodes with other conductors that do not carry any of the currents essential to the performance of the tubes or which may normally be insulated from all tube elements.

## IRON-CORED INDUCTANCES

(Continued from page 7)

which it offers that inductance are also stated. There has been no accepted method of designating this inductance. Some standard procedure should be followed in order to give a meaning to the indicated inductance of a coil. The procedure proposed here is to state the inductance which a coil would offer to a certain magnitude of alternating current of given frequency which has been superimposed upon a given direct current, it being understood that the core of the coil had been demagnetized before the direct current had been increased from zero to the given magnitude. An example is: The alternating-current inductance is twenty-five henries for one-hundred milliamperes direct current and twenty milliamperes alternating current at sixty cycles per second. It would be helpful from the standpoint of analysis and design if curves of the type shown in Figure 3 were furnished for iron-cored inductances.

### References

(1) Frederick E. Terman, *Measurements in Radio Engineering* (New York: McGraw-Hill Book Company, Inc., 1935), pp. 53.

(2) C. R. Hanna, "Design of Reactances and Transformers Which Carry Direct Current," *Transactions of the American Institute of Electrical Engineers*, 46: pp. 158, 1927.

(3) T. J. Rehfish and H. T. Bissmire, "A. C. Impedance of Chokes and Transformers," *The Wireless Engineer*, 18: pp. 266, 1941.

(4) David Owen, "A Bridge for the Measurement of Self-Induction in Terms of Capacity and Resistance," *Physical Society of London Proceedings*, 27: pp. 39-55, 1914-1915.

# JOHNSON

*..for Dependability*

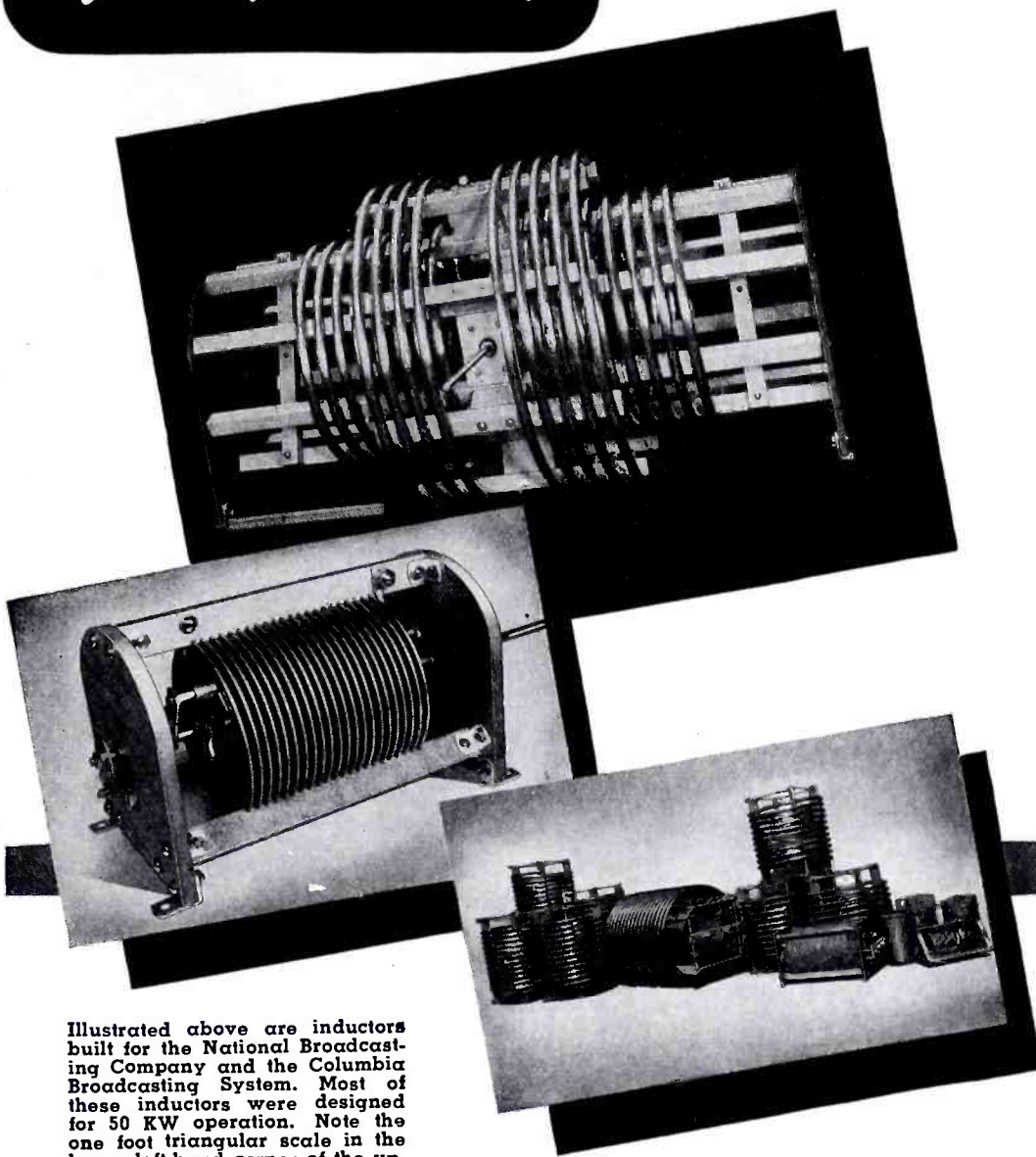

Illustrated above are inductors built for the National Broadcasting Company and the Columbia Broadcasting System. Most of these inductors were designed for 50 KW operation. Note the one foot triangular scale in the lower left-hand corner of the upper photo.

Whether your application is 50 KW or 100 watts, Johnson Inductors are Engineered with the same careful attention. Johnson Inductors are available in standard designs, your special specifications or Johnson Engineers will make circuit recommendations including suggested inductor designs for your particular application. Write today requesting help on YOUR problem—no obligation.

**NEW CATALOG 967E NOW READY.**



**E. F. JOHNSON CO**

WASECA, MINNESOTA

EXPORT, 26 WARREN ST., NEW YORK, N. Y.

"MANUFACTURERS OF RADIO TRANSMITTING EQUIPMENT"





**SUN  
DELIVERS  
the  
GOODS!**

**GREATEST STOCK EVER IN RADIO HISTORY!  
—PARTS and SUPPLIES OF ALL TYPES—**

SUN RADIO, too, has been doing its part in this great preparedness campaign! Our present stock of radio parts and electronic equipment is the greatest ever in our history. Months back, visualizing the growing tendency of government restriction and allotment of material for commercial and civilian use we placed enormous orders with our regular factory suppliers for parts and supplies of all types. Therefore, why not try us when you next require something urgently? You'll be amazed at our prompt, rapid service even in the face of present, trying conditions.

*A Complete Source of Supply for*  
**ENGINEERS • LABORATORIES**  
**INDUSTRIAL ORGANIZATIONS • MANUFACTURERS**  
**BROADCAST STUDIOS • RADIO AMATEURS**  
**SCHOOLS • COLLEGES • ARMY-NAVY POSTS • AIRPORTS**  
 Have You a Copy of Our 416 Page Catalog? Address Dept. CM on Firm Letterhead.  
*New York's Oldest Complete Radio Organization*

**SUN RADIO CO.**

212 FULTON STREET • BARCLAY 7-1840 • NEW YORK CITY

**THE INDUSTRY OFFERS .-. .**

**DECADE CAPACITOR**

A choice of capacity values from .01 to 11.1 mfd. in .01 mfd. steps, or other ranges, is provided by the Decade Capacitor Type DK, developed by Industrial Instruments, Inc., 156 Culver Ave., Jersey City, N. J. The instrument is said to have 1% accuracy. Dials are calibrated directly in capacitance so that reading from left to right totals up the value available at the binding posts. Adjustments are made progressively in small uniform steps. The instrument measures  $7 \times 8 \times 5\frac{3}{4}$ ", and weighs 8 lbs. Three models are available: 11.1 total in .01 mfd. steps; 1.11 mfd. in .001 steps; and 1.11 in .001 steps with mica dielectric throughout.

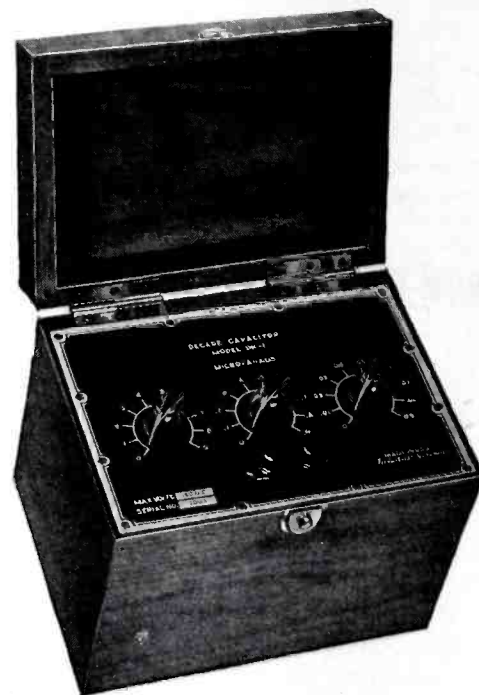

**"DOUBLE-FLOW" MERCURY SWITCHING**

A mercury switch unit, using the "double-flow" principle, is announced by Durakool, Inc., Elkhart, Ind. In this unit, two tails of mercury pulling in opposite directions, over a ceramic barrier until severed, are said to prevent double contacting where vibrations exist. When closing, the two approaching bodies of mercury pile up a double thick electrical conductor. Double flow operates either as a slow rolling motion or equally well on a very high speed mechanical snap action.

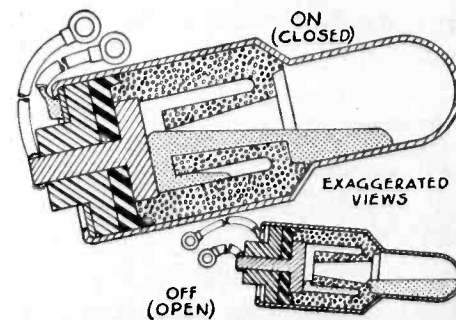

**ELASTIC'S ANCHOR TYPE STOP NUTS**

Anchor type nuts for vibration-proof fastenings on blind mounting applications are being made by Elastic Stop Nut Corporation, Union, New Jersey. The bolts, which are inserted from the outside, pass first through the removable plate, thence through the structure into the stationary nuts.

These nuts are offered in a wide range of size, material, and thread system, every

**PREMAX**  
**Antennas**  
*For Police and  
Mobile Units*

Standard types now adopted by police departments, mobile short wave transmitters, ship-to-shore and other essential defense units.

Premax Antennas are fully adjustable and telescoping, light in weight but very sturdy. Made in Monel, Aluminum or Steel.

Send for Bulletin R-42 showing Antennas and Mountings.



4213 Highland Avenue  
NIAGARA FALLS, N. Y.

**LAMINATIONS**  
 for Output TRANSFORMERS  
 of Highest Permeability

Standard stocks in a wide range of sizes for Audio, Choke, Output and Power Transformers. Write for dimension sheets.

**permanent  
MAGNETS**

ALNICO (Cast or Sintered)

COBALT-CHROME-TUNGSTEN

Cast, formed or stamped permanent magnets for all purposes. Engineering cooperation backed by 38 years experience in magnet making.

TOOLS » DIES » STAMPINGS  
HEAT TREATING

**Thomas & Skinner**  
Steel Products Co.

1113 E. 23rd St. Indianapolis, Ind.



nut incorporating a self-locking feature, a fiber locking collar which is an integral part of each nut. This locking fiber is said to prevent the bolt from becoming loose after it is installed in the nut, regardless of the severity of the vibration to which it is subjected. It is pointed out too that the fiber of the collar, being softer than the metal screw, cannot damage the threads or their plated surfaces.

\* \* \*

#### PRECISION'S 31 RANGE TESTER

A compact 31 range, a-c/d-c multi-range tester incorporating ranges to 1200 volts D. C.; 2400 volts A. C.; 5 megohms; 600 milliamperes and plus or minus 62 db is now available from Precision Apparatus Company, Brooklyn, N. Y. The 3" square, bakelite cased, 800 microampere meter has a scale plate with large sized numerals. Accuracy is said to be 2% and 3%. Size is 7" x 4½" x 3".



\* \* \*

#### KNIGHT INDUSTRIAL INTERCOMMUNICATION SYSTEM

An industrial intercommunication system has been announced by Allied Radio Corporation, Chicago, Ill.

The system has 2¼ watts power output, enabling ten sub-stations to carry five simultaneous two-way conversations with privacy. Up to 2,000 feet of cable may be used between each station. Housed in rich walnut-finished cabinets, 12" x 6" x 5¾". For 110-115 volt a-c/d-c operation.

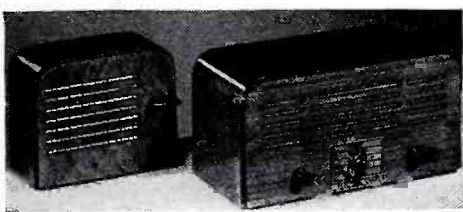

\* \* \*

#### AEROVOX TEMPERATURE COMPENSATING CAPACITORS

Compensating mica (type K) capacitors obtainable in any temperature coefficient from -.005% to +.005% per degree C. over a temperature range between -40° C. to +70° C. are now being made by Aerovox Corporation, New Bedford, Mass. Such capacitors can be used to correct the normally positive temperature coefficient of inductances for the maintenance of constant L-C products (resonant frequency) of tuned circuits independent of temperature.

They are supplied only in low-loss (yellow) XM bakelite cases, sealed for immersion, and are available in a limited range of capacities and voltage ratings.

To appreciate the purpose served by temperature compensating capacitors, it should be noted that the normal temperature coefficient of the components in tuned circuits

## BLILEY CRYSTAL UNITS

*Engineered for Accurate Frequency Control*

—|—

LEFT: Type M03 temperature controlled unit specially designed for high frequencies.

CENTER: Type M02 unit is ruggedly built for portable and mobile transmitters; 2,000kc. to 30,000kc.

RIGHT: Type BC46T Precision Variable Air Gap Temperature controlled unit primarily for Broadcast frequencies. Approved by F. C. C.



BLILEY Crystal Units for frequencies from 20kc. to 30mc.—three of which are illustrated—conform to highest commercial standards of design and performance. Write for your copy of Catalog G-12 describing the complete line.

**BLILEY ELECTRIC COMPANY**  
UNION STATION BUILDING ERIE, PA.

## FREQUENCY MODULATED GENERATOR

### TYPE 150-A

Here is a signal generator developed specifically for use in the design of FM equipment. Built into it are the features requested by FM engineers. Both Frequency and Amplitude Modulation available separately or simultaneously. All controls direct reading. Expanded scale meters. Power line regulation optional.



#### Brief Specifications:

\*Frequency Range 41-50 MC and 1-10 MC  
Output from 0.1  $\mu$ V to 0.1 Volt with attenuator, and 0.1 Volt to 1 Volt with special tap.

Deviation from zero to 200 KC  
Internal AF-100, 400, 1K, 4K and 10K cycles.  
RMA Pre-emphasis circuit.  
Vernier F Control for selectivity.

\*Quotations on other frequency ranges supplied on request.

**BOONTON RADIO CORPORATION**

Boonton, New Jersey

U. S. A.





# WAXES AND COMPOUNDS

FOR  
INSULATION and WATERPROOFING  
of ELECTRICAL and RADIO  
COMPONENTS

● such as transformers, coils, power packs, pot heads, sockets, wiring devices, wet and dry batteries, etc. Also WAX SATURATORS for braided wire and tape and WAXES for radio parts. The facilities of our laboratories are at your disposal to help solve your problems.

FOUNDED 1846  
*Zophar* MILLS, Inc.  
120-26th ST., BROOKLYN, N. Y.

# 359



SECONDS

Recently, a Fairchild owner had occasion to make a recording in Cleveland and to play it back in N. Y. on other Fairchild equipment. The recording was made in 359 seconds. The playback was made in precisely 359 seconds. Broadcast stations have learned to depend on this split second performance of Fairchild reproducing equipment. Write for free descriptive literature.

"...it had to satisfy Fairchild first"

**FAIRCHILD**  
Sound Equipment Division  
**INCORPORATED**  
AVIATION CORPORATION  
88-06 Van Wyck Boulevard, Jamaica, L. I., N. Y.

is usually positive. Thus the inductance of the coils and the capacitance of the capacitors both increase with an increase in temperature. When coils and capacitors are used in tuned circuits such as oscillators or amplifiers, the resonant frequency of the circuit will vary with the temperature so that the frequency of an oscillator will decrease as the temperature increases. So that the frequency of an oscillator or the constants of an amplifier circuit may remain constant, it is necessary that either the inductance or the capacitance have temperature characteristics that compensate for any change in the characteristics of the other. These new capacitors provide the capacitance compensation for such situations.

\* \* \*

### KELVIN-WHEATSTONE BRIDGE

A Kelvin-Wheatstone Bridge, with an effective range from as low as 0.0001 ohm to as high as 11,000,000 ohms is now available from Shallcross Mfg. Co., Collingdale, Pa.

The rheostat arm consists of four decades, variable in 1 ohm increments. The ratio arm has two sets of multipliers. The set designated "W" is for use in Wheatstone Bridge measuring and the other set designated "K" is for use when measuring with the Kelvin Bridge method.

A built-in galvanometer having a deflection of 1 mm/microampere, is an integral part of the set.

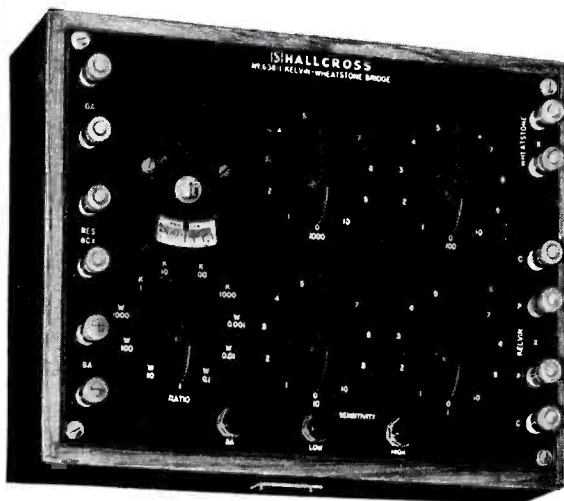

\* \* \*

### HEAVY DUTY LEVER SWITCH

A lever switch, said to provide positive action independent of contact springs is now available from Donald P. Mossman, Inc., Chicago, Ill. For use on heavy duty, multiple contact installations, it has many applications.

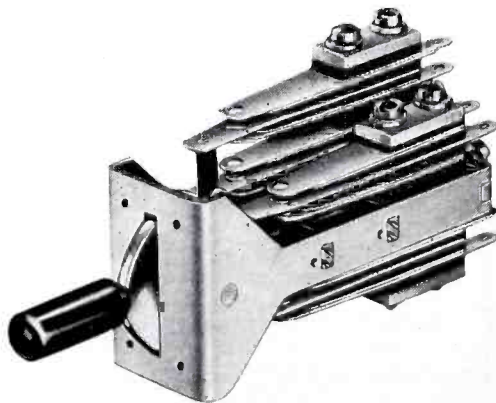

\* \* \*

### POST'S DECIMAL EQUIVALENT CHART

A Decimal Equivalent Wall Chart 26" X 39" has been prepared by Frederick Post Co., 3650 N. Avondale Ave. Chicago, Ill.

The chart offers all the equivalents from 1/64 to 63/64, and is free.

# WANTED!

Audio Transformer Designer — Should have education and experience necessary to establish basic designs and supervise production engineering on both "voice" and "control" applications. Work will be on interesting National Defense projects and expanded commercial products after the present emergency is over. Write, giving information covering education and experience. Salary arranged. All communications will be treated confidentially.

**Raytheon Mfg. Co.**  
190 Willow St., Waltham, Mass.

# — MICO — ENGRAVER

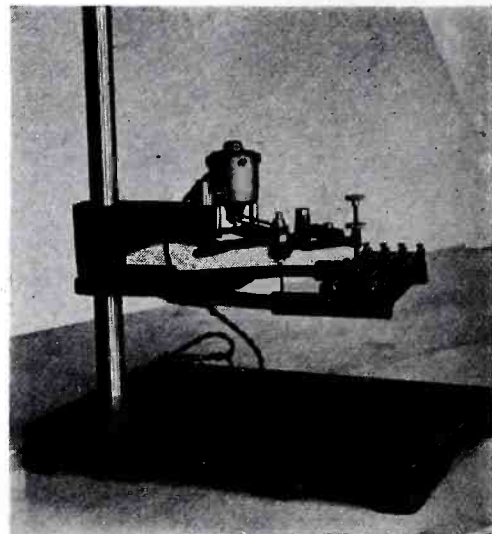

An engraver for large panels

Sturdy for continuous production  
Simple for inexperienced operators  
Quality engraving for quality products

Literature on request

Price with Type — \$132

**Mico Instrument Co.**  
18 ARROW STREET  
CAMBRIDGE, MASS.



# NEWS BRIEFS

## ISOLANTITE PRODUCTION TO BE INCREASED TEN-FOLD



A million dollar program of expansion and improvement for Isolantite, Inc., Belleville, N. J., is now under way. W. D. Waltman, president of Isolantite, has just announced.



W. D. Waltman (top), K. D. Hamilton (bottom).

A new three story building which will add approximately 80,000 square feet will be one of the features of the expansion program. In addition, new presses, machinery, kilns will be provided for increased production.

The enlarged plant will continue under the direct supervision of K. D. Hamilton, vice-president and

general manager.

\* \* \*

## ARMSTRONG MEDAL TO HOUCK

The Armstrong Medal of The Radio Club of America was awarded by J. L. Callahan, president of the club, to Harry William Houck for his outstanding contributions to the radio art, at the 32d annual banquet, held recently at the Engineers Club.

After assisting at the birth of the Superhetrodyne in Major Armstrong's wartime laboratory in Paris, Houck designed the second harmonic superhetrodyne, the first type to be placed in large commercial production. Radio receivers operating from alternating current power lines, from their very inception, leaned heavily on the technique, the designs and the inventions of the medalist. His researches on capacitors—paper, mica and electrolytic—made practicable the filter systems used in all modern radio receivers.

\* \* \*

## JIMMY YOUNGBLOOD NOW EASTERN CLAROSTAT SALES ENGINEER

Jimmy Youngblood has recently been transferred from Marion, Ind., to the home office of Clarostat in Brooklyn, N. Y. He has been assigned to manufacturing accounts and is also handling National Defense matters in the East.

\* \* \*

## IRC EXPANDS FACTORY

To meet expanded defense requirements, International Resistance Company has added approximately 30% more manufacturing space at 401 North Broad St., Philadelphia. This is the third expansion move since IRC's removal to its present quarters five years ago.

## AT LAST A GOOD PAPER BASE RECORDING BLANK



**M**ANY recording engineers have rejected the idea of using paper base discs for recording. You may feel that way about them, too. But we think you may change your mind when you see the new, improved Presto Monogram Disc. We sent samples of this disc to a few stations in July. In every case they started to use them immediately in quantity.

They are not as smooth as our glass or recoated aluminum discs and we don't recommend them for reproducing delayed broadcasts, but they're ideal for reference record-

ings. They're lightweight, easy to file, safe to handle or mail anywhere and the price is 40% less than our standard discs.

The base of the Monogram disc is cardboard—the flattest, smoothest stock obtainable. The coating material is exactly the same as our highest grade discs. They cut with the same needle pressure and angle. Surface noise is nil.

The Monogram disc is made in all sizes up to 16". It's worth knowing about. Order a sample carton of 10 from your distributor today.

## PRESTO RECORDING CORP.

242 WEST 55th ST. N.Y.

In Other Cities, Phone ... ATLANTA, Jack. 4372 • BOSTON, Bel. 4510  
CHICAGO, Har. 4240 • CLEVELAND, Me. 1565 • DALLAS, 37093 • DENVER,  
Ch. 4277 • DETROIT, Univ. 1-0180 • HOLLYWOOD, Hil. 9133 • KANSAS  
CITY, Vic. 4631 • MINNEAPOLIS, Atlantic 4216 • MONTREAL, Wel. 4218  
PHILADELPHIA, Penny. 0542 • ROCHESTER, Col. 5548 • SAN FRANCISCO,  
Yu. 0231 • SEATTLE, Sen. 2560 • WASHINGTON, D. C., Shop. 4003

World's Largest Manufacturers of Instantaneous Sound Recording Equipment and Discs



## SUPER-FINE OIL

### Recommended . . .

for all delicate and precise  
Electrical and Laboratory Equipment

**Leaves no residue of  
DIRT or STICKY GUM . . .**

### Available . . .

in small bottles with applicator,  
as illustrated, or in 8 ounce,  
16 ounce and gallon containers.

**DAVENOIL COMPANY**  
158 SUMMIT STREET • NEWARK, N. J.

## MEGABRIDGE Insulation Resistance TESTER

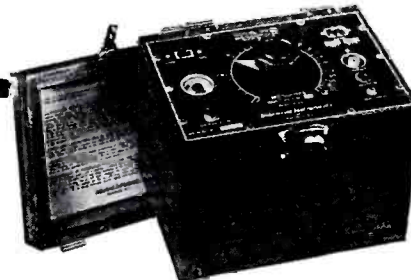

• This indispensable instrument pays for itself in a short while—out of actual savings in time, effort, trouble.

The Megabridge is the most rapid device for routine insulation measurements, which still retains the Wheatstone Bridge principle. Entirely self-contained and ready for operation. Requires no batteries or 'phones. Null point indicated on visual balance, quickly and accurately. Now employed in many radio and electronic labs. and shops.

• **Write for DATA . . .**

Bulletin MB-203 describing Megabridge, sent on request. Submit your checking or testing problems, since we also design and build special instruments.

**Industrial Instruments, Inc.**  
156 Culver Ave., Jersey City, N. J.



**GHIRARDI'S NEW BOOK**

A new 710 manual-sized (8½ x 11 inches) page Radio Troubleshooters Handbook by Alfred A. Ghirardi has just been published. In it are 386 pages of "Case Histories" covering over 4,600 receiver and automatic record changer models. Featured are a 50-page tabulation of I-F peaks and alignment data for practically every known superhet receiver; 60-pages of tabulated data and charts for the auto-radio specialist; replacement and comparable battery specifications and data charts for 1,250 portable radio receiver models. A 20-page

tube chart giving classification, interchangeability and socket connections of all types of American receiving tubes.

Included among the remaining 180 pages are comprehensive trade directories of all manufacturers related in any way to the radio industry, and 53 more reference charts and graphs presenting permanently useful data on a variety of important subjects such as ballast resistors, dial lamps, tube testing, magnet wire, tuning coils, grid bias resistors, resistor "preferred" values and tolerances, condensers, transformers, all RMA and manufactur-

er's color codes (including two original resistor and condenser color code and value identification charts) parallel and series circuit network calculations, decibel, volume and tone controls, filters, conversion factors, "Time constants," reactance, radio servicing formulas, etc.

\* \* \*

**DU MONT AND RCA EXCHANGE PATENT LICENSES**

Patent license agreements between Radio Corporation of America and the Allen B.



**164 PAGES  
SETS-PARTS  
SUPPLIES  
FLUORESCENT**

*Burstein Applebee Co.*

## BIG FREE CATALOG

### BROADCASTING EQUIPMENT

A complete line of transmitting tubes and equipment for broadcasting stations and studios as well as sets, parts, supplies, testers, public address systems, etc.



**HUGE STOCKS AT YOUR COMMAND**

Even with the great demand made by the Defense Program our huge stocks bought months ago enable us to fill orders promptly and efficiently. Start sending your orders to B-A now.

## BURSTEIN-APPLEBEE COMPANY

1012-14 MCGEE STREET ★ KANSAS CITY, MISSOURI

**WE WANT ELECTRONIC ENGINEERS AND RADIO TECHNICIANS**

Here is an opportunity to serve your country and travel to any point in the United States or possessions at liberal salary and all expenses paid. Employment guaranteed for minimum of one year or longer. Electronic Engineers must be graduate electrical engineers with major in Electronics or equal—age 24-30. Radio technicians must be high school graduates with a minimum of four years experience—age 20-30. Single men preferred.

EMPLOYMENT AT ONCE

Write Air Mail, giving full personal history, personal and experience references, and including snapshot, if possible. Arrangements will be made for personal interview. Address: Chief Engineer, Minneapolis-Honeywell Regulator Company, Minneapolis, Minnesota.

## CRYSTALS by HIPOWER

The Hipower Crystal Company, one of America's oldest and largest manufacturers of precision crystal units, is able to offer the broadcaster and manufacturer attractive prices because of their large production and the exclusive Hipower grinding process. Whatever your crystal need may be, Hipower can supply it. Write today for full information.

HIPOWER CRYSTAL CO.

Sales Division—205 W. Wacker Drive, Chicago  
Factory—2035 Charleston Street, Chicago, Ill.

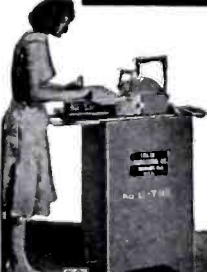

We manufacture a complete line of Electric Spot Welders, ¼ to 250 KVA. Standard and Special Transformers. Incandescent lamp, radio tube, neon tube and fluorescent tube making equipment. Glass cutting, slicing and working equipment. College laboratory units. Vacuum pumps. Wire Butt Welders. A.C. Arc Welders from 100-400 Amps.

Write for Information.

Eisler Engineering Company

CHAS. EISLER, Pres.  
741 S. 13th St. (Avon Ave.) Newark, N. J.



AMATEUR  
UNCON-  
DITIONALLY  
GUARANTEED



COMMERCIAL  
WRITE US  
FOR PRICES  
Fast Service

PETERSEN RADIO CO., Council Bluffs, Iowa

### RADIO ENGINEER WANTED

Interesting work on a national defense project for a technically trained man having experience in the design and operation of ultra high frequency radio apparatus. Write giving information covering education and experience. Salary arranged. All communications will be treated confidentially. Raytheon Manufacturing Company, 190 Willow Street, Waltham, Massachusetts.

### CANNON SOUND PLUGS AND RECEPTACLES

NOW STOCKED IN NEW YORK—The Cannon Electric Development Co. of Los Angeles has appointed us as distributors of their sound plugs and receptacles. Here is more evidence of Terminal's regular and reliable delivery of essential materials in the face of trying conditions.

**TERMINAL RADIO CORP.**  
2 stores in New York City  
Vanderbilt 6-5050

68 West 45th Street  
80 Cortlandt Street

### RECORD MEN

EXPERIENCED AND ASSISTANTS

Wax Recordists, Matrix Electroformers, Pressmen, Compounding and Mill Room Positions open in Northern New Jersey and vicinity of Boston. Written applications only.

POINSETTIA, INC., PITMAN, N. J.

**STATEMENT OF THE OWNERSHIP, MANAGEMENT, CIRCULATION, ETC., REQUIRED BY THE ACTS OF CONGRESS OF AUGUST 24, 1912 AND MARCH 3, 1933, OF COMMUNICATIONS**

Published monthly at New York, N. Y., for October 1, 1941.  
County of New York, } ss.:  
State of New York, }

Before me, a Notary Public, in and for the State and county aforesaid, personally appeared B. S. Davis, who, having been duly sworn according to law, deposes and says that he is the Business Manager of COMMUNICATIONS, and that the following is, to the best of his knowledge and belief, a true statement of the ownership, management, etc., of the aforesaid publication for the date shown in the above caption, required by the Act of August 24, 1912, as amended by the Act of March 3, 1933, embodied in section 537, Postal Laws and Regulations, to wit: 1. That the names and addresses of the publisher, editor, managing editor, and business manager are: Publisher, Bryan Davis Publishing Co., Inc., 19 East 47th Street, New York, N. Y.; Editor, Lewis Winner, New York, N. Y.; Managing Editor, None. Business Manager, B. S. Davis, Ghent, N. Y.; 2. That the owners are: Bryan Davis Publishing Co., Inc., 19 E. 47th St., New York, N. Y.; B. S. Davis, Ghent, N. Y.; J. C. Munn, Union City, Pa.; J. A. Walker, St. Albans, L. I., N. Y.; A. B. Goodenough, Port Chester, N. Y.; P. S. Weil, Great Neck, L. I., N. Y. 3. That the known bondholders, mortgagees, and other security holders owning or holding 1% or more of the total amount of bonds, mortgages, or other securities are: None. 4. That the two paragraphs next above, giving the names of the owners, stockholders, and security holders, if any, contain not only the list of stockholders and security holders as they appear upon the books of the company, but also, in cases where the stockholder or security holder appears upon the books of the company as trustee or in any other fiduciary relation, the name of the person or corporation for whom such trustee is acting, is given; also, that the said two paragraphs contain statements embracing affiant's full knowledge and belief as to the circumstances and conditions under which stockholders and security holders who do not appear upon the books of the company as trustees, hold stock and securities in a capacity other than that of a bona fide owner; and this affiant has no reason to believe that any other person, association, or corporation has any interest direct or indirect in the said stock, bonds, or other securities than as so stated by him.

(Signed) B. S. DAVIS, Business Manager.  
Sworn to and subscribed before me this 26th day of September, 1941.  
(Seal) JAMES A. WALKER, Notary Public.

Queens Co. Clk's No. 2500, Reg. No. 6710.  
New York Co. Clk's No. 323, Reg. No. 3W182.  
Commission expires March 30, 1943.



Du Mont Labs., Inc., were recently announced by Allen B. Du Mont. The Du Mont organization is thereby licensed under standard RCA patent license agreements, while Du Mont in turn grants RCA a non-exclusive, non-transferable license under all Du Mont patents covering important advances and refinements in cathode-ray oscillography and in television transmission and reception.

\* \* \*

**PAUL V. GALVIN HEADS R. M. A.**

At a recent meeting of the board of directors of the Radio Manufacturers Association, in New York, Paul V. Galvin was elected president to succeed the position vacated by James S. Knowlson, who recently resigned to become Deputy Director of OPM Priorities Division.

\* \* \*

**NEW SOLA CATALOG**

Protection through the use of transformers that offer complete independence from the effects of line voltage variations is fully described in a new bulletin No. CV-74 just released by the Sola Electric Company, 2525 Clybourn Avenue, Chicago, Ill.

\* \* \*

**KAAR MANAGING ENGINEER OF G-E RECEIVERS**

Appointment of I. J. Kaar as managing engineer of the receiver division of the General Electric radio and television department, Bridgeport, Conn., has been announced by W. Stewart Clark, manager of the G-E Bridgeport works. Since November, 1934, Mr. Kaar had been designing engineer of the division.

\* \* \*

**CANNON ISSUES AIRCRAFT DATA**

A 40 page bulletin (K) describing a variety of cable connectors, types K and 2K, for aircraft use, has just been published by the Cannon Electric Development Co., Los Angeles, Calif. Charts, insert arrangements drawn to scale, and other important statistical information are included.

\* \* \*

**PRECISION'S NEW CATALOG**

The Precision Apparatus Company, Brooklyn, N. Y., has just issued their 1942 catalog, in which 48 test instruments are illustrated and described. In addition, valuable technical test data, including diagrams, are also presented.

\* \* \*

**APCO LOSES SMITH**

President-elect C. M. Smith, Jr., has accepted a position in the radio broadcast field and will therefore be ineligible to continue as a member of APCO.

\* \* \*

**HYTRON PURCHASES NEW PLANT**

Bruce A. Coffin, general manager, of Hytron Corp., Salem, Mass., has announced that they have purchased the "Sunshine Factory" in Newburyport, formerly used by the W. G. Dodge Company.

The new plant has approximately 100,000 square feet of floor space and with the Salem plants, will provide facilities for more than triple the present output.

Hytron's new plant is located 20 miles north of the present Salem plant.

\* \* \*

**NEELY ENTERPRISES AT APCO CONVENTION**

Norman B. Neely, Frank B. McRae and Homer E. Beren of Neely Enterprises were present during the recent APCO convention in Oakland, Cal., and exhibited Radio Engineering Laboratories mobile and station equipment, as well as certain items of the Presto Recording Corporation, the Hewlett-Packard Company, The Daven Company and Audio Development Company.

**Here's why OHMITE Resistors are the best answer for Resistance Problems**

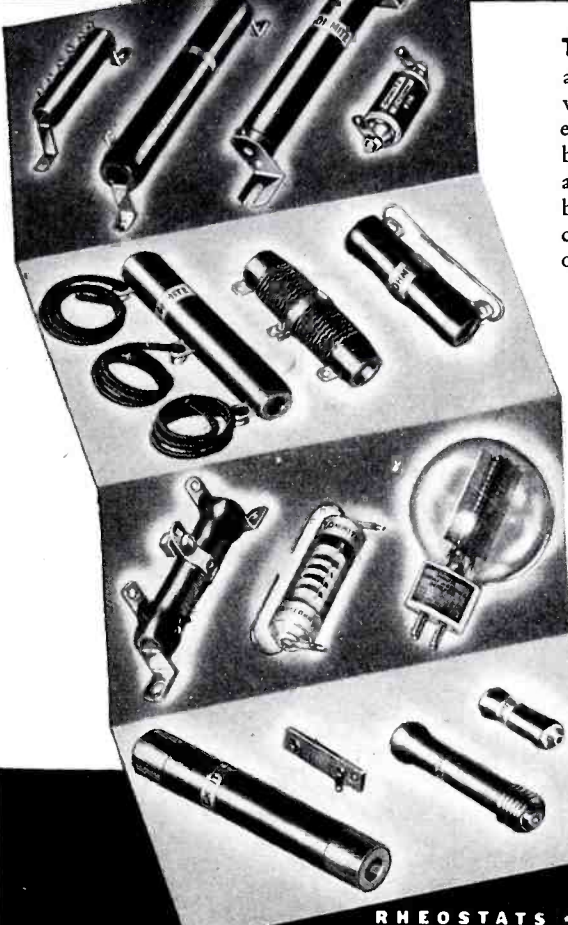

**THE EXTENSIVE RANGE** of Ohmite types and sizes makes possible an almost endless variety of regular or special resistors to meet every need. Core sizes range from 2 1/2" diameter by 20" long to 1/8" diameter by 1" long. They are available in fixed, adjustable, wire or flexible lead, tapped, ferrule, Edison base, bracket, cartridge, strip, precision, non-inductive, and other types.

**YOU CAN OFTEN SAVE** by using Ohmite stock units or calling on the specialized experience of Ohmite Engineers.

**OHMITE Vitreous Enamelled Resistors** have proved their dependability in every climate from the arctic to the tropics. That's why they are so widely used in Industry and in the Armed Forces of the Nation.

*Write on company letterhead for complete, helpful 96 page Catalog and Engineering Manual No. 40.*

**OHMITE MANUFACTURING CO.**  
4869 Flournoy St., Chicago, U.S.A.

*Be Right with*  
**OHMITE**

RHEOSTATS • RESISTORS • TAP SWITCHES

**JONES 500 SERIES PLUGS AND SOCKETS**

Designed for 5,000 volts and 25 amperes. All sizes polarized to prevent incorrect connections, no matter how many sizes used on a single installation. Fulfills every electrical and mechanical requirement. Easy to wire and instantly accessible for inspection. Sizes: 2, 4, 6, 8, 10, and 12 contacts. Send for a copy of Bulletin 500 for complete information. Write today.

**HOWARD B. JONES**  
2300 WABANSIA AVENUE, CHICAGO

**"Mangrid"**  
**GRID WIRE**  
*Economy with Quality*

**WILBUR B. DRIVER CO.**  
NEWARK, NEW JERSEY



# Radio's MASTER ENCYCLOPEDIA



The Radio Industry at your finger tips

REFERENCE BOOK  
BUYING GUIDE  
SALES CATALOG  
ENCYCLOPEDIA

**9th EDITION  
OVER 800 PAGES**

## THE ONLY OFFICIAL RADIO PARTS AND EQUIPMENT MANUAL

It took six years and thousands of dollars to develop this "MASTER CATALOG" of the radio industry to its present size—yet it costs you only \$2.50.

Compiled in co-operation with and approved by the Radio Manufacturers Group as the industry's official source book.

### GIVES THIS IMPORTANT DATA

Contained within the hard covers of this 800 page MASTER BOOK are the listings of the products of 90% of all Radio Parts and Equipment Manufacturers in the industry. In it you will find many thousands of items, such as electronic devices, transmitting and receiving sets, tubes, antennas, transformers, condensers, replacement parts, meters, laboratory test equipment, relays, plugs, coils, wire, and numerous other radio components. Thousands of clear illustrations with descriptions and specifications. —Yes, this is your "MUST HAVE BOOK".

### •• WHO USES IT? ••

As the official source book of the radio industry it is constantly used by many American and Foreign governmental agencies, also industrial organizations, engineers, purchasing agents, laboratories, radio amateurs and service men, radio distributors, broadcast stations, schools, colleges, libraries, and by many others interested in Radio and allied fields.

### SAVES TIME—SAVES MONEY

WHERE, WHAT AND HOW MUCH: Such information is instantly at your fingertips. This valuable RADIO MASTER eliminates the maintenance of bulky files. It is completely indexed for speedy reference.

If you buy, sell or specify you will find the RADIO MASTER an indispensable and handy book to have around at all times.

### MONEY BACK GUARANTEE!

Order your copy today—look it over. You will find it to be an excellent investment; if not, return it to us in five days for full refund.

The price is only \$2.50 shipped anywhere in U.S.A. — \$3.00 elsewhere. We prepay transportation charges if remittance accompanies order.

**UNITED CATALOG PUBLISHERS, Inc.**

106A Lafayette St. New York, N. Y.

## Index to Advertisers

A	
Advance Solvents and Chemical Corp.	28
Amperex Electronic Products, Inc.	Inside Front Cover
Astatic Corp., The.....	25
B	
Bliley Electric Co.....	31
Boonton Radio Corp.....	31
Burstein-Applebee Co.....	34
D	
Daven Co., The.....	27
Davenoil Co.....	33
Driver Co., Wilbur B.....	35
E	
Eisler Engineering Co.....	34
Eitel-McCullough, Inc.....	3
F	
Fairchild Aviation Corp.....	32
G	
General Electric Co.....	17
General Radio Co.....	Inside Back Cover
H	
Hipower Crystal Co.....	34
I	
Industrial Instruments, Inc.....	33
Isolantite, Inc.....	1
J	
Johnson Co., E. F.....	29
Jones, Howard B.....	35
L	
Lapp Insulator Co.....	Back Cover
Lenz Electric Mfg. Co.....	19
M	
Mico Instrument Co.....	32
Miller Co., J. W.....	26
Minneapolis-Honeywell Regulator Co.....	34
O	
Ohmite Mfg. Co.....	35
P	
Petersen Radio Co.....	34
Poinsettia, Inc.....	34
Premax Products.....	30
Presto Recording Corp.....	33
R	
RCA Mfg. Co., Inc.....	4, 15
Radio Amateur Call Book, Inc.....	36
Raytheon Mfg. Co.....	32, 34
Royal Typewriter Co.....	36
S	
Solar Mfg. Corp.....	23
Square D Company.....	26
Sun Radio Co.....	30
T	
Terminal Radio Corp.....	34
Thomas & Skinner Steel Prods. Co....	30
U	
United Catalog Publishers.....	36
United Transformer Corp.....	20
Z	
Zophar Mills, Inc.....	32

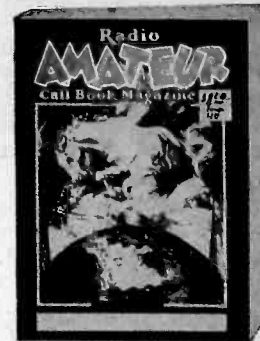

## Radio Engineers who are RADIO AMATEURS buy a fresh copy today of the RADIO AMATEUR CALL BOOK

The CALLBOOK is the only publication that lists all licensed radio amateurs in the United States and foreign countries.

Complete . . . Accurate . . . Up-to-Date

Issued Quarterly

MARCH . . . JUNE . . . SEPTEMBER  
and DECEMBER

Annual subscription \$4.00  
Single copies \$1.25

Buy your copy now from your radio jobber  
or direct from:

**Radio Amateur Call Book, Inc.**  
608 S. Dearborn St., Chicago, Ill., U. S. A.

## SECRETARY KNOWS BEST!

Only your secretary knows which make suits her style of typing best. So let her pick the new machine.

We'll gladly put a new Royal in your office on free trial. See for yourself that a Royal is easier to operate, means *better* work *faster*. Just call us.



# ROYAL

## WORLD'S NO. 1 TYPEWRITER

Royal Typewriter Co., Inc.  
2 PARK AVE., NEW YORK, N. Y.  
Branches and Representatives  
the World Over



# MAKING INSTRUMENTS DIRECT READING

with

## VARIABLE RESISTORS



**Type 650-A Impedance Bridge, direct-reading over these ranges:**

**Resistance: 1 milliohm to 1 megohm**

**Capacitance: 1 micromicrofarad to 100 microfarads**

**Inductance: 1 microhenry to 100 henrys**

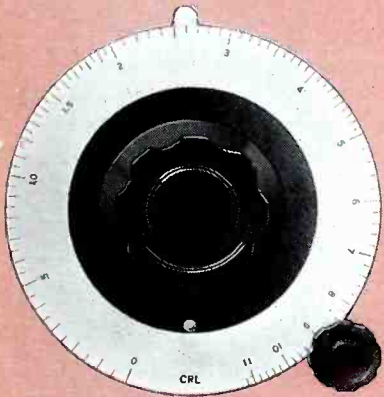

**The CRL Dial with semi-logarithmic scale.**



**The cam on the CRL potentiometer. The contact arm is not connected directly to the potentiometer shaft, but turns freely on it. At the outer end a spring is pressed against a follower which rides on the cam. The cam follower rocking up and down on the cam changes the angular position of the contact arm and the scale. Adjustment of the eight screws will take up all differences between individual potentiometers and the master potentiometer which itself is an average.**

**I**N RESEARCH and production testing the convenience of having instruments read directly in the quantities they measure has been appreciated for some time by the manufacturer and the user of electrical measuring instruments. So rapid have been the improvements in most direct-reading instruments that they now have considerably greater accuracy than similar units manufactured several years ago without the direct-reading feature.

In general, direct-reading scales are used only with resistors and capacitors; the accuracies obtainable are high, frequently as great as 0.1% of full-scale. In order to maintain high accuracy in a direct-reading instrument, constant fractional accuracy must be obtained and the rate of variation of the unknown should be logarithmic. In any linear scale the fractional accuracy decreases directly with the quantity varied.

The circuit used with any direct-reading instrument has to be chosen so that the magnitude of the variable element is proportional to the unknown.

One of the most interesting examples of a direct-reading instrument is the Type 650-A Impedance Bridge. This bridge measures five quantities over exceptionally wide ranges with the following maximum errors: for resistance, 2%; for capacitance, 2%; for inductance, 10%; for dissipation factor ( $R/X$ ), 20%, and for storage factor ( $X/R$ ), 20%.

For the measurement of so many different quantities and for the very large ranges obtainable from this bridge, four circuits and a number of multipliers are selected by two multi-position switches. The balances are obtained by the use of two of the four variable resistors.

The semi-logarithmic scales on the four dials . . . the CRL, D, DQ and Q dials . . . are direct-reading. The potentiometers used with these dials are wound on tapered cards. The scales can be made direct-reading either by hand calibration of each point to fit the irregularities introduced by variations in wire size and spacing, or these irregularities can be controlled to fit a pre-engraved scale.

Originally the CRL dial of this bridge was hand calibrated with every line set to its proper resistance value. Later, the calibrations on a production lot were averaged and a master constructed. From this master calibration, other dials were engraved on a pantograph engraving machine. These dials are now photo-etched. In the quantities in which these instruments are now manufactured, it has proved much more economical to provide the CRL potentiometers with the photo-etched dial scale and to compensate for irregularities by means of a flexible cam, than to engrave each dial separately.

Many other General Radio direct-reading instruments use resistors as the variable element. The dial scales are calibrated in a manner similar to those on the Type 650-A Bridge.

## GENERAL RADIO COMPANY

CAMBRIDGE, MASSACHUSETTS



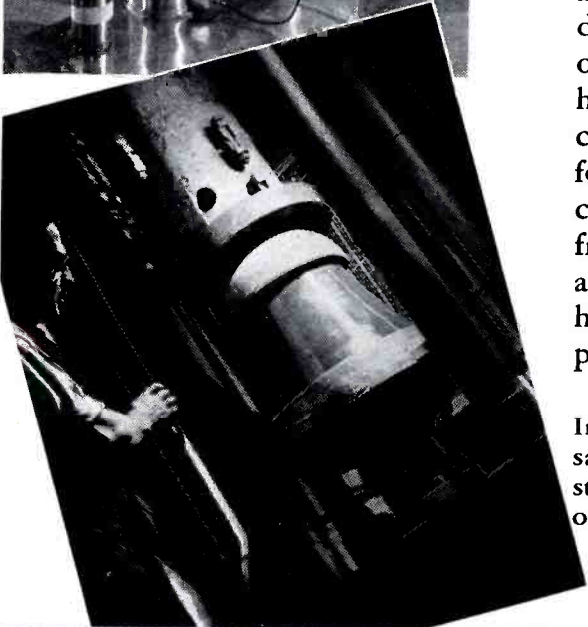
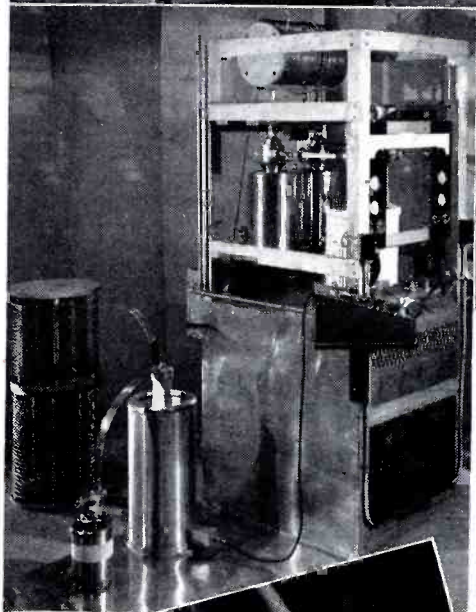

**PERFORMANCE CHARACTERISTICS OF LAPP RADIO INSULATORS ARE DEPENDABLE FACTORS**

Lapp's contributions to radio broadcast engineering are recognized as highly significant in the advance of the science. Practically every development of antenna structure design, for example, has been worked out with the co-operation of Lapp engineers. Since Lapp developments have been wholly pioneering in nature, it has been necessary to maintain complete testing facilities. In the Lapp laboratory is the usual equipment for 60-cycle electrical, mechanical and ceramic testing. In addition is complete equipment for determining characteristics of units at radio frequency—heat run, radio frequency flashover, corona determination and capacitance. For mechanical testing (lower picture), a 1,500,000 lb. hydraulic testing machine is used—for test of new designs, and for proof-test of every insulator before shipment.

In the construction of new broadcast equipment—or the modernizing of old—the safe bet is to specify "insulators by Lapp." Descriptive literature on Lapp antenna structure insulators, porcelain water coils and gas-filled condensers is available on request. Lapp Insulator Co., Inc., LeRoy, N. Y.

*Specify* **LAPP**  
**FOR SECURITY IN ANTENNA STRUCTURE INSULATORS**