

# COMMUNICATIONS

**DEFENSE  
COMMUNICATIONS  
BOARD**

**FREQUENCY  
MODULATION**

**ROCHESTER  
FALL MEETING**

**OCTOBER**

**1 9 4 0**



# 32RA

(A-C)

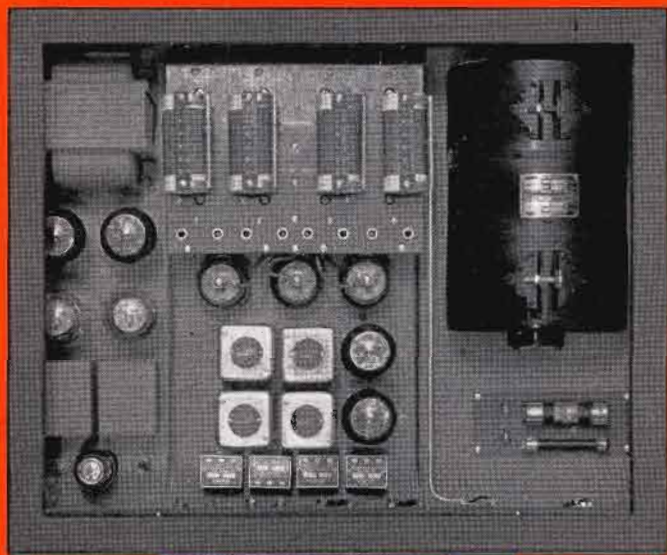
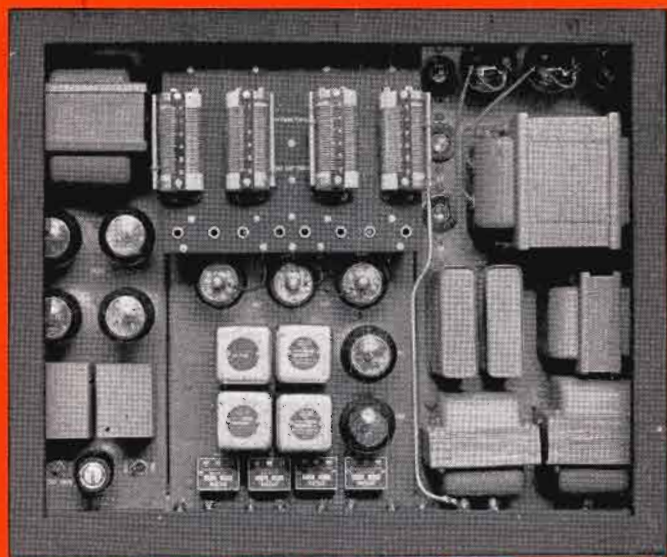

# 32RB

(D-C)

**F**ifty watts radiotelephone, seventy-five watts radiotelegraph with operation from a-c or various d-c voltages is possible with Collins 32RA—32RB Transmitters.

These two highly developed equipments have identical four channel "quick shift" radio frequency units, audio modulator units, transmitter cabinets and meters. For a-c operation (32RA) a heavy duty power supply chassis operates from a 110 volt 50/60 cycle a-c source. For d-c operation (32RB) a dynamotor having a primary input of 12, 24, 32 or 110 volts replaces the a-c power supply as specified.

Standardization of your a-c—d-c transmitter installations is completely solved with the 32RA—32RB combination.

Frequency Range: 1.5 to 15 mc.

Frequency Change Method: Panel control instantly selects any of four frequencies.

A-F Response: Uniform within  $\pm 2$  db from 200 to 4000 c.p.s.

A-F Amplitude Distortion: Less than 5% r.m.s. total harmonics at any modulation level.

Residual Noise Level: More than 40 db below 100% modulation.

R-F Output Impedance: 30 to 1200 ohms, power factor 70 per cent.

Cabinet Dimensions: 12½" high, 22" wide and 18" deep.

Net Weight: 32RA 127 pounds, 32RB 100 pounds.

# COLLINS RADIO COMPANY

CEDAR RAPIDS, IOWA . . . NEW YORK, N. Y. 11 WEST 42 STREET

# LENZ

## WIRES & CABLES

### FOR AIRCRAFT WIRING

Lenz Wires and Cables can be made to meet the requirements of Aircraft Manufacturers and Government specifications. Such desirable qualities as flame resistance, moisture resistance and high dielectric strength are developed to a high degree. Some of the Lenz Wires that have found particularly wide acceptance among Manufacturers of Aircraft and Aircraft Instruments are described below.

#### AEROLAC

A combination of spiral wrapped acetate tape and cotton textile impregnated with a flame resistant compound. Voltage breakdown at room temperature 4000 Volts. Voltage breakdown after 24 hours immersion in water 4000 Volts.

#### SPIBRAC

Insulation consists of spiral wrapped varnished cambric with cotton braid and impregnated with flame resistant compound. High Voltage Breakdown. Made to U. S. Government Specifications.

#### LENCEL

A wire of high dielectric characteristics but small diameter, extremely desirable for use in cables where size must be kept to a minimum.

#### LENGLAS

A flameproof fibreglas insulated wire. Insulation will not support combustion even when conductor is heated to incandescence.

#### AEROGLAS

A combination of spiral wrapped acetate tape and double fibreglas braid, lacquer impregnated. Offers extremely high voltage breakdown and excellent flame resistant qualities.

#### LENZ R. E. HOOK-UP WIRE

Patent No. 2,170,306  
Especially recommended for High Frequency Instrument Wiring. Offers high voltage breakdown, high insulation resistance and low Power factor under adverse climatic conditions. Used for aircraft radio receivers and direction finding equipment.

### LENZ SHIELDED WIRES & CABLES

All Lenz Wires are furnished in various sizes of conductors in both solid and stranded construction and with color coded insulation.

#### OUR ENGINEERS

will be glad to collaborate in the design of special wires and cables to suit your exact requirements.



## LENZ ELECTRIC MANUFACTURING CO.

1751 No. Western Avenue - CHICAGO, ILLINOIS

Enjoying its 35th Year of Successful Business

RAY D. RETTENMEYER

Editor

## • Contents •

### COVER ILLUSTRATION

A U. S. Forest Service airplane in flight. Radio-equipped parachute fire-fighters are dropped from planes of this type.

- 5 DEFENSE COMMUNICATIONS BOARD
- 6 THE DESIGN OF A PRACTICAL LOW-PASS FILTER FOR 600-OHM AUDIO TRANSMISSION LINES  
By Scott Helt
- 8 F-M BROADCAST TRANSMITTERS By W. R. David
- 11 SYSTEM OF PHASE AND FREQUENCY MODULATION  
By Samuel Sabaroff
- 14 TECHNICAL PROGRAM OF THE ROCHESTER FALL MEETING
- 16 BOOK REVIEWS
- 18 VETERAN WIRELESS OPERATORS ASSOCIATION NEWS
- 19 OVER THE TAPE
- 22 SOME NOTES ON VIBRATORY MOMENTUM AND GROOVE SKATING IN DISC REPRODUCTION  
By J. C. Parvey
- 28 FACSIMILE DEMONSTRATION
- 29 ACOUSTIC TONE GUARD
- 34 THE MARKET PLACE
- 40 INDEX OF ADVERTISERS

## • Editorial Comment •

**A** DEFENSE Communications Board has been set up by Presidential Order to coordinate communications to the National Defense Program. James Lawrence Fly, Chairman of the FCC, has been appointed Chairman of the new Board—other members are: Rear Admiral Leigh Noyes, Director of Naval Communications; Maj. Gen. J. O. Mauborgne, Army Chief Signal Officer; Herbert E. Gaston, Assistant Secretary of the Treasury, representing the Coast Guard; and Breckenridge Long, Assistant Secretary of State, in charge of the State Department Division of International Communications.

Data on the functions and duties of the Board as well as the text of the Presidential Order is given on page 5.

**T**HIS year the Rochester Fall Meeting is being held on November 11, 12 and 13 at the Sagamore Hotel in Rochester, N. Y. Details on page 14.

**A**NOTHER gathering of interest is the 1940 Fall Convention of the Society of Motion Picture Engineers. According to the tentative program of this meeting, which is to be held October 21-25 at the Hollywood Roosevelt Hotel, Hollywood, Calif., there are a number of papers of interest to radio engineers. Among them are several papers dealing with microphone operation and design, others on developments in disc recording and reproduction, speaker testing, and television.

**A** THIRD gathering which should be kept well in mind is the National Police Communication Conference to be held in Orlando, Florida, December 2-5. Data on this meeting will appear in the November issue of COMMUNICATIONS.

**B**ACK in 1920 a number of experimenters began transmitting regular radio programs. It seems only proper, then, that in 1940 radio should celebrate its twentieth birthday. This is just what will happen—a 20-day national birthday party, November 11-30. The story of radio broadcasting has often been told. But, it is a story that is well worth repeating.

Copyright 1940, Bryan Davis Publishing Co., Inc.

BRYAN S. DAVIS  
President

JAMES A. WALKER  
Secretary

Chicago Office—608 S. Dearborn Street  
Telephone: Wabash 1903

Published Monthly by the

**BRYAN DAVIS PUBLISHING CO., Inc.**

19 East 47th Street  
New York City

New York Telephone: PLaza 3-0483

PAUL S. WEIL  
Advertising Manager

A. GOEBEL  
Circulation Manager

Wellington, New Zealand—Te Aro Book Depot  
Melbourne, Australia—McGill's Agency

Entered as second-class matter October 1, 1937, at the Post Office at New York, N. Y., under the act of March 3, 1879. Yearly subscription rate: \$2.00 in the United States and Canada, \$3.00 in foreign countries. Single copies: twenty-five cents in United States and Canada, thirty-five cents in foreign countries.

## **Isolantite Insulators Increasingly Important TO AERIAL COMMUNICATION**

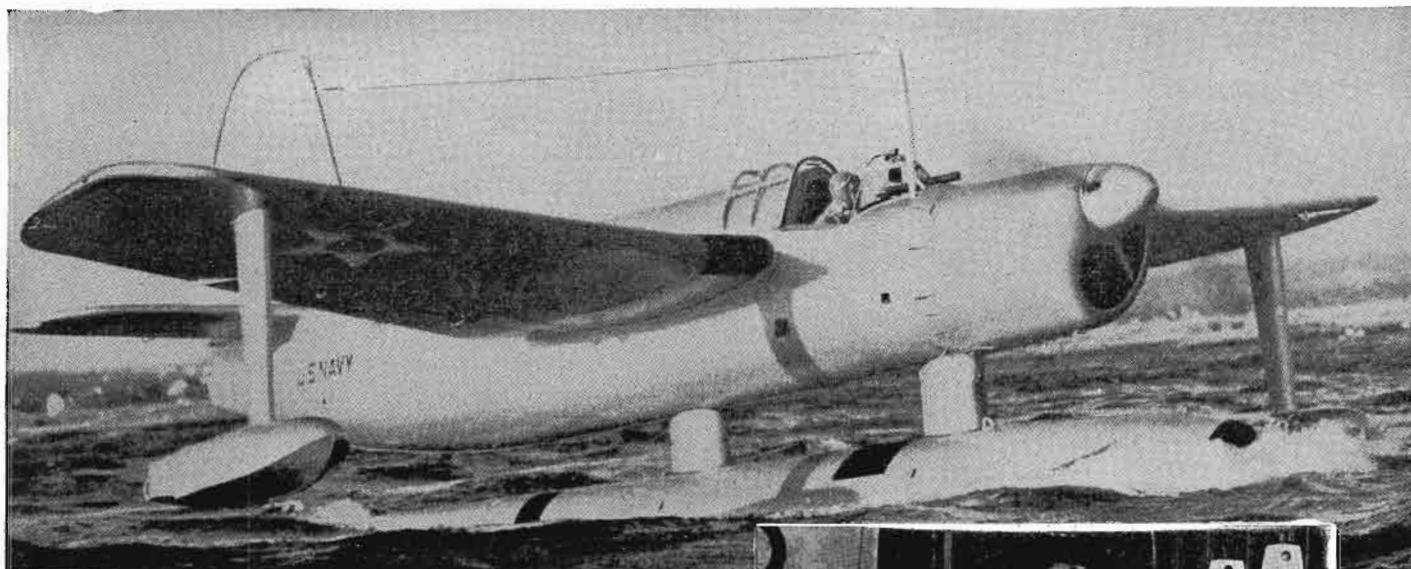

Visible atop this latest Scout Observation Seaplane are Isolantite Antenna Supports. These reliable, highly-efficient insulators for radio apparatus meet the United States Government's rigid specifications.

**I**SOLANTITE\* Insulators are unobtrusive—but vital—factors in the dependability and efficiency of modern aircraft communications, both military and civil.

Isolantite possesses great structural strength which does more than double duty: It assures mechanical protection against landing shocks and flying stresses . . . it permits small, weight-saving cross sections. This smallness gives an additional major advantage — it makes possible more efficient, longer range radio apparatus by reducing dielectric power loss. These excellent electrical and physical properties are practically unaffected by the extremes of temperature and humidity encountered in flying.

Among those who rely upon the superb characteristics of Isolantite Insulators are the United States Army and Navy Air Services, the Transatlantic and Transpacific Clippers, the commercial air lines, and business executives with private planes.

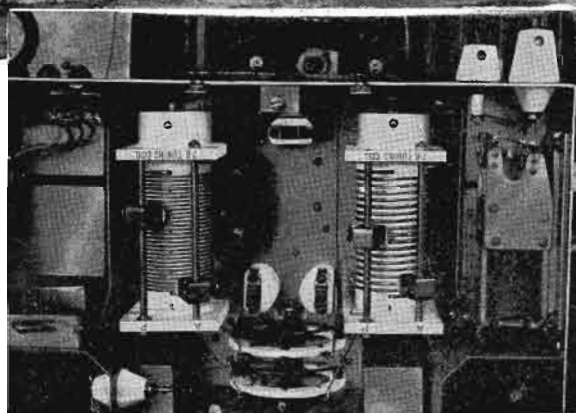

Typical installation showing the use of standard Isolantite Insulators in the radio equipment of a commercial plane

Your requirements may call for high frequency insulators of special shape or streamlined section. If so, you will benefit by availing yourself of our experience in design of insulators.

\*Registered trade-name for the products of Isolantite, Inc.

# **ISOLANTITE**

## **CERAMIC INSULATORS**

ISOLANTITE, INC. FACTORY: BELLEVILLE, NEW JERSEY  
SALES OFFICE: 233 BROADWAY, NEW YORK, N. Y.

**RATINGS UP..PERFORMANCE IMPROVED..PRICE UNCHANGED**



# RCA - 833 - A

**R-F POWER AMPLIFIER, CLASS B MODULATOR**  
**1.6 KW\* Maximum Power Output at Frequencies up to 20 Mc**

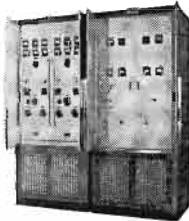

**Chosen for RCA'S  
 Outstanding New AVT-22  
 Communications Transmitter**

A typical example of the capabilities of the RCA-833-A is found in the new, ultra modern RCA AVT-22 General Communications Transmitter. Using two 833-A's in the final class C power amplifier and two 833-A's in the class B modulator, this equipment has a maximum power output of 2½ kw on frequencies of from 2½ to 12 megacycles, and an output of 2 kw from 12 to 19 megacycles. Power output of the AVT-22 can be doubled by using two additional 833-A's, in both the modulator and final stages. The unit, employing a total of eight RCA-833-A's, is then known as the AT-22A.

Measured by every characteristic from long life to power output—or any other factor by which tubes are judged—the RCA-833 has long enjoyed a reputation unexcelled. Now, with the famous RCA Zirconium-coated plate and with other processing refinements, a new, improved form of this type—the RCA-833-A—offers even greater value for r-f amplifier or class B modulator service. The 833-A provides an increased maximum plate dissipation of 450 watts (ICAS) at no increase in price. It can be operated in class C telegraph service with a maximum input of 2000 watts, (ICAS) at frequencies as high as 20 megacycles. (Forced air ventilation is required with ICAS ratings.) With CCS ratings, the maximum input is 1800 watts.

Small and compact, the 833-A offers Kilowatts of power in a tube less than 9" in over-all height and 4⅝" in diameter! By employing forced-air cooling, it can

be used to boost power substantially in applications now served by the popular RCA-833. Because of its high pervance, this new tube operates at high plate efficiency with low driving power. The plate, grid and filament are supported by their respective post terminals. This design provides a rugged structure which makes bases unnecessary.

**MAXIMUM RATINGS AS R-F POWER AMPLIFIER — CLASS C TELEGRAPHY**

|                   | Natural Cooling |      | Forced-air Cooling |              |
|-------------------|-----------------|------|--------------------|--------------|
|                   | CCS             | CCS  | ICAS               | ICAS         |
| D-C Plate Voltage | 3000            | 4000 | 4000               | volts        |
| D-C Plate Current | 500             | 500  | 500                | milliamperes |
| D-C Grid Current  | 75              | 100  | 100                | milliamperes |
| Plate Input       | 1250            | 1800 | 2000               | watts        |
| Plate Dissipation | 300             | 400  | 450                | watts        |

List Price \$85.00

\*ICAS Ratings for class C telegraph service.



## Transmitting Tubes

**PROVED IN COMMUNICATIONS' MOST EXACTING APPLICATIONS**

RCA MANUFACTURING COMPANY, INC., CAMDEN, N. J. • A Service of the Radio Corporation of America

# DEFENSE COMMUNICATIONS BOARD

**T**HE purpose of the Defense Communications Board, created Sept. 24 by Executive Order, is to coordinate the relationships of all branches of communication to the national defense.

The Defense Communications Board was initiated jointly by the various Government departments and agencies having a vital interest in this phase of the preparedness program. The board is basically a planning agency, without operating or procurement functions. As such it is charged with the important duty of charting the utilization and control of our communication systems in the best interests of the national security.

The board will have no power to censor radio or other communications, or to take over any facilities.

This task of planning is not confined to radio broadcasting, but also embraces common carriers such as commercial radiotelephone and radiotelegraph as well as other telephone, telegraph and cable facilities.

The board does not propose to interfere with the normal operation of broadcasting or other forms of communication any more than is necessary for the national protection. Through correlated planning, it will seek to gear the great and strategically valuable American communications system, in both the domestic and international fields, to meet any situation the national interest may require.

The various branches of the communications industry will cooperate in an advisory capacity with the board, which will be composed of the Chairman of the Federal Communications Commission, the Chief Signal Officer of the Army, the Director of Naval Communications, an Assistant Secretary of State, and an Assistant Secretary of the Treasury. Where the activities of the board impinge upon any functions of Government departments, representatives of such departments will be placed upon appropriate committees.

The board has had the cooperation of the radio industry in the preparation of this order. With industry cooperation, the board will appoint committees from every branch of communications—

broadcast and other radio services, cable, telegraph and telephone—as well as from labor groups. All plans involving the utilization of private facilities, or requiring industry cooperation, will be

adopted only after consultation with such industry representatives, and the particular private companies whose properties may be involved.

The executive order reads as follows:

## EXECUTIVE ORDER

### Creating the Defense Communications Board and Defining Its Functions and Duties

WHEREAS, coordinated planning for the most efficient control and use of radio, wire, and cable communication facilities under jurisdiction of the United States in time of national emergency involves the consideration of the needs for communication of the armed forces of the United States, of other government agencies, of industry, and other civilian activities; and

WHEREAS, such planning must be accomplished as a matter of preparation for national defense; and

WHEREAS, the interest of national defense in the matter of control and use of communication facilities during any war in which the United States may become a belligerent is deemed paramount:

NOW, THEREFORE, by virtue of the authority vested in me as President of the United States, and by the Communications Act of 1934 (48 Stat. 1064), as amended, it is ordered as follows:

1. There is hereby created the "Defense Communications Board," hereinafter called the Board, consisting of the Chairman, Federal Communications Commission, the Chief Signal Officer of the Army, the Director of Naval Communications, the Assistant Secretary of State in charge of the Division of International Communications, and the Assistant Secretary of the Treasury in charge of the Coast Guard.

2. The functions of the Board shall be, with the requirements of national defense as a primary consideration, to determine, coordinate, and prepare plans for the national defense, which plans will enunciate for and during any national emergency—

a. The needs of the armed forces of the United States, of other governmental agencies, of industry, and of other civilian activities for radio, wire, and cable communication facilities of all kinds.

b. The allocation of such portions of governmental and non-governmental radio, wire, and cable facilities as may be required to meet the needs of the armed forces, due consideration being given to the needs of other governmental agencies, of industry, and of other civilian activities.

c. The measures of control, the agencies to exercise this control, and the principles under which such control will be exercised over non-military communications to meet defense requirements.

3. The Chairman of the Federal Com-

munications Commission shall be the Chairman of the Board. In the absence of the designated Chairman, the temporary chairmanship shall devolve upon the remaining members of the Board in the following order:

1. The Chief Signal Officer of the Army or the Director of Naval Communications, whichever may be senior in rank.

2. The Chief Signal Officer of the Army or the Director of Naval Communications, whichever may be junior in rank.

3. The Assistant Secretary of State in charge of the Division of International Communications.

4. The Assistant Secretary of the Treasury in Charge of the Coast Guard.

In the absence of any regularly designated member, the agency which he represents may be represented by an alternate from that agency, designated by the head thereof, but such alternate shall not serve as Chairman. The Assistant Secretary of the Treasury in Charge of the Coast Guard is designated as the Secretary of the Board.

4. The Board shall take no cognizance of matters pertaining to censorship. The Board shall study the physical aspects of domestic standard broadcasting and shall recommend such precautions, supplementary facilities and reallocations as it shall deem desirable under foreseeable military conditions. It shall also make plans for the speedy and efficacious use of all necessary facilities in time of military emergency.

5. The Board shall appoint such committees as may be necessary to carry out its functions and to provide for continuing studies and for contact with other government agencies and with the civil communication industry.

6. Except as otherwise instructed by the Board, committees appointed thereby shall have no power to make final disposition of any matter presented to them by the Board for study, but they shall express by written report their findings and recommendations. Minority reports may be submitted if deemed of sufficient importance to warrant further consideration by the Board.

7. The Board and the committees shall call for consultation such representatives of other government agencies and of the civilian communication industry as may be deemed advisable in obtaining full knowl-

(Continued on page 28)

# The design of a PRACTICAL LOW-PASS FILTER

## for 600-ohm audio transmission lines

THE "Standards of Good Engineering Practice" of the Federal Communications Commission, which became generally effective August 1st, 1939, dictates that the licensee shall install equipment to limit the transmission of audio frequencies beyond 7,500 cps when the transmission of such frequencies results in interference to broadcast stations occupying adjacent channels.

Section 12.6 a, Paragraph 4, under F, reads as follows:

"In the event interference is caused to other stations by modulating frequencies in excess of 7500 cycles or spurious emissions, including radio-frequency harmonics and audio-frequency harmonics outside the band plus or minus 7500 cycles per second of the authorized carrier frequency, the licensee shall install equipment or make adjustments which limit the emissions to within the band or to such an extent as to reduce the interference to where it is no longer objectionable."

This paper will describe an inexpensive composite type of low-pass filter which engineers, who of necessity must comply with this requirement, will find suitable for the purpose. While this filter was designed for cut-off at 8,000 cps, it is only necessary to change the calculations for  $F_c$  to 7,500 cycles, and  $F_\infty$  of one section to 7,600 cycles, when cut-off at 7,500 cycles is desired, and the same general transmission and attenuation characteristics will be ob-

By **SCOTT HELT**

WIS  
(Columbia, S. C.)

tained. Also, the mathematical development of this type filter with  $F_c$  of 7,500 cycles per second will be shown for the convenience of the reader.

The filter has been in intermittent use at Station WIS for more than three years with very satisfactory results. Numerous measurements made to determine its operating characteristics during these years have indicated that it has very low insertion loss (less than 1.0 db at any frequency within the pass band), that its characteristics are substantially constant, and that its use neither introduces distortion at any frequency within its pass band, nor does it contribute any appreciable noise to the circuit in which it is connected.

It is not in continuous operation at this station since no licensee on adjacent channels has ever complained of side-band interference from Station WIS, although the equipment of the station is operated within the requirements for high-fidelity performance as indicated by measurements at the antenna, but the device has been extremely useful in attenuating the higher audio frequencies when objectionable high-frequency line noise is occasionally encountered on network programs—particularly those originating at great distances from the station where the land wires are long and therefore subject to an unusual amount of inductive interference, line "sings," and other high-frequency noise components which might be so noticeable to the listener as to appreciably detract from his enjoyment of the program material.

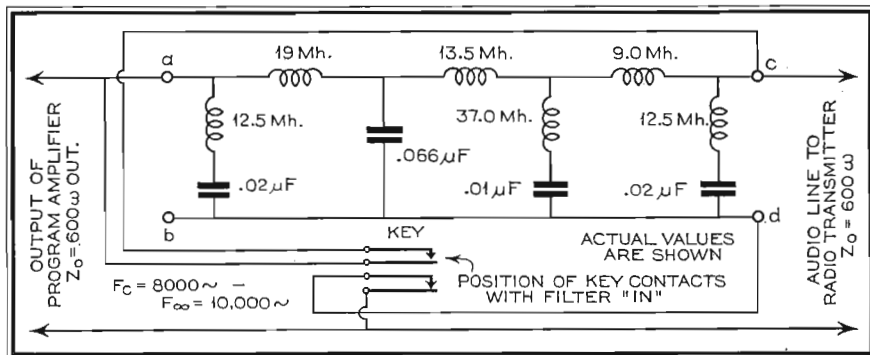

Above: Installation circuit of composite low-pass filter at WIS. Left: Composite 600-ohm low-pass filter.

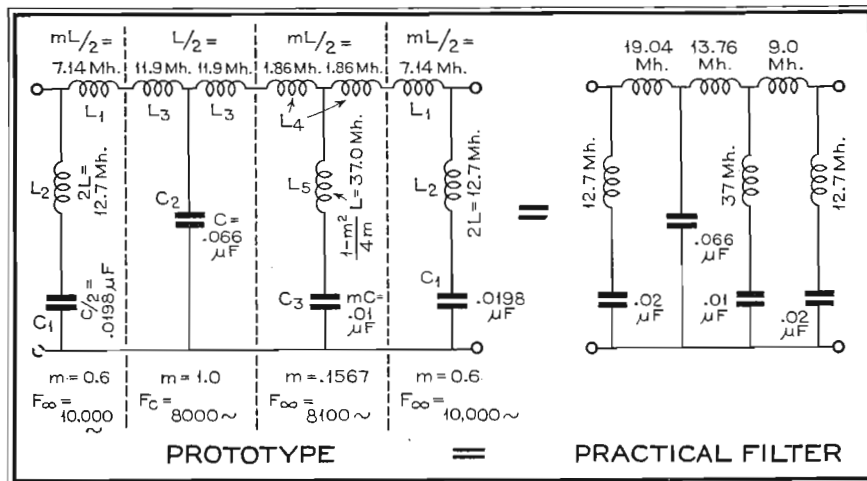

Also, persons are frequently placed before the local microphones, particularly some public speakers, whose voices are noticeably sibilatory. Such persons have that peculiar characteristic of speech which leads to over emphasis of the sibilants s, z, sh, zh, and ch, and they are known technically as sibilators. Such voices are superfluous in "s" or hiss quality, and are particularly annoying to the listener when the signal is transmitted and received by means of high-fidelity equipment. Use of the low-pass filter to attenuate the higher audio frequencies, when such persons



are before the microphone, very noticeably improves the quality of speech, and such voices are definitely made more pleasing to the ear.

The filter to be described is connected to a key associated with the transmitter speech-input equipment, as described in the accompanying diagram, and may be inserted at will by the operator into the 600-ohm line connecting the output of the compression amplifier and the transmitter speech-amplifier input circuit. A high-fidelity receiver is used for monitoring the signal directly from the air, and this provides the operator with an excellent opportunity for aurally investigating the material to determine whether the filter is needed.

In the design of the low-pass filter, the cut-off frequency was made 8,000 cps to operate in a 600-ohm audio-frequency transmission line. In order to achieve a sharp cut-off, one value of  $F_\infty$  (frequency of infinite attenuation) was selected equal to 8,100 cps. The terminating half sections at input and output to the filter, with  $M$  of .6, have by the equations

$$F_\infty = \frac{F_c}{\sqrt{1-M^2}} \dots \dots \dots (1)$$

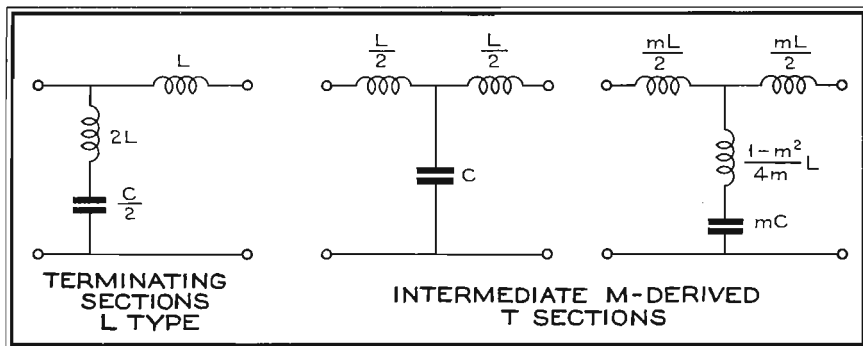

$$M = \sqrt{1 - \left(\frac{F_c}{F_\infty}\right)^2} \dots \dots \dots (2)$$

a value of  $F_\infty$  25% above the cut-off frequency, or at 10,000 cycles per second. Since it is desirable in this case to work close to the cut-off frequency, it was necessary to use a terminating half section with a small value of  $M$ , but the value of  $M$  is limited to the value of .6 shown to avoid reflections.

When designing a filter of this type, any value of  $F_\infty$  within the attenuating band can be secured by the proper selection of  $M$  in the derived sections. The relations (a.) and (b.) will make the shunt arm resonant at any desired value of  $F_c$ .

$$(a) \quad L = \frac{\sqrt{LC}}{1} \cdot \sqrt{\frac{L}{C}} = \frac{R}{\pi F_c}$$

$$F_c = \frac{R}{\pi \sqrt{LC}}$$

$$(b) \quad C = \sqrt{LC} \cdot \sqrt{\frac{L}{C}} = \frac{1}{\pi F_c}$$

$$L = \frac{600}{\pi \cdot 8000} = .0238 \text{ Hy}$$

$$L_2 = \frac{.0238}{2} = .0119 \text{ Hy}$$

$$C = \frac{1}{\pi \times 8000 \times 600} = .066 \text{ } \mu\text{fd}$$

For the section with  $F_\infty = 8,100$  cycles:

$$M = \sqrt{1 - \left(\frac{8000}{8100}\right)^2} = .1567$$

$$\frac{1-M^2}{4M} = \frac{1 - (.1567)^2}{4(.1567)} = 1.556$$

$$L_4 = \frac{ML}{2} = \frac{(.1567)(.0238)}{2} = .00186 \text{ Hy}$$

$$L_5 = \frac{1-M^2}{4M} L = (1.556)(.0238) = .037 \text{ Hy}$$

$$C_3 = MC = (.1567)(.066) = .01 \text{ } \mu\text{fd}$$

For the terminating half section  $M = 0.6$ .

$$L_1 = \frac{ML}{2} = \frac{(.6)(.0238)}{2} = .00714 \text{ Hy}$$

(Continued on page 26)

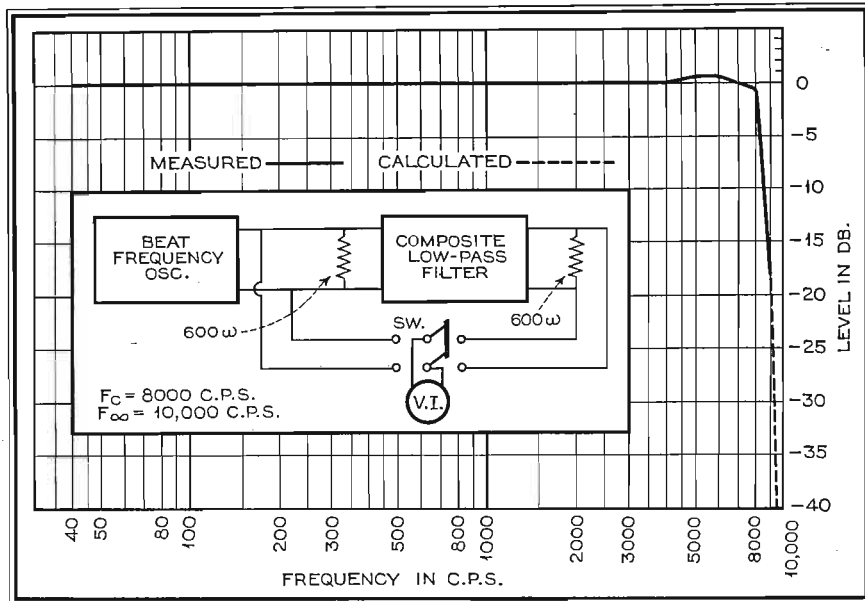

Illustrating the transmission characteristic of the filter.

The terminating and intermediate sections.

Below are shown the terminating and intermediate sections used in making up the prototype. The components for the filter are mathematically developed as follows:

$$L = \frac{R}{\pi F_c}$$

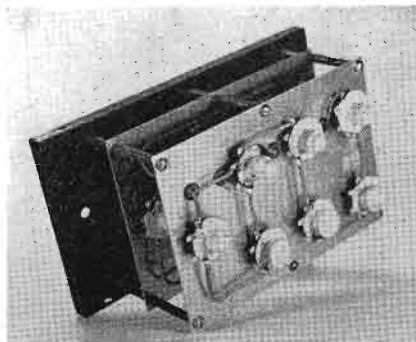

Two views of filter showing construction and comparative size.

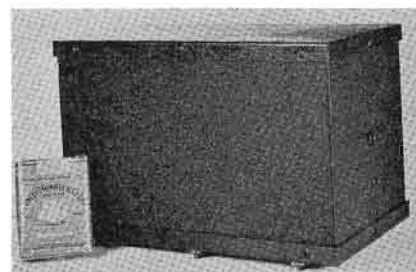

# F-M BROADCAST TRANSMITTERS\*

By **W. R. DAVID**

General Electric Co.

**T**HERE are two generally well known methods of producing wide-band frequency modulation, one, the phase-modulation method and the other, direct frequency modulation. The latter is also frequently referred to as the reactance-tube method. As both methods and the circuits employed have been described and analyzed mathematically by others in IRE and AIEE papers, only a brief comparison of the two methods is given here.

First, it seems appropriate to explain that phase modulation and frequency modulation are interrelated. We always have phase and frequency modulation simultaneously. Here again this relation has been explained and analyzed mathematically by others.

## Phase Modulation Method

The usual transmitter circuit arrangement to produce wide band f-m by the phase-modulation method starts with a relatively low-frequency crystal-controlled oscillator, say around 200 kc. The output of this oscillator is divided into two parts. One part is passed through a network which shifts the phase by 90 degrees. The second part of the original oscillator output is amplitude modulated by means of a balanced modulator which suppresses the original carrier frequency, leaving only the side bands. When these side bands are recombined with the first part of

the r-f signal, there is produced a phase modulated signal which can be modulated up to a phase shift of about  $\pm 30^\circ$  with good linearity.

This corresponds to a very narrow frequency swing and a great many stages of frequency multipliers are necessary to produce wide-band frequency modulation. (Wide band f-m is now standardized by FCC at swing  $\pm 75,000$  cycles about the mean carrier frequency.) In fact, the signal frequency variations are multiplied more than 3,000 times. To obtain a multiplication as great as this value, without increasing the mean carrier frequency to an undesired high value, it is necessary to multiply the frequency several times, then heterodyne down to a lower carrier frequency and multiply again to produce the desired frequency swing and mean carrier frequency. Each multiplication increases the frequency shift by the same amount as the mean carrier frequency. Heterodyning down decreases the mean carrier frequency, but not the frequency shift.

Phase modulation must undergo additional treatment before it becomes true frequency modulation of the desired type. Its shift is proportional to the modulating frequency and, therefore, a corrective network must be inserted in the audio input channel to make the

\*Paper given before Institute of Radio Engineers, Pacific Coast Convention, August 28, 1940.

amplitude of the applied audio signal inversely proportional to frequency, thus resulting in a flat overall frequency response.

The limitations of this method are:

- (1) It is difficult to fully modulate the transmitter at audio frequencies less than 50 cycles.
- (2) Frequency stability is not that of the first crystal oscillator; it is a combination of the error of the first crystal, the multiplications employed, and the error of the second crystal.
- (3) The high multiplication factor requires elaborate shielding of the circuits and special filtering of the leads between the power supplies and the various units.
- (4) The shielding and filtering (3) are usually accomplished at considerable sacrifice of accessibility.
- (5) Many tubes are required and even though a number of them are receiver type, the possibility of failure with program interruption exists.
- (6) The circuit is comparatively complicated.

## Direct Frequency Modulation

The usual transmitter circuit arrangement to produce wide-band f-m by the direct frequency modulation method employs a reactance-tube frequency modulator and its associated oscillator followed by a relatively few multiplier and amplifier stages. The oscillator operates in a conventional oscillator circuit, across which is connected the plate and control grid of the reactance-tube frequency modulator. The insertion of a properly chosen network, consisting of a capacitor between the plate and grid and a resistor between the grid and cathode of the modulator tube, results in a change in modulator plate current which is 90 degrees out of phase with the plate current drawn by the oscillator.

Thus the modulator functions as a capacitance connected across the frequency-determining circuits of the oscillator and varying in accordance with the voltage impressed on the grid of the modulator. Therefore, if we apply an audio-frequency voltage to the grid of the modulator, the oscillator will be

**One-kilowatt frequency-modulation transmitters in various stages of completion at G-E Schenectady works.**



subjected to the effect of a varying capacitance across its frequency-determining circuit, causing the oscillator frequency to swing above and below the mean carrier frequency at the rate determined by the applied audio frequency.

In this method, the magnitude of frequency shift depends only on the amplitude of the modulating signal. Hence, unlike the phase modulation method, no corrective network is needed in the audio input channel. Direct frequency modulation is almost ideal for producing wide-band frequency modulation, but it will not provide the desired stability of the mean carrier frequency until another circuit is added.

Two types of circuits are now employed for mean carrier frequency stabilization, both using the feed-back principle. One comprises a crystal oscillator, converter, and discriminator and the combination of these develops a corrective voltage for the modulator tube when there is any change in the mean carrier frequency. The other circuit comprises several stages of frequency dividers, crystal oscillator, and amplifiers. It includes also a synchronous motor which varies a capacitor in the frequency-determining circuit of the oscillator by the proper amount to correct any change in the mean carrier frequency. The first method of frequency stabilization is electronic, and the second mechanical. Inherent advantages are claimed for each method.

About the only limitation of the di-

**A front view of the 250-watt f-m transmitter.**

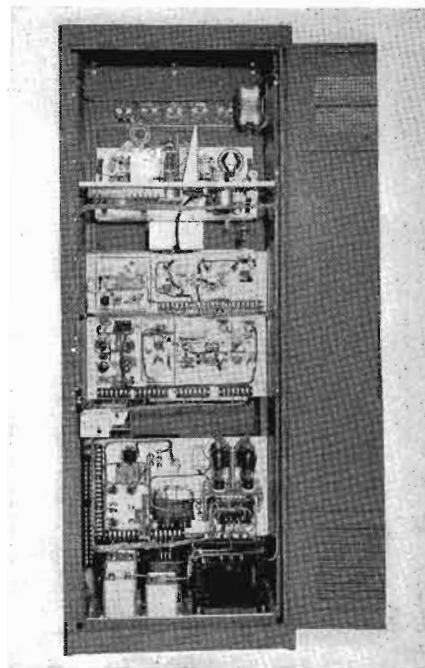
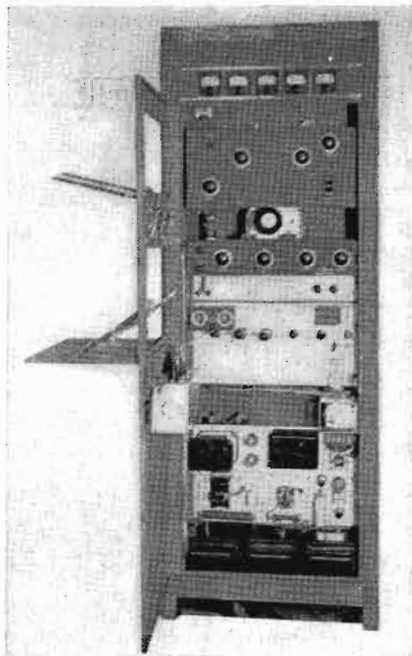
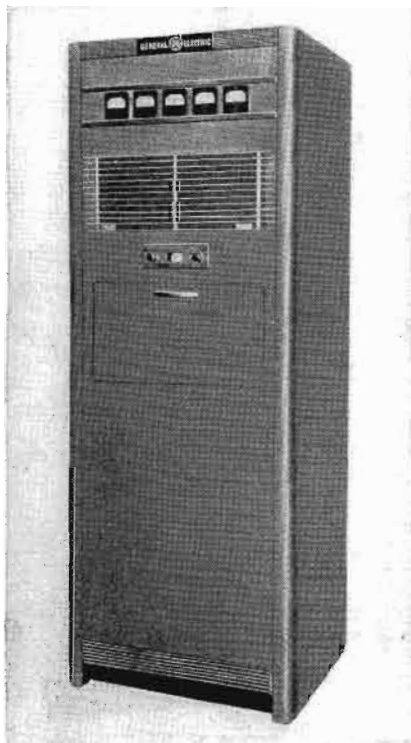

**Front and rear views (doors open) of a 250-watt 30-44 megacycle f-m transmitter.**

rect frequency-modulation method of producing wide-band frequency modulation is the necessity for indirect frequency control. However, with careful design the stability of direct crystal control can be closely approached.

#### Problems of FM Broadcast Transmitter Design

The electrical problems of f-m broadcast transmitter design are chiefly frequency stability, low noise level, low distortion, modulation linearity, and proper audio-frequency response. With the exception of frequency stability, which we covered earlier in this paper, all of the problems are handled more readily with f-m than with a-m.

The low noise level problem may be divided into two parts—i.e., f-m noise level and a-m noise level. Low f-m noise level may be obtained by separating the d-c and a-c wiring in the transmitter cabinet, employing a regulated power supply for the modulator-oscillator stage, careful r-f shielding and bonding, using low-microphonic tubes, and by shock mounting the modulator and oscillator stages, etc. Incidentally shock mounting, as mentioned, did not prove to be as essential as our initial development work indicated.

With these precautions, an f-m noise level in the order of 60 db below  $\pm 75$  kc swing is consistently possible with production transmitters. This value can be lowered to 70 db by using a small amount of stabilized feed back. Low a-m noise may be obtained by the same precautions employed in a-m transmitters. In addition, care must be exercised in the design of the phase-shifting net-

work of the modulator stage and proper saturation of the amplifier stages. An a-m noise of 60 db below 100% amplitude modulation is consistently possible in production 1 kw transmitters without employing feed-back and with a-c filament excitation.

Low distortion, modulation linearity, and flat audio-frequency response are obtained by careful circuit design and I should add that extensive experience in such design work is of great help.

#### General Electric FM Broadcast Transmitter

General Electric's 250-watt f-m broadcast transmitter Type GF1B will be described in more detail than the larger GE transmitters since the unit serves also as an exciter for the transmitters of higher output rating. The radio-frequency circuits of this transmitter consist of the modulator-oscillator, frequency multipliers, r-f amplifiers and the frequency stabilizer. The modulator-oscillator is really the heart of the transmitter. In this stage, wide-band frequency modulation is generated directly by means of a master oscillator and a reactance-tube modulator.

The circuit may be described in greater detail by referring to the block diagram (Fig. 1) and the simplified schematic diagram (Fig. 2). The block diagram shows every stage in the transmitter and its function, the crystal oscillator and frequency stabilizing circuit, power supplies and modulation monitor. The simplified schematic shows the audio stage, pre-emphasis network, modulator-oscillator circuit, and the frequency stabilizing circuit.

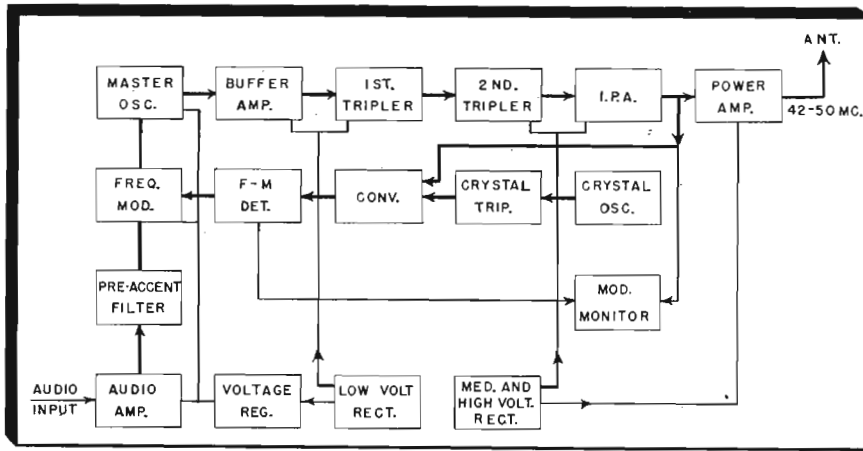

Components of Simplified Schematic

- R 124 L 121 Pre-emphasis network
- C 102 R 101 Phase shifting network
- L 101 C 109 Frequency determining circuit of oscillator
- L 119 Oscillator plate choke
- L 120 Oscillator grid choke
- C 107 Oscillator grid capacitor
- C 103 Capacitor
- R 102 Oscillator grid resistor
- L 102 Oscillator plate inductor
- L 101 Oscillator grid inductor
- R 194 C 137 Filter network to permit passage only of corrective voltages having frequencies considerably lower than the lowest audio frequency it is desired to transmit.
- L 134 Feedback to lower f-m noise level
- C 195 Discriminator filter r-f bypass capacitor
- C 101 Modulator grid by-pass capacitor.

A comparison of this circuit with the circuits of other f-m broadcast transmitters will emphasize its simplicity. There are fewer circuits and tubes and only two tripler stages are required. The frequency stabilizing circuit is extremely simple. Aside from the crystal oscillator and its tripler stage, only two tubes are used for the entire frequency stabilizing circuit. Furthermore, it is completely electronic.

A description of the frequency stabilizing circuit follows:

By referring to the simplified schematic, we see that part of the r-f output voltage is taken from the output of the IPA stage and combined in a converter or mixer tube along with the frequency-multiplied output from a temperature-controlled crystal oscillator. The crystal frequency is such that the resulting difference in frequency in the output of the converter tube is very

Fig. 1. Block diagram of the f-m transmitter.

much lower than either the crystal or IPA frequency.

Since the crystal-oscillator frequency is extremely stable, any variations in the IPA or transmitter output frequency will result in the same number of kilocycles variation in the "difference" or intermediate frequency. By this arrangement, changes representing a very small percent of the output frequency, become a very much larger percent of the intermediate frequency appearing in the plate circuit of the converter. Thus we obtain a great magnification in percent of any change in the output center frequency.

The intermediate frequency is applied to a form of f-m detector which converts frequency changes into amplitude changes. This f-m detector, also called discriminator or slope filter, is so adjusted by tuned circuits that when the i-f is exactly the correct value, no output voltage is obtained from the discriminator rectifier to be applied to the frequency-modulator grid. Hence, noth-

ing happens to change the M.O. frequency.

If the output frequency becomes slightly *higher* than the assigned carrier frequency, the intermediate frequency follows and the disc. rect. instantly produces a voltage of the correct polarity to force the output carrier back on its assigned frequency. If the output frequency should become slightly *lower* than the assigned carrier frequency, a voltage of the opposite polarity derived from the discriminator would immediately cause the frequency modulator tube to correct the M.O. frequency in the opposite direction. By proper selection of intermediate frequency and frequency modulator characteristics, it is possible to obtain a very rapid and forceful correction of any change in mean carrier output frequency.

Since the intermediate-frequency circuit operates at very low frequency as compared to the output carrier, instability in this circuit has relatively small effect on output stability. Even so, these intermediate-frequency circuits have been very carefully designed and stabilized to minimize such effects, however small. Thus, it should be evident that the transmitter stability is completely controlled by the highly stable crystal oscillator.

The stabilizer circuit exerts such a great corrective force on the output carrier that it would effectively oppose the desired frequency modulation, completely demodulating the output signal, were it not for the fact that a filter network is placed between the discriminator rectifier output and the grid of the modulator tube. This permits passage only of corrective voltages having frequencies considerably lower than the lowest audio frequency to be transmitted.

Provision is made in this transmitter

Fig. 2. Schematic of frequency-modulation transmitter.

(Continued on page 29)

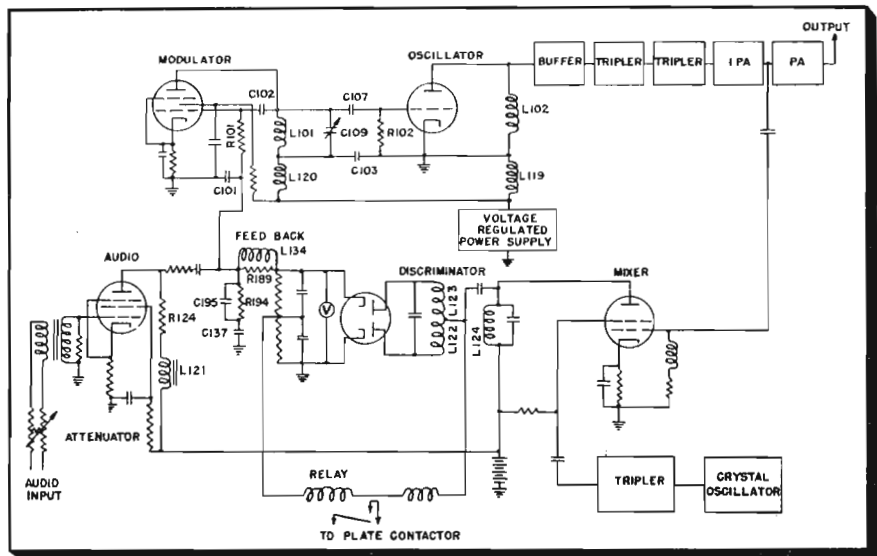

# System of PHASE & FREQUENCY MODULATION

By **SAMUEL SABAROFF**

WCAU Broadcasting Co.

A **PHASE**-modulated carrier is defined as a carrier in which the instantaneous phase varies in accordance with a modulating signal. Similarly, the frequency of a frequency-modulated carrier is defined as varying in accordance with a modulating signal. The frequency of a carrier, however, is the rate of change of its phase, i.e.:

$$\omega = \frac{d\phi}{dt} \dots\dots\dots (1)$$

where

$\omega$  = instantaneous frequency  
 $\phi$  = instantaneous phase

It is evident that the production of a phase-modulated carrier introduces also a distorted variation in the frequency of the carrier and vice versa. It is possible, however, to predistort the modulating signal so that a frequency modulated carrier may be produced by a variation in its phase or a phase-modulated carrier may be produced by a variation in its frequency.<sup>1</sup> It is intended in this paper to discuss a means for producing a phase-modulated carrier and to extend this, by the method of predistortion, to the production of a frequency-modulated carrier.

Various methods for producing a phase-modulated carrier are known. These involve usually, a varying load or circuit parameter controlled by a modulating signal. There has been recently described a method of utilizing the variation in phase of a resultant produced by combining two out-of-phase voltages, one of which varies in amplitude in accordance with a modulating signal.<sup>2,3</sup> This paper will concern itself with a generalization of this method of obtaining a phase-modulated or frequency-modulated carrier.

In Fig. 1, two voltages  $N + nx$  and  $L + lx$  with a phase difference  $\gamma$  are combined to form the resultant  $R$  having the phase angle  $\phi$ . As the modulating signal, represented by  $x$ , varies, the resultant  $R$  will vary in both phase and amplitude. The expression for  $R$  is

$$R = [L + lx + (N + nx) \cos(\gamma)] + j(N + nx) \sin(\gamma) \dots\dots\dots (2)$$

Let

$$\left. \begin{aligned} A &= N \sin(\gamma) \\ a &= n \sin(\gamma) \\ K &= L + N \cos(\gamma) \\ k &= l + n \cos(\gamma) \end{aligned} \right\} \dots\dots\dots (3)$$

From (1) and (2), the resultant is

$$R = (K + kx) + j(A + ax) \dots\dots\dots (4)$$

and the phase angle of the resultant is given by

$$\phi = \tan^{-1} \left( \frac{A + ax}{K + kx} \right) \dots\dots\dots (5)$$

A requirement of phase modulation is the existence of a linear relation between a modulating signal and the resultant phase shift. It is evident from (5) that this is not in general, true with respect to  $\phi$  and  $x$ . It is approximately true for small modulating signals, however, especially when operation is maintained about a point of inflection. Inflection points may be found by differentiating  $\phi$  with respect to  $x$  twice, and equating to zero, as follows

$$\frac{d\phi}{dx} = \frac{(aK - kA)}{(K + kx)^2 + (A + ax)^2} \dots\dots\dots (6)$$

$$\frac{d^2\phi}{dx^2} = -2(aK - kA) \frac{[aA + kK + x(k^2 + a^2)]}{[(K + kx)^2 + (A + ax)^2]^2} = 0 \dots\dots\dots (7)$$

Thus, from (7)

$$(aK - kA) = 0 \dots\dots\dots (8a)$$

or

$$(aA + kK) + x(k^2 + a^2) = 0 \dots\dots\dots (8b)$$

The condition described in (8a) is trivial since, from (6), the modulating signal will therefore produce no variation in  $\phi$ . Since operation takes place about the point  $x = 0$ , equation (8b) becomes, after substituting (3)

$$(Ll + Nn) + (Ln + Nl) \cos(\gamma) = 0 \dots\dots\dots (9)$$

which is non trivial and physically realizable.

The deviation when (9) is satisfied is easily found to be

$$\Delta\phi = \tan^{-1} \left\{ x \frac{(nL - Nl) \sin(\gamma)}{[L^2 + N^2 + 2NL \cos(\gamma)]} \right\} \dots\dots\dots (10)$$

For small values of  $x$ ,  $\Delta\phi$  becomes

**Fig. 1. Voltage vector diagram.**

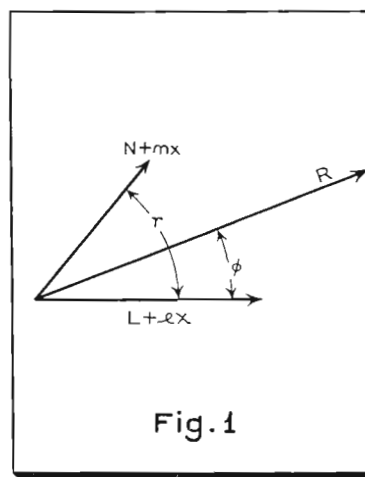

**Fig. 2. Plots of equations 2 and 21.**

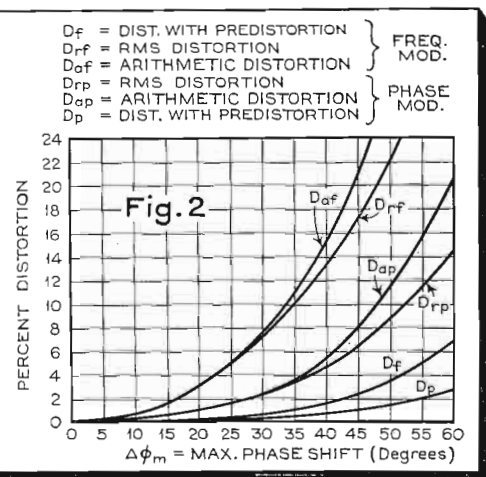

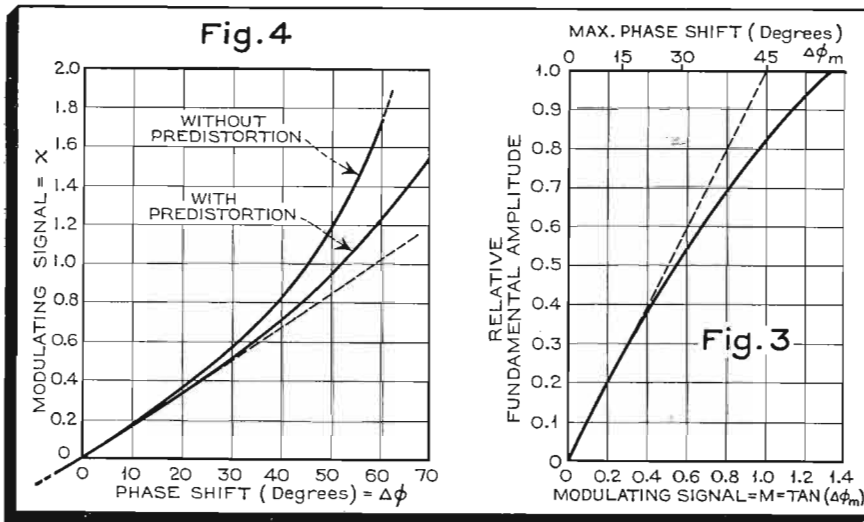

**Fig. 3. Relation between modulating signal and fundamental amplitude. Fig. 4. Relation of modulating signal and phase shift.**

$$\Delta\phi \approx x \frac{(nL - Nl) \sin(\gamma)}{[L^2 + N^2 + 2NL \cos(\gamma)]} \dots (11)$$

thus approximately satisfying the condition for linearity. An estimate of the distortion when  $x$  is appreciable may be obtained by assuming  $x$  to be sinusoidal and then considering the harmonic content of the resulting phase and frequency shifts.

Let

$$x = m \cos(\theta) \dots (12)$$

and

$$M = m \frac{(nL - Nl) \sin(\gamma)}{L^2 + N^2 + 2NL \cos(\gamma)} \dots (13)$$

where

$m$  = amplitude of modulating signal  
 $\theta = qt$   
 $q$  = modulation frequency

The deviation, from (10), (12) and (13) is

$$\Delta\phi = \tan^{-1} [M \cos(\theta)] \dots (14)$$

The expansion of (14) in a fourier series is

$$\Delta\phi = 2 \sum_{r=1}^{\infty} \frac{1}{r} \left( \frac{M}{1 + \sqrt{1 + M^2}} \right)^r \sin\left(r \frac{\pi}{2}\right) \cos(r\theta) \dots (15)$$

where  $r$  is odd.

An alternate form of (15) is

$$\Delta\phi = 2 \sum_{r=1}^{\infty} \frac{1}{r} \tan^r\left(\frac{\Delta\phi_m}{2}\right) \sin\left(r \frac{\pi}{2}\right) \cos(r\theta) \dots (16)$$

where

$$\Delta\phi_m = \tan^{-1}(M) = \text{maximum phase shift.}$$

Distortion expressed as the ratio of the arithmetic sum of the harmonics to the fundamental is found to be

$$D_{ar} = \frac{\tanh^{-1} \tan\left(\frac{\Delta\phi_m}{2}\right) - \tan\left(\frac{\Delta\phi_m}{2}\right)}{\tan\left(\frac{\Delta\phi_m}{2}\right)} \dots (17)$$

Distortion expressed as the ratio of the r-m-s sum of the harmonics to the fundamental is given closely by

$$D_{rp} = \frac{\tan^2\left(\frac{\Delta\phi_m}{2}\right)}{3} \sqrt{1 + \frac{9}{25} \tan^4\left(\frac{\Delta\phi_m}{2}\right)} \dots (18)$$

Equations (17) and (18) have been plotted in Fig. 2.

The frequency variations produced by the varying phase can be obtained by differentiating (15) with respect to time. Performing this operation, remembering that  $0 = qt$ , we have

$$\frac{d\Delta\phi}{d\theta} = -2 \sum_{r=1}^{\infty} \left( \frac{M}{1 + \sqrt{1 + M^2}} \right)^r \sin\left(r \frac{\pi}{2}\right) \sin(r\theta) \dots (19)$$

The arithmetic distortion in the resulting frequency variation is

$$D_{ar} = \frac{M^2}{2 [1 + \sqrt{1 + M^2}]} \dots (20)$$

The r-m-s distortion can be shown to be

$$D_{rr} = \frac{M^2}{2 [1 + \sqrt{1 + M^2}] (1 + M^2)^{1/4}} \dots (21)$$

Equations (20) and (21) have also been plotted in Fig. 2. It is interesting to note the close agreement in the r-m-s and arithmetic distortion for small phase shifts.

It must be remembered that the frequency modulation resulting from a variation in phase will increase linearly with the modulation frequency. A frequency modulation that is independent of the modulation frequency can be obtained by predistorting the modulating signal in such a manner that its amplitude varies inversely with the modulation frequency. Such predistortion of the modulation frequency characteristic is unnecessary when phase modulation is desired.

Another kind of distortion in the form of amplitude limiting becomes evident for large phase shifts. The curve in Fig. 3 shows the relation between the modulating signal and the resulting fundamental amplitude for both phase and frequency modulation. The limiting effect is negligible for phase shifts not exceeding 25 degrees. For a 45-degree phase shift the fundamental amplitude has been compressed 18 percent.

It is evident from the foregoing that the described method for producing a phase or frequency-modulated carrier is satisfactory only for relatively small phase shifts. This is due entirely to the nonlinear relation (equation (10)) between the modulating signal and the resulting phase shift. It is possible to increase this linearity by properly predistorting the modulating signal. Rewrite (10) so that

$$\Delta\phi = x = \tan^{-1} [f(x)] \dots (22)$$

where

$x$  = modulating signal  
 $f(x)$  = predistorted signal

Solving for  $f(x)$  from (22)

$$f(x) = \tan(x) \dots (23)$$

(Continued on page 24)

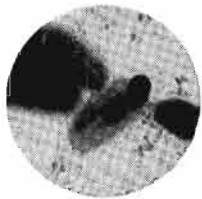

Bacillus S. paratyphi,  
magnified 12,000 diameters

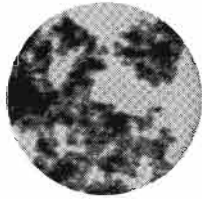

Lacquer pigments,  
magnified 27,000 diameters

FROM RCA LABORATORIES COME

# Radio Eyes

## FOR MICROBE HUNTERS



Anthony van Leuwenhoek of Amsterdam was the first to peer into the universe of the infinitesimal. With his crude microscope, he discovered in 1683 the "small beasts" which Pasteur and Koch and Theobald Smith later branded the most dangerous enemies of man—the germs of disease.

**B**UT there are micro-organisms too small for optical microscopes to detect. These instruments operate by visible light, which cannot resolve objects much smaller than the wavelength of the light. Bacteriologists have been able to see only the larger microbes. They have been able only to hope that somewhere, somehow, an instrument would be found that would magnify not 1,500, but 20,000... 50,000... 100,000 diameters!

Scientists in RCA Laboratories have engineered such a microscope. They studied the electrons active in radio and television, whose length was but a tiny fraction of that of a light wave. Research proved these electrons could be used as "seeing" rays. Focused by powerful magnets upon photographic film, they would reveal what had hitherto been invisible.

### *Research is Radio's Road to Progress*

RCA's contribution to the development of the electron microscope is the result of a far-seeing policy laid down by the founders of the company in 1919: *that fundamental research must be the keystone of every activity of RCA.*

RCA research has made broadcasting better. It has made receiving sets better. It has perfected a magic voice for the motion picture. It has pioneered in television. It has developed facsimile transmission of pictures and printed matter. It has made substantial contributions to industrial progress in fields outside of radio... From *continuing* RCA research will come still more progress... still greater services to America and to the world.

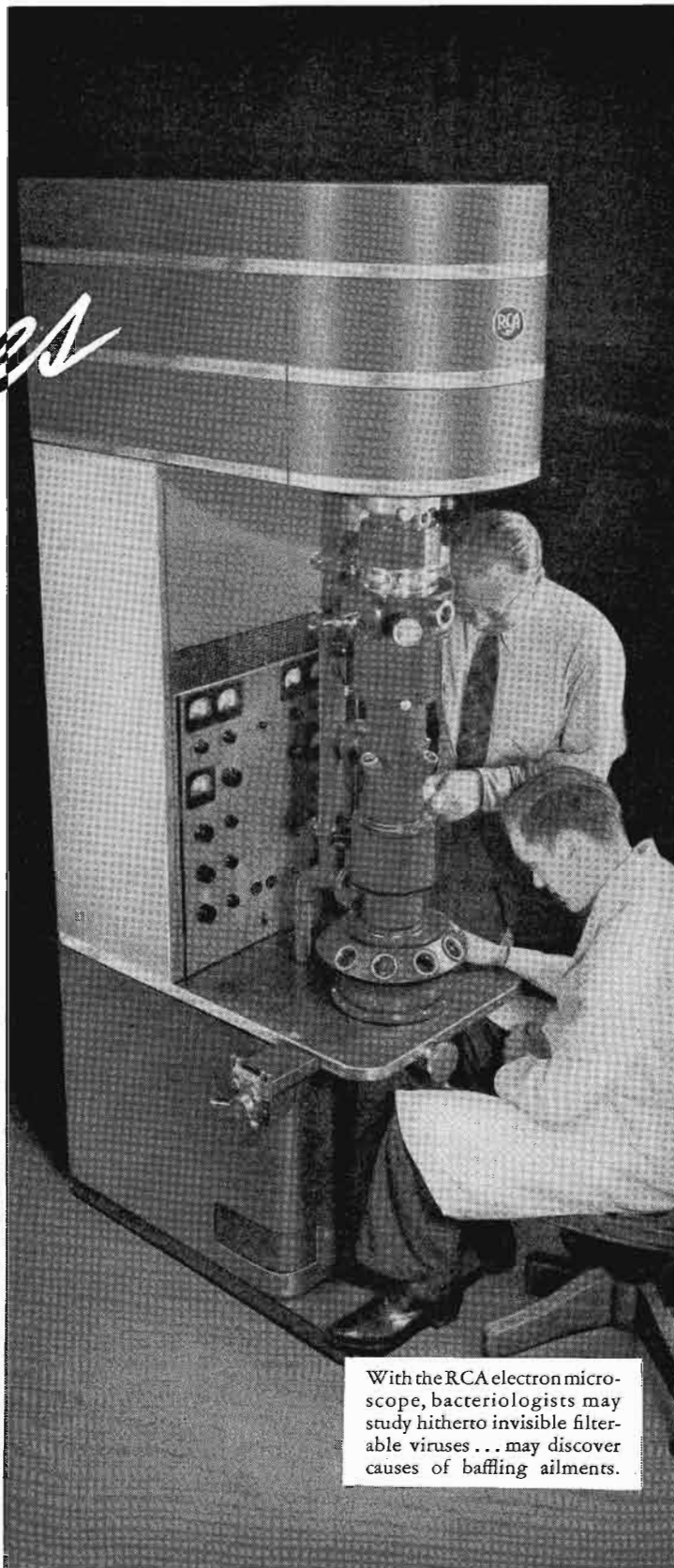

With the RCA electron microscope, bacteriologists may study hitherto invisible filterable viruses... may discover causes of baffling ailments.



# RADIO CORPORATION OF AMERICA

RADIO CITY, NEW YORK

RCA Manufacturing Co., Inc.  
RCA Laboratories

Radiomarine Corporation of America  
R. C. A. Communications, Inc.

National Broadcasting Company  
RCA Institutes, Inc.

# Technical program of the ROCHESTER FALL MEETING

**T**HE Rochester Fall Meeting of the Institute of Radio Engineers and the RMA Engineering Division, sponsored by the Rochester Fall Meeting Committee, will be held at the Sagamore Hotel, Rochester, N. Y., on November 11, 12 and 13. In compiling the technical program considerable emphasis has been placed on television and frequency modulation. In addition much new data will be given on audio frequencies, as well as on inductive tuning, plastics, tubes, etc.

The program of the technical meetings is as follows:

## MONDAY, NOVEMBER 11

8:30 A.M.—Registration.

9:00 A.M.—Inspection of Exhibits.

9:30 A.M.—Technical Session.

“Measurement of Electrode Temperatures of Tubes during Exhaust and Operation,” A. D. Power, RCA Mfg. Co., Radiotron Division.

“Notes on the Use of Inverse Feedback in Electric Phonographs,” Henry P. Kalmus and Dorman D. Israel, Emerson Radio & Phonograph Corporation.

“Recent Improvements in Frequency Modulation Receiver Design,” J. A. Worcester, General Electric Company.

12:30 P.M.—Group Luncheon—Main Dining Room.

2:00 P.M.—Technical Session.

“The Role of the Limiter in F. M. Noise Suppression,” C. W. Carnahan, Zenith Radio Corporation.

“The Application of Inductive Tuning to Ultra-High Frequencies,” B. V. K. French, P. R. Mallory & Company.

“A Phase Curve Tracer for Television,” Bernard D. Loughlin, Hazeltine Service Corporation.

4:00 P.M.—Inspection of Exhibits  
Committee Meetings

Meeting—RMA General Standards Committee.

## TUESDAY, NOVEMBER 12

9:00 A.M.—Registration.

Inspection of Exhibits.

9:30 A.M.—Technical Session.

Annual Message of RMA Director of Engineering, Dr. W. R. G. Baker.

“Dielectric Characteristics of a New Cellulose Ester Sheet Plastic,” C. E. Hall, Eastman Kodak Company.



**A. F. Van Dyck**

“Common-Channel Interference from two Frequency Modulated Signals,” H. A. Wheeler, Hazeltine Service Corporation.

“Radio Tubes Today,” R. M. Wise, Hygrade Sylvania Corporation.

12:30 P.M.—Group Luncheon—Main Dining Room.

Luncheon—IRE Electronics Committee.

Luncheon—RMA Committee on Television Receivers.

2:00 P.M.—Technical Session.

“The Coaxial Tuning Condenser,” Frank W. Godsey, Jr., Sprague Specialties Company.

**L. C. F. Horle**



“Television in Color,” P. C. Goldmark, Columbia Broadcasting System.

“A Study of Impulsive Noise in Frequency Modulation Receivers,” V. D. Landon, RCA Mfg. Co., Victor Division.

4:00 P.M.—Inspection of Exhibits  
Committee Meetings

Meeting—RMA Committee on Vacuum Tubes.

Meeting—RCA Committee on Broadcast Receivers.

6:15 P.M.—Fall Meeting Dinner (Stag)

Toastmaster—A. F. Van Dyck.

Speaker—J. S. Knowlson.

Subject—Engineers and Industry.

## WEDNESDAY, NOVEMBER 13

9:00 A.M.—Inspection of Exhibits

9:30 A.M.—Technical Session

“Special Oscilloscope Tests for Television Waveforms,” A. V. Loughren and W. F. Bailey, Hazeltine Service Corporation.

“Extending the Range of Audio Reproduction,” H. F. Olson, RCA Mfg. Co., Victor Division.

“The Kettle Drum Baffle” (with demonstration), R. T. Bozak, Bozak Associates.

“Improvements in High Fidelity Audio Frequency Amplifiers” (with demonstration), Lincoln Walsh, Consulting Engineer.

12:30 P.M.—Group Luncheon—Main Dining Room

Luncheon—RMA Committee on Facsimile.

2:00 P.M.—Technical Session

“The Evolution of a New Type of Metal Receiving Tube,” D. W. Jenks, General Electric Company.

“Discussion of Fluorescent Materials” (with demonstration), B. F. Ellefson, Hygrade Sylvania Corporation.

“Summary of the Significance of the Papers at This Meeting,” Donald Fink, McGraw-Hill Publishing Company.

4:00 P.M.—Exhibits Close

Committee Meetings

Meeting—RMA Committee on Sound Equipment.

Meeting—RMA Committee on F-M Receivers.



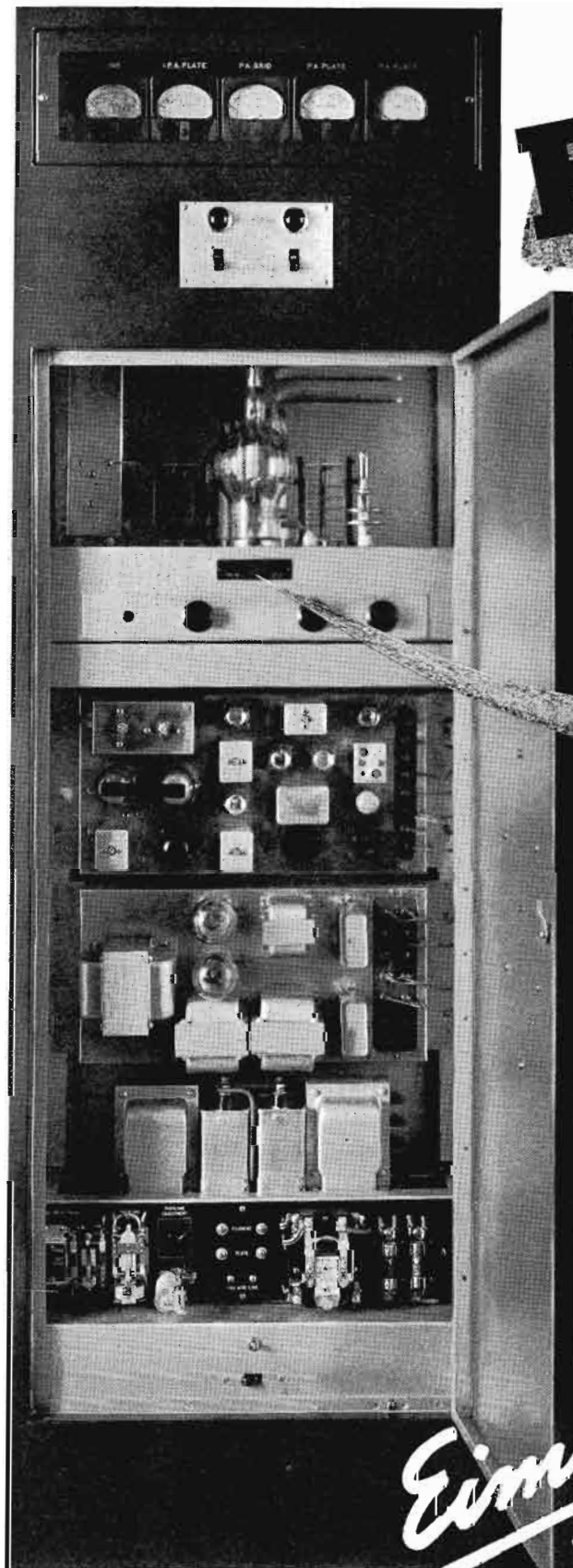

One of ten FM stations for the Connecticut State Police Department designed by Daniel E. Noble and constructed by Fred M. Link. This system will permit two way conversation between officers and fixed stations throughout the state. Contact with headquarters is never broken. A close approach to the ideal in police radio service.

# FM and Eimac Join the Conn. State Police Force

The first statewide 2-way telephone system in the USA ... using Dr. Edwin H. Armstrong's Frequency Modulation system

Daniel E. Noble, pioneer designer of FM stations is responsible for this decidedly practical use of FM communication. There are ten such stations being installed for the Connecticut State Police Department. First one placed in operation August 1, 1940 and the tenth will go into operation about September 15th. This represents just one more "first" for Eimac and an important "first" it is, too.

Mr. Noble says: "I selected the Eimac 250T tube because of its excellent ultra high frequency operating characteristics."

The idea of statewide radio telephone communications is a step in the right direction. The idea of using FM is certainly a wise one, but the idea of using Eimac Tubes for all these transmitters is a logical one. Eimac Tubes not only provide the utmost in dependability but are the tried and proven tube for use in FM.

*Engineers interested in FM should consider well Eimac's background, take no chances on untried tubes. Write for further details or see your nearest representative.*

## EIMAC REPRESENTATIVES

California, Nevada  
HERB BECKER, 1530 W.  
104th St., Los Angeles, Cal.

N. Caro., S. Caro., Georgia,  
Tenn., Flor., Ala., Miss.  
JAMES MILLAR, 316  
Ninth St. N. E., Atlanta,  
Georgia

N. Y., N. J., Penn., Md., Del.,  
Dist. of Col., Maine, N. H.,  
R. I., Conn., Mass.

ADOLPH SCHWARTZ,  
14726 Elm Ave., Flushing,  
New York

Wash., Ore., Idaho, Mont.  
GENERAL SALES CO.,  
Verner O. Jensen, 2605-07  
Second Ave., Seattle, Wash.

Texas, La., Okla., Ark.  
J. EARL SMITH, 2821  
Live Oak St., Dallas, Texas

Chicago, Illinois, Wisconsin  
G. G. RYAN, 549 W.  
Washington Blvd., Chicago,  
Ill.

Ohio, Mich., Ky., Ind., Minn.  
Mo., Kan., Neb., Iowa

PEEL SALES ENGINEERING CO., E. R. Peel  
154 E. Erie St., Chicago, Ill.

Colo., Wyo., New Mexico,  
Arizona, Utah  
RICHARD A. HYDE,  
4253 Quitman St., Denver,  
Colo.

# BOOK REVIEWS

*FUNDAMENTALS OF ELECTRICITY AND ELECTROMAGNETISM*, by Vernon A. Suydam, published by D. Van Nostrand Co., 250 Fourth Ave., New York City, 1940, 690 pages, price \$4.75.

This book is intended as a text for the advanced student of electricity and magnetism, much of the material coming from the author's lecture notes on the subject. Written from the viewpoint of the physicist, this excellent treatise should be equally useful as a text and as a reference book for the industrial physicist or engineer. While there are a number of excellent texts available on the subject, this book appears to have more useful fundamentals for the communications engineer than any which has come to the attention of the reviewer. It gives a clear, logical and systematic treatment of the fundamentals which are basic to the communications field.

The chapters on magnetostatics and terrestrial magnetism are especially well written and understandable, while the data on "The Magnetic Circuit" should be quite interesting to engineers dealing with electromagnetic devices. Two lengthy chapters are devoted to complex quantities and their application to alternating-current theory. In addition, considerable data is given on a-c bridges, as well as on vacuum tubes, tube rectifiers, mercury-arc rectifiers, r-f amplification and detection, radio transmitters, piezo-electric frequency control and many other allied subjects.

This book is highly recommended.

R. D. R.

*A DICTIONARY OF RADIO TERMS*, edited by L. O. Gorder, published by Allied Radio Corp., 833 W. Jackson Blvd., Chicago, 1940, 36 pages, paper covers, 10c.

This booklet contains simple, illustrated definitions of approximately 800 terms and abbreviations most likely to be encountered in magazines, books or lectures on radio and allied fields. Schematic symbols, tips on reading circuit diagrams, instructions for reading the RMA code, historic data and other useful information are included.

Although the definitions are not always technically accurate, they are not involved and will easily suffice for the layman. The booklet is certainly worth the modest purchase price and is recommended to those who are constantly besieged with questions from laymen.

R. H.

*PRINCIPLES AND PRACTICE OF RADIO SERVICING*, by H. J. Hicks, published by McGraw-Hill Book Co., 330 W. 42nd St., New York City, 1939, 305 pages, price \$3.00.

This book has been written especially as a text for the radio service man. Fundamental principles are explained in an elementary style so that the reader will un-

derstand the why as well as the how of servicing and operation.

The first two chapters are devoted to the fundamentals of electricity and magnetism as well as to the principles of radio. Such items as the electromagnetic wave, the Kennelly-Heaviside layer, fading, etc., are treated in some detail. The chapter on antennas and static reduction is especially well written. In addition to a thorough discussion and explanation of the functional portions of radio receivers, some 40 pages are devoted to servicing.

Of particular interest is a chapter on public-address systems, which contains much of interest. In addition, there is a chapter devoted to the business side of servicing, covering such items as cost accounting and advertising. An appendix contains data on the regulations of fire underwriters, many practical charts and tables, symbols, formulas, and abbreviations.

This text should be useful as a reference book.

R. D. R.

*WE PRESENT TELEVISION*, edited by John Porterfield and Kay Reynolds, published by W. W. Norton & Co., 70 Fifth Ave., New York City, 1940, 298 pages, price \$3.00.

This book presents its subject, so to speak, through the eyes of a number of well known exponents of the varied activities of the art . . . such men as Waldemar Kaempffert, Alfred H. Morton, Donald Fink, O. B. Hanson, Thomas H. Hutchinson, Thomas Lyne Riley, Earle Larimore, Charles E. Butterfield, Harry R. Lubcke, J. R. Poppele, Benn Hall, and Robert E. Jones.

This treatise discusses the technique of television, facsimile and of frequency modulation. It also considers the problems of finances, the part of the actor, programming, the director, as well as other interesting aspects of the television art.

The book is intended for the lay reader and is written by men who know their subject. It is recommended to anyone interested in obtaining a composite view of the art.

R. D. R.

*THE NATIONAL PHYSICAL LABORATORY REPORT FOR THE YEAR 1939*, published by His Majesty's Stationery Office (publication available from The National Physical Laboratory, Teddington, Middlesex, England), 100 pages, price 2s.6d.

This report covers briefly the work of the various departments (including the Physics, electricity, radio, meteorology, engineering, metallurgy, aerodynamics departments) during the year, as well as the scientific papers that have been published. A brief resume is given of the results accomplished in each field.

Some nine pages are devoted to the report of the radio department. The por-

tion covering ultra-high-frequency wave propagation and radio direction finding is especially timely. The work of the British on Adcock direction finders has always excited the admiration of the radio fraternity.

A yearly summary of the developments in the field becomes increasingly important with each passing year. Hence this book is recommended.

R. D. R.

*TELEVISION RECEIVING EQUIPMENT*, by W. T. Cocking, published by Iliffe & Sons, Ltd., Dorset House, London, England, 298 pages, price 7s.6d.

This book is intended for the student or engineer who is already familiar with radio receiver design. It deals specifically with the cathode-ray type of receiver rather than projection units, the subject being treated as an extension of radio receiver theory.

The first chapter deals with general television principles and serves to acquaint the reader with the essential differences between the vision and sound receivers. This section, written in elementary terms, may be easily understood by the lay reader.

Next the author deals with the television signal. While this chapter is especially well written, the reviewer feels that it is too short to adequately cover this important subject.

The next sixteen chapters are each devoted to a separate functional portion of the television receiver. The data given on electromagnetic and electrostatic deflection is particularly good.

While the author has assumed that the reader has a knowledge of receiver design, he has studiously avoided a mathematical presentation of any portion of the subject. Simple formulas are resorted to only in those cases where mathematics can hardly be avoided. As a result *Television Receiving Equipment* is recommended to those interested in a complete but elementary treatment of television receivers.

R. D. R.

*RCA HAM GUIDE*, prepared by the Commercial Engineering Section, RCA Manufacturing Co., Inc., Harrison, N. J., 48 pages, 8½ by 11 in, paper covers, price 15c.

The RCA Ham Guide, as its name implies, is intended primarily for the great fraternity of radio amateurs. In its pages are given authoritative technical data on RCA's amateur transmitting tubes, circuits for utilizing them to best advantage, and helpful information on the design and operation of amateur transmitters. Detailed descriptions with illustrations for constructing two complete amateur transmitters are shown on pages 29-47.

The book is recommended to amateurs and to anyone else who is desirous of obtaining information on low power transmitters and associated equipment.

R. H.

**NEW**



# "SEALDTITE" TUBULAR PAPER CAPACITORS

*Wax-molded*

**the only major advance  
in the last decade**

**2 to 5 times  
average life expectancy**

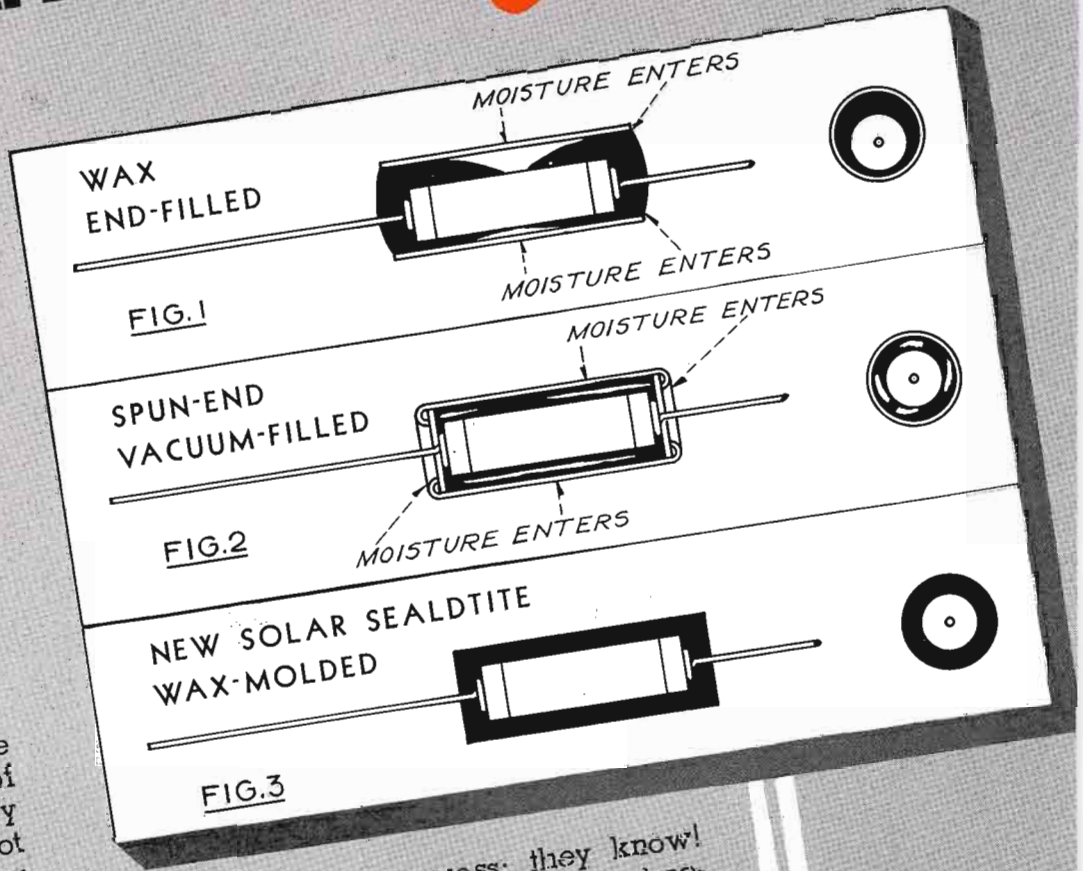

Now has an engineer's dream come true! Here is a new paper tubular of standard size and price, but totally sealed so that immersion does not harm it. It speaks for itself in any laboratory, any climate.

The new Sealdtite has a standardized non-inductive winding with full-diameter hot-soldered leads. But this assembly is not stuck into a tube with the doubtful results shown in figures 1 and 2. It is held mechanically centered in molds; an exclusive newly developed Sealdtite wax compound is molded around it. The even walls totally exclude moisture. Hard; will not soften at any ordinary operating temperatures. For convenience, enclosed in a labeling tube.

Engineers do not guess; they know! You too will be astounded at test results, for the new Sealdtite is a major advance in the capacitor art. Sealdtites for Safety!

We will gladly furnish samples without charge upon letter-head request.

*Investigate!*

**SOLAR MFG. CORP.**  
Bayonne, New Jersey



# VETERAN WIRELESS OPERATORS ASSOCIATION NEWS



W. J. McGONIGLE, President

RCA BUILDING, 30 Rockefeller Plaza, New York, N. Y.

GEORGE H. CLARK, Secretary

## W. E. BEAKES

### Among Our Pioneers

"Pioneer" is no exaggeration. William E., familiarly known to thousands as plain "Bill," Beakes began his radio career in the United States Signal Corps in 1902. Upon his honorable discharge from Army Service in 1904, he became associated with Professor Fessenden during the latter's early experiments at his Washington laboratory, at Brant Rock in Massachusetts, and Macrihanish in Scotland. Bill Beakes personally handled many of the dispatches from the Brant Rock Station covering the San Francisco fire of 1906. These were the first press dispatches ever sent across the Atlantic by radio.

He was loaned to the United Fruit Company by Fessenden in 1910, to investigate radio conditions in the Tropics. This led to his definite association with the United Fruit Company as Chief Engineer; and, upon the creation of the United Fruit Company's radio subsidiary, the Tropical Radio Telegraph Company, he carried his new title and activities to Tropical Radio, with which Company he has been associated ever since, progressively as Vice President and General Manager and, in 1938, upon the death of John L. Warren, as President and General Manager.

Bill Beakes supervised the construction and design of Tropical's very extensive network of high-power stations throughout Central America and Panama and its complementary stations at New Orleans, Miami and Boston in the United States. Those who are familiar with radio in the decade preceding the 20's will appreciate some of the difficulties he encountered, particularly in the tropical area and before the advent of short wave. Yet the chain of stations was gradually completed and the service improved, until today Tropical can justifiably boast of a system and service in both radiotelegraphy and radiotelephony which requires no apology when compared with any other system in the world.

To the early pioneer work in long-wave transmission, we must add his similarly effective and pioneering work in the introduction of high-frequency transmission in the tropical areas. One fact little known is that the United Fruit Company was the first company to engage in radiotelegraphy in all Latin America. As in many other fields, the first to engage in an activity "has the jump"; and in the case of United Fruit and later Tropical, that initial advantage has never been lost. It has been Bill Beakes' function to see to it that the lessons painstakingly learned in the early days have been capitalized in the form of a radio layout which is modern and efficient and yet not out of tune with the actual or potential demands for traffic.

Another of his accomplishments, and one which probably has been more important than any other in building Tropical

to its present state of efficiency, has been his attitude toward his men. Many of those on Tropical's payrolls are old-timers who have come through the various stages of radio development with him. Tropical's attitude toward its personnel has always been that of a family, and the teamwork which has necessarily been the result of

50-kw transmitters furnished the United Fruit Company and Tropical Radio by the old American Marconi Company.

He has always shown a keen interest in internal combustion engines and their development, gasoline and semi-diesel. He has found time, during a busy life, to follow up speed-boat racing and later avia-

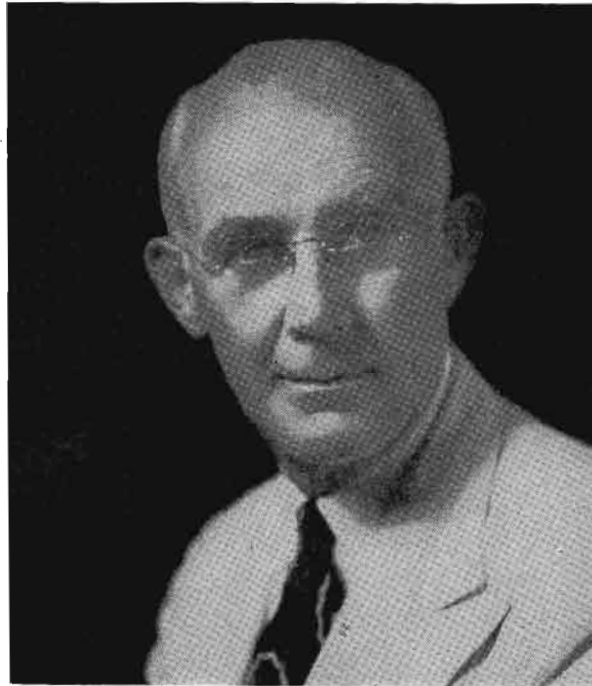

W. E. Beakes.

such an attitude has made the association of T. R. T. men with Bill Beakes a happy one for them as it has for him.

Evidencing the confidence in his fairness and good judgment is the fact that he has officially represented several of the Central American countries at world radiotelegraph conferences during the past twenty years, and has participated in the preparation of major regulations reflected in international telegraph agreements reached at such conferences.

He holds several patents covering early methods of spark synchronous transmitters on crystals, and antenna forms, all of which were assigned to either the old Fessenden Company or the United Fruit Company. He designed and built the first successful and really efficient synchronous spark gap of high power, 50 kw, which, if it was considered high power in the early days, is still high power. All the transmitter gaps on the United Fruit Company ships were redesigned by him and rebuilt to his specifications. He also re-designed all the early American Marconi

tion; has owned his own boats and planes and personally handled both, is keenly interested in hunting, is a fair shot and an enthusiastic skeet follower; he has been well up in the standing at many of the national competitive championship skeet-shooting events in recent years. He has his own skeet field on the land of the Tropical station at Hingham, Massachusetts, with a double layout, and this is considered one of the finest fields in the country. The World's five-man team record in skeet was made at his field in 1939.

As the development of radio enters new fields, he finds his time well occupied in keeping abreast of what other pioneers are doing and determining to what extent the results of their findings can be applied to the System he heads. As he looks back on the rapid development of radio in the space of what is a short term of years compared with the development of other sciences, he can and does experience a deep satisfaction and thankfulness because of having had the opportunity to be of ser-

(Continued on page 33)

# OVER THE TAPE . . .

## NEWS OF THE COMMUNICATIONS FIELD

### GLOVER JOINS JENSEN RADIO

Ralph P. Glover, well known sound engineer for many years, has joined the staff of Jensen Radio Manufacturing Company. Thomas A. White, Jensen vice-president and sales manager, announced the new connection which became effective in September.

### INTERNATIONAL NICKEL BULLETIN

The Development and Research Division of the International Nickel Co., Inc., 67 Wall Street, New York City, have issued an interesting bulletin covering the engineering properties of Monel. Write to the above organization for Bulletin T-5.

### BENEFITS TO RCA EMPLOYEES ENTERING U. S. ARMED FORCES

All employees of the Radio Corporation of America and its subsidiaries, of six months or more standing, who may be called or who may volunteer for service in the armed forces of the United States, will be paid the difference between what they earn in their last month of employment and what they receive for their first month's service.

This announcement was made by David Sarnoff, president of RCA, following the regular meeting of the corporation's board of directors.

The directors also decided, Mr. Sarnoff said, that, in addition to all other rights and privileges to be provided by the corporation under the Selective Service Act, the corporation will continue in force for one year, the group life insurance of those who may be called or who may volunteer for service. The RCA will pay the full premium, including the employee's portion.

Besides employees of the Radio Corporation of America, these provisions will apply to employees of the National Broadcasting Company, RCA Manufacturing Company, R.C.A. Communications, Inc., Radiomarine Corporation of America and RCA Institutes, Inc.

### SOLAR APPOINTMENT

Solar Manufacturing Corporation, Bayonne, N. J., manufacturers of capacitors, announces the appointment as district manager for the state of Michigan, of Mr. R. C. Merchant, 4829 Woodward Avenue, Detroit.

### SHURE CATALOG

A new 12-page Shure Catalog No. 153 covering the complete Shure line is ready for the trade. This enlarged catalog includes the new items for 1941 such as the "Stratoliner" microphones, magnetic recording head, etc. A copy of this new catalog may be obtained by writing to Shure Brothers, 225 W. Huron Street, Chicago.

### G-E SELECTIVE SERVICE POLICY

General Electric Company employees who are called for military service or those

who voluntarily enlist for the 12 months' training period will receive a full month's pay and be granted a year's leave of absence, it was announced today by Charles E. Wilson, president of the company. Only employees with one year or more of continuous employment with the company will be eligible to receive this adjustment.

Provision has also been made for continuance, during an employee's military service, of various benefits such as additional group life insurance, additional pension, etc.

At the expiration of military service, employees will be restored to their former positions or to positions of like seniority, status and pay, unless circumstances make it impossible or unreasonable to do so. Re-employment applications must be made within 40 days after discharge as provided by law.

### HALLICRAFTERS BULLETINS

Two new bulletins have recently been made available by the Hallicrafters, 2611 S. Indiana Ave., Chicago. One of these bulletins gives data on the Hallicrafters line of radiotelephones for fishermen—three models are described, 12, 25 and 50-watt units. The second folder deals with four units—a 12-watt radiotelephone, a 25-watt radiotelephone, a 50-watt radiotelephone, and a radiocompass.

### WASHER FIRM PUBLISHES NEW STOCK LIST

The Wrought Washer Mfg. Co., of Milwaukee, Wis., producer of washers, expansion plugs, stampings, tools and dies, serving the radio and sound industry, has announced the publication of a new stock list—No. 55-D—available to radio equipment manufacturers upon request.

This new publication lists thousands of washer specifications in various materials, including steel, brass, copper, aluminum, fibre, etc., carried in actual inventory available for immediate shipment.

### ERIE RESISTOR BULLETIN

A 12-page bulletin of interest to users of molded plastics has been published by the plastics division of Erie Resistor. In addition to giving useful information on injection molded plastics this catalog describes the designing, engineering and production facilities of this company. Copies may be secured by writing to the Plastics Division of Erie Resistor Corporation, 640 West 12th Street, Erie, Pa.

### FANSTEEL BULLETIN

Fansteel Metallurgical Corp., North Chicago, Illinois, have issued a new bulletin describing their line of Fansteel-I. T. & T. selenium rectifiers. This bulletin explains the principle of the selenium dry plate rectifier and enumerates its characteristics and advantages. Recommended circuit arrangements are given.

### WESTERN ELECTRIC'S SELECTIVE SERVICE POLICY

C. G. Stoll, president of the Western Electric Company, has announced the Company's policy in regard to employees who may be called up for military service under the Selective Training and Service Act of 1940, as well as members of the National Guard or the Organized Army Reserves in the Company employ who may be inducted into Regular Army service.

For the first three months of military service, employees of a year or more's standing will receive their regular Company pay less Government pay. Under the Company's pension plan, employees called into military service will receive full credit for their previous term of employment plus the period of Government service upon reinstatement in the Company's service. Eligibility for Company death benefits will not be affected, the Company making up the difference between the Federal and State benefits and the total provided for under its own plan.

All regular employees of Western Electric called up for training or service will be granted leave of absence for a period of twelve months. Upon application within forty days of the conclusion of their military service, such employees will be reinstated by the Company in their previous positions or in positions of comparable status and pay, unless the Company's circumstances shall have so changed as to make it impossible or unreasonable to do so.

### REK-O-KUT BULLETIN

Rek-O-Kut Corporation, 173 Lafayette St., New York City, have made available an interesting bulletin covering their line of recording assemblies and components. Copies may be secured from the above organization.

### HICKOK BULLETIN

The Hickok Electrical Instrument Co., 10514 Dupont Ave., Cleveland, Ohio, have made available a catalog covering their line of test equipment. Items in this bulletin include: tube and set testers, signal generators, v-t voltmeters, oscillographs, traccometers, volt-ohm-milliammeters, etc.

### RCA APPOINTMENTS

Orrin E. Dunlap, Jr., has joined the executive staff of the Radio Corporation of America as manager of the department of information, it was announced by David Sarnoff, president. In this position he succeeds Horton H. Heath, who has been appointed RCA director of advertising and publicity.

### NEW LOCATION

The Communications Company, Inc., have recently moved from Hialeah, Florida, to larger quarters in Coral Gables, Florida. This organization specializes in marine, police, and aeronautical radio equipment.

(Continued on page 30)

# START OUT ON TOP STAY ON TOP

## with General Electric **FM** Broadcast Transmitters

**G-E'S FULL dynamic range, amazing frequency response, and low harmonic distortion promise to every listener the complete thrill of FM.**

Broadcasters find almost unbelievable the complete accessibility of all parts and tubes . . . the ease with which detailed inspection can be made *without disassembly*. Floor space requirements of G-E transmitters are surprisingly small; all units are self-contained; installation is no problem at all.

Every G-E transmitter is thoroughly inspected and tested before it leaves the factory. Square-wave measurements, cross-modulation checks, noise-level tests, linearity measurements—from every angle performance is *proved* before a unit is allowed to go into service.

### Continuity of Service

*Automatic reclosing devices to restore service after temporary overloads, plus complete accessibility of parts and tubes, make service continuity no object of concern to G-E users.*

### Instant-acting Electronic Frequency Control

*Any tendency toward center-frequency drift is instantly corrected in all G-E FM transmitters by constant electronic comparison of output frequency with a precision crystal frequency. ONLY FOUR TUBES are used in the stabilizing circuit. There are no moving parts.*

*The low temperature-coefficient crystal is mounted in a hermetically sealed G-E Thermocell. Stability is better than  $\pm 1000$  cycles (100% better than FCC requirements) over a normal room temperature range.*

### True High Fidelity

*Excellent frequency response (flat within 1 db from 30 to 16,000 cycles) and low harmonic distortion (less than  $1\frac{1}{2}\%$  from 30 to 7,500 cycles) mean full realization of FM's capabilities.*

### Full Dynamic Range

*With noise level down 70 db from the 100% modulation level, all the brilliance and naturalness of even a full symphony reaches the receiver undiminished. G-E transmitters now in service are known for their exceptional fidelity.*

### Ease of Installation

*Each unit of the G-E line is completely self-contained and sturdily built. Extremely small floor space is required. Installation is simple.*

### Ease of operation

*G-E research has simplified circuit design—eliminated trick, hard-to-adjust circuits. No special training is required in operating procedure. Frequent critical retuning or adjusting is not necessary. Control circuits, too, are unusually simple.*

### Low Maintenance Expense

*G-E's small tube complement, unusual accessibility for routine inspections, and conservative operation of all components make for big savings in upkeep. Efficient operation keeps power cost down.*

### Smart Styling

*Smooth, flowing lines give striking appearance to a thoroughly practical design. Ray Patten, leading industrial designer, is responsible for the styling.*

### USE G-E TRANSMITTING TUBES

Since 1913, G.E. has been designing and building radio tubes for all services . . . on land and sea, and in the air. G-E tubes have been extensively used by the U.S. Government for years.

Give G-E tubes a chance to show you really superior performance. Place your next order through our local representative.



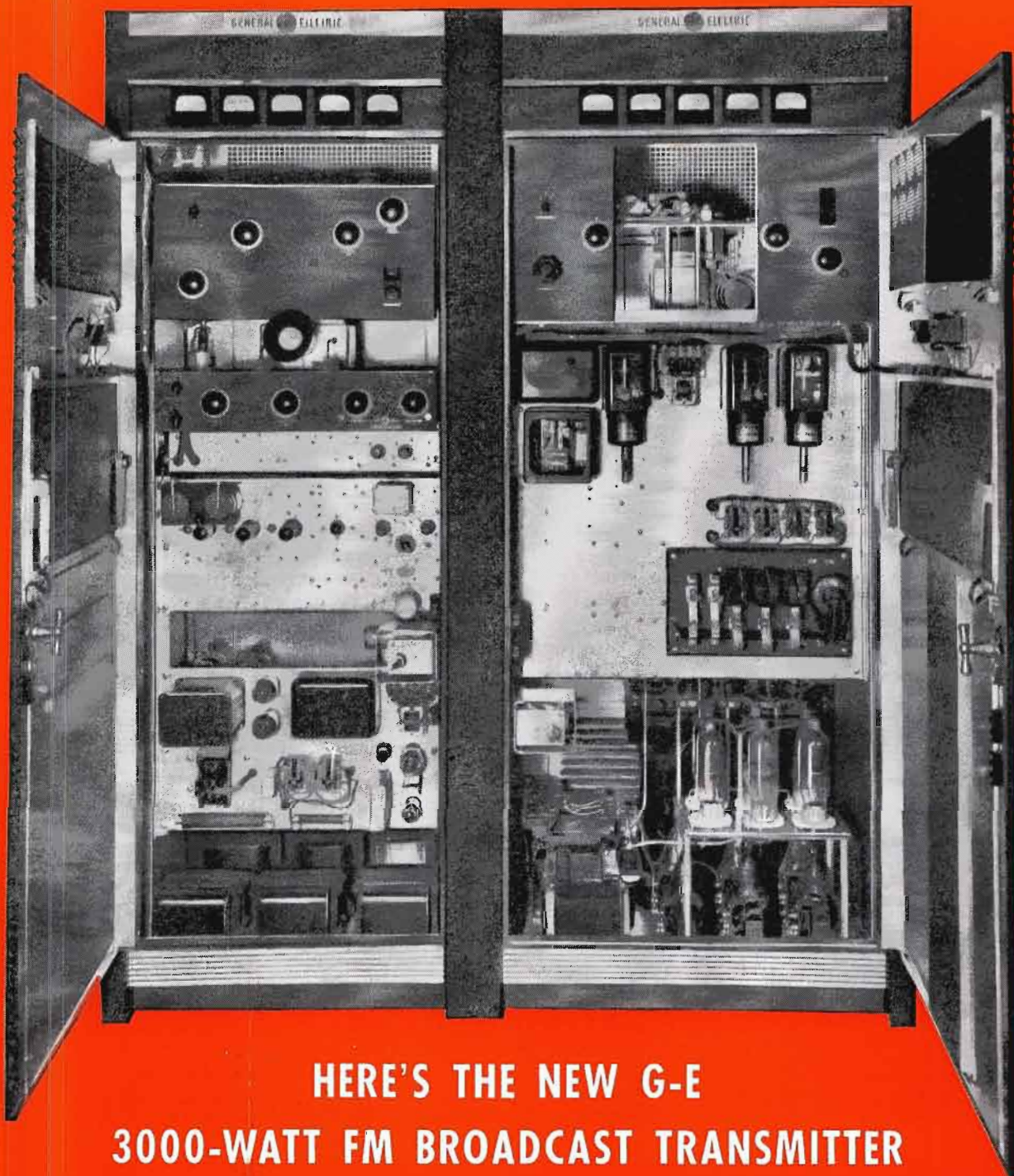

Quiet, compact, efficient this cooling system adequately supplies the requirements of both GL-8002-R's. The blower and filter are rubber-mounted inside the amplifier cabinet.

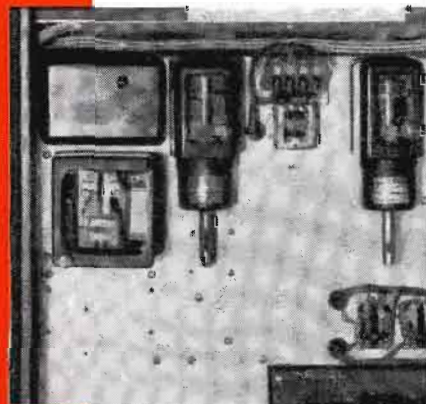

Overload relays protect against both a-c and d-c overloads; automatic reclosers restore service instantly. No lost time here!



The tiny GL-8002-R used in the 3000-watt FM transmitter was specially designed by G-E engineers for ultra-high-frequency application. It has a center-tapped filament and three grid-leads. Output: 1800 watts up to 120 mc.

## HERE'S THE NEW G-E 3000-WATT FM BROADCAST TRANSMITTER

Consisting of a standard 250-watt transmitter (as exciter) and a 3000-watt push-pull neutralized amplifier (completely self-contained), the G-E 3000-watt transmitter strikes a new note in compactness and efficiency.

The amplifier uses two GL-8002-R forced-air-cooled triodes, with six GL-872-A's in the 3-phase rectifier. Total power consumption for the entire transmitter, including blower, is about 11 kw. Only 11.1 sq ft of floor space is required. Complete specifications are contained in bulletin GEA-3485. Ask for your copy. General Electric, Schenectady, New York.

### G-E UNITS NOW IN OPERATION

W8XVH—Columbus, O.—250 watts

W9XYH—Superior, Wis.—250 watts

W1XTG—Worcester, Mass.—1000 watts

W2XOY—Schenectady, N. Y.—2500 watts\*

Hinchenbrook Island, Alaska—two 250-watt units†

Ralston Island, Alaska—two 250-watt units†

\*Operated experimentally since March 9, 1937

†Operated by Civil Aeronautics Administration

# GENERAL ELECTRIC

# Some notes on VIBRATORY MOMENTUM AND GROOVE SKATING in disc reproduction

By **J. C. PARVEY**  
Audak Co.

**D**URING the past two years, much has been written dealing with disc reproducers and their ills. Controversy has raged on all sides regarding ways and means of doctoring them. Pickups have been counterbalanced, special needles have been developed and recommended, heads have been off-set at various angles, disc material has been softened and recording levels juggled. Even so, disc wear still goes on.

Most popular is the belief that the lighter the weight of the pickup on the record, the lower the wear will be. In support of this theory, manufacturers have, during the past four years, reduced the average weight of the pickup on the record from about four ounces to the present-day average of about 2½ ounces. Some pickups claim a needle-point pressure as low as fifteen grams. However, other factors have to be taken into consideration and it is the purpose of this article to define them.

Sometimes records that are played with very low needle-point pressure actually develop greater record wear than when played with pickups having somewhat higher needle pressure. This observation seemed to be in direct contradiction to the generally accepted belief that the low needle-point pressures insured longer disc life. In an effort to track down the matter the following investigation was made:

Three "magnetically powered" pickups were selected. They were as follows:

Type "A"—"Relayed-Flux" type with

**The relayed-flux type pickup.**

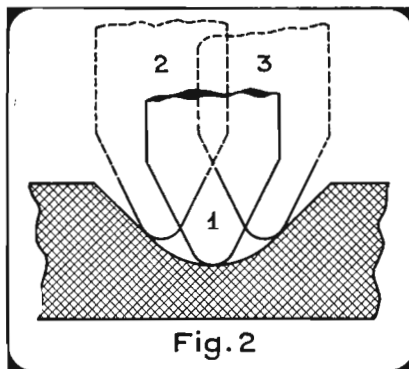
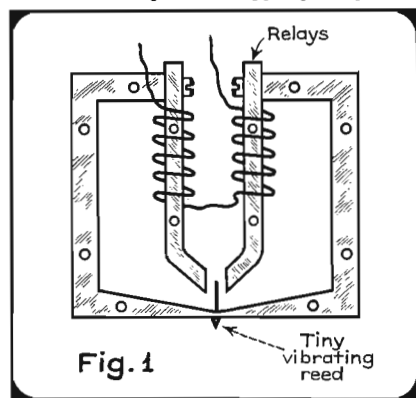

**Illustrating groove skating.**

a specially designed magnetic circuit (Fig. 1). This unit has a negligible moving mass and a reasonably high voltage output. The maximum displacement of this mass is .00015", when reproducing the highest recorded amplitudes. The combination of this mass and the small displacement makes for small "vibratory momentum." ( $M = mv$  where  $M$  is the "vibratory momentum,"  $m$  is the vibrating mass and  $v$  is the velocity of this mass. It will be observed that a pickup may have a small vibrating mass and still have a high

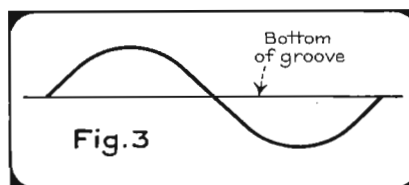

**Another method of illustrating groove skating.**

"vibratory momentum." On the other hand, a pickup may have a larger vibratory mass and have a lower "vibratory momentum." This unit has a low needle impedance and will track with a needle-point pressure as low as fifteen grams. It is flat within  $\pm 1$  db to over 10,000 cycles. It has the comparatively high output of minus thirty decibels (ref. .006W).

Type "B"—A moving coil type of pickup with the voice coil consisting of

a single turn of wire to make the moving mass as small as possible. This unit also has a very low needle impedance. While the actual moving mass is very small, it is a little over three times as great as that of type A. The maximum displacement of the coil is also somewhat greater and that, combined with its slightly greater moving mass, results in a somewhat higher vibratory momentum. The output of this unit is approximately minus seventy decibels.

Type "C"—A moving coil pickup with sufficient number of turns to bring up the output level to about minus fifty-five decibels. The moving mass of this pickup is about thirteen times larger than the pickup having but a single turn of wire in the voice coil. Needle impedance is low and comparable to that of the other two pickups used in the tests. Tracking appeared satisfactory with a needle-point pressure as low as fifteen grams.

The turntable used in the tests consisted of a synchronous drive motor equipped with a reasonably flat turntable bed.

In each case the pickup was set up with a needle-point pressure of eighteen grams and connected to an amplifying system equipped with an output meter. Repeated playings were made of a frequency record cut in acetate (instantaneous). After twenty playings, sur-

(Continued on page 25)

**Frequency response that may be expected from various size records.**

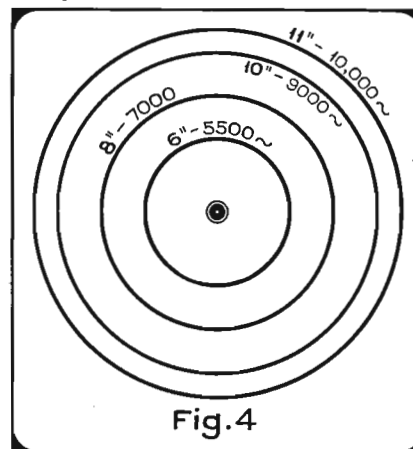



for **F-M**



To take full advantage of the high fidelity possibilities of F-M, studio equipment and accessories must be brought up to maximum fidelity characteristics. The simplest method of accomplishing this (already adopted by most broadcasting stations) is the . . .



## Universal Broadcast Equalizer

The universal characteristics of the UTC 3-A equalizer have made it the most popular item for broadcast and recording equalization. This unique unit, with which most communications engineers are already familiar, is an accurately calibrated, quickly adjustable, combined low and high frequency equalizer. The low frequency controls include a switch for adjusting the maximum equalization frequency to 25, 50, or 100 cycles and a calibrated T-pad for exact adjustment of the amount of equalization. The high frequency portion of this unit includes a switch to obtain resonance at 4000, 6000, 8000 or 10,000 cycles, and a similar calibrated control reading directly in DB. The 3A unit is ideal for equalizing lines, pickup and recording equipment, due to its flexible nature. **Net Price \$85.00**

## LEVEL COMPENSATING EQUALIZER Model 3-AX

The insertion loss effected by an equalizer is roughly proportional to the amount of equalization. It is therefore found that when readjusting the equalizer a change in the amplifier gain setting is generally necessary. This presents some difficulty in cases where very rapid changing of equalization is necessary.

Through a unique arrangement of compensating pads, the 3-AX equalizer presents the same general characteristics as the 3-A unit but does not require gain resetting. The compensation, based on months of aural tests, effects a constant insertion loss of approximately 50 DB. **Net Price \$140.00**

**UNITED TRANSFORMER CORP.**

150 VARICK STREET ★ NEW YORK, N. Y.  
 EXPORT DIVISION: 100 VARICK STREET NEW YORK, N. Y. CABLES: "ARLAB"

Predistortion of the modulating signal in accordance with (23) would result in absolute linearity between the modulating signal and the resulting phase shift or frequency variation. This is physically impossible since it involves the production of infinite amplitudes at the maximum possible phase shift of 90 degrees. (23) can, however, be easily approximated. Writing the first two terms of the series for  $\tan(x)$  and substituting (23) in (22) we have

$$\Delta\theta = \tan^{-1} \left( x + \frac{x^3}{3} \right) \dots\dots\dots (24)$$

Without predistortion equation (24) would be

$$\Delta\phi = \tan^{-1} (x) \dots\dots\dots (25)$$

(24) and (25) have been plotted in Fig. 4. The increase in linearity with predistortion is clearly evident. The approximate harmonic distortion when predistortion to the extent indicated in (24) is used is shown in Fig. 2. From Fig. 2, for a maximum of 5 percent r-m-s distortion, the maximum phase shift for phase modulation is about 40 degrees and about 25 degrees for frequency modulation when no predistortion is used. With predistortion, the phase shift for 5 percent distortion is about 55 degrees for frequency modulation, and for a phase shift of 60 degrees for phase modulation the distortion is less than 3 percent.

The changes in amplitude of the resultant accompanying its variations in phase have as yet not been considered. Variation in amplitude of the phase or frequency-modulated carrier is not required and is removed by means of limiters in the transmitter or receiver. It is necessary, however, to know the extent of any amplitude variation so that the range of the necessary limiter may be determined. From (2) is obtained

$$|R| = \sqrt{(L+lx)^2 + (N+nx)^2 + 2(L+lx)(N+nx)\cos(\gamma)} \dots\dots\dots (26)$$

giving the variations in amplitude of the resultant as the modulating signal varies.

The practical application of the above analysis is not difficult. Two examples will be considered for purposes of illustration.

Example 1: Assume that  $L = N$  and  $l = -n$  which is sufficient to satisfy equation (9). Assume also that  $|nx| \geq N$  and that the maximum permissible ratio of variation of the amplitude of the resultant is  $S$ .

The proper phase shift for a given amount of distortion in either phase or frequency modulation without the use of predistortion, can be obtained from Fig. 2.

The ratio of minimum to maximum resultant amplitudes as calculated from (26) is

$$S = \cos \left( \frac{\gamma}{2} \right) \dots\dots\dots (27)$$

The instantaneous phase shift is from (10)

$$\Delta\phi = \tan^{-1} \left[ x \frac{n}{N} \tan \left( \frac{\gamma}{2} \right) \right] \dots\dots\dots (28)$$

The maximum possible phase shift is,

$$\Delta\phi_M = \tan^{-1} \left( \frac{1}{S} \sqrt{1-S^2} \right) = \frac{\gamma}{2} \dots\dots\dots (29)$$

The actual maximum phase shift is determined by the distortion or amplitude variation limitation, whichever requires the smaller phase shift.

Distortion may be reduced by the use of predistortion as indicated in equations (22), (23), (24) and (25), and in Fig. 4. The equation of predistortion may be obtained as follows:  $\Delta\phi = x \Delta\phi_M$  where  $\Delta\phi_M$  is the maximum possible phase shift determined by other than distortion requirements and  $|x| \leq 1$ , then after putting  $f(x)$  for  $x$  in (28), we have

$$\Delta\phi = x \Delta\phi_M = \tan^{-1} \left[ f(x) \frac{n}{N} \tan \left( \frac{\gamma}{2} \right) \right] \dots\dots\dots (30)$$

Solving for  $f(x)$

$$f(x) = \frac{N \tan(x \Delta\phi_M)}{n \tan \left( \frac{\gamma}{2} \right)} \dots\dots\dots (31)$$

which is the equation of predistortion.

$f(x)$  is an odd function and therefore can be approximated by a push-pull type of distortion amplifier. The design of such an amplifier will not be here considered.

Example 2: Let  $N = 1 = 0$  and  $\gamma = 90$  degrees, thus satisfying equation (9). Assume that the ratio of minimum to maximum resultant amplitudes equal to  $S$ . This is the scheme used in the Armstrong system of frequency modulation.<sup>2,3</sup>

The instantaneous phase is, from (10)

$$\Delta\phi = \tan^{-1} \left( x \frac{n}{L} \right) \dots\dots\dots (32)$$

Assuming that  $|x| \geq 1$ , the maximum phase shift is

$$\Delta\phi_M = \tan^{-1} \left( \frac{n}{L} \right) \dots\dots\dots (33)$$

from which the value of  $n/L$  may be determined from the allowable distortion by reference to Fig. 2.

By the use of (26) there is obtained

$$\frac{n}{L} = \frac{1}{S} \sqrt{1-S^2} \dots\dots\dots (34)$$

which is the value of  $n/L$  as required by the amplitude variation limitation.

The actual phase shift is determined by either the distortion or amplitude variation limitation, whichever requires the smaller phase shift.

The use of predistortion decreases modulation distortion. The equation of predistortion, obtained as in example 1, is

$$f(x) = \frac{L}{n} \tan(x \Delta\phi_M) \dots\dots\dots (35)$$

where again,  $\Delta\phi_M$  is the maximum possible phase shift obtained by other than distortion requirements.

**BIBLIOGRAPHY**

- 1—Hans Roder, Discussion on "Amplitude, Phase and Frequency Modulation," by D. G. C. Luck and Hans Roder, PIRE, Vol. 20, No. 5, pp. 884-887, May, 1932.
- 2—Edwin H. Armstrong, "A Method of Reducing Disturbances in Radio Signaling by a System of Frequency Modulation," PIRE, Vol. 24, No. 5, pp. 689-740, May, 1936.
- 3—D. L. Jaffe, "Armstrong's Frequency Modulator," PIRE, Vol. 26, No. 4, pp. 475-481, April, 1938.

## GROOVE SKATING

(Continued from page 22)

face noise increased, while at frequencies above 8,000 cycles the output dropped. The point-pressure was then increased to about 38 grams and another freshly cut acetate frequency record played repeatedly. On investigation it was found that, in spite of low needle impedance, when the needle-point-pressure was lowered below a certain minimum, the reproducer point would "skate" up the side-walls of the groove. The extent of this "groove-skating" depended on how eccentric the groove was running under the point of the needle, and extent of turntable wobble, etc. To a lesser degree, it will be present even on a perfectly concentric record due to the radial pressure on the reproducer-point caused by the turntable wobble, record warping, etc. Assuming a record to be a thirty-second of an inch eccentric, it is obvious that the pickup will be oscillated radially a distance of one sixteenth of an inch. However, the pickup structure will resist this movement and the point will "skate" up first one wall, then down, and up the side of the other wall of the groove. That such action is taking place is shown by the periodic fluctuation in output level indicated on the scale of the output meter. Fluctuation may be as great as 6 db, depending on the degree of eccentricity, etc. Groove-skating" not only introduces surface noise and distortion, but also tends to "wipe" out the recording, especially the higher frequencies. It was also noted that after about twenty playings the surface noise increased and the higher frequencies were depressed more with pickups having greater moving mass.

The results of the tests may be summarized as follows:

(1) These tests show that, as factors in record wear, "vibratory-momentum" and "groove-skating" rank No. 1 and No. 2 respectively.

(2) The unit with the lowest "vibratory-momentum" and the least "groove-skating" shows the lowest harmonic distortion, other things being equal.

(3) Even though the needle impedance be very low, the unit will show higher distortion if it has a greater "vibratory-momentum" and "groove-skating."

(4) Even though the needle impedance be higher the unit will show lower distortion if it has a lower "vibratory-momentum" and is free of "groove-skating."

(5) Even with needle impedance reduced to the vanishing point, there is a definite downward limit to which the needle pressure can be reduced. This downward limit is determined by the

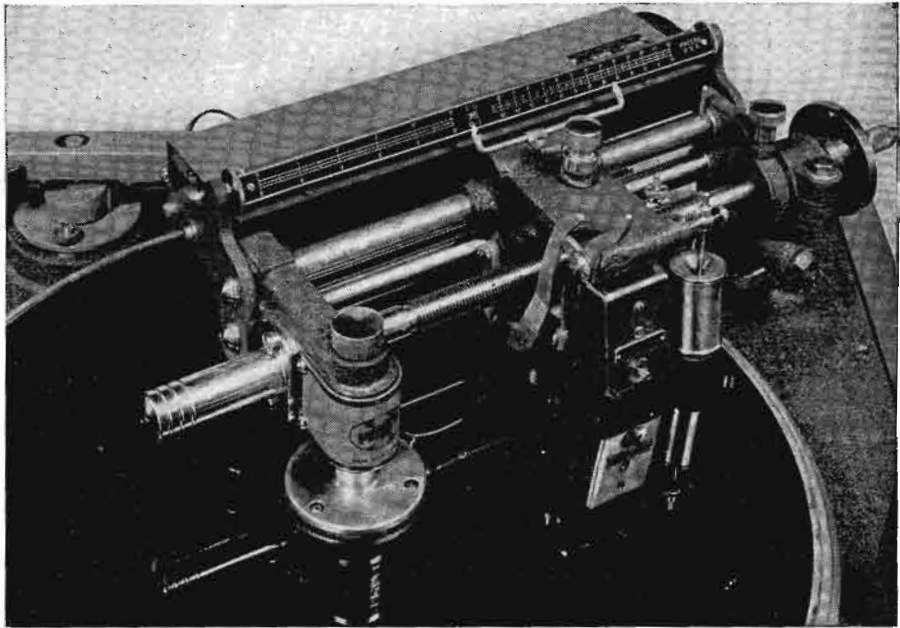

## MODERNIZE YOUR RECORDING INSTALLATION WITH THIS NEW PRESTO TURNTABLE

Here is a new turntable designed to replace the famous Presto 6-C and 6-D recording turntables which have been standard equipment in United States and Canadian broadcasting stations for the last four years.

Mounting and operating dimensions are identical with the previous equipment but the performance has been greatly improved.

### NEW FEATURES OF PRESTO 6-N TABLE:

1. **Less Vibration.** Records made on the 6-N table reproduce on the highest fidelity playback equipment without a trace of flutter or rumble.
2. **Wider Frequency Response — Higher Sound Level.** Presto 1-C cutting head records useful range of 50-8000 C.P.S.—gives 6 to 8 D B higher play-

back level than previous heads.

3. New cutting head mounting spaces grooves more accurately, facilitates quick change of feed screws.
4. New overhead cutting mechanism redesigned to simplify alignment with the turntable, can be removed for transportation by loosening one screw.
5. Standard table includes spiraling feed screw, vertical damper, cam lever for lowering cutting needle, 4 pitch time scale, automatic equalizer and Presto 1-C high fidelity cutting head.

LIBERAL TRADE-IN ALLOWANCE TO  
STATION OWNERS WHO WISH TO  
REPLACE EITHER 6-C or 6-D TABLES  
WITH THE NEW PRESTO 6-N TABLE.  
Write giving type and serial number  
for cost of exchange.

**PRESTO** RECORDING CORPORATION  
242 West 55th Street, New York, N. Y.

World's Largest Manufacturers of Instantaneous Sound Recording Equipment

# Command Performance

## LINGO

**VERTICAL RADIATORS**  
are "Engineered"  
to give you the  
performance you  
demand . . .

Engineers are quick to recognize a product that proves itself by performance. We feel proud that Lingo Radiators are setting new standards for performance and efficiency and that alert engineers everywhere are being convinced by the yardstick of results. In most cases results are superior to what was anticipated. If this sounds "good if true" we invite you to write and let us provide you with the facts that prove **EXCEPTIONAL HIGH EFFICIENCY . . . LOW MAINTENANCE COST . . . EXCELLENT STABILITY . . .** and a 5-YEAR INSURANCE SAFEGUARD!

### Free Technical Data

*We will be glad to make free recommendations, quote prices and give you the facts as they apply in your case. In writing, please give location, power and frequency of station.*

**JOHN E. LINGO & SON, Inc.**

Dept. C10 CAMDEN, N. J.

LICENSED MANUFACTURERS  
OF PATENTED TURNSTILE  
ANTENNAS FOR FM

**LINGO**  
VERTICAL  
TUBULAR STEEL  
RADIATORS

point at which "groove-skating" begins.

(6) Reducing needle pressure to the point of "groove-skating" will result in distortion and damaging of the record rather than preserving it.

(7) Once the design and working elements of a pickup permit reduction of point-pressure below two ounces, it is important that the factors of "vibratory-momentum" and "groove-skating" do not wipe out any advantage gained of such lower point-pressure.

A great deal has been said about frequency range of pickups. There is talk of 10,000 cycles and even 15 kilocycles. There are those who take such things at face value and actually ask for information on fifteen kilocycle range pickups. There is a definite limitation to the frequency range that can be reproduced from commercial discs. Assuming a pickup capable of a range of 10 kilocycles, or over—such a pickup will not be able to properly reproduce a frequency of 10,000 cycles from a ten-inch disc—except at the outside edge of such a record. The reason is that wave lengths at such a frequency become too short for the point to properly engage them. Fig. 4 shows approximately what may be expected from commercial disc records with a really high range pickup.

From Fig. 4 it will be seen, as far as actual frequency range is concerned, the user of commercial records need not concern himself with frequencies above 8,000 cycles. This does not mean that the use of a pickup going above that frequency is unnecessary additional expense, for the reason that, in general, a pickup capable of real wide range has other vitally important characteristics. As a rule, such a pickup, if properly designed, should have a much lower "vibratory-momentum"—a much lower needle impedance, and should be reasonably free of "groove-skating."

• • •

### LOW-PASS FILTER

(Continued from page 7)

$$\frac{1 - M^2}{4M} L = \frac{1 - (.6)^2}{(4)(.6)} L = .00635 \text{ Hy}$$

$$L_2 = 2 (.00635) = .0127 \text{ Hy}$$

$$M_c = .6 (.066) = .0396$$

$$C_1 = \frac{.0396}{2} = .0198 \mu\text{fd}$$

It is important that M must be used as 0.6 for the two terminating sections, since when this value is used  $Z_0$  has a small variation over a considerable portion of the pass band, and a constant-impedance termination will produce appreciable reflection only near the cut-off frequency.

It will be seen that the theoretical values of the components are such that

they cannot be readily obtained from manufacturers' or distributors' stocks. Therefore, in the construction of the filter, practical values were made use of that could readily be obtained, and by judicious selection of these parts no great departure was made from the calculated values. The chokes are of the iron-core type used in receiver and amplifier construction. Chokes of stock values were placed in series to secure the total inductance required in each case, and they were mounted on aluminum decks as shown in the photograph, so that each section was adequately shielded from any other section. It is necessary to separate the individual chokes appreciably to avoid mutual inductance insofar as possible. This is because:

$$L = L_1 + L_2 + 2M$$

From the curve shown on the filter's performance after assembly, it will be seen that the slight difference between the theoretical values and the actual values did not materially affect the operating characteristics. Following is shown a list of the chokes actually used:

- 2—2.5 mh iron core chokes
- 2—10.0 mh iron core chokes

One of each of these was used in the

## LAMINATIONS

for Output TRANSFORMERS  
of Highest Permeability

Standard stocks in a wide range of sizes for Audio, Choke, Output and Power Transformers. Write for dimension sheets.

## M permanent MAGNETS

ALNICO (Cast or Sintered)

COBALT-CHROME-TUNGSTEN

Cast, formed or stamped permanent magnets for all purposes. Engineering cooperation backed by 38 years experience in magnet making.

TOOLS » DIES » STAMPINGS  
HEAT TREATING

**Thomas & Skinner**  
Steel Products Co.

1113 E. 23rd St. Indianapolis, Ind.

terminating sections, where the theoretical design specifies 12.6 mh. The value of 12.5 mh is very close.

- 1— 3.5 mh iron core choke
- 1— 5.5 mh iron core choke
- 1—10.0 mh iron core choke

The series value of 19.0 mh was used where the design specified 19.04 mh.

- 1—10.0 mh iron core choke
- 1— 3.5 mh iron core choke

These two chokes were used in series where the design specifies 13.76 mh.

- 1—5.5 mh iron core choke
- 1—3.5 mh iron core choke

These two chokes in series are actually required to provide 9.0 mh for one section of the filter.

- 1—30.0 mh iron core choke
- 1— 7.0 mh iron core choke

These two values were used in series to provide the value of 37.0 mh required in one section of the filter.

The condensers were of the tubular paper type, selected for accuracy. A value of .02 mfd was used where the design specified .0198 mfd. The value of .066 mfd is made up of two condensers in parallel, one .006 mfd and one .06 mfd.

For the convenience of those who desire to construct a filter of this type in order to comply with the new requirement of the Federal Communications Commission as regards the transmission of the higher audio frequencies, the mathematical development of the prototype follows. It is only necessary to substitute the new values in the prototype for cut-off at 7500 cps, and infinite attenuation at 10,000 cps.

$$L = \frac{600}{\pi (7500)} = .0255 \text{ Hy}$$

$$L_s = \frac{.0255}{2} = 12.75 \text{ mh}$$

$$C = \frac{1}{\pi (7500) (600)} = (.0707) \mu\text{fd}$$

For the section with  $F_\infty = 7,600$  cycles:

$$M = \sqrt{1 - \left( \frac{7500}{7600} \right)^2} = .162$$

$$L_4 = \frac{ML}{2} = \frac{1.5 (.162) (.0255)}{2} = 2.0 \text{ mh}$$

$$L_6 = \frac{1 - M^2}{4M} L = \frac{1 - .162^2}{4(.162)} (.0255) = 38.2 \text{ mh}$$

$$C_s = MC = (.162) (.0707) = .0114 \mu\text{fd}$$

For the terminating half sections:

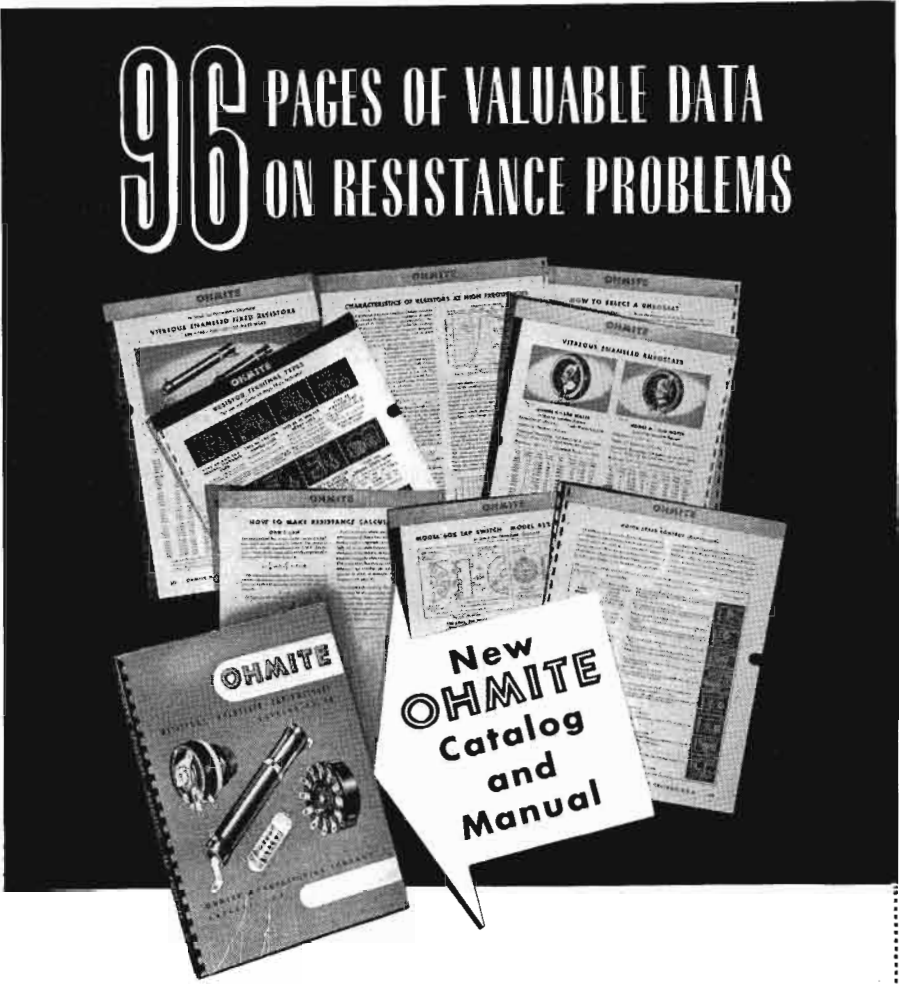

**H**ERE'S a book that really works for you! The new Ohmite Catalog and Engineering Manual No. 40 is a complete handy reference on resistance application problems. It contains useful reference tables, complete dimensional drawings, valuable engineering data and a manual of resistance measurements. It describes the most complete line of stock units and special units for Industrial, R.F., and Precision applications. It gives a complete listing of Generator Field Control Rheostats. It tells you how to select the right units for any of your needs.

Design and Application Engineers! . . . Laboratory Men! . . . Production Managers! . . . Purchasing Departments! . . . You'll find it an invaluable guide on the use of Resistors, Rheostats, Tap Switches, Chokes, and Attenuators in radio and electronic equipment--in products, machine tools and special applications--in the control of motor speed, generator fields of heat and light, of signal and supervisory circuits--in instrument rooms, maintenance and production--in laboratories and electrical equipment.

You'll want it handy for ready reference--and you can have it without charge. Send for it now. Just clip this coupon to your letterhead or write us on company stationery.

**OHMITE MANUFACTURING CO.**  
 4870 Flournoy St., Chicago, U. S. A.  
 Please send Catalog 40.

Company .....

Individual .....

Position .....

Address .....

City..... State.....

CM-10

*Be Right with* **OHMITE**  
 RHEOSTATS • RESISTORS • TAP SWITCHES

# LINK

Emergency and police u-h-f radio equipment of superlative performance

LINK u-h-f, frequency-modulated and amplitude-modulated radio apparatus is today the preference of leading radio engineers and technicians throughout the country

Public utilities; state, county and municipal police; various government groups and many others are more and more specifying Link radio

Imitation is the sincerest flattery. LINK equipment is frequently imitated but never duplicated. Original in design and exceptional in construction, it is low in maintenance and operating costs

LINK emergency and police F-M utilizes the Armstrong phase shift system of frequency modulation. Hundreds of units in field service and many months of continuous operation preclude any doubt as to its definite superiority and leadership

There are also available equally outstanding designs of crystal-controlled heterodyne frequency monitors, transmitting and receiving antennas, intermediate-frequency transmitters and receivers, broadcasting station equipment and many other special electronic developments

LINK frequency-modulated emergency and police radio equipment is licensed under the patents of Major E. H. Armstrong

For the best in communications—specify LINK.

**FRED M. LINK**

125 West 17th Street  
New York City

$$L_1 = \frac{ML}{1 - M^2} = \frac{(.6)(.0255)}{1 - (.6)^2} = 7.65 \text{ mh}$$

$$L = \frac{4M}{1 - (.6)^2} L = \frac{4(.6)}{1 - (.6)^2} (.0255) = 67.9 \text{ mh}$$

$$L_2 = 2(.00679) = 13.58 \text{ mh}$$

$$MC = \frac{(.6)(.0707)}{.04242} = .0212 \text{ } \mu\text{fd}$$

It is hoped that broadcast engineers will find the design and construction of this filter of interest, and that it may prove useful in the field. For a detailed discussion of composite filter design, the reader is directed to "Communication Engineering" by Prof. W. L. Everitt, which has a good account of the theory of such filters.

## FACSIMILE DEMONSTRATION

A demonstration of record communication between airplane and ground by radio and between two distant points over an ordinary telephone wire by means of facsimile communication was shown recently by William G. H. Finch, President of Finch Telecommunications, Inc., at the company's

Right: The Finch duplex facsimile unit.  
Below: A transmitted sketch.

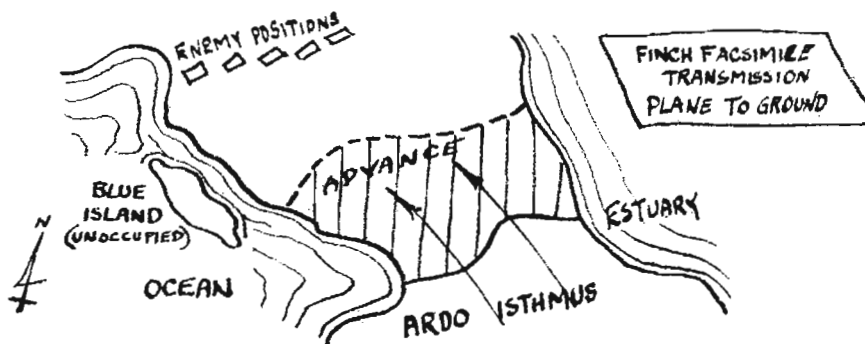
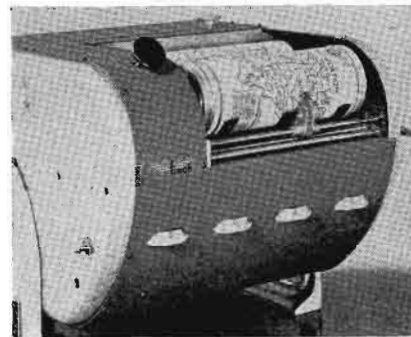

## NEW ULTRA HIGH FREQUENCY MICROVOLTER\*

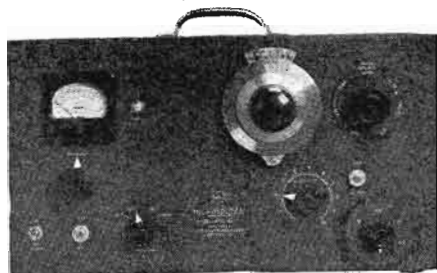

\*Reg. U.S. Pat. Off.

**FERRIS INSTRUMENT CORPORATION**

- Frequency range 5 to 175 megacycles
- Low Resistance Attenuator
- Terminated Transmission Line
- Output .2 to 100,000 microvolts
- Panel Jack for 2 volts output
- 400-1000 cycles and External Modulation

Write for catalog C1, giving details of instruments of our manufacture

Boonton,  
New Jersey

## DEFENSE BOARD

(Continued from page 5)

edge of the situation being studied, to the end that the needs of all may be considered and provided for in so far as the situation permits. Other governmental agencies are directed to cooperate in providing assistance required by the Board in its studies.

8. During any war in which the United States is a belligerent, or any national emergency, the existing Interdepartment Radio Advisory Committee shall act as a Committee of the Board, but only in an advisory capacity. While the Interdepartment Radio Advisory Committee is so acting as an advisory committee, all of its reports, recommendations, or communications normally prepared for submission to the President shall instead be submitted to the Board, for consideration from the standpoint of national defense and for disposition.

9. Reports containing the findings and recommendations of the Board shall be submitted to the President for final action through one of his administrative assistants.

plant in Passaic, N. J. Mr. Finch explained the design and manufacture of the facsimile equipment.

The Finch Duplex Facsimile unit, now in production, is designed to transmit and receive facsimile messages simultaneously and is a small and compact instrument. Its dimensions are 14 7/8 x 13 3/4 x 12 3/4 inches high. Complete with its power supply unit the instrument weighs less than 50 pounds. It is housed in a stream-lined metal case with a window which permits easy view of the receiving and transmitting drums in operation.

The fields to which facsimile has the strongest immediate appeal are pri-

marily those where messages are to be sent from or received at a point which is in motion, Mr. Finch said, such as airplanes, trucks, military detachments in the field, ships, trains, police radio cars, etc. For large industrial corporations, offices and plants," Mr. Finch said, "facsimile can be used with existing telephone or factory-call systems for inter-office communication."

• • •  
**ACOUSTIC "TONE GUARD"**

A NEW treatment of the acoustical problem presented by record surface and mechanical noises present in all phonographs, has been developed by RCA engineers at Camden, and incorporated in the

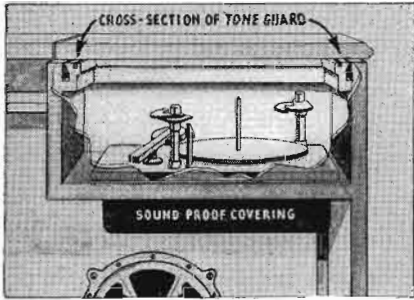

new RCA Victrola home entertainment instruments. Simple in its operation, the new method has been christened "Tone Guard." It is a simple system of grooved wells around the inside edge of the phonograph compartment directly beneath the lid acting as tuned acoustical filter.

• • •  
**F-M TRANSMITTERS**

*(Continued from page 10)*

for mounting two temperature-controlled crystal cells with a switch for changing from one to the other during operation.

Since the voltage output of the discriminator rectifier due to any frequency drift, bears a linear relation to the amount of such drift, a d-c voltmeter placed across the rectifier output will indicate the magnitude of this drift. Such a mean-frequency indicator has been built into this transmitter to furnish the operator with a positive check on mean carrier frequency at all times. Two degrees of sensitivity are provided, one for tuning operations and a second for normal operation.

The main audio amplifier supplies the audio signal, through the pre-accentuation filter, to the grid of the frequency modulator. Very little gain is required of this amplifier stage for complete modulation, and its main function is to permit obtaining the proper action of the pre-accentuation filter.

The pre-accentuation filter at the transmitter has a very definite purpose in obtaining high-fidelity noise-free reception of broadcast transmissions,

# Specify DAVEN ATTENUATORS

**To INSURE PRECISE QUALITY  
and RUGGED DEPENDABILITY  
in your SPEECH INPUT EQUIPMENT**

**Substitutes, whose only merit can be a claim that they are "just-as-good", are NEVER the equal of the original. When ordering new speech input equipment, insist upon DAVEN ATTENUATORS, particularly when these precision components COST YOU NO MORE. DAVEN leadership in the field is clearly indicated not only by the caliber but also the number of organizations who are satisfied users.**

Our catalog lists the most complete line of precision attenuators in the world. However, due to the specialized nature of high fidelity audio equipment, a large number of requirements are encountered where stock units may not be suitable. If you have such a problem, write to our engineering department.

## THE DAVEN COMPANY

158 SUMMIT STREET • NEWARK, NEW JERSEY

when receivers having the proper characteristics are used. It has been found that when high-fidelity transmission and reception systems are used in any type of modulation, a great proportion of the accompanying noise lies in the higher audio frequencies between 5,000 and 15,000 cycles. In all types of broadcast programs, the relative amplitude of these high frequencies is very low compared to frequencies from 30 to 5,000 cycles. Consequently, any reception of these high frequencies is usually covered up by the high noise level. Now, if by means of a pre-accentuation filter, the relative modulation of the transmitter is "stepped up" at these higher frequencies, while the receiver is made correspondingly less sensitive for the same frequencies, there will be a noticeable improvement in signal-to-noise ratio. The advantages of using such filters in frequency-modulation transmitters and receivers is even more pronounced than in case of amplitude-modulated systems.

#### Modulation Indicator

An electronic modulation-level indicator of the cathode-ray type is built into this transmitter. It operates by means of a combined application of both audio and frequency-modulated r-f, and serves to indicate to the operator the percentage modulation or fre-

quency swing taking place in the transmitter output.

#### Rectifiers

Two rectifiers of conventional single-phase full-wave type are employed. The low-voltage rectifier supplies all plate voltages to the low-level stages, both r-f and audio. The second rectifier has two output voltages, one supplying plate power to the final frequency multiplier and IPA stages, and the other supplying high-voltage plate power to the power amplifier.

#### Automatic Voltage Regulator

A refinement which contributes materially to the stability and high-quality transmission of this transmitter is the electronic voltage regulator which maintains a constant plate voltage on the modulator and oscillator stages regardless of variations in supply line voltage.

A regulating-type of transformer supplies constant filament voltage to the modulator and oscillator tubes, relatively independent of line voltage fluctuations.

#### Power and Control Circuits

The 115-volt, single-phase, 60-cycle power supply is supplied to the transmitter through a circuit-breaker type of hand-operated switch. Power for the crystal and modulator-oscillator compartment heaters is furnished by a sep-

arate fused circuit, usually connected to the station lighting supply.

Control circuits, unusually simple in design, provide for complete protection and efficient operation of the equipment. Relays of different types guard against such things as severe overloads and premature application of plate voltage.

Several conveniently located instruments on the front panel indicate such information as plate voltage, filament voltage, and plate currents.

#### Larger Size Transmitters

In addition to the 250-watt unit, General Electric now offers transmitters in the 1-kw, 3-kw, and 50-kw sizes. The 1-kw amplifier is built in the same size and type of cabinet as its 250-watt exciter. The tube complement consists of two GL-833 tubes in a single Class C amplifier stage, while the rectifier employs four GL-872A tubes. In addition to the previously described features of the exciter unit, the 1-kw amplifier, when tied in with the 250-watt controls, provides an automatic "off-on" control circuit.

The 250-watt unit serves as an exciter for either the 1-kw or 3-kw amplifiers, and these respectively serve as drivers for the 10-kw and 50-kw units. The 3-, 10-, and 50-kilowatt amplifiers all employ new ultra-high-frequency tubes developed by General Electric especially for frequency modulation and television.

## Over the Tape—continued from page 19

### NEW G-E BUILDING

The General Electric Company has announced that contracts have been awarded for the construction of a new building in its Schenectady works to be used in the manufacture of radio transmitters. The building will be of brick and steel construction, 800 feet by 168, with provision for multi-story offices in front. The cost probably will be in excess of \$500,000. The contract has been awarded to the James Stewart Co. of New York City. It is understood that construction will start immediately.

### DRAKE ELECTRIC BULLETIN

The Drake Electric Works, Inc., 3656 Lincoln Ave., Chicago, have issued Catalog Sheet No. 1A dealing with their line of industrial soldering irons. Copies are available from the above organization.

### NEW COLLINS PLANT

Collins Radio Company announces that construction of a new plant has been started, located on a twenty-six acre tract which will provide space for field experimentation and expansion.

The building will have 52,000 sq. ft. floor space. Of the wide span truss construction, it incorporates such modern features as unobstructed floor area and high intensity fluorescent lighting throughout. Dust filtered air with controlled temperature and humidity will aid precision

manufacturing. Climatic and other test chambers are built in, and there are extensive power outlets for test areas.

This new building will be used in conjunction with the present 40,000 sq. ft. Collins plant. All research, engineering, and precision manufacturing will be transferred to the new building which will be ready for occupancy about November 1.

### ALLIED CATALOG

Allied Radio Corporation, 833 W. Jackson Blvd., Chicago, have just issued their 1941 Catalog. This issue contains 208 pages. It may be secured from the above organization.

### RCA BULLETINS

Three new bulletins are now available from the RCA Manufacturing Co., Inc., Camden, N. J. One bulletin describes the 305-A cathode-ray oscilloscope designed for television, broadcasting, experimental and industrial applications. Rather complete data on the Type 250-K 250-watt broadcast transmitter is contained in the second folder. The third bulletin describes the Type 315-A electronic switch.

### RADEX BULLETIN

Radex Corporation, 1733 Milwaukee Ave., Chicago, have a new bulletin describing their line of frequency-modulation coil kits, chokes, as well as antenna, r-f,

oscillator and i-f coils. Other items included in the bulletin are a radiating loop and a signal tracer.

### WESTINGHOUSE CATALOG

A new 16-page illustrated catalog of rectangular case switchboard instruments, types HA, HX, HY, and HZ, is announced by the Westinghouse. These instruments are especially designed for flush and projection mounting on switchboards, panels, control desks, or similar apparatus. Copies of catalog section 43-205 may be obtained from Dept. 7-N-20 Westinghouse Electric & Manufacturing Co., East Pittsburgh, Pa.

### I.G.E. VICE-PRESIDENTS RETIRE

The retirement of E. Arthur Baldwin and Otto Pruessman, Vice-Presidents and European and Far Eastern Managers of the International General Electric Company, respectively, has been announced by Clark H. Minor, President. The retirements became effective September 1.

### JEWETT RESIGNS

Dr. F. B. Jewett, vice-president of the American Telephone and Telegraph Company in charge of research, has tendered his resignation as president of Bell Telephone Laboratories, Incorporated, and will become chairman of the board of directors. Dr. O. E. Buckley, executive vice-president of the Labora-



*Bliley*



Bliley Quartz Crystals and Mountings are precision-made for all frequencies between 20Kc. and 30Mc. Catalogue G-11 describes the complete line. Write for your copy.

**QUARTZ  
CRYSTALS**

FOR GENERAL COMMUNICATION FREQUENCIES

**BLILEY ELECTRIC COMPANY**  
UNION STATION BUILDING ERIE, PA.



**HANDI-MIKES** An indispensable part of all portable sound equipment . . . sports, call sys., sound trucks, sm. transmitters, etc. Clear, crisp voice reproduction. Bal. grip, pol. chrome plate, snap switch, 6 ft. flex. cord. Choice of circuits and switches, single and double button carbon, crystals, dynamics, all impedances. At your dealer or jobber.

**UNIVERSAL MICROPHONE CO. LTD.**  
INGLEWOOD, CALIF., U. S. A.

**WANTED**

**RADIO & MECHANICAL ENGINEERS**

Engineers with two or more years radio design experience wanted. Apply stating education, experience and salary required.

**COLONIAL RADIO CORP., 254 Rano St., Buffalo, N. Y.**



**PRECISION . . .**  
performance at a reasonable price is offered by the Micrometer Frequency Meter. Heterodyne-type, it will monitor from 1.5 to 56 mc., with accuracy better than 0.01%.

*Write for data.*

**LAMPKIN LABORATORIES, BRADENTON, FLA.**

When You Renew Your Subscription to

**COMMUNICATIONS**

Remember the Group Rate—\$1.00 a year for four or more subscriptions.

Regular Rate—\$2.00 a year in U. S. A.—\$3.00 in foreign countries

communications



**SX-28**

**Model SX-28 Super Sky rider** is a 6 band, 15 tube receiver giving you complete front panel control over every phase of the circuit. 2 stages of preselection . . . high fidelity push-pull audio . . . calibrated electrical bandspread . . . micrometer scale on main tuning knob . . . 6-position selectivity control . . . band pass audio filter . . . automatic noise limiter . . . new crystal filter circuit . . . ball bearing tuning mechanism . . . semi-floating main tuning and bandspread condensers. Covers 540kc to 43mc. Panel is exact rack size. Chassis has rigid girder construction. Hallicrafters-Jensen Bass Reflex speakers available. With crystal and tubes, less only speaker . . . . . \$159.50 NET

USED BY 33 GOVERNMENTS • SOLD IN 89 COUNTRIES

**Model S-27** is the first general-coverage U.H.F. communications receiver to incorporate Frequency Modulation reception. Covers 3 bands: 27 to 46mc; 45 to 84mc; 81 to 145mc. Switch changing from FM to AM reception. Acorn tubes in R.F. and newly developed converter system. High gain 1853 tubes in I.F. stages. Beam power tubes and 6C8G phase inverter in A.F. Amplifier. A VR 150 voltage regulator tube is used to assure excellent electrical stability. 955 plate-tuned oscillator. I.F. selectivity automatically sharpened to receive amplitude modulated U.H.F. signals or broadened for wide band frequency modulated signals. With tubes, less only speaker . . . . . \$175.00 NET

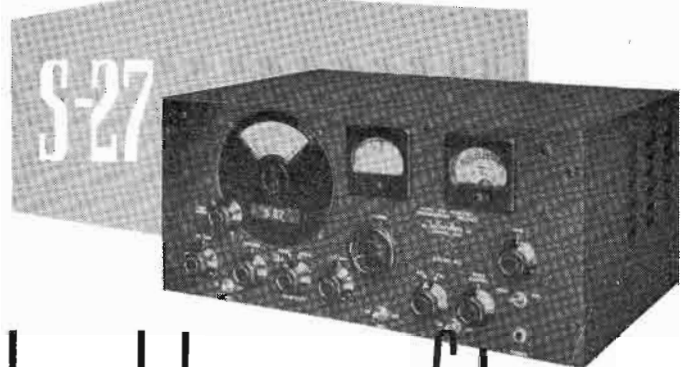

hallicrafters

# A SMALL FUSE That Has A Time Lag

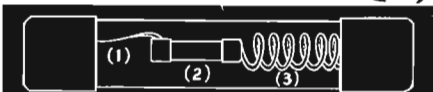

## HOW IT WORKS

Has 3 Main Elements (1) A Fuse Link (2) A Resistor to furnish heat inertia and (3) A Spring for tension

- 1 ON OVERLOADS 2 SEPARATES FROM 1
- 2 ON SHORT CIRCUITS 1 MELTS
- 3 THE SPRING ACTION PREVENTS CRYSTALLIZATION ON REPEATED HEATING AND COOLING OF 1

## Blows But Holds Awhile

When you want a fuse with a high time lag for use where inductive and composite surges are encountered—especially for the protection of power packs, solenoids, and small motors—you have it with the SLO-BLO Littelfuse. It safely holds on surges—protects equipment and prevents needless "blows" and fuse expense.

There seem to be endless applications where the SLO-BLO Littelfuse with its time lag can be used. What's your problem? Our engineers can help. Write for literature, prices and samples.



**LITTELFUSE INC.**  
4751 RAVENSWOOD AVE. CHICAGO, ILL.



SEND  
and  
RECEIVE

## Pictures and Text by RADIO or WIRE . . .

WITH the new Finch Facsimile Duplex instrument, you can receive or transmit illustrated messages the size of a telegram blank at the rate of 8 sq. in. per minute. Write for Booklet C-10.

Finch Telecommunications, Inc.  
PASSAIC, N. J. Also New York, N. Y.  
and Washington, D. C.



tories, succeeds Dr. Jewett as president. There is no change in Dr. Jewett's responsibilities for the general program of research in the Bell System, but the change will increase the time he has available in an advisory capacity to the Government as president of the National Academy of Sciences and as a member of the National Defense Research Committee. Dr. Buckley, the new president, entered the Bell System in 1914, since when he has been intimately associated with telephone research. He became director of research in 1933 and executive vice-president in 1936. Dr. R. W. King, who has been assistant to the president, will be transferred to the American Telephone and Telegraph Company as assistant vice-president and will continue to aid Dr. Jewett.

### GATES CONTRACTS COMPLETED

Gates American Corporation announces the completion of some important contracts in south and southwest. For Mutual Broadcasting at Omaha, with their new station going on the air the middle of September, Gates has installed their Deluxe transmitter, with 20D speech input console, turntables, monitors and remote equipment. The same type of equipment has also been installed for Hazelwood, Inc., of Orlando, Florida, at a newly authorized station. A complete Model 20D speech input console and Model 27-C limiting amplifier has been delivered to the Textile Broadcasting Company of Greenville, S. C.

The Government of Newfoundland, in cooperation with the engineering department of Posts and Telegraphs, is converting its present battery operated toll equipment into complete a-c operation by the supply of a special designed automatic regulated power supply and numerous types of coprous oxide rectifiers—which equipment is being designed by Gates American.

Another station installation is that of Rocky Mount, N. C., for Station WEED, which has ordered a complete Gates 20 series speech input console for its new studios.

### DOOLITTLE APPOINTMENT

Mr. Harry J. Kayner has been appointed to the position of Assistant Chief Engineer in charge of development of Doolittle Radio, Inc. Mr. Kayner has been active in the field for a number of years and was most recently with the Belmont Radio Corp.

### WESTINGHOUSE DOUBLES RADIO PLANT SPACE FOR PREPAREDNESS

First of three new buildings at the Westinghouse Electric & Manufacturing Company's Radio Division in Baltimore is now completed aiding the Government's preparedness program by doubling the company's production facilities for special Army and Navy radio equipment. Ninety workers erected the temporary timber structure in 45 working days after the first foundation pile was driven last August 7. The building will provide 34,000 square feet of additional radio manufacturing space and employment for approximately 300 persons, stated George H. Parkman, Westinghouse construction engineer.

Mr. Parkman also announced that two additional two-story brick and steel

You and your associates can obtain a year's subscription to COMMUNICATIONS (12 issues) for only \$1.00 each by using the Group Subscription Plan.

A regular yearly subscription to COMMUNICATIONS costs \$2.00 — but when four or more men sign up at one time, each one is entitled to the half-price rate. (Foreign subscribers on the "G-S-P" only pay \$2.00 each).

## COMMUNICATIONS

19 E. 47th St., N. Y. C.

Please enter annual subscriptions (12 issues) for each of the undersigned for which payment is enclosed at the rate of \$1.00 each. (This rate applies only on 4 or more subscriptions when occupations are given.) Foreign Subscriptions are \$2.00 each.

Name .....

Street .....

City-State .....

Occupation or title .....

Employed by .....

Nature of business .....

(State if Manufacturer, Broadcast Station, etc.)

Product .....

Name .....

Street .....

City-State .....

Occupation or title .....

Employed by .....

Nature of business .....

(State if Manufacturer, Broadcast Station, etc.)

Product .....

Name .....

Street .....

City-State .....

Occupation or title .....

Employed by .....

Nature of business .....

(State if Manufacturer, Broadcast Station, etc.)

Product .....

Name .....

Street .....

City-State .....

Occupation or title .....

Employed by .....

Nature of business .....

(State if Manufacturer, Broadcast Station, etc.)

Product .....

buildings are scheduled for completion at the Radio Division before November 15, adding approximately 35,000 feet of manufacturing, laboratory and office space. "This new construction," he stated, "is being rushed on an emergency basis primarily to meet production demands resulting from increased Government preparedness orders."

Equipment, including special machine tools, is already being placed in the new factory building. The one-story structure has been designed to provide a 14-foot clearance under the supporting trusses so that mobile radio assemblies may be moved from one work area to another without interruption of production.

The building is 285 feet long and 120 feet wide, its foundation resting on 90 35-foot wood piles. Its roof is supported on 60-foot spans from center columns. Special solar-heat absorbing glass has been used in the windows to reduce summer heat inside the plant.

One of the buildings nearing completion is a laboratory, 90 by 140 feet, in which some 200 engineers and technicians will be employed on Government radio development work. The other is a new office building containing 10,640 square feet of floor space. Foundations for both buildings were started August 15.

In addition, Mr. Parkman said, service activities will be transferred to the new building from present space in the industrial building.

With completion of the building program, the Westinghouse Radio Division will have 135,000 square feet of manufacturing space and 33,000 square feet of office space.

#### RCA PROMOTES BRUNET

Meade Brunet, well known figure in the radio industry for twenty years, has been appointed Manager of the Engineering Products Division in addition to his position as Manager of the Company's Washington office, it has been announced by F. R. Deakins, Vice-President of the RCA Manufacturing Company in charge of Special Products. James L. Schwank, former Manager of the Engineering Products Division, has been transferred to Mr. Deakins' office.

#### VWOA NEWS

(Continued from page 18)

vice to his Company, his men, and the public at large in bringing radio to the peoples of the Caribbean following his active participation in the earliest transatlantic transmissions. His associates and friends hope that he will be spared for a goodly number of years to come, to carry on that work.

"Bill" always finds time to attend VWOA functions and we recall with pleasure his easy persuasion from making his scheduled train to stay over in New York and attend "DeForest Day" at the New York World's Fair. He is one of our most distinguished Life Members and a true "Wireless Pioneer."

Our salute to you "Bill" Beakes and may you long continue the spirit of the "Wireless Pioneer!"

A VWOA "Wireless Pioneer's Medal" has been awarded to "Bill" and will be presented to him at an appropriate function.

# DECORATED!



## for maximum electrical efficiency

Throughout the electrical industry one solder is recognized as first in the field:

**KESTER ROSIN-CORE SOLDER.**

This famous product is the result of Kester's 43 years of continuous solder manufacture. The rosin-flux is scientifically prepared in Kester laboratories specifically for elec-

trical work. This flux eliminates corrosion and gives added protection against fire hazard.

For perfect wiring results, specify Kester Rosin-Core Solder on every job.

Write Kester engineers for expert advice on any soldering operation. There is no obligation.

### KESTER SOLDER COMPANY

4231 Wrightwood Avenue, Chicago, Illinois

Eastern Plant: Newark, N. J.

Canadian Plant: Brantford, Ont.

**KESTER  
CORED SOLDERS**  
STANDARD FOR INDUSTRY

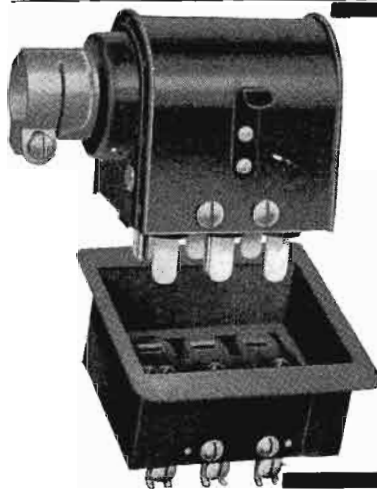

### JONES 500 SERIES POWER PLUGS AND SOCKETS

A new series for heavy currents and high voltages. Engineered to fulfill all electrical and mechanical requirements. Sizes: 2, 4, 6, 8, 10, and 12 contacts. Bulletin No. 500 in preparation. Apply for a copy.

No. 10 Catalog, listing our regular lines and many new items now ready. Send for your copy today.

**HOWARD B. JONES**  
2300 WABANSIA AVENUE, CHICAGO



**AMPEREX**  
**WATER and AIR COOLED**  
**TRANSMITTING and RECTIFYING TUBES**

**AMPEREX ELECTRONIC PRODUCTS, Inc.**  
 79 WASHINGTON STREET BROOKLYN, NEW YORK  
 Export Division: 100 Varick Street, New York, U. S. A. Cables: "ARLAB"

**PIEZO Electric Crystals Exclusively**

- Quality crystals for all practical frequencies supplied SINCE 1925. Prices quoted upon receipt of your specifications.

**Our Pledge: QUALITY FIRST**  
**SCIENTIFIC RADIO SERVICE**  
 UNIVERSITY PARK HYATTSVILLE, MD.



We manufacture a complete line of equipment. Spot Welders, electric, 1/4 to 500 KVA. Standard and Special Transformers. Incandescent lamp and radio tube manufacturing equipment. Glass cutting, slicing, and glass working equipment. College laboratory units, vacuum pumps, and neon sign manufacturing equipment. Wire Butt Welders. A.C. Arc Welders from 100 to 400 Amps. CHAS. EISLER, PRES.

**Eisler Engineering Company**  
 741 S. 13th St. (Avon Ave.), Newark, N. J.

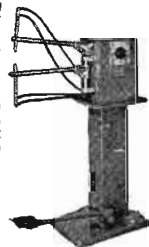

**MANUFACTURERS**

More than 9000 engineers associated with the radio, television, broadcast, recording and two-way communications fields want to read about your new products in COMMUNICATIONS. Send complete data to "The Market Place" editor.

**THE MARKET PLACE**  
**POLICE ANTENNA**

Wunderlich Radio, Inc., S. F. Airport, South San Francisco, California, have announced a controlled current antenna intended for transmission and reception in the medium frequency police band. It is

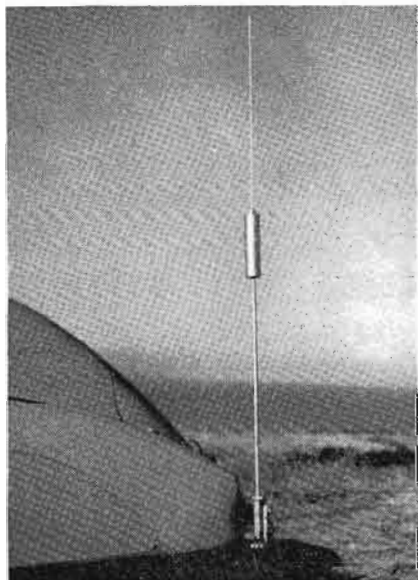

said to provide a 12 db gain over base loaded type mobile antennas.

**ARC WELDER**

General Electric has announced a new 200-ampere, d-c arc welder which will pro-

vide any welding current from 25 to 250 amperes. This wide range allows all-day manual welding to be done with currents up to 200 amperes, using electrodes from 1/16 to 3/16 inch in diameter. Capacity is also provided for the use of electrodes as large as 1/4 inch on occasional short jobs. General Electric Company, Schenectady, N. Y.

**HANDI-MIKES**

Universal Microphone Co., Inglewood, Calif., are now distributing their new handi-mikes for use in the field of portable sound equipment . . . sports events, call systems, small transmitters, sound trucks and all places where close talking, clear reproduction unit is required. Further information is available from the manufacturer.

**HIGH-EFFICIENCY 50 KW TRANSMITTER**

More signal power per kilowatt input is realized in the new air-cooled 50-kw transmitter now manufactured by the Westinghouse Electric & Manufacturing Company for commercial broadcasters.

A new circuit design, resulting in 47.5% overall efficiency, reduces operating costs to a minimum. The use of air-cooled tubes in all stages eliminates water jackets, pumps, cooling radiators, water storage tanks, distilled water, and attendant expense. A further saving is possible due to the fact that warm air is readily available to heat the building which houses the transmitter. Except for the main high-voltage rectifier, metal rectifiers, which have practically unlimited life are used throughout. Some of the other advantages incorporated in this new transmitter are

equalized feedback in audio system, variable compressed gas condensers, complete fuseless overload protection, spare rectifier tube at operating temperature, ease of adjustment, and the conservative operation of all tubes.

The actual space required for the eight unit cubicles of the type HG transmitter, including the main rectifier unit, is 33 1/4 feet wide, 54 inches deep, and 84 inches high. Approximately an equivalent space is also required for supplementary equipment such as modulation transformer, Heising choke, main plate transformer, and voltage regulators.

For additional information write to Dept. 7-N-20, Westinghouse Electric & Mfg. Co., East Pittsburgh, Pa.

**MAGNIFYING GLASS**

The Permo Products Corp., 6415 Ravenswood Ave., Chicago, have available a 10-power magnifying glass mounted in a protecting rubber holder. This device is useful for inspecting playback needle points, recording needles, record grooves, etc. It should also be useful for draftsmen, tool makers, and the like.

**FUSES**

Littelfuse are now manufacturing Underwriters approved 3-AG glass enclosed fuses in ratings up to 8 amperes for 250-volt a-c or d-c service or less. This extension of Underwriters' approved fuses from 3 to 8 amperes opens up many new fields that previously had to use bulky cartridge or plug fuses and their mountings. This applies especially to electric appliances, heavy duty power supplies, amplifiers, radio, motors, etc. Littelfuse's new "sleeve type"

3-AG fuses (4 to 8 amps. incl.) have a separate glass sleeve over the entire fuse element that takes the pressure shocks under short circuits. (The 8-amp. rating fuse is powder packed.) The illustration shows space saving possible by using the



new 3-AG approved fuse instead of the standard cartridge type. Bulletin, technical data and prices may be obtained by writing to Littelfuse Inc., 4757 Ravenswood Ave., Chicago.

#### MARINE RADIO TELEPHONE

A marine radio telephone of 25 watts output, designed especially for the "deep sea" yachtsman and for commercial ships plying coastal waters, has been announced by the Western Electric Co., 195 Broadway, New York City. The new unit, known as the 226C, features crystal control on both receiver and transmitter, high intelligibility, and semi-automatic operation. Simplicity keynotes the new design. Installation involves connection only to antenna, ground and power supply. The compact cabinet lends itself to mounting on a bulkhead, shelf, a locker top or other convenient support. Only three control knobs appear on the panel and the trans-

mitter goes on the air at the pressure of a finger on the handset button.

#### SOUND-LEVEL METER

A new portable sound-level meter, lighter and more compact than any previous instrument of this kind, has been built by Walter Mikelson and others of the General Electric general engineering laboratory in Schenectady. It weighs only 19 pounds but has a range of 24 to 120 decibels or roughly from the rustle of leaves to the scream of a factory whistle.

The new meter may be used quickly and conveniently for almost any kind of noise study, including airplane engine, cabin and propeller noises; traffic noise; sound in theaters, auditoriums and radio studios; and noises of motors, fans, generators, turbines, pumps, bearings, gears, cylinders and other parts of machinery.

Essential parts of the device are a microphone, an amplifier and an indicating instrument. An arm extension protects the microphone from sound reflected from the case. The amplifier consists of five stages which are resistance coupled. The battery-operated tubes are mounted on a shock-proof base, thus reducing errors due to vibration.

A switch permits the selection of one of three ear-weighting networks, 40 decibels, 70 decibels or flat frequency response giving the instrument a response similar to that of the human ear. In field use the instrument is calibrated by applying a precision mouth-blown calibrating unit to the microphone. After adjustment a single knob controls the instrument.

It is designed to perform in accordance with the recently adopted American Standards Association standards for sound level meters. The complete instrument, including the microphone and mounting arm, calibrating unit and batteries, is contained in a carrying case 12¾ inches long, 7¾ inches wide and 9¾ inches high.

A vibration velocity unit may be substituted for the microphone on the instrument, thus providing a means of measuring vibration as well as noise.

#### POWER RHEOSTAT

Sturdiness, both mechanically and electrically, characterize the new power rheostat just introduced by Clarostat Mfg. Co., Inc., of 285-7 N. Sixth St., Brooklyn, N. Y. Selected resistance wire is wound on an insulated aluminum

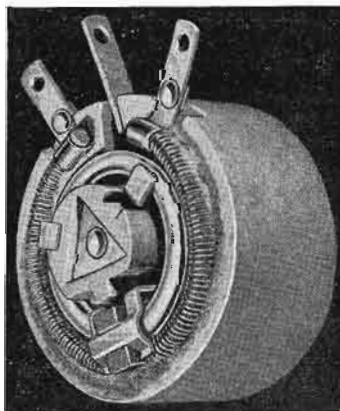

core. The resistance element is bent round, placed in the slot of the ceramic shell, and firmly imbedded in a cold-setting inorganic cement similar to that used for the well-known Clarostat Greenohm power resistors.

**HIGHER FIDELITY**  
is  
*Built into*  
**FAIRCHILD'S**  
**Distortion Free**  
**AMPLIFIER!**



**A Feed-Back Amplifier Flat within .3 Decibel from 15 to 15,000 Cycles!**

Precision-built by Fairchild laboratory engineers, the new Unit 246 Feed-Back Amplifier provides greater fidelity for broadcasting, recording, playbacks, and laboratory work.

Fits 19½" relay rack—7" high panel. 2 Units—amplifier and power supply each this size.

#### **SPECIFICATIONS PROVE UNIT 246 AMPLIFIER'S PERFORMANCE**

Overall gain—75 decibels.  
Noise level—50 decibels below "0" level.  
Rated at 23 watts into 500 Ohm resistive load.  
Input impedance Multiple line: 50, 125, 250, 500 Ohms.  
Output impedance: 16 and 500 Ohms.  
Input line volts: 110-125V; 50-60 cycles AC.  
Distortion: .3% at rated output.

*Write for descriptive literature today!*

"...it had to satisfy Fairchild first"

**FAIRCHILD**  
Sound Equipment Division  
**AVIATION CORPORATION**  
88-06 Van Wyck Boulevard, Jamaica, L. I., N. Y.



**WAXES**  
AND  
**COMPOUNDS**  
FOR  
**INSULATION and WATERPROOFING**  
of **ELECTRICAL and RADIO**  
**COMPONENTS**

● such as transformers, coils, power packs, pot heads, sockets, wiring devices, wet and dry batteries, etc. Also WAX SATURATORS for braided wire and tape and WAXES for radio parts. The facilities of our laboratories are at your disposal to help solve your problems.

**Zophar MILLS, Inc.**  
FOUNDED 1846  
120-26th ST., BROOKLYN, N. Y.



E. H. RIETZKE PRES. OF CREI

**Here's How YOU CAN Qualify for a BETTER RADIO JOB!**

Are you "pinned down" into a routine radio job? The lack of technical training is the stumbling block that keeps the average radioman from getting a better job or even holding his present job. But you CAN do something about it—if you will! Your radio experience backed by technical training will equip you to share in the good-paying jobs that await trained men. CREI home study courses in Practical Radio and Television Engineering are prepared for experienced radiomen who realize not only the value—but the necessity of CREI training if they are to make good in the important jobs where trained men are always in demand.

Write for **FREE** New illustrated booklet

To help us intelligently answer your inquiry—please state briefly your radio experience, education, and present position—and if interested in home study or residence training.



**CAPITOL RADIO ENGINEERING INSTITUTE**

DEPT. CO-10, 3224-16th St., N.W., WASH., D.C.

**D.C. Motors**



Pincor small motors are especially well adapted for band switching, remote control, etc. for aircraft use or wherever a small, light weight motor is required to give un-failing service. They are available in capacities to meet every requirement. Consult our engineers about your small motor needs.

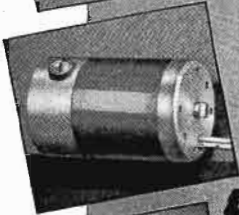

**PINCOR PRODUCTS**

Pincor line includes: Dynamotors, Generators, Converters, Power Plants, Motor-Generator Sets, Pumps. Write for literature.



**PIONEER GEN-E-MOTOR CORPORATION**

Dept. R-5, 466 W. SUPERIOR ST., Chicago, Ill.  
Export Address: 25 WARREN ST., N. Y., N. Y.  
Cable: SIMONTRICE, New York

**RECORD SHAVINGS DISPOSER**

A new device developed by Presto Recording Corporation, 242 W. 55 St., New York City, for cleaning the surface of a disc while recording and disposing of the shavings cut from the disc so that they cannot tangle under the cutting needle is shown in accompanying illustration. Known as the Presto 400-A blower system, it directs a tiny blast of air across the surface of the disc just behind the cutting

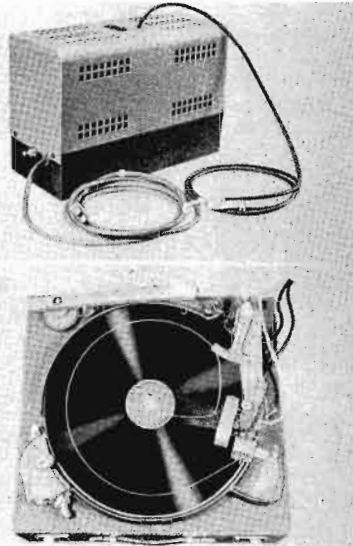

head, which throws the waste thread to the center of the disc and prevents the thread from becoming tangled under the cutting needle. At the same time the airstream removes lint or grit from the surface of the disc just before it passes under the cutting needle.

**U-H-F TRANSMITTER-RECEIVER**

A new portable ultra-high-frequency transmitter-receiver having 75 calibrated frequency channels from 28 to 65 megacycles has just been announced by the Westinghouse Electric & Manufacturing Company. Compact and weighing only thirty pounds complete with batteries, antenna, microphone, headphones and key, this type HR communicator combines phone or continuous wave operation. It is ideal for communication between scattered field groups, as in traffic, fire, large scale construction, or rescue control work.

A crystal-frequency standard permits calibration for accurate adjustment of both transmitter and receiver to the desired

frequency. Equipment is so designed that several sets in a relatively small area can operate on the same channel without heterodyne interference. Sending on one channel, receiving on another is easy with the push-to-talk send-receive control.

Tube complement consists of 3-958 triodes, 1-959 pentode, 2-30 triodes, and 1-1E7G twin pentode. Radio frequency carrier output is 0.5 watt minimum; average receiver sensitivity is 5 microvolts. Power is obtained from a plug-in type dry battery good for 10 hours continuous operation, or considerably longer on intermittent service. Entire equipment is resistant to moisture, salt sea air, and temperature variations; can be placed in full field operation in less than thirty seconds.

Further information on the HR communicator may be obtained by writing the Westinghouse Elec. & Mfg. Co., Radio Division, Baltimore, Md.

**F-M AND TELEVISION CABLE**

A new high frequency transmission cable is announced by Belden Manufacturing Company, 4689 W. Van Buren Street, Chicago. Of the 100 ohm twisted pair type, this new cable is designed for use with television or frequency modulation.

The new 8219 cable consists of 18 gauge stranded tinned copper, celanese braid, rubber covered, color coded, twisted pair with fillers, celanese wrap,

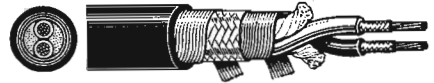

tinned copper shield, cotton wrap, and rubber sheath. Outer diameter of the cable is .350". The cable has the following characteristics:

| Freq. Kc. | Surge Imp. Ohms | Power Fact. | D.B. Loss 100 ft. | Min. Punct. Volts | Max. Cap. Watts |
|-----------|-----------------|-------------|-------------------|-------------------|-----------------|
| 100       | 90.             | 2.18        | .060              | 10000             | 250             |
| 40000     | 92.             | 2.01        | 6.180             | 10000             | 250             |

No. 8218 cable is similar in construction, except that it does not have the outer tinned copper shield. Outer diameter is .270". This cable has characteristics as follows:

| Freq. Kc. | Surge Imp. Ohms | Power Fact. | D.B. Loss 100 ft. | Min. Punct. Volts | Max. Cap. Watts |
|-----------|-----------------|-------------|-------------------|-------------------|-----------------|
| 100       | 105.            | 1.51        | .048              | 10000             | 250             |
| 40000     | 106.            | 2.27        | 5.800             | 10000             | 250             |

**IN PURSUIT OF HAPPINESS**

... Plan a visit to The Chelsea—Atlantic City's most distinctive beach front hotel. Laze on the Sundeck. Dine superbly in our beautiful room at the ocean's edge. Ride, golf, bicycle. Pass time pleasantly in the Game Room. Or visit our magnificent new Bar, where choice wines and liquors are always available.

**WRITE FOR BOOKLET AND SPECIAL AUTUMN RATES**

**Hotel Chelsea**

**ON THE BOARDWALK  
ATLANTIC CITY, N. J.**

### STANDARD SIGNAL GENERATOR

In the accompanying illustration is shown the Ferris Model 40-A u-h-f standard signal generator. This unit has a frequency range of 20 to 250 megacycles covered in four self-contained bands. Accuracy of cali-

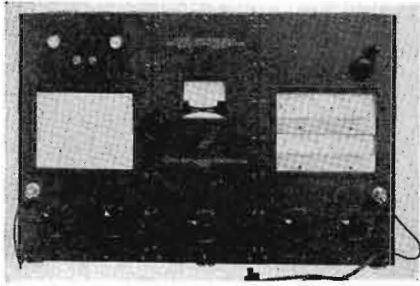

bration is said to be 1% for the direct-reading scale and 0.1% for the tabulated data furnished. Literature may be obtained by writing to the Ferris Instrument Corp., Boonton, N. J.

### RECORDING ASSEMBLY

Universal Microphone Co., Inglewood, Calif., has just started to distribute a new item that is not listed in its catalogs. Sale will be restricted to manufacturers only. Known as manufacturers' type of recording head and arm assembly, it is available to manufacturers for mounting in their own

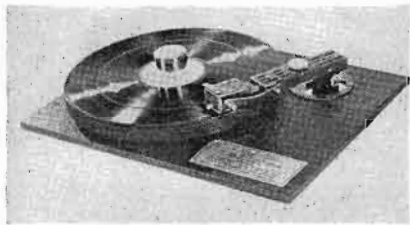

cabinet and for operation on their own motors.

The assembly is rugged and compact, non critical in operation and is not affected by temperature changes or humidity, it is said. Adjustable needle pressure and pivot bearing are some of the features. It cuts 118 lines per inch. Cutting head, arm and lead screw are, of course, included in the assembly.

### RCA TUBES

Three new transmitting tubes and a receiving tube have been made available by the Radiotron Division, RCA Manufacturing Co., Inc., Harrison, N. J. These tubes are designated as follows: RCA-833-A r-f power amplifier, modulator; RCA-1627 r-f power amplifier, modulator; RCA-8003 oscillator, power amplifier, modulator; RCA-12A6 beam power amplifier.

The 833-A is a transmitting triode similar to RCA-833, but it has an improved construction and can be operated at higher output with forced-air cooling. The 833-A has a maximum plate dissipation rating of 450 watts (ICAS). It can be operated in Class C telegraph service with a maximum input of 2,000 watts (ICAS) at frequencies as high as 20 megacycles. The 833-A is directly interchangeable with the type 833 in circuits designed for the latter.

The 1627 is a transmitting triode the same as RCA-810 except that it is designed with a filament rated at 5 volts, 9 amperes. Other data are the same as for RCA-810.

The 8003 is a transmitting triode having

## Defense Contract

*Controls*



★ Are you working on a negotiated defense contract . . . or a contract including government specified equipment designed by other than government engineers?

If so . . . Guardian Electric is prepared to cooperate as a *primary* and *secondary* source of supply for electrical controls.

## RELAYS BY GUARDIAN

and Complete Control Assemblies for:

Bomb Releases . . . Fire Controls . . . Communication equipment for tanks, airplanes . . . Portable Pack . . . Radio Remote Controls . . . Signal Corps requirements . . . Controls for synchronized and non-synchronized Machine Gun Fire on Aircraft . . . Anti-aircraft Gun Control . . . Special Switches for various applications to meet government specifications, and innumerable other special control assemblies, complete, or in part.

SERVICE! Guardian offers the highest speed sample and engineering service in the control industry . . . quality controls to meet the most rigid inspections and delivery schedules. Send a blue print of sketch for *cost-free* engineering suggestions. Your letterhead brings new Guardian Catalog "C" by return mail. Write

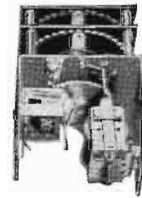

Type-R Stepping Relay

## GUARDIAN ELECTRIC

1623 WEST WALNUT STREET

CHICAGO, ILLINOIS

## For their AIRLINE TRANSMITTERS

on which human lives must depend, Communications Co. Inc., Coral Gables, Florida used

## JOHNSON CONDENSERS and INDUCTORS

This is but one of the many users now depending on Johnson where specifications are exacting. Investigate the advantages Johnson has to offer YOU.

Write for catalog 301E.

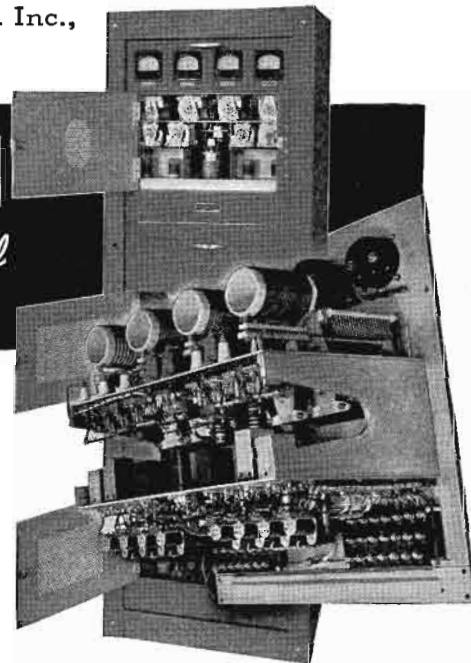

## E. F. JOHNSON CO

WASECA, MINNESOTA

EXPORT: 26 WARREN ST., NEW YORK, N. Y.

"MANUFACTURERS OF RADIO TRANSMITTING EQUIPMENT"

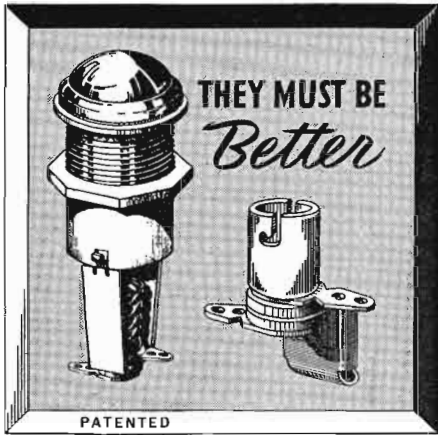

**FOR DRAKE ASSEMBLIES ARE USED  
BY LEADING AIRPLANE MAKERS**

Airplane parts *must be dependable!* For serious consequences may follow the failure of even so small a part as a pilot light assembly. That's why so many of America's airplane manufacturers specify DRAKE Pilot Light Assemblies. Among radio makers, too, DRAKE Dial and Jewel Assemblies have won an enviable preference because they are so *dependable*. If your product calls for pilot light assemblies, ask about the complete DRAKE line. Standard and special types of every description and in any quantities are produced with amazing speed and efficiency.

*Will You Write for Our Catalog?*

**DRAKE MANUFACTURING CO.**  
1713 W. HUBBARD ST. • CHICAGO, U.S.A.

**RADIOCARB**  
the  
CARBONIZED NICKEL

made only by  
**WILBUR B. DRIVER CO.**  
NEWARK, NEW JERSEY

a maximum plate dissipation of 100 watts. In self-rectifying oscillator circuits such as those used in therapeutic applications, two 8003's are capable of delivering a useful power output (at 75% circuit efficiency) of 375 watts. The 8003 is rated for operation at frequencies as high as 30 megacycles but it may be used with reduced plate voltage and input at higher frequencies up to 50 megacycles.

The 12A6 is a beam power amplifier of the metal type with a 12.6-volt, 0.15-ampere heater for use in a-c/d-c receivers. With 250 volts on plate and screen, the 12A6 can handle a power output of 2.5 watts with 10% distortion.

**C-R TELEVISION TUBE LEAD WIRE**

A new corona-resistant wire has just been announced by Belden Manufacturing Company, 4689 W. Van Buren Street, Chicago. The special construction of the new 8868 makes it suitable for the high voltages carried in cathode-ray tube television circuits. A special rubber compound, high heat resisting Pyro-Glaze seal and braid of Belden Fiberglas (pure glass) protect this wire against corona and heat. The wire is white and has an outer diameter of .200".

**DETERMOMH RESISTANCE BOX**

The Determohm resistance box, a product of the Ohmite, is now available in 2 new ranges, one of 1 to 9,999 ohms and the other of 10 to 99,990 ohms. These sizes



are in addition to the 100 to 999,900 range box previously available.

The Ohmite Determohm is a decade resistance box of  $\pm 5\%$  accuracy for industrial and laboratory uses. One of the chief uses of the Determohm is in the determination of replacement resistors in radio sets. It may also be used as a voltmeter mul-

tiplier, or can be used with auxiliary apparatus in an ohmmeter, resistance bridge circuit or in many other applications.

The resistance element is made up of wire wound resistors which are connected to tap switches. The Determohm may be connected directly in radio and electrical circuits which do not cause the instrument to dissipate more than one watt for each tap in the circuit.

The Ohmite Determohm is enclosed in an attractive wrinkle-finish black metal case, and the range of each box is covered by means of four switches. Overall dimensions of the Determohm are: width 6-3/16", length 8 3/8", depth 3 1/4", Ohmite Manufacturing Company, 4835 Flournoy Street, Chicago.

**CATHODE-RAY STOPWATCH**

An ingenious method whereby a conventional cathode-ray oscillograph is employed as an indicator for determining the transit time of electrical switching equipment, such as relays and contactors, together with a graphical solution of the pattern obtained from the cathode-ray oscillograph, examples of the method and its extension to other problems, is the subject of the latest issue of the Du Mont Oscillographer. This paper is the first of the entries in the Du Mont Cathode-Ray Symposium and Prize Contest recently announced, and is representative of the cathode-ray application ideas being reported by contestants. A copy may be had by writing Allen B. Du Mont Labs., Inc., Passaic, N. J.

**CHIP CHASER**

In the accompanying illustration is shown a device designed to solve the problem of controlling thread when cutting an instan-

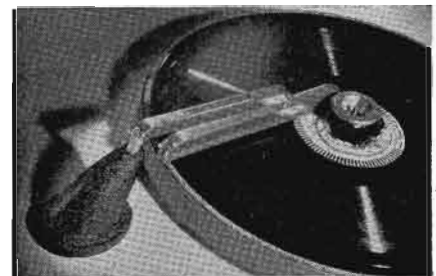

taneous recording. Called a "Chip Chaser," it is described in a bulletin available from Audio Devices, Inc., 1600 Broadway, New York City.

**Two Amazing New Values!**

|  |   |  |
|--|---|--|
|  | <p><b>TYPE 1658</b><br/><b>20 STEP</b><br/><b>LADDER</b></p> <p>•</p> <p><b>\$5.75 Net</b><br/>With<br/>Dial, Knob<br/>and Cover</p> <p>•</p> <p>2% Wire<br/>Wound Re-<br/>sistors Used<br/>Throughout</p>                          |  |
|  | <p><b>TYPE 1722</b><br/><b>20 STEP</b><br/><b>BRIDGED-T</b></p> <p>•</p> <p><b>\$10.75 Net</b><br/>With<br/>Dial, Knob<br/>and Cover</p> <p>•</p> <p>2% Wire<br/>Wound Re-<br/>sistors Used<br/>in All Import-<br/>ant Elements</p> |  |

*Small and compact, but embodying the outstanding construction features found in all Cinema Engineering attenuators. . . . Complete catalogue available upon request.*

Sales Office: 5334 Hollywood Blvd. Hollywood, Calif. **CINEMA ENGINEERING CO.** Factory: 1508 S. Verdugo Ave. Burbank, Calif.



### STRATOLINER MICROPHONE

The Shure Stratoliner Series 508 dynamic microphone is a general purpose unit of the moving conductor type. The die-cast case is finished in satin chrome. The Stratoliner is available in 50-ohm, 250-ohm and in high-impedance types.

Additional details and prices may be



obtained directly from Shure Brothers, 225 W. Huron St., Chicago.

### ATTENUATOR

The Cinema Engineering Company, Burbank, Calif., has just released a popular priced 20-step bridge-T attenuator. This unit uses close tolerance carbon resistors in some circuit locations but all the resistors of functional importance in these new units are wire wound, two per cent accuracy. The Type 1722 bridge T mixer, as this new unit will be designated, will have precision surfaced contact points, full reamed sleeve bearing and ground shaft and other constructional features found in the higher priced Cinema Engineering attenuators.

### QUADGET, PADGET

The McProud Quadget and Padget are two devices designed to simplify equalizer and attenuator design. Built in the form of a sliding chart, the Quadget contains all the information required to design a constant-impedance equalizer for 500-ohm circuits. The Padget, also built in the form of a sliding chart or rule, permits the user to determine the resistors required for various types of attenuators without resorting to calculations. Further information may be secured from Norman B. Neely, 1656 N. Serrano St., Los Angeles, Calif.

### COLOR-CODED CONDENSERS

All Mallory tubular paper condensers now bear a colored label bearing the RMA code. A bottom band of color properly



coded to RMA standards gives the voltage rating as well.

The color-code band goes completely around the condenser so that it may be readily seen and the voltage identified no matter how the condenser is placed in the set. Construction remains unchanged; the labels are merely applied over the customary cardboard tube and wax coating.

Additional information may be obtained directly from P. R. Mallory & Co., Inc., Indianapolis, Ind.

## Do you know about the TYPE 160-A Q-METER?

WE have replaced the type 100-A Q-Meter with the type 160-A Q-Meter and have built into it numerous features requested by engineers.

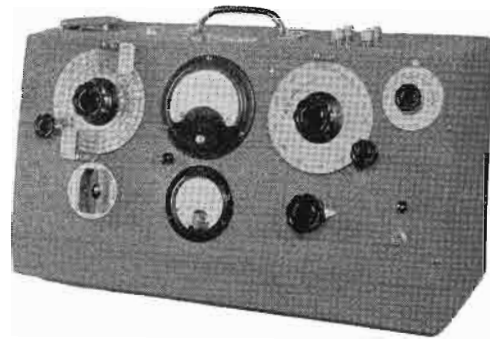

- Frequency Range—50 k.c. to 75 m.c. Also 1 k.c. to 50 k.c. with external oscillator.
- Q Range up to  $Q = 625$ .
- Improved 4" high speed Q Voltmeter.
- Improved Main and Vernier Q Condensers.
- Reduced internal inductance in measuring circuit.
- Availability of oscillator output voltage for general laboratory work.

Your type 100-A Q-Meter can be converted into a type 160-A.

The Q-Meter is the standard instrument of the Radio Industry for the measurement of coils, condensers, dielectrics, antennae, transmission lines, etc.

May we send you detailed information?

**BOONTON RADIO CORPORATION**  
Boonton, New Jersey U. S. A.

## New BRUNO CONNECTORS for HIGH FREQUENCY TRANSMISSION LINES for AIRCRAFT, MOBILE and STATIONARY INSTALLATIONS

Lock nut type—Gas seal and Electrical connections made simultaneously—Friction and constriction contact for center conductor—Safety outer conductor friction collar contact between connectors—Both contacts securely made even if lock nut loosens—May be used on gas filled or normal Transmission Lines—Made from Aluminum Alloy (17 ST)—Heavy Phosphorous Bronze contacts—XXX Bakelite used—Will meet requirements of Commercial Airlines and competent gov't agencies.

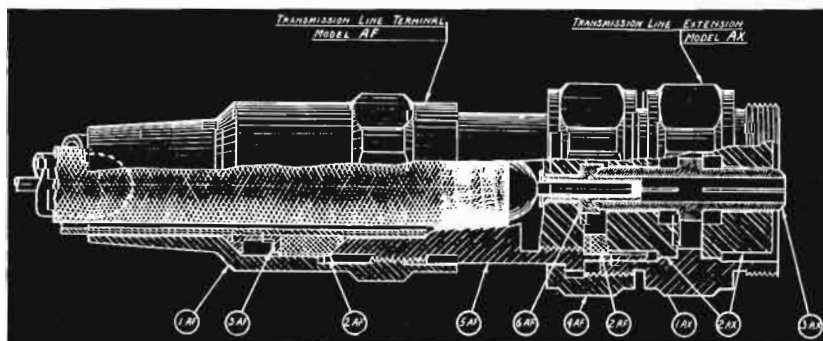

Available in various sizes to accommodate  $\frac{3}{8}$ "  $\frac{1}{2}$ "  $\frac{3}{4}$ " and  $\frac{7}{8}$ " lines—Obtainable in several types and models to meet special application.

Write for Bulletin "CA" describing full line.

**SELECTAR MFG. CORP., 30 W. 15th St., New York, N. Y.**

# RECOTON Recording Needles

**MAKE BETTER RECORDINGS**

Because

- Diamond-dust Polished
- Absolutely Uniform
- Swedish Steel Alloy

Write for price list . . . also ask about our Sapphire Cutting Needle.

**RECOTON CORPORATION**  
178 Prince St. New York, N. Y.

## Equalizer Design Simplified!

USE THE **McPROUD QUADGET**

A device intended to simplify the design of constant impedance equalizers, specifically for 500 ohm circuits. However, it is possible to adapt the values given to circuits of any other impedance. Also indicates specifications for high and low frequency "Shelf Suppressors."

QUADGET is an indispensable aid to every radio, electronic engineer and technician. Easier to use than a slide rule.

**PRICE \$1.50**

Complete with carrier envelope and instructions. Money refunded without question if not entirely satisfied.

**NORMAN B. NEELY**  
1656 N. Serrano St., Los Angeles, Cal.

## Index to Advertisers

|                                       | Page               |
|---------------------------------------|--------------------|
| A                                     |                    |
| Amperex Electronic Products, Inc..... | 34                 |
| B                                     |                    |
| Bliley Electric Co.....               | 31                 |
| Boonton Radio Corp.....               | 39                 |
| C                                     |                    |
| Capitol Radio Engineering Inst.....   | 36                 |
| Cinema Engineering Co.....            | 38                 |
| Collins Radio Co.....                 | Inside Front Cover |
| Colonial Radio Corp.....              | 31                 |
| D                                     |                    |
| Daven Co., The.....                   | 29                 |
| Drake Mfg. Co.....                    | 38                 |
| Driver Co., Wilbur B.....             | 38                 |
| E                                     |                    |
| Eisler Engineering Co.....            | 34                 |
| Eitel-McCullough, Inc. ....           | 15                 |
| F                                     |                    |
| Fairchild Aviation Corp.....          | 35                 |
| Ferris Instrument Corp.....           | 28                 |
| Finch Telecommunications, Inc.....    | 32                 |
| G                                     |                    |
| General Electric Co.....              | 20, 21             |
| General Radio Co.....                 | Inside Back Cover  |
| Guardian Electric Co.....             | 37                 |
| H                                     |                    |
| Hallicrafters, Inc., The.....         | 31                 |
| I                                     |                    |
| Isolantite, Inc. ....                 | 3                  |
| J                                     |                    |
| Johnson Co., E. F. ....               | 37                 |
| Jones, Howard B.....                  | 33                 |
| K                                     |                    |
| Kester Solder Co.....                 | 33                 |
| L                                     |                    |
| Lampkin Laboratories .....            | 31                 |
| Lenz Electric Mfg. Co.....            | 1                  |
| Lingo & Son, Inc., John E.....        | 26                 |
| Link, Fred M.....                     | 28                 |
| Littelfuse, Inc. ....                 | 40                 |
| N                                     |                    |
| Neely, Norman B.....                  | 40                 |
| O                                     |                    |
| Ohmite Mfg. Co.....                   | 27                 |
| P                                     |                    |
| Pioneer Genemotor Corp.....           | 36                 |
| Presto Recording Corp.....            | 25                 |
| R                                     |                    |
| RCA Mfg. Co., Inc.....                | 4, Back Cover      |
| Radio Corporation of America.....     | 13                 |
| Recoton Corp. ....                    | 40                 |
| S                                     |                    |
| Scientific Radio Service.....         | 34                 |
| Selectar Mfg. Corp.....               | 39                 |
| Solar Mfg. Corp.....                  | 17                 |
| T                                     |                    |
| Thomas & Skinner Steel Products Co... | 26                 |
| U                                     |                    |
| United Transformer Corp.....          | 23                 |
| Universal Microphone Co., Ltd.....    | 31                 |
| Z                                     |                    |
| Zophar Mills, Inc. ....               | 35                 |

A GRACIOUS HOST FROM COAST TO COAST

IN NEW YORK..

**The Gotham**

IN CHICAGO..

**The Drake**  
**The Blackstone**

IN LOS ANGELES..

**The Town House**

IN BELLEAIR, FLA..

**Belleview Biltmore**

A. S. KIRKBY, *Managing Director*

**KIRKBY HOTELS**

### WHEN YOU CHANGE YOUR ADDRESS

Be sure to notify the Subscription Department of COMMUNICATIONS at 19 E. Forty-seventh St., New York City, giving the old as well as the new address, and do this at least four weeks in advance. The Post Office Department does not forward magazines unless you pay additional postage, and we cannot duplicate copies mailed to the old address. We ask your cooperation.

WITH THE  
G-R TYPE 775-A  
FREQUENCY-LIMIT  
MONITOR



*for High Frequency Monitoring in*  
RELAY  
INTERNATIONAL  
FACSIMILE  
EXPERIMENTAL  
POLICE  
BROADCASTING  
FREQUENCY MODULATION  
TELEVISION\*

*and other services operating between  
1,500 kc and 45 Mc\**

MEET THE  
F.C.C. FREQUENCY  
MONITORING  
RULES

Use of this simple-to-operate, easily installed monitor insures compliance with F.C.C. regulations for Police and High-Frequency Broadcast stations.

FEATURES

- Visual indication of deviation outside legal allowance
- Warning lamps light if transmitter deviates, and shows direction of deviation
- Easier to watch than continuously-indicating type of instrument
- No subsequent adjustments needed after installation
- Simple to use . . . lamps out, frequency OK; one lamp lighted, frequency off
- Can be used on one to four channels, selected by panel switch
- Very compact, requires only 7 inches of relay-rack space
- Entirely a-c operated from built-in supply

TYPE 775-A FREQUENCY-LIMIT MONITOR . . . . . \$240.00  
TYPE 376-M QUARTZ PLATES (one required for each channel) . . . . . \$50.00

When ordering, please specify carrier frequency; tolerance; whether frequency deviation limit is 100 to 1,000 cycles or 500 to 3,000 cycles or whether aural monitoring is to be used.

*\*Although this instrument is designed for operation only up to 45 Mc, with care it can be used at frequencies between 45 and 108 Mc.*

● WRITE FOR BULLETIN 646 FOR COMPLETE DATA

**GENERAL RADIO COMPANY**

**CAMBRIDGE, MASS.**

**Branches: New York and Los Angeles**

# For stations at the TOP!

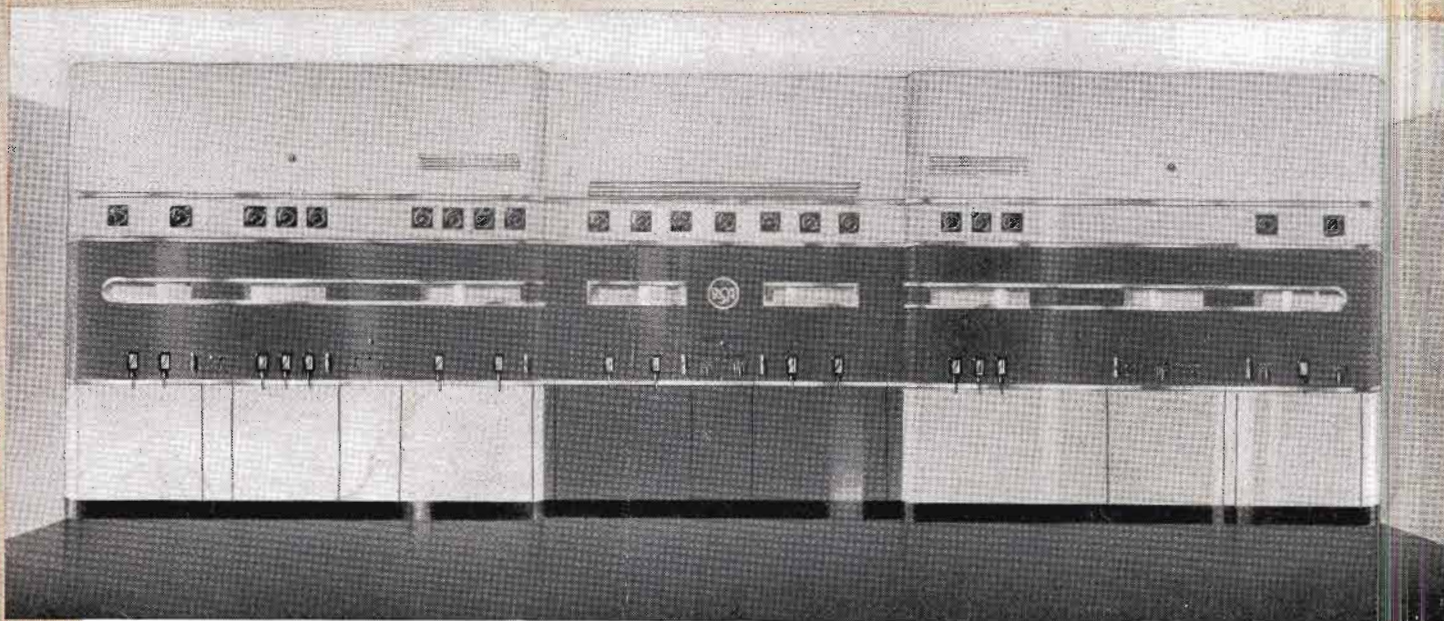

## RCA 50,000 Watt Broadcast Transmitter

**Model 50-E...Top Performance...Efficiency...Economy!**

**Y**OUR NEW 50,000-WATT TRANSMITTER is perhaps the most important investment your station will ever be called on to make! Choose wisely and your operating costs will be lower—your performance finer, more trouble-free. Choose wisely and we believe you'll choose RCA. Here are a few of the reasons why:

The new RCA Model 50-E Transmitter offers you lower installation costs because it takes up only 278 square feet of space—requires a much *smaller* building to house it. Airstream-cooled throughout, it saves you the cost of water coolers and tanks, water pipes and pumps and associated equipment. RCA-engineered high level Class B Modulation requires lower current consumption—the 50-E draws only 115 kilowatts from your power line at average program modulation! The exciter is capable of operation as a complete 5 kw. Transmitter at a second's notice—eliminating a separate stand-by transmitter.

Unified front panel construction gives finer appearance, cleaner design, easier installation... and permits either straight-line or "folded" layout for your requirements, without extra work or extra cost. It's particularly adaptable to modern buildings.

See exhibit of all RCA services... including Television... at RCA Building, New York World's Fair—and Golden Gate Exposition, San Francisco.

- ★ Unified Front Panel Construction
- ★ High Level, Class B Modulation
- ★ Air-Cooled Operation Throughout
- ★ Small Floor Space Requirements
- ★ 5 Kw. Stand-By Service
- ★ Lower Operating Costs
- ★ Higher-Fidelity Performance

Use RCA Radio Tubes in your Station for Finer Performance.



# Broadcast Equipment

RCA Manufacturing Co., Inc., Camden, N. J. • A Service of the Radio Corporation of America

