

COMMUNICATIONS

including
**TELEVISION
ENGINEERING**

MAY
1939

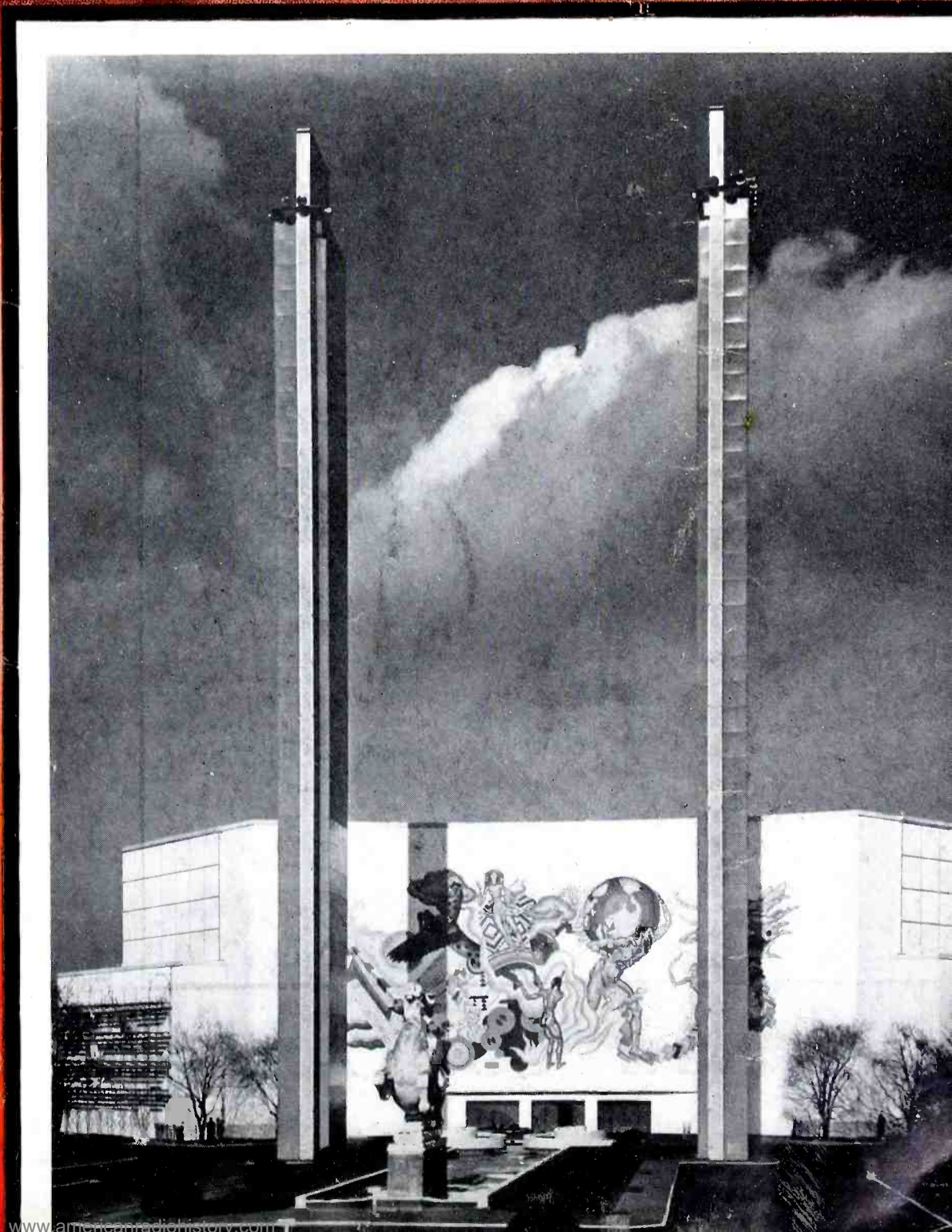



AMPEREX

High and Ultra-High FREQUENCY TUBES

The imminence of commercial television, the launching of Frequency modulation and the development of beam landing systems has sharpened interest in High and Ultra-High Frequency tubes.

AMPEREX for many years has held a dominant position in the high frequency vacuum tube field. Its designs have been closely followed by many reputable tube manufacturers and its products have received general acceptance. In fact, most ultra-short wave generators used by the medical profession, as well as a majority of the new airplane beacon stations are equipped with AMPEREX tubes.

The AMPEREX line of Ultra-High Frequency tubes comprises diversified types of both air and water cooled tubes, ranging in power output from 50 to 5,000 watts, and in frequency from 30 to 100 megacycles. Some of the air cooled types are shown here.

Visit our display at the N. A. B. Convention in Atlantic City, July 10-13, Ambassador Hotel

AMPEREX ELECTRONIC PRODUCTS, Inc.

79 WASHINGTON STREET

www.americanradiohistory.com

BROOKLYN, NEW YORK



More than
Just a GOOD
Condenser

Backed by a Great Plant

AEROVOX production once again is in full swing. The new plant, owned outright by AEROVOX, is four times larger than former Brooklyn plant

which ranked among industry's largest. So AEROVOX, better than ever before, can meet your requirements.

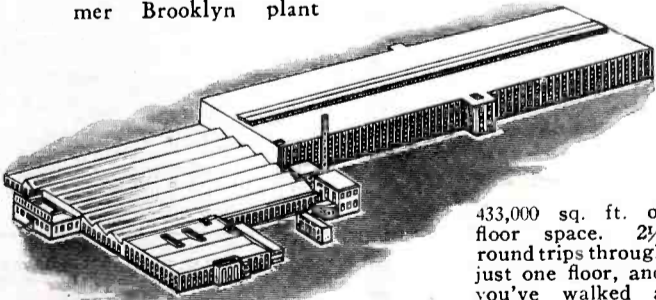

433,000 sq. ft. of floor space. 2½ round trips through just one floor, and you've walked a full mile!

SINCE the best condenser can be the poorest condenser in use, if improperly applied, AEROVOX offers A.A.E.* service to radio-set, sound-system, electronic-equipment and other manufacturers who cannot risk condenser failures, yet seek reasonable economies.

Instead of merely selling condensers, AEROVOX prefers to sell a *satisfactory* and *economical* condenser application. Over a century of total condenser-application experiences possessed by AEROVOX sales engineers can be drawn upon in assuring you of the lowest-cost assembly consistent with a safe performance.

*Aerovox Application Engineering

Submit Your Problem . . .

Tell us the results you desire. Our engineers will collaborate in evolving the best assembly consistent with economy. Be sure you have our catalog in your working library.

AEROVOX CORPORATION
New Bedford, Mass.

Sales Offices in All Principal Cities

RAY D. RETTENMEYER

Editor

• Editorial Comment •

THE Federal Communications Commission's Television Committee, composed of Commissioners Craven, Brown and Case, have just completed a tour of the various television laboratories in an effort to determine the present status of the art. It is expected that their findings will soon be announced.

At the present time there are at least two applications before the Commission "for the purpose of developing television broadcasting as a service to the public". Industry standards were submitted to the FCC some time ago by the RMA, and television receivers are now on the market.

In view of the foregoing and the fact that considerable experimental development work has been done on television by organizations who can only lose by a premature announcement of receivers, we sincerely hope that the FCC will see fit to grant commercial television broadcasting licenses. We believe that the industry and the public would stand to gain from such a decision. Certainly the broadcasters cannot be expected to long maintain costly experimental operation without any financial return for their efforts.

THE National Convention of the Institute of Radio Engineers will be held in San Francisco, California, on June 27, 28, 29 and 30. An interesting program of technical papers has been prepared and a number of inspection trips will be held. Additional information will appear in a later issue of COMMUNICATIONS.

TELEVISION demonstrations have been proving extremely popular at both the New York and the San Francisco Fairs. Those who are viewing television for the first time seem favorably impressed with the quality of the pictures received.

MUCH has been said concerning the entertainment aspects of television, but little emphasis has been placed on its educational value. The educational possibilities of this medium are numerous, and undoubtedly will receive a great deal of attention as the art progresses.

• Contents •

COVER ILLUSTRATION

The Hall of Communications at the New York World's Fair, 1939.
See article on page 5.

- 5 RADIO AT THE FAIR By J. G. Sperling
- 9 RECEIVER CHARACTERISTICS OF SPECIAL SIGNIFICANCE TO BROADCASTERS By Dudley E. Foster
- 14 NEW HIGH FIDELITY RECEIVER
By L. G. Pacent and H. C. Likel
- 16 AMPLIFIER BAND-WIDTH SIMILITUDE PRINCIPLES
By Simon Ramo
- 17 TELEVISION LIGHTING—Part I By W. C. Eddy
- 20 TELEVISION ECONOMICS—Part IV
By Dr. Alfred N. Goldsmith
- 26 THE FUNDAMENTALS OF TELEVISION ENGINEERING—Part II, The Necessity for Wide Frequency Bands
By F. Alton Everest
- 28 SOUND MOTION PICTURE FILMS IN TELEVISION—Part I
By John A. Maurer
- 29 VETERAN WIRELESS OPERATORS ASSOCIATION NEWS
- 31 COMMUNICATION INSTRUMENT PURCHASING DIRECTORY
- 40 THE MARKET PLACE
- 44 INDEX OF ADVERTISERS

Copyright 1939, Bryan Davis Publishing Co., Inc.

BRYAN S. DAVIS
President

JAMES A. WALKER
Secretary

Chicago Office—608 S. Dearborn Street

Telephone: Wabash 1903

Published Monthly by the

BRYAN DAVIS PUBLISHING CO., Inc.

19 East 47th Street

New York City

New York Telephone: PLaza 3-0483



Wellington, New Zealand—Te Aro Book Depot
Melbourne, Australia—McGill's Agency

SANFORD R. COWAN
Manager

PAUL S. WEIL
Advertising Manager

A. GOEBEL
Circulation Manager

Entered as second class matter October 1, 1937, at the Post Office at New York, N. Y., under the act of March 3, 1879. Yearly subscription rate: \$2.00 in the United States and Canada, \$3.00 in foreign countries. Single copies: twenty-five cents in United States and Canada, thirty-five cents in foreign countries.

PRESTO ANNOUNCES THEIR NEW 8-A COMMERCIAL RECORDING TURNTABLE

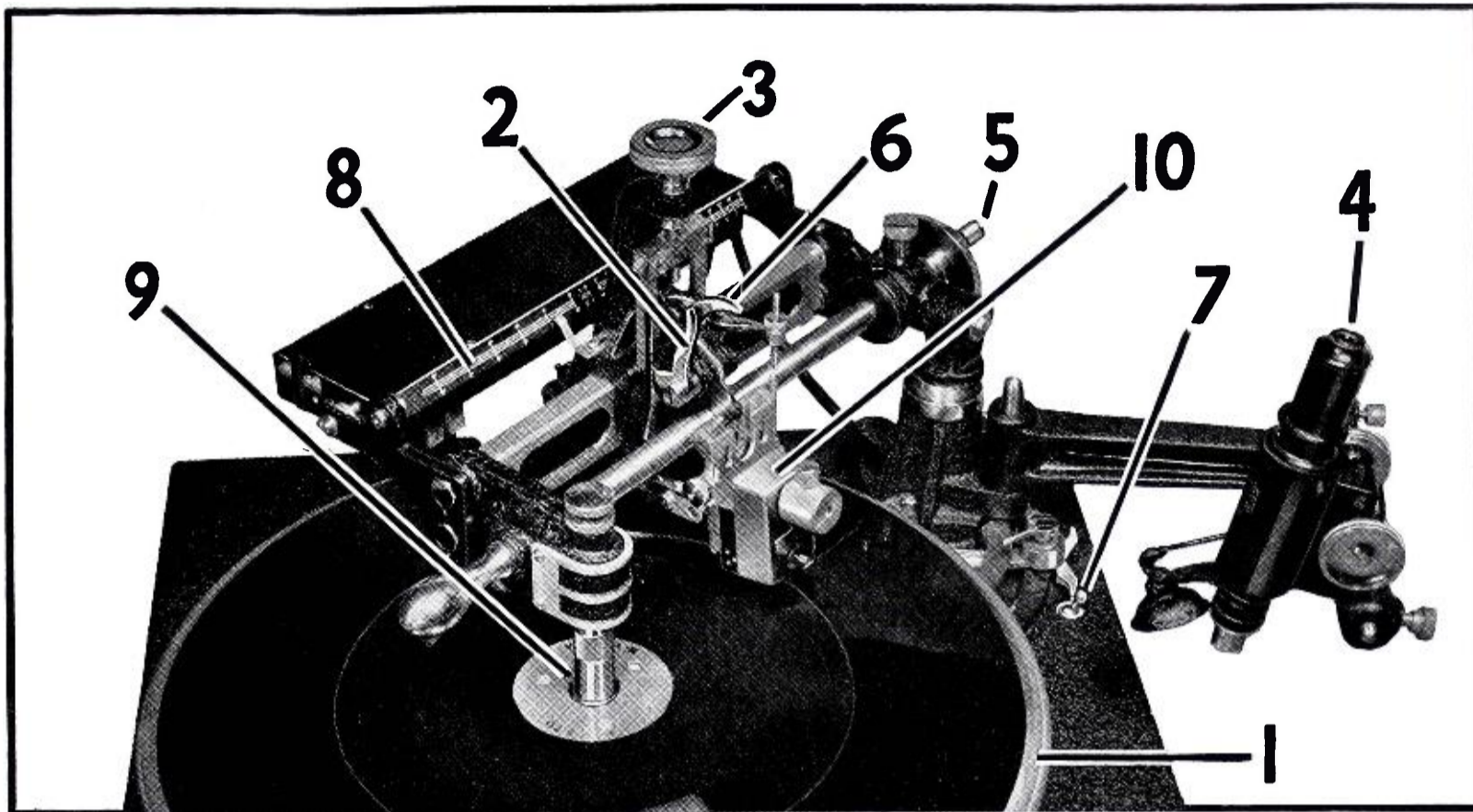

WITH 15 ORIGINAL AND IMPROVED OPERATING FEATURES

1. Rim driven turntable, originated by Presto, now adopted by every manufacturer of instantaneous recording equipment.
2. Cam lever lowers cutting head gently, prevents damage to sapphire needles.
3. Thumbscrew rapidly adjusts angle of needle while cutting.
4. Forty-power microscope for examining cut.
5. Spiralling feed screw makes starting and run-out grooves.
6. Lever engages cutter carriage with feed screw.

7. Combination speed change and motor switch lever prevents flats on idler wheels.

8. Four-sided, rotating scale shows recording time at 96, 112, 120 and 140 lines per inch at 78 and 33 $\frac{1}{3}$ RPM.

9. Flangeless drive permits quick removal of shavings.

10. Improved high fidelity cutter records uniformly a frequency range from 40 to 8,000 cycles and gives 4 db higher playback level.

11. New, vibrationless motor.

12. Shockproof mountings suppress vibration from outside sources.

13. Vertical damper suppresses transient modulation, eliminates flutter, prevents patterns due to vibration or surface irregularity in discs.

14. Sixty-pound cast iron base assures permanent alignment of turntable and cutting mechanism.

15. Automatic equalizer assures full frequency response range throughout 33 $\frac{1}{3}$ RPM recordings.

Mounting dimensions of the new Presto 8-A recorder are the same as the Presto 6-C and 6-D portable recorders. A liberal trade-in allowance will be made to radio stations and studios that wish to bring their recording facilities up to date. In writing give type and serial number of your present turntables.

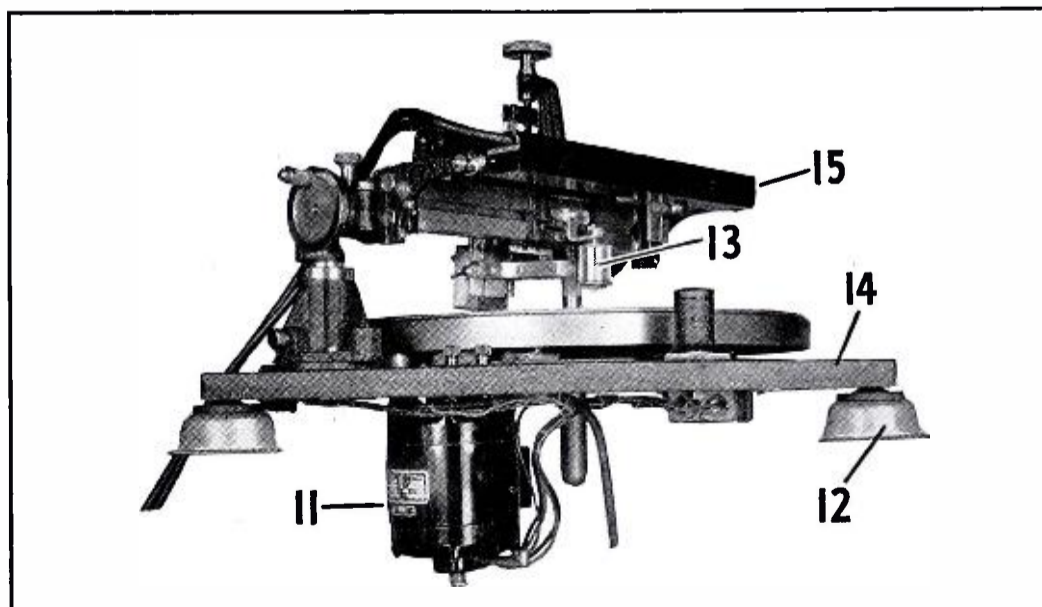

PRESTO
RECORDING CORPORATION 242 West 55th Street, New York, N. Y.



The Mighty 1939 Radio Parts Industry Show

It's your show . . . this year more than ever! . . . A mighty gathering of the Radio Parts Industry . . . planned for you and streamlined for action . . . up and down the streets of Radio Parts City and its exhibits.

Two days will be devoted to Jobbers—and two days to Servicemen, Retailers, Amateurs and others in the trade . . . insuring fullest attention and maximum benefit for each of you.

JOBBER DAYS . . . Wednesday, June 14 and Thursday, June 15. In cooperation with all branches of the Industry, these two days will be devoted to jobbers only.

SERVICEMEN DAYS . . . Friday, June 16 and Saturday, June 17. The Convention of the Radio Servicemen of America will open on Friday, June 16—with special lectures, meetings, and exhibits of new parts and apparatus for the Servicemen.

AMATEUR DAY . . . Saturday, June 17. This will be a big day for all the Hams. There'll be new Ham Gear to see, new developments to discuss with factory men, engineers, and fellow-hams. Booths manned by technical men on Servicemen and Amateur Days.

NEW PRODUCTS . . . NEW IDEAS . . . NEW EXHIBITS

It's your one and only opportunity of the year to meet the complete Parts Industry—face to face . . . to make personal contacts with Manufacturers, Jobbers, Engineers, Sound Specialists, Servicemen and Amateurs—from all parts of the world . . . to see all the very latest developments in Parts and Apparatus, Public Address, Ham Gear . . . and get valuable ideas you can use in your own field.

IT PAYS TO ATTEND THE TRADE SHOW
This is your Annual Homecoming. You owe it to yourself to come. Make your plans now—and don't let anything stop you!

Stevens Hotel-Chicago

1939 JUNE 1939			
WED	THU	FRI	SAT
14	15	16	17
OPEN these two days to Jobbers, Manufacturers, Manufacturers' Agents, and Manufacturers' Engineers only.		OPEN on these two days to Servicemen, Amateurs, Retailers, Students and others in the trade.	



National Radio Parts Trade Show

Sponsored by Radio Manufacturers Association and Sales Managers Club
★Executive Office—53 West Jackson Boulevard, Chicago, Illinois

COMMUNICATIONS

FOR MAY, 1939

RADIO AT THE FAIR

By J. G. SPERLING

THE New York World's Fair 1939 will have within its 1216½ acre site the most complete facilities for public-address system operation, sound broadcasting, and television transmission ever set up for a semi-permanent project.

The Fair Public-Address Center is located in the Communications Building, a gigantic structure situated in the center of the group of buildings devoted to the communications art (see front cover). The Center consists of four studios, control rooms and a large master control room. The entire center is enclosed in glass so that it will also serve as a functioning exhibit.

Studios A and B are intended for the presentation of live shows and have associated control rooms. Studio A, the largest in the Center, is 32 feet long, 18½ feet wide and has a 15-foot ceiling, and is intended for the presentation of live orchestral shows. Studio B is a speaker's studio and is furnished

A description of the communications system and interesting exhibits at the New York World's Fair.—Editor.

to appear as a man's study. It is 13 feet square with a 15-foot ceiling.

The other studios C and D respectively are identical in size and equipment. They measure 7'3" x 10'6" with a 10-foot ceiling. Recordings and piped-in programs will be transmitted from here.

All equipment within the Public-Address Center are of RCA manufacture. The control rooms of Studios A and B are equipped with the new RCA self-contained console tables containing pre-, line- and talk-back amplifiers, mixer board and switching facilities in one

Showing the loudspeaker system installed at the base of the Perisphere.

unit. Provisions are provided for the control of three microphones, remote or nemo telephone pick-up circuits and two transcription turntable inputs. The consoles in studios C and D are also identical. Each console has provisions for the following inputs: two transcription turntables, one microphone, two remote telephone lines (RL's) and one radio receiver. Standard control and monitoring facilities are provided. Each console has provisions for two separate channel outputs, in conformity with standard practice.

The master-control room is the focal point of the entire Center not only from the technical standpoint but from an exhibitional view. This unit contains all the operation controls for the program selection, control and distribution to the p-a system and to several radio-program circuits. There are five panels on the console, each controlling a separate function, namely, program selec-

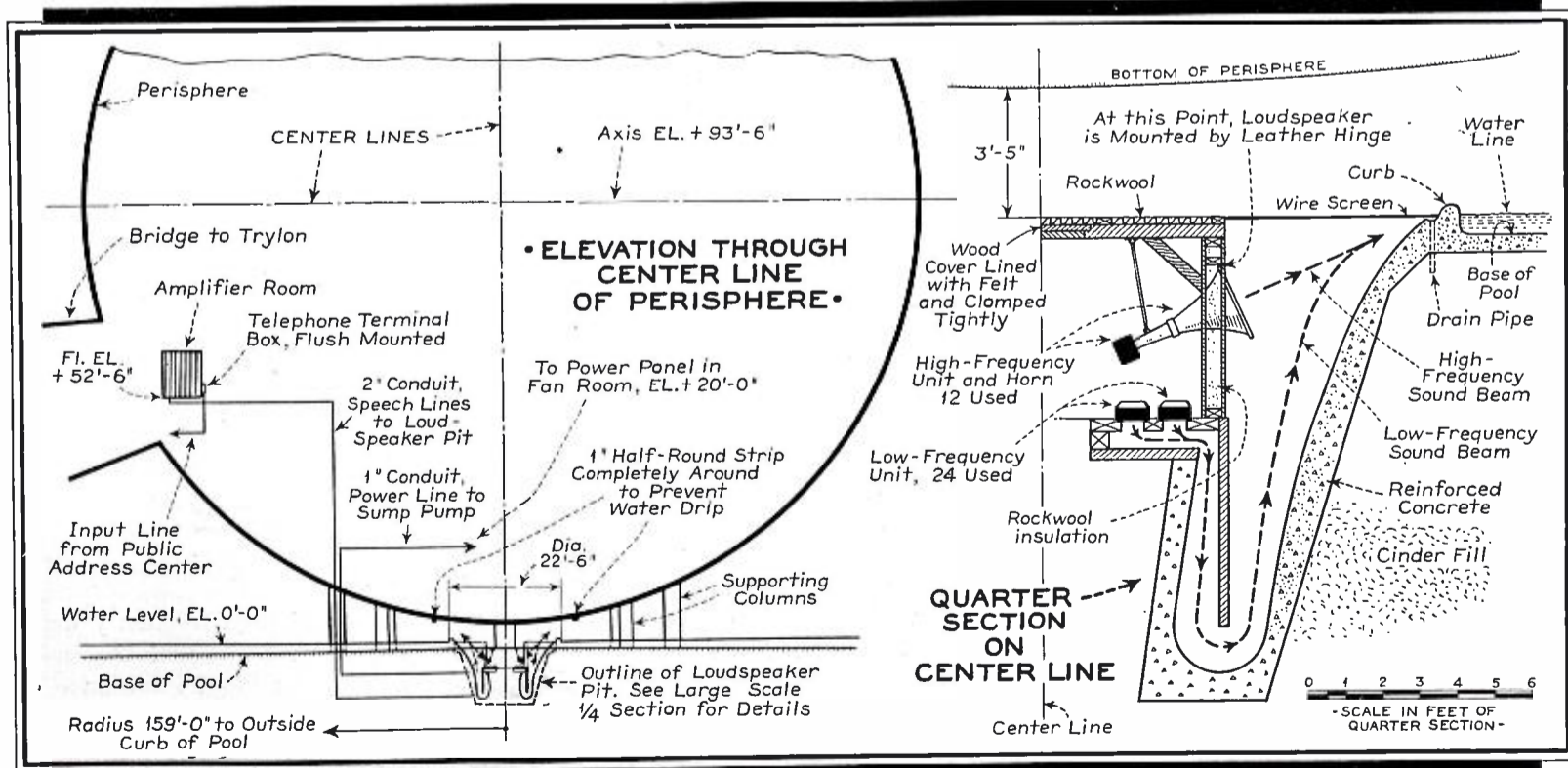

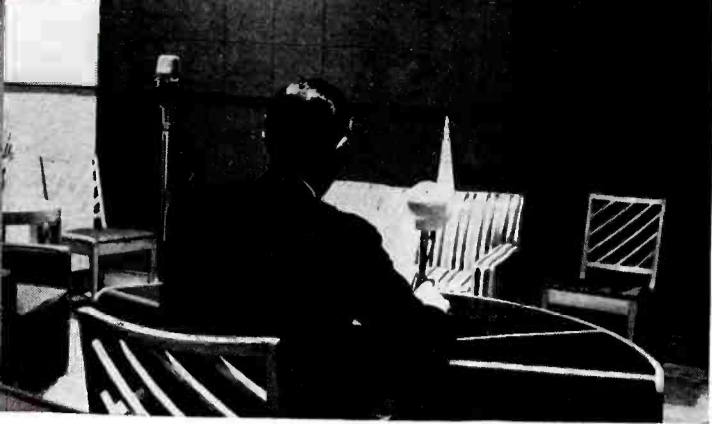

Left: Studio B located in Communications Building at the New York World's Fair. Note the Trylon-Perisphere mike.

Below: A 20-ton multi-voiced sound reproducer which, with its moving speaker system, guides visitors touring the General Motors exhibit. Photo from Electrical Research Products, Inc.

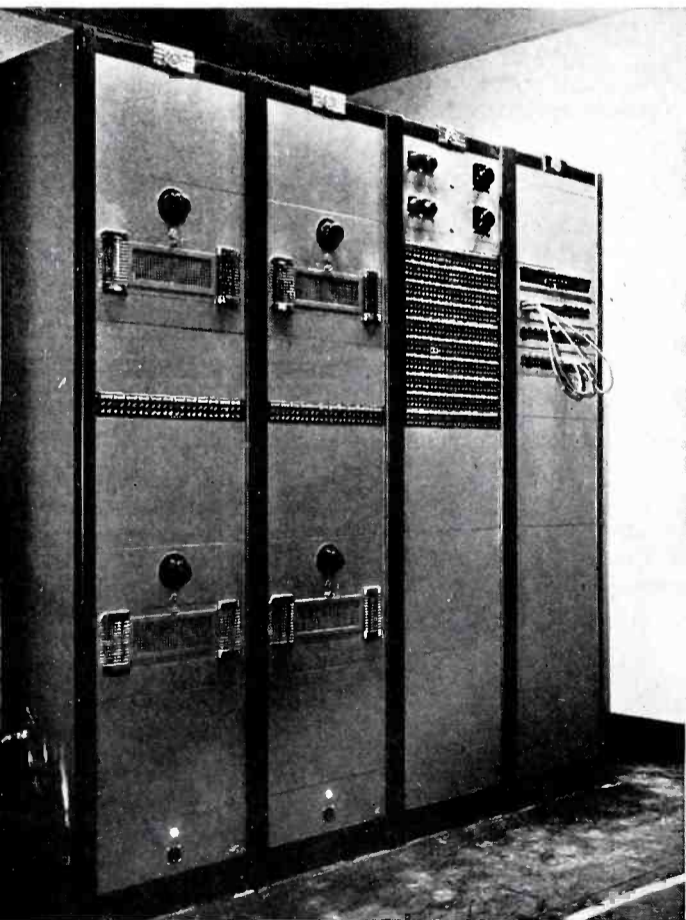
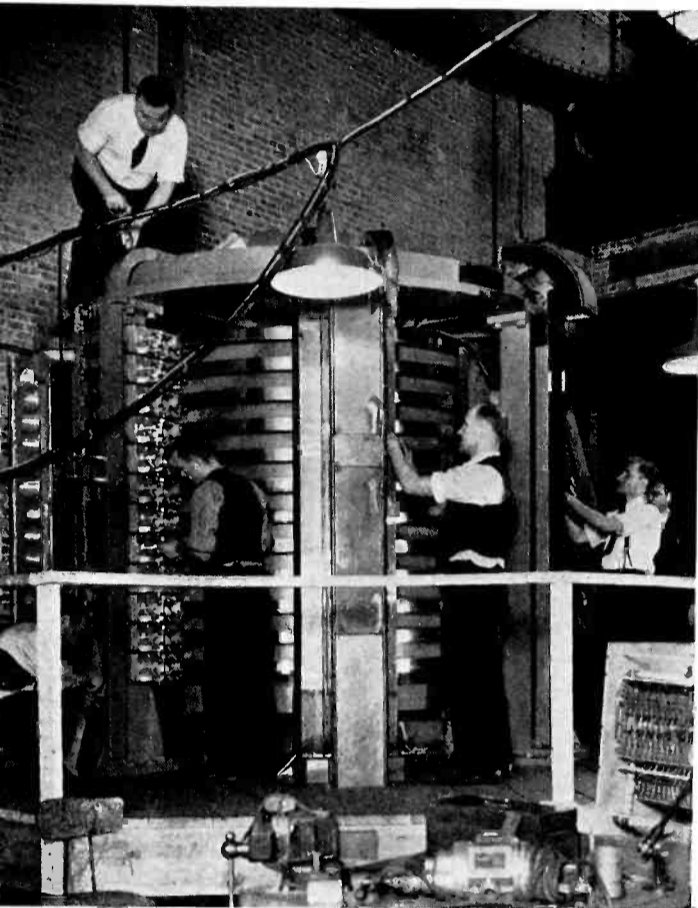

tion, program control, program distribution panel, secondary program distribution, and an order wire (PL) board.

The program-selector panel is identical in many respects to that contained in the master control console initially built for WMCA and now carried as a standard RCA item. This unit contains controls and indicators for an automatic pre-set relay system which permits independent switching to any of six program channels or ten console input lines. The ten console lines terminate in jacks on the main patchboard. The relay system is so designed that a de-



Playing marimba with light beams at Westinghouse exhibit. Hammers are operated by relays energized by photocells.

sired input line may be pre-set on the controls prior to the actual switching operation without disturbing a previous input line which may still be in use. The pre-setting and switching operations are independent of the incoming lines or channels. The master key provides for changeover of several channels simultaneously, except that any or all channels may be exempted from control by operation of the master key by means of a lock-out key for each channel. "On" indicator lamps show on which line each output channel is operating, while the "Pre-Set" indicator lamps show which lines are pre-set.

The program-control panel contains controls and volume indicators for the six outgoing program channels. Each of these channels is of the bridging type, providing individual means for amplification, level control, level indication and monitoring. The busses of four channels may be used to feed any combination of 50 p-a lines. These lines serve the various public-address outlet stations at the Fair. Each of the pro-

This is the main RCA patchboard and line equalizing units of the Fair's p-a system.

gram lines has a 4-point selector switch for connecting it to any of the four available channels. The outputs of channels 5 and 6 each feed two radio program jacks, located on the main patch-board, at zero level. Four monitor busses are installed, one for each of the first four channels. Six volume-indicator meters show the output level on each channel. At the top of the program control panel, located in the center of the console, a 9-inch cathode-ray tube gives visual indication of the signal on any one of the half-dozen channels selected.

The program-distribution panels control the level and a-c power to any of the fifty remote p-a outlets. A switch operates a relay installed at the p-a

outlets, controlling the a-c to the equipment at these points.

The order-wire panel has provisions for the operation of six incoming order (PL) lines. The main patch board has all incoming lines terminated here. Also located here are two equalizers.

Each of the p-a outlets consists of a loudspeaker system and an amplifying system. All equipment necessary for the operation of the outlets, except that of the loudspeaker system, is installed in the cabinet housing the power amplifiers. A typical outlet embodies two cube loudspeakers driven by four 50-watt amplifiers. The amplifying system consists of four power amplifiers with a single volume speaker used to vary the level of both speakers.

The new cube loudspeaker measures 36 inches on each side and contains separate low- and high-frequency driving units and an associated crossover network having an input impedance of fifteen ohms. Both units are of the permanent-magnet type.

The most unusual feature of the Fair's

sound system lies in the fact that the outer surface of a building is being used as a giant exponential horn. The mouth of the horn is formed by the outer curving surface of the 200-foot Perisphere and the flat surface of the 320-foot pool of water beneath the giant globe. In effect this "horn" provides an unprecedented sound coverage around a horizontal angle of 360 degrees. It is capable of producing $2\frac{1}{2}$ bars of sound pressure at 20 cycles per second at the edge of the pool. The "horn" works from a throat and driving mechanism especially designed and located beneath the Perisphere in an acoustical pit, 12 feet deep and 22 feet in diameter. This is the first exponential reflex horn ever constructed from concrete and planking. Mounted on a wooden baffle erected in this sound chamber are 24 100-watt low-frequency horns, and 12 25-watt high-frequency horns.

Pointed downwards, the low-frequency horns project their sound into the bottom of the pit. From this point

An RCA single-control console with a dual-channel output is installed in studios C and D of the Fair's p-a system.

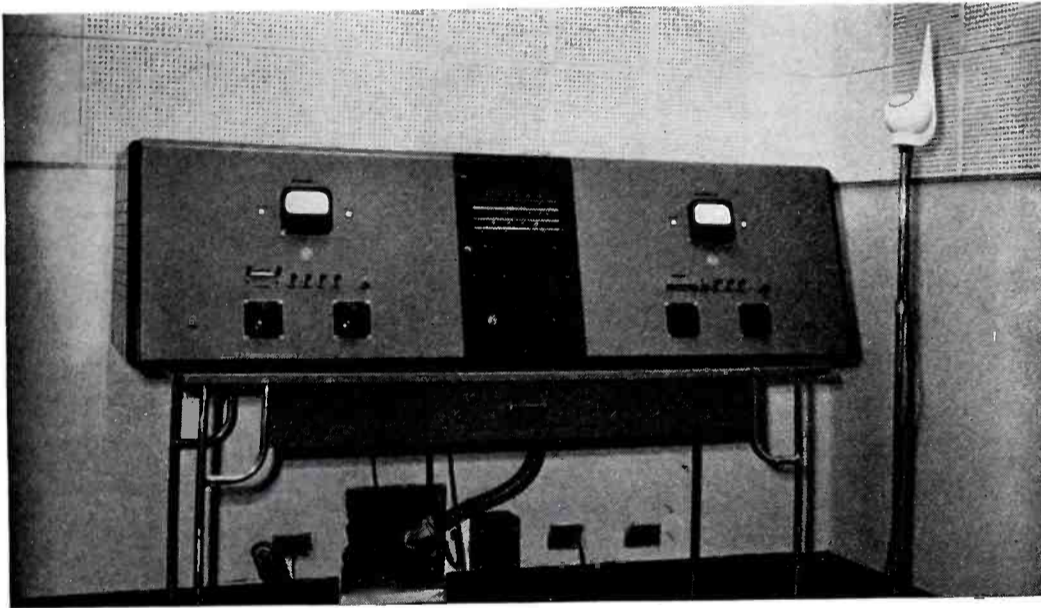

the waves are deflected up and outwards, mingling with the high-frequency waves at a middle point in space between the bottom of the Perisphere and the top of the grille which covers the pit. The high-frequency horns face directly outwards and emit waves at a tangent to the sphere's curve. The illusion this produces as the sound is sprayed out in every direction is that of sound originating in space without any apparent source, as the grille on the pit is so constructed as to simulate the appearance of the surrounding water-surface.

The sound-reinforcement system located at the "Lagoon Of Nations" is second only in size to that at the Perisphere. A huge sound projector has been installed in four circular struc-

The antenna at the RCA exhibit. Note the television array at the top.

tures located two on each side of the center fountain ring. The four elements taken together are equivalent to a horn with a mouth opening 30 feet square. There are eight acoustic couplers, each of which is comprised of a separate low-register, or bass, and high-register, or treble, element. The huge bass loudspeaker is actuated by eight 125-watt loudspeaker units with 24-inch diameter diaphragms and field magnets weighing 500 pounds each. The treble units are smaller but handle an equivalent amount of electric energy. Separate amplifiers are used to drive the units of the two registers. The four elements of the sound projector and associated amplifiers are so arranged that the distribution is stereophonic. This presentation is the first known example of acoustic perspective or stereophonic distribution outdoors in four directions, or over a 360 degree area. The microphones and amplifiers are arranged in two or four distinct channels. The listener hears the electrically transferred music of the band exactly as if the band itself were

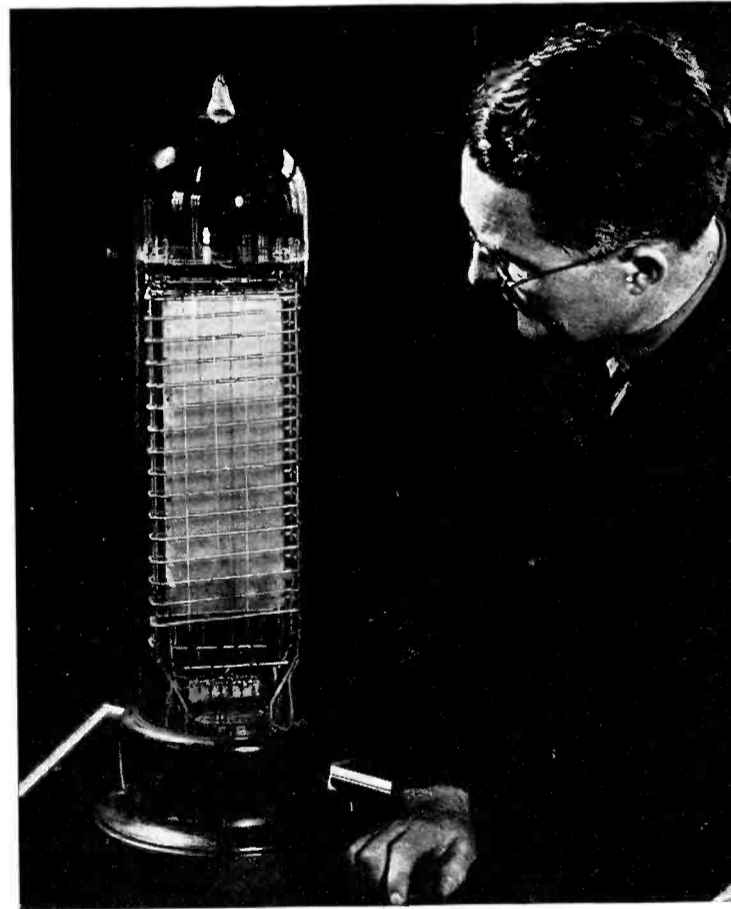
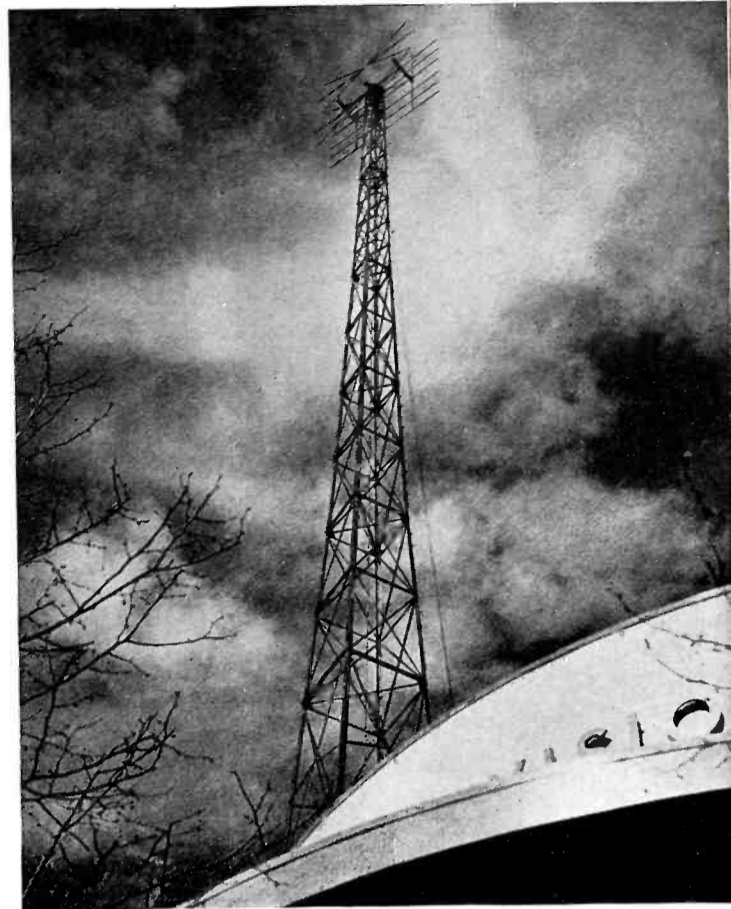

A 27-in. triode built by Westinghouse to demonstrate, at the New York World's Fair, how a stream of electrons is affected by a magnetic field.

present and the relative locations of the various instruments is plainly discernible because of the special effect peculiar to stereophonic reproduction.

The amplifiers and control desk for the "Lagoon of Nations" is located in a room atop one of the Government Buildings located near the Lagoon. Four 500-watt amplifiers are located here. Each amplifier is composed of two separate output amplifiers, a bass and a treble. A radio receiver and two synchronized studio-type turntables and associated lateral and vertical pick-ups are built into the control desk where eight mixers and four master-gain controls with volume-level indicators are

The master control console located in the Communications building.

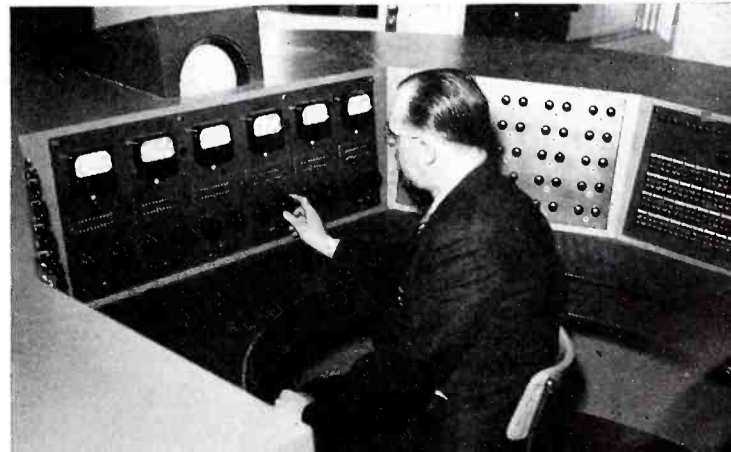

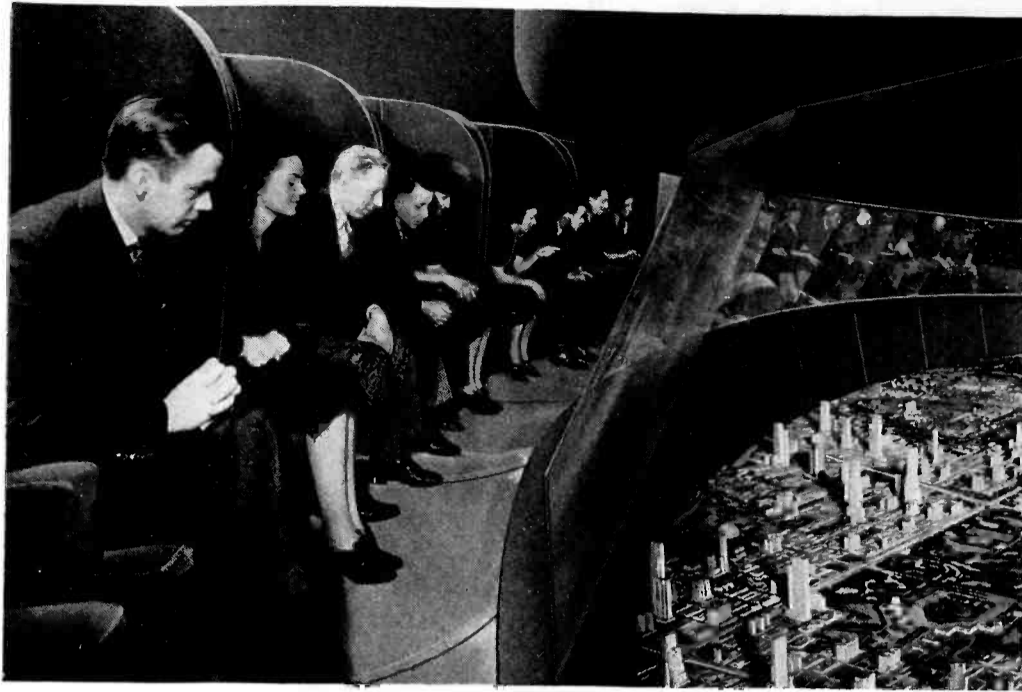

Visitors of General Motors exhibit viewing world of tomorrow from moving sound chairs. See sound reproducer, p. 6. ERPI photo.

located. The master-gain controls are interlocked so that they may be operated as a unit or in two groups of two each. This provision makes possible the production of echo and antiphonal musical effects in the area surrounding the "Lagoon Of Nations."

Next in size to the facilities provided by the World's Fair Administration is the radio set-up provided by the municipal, non-commercial, radio station of the City of New York—WNYC. This station will have complete studio facilities in the New York City Building. There are four studios and a master-control room. The largest studio is of auditorium size, seating over 200. Next come two studios, 18' x 25', and a small speaker studio 10' x 10'. RCA equipment is used throughout. In addition, provision has been made for employing the Mayor's office as a studio if the occasion arises. The various control rooms employ the console control units, models 80-B, and 80-AX. Complete short-wave equipment is available for picking up remote points about the fair grounds. A 50-watt relay broadcast transmitter operating on 1622 kc is mounted in the master-control room. In addition there are also two pack transmitters operating on 2058 kc and 2190 kc, with appropriate receivers in "Master." On the opening days of the Fair there were available (and used) 13 remote lines to various points about the Fair grounds. As many as three separate programs can be sent out from the WNYC studios at the Fair, simultaneously.

The Crosley Corporation will maintain a studio in its own building in the Communications zone for its station WLW. Some of the programs emanating there will go to its own transmit-

A view looking into the General Electric television studio at the New York World's Fair.

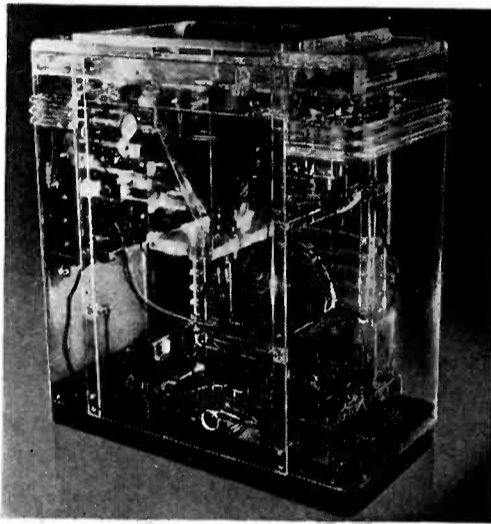

Above: This "phantom" instrument is an exact duplicate of the RCA television receivers except that its cabinet is built of a transparent plastic material. Note two television chassis and all-wave radio chassis.

ter and some will go to the Mutual and NBC networks.

The Columbia Broadcasting System, the National Broadcasting Company and Mutual Broadcasting System will not have any studios at the Fair but will have an extensive web of remote lines about the Fair grounds.

Television made its official bow to the public with the opening of the New York World's Fair. NBC is the only broadcaster in the New York Metropolitan area. The CBS television studios and transmitter will be finished shortly and will start television transmissions in the near future. NBC uses its portable television transmitter for its remote pick-ups. During the opening ceremonies at the Fair the NBC television camera was mounted alongside of the news-reel men and highly successful shots were secured and transmitted.

Television will be shown by many exhibitors at the Fair. Among them will be RCA, General Electric, Westinghouse and Ford.

RCA will demonstrate the theory and practice of television in their "radio tube" building. Among the exhibits will be a television laboratory, Hall of Television, Radio Living Room of Tomorrow, Television camera set-up and model transmitter. Thirteen television receivers will be in operation as well as a projection type receiver which will focus on a six- by ten-foot screen.

General Electric Company will have a studio in their building so that the visitors may not only see television in
(Continued on page 30)



Of Special Significance to Broadcasters

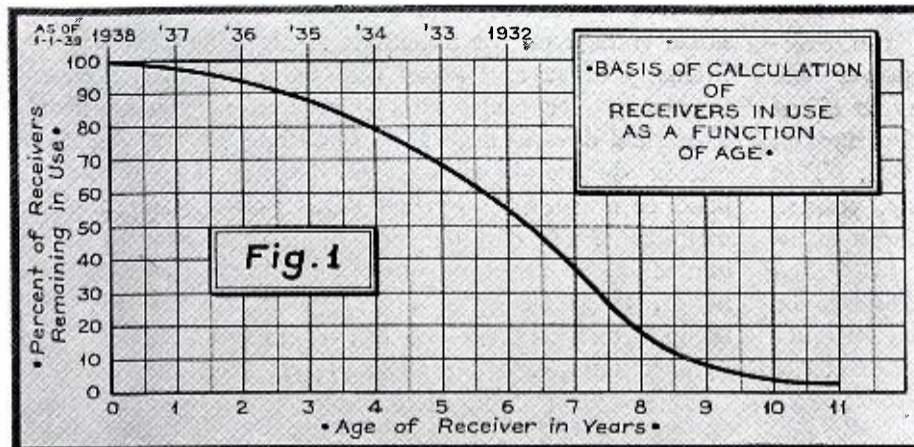

THE broadcaster is interested in the receiver as the outlet for his program. Broadcasting is a system of which the two interdependent and essential parts are transmitter and receiver. What special characteristics of the receiver are of primary interest to the broadcaster? He wants to know how many receivers can receive his programs. The number which will be tuned to his station depends upon how "good" the program is and what other stations are available to the listener. Not only what other program content, but how free programs are from interference.

The first thing of interest is the quantity of receivers in use, the total quantity regardless of where they are located, and what their characteristics are.

It is number of receivers rather than number of homes which count primarily. Without auto receivers the time spent in driving would not be devoted to listening. The second set or third set in a home would not be purchased if there were not a demand for additional receiving facilities. True, each additional receiver in a home has a smaller audience per receiver, but a larger total.

The quantity of receivers in use, is as follows:

AS OF JANUARY 1st, 1939		
Year of Mfr.	No. Mfd.	No. in Use
Before 1932....	22,432,000	2,240,000
1932....	2,444,000	1,340,000
1933....	4,157,000	2,920,000
1934....	4,556,000	3,660,000
1935....	6,026,000	5,240,000
1936....	8,000,000	7,520,000
1937....	7,000,000	6,860,000
1938....	6,000,000	6,000,000
	60,615,000	35,780,000

The basis on which the receiver obsolescence has been calculated is shown in Fig. 1.

SENSITIVITY

Receiver sensitivity was a primary consideration in the early days of broadcasting and every effort was made to obtain the highest possible sensitivity. With present-day high-transconductance tubes and with the superheterodyne circuit, receivers of any desired sensitivity can be made. The practical limit of sensitivity is due to noise both internal and external.

Internal receiver noise is due to thermal agitation in the antenna input circuit and to shot noise originating in the amplifier tubes. This noise sets a limit to the sensitivity beyond which it is useless to go, any further increase in receiver amplification would increase noise and signal together, their ratio remaining unchanged. In broadcast receivers for home use there is little or no advantage in adding to the cost of the receiver in order to secure the best possible signal-to-noise ratio, because in many localities external noise is a more serious factor. In automobile receivers much attention is paid to obtaining good signal-to-noise ratio because that type of receiver must operate with an antenna of small effective height and consequently with little input signal in a great many cases. For that reason automobile sets are designed with a high antenna-stage gain as possible, and most of them use a stage of radio-frequency amplification also. High antenna-stage gain means that the signal is amplified as much as possible before being applied to a thermionic tube which can introduce shot noise. A stage of radio-frequency amplification aids signal-to-noise ratio because it produces additional amplification of the signal before reaching the

converter (first detector) and the ratio of conversion conductance to plate current is less on converters than in tubes operating as amplifiers (about one-quarter to one-third as much).

Since shot noise varies as the square root of the plate current, it can be seen that it is desirable to keep the ratio of transconductance to plate current large.

The amount of noise voltage appearing in the output of the receiver is proportional to the square root of the frequency band width, the effective width being governed by both selectivity and audio pass band. The usual measure of receiver noise is the equivalent noise-sideband input, which is obtained by measuring the output with and without modulation on a given small carrier input. It is the single-sideband input voltage equivalent to the noise produced in the receiver. In automobile receivers the equivalent noise-sideband input voltage may be as low as 0.1 or 0.2 μv while in home receivers it is usually of the order of 1 μv . Signals of the order of ten times the noise value are necessary for satisfactory broadcast reception, so that it can be seen that automobile receivers need not be more sensitive than 1 or 2 μv and home receivers need not be more sensitive than about 10 μv .

This paper was presented before the Second Annual Broadcast Engineering Conference which was held at the Ohio State University, Columbus, Ohio, from February 6 through 17, 1939.

The practical sensitivity limit due to external noise is more difficult to evaluate since external noise is essentially a local factor, that is, it is caused by electrical disturbances in the immediate vicinity. Comparatively few data have been gathered concerning the noise field to be expected in various localities, but it is known that household electric appliances generate radio-frequency voltages across the power line which vary from about 100 μ v to about 20 mv (the higher values being typical of electric razors, for example). This value is the radio-frequency voltage across the power line and there is an additional factor, the "coupling" between the a-c line and the antenna or lead-in which must be taken into account to obtain the noise voltage at the antenna. This coupling factor varies with the type and location of the antenna and with the type of house wir-

ing. The factor is best (most attenuation) with conduit wiring and a doublet antenna with transmission-line lead-in, and is poorest with open wiring and an indoor antenna. In a typical case the attenuation is about 20 db, and if we consider a typical electrical device to have 1 mv of noise across the line, we see that there will be about 100 μ v of noise voltage on the antenna. A signal intensity of several times that value is necessary for satisfactory reception. Electrical devices not in the same house but in the neighborhood will likewise produce noise, although not of as great magnitude. It can be seen then, that except in electrically quiet neighborhoods, there is little advantage in a home broadcast receiver having much greater sensitivity than 25 to 50 μ v.

Three general noise-reducing types of antenna have been used.

(1) *Doublet antenna located in a*

operation of electrical manufacturers, in reducing the noise-making propensities of electrical devices. Such progress is gradual because of the multiplicity of such devices, although this line of attack on the problem promises to be eventually very valuable.

The other possibility for improvement in signal-to-noise ratio is by increase in signal field intensity and past experience has shown this to be the most effective means.

Fig. 2 shows the sensitivity of a-c home broadcast receivers in use today that were manufactured in the years 1933-1938 inclusive, data for earlier years not being available. This shows the percent of sets which will deliver 500 mw output (standard output) for any given signal.

The input signal has the standard test modulation of 30% at 400 cycles. This shows that receivers in use today vary

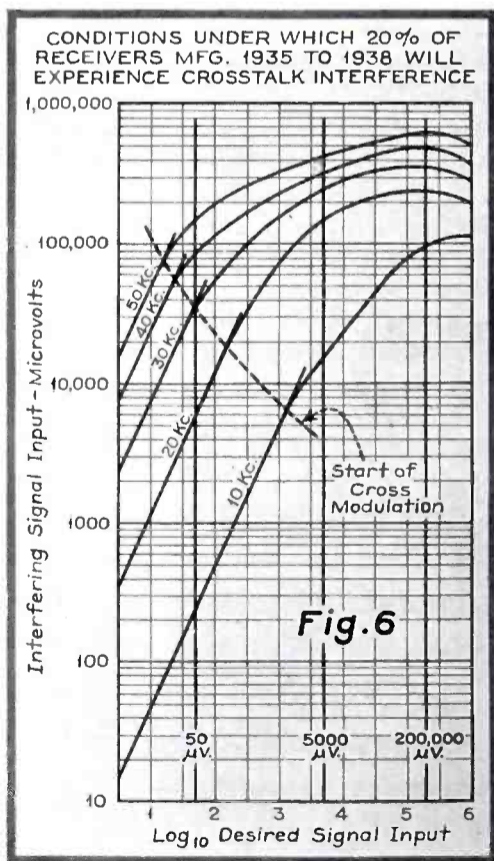
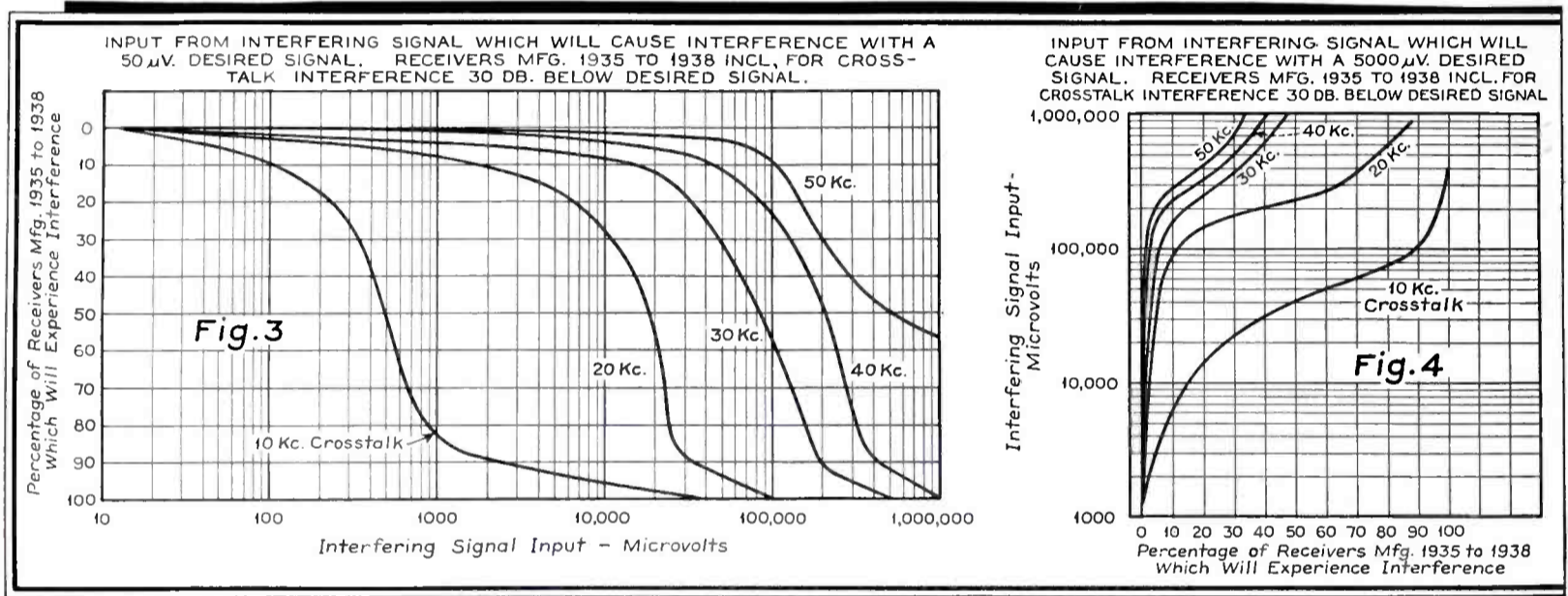

relatively noise-free position and connected to the receiver by a transmission line which does not pick up noise.

(2) *Balancing type in which one portion of the antenna is located to have a larger ratio of noise to signal than the other portion, the noise voltages of the two portions being then balanced out to leave the remaining signal relatively free from noise.*

(3) *Loop antenna which depends upon its directional qualities and upon the fact that noise sources usually have a larger electric than magnetic field.*

Each of these three types of antenna has merit in reducing noise, the type which will give greatest improvement depends upon local conditions. Noise-limiting circuits have also been used to a limited degree in receivers and under some conditions and on some types of noise are beneficial, but when adjusted for maximum noise reduction are likely to introduce distortion.

Progress has been made, by the co-

in sensitivity from 1 microvolt to 2000 microvolts, the median value being 67 μ v.

These data are for 1000 kc and include both superheterodynes and t-r-f receivers. The variation of sensitivity over the broadcast band is small for superheterodynes, but may amount to more than a two-to-one variation over the band for t-r-f receivers. It is of interest to note that battery sets of today have good sensitivity, those manufactured in 1938 having sensitivities varying from 6 to 45 μ v.

SELECTIVITY

There are two commonly used measurement methods for selectivity, the single-signal method and the two-signal method, but only one of these gives results applicable to field conditions.

In the single-signal method, which unfortunately has been the only method used until quite recently, one generator is used and its output is impressed on the receiver under test, the input re-

quired for a specified receiver output being measured at receiver resonance and on either side thereof. The single-signal method is simple to apply but does not represent the conditions to which receivers are subjected in service. In the field, receivers are required to select one of several simultaneously applied signals. It would be difficult to apply several signals simultaneously to a receiver under test in the laboratory and since the two principal phenomena which the single-signal method does not take into account are included by using two simultaneous signals as well as when several are used, the two-signal method thus gives selectivity data from which the performance of the receiver under field conditions may be obtained.

In the two-signal selectivity method, the input from one signal generator, the desired signal, is set at one of the standard values, these being 50 μ v, 5 mv, 100

the other and is due to curvature of the tube characteristic. It is usually due to the characteristic of the first tube in the receiver, although the second tube may occasionally contribute to the effect.

The cross modulation is given by the expression¹.

$$M = \frac{m E^2 S_m''}{2 S_m}$$

where M is cross modulation
 m is modulation of interfering signal
 E is peak carrier value of interfering signal
 S_m is transconductance of the tube at the operating point under consideration
 S_m'' is second derivative of tube transconductance with respect to grid voltage at the same operating point.

This expression indicates that the cross modulation depends upon the

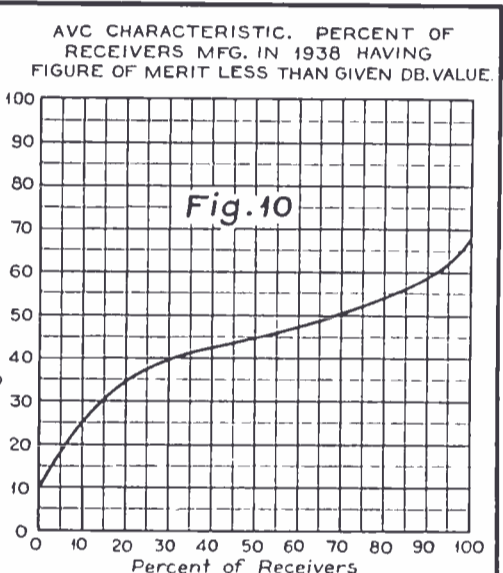
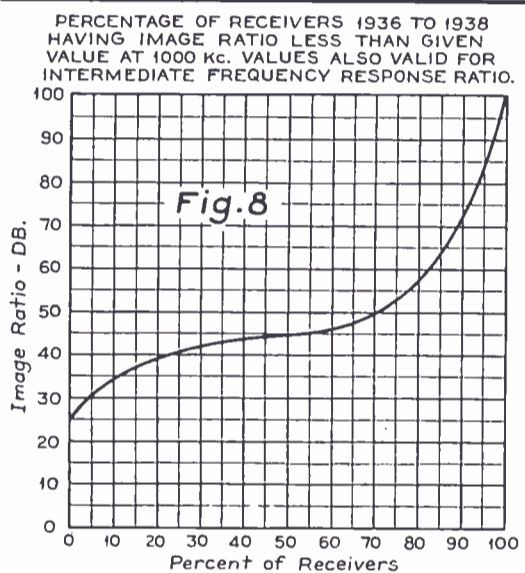
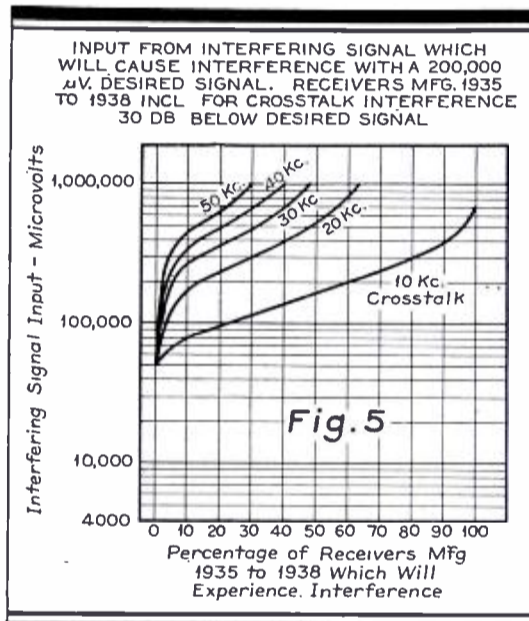
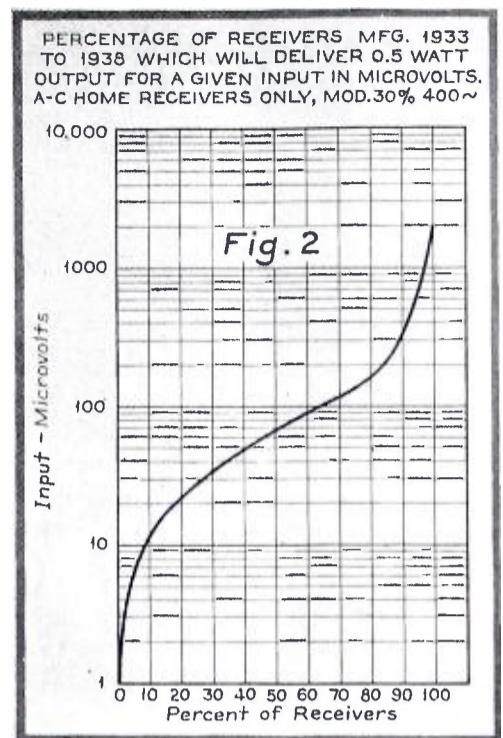

mv and 2 v, and is modulated 30% by a 400-cycle tone. The receiver is tuned to this signal and the volume adjusted to give standard 500-mw output. The modulation is switched off, leaving the carrier applied and the output of the other generator is then applied simultaneously. The second generator, or interfering signal, modulated 30% at 400 cycles, is tuned successively to one, two, three, etc., channels off receiver resonance and the generator output varied until the output of the receiver is 30 db below the value obtained from the first generator, or 0.5 mw. This 30-db ratio between desired and interfering signal is the IRE standard and is a practical value confirmed by many observers.

The two phenomena which are not taken into account by the single-generator test method are those of cross-modulation and masking. In the presence of two signals, cross modulation results in the impressing of the modulation from one of the signals on

square of peak value of the interfering carrier only and not to the value of the desired carrier. However, the desired carrier affects the operating point because its intensity determines the avc voltage, so that in practice the cross modulation depends to some degree on the desired carrier also.

The cross modulation would be independent of the desired carrier only if the tube characteristic were a true exponential. Actual tubes, even of the remote cut-off type, depart sufficiently from a true exponential characteristic so that the cross modulation varies with grid bias. The cross modulation is not zero even with true exponential tubes but is small and invariable with bias.

The other effect disclosed by the two-signal method is that of masking or apparent "demodulation" of a weaker signal by a stronger one. This effect occurs when two modulated signals of

different radio frequencies are impressed on a linear detector. Detectors today are nearly all linear with inputs over 50 μ v, except for very low-priced, insensitive receivers, so that the masking effect has an important influence on the results of two-signal tests. If an interfering signal with 400-cycle modulation, separated 20 kc from a desired signal, is applied simultaneously with the desired signal to a linear detector, the first-order output consists only of frequencies 19.6 kc, 20 kc, and 20.4 kc which are inaudible. It is only the second-order output that produces an audible interfering signal.

It may be shown that the audio output due to the smaller signal in the presence of the larger is given by²

$$V = \frac{k m x^2}{2} E \left(1 + \frac{x^2}{8} \right) \cos qt$$

¹Stuart Ballantine and H. A. Snow. "Reduction of Distortion and Cross-Talk in Radio Receivers by Use of Variable-Mu Tetrodes." *Proc. I.R.E.*, pp. 2102-2127, Dec. 1930.

²E. B. Moullin, "Detection by a Straight Line Rectifier of Modulated and Heterodyne Signal," *Wireless Engineer and Experimental Wireless*, July 1932.

where V is audio-frequency output
 k is detection coefficient
 m is modulation of the smaller signal
 E is magnitude of larger carrier
 e is magnitude of smaller carrier
 q is 2π times modulation frequency
 x is e/E .

We see from this expression that when the smaller signal is 0.256 times the larger, the audio output of the smaller (for equal modulation percentages of the original signal) will be 30 db below that of the larger or desired signal.

Data from measurements taken by the two-signal method for receivers now in use and manufactured in years 1935 to 1938 inclusive have been plotted for three values of desired signal input, namely 50 μ v, 5 mv and 200 mv and are shown in Figs. 3, 4 and 5. These figures show what percentage of sets will experience crosstalk interference under varying conditions of desired and interfering signal.

A still more illuminating method of plotting these data is shown in Figs. 6 and 7. In Fig. 6 is shown the interfering signal which will cause crosstalk in 20% of receivers in use for varying values of desired signal input and frequency separation. If cross modulation did not occur the interfering and desired signal levels would increase together as they do for lower signal levels of Fig. 6. The straight lines are those values which would be obtained from single-signal tests corrected for masking effect. The dotted line shows the locus of start of cross modulation and from the curvature of the lines above that locus can be seen the importance of cross modulation in determining interference susceptibility. A similar set of data for the median receiver, that is 50% of receivers less susceptible to crosstalk and 50% more susceptible to crosstalk, is shown in Fig. 7.

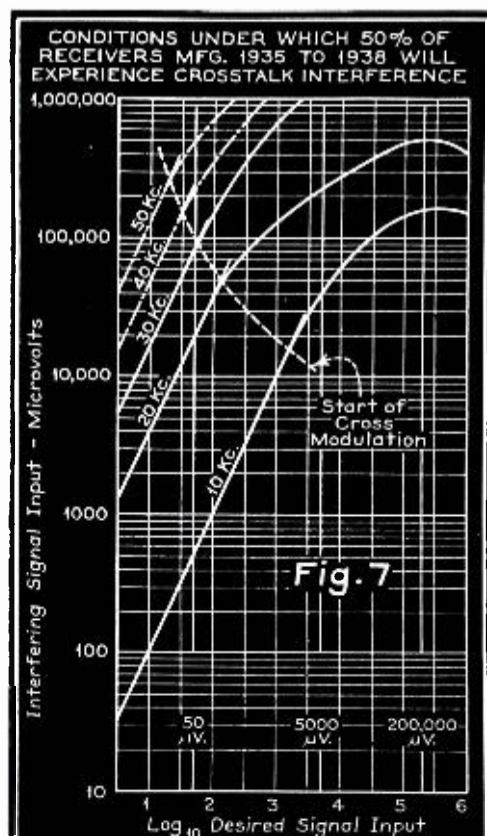

These curves, Figs. 3 to 7, or curves similar to those of Figs. 6 and 7 derivable from the other three, enable us to find the answers to many field coverage problems. For example, suppose there are two broadcast stations A and B separated by 30 kc, how close to station B can station A be received by 80% of receivers?

If we know the way in which field intensity of A and B vary with distance we may find the answer by reference to Fig. 6.

It is to be noted that the receiver inputs for these curves are expressed in microvolts, whereas field intensities are in microvolts per meter, so that it is necessary to assume some value of effective height for the receiver antenna. Little quantitative data has been gathered on this point, but it is believed that the average effective height of a-c home receivers is of the order of 1 meter; for farm receivers the effective height is probably of the order of 4 meters, while for automobile receivers it is of the order of 0.1 meter.

SPURIOUS RESPONSES

There are still other receiver characteristics which have a bearing on whether or not interference will exist in a given case. These are classified generally under the head of spurious responses and occur principally in superheterodyne receivers. These spurious responses require specific frequencies or combinations of frequencies for their production, so that the frequency combination of transmitters as well as receiver characteristics must be known in a given case to determine whether or not interference will occur.

It has been mentioned that these spurious frequencies are confined principally to superheterodynes. It may be asked then, why is the superheterodyne circuit so universally used? The superheterodyne is used because it provides so much better adjacent-channel selectivity, permits better sensitivity with less tendency to regeneration, enables the attainment of almost any desired selectivity shape close to resonance where it affects audio fidelity, permits construction of good short-wave receivers, and has still other minor advantages. The only field in which the tuned-radio-frequency principle is still used is that of the lowest priced receivers where performance must be sacrificed to obtain lowest cost construction. This is the field below \$15 list price and even in this price range there is a tendency towards adoption of the superheterodyne principle.

IMAGE RESPONSE

The superheterodyne receiver de-

pends upon the heterodyning or frequency conversion of the incoming carrier frequency by means of the local oscillator to form the intermediate frequency, a carrier either higher or lower in frequency than the local oscillator may form the same intermediate frequency. An intermediate frequency of 455 kilocycles is now predominant in the United States and has been adopted as standard by the Radio Manufacturers Association because it represents the best compromise from a design standpoint and from the standpoint of relative freedom from interference.

The oscillator frequency is ordinarily higher than the frequency of the carrier it is desired to receive and is separated from it by the i-f. For example with an i-f of 455 kc the oscillator frequency must be 1,055 kc to receive a 600-kc station. If, however, with the same 1,055-kc oscillator frequency, a signal of 1,510 kc is impressed on the first detector or converter tube, the output thereof will likewise be 455 kc. The ratio between the input required at 1,510 kc to that required at 600 kc for the same output with the oscillator at 1,055 kc is known as the image ratio. It may be seen that the image frequency is separated from the desired frequency in all cases by twice the i-f. This means that image interference from stations in the 550-1,600 kc broadcast band can only occur with 455 kc i-f when receiving stations with frequencies between 550 and 690 kc. Other services with frequencies higher than 1,600 kc may, however, produce image interference with broadcast stations above 690 kc.

It has been noted above that for two-signal crosstalk interference an output ratio of 30 db between desired and interfering signals has been standardized as necessary for freedom from objectionable interference. In measuring spurious response ratios, however, it is standard practice to use the same output for both desired and interfering signals. This does not mean that the desired signal will be free from interference when the difference in level between it and the interfering signal is that given by the image ratio, but is merely the result of long established practice in expressing spurious-response ratios. To obtain condition for freedom from interference the spurious-response input should be reduced 30 db (voltage ratios 31.6-to-1) below the value given as spurious-response input or ratio. That this is a valid procedure follows from the considerations that the vast majority of second detectors in use today are linear (output directly proportional to input) at standard measurement output and that the automatic-volume-control voltage generated by the

interfering carrier which will produce output 30 db below the desired carrier is negligible in comparison with that of the desired carrier. This means that if the spurious-response ratio of a given receiver is 30 db the desired and interfering signals may have equal intensity at the receiver input without interference occurring.

The image ratio is due to selectivity preceding the converter tube and varies over the broadcast band, usually being poorer at the higher frequencies. In some receivers special circuits, called image-rejection circuits, are employed to augment the inherent selectivity of radio-frequency circuits to image responses.

In receivers having one tuned circuit preceding the converter (two-gang tuning condensers) the average image ratio is about 4 times as good at 600 kc as it is at 1,400 kc, whereas in the case of three-gang tuning condensers the average ratio is about 10 times as good at 600 kc as at 1,400 kc.

The manner in which the image ratio at 1,000 kc varied for receivers manufactured 1936-38 is shown in Fig. 8. It is seen that the poorest receivers had an image ratio of about 25 db and the best about 100 db.

INTERMEDIATE-FREQUENCY RESPONSE

If a signal having a frequency close to that of the intermediate-frequency amplifier of the receiver be impressed on the receiver input, some of it will be passed by the radio-frequency circuits and appear at the receiver output. The ratio between the signal required at intermediate frequency to that at the desired frequency is called the intermediate-frequency ratio. Here again, special circuits are frequently employed, usually on two-gang condenser receivers, to augment the inherent radio-frequency circuit rejection of the i-f.

Due to the choice of 455-kc i-f this type of interference occurs only in those regions where there is a high signal intensity with frequencies in the region of 455 kc. Stations with frequencies 440 to 470 kc may produce this type of interference in their immediate vicinity. This is usually confined to coastal regions, although 454 kc is allocated to stations in the Great Lakes regions also, but at present is little used there.

The i-f response ratio of receivers is better at the high-frequency than at the low-frequency end of the broadcast band, averaging about 4 times as good at 1,400 kc as at 600 kc.

The values of i-f response ratio found necessary in practice are similar to those for image ratio, and examination of data on i-f ratio at 1,000 kc for receivers manufactured 1936-38 shows that Fig. 8 for image ratio is also

valid (within accuracy of data) for determining the percentage of receivers manufactured in 1936-38 which have an i-f ratio less than a given value. The receivers manufactured in those years comprise two-thirds of those now in use, so that it is very unlikely that similar data for earlier years, which is now lacking, could materially alter the results.

INTERMEDIATE-FREQUENCY HARMONICS

Whenever signals are impressed on a non-linear device there is a group of frequencies in the output, consisting not only of the fundamental input frequencies, but also of harmonics and combinations of harmonics thereof. There are two portions of a superheterodyne receiver which, in order to perform the desired function, must have a non-linear characteristic, namely the converter and the second detector. When i-f energy is impressed on the second detector, harmonics of the i-f are present in the output, and if permitted to couple back into the radio-frequency portion of the receiver result in a whistle when the impressed signal is the same as the resultant harmonic. The whistle due to the second detector can be effectively eliminated by proper filtering and shielding and in the vast majority of receivers is thus eliminated.

However, the harmonic whistle due to the converter is not thus readily dealt with because the action which produces it all takes place within the converter itself. We are here concerned primarily with the second harmonic since the amplitude of the third and higher order harmonics is always much less than that of the second.

The mechanism of production of harmonic whistle is best explained by consideration of specific frequencies. Assume an impressed signal of 910 kc and that the i-f is 455 kc, the oscillator frequency will then be 1,365 kc. There will result in the converter not only the 455-kc i-f frequency, but also, along with still other frequencies, the second harmonic of the impressed signal or 1820 kc. This 1820-kc component existing together with 1,365-kc oscillator frequency likewise produces 455-kc frequency, the difference between 1,820 and 1,365 kc. Now if the oscillator be slightly detuned to say 1,366 kc, from the 910-kc fundamental component the output will be 456 kc, and from the 1,820-kc component there will be an output of 454 kc. Both of these are within the i-f passband and will be amplified at i-f and impressed on the second detector with the result that the difference, or 2 kc, will be present as a whistle in the receiver output.

It can be seen that this whistle can occur only for impressed frequencies

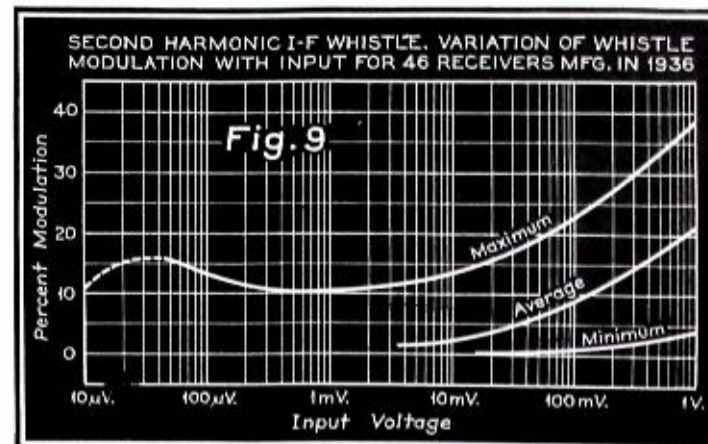

close to the second harmonic of the i-f and that selectivity ahead of the converter is of no benefit in protecting against this whistle modulation.

This spurious-response whistle is proportional to the square of the applied voltage and so is most troublesome where field strength is greatest. It is measured as the equivalent modulation percentage and typical values for receivers are shown as a function of input voltage in Fig. 9.

For frequencies which differ somewhat from 910 kc a spurious output may occur but will not cause a whistle. For example, with 930 kc applied, if the oscillator frequency is 1,385 kc, the i-f resultant is 455 kc due to fundamental and 475 kc due to generation of the 1,860-kc component. The 20-kc difference is too high to pass through the audio-frequency amplifier. However, with the same applied 930 kc, if the receiver be detuned so that the oscillator frequency becomes 1,405 kc the difference between the oscillator frequency and the 1,860-kc component becomes 455 kc, and the signal is again heard with that tuning. Here the selectivity preceding the converter does reduce the effect and it becomes negligible for frequencies over 30 or 40 kc removed from that of twice the i-f.

There are still other special frequency combinations, such as two stations in the same locality separated by the i-f, which may result in spurious responses but those already described are the principal ones.

EXTERNAL CROSS-MODULATION

There is an additional type of interference not due to receiver characteristics but to external factors which has proven troublesome in some instances. This is known as external cross modulation and is due to the presence of a non-linear element or rectifier adjacent to the receiving antenna in the presence of two or more strong signals. This type of interference is of special significance to the broadcaster because it is beyond the control of the receiver designer, whereas the transmitter location

(Continued on page 36)

New High

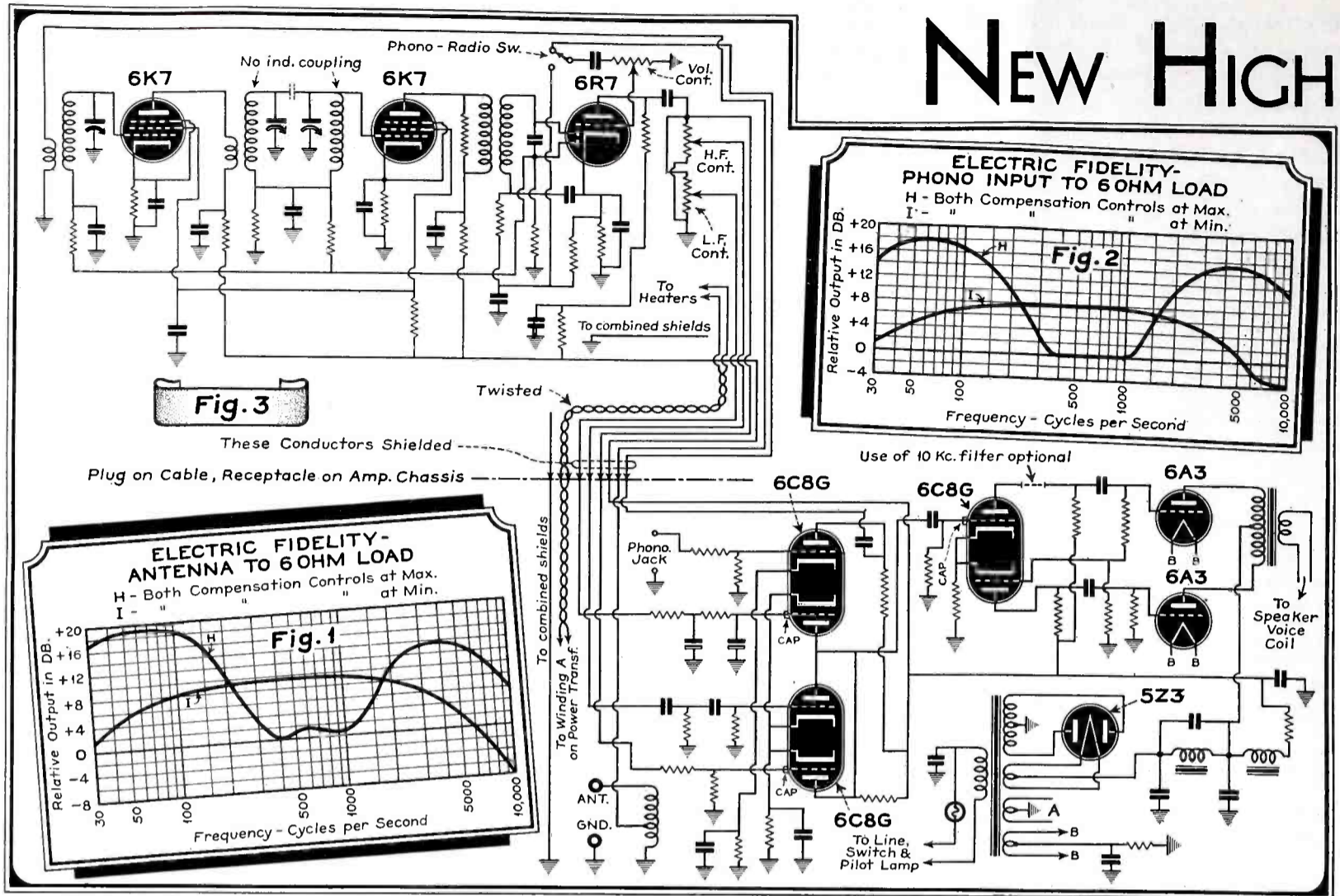

Showing circuit diagram of receiver and fidelity characteristics for max. and min. positions of compensation controls.

THIS receiver design differs from others, past and present, in the following ways: It is strictly for high-fidelity reception; it includes no short wave, no push buttons and no tuning indicator; the t-r-f tuner is on a very small chassis separate from the amplifier, so it provides remote control; the audio system contains separately controllable compensation for the high and low frequencies, the adjustments of which are mounted on the tuner chassis; ten watts of undistorted power output is available at the speaker voice coil; a permanent-magnet field speaker is used.

It is well known that, except under unusual conditions, a very specialized, highly sensitive and selective receiver is required to reproduce signals from distant stations satisfactorily. The quality of such signals when reproduced, because of high signal-to-noise ratio, tendency to fading, and due to side-band cutting by the receiver, cannot be called high fidelity. Further it is also well known that under any condition, a specialized receiver capable of wide-band acceptance and proper audio and speaker characteristics is necessary to reproduce a high-fidelity signal from any station. Signal-to-noise ratio and fading conditions can only be depended

upon to be good in the primary service area of a station. Therefore this receiver need not be sensitive. Thus it is seen that the attributes of a long-range receiver and those of a high-fidelity receiver are almost exact opposites. Any attempt to combine them in the same receiver is likely to make that receiver more costly and to reduce the effectiveness with which it fulfills both of its functions.

In designing the high-fidelity receiver the idea of employing push-button tuning was dropped. It was felt that with an insensitive receiver, where the dial is not crowded with stations and where only a few of those available are to be tuned and their location may be marked on the dial, manual tuning is not a hardship.

A tuning indicator might be desirable, but it cannot be operated from the regular circuits of a high-fidelity receiver. This is due to the fact that in this type of receiver the acceptance curve must be relatively flat around the carrier frequency of the station being tuned. Inasmuch as the tuning indicator indicates in effect, the amplitude of the acceptance curve at the carrier frequency of the received signal, the receiver may be considerably detuned without the indicator showing any change in value. This

difficulty may be overcome by including extra sharply-tuned circuits tracked to the center of the high-fidelity band-pass circuits. These circuits would serve no purpose but the operation of the tuning indicator. As they complicate the design, increase the tuner size and cost, it did not seem good judgment to include them in the design.

The tuned-radio-frequency circuit of this receiver (Fig. 3) consists of a conventional high-gain antenna stage to obtain as good a signal-to-noise ratio as possible. This is followed by a band-pass stage which is coupled to the detector and avc diodes by an untuned transformer. The avc is applied to both r-f stages. The result is a circuit with very broad band acceptance but sufficient selectance to avoid interference in a relatively congested section. To keep down distortion, the avc has been made just great enough to prevent blasting when changing from the weakest to the strongest station within the proper range of the receiver. The tuning range covers the standard broadcast band.

This circuit has been built on a chassis only $8\frac{1}{8} \times 4\frac{1}{8} \times 3\frac{5}{8}$ inches over the chassis only, or $8\frac{1}{8} \times 4\frac{1}{8} \times 6$ inches over the dial and knobs. This small size lends itself to remote control and as a matter of fact the design was worked up with it in mind. This was done because we

FIDELITY RECEIVER

By
L. G. PACENT
 President
 PACENT ENGINEERING CORP.
H. C. LIKEL
 Chief Engineer

believe that a high-fidelity receiver should be tuned and the tone adjusted from the point at which it is to be listened to or as near there as possible; at any rate, never from directly above the loudspeaker, the usual "all in one cabinet" practice. By having the tuner connected to the amplifier chassis by a cable it becomes possible not only to tune and control volume as is done in the usual remote-control devices, but also to control the high and low-frequency compensation.

Of course, there are those who will maintain that since many of the broadcasting stations now claim to be linear from the microphone to the antenna up to at least 8 kc, the receiver needs no compensation. They are quite correct if this reproduction is to be at the best loudness level for hearing this type of sound in question. This is usually not the case, however, particularly for such features as opera, concert, orchestra, etc., where high-fidelity reproduction is most important. In these cases the maximum allowable loudness in the home is much less than the best loudness for this entertainment. Under these conditions compensation is absolutely necessary if the reproduced sound is to have the same tonal balance at the home volume as it would have if listened to at concert volume. A little study of the chart showing the field of audition will disclose the reason. See Fig. 4.

Suppose that we ran through the frequency spectrum, generating a sound wave which at every frequency contained the amount of energy representing the greatest loudness in a sound

wave from a symphony orchestra listened to in a concert hall. The loudness as indicated by the ear at any frequency would be in proportion to the ordinate included between the threshold of hearing and that energy level, or the threshold of feeling, whichever is lower, as for instance ordinates "a," "b" and "c."

Now suppose we run through the frequency spectrum again in the same way but at the energy level representing maximum home loudness. Here we see that the sound at the frequency of "a," which at the higher energy level was about one-fourth as loud as the maximum loudness, as represented by "c," is not heard at all.

Before the ordinate "b" was about 66% that of the maximum, "c." Now the corresponding ordinate "d" is only about 57% of the maximum at its energy level, "e." This changing in the loudness ratio between the middle frequencies and the "high" and "low" must occur every time the reproduction

level is changed. Because of the different heights of the various frequency components in each sound wave and the many changes in loudness level that a reproducer must meet, no exact and fixed compensation curve can be arrived at. However, the calculated compensation curves when the reproduction level is lower than the best listening level always take the general shape of audio-frequency-response curve with the bass and treble adjustments at full on. When the reproduction level is greater than the best listening level the compensation curve takes the opposite shape. This is the shape of the audio characteristic when the bass and treble controls are set at minimum. Fig. 1 shows these two curves.

This compensation and the control over it is accomplished by feeding the audio-frequency output of the radio chassis to the amplifier over three separately shielded lines. One of these lines connects directly to the source of the audio voltage; the other two are connected to this point through potentiometers. On the amplifier chassis are found three 6C8G twin triode amplifier tubes. The direct line connects to one of these grids through a linear voltage divider which gives a loss of over 20 db. This tube amplifies all frequencies delivered to its grid equally. The two

(Continued on page 35)

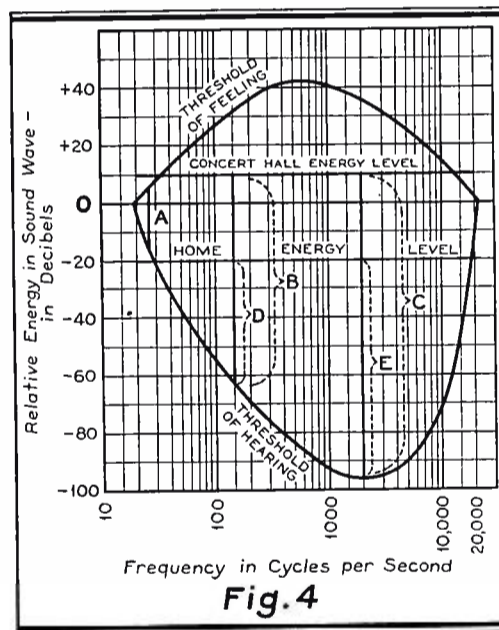
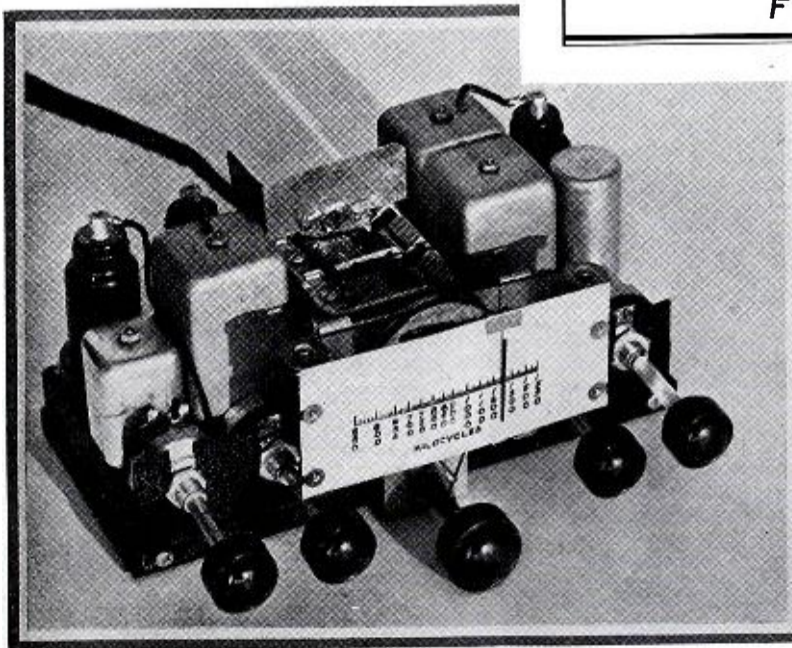
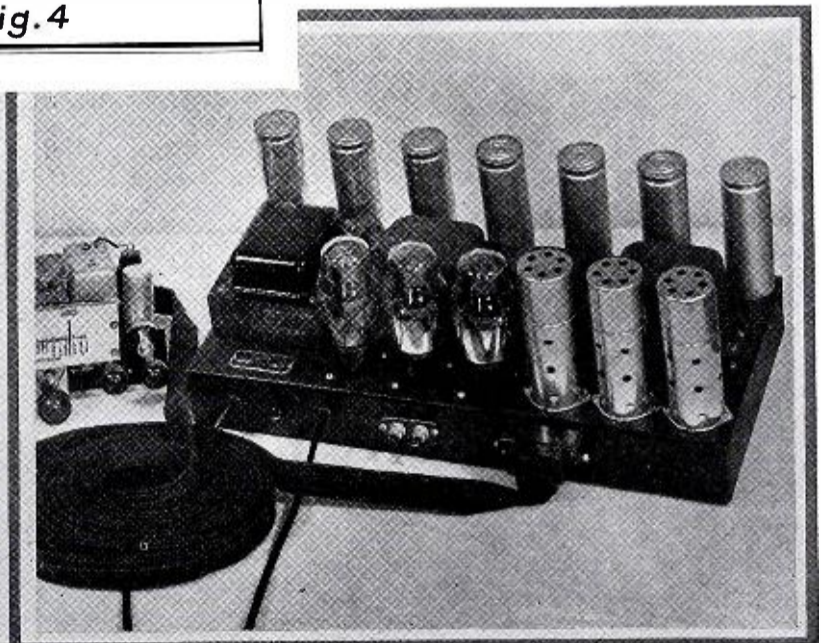

Fig. 4

Below: A close up of the remote tuning mechanism.



Below: The receiver chassis assembled.



Amplifier Band-Width

SIMILITUDE PRINCIPLES

By SIMON RAMO

Gen. Engineering Labs.
GENERAL ELECTRIC CO.
Schenectady

TWO questions which are often asked when amplifier design or the utility of a new tube for amplifier application is the subject of discussion are:

(1) Given the input and output capacities of the amplifier tubes to be used, a specified type of amplifier circuit (such as resistance-coupled, transformer-coupled, etc.), and a required band-width to be passed, can more or less gain be obtained by operating at different center-band frequencies. Conversely, if the gain is specified, will the band-width passable by one particular circuit and set of tube capacities vary with the center-band frequency?

(2) For any given type of amplifier coupling, a specified center-band frequency, and a required gain, how do the gain and band-width vary with tube capacity?

These questions are usually answered for particular, common types of amplifier circuits by comparing the performance of amplifiers designed for different frequencies, tube capacities, band-width, etc. The experienced amplifier designer knows the effect on band-width, for example, of halving the tube capacities in a double-tuned transformer-coupled amplifier simply because he has designed such amplifiers for many different tubes. Almost intuitively he can give fairly complete answers to the above questions by drawing from his past experience.

Valuable information which may be considered as partial answers to the above questions need not wait upon a study of a huge number of previously designed amplifiers. Studies of what may be called "universal principles" because they hold for any form of amplifier circuit are surprisingly easy to make by the use of simple dimensional or similitude analyses. A demonstration of this is presented in the following.

CHANGE OF BAND-WIDTH WITH FREQUENCY

In Fig. 1 is shown a network terminated at each end by a condenser. The network in between the two condensers we will not specify except to state that it contains only resistances, self and mutual inductances, and condensers. This network has a curve of

gain (output voltage over input voltage) versus frequency which in the neighborhood of the angular frequency ω_1 is as shown in Fig. 2.

Now suppose that we wish to redesign the network so that it will have the same gain at some new frequency ω_2 that the present network has at ω_1 . We are to use the identical network as far as structure is concerned. Only the numerical values of the inductances, resistors, etc., are to be changed. That is, if the network was originally a transformer-coupled amplifier, it must remain a transformer-coupled amplifier with the same elements connected in the same way. However, the input and the output condensers shown in Fig. 1 must remain at the original numerical values for they represent the tube capacities. We might say that we have given two designers the same amplifier tubes, specified the same type of amplifier circuit, and asked each of them to design so as to arrive at the same gain at two different frequencies.

Let us term the new network, No.

2, and the original network, No. 1. One way the new network may be obtained is to alter all impedances in the same ratio. Thus, since the input and output capacities must remain unchanged by hypothesis, let us keep all condensers in the entire network unchanged for the new design. Then the impedances of all condensers will have changed to

$$\frac{1}{\omega_2 C} = \left(\frac{\omega_1}{\omega_2} \right) \frac{1}{\omega_1 C} \dots (1)$$

Accordingly the impedances of all inductances whether mutual or self should also be changed in the ratio

$$\left(\frac{\omega_1}{\omega_2} \right). \text{ Thus if}$$

$$L_2 = \left(\frac{\omega_1}{\omega_2} \right)^2 L_1 \dots (2)$$

in which L_1 indicates inductances in the original network and L_2 indicates inductances of the new network, then

$$\omega_2 L_2 = \omega_2 \frac{\omega_1^2}{\omega_2^2} L_1 = \left(\frac{\omega_1}{\omega_2} \right) \omega_1 L_1 \dots (3)$$

Before we can proceed with this method of design for the new network, we must make some assumptions about the variation of resistance in the circuit with frequency. Of course, what is required is that

$$R_2 = \left(\frac{\omega_1}{\omega_2} \right) R_1 \dots (4)$$

in which the subscripts have the same meaning as in the case of the inductances. If equation (4) is to be true for all resistors of the network, then what it means is that all lumped resistors (such as those in a resistance-coupled amplifier) are to be changed in

the ratio, $\left(\frac{\omega_1}{\omega_2} \right)$. In the case of

resistances associated with coils, equation (4) will be satisfied automatically if the coils are designed for the same Q at both frequencies. For then

$$R_2 = \frac{\omega_2 L_2}{Q} = \frac{\omega_2 \left(\frac{\omega_1}{\omega_2} \right)^2 L_1}{Q} =$$

(Continued on page 33)

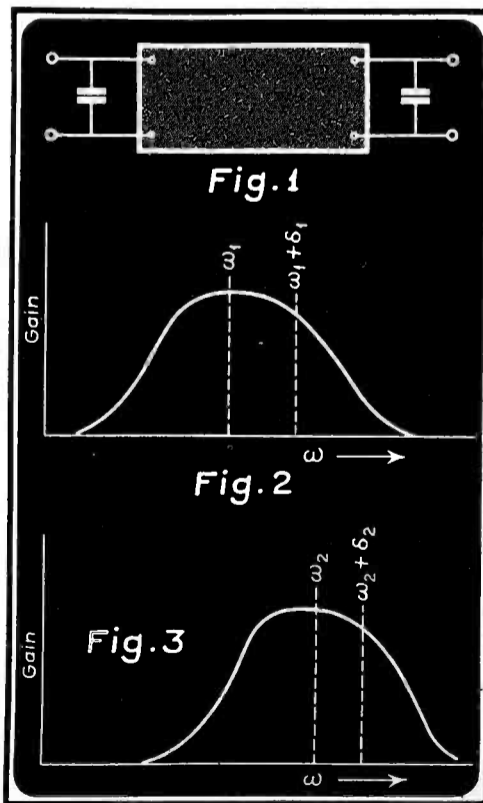

TELEVISION ENGINEERING

The lens, lamp and reflector installation reinforced with floor lights. A general view of the floor complication with a multi-set production in the studio.

By **W. C. EDDY**

Television Department
NATIONAL BROADCASTING CO.

THE subject of illumination is one that concerns engineering and production departments alike. To one department it represents stronger signals, greater focal depth and better pictures, while to the other department light becomes a ready tool to be used in the staging of television productions. Whatever its classification, light remains an important component of television.

If we were to trace the history of television lighting from its inception we would necessarily have to recount much that is already familiar to those in the art. A review of some of the developmental work carried on in the past three years should be sufficient history to demonstrate the need for a new lighting system and to cover the various steps in its evolution. This work has covered the investigation of practically every feasible light source known to the art and demonstrates the steps taken in arriving at our present illumination equipment.

As a part of the RCA field test of television, the National Broadcasting Company approached the lighting problem from a developmental angle. By observing the various proposed illumination systems under actual operating conditions they were able to formulate unbiased opinions as to the practicability or failures of the equipment under test. Their work in television lighting can then be taken as an authoritative review of equipment available today.

The Radio City studios were originally equipped with standard moving-

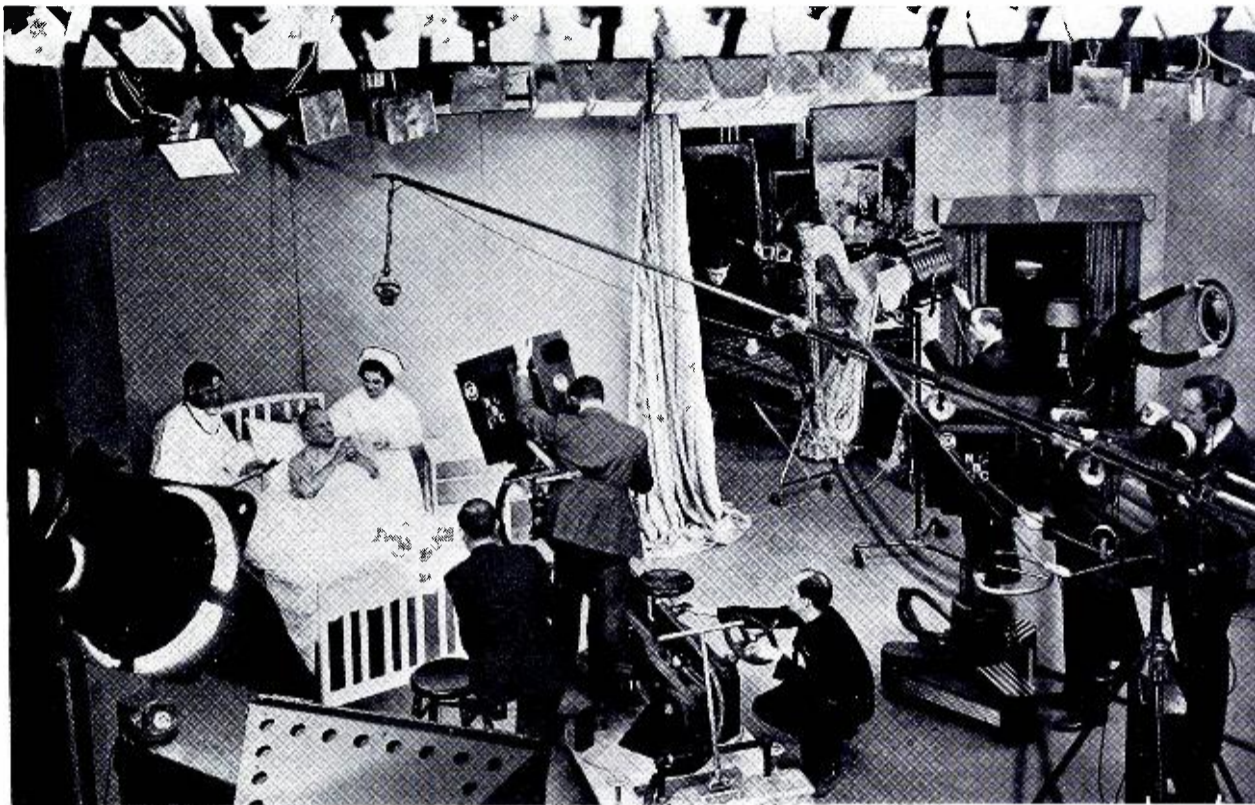

TELEVISION LIGHTING

Part I

picture type incandescent illumination. This consisted roughly of a group of 2-kw focusing spots on portable floor stands, two 5-kw focusing spots on dolly stands and two broadsides or flooding units mounting nine 500-watt bulbs. The general theory in back of this installation was to flood the set from down front with the broads, reinforcing this flat illumination with the spots as required. The primary consideration at this period was to get a picture of satisfactory detail so this equipment was for the time usable. The fixtures did require considerable floor space that would normally be allotted to camera operation, but the programming was simple and cameras all but stationary. As the field test advanced deficiencies in the character of the lighting became apparent. First of all, coming from

directly in front, it had a tendency to flatten the picture. The use of spots from the wings could in a measure counter-balance this defect but this practice required that each unit in use be manned by an operator. Even under the best conditions of use and operation the resultant picture was spotty, non-dimensional and unsatisfactory.

In order to alleviate the crowded condition of the studio floor, the two broad units were mounted on the ceiling over the camera section and the spots moved further back in an attempt to create more camera space. This did not improve matters from the picture standpoint. The spots were focused to an even more intense beam than before in an attempt to compensate the flat front light of the broadsides. One advantage was gained in this move, however, an advantage quite



The lens, lamp and reflector array as seen from the television stage.

important from the programming standpoint. By raising the flooding units from the floor stands to the ceiling the direct glare of the unprotected lamps was reduced to a minimum, adding not only to the actors' comfort but to their general appearance as well. It proved definitely that an ideal lighting system should take into consideration the angle of light arrival on the set. To establish an angle that would permit of unrestricted movement about the acting area without excessive glare or distorting shadows required a series of tests under working conditions. Although fourteen degrees above eye level is generally quoted as the angle for decreasing the glare of an open lamp, our tests showed that for complete normalcy in movement and appearance this angle should be held to thirty-four degrees above the horizon as a minimum. With the light arriving on the face at this angle, very few if any disagreeable shadows are created, forty-five degrees marking the point where the shadows of the eyebrows and chin begin to create distortion. It must be recognized, however, that any such angular limitations of light are a pure generality and that certain situations will arise where these figures will be found at fault. By limiting our lighting to this angular cone as we now do, we feel that the results obtained verify our conclusions and that the situations where this rule of thumb does not apply are too infrequent to merit serious consideration.

We do not specify, of course, that

only light from this angle can be used on a set with safety. As in the theatre we employ the equivalent of footlights which work well below the eye horizon and various modeling units from stage right and left. It might be of interest in the discussion of this phase of lighting to point out that the general theory which we have outlined has been put to a satisfactory test in the public demonstration studios at Radio City where several hundred subjects are televised every day. In designing the lighting installation for this particular duty we assumed an average height of eye of five feet-one inch from observation of some three hundred visitors. The three lighting banks were then arranged to flood the subject from an angle of thirty-five degrees with a fixed equivalent of the mobile footlights placed several feet in front of the railing. No attempt was made to use modeling light because of the varied and unpredictable subject matter that was to appear before the cameras. The installation was designed to be unattended and to furnish a reasonably satisfactory illumination without further adjustment. The results to date have been most gratifying a usable television picture being presented in nearly every case.

Returning to our discussion of studio lighting we find the illumination equipment again reinforced, this time with twelve scoop reflectors each mounting one high-intensity 1,000-watt lamp. These units being lighter and therefore considerably more flexible than their predecessors, could be arranged to cover a large set with a more even illumination than was possible with the original floor broads. It did require careful readjustment of equipment for each change of set and even with the utmost care in blending the beams from these fixtures the background generally appeared spotty. Physically it was an impossibility to mount enough light units of this dimension on the ceiling to flood the acting area with a satisfactory light for television cameras. As an alternative, the broadsides were again put back into use from each side of the set and the scoops readjusted to reinforce and blend these two main sources of light. In addition the spots and suns were stationed in the wings and in back of the cameras to be used as the occasion demanded. It was apparent that the addition of scoops to our lighting equipment solved none of the existent problems other than to give us sufficient apparatus to create any lighting level on the set that might be demanded. With the installation of these fixtures in the studio we were again forced to take over floor space that had previously been surrendered to camera operation. All in all, this phase of our ex-

perimental work netted us little other than to point out the marked deficiencies of such a fixture in our application.

Before leaving this phase, it might be well to cover some of the associated problems that were being investigated during this period. As we have pointed out, incandescent sources of illumination were employed throughout our experiments. Arc lamps presented many inherent difficulties that stood in the way of their being adapted into our installation. The possibility of flicker, resulting from maladjustment, the fumes that were necessarily dissipated from the carbons were complications that prohibited their use, while the personnel for manning the individual lights would further complicate the congestion on the floor. In addition the possibility of acoustical or electrical pick up from the lamps operating close to the cameras and microphone boom made further consideration of this source of light unnecessary. Our complete attention was then given over to the investigation of incandescent lamps of various types and the standard lighting fixtures available on the market.

Gelatin screens were used to decrease the glare from the open type reflectors when lamped with high-intensity bulbs. These screens succeeded in diffusing and "softening" the light of the clear bulbs, but were ultimately discarded in favor of the frosted lamps. Soft light, as such, appeared to have little merit in television where the set lighting would average fifteen-hundred foot candles.

The ambient heat problem created by the lights was a problem that did merit consideration and to which considerable thought and experimentation was devoted. Water filters had been tried with excellent results in the reduction of radiated heat, but the complications of the cooling system were such as to nullify the results obtained. With the advent of heat-absorbing glass on the market, a second series of filters were constructed for the equipment in the studio. These filters, while entirely successful in reducing the radiant heat of the light beam, decreased the light to such a point that for equal light on the stage, little change was noted in the studio temperatures, a fact which again returned us to the open type of light as our most practical unit. With the demand for more light on the sets, a routine request, it was apparent that our ideal lighting system must utilize lamps of considerably higher efficiency if we hoped to maintain our foot candles on the set and still keep the studio temperature within reason. Some work was done with the high-intensity or short-life lamps, but the relamping cost and undependability of this filament soon brought us back to standard mazda.

Realizing that further acquisition of fixtures designed for the larger and more immobile movie sets would continue us in the vicious cycle of experimentation that would lead nowhere, a radical change was suggested. Instead of a few high-power units such as the broads and spots, the ceiling would be equipped with a large number of small light units arranged in arcs about the acting area. These fixtures, each consisting of a standard lamp, reflector and lens assembly, were positioned on a gridiron over the camera space in such manner that the foot-candle reading on the set illuminated was approximately constant at all points. The light radiating from a multi-unit source was naturally diffused and arriving on the set from all angles and directions reduced shadows to a minimum. It was of course extremely flat lighting, but without a doubt produced a picture that was more satisfactory from the engineering standpoint. The equipment was, for the major part, on the ceiling with the floor given over entirely to camera operation. The light was uniform on the set providing the actors stayed within the confines illuminated and the light was generally satisfactory from all camera angles. It did fall short, though, in light quality. Shadows are normal in nature and as much a part of good lighting technique as light itself. To illuminate every part of a subject to a uniform level is to destroy any possible illusion of a third dimension. With equal light from every direction, we, of course, had little contrast in the picture. To satisfy the demands of the observers in the field we were again forced to bring out the suns and spots to create high lights on top of this already high-level illumination. A further deficiency was immediately apparent in the continued high ambient temperature of the studio brought about by the low efficiency of the individual units. The most glaring fault in this installation, however, lay in its lack of flexibility. For one area, and for that area alone, it provided excellent foundation light, but its weight,

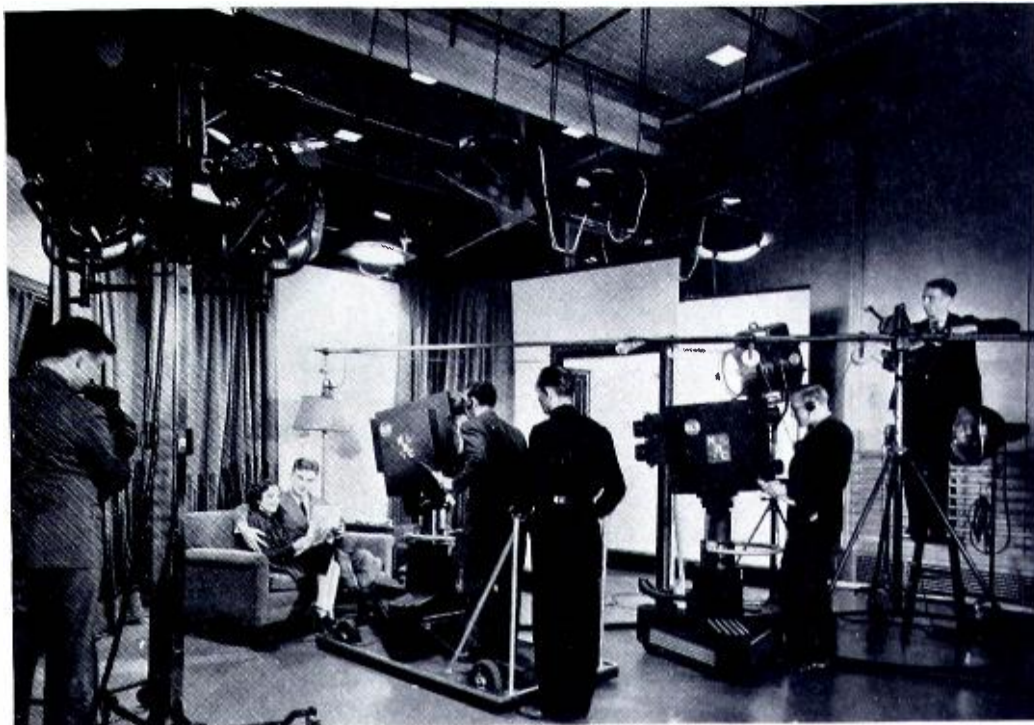

One of the earliest lighting arrangements capable of illuminating a single fixed set area.

bulk, and general arrangement precluded anything but a major installation change to shift the position of this illuminated area. The use of this type of light required that the program department bring their work under the light rather than the more satisfactory method of lighting the sets as selected. For simple programs, such a procedure might be followed, but as the product became more complicated, a single stage was incapable of handling a sequence of scenes. This fact added another "must" to our list of specifications for television lighting; that of extreme flexibility in movement. It was apparent from the first that we could not satisfactorily limit ourselves to flat lighting alone. We had two alternatives. We could illuminate the set to the required level with flat lighting from overhead and with the floor light build up the contrast from one side or we could establish a lighting angle for our overhead array and in this manner unbalance the light playing on the set. At this time the total light from the entire

bank was little more than enough to create a good electrical picture, so we were forced to use the first method and add our modeling from the floor. Once again we encroached on the area assigned to camera operation as more and more lights were brought from the storeroom to answer the demand for higher contrast in the pictures. To resolve this problem into a specification for the new installation was to specify sufficient lamps for twice the light normally required. Then with full flexibility in arrangement it would be practical to create and maintain a definite modeling angle of illumination with the minimum of floor equipment.

Reviewing the many characteristics of the installations under test, we were forced to admit that no one arrangement would prove satisfactory as a television lighting system. Each experimental set-up made its individual contribution to the system now in use at Radio City creating a list of specifications around which we designed our equipment. The lighting problem then resolved into the mechanics of creating units which would encompass these specifications and to formulate a reasonable technique for their operation.

(To be continued)

• • •

SOLAR TELEVISION BULLETIN

Incorporating work on television development problems by condenser engineers, Solar Manufacturing Corporation's Bulletin T-1 gives specifications and standards for the high-voltage condensers necessary for television work. Diagrams and specifications showing a variety of types adapted to various television uses are embodied in the bulletin. It is available upon application to the company, 599-601 Broadway, New York City.

A view of an early lighting set-up from back stage, showing floor mounted lights equipped with heat absorbent filters.

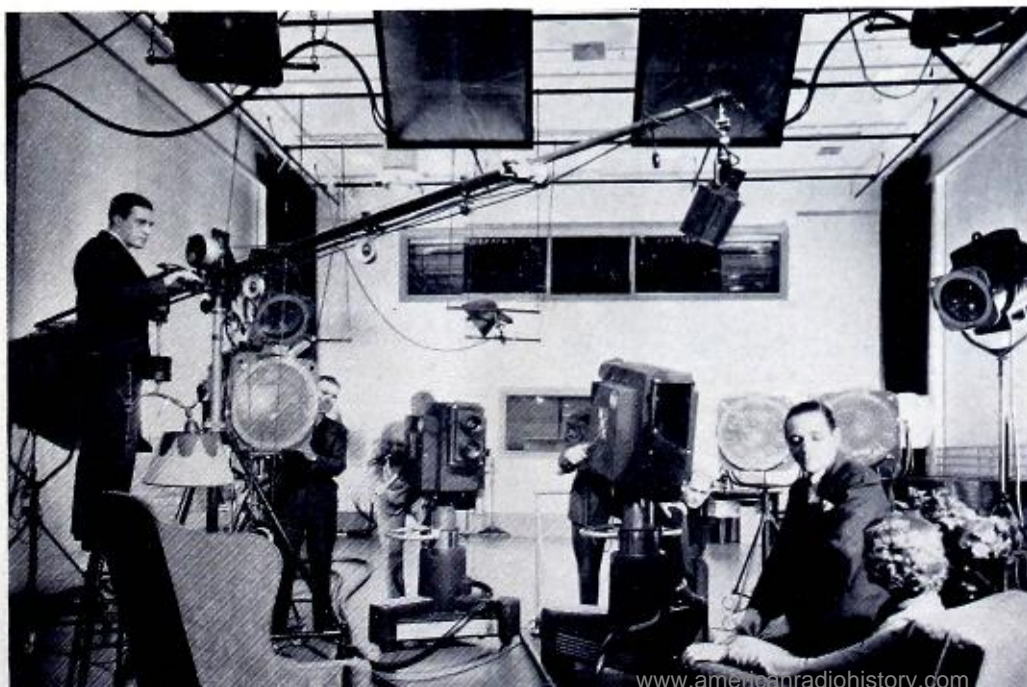

TELEVISION ECONOMICS

Part IV

By

Dr. ALFRED N. GOLDSMITH

Consulting Industrial Engineer

(b) **FILM PROJECTORS.** A number of types of motion-picture projectors may be used for film projection in television. The two major groups are often considered to be intermittent and non-intermittent projectors. In the intermittent projectors, the film is drawn through the projection gate in steps of one frame at a time, picture projection taking place when the projector shutter is open, and film motion taking place during the periods when the shutter of the projector is closed. In non-intermittent projectors, the film moves uniformly through the gate. Thus gate tension on the film may be reduced and sprocket wear and resulting framing inaccuracy kept at a minimum, with resulting increased film life and maintenance of picture quality throughout use of the film. In non-intermittent projectors, there may or may not be shuttering means, but there must be provided an "optical rectifier," this latter being an optical system which moves the projected image of a film frame oppositely to the effect of the film motion and exactly compensates such motion. In practice, mathematically exact compensation of film motion throughout the rectification cycle seems unlikely since, in general, film motion is directly pro-

portional to time (that is, according to a linear function) while the optical rectifier causes a reverse motion of an amount which is a sinusoidal or other non-linear function of elapsed time. In the case where a sinusoidal motional-rectification function applies, a so-called "sine error" is introduced, this being proportionate to the difference between a linear and a sinusoidal function. If a complete optical-rectification cycle occurs for a small angular motion of the rectifying system, the sine error becomes negligible, although careful optical design is then generally necessary to avoid undue loss of light through the system.

When intermittent projectors are used (or indeed any other form of projector in which the image brightness varies from time to time, of course neglecting actual motion of objects in the field), it becomes essential to synchronize the iconoscope scanning cycles

Film scanner used at Grand Central Station Studios of the Columbia Broadcasting System.

on the one hand and the projector illumination periods on the other hand. One way of doing this is to "flash" the projected pictures on the mosaic only during the iconoscope return-line or blanking periods and not during the actual scanning periods, thus depending entirely on iconoscope image storage or persistence during the scanning period for signal output. This requires limiting the image-projection period to 1/800th second by the use of a shutter having a small angular aperture, with resulting loss of light and the necessity for a powerful projection illuminant even with 35-mm film.

Inasmuch as television in America uses 30 frames per second, and since available 35-mm sound films are intended for projection at 24 frames per second, an expedient has become necessary to project such films for television purposes. This comprises briefly projecting a first frame of film three times at intervals of 1/60th of a second, rapidly pulling the next frame into place during a closed-shutter period, and briefly projecting a second frame twice at intervals of a sixtieth of a second, whereafter the identical cycle is continually repeated. It will be seen that two film frames have thus been projected in 5/60ths or 1/12 of a second, that is, at an *average* rate of 24 frames per second. The minor accelerations and decelerations of motion of objects in the image thus resulting have been found to be unobjectionable.

An important and more basic distinction between television projectors disregards intermittency or non-intermittency of projection and concentrates on the degree of steadiness of illumination of the projected image on the mosaic. Assuming that successive frames of a stationary field are projected, in most intermittent and non-intermittent projectors there are marked brightness variations during the frame cycle. Indeed, such variations usually reach 100%. In view of the performance and scanning method of the iconoscope, it then becomes necessary with any variable-brightness projector to synchronize the projection cycle rigidly with the iconoscope scanning cycle in a suitable relationship.

Constant-brightness projectors, which maintain the image brightness at a uni-

(Continued on page 22)

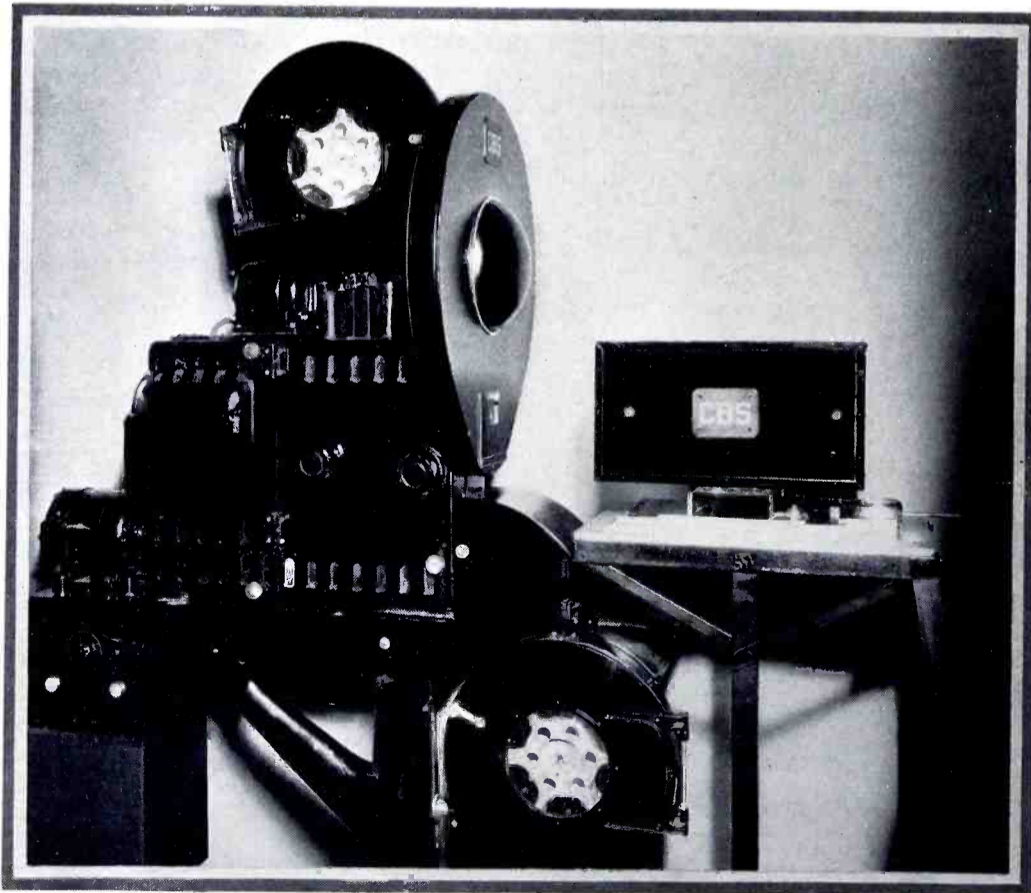

In Television too.

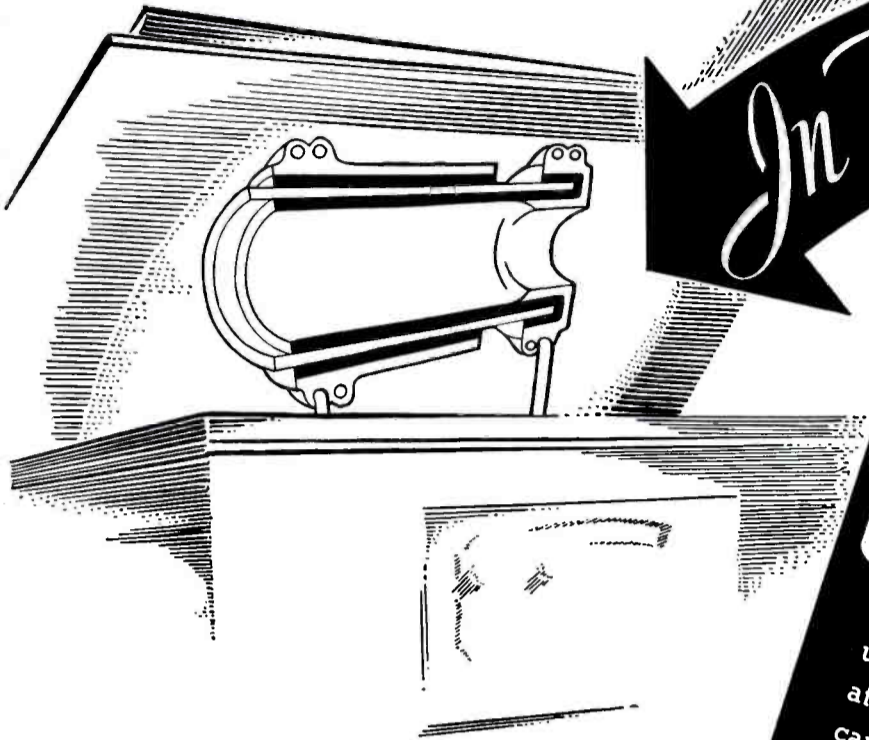

it's
CENTRALAB

Centralab Ceramic Capacitors find a definite use in Television because of their low loss at ultra high frequencies . . . because they can be supplied in a wide range of accurately controlled negative temperature coefficients, for circuit temperature compensation. The high quality ceramic insulation is unsurpassed for low power factor. Extreme accuracy is obtainable on rated capacity value and temperature coefficient.

A special bulletin showing engineering data is available on request. Specify Bulletin No. 630.

COMPENSATING CERAMIC CAPACITOR

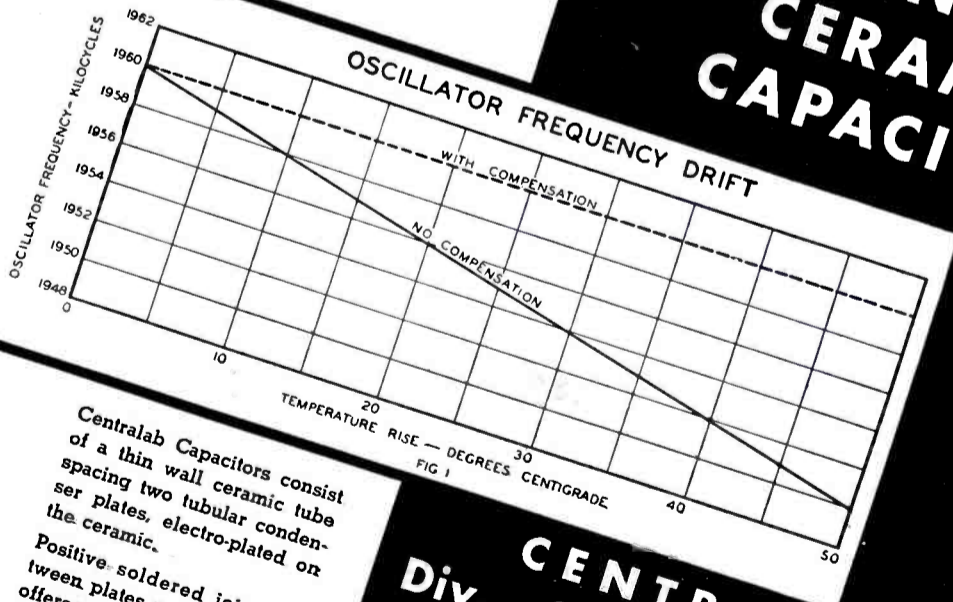

Centralab Capacitors consist of a thin wall ceramic tube spacing two tubular condenser plates, electro-plated on the ceramic. Positive soldered joint between plates and wire leads offers permanent capacitance under all life and aging tests.

CENTRALAB
Div. of Globe-Union Inc.
Milwaukee, Wis.

Outstanding



10 BILLION TO 1



LIKE THE STARS IN THE HEAVENS

ten billion to one is beyond comprehension, yet that is the ratio of the resistance range of the Rider VoltOhmyst. Electronic engineers have been quick to visualize the lasting usefulness of this new Electronic D-C Voltmeter-Ohmmeter with ranges wide enough for the engineering requirements of today and tomorrow. It is designed for use on television, radio facsimile and aircraft receivers and transmitters, sound power, and other engineering work.

The Rider VoltOhmyst measures 0.05 to 5000 volts D-C in nine ranges—0.1 ohm to 1,000,000,000 ohms in seven decade ranges with a greater convenience than any other existing instrument. As an example, you can measure any D-C control or operating voltage wherever it may be without being concerned with the circuit complications—with the signal present in the circuit. For, the Rider VoltOhmyst has one scale—one zero adjustment. You just put the proper probe on the point to be measured and the scale shows the voltage or resistance without any adjustments as you change ranges. 3% accuracy on the Ohmmeter. 2% on the Voltmeter. Input resistance of the Voltmeter is 16,000,000 ohms up to 500 volts and 160,000,000 ohms from 500 to 5000 volts.

Operates over 105-130 volts, 25-60 cycles. NET PRICE **\$57.50**

SERVICE INSTRUMENTS, Inc.

404 Fourth Ave., New York
Foreign Division
147 W. 45th Street, N. Y.
Cables—"Servicin"

SEND FOR
COMPLETE
SPECIFICATIONS
AND
LITERATURE

The RIDER VoltOhmyst

TELEVISION ECONOMICS

(Continued from page 20)

form value throughout the frame cycle, do not require such synchronizing with the iconoscope scanning cycle because the pictures projected by them are, to all intents and purposes, optically identical with direct studio pick-up. Accordingly constant-brightness projectors permit non-synchronous operation of the projector relative to the iconoscope scanning. The advantages of this method of operation are experienced under practical studio conditions. If backgrounds are electrically injected by such projectors, their timing and rate of projection are independently controllable and more readily matched to foreground action. When personal and film presentations are mixed in the program, film sections can be lengthened or shortened within reasonable limits (at least several percent) determined by permissible pitch change of the transmitted sound. Newsreel material can, to a certain extent, be "edited" or cut in the projector by speeding up or slowing down the machine to fit program requirements to match inserted dialogue, and to emphasize dramatic values. Slow motion can be simulated. A lagging program can be reasonably speeded up or slowed down. Film made at 16, 24 or other number of frames per second can be interchangeably used by mere change in projector speed. Since film presentations, either for individual or grouped stations, have certain advantageous economic features, it is desirable that the projection of film shall be carried out by such means as will enable most flexible and controllably timed operation.

The manual brightness control of television pictures from films requires considerable adroitness and instantaneous response on the part of the control operator. Automatic brightness control for the picture may therefore be desirable, as well as automatic volume control for the accompanying sound which is reproduced from film.

One form of non-intermittent variable-brightness projector has recently been described which is intended for synchronous operation with either the storage-type of pick-up tube (iconoscope) or the instantaneous-response type (dissector tube).

The essential portion of the optical rectifier in this case consists of two rotating discs each containing 24 achromatic lenses, the light path being through at least two lenses (one in each of the discs) at a given time. The lens discs are driven from the film-drive sprocket shaft by means of four gears, which are so arranged that eccentric errors in the gear system are stated to

be subtractive by virtue of the optical meshing of the lens pairs. The spacing and radial positions of the lenses are accurate to 0.0002 inch. A special aligning instrument is required for the placement of the lenses. The gears are bronze against steel, and are "enveloped" or "shaved" to a smooth finish on the tooth faces to insure continued accuracy.

Spiral slots in a selection disc or shutter follow the moving lenses in the optical rectifier. The slots are so arranged, as explained above, that alternate frames of film are scanned twice and three times respectively, in synchronism with the video framing frequency. One spiral slot in the selection disc covers 3/5ths of a revolution, the other 2/5ths.

The projector as stated is of the variable-brightness synchronized-operation type, and has an optical transition period from picture to picture which is less than the return-line or blanking period on the pick-up tube, with which interval of about 1/600th of a second the optical transition period is synchronized. The machine is designed for operation with 35-mm or 16-mm film, and at 24 frames of film per second.

The sine error, mentioned above, exists as a vertical displacement of the picture. If image jump or vertical "bounce" occurs in a film projector, the effect on picture interlacing is injurious. The designer of the previously described projector is of the opinion that "a system in which the optical compensator is a single unit is going to require that the driving gear be extremely accurate," and holds that where a pair of gears of the symmetrical double-unit type are used to drive the optical rectifier, they need be much less accurate. There are, however, differences of engineering opinion on this point.

Film shrinkage is compensated in this projector by means of a variable-diameter graduated sprocket. Such shrinkage is usually regarded as sufficiently constant throughout a single film reel to permit one setting of this sprocket per reel. A number of additional adjustments are also provided in this projector. A mobile idler roller in the loop between the film-drive sprocket and the gate enables framing. Image size is controlled by means of an adjustable low-power auxiliary lens placed in front of the movable picture-pick-up tube.

The total image errors in this machine are claimed to be not in excess of 1/8th percent. In general, the required degree of accuracy in television film projectors will depend on the relationship between loss of definition, on the one hand, and extent of line pairing, on the other hand; as well as the

nature of the picture bounce or other inaccuracies which may be involved.

E-7. Video Test Equipment

There are three types of picture-testing equipment commonly used, namely test charts, single-image transmission means, and electrical test and measuring equipment.

Tapered-wedge charts provide a speedy and inexpensive method of studying picture resolution, half-tone reproduction, and geometrical distortions. When such charts are sectionalized, they enable study and comparison of all integral portions of the picture. To some extent the chart readings are qualitative, but with care in reading the charts and then interpreting the results with good judgment according to simple rules, an acceptably accurate estimate of picture quality is obtainable.

One form of sectionalized resolution chart contains 12 areas. In each of these areas are wedges with curved sides, thus giving a uniform line-resolution scale. The chart enables determining the following:

(a) Vertical and horizontal resolutions in all portions of the field.

(b) Upper cut-off frequency. If the reading on the resolution wedge is multiplied respectively by the frame repetition frequency, the aspect ratio, the total number of scanning lines, and one-half of the fraction obtained by dividing unity by the difference between unity and the percentage of time required for the scanning spot to return to the beginning of the next line (this last being expressed as a fraction), the resulting product will be the upper frequency in question.

(c) "Hang-over" at high frequencies. This effect is sometimes visible for several cycles. It may be due to a resonant or peak response to a frequency corresponding to the particular part of the wedges where it is shown.

(d) Sharpness of focus of pick-up lens. The amplitude of scanning at the iconoscope is reduced, thus permitting the observation of a relatively small section of the chart test pattern and the mosaic area. Defects due to limitations of the kinescope scanning spot are thus reduced in relative proportion, and only the remainder of the system is primarily studied.

(e) Overall figure of merit for resolution. The total number of random-located black-and-white dots which can be separately located and identified in the received picture corresponds to this particular "figure of merit." Essentially it is obtained by appropriately averaging the products of horizontal and vertical resolution in each portion of each of the sections of the test chart, and summing these products.

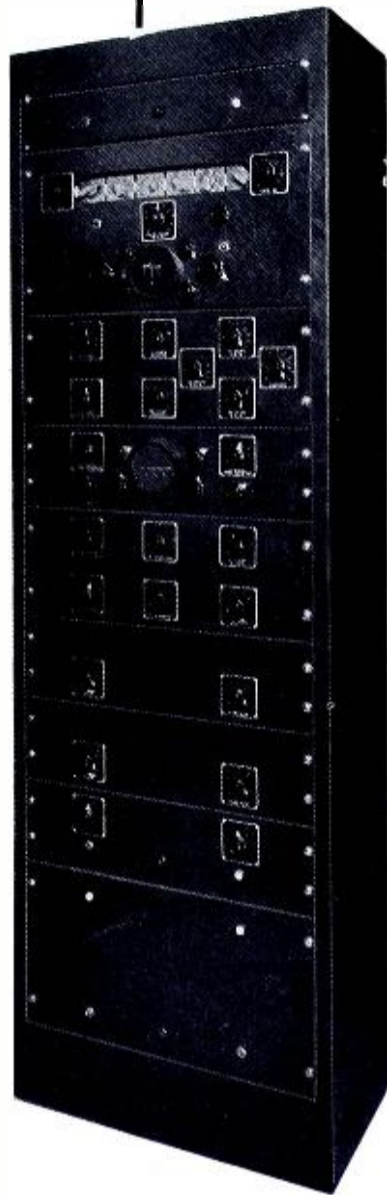

Du MONT SYNCHRONIZING-SIGNAL GENERATORS

really "sync!"

IT is with exceptional pride that DuMont engineers announce the development of the first really commercial television synchronizing-signal generator to be made available in this country.

The complete assembly furnishes outputs as follows: Horizontal and Vertical Blanking Signals; Horizontal and Vertical Synchronizing Signals; Horizontal and Vertical Equalizing Pulses; Linear Horizontal Sweep Wave; Linear Vertical Sweep Wave; Special Sharp Vertical Synchronizing Pulses; and Special Horizontal Pulses.

Illustrated at left, Type 203 Synchronizing-Signal Generator comprises: Type 203-A Frequency Divider; Type 203-B Blanking Pulse Shaping Unit; Type 203-C Synchronizing Pulse Shaping Unit; Type 203-D Master Horizontal Sweep Generator; Type 203-E Master Vertical Sweep Generator; Type 203-F Monitor Oscillograph; Type 203-G Regulated Power Supply; Type 203-H Auxiliary Power Supply and Pulse Amplifier; Type 203-J Power Supply.

This equipment provides satisfactory day-in-and-day-out operation without assistance of trained personnel. Its improved circuits, incorporating the most recent developments in communication engineering practice, make it so stable that it may be turned on and off at will, and operated only when necessary. All components are operated well below rating, insuring trouble-proof operation for years to come.

Type 203 Synchronizing-Signal Generator is representative of the complete DuMont line of television transmitting equipment for all purposes.

Complete information on request.



ALLEN B. DU MONT LABORATORIES, INC.
PASSAIC NEW JERSEY

CABLE ADDRESS—WESPEXLIN, NEW YORK

(f) Half-tone shading. The apparent fidelity of the shading between white and black can be studied in the reproduced picture.

(g) Iconoscope dark spot. Shading introduced in the iconoscope for reasons previously discussed and not thereafter eliminated will be correspondingly visible in the reproduced picture (that is, in the absence of accurate shading control or neutralization).

(h) Accuracy of interlacing. This can be studied by direct or magnified observation of the kinescope picture.

(i) Aspect ratio. Incorrect ratio of horizontal and vertical deflections

throughout the system can be determined by measurement of the picture dimensions.

(j) Inaccurate trapezoid correction. In the iconoscope, unsuitable yoke construction for the deflection coils, or inaccurate compensations for tilt of the scanning beam against the mosaic, results in a non-rectangular (or unevenly line-spaced) picture in the kinescope.

(k) Linearity of vertical and horizontal deflections. Foreshortening, either vertically or horizontally, of areas in various parts of the picture will be produced by this fault.

A second method of test involves the

*There's Economy
in Their
Dependability*

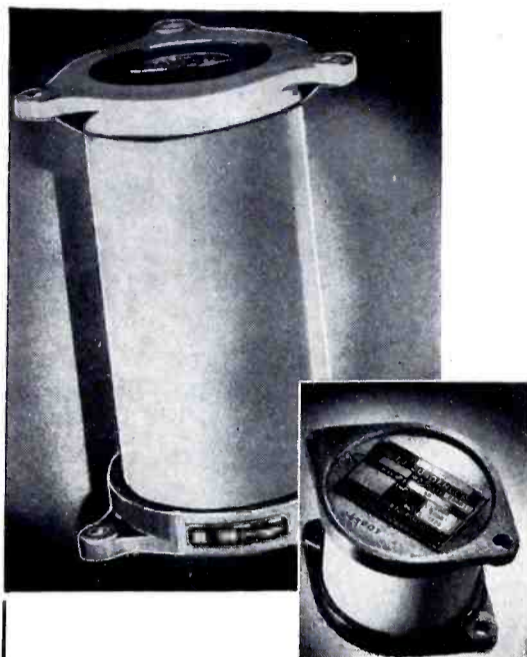

CORNELL - DUBILIER

Mica

TRANSMITTER CAPACITORS

TYPES 50 TO 59

Cornell-Dubilier is at its traditional best in these mica transmitter capacitors. But to capacitor quality Cornell-Dubilier engineers have added adaptability. The type 50-59 series of transmitter capacitors are designed to permit mounting in either vertical or horizontal position. Series or series-parallel circuit combinations can be obtained by simply bolting low resistance terminals together. These units are available in a complete capacity range from 1,000 to 50,000 volts.

The type 50-59 series and other capacitors, including the complete line of Dykanol transmitter units, in ratings up to 150,000 volts described in catalog 160T, free to accredited engineers and manufacturers.



**CORNELL-DUBILIER
ELECTRIC CORPORATION**
1005 Hamilton Blvd., So. Plainfield, N. J.
Cable Address: "CORDU"

use of fixed-pattern pick-up tubes (wherein the pattern is internal to the tube). These devices have been termed "monoscopes," "monotrons," or "phas-majectors." They may be substituted for the iconoscope for transmission tests, using a selected and appropriate pattern containing either linear or half-tone subjects. In one form of these devices, the signal plate is a sheet of aluminum foil which has a natural coating of aluminum oxide of high secondary-emission ratio. The test design is printed on this plate with a carbon ink of low emission ratio, after which the volatile components of the ink are removed by heating the plate in hydrogen. A conductive coating in the bulb is operated at a positive potential relative to the signal plate and acts as a collector. The signal plate itself is at the potential of the final gun anode, which is about 1,000 volts positive. This device is a satisfactory routine testing and checking means for receiver resolution, half-tone gradation, hum, and transient responses in the video amplifier.

In another form of this device, the reverse method of image transmission is used in that an ink having high secondary emission is printed on the signal plate. This particular form is stated to produce a signal of 0.2-volt across 10,000 ohms.

Among the electrical test instruments which have been found useful in television transmitter installations are the following:

(a) Cathode-ray oscillographs of specialized design, which enable study of operation in various parts of the system. Electrostatic-deflection tubes must be used, a satisfactory sensitivity being of the order of 1 rms volt for a 1-inch peak-to-peak deflection. A screen of medium fluorescent after-glow or persistence, and not less than 3 inches in diameter, is advisable. Great care is required to insure absence of relative phase shift in the respective amplifiers for the vertical and horizontal deflection circuits operating with this instrument. An unusually wide range of frequencies must be covered by such oscillographs, e.g., from 20 cycles to well beyond 4 megacycles and preferably to 7 mc. The sweep or time-axis oscillator should run from 10 cycles to several hundred thousand cycles per second. Wave-form distortion must be avoided in the instrument, both for square waves and for damped oscillations of low frequency. A typical assembly of this sort with its amplifiers contains 10-15 tubes and about 150-200 component parts.

(b) Square-wave generators operating at the field frequency of 60 cycles are relatively simply constructed, requiring few tubes and component parts.

F. NON-RADIO STUDIO EQUIPMENT

This group comprises necessary studio equipment which is not a part of the video or audio pick-up equipment nor the associated electrical circuits, but which is necessary for effective studio operation and presentations.

F-1. Studio Acoustics

Television studios present more difficult acoustic problems than the usual broadcasting studios. The microphone cannot be placed at will nor exclusively according to the requirements of best audio pick-up, but must be so located that it is not visible in the picture. Further, the actors are mobile, and the sound pick-up must to some extent follow them. In addition, the pictorial requirements include the erection of appropriate sets in the studio the acoustics of which sets are not so flexibly controllable as the acoustics of a permanent studio.

As a general rule, it will be advisable to keep the acoustics of the television studio rather more "dead" than for audio broadcasting studios. The sets may similarly be constructed so that they are visually adequate but acoustically harmless. One convenient method is to permit sound to pass directly through the walls of the set by constructing these of sound-permeable material painted or otherwise constructed to resemble the represented wall or other surface.

In one experimental studio, the walls were covered with perforated transite backed by rock wool. It has been proposed to use studios of controllable acoustics by installing either sliding or rotatable wall panels of reflecting material or through similar measures, but there is some doubt as to whether such measures will be the most practical ones under the urgent conditions of normal television transmission with personal pick-up and with numerous sets in the same studio. It is obvious that controllable amounts of reverberation are desirable in the transmitted sound in order to simulate room acoustics or changes therein. One method of securing such reverberation is by the use of echo chambers, or else by the use of long sound paths with terminal reflections of some desired type (for example pipes or tubes). Such methods are relatively limited and inflexible and require the exclusive use of the enclosing space for the installation.

Fortunately it is now possible to introduce reverberation electrically. In one form of reverberation synthesizer, a continuous sound record is made on a loop of magnetic tape in a telegraphophone recorder. A number of reproducing heads are spaced along the tape at controllable distances from the

recording head, and these heads pick up time-retarded or delayed replicas of the original sound. The delayed replicas are controlled as to amplitude, frequency characteristics and, if desired, phase, by appropriate amplifiers and associated circuits. The suitably modified replicas are then mixed with the original sound and used either for broadcast transmission or recording. The synthetic reverberation thus produced consists then of the original sound (preferably picked up in an acoustically dead studio) and a number of replicas, the respective delays, amplitudes, and frequency characteristics of which have been readily controlled. Faithful duplicates (that is, aural simulations) of the reverberation characteristics of rooms of various sizes, shapes, and wall materials can thus be produced. The telegraphone recording has the advantage of not requiring any expendable material to be used in the process since the loop of tape is magnetically wiped clean before it again reaches the main recording head. Telegraphone recording has the further advantage that the record, throughout its use for reverberation production, remains at full amplitude on the tape, thus avoiding the loss of high frequencies and the intrusion of ground noise inherent in fading records. It appears likely that synthetic reverberation, as applied to sound picked up in an acoustically deadened studio, will afford a simple and economic means of securing natural and desired sound quality in the transmissions for television broadcasting, or for recordings in motion-picture and similar fields.

Since high-fidelity "top-tilted" audio transmission with pre-emphasis of higher frequencies up to 15,000 cycles will be normal for television purposes, the noise level in the studio, whether



IN ALL COLORS IN THE SPECTRUM FOR TELEVISION APPLICATION . . .

SILICATES and Tungstates, in all colors in the spectrum, are available for cathode ray tube applications. TUNGSTEN — MOLYBDENUM — KULGRID. Leading tube manufacturers are well acquainted with the life-long dependability and production accuracy of Callite Tungsten—Molybdenum and Kulgrid lead-in wires. Don't accept inferior substitutes. Depend on Callite quality products for maximum production efficiency.

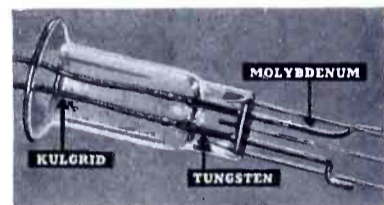

Call on Callite engineers for detailed information on fluorescent materials, lead-in wires and contact points.

CALLITE PRODUCTS DIVISION

EISLER ELECTRIC CORP. • 542 39th ST. • UNION CITY, N. J.

from inside sources or external causes, must be kept at a rigidly controlled minimum.

F-2. Studio Lighting.

At the present time studio lighting equipment for television is generally similar to that used for motion-picture purposes except that the lighting methods are less elaborate and the required surface illuminations are higher. In

one studio, 30'x50'x18' in size, a lighting power of 50 to 80 kilowatts is used, thus producing an unusually intense illumination of each comparatively small set. In another larger studio group, about 60'x180' in all, a stated total power of about 250 kilowatts is at hand. As previously indicated, an illumination level of 1,000 to 2,000 foot-candles (or

(Continued on page 38)

Block diagram of film scanner used by the Columbia Broadcasting System.

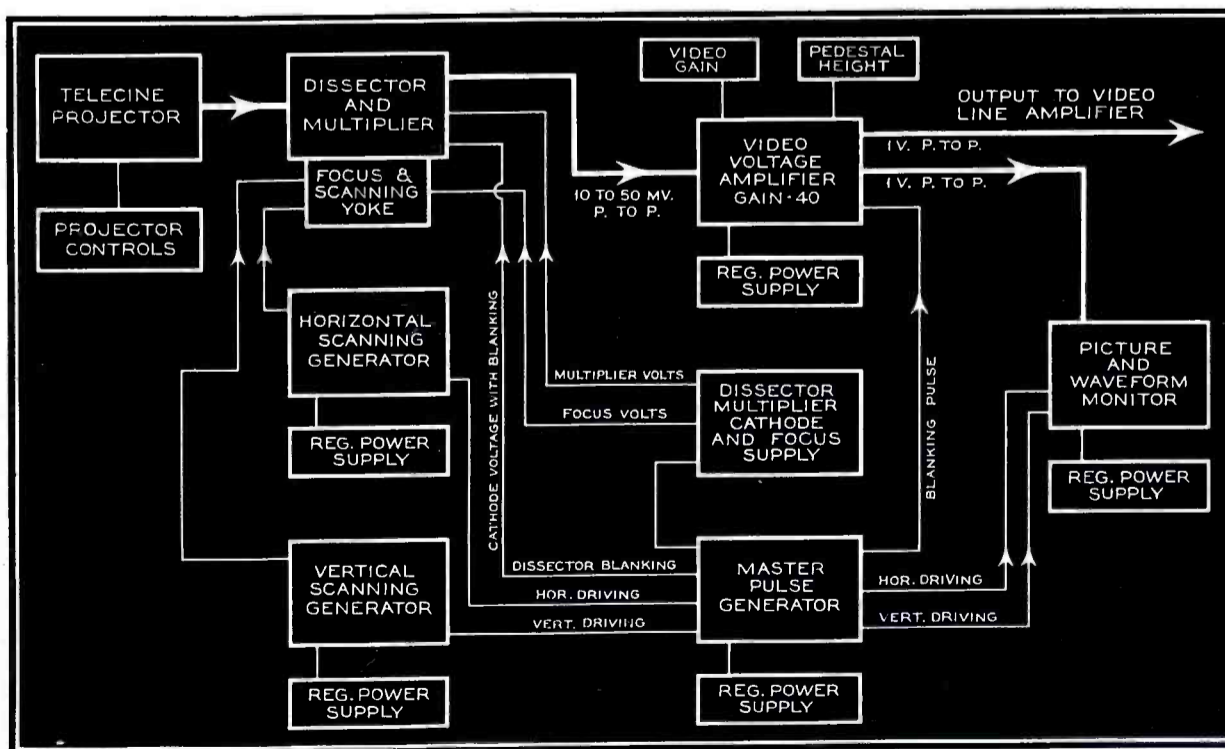

A photograph of this television film scanner is shown on page 20.

THE FUNDAMENTALS OF

Part II: The Necessity

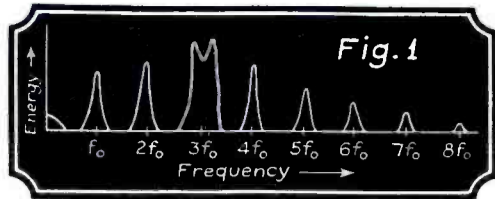

TRANSMISSION OF INFORMATION

IT is a well-known fact that the frequency band available and the time available for the transmission are two very important factors which govern the amount of information that can be transmitted. This holds true in a general way for all types of signals such as telegraphic, voice, music, facsimile, or television and for all media of transmission, such as air for sound waves, wires, or the medium in which radio waves are propagated. The amount of information that can be transmitted can be arbitrarily specified in a rather vague term which we will call "information units." The frequency band available extends from some lower frequency, f_1 , to some higher frequency, f_2 , and covers a frequency range of $(f_2 - f_1)$ cycles. The time t available for the transmission let us express in seconds. These factors can be expressed as

$$\text{Information units} = (f_2 - f_1) t \dots (1)$$

Equation (1) can best be explained by a practical illustration. It has been found that a certain photograph can be sent via a facsimile system in 300 seconds and that the band required had a maximum width of 2000 cycles. By multiplying 300 by 2000, we get 600,000 information units contained in this picture of practically perfect quality. To obtain the same quality with a television image containing 600,000 information units in a time of 1/30 second to come within the eye retentive period for avoiding flicker would require a wider frequency band. The width of this band would be found by dividing the number of information units by the time available, or 1/30 second. This gives a frequency band width of 18,000,000 cycles necessary to transmit this nearly perfect picture in 1/30 second. Actually, however, it has been shown that an information content of about 1/6 of this, or 100,000 information units is ample for television. This brings the necessary frequency range down to a much lower value.

Often it is found that the transmission of a certain amount of information takes up a much wider frequency range than indicated by equation (1). It must be pointed out that equation (1) is only a qualitative statement. One of the reasons for this lies in the fact that "information" is such an intangible quantity. It is evident that more actual information exists in a television image

than in the click of a telegraph sounder, but how much more? How can one measure it? A Chinese proverb tells us that "a picture is worth ten thousand words", but yet one is forced to question the absolute accuracy of the proverb as it probably errs on the conservative side.

Equation (1) also says nothing about how efficiently the $(f_2 - f_1)$ frequency

Even though the actual shape of these concentrations change with picture content, it is obvious that the $(f_2 - f_1)$ frequency band is not being used to the fullest extent. The use of double-sideband transmission is also representative of inefficient use of the $(f_2 - f_1)$ band.

So even though equation (1) is highly vulnerable from the quantitative standpoint, it does rest upon a basic law

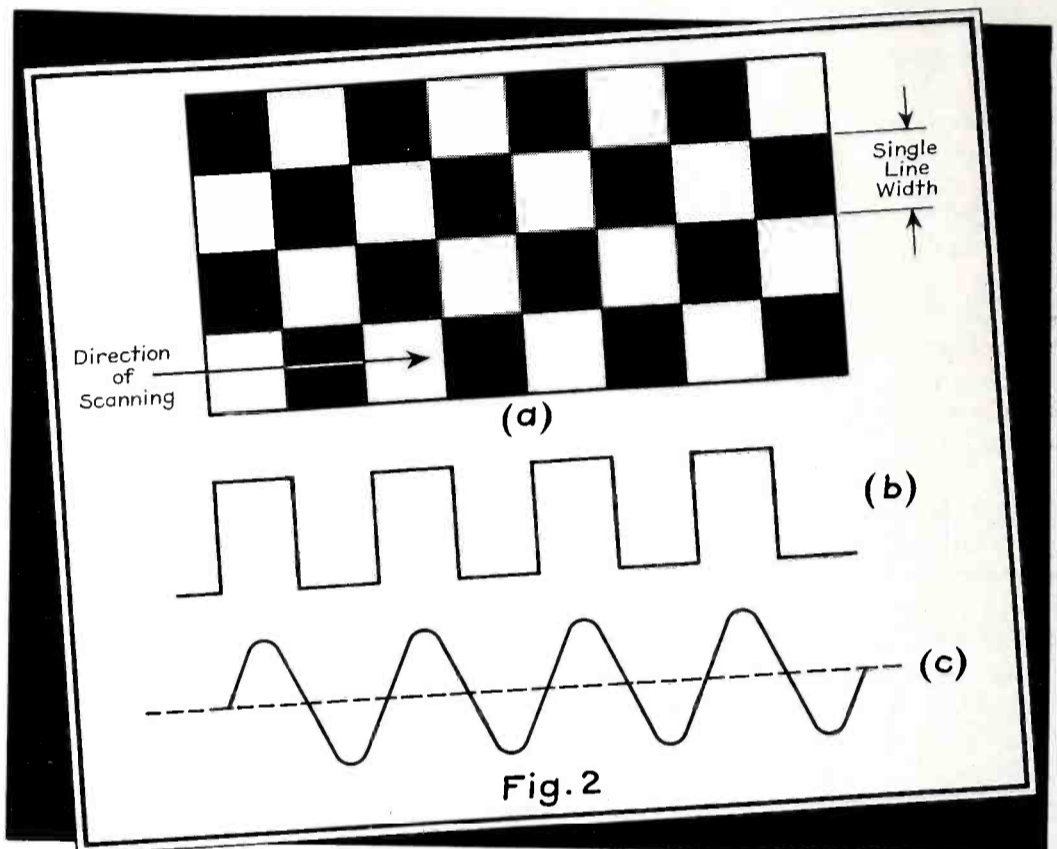

band is used. With the ordinary television signal, the energy distribution throughout this band is similar to that shown in Fig. 1. It is seen that there are energy concentrations in the region of the line-scan frequency²⁻³. This frequency may be found from

$$f_0 = (f) (n) \dots (2)$$

Where

f_0 = line scan frequency, cycles per second

f = frame repetition rate, or the number of complete pictures per second

n = total number of scanning lines per frame.

For the present standards (see Table I) $f = 30$ and $n = 441$, making $f_0 = 13,230$ cycles per second. Concentrations of energy will then be found in the regions surrounding 13.2 kc, 26.4 kc, 52.8 kc, etc., the amount of energy decreasing greatly as the frequency increases.

TABLE I

SHOWING A SUMMARY OF SOME OF THE MAJOR STANDARDS PROPOSED BY RMA TELEVISION COMMITTEE

Channel Characteristics

Television channel width...	6	mc
Separation between sound and picture carriers.....	4.5	mc
(Sound carrier higher frequency than picture carrier)		
Guard band between sound carrier and high-frequency edge of channel.....	0.25	mc

Picture Characteristics

Frame frequency.....	30
Field frequency for interlacing..	60
Number of lines per frame.....	441
width	4
Aspect ratio —————	—
height	3

TELEVISION ENGINEERING

for Wide Frequency Bands

By
F. Alton Everest
Instructor in Electrical Engineering -
OREGON STATE COLLEGE

which demands a payment in the form of an increased frequency band required in exchange for an increase in picture quality.

FREQUENCY BAND WIDTH DETERMINATION

A common method of determining the frequency band required for the transmission of television images will be described which, although criticized

where

n = number of lines per frame
 f = number of frames per second
width

R = aspect ratio = $\frac{\text{width}}{\text{height}}$ of picture

Practical experience has indicated that the value calculated from equation (3) is a pessimistic figure and that only about 70% of this band is actually

RESULTS OF DEMANDING WIDE FREQUENCY BAND

Here we see the penalties we must pay for transmitting lots of information at a rapid rate as, for instance, a television picture which has high quality and which shows motion. The penalty, of course, is the wide frequency band, and the use of these wide frequency bands makes the case for television quite difficult.

First, it is evident that a series of 6-mc transmission channels is not available in the common radio spectrum as usually used today. The entire broadcast band is only about 1-mc wide and even if this region were unused, it would not be satisfactory because the side-bands generated would be such a large percentage of the carrier. A ratio of about ten-to-one between the carrier frequency and the highest modulating frequency is highly desirable from the circuit design standpoint. The spectrum from a few hundred kilocycles to several megacycles is already allotted to a multitude of different services. The prior rights of these services on these frequencies must be respected. All of these factors point toward the utilization of the ultra-high-frequency regions, the propagation characteristics of which relatively little is known. But considerations taking into account the lack of sky-wave, the video-frequency band width, the urban propagation characteristics, and apparatus limitations, have led to the adoption of the region around 40 to 100 mc for television transmission.

One characteristic of these waves^{4,5,6} from 3 to 6 meters is that they behave very much like light in that they tend to cast shadows behind mountains, etc. They also are not ordinarily reflected from the ionized layers except at acute angles, and thereby do not follow around the curvature of the earth. This, of course, limits the service area materially, 30 to 50 miles^o being the general order of maximum distance to which satisfactory signals can be transmitted. The absolute distance, however, depends upon many factors such as height of transmitting antenna, height of receiving antenna, intervening structures or hills, and the base noise level of the locality. Interference from automobile ignition systems is particularly troublesome at these frequencies causing a speckled picture (giving the appearance of a snowstorm) and often the temporary loss of synchronization. The signal

(Continued on page 30)

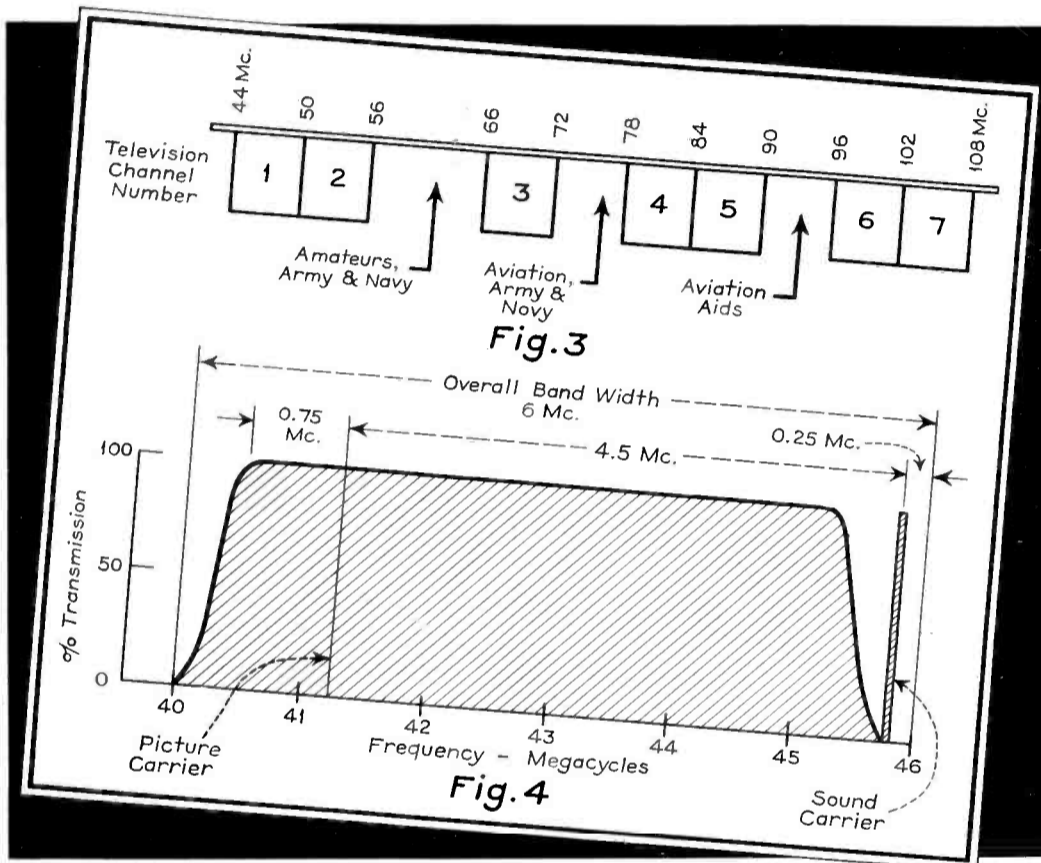

by many for its crudeness, does give a physical picture of the process. This analysis is based upon the scanning of a checkerboard pattern with squares the size of the elemental areas. That is, the squares are the same width as the scanning spot. The theoretical signal resulting from scanning across one line of the pattern of Fig. 2-A⁸ is shown as the rectangular wave of Fig. 2-B. Neglecting such things as aperture distortion, etc., the rectangular wave can be simulated by the sine wave of Fig. 2-C, and its frequency can be determined from the speed of the scanning spot. This, the frequency band representing the scanning of these alternate black and white squares, which represents the worst possible conditions of picture resolution, is given by

$$\text{Approx. frequency band required} = \frac{1}{2} n^2 R f \dots\dots\dots (3)$$

needed. Adopting the standard motion-picture aspect ratio of 4/3 and lumping 1/2, the 0.7 factor and the 4/3 aspect ratio into one constant, equation (3) becomes

$$\text{Actual Frequency band required} = 0.47 n^2 f \dots\dots\dots (4)$$

Let us calculate an example using the present standards of $f = 30$ frames per second and $n = 441$ lines per frame. This results in a calculated necessary frequency range of 2.75 mc, which, with double-side-band transmission, calls for a frequency band of 5.5 mc plus enough for the accompanying sound and the necessary guard bands. The frequency band required is directly proportional to the frame repetition frequency and proportional to the square of the number of lines. Doubling the number of lines gives rise to quadrupling the frequency band required.

FILMS IN TELEVISION

By **JOHN A. MAURER**

THE BERNDT-MAURER CORP.

IN television broadcasting the sound-motion-picture film has a role that is analogous to that of the "electrical transcription" disc in sound broadcasting. It furnishes a convenient means of repeating a program, or of syndicating it to a number of stations.

But the role of the sound-motion-picture film in television is likely to be far more significant than is indicated by the above analogy. The electrical transcription merely repeats a program of sound entertainment as it was originally performed by the artists. A "live" broadcast of the performance would have been superior. There is nothing creative about the process of recording a sound program on a disc.

By contrast, a television transcription, if we may call it that, on motion-picture film, can be a medium for the creation of effects that could not be produced in a "live" broadcast. On film it is possible to build a program of far greater entertainment value than can be achieved in the studio before the electrical camera. Furthermore, the cost and effort of building such a program will be appreciably lessened by employing the medium of film.

There has been, and doubtless always will be, a debate as to how much of the satisfaction of watching a television picture depends on the knowledge that the persons seen on the fluorescent screen are actually standing in the flesh before the camera. The writer admits freely that no small part of the fascination of watching a televised football game, horse race, or tennis match will be inherent in the fact that the contest is taking place at that instant, with the outcome still uncertain. But when the object of a program is purely entertainment, it is his belief that the public will prefer the method of production which secures the greatest entertainment values. This means building programs in film and broadcasting them from film. Even in the field of sports the film transcription can furnish a desirable service. Certainly the writer would prefer to see a telecast of a world series game on the evening of the day it was played rather than not see it at all because

This is the first article of a series dealing with the use of sound motion picture film in television.—Editor.

it occurs during business hours. At least, if this attitude is not shared by the public in general, newspapers would do well to discontinue their sporting pages.

Be it understood that when the writer speaks of the greater resources which the motion-picture film brings to the program builder, he does not contemplate an era in which television transmitters will radiate feature motion-picture productions, so that the owner of a receiving set can sit in his home and see the equivalent of what he has been accustomed to enjoy in the theatre. There are several things wrong with that concept, but it will be sufficient to indicate one of them. Suppose Mr. Smith-Jones misses the beginning of the picture. Are we going to make it possible for him to stay and see it over again? The answer is evidently "No."

Television will undoubtedly develop its own distinctive type of program material, which will not be that of the stage, the movie house, or the popular magazine, and yet will derive some of its characteristics from each of these. But in seeking its own form of entertainment, television can ill afford to deny itself the freedom that the film technique has to offer.

Of what does this freedom consist? First of all, freedom from the tyranny of the clock. It has been said many times that in a direct television broadcast there are no retakes. The actors must be letter perfect in their lines, and must go from scene to scene without pause. Yet it is scarcely possible to go through the long series of rehearsals that lead to the smooth perfection of legitimate stage performances. All this the film technique can obviate. The period of preparing a program can actually be shortened, since the actors can learn their speeches for one scene, rehearse this scene until it is perfect, enact it for the camera and then pass on to the next. A perfect performance is assured, at the cost of much less effort

and nervous tension for all concerned.

In other ways the film technique removes limitations. Notably it removes limitations of space and time. If the script calls for an actor to go from his apartment into the street, the motion-picture camera can follow him there, and need keep no record of the time it took him to get there. The television camera conceivably can be made to do the one, but not the other.

Two important and related advantages of the film camera over the electrical camera are its greater depth of focus and its ability to function with lower levels of studio illumination. These advantages are likely to be transitory, as television pick-up apparatus is made more and more sensitive, but at present they are very real advantages.

Even in handling the sound part of an entertainment program, television may well borrow from the technique of the sound-motion picture. Programs for broadcast will hardly need the elaborate effects that Hollywood builds, in which as many as twenty sound tracks may be re-recorded into one, and where, to take one actual though extreme example, a record of the squeal of a pig, run backward at reduced speed, becomes a principal part of the rending sound that accompanies the splitting up of a glacier. Nevertheless, there will be many occasions when improved sound pickup can be obtained by such procedures as recording the sound first and then photographing the action to a synchronized playback. This method has been used for years in motion-picture production, especially in scenes where it would be difficult to place the microphone close enough for good pickup.

Since the motion-picture technique can be employed to such marked advantage in preparing television programs, we can well afford to consider from all angles the question of how and in what form films may best be employed. This requires a study of many factors, some purely technical, some economic. The articles which are to follow this one will treat a number of these factors in detail. The remainder of the present ar-

(Continued on page 30)



VETERAN WIRELESS OPERATORS ASSOCIATION NEWS



W. J. McGONIGLE, President

RCA Building, 30 Rockefeller Plaza, New York, N. Y.

H. H. PARKER, Secretary

DE FOREST DAY

ALL branches of the electrical communications and radio industries will join in a tribute of appreciation to Dr. Lee de Forest on the occasion of de Forest Day at the New York World's Fair 1939 during the week of September 17-23, 1939. A Jubilee Dinner will be held on some evening during that week at a prominent hotel in New York City. It is expected that all the leaders of the industries mentioned will be present to add their word of tribute to a great scientist and lovable character. Plans include Dr. de Forest's presence and participation. Our Association originated the idea of de Forest Day at the Fair and we are cooperating with all other interested agencies in bringing to fruition the Jubilee Dinner.

The Institute of Radio Engineers, American Institute of Electrical Engineers, Radio Manufacturers Association, National Association of Broadcasters, Radio Club of America, American Radio Relay League, American Association for the Advancement of Science and other organizations are expected to participate. Further details will be announced on this page in coming issues. The exact price has not been set for the Dinner but we welcome inquiries from our members and readers of COMMUNICATIONS regarding their ticket requirements. Your cooperation will be gratefully appreciated.

IN MEMORIAM

Raymond F. Trop, Chairman of our Boston Chapter at the time, died suddenly on February 16th, 1939, at the age of 53. Born November 28th, 1885, at Payne, Ohio, he enlisted in the Navy at the age of 17 and attended Electrical School at the Brooklyn Navy Yard. As a radio operator he was assigned to the U.S.S. *Connecticut* and operated at the Navy station NAD at the Boston Navy Yard. Upon leaving the Navy he was installing engineer for the Wireless Specialty Apparatus Company for five years. He held the rank of Lieut. J. G. at the start of the World War and was assigned as assistant to the District Communications Supt. of the First Naval District. Following the War, he affiliated with the Massachusetts Radio and Telegraph School as part owner and treasurer and continued this association for twenty years until his decease. Surviving are his widow and four children—three boys, all wireless operators, and one girl. Funeral services were attended by a representative group of his fellow VWOA members. Mr. Trop was the first wireless operator to contact the returning U. S. Fleet on the round-the-world cruise, for which he received a letter of commendation from the Navy and in later years our Association awarded him a Scroll of Honor.

We express our sincere condolences to his family and to our Boston Chapter in their great loss.

SAN FRANCISCO

A long and interesting report from Gilson Willets, Charter Member and Chairman of our San Francisco Chapter, re their very successful cruise on the 11th of February.

GVW says in part: "Our cruise was a great success. Had it not been for the cooperation and enthusiasm of "Bill" Fenton of Mackay Radio and Col. Stanford, U. S. Army Signal Corps, I fear the affair would not have turned out so well. They are grand fellows and real boosters for the Association.

"Enclosed you will find my personal check covering the following new members and renewals—Colonel Leland Stanford; Irwin L. Kaufman, who returns to the fold; C. L. McCarthy, who started operating in 1916 and is now with KJBS and KQW; W. W. Fanning, who started in 1904 and has been continuously active—at present doing experimental work for the Navy and Coast Guard—his numerous patents are familiar to all oldtimers; Fred Mangelsdorf, active in the Army and Federal Telegraph Company and at present a teacher in Oakland public schools—started in radio in 1917.

"Among those present at the cruise were: E. W. Neff, Lt. Cmdr. Huppert, USNR, Sydney Fass, C. H. Cannon, L. Fassett, C. L. McCarthy, D. Mann Taylor, Ray Farrell, E. H. Price, J. J. McArdle, Fred Mangelsdorf, H. H. Wickersham, Arthur Halloran, E. N. Sargent, Ray Meyers, Cmdr. W. J. Ruble, USN, Irwin L. Kaufman, Phil Vogel, N. O. Gunderson, F. J. Hill, C. T. Furlong, C. Pelmulder, Stephen Parkars, R. T. Spencer, W. H. Phillips, Fred G. Roebuck, A. J. Bookmyer, Elmer D. Freeman, Col. Stanford, Stanley W. Fenton, Master Sgt. L. C. Norton, USA, Lewis A. McClanahan, Andy B. Wauchape, Elmer D. Freeman, Edward D. Stevens, L. C. Rayment, D. Kennedy, and others.

"The first speaker was "Jim" Furlong, now in the Radio Laboratory at Mare Island who started his studies and experiments in 1898 and first operated in 1902. He briefly described the first wireless stations erected on the Pacific coast and their eventual fate. He told of the early stations on Telegraph Hill, Vernon Heights, the Palace Hotel (origin of "PH", now KPH) in 1904, the Occident and Orient Wireless Telegraph Company's station on Russian Hill, the early Massy and United Wireless stations and their work here. It was in 1910 that this illustrious wireless pioneer sent the first message out of Alaska.

"When Mr. Furlong finished, Mr. Fenton, otherwise "Bill", to the gang read a splendid tribute to the VWOA and warm greetings from Fred Dewey who was unable to attend due to a severe illness. The warmth of Fred Dewey's greetings was applauded with loud cheers. It was well re-

membered by many present that Mr. Dewey's efforts had much to do with the success of the first two VWOA cruises on the Pacific Coast.

"When Col. Stanford of the Presidio of San Francisco read an army net radiogram he had sent to Master Sgt. Morgan in Alaska notifying that heroic soldier of the award of a Marconi Memorial Scroll of Honor to him and Master Sgt's reply and that of his commanding officer and their appreciation of the award.

"Ray Meyers, holder of a VWOA Gold Medal, and 'entertainer extraordinary' then kept the meeting in 'stitches' for a considerable period with his dissertation on radio and his experiences with it. Ray introduced Commander Rubel, who has charge of all U. S. Navy Communications on the Pacific Coast, who in turn related some of his experiences dating back to 1909.

"Arthur Halloran, who first worked with wireless in 1896, gave a brief but impressive address in which he spoke very highly of our organization. Mr. Halloran edited *Radio* for many years and through him many of the pioneer Pacific Coast radio columns were published.

"Then after further informal discussion and reminiscing we adjourned to the proper place for liquid refreshments. All in all a most successful cruise—the unanimous opinion of those present."

STODDART

A telegram received from Richard Stoddart when he was notified of the award of a Marconi Memorial Scroll of Honor for his radio work on the Hughes Round-the-World flight in the plane "World's Fair 1939," follows:

"I am sincerely grateful to the Veteran Wireless Operators Association for the honor they have bestowed upon me. Especially so because it comes from a group of men with whom I have had the pleasure of working with during my ten years as a commercial ship and coast station operator. It is hardly necessary for me to say that whatever success was achieved in radio on the Round-the-World flight cannot possibly be credited to one person. The splendid cooperation given us by the ship and coast station operators, also the broadcast engineers, many of whom are members of the VWOA was vitally needed to make our flight a success. So in accepting this award from you I would rather not feel as a radio engineer who has done anything outstanding but as a representative of all the radiomen who helped to make this event a success. I wish to take this opportunity on behalf of Mr. Hughes and myself to extend to all radiomen everywhere our deep appreciation for the services which they so willingly rendered." (Signed) Richard R. Stoddart.

RADIO AT THE FAIR

(Continued from page 8)

action but actually take part in its programs. Receivers among the audience will enable them to see the participants. In addition there will be a number of receivers tuned to the various television transmitters in operation during the tenure of the Fair.

Visitors to the Westinghouse exhibit will also be invited to speak and act for a few minutes before a television camera located in a glassed-in studio. The other visitors can hear their voices and see them on one of the four Westinghouse receiving sets. About 125 persons can be accommodated at one time.

The Ford Motor Company will have a receiver installed in its executive lounge in the Ford Building for the entertainment of guests and as a means of advertising the line of cars. The idea is described as a gesture of courtesy and not as an indication that Ford will enter television manufacturing.

• • •

TELEVISION FUNDAMENTALS

(Continued from page 27)

strength must be high enough to override such interference of local origin. In general, a single transmitter of moderate power can cover a metropolitan area very well at these frequencies.

Television will not have reached the acme of development until it too has an interconnected network of stations from coast to coast. The short transmission range complicates this problem greatly for the type of interconnecting links that can transmit the necessary wide frequency bands are very expensive. Coaxial cables have been developed to the point where they can be used for such purposes, and the recent progress in the development of wave-guides, which are metallic tubes filled with some dielectric, appears to have merit for this purpose. Another possible means of interconnecting television transmitters lies in the utilization of highly directional beam radio transmitters. Frequencies of the order of hundreds of megacycles are ideally suited for the design of highly directional radiating systems. It seems entirely feasible to operate these receiving-transmitting relay links unattended. The cost of such systems, whether special land lines or radio links, is very high at the present state of development.

STANDARDS OF TELEVISION TRANSMISSION

For a successful service, it is necessary that any television receiver manufactured any place in the United States operates satisfactorily on trans-

missions from any television broadcast station in the United States. In order to accomplish this with such a complex system, the necessity for some close cooperation between manufacturers and television broadcasters is obvious. This cooperation has been realized in this country through the efforts of the Television Committee of the Radio Manufacturers Association¹⁰. This committee to formulate standards was composed of men representing practically all of the major television organizations. It is evident that if this committee mutually agrees upon television standards, the television industry which they represent will abide by them for the benefit of all, including the consumer.

This committee has been working since 1935, and it was not until the first of 1939 that the final decisions were completed. The Federal Communications Commission has made experimental allocations upon the basis of these standards. It is fortunate that such thorough investigation has preceded the formulation of these standards, for once adopted, they will tend to solidify techniques. The further the advance before solidification, the greater the net progress.

THE PROPOSED STANDARDS

Table I gives a summary of the standards proposed by the RMA Television Committee which are of the most interest at the receiving end. Fig. 3 shows graphically the location of the seven television channel assignments, each of 6-mc width. In addition to these seven channels between 44 and 108 mc, there are twelve additional 6-mc channels tentatively set aside for television between 156 and 294 mc. These are considered more important for relay and research purposes than for regular television broadcasting at the present time. To allow room for the increase in definition and the resulting increase in frequency bands, vestigial side-band transmission is contemplated. A typical channel (Channel I) is portrayed in Fig. 4 using vestigial transmission. One side-band (the upper one) is transmitted completely and 0.75 mc of the lower side band. Beginning at this point, the lower side band is attenuated as rapidly as possible with circuits available for operation at these frequencies. The overall band width is 6 mc. A 0.25-mc guard band is allowed between the upper edge of the channel and the sound carrier. The picture carrier is placed 4.5 mc below the sound carrier.

Because of the relative crowding of the region within the channel as shown by Fig. 4, and because television channels are adjacent to each other and to other services, it will be imperative that the lower side band transmitted ves-

tigially be cut off entirely within the channel limit. The need for highly selective receiver circuits is also evident.

(To be continued)

BIBLIOGRAPHY

- (1) Hartley, "Transmission of Information," *Bell System Technical Journal*, Vol. VII, No. 3, July 1928, p. 535.
- (2) Mertz and Gray, "A Theory of Scanning," *Bell System Technical Journal*, Vol. XIII, No. 3, July 1934.
- (3) Wilson, "Television Engineering" (Sir Isaac Pitman and Sons Ltd.), Chapter IV, "Analysis of Finite Aperture Scanning Methods"; Chapter XII, "Physical Limitations." (An excellent list of references is included at the end of each chapter.)
- (4) Jones, "Propagation of Wavelengths Between Three and Eight Meters," *Proc. Institute of Radio Engineers*, Vol. 21, No. 3, March 1933, p. 349.
- (5) Trevor and Carter, "Notes on Propagation of Waves Below Ten Meters in Length," *Proc. I.R.E.*, Vol. 21, No. 3, March 1933, p. 387.
- (6) Beverage, "Some Notes on Ultra-High-Frequency Propagation," *RCA Review*, January 1937. (Also giving extensive bibliography.)
- (7) Pock and Epstein, "Partial Suppression of One Side Band in Television Reception," *RCA Review*, January 1937.
- (8) Everest, "Amplification Problems of Television," *COMMUNICATIONS*, January 1938, p. 15.
- (9) Goldsmith, "Television Economics," *COMMUNICATIONS*, Feb. 1939, Section A-1, p. 18.
- (10) Murray, "Television Standards," *COMMUNICATIONS*, Dec. 1938, p. 14.

• • •

FILMS IN TELEVISION

(Continued from page 28)

ticle will be devoted to outlining briefly the ground to be covered.

Two standard sizes of sound-motion-picture films are in common use: 35 mm and 16 mm. Television-scanning equipment for both sizes of film has been built experimentally. 35-mm film gives a known high standard of performance, somewhat unnecessarily good as regards the picture. It gives sound reproduction at least equal to high-quality-sound broadcasts of the present time. But it is at a serious disadvantage economically. If a television broadcast service is eventually to be set up with a degree of coverage at all approximating that now obtained with sound broadcasting, the difference in cost between any reasonable program service to the stations on 35-mm film and on 16-mm film is enormous. It becomes worth while to study the technical requirements of the picture and of the sound with the greatest care, in order to determine how successfully they can be met with 16-mm film. Conceivably a standard differing in some respects from that commonly used will be the proper solution. Thus, for example, it has been proposed to run the 16-mm film at a

(Continued on page 32)

Purchasing Directory of COMMUNICATION INSTRUMENTS

The following pages contain information which we believe will be of assistance and value to all executives, engineers and purchasing agents in the field.

In presenting this data **COMMUNICATIONS** assumes no responsibility for omissions. We have attempted to supply comprehensive and accurate information in a usable form. Any omissions are unintentional and should be called to our attention.

For convenience we have listed both instruments and manufacturers. The numbers following the names and addresses of the manufacturers indicate the type of equipments available from those organizations.

THE INSTRUMENTS

Instrument	Key No.
Ammeters	(1)
Antenna Ammeters	(2)
A-F Oscillators	(3)
A-F Signal Generators	(3)
B-F Oscillators	(3)
Bridges	(4)
Capacitance Bridges	(4)
Capacitor Analyzers	(5)
Capacity Meter	(5)
C-R Oscilloscopes	(6)
Conductivity Bridges	(4)
Crystal Calibrators	(3-24-A)
Decade Boxes	(7)
Distortion & Noise Meters	(8)
Electrostatic Voltmeters	(9)
Field-Strength Measuring Sets	(10)
Frequency Indicators	(11)
Frequency Modulators	(12)
Frequency Monitors	(13)
Gain Indicators	(30)
Galvanometers	(30)
Impedance Bridges	(4)
Impedance Meters	(14)
Inductance Bridges	(4)
Inductance Meters	(14)
Insulation Testing Instruments	(15)
Kilovoltmeters	(30)
Megohmmeters	(15)
Meggers	(15)
Microammeters	(1)
Microvolts	(16)
Microvoltmeters	(30)
Milliammeters	(1)
Milliohmmeters	(18)
Millivoltmeters	(30)
Multivibrators	(3-24-A)
Neon Tube Oscilloscopes	(17)
Ohmmeters	(18)
Oscillators	(3, 24)
Oscillograph Wobblers	(19)
Output Meters	(20)
Phase Meters	(20)
Phase Monitors	(21)
Power-Factor Bridges	(4)
Power-Level Indicators	(22)
Q-Meters	(23)
QX-Checkers	(23)
R-F Oscillators	(24)
R-F Signal Generators	(24)
Ratio Meters	(25)
Receiver Analyzers	(26)
Resistance Analyzer & Indicator	(18)
Resistance Bridges	(4)
Resistor Tester	(18)
Signal Generators	(3, 24)
Sound Frequency Analyzers	(8)
Sound Level Meters	(8)
Square-Wave Generators	(27)
Television Testing Equipment	(27)
Thermo-Ammeters	(2)
Thermocouples	(28)
Tube Testers	(29)
Universal Bridges	(4)
Vacuum-Tube Bridge	(4)
Vacuum-Tube Thermocouples	(28)
Vacuum-Tube Voltmeters	(30)
Video Sweep Oscillators	(27)
Voltammeters	(1, 30)
Voltmeters	(30)
Volt-Milliammeters	(1, 30)
Volt-Ohmmeters	(18, 30)
Volt-Ohm-Milliammeters	(1, 18, 30)
Volume-Level Indicators	(31)
Wave Analyzers	(32)
Wave Meters	(33)

THE MANUFACTURERS

AEROVOX CORP., New Bedford, Mass. 4, 5.

- APPROVED TECHNICAL APPARATUS CO., 57½ Dey St., New York, N. Y. 1-18-30, 5, 18, 29.
- ASSOCIATED RESEARCH, INC., 16 N. May St., Chicago, Ill. 4, 18, 15.
- VICTOR J. ANDREW, 6429 S. Laverne Ave., Chicago, Ill. 2, 10, 21, 24.
- BALLANTINE LABORATORIES, INC., Boonton, N. J. 8, 30.
- ALFRED W. BARBER LABORATORIES, 35-33 172nd St., Flushing, N. Y. 14, 27.
- BENDIX RADIO CORP., Baltimore, Md. 3-24-A, 10, 13, 29.
- JAMES G. BIDDLE CO., 1211-13 Arch St., Philadelphia, Pa. 5, 11, 15, 18.
- BOONTON RADIO CORP., Boonton, N. J. 3, 23, 24.
- THE BRISTOL CO., Waterbury, Conn. 1, 30.
- BROWN INSTRUMENT CO., 4482 Wayne Ave., Philadelphia, Pa. 30.
- BURTON-ROGERS CO., 857 Boylston St., Boston, Mass. 1, 3, 18, 22, 24, 26, 29, 30.
- CINEMA ENGINEERING CO., 1508 S. Verdugo, Burbank, Calif. 4, 7, 30, 31.
- THE CLOUGH-BREngle CO., 2815 W. 19th St., Chicago, Ill. 1-18-30, 3, 4, 6, 16, 22, 24, 29, 30.
- COLUMBIA ELECTRIC MFG. CO., 4519 Hamilton Ave., N. E., Cleveland, Ohio. 1.
- COMMERCIAL RADIO EQUIPMENT CO., 7205 Baltimore St., Kansas City, Mo. 13.
- CONSOLIDATED WIRE & ASSOC. CORPS., Peoria & Harrison Sts., Chicago, Ill. 5, 22, 29.
- THE DAVEN CO., 158-160 Summit St., Newark, N. J. 7, 22, 30.
- DAYCO RADIO CORP., Dayton, Ohio. 1-30, 3, 6, 24, 29.
- DEJUR-AMSCO CORP., Shelton, Conn. 1, 18, 30.
- TOBE DEUTSCHMANN CORP., Canton, Mass. 4, 5, 8.
- DOOLITTLE & FALKNER, INC., 7421-23 S. Loomis Blvd., Chicago, Ill. 10, 11.
- ALLEN B. DUMONT LABORATORIES, INC., 2 Main Ave., Passaic, N. J. 6, 27.
- ELECTRICAL RESEARCH PRODUCTS, INC., 195 Broadway, New York, N. Y. 8.
- THE ESTERLINE-ANGUS CO., Indianapolis, Ind. 1, 18, 30.
- FEDERAL TELEGRAPH CO., 200 Mt. Pleasant Ave., Newark, N. J. 10.
- FERRANTI ELECTRIC, INC., 30 Rockefeller Plaza, New York, N. Y. 30.
- FERRIS INSTRUMENT CORP., Boonton, N. J. 3, 3-24-A, 8, 10, 24, 30.
- GENERAL ELECTRIC CO., Schenectady, N. Y. 1, 3, 6, 18, 24, 29, 30.
- GENERAL RADIO CO., 30 State St., Cambridge, Mass. 3, 3-24-A, 4, 6, 7, 8, 11, 12, 13, 24, 28, 30, 32, 33.
- G-M LABORATORIES, INC., 1733 Belmont Ave., Chicago, Ill. 30.
- THE HICKOK ELECTRICAL INSTRUMENT CO., 10514 Dupont Ave., Cleveland, Ohio. 1, 3, 5, 6, 11, 18, 22, 24, 26, 29, 30.
- IDEAL COMMUTATOR DRESSER CO., 1236 Park Ave., Sycamore, Ill. 15.
- INDUSTRIAL INSTRUMENTS, INC., 162 W. 23rd St., Bayonne, N. J. 4.
- INTERNATIONAL RESISTANCE CO., 401 N. Broad St., Philadelphia, Pa. 18.
- JACKSON ELECTRICAL INSTRUMENT CORP., Dayton, Ohio. 3, 5, 6, 18, 24, 29, 30.
- LAMPKIN LABORATORIES, Bradenton, Florida. 11.
- LEEDS & NORTHRUP CO., 4902 Stenton Ave., Philadelphia, Pa. 4, 7, 11, 15, 30.
- FRED M. LINK CO., 15 E. 26th St., New York, N. Y. 13.
- JOHN MECK INSTRUMENTS, 164 N. May St., Chicago, Ill. 4, 8, 29.
- MILLION RADIO & TELEVISION, 685 W. Ohio St., Chicago, Ill. 1-18-30, 29, 30, 31.
- MONARCH MANUFACTURING CO., 3343 Belmont Ave., Chicago, Ill. 3, 4, 8, 22, 24, 30.
- THE MUTER CO., 1255 S. Michigan Ave., Chicago, Ill. 4, 7.
- OHMITE MANUFACTURING CO., 4835 Flournoy St., Chicago, Ill. 7.
- PHILCO RADIO & TELEVISION CORP., Tioga & C Sts., Philadelphia, Pa. 1-18-30, 3, 5, 6, 22, 24, 26, 29.
- PRECISION APPARATUS CORP., 821 E. New York Ave., Brooklyn, N. Y. 1-18-30, 24, 29.
- PREMIER CRYSTAL LABORATORIES, 55 Park Row, New York, N. Y. 11.
- RCA MANUFACTURING CO., INC., Camden, N. J. 3, 3-24-A, 4, 6, 8, 10, 12, 20, 22, 24, 27, 29, 31.
- RADIO CITY PRODUCTS CO., INC., 88 Park Pl., New York, N. Y. 1-30, 24, 26, 29.
- RADIO ENGINEERING LABS., INC., 35-54 36th St., Long Island City, N. Y. 33.
- RADIO TRANSCEIVER LABS., 8627 115th St., Richmond Hill, N. Y. 10.
- RAWSON ELECTRICAL INSTRUMENT CO., 110 Potter St., Cambridge, Mass. 1, 18, 30.
- READRITE METER WORKS, 136 E. College Ave., Bluffton, Ohio. 1-18-30, 3, 5, 22, 24, 26, 29.
- RELIANCE INSTRUMENT CO., 1135 Van Buren St., Chicago, Ill. 1, 30.
- ROLLER-SMITH CO., 233 Broadway, New York, N. Y. 1, 30.
- SENSITIVE RESEARCH INSTRUMENT CO., 4545 Bronx Blvd., New York, N. Y. 1, 9, 18, 25, 28, 30.
- SERVICE INSTRUMENTS, INC., 404 4th Ave., New York, N. Y. 18, 26, 30.
- SHALLCROSS MFG. CO., 10 Jackson Ave., Collingsdale, Pa. 4, 7, 15, 18, 22, 27, 30.
- SIMPSON ELECTRIC CO., 5216-18 W. Kinzie St., Chicago, Ill. 1, 18, 26, 29, 30.
- SOLAR MANUFACTURING CORP., 599 Broadway, New York, N. Y. 5.
- SOUND APPARATUS CO., 150 W. 46th St., New York, N. Y. 22.
- STANDARD PIEZO CO., 126 Cedar St., Carlisle, Pa. 11, 13.
- THE STERLING MFG. CO., 9205-23 Detroit Ave., Cleveland, Ohio. 1, 18, 30.
- SUNDT ENGINEERING CO., 4238 Lincoln Ave., Chicago, Ill. 17.
- SUPERIOR INSTRUMENTS CO., 136 Liberty St., New York, N. Y. 1-18-30, 3, 3-24, 26, 29, 30.
- SUPREME INSTRUMENTS CO., Greenwood, Miss. 1-18-30, 6, 7, 12, 24, 26, 29.
- TECH LABORATORIES, 7 Lincoln St., Jersey City, N. J. 4, 22, 31.
- TELEVISO CO., 337-45 N. Pulaski Rd., Chicago, Ill. 3, 16, 24, 30.
- THWING-ALBERT INSTRUMENT CO., 3323 Lancaster Ave., Philadelphia, Pa., 28, 30.
- THE TRIPLET ELECT. INST. CO., Bluffton, Ohio. 1, 1-18-30, 2, 3, 4, 5, 6, 18, 22, 24, 29, 30.
- TRIUMPH MANUFACTURING CO., 4017-19 W. Lake St., Chicago, Ill. 1-18-30, 3, 6, 19, 24, 29.
- UNITED SOUND ENGINEERING CO., 2233 University Ave., St. Paul, Minn. 3, 6, 24.
- WESTERN ELECTRIC CO., 195 Broadway, New York, N. Y. 8, 10, 13, 21, 31.
- WESTINGHOUSE ELECTRIC & MFG. CO., E. Pittsburgh, Pa. 1, 18, 30.
- WESTON ELECTRICAL INSTRUMENT CORP., Frelinghuysen Ave., Newark, N. J. 1, 1-18-30, 3, 5, 18, 22, 24, 26, 27, 28, 29, 30, 31.



... only a
Hummingbird

but Speed and Skill Prevail against Size!

No larger than this tiny master of the air—small Relays by Guardian possess surprising ability to overcome many perplexing design and assembly problems, where like the big-bodied eagle . . . bulky electrical controls and mechanical methods become too involved, too power-consuming, too awkward and slow to compete with the compact efficiency of Relays by Guardian.

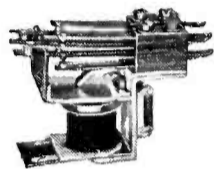

Series 110 AC Relay

Your controls may consist of small, compact stepping switches, contact switches, solenoids, time-delay, muting and holding relays—singly—or in combination with discs, metal housings, brackets, leads and special parts.

Here, at Guardian, you can get all these PLUS a better control completely designed, fabricated and tested in one plant ready for immediate production assembly.

ANY QUANTITY AS YOU WANT THEM—WHEN YOU WANT THEM

Submit Your Problem—Let Guardian Solve It.
It Will PAY to Write for Catalog "C" Today!

GUARDIAN  **ELECTRIC**
1623 W. WALNUT STREET CHICAGO, ILLINOIS

RCA APPOINTMENTS

Frank E. Mullen, Manager of the Department of Information, was elected Vice-President in Charge of Advertising and Publicity for the Radio Corporation of America, it was announced today by David Sarnoff, President, following the regular meeting of the Board of Directors.

Mr. Horton Heath, Assistant to Mr. Mullen, was promoted to Manager of the Department of Information, which will continue under Mr. Mullen's direction.

DRIVER EXHIBIT

Wilbur B. Driver Company, Newark, N. J., manufacturers of "Tophet" Resistance Wire, are having an exhibit at the New York World's Fair, in the Metals Building directly opposite the Trylon. The exhibit will feature the various stages of the manufacture of "Tophet" from the ingot as cast to the finished material. There will also be shown numerous finished products in which "Tophet" is used.

ARTHUR D. LITTLE APPOINTMENT

Arthur D. Little, Inc., industrial research organization of Cambridge, Massachusetts, has reported the election of Charles E. Spencer, Jr., President of the First National Bank of Boston, to its Board of Directors.

SICKLES BULLETIN

The F. W. Sickles Co., 300 Main St., Springfield, Mass., have made available a bulletin describing in considerable detail their line of television coils and transformers. To secure a copy write to the above organization.

RECORDING BLANKS BULLETIN

Duralite, a new type of instantaneous recording blank, is discussed in a bulletin available from Musicraft Records, Inc., 10 W. 47th St., New York City. Features, prices and specifications are given.

TACO BULLETIN

Technical Appliance Corporation, 17 E. 16 Street, New York City, have recently issued a bulletin on television antennas. Copies may be secured without charge from the above organization.

IRC VOLUME CONTROL GUIDE

The International Resistance Company, 415 N. Broad Street, Philadelphia, Pa., have recently issued a volume control and resistor guide. The IRC line of volume and tone controls, resistors and attenuators are covered in considerable detail. In addition, a great deal of other valuable information is included. Copies may be secured from the above organization.

ULRICH JOINS HYTRON

Vinton K. Ulrich became Advertising and Sales Manager of the Hytronic Laboratories, the research and electronic division of the Hytron Corporation, announces G. J. Hallam, General Sales Manager. The Laboratories manufacture amateur transmitting tubes. "Bantam Juniors" for hearing aids, and electronic tubes for diathermy machines and industrial applications. Mr. Ulrich will make his office at the Hytron plant, 76 Lafayette Street, Salem, Massachusetts.

FILMS IN TELEVISION

(Continued from page 30)

speed of 45 feet per minute instead of the standard 36 feet. This gives 30 frames per second instead of 24, which simplifies the construction of the television scanning machine. At the same time it makes easier the attainment of a given standard of sound quality. These advantages must be weighed against the disadvantage of inability to use films produced originally for theatrical purposes, except as these may be made available by special printing operations to convert them from 24 to 30 frames per second.

The motion-picture industry today is experimenting on a larger scale than ever before with new film stocks, which require changes in production methods, but bring significant advances in both picture and sound quality. Some of these new types of film permit revolutionary improvements in the performance of 16-mm sound films. It is especially important to take this factor into account in deciding what dimensional standards are necessary for television.

A major element in the building of television programs on film will be the availability of suitable film laboratory service. For some applications such as sports programs, extremely rapid processing of films will be necessary, yet this must be accomplished without loss of quality. For programs that are to be syndicated, rapid production and distribution of large numbers of copies will be a problem, to a far greater extent than is now the case in theatrical distribution of films. Almost without doubt new methods will have to be developed to cope with these requirements.

Television will create many new jobs for motion-picture cameramen and sound-recording engineers. These men will need to be adaptable, since the exigencies of program production will place a premium on resourcefulness and ingenuity. It is not conceivable that the highly-specialized type of production organization to which Hollywood is accustomed could meet the needs of the television industry. Costs would mount out of all practicability, even if this type of organization could succeed in producing enough finished program material to meet the demand.

Each of the above topics is susceptible of detailed analysis from the engineering and economic standpoints. These analyses will be presented, and definite conclusions will be drawn. Should these conclusions be disputed, it is felt that only general enlightenment can result from the ensuing discussion.

SIMILITUDE PRINCIPLES

(Continued from page 16)

$$\left(\frac{\omega_1}{\omega_2}\right) \frac{\omega_1 L_1}{Q} = \left(\frac{\omega_1}{\omega_2}\right) R_1 \quad (5)$$

Now it is seen that since every impedance of Network No. 2 bears the same ratio to the corresponding impedance in Network No. 1, then the gain versus frequency characteristic of the new network (Fig. 3) will show the same gain at ω_2 as appears in Fig. 1 at ω_1 .

Now there will be some frequency $(\omega_1 + \delta_1)$, at which the gain for Network No. 1 will be equal to the gain which Network No. 2 has at some frequency $(\omega_2 + \delta_2)$, in which the relation between δ_1 and δ_2 is yet undetermined. The impedances of the two networks at these two frequencies are listed in the following table in which it is assumed that the Q of all coils is constant over the band of each amplifier.

	Network No. 1	Network No. 2
Capacitances:	1	1
	$(\omega_1 + \delta_1) C$	$(\omega_2 + \delta_2) C$
Inductances:	$(\omega_1 + \delta_1) L_1$	$(\omega_2 + \delta_2) L_2$

Resistances:

$$\left(1 + \frac{\delta_1}{\omega_1}\right) R_1 \quad \left(1 + \frac{\delta_2}{\omega_2}\right) R_2$$

It will be seen that if

$$\delta_2 = \frac{\omega_2}{\omega_1} \delta_1 \quad \dots \dots \dots (6)$$

then

$$\frac{1}{(\omega_2 + \delta_2) C} = \left(\frac{\omega_1}{\omega_2}\right) \frac{1}{\left(\omega_1 + \frac{\omega_1}{\omega_2} \delta_2\right) C}$$

$$\left(\frac{\omega_1}{\omega_2}\right) \frac{1}{(\omega_1 + \delta_1) C} \quad \dots \dots \dots (7)$$

$$(\omega_2 + \delta_2) L_2 = \left(\frac{\omega_1}{\omega_2}\right) \left(\omega_1 + \frac{\omega_1}{\omega_2} \delta_2\right)$$

$$\left(\frac{\omega_2}{\omega_1}\right) L_2 = \left(\frac{\omega_1}{\omega_2}\right) (\omega_1 + \delta_1) L_1 \quad (8)$$

$$\left(1 + \frac{\delta_2}{\omega_2}\right) R_2 = \left(1 + \frac{\delta_1}{\omega_1}\right) \left(\frac{\omega_1}{\omega_2}\right) R_1 =$$

$$\left(\frac{\omega_1}{\omega_2}\right) \left(1 + \frac{\delta_1}{\omega_1}\right) R_1 \quad \dots \dots \dots (9)$$

In other words, all impedances of Network No. 2 at frequency $(\omega_2 + \delta_2)$ will bear the same ratio to the corresponding impedances in Network No. 1 at frequency $(\omega_1 + \delta_1)$. The ratio of band

Engineers you know will be glad to tell you about Fairchild

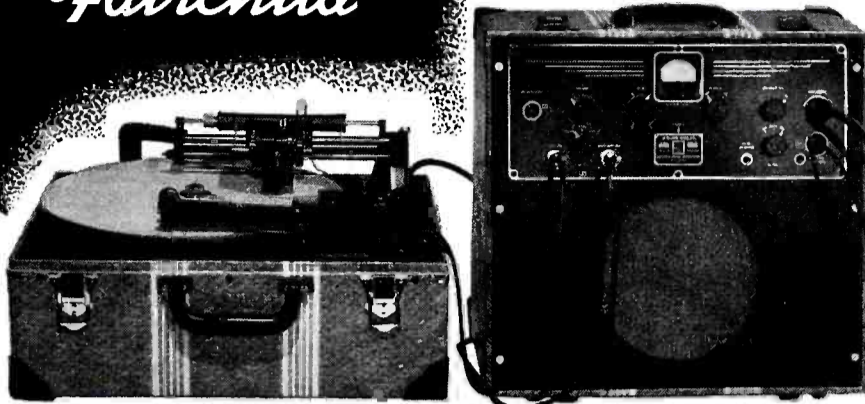

You're sure to know at least a few of the hundreds of engineers who use Fairchild F.26-2 Recorders. Just ask them to tell you about the results they achieve with this equipment. You'll find they're as proud of these fine precision instruments as we are.

For Fairchild sound recording equipment paces the industry. For example, the Fairchild F.26-2 Recorder has:

1. High gain amplifier to permit the use of a microphone without the necessity of a pre-amplifier.
2. Instantaneous change of speed from 33 1/3 RPM to 78 RPM through push button control.
3. Floating motor mount to eliminate all possibility of objectionable motor vibration.
4. Direct synchronous speed gear and worm drive at 33 1/3 RPM to assure split second timing for wow free recorded programs.
5. Provision within the Recorder itself for variation of pitch and direction of cut. No expensive additional feed screws necessary.
6. Dynamically balanced 16 pound cast-iron turntable.

The Fairchild Recorder is a complete unit. It is instantly ready to record on any type of disc up to 17 1/4". With the exception of the microphone and stand, no additional purchases are necessary.

Send today for descriptive literature.

"... it had to satisfy Fairchild first"



FAIRCHILD

Sound Equipment Division

AERIAL CAMERA CORPORATION
88-06 Van Wyck Boulevard, Jamaica, L. I., N. Y.

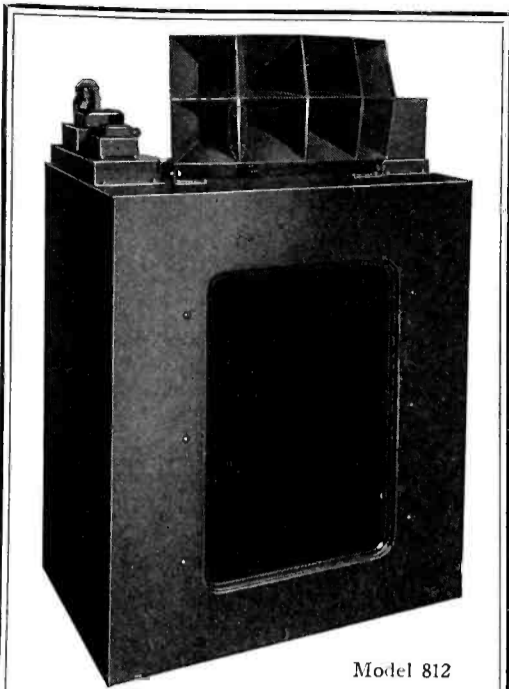

Model 812

**ICONIC
THEATRE QUALITY
SPEAKER SYSTEMS**

Broadcast engineers will like the Iconic because, whether in monitor or audition room, each voice and instrument is heard in its true natural tones. Operators of small theatres and school auditoriums will like the theatre quality with which ICONIC meets their every requirement. For full information about the Iconic System, sound reproducers, theatre systems, or speakers see your dealer or write

LANSING MANUFACTURING CO.
6900 McKinley Ave. Los Angeles, Calif.

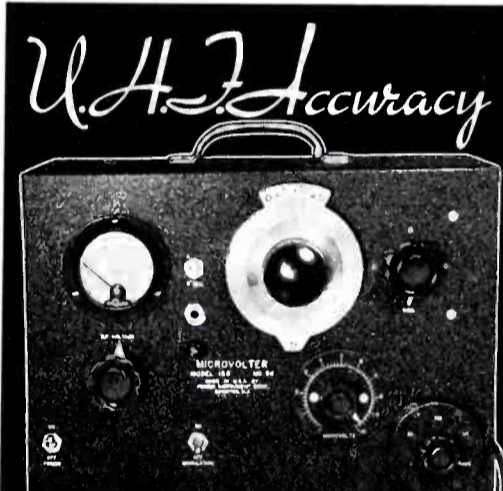

U. H. Accuracy

**FERRIS MODEL 18-B
MICROVOLTER**

- ★ Extends frequency range covered by Signal Generator to 100 megacycles.
- ★ Additional coil to extend range to 150 megacycles.
- ★ Ferris transmission line output system eliminates connecting lead errors.
- ★ Output up to 100,000 microvolts across fixed 14 ohms.
- ★ Write for data on this and other Ferris Signal Generators.

FERRIS INSTRUMENT CORPORATION
BOONTON, NEW JERSEY

width of Network No. 2 to Network No. 1 is obviously ω_2/ω_1 .

The above may meet with objection in the case of amplifiers which contain lumped resistances because the resistances in the table were all assumed to vary with frequency in such a way as to maintain constant Q. Admittedly this will not always be the case. However, if the resistances are assumed not to vary with frequency at all, then the ratio of R_2 to R_1 remains ω_1/ω_2 at all frequencies so that all the above statements are still true.

If the previous analysis were carried through with respect to the ratio of output voltage to input current, as would be needed for tubes with high plate resistance, we would find a marked change in the conclusions: namely, for voltage-to-voltage ratio considerations an amplifier may theoretically be built to give a broader band-width at the same gain at a higher frequency directly in the ratio of frequencies. For voltage-to-current ratio considerations a network may theoretically be designed at a higher frequency to give a broader band-width at a higher frequency directly in the ratio of frequencies but the gain for this network will go down inversely with frequency so that the product of gain and band-width will remain constant.

**CHANGE OF BAND-WIDTH WITH
TERMINAL CAPACITIES**

Proceeding as before, if the terminal condensers are altered in a given ratio n , then a new network may be designed having the same structure as the original but with the numerical values of the design parameters altered so that if C_1 and C_2 represent any condenser in the original and the new network respectively, then:

$$\frac{1}{\omega C_2} = \left(\frac{1}{n}\right) \frac{1}{\omega C_1} \dots\dots\dots (10)$$

Thus if

$$L_2 = \left(\frac{1}{n}\right) L_1 \text{ and } R_2 = \left(\frac{1}{n}\right) R_1$$

$$\omega L_2 = \left(\frac{1}{n}\right) \omega L_1 \dots\dots\dots (11)$$

$$R_2 = \left(\frac{1}{n}\right) R_1 \dots\dots\dots (12)$$

The new network will have a voltage-to-voltage ratio which is for all frequencies the same as the original network. Thus, for this case, the frequency characteristic and the band-width will remain the same. If, however, the voltage-to-current ratio must be considered, then, since the impedance of the entire network has been changed in the ratio $1/n$, the gain of the new network is also changed everywhere in the ratio $1/n$.



Distinctive

 Convenience, gracious service and quiet luxury distinguish this world famous hotel. Here an atmosphere of true refinement is enjoyed by the most discriminating.

Under the same management as the internationally famous Gotham, New York City; Drake, Chicago; and Town House, Los Angeles.

A. S. KIRKEY
Managing Director

The Blackstone
MICHIGAN AVENUE
CHICAGO

**WHEN YOU CHANGE
YOUR ADDRESS**

Be sure to notify the Subscription Department of COMMUNICATIONS at 19 E. Forty-seventh St., New York City, giving the old as well as the new address, and do this at least four weeks in advance. The Post Office Department does not forward magazines unless you pay additional postage, and we cannot duplicate copies mailed to the old address. We ask your cooperation.

MICROMETER FREQUENCY METER



... an accurate, AC-operated, heterodyne meter; ONE instrument will check several transmitters, 1.5 to 56 mc., within 0.01%.

- **RATIO-COUPLED OSCILLATOR:** stability 5 to 10 times that of usual circuits; temperature coefficient less than 2 cycles/10°/°C.; line voltage effect 1 cycle per million for 1% change.
- **MICROMETER CONDENSER:** rugged cylinder-and-tube construction on regular micrometer head—no flimsy plates.
- **PRECISION DIAL:** rotates micrometer head, has 50-turn range and Veeder counter, reads to 10,000 divisions.
- **PER CENT DEVIATION CURVES:** results readily compared with FCC tolerances.

—Write today for data—

LAMPKIN
LABORATORIES
BRADENTON . . . FLORIDA

HIGH-FIDELITY RECEIVER

(Continued from page 15)

lines from the potentiometers go to two other triode element grids, one reacting its grid through a non-resonant low-pass filter, the other through a non-resonant high-pass filter. The output of the three tubes is joined in the plate circuit. Obviously, at this point, when the potentiometers are at full, the pass frequencies of the filters will be greater in magnitude than other frequencies by approximately the loss in the linear voltage divider, minus any loss in the filters.

By proper adjustment of the volume control and the bass and treble controls any degree of compensation between the two extremes shown by the curves may be had. Of course, full positive compensation should only be used when operating at extremely low volume. The greater the loudness of the reproduction the less compensation needed until at the maximum loudness of which the set is capable the compensation controls should be set at the minimum position, which, because of the distributed constants in the cable and elsewhere results in the proper shape of response curve for this condition.

To employ ample compensation as is done here a relatively large power output must be available. For instance,

when 16 db of bass compensation is used a fifty cycle note will demand the full 10 watts output of which the amplifier is capable when the middle frequency is only 0.25 watt. As this is a good setting for the average living room it makes it obvious that any instrument with lower output must either overload on the bass or be insufficiently compensated. The physical dimensions of amplifier chassis are as follows:—length, 17 inches; width 9 $\frac{5}{8}$ inches, and 6 $\frac{3}{4}$ inches high overall.

So that record reproduction may be controlled from the remote r-f chassis, the crystal pickup output is fed through one of the 6C8G triode elements which is used as a line-matching device. The output of this tube is delivered to a shielded wire in the cable which connects to the phono-radio switch on the r-f chassis. The remaining two triodes are used in an inverter circuit which feeds the 6A3 push-pull output stage. The fidelity curve is shown in Fig. 2.

To keep the entire design on the same high plane only Class "A" amplification has been used throughout and only triode tubes in the audio amplifier. A 10-kc filter is provided for use when needed.

The actual reproduction of the sound has been entrusted to a special twelve-inch high-fidelity permanent-magnet speaker. This gives an advantage over any electric field speaker which requires a hum-bucking coil to eliminate hum. The very presence of the hum-bucking coil is an admission of an a-c component to the flux density in the air gap. Although the hum-bucking coil sets up in the voice-coil circuit an equal and opposite emf to that generated in the voice coil itself by the a-c flux and thus makes the speaker quiet when no signal is applied, it does not prevent this a-c flux from modulating any signal when it is applied. This effect does take place, and it can be very easily proven either mathematically or experimentally.

For best results, the special high-fidelity speaker should be mounted in a cabinet of heavy wood, braced on all large surfaces and lined with sound absorbing material. Cabinets built of 5-ply, 13/16-in. thick paneling, cross braced, with nominal 1x3-in. lumber strips screwed to the large surfaces such as the back, and lined with Ozite, a sound absorbing material, have proved satisfactory.

The interior cubical content of the cabinet should be 12,000 cubic inches, or larger if possible, and in no case less than 10,000 cubic inches, if good low-frequency is desired. A cabinet with outside dimensions of 36x36x11-in., with the speaker mounting in the



IT'S GRAND FOR BANDS

New MULTI-UNIT Crystal Microphones provide maximum amplification and cannot be acoustically overloaded. Performance, flexibility and beauty all combined. List price, MU-2, complete, \$29.50

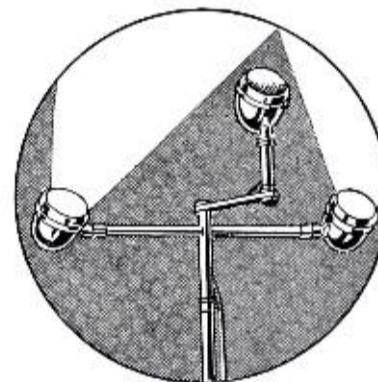

New MIKE-LITE Gives Great Delight

This includes Model T-3 Crystal Microphone with two adjustable spotlights that throw a flattering halo of soft, warm light on entertaining artists and speakers. Complete, as described, with stand, transformer and cable. List Price, \$62.50



We'll Be Seein' You

Astatic's complete line of quality crystal microphones and pickups will be on display at the Chicago Radio Parts Show. Don't miss this important exhibit.

**ASTATIC MICROPHONE
LABORATORY, Inc.**
YOUNGSTOWN, OHIO

Licensed Under Brush Development Co. Patents

Astatic Patents
Pending

You and your associates can obtain a year's subscription to **COMMUNICATIONS** (12 issues) for only \$1.00 each by using the Group Subscription Plan.

A regular yearly subscription to **COMMUNICATIONS** costs \$2.00 — but when four or more men sign up at one time, each one is entitled to the half-price rate. (Foreign subscribers on the "G-S-P" only pay \$2.00 each).

COMMUNICATIONS

19 E. 47th St., N. Y. C.

Please enter annual subscriptions (12 issues) for each of the undersigned for which payment is enclosed at the rate of \$1.00 each. (This rate applies only on 4 or more subscriptions when occupations are given.) Foreign Subscriptions are \$2.00 each.

Name
 Street
 City-State
 Occupation or title
 Employed by
 Nature of business
 (State if Manufacturer, Broadcast Station, etc.)
 Product

Name
 Street
 City-State
 Occupation or title
 Employed by
 Nature of business
 (State if Manufacturer, Broadcast Station, etc.)
 Product

Name
 Street
 City-State
 Occupation or title
 Employed by
 Nature of business
 (State if Manufacturer, Broadcast Station, etc.)
 Product

Name
 Street
 City-State
 Occupation or title
 Employed by
 Nature of business
 (State if Manufacturer, Broadcast Station, etc.)
 Product

center of one large face and the other one strongly braced has been found satisfactory. The cabinet should be practically air tight except for the speaker opening. Care should be taken so that all parts are very tightly fitted and glued where possible, or buzzes will result.

WESTERN ELECTRIC BULLETIN

The 2A Phase Monitor is described in a bulletin now available from the Western Electric Company, 195 Broadway, New York City. The phase monitor has been especially designed to facilitate the adjustment of directional antenna arrays.

RECEIVER CHARACTERISTICS

(Continued from page 13)

has an important effect upon it.

The rectification may be caused by poor joints in the antenna itself, by metal lath touching a steam pipe, by a loose ground connection on the electrical supply neutral or any similar case of loose contact between two conductors. Since such a rectifier is needed to form combination frequencies, and since it must be close to the receiving antenna in order for any appreciable energy of the combination frequencies to be induced therein, it can be understood why external cross-modulation does not exist in all receiving locations, even where field intensities of the proper order of magnitude are present. However, where it does occur, external cross-modulation interference is decidedly objectionable. Before its cause was determined about four years ago, it was highly mysterious in origin. From the conventional power-series expansion of two cosine terms the resultant new frequencies generated by the external non-linear element can be determined.

If a and b are the applied frequencies the resultant frequencies are: $a + b$, $a - b$, $2a + b$, $2a - b$, $2b + a$, $2b - a$, $2a$, $2b$, etc.

The frequencies which usually cause difficulty are those given by the $2a - b$

or $2b - a$ terms as many of the others fall outside the broadcast band. For example if there are broadcast stations at 700 kc and at 800 kc new frequencies of 600 kc, 900 kc, 1400 kc, 1,600 kc, etc., will be generated by a non-linear element and may be present as spurious responses on a receiver in proximity thereto.

The most comprehensive survey of cross modulation so far, is one undertaken by the Radio Manufacturers Association in Seattle during the past year. Seattle was chosen for study because of extensive reports of external cross modulation there, which were found to be due in large measure to the presence of three broadcast stations close together, two of them using a common antenna, and located near the population center. The complete results of this survey are expected to be published in the near future.

The power-series expansion shows that the output of the $2a - b$ term is proportional to the product of the square of one voltage and the first power of the other voltage (field intensity).

The Seattle survey showed that in receiving locations where external cross-modulation interference existed, the product of field intensities was greater than 0.1×10^{-3} volts cubed. That is, if the field intensities of two stations were equal at a given locality each was required to have an intensity of 100 mv per meter. Many locations with this field intensity present did not have such interference because the non-linear element was not present.

It may be seen that in order to prevent occurrence of external cross-modulation, two or more transmitters should be located so that the 100 mv contour lines do not overlap.

AUTOMATIC VOLUME CONTROL

There is one more receiver characteristic, which, while it does not have to do with interference problems, is of interest to broadcasters from the aspect of

DEFEAT DIRT—ENEMY OF COMMUNICATION EQUIPMENT!

IDEAL JUMBO CLEANER

BLOWS VACUUMS SPRAYS

Ends "dirt costs" on delicate electrical equipment and precision instruments.
3 Features. Blows or vacuums dust, dirt, and filth from inaccessible places. Sprays all liquids.
Dry Air Stream at Low Pressure—eliminates corrosion or damage to delicate parts or adjustments.
Powerful—full 1 H.P. Universal motor—blows high velocity, low pressure air stream—24,200 ft. per minute.
Portable—weighs only 14 pounds.
Versatile—many special attachments—can be used for a wide variety of cleaning operations.

ASK ABOUT FREE TRIAL DEMONSTRATION

Electrical Products Division

IDEAL COMMUTATOR DRESSER COMPANY
 1062 PARK AVENUE SYCAMORE, ILLINOIS

Inexpensive



Finer than Gossamer

**.001" WIRE
MAGNIFIED
1,000 TIMES**

**.000035" WIRE
(THE FILAMENT USED IN A 1/200
AMP. INSTRUMENT LITTELFUSE)
Magnified 1,000 TIMES**

**1/200 AMP.
INSTRUMENT
LITTELFUSE**

THE fine platinum wire used in a 1/200 amp. Instrument Littelfuse is so small, so delicate, so fine that even when magnified 1,000 times, the cross-section is actually smaller than the period at the end of this sentence. It takes good fuses to protect the most delicate instruments—and when it's a question of high-speed fuses that protect, Littelfuse makes them. Write for your copy of the Littelfuse catalog.

LITTELFUSE INCORPORATED
4242 LINCOLN AVE. CHICAGO, ILL.



Monarch Output Meter

MONARCH Model 41 Output Meter measures audio frequency power output directly in watts. No calculations or accessory equipment required.

Five power output ranges provided from .0025 to 25 watts. Eleven impedance values for quickly matching any power tube or combination of tubes.

Makes standard tests on public address systems and receivers for sensitivity, fidelity, band width, power output, AVC action, hum and noise levels.

Send for details.

MONARCH MFG. CO.

3341 W. Belmont Ave.
CHICAGO, ILL.

fading considerations. This is the automatic-volume-control characteristic.

The avc figure of merit of a receiver is expressed as the number of decibels below 100,000 μ v the input can be reduced before the output is reduced 10 db, the volume control being set so that audio overload does not occur.

The percentage of receiver models of 1938 having an avc figure of merit less than a given ratio expressed in db is shown in Fig. 10.

The figure of merit is based on 10-db output variation, as experience has indicated that variation of this magnitude is tolerable before readjustment of the volume control becomes necessary. Because of this definition of figure of merit a receiver without avc still has a 10-db figure of merit. However, it may be seen that for the majority of receivers the input field intensity may vary 100-to-1 before the output varies 10 db.

It should be borne in mind, that avc is not of benefit in the case of selective fading where the ratio of carrier to sidebands alters with consequent serious distortion, but it is very effective in materially reducing the change in output level due to input field-intensity variation.

In determining whether or not a given station can give acceptable service at a specified location, data are required not only on the field intensity of the desired station at that place, but also on electrical noise levels and the field intensity of other stations. With such information and the data on receiver characteristics given in this paper, the percentage of receivers which can expect good program service in that locality may be determined.

The several factors which determine the possibility of good program service in a given location may be divided into those external to the receiver and those which are receiver characteristics.

FACTORS EXTERNAL TO THE RECEIVER

Field Intensity Desired Signal
Frequency of Desired Signal
Field Intensity of Undesired Signals
Frequency of Undesired Signals
Electrical Noise Levels
External Cross Modulation
Type of Receiving Antenna
Signal Intensity Variation (fading)

RECEIVER CHARACTERISTIC FACTORS

Sensitivity
Two-Signal Selectivity
Image Ratio
Intermediate-Frequency Response Ratio
Second-Harmonic I-F Interference
AVC Characteristic

Acknowledgment is made to the RMA Data Bureau for furnishing certain data on 1938 receiver characteristics.

WBTH
Going Up!
KTSW
CKJB
CJKL

**-all over
the continent
LINGO
Vertical Tubular Steel
RADIATORS**

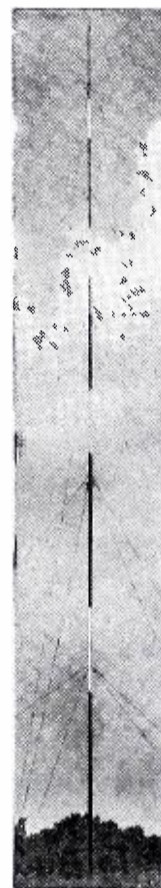

Engineers are quick to recognize a product that proves itself by performance. Lingo "Tube" Radiators have turned fiction into fact by out-performing the most exceptional verbal or written claims made for them. No wonder so many are now in use—no wonder their users are such good boosters. Write to our customers—then write to us. Just send your location, frequency and power. All recommendations and costs will be promptly quoted without obligation.

**Just off the press—
"Set Your Course by
This New Star"**

Write for new illustrated folder. Contains complete details and answers to your questions about Lingo Radiators. We'd like to send you a copy right away.

**LINGO
Portable
Dural
Radiators**

★
**Write
Today
for
Free
Circular**

Of extreme light-weight for emergency use. Can be erected by two men in 15 minutes. Compact; easily stored and transported. Standard lights, 40 to 100 feet.

JOHN E. LINGO & SON, INC.
Dept. C-5 Camden, N. J.

**LINGO
VERTICAL
TUBULAR STEEL
RADIATORS**

BROADCASTING

the fact that you can expand and simplify your field work with our

U. H. F. Portable Pack Transmitter-Cueing Receiver Unit



2 watts in the antenna and integral amplifier for all low level microphones — Batteries self contained — Panel Locks on all tuning controls.

Write for Bulletin 386

RADIO TRANSCEIVER LABORATORIES
8627 115th Street, Richmond Hill, N. Y.

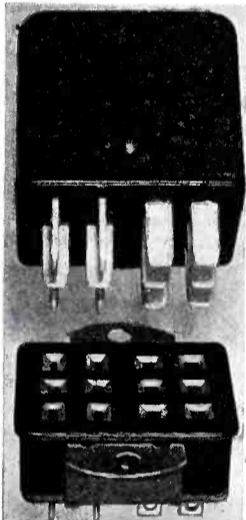

“300” SERIES

**A COMPLETE NEW LINE OF
SMALL PLUGS—SOCKETS**

2 CONTACTS TO 33 CONTACTS

PLUGS WITH CAPS



PLUGS WITH BRACKETS

SOCKETS WITH CAPS

SOCKETS WITH BRACKETS

Ask for Bulletin 300

HOWARD B. JONES

2300 WABANSIA AVENUE, CHICAGO, ILLINOIS



Frequency Measuring Service

Many stations find this exact measuring service of great value for routine observation of transmitter performance and for accurately calibrating their own monitors.



MEASUREMENTS WHEN YOU NEED THEM MOST

at any hour every day in the year

R.C.A. COMMUNICATIONS, Inc.

Commercial Dept.

A RADIO CORPORATION OF AMERICA SERVICE

66 BROAD STREET

NEW YORK, N. Y.

TELEVISION ECONOMICS

(Continued from page 25)

about 11,000-22,000 lux) is required.

The key lighting (for general illumination) is generally from the ceiling, as is also the back lighting (for silhouetting the actors and causing them to “stand out” from the background). Modeling lights, which are required to bring out the shading or form of persons or objects or to produce particular effects, are generally of the spotlight variety and are usually placed on the floor of the studio. The usual assortment of “rifle” spots (lamps with corrugated diffusing mirrors), flood lights (for broad illumination of large areas), and focussing spots (for intense illumination of smaller areas) are provided in the usual powers of 2-5 kilowatts. Multiple lamps of the “scoop” or “broadside” variety have not been so much used as yet. The key lights, as well as various drops used for backgrounds or walls, are suspended from overhead pipes. Flexible adjustment of the key lighting from the floor, both in altitude and azimuth, is provided.

Most of the key lighting is obtained from banks of incandescent lamps backed by silvered reflectors. High-pressure mercury capillary lamps are under study by several studio groups. Such water-cooled capillary lamps give a large amount of effective light with relatively little heat. The blue-green color of the light tends to match the sensitiveness curve of the iconoscope. The absorption of infra-red light in the water-jacket cools the resulting illumination, and also reduces the effect of the residual chromatic aberration in the lens systems.

In view of the use of studio lighting for long periods, both during rehearsals and actual performances, all lighting units must have a rating based on continuous rather than intermittent or short-period use. Such a rating raises the cost of the lighting units unless a fairly conventional type of incandescent lamp of moderate wattage is employed at a suitably restricted voltage, and is used in the open so that special or increased ventilation needs do not arise.

Where background projection is desired, special measures have been carried out. Thus, the walls of the studio near the background projector have been painted black to prevent reflected and diffused light from affecting the projected image, the other walls of the studio being covered with white aluminum paint.

The problem of removing heat from the lamps in television studios requires full consideration in each instance. In one studio, a liberal air-conditioning arrangement has been provided to give a

30-degree temperature differential between the entering air and the studio temperature. It is interesting in this connection to consider specifications which have been proposed for air-conditioning in motion-picture studios where sound recording is carried on and where the air-conditioning equipment must not cause objectionable noise. It is desired that the increase in noise level, measured 5' to 8' from the floor and not near a wall, shall be less than 30 db above an arbitrarily selected noise level of 10^{-10} watts per square centimeter in the frequency range from 30 to 300 cycles, and less than 20 db above the same level for the frequency range from 300 to 10,000 cycles. It is suggested that the loudness be measured either by the use of the usual weighted electrical network or by means of frequency analysis and evaluation. It is obvious that in large and continuously active television studios the provision of adequate air-conditioning, with proper diffusion of air and avoidance of drafts as well as the silencing of the system, introduces substantial but necessary expense factors. Discomfort of the actors is inevitably reflected in reduced realism of the performance, and excessive heat may cause blunders in acting as well as injury to make-up during the time that the actor is on the stage.

The type of make-up to be used in the studio can be standardized only when the color of the studio illumination and the spectral response of the iconoscope are completely controlled and standardized. This does not necessarily involve white studio lighting nor completely uniform color response in iconoscopes, since it is possible without undue loss of sensitivity to add light color filters of appropriate tint in front of the television camera lens to compensate for minor deviations in the lighting color or the iconoscope color characteristic. While such measures may appear to be a refinement at this time, a reliable routine in future television production will require pick-up methods which will invariably yield the same picture quality for a given make-up. At present, television make-up closely resembles motion-picture make-up.

In motion-picture work, modelling lights present something of a problem, and one which is solved to some extent in a different way by each cameraman. Some cameramen tend to use powerful general lighting and to superimpose a moderate amount of modelling light above this general level. Others tend to reduce general lighting to a minimum, and to build up their effects primarily through modelling lights. In television, in contradistinction to motion pictures, the performance is continuous, retakes are impossible (except

from film transmissions), and the performers are generally mobile except during brief intervals now and then for a close-up. This makes the problem of modelling even more difficult for television purposes, and it cannot confidently be stated that this problem has as yet been artistically solved. If actors are to be followed by modelling spot lights throughout a performance, numerous trained personnel and considerable equipment will be required at increased cost. If inadequate modelling is used, a flat impression in the picture is obtained, and fine shades of expression and significant action may both be lost. The balancing of these factors on an economic basis will require good judgment in each individual instance.

F-3. General Studio Arrangements

It is obviously necessary to provide ample facilities for carrying sets and properties into and out of the studio without interference or loss of time. Ample scene docks for the storage of sets should be provided. Sometimes so-called "catwalks" will be built around the top of the more elaborate sets to support some of the lights unless substitute galleries forming a part of the studio structure are provided. It is possible that the lighting methods of the television studio will in certain respects more closely approach those of the legitimate theatrical stage than those of the motion-picture studio in view of the nature, variety, and length of the individual scene presentations. At present, the various sets are arranged in sequence around the walls of a studio, a compact arrangement but one making real demands on studio personnel.

Ample space must be provided in studios so that cameras, lights, microphone booms, and studio personnel can readily move from point to point without delay. Careful consideration must be given to providing adequate terminal or electrical outlet facilities throughout the studio for camera cables, microphone connections, lighting power, and the like. In view of the rapid changes which may be expected in television studio technique, it is advisable at this time to avoid "chopping up" studios into arbitrarily shaped sections or to attempt to "freeze" current practice in the form of permanent installations. The minimum of fixed equipment consistent with program production needs is desirable during the present evolutionary stage of television development.

(To be continued)

• • •

CORNISH WIRE OFFICES

Cornish Wire Co., Inc., has moved to more convenient offices at 15 Park Row, New York City. For the past nineteen years Cornish was located at 30 Church Street.

MAINTAIN ORIGINAL MOTOR EFFICIENCY WITHOUT DISASSEMBLING!



Ideal Motor Maintenance Tools keep all sizes and types of motors in condition to deliver peak performance.

Ideal Resurfacers—maintain smooth and true Commutators and Rings. A type and size for every job. Grades from "extra coarse" to "polish"—8 in all.

Precision Grinders—restore smooth surface to neglected Commutators or Rings that are rough, out of round, etc. Portable. Mounts to the motor frame and does the work while the motor turns over under its own power. No dismantling.

Ideal "Universal" Power Mica Undercutter—for cutting down high mica. Small, yet sturdy and powerful. For large or small commutators— for field and shop use, without removing brush rigging. Ball bearing construction.

Commutator Saws and Milling Undercutters—made of special No. 1 high speed steel. Cut faster, unusually outlast ordinary saws four to one. Available in all popular sizes.

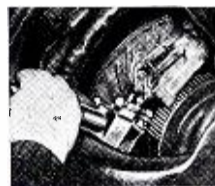

Ask for Free Trial Demonstration

Industrial Products Division

IDEAL COMMUTATOR DRESSER COMPANY

1062 Park Avenue, Sycamore, Illinois

TELEVISION PRESENTS A NEW PROBLEM



The Shallcross line of kilovoltmeters, ranging from one to two hundred kilovolts, have been used for years by other branches of the electrical industry. The dependability, accuracy, and fair price of these instruments will interest you.

Let us help you with the problem of high voltage measurement. Write for Bulletin 700-SE.

RESISTANCE RANGE FROM 1 OHM TO 10 MEGOHMS



SHALLCROSS MFG. CO.
COLLINGDALE, PA.

THE MARKET PLACE

NEW PRODUCTS FOR THE COMMUNICATIONS FIELD

FLUORESCENT MATERIALS

Announcement has been made by the engineering department of Callite that silicates and tungstates in all colors in the spectrum are now available. Immediate delivery can be made on these fluorescent materials. Callite engineers are ready to cooperate with tube manufacturers on their requirements. More details available at the main office of *Callite Products Division, Eisler Electric Corp.*, at 544-39th St., Union City, N. J.—COMMUNICATIONS

COAXIAL CABLE

A new transmission cable which uses air as the principal dielectric is announced by Belden. It has been specially engineered for use as antenna transmitting cable, photoelectric and television circuits, or in any other application where a cable having unusual low loss properties is desired. Belden 8215 consists of a Size 12 solid tinned copper conductor over which is threaded a newly designed low-loss insulating bead. Over the series of beads then is a closely woven tinned copper shield. The shield, in turn, is sheathed in rubber and the whole cable covered with a weatherproofed braid which insures complete moisture and weather resistance. Belden 8216 is a coaxial type cable using a 15 solid tinned copper conductor with an extremely low-loss rubber compound for a dielectric. It has a closely woven tinned copper shield over the compound and an outer sheath of tougher weatherproofed rubber insulation. *Belden Mfg. Co.*, 4689 W. Van Buren St., Chicago.—COMMUNICATIONS.

RECORDING DISCS

A new instantaneous recording disc to be known as the Presto Monogram disc, which will retail at prices that are said to be 25% lower than discs previously offered has just been announced. The disc has a special base. They are coated with the Presto "Q" material, which is said to be satisfactory recording medium. The quality of reproduction and the surface noise characteristics of the new discs are equal to the Presto Green Seal disc.—*Presto Recording Corp.*, 242 W. 55th St., New York City.—COMMUNICATIONS.

TWO-INCH PERMAG SPEAKER

The new "Little General" two-inch Permagn speaker announced by Oxford-Tartak is designed for use wherever a 2-inch speaker is required. The "Little General" has been laboratory-tested by Oxford to gain maximum performance. Further details are available by writing Dept. M, *Oxford Tartak Radio Corp.*, 915 W. Van Buren St., Chicago.—COMMUNICATIONS.



Above: Amperite Kontak unit.

Below: Belden cable.

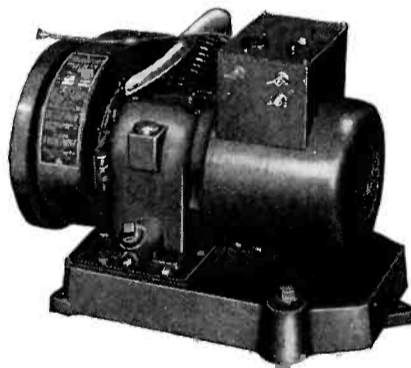
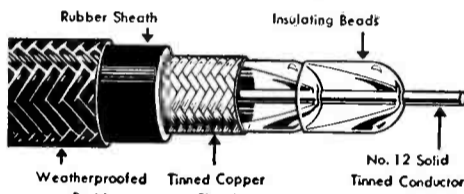

Above: Pioneer power plant.

Below: Oxford-Tartak speaker.

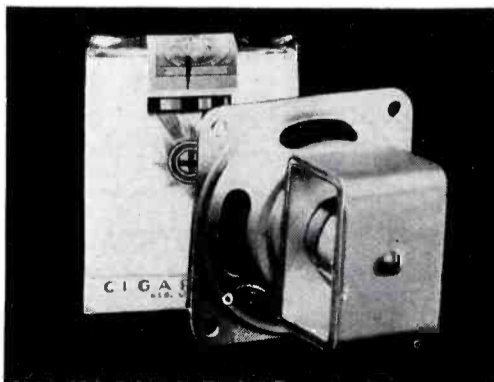

KONTAK UNIT

With the new Amperite Kontak unit with hand volume control, Model KKH, the volume can be adjusted at the instrument. Any number up to five of these units can be connected in parallel. The volume of any instrument can be varied without having any effect on the other instruments, it is said. The T-pad connection used in the volume control makes this possible. The output of the Kontak unit is —40 db. Further information may be secured from *Amperite Co.*, 561 Broadway, New York City.—COMMUNICATIONS.

DISTORTION METER

The new General Radio distortion-measuring equipment, consisting of a direct-reading distortion meter, a multi-frequency filter panel, and a push-button-operated oscillator, is designed for accurate measurements with rapid and convenient operation.

The Type 732-B Distortion and Noise Meter is direct-reading in percent distortion and in noise and hum level. Measurements can be made on the radio-frequency output of the transmitter and on audio-frequency equipment such as lines and amplifiers. The distortion and noise meter operates at 400 cycles; for other frequencies, Type 732-P1 Range Extension Filters must be used. This filter panel contains five auxiliary filters so that measurements can be made at 50, 100, 400, 1000, 5000 and 7500 cycles as recommended by the FCC.

To supply the test signal, Type 608-A Oscillator has been designed. This oscillator operates on the inverse feedback principle, which makes possible an overall distortion of less than 0.1%.

General Radio Co., 30 State St., Cambridge, Mass.—COMMUNICATIONS.

POWER PLANTS

A wide range of portable electric and power plants is offered this year by Pioneer. All are of new streamlined design. Among the various plants produced by this company are the "Pincor" Gold Crown and combination a-c—d-c Blue Diamond.

Pioneer's Gold Crown series consists of a complete line of units for heavy duty service. All desired voltages are available: 32 or 110 volts direct current. Also 110 and 220 volts alternating current, 600, 1000, 1500 watts and up. Pioneer's new Blue Diamond plants were designed to serve a dual purpose, supplying 300 watts, 110 volts alternating current 60 cycles; and from the same plant, 200 watts, 6 volts direct current; 250 watts 12 volts direct current or 325 watts 32 volts direct current. All of the above plants are available with filter and ignition shielding for radio operation. *Pioneer Gen-E-Motor Corp.*, 466 W. Superior St., Chicago.—COMMUNICATIONS.

"TOPHET" Resistance Wire
is to the Electric Heating
Appliance what the Trylon-
Perisphere is to the World's
Fair.

Visit our exhibit at the
World's Fair, in
the Metals Build-
ing opposite
the Trylon.

WILBUR B. DRIVER CO.
NEWARK, NEW JERSEY

"The Market Place"

Manufacturers are requested
to send data on their new
products for use in the com-
munications and broadcast-
ing field, promptly, for inclu-
sion in "The Market Place"
section.

FOR better PERFORMANCE A better HEADPHONE

**BRUSH
PIEZO
ELECTRIC
DEVICES**

BRUSH MODEL A-1

This exceptional Brush (Model A-1) headset will meet with approval among your most demanding customers, in fields of broadcasting, recording, speech correction and sound research work. It carries positive assurance of faithful, high fidelity, wide range response and light weight. Response of the Model A-1 is 50 to 12,000 c.p.s. You'll find it easy meeting the strictest specifications with these fine BRUSH headphones.



LIST PRICE \$27.50
● Model-BJ Headset—A popular communications type headset, lightweight aluminum case, molded rubber ear-pieces, single cord for convenience.
LIST PRICE \$12.00

THE BRUSH DEVELOPMENT CO.

3317 PERKINS AVENUE, CLEVELAND, OHIO

MADE BETTER TO
WORK BETTER



● The combination of high tensile strength that assures a lasting bond, and faster, cleaner work made possible by quick acting flux of pure water white rosin, has given Gardiner Rosin-Core Solders an outstanding reputation for efficiency and economy on radio work by expert or amateur. Yet, due to modern production methods and big sales, Gardiner Solders cost less than even ordinary kinds. Made in various alloys and core sizes . . . and in gauges as small as 1/32 of an inch . . . in 1, 5 and 20-lb spools. Eastern Sales Office and Warehouse: DAVID M. KASSON & CO., 401 Broadway, N. Y.



QUARTZ CRYSTALS

Piezo-Electric quartz blanks suitable for grinding to commercial frequencies.

Rough and semi-finished blanks to meet any commercial tolerances.

Quartz cut to any specifications.

Prices and information upon request.

G. C. HUNT and SONS

CARLISLE

PENNSYLVANIA

PAPER TUBULAR CAPACITORS

The research laboratories of the Cornell-Dubilier Electric Corporation at this time announce a new and improved paper tubular capacitor. This unit supplementing the old type DT "Dwarf Tiger" is being impregnated in Dykanol "D" the high dielectric, non-inflammable impregnant used in C-D high voltage transmitting capacitors. This new method of manufacture has made possible the production of tubulars with an internal series resistance of over 5,000 megohms per microfarad, it is said. Approximately fifty capacities are available in 400, 600, 1,000 and 1,600 voltage ratings.

Catalog No. 165A describing these units, free on request at the main office of the Cornell-Dubilier Electric Corporation, South Plainfield, New Jersey.—COMMUNICATIONS.

TELEVISION POWDERS

Pfaltz & Bauer, Inc., offer a complete line of fluorescent materials for cathode-ray tubes. The line consists of nine primary colors, which is augmented by a range of specially compounded colors which are made for specific requirements. The full line of colors are said to possess high light intensity and give clear cut images. Information on colors and prices will be furnished upon request. Pfaltz & Bauer, Inc., Empire State Bldg., New York City.—COMMUNICATIONS.

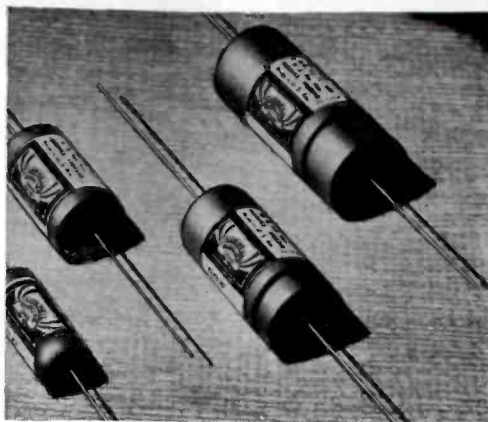

Cornell-Dubilier capacitors.

Kenyon transformer.

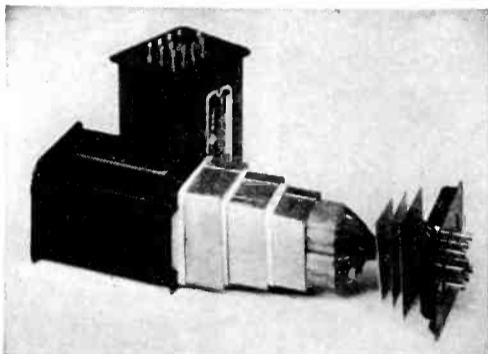

TELESCOPIC TRANSFORMERS

Two new telescopic-shielded humbucking transformers, type P-202 and T-6, have recently been introduced by Kenyon Transformer Co., Inc.

Type P-202 is designed for a multiple line primary of 500/333/250/200/125/50 ohms and a secondary of 50,000 ohms (single Class "A" grid) having a frequency response of plus or minus 2 db, 60-10,000 cycles, shielding 90 db, mounted in 4 high-permeability alloy annealed steel cases.

Type T16 is designed with a primary of 200 ohms and secondary of 20,000 ohms (single Class "A" grid), having a frequency response of plus or minus 3 db, 60-10,000 cycles, shielding 50 db, mounted in two high-permeability alloy annealed steel cases and plain steel outer case. These units are designed for use in low-level input circuits where hum pickup must be kept to absolute minimum.

Complete information may be obtained from the Kenyon Transformer Co., Inc., 840 Barry Street, New York City.—COMMUNICATIONS.

PRECISION EXPANDS

Precision Apparatus Corporation has expanded its facilities for the second time within the period of one year to meet the demand for their new line of test equipment. Both the executive offices and factory are now located at 647 Kent Avenue, in Brooklyn, New York.

MOBILE RECORDING INSTALLATION

A VERY interesting application of sound recording apparatus in radio broadcasting has just been announced by the Sound Recording Equipment Division of the Fairchild Aerial Camera Corporation, Jamaica, New York. It concerns a mission of Norsk Rikskringkasting (Norwegian State Broadcasting Company) which is now in the United States to make a series of educational recordings for future broadcasting over radio stations in Norway. This mission, consisting of E. Schibbye, Secretary (in charge of expedition), Karl C. Lyche, Assistant Editor, Karl K. Larsen, Director of Laboratories, and E. W. Petersen, Recording Engineer, plans to

tour the middle western part of the United States, especially Wisconsin and Minnesota, where there are many people of Norwegian descent.

The folk life of Norwegians living in the United States will be recorded and microphones will be taken into Churches, farm houses, meeting halls and other places where the people will be interviewed. Recordings of these interviews will be made in the same manner as though they were a live broadcast. In addition to recording the Norwegian life in the United States, this mission also plans to record many other programs that will be of general interest to the radio audience in Norway. In the same manner as a radio commentator or a news commentator would describe an important event such as the first run of a new train, dedication of a highway, or sports events, the Norwegian announcers will describe these events and their descriptions recorded. In this way a complete library of interesting and educational recordings will be made. These recordings will then be catalogued and broadcast over the Norwegian stations over a six or twelve-month period and are really classed as educational broadcasts or travelogue broadcasts.

For this work the Norwegian State Broadcasting Company has selected recording equipment manufactured by the

Fairchild Aerial Camera Corporation. Two portable recorder mechanisms and a portable recording amplifier have been mounted in a seven passenger Plymouth Sedan. The recorder mechanisms are installed over the rear seat on an anti-vibration mount. This mount has convenient adjustments for leveling the equipment if the automobile is parked on a road with a high crown or on a hill so that the car is not level. Mounted in the space normally occupied by the left auxiliary seat is a control panel with a voltmeter, frequency meter, ammeter and switch for operating the motor generator. On top of this control panel is mounted a Fairchild Unit 219 recording amplifier.

The power supply equipment in rear of car.

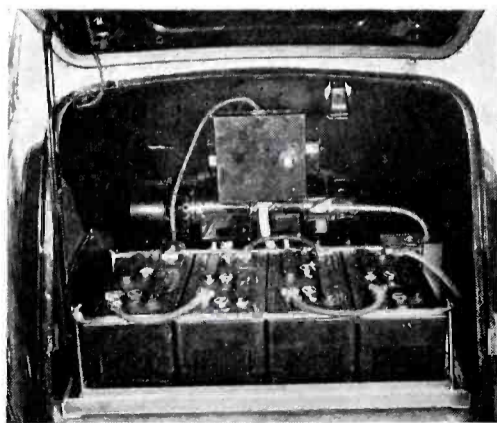

The mobile recording equipment in operation.



BLILEY CRYSTALS



are manufactured for all frequencies from 20 Kc. to 30 Mc. Bliley Broadcast Frequency Crystals are approved by the F. C. C. Precision manufacturing and correctly designed holders assure full dependability.

BLILEY ELECTRIC COMPANY

UNION STATION BUILDING

ERIE, PA.

HOTEL DRAKE

SOUTH CAROLINA AVENUE AT PACIFIC ATLANTIC CITY, NEW JERSEY

European Plan Hotel—Moderate Rates
 • 150 Outside Rooms Beautifully Furnished • Also Small Apartments • Fully Equipped, including Electric Refrigeration • Convenient to Piers, Theatres and Churches • Also Bus and Railroad Depot • Garage Accommodations.

For Literature and Rates, Address
 W. GRAHAM FERRY, Mgr.



VULCANIZED FIBRE
PHENOL FIBRE
TAYLOR INSULATION

TAYLOR FIBRE CO., Norristown, Pa.

DESIGN-DEVELOPMENT-CONSTRUCTION

of
VACUUM TUBES AND ELECTRONIC DEVICES

Tubes built to specifications. Coils and other components sealed in hermetical cans and bulbs.

VACUTRON, INC.

20 West 22nd Street

New York, N. Y.

"PINCOR"

LONG LIFE

SMOOTH

SILENT

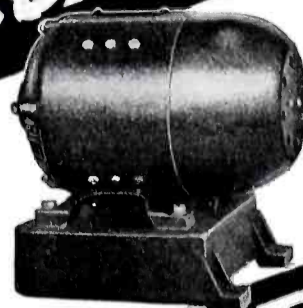

DYNAMOTORS and CONVERTERS



A Complete Line For Every Purpose

Radio Engineers have learned from experience that Pioneer Gen-E-Motor Corporation's dynamotors, gen-e-motors and converters provide the last word in dependable power supply units for air craft, police, marine and auto radios and public address systems. They are available in a wide range of capacities for every requirement. Designed and constructed to give maximum long life and service. Light weight and compact. For complete information fill out and mail coupon below.

VISIT BOOTH NO. 210 AT THE CHICAGO TRADE SHOW

PIONEER GEN-E-MOTOR CORPORATION
 Dept. R-5E, 466 W. Superior Street, Chicago, Ill.

Please send me "Pincor" Silver Band Dynamotor Catalog and Data Sheets.

Name

Address

City..... State.....



By building a gas-filled condenser of mechanically sound design, leak-proof, Lapp engineers have produced the first truly trouble-free condenser for broadcast use. Fixed, adjustable and variable types, in three voltage ratings and capacitance 100 to 2000 mmf. Write for literature.

LAPP INSULATOR CO., INC.
 LEROY, N. Y., U. S. A.

PIEZO Electric Crystals Exclusively

• Quality crystals for all practical frequencies supplied SINCE 1925. Prices quoted upon receipt of your specifications.

Our Pledge: **QUALITY FIRST**

SCIENTIFIC RADIO SERVICE

UNIVERSITY PARK

HYATTSVILLE, MD.



We manufacture a complete line of equipment
 Spot Welders, electric, from 1/4 to 500 KVA; Transformers, special and standard types; Incandescent Lamp Manufacturing Equipment; Radio Tubes, Ex-Ray, Cathode Ray, Photo Cells, Electronic Equipment Vacuum Pumps, etc. Tungsten Slugs, Rod and Wire Manufacturing Equipment; General Glass Working Machines and Burners; College Glass Working Units for students and laboratory; Photo-Flash Lamp Equipment; Neon Sign Manufacturing Equipment; Thermos Bottle Equipment; Wire Butt Welders. CHAS. EISLER, Pres.

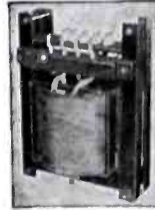

EISLER ENGINEERING COMPANY

739-750 So. 13th St. (Near Avon Ave.)

Newark, New Jersey.

Now... **5 VITAL FEATURES COMBINED IN AMPERITE VELOCITY WITH ACOUSTIC COMPENSATOR**



- it's a VELOCITY
- it's a DYNAMIC
- UNI-DIRECTIONAL
- NON-DIRECTIONAL
- HIGH OR LOW PITCH

UNI-DIRECTIONAL PICK-UP FIELD COMPENSATOR UP

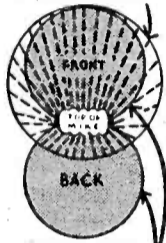

PICK-UP FIELD COMPENSATOR DOWN

By moving up the Acoustic Compensator, you change the Amperite Velocity Microphone to dynamic operation — without peaks. At the same time you reduce the back pickup, making the microphone practically UNI-DIRECTIONAL.

With the Acoustic Compensator down, the microphone is BI-DIRECTIONAL... 120 degrees front and back without frequency discrimination. Rotating the microphone until it parallels the ceiling makes the microphone NON-DIRECTIONAL.

THE ACOUSTIC COMPENSATOR is a regular feature of these models: RBHk (hi-imp); RBMk (200 ohms) LIST \$42.00. RSHk (hi-imp); RBSk (200 ohms) LIST \$32.00

Write for Complete Illustrated Bulletins and Valuable Sales Helps.

AMPERITE CO. 561 BROADWAY, N. Y. Cable Address: Alkem, New York

AMPERITE Velocity MICROPHONES



CHECK YOUR OIL, SIR!

When you make this your service station there's no need to use the old "oil" on your customers. With real values to offer you can forget the high-pressure stuff. And it's real values you get when you order from Wholesale Radio Service Company. We stock only top-quality equipment — all nationally advertised goods. We carry a complete line of more than 50,000 radio items. You can't beat the prices. Shop here and watch your business step on the gas!

WHOLESALE RADIO SERVICE CO. INC.
 100 SIXTH AVE., NEW YORK, N. Y.
 CHICAGO, ILL. • ATLANTA, GA. • BOSTON, MASS.
 BRONX, N. Y. • NEWARK, N. J. • JAMAICA, L. I.

Index to Advertisers

A	
Aerovox Corp.	1
Amperex Electronic Products, Inc.	Inside Front Cover
Amperite Co.	44
Astatic Microphone Lab., Inc.	35
B	
Bliley Electric Co.	43
Brush Development Co., The.	41
C	
Callite Products Division.	25
Centralab.	21
Cornell-Dubilier Elec. Corp.	24
D	
Driver Co., Wilbur B.	41
DuMont Laboratories, Inc., Allen B.	23
E	
Eisler Engineering Co.	43
F	
Fairchild Aerial Camera Corp.	33
Ferris Instrument Co.	34
G	
Gardiner Metal Co.	41
General Radio Co.	Inside Back Cover
Guardian Electric Co.	32
H	
Hunt & Sons, G. C.	41
I	
Ideal Commutator Dresser Co.	36, 39
J	
Jones, Howard B.	38
L	
Lampkin Labs.	35
Lansing Mfg. Co.	34
Lapp Insulator Co., Inc.	43
Lingo & Son, Inc., John E.	37
Littelfuse, Inc.	37
M	
Monarch Mfg. Co.	37
N	
National Radio Parts Trade Show.	4
P	
Pioneer Genemotor Corp.	43
Presto Recording Corp.	3
R	
R. C. A. Communications, Inc.	38
RCA Mfg. Co. Inc.	Back Cover
Radio Amateur Call Book, Inc.	44
Radio Transceiver Labs.	38
S	
Scientific Radio Service.	43
Service Instruments, Inc.	22
Shallcross Mfg. Co.	39
T	
Taylor Fibre Co.	43
V	
Vacutron, Inc.	43
W	
Wholesale Radio Service Co., Inc.	44
Z	
Zophar Mills, Inc.	44



WAXES

AND

COMPOUNDS

FOR

INSULATION and WATERPROOFING of ELECTRICAL and RADIO COMPONENTS

● such as transformers, coils, power packs, pot heads, sockets, wiring devices, wet and dry batteries, etc. Also WAX SATURATORS for braided wire and tape and WAXES for radio parts. The facilities of our laboratories are at your disposal to help solve your problems.

Zophar MILLS, Inc. FOUNDED 1846
 120 - 26th ST., BROOKLYN, N. Y.



Radio Engineers

who are

RADIO AMATEURS

buy a fresh copy today of the

RADIO AMATEUR CALL BOOK

The CALLBOOK is the only publication that lists all licensed radio amateurs in the United States and over a hundred and seventy-five different foreign countries.

Each issue also contains a world map showing amateur prefixes, press time and weather schedules, amateur prefixes listed alphabetically and by countries and a world time conversion chart.

Complete . . . Accurate . . . Up-to-Date

Issued Quarterly

MARCH . . . JUNE . . . SEPTEMBER

and DECEMBER

Annual subscription \$4.00

Single copies \$1.25

Buy your copy now from your radio jobber or direct from:

Radio Amateur Call Book, Inc.
 608 S. Dearborn St., Chicago, Ill., U. S. A.



With these three new instruments—A complete distortion run on your transmitter in less than a minute

• THE NEW ASSEMBLY illustrated is the simplest equipment available for making distortion measurements on any broadcast transmitter at the six test frequencies recommended by the F.C.C.

With this assembly the effects of aging and drift in tubes and other circuit elements may be detected readily . . . incorrect adjustment of any controls can be checked quickly.

The operation of this equipment is so simple and rapid that distortion measurements can now be worked into the daily station routine and logged regularly.

TYPE 732-B DISTORTION AND NOISE METER

A redesign of the original Type 732-A instrument, retaining all of its desirable features with many improvements. Designed to operate with the Type 732-P1 Range-Extension Filters for measurements at 50, 100, 400, 1000, 5000 and 7500 cycles. The r-f input operates over carrier ranges from 0.5 to 8 Mc or from 3 to 60 Mc and employs a tuned-circuit system which requires comparatively little power. **TYPE 732-B DISTORTION AND NOISE METER** (for either 0.5 to 8 Mc or 3 to 60 Mc carrier) \$245.00

TYPE 732-P1 RANGE-EXTENSION FILTERS

These filters are designed to supply five additional test frequencies for the Type 732-B instrument. The desired filter is selected by a switch on the panel. At distortions greater than 0.5% the error is less than 10% of the true value $\pm 0.15\%$ distortion. **Price: \$150.00**

TYPE 608-A OSCILLATOR

This new oscillator is of the discrete-frequency type, with two sets of push-button switches providing frequencies of 20, 25, 30, 40, 50, 60, 75, 100 and 150 cycles with multipliers of 1, 10 and 100 times these frequencies. The output is unusually low in distortion making the instrument particularly useful for distortion measurements. **Price: \$260.00**

• WRITE FOR BULLETIN 424 FOR COMPLETE DATA

GENERAL RADIO COMPANY CAMBRIDGE MASSACHUSETTS

RCA ICONOSCOPES



Television transmission with the RCA 1850 Iconoscope under studio conditions. A lens in the "camera" focuses the scene on the photosensitive mosaic of the "Ike".

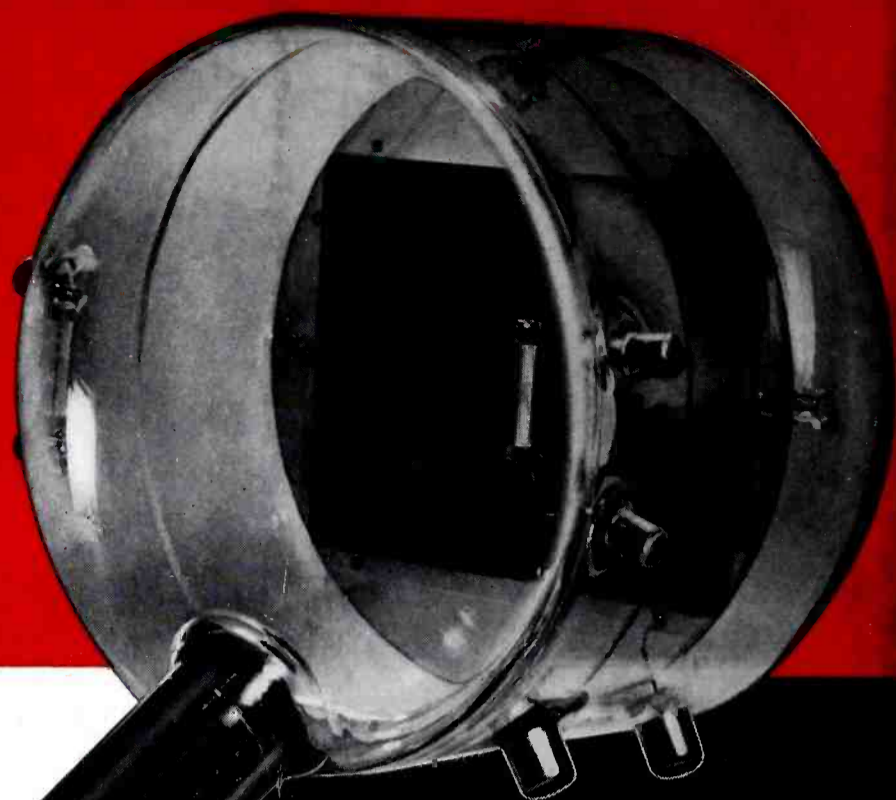

Paving the Way to **HIGH-DEFINITION TELEVISION**

Not since the development of the electronic tube itself, has there been an event of such tremendous significance to the fields of entertainment, communications and education as the introduction of the RCA Iconoscope. A tribute to modern engineering genius, the Iconoscope is literally the "heart" of Television in its most practical, most modern form. It is the Iconoscope which made possible the public advent of High-Definition Television in New York City over both the CBS and NBC Broadcasting Systems. The Iconoscope is truly the Aladdin's lamp of the most amazing system of communication ever devised by man!

By providing a means of electronic scanning at the transmitter, the Iconoscope affords a practical solution to such all-important problems as those of flexibility and definition. Its construction permits the storing up of effects from a light image between successive scanings. The resulting high sensitivity permits its use under a wide range of lighting conditions.

Two Iconoscope types, RCA 1849, designed for pick-up from movie film, and RCA 1850, for direct pick-up of scenes, are now ready for delivery. These are described in detail in an RCA Technical Bulletin now available from RCA Commercial Engineering Section, Harrison, New Jersey.

Visit the RCA Television Exhibits at the Golden Gate International Exposition and the New York World's Fair

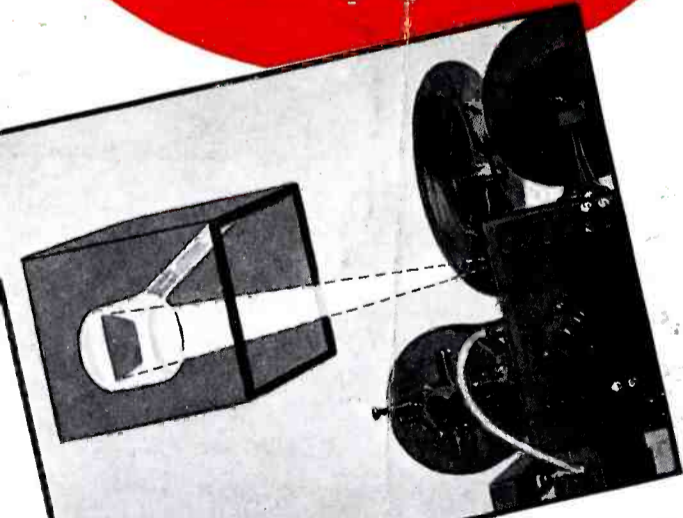
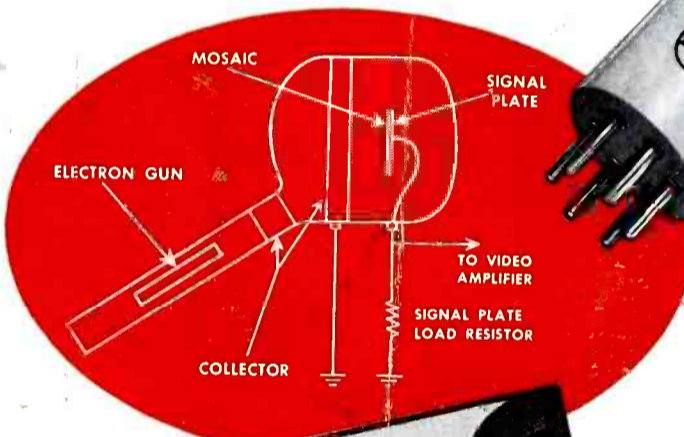

Portraying the use of the RCA 1849 Iconoscope in transmitting a scene from film.



for TELEVISION

RCA Manufacturing Company, Inc., Camden, N. J. A Service of the Radio Corporation of America

For more information on Television — It's RCA All the Way!