

FOR MODERN BROADCASTING



AUDIO FACILITIES

Custom-Built **STUDIO CONSOLES** to fill your **OPERATING REQUIREMENTS**



by *Western Electric*

Western Electric

Custom-Built CONSOLES

APPPLICATION ENGINEERED to your requirements, keyed by their versatility, utility, and attractive appearance, the new Western Electric custom-built consoles are as modern as tomorrow—the ideal Audio Facility complement for the up-to-the-minute radio broadcasting plant.

Radio Broadcast Network centers and stations large and small value the unique performance features that can be engineered into these consoles. Western Electric audio engineers will help solve your speech input problems by engineering to your specifications the custom-built consoles which will provide the facilities your broadcasting plant needs for efficient, modern broadcasting. Standardized components such as high quality amplifiers, switching and volume regulating devices, and level indicators are arranged in attractive console and cabinet combinations—to give the best in smooth, professional program operation at your station.

A few of the difficult assignments for which these consoles are ideally adapted are; large or theatre-type studios where multiple microphone pickups and various sound and reverberation effects must be used for variety shows, studios used as a terminus for special event broadcasts in which fast switching is imperative, and multiple studio operation. The typical custom-built console has the more frequently used controls located at arm-rest height, eliminating fatiguing arm movements. Volume and other circuit indicators are so located as to facilitate the engineer's observation of both the program level and the studio action. Patching panels, which greatly increase the flexibility of operation, are located where they can be used most conveniently.

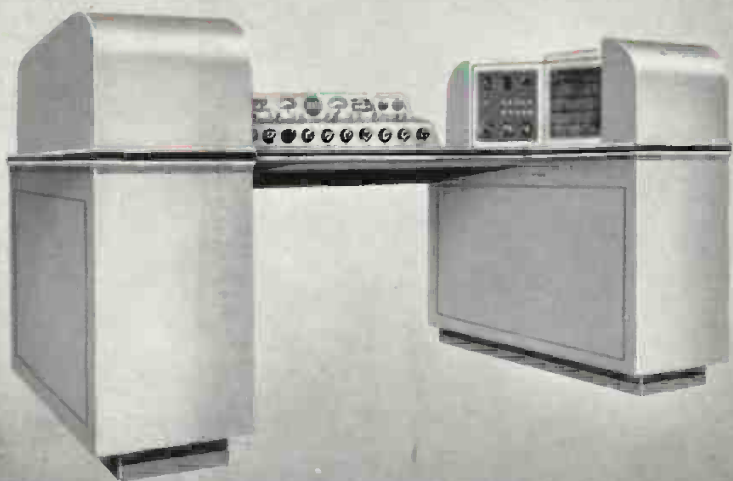

Western Electric custom-built consoles utilize standard amplifiers, keys, jacks, volume controls and indicators, and other time tested apparatus parts. These are custom assembled to the user's operative requirements in conveniently functional desk cabinet units, attractively styled and durably finished in two tone colors.

Typical Custom-Built Consoles



Four typical custom-built consoles are illustrated on the following pages. Schematics of three typical console circuit arrangements are included at the end of this bulletin.

A typical large multi-facility console is illustrated on pages 6 and 7. This operating desk cabinet together with a wall type power and auxiliary cabinet illustrated on page 10 is appropriate for installation in a control booth associated with a large studio, with or without theater facilities. A typical circuit arrangement having maximum facilities accommodated by this cabinet space are shown on Drawing A. From an operating standpoint, this includes facilities for the connection of 16 microphones, 2 transcription reproducers, 8 incoming remote lines, and 6 program trunks. Eight premixing amplifiers are provided and are normaled through jacks

to mixer volume controls to provide high level, noiseless mixing. Thus, a 10 channel mixed circuit will provide normally, 6 microphone inputs, 2 transcription turntable inputs, and 2 line inputs, individually or simultaneously in any combination to blend one program. Patching jacks will allow further combinations. (For example, if necessary for special shows, up to 10 microphones can be connected in for simultaneous operation.)

Three of the microphone mixers feed through a single submaster volume control so that the level of three inputs may be adjusted simultaneously by a single submaster volume control. A two input reverberation mixer is provided for patch-

View showing custom-built console and wall recessed power and auxiliary cabinet installed in a control booth. Action in the associated studio is clearly visible to the control operator and production director through the double glazed window.

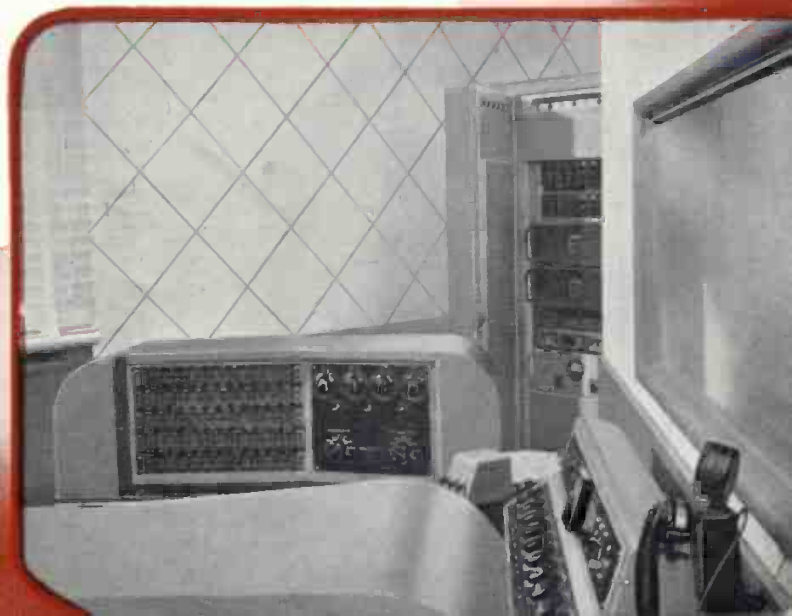



ing in ahead of the regular mixer controls as is one set of high and low pass sound effects filters. Accessory elements are also provided such as utility level controls, transfer keys, repeating coils, and jack multiples.

Beyond the regular microphone mixer and submaster volume controls, the transmission path goes through a single key known as the microphone key which serves to connect or disconnect between the regular microphone circuits and the main amplifier channels in a single operation. This key also governs studio loudspeaker cutoff. Two transcription inputs feed directly into the main amplifier without passing through this key so that transcribed programs or announcements can be heard on the studio loudspeaker when program is not being originated through studio microphones.

The two line circuits are regularly normalized through their own line equalizers and repeating coils, each having its own

line keys so as to switch between regular broadcast and prebroadcast check amplifier circuits.

Each of the two main program channels consists of a booster amplifier, master volume control, a main amplifier and an output network feeding an individual volume level indicator meter and into a channel transfer key. The check channel provides means for checking incoming remote line circuits prior to broadcasting. An output key follows the channel transfer key and has three positions corresponding to the three operating conditions respectively "rehearsal", "standby", and "program". Corresponding lamps indicate key position. A cue selector key provides cue monitoring from master control and pre-set keys and lamps on the main control panel give visual indication of what is being fed from the studio at any given time.

A single, large "go ahead" bull's eye on the main control panel directly in



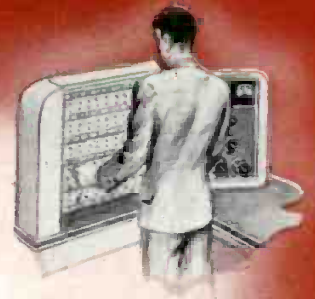

front of the operator lights to indicate when the studio console is cut through to the main outgoing transmission line. Monitoring circuits are provided for inputs ahead of the output key as well as

the three additional outputs for recording, house monitor and audience sound reinforcement. A system of tube check circuits is incorporated on the main console.

CUSTOM BUILDING

The description of the custom-built console above included the facilities of a typical installation. However, the facilities to be included in a particular custom-built console are dictated by the needs of the broadcasting plant which will use it. Western Electric engineers are ready to work closely with the engineers of the broadcasting station to provide optimum facilities needed for a particular station's operating requirements.

When the operating and space requirements for each studio and control room have been ascertained, the console circuit arrangement and control panel-layouts are custom-designed, and standard amplifiers and other apparatus components are selected to provide the desired operating features. Components in the console such as the amplifiers are standard, well-designed, time proven elements; and the console itself is custom-designed and manufactured in order to obtain the maximum of performance for the broadcasting plant.

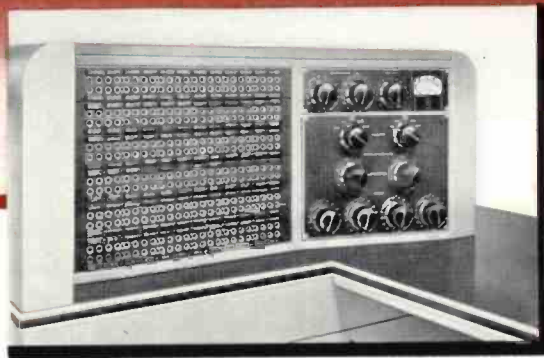

Left hand turret showing patching jack group for low audio level circuits and panel for auxiliary input controls.



Main control panel showing convenient placement of frequently used controls and indicators directly in front of the operative engineer and in line with his vision into the studio.

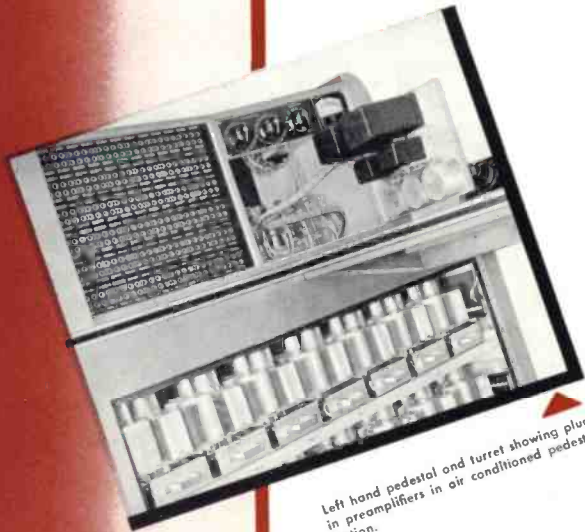

Left hand pedestal and turret showing plug-in preamplifiers in air conditioned pedestal section.

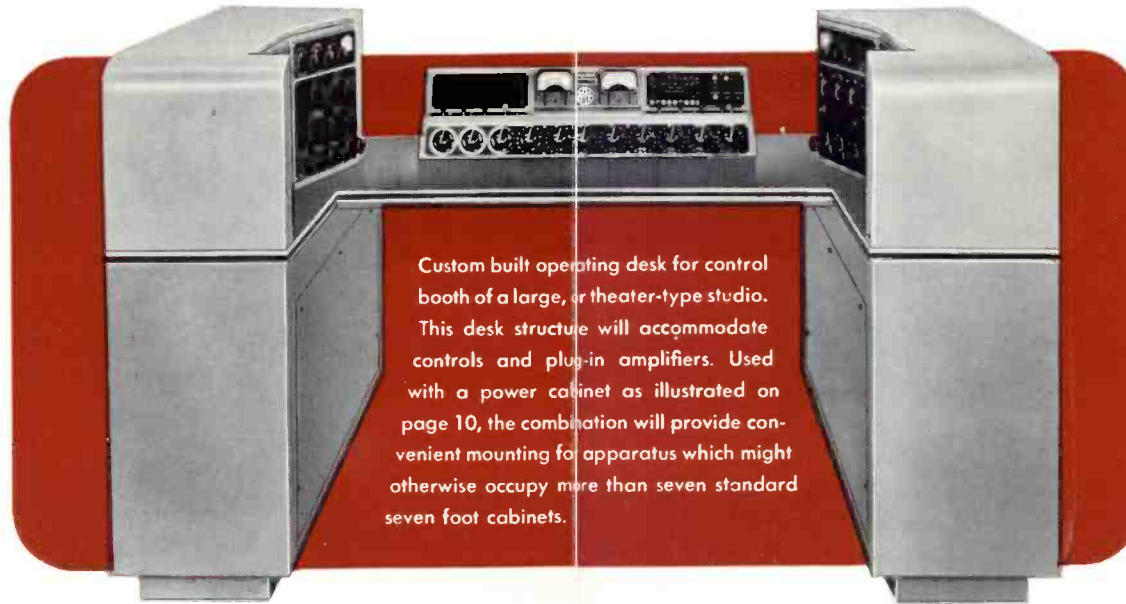

Custom built operating desk for control booth of a large, or theater-type studio. This desk structure will accommodate controls and plug-in amplifiers. Used with a power cabinet as illustrated on page 10, the combination will provide convenient mounting for apparatus which might otherwise occupy more than seven standard seven foot cabinets.

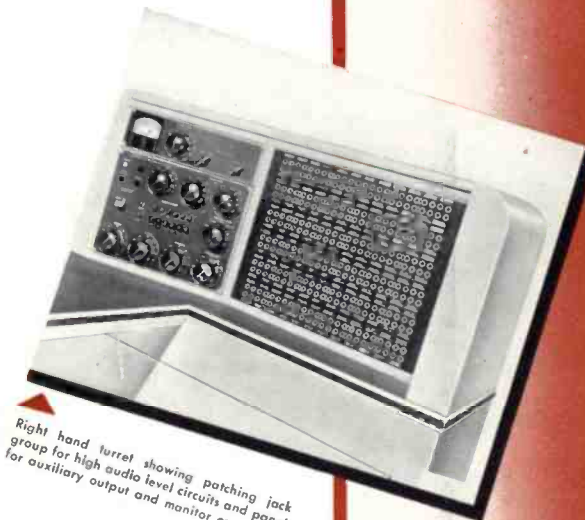

Right hand turret showing patching jack group for high audio level circuits and panel for auxiliary output and monitor controls.

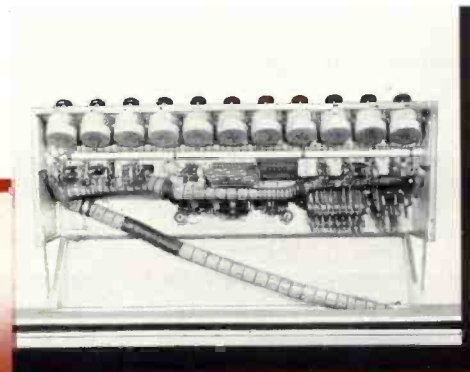

Main control raised for access to terminals and wiring.

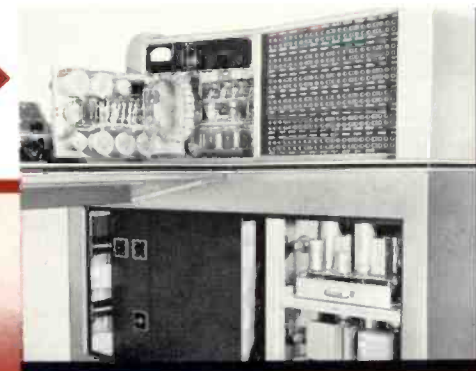

Right hand pedestal and turret showing plug-in main, monitor and reverberation channel amplifiers in air conditioned pedestal section.

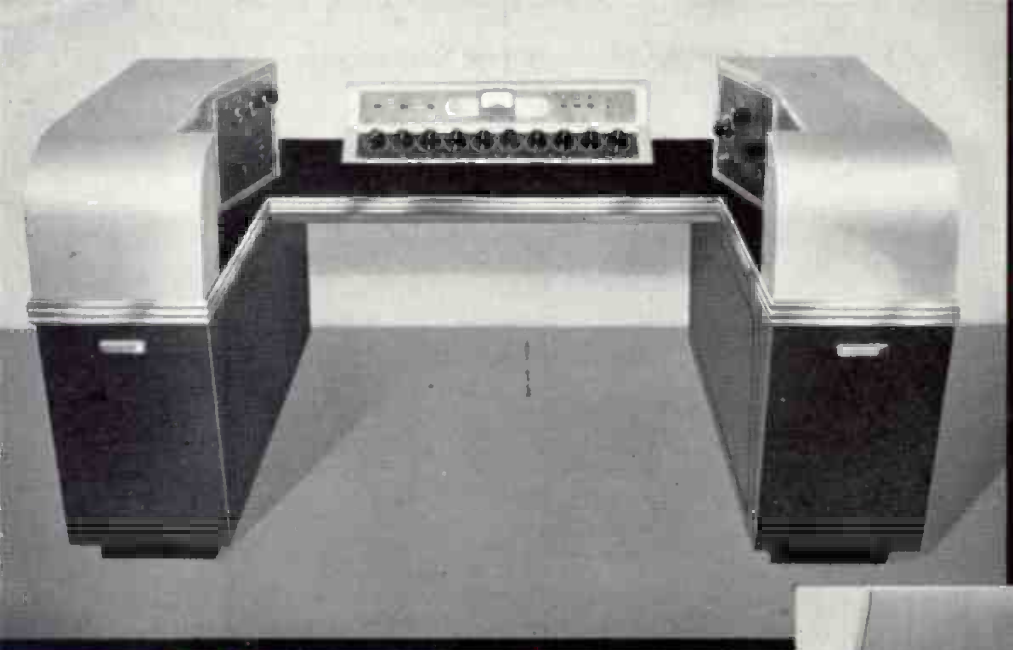

Large sized custom built control desk consisting of three main structural elements. Two of the elements are the pedestal and turret units and the third is an operating shelf supported between the pedestal units and mounting the main control panel.

The plug-in amplifiers in the pedestal units are assembled through left out doors in the pedestal sides. Where desired the front face of the pedestal can be supplied with the patch cord drawer shown opened in this view.



The hood-like turret covers are hinged at the rear and are easily raised for access to the apparatus and wiring within the turrets. The main control panel is hinged for a similar reason. All external connections are made by cables entering the pedestals through either the floor or the rear wall and terminating on the terminal strips of the front of each turret.

25B Speech
Input Equipment

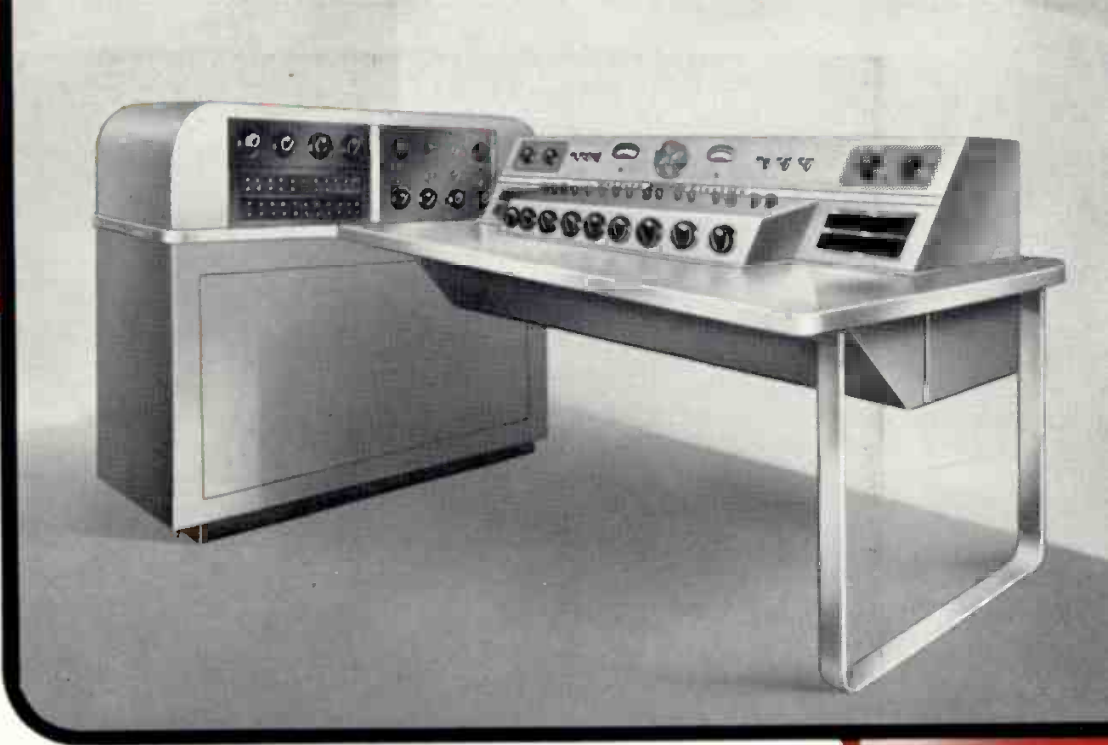

Custom built console using a standard console element (Western Electric 25B speech input equipment) as the main component. The auxiliary pedestal and turret provide space for custom-required equipment.

Floor plan showing one compact control booth layout which can be made with minimum floor space conditions utilizing the console assembly illustrated above with power and auxiliary cabinet illustrated on page 10.

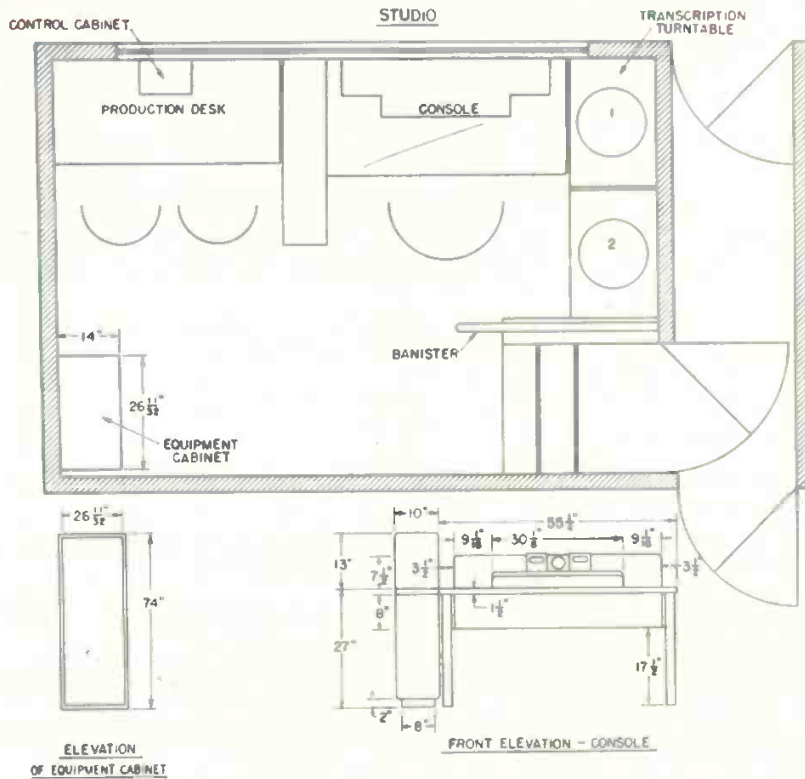



Custom-built operating desk for a broadcast studio having limited control booth space. This type of custom-built console contains controls and preamplifiers, other apparatus being located in an apparatus room common to a number of studios.

Wall recessed rack cabinet for power supply and auxiliary equipment for use with custom-built console. Plug-in amplifier and rectifier design permits front access to all elements.

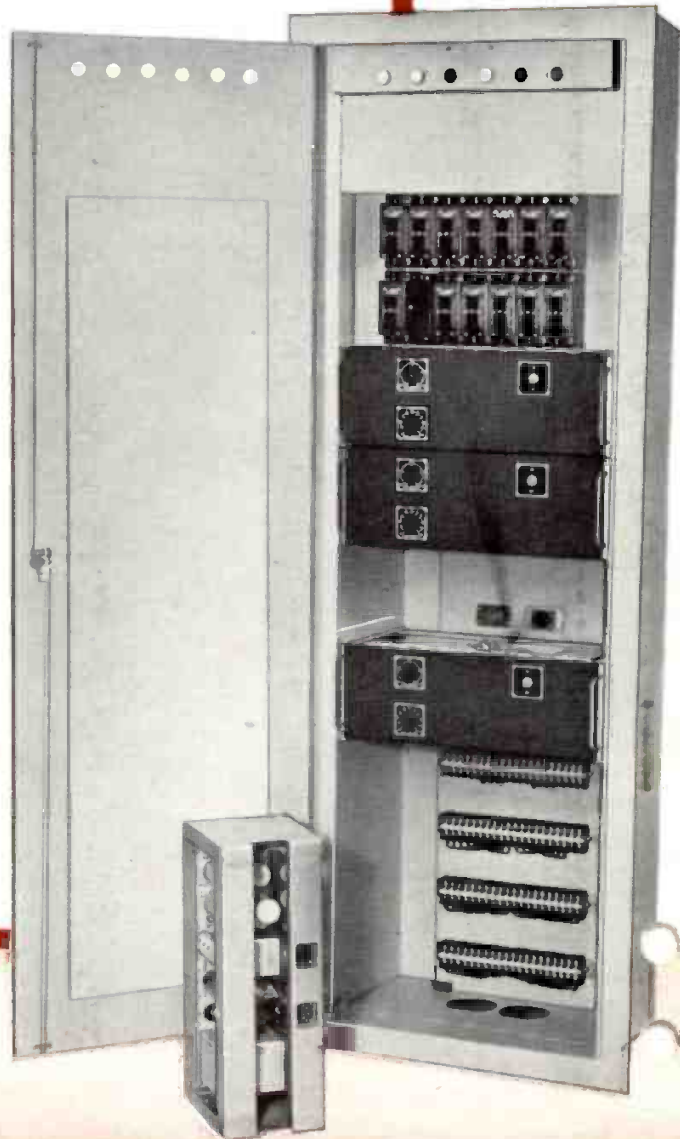

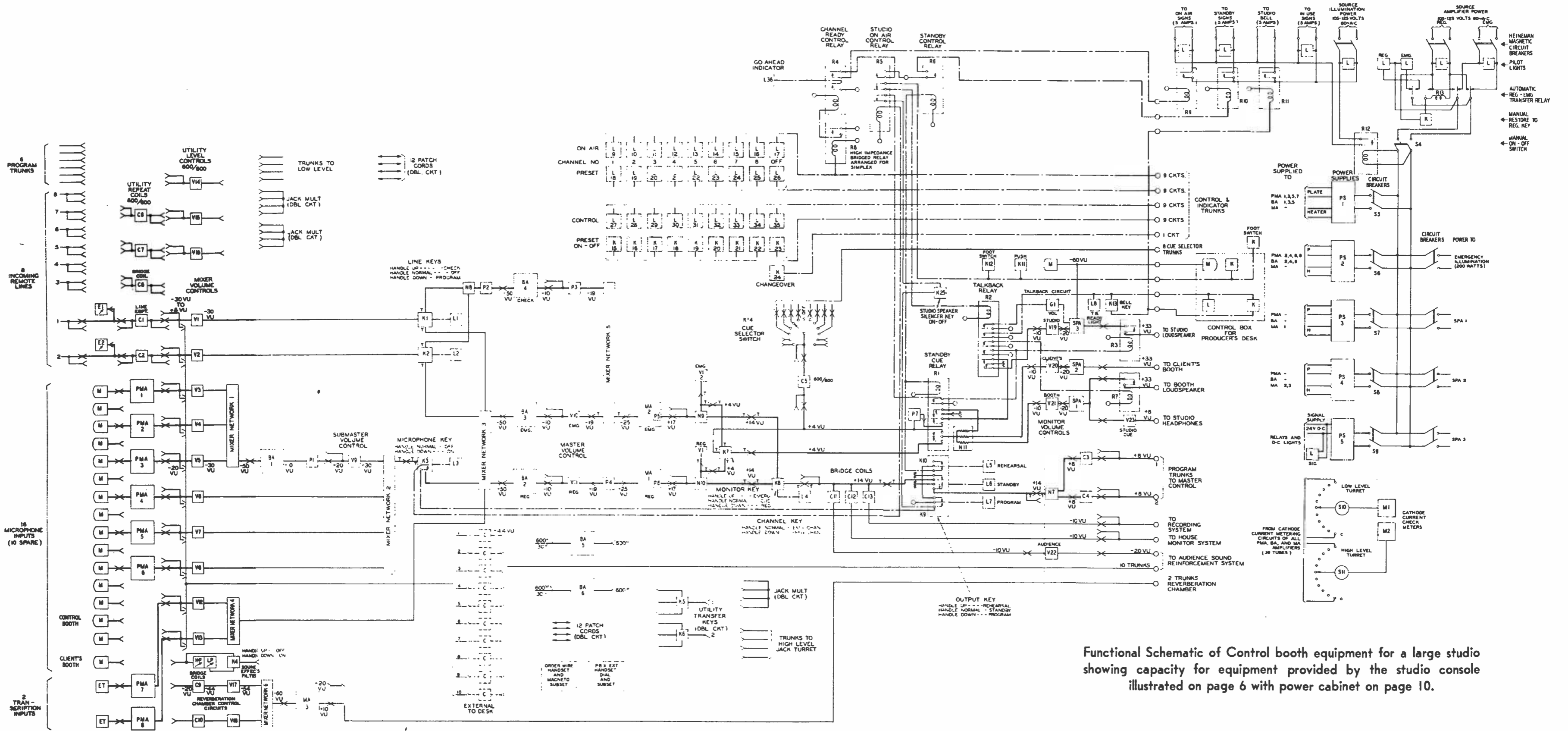

Functional Schematic of Control booth equipment for a large studio showing capacity for equipment provided by the studio console illustrated on page 6 with power cabinet on page 10.

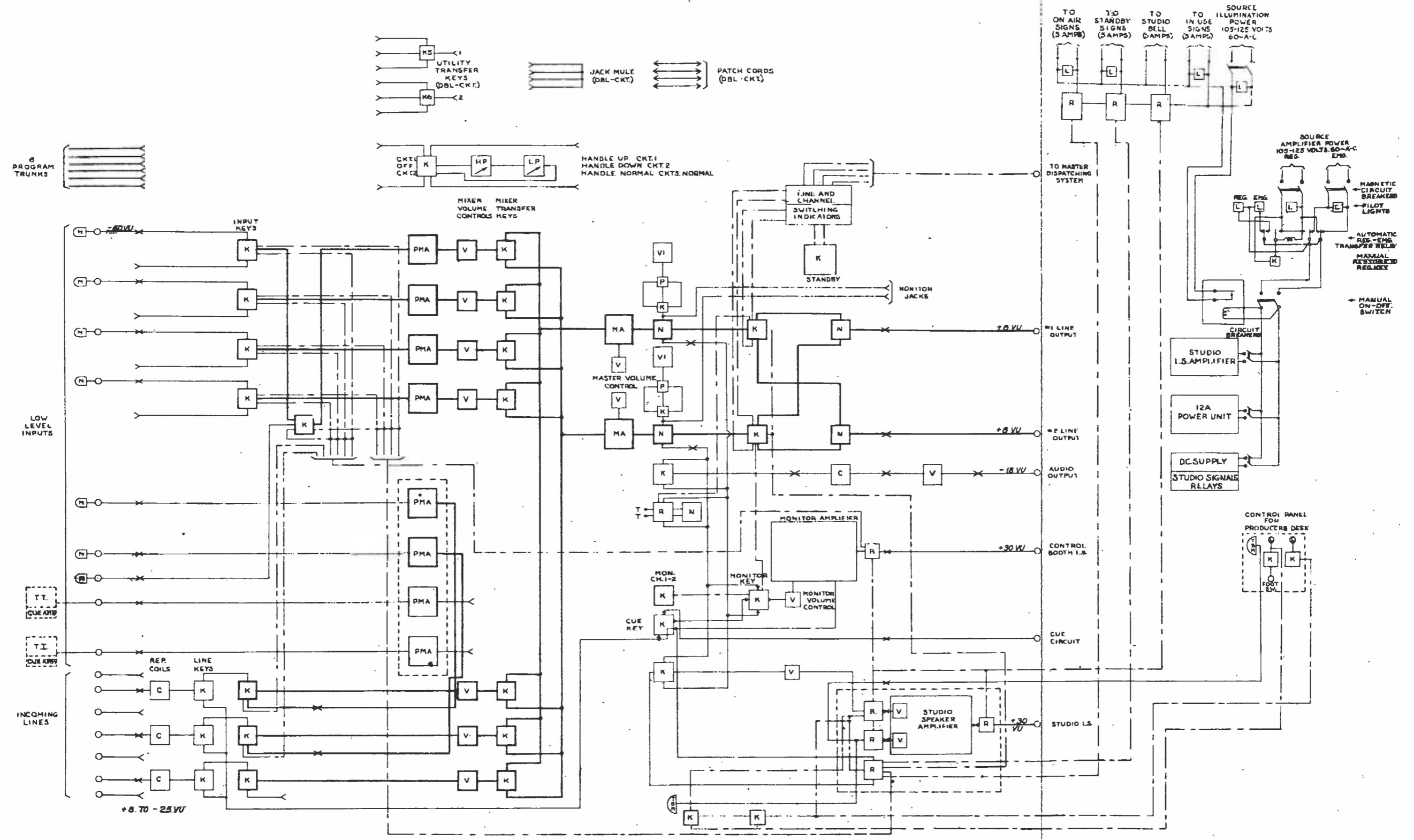

Functional Schematic for Control booth equipment utilizing a 25B Speech Input Equipment with auxiliary control circuit and equipment. See page 9 for console assembly and page 10 for typical power cabinet.

- KEYS.**
- 3 POSITION LOCKING.
 - KEY 1 MICROPHONE CHOICE KEY SUB STUDIO.
HANDLE UP MIC. 1.
HANDLE NORMAL OFF.
HANDLE DOWN MIC. 2.
 - KEY 2 AND KEY 3 ELECTRIC TRANSCRIPTION CHOICE KEY.
HANDLE UP ET 1 OR ET 3.
HANDLE NORMAL OFF.
HANDLE DOWN ET 2 OR ET 4.
 - KEY 4 & K 5 REMOTE LINE CHOICE KEY.
HANDLE UP RE 1 OR RE 3.
HANDLE NORMAL OFF.
HANDLE DOWN RE 2 OR RE 4.
 - K 6 TO K 8 INCL. MIC. CHOICE KEY MAIN STUDIO.
HANDLE UP MIC. 1, MIC. 3 OR MIC. 5.
HANDLE NORMAL OFF.
HANDLE DOWN MIC. 2, MIC. 4 OR MIC. 6.
 - K 9 TO K 16 INCLUSIVE CHANNEL CHOICE KEY.
HANDLE UP STUDIO CHANNEL 1.
HANDLE NORMAL OFF.
HANDLE DOWN STUDIO CHANNEL 2.
 - K 18 TO K 25 INCLUSIVE OUTPUT LINE KEYS.
HANDLE UP CHANNEL 1.
HANDLE NORMAL OFF.
HANDLE DOWN CHANNEL 2.
 - 3 POSITION KEY 1-NON LOCKING.
 - K 17 MONITOR KEY.
HANDLE UP MA 1.
HANDLE NORMAL MA 2.
HANDLE DOWN TALKBACK.
 - K 26 AND K 27 STUDIO SPEAKER CUT OFF KEYS.
HANDLE UP-NON LOCKING (NO DOWN).
HANDLE NORMAL SPEAKER ON.
HANDLE DOWN SPEAKER OFF.
 - 2 POSITION LOCKING.
 - K 24 AND K 28 MIC. ANNOUNCE KEYS.
HANDLE NORMAL MIC. ON.
HANDLE DOWN MIC. OFF.
 - 2 POSITION 1-NON LOCKING.
 - K 29 INTERCOMMUNICATION KEY.
HANDLE NORMAL LISTEN.
HANDLE DOWN (NON LOCKING) TALK.
 - 12 POSITION PUSH BUTTON KEY.
 - K 29 AND K 30 INTERCOMMUNICATION AND DUE SELECTOR KEYS.
 - 2 POSITION TURNBUTTON KEY.
 - K 31 REGULAR-EMERGENCY POWER SUPPLY KEY.
HANDLE NORMAL REGULAR SUPPLY.
HANDLE TURNED 90° OFF. (CONTACTS PROVIDED FOR EMERG. SUPPLY.)

- NOTES**
- 1.- AMPLIFIER AND RECTIFIER TABLE.
PMA 1 TO 6 INCLUSIVE } 2-129A AMPLIFIERS
BA 1 AND BA 2. } 208 RECTIFIER
PS 1
 - 2.- ANTICIPATED NORMAL PROGRAM LEVELS ARE INDICATED IN VU.
 - 3.- VOLUME CONTROLS V 1 TO V 8 INCLUSIVE ARE 30 STEP ROTARY CONTROLS.- 25 STEPS 1 1/2 DB EACH.- 4 STEPS TAPERED TO OFF OR INFINITE ATTENUATION.
 - 4.- VOLUME CONTROLS V 9 TO V 11 INCLUSIVE ARE 20 STEP ROTARY CONTROLS.- 17 STEPS 2 DB EACH.- 3 STEPS TAPERED TO OFF OR INFINITE ATTENUATION.
 - 5.- ALL TRUNKS 2-CONDUCTOR SHIELDED.

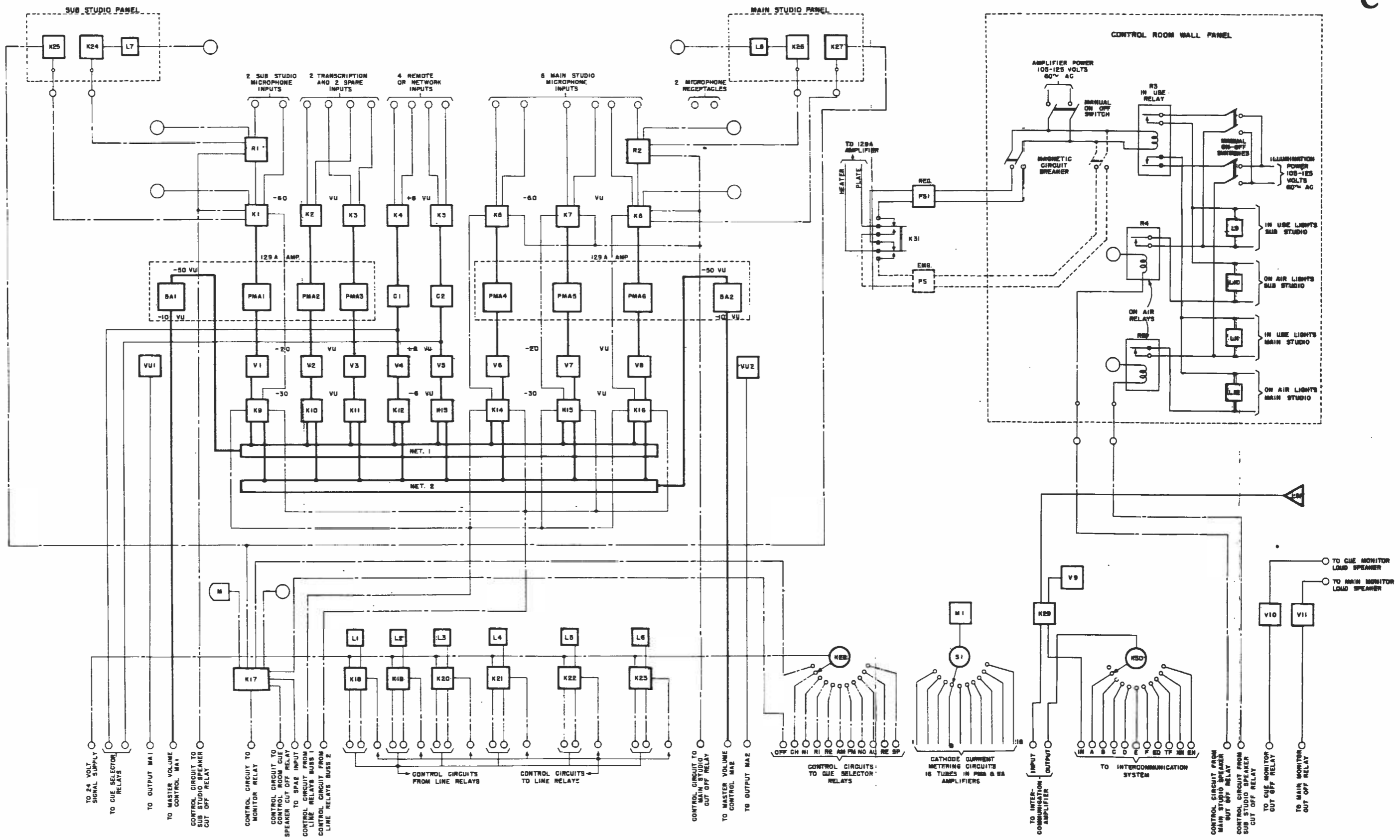

Functional Schematic for studio having limited control booth space for which the console is illustrated on page 9. See Drawing D for associated apparatus room equipment required for a four studio layout.

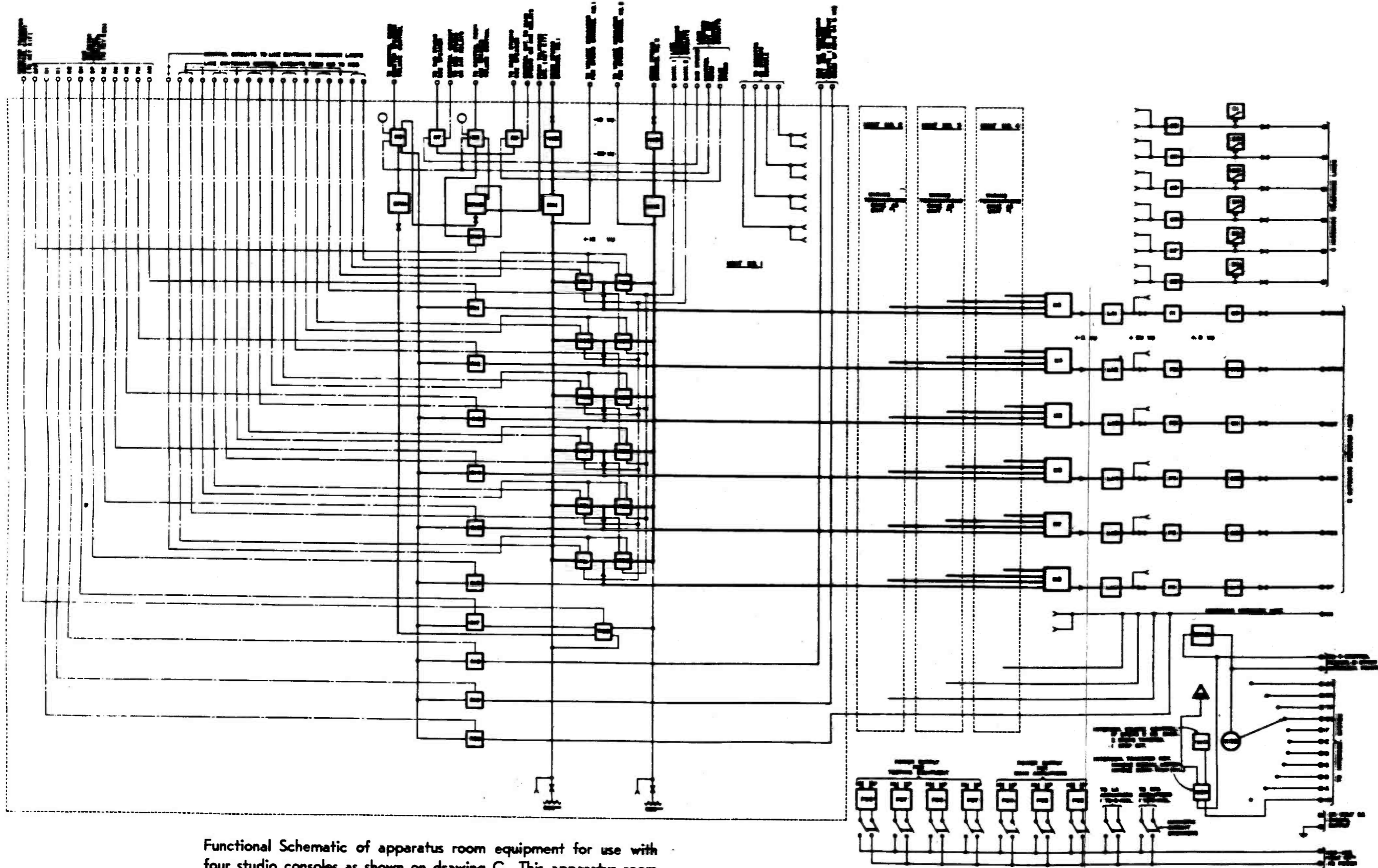

1. 11
2. 11
3. 11
4. 11
5. 11
6. 11
7. 11
8. 11
9. 11
10. 11
11. 11
12. 11
13. 11
14. 11
15. 11
16. 11
17. 11
18. 11
19. 11
20. 11
21. 11
22. 11
23. 11
24. 11
25. 11
26. 11
27. 11
28. 11
29. 11
30. 11
31. 11
32. 11
33. 11
34. 11
35. 11
36. 11
37. 11
38. 11
39. 11
40. 11
41. 11
42. 11
43. 11
44. 11
45. 11
46. 11
47. 11
48. 11
49. 11
50. 11
51. 11
52. 11
53. 11
54. 11
55. 11
56. 11
57. 11
58. 11
59. 11
60. 11
61. 11
62. 11
63. 11
64. 11
65. 11
66. 11
67. 11
68. 11
69. 11
70. 11
71. 11
72. 11
73. 11
74. 11
75. 11
76. 11
77. 11
78. 11
79. 11
80. 11
81. 11
82. 11
83. 11
84. 11
85. 11
86. 11
87. 11
88. 11
89. 11
90. 11
91. 11
92. 11
93. 11
94. 11
95. 11
96. 11
97. 11
98. 11
99. 11
100. 11

Functional Schematic of apparatus room equipment for use with four studio consoles as shown on drawing C. This apparatus room equipment can be mounted in standard rack cabinets.

DISTRIBUTOR IN THE UNITED STATES

Graybar
ELECTRIC COMPANY

Executive Offices: 420 Lexington Avenue, New York 17, N. Y.
Offices in more than 90 principal cities
A NATIONAL ELECTRIC SERVICE

DISTRIBUTOR FOR CANADA AND NEWFOUNDLAND

Northern Electric
COMPANY LIMITED

General Offices: 1620 Notre Dame Street, W.
Plant: 1261 Shearer Street,
Montreal, P. Q., Canada
TWENTY-FOUR BRANCHES FROM COAST TO COAST

1-B-47-65C

Printed in U.S.A.

WECO-T-2359