

National **Technics**

TAPE DECK

RS-1500US

RS-1506US

OPERATING INSTRUCTIONS



Before operating this set, please read these instructions completely.

IMPORTANT (FOR ENGLAND)

THE WIRES IN THIS MAINS LEAD ARE COLOURED IN ACCORDANCE WITH THE FOLLOWING CODE:

BLUE: NEUTRAL
BROWN: LIVE



As the colours of the wires in the mains lead of this apparatus may not correspond with the coloured markings identifying the terminals in your plug proceed as follows:

- * The wire which is coloured blue must be connected to the terminal which is marked with letter N or coloured black.
- * The wire which is coloured brown must be connected to the terminal which is marked with the letter L or coloured red.

If a 13 amp (BS. 1363) plug is used, a 3 amp fuse must be fitted, or if any other type of plug is used, a 5 amp fuse must be fitted either in the plug or adaptor or at the distribution board.

1

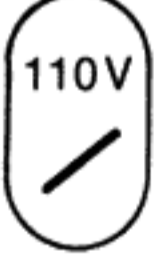
VOLTAGE ADJUSTMENT INSTÄLLNING AV NÄTSPÄNNING REGLAGE DU VOLTAGE NETSPANNINGS BIJREGELING AJUSTE DEL VOLTAJE EINSTELLEN DER SPANNUNG

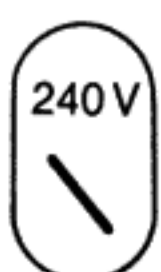
SETTING OF VOLTAGE SELECTOR	LOCAL VOLTAGE
INSTÄLLNING AV SPÄNNINGS-VÄLJAREN	ORTENS NÄTSPÄNNING
REGLAGE DU SELECTEUR DE VOLTAGE	TENSION LACALE
POSITIES VAN DE NETSPANNINGS KEUZE SCHAKELAAR	PLAATSELIJKE NETSPANNING
AJUSTE DEL VOLTAJE	VOLTAJE LOCAL
EINSTELLUNG DES SPANNUNGSWÄHLERS	ÖRTL. NETZSPANNUNG
	AC 110, 115V 50/60 Hz
	AC 120, 125, 127V 50/60 Hz
	AC 210, 220V 50/60 Hz
	AC 230, 240, 250V 50/60 Hz

2

POWER SOURCE NETSPANNING STRÖMKÄLLOR CORRIENTE ALIMENTATION STROMQUELLEN AC power line Nät drift Ligne à courant fort ca Wisselspannings voeding Línea de alimentación de corriente alternada Wechselstrom-netzkabel

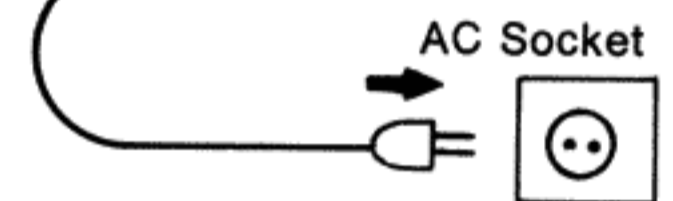
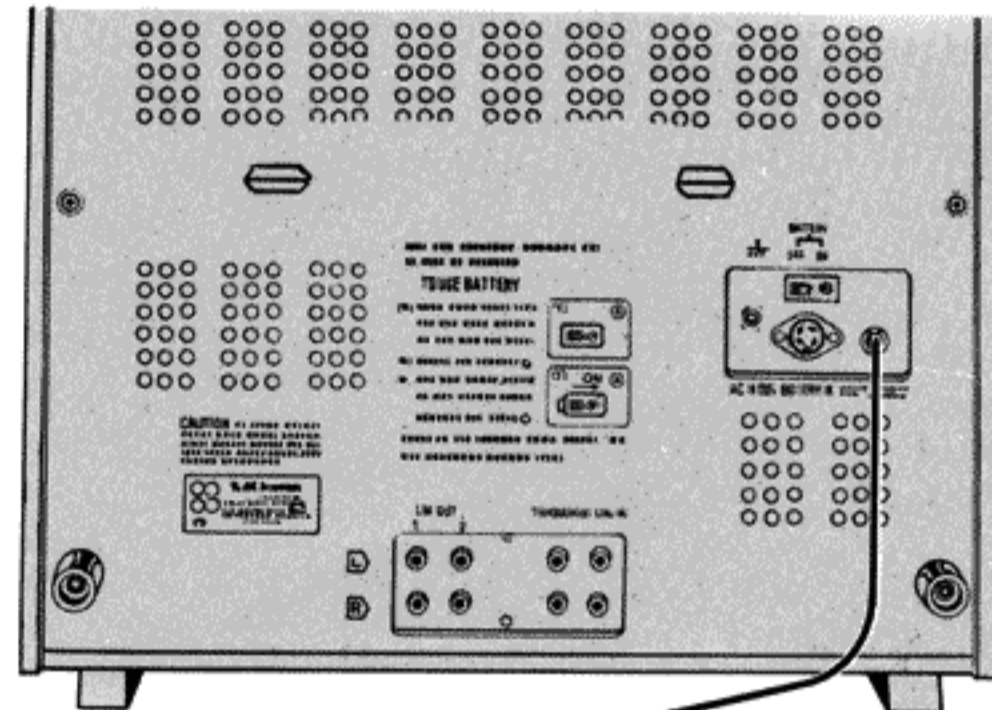

DC power supply Gelijkspannings voeding Batteridrift Fuente de alimentación de corriente continua Alimentation CC Gleichstromversorgung

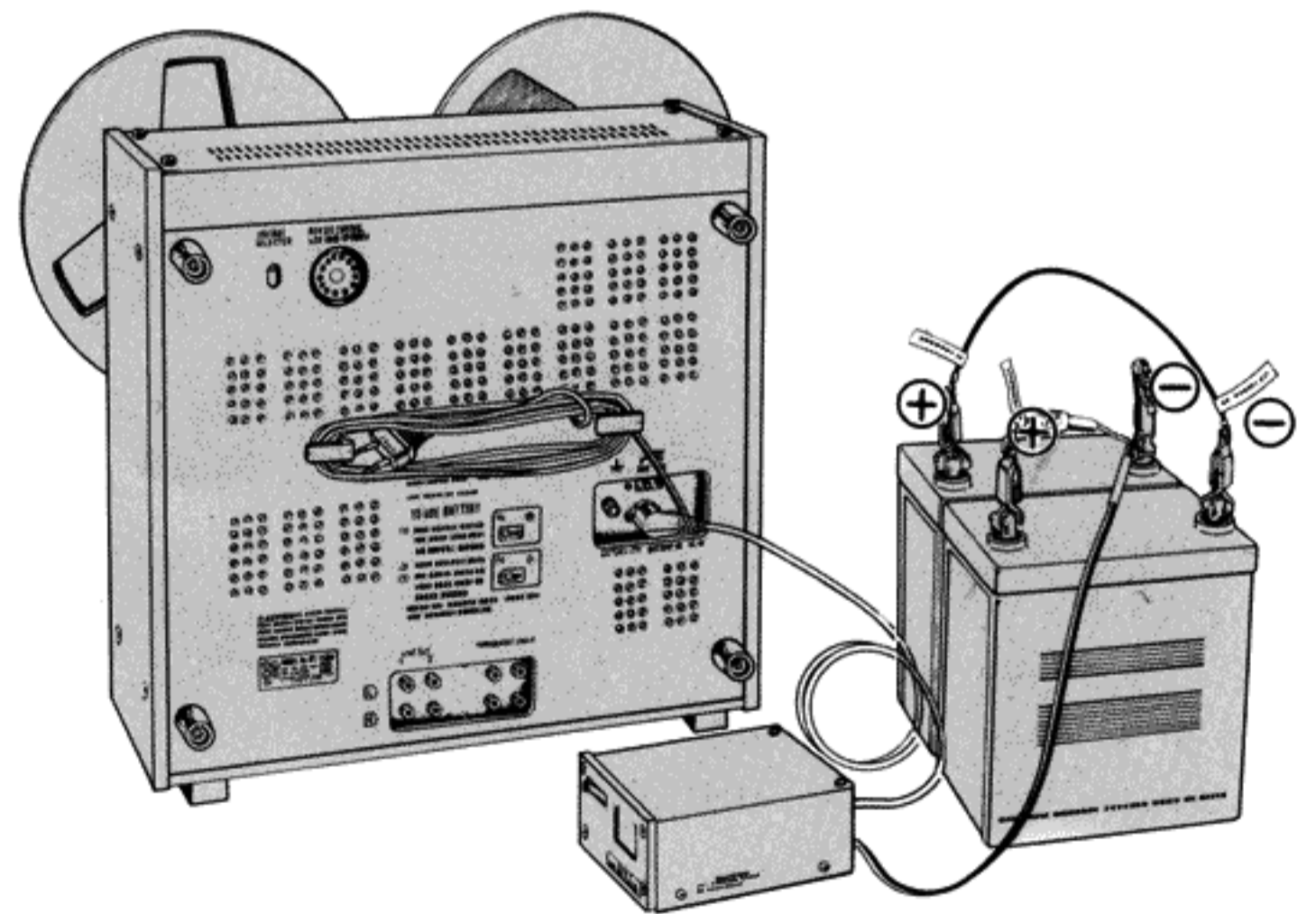

Technics Battery Adaptor (RP-086, optional)

Automobile Battery

Always use the Battery Adaptor to connect the unit to an automobile battery.

Connect the Battery Adaptor Output Plug to the DC IN Connector.

* An automobile battery provides up to 10 hours of continuous recording in case of usage of two 12V 26A-h new and fully charged batteries.

3

CONTROLS

BEDIENINGSKNOPPEN

KONTROLLER

CONTROLES

COMMANDES

BEDIENUNGSELEMENTE

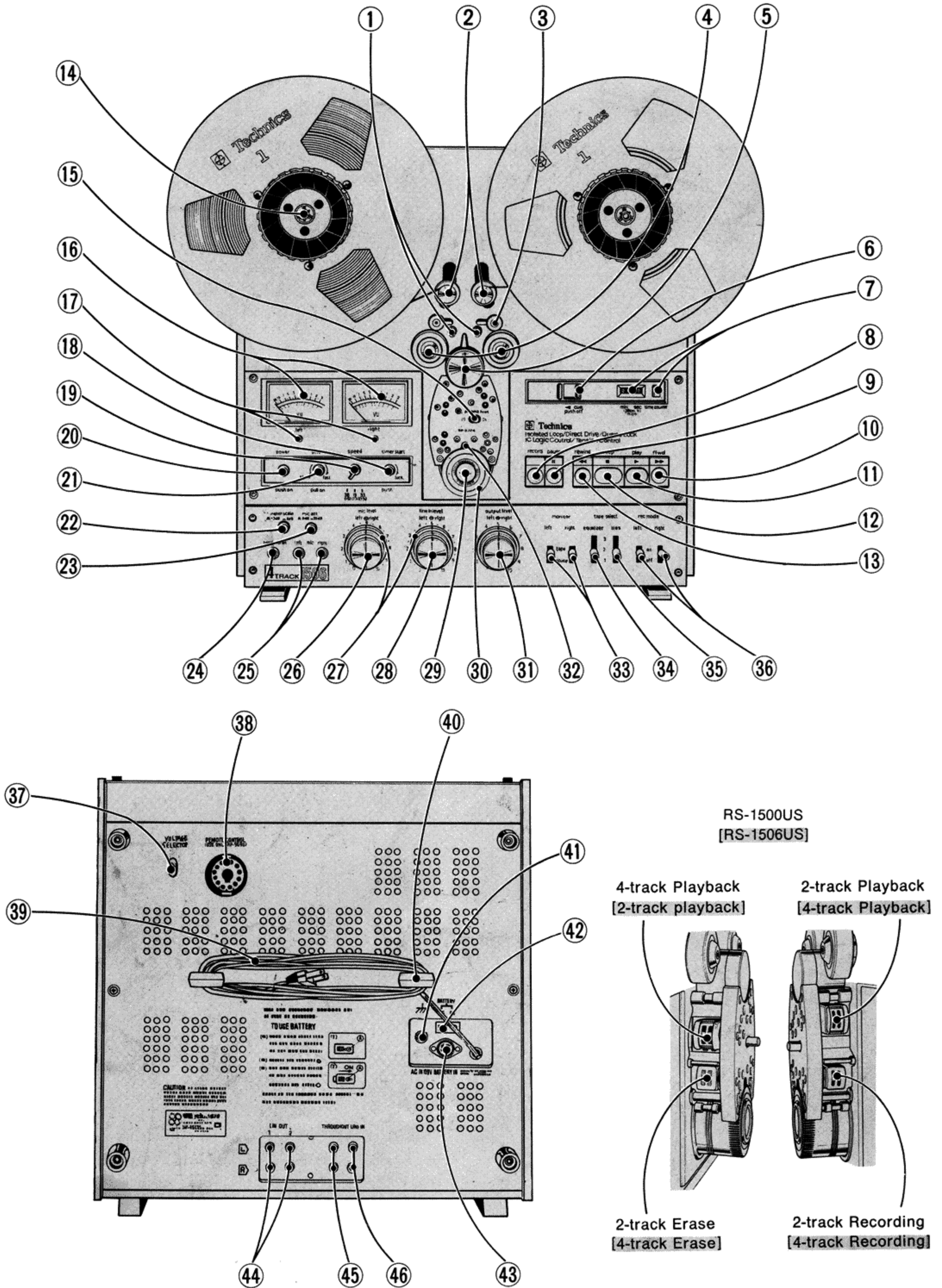

4

CONNECTIONS

ANSLUTNINGAR

BRANCHEMENTS

AANSLUITINGEN

CONEXIONES

ANSCHLÜSSE

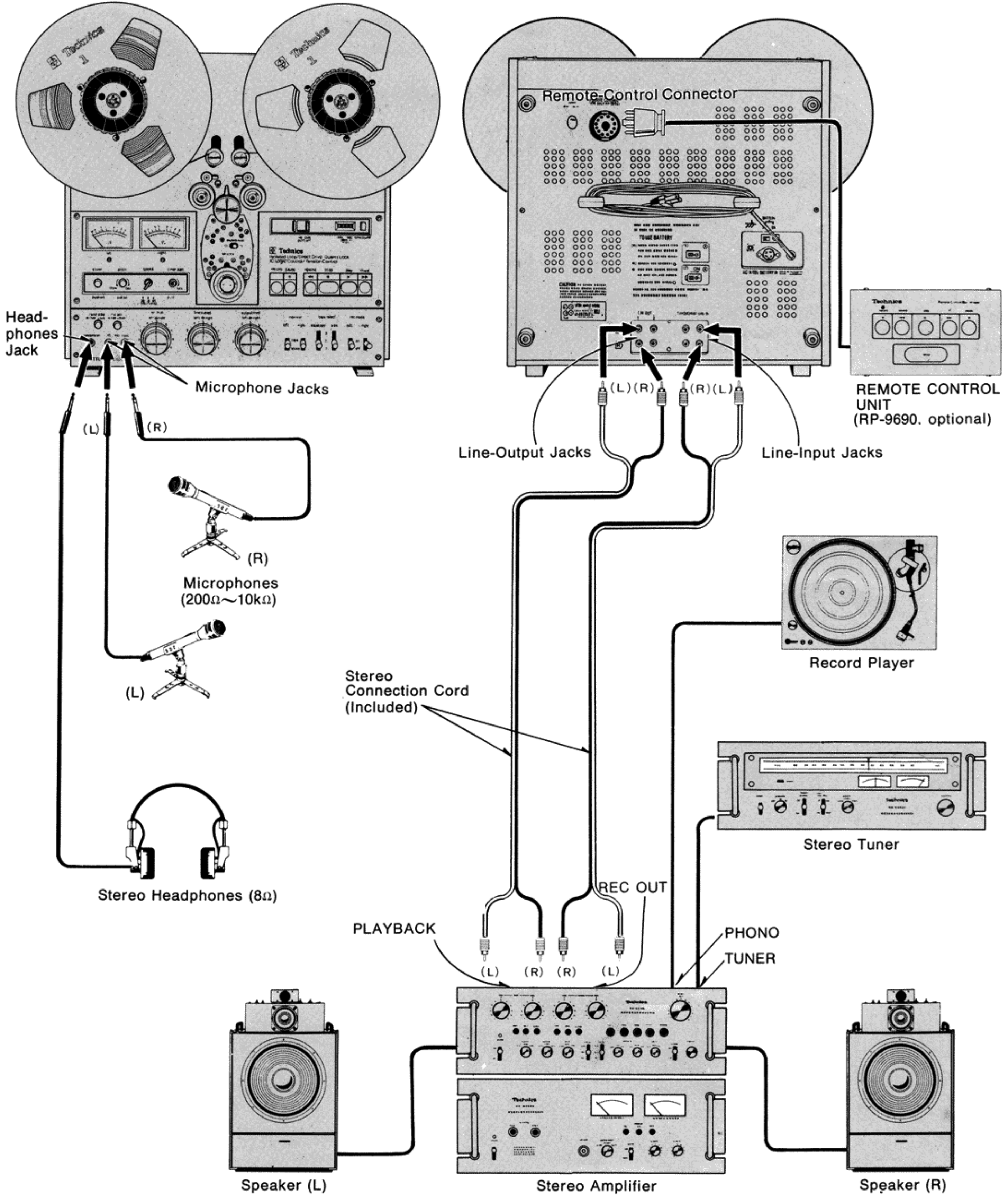

5 **TAPE THREADING**
ISÄTTNING AV BANDET
MISE EN PLACE DE LA BANDE
HET INLEGGEN VAN DE BAND
MANERA DE METER LA CINTA
EINLEGEN DES BANDES

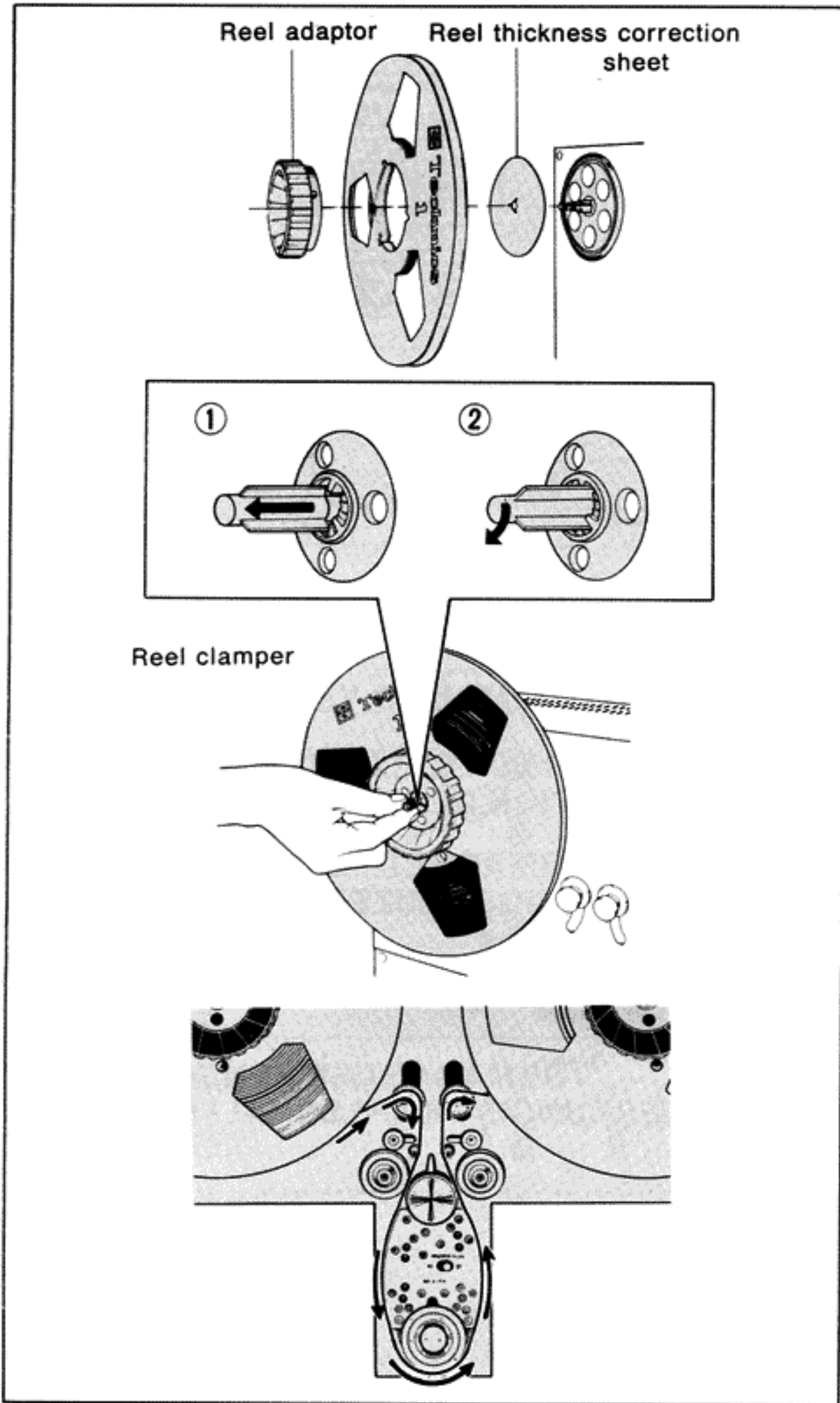

6 **How to exchange the reels**
Byte av spolar
Comment effectuer l'échange des bobines
Hoe de spoelen te verwisselen
Manera de cambiar los carretes
Auswechseln der Spulen

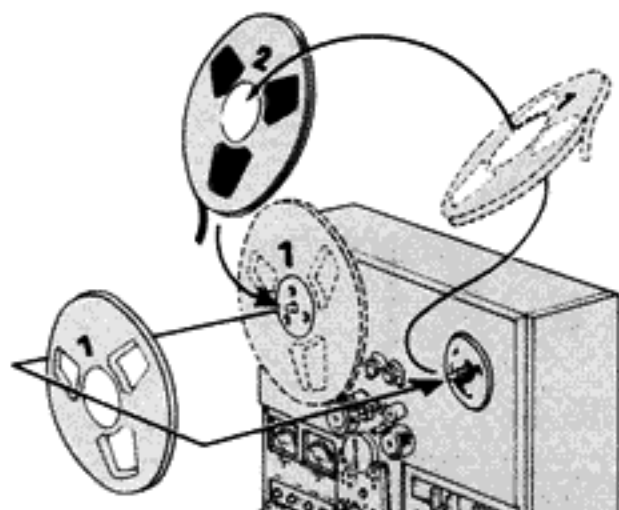

7 **PLAYBACK** **TERUGSPELINGEN**
AVSPELNING **REPRODUCCION**
LECTURE **WIEDERGABE**
2-track/4-track 2-channel (stereo) playback
2-spårs/4-spårs 2-kanals (stereo) avspelning
Lecture 2-pistes/4-pistes 2-canaux (stéréophonique)
2-sporen/4-sporen 2-kanalen (stereo) tengspelingen
Reproducción de 2 pistas/4 pistas y 2 canales (estéreo)
2-Spur/4-Spur 2 Kanal (Stereo) Wiedergabe

<p>1 Power Switch "on"</p>	
<p>2 Pitch Control "off"</p>	
<p>3 Tape Speed Selector</p>	
<p>4 2-track 2-channel playback 2-4 Track Selector "2t" 4-track 2-channel playback 2-4 Track Selector "4t"</p>	
<p>5 Record Mode Switches "off"</p>	
<p>6 Monitor Switches "Tape"</p>	
<p>7 Output Level Controls "8"</p>	
<p>8 Play Button "Play"</p>	
<p>9 Stereo Amplifier "Tone Control" "Volume Control"</p>	
<p>10 Stop Button "Stop"</p>	

- 8** **Fast forward and rewind**
Snabbspolning framåt och bakåt
Bobinage rapide et rebobinage
Snel opspoelen en terug spoelen
Avance rápido y rebobinado
Schnellvorlauf und Rückspulen

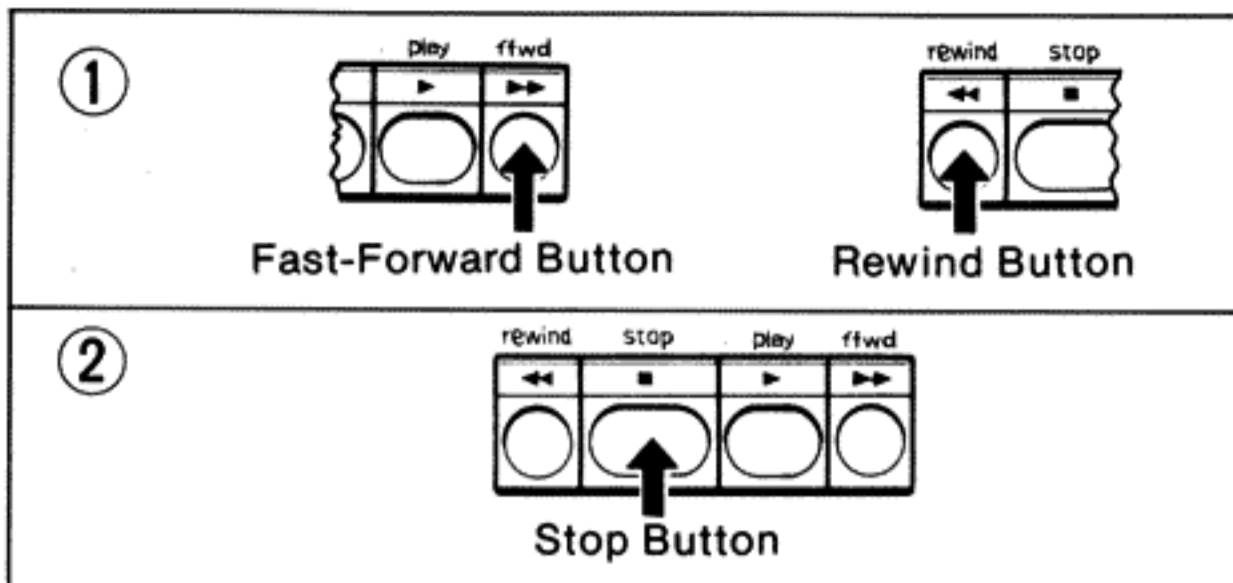

- 10** **Time Counter** **Tijd klok**
Tidsräkneverk **Contador de tiempo**
Compteur de durée **Echtzeit-Zählwerk**

38 cm/s	min sec	
38 cm/s	1030	Actual Time 10 min 30 sec
19 cm/s	1030	21 min
9.5 cm/s	1030	42 min

- 9** **Level Meter zero-point adjustment**
Nollställning av nivåinstrumenten
Vis de réglage av point zero des indicateurs de niveau
Niveau meters nulpunt instellings schroeven
Tornillos para el ajuste a cero de los medidores
Nullpunkt-justierschrauben für VU-Meter

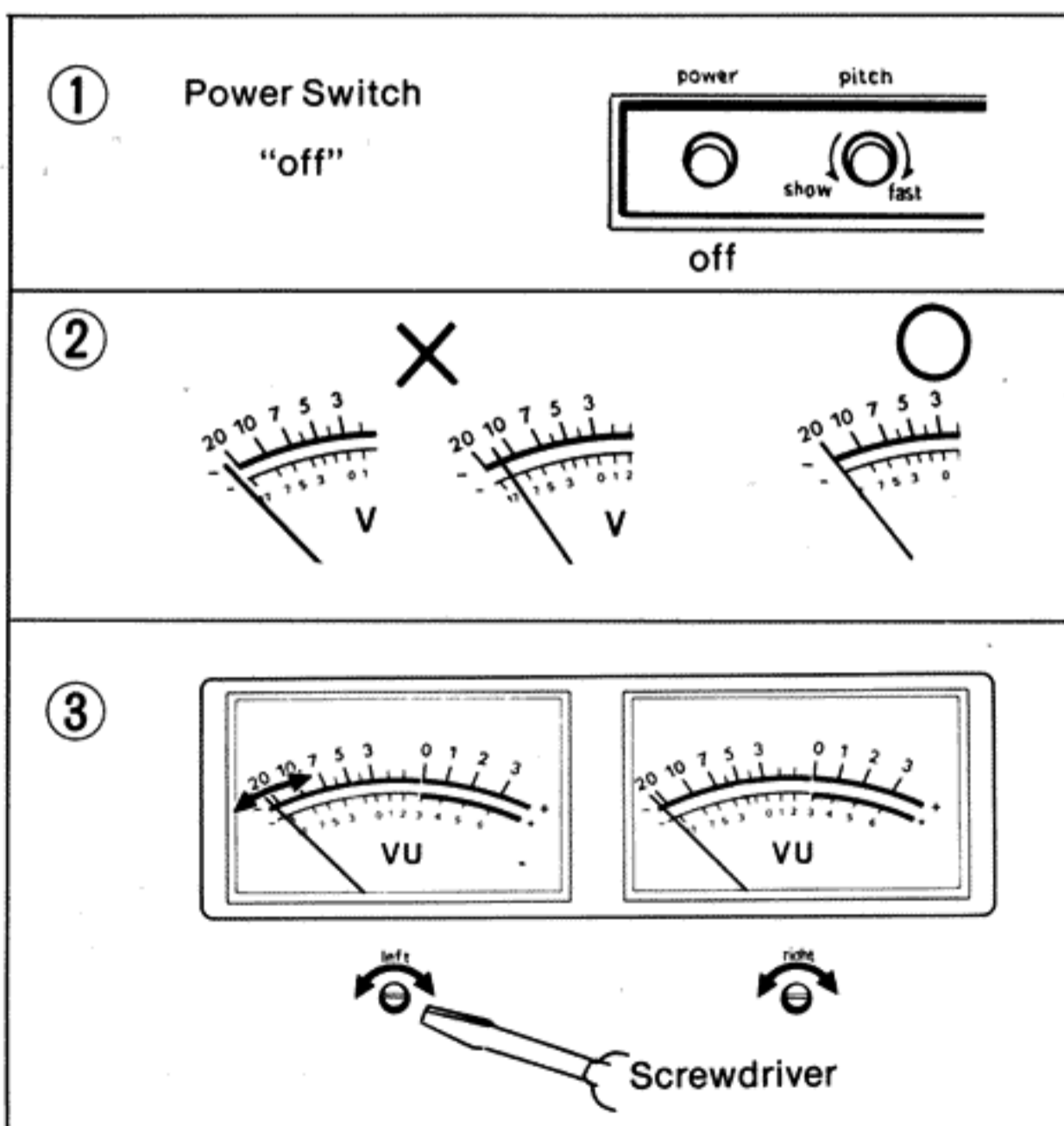

- 11** **TAPE BIAS AND EQUALIZATION SELECTOR**
BIAS OCH EQUALIZER VÄLJARNAS LÄGEN
SELECTEURS D'EGALISATION ET DE POLARISATION DE LA BANDE
BAND VOORMAGNETISERINGS EN VEREFFENINGS KEUZE SCHAKELAARS
SELECTORES DE POLARIZACIÓN DE CINTA E IGUALACIÓN
BAND—, VORMAGNETISIERVNGS—UND ENTZERRUNGS—WAHLSCHALTER

BIAS	1	2	3
EQUALIZATION			
1		TDK S	
2	FUJI FM	TECHNICS RT10B218 SCOTCH #206 SCOTCH #207 AMPEX GRAND MASTER AMPEX 20/20+ BASF STUDIO SERIES BASF PROFESSIONAL SERIES SONY FeCr (DUAD)	SCOTCH #250 MAXELL UD MAXELL LN FUJI FB
3	SCOTCH #211 SCOTCH #212 SCOTCH #213 FUJI FG AGFA PE-36	SCOTCH Classic SONY SLH	TDK AUDUA

This unit is adjusted for use with TECHNICS RT-10B218 (Scotch #207) tape.

12 RECORDING
INSELNING
ENREGISTREMENT
[RS-1506US]

OPNEMEN
GRABACION
AUFNAHME

2-track [4-track] 2-channel (stereo) recording
 2-spårs [4-spårs] 2-kanals (stereo) inspelning
 Enregistrement 2 pistes [4 pistes] 2 canaux (stereophonique)
 2-sporen [4-sporen] 2 kanalen (stereo) opnamen
 Grabacion de 2 pistas [4 pistas] y 2 canales (estéreo)
 2-Spur [4-Spur] 2-Kanal (Stereo)-Aufnahmen

1	Tape Speed Selector				38 cm 19 cm 9.5 cm	
2	2-track 2-channel recording 2-4 Track Selector "2t"	RS-1500US		4t	2t	
	4-track 2-channel recording 2-4 Track Selector "4t"	[RS-1506US]		2t	4t	
3	Pitch Control "off"	power	pitch	speed		
4	Bias Selector Equalization Selector "Select them for tape-type"	3	2	1		
5	Monitor Switches "Source"	monitor	source			
6	Record Mode Switches "on"	rec mode	on			
7	Meter Scale Selector "3dB" or "6dB"	meter scale -3dB -6dB	+3dB	+6dB		
8	Microphone Level Controls Line-Input Level Controls "Adjust"			mic level	line level	
9	Record Button Play Button	record pause	rewind	stop	play	ffwd
10	Monitor Switches "Tape" "Source"	monitor	tape	source		
11	Stop Button "Stop"	rewind	stop	play	ffwd	

13 MIX RECORDING
MIXINGSINSELNINGAR
MIXAGE À LA ENREGISTREMENT
GEMENGDE OPNAMEN
GRABACIÓN MIXTA
GEMISCHTE AUFNAHME

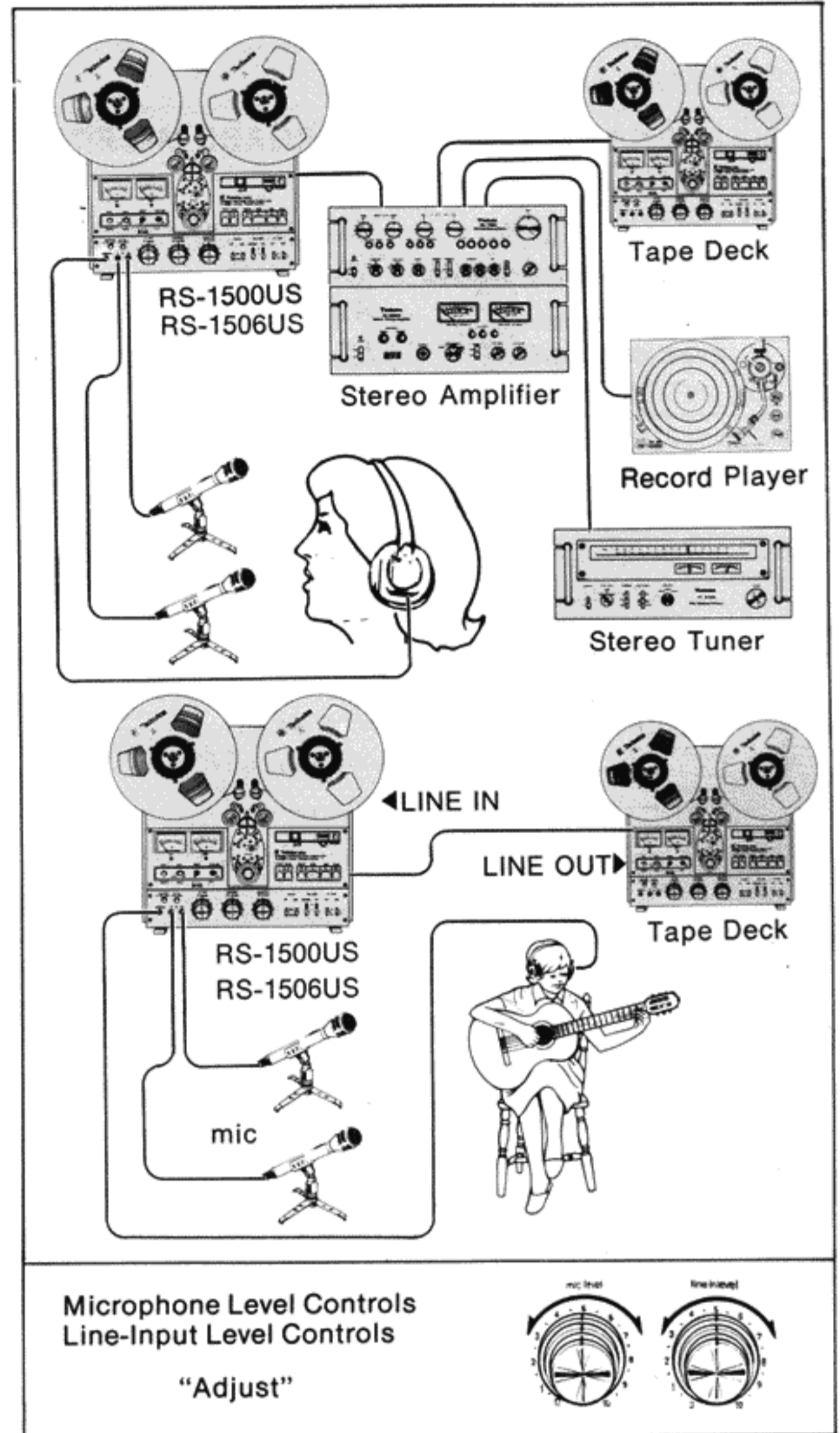

14 Erasing
Radering
Uitwissen
Borrado de los sonidos
grabados
Effacement
Löschen

1	Microphone Level Controls Line-Input Level Controls "0"	mic level	line level			
2	Record Mode Switches "on"	rec mode	on			
3	Record Button Play Button	record pause	rewind	stop	play	ffwd

15 TIMER RECORDING AND PLAYBACK

IN- OCH AVSPELNING MED TIDUR

ENREGISTREMENT ET LECTURE AVEC MINUTERIE

OPNAME EN TERUG SPELEN MET BEHULP VAN EEN TIJDKLOK

GRABACIONES y REPRODUCCIONES con REGULADOR de TIEMPO

AUFNAHME UND WIEDERGABE MIT EINEM ZEITSCHALTER

Timer recording
Inspelning med tidur
Enregistrement avec minuterie

Tijdklok opnamen
Grabaciones con regulador de tiempo
Schaltuhr-Aufnahme

Timer playback
Avspelning med tidur

Tijdklok terugspeling
Reproducciones con regulador de tiempo

Lecture avec minuterie

Schaltuhr-Wiedergabe

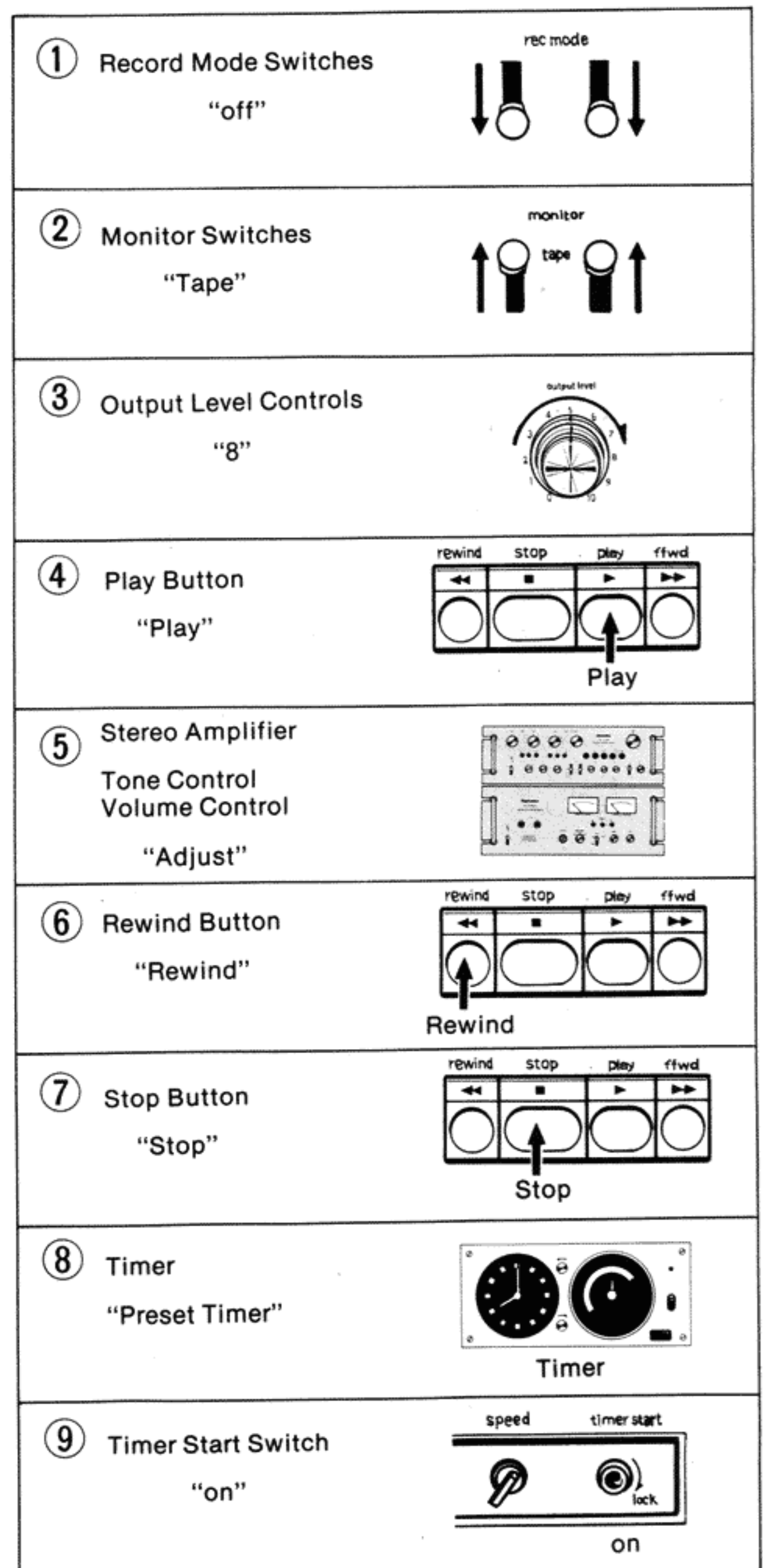
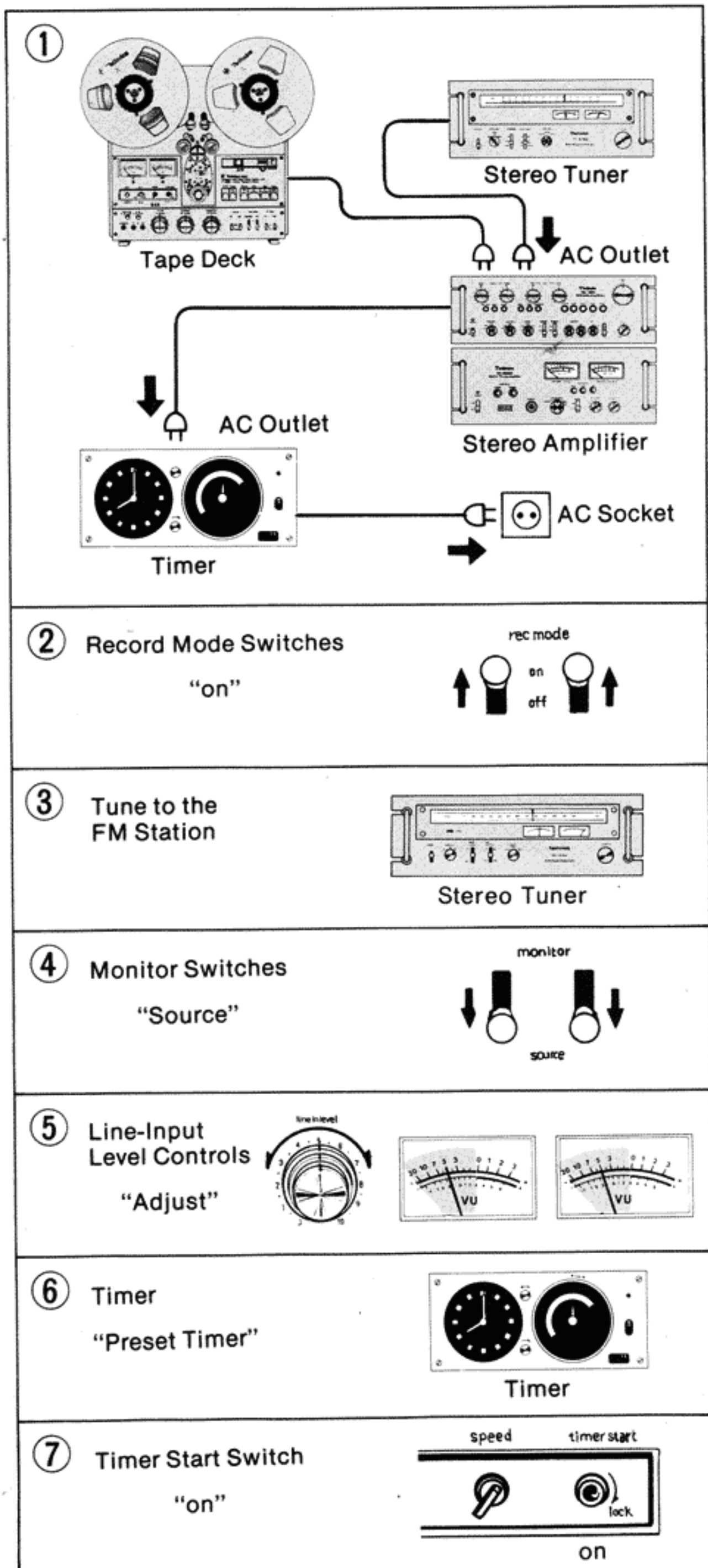

16

TAPE EDITING
REDIGERING AV BAND
MONTAGE SONORE
BAND EDITING
MONTAJE DE LAS CINTAS
REDIGIEREN VON BÄNDERN

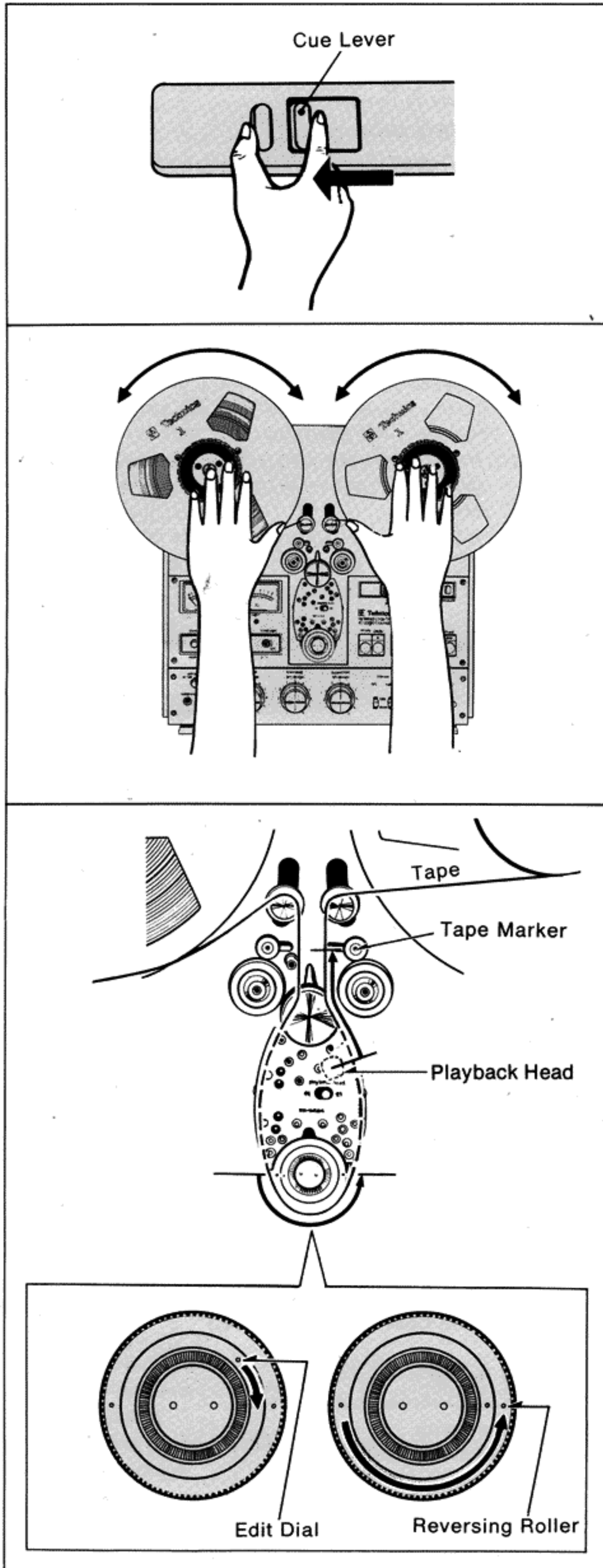
**17**

How to splice the tape
Bandskarvning
Réparation de la bande
Het knippen van een band
Cómo unir las cintas
Kleben des Bandes

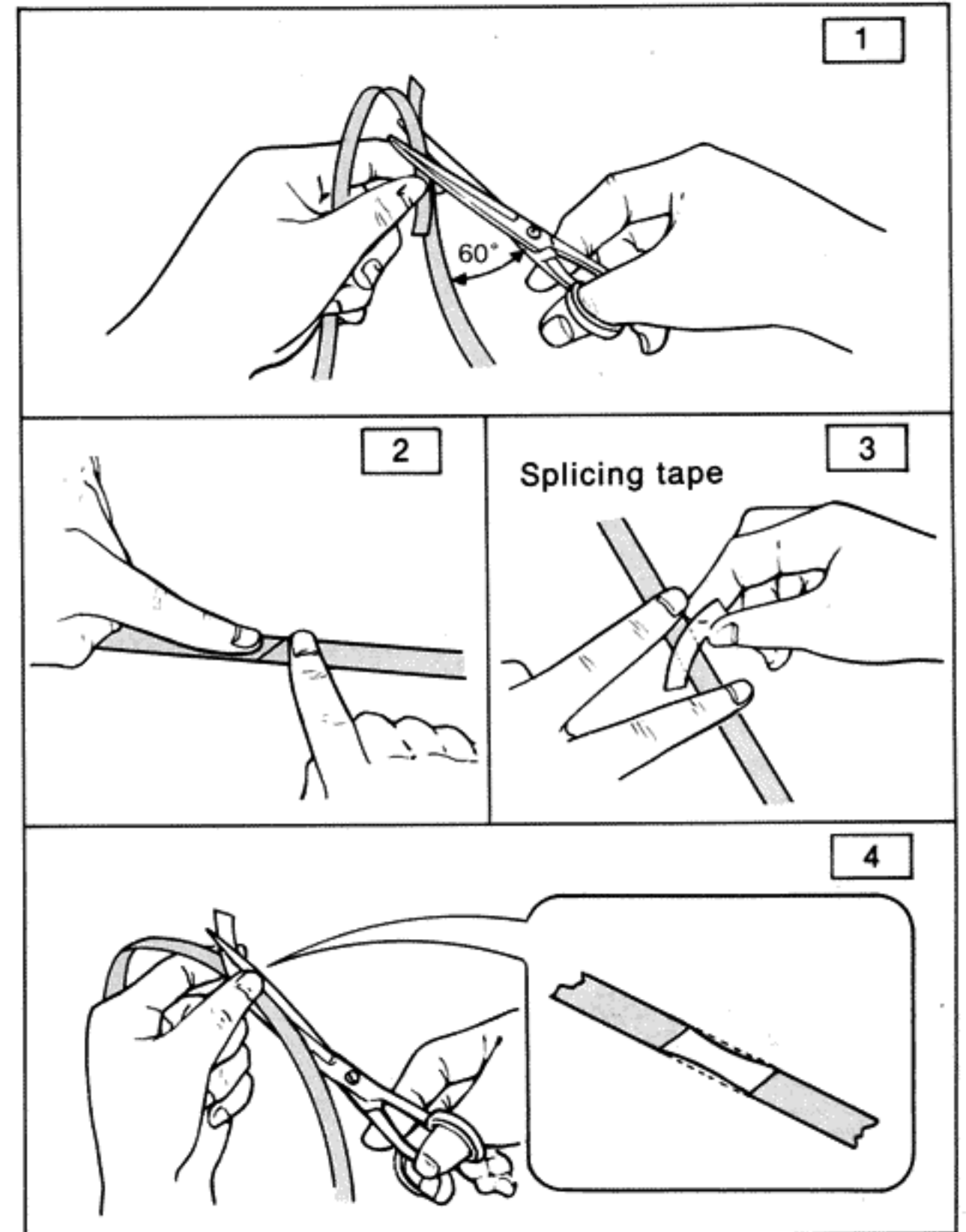
**18**

SERVICING
UNDERHÅLL
ENTRETIEN

ONDERHOUD
MANTENIMIENTO
WARTUNG

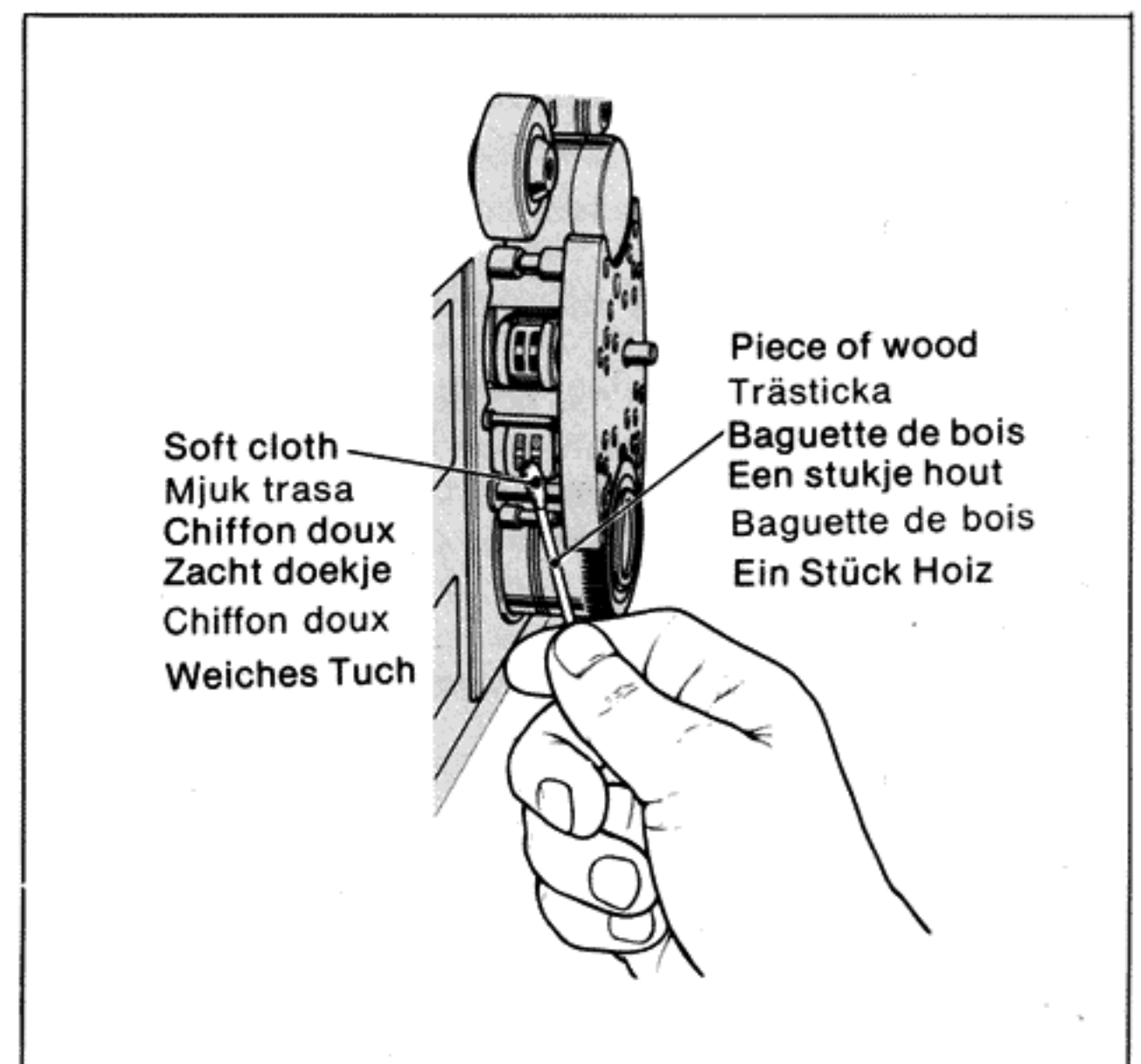

(ENGLISH)

We thank you for selecting the model RS-1500US/RS-1506US Technics open-reel tape deck for your recording and playback enjoyment.

To obtain the maximum benefit of the many features of this deck, please read these operating instructions carefully.

UNPACKING & PLACEMENT

1. Unpacking

Save packing cartons and spacers for future use, to protect the units in the event that they are transported.

When unpacking, do not overlook the Empty 26.5 cm Reel, the two Stereo Connection Cords, the two Reel Adaptors, the two Reel-thickness Correction Sheets, and the Dust Cover packed with the unit.

2. Placement

- Avoid extremely hot (above 35°C) or cold (below 5°C) locations. Do not place in direct sunlight.
Avoid unstable locations (such as slanted or vibrating locations).
- **Avoid humid and dusty locations.**
- **To assure good heat dissipation, avoid blocking of the ventilation holes by curtains, etc.**
- **Use power source frequency of either 50 Hz or 60 Hz**
Because this unit has DC servomotors, power frequency of either 50 Hz or 60 Hz may be used.
- **Power should be within $\pm 5\%$ of the rated voltage**
Note that the unit's performance will be uneven, or the unit may be damaged, if the power exceeds $\pm 10\%$ of the rated voltage.
- **Cleaning of the head assembly**
One of the most important factors in determining good tape recorder performance is regular cleaning of the head assembly. Refer to "SERVICING" on page E-4 and be sure to always keep the head surfaces clean.

VOLTAGE ADJUSTMENT (Refer to figure ①.)

Before connecting this unit to the AC outlet, make sure that the unit is properly set to your local voltage. This unit has been set to operate on the voltage indicated on the CAUTION card attached to the unit.

If you use the unit in a different voltage area, readjust it to your local voltage by setting the VOLTAGE selector with a screwdriver.

TAPE

- Never use tape that is creased, curled, dirty, worn stretched or old.
Such tapes are noisy and may damage the head or produce poor recordings.
- When new tape or tape that has not been used for a long period of time is used, run the entire tape at fast-forward and then rewind it before actual recording. The windings of tape that has not been used for an extended period will become loose and recording quality will be poor.
- Do not use paper tape.
Such tape will result in unstable running and contamination of the head by the dust.
- Make sure the reels are not warped.
- Do not place tape near magnetic fields (near speakers, amplifiers, television sets, etc.).
- Avoid storing tape in high temperature, high humidity locations.
- Place the tape in a polyethylene bag and then a box when storing.

POWER (Refer to figure ②.)

The unit will become operative approximately 3 seconds after the Power Switch is set to the "ON" position.

AC Power Line

Plug the Power Cord into an AC Socket. This unit can be used on either 50 Hz or 60 Hz power.

DC Power Supply

The capstan-drive mechanism and reel-base-drive mechanism of this unit employ a DC-drive system and can be operated on DC power (using the optional Battery Adaptor RP-086).

This unit can thus be used for live recording even when an AC power line is not available.

* Note that the level meter lamps will not be illuminated when a DC power supply is used.

Setting the Battery Selector

Always turn the Power Switch off and set the Cue Lever to the "off" position before setting the Battery Selector.

Set the Battery Selector on the rear panel.

DC Power Operation

The Cue Lever is interlocked with the DC Power Switch. When the Battery Selector is set to the "ON" position, the Power Switch of this unit becomes inoperative. (However, the level meter lamps will be illuminated when the Power Switch is set to the "ON" position while connected to an AC line.)

- During DC Power operation, avoid fast forward and rewind if possible, because such operation not only accelerates discharging of the battery, but also accelerates head wear.
- Follow the reverse procedure to return the Battery Selector to the "OFF" position.
- Also return the Cue Lever to the "off" position.

CONTROLS (Refer to figure ③.)

- ① Guide Pins
- ② Tension Rollers
- ③ Tape Marker
- ④ Double Pinch Rollers
- ⑤ Capstan
- ⑥ Cue Lever/DC Power Switch
- ⑦ Time Counter, Reset Button
- ⑧ Record Button (record) (●)
- ⑨ Pause Button (pause) (II)
- ⑩ Fast-Forward Button (f fwd) (▶▶)
- ⑪ Playback Button (play) (▶)
- ⑫ Stop Button (stop) (■)
- ⑬ Rewind Button (rewind) (◀◀)
- ⑭ Reel Clamper
- ⑮ 2-4 Track Selector
- ⑯ Level Meters
- ⑰ Level Meter Zero-Point Adjustment Screws
- ⑱ Timer Start Switch (timer start)
- ⑲ Tape Speed Selector (speed)
- ⑳ Power Switch (power)
- ㉑ Pitch Control (pitch control)
- ㉒ Meter Scale Selector (meter scale)
- ㉓ Microphone Attenuator Switch (mic att)
- ㉔ Headphones Jack (headphones)
- ㉕ Microphone Jacks (mic)
- ㉖ Microphone Level Controls (mic level)
- ㉗ Preset Markers
- ㉘ Line-Input Level Controls (line in level)
- ㉙ Edit Dial
- ㉚ Reversing Roller
- ㉛ Output Level Controls (output level)
- ㉜ Stroboscope Lamp
- ㉝ Monitor Switches (monitor)
- ㉞ Equalization Selector (EQ)
- ㉟ Bias Selector (bias)
- ㊱ Record Mode Switches (rec mode)
- ㊲ Voltage Selector (VOLTAGE SELECTOR)

- ③⑧ Remote-Control Connector (REMOTE CONTROL)
- ③⑨ Power Cord
- ④⑩ Power Cord Holder
- ④① Ground Terminal (GND)
- ④② Battery Selector
- ④③ DC IN Connector (DC IN)
- ④④ Line Output Jacks (LINE OUT) (1, 2)
- ④⑤ "Throughout" Jacks (THROUGHOUT)
- ④⑥ Line-Input Jacks (LINE-IN)

CONNECTIONS (Refer to figure ④.)

Note:

A "click" noise may be heard when the power switch is turned on or off. To avoid this, be sure to set the volume control of the amplifier to the minimum position.

TAPE THREADING NOTES (Refer to figure ⑤.)

1. Be sure that the magnetic side of the tape touches the head.
2. Note that the tape will not run even if the operation controls are pushed, if the tape is loose and is not touching the Tension Rollers when threaded.
3. 38-cm/s 2-track recorded tape generally must be rewound before use.
In this case, thread the tape by reversing the positions of the full reel and empty reel and rewind the tape once before playing it.
4. 18 μ thick 300% tape is extremely thin and may stretch or be wound irregularly. Its use must be avoided.
 - Do not use any Reel Thickness Correction Sheets except those supplied as an accessory.
 - Use left and right reels having the same shape.
 - The use of 26.5cm and 18 cm reels is recommended.
 - Do not use the Reel Thickness Correction Sheets except when using 26.5cm metal reels. They are not necessary when plastic reels are used.

How to exchange the reels (Refer to figure ⑥.)

PLAYBACK (Refer to figure ⑦.)

2-track/4-track 2-channel (stereo) playback

- Connect the stereo amplifier, stereo set or other playback equipment.
(Refer to figure ④.)
Furthermore, set the monitor switch of the connected stereo amplifier or stereo set to the "tape" position. No sound will be heard if it is set to the "source" position.
- Set the volume control of the stereo amplifier to minimum when connecting this unit to a stereo amplifier, etc. Otherwise, the tweeter of the speaker system may be damaged by a sudden excessive input.
- Set the Record Mode Switches to the "off" position.
(Playback is also possible at the "on" position, but set them to the "off" position so that the recorded tape is not erased by mistake.)
- Some of the various types of stereo headphones available are high impedance, but, since their output is insufficient, do not use them.
- When the Pause Button is pushed, the tape will stop, but its pilot lamp will not be illuminated. To continue playback, push the Play Button.
- The positions of the Equalization and Bias Selectors have no effect on playback.
- Turn the reels over to playback the other side in the same way.

2-track/4-track 1-channel (monaural) playback

- For monaural playback, the usual method is to set the Monitor Switch of only the channel (L or R) to be played back to the "tape" position, playback the tape, and then turn the reels over to playback the other side in the same way.
The playback procedure is identical to that for stereo playback.

Fast forward and rewind (Refer to figure ⑧.)

Level Meter zero-point adjustment

(Refer to figure ⑨.)

Time Counter (Refer to figure ⑩.)

This unit employs a Time Counter for the 38cm/s tape speed.

- * At 19cm/s 1/2 of the actual time is shown. (For example, when the tape has run for 1 minute, 00.30 is displayed.) At 9.5cm/s 1/4 the actual time is displayed.

Pitch Control

The recording and playback tape speed can be varied approx. $\pm 6\%$ with this control.

The speed decreases when the control is pulled out and turned counterclockwise, and increases when the control is turned clockwise. This is especially convenient when playing an instrument (guitar, etc.) along with a music tape.

Note:

Always push this control in during normal recording and playback.

BEFORE BEGINNING RECORDING

Tape Bias and Equalization Selectors (Refer to figure ⑪.)

A suitable bias and equalization must be used for the characteristics of the tape to be amply displayed and low distortion recordings obtained. This unit can be matched to the characteristics of the tape by switching both the bias and equalization in 3 steps.

Level Meters and Meter Scales

The level meters of this unit employ a full +3 dB scale and +6 dB double scale.

Use the +3 dB scale for ordinary tape.

When using low-noise high-output tape, use these meters according to whether a wide dynamic range low-distortion recording, or a recording with a better signal-to-noise ratio, is desired.

+3 dB () position

This position is suggested for a to wide-dynamic-range low-distortion recording.

+6 dB () position

This position increases the recording level 3 dB higher than the +3 dB position, thus giving a recording with a better signal-to-noise ratio.

Microphone Attenuator Switch

Low-distortion recording is possible by adjusting the Microphone Attenuator Switch to the 20 dB position. When excessive inputs enter the microphone, such as for recording by placing the microphone near musical instruments, the attenuator will eliminate distortion.

RECORDING (Refer to figure 12.) [RS-1506US]

2-track [4-track] 2-channel (stereo) recording

- Connect the tuner, stereo amplifier record player, microphone or other recording source to this unit. (Refer to figure 4).
- Load and thread the tape, and set the tape speed according to the recording source.
- Set the Monitor Switches to the "source" position and adjust the recording level. Select either a wide-dynamic-range low-distortion recording, or a recording with high signal-to-noise ratio, with the Meter Scale Switch. (See the "Level Meters and Meter Scales" section.)

Adjust the recording level from the line input with the Line Input Controls and the recording level from a microphone with the Microphone Input Level Controls.

Adjust so that the indication needles of the Level Meters deflect to within the range at which they do not enter the red zone.

- Lightly depress the Play Button while simultaneously pushing the Record Button and Pause Button. When the Play Button is released and the Record Button and Pause Button are then released, the record lamp and pause lamp will illuminate. (The record lamp will not illuminate if only the Pause Button is pushed.)
- Turn the reels over to record the other side in the same way.

Note:

- Since RS-1500US is designed for 4-track 2-channel play, and for 2-track 2-channel record and playback, 4-track 2-channel (two-way) recording is, therefore, impossible.
- Recording from the fast forward or rewind mode is impossible.

2-track [4-track] 1-channel (monaural) recording

For monaural recording, the usual method is to set the Record Mode Switch of only the channel (L or R) to be recorded to the "on" position, record the tape, and then turn the reels over to record the other side in the same way. The recording procedure is identical to that for stereo recording.

MIX RECORDING (Refer to figure 13.)

Re-Recording

Recording can be performed while playing back a recorded tape without halting the tape as follows:

1. Set the Recording Mode Switches to the "on" position in the playback state.
2. When the Record Button is pushed while the Play Button is being depressed, the unit is placed in the record state and recording is started.

* The unit can be switched to the record mode by merely pushing the Record Button during playback. Confirm that the record lamp is illuminated and that the recording is being made.

Erasing (Refer to figure 14.)

Record Mode Switches

These switches are used to select the channel to be recorded. When a switch (left or right) is set to the "on" position, that channel is recorded. When recording in stereo, set both switches (left and right) to the "on" position, and when recording in monaural set only the switch of the channel to be recorded to the "on" position.

When playing back, set both switches (left and right) to the "off" position. A valuable recorded tape will not be erased even if the recording operation is performed by mistake.

Pause Button

When the Pause Button is pushed during recording, the tape will stop but the record lamp will remain illuminated. When the Play Button is then pushed, the tape will begin to run again. When the Pause Button is pushed during playback, the tape is stopped and the lamp is not illuminated.

* The Pause Button is inoperative during fast forward and rewind.

TIMER RECORDING AND PLAYBACK

(Refer to figure 15.)

Timer Start Switch

This is used when timer recording and timer playback are performed by using the unit in conjunction with a timer.

Timer Recording (Recording from FM broadcasts for instance)

Refer to figures 15 and 4 for the connection of the sound source.

Timer Playback

- Thread the tape to be played back. Make power connections and connections to other equipment in the same way as for timer recording.
- Always release the Timer Start Switch at the end of timer recording and playback.
- The Record Button and Play Button need not be pushed when the Timer Start Switch is locked. Timer recording and playback are performed by merely setting the Record Mode Switches.
- Several timer recordings can be made by means of the timer. (See the timer instruction manual.)

TAPE EDITING (Refer to figure 16.) [RS-1506US]

"Editing" to create your own master tapes is one of the most enjoyable times for an audiophile. An original master tape created by forming sound synthesized by playing back and mixing recordings produced by yourself is the enjoyment of a handmade work of art and produces a greater sense of value than commercial tapes.

Since editing is the process of cutting out unnecessary parts and splicing in necessary parts of a recorded tape, the necessary parts must first be located. To do so, set the switches and controls to the positions for 2-track [4-track] tape playback, and monitor the tape with headphones.

Items Required for Editing

- Splicing tape
(Never use cellophane tape or similar material.)
- Scissors
Nonmagnetic scissors for tape editing use are suggested.

[Editing Notes]: [RS-1506US]

A recording which is later to be edited should be made in one direction (tracks 1 and 3) only.

For a tape which has been recorded in both directions (on 4 tracks), if the sounds for one direction are edited, great care must be taken not to accidentally interrupt the sounds for the other direction.

When editing tape which was recorded in 2-track stereo, set the 2-4 Track Selector to the "4t" position. It will then be possible to edit in the usual way, although the level of the right-channel sounds will be low.

Marking and cutting

The Cue Lever is convenient for tape cueing and marking the recording points.

1. When the Cue Lever is pushed in the direction of the arrow during fast forward and rewind, the tape approaches the playback head, and the monitor sound is heard. The Cue Lever is locked when pushed completely. Search for the recording point by listening to the monitor sound.
2. Search for the part recorded first or the part recorded last by locking the Cue Lever in the stopped mode and turning the reels by hand.
3. Search for the cutting point. The cutting point of the tape is positioned over the playback head.
4. Next, align the "point" of the editing dial at the inside of the Reversing Roller with the "point" of the Reversing Roller.
5. Then, turn the reels in the playback direction by hand to rotate the Reversing Roller another half revolution, and align the point of the editing dial with the other point of the Reversing Roller. Since the cutting point is now at the position of the Tape Marker, place a mark on the tape with a colored pencil, etc. (The tape can be marked by pushing it against the Tape Marker with your finger.)
6. Turn the reels by hand to loosen the tape, and cut the tape at the position of the mark. Locating and cutting the tape for editing is simple if performed in this manner.

Note:

Since the output level is increased in the cue mode, set the Line-Output Level Controls to a lower setting.

How to splice the tape (Refer to figure 17.)

Degaussing the heads [RS-1506US]

When the tape deck is used for an extended period of time, degauss the heads once a month with a head degausser (optional). (Refer to the head degausser manual for details.)

The degauss points are the 4-track [2-track] Playback Head, 2-track [4-track] Erase Head, 2-track [4-track] Playback Head, 2-track [4-track] Recording Head, and the Tension Rollers and other metal parts which touch the tape. Never place recorded tapes near the head degausser.

Units must be turned off when use degausser.

IN CASE OF DIFFICULTY

If this unit does not function normally, turn on the power and check the following points. If operation is still abnormal, consult with the store where purchased.

With tape threaded, tape won't move even when the Play Button is pushed.

- Is Power Cord disconnected?
- Is Power Switch set to the "OFF" position?
- Is tape too loose (Tension Rollers up)?
- Is Battery Selector set to incorrect position?

Tape moves, but no playback sound is heard.

- Is the tape blank?
- Are connections to Stereo Amplifier and/or Speakers incorrectly made or disconnected?
- Are Output Level Controls set to minimum position?
- Is volume control of Stereo Amplifier set too low?
- Are Monitor Switches of this unit or of Stereo Amplifier set to "SOURCE" position?

Sound is distorted

- Is recording level too high?
- Is input impedance of Stereo Amplifier improper?

Recordings can't be made.

- Are connections of Microphones and/or Tuner incorrect or disconnected?
- Are Microphone or Line Input Controls set too low?
- Are Record Mode Switches set to "OFF" position?
- Is Microphone Switch set to "OFF" position?

Playback sound is coarse, wavering; clear recordings can't be made.

- Are head surfaces dirty?
- Is foreign material attached to Pressure Rollers or Capstan?
- Is tape creased or wrinkled?
- Is tape threaded incorrectly?

SERVICING (Refer to figure 18.)

Servicing the Heads [RS-1506US]

The heads, capstan and pinch rollers constantly contact the tape and become dirty easily, thus adversely affecting the sound quality and volume, and causing noise, faulty erasure, and deterioration in the frequency response.

When dust and dirt collect on the surface of the heads, the superior sound quality and characteristics of the unit will not be sufficiently displayed. To maintain the unit in top condition at all times, clean the heads as described below (after every 5~10 hours of use).

The heads are the 4-track [2-track] Playback Head and 2-track [4-track] Erase Head from the top left, and the 2-track [4-track] Playback Head and 2-track [4-track] Recording Head from the top right.

Wipe the heads with the cotton swabs (supplied) immersed in a small amount of alcohol.

In addition, also carefully wipe the left and right Tension Rollers, Tape Guides, Tape Shifter, Reversing Roller, and Capstan. Wipe the Pinch Rollers with a soft cloth.

Notes:

1. Do not bring magnets or magnetic metal (screwdrivers, tweezers, etc.) near the heads. If the heads become magnetized, noise will occur during playback.
2. Do not lubricate any of the parts of the transport mechanism.
3. Do not use heavy rubbing to clean the heads.

Servicing the Panels

Wipe the panels with a soft cloth.

If the panels are extremely dirty, wipe them with a cloth dipped in soapy water, and then wipe dry.

Note:

Do not bring benzine, insecticides, or other harsh chemicals into contact with the cabinet finish, because discoloration or deformation may occur.

SPECIFICATIONS

Track System: [RS-1506US]	4 heads system 2-track [4-track] 2-channel recording, playback, erasing and 4-track [2-track] 2-channel playback
Motors: Capstan;	3-direct-drive motor system Quartz control phase-locked DC brushless servo direct-drive motor
Reel Tables;	2-tape tension controlled DC brushless direct-drive motor
Reel Size:	13 cm to 26.5 cm (5" to 10-1/2") outside diameter
Tape Tension Control:	Automatic control for above size of reel
Tape Speed:	38 cm/s, 19 cm/s and 9.5 cm/s (15 ips, 7-1/2 ips and 3-3/4 ips)
Speed Deviation:	± 0.1% at 38 cm/s (15 ips)
Speed Fluctuation:	0.05% at 38 cm/s (15 ips)
Pitch Control:	± 6% (recording and playback)
Wow and Flutter:	(recording and playback)
38 cm/s (15 ips);	0.018% (WRMS), ± 0.035% (peak DIN)
19 cm/s (7-1/2 ips);	0.03% (WRMS), ± 0.06% (peak DIN)
9.5 cm/s (3-3/4 ips);	0.06% (WRMS), ± 0.12% (peak DIN)
Time Counter	
Accuracy:	± 1% at 38 cm/s (15 ips)
Fast Winding Time:	150 sec. for 762 m (2500 feet) tape
Auto-Stop Sensing:	
End of Tape;	Tension roller switches
During Running;	within 3 sec. after accidental stop of tape
Frequency Response:	
38 cm/s (15 ips);	30—30,000 Hz ± 3 dB (rec. level = -10 dB from 0VU)
19 cm/s (7-1/2 ips);	20—25,000 Hz ± 3 dB (rec. level = -20 dB from 0VU)
9.5 cm/s (3-3/4 ips);	20—15,000 Hz ± 3 dB (rec. level = -20 dB from 0VU)
Signal-to-Noise Ratio:	NAB weighted (185 nWb/m + 6 dB)
[RS-1506US]	
38 cm/s (15 ips);	60 dB [57 dB]
19 cm/s (7-1/2 ips);	60 dB [57 dB]
9.5 cm/s (3-3/4 ips);	58 dB [55 dB]
Distortion (THD):	measured via tape at 400 Hz (at any speed)
Operating level	
(0VU);	less than 0.8%
Peak level	
(185 nWb/m + 6 dB);	less than 2%
Channel Separation:	better than 50 dB
Erasing Ratio:	better than 65 dB (rec. level = +10 dB at 1 kHz)

Recording Bias:	120 kHz
Bias level;	Tape Selector at "1" 90% at "2" 100% at "3" 110%
Equalization:	NAB standard position "2" of "EQ" and "BIAS" selectors set for Technics RT-10B218 (Scotch #207) tape
Recording Level	
Calibration:	referenced to 185 nWb/m
Inputs:	
MIC;	unbalanced phone type jack sensitivity 0.25 mV (-72 dB)/4.7 kΩ (at 0VU, Mic level control max. position) 2.5 mV (-52 dB)/4.7 kΩ with 20 dB mic attenuator switch on overload margin 55 dB (75 dB with 20 dB mic. att.) applicable microphone impedance 200 Ω ~ 10 kΩ
LINE;	phono type jack sensitivity 60 mV (-24 dB)/150 kΩ overload margin = infinity (line input connected to LINE IN level control before pass through the amplifier)
THROUGH OUT;	same as LINE IN (connected in parallel to LINE IN)
Outputs:	
LINE;	2 pairs of phono type jack output level 0.55 V at 0VU (output level control at "8") 0.775 V or more at output level control max. output impedance less than 3 kΩ load impedance 22 kΩ over stereo phone type jack
HEADPHONE;	output level 80 mV at 0.55 V line output load impedance 8 Ω
Power Requirements:	AC 110/125/220/240 V, 50/60 Hz or DC 24 V, 4.5 A (with optional battery adaptor)
Power Consumption:	120 W
Weight:	25 kg (55 lbs)
Dimensions:	45.6 cm × 44.6 cm × 25.8 cm (18" × 17-1/2" × 10-1/8")

Specifications based on use of Technics RT-10B218 (Scotch #207) tape.
(Specifications are subject to change without notice.)

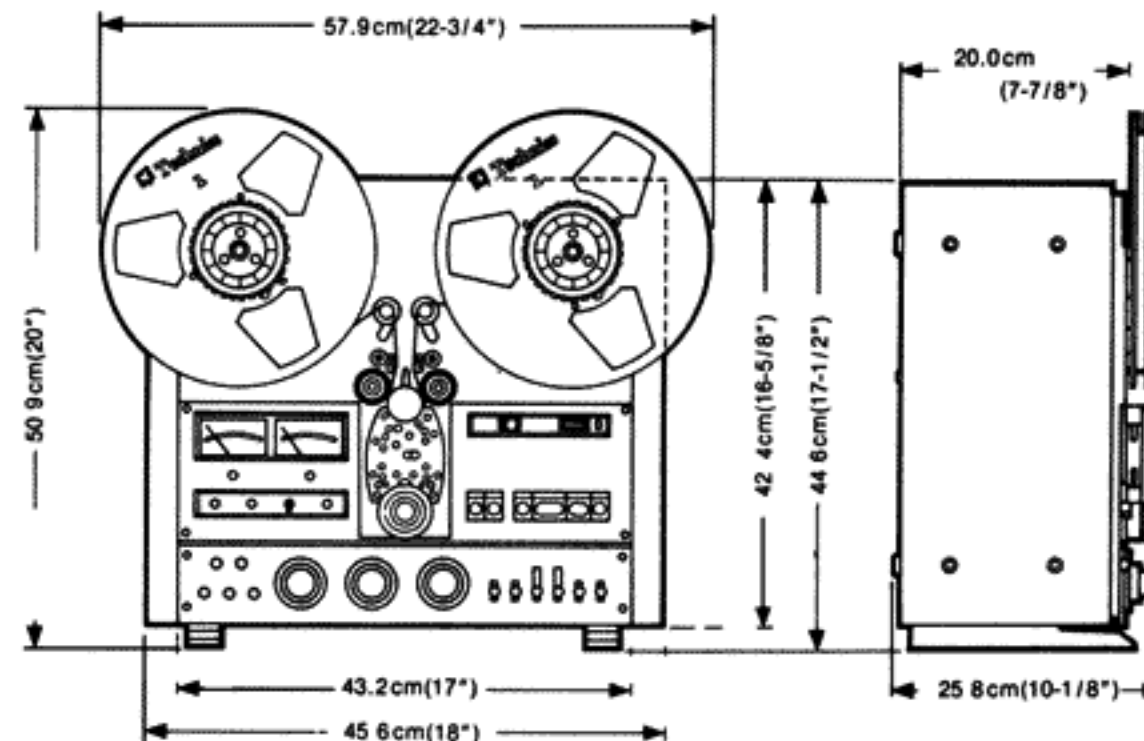

Matsushita Electric
Matsushita Electric Trading Co., Ltd.
P.O. Box 288, Central Osaka, Japan



Printed in Japan
QQT2192 H0877n1097