

# TECHNICAL MANUAL



## *SYLVANIA* *RADIO TUBES*

A Technical Publication of

**SYLVANIA**  
**ELECTRIC**  
PRODUCTS INC.

*EMPORIUM, PENNA.*

**COPYRIGHT 1951, BY  
SYLVANIA ELECTRIC PRODUCTS, INC.**

**EIGHTH EDITION  
COMPLETELY REVISED  
2nd Printing**

The information in this Technical Manual is furnished without assuming any obligations.

**Printed in U. S. A.  
FORM 202**

# THE SYLVANIA TECHNICAL MANUAL

## FOREWORD

Daily developments in every field of the electronics industry have necessitated many new tube types. Keeping abreast of these many types is always a problem for servicemen and engineers. In preparing the eighth edition of this manual, every effort has been expended to assure the completeness of its contents.

One important item is the size of the book. Although more than 45 types have been added to this edition, it has still turned out to be a thinner book, easier to handle and with less danger of torn pages. To accomplish this goal, much of the previously vacant half-pages have been utilized. Many curves have been dropped on those types which are now of interest only on a renewal basis. There are, consequently, many places where data on a particular type begins at mid-page and many pages which contain two or more types. At all times, however, numerical-alphabetical order has been maintained.

The increased number of cathode ray tubes has made it preferable to establish a separate section for these types. In this manner, comparisons may be made far more easily than if they were kept in the balance of the manual. Where A and B versions of television picture tubes have been included at the bottom of a listing, it should be noted that the basic diagram is shown only for the primary version. Differences encountered in the suffixed versions must be taken into consideration when studying this diagram.

The new loose-leaf binder requires no explanation. Its added simplicity of operation will make it more convenient to keep it up to date by means of the monthly supplement sheets. These additions are published in conjunction with Sylvania News, available without charge by sending a request to Sylvania Electric Products, Inc., Advertising Department, Emporium, Pennsylvania.

# TABLE OF CONTENTS

Foreword.....	III
Active Types.....	In Numerical Order
Active Television Picture Tube Types.....	In Numerical Order
Fundamental Electrical Laws.....	Appendix 1-2
Fundamental Properties of Vacuum Tubes.....	3-4
Definitions.....	5-7
General Tube and Circuit Information.....	8-23
Interpretation of Receiving Tube Ratings.....	8
B Voltage Supplies.....	9
Heater Voltage Supplies.....	10
Volume Control Considerations.....	11
Shielding.....	12
Filtering.....	12
Lock-In Types.....	13
Metal Types.....	13
G, GT and GT/G Types.....	13
Miniature Types.....	14
Battery Tubes.....	14
Tube and Base Diagram Symbols.....	15
Base Connection Diagrams.....	15
Cathode Ray Tubes.....	16
Tube Dimensions ST12.....	17
ST 14 & 16.....	18
T9, GT.....	19
• Lock-In.....	20
Miniature.....	20
Metal.....	21
Use of Curves.....	22-23
Resistance Coupled Data Explanation.....	24-25
Tabulations for Individual Types.....	26-55
Obsolete and Seldom Encountered Types.....	56-82
Sylvania Panel Lamps.....	83
Sylvania Ballast Lamps.....	84
Sylvania Product Directory.....	85
Sylvania Aids for Servicemen.....	86



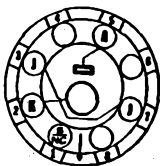

4AJ-0-0



Sylvania Type **0A3**  
 Sylvania Type **0B3**  
 Sylvania Type **0C3**  
 Sylvania Type **0D3**

**RATINGS**

	0A3	0B3	0C3	0D3
Minimum Starting Voltage Required	105	125	133	185 Volts
Operating Current—Minimum	5	5	5	5 Ma.
Operating Current—Maximum	40	30	40	40 Ma.
Maximum Peak Current for 10 Seconds	100	100	100	100 Ma.

**TYPICAL OPERATION**

Heater Voltage	None Required			
Operating Voltage	75	90	105	150 Volts
Regulation (Maximum Voltage Change Minimum to Maximum Current)	6.5	6	4	5.5 Volts



4V-0-0



Sylvania Type **0A4G**

**COLD CATHODE CONTROL TUBE**

**PHYSICAL SPECIFICATIONS**

Base	Small Octal 6-Pin
Bulb	ST-12
Maximum Overall Length	4 1/8"
Maximum Seated Height	3 3/16"
Mounting Position	Any

**RATINGS**

Min. Anode to Cathode Breakdown Voltage (Starter Anode Potential 0 Volts)	225 Volts
Starter Anode to Cathode Breakdown Voltage—Min.	70 Volts
Max.	90 Volts
Max. Starter Anode Current for Anode Breakdown	100 $\mu$ a.
Starter Anode to Cathode Voltage Drop (Approx.)	60 Volts
Anode to Cathode Voltage Drop (Approx.)	70 Volts
Anode Current—Continuous Max.	25 Ma.
Instantaneous Max.	100 Ma.

**TYPICAL OPERATION**

Anode Supply Voltage (RMS)	105 to 130 Volts
Starter Anode Voltage—Peak AC	70 Volts
Peak RF	55 Volts

Note: To assure stable operation, the 0A4G should be shielded from external light sources.

# 0A5 Sylvania Type

TRIGGER TUBE

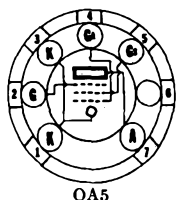

## PHYSICAL SPECIFICATIONS

Base .....	Miniature Button 7 Pin
Bulb .....	T-5 1/2
Maximum Overall Length .....	1 5/8"
Maximum Seated Height .....	1 5/8"
Mounting Position .....	Any

## RATINGS

Maximum Anode Operating Voltage DC .....	1000 Volts
Minimum Anode Operating Voltage DC (1) .....	500 Volts
Minimum Trigger Grid Firing Voltage (2) .....	+180 Volts
Minimum Hold-Off Voltage DC (3) .....	1500 Volts
Minimum Trigger Grid Pulse Voltage to Fire (2) .....	50 Volts
Maximum Trigger Grid Pulse Current (4) .....	40 $\mu$ a.
Maximum Discharge Capacitance .....	0.5 $\mu$ fd.
Maximum Power Input (5) .....	1.0 Watt
Maximum Repetition Rate .....	See Note 5
Minimum Peak Cathode Current to Produce Arc .....	10 Amperes
Ambient Temperature Range .....	-40 to +60° C.

(1) Operation at 250 volts is possible providing higher trigger pulse voltages are available.

(2) This is the sum of bias voltage and triggering pulse.

(3) Voltages above this limit may cause the tube to fire without application of pulse voltage. Measured in a typical circuit with a trigger grid bias of 90 volts and a keep-alive current of 50  $\mu$ a.

(4) Measured in a typical circuit with 50  $\mu$ a keep-alive current and 90 volts trigger grid bias.

(5) The maximum power input is given by  $W = \frac{1}{2} CV^2 f$  where C is the discharge capacitance in microfarads, V is the anode voltage in kilovolts and f is the number of flashes or pulses per second. This relation also determines the maximum repetition rate.

## TYPICAL OPERATION

In an Electroflash Trigger Circuit

Anode Voltage DC .....	750 Volts
Trigger Grid Voltage .....	+90 Volts
Trigger Grid Circuit Resistance .....	0.25 Megohm
Trigger Pulse Voltage .....	85 Volts
Keep-Alive Current .....	50 $\mu$ a.
Discharge Condenser .....	0.25 $\mu$ fd.

## APPLICATION

Sylvania Type 0A5 is a miniature cold cathode gas discharge tube designed for use as a trigger tube for switching service requiring extremely high instantaneous peak currents (hundreds of amperes). It is sensitive enough and will carry high enough current to permit photocell operation of some devices without special amplifiers. The circuit below shows its use in a typical portable Electroflash unit, where its use reduces the current carrying capacity requirement of the switch and also reduces the shock hazard.

Note that for most applications the shield grid (Pin 5) is left floating. This increases the sensitivity. Connection to the cathode through a 10 meg. resistor increases the hold-off voltage considerably, but a higher trigger grid current will be required.

Sylvania Type 0A5 is manufactured under license granted by Edgerton, Germeshausen, and Grier, but no license is granted nor is a license to be implied under their circuit patents.

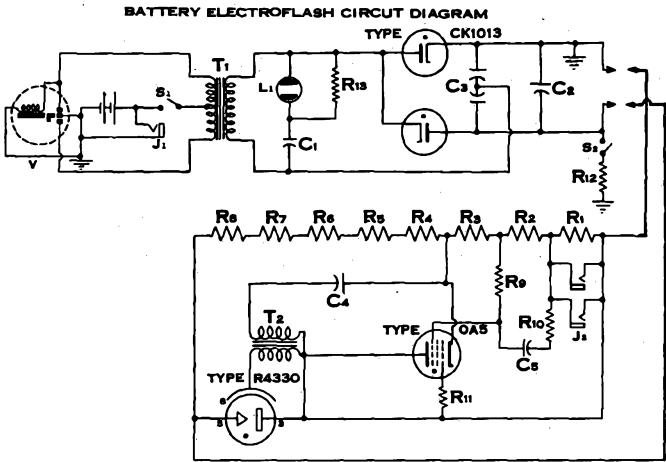

**PARTS LIST**

Condenser	Capacity	Working Voltage	Resistor	Ohms	Watts
C1	.001 $\mu$ fd.	2500	R12	5000	10
C2	.32 $\mu$ fd.	2500	R13	47,000	1/2
C3	.05 - .05 $\mu$ fd.	2000	<b>MISCELLANEOUS</b> Battery 4 Volt Storage J1 Battery charging connection J2 Camera and Synchronizer connection L1 Neon Indicator Lamp S1 Off-On switch S.P.S.T. S2 Safety switch T1 Vibrator Transformer T2 Trigger Transformer V Vibrator		
C4	.25 $\mu$ fd.	1000			
C5	.01 $\mu$ fd.	600			
Resistor	Ohms	Watts			
R1	.51 Meg.	1/2			
R2	1.8 Meg.	1/2			
R3	.47 Meg.	1/2			
R4 to R8	1.6 Meg. each	1			
R9	10 Meg.	1/2			
R10	.27 Meg.	1/2			
R11	10 Meg.	1/2			

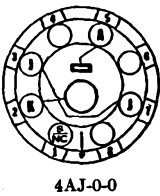

**Sylvania Type **OB3****  
**Sylvania Type **OC3****  
**Sylvania Type **OD3****  
**VOLTAGE REGULATORS**

(SEE TYPE OA3 FOR SPECIFICATIONS AND RATINGS)

# 0Z4 Sylvania Type 0Z4G Sylvania Type

FULL WAVE GAS RECTIFIERS

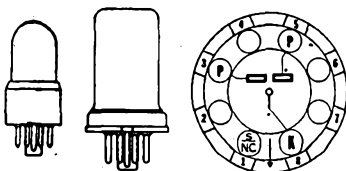

4R-1-0 (0Z4)  
4R-0-0 (0Z4G)

## PHYSICAL SPECIFICATIONS

	0Z4	0Z4G
Base.....	Small Wafer Octal 6 Pin	Dwarf Octal 5 Pin
Bulb.....	Metal 8-3	T-7
Maximum Overall Length.....	2 3/8"	2 3/8"
Maximum Seated Height.....	2 1/8"	2 1/8"
Mounting Position.....	Any	Any

## RATINGS

Heater Voltage.....	None Required
Peak Starting Plate Voltage.....	300 Min.
Peak Plate Current (Operating).....	200 Ma.
Peak Plate to Plate Voltage.....	1000 Volts
DC Output Current.....	30 Ma. Min. 90 Ma. Max

## TYPICAL OPERATION

Heater Voltage.....	None Required
AC Plate Voltage (RMS).....	300 Volts
DC Output Current.....	90 Ma.

# 1A5<sup>GT</sup> Sylvania Type

POWER AMPLIFIER PENTODE

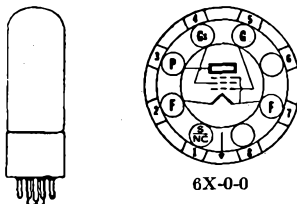

6X-0-0

## PHYSICAL SPECIFICATIONS

Base.....	Intermediate	Octal 7-Pin
Bulb.....		T-9
Maximum Overall Length.....		3 3/8"
Maximum Seated Height.....		2 3/4"
Mounting Position.....		Any

## RATINGS

Maximum Filament Voltage.....	1.6 Volts
Filament Voltage (Design Center for AC-DC Oper.).....	1.3 Volts
Maximum Plate Voltage.....	110 Volts
Maximum Screen Voltage.....	110 Volts
Maximum Total Zero Signal Cathode Current.....	6 Ma.

## TYPICAL OPERATION AS A CLASS A<sub>1</sub> AMPLIFIER

Filament Voltage.....	1.4	1.4 Volts
Filament Current.....	.050	.050 Ampere
Plate Voltage.....	85	90 Volts
Screen Voltage.....	85	90 Volts
Grid Voltage*.....	-4.5	-4.5 Volts
Plate Current.....	3.5	4.0 Ma.
Screen Current.....	0.7	0.8 Ma.
Plate Resistance.....	0.3	0.3 Megohm
Mutual Conductance.....	800	850 μmhos
Load Resistance.....	25,000	25,000 Ohms
Power Output.....	100	115 Milliwatts
Total Harmonic Distortion.....	10	7 Percent

\*Self bias is recommended for battery operation although it reduces the power output slightly. It makes a separate bias supply unnecessary and allows the bias to decrease in proportion with the decrease in B supply volts with age.



7Z-1-0



# Sylvania Type 1A7GT

HEPTODE CONVERTER

## PHYSICAL SPECIFICATIONS

Base .....	Small Wafer Octal 8-Pin Metal Sleeve
Bulb .....	T-9
Cap .....	Miniature
Maximum Overall Length .....	3 3/8"
Maximum Seated Height .....	2 3/4"
Mounting Position .....	Any

## RATINGS

Filament Voltage .....	1.4 Volts
Filament Current .....	0.05 Ampere
Maximum Plate Voltage .....	110 Volts
Maximum Screen Voltage .....	60 Volts
Maximum Screen Supply Voltage .....	110 Volts
Maximum Anode-Grid Voltage .....	110 Volts
Maximum Cathode Current .....	4.0 Ma.

## TYPICAL OPERATION

Filament Voltage .....	1.4 Volts
Filament Current .....	0.05 Ampere
Plate Voltage .....	90 Volts
Screen Voltage** .....	45 Volts
Anode-Grid Voltage .....	90 Volts
Control-Grid Voltage (G)† .....	0 Volts
Oscillator Grid Resistor (Go) .....	200000 Ohms
Plate Resistance .....	0.6 Megohm
Plate Current .....	0.55 Ma.
Screen Current .....	0.6 Ma.
Anode-Grid Current .....	1.2 Ma.
Oscillator Grid Current .....	0.035 Ma.
Total Cathode Current .....	2.4 Ma.
Conversion Conductance:	
Control Grid Voltage at 0 Volts .....	250 μmhos
Control Grid Voltage at -2 Volts .....	50 μmhos
Control Grid Voltage at -3 Volts .....	5 μmhos

\*\*Obtained preferably by using a properly by-passed 70,000 ohm resistor in series with a 90 volt supply.

†A resistance of at least 1 megohm should be in the grid return to negative filament pin.

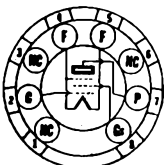

8CP-0-0



# Sylvania Type 1AC5

OUTPUT PENTODE

## PHYSICAL SPECIFICATIONS

Base .....	Subminiature Button 8 Pin
Bulb .....	T-3
Maximum Overall Length .....	1 3/4"
Maximum Seated Height .....	1 1/2"
Mounting Position .....	Any

## RATINGS

Filament Voltage DC .....	1.25 Volts
Maximum Plate Voltage .....	67.5 Volts
Maximum Screen Voltage .....	67.5 Volts
Maximum Cathode Current .....	4.0 Ma.

# 1AC5 (Cont.)

## TYPICAL OPERATION

### CLASS A AMPLIFIER

Filament Voltage DC	1.25	1.25	1.25 Volts
Filament Current	40	40	40 Ma.
Plate Voltage	30	45	67.5 Volts
Screen Voltage	30	45	67.5 Volts
Grid Voltage	-2.0	-3.0	-4.5 Volts
Plate Current	0.50	1.0	2.0 Ma.
Screen Current	0.10	0.2	0.4 Ma.
Plate Resistance (Approx.)	200	170	150 Megohm
Mutual Conductance	450	600	750 $\mu$ mhos
Load Resistance	50,000	40,000	25,000 Ohms
Power Output	5	15	50
Total Harmonic Distortion	10	10	10%

## APPLICATION

Sylvania Type 1AC5 is an Output Pentode suitable for use in very small radio sets or amplifiers. The other types required for a normal set complement and designed for such usage are Types 1E8 (Converter), 1T6 (Diode Pentode) and 1AD5 (RF Pentode).

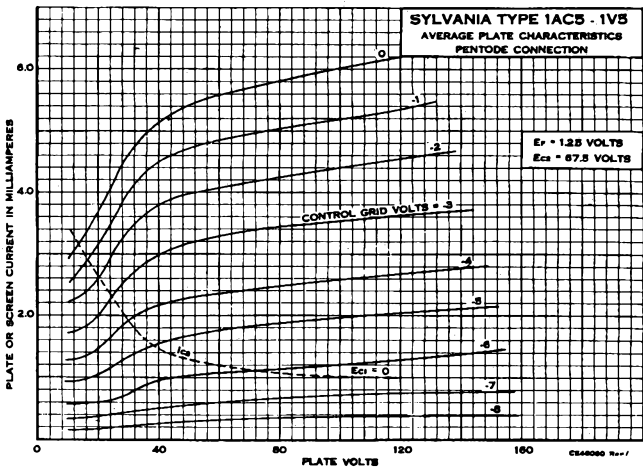
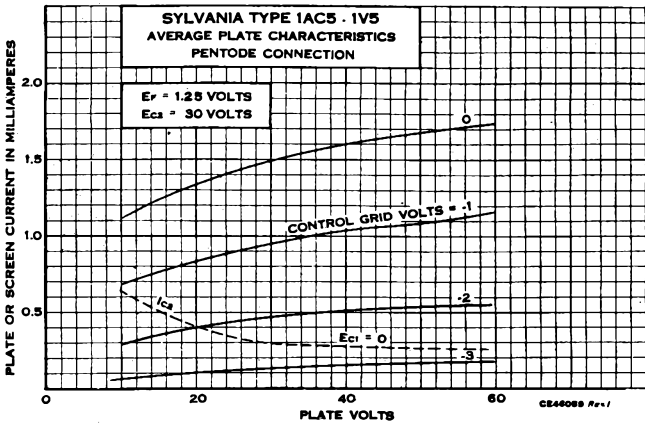

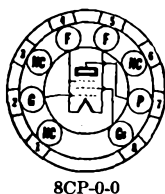

8CP-0-0



# Sylvania Type 1AD5

SHARP CUT-OFF RF PENTODE

## PHYSICAL SPECIFICATIONS

Base.....	Subminiature Button 8 Pin
Bulb.....	T-3
Maximum Overall Length.....	1 3/4"
Maximum Seated Height.....	1 1/2"
Mounting Position.....	Any

### Direct Interelectrode Capacitances:\*

	Unshielded	Shielded*
Grid to Plate.....	.01 Max.	.009 $\mu$ f. Max.
Input.....	1.8	1.9 $\mu$ f.
Output.....	2.8	3.0 $\mu$ f.

\*With 0.405" diameter shield connected to negative filament. Leads numbering 1, 3 and 6 must be grounded to obtain these values.

## TYPICAL OPERATION

Filament Voltage DC.....	1.25	1.25	1.25 Volts
Filament Current.....	40	40	40 Ma.
Plate Voltage.....	30	45	67.5 Volts
Screen Voltage.....	30	45	67.5 Volts
Grid Voltage.....	0	0	0 Volts
Plate Current.....	0.45	0.9	1.85 Ma.
Screen Current.....	0.16	0.35	0.75 Ma.
Plate Resistance (Approx.).....	0.7	0.7	0.7 Megohm
Mutual Conductance.....	430	580	735 $\mu$ mhos
Control Grid Voltage for $I_b=10 \mu$ a. (Approx.).....	-3.0	-4.0	-6.0 Volts

## APPLICATION

Sylvania Type 1AD5 is an RF Pentode tube suitable for use in very small radio sets or amplifiers. The other types required for a normal set complement and designed for such usage are Types 1E8 (Converter), 1T6 (Diode Pentode) and 1AC5 (Output Pentode).

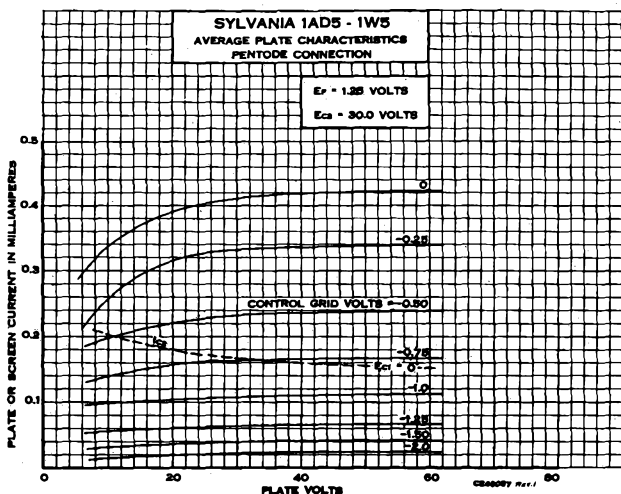

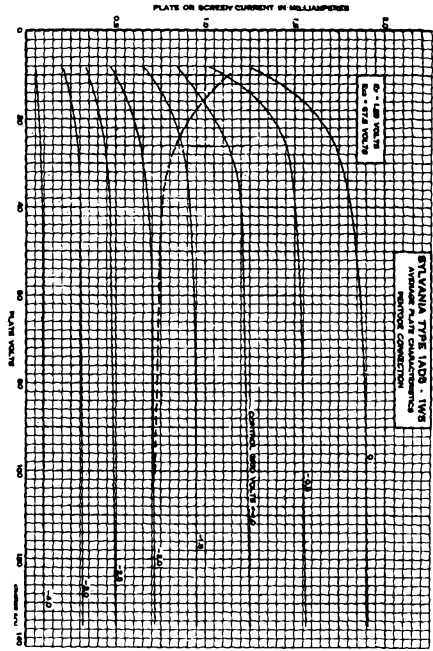
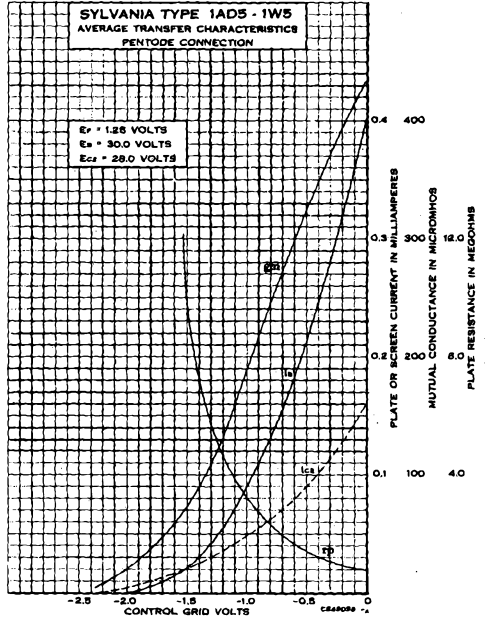
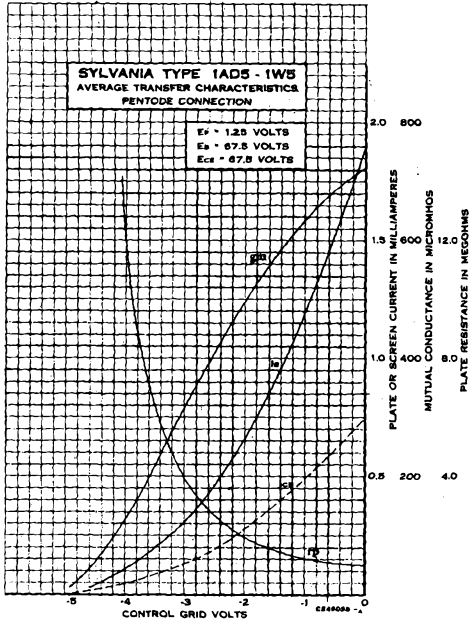



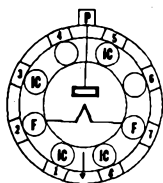

3C-0-7



# Sylvania Type 1B3GT

HALF-WAVE RECTIFIER

## PHYSICAL SPECIFICATIONS

Base .....	Short Intermediate Shell Octal 6-Pin
Bulb .....	T-9
Cap .....	Small
Maximum Overall Length .....	4 1/16"
Maximum Seated Height .....	3 1/2"
Mounting Position .....	Any

## RATINGS

Filament Voltage AC or DC .....	1.25 Volts
Filament Current .....	200 Ma.
Maximum Peak Inverse Plate Voltage .....	30,000 Volts
Maximum Peak Plate Current .....	17 Ma.
Maximum Average Plate Current .....	2 Ma.
Maximum Frequency of Supply Voltage .....	300 Kc.
Direct Interelectrode Capacitances*	
Plate to Filament (Approx.) .....	1.2 $\mu$ f.

\* Unshielded.

## APPLICATION

Sylvania Type 1B3GT is a high-vacuum half-wave rectifier designed for high voltage service where low currents are required. Typical examples are for operation of cathode-ray tubes and electroflash units.

When the high voltage is supplied by an oscillator care should be taken to use large leads and long radius corners to avoid corona loss. When the filament is also supplied by the oscillator the adjustment for proper operating temperature should be made optically by comparison with a similar filament on a readily metered supply.

## WARNING

The voltages employed in some television receivers and other high voltage equipment are sufficiently high that high-voltage rectifier tubes may produce X-rays which can constitute a health hazard, unless such tubes are adequately shielded.



6X-0-0



# Sylvania Type 1C5GT

POWER OUTPUT PENTODE

## PHYSICAL SPECIFICATIONS

Base .....	Intermediate Octal 7-Pin
Bulb .....	T-9
Maximum Overall Length .....	3 3/4"
Maximum Seated Height .....	2 3/4"
Mounting Position .....	Any

## TYPICAL OPERATION

Filament Voltage .....	1.4	1.4 Volts
Filament Current .....	0.10	0.10 Ampere
Plate Voltage .....	83	90 Volts
Screen Voltage .....	83	90 Volts
Grid Voltage* .....	-7.0	-7.5 Volts
Plate Current .....	7.0	7.5 Ma.
Screen Current .....	1.6	1.6 Ma.
Plate Resistance .....	110000	115000 Ohms
Mutual Conductance .....	1500	1550 $\mu$ mhos
Amplification Factor .....	165	180
Load Resistance .....	9000	8000 Ohms
Power Output .....	200	240 M.w.
Total Harmonic Distortion .....	10	10 Per Cent

\*Negative filament return, Pin No. 7.

# 1C8 Sylvania Type

PENTAGRID CONVERTER

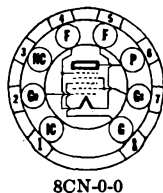

8CN-0-0

## PHYSICAL SPECIFICATIONS

Base.....	Flexible Leads
Bulb.....	T-3
Maximum Bulb Length.....	1 1/2"
Minimum Lead Length.....	1 3/4"
Mounting Position.....	Any

For additional data reference should be made to Type 1E8 which has the same operating conditions but differs in lead length.

# 1D21 Sylvania Type

STROBOTRON

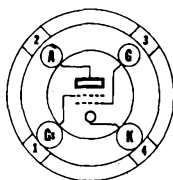

1D21

## PHYSICAL SPECIFICATIONS

Base.....	Small 4 Pin
Bulb.....	T-9
Maximum Overall Length.....	4 3/8"
Maximum Seated Height.....	3 5/8"
Mounting Position.....	Any

## RATINGS

Maximum Anode Voltage DC*.....	300 Volts
Maximum Peak Inverse Anode Voltage.....	50 Volts
Minimum Peak Cathode Current.....	5 Amperes
Maximum Average Cathode Current.....	50 Ma.
Maximum Pulse Frequency.....	240 pps
Maximum Average Grid Current.....	15 Ma.
Maximum Control Grid Circuit Resistance.....	5 Megohms
Maximum Grid Current (Surge).....	1 Ma.
Maximum Shield or Control Grid Voltage†.....	±50 Volts
Minimum Grid Pulse Voltage.....	175 Volts
Approx. Tube Voltage Drop—Glow Discharge.....	70 Volts
—Arc Discharge.....	20 Volts
Ambient Temperature Range.....	-55 to +90° Cent.

## TYPICAL OPERATION

Anode Voltage*.....	300 Volts
Average Cathode Current.....	50 Ma.
Peak Cathode Current.....	10 to 200 Amperes
Control Grid Voltage†.....	0 Volts
Shield Grid Voltage†.....	+30 Volts
Pulse Voltage.....	175 Volts

\*Measured from anode to shield grid.

†Either grid may be used for control with proper bias on the other grid.

## APPLICATION

Sylvania Strobotron Type 1D21 is a gas discharge tube which when used in a suitable circuit may be used for studying the motion of rotating or reciprocating parts up to 14,400 revolutions per minute.

A circuit for a simple stroboscope requiring a minimum of parts and capable of operating over the range from 600 to 6720 revolutions per minute is shown below.

Sylvania Strobotron tubes are manufactured under license granted by Edgerton, Germeshausen, and Grier, but no license is granted nor is a license to be implied under their circuit patents.

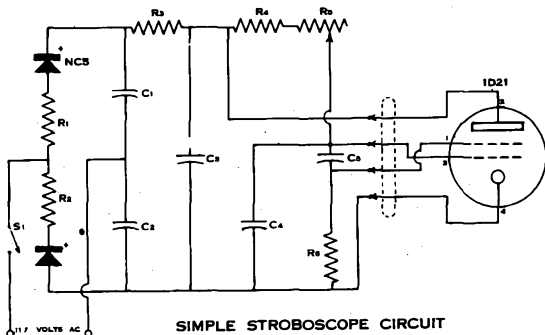

## PARTS LIST

R1—10 ohm, 1 w. res.	C1—20 $\mu$ fd., 450 v. elec. cond.
R2—10 ohm, 1 w. res.	C2—20 $\mu$ fd., 450 v. elec. cond.
R3—3500 ohm, 10 w. wirewound res.	C3—1 $\mu$ fd., 400 v. cond.
R4—50,000 ohm, 1 w. res.	C4—.1 $\mu$ fd., 400 v. cond.
R5—1 megohm pot.	C5—.01 $\mu$ fd., mica cond.
R6—2 megohm, 1 w. res.	S1—S.p.s.t. toggle sw.

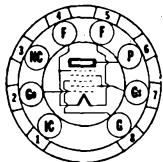

8CN-0-0

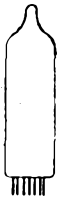

## Sylvania Type 1E8

## PENTAGRID CONVERTER

## PHYSICAL SPECIFICATIONS

Base.....	Subminiature Button 8 Pin
Bulb.....	T-3
Maximum Overall Length.....	1 3/4"
Maximum Seated Height.....	1 1/2"
Mounting Position.....	Any

## Direct Interelectrode Capacitances:

	Unshielded
Control grid to all other electrodes.....	6.0 $\mu$ f.
Control grid to plate.....	0.4 $\mu$ f. Max.
Plate to all other electrodes.....	5.0 $\mu$ f.
Oscillator grid to control grid.....	0.2 $\mu$ f. Max.
Oscillator grid to all other electrodes.....	2.4 $\mu$ f.

## TYPICAL OPERATION

Filament Voltage DC.....	1.25	1.25	1.25 Volts
Filament Current.....	40	40	40 Ma.
Plate Voltage.....	30	45	67.5 Volts
Screen Supply Voltage.....	30	45	67.5 Volts
Screen Grid Resistor.....	10,000	15,000	20,000 Ohms
Grid Voltage.....	0	0	0 Volts
Plate Current.....	0.30	0.6	1.0 Ma.
Screen Current.....	0.8	1.1	1.5 Ma.
Plate Resistance (Approx.).....	0.3	0.4	0.4 Megohm
Conversion Transconductance.....	115	140	150 $\mu$ hos
Oscillator Grid Resistance.....	0.1	0.1	0.1 Megohm
Oscillator Grid Current.....	30	50	70 $\mu$ a.
Control Grid Voltage for $G_c=5 \mu$ hos approx.....	-7.0	-8.0	-9.0

## Oscillator Characteristics\*

Mutual Conductance.....	730 $\mu$ hos
-------------------------	---------------

\*In a non-oscillating condition with plate and screen tied together at a voltage of 30 volts, and zero volts on the oscillator and control grids.

## APPLICATION

Sylvania Type 1E8 is a converter tube for use in very small radio sets. The other types required for a normal set complement and designed for such usage are Types 1T6 (Diode Pentode), 1AC5 (Output Pentode) and 1AD5 (RF Pentode).

This type corresponds in service and circuit requirements to Type 1R5 except for optimization of the performance at low voltages.

# 1G4<sup>GT</sup> Sylvania Type

MEDIUM-MU TRIODE

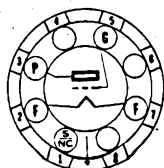

5S-0-0

## PHYSICAL SPECIFICATIONS

Base.....	Intermediate Octal 7 Pin
Bulb.....	T-9
Maximum Overall Length.....	3 <sup>5</sup> / <sub>16</sub> "
Maximum Seated Height.....	2 <sup>3</sup> / <sub>4</sub> "
Mounting Position.....	Any

## TYPICAL OPERATION

Filament Voltage DC.....	1.4 Volts
Filament Current.....	50 Ma.
Plate Voltage.....	90 Volts Max.
Grid Voltage*.....	-6.0 Volts
Plate Current.....	2.3 Ma.
Mutual Conductance.....	825 μmhos
Amplification Factor.....	8.8

\*Negative filament return, Pin No. 7.

# 1G6<sup>GT</sup> Sylvania Type

DUO TRIODE POWER AMPLIFIER

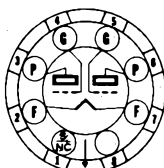

7AB-0-0

## PHYSICAL SPECIFICATIONS

Base.....	Intermediate Octal 7 Pin
Bulb.....	T-9
Maximum Overall Length.....	3 <sup>5</sup> / <sub>16</sub> "
Maximum Seated Height.....	2 <sup>3</sup> / <sub>4</sub> "
Mounting Position.....	Any

## TYPICAL OPERATION

Filament Voltage DC.....	1.4 Volts
Filament Current.....	100 Ma.

### CLASS A AMPLIFIER (Each Triode)

Plate Voltage.....	90 Volts
Grid Voltage.....	0 Volt
Plate Current.....	1.0 Ma.
Plate Resistance.....	4000 Ohms
Mutual Conductance.....	825 μmhos
Amplification Factor.....	33

### CLASS B POWER AMPLIFIER

Plate Voltage.....	90 Volts Max.
Grid Voltage.....	0 Volt
Plate Current Per Plate (Zero Signal).....	1.0 Ma.
Peak Plate Current Per Triode.....	20 Ma. Max.
Load Resistance (Plate to Plate).....	12000 Ohms
Power Output*.....	675 Mw.
Distortion (Approx.).....	3 Per Cent

# 1H5<sup>GT</sup> Sylvania Type

DIODE HIGH-MU TRIODE

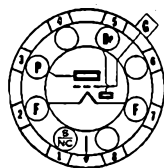

5Z-1-7

## PHYSICAL SPECIFICATIONS

Base.....	Small Wafer 7 Pin Octal Metal Sleeve
Bulb.....	T-9
Cap.....	Miniature
Maximum Overall Length.....	3 <sup>5</sup> / <sub>16</sub> "
Maximum Seated Height.....	2 <sup>3</sup> / <sub>4</sub> "
Mounting Position.....	Any



6AR-0-1 & 5



# Sylvania Type 1L4

SHARP CUT-OFF RF PENTODE

## PHYSICAL SPECIFICATIONS

Base.....	Miniature Button 7 Pin
Bulb.....	T-5 1/2"
Maximum Overall Length.....	2 1/8"
Maximum Seated Height.....	1 1/4"
Mounting Position.....	Any

## RATINGS

Filament Voltage	
Battery Operation—Must Never Exceed.....	1.6 Volts
AC DC Power Line Operation—Design Center.....	1.3 Volts
Maximum Plate Voltage.....	110 Volts
Maximum Screen Voltage.....	90 Volts
Maximum Total Cathode Current.....	6.5 Ma.
Minimum Grid Bias.....	0 Volt

Direct Interelectrode Capacitances:*	
Grid to Plate.....	0.010 $\mu\text{f}$ Max.
Input.....	3.6 $\mu\text{f}$
Output.....	7.5 $\mu\text{f}$

\*Measured without tube shield.

## TYPICAL OPERATION

Filament Voltage DC.....	1.4	1.4 Volts
Filament Current.....	50	50 Ma.
Plate Voltage.....	90	90 Volts
Screen Voltage.....	67.5	90 Volts
Grid Voltage.....	0	0 Volts
Plate Resistance.....	0.6	0.35 Megohm
Mutual Conductance.....	925	1025 $\mu\text{mbos}$
Plate Current.....	2.9	4.5 Ma.
Screen Current.....	1.2	2.0 Ma.
Grid Bias for 10 $\mu\text{a}$ . Plate Current.....	-6.0	-8.0 Volts

For use in resistance coupled amplifiers see appendix.

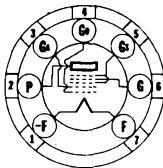

7DC-0-0



# Sylvania Type 1L6

PENTAGRID CONVERTER

## PHYSICAL SPECIFICATIONS

Base.....	Small Button 7 Pin
Bulb.....	T5 1/2"
Maximum Overall Length.....	2 1/8"
Maximum Seated Height.....	1 1/4"
Mounting Position.....	Any

## RATINGS

Filament Voltage DC.....	1.4 Volts
Filament Current.....	50 Ma.
Maximum Plate Voltage.....	110 Volts
Maximum Screen Supply Voltage.....	110 Volts
Maximum Screen Voltage.....	65 Volts
Maximum Anode Grid Voltage.....	110 Volts
Maximum Cathode Current.....	4.0 Ma.
Minimum Signal Grid Circuit Resistance.....	1.0 Megohm

# 1L6 (Cont'd)

## Direct Interelectrode Capacitances:

	Shielded*	Unshielded
Grid G to Plate .....	0.30	0.45 $\mu\text{mf}$ Max.
Grid G to Grid Ga .....	0.24	0.24 $\mu\text{mf}$
Grid G to Grid Go .....	0.19	0.19 $\mu\text{mf}$
Grid Go to Grid Ga .....	0.80	0.80 $\mu\text{mf}$
Grid G to All (RF Input) .....	7.5	7.5 $\mu\text{mf}$
Grid Ga to All except Go (Oscillator Output) .....	2.6	2.6 $\mu\text{mf}$
Grid Go to All except Ga (Oscillator Input) .....	2.2	2.2 $\mu\text{mf}$
Plate to All (Mixer Output) .....	12.0	7.0 $\mu\text{mf}$
Grid Go to Plate .....	0.10	0.15 $\mu\text{mf}$ Max.

\*With  $\frac{3}{4}$ " diameter shield (RMA Std. 316) connected to Pin 1.

## TYPICAL OPERATION

Filament Voltage .....	1.4 Volts
Filament Current .....	50 Ma.
Plate Voltage .....	90 Volts
Screen Voltage* .....	45 Volts
Anode Grid Voltage (Ega) .....	90 Volts
Control Grid Voltage .....	0 Volts
Control Grid Circuit Resistance .....	1.0 Megohm
Oscillator Grid Resistor (Rgo) .....	0.2 Megohm
Plate Resistance (Approx.) .....	0.65 Megohm
Plate Current .....	0.5 Ma.
Screen Current .....	0.6 Ma.
Anode Grid Current .....	1.2 Ma.
Oscillator Grid Current .....	0.035 Ma.
Total Cathode Current .....	2.35 Ma.
Conversion Transconductance	
Control Grid Voltage at 0 Volts .....	300 $\mu\text{mhos}$
Control Grid Voltage at -3.5 Volts (Approx.) .....	10 $\mu\text{mhos}$
Oscillator Mutual Conductance** .....	550 $\mu\text{mhos}$

\*\*Not oscillating, Eb = 90 V, Egs = 45 V, Ega = 90 V, Eg and Ego = 0 V.

\*Obtained preferably by using a properly bypassed dropping resistor of from 45,000 ohms to 75,000 ohms in series with the B supply.

## APPLICATION

Sylvania Type 1L6 is a miniature type pentagrid converter designed for use in low drain battery operated receivers. It is similar in construction and application to Types 1A7GT and 1LA6. The small size and low current requirements recommend it for use in small portable receivers.

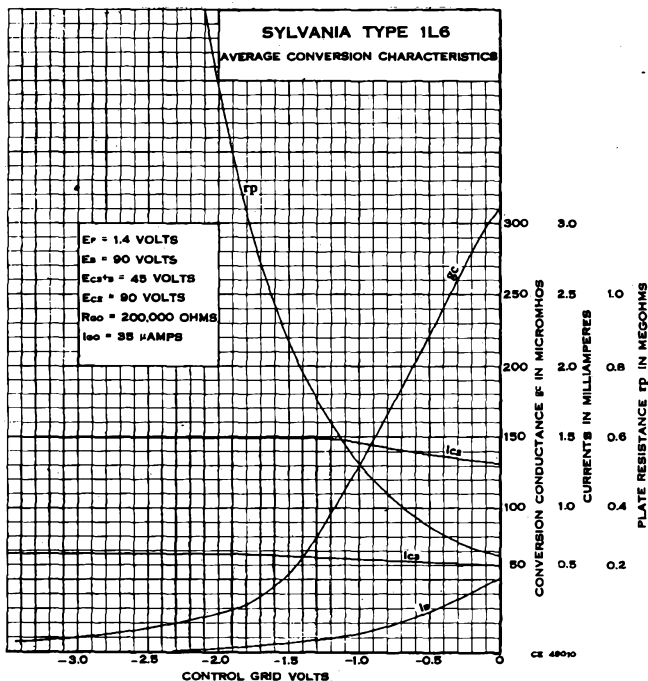

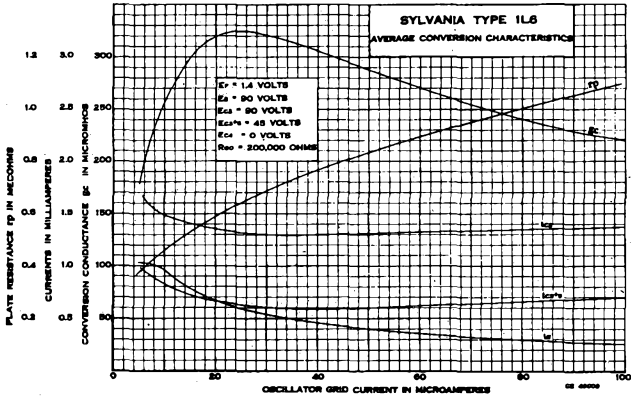

5AD-L-0

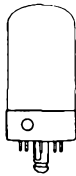
**Sylvania Type 1LA4**

POWER OUTPUT PENTODE

**PHYSICAL SPECIFICATIONS**

Base.....	Lock-In 8 Pin
Bulb.....	T-9
Maximum Overall Length.....	2 <sup>35</sup> / <sub>16</sub> "
Maximum Seated Height.....	2 <sup>1</sup> / <sub>4</sub> "
Mounting Position.....	Any

**RATINGS**

Maximum Filament Voltage.....	1.6 Volts
Filament Voltage (Design Center for AC-DC Operation).....	1.3 Volts
Maximum Plate Voltage.....	110 Volts
Maximum Screen Voltage.....	110 Volts
Maximum Total Zero Signal Cathode Current.....	6 Ma.

**TYPICAL OPERATION AS A CLASS A<sub>1</sub> AMPLIFIER**

Filament Voltage DC.....	1.4	1.4 Volts
Filament Current.....	50	50 Ma.
Plate Voltage.....	85	90 Volts
Screen Voltage.....	85	90 Volts
Grid Volts*.....	-4.5	-4.5 Volts
Self-Bias Resistor*.....	1000	950 Ohms
Plate Current.....	3.5	4.0 Ma.
Screen Current.....	0.7	0.8 Ma.
Plate Resistance.....	0.3	0.3 Megohm
Mutual Conductance.....	800	850 μmhos
Load Resistance.....	25,000	25,000 Ohms
Power Output.....	100	115 Milliwatts
Total Harmonic Distortion.....	10	7 Per Cent

\*Self bias is recommended for battery operation. Although it reduces the power output slightly it makes a separate bias supply unnecessary and allows the bias to decrease in proportion with the decrease in B supply volts with age.

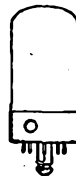

7AK-L-0

**Sylvania Type 1LA6**

HEPTODE CONVERTER

**PHYSICAL SPECIFICATIONS**

Base.....	Lock-In 8 Pin
Bulb.....	T-9
Maximum Overall Length.....	2 <sup>35</sup> / <sub>16</sub> "
Maximum Seated Height.....	2 <sup>1</sup> / <sub>4</sub> "
Mounting Position.....	Any

# 1LA6 (Cont'd)

## RATINGS

Maximum Filament Voltage.....	1.6 Volts
Design Center for AC-DC Operation.....	1.3 Volts
Maximum Plate Voltage.....	110 Volts
Maximum Screen Supply.....	110 Volts
Maximum Screen Voltage.....	65 Volts
Maximum Anode-Grid Voltage.....	110 Volts
Maximum Cathode Current.....	4.0 Ma.

### Direct Interelectrode Capacitances:\*

Grid G to Plate.....	0.4 $\mu$ mf
Mixer Input.....	7.5 $\mu$ mf
Mixer Output.....	8.0 $\mu$ mf
Oscillator Input.....	2.8 $\mu$ mf
Oscillator Output.....	3.2 $\mu$ mf

\*With 1 $\frac{1}{8}$ " diameter tube shield (RMA Std. 308) connected to negative filament.

## TYPICAL OPERATION

Filament Voltage DC.....	1.4 Volts
Filament Current.....	50 Ma.
Plate Voltage.....	90 Volts
Screen Voltage**.....	45 Volts
Anode-Grid Voltage.....	90 Volts
Control Grid Voltage (G).....	0 Volt
Oscillator Grid Resistor (Go).....	200000 Ohms
Plate Resistance.....	0.75 Megohm
Plate Current.....	0.55 Ma.
Screen Current.....	0.6 Ma.
Anode-Grid Current.....	1.2 Ma.
Oscillator Grid Current.....	0.035 Ma.
Conversion Conductance.....	250 $\mu$ mhos
Control Grid Voltage at -3 Volts.....	10 $\mu$ mhos

\*\*Obtained preferably by using a properly by-passed voltage dropping resistor of 45,000 to 70,000 ohms in series with the "B" voltage supply.

A resistance of at least 1 megohm should be in the grid return to negative fil.

# 1LB4 Sylvania Type

## POWER OUTPUT PENTODE

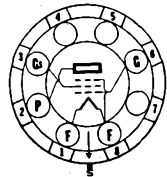

5AD-L-0

## PHYSICAL SPECIFICATIONS

Base.....	Lock-In 8 Pin
Bulb.....	T-9
Maximum Overall Length.....	2 $\frac{3}{8}$ "
Maximum Seated Height.....	2 $\frac{1}{4}$ "
Mounting Position.....	Any

## RATINGS

Maximum Filament Voltage.....	1.6 Volts
Design Center for AC-DC Operation.....	1.3 Volts
Maximum Plate Voltage.....	110 Volts
Maximum Screen Voltage.....	110 Volts
Maximum Cathode Current.....	6.0 Ma.

## TYPICAL OPERATION

Filament Voltage DC.....	1.4	1.4	1.4	1.4 Volts
Filament Current.....	50	50	50	50 Ma.
Plate Voltage.....	45	62.5	67.5	90 Volts
Screen Voltage.....	45	62.5	67.5	90 Volts
Grid Voltage.....	-4.5	-5.0	-6.0	-9.0 Volts
Plate Current (Zero Signal).....	1.6	3.8	3.8	5.0 Ma.
Screen Current (Zero Signal).....	0.3	0.8	0.8	1.0 Ma.
Plate Resistance (Approx.).....	0.4	0.3	0.3	0.25 Megohm
Mutual Conductance.....	650	875	875	925 $\mu$ mhos
Load Resistance.....	20000	16000	16000	12000 Ohms
Power Output.....	35	90	100	200 Mw.
Total Harmonic Distortion.....	10	10	10	10 Per Cent





7AO-L-8

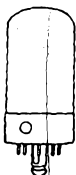

## Sylvania Type 1L

SHARP CUT-OFF RF PENTODE

### PHYSICAL SPECIFICATIONS

Base.....	Lock-In 8 Pin
Bulb.....	T-9
Maximum Overall Length.....	2 <sup>3</sup> / <sub>8</sub> "
Maximum Seated Height.....	2 <sup>1</sup> / <sub>4</sub> "
Mounting Position.....	Any

### RATINGS

Maximum Filament Voltage.....	1.6 Volts
Design Center for AC-DC Operation.....	1.3 Volts
Maximum Plate Voltage.....	110 Volts
Maximum Screen Voltage.....	45 Volts

#### Direct Interelectrode Capacitances:\*

Grid to Plate.....	0.007 $\mu$ f. Max.
Input.....	3.2 $\mu$ f
Output.....	7.0 $\mu$ f

\*With 1<sup>3</sup>/<sub>16</sub>" diameter shield (RMA Std. 308) connected to negative filament

### TYPICAL OPERATION

Filament Voltage DC.....	1.4	1.4 Volts
Filament Current.....	50	50 Ma.
Plate Voltage.....	45	90 Volts
Screen Voltage.....	45	45 Volts
Grid Voltage*.....	0	0 Volt
Suppressor.....	Connected to Negative Filament at Socket	
Plate Current.....	1.1	1.15 Ma.
Screen Current.....	35	30 Ma.
Plate Resistance.....	0.7	1.5 Megohm Approx.
Mutual Conductance.....	750	775 $\mu$ mhos
Grid Voltage for $I_b=10 \mu$ a.....	-3.4	-3.4 Volts

\*A resistance of at least 1 megohm should be in the grid return to negative filament Pin No. 8.

For data on use as a resistance coupled amplifier see appendix.



7AK-L-0



## Sylvania Type 1LC6

HEPTODE CONVERTER

### PHYSICAL SPECIFICATIONS

Base.....	Lock-In 8 Pin
Bulb.....	T-9
Maximum Overall Length.....	2 <sup>3</sup> / <sub>8</sub> "
Maximum Seated Height.....	2 <sup>1</sup> / <sub>4</sub> "
Mounting Position.....	Any

### RATINGS

Maximum Filament Voltage.....	1.6 Volts
Design Center for AC-DC Operation.....	1.3 Volts
Maximum Plate Voltage.....	110 Volts
Maximum Screen or Anode Grid Supply.....	110 Volts
Maximum Anode-Grid Voltage.....	50 Volts
Maximum Screen Grid Voltage.....	45 Volts
Maximum Cathode Current.....	3.0 Ma.

#### Direct Interelectrode Capacitances:\*

Grid G to Plate.....	0.28 $\mu$ f.
Mixer Input.....	9.00 $\mu$ f.
Mixer Output.....	5.50 $\mu$ f.
Oscillator Input.....	2.40 $\mu$ f.
Oscillator Output.....	4.80 $\mu$ f.

\*With 1<sup>3</sup>/<sub>16</sub>" dia. tube shield (RMA Std. M8-308) connected to negative filament.

# 1LC6 (Cont'd)

## TYPICAL OPERATION

Filament Voltage.....	1.4	1.4 Volts
Filament Current.....	0.050	0.050 Ampere
Plate Voltage.....	45	90 Volts
Screen Voltage*.....	35	35 Volts
Anode-Grid Voltage.....	45	45 Volts
Control Grid Voltage.....	0	0 Volt
Oscillator Grid Resistor.....	200000	200000 Ohms
Plate Resistance.....	300000	650000 Ohms
Plate Current.....	0.7	0.75 Ma.
Screen Current.....	0.75	0.70 Ma.
Anode-Grid Current.....	1.4	1.4 Ma.
Oscillator Grid Current.....	0.035	0.035 Ma.
Total Cathode Current.....	2.9	2.9 Ma.
Conversion Conductance:		
At 0 Volts.....	250	275 $\mu$ mhos
At -2 Volts.....	50	50 $\mu$ mhos
At -3 Volts.....	5	5 $\mu$ mhos approx.

\*Obtained preferably by using a properly by-passed voltage dropping resistor in series with B voltage supply. In order to avoid oscillation difficulties the screen voltage must be at least 10 volts lower than the oscillator anode.

†A resistance of at least 1 megohm should be in the grid return to negative filament, Pin No. 8.

Note: The characteristics of the oscillator section (not oscillating) are: GM=550  $\mu$ mhos (approx.), MU=14, and anode-grid current=2.7 ma.

Conditions: Ep=90 volts, Ega=45 volts, Ega=35 volts, and Ego and Egs=0 volts.

# 1LD5 Sylvania Type

DIODE PENTODE

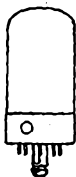

6AX-L-8

## PHYSICAL SPECIFICATIONS

Base.....	Lock-In 8 Pin
Bulb.....	T-9
Maximum Overall Length.....	2 $\frac{3}{4}$ "
Maximum Seated Height.....	2 $\frac{1}{2}$ "
Mounting Position.....	Any

## RATINGS

Maximum Filament Voltage.....	1.6 Volts
Design Center for AC-DC Operation.....	1.3 Volts
Maximum Plate Voltage.....	110 Volts
Maximum Screen Voltage.....	50 Volts
Maximum Diode Drop for 0.5 Ma.....	10 Volts

Diode plate located at negative end of filament.

Direct Interelectrode Capacitances\*:

Grid to Plate.....	0.18 $\mu$ mf.
Input.....	3.20 $\mu$ mf.
Output.....	6.00 $\mu$ mf.

\*With 1 $\frac{1}{4}$ " dia. shield (RMA Std. 308) connected to negative filament.

## TYPICAL OPERATION

Filament Voltage DC.....	1.4	1.4 Volts
Filament Current.....	50	50 Ma.
Plate Voltage.....	45	90 Volts
Screen Voltage.....	45	45 Volts
Grid Voltage.....	0	0 Volt
Plate Current.....	0.55	0.6 Ma.
Screen Current.....	0.12	0.1 Ma.
Plate Resistance.....	900000	750000 Ohms
Mutual Conductance.....	550	575 $\mu$ mhos

For resistance coupled information refer to table in appendix.

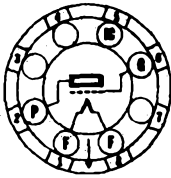

4AA-L-0



## Sylvania Type 1LE3

MEDIUM-MU TRIODE

### PHYSICAL SPECIFICATIONS

Base.....	Lock-In 8 Pin
Bulb.....	T-9
Maximum Overall Length.....	2 <sup>35</sup> / <sub>64</sub> "
Maximum Seated Height.....	2 <sup>1</sup> / <sub>4</sub> "
Mounting Position.....	Any

### RATINGS

Maximum Filament Voltage.....	1.6 Volts
Design Center for AC-DC Operation.....	1.3 Volts
Maximum Plate Voltage.....	110 Volts

#### Direct Interelectrode Capacitances:\*

Grid to Plate.....	1.7 $\mu$ f.
Input.....	1.7 $\mu$ f.
Output.....	3.0 $\mu$ f.

\*With 1<sup>1</sup>/<sub>4</sub>" diameter shield (RMA Standard 308) connected to negative filament.

### TYPICAL OPERATION

Filament Voltage DC.....	1.4	1.4 Volts
Filament Current.....	0.050	0.050 Ampere
Plate Voltage.....	90	90 Volts
Grid Voltage*.....	0	-3 Volts
Plate Current.....	4.5	1.4 Ma.
Plate Resistance.....	11200	19000 Ohms
Mutual Conductance.....	1300	760 $\mu$ mhos
Amplification Factor.....	14.5	14.5

\*Negative Filament return to Pin No. 8.

For use in resistance coupled circuits, see appendix.



7AO-L-8



## Sylvania Type 1LG5

SEMI-REMOTE CUT-OFF

RF PENTODE

### PHYSICAL SPECIFICATIONS

Base.....	Lock-In 8 Pin
Bulb.....	T-9
Maximum Overall Length.....	2 <sup>35</sup> / <sub>64</sub> "
Maximum Seated Height.....	2 <sup>1</sup> / <sub>4</sub> "
Mounting Position.....	Any

### RATINGS

Maximum Filament Voltage Must Never Exceed.....	1.6 Volts
AC-DC Power Line Design Center.....	1.3 Volts
Maximum Plate Voltage.....	110 Volts
Maximum Screen Voltage.....	110 Volts

#### Direct Interelectrode Capacitances:\*

Grid to Plate.....	.007 $\mu$ f. Max.
Input.....	3.2 $\mu$ f.
Output.....	7.0 $\mu$ f.

\*With 1<sup>1</sup>/<sub>4</sub>" diameter shield (RMA Std. 308) connected to negative filament.

### TYPICAL OPERATION

Filament Voltage DC.....	1.4	1.4	1.4 Volts
Filament Current.....	50	50	50 Ma.
Plate Voltage.....	45	90	90 Volts
Screen Voltage.....	45	45	90 Volts
Control Grid Voltage.....	0	0	-1.5 Volts
Control Grid Resistor.....	2.0	2.0	2.0 Megohm
Suppressor Grid.....	Connected to Negative Filament at Socket		
Plate Current.....	1.5	1.7	3.7 Ma.
Screen Current.....	0.45	0.4	0.9 Ma.
Mutual Conductance.....	800	800	1150 $\mu$ mhos
Plate Resistance (Approx.).....	0.35	>1.0	0.5 Megohm
Control Grid Voltage for G <sub>m</sub> =10 $\mu$ mhos (Approx.).....	-9.0	-10.0	-19 Volts

# 1LH4 Sylvania Type

DIODE HIGH-MU TRIODE

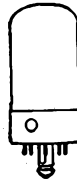

5AG-L-1

## PHYSICAL SPECIFICATIONS

Base.....	Lock-In 8Pin
Bulb.....	T-9
Maximum Overall Length.....	2 <sup>31</sup> / <sub>16</sub> "
Maximum Seated Height.....	2 <sup>1</sup> / <sub>4</sub> "
Mounting Position.....	Any

## RATINGS

Maximum Filament Voltage.....	1.6 Volts
Design Center for AC-DC Operation.....	1.3 Volts
Maximum Plate Voltage.....	110 Volts
Maximum Diode Drop at 0.5 Ma.....	10 Volts

## TYPICAL OPERATION

Filament Voltage DC.....	1.4 Volts
Filament Current.....	50 Ma.
Plate Voltage.....	90 Volts
Grid Voltage*.....	0 Volt
Plate Current.....	0.15 Ma.
Plate Resistance.....	240000 Ohms
Mutual Conductance.....	275 μmhos
Amplification Factor.....	65

\*A resistor of at least 1 megohm should be in the grid return so negative filament, pin No. 8.

Note; Diode plate location at negative end of filament.

For use in resistance coupled circuits, see appendix.

# 1LN5 Sylvania Type

SHARP CUT OFF RF PENTODE

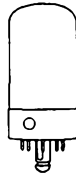

7AO-L-8

## PHYSICAL SPECIFICATIONS

Base.....	Lock-In 8 Pin
Bulb.....	T-9
Maximum Overall Length.....	2 <sup>11</sup> / <sub>16</sub> "
Maximum Seated Height.....	2 <sup>1</sup> / <sub>4</sub> "
Mounting Position.....	Any

## RATINGS

Maximum Filament Voltage.....	1.6 Volts
Design Center for AC-DC Operation.....	1.3 Volts
Maximum Plate Voltage.....	110 Volts
Maximum Screen Voltage.....	110 Volts

Direct Interelectrode Capacitances:\*

Grid to Plate.....	0.007 μf. Max.
Input.....	3.0 μf.
Output.....	8.0 μf.

\*With 1<sup>1</sup>/<sub>16</sub>" dia. (RMA Std. 308) shield connected to negative filament.

## TYPICAL OPERATION

Filament Voltage DC.....	1.4 Volts
Filament Current.....	50 Ma.
Plate Voltage.....	90 Volts
Screen Voltage.....	90 Volts
Grid Voltage*.....	0 Volt
Plate Current.....	1.6 Ma.
Screen Current.....	0.35 Ma.
Plate Resistance.....	1.1 Megohms Approx.
Mutual Conductance.....	800 μmhos
Mutual Conductance at -4.5 Volts (Approx.).....	10 μmhos

\*Negative filament return, Pins No. 8 and 5.

For use in resistance coupled circuits, see appendix.



5Y-1-7

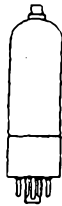

# Sylvania Type 1LN5

SHARP CUT-OFF RF PENTODE

## PHYSICAL SPECIFICATIONS

Base	Small Wafer 7-Pin Octal Metal Sleeve
Bulb	T-9
Cap.	Miniature
Maximum Overall Length	3 3/4"
Maximum Seated Height	2 3/4"
Mounting Position	Any

### Direct Interelectrode Capacitances:\*

Grid to Plate	0.007 $\mu$ f. Max.
Input	3.4 $\mu$ f.
Output	10.0 $\mu$ f.

\*With 1 1/8" diameter shield (RMA Std. 308) connected to negative filament.

## TYPICAL OPERATION

Filament Voltage DC	1.4 Volts
Filament Current	50 Ma.
Plate Voltage	90 Volts
Screen Voltage	90 Volts
Grid Voltage*	0 Volt
Plate Current	1.2 Ma.
Screen Current	0.3 Ma.
Plate Resistance (Approx.)	1.5 Megohms
Mutual Conductance	750 $\mu$ mhos
Mutual Conductance at -3.2 Volts (Approx.)	500 $\mu$ mhos
Mutual Conductance at -4 Volts (Approx.)	5 $\mu$ mhos

\*Negative filament return, Pin No. 7.

For Resistance Coupled Amplifier Data refer to type 1LN5 in appendix.

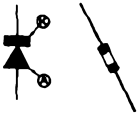

# Sylvania Type 1N34

CRYSTAL DIODES

## PHYSICAL SPECIFICATIONS

Style	See Outline
Connections	.025 Leads
Maximum Body Length	3/4"
Maximum Body Diameter	5/8"
Maximum Lead Length per Lead	1 1/8"
Mounting Position	Any
Temperature Range	-50 to +75° C.
Nominal Shunt Capacitance	1 $\mu$ f.

Cathode Terminal Indicated by Green Band on Body.

## RATINGS

Type	Peak Inverse Working Voltage	Peak Current Ma.	Transient Surge Current Ma.	Average Current At 1 Volt Ma.	Minimum Forward Current At 1 Volt Ma.	Maximum Reverse Current $\mu$ a.
1N34 $\emptyset$	60	150	500	40	5.0	50 at -10 v; 800 at -50 v
1N35*	50	60	100	22.5	7.5	10 at -10 v
1N38 $\emptyset$	100	150	500	40	3.0	6 at -3 v; 625 at -100 v
1N39	200	150	500	40	3.0	200 at -100 v; 800 at -200 v
1N40 $\diamond$	25	60	100	22.5	12.75 $\dagger$	50 at -10 v
1N41 $\diamond$	25	60	100	22.5	12.75 $\dagger$	50 at -10 v
1N42 $\diamond$	50	60	100	22.5	12.75 $\dagger$	6 at -3 v; 625 at -100 v
1N54 $\emptyset$	35	150	500	40	5.0	10 at -10 v
1N55 $\emptyset$	150	150	500	40	3.0	300 at -100 v; 800 at -150 v
1N56 $\emptyset$	40	200	1000	50	15.0	300 at -30 v
1N57	80	150	500	40	4.0	500 at -75 v
1N58 $\emptyset$	100	150	500	40	4.0	800 at -100 v
1N60	50	150	500	40	**	**
1N71 $f$	40	200	1000	50	15.0	300 at -30 v

\*Type 1N35 consists of two Diode units mounted in a fibre assembly. The units are matched within 10% for resistance in the forward direction at 1 volt.

$\dagger$ At 1.5 volts.

$\diamond$ Each unit contains 4 selected diodes matched within  $\pm 2.5\%$  in the forward direction at 1.5 volts.

$\emptyset$ Available in ceramic or glass cartridge. The letter A following the type number designates glass type.

\*\*Units are tested in a circuit employing an input of 1.8 volts rms at 40 mc. 70% modulated at 400 cycles. Demodulated output across a 4700 ohm resistor shunted by a 5  $\mu$ f. capacitor is a minimum of 1.1 volts peak to peak.

$f$ Consists of four matched low impedance germanium diodes each of which, with a voltage of one volt impressed in the forward direction, will pass a current within one ma. of the average current of the four. Ratings shown above are for each diode.

# 1N34 (Cont'd)

## APPLICATION

Sylvania Germanium diodes are ruggedly built semi-conductors which may be used whenever a diode of their voltage and current rating is required. Their advantages are small size, no heater, low capacitance, no contact potential, and ruggedness.

A booklet describing their applications is available on request.

## 1P5<sup>GT</sup> Sylvania Type

REMOTE CUT-OFF RF PENTODE



5Y-1-7

## PHYSICAL SPECIFICATIONS

Base.....	Small Wafer 7-Pin Metal Sleeve
Bulb.....	T-9
Cap.....	Miniature
Maximum Overall Length.....	3 <sup>5</sup> / <sub>16</sub> "
Maximum Seated Height.....	2 <sup>3</sup> / <sub>4</sub> "
Mounting Position.....	Any
<b>Direct Interelectrode Capacitances:*</b>	
Grid to Plate.....	0.007 $\mu$ f. Max.
Input.....	2.2 $\mu$ f.
Output.....	10.0 $\mu$ f.

\*With 1<sup>3</sup>/<sub>16</sub>" diameter shield (RMA 308) connected to negative filament.

## TYPICAL OPERATION

Filament Voltage DC.....	1.4 Volts
Filament Current.....	50 Ma.
Plate Voltage.....	90 Volts
Screen Voltage.....	90 Volts
Grid Voltage*.....	0 Volt
Plate Current.....	2.3 Ma.
Screen Current.....	0.7 Ma.
Plate Resistance (Approx.).....	0.8 Megohm
Mutual Conductance.....	750 $\mu$ mhos
Mutual Conductance at -12 Volts Bias.....	10 $\mu$ mhos

\*Negative Filament return, Pin No. 7.

## 1Q5<sup>GT</sup> Sylvania Type

BEAM POWER AMPLIFIER



6AF-0-0

## PHYSICAL SPECIFICATIONS

Base.....	Intermediate Octal 7-Pin
Bulb.....	T-9
Maximum Overall Length.....	3 <sup>5</sup> / <sub>16</sub> "
Maximum Seated Height.....	2 <sup>3</sup> / <sub>4</sub> "
Mounting Position.....	Any

## RATINGS

Filament Voltage DC.....	1.4 Volts
Filament Current.....	100 Ma.
Maximum Plate Voltage.....	110 Volts
Maximum Screen Voltage.....	110 Volts
Maximum Cathode Current at Zero Signal.....	12 Ma.

## TYPICAL OPERATION

Filament Voltage DC.....	1.4	1.4 Volts
Filament Current.....	100	100 Ma.
Plate Voltage.....	85	90 Volts
Screen Voltage.....	85	90 Volts
Grid Voltage.....	-5.0	-4.5 Volts
Peak A-F Signal Voltage.....	5.0	4.5 Volts
Plate Current (Zero Signal).....	7.0	9.5 Ma.
Screen Current (Zero Signal).....	0.8	1.6 Ma.
Mutual Conductance.....	1950	2200 $\mu$ mhos
Load Resistance.....	9000	8000 Ohms
Power Output.....	250	270 Mw.
Total Harmonic Distortion.....	5.5	6.0 Per Cent



7AT-0-0



## Sylvania Type 1R5

## HEPTODE CONVERTER

## PHYSICAL SPECIFICATIONS

Base.....	Miniature Button 7-Pin
Bulb.....	T-5 $\frac{1}{2}$
Maximum Overall Length.....	2 $\frac{1}{8}$ "
Maximum Seated Height.....	1 $\frac{1}{8}$ "
Mounting Position.....	Any

## RATINGS

Maximum Filament Voltage.....	1.6 Volts
Desing Center for AC-DC Operation.....	1.3 Volts
Maximum Plate Voltage.....	90 Volts
Maximum Screen Voltage.....	67.5 Volts
Maximum Screen Supply.....	90 Volts
Maximum Cathode Current.....	5.5 Ma.

## Direct Interelectrode Capacitances:\*

Grid Go to Plate.....	0.10 $\mu$ mf.
Signal Input.....	7.0 $\mu$ mf.
Mixer Output.....	7.5 $\mu$ mf.
Oscillator Input.....	3.8 $\mu$ mf.
Grid (G) to Plate.....	0.4 $\mu$ mf. Max.
Grid (G) to Grid (Go).....	0.2 $\mu$ mf. Max.
Grid (Go) to Plate.....	0.1 $\mu$ mf. Max.

\*Without shield.

## TYPICAL OPERATION

Filament Voltage.....	1.4	1.4	1.4	1.4 Volts
Filament Current.....	0.050	0.050	0.050	0.050 Ampere
Plate Voltage.....	45	67.5	90	90 Volts
Screen Voltage.....	45	67.5	45	67.5 Volts
Grid Voltage.....	0	0	0	0 Volt
Oscillator-Grid Resistor (Rgo).....	0.1	0.1	0.1	0.1 Megohm
Plate Resistance (Approx.).....	0.6	0.5	0.8	0.6 Megohm
Plate Current.....	0.7	1.4	0.8	1.6 Ma.
Screen Current.....	1.9	3.2	1.9	3.2 Ma.
Oscillator-Grid Current.....	0.15	0.25	0.15	0.25 Ma.
Total Cathode Current.....	2.75	5.0	2.75	5.0 Ma.
Conversion Conductance.....	235	280	250	300 $\mu$ mhos
Grid Voltage (G) for Conversion Conductance of 5 $\mu$ mhos.....	-9	-14	-9	-14 Volts

## APPLICATION

Sylvania Type 1R5 is a pentagrid converter of the miniature line especially designed for mixer-oscillator service in compact, light weight, portable equipment. The operating efficiency allows the tube to be used with extremely low B. Supply voltages. The internal construction of the tube is similar to that of Sylvania Type 6SA7GT, with the exception of the filament. Circuit applications for Type 6SA7GT may be used for Sylvania type 1R5.

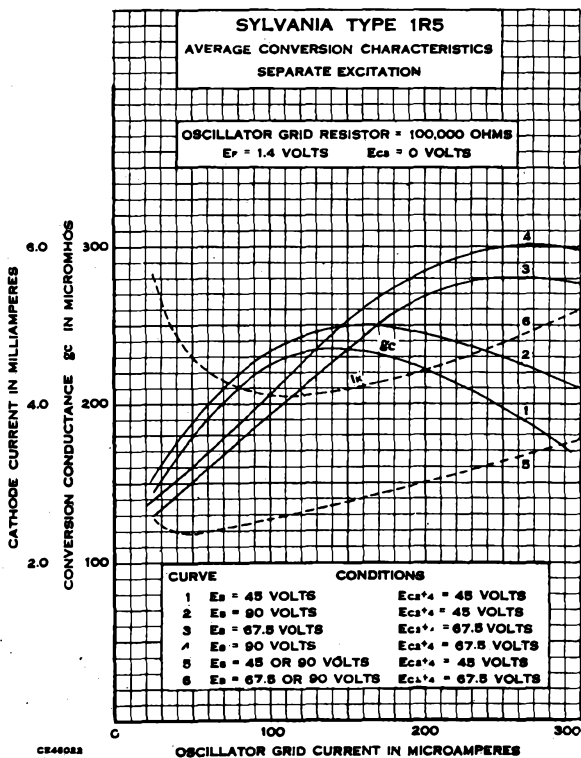
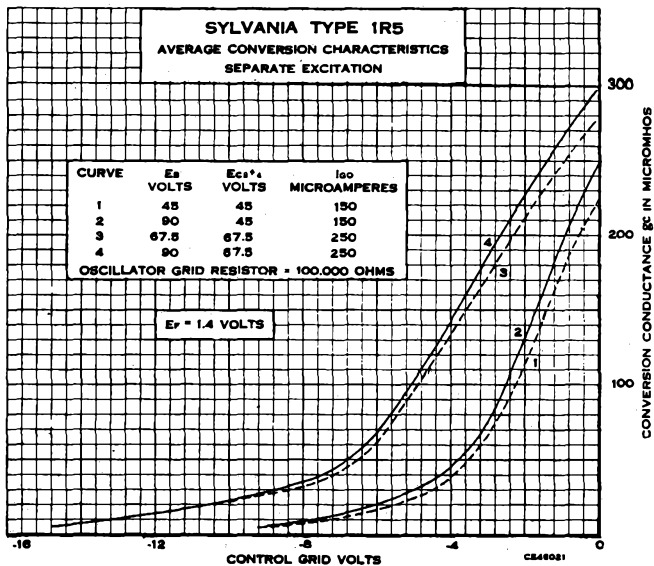





7AV-0-0



# Sylvania Type 1S4

POWER AMPLIFIER PENTODE

## PHYSICAL SPECIFICATIONS

Base.....	Miniature Button 7-Pin
Bulb.....	T5 1/2
Maximum Overall Length.....	2 1/2"
Maximum Seated Height.....	1 1/2"
Mounting Position.....	Any

## RATINGS

Maximum Filament Voltage.....	1.6 Volts
Design Center for AC-DC Operation.....	1.8 Volts
Maximum Plate Voltage.....	90 Volts
Maximum Screen Voltage.....	67.5 Volts
Maximum Cathode Current Zero Signal.....	9.0 Ma.
Maximum Cathode Current Maximum Signal.....	11.0 Ma.

## TYPICAL OPERATION

### CLASS A AMPLIFIER

Filament Voltage DC.....	1.4	1.4	1.4 Volts
Filament Current.....	0.100	0.100	0.100 Amperes
Plate Voltage.....	45	67.5	90 Volts
Screen Voltage.....	45	67.5	67.5 Volts
Grid Voltage*.....	-4.5	-7	-7 Volts
Peak A-F Signal Voltage.....	4.5	7	7 Volts
Zero Signal Plate Current.....	3.8	7.2	7.4 Ma.
Zero Signal Screen Current.....	0.8	1.5	1.4 Ma.
Plate Resistance (Approx.).....	0.1	0.1	0.1 Megohm
Mutual Conductance.....	1250	1550	1575 $\mu$ mhos
Load Resistance.....	8000	5000	8000 ohms
Power Output.....	65	180	270 Milliwatts
Total Harmonic Distortion.....	12	10	12 Per Cent

\*Negative Filament Return, Pin No. 1

## APPLICATION

Sylvania Type 1S4 is a power amplifier pentode of the Miniature construction, especially designed for output service in compact, light weight, portable equipment. The high operating efficiency allows the tube to be used with extremely low B. Supply voltages.

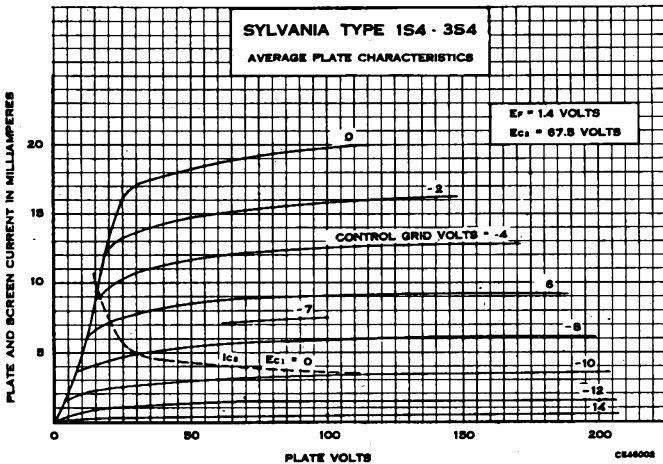

# 1S5 Sylvania Type

DIODE PENTODE AMPLIFIER



6AU-0-0

## PHYSICAL SPECIFICATIONS

Base.....	Miniature Button 7-Pin
Bulb.....	T5 1/2
Maximum Overall Length.....	2 1/8
Maximum Seated Height.....	1 1/8
Mounting Position.....	Any

## RATINGS

Maximum Filament Voltage.....	1.6 Volts
Design Center for AC-DC Operation.....	1.3 Volts
Maximum Plate Voltage.....	90 Volts
Maximum Screen Voltage.....	90 Volts
Maximum Signal Cathode Current.....	3.0 Ma.
Maximum Diode Current.....	0.25 Ma.

### Direct Interelectrode Capacitances:\*

Grid to Plate.....	0.2 $\mu$ f.
Input.....	2.2 $\mu$ f.
Output.....	2.4 $\mu$ f.

\*With no external shielding.

## TYPICAL OPERATION

Filament Voltage DC.....	1.4	1.4 Volts
Filament Current.....	50	50 Ma.
Plate Voltage.....	67.5	90 Volts
Screen Voltage.....	67.5	90 Volts
Grid Voltage.....	0	0 Volt
Plate Current.....	1.6	2.7 Ma.
Screen Current.....	0.4	0.5 Ma.
Plate Resistance (Approx.).....	0.6	0.5 Megohm
Mutual Conductance.....	625	720 $\mu$ mhos

Note; Diode plate located at negative end of filament.

## APPLICATION

Sylvania Type 1S5 is a diode pentode of the miniature construction, especially designed for detector-audio service in compact, light weight, portable equipment. The high operating efficiency allows the tube to be used with extremely low B supply voltages. The internal construction of Type 1S5 is similar to that of Sylvania Type 1LD5.

For use in resistance coupled circuits, see appendix.

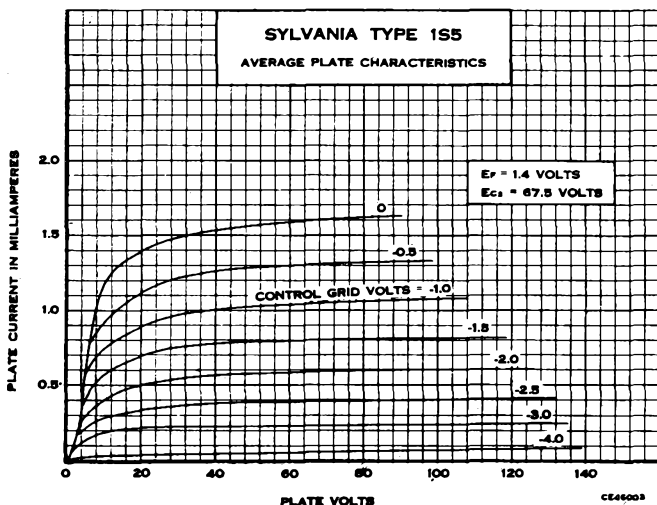

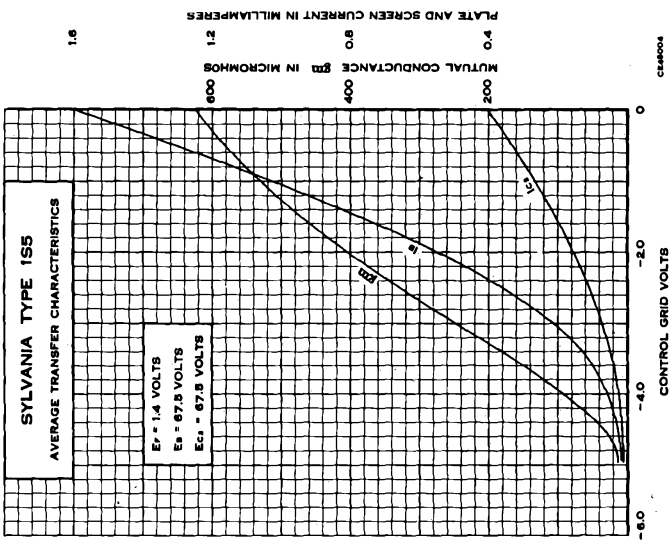

8DA-0-0



### Sylvania Type 1S6

DIODE PENTODE

#### PHYSICAL SPECIFICATIONS

Base.....	Flexible Leads
Bulb.....	T-3
Maximum Bulb Length.....	1 1/2"
Minimum Lead Length.....	1 1/4"
Mounting Position.....	Any

For additional data and curves, reference should be made to Type 1T6 which has the same operating conditions but differs in lead length.



6AR-0-1 & 5



### Sylvania Type 1T4

REMOTE CUT-OFF RF PENTODE

#### PHYSICAL SPECIFICATIONS

Base.....	Miniature Button 7-Pin
Bulb.....	T5 1/2
Maximum Overall Length.....	2 1/8"
Maximum Seated Height.....	1 1/8"
Mounting Position.....	Any

#### RATINGS

Maximum Filament Voltage DC.....	1.6 Volts
Filament Voltage DC (design center of AC-DC Power Line Operation).....	1.3 Volts
Maximum Plate Voltage.....	90 Volts
Maximum Screen Voltage.....	90 Volts
Maximum Total Cathode Current.....	5.5 Ma.
Minimum Grid Bias Voltage.....	0 Volt

#### Direct Interelectrode Capacitances:\*

Grid to Plate.....	0.01 $\mu$ f. Max.
Grid to all Electrodes Except Plate.....	3.6 $\mu$ f.
Plate to All Electrodes Except Grid G.....	7.5 $\mu$ f.

\*With close-fitting tube shield connected to negative filament.

# 1T4 (Cont'd)

## TYPICAL OPERATION

Filament Voltage DC.....	1.4	1.4	1.4	1.4 Volts
Filament Current.....	50	50	50	50 Ma.
Plate Voltage.....	45	67.5	90	90 Volts
Screen Voltage.....	45	67.5	45	67.5 Volts
Grid Voltage.....	0	0	0	0 Volt
Plate Current.....	1.7	3.4	1.8	3.5 Ma.
Screen Current.....	0.7	1.5	0.65	1.4 Ma.
Plate Resistance (Approx.).....	0.35	0.25	0.8	0.5 Megohm
Mutual Conductance.....	700	875	750	900 $\mu$ mhos
Grid Voltage for 10 $\mu$ mhos.....	-10	-16	-10	-16 Volts

## APPLICATION

Sylvania Type 1T4 is a rf-if remote cut-off pentode of the miniature style of construction. It is especially designed for radio frequency amplifier service in compact, light weight, portable equipment. The high operating efficiency allows the tube to be used with extremely low B supply voltages. The construction incorporates internal shielding which is connected to minus filament, and eliminates the need for an external bulb shield. A shielded socket should be employed to obtain the minimum Grid-plate capacity.

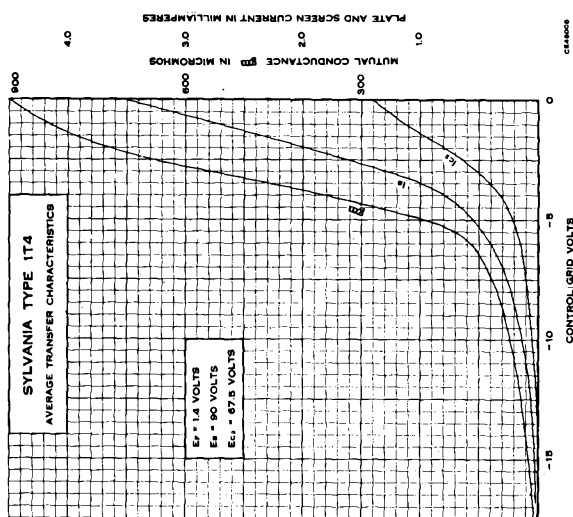
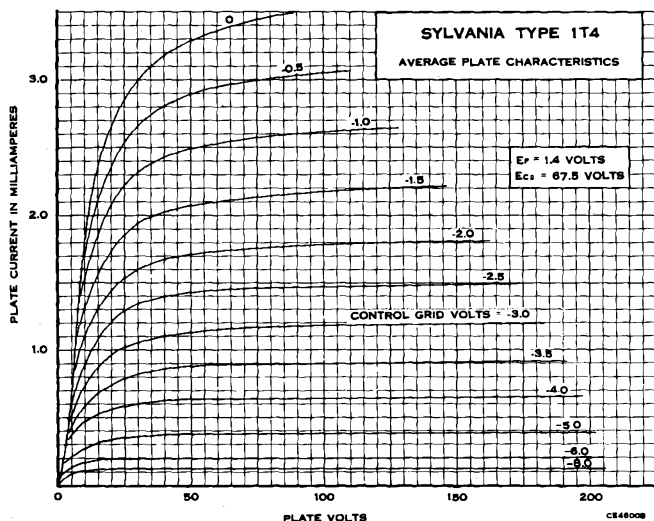

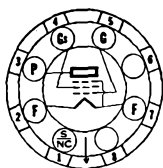

6X-0-0



# Sylvania Type 11C

PENTODE POWER AMPLIFIER

## PHYSICAL SPECIFICATIONS

Base .....	Intermediate Octal 7 Pin
Bulb .....	T-9
Maximum Overall Length .....	3 <sup>5</sup> / <sub>16</sub> "
Maximum Seated Height .....	2 <sup>3</sup> / <sub>4</sub> "
Mounting Position .....	Any

## RATINGS

Maximum Filament Voltage	
Dry Battery Operation—Must Never Exceed .....	1.6 Volts
AC-DC Power Line Operation—Design Center .....	1.3 Volts
Maximum Plate Voltage .....	110 Volts
Maximum Screen Voltage .....	110 Volts
Maximum Cathode Current (Zero Signal) .....	7.3 Ma.

## TYPICAL OPERATION

	Self Bias	Fixed Bias
Filament Voltage .....	1.4	1.4 Volts
Filament Current .....	0.05	0.05 Ampere
Plate Voltage .....	84.0	90 Volts
Screen Voltage .....	84.0	90 Volts
Control Grid Voltage .....	-6.0	-6.0 Volts
Plate Resistance (Approximate) .....	0.25	0.25 Megohms
Mutual Conductance .....	1050	1150 $\mu$ mhos
Plate Current (Zero Signal) .....	5.4	6.5 Ma.
Plate Current (Maximum Signal) .....	5.5	6.5 Ma.
Screen Current (Zero Signal) .....	0.6	0.8 Ma.
Screen Current (Maximum Signal) .....	1.5	1.5 Ma.
Load Resistance .....	14000	14000 Ohms
Total Harmonic Distortion .....	7.5	7.5 Per Cent
Power Output .....	145	170 Milliwatts

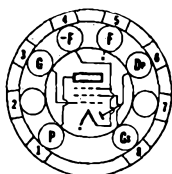

8DA-0-0



# Sylvania Type 1T6

DIODE PENTODE

## PHYSICAL SPECIFICATIONS

Base .....	Subminiature Button 8 Pin
Bulb .....	T-3
Maximum Overall Length .....	1 <sup>3</sup> / <sub>4</sub> "
Maximum Seated Height .....	1 <sup>1</sup> / <sub>2</sub> "
Mounting Position .....	Any

## RATINGS

Filament Voltage .....	1.25 Volts
Maximum Plate Voltage .....	67.5 Volts
Maximum Screen Voltage .....	67.5 Volts
Maximum Cathode Current (Pentode Section) .....	2.0 Ma.
Maximum Diode Current for continuous operation .....	0.25 Ma.

## TYPICAL OPERATION

### CLASS A OPERATION

Filament Voltage DC .....	1.25	1.25	1.25 Volts
Filament Current .....	40	40	40 Ma.
Plate Voltage .....	30	45	67.5 Volts
Screen Voltage .....	30	45	67.5 Volts
Grid Voltage .....	0	0	0 Volts
Plate Current .....	0.33	0.75	1.6 Ma.
Screen Current .....	0.10	0.21	0.4 Ma.
Plate Resistance (Approx.) .....	0.5	0.5	0.4 Megohm
Mutual Conductance .....	330	475	600 $\mu$ mhos
Average Diode Current with 10 Volts DC .....	1.5	1.5	1.5 Ma.

## AS A RESISTANCE COUPLED AMPLIFIER

Plate Voltage.....	30	45	67.5 Volts
Screen Voltage.....	30	45	67.5 Volts
Voltage Gain (Approx.).....	30 (1)	50 (2)	60 (2)
(1) With $R_{c2}=2.2$ megohms	$R_b=1.0$ megohms	$R_{c1}=4.7$ megohms	
(2) With $R_{c2}=3.9$ megohms	$R_b=1.0$ megohms	$R_{c1}=4.7$ megohms	

## APPLICATION

Sylvania Type 1T6 is a diode audio pentode tube suitable for use in very small radio sets or amplifiers. The other types required for a normal set complement and designed for such usage are Types 1E8 (Converter), 1AD5 (RF Pentode Amplifier) and 1AC5 (Output Pentode).

This type corresponds in service and circuit design to Types 1LD5 and 1S5 but is rated for use at lower voltages. The gains are comparable considering the reduced size and voltages.

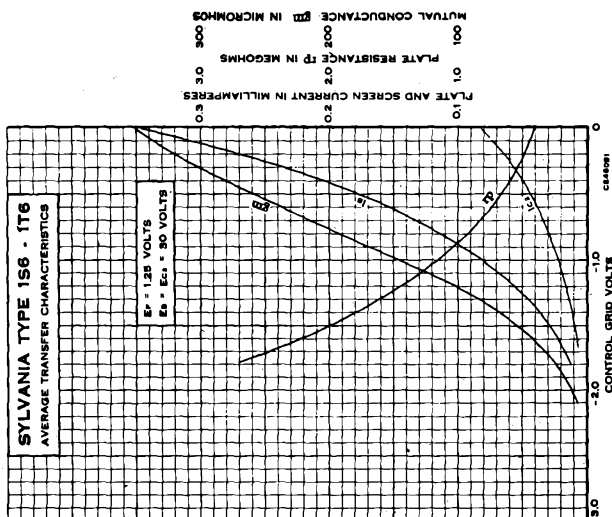
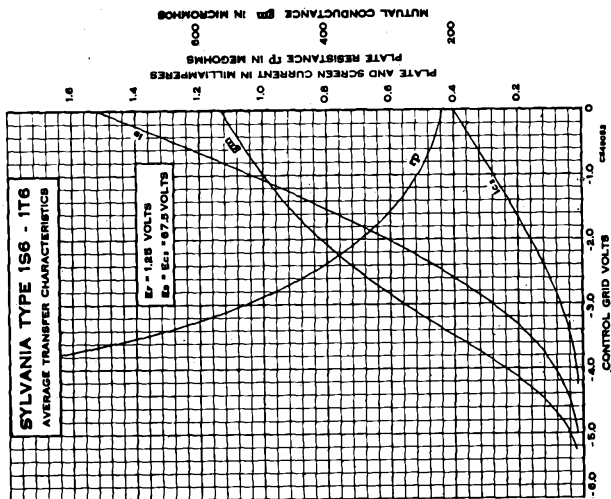

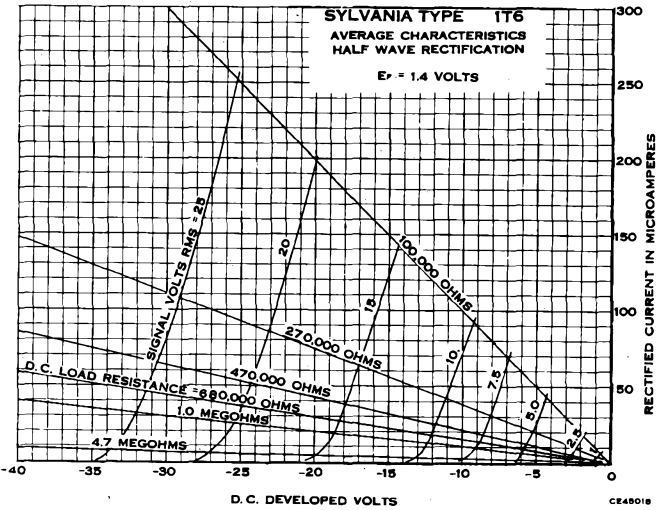
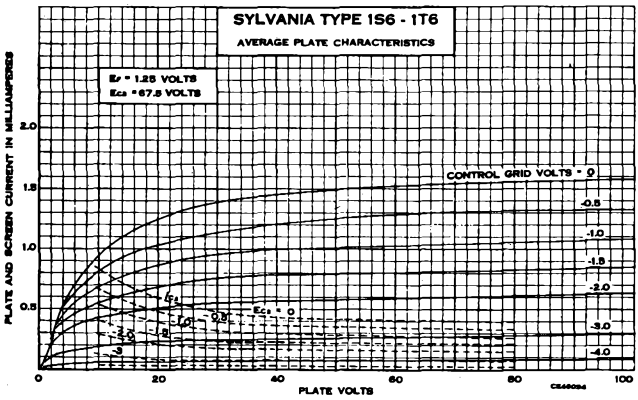
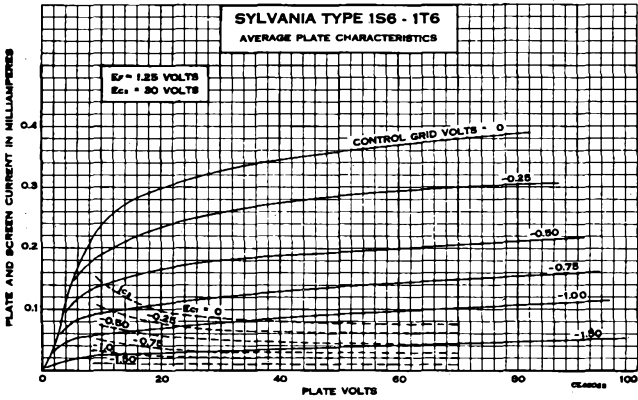

# 1U4 Sylvania Type

SHARP CUT-OFF RF PENTODE

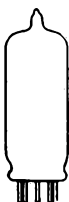

GAR-0-1 & 5

## PHYSICAL SPECIFICATIONS

Base	Miniature 7-Pin
Bulb	T-5 $\frac{1}{2}$
Maximum Overall Length	2 $\frac{1}{8}$ "
Maximum Seated Height	1 $\frac{3}{8}$ "
Mounting Position	Any

## RATINGS

Maximum Filament Voltage	1.6 Volts
Design Center for AC-DC Operation	1.3 Volts
Maximum Plate Voltage	110 Volts
Maximum Screen Voltage	110 Volts
Maximum Control Grid Voltage	-30 Volts
Minimum Control Grid Voltage	0 Volts
Maximum Total Cathode Current	6.5 Ma.

### Direct Interelectrode Capacitances:\*

Grid to Plate	.008 $\mu$ f. Max.
Input	3.6 $\mu$ f.
Output	7.5 $\mu$ f.

\*With tight fitting external shield.

## TYPICAL OPERATION

Filament Voltage DC	1.4 Volts
Filament Current	50 Ma.
Plate Voltage	90 Volts
Screen Voltage	90 Volts
Control Grid Voltage	0 Volts
Plate Resistance (Approx.)	1.5 Megohms
Mutual Conductance	900 umhos
Plate Current	1.6 Ma.
Screen Current	0.45 Ma.
Grid Bias Voltage for Mutual Conductance of 10 umhos	-4.5 Volts

## APPLICATION

Sylvania Type 1U4 is a sharp cut-off RF pentode very similar in application and characteristics to Type 1LN5. Data required for its use in resistance coupled amplifier circuits are shown in appendix.

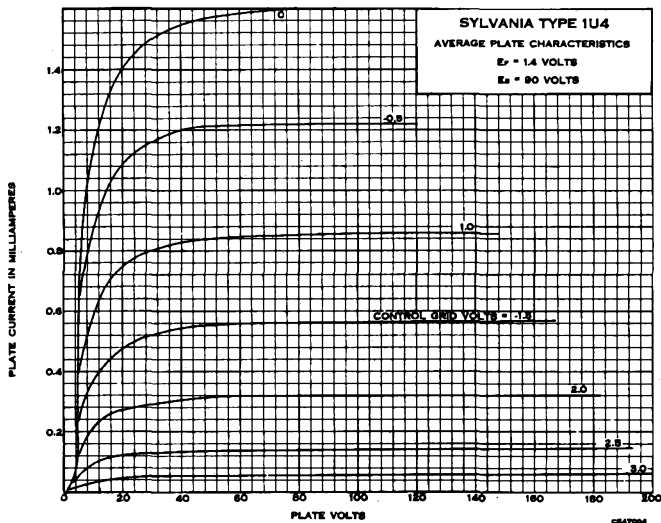



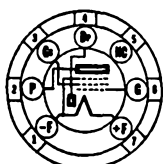
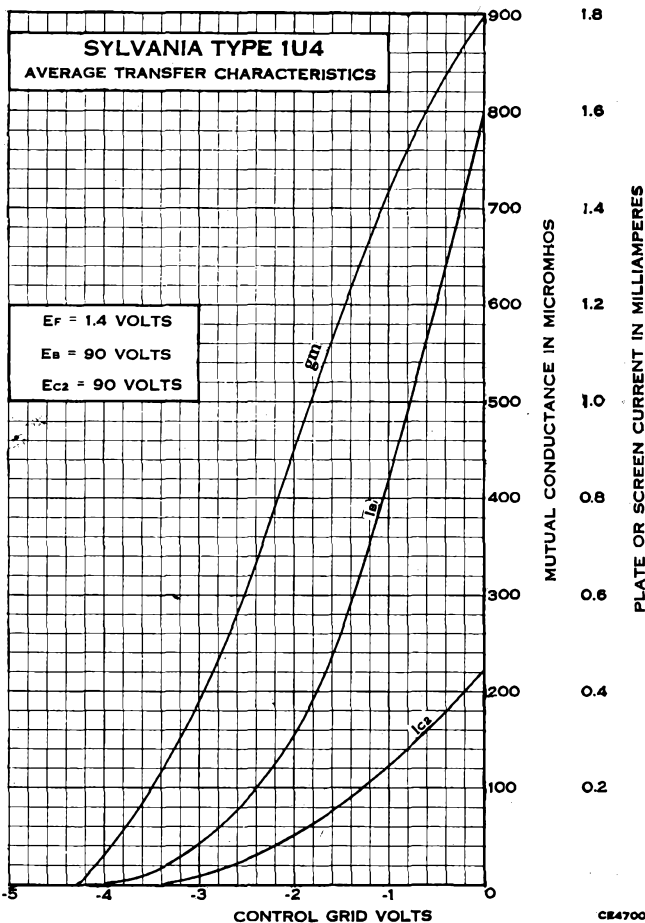

6BW-0-0



## Sylvania Type 1U5

DIODE PENTODE AMPLIFIER

### PHYSICAL SPECIFICATIONS

Base .....	Miniature Button 7 Pin
Bulb .....	T6 1/2
Maximum Overall Length .....	2 1/8"
Maximum Seated Height .....	1 7/8"

Note: With the exception of the base diagram given above, the characteristics of type 1U5 are identical, except for Capacitances, with those given for type 185 including curves, and Resistance Coupled Amplifier data given in appendix.

# 1V2 Sylvania Type

HALF WAVE VACUUM RECTIFIER

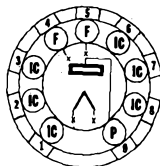

9U-0-0

## PHYSICAL SPECIFICATIONS

Base.....	Miniature-Button 9-pin
Bulb.....	T6 <sup>1</sup> / <sub>2</sub>
Maximum Overall Length.....	2 <sup>3</sup> / <sub>16</sub> "
Maximum Seated Height.....	1 <sup>15</sup> / <sub>16</sub> "
Mounting Position.....	Any

## RATINGS

Heater Voltage (AC).....	0.625 Volts
Heater Current.....	0.3 Amperes
Peak Inverse Plate Voltage (Max.).....	7,500 Volts
Peak Plate Current (Max.).....	10 Ma.
Average Plate Current (Max.).....	0.5 Ma.
Direct interelectrode Capacitance (Approx.) with no external shield Plate to Filament.....	0.8 μf.

## APPLICATION

Sylvania Type 1V2 is a half-wave rectifier designed especially for use in television circuits using fly-back or high frequency oscillator supplies.

# 1V5 Sylvania Type

OUTPUT PENTODE



8CP-0-0



## PHYSICAL SPECIFICATIONS

Base.....	Flexible Leads
Bulb.....	T-3
Maximum Bulb Length.....	1 <sup>1</sup> / <sub>2</sub> "
Minimum Lead Length.....	1 <sup>3</sup> / <sub>4</sub> "
Mounting Position.....	Any

For additional data and curves, reference should be made to Type 1AC5 which has the same operating conditions but differs in lead length.

# 1W4 Sylvania Type

POWER AMPLIFIER PENTODE

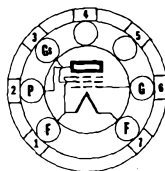

5BZ-0-0

## PHYSICAL SPECIFICATIONS

Base.....	Miniature Button 7-pin
Bulb.....	T5 <sup>1</sup> / <sub>2</sub>
Maximum Overall Length.....	2 <sup>1</sup> / <sub>2</sub> "
Maximum Seated Height.....	1 <sup>7</sup> / <sub>8</sub> "
Mounting Position.....	Any

**RATINGS**

Filament Voltage.....	1.4 Volts
Maximum Plate Voltage.....	110 Volts
Maximum Screen Grid Voltage.....	110 Volts
Maximum Cathode Current.....	6.0 Ma.

**TYPICAL OPERATION**

Filament Voltage DC.....	1.4	1.4	1.4	1.4 Volts
Filament Current.....	50	50	50	50 Ma.
Plate Voltage.....	45	62.5	67.5	90 Volts
Screen Voltage.....	45	62.5	67.5	90 Volts
Grid Voltage.....	-4.5	-5.0	-6.0	-9.0 Volts
Plate Current.....	1.6	3.8	3.8	5.0 Ma.
Screen Current.....	0.3	0.8	0.8	1.0 Ma.
Plate Resistance (approx.).....	0.4	0.3	0.3	0.25 Megohms
Mutual Conductance.....	650	875	875	925 $\mu$ mhos
Load Resistance.....	20,000	16,000	16,000	12,000 Ohms
Power Output.....	35	90	100	200 Milliwatts
Total Harmonic Distortion.....	10	10	10	10 %

**APPLICATION**

Sylvania Type 1W4 is a miniature filament type power output tube for use in low drain battery operated receivers. Electrical characteristics are identical with those for Type 1LB4, including design for maximum power output with low B supply voltage.



8CP-0-0

**Sylvania Type 1W5****SHARP CUT-OFF RF PENTODE****PHYSICAL SPECIFICATIONS**

Base.....	Flexible Leads
Bulb.....	T-3
Maximum Bulb Length.....	1 1/2"
Minimum Lead Length.....	1 1/4"
Mounting Position.....	Any

For additional data and curves, reference should be made to Type 1AD5 which has the same operating conditions but differs in lead length.

# 1X2 Sylvania Type

HIGH VOLTAGE HALF-WAVE RECTIFIER

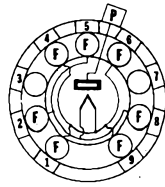

9Y-0-1, 4, 6 & 9

## PHYSICAL SPECIFICATIONS

Base.....	Miniature Button 9-Pin
Bulb.....	T6 $\frac{1}{2}$
Cap.....	Skirted Miniature
Maximum Overall Length.....	2 $\frac{1}{16}$ "
Mounting Position.....	Any

## RATINGS AND OPERATION

Filament Voltage.....	1.25 Volts
Filament Current.....	200 Ma.
Peak Inverse Plate Voltage (Max.).....	15,000 Volts
Peak Plate Current (Max.).....	10 Ma.
DC Output Current (Max.).....	1 Ma.
Frequency of Supply Voltage (Max.).....	300 kc.

## APPLICATION

Sylvania Type 1X2 is a high voltage, half-wave rectifier. It is designed for use in television circuits using either rf or fly-back type of power supply, as well as for use at power line frequency. See type 1B3GT for suggestions on reducing corona loss etc.

# 2X2A Sylvania Type

HIGH VOLTAGE HALF-WAVE  
RECTIFIER

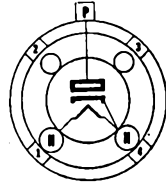

4AB-0-0

## PHYSICAL SPECIFICATIONS

Base.....	Small 4 Pin
Bulb.....	ST12
Cap.....	Small Metal
Maximum Overall Length.....	4 $\frac{1}{2}$ "
Maximum Seated Height.....	3 $\frac{3}{8}$ "
Mounting Position.....	Any

## RATINGS AND OPERATION

Heater Voltage.....	2.5 Volts
Heater Current.....	1.75 Amperes
Maximum RMS Plate Voltage.....	4500 Volts
Peak Inverse Plate Voltage.....	12,500 Volts
Peak Plate Current.....	100 Ma.
Minimum Effective Plate Supply Impedance.....	0 Ohms
DC Output Current (Maximum).....	7.5 Ma.

## APPLICATION

Sylvania Type 2X2/879 is a high voltage, high vacuum half wave rectifier. It is designed for use in applications requiring high DC voltages at low current loads such as for anode supplies for cathode ray tubes. Filter requirements for this type of service are easily met since a simple resistive, capacitive filter is usually adequate. Care should be taken to provide adequate insulation as in any high voltage installation.



7BB-0-0



# Sylvania Type 3A4

POWER AMPLIFIER PENTODE

## PHYSICAL SPECIFICATIONS

Base.....	Miniature Button 7 Pin
Bulb.....	T5 1/2
Maximum Overall Length.....	2 1/8"
Maximum Seated Height.....	1 1/8"
Mounting Position.....	Any

## TYPICAL OPERATION

Filament Voltage.....	1.4 or 2.8* Volts
Filament Current.....	200 or 100 Ma.
Plate Voltage.....	135 150 Volts
Screen Voltage.....	90 90 Volts
Grid Voltage.....	-7.5 -8.4 Volts
Plate Current.....	14.8 13.3 Ma.
Screen Current.....	2.6 2.2 Ma.
Mutual Conductance.....	1900 1900 μmhos
Load Resistance.....	8000 8000 Ohms
Power Output Maximum Signal.....	600 700 Mw.

\*For operation at 2.8 volts (filaments in series) a shunting resistor must be connected between pins 1 and 5 to make the voltage at this point equal to that across pins 5 and 7.

## APPLICATION

Sylvania Type 3A4 is a miniature power amplifier pentode. It is similar to types 3Q4 and 3S4, but has higher plate voltage and current ratings with greater power output.

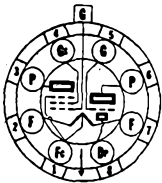

8AS-0-1

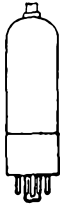

# Sylvania Type 3A8<sup>GT</sup>

DIODE TRIODE  
RF PENTODE

## PHYSICAL SPECIFICATIONS

Base.....	Intermediate Octal 8-Pin
Bulb.....	T-9
Cap.....	Miniature
Maximum Overall Length.....	3 1/2"
Maximum Seated Height.....	2 1/4"
Mounting Position.....	Any

## RATINGS

	Series	Parallel
Maximum Filament Voltage		
Dry Battery Operation Must Never Exceed.....	3.2	1.6 Volts
AC-DC Power Line Operation Design Center.....	2.6	1.3 Volts
Maximum Plate Voltage		
Pentode.....	110	110 Volts
Triode.....	110	110 Volts
Maximum Screen Voltage.....	110	110 Volts
Minimum Diode Current with 10 Volts DC applied*.....	0.5	0.5 Ma.
Maximum Diode Current Continuous Operation.....	0.25	0.25 Ma.

	Triode	Pentode
Direct Interelectrode Capacitances:†		
Grid to Plate.....	2.0	0.012 μmf. Max.
Input.....	2.6	3.0 μmf.
Output.....	4.2	10.0 μmf.

\*The diode triode filament is connected to pins 1 and 7. The diode is located at the negative end of the filament.

†With 1 1/4" diameter shield (RMA Std. 308) Connected to Negative Filament.

# 3A8<sup>GT</sup> (Cont'd)

## TYPICAL OPERATION

	Series	Parallel
Filament Voltage DC.....	2.8	1.4 Volts
Filament Current.....	50	50 Ma.
	Triode	Pentode
Plate Voltage.....	90	90 Volts
Screen Voltage.....		90 Volts
Grid Voltage**.....	0	0 Volt
Plate Resistance (Approximate).....	0.2	0.8 Megohm
Mutual Conductance.....	325	750 $\mu$ mhos
Plate Current.....	0.2	1.5 Ma.
Screen Current.....		0.5 Ma.

\*\*Grid bias voltage is measured from the negative filament terminal of each unit. With Series filament, pin number 7 is the negative for the diode triode section and pin number 1 for the pentode section. With parallel filaments pin number 7 becomes negative for both.

Data for use in Resistance Coupled Amplifiers may be obtained by referring to types 1LN5 and 1LH4 in appendix.

## 3D6 Sylvania Type

### BEAM POWER AMPLIFIER

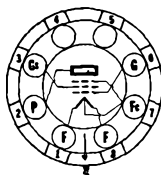

6BB-L-0

## PHYSICAL SPECIFICATIONS

Base.....	Lock-In 8-Pin
Bulb.....	T-9
Maximum Overall Length.....	2 <sup>3</sup> / <sub>4</sub> "
Maximum Seated Height.....	2 <sup>1</sup> / <sub>2</sub> "
Mounting Position.....	Any

## RATINGS

	Series	Parallel
Maximum Filament Voltage DC.....	3.5*	1.75* Volts
Minimum Filament Voltage DC.....	2.8	1.40 Volts
Filament Current.....	0.110	0.220 Ampere
Maximum Plate Voltage.....	180	180 Volts
Maximum Screen Voltage.....	135	135 Volts
Maximum Cathode Current <sup>†</sup> .....	30	30 Ma.
Maximum Plate Dissipation.....	4.5	4.5 Watts
Maximum Screen Dissipation.....	0.9	0.9 Watt

\*For parallel operation, connect pins No. 1 and No. 8 to positive voltage supply, and pin No. 7 to negative voltage supply. For series operation, connect pin No. 1 to positive and pin No. 8 to negative.

<sup>†</sup>When series operated, a shunting resistor should be connected across the section of filament between pins No. 7 and No. 8 of sufficient value to by-pass any cathode current in excess of the maximum per section. If other tubes in a series filament arrangement contribute to the filament current of Type 3D6, an additional shunting resistor may be required between pins No. 1 and No. 8.

### Direct Interelectrode Capacitances:

	Note 1	Note 2
Control Grid to Plate.....	0.30	0.30 $\mu$ mf.
Input.....	7.5	7.5 $\mu$ mf.
Output.....	5.5	6.5 $\mu$ mf.

Note 1. With no external shield (Pin No. 5 connected to filament center tap).

Note 2. With 1<sup>3</sup>/<sub>4</sub>" diameter shield (RMA Std. M8-308) connected to negative filament (Pin No. 5 connected to filament center tap).

## TYPICAL OPERATION A-F POWER AMPLIFIER CLASS A<sub>1</sub>

Filament Voltage.....	1.4	1.4	1.4 Volts
Filament Current.....	0.220	0.220	0.220 Ampere
Plate Voltage.....	90	135	150 Volts
Screen Voltage.....	90	90	90 Volts
Grid Voltage.....	-4.5	-4.5	-4.5 Volts
Peak A-F Signal Voltage.....	4.5	4.5	4.5 Volts
Plate Current Zero Signal.....	9.5	9.8	9.9 Ma.
Plate Current Maximum Signal.....	8.5	9.8	10.2 Ma.
Screen Current Zero Signal.....	1.6	1.2	1.0 Ma.
Screen Current Maximum Signal.....	3.2	2.0	1.8 Ma.
Mutual Conductance.....	2400	2400	2400 $\mu$ mhos
Load Resistance.....	8000	12000	14000 Ohms
Total Distortion.....	5	5	5 Per Cent
Power Output.....	270	500	600 Mw.

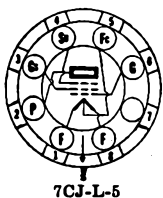

7CJ-L-5

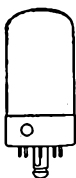

# Sylvania Type 3E6

SHARP CUT-OFF RF PENTODE

## PHYSICAL SPECIFICATIONS

Base.....	Lock-In 8-Pin
Bulb.....	T-9
Maximum Overall Length.....	2 <sup>3</sup> / <sub>8</sub> "
Maximum Seated Height.....	2 <sup>1</sup> / <sub>4</sub> "
Mounting Position.....	Any

## RATINGS

	Parallel	Series
Maximum Filament Voltage.....	1.6	3.2 Volts
Design Center for AC, DC Operation.....	1.3	2.6 Volts
Maximum Plate Voltage.....	110	110 Volts
Maximum Screen Voltage.....	110	110 Volts
Maximum Cathode Current.....	12.0	6.0* Ma.

For parallel filament operation, connect pins 1 and 8 to positive supply and pin 5 to negative supply. For series operation, pin No. 1 is positive and pin No. 8 is negative.

\*For each 1.4 volt section. A shunting resistor across the negative filament section is necessary to limit current to value given.

### Direct Interelectrode Capacitances:\*\*

Grid to Plate.....	0.007 $\mu$ f. Max.
Input.....	5.5 $\mu$ f.
Output.....	8.0 $\mu$ f.

\*\*With 1<sup>5</sup>/<sub>16</sub>" dia. shield (RMA Std. 308) connected to negative filament.

## TYPICAL OPERATION

	Parallel	Series
Filament Voltage DC.....	1.4	2.8 Volts
Filament Current.....	100	50 Ma.
Plate Voltage.....	90	90 Volts
Screen Voltage.....	90	90 Volts
Grid Voltage.....	0	0 Volt
Grid Resistor.....	2.0	2.0 Megohms
Plate Current.....	4.2	2.9 Ma.
Screen Current.....	1.7	1.2 Ma.
Mutual Conductance.....	2000	1700 $\mu$ mhos
Plate Resistance.....	0.25	0.325 Megohm
Grid Voltage for $I_b=10 \mu$ a.....	-5.5	-4.0 Volts

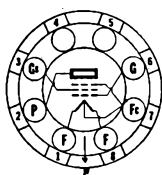

6BB-L-0

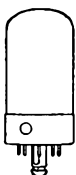

# Sylvania Type 3LF4

BEAM POWER AMPLIFIER

## PHYSICAL SPECIFICATIONS

Base.....	Lock-In 8-Pin
Bulb.....	T-9
Maximum Overall Length.....	2 <sup>3</sup> / <sub>8</sub> "
Maximum Seated Height.....	2 <sup>1</sup> / <sub>4</sub> "
Mounting Position.....	Any

## RATINGS

	Series*	Parallel†
Maximum Filament Voltage		
Dry Battery Operation must never Exceed.....	3.2	1.6 Volts
AC-DC Power Line Operation—Design Center.....	2.6	1.3 Volts
Maximum Plate Voltage.....	110	110 Volts
Maximum Screen Voltage.....	110	110 Volts
Maximum Cathode Current.....	6*	12 Ma.

# 3LF4 (Cont'd)

## TYPICAL OPERATION CLASS A AMPLIFIER

	Series*			Parallel†	
Filament Voltage.....	2.8	2.8	1.4	1.4	1.4 Volts
Filament Current.....	0.050	0.050	0.100	0.100	0.100 Ampere
Plate Voltage.....	90	110	85	90	110 Volts
Screen Voltage.....	90	110	85	90	110 Volts
Grid Voltage.....	-4.5	-6.6	-5.0	-4.5	-6.6 Volts
Peak A-F Signal Voltage.....	4.5	5.1 <sup>δ</sup>	5.0	4.5	5.4 <sup>δ</sup> Volts
Plate Current.....	8.0	8.5	7.0	9.5	10 Ma.
Screen Current.....	1.0	1.1	0.8	1.3	1.4 Ma.
Plate Resistance (App.).....	80000	110000	70000	90000	100000 Ohms
Mutual Conductance.....	2000	2000	1950	2200	2200 μmhos
Load Resistance.....	8000	8000	9000	8000	8000 Ohms
Total Harmonic Distortion.....	8.5	8.5	5.5	6.0	6.0 Per Cent
Power Output.....	230	330	250	270	400 Mw.

\*A resistor of 270 ohms must be used in parallel with the negative section of the filament (Pins 7 and 8) in order to insure that the value of 6.0 Ma. total cathode current for each 1.4 volt section of the filament is not exceeded. When other tubes in series filament circuits contribute to the filament current of the 3LF4, an additional shunt resistor between pins 1 and 8 will be required.

†For parallel operation, connect pins 1 and 8 to the positive of the voltage supply and pin 7 to the negative.

δUse of a peak signal voltage equal to the bias voltage gives power output of 400 Mw. at 10% distortion and 500 Mw. at 10% distortion for the parallel connection.

# 3Q4 Sylvania Type

## BEAM POWER AMPLIFIER



7BA-0-0

## PHYSICAL SPECIFICATIONS

Base.....	Miniature Button 7 Pin
Bulb.....	T-5 1/2
Maximum Overall Length.....	2 1/8"
Maximum Seated Height.....	1 7/8"
Mounting Position.....	Any

## RATINGS

	Parallel	Series
Filament Voltage	1.6	3.2 Volts
Dry Battery Operation Must Never Exceed.....	1.3	2.6 Volts
AC-DC Power Line Operation Design Center.....	90	90 Volts
Maximum Plate Voltage.....	90	90 Volts
Maximum Screen Voltage.....	12	6 Ma.
Maximum Cathode Current (Zero Signal)*.....		

\*When series filament connections are used a shunting resistor should be used across the negative filament section (pins 1 and 5) to limit cathode current to the value specified. If other tubes in a series filament string contribute to the filament current of the 3Q4, another resistor should be connected between pins 1 and 7 so chosen to carry any excess current over ratings.

## TYPICAL OPERATION CLASS A<sub>1</sub> AMPLIFIER

	Parallel Filament		Series Filament
Filament Voltage DC.....	1.4	1.4	2.8 Volts
Filament Current.....	100	100	50 Ma.
Plate Voltage.....	85	90	90 Volts
Screen Voltage.....	85	90	90 Volts
Grid Voltage.....	-5.0	-4.5	-4.5 Volts
Peak Signal Voltage.....	5.0	4.5	4.5 Volts
Zero Signal Plate Current.....	6.9	9.5	7.7 Ma.
Zero Signal Screen Current.....	1.5	2.1	1.7 Ma.
Plate Resistance (Approximate).....	0.12	0.10	0.12 Megohm
Mutual Conductance.....	1975	2150	2000 μmhos
Load Resistance.....	10000	10000	10000 Ohms
Total Harmonic Distortion.....	10	7	7 PerCent
Maximum Signal Power Output.....	0.25	0.27	0.24 Watt





7AP-0-0



## Sylvania Type 3Q5

BEAM POWER AMPLIFIER

### PHYSICAL SPECIFICATIONS

Base.....	Intermediate Octal 7 Pin
Bulb.....	T-9
Maximum Overall Length.....	3 $\frac{1}{8}$ "
Maximum Seated Height.....	2 $\frac{3}{4}$ "
Mounting Position.....	Any

### RATINGS

Maximum Filament Voltage.....	Series	Parallel
Dry Battery Operation Must Never Exceed.....	3.2	1.6 Volts
AC-DC Power Line Operation Design Center.....	2.6	1.3 Volts

### TYPICAL OPERATION

Filament Voltage DC.....	Series Filament	Parallel Filament
Filament Current.....	2.8	1.4 Volts
	50	100 Ma.

For other rating and operating data refer to Sylvania Lock-In type 3LF4.

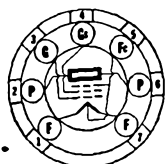

7BA-0-0

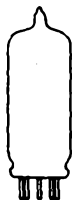

## Sylvania Type 3S4

PENTODE POWER AMPLIFIER

### PHYSICAL SPECIFICATIONS

Base.....	Miniature Button 7-Pin
Bulb.....	T5 $\frac{1}{2}$
Maximum Overall Length.....	2 $\frac{1}{8}$ "
Maximum Seated Height.....	1 $\frac{7}{8}$ "
Mounting Position.....	Any

### RATINGS

Maximum Filament Voltage.....	Parallel†	Series
Design Center for AC-DC Operation.....	1.6	3.2 Volts
Maximum Plate Voltage.....	1.3	2.6 Volts
Maximum Screen Voltage.....	90	90 Volts
Maximum Cathode Current.....	67.5	67.5 Volts
	12.0	6.0* Ma.

†For parallel filament operation, tie pins 1 and 7. Negative end of filament connected to pin No. 5.

\*A shunting resistor across negative filament section, pins 1 and 5, is necessary to limit cathode current to value given.

### TYPICAL OPERATION

#### AMPLIFIER CLASS A<sub>1</sub>

	Parallel Filament		Series Filament	
Filament Voltage DC.....	1.4	1.4	2.8	2.8 Volts
Filament Current.....	100	100	50	50 Ma.
Plate Voltage.....	67.5	90	67.5	90 Volts
Screen Voltage.....	67.5	67.5	67.5	67.5 Volts
Grid Voltage.....	-7	-7	-7	-7 Volts
Peak A-F Grid Voltage.....	7	7	7	7 Volts
Zero Signal Plate Current.....	7.2	7.4	6.0	6.1 Ma.
Zero Signal Screen Current.....	1.5	1.4	1.2	1.1 Ma.
Mutual Conductance.....	1550	1575	1400	1425 $\mu$ mhos
Plate Resistance (Approx.).....	0.1	0.1	0.1	0.1 Megohm
Load Resistance.....	5000	8000	5000	8000 Ohms
Total Harmonic Distortion.....	10	12	12	13 Per Cent
Maximum Signal Power Output.....	180	270	160	235 Milliwatts

# 3S4 (Cont'd)

## APPLICATION

Sylvania Type 3S4 is a power amplifier pentode of miniature construction and is very similar to type 1S4 but designed for operation at either 1.4 volts or 2.8 volts. It is particularly suitable as an output tube in compact, light weight, portable equipment which may be operated on batteries or AC-DC power lines. The high operating efficiency allows the tube to be used with light weight low B supply voltages. Circuit applications are similar to those for Sylvania Types 1LB4 and 3Q5GT.

# 3V4 Sylvania Type

PENTODE POWER AMPLIFIER

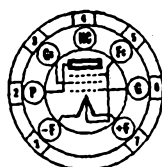

6BX-0-0

## PHYSICAL SPECIFICATIONS

Base.....	Miniature Button 7 Pin
Bulb.....	T-5 1/2
Maximum Overall Length.....	2 1/4"
Maximum Seated Height.....	1 1/8"
Mounting Position.....	Any

Note: With the exception of the base diagram given above the characteristics of type 3V4 are identical with those of type 3Q4 given on a previous page.

# 5AX4<sup>GT</sup> Sylvania Type

FULL WAVE RECTIFIER



5T-0-0

## PHYSICAL SPECIFICATIONS

Base.....	Intermediate Octal 5-Pin
Bulb.....	T-9
Maximum Overall Length.....	3 3/4"
Maximum Seated Height.....	2 13/16"
Mounting Position	
Vertical.....	Base up or down
Horizontal.....	Pins 6 and 8 in vertical plane

## RATINGS

Filament Voltage AC or DC.....	5.0 Volts
Filament Current.....	2.5 Amperes
Maximum AC Plate Supply Voltage per Plate	
Capacitor Input.....	350 Volts
Choke Input.....	500 Volts
Maximum Peak Inverse Plate Voltage.....	1400 Volts
Maximum Peak Plate Current per Plate	
Steady State.....	525 Ma.
Transient.....	3.5 Amperes
Maximum DC Output Current.....	175 Ma.

## TYPICAL OPERATION

### FULL WAVE RECTIFIER

	Capacitor	Choke
Input to Filter		
Filament Voltage.....	5.0	5.0 Volts
AC Plate Supply Voltage per Plate.....	350	500 Volts
Filter Input Capacitance.....	10	μf.
Filter Input Inductance.....		10 Henries
Effective Plate Supply Impedance per Plate.....	50	Ohms
DC Output Current.....	175	175 Ma.
DC Output Voltage.....	330	375 Volts
Tube Voltage Drop, with 175 Ma. DC Plate Current per Plate.....		65 Volts

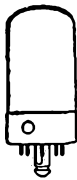

# Sylvania Type 5AZ4

FULL-WAVE RECTIFIER

## 5T-L-0 PHYSICAL SPECIFICATIONS

Base.....	Lock-In 8 Pin
Bulb.....	T-9
Maximum Overall Length.....	3 $\frac{5}{8}$ "
Maximum Seated Height.....	2 $\frac{3}{8}$ "
Mounting Position.....	Vertical†

†Horizontal operation permitted if pins 6 and 8 are in vertical plane.

## RATINGS

Filament Voltage AC.....	5.0 Volts
Filament Current.....	2.0 Amperes
Maximum Peak Inverse Voltage.....	1400 Volts
Maximum Steady State Peak Current Per Plate.....	400 Ma.
Maximum Transient Peak Current Per Plate.....	2.2 Amperes
Average Tube Voltage Drop at 125 Ma. Per Plate.....	60. Volts

The maximum values of plate supply voltage and output current are inter-related as well as dependent upon whether choke or condenser input is used. Intermediate values may be determined from the following table:

	Condenser Input			Choke Input	
AC Input Per Plate (RMS)	500	350	70	500	350 Volts
Output Current	85	125	150	125	150 Ma.

## TYPICAL OPERATION

	Filter Circuit	
	Choke Input	Condenser Input
Filament Voltage AC.....	5.0	5.0 Volts
Filament Current.....	2.0	2.0 Amperes
AC Plate Voltage Per Plate (RMS).....	500	350 Volts
DC Output Current.....	125	125 Ma.
Minimum Plate Supply Impedance Per Plate.....		50 Ohms
Input Choke.....	10	... Henrys

## APPLICATION

Sylvania Type 5AZ4 is a lock-in full-wave filament type rectifier having the same ratings as Type 5Y3GT. Reference should be made to this type for the load curve under typical operating conditions.

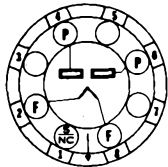

5T-0-0

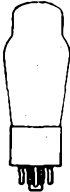

# Sylvania Type 5R4<sup>GY</sup>

FULL WAVE RECTIFIER

## PHYSICAL SPECIFICATIONS

Base.....	Medium Octal 5-Pin
Bulb.....	ST-16
Maximum Overall Length.....	5 $\frac{5}{16}$ "
Maximum Seated Height.....	4 $\frac{1}{4}$ "
Mounting Position*.....	Vertical

\*Horizontal operation if pins 1 and 4 are in a vertical plane.

## RATINGS

Filament Voltage AC or DC.....	5.0 Volts
Filament Current.....	2.0 Amperes
Maximum Peak Inverse Voltage (No-Load Conditions).....	2800 Volts
Maximum Peak Plate Current.....	.650 Ma.

## TYPICAL OPERATION

### WITH CONDENSER-INPUT FILTER

AC Plate Voltage per Plate (RMS)	
Full Load.....	900 Volts
No Load.....	1000 Volts
Total Effective Plate-Supply Impedance per Plate**.....	575 Ohms
DC Output Current (Maximum).....	150 Ma.

\*\*For input condenser larger than 4  $\mu$ f. a larger plate-supply impedance may be necessary to limit peak plate current to the rated value.

### WITH CHOKE-INPUT FILTER

AC Plate Voltage per Plate (RMS)	
Full Load.....	950 Volts
No Load.....	1000 Volts
Input-Choke Inductance (Minimum).....	10 Henrys
DC Output Current (Maximum).....	175 Ma.

## APPLICATION

Sylvania Type 5R4GY is a full wave rectifier of the coated filament type. Operating conditions given above apply for use at altitudes up to 20,000 feet.

# 5U4G Sylvania Type

FULL-WAVE RECTIFIER

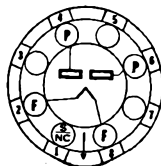

5T-0-0

## PHYSICAL SPECIFICATIONS

Base.....	Medium Octal 5-Pin
Bulb.....	ST-16
Maximum Overall Length.....	5 5/8"
Maximum Seated Height.....	4 3/4"
Mounting Position.....	Vertical†

†Horizontal operation permitted if pins 1 and 4 are in vertical plane.

## RATINGS

Filament Voltage (AC).....	5.0 Volts
Filament Current.....	3.0 Amperes
Peak Inverse Voltage.....	1550 Volts
Tube Drop at 225 Ma. per Plate.....	58 Volts
Peak Plate Current (Per Plate).....	675 Ma.

## TYPICAL OPERATION

	Choke Input*	Condenser Input*
RMS Voltage Per Plate.....	550	450 Volts
DC Output Current (Maximum).....	225	225 Ma.
Plate Supply Impedance (Minimum).....		75 Ohms
Input Choke (Minimum).....	3	... Henrys

\*Filter Circuit.

## APPLICATION

Sylvania Type 5U4G is a high vacuum full-wave rectifier tube designed for heavier duty service than Type 5Y3G. Choke input filter arrangements are preferred for use with this tube, although somewhat higher plate supply voltages will be required to obtain the same output voltage obtained with condenser input filter circuits, but peak currents are reduced and voltage regulation is greatly improved under variable loads. Type 5U4G is identical to the older Type 5Z3 except for basing.

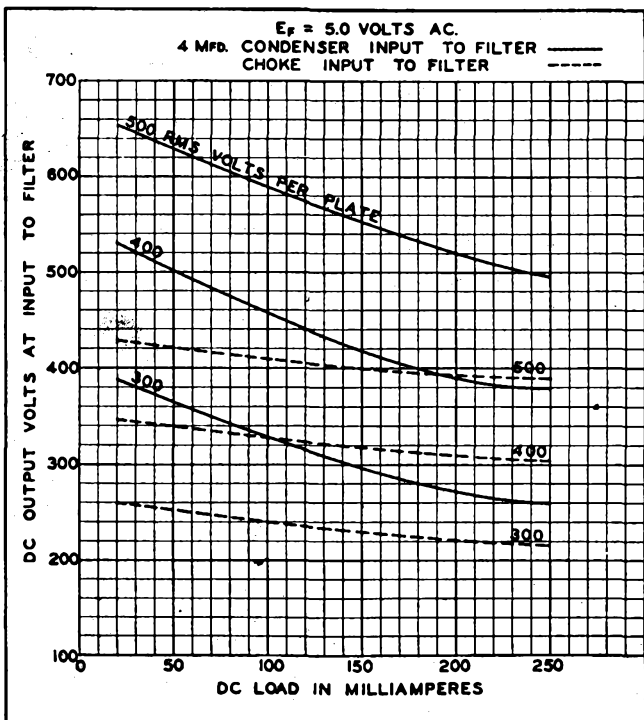



5L-0-0



# Sylvania Type 5V4G

FULL-WAVE RECTIFIER

## PHYSICAL SPECIFICATIONS

Base.....	Medium Octal 5-Pin
Bulb.....	ST-14
Maximum Overall Length.....	4 5/8"
Maximum Seated Height.....	4 1/4"
Mounting Position.....	Any

## RATINGS

AC Heater Voltage.....	5.0 Volts
Heater Current.....	2.0 Amperes
Peak Inverse Voltage.....	1400 Volts
Tube Voltage Drop at 175 Ma. Per Plate.....	25 Volts
Peak Plate Current (Per Plate).....	525 Ma.

## TYPICAL OPERATION

### CONDENSER INPUT TO FILTER

AC Voltage per Plate (RMS).....	375 Volts Max.
DC Output Current.....	175 Ma. Max.
Plate Supply Impedance per Plate.....	100 Ohms Min.

### CHOKE INPUT TO FILTER

AC Voltage per Plate.....	500 Volts Max.
DC Output Current.....	175 Ma. Max.
Input Choke Value.....	4.0 Henrys Min.

## APPLICATION

Sylvania 5V4G is a cathode type high vacuum rectifier designed for full-wave applications. This glass tube is identical to Type 83V except that it is equipped with an octal base. It is important to note that the base of this rectifier may contain all eight pins, although only four of these are connected. Sockets designed for Type 5V4G must accommodate the eight pin base. The cathode is connected internally to the heater, similar to the 83V construction.

The filament voltage should be held close to its rated value of 5 volts. Since the filament current is rather high it is necessary to employ wire of the proper current carrying capacity.

The performance of the 5V4G is quite similar to that of any other high vacuum rectifier. Conventional filter circuits, either of the condenser-input or choke-input type, are applicable but care must be exercised so as not to exceed the recommended maximum values of plate voltage and output current. Choke-input filters will reduce the peak plate current and afford improved voltage regulation, although there will be a sacrifice in d-c output voltage.

# 5V4G (Cont.)

TYPES 5V4G, 83V

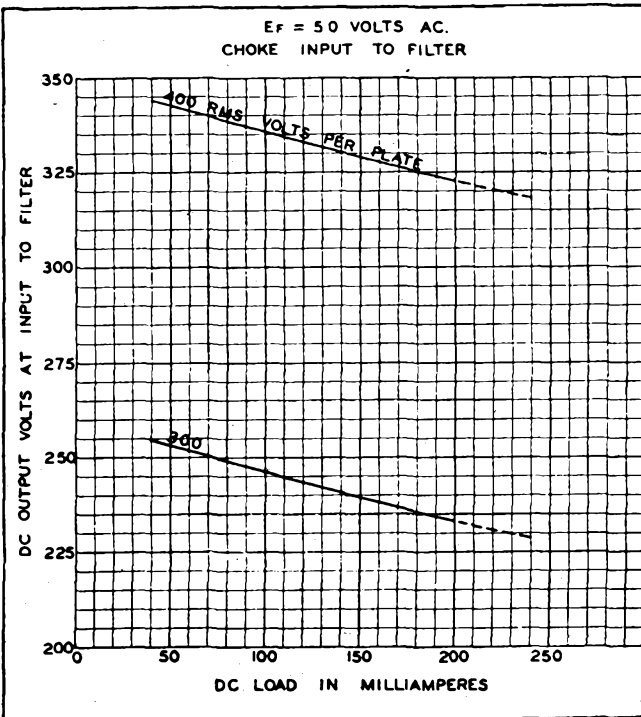
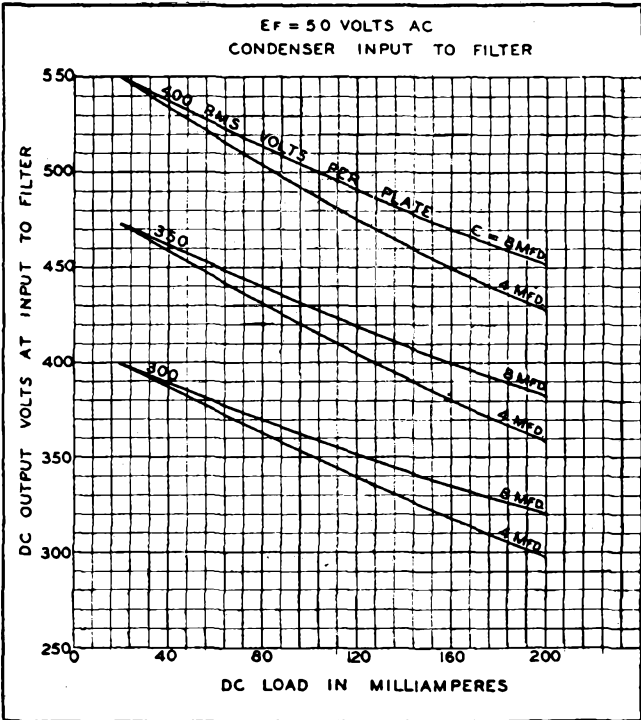



5T-1-0 (5W4)  
5T-0-0 (5W4GT)

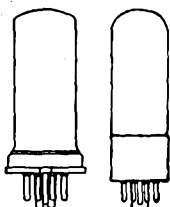

## Sylvania Type 5W4<sup>GT</sup>

FULL-WAVE RECTIFIER

### PHYSICAL SPECIFICATIONS

	5W4	5W4GT
Base.....	Small Wafer Octal 5-Pin	Medium Octal 5-Pin
Bulb.....	Metal 8-6	T-9
Maximum Overall Length.....	3 1/4"	3 3/8"
Maximum Seated Height.....	2 11/16"	2 13/16"
Mounting Position.....	Any	Any

### RATINGS

Filament Voltage AC.....	5.0 Volts
Filament Current.....	1.5 Amperes
Maximum Peak Inverse Voltage.....	1100 Volts
Tube Voltage Drop at 110 Ma. per Plate.....	50 Volts
Maximum Peak Plate Current (Per Plate).....	300 Ma.

### TYPICAL OPERATION

Filament Voltage AC.....	5.0 Volts
Filament Current.....	1.5 Amperes
RMS Voltage Per Plate.....	350 Volts
DC Output Current.....	100 Ma.
Minimum Plate Supply Impedance.....	50 Ohms

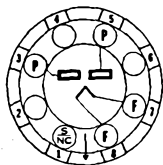

5Q-0-0



## Sylvania Type 5X4G

FULL-WAVE RECTIFIER

### PHYSICAL SPECIFICATIONS

Base.....	Medium Octal 8-Pin
Bulb.....	ST-16
Maximum Overall Length.....	5 5/8"
Maximum Seated Height.....	4 3/4"
Mounting Position.....	Vertical†

†Horizontal operation permitted if pins 1 and 4 are in a vertical plane.

For operation data, and curves refer to corresponding Type 5U4G which is identical except for basing.

# Sylvania Type 5Y3GT

# Sylvania Type 5Y4G

FULL-WAVE RECTIFIER

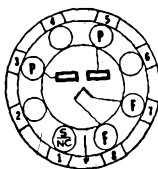

5Q-0-0  
5Y4G

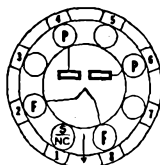

5T-0-0  
5Y3GT

## PHYSICAL SPECIFICATIONS

	5Y3GT	5Y4G
Base.....	Intermediate Octal 5-Pin	Medium Octal 8-Pin
Bulb.....	T-9	ST-14
Maximum Overall Length.....	3 3/8"	4 5/8"
Maximum Seated Height.....	2 1/16"	4 1/16"
Mounting Position.....	Vertical*	Vertical†

\*Horizontal operation permitted if Pins 2 and 4 are in a vertical plane.

†Horizontal operation permitted if Pins 1 and 4 are in a vertical plane.

## RATINGS

Filament Voltage AC.....	5.0 Volts
Filament Current.....	2.0 Amperes
Maximum Peak Inverse Voltage.....	1400 Volts
Maximum Steady State Peak Current per Plate.....	375 Ma.
Maximum Transient Peak Current per Plate.....	2.2 Amperes
Average Tube Voltage Drop at 125 Ma. per Plate.....	60 Volts

The maximum values of plate supply voltage and output current are inter-related as well as dependent upon whether choke or condenser input is used. Intermediate values may be determined from the following table:

	Condenser Input			Choke Input	
AC Input per Plate (RMS).....	500	350	70	500	350 Volts
Output Current.....	85	125	150	125	150 Ma.

## TYPICAL OPERATION

	Filter Circuit	
	Choke Input	Condenser Input
Filament Voltage AC.....	5.0	5.0 Volts
Filament Current.....	2.0	2.0 Amperes
AC Plate Voltage per Plate (RMS).....	500	350 Volts
DC Output Current.....	125	125 Ma.
Minimum Plate Supply Impedance per Plate.....	50 Ohms	50 Ohms
Input Choke.....	10	... Henrys

## APPLICATION

Sylvania Types 5Y3GT and 5Y4G are full-wave vacuum type rectifiers similar to Type 80 and are used for supplying direct current power from an a-c power supply line.

The filament employed in these types is of the oxide coated type. This filament is operated on alternating current from a five volt winding on the power transformer. The filament voltage should be held close to its rated value of 5 volts. Since the filament current is rather high (2.0 amperes) it is necessary to employ wire of the proper current carrying capacity. It is unnecessary to provide the filament winding with a center tap for most applications.

(Curves are shown on the following page).



(Cont.) 5Y3<sup>GT</sup>

(Cont.) 5Y4G

TYPES 5Y3G, 5Y4G, 80

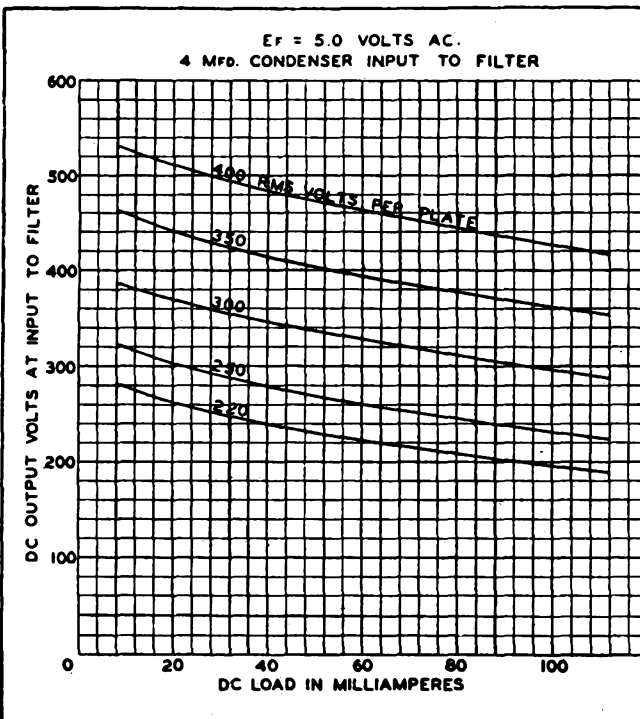
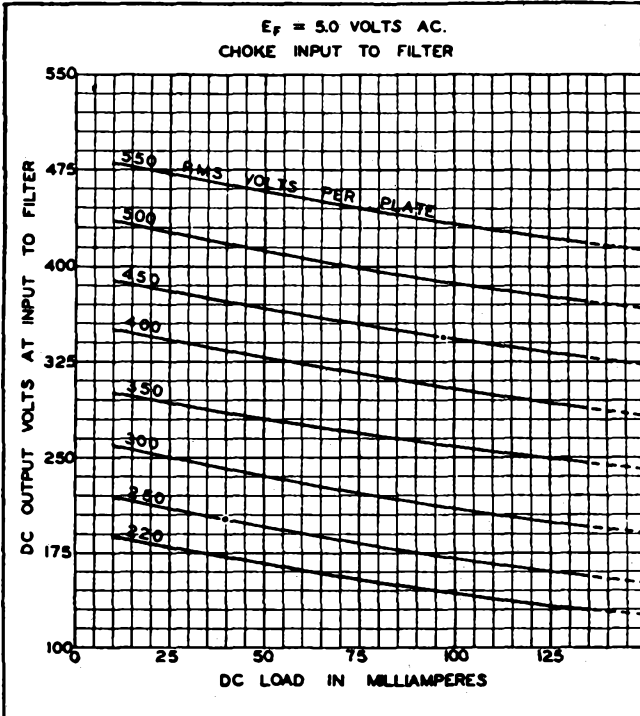

SYLVANIA RADIO TUBES

# 5Z3 Sylvania Type

FULL-WAVE RECTIFIER



4C-0-0

## PHYSICAL SPECIFICATIONS

Base.....	Medium 4-Pin
Bulb.....	ST16
Maximum Overall Length.....	5 3/8"
Maximum Seated Height.....	4 3/4"
Mounting Position.....	Vertical†

†Horizontal operation permitted if pins 1 and 2 are in a vertical plane.

For further data on this type, refer to corresponding Type 5U4G, which is identical except for basing.

# 5Z4<sup>GT</sup> Sylvania Type

FULL-WAVE RECTIFIER

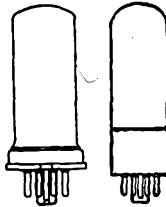

5L-1-0 (5Z4)  
5L-0-0 (5Z4GT)

## PHYSICAL SPECIFICATIONS

	5Z4	5Z4GT
Base.....	Small Wafer Octal 5 Pin	Intermediate Octal 5 Pin
Bulb.....	Metal 8-6	T9
Maximum Overall Length.....	3 1/4"	3 3/8"
Maximum Seated Height.....	2 11/16"	2 13/16"
Mounting Position.....	Any	Any

## RATINGS

Heater Voltage.....	5.0 Volts
Heater Current.....	2.0 Ampere
Peak Inverse Voltage.....	1400 Volts
Peak Plate Current per Plate.....	375 Ma.
Tube Drop at 125 Ma. per Plate.....	20 Volts

## TYPICAL OPERATION

	Choke Input	Condenser Input
Heater Voltage.....	5.0	5.0 Volts
Heater Current.....	2.0	2.0 Ampere
RMS Voltage Per Plate.....	500	350 Volts
DC Output Current.....	125	125 Ma.
Minimum Plate Supply Impedance Per Plate.....	5.0	50 Ohms
Minimum Input Choke.....		Henrys

# 6A5G Sylvania Type

POWER AMPLIFIER TRIODE

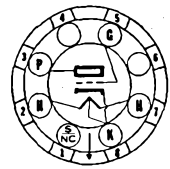

6T-0-0

## PHYSICAL SPECIFICATIONS

Base.....	Medium Octal 8 Pin
Bulb.....	ST16
Maximum Overall Length.....	5 3/8"
Maximum Seated Height.....	4 3/4"
Mounting Position.....	Any

**RATINGS**

Heater Voltage.....	6.3 Volts
Heater Current.....	1.25 Amperes
Maximum Plate Voltage.....	325 Volts
Maximum Plate Dissipation.....	15 Watts

**Direct Interelectrode Capacitances:\***

Grid to Plate.....	16 $\mu$ f.
Input.....	7 $\mu$ f.
Output.....	5 $\mu$ f.

\*Unshielded.

**TPYICAL OPERATION as Amplifier**

	Class A One Tube	Push-Pull Class AB <sub>1</sub> Two Tubes	
		Fixed Bias	Self Bias
Heater Voltage.....	6.3	6.3	6.3 Volts
Heater Current.....	1.25	1.25	1.25 Amperes
Plate Voltage.....	250	325	325 Volts
Grid Voltage.....	-45	-68	Volts
Self-Bias Resistor.....	750	..	850 Ohms
Plate Current (Per Tube).....	60	40	40 Ma.
Plate Resistance.....	800	..	Ohms
Mutual Conductance.....	5250	..	$\mu$ mhos
Amplification Factor.....	4.2	..	..
Load Resistance (Total).....	2500	3000	5000 Ohms
Power Output.....	3.75	15.	10 Watts
Harmonic Distortion.....	5.0	2.5	5.0 Per Cent

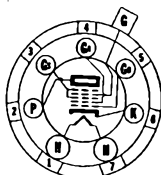

7C-0-0

**Sylvania Type 6A7****HEPTODE CONVERTER****PHYSICAL SPECIFICATIONS**

Base.....	Small 7 Pin
Bulb.....	ST12
Cap.....	Small Metal
Maximum Overall Length.....	4 $\frac{17}{32}$ "
Maximum Seated Height.....	3 $\frac{29}{32}$ "
Mounting Position.....	Any

**RATINGS**

Heater Voltage AC or DC.....	6.3 Volts
Heater Current.....	300 Ma.
Maximum Plate Voltage.....	300 Volts
Maximum Screen Voltage.....	100 Volts
Maximum Screen Supply.....	300 Volts
Maximum Anode-Grid Supply.....	300 Volts
Maximum Anode-Grid Voltage.....	200 Volts
Maximum Plate Dissipation.....	1.0 Watt
Maximum Screen Dissipation.....	0.3 Watt
Maximum Anode-Grid Dissipation.....	0.75 Watt
Maximum Cathode Current.....	14 Ma.
Maximum Heater-Cathode Voltage.....	90 Volts

For typical operating conditions see Type 6A8G.

# 6A8G/GT Sylvania Type

HEPTODE CONVERTERS

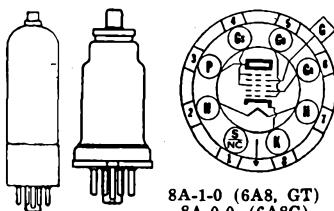

8A-1-0 (6A8, GT)  
8A-0-0 (6A8G)

## PHYSICAL SPECIFICATIONS

	6A8	6A8G	6A8GT
Base.....	Small Wafer	Small	Small Wafer
Bulb.....	Octal 8 Pin	Octal 8 Pin	Octal 8 Pin
Cap.....	Metal 8-4	ST12	Metal Sleeve
Maximum Overall Length.....	Miniature	Miniature	T9
Maximum Seated Height.....	3 1/8"	4 1/2"	Miniature
Mounting Position.....	2 3/8"	3 3/4"	3 1/8"
	Any	Any	2 3/4"
			Any

## TYPICAL OPERATION

Heater Voltage.....	6.3	6.3 Volts
Heater Current.....	300	300 Ma.
Plate Voltage.....	100	250 Volts
Signal Grid Voltage.....	-1.5	-3.0 Volts
Screen Voltage.....	50	100 Volts
Anode-Grid Voltage.....	100	250* Volts
Oscillator Grid Resistance.....	50,000	50,000 Ohms
Plate Current.....	1.1	3.5 Ma.
Screen Current.....	1.3	2.7 Ma.
Anode-Grid Current.....	2.0	4.0 Ma.
Oscillator Grid Current.....	0.25	0.4 Ma.
Self-Bias Resistor.....	300	300 Ohms
Plate Resistance.....	0.5	0.3 Megohm
Conversion Conductance.....	360	550 μmhos
Conversion Conductance at		
Signal Grid Bias of -20 (Approx.).....	3	..... μmhos
Signal Grid Bias of -35 (Approx.).....		6 μmhos

\*Through a 20,000 ohm resistor.  
For ratings, refer to Type 6A7. Other data will be found under Lock-In Type 7B8 which is nearly identical in electrical characteristics.

# 6AB4 Sylvania Type

RF TRIODE

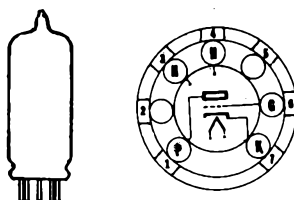

5CE-0-2

## PHYSICAL SPECIFICATIONS

Base.....	Miniature Button 7-Pin
Bulb.....	T-5 1/2
Maximum Overall Length.....	2 1/2"
Maximum Seated Height.....	1 1/8"
Mounting Position.....	Any

## RATINGS

Heater Voltage AC or DC.....	6.3 Volts
Maximum Plate Voltage.....	300 Volts
Maximum Plate Dissipation.....	2.5 Watts
Maximum Heater-Cathode Voltage.....	90 Volts
Maximum Negative Control DC Grid Voltage.....	-50 Volts

Direct Interelectrode Capacitances:

	Shielded*	Unshielded
Grid to Plate.....	1.5	1.5 μf.
Input.....	2.4	2.2 μf.
Output.....	1.4	0.50 μf.
(Grounded Grid Operation)		
Plate to Cathode.....	0.20	0.24 μf.
Input.....	5.2	5.0 μf.
Output.....	2.6	1.7 μf.

\*RMA standard shield No. 316.

It is recommended that pin number 2 be grounded.

SYLVANIA RADIO TUBES

**TYPICAL OPERATION****CLASS A<sub>1</sub> AMPLIFIER**

Heater Voltage AC or DC.....	6.3	6.3 Volts
Heater Current.....	150	150 Ma.
Plate Voltage.....	100	250 Volts
Cathode Resistor.....	270	200 Ohms
Plate Current.....	3.7	10 Ma.
Plate Resistance.....	15,000	10,900 Ohms
Mutual Conductance.....	4,000	5,500 $\mu$ mhos
Amplification Factor.....	60	60
Control Grid Voltage (approx.) for $I_b = 10 \mu$ a.....	-5	-12 Volts

**APPLICATION**

Sylvania Type 6AB4 is a miniature triode to be used as a ground-grid rf amplifier, frequency converter or oscillator at frequencies below 300 megacycles.

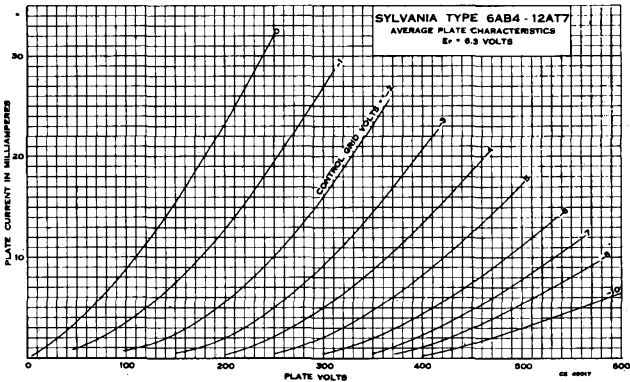

6Q-0-0

**6AC5<sup>GT</sup> Sylvania Type****HIGH-MU POWER AMPLIFIER****TRIODE****PHYSICAL SPECIFICATIONS**

Base.....	Intermediate Octal 6 Pin
Bulb.....	T9
Maximum Overall Length.....	3 $\frac{5}{16}$ "
Maximum Seated Height.....	2 $\frac{3}{4}$ "
Mounting Position.....	Any

**RATINGS**

Maximum Plate Supply Voltage.....	250 Volts
Maximum Plate Dissipation.....	10 Watts
Maximum Heater-Cathode Voltage.....	90 Volts
Maximum Peak Plate Current per Tube.....	110 Ma.

**TYPICAL OPERATION FOR TWO TUBES:**

Heater Voltage.....	6.3 Volts
Heater Current.....	0.4 Ampere
Plate Voltage.....	250 Volts
Grid Voltage.....	0 Volt
Peak Input Signal (Grid to Grid).....	70 Volts
DC Plate Current (Zero Signal).....	5 Ma.
Load Resistance (Plate to Plate).....	10000 Ohms
Power Output†.....	8 Watts

†With peak input of 950 milliwatts to grids.

# 6AC7/1852 Sylvania Type

TELEVISION AMPLIFIER PENTODE

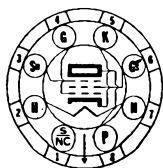
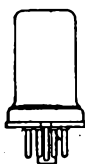

8N-1-1

## PHYSICAL SPECIFICATIONS

Base.....	Small Wafer Octal 8 Pin
Bulb.....	Metal 8-1
Maximum Overall Length.....	2 3/8"
Maximum Seated Height.....	2 1/16"
Mounting Position.....	Any

## RATINGS

Heater Voltage.....	6.3 Volts
Heater Current.....	0.450 Ampere
Maximum Plate Voltage.....	300 Volts
Maximum Screen Supply Voltage.....	300 Volts
Maximum Screen Voltage.....	150 Volts
Maximum Plate Dissipation.....	3.02 Watts
Maximum Screen Dissipation.....	0.38 Watt
Maximum Grid Resistor*	
Self Bias Fixed Screen Voltage.....	0.25 Megohm
Self Bias Series Screen Resistor.....	0.50 Megohm
Self-Bias Resistor (Minimum).....	160 Ohms
Maximum Heater-Cathode Voltage.....	90 Volts

\*For maximum voltage conditions.

### Direct Interelectrode Capacitances: †

Grid to Plate.....	0.015 $\mu$ f. Max.
Input.....	11 $\mu$ f.
Output.....	5 $\mu$ f.

†With shell connected to cathode.

## TYPICAL OPERATION CLASS A<sub>1</sub>

Heater Voltage.....	6.3	6.3 Volts
Heater Current.....	0.450	0.450 Ampere
Plate Voltage.....	300	300 Volts
Screen Supply Voltage.....	150	300 Volts
Screen Resistor.....		60000 Ohms
Suppressor Grid Voltage.....	0	0 Volts
Self-Bias Resistor.....	160	160 Ohms
Plate Current.....	10	10 Ma.
Screen Current.....	2.5	2.5 Ma.
Mutual Conductance.....	9000	9000 $\mu$ mhos
Plate Resistance (Approximate).....	1.0	1.0 Megohm

# 6AD4 Sylvania Type

HIGH MU TRIODE

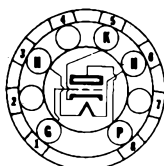

8DK-0-0

## PHYSICAL SPECIFICATIONS

Base.....	Flexible Leads
Bulb.....	T-3
Maximum Overall Bulb Length.....	1 3/8"
Minimum Lead Length.....	1 1/2"
Mounting Position.....	Any

## RATINGS

Heater Voltage AC or DC.....	6.3 Volts
Maximum Plate Voltage.....	150 Volts
Maximum Plate Dissipation.....	0.3 Watt
Maximum Heater-Cathode Voltage.....	90 Volts
Maximum Cathode Current.....	2 Ma.
Maximum Control Grid Circuit Resistance (cathode bias).....	1 Megohm

### Direct Interelectrode Capacitances:

	Unshielded	Shielded*
Grid to Plate.....	0.80	0.70 $\mu$ f.
Input.....	1.70	1.90 $\mu$ f.
Output.....	0.70	2.20 $\mu$ f.

\*External shield of 0.405" diameter connected to cathode.

### TYPICAL OPERATION CLASS A<sub>1</sub> AMPLIFIER

Heater Voltage.....	6.3 Volts
Heater Current.....	150 Ma.
Plate Voltage.....	100 Volts
Cathode Bias Resistor.....	820 Ohms
Plate Current.....	1.4 Ma.
Mutual Conductance.....	2000 $\mu$ mhos
Amplification Factor.....	70
Plate Resistance.....	35,000 Ohms
Control Grid Voltage for $I_b = 10 \mu$ a.....	-3.0 Volts

For use in resistance coupled circuits, see data in appendix.

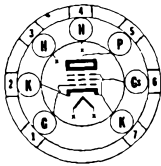

7BD-0-2 & 7



### Sylvania Type **6AG5**

SHARP CUT-OFF RF PENTODE

### PHYSICAL SPECIFICATIONS

Base.....	Miniature Button 7 Pin
Bulb.....	T-5 $\frac{1}{2}$
Maximum Overall Length.....	2 $\frac{1}{8}$ "
Maximum Seated Height.....	1 $\frac{1}{8}$ "
Mounting Position.....	Any

### RATINGS

Heater Voltage AC or DC.....	6.3 Volts
Heater Current.....	300 Ma.
Maximum Plate Voltage.....	300 Volts
Maximum Screen Voltage.....	150 Volts
Maximum Plate Dissipation.....	2 Watts
Maximum Screen Dissipation.....	0.5 Watt
Maximum Heater-Cathode Voltage.....	90 Volts
<b>Direct Interelectrode Capacitances: (Without External Shield)</b>	
Grid to Plate.....	0.025 $\mu$ mf. Max.
Input.....	6.5 $\mu$ mf.
Output.....	1.8 $\mu$ mf.

### TYPICAL OPERATION CLASS A<sub>1</sub> AMPLIFIER PENTODE CONNECTION

Heater Voltage.....	6.3	6.3	6.3 Volts
Heater Current.....	300	300	300 Ma.
Plate Voltage.....	100	125	250 Volts
Screen Voltage.....	100	125	150 Volts
Self-Bias Resistor.....	100	100	200 Ohms
Plate Current.....	5.5	7.2	7.0 Ma.
Screen Current.....	1.6	2.1	2.0 Ma.
Grid Bias for 10 $\mu$ a Plate Current.....	-5.0	-6.0	-8.0 Volts
Plate Resistance (Approx.).....	0.3	0.5	0.8 Megohm
Transconductance.....	4750	5100	5000 $\mu$ mhos

### TRIODE CONNECTION

Heater Voltage.....	6.3	6.3 Volts
Heater Current.....	300	300 Ma.
Plate Voltage.....	180	250 Volts
Self-Bias Resistor.....	350	825 Ohms
Plate Current.....	7.0	5.5 Ma.
Plate Resistance.....	7900	11,000 Ohms
Amplification Factor.....	45	42
Transconductance.....	5700	3800 $\mu$ mhos

### APPLICATION

Sylvania Type 6AG5 is a sharp cut-off pentode of miniature construction having high mutual conductance. It is useful as a RF amplifier for frequencies up to 400 megacycles. Input and output capacitances are low and the dual cathode leads aid in preventing degeneration, by providing the means for cathode return isolation.

# 6AG5 (Cont.)

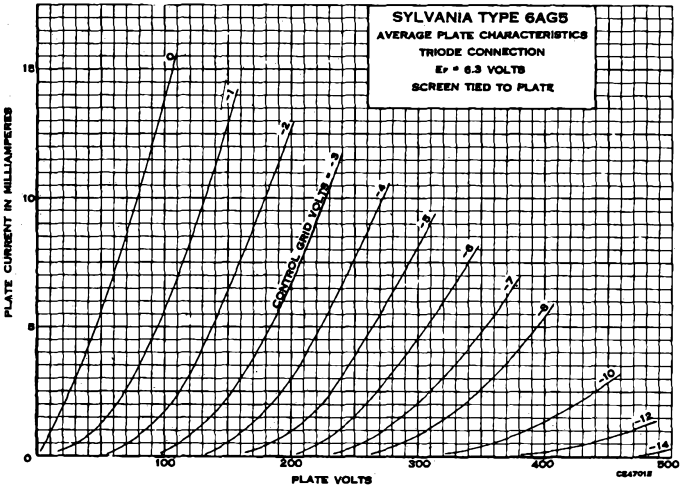
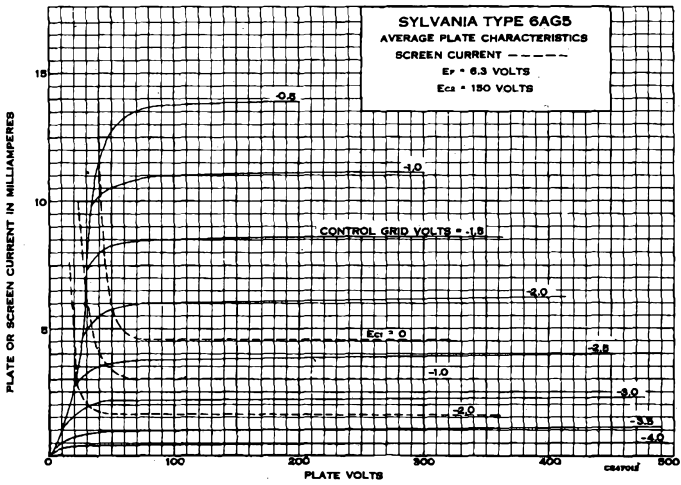



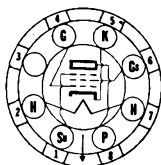

8Y-1-3

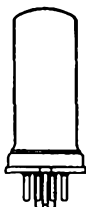

# Sylvania Type 6AG7

TELEVISION AMPLIFIER PENTODE

## PHYSICAL SPECIFICATIONS

Base.....	Small Wafer Octal 8 Pin
Bulb.....	Metal 8-6
Maximum Overall Length.....	3 1/4"
Maximum Seated Height.....	2 1/16"
Mounting Position.....	Vertical §

§Horizontal if plane of pins number 2 and 7 is vertical.

## RATINGS

Heater Voltage AC or DC.....	6.3 Volts
Heater Current.....	0.650 Ampere
Maximum Plate Voltage.....	300 Volts
Maximum Screen Voltage.....	300 Volts
Maximum Plate Dissipation.....	9.0 Watts
Maximum Screen Dissipation.....	1.5 Watts
Minimum External Control Grid Voltage.....	0 Volts
Maximum Heater-Cathode Voltage.....	90 Volts
<b>Direct Interelectrode Capacitances: Shell Connected to Cathode.</b>	
Grid to Plate.....	0.060 $\mu$ f. Max.
Input.....	13.0 $\mu$ f.
Output.....	7.5 $\mu$ f.

## TYPICAL OPERATION CLASS A<sub>1</sub> AMPLIFIER

Heater Voltage.....	6.3 Volts
Heater Current.....	0.650 Ampere
Plate Voltage.....	300 Volts
Screen Voltage.....	150 Volts
Control Grid Voltage*.....	3.0 Volts
Self-Bias Resistor.....	81 Ohms
Peak AF Signal Voltage.....	3.0 Volts
Plate Resistance.....	0.13 Megohm
Mutual Conductance.....	11000 $\mu$ mhos
Zero Signal Plate Current.....	30 Ma.
Maximum Signal Plate Current.....	30.5 Ma.
Zero Signal Screen Current.....	7.0 Ma.
Maximum Signal Screen Current.....	9.0 Ma.
Load Resistance.....	10000 Ohms
Power Output.....	3.0 Watts
Total Distortion.....	7.0 Per Cent

\*Maximum grid circuit resistance should not exceed 0.25 megohm if fixed bias is used, or 1.0 megohm if self-bias is used.

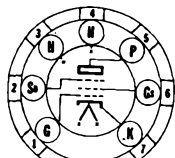

7BK-0-0



# Sylvania Type 6AH6

SHARP CUT-OFF RF PENTODE

## PHYSICAL SPECIFICATIONS

Base.....	Small Button Miniature 7 Pin
Bulb.....	T-5 1/2
Maximum Overall Length.....	2 1/8"
Maximum Seated Height.....	1 7/8"
Mounting Position.....	Any

## RATINGS

Heater Voltage AC or DC.....	6.3 Volts
Maximum Plate Voltage.....	300 Volts
Maximum Screen Voltage.....	150 Volts
Maximum Plate Dissipation.....	3.2 Watts
Maximum Screen Dissipation.....	0.4 Watts
Maximum Cathode Current.....	13.0 Ma.
Maximum Heater-Cathode Voltage.....	90 Volts

# 6AH6 (Cont'd)

## Direct Interelectrode Capacitances:\*

Grid to Plate.....	.020 $\mu$ f. Max
Input.....	10 $\mu$ f.
Output.....	3.6 $\mu$ f.

\*With  $\frac{3}{4}$ " diameter shield (RMA No. 316) connected to cathode.

## TYPICAL OPERATION

	Pentode Connection	Triode Connection
Heater Voltage AC or DC.....	6.3	6.3 Volts
Heater Current.....	450	450 Ma.
Plate Voltage.....	300	150
Screen Voltage.....	150	150
Suppressor Grid Voltage.....	tie to K	tie to P
Control Grid Voltage.....	Obtained by 160 Ohm Cathode Resistor	3600 Ohms
Plate Resistance (Approx.).....	500,000	11,000 $\mu$ mhos
Mutual Conductance.....	9,000	40
Amplification Factor.....	10	12.5 Ma.
Plate Current.....	2.5	Ma.
Screen Current.....	-7.0	-7.0 Volts
Control Grid Voltage for $I_b = 10 \mu$ a (Approx.).....		

## APPLICATION

Sylvania Type 6AH6 is a sharp cut-off pentode designed for use in television, video and I.F. circuits where wide band amplification or low impedance output is required. The triode rating is to permit its use in cathode follower circuits.

The suppressor grid is not designed to have a large enough control characteristic for practical use.

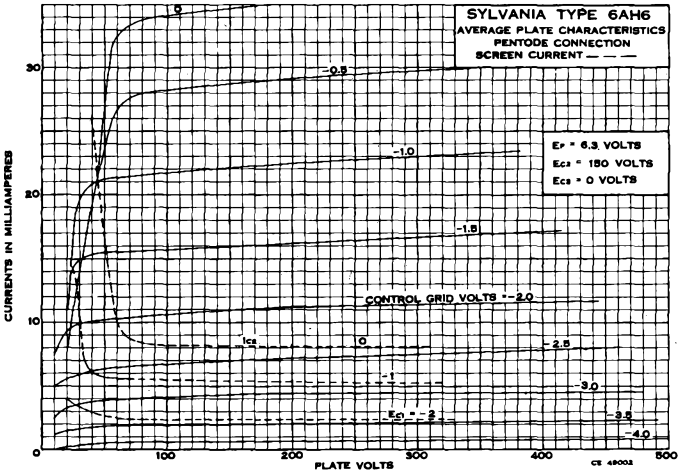

# 6AJ5 Sylvania Type

SHARP CUT-OFF PENTODE

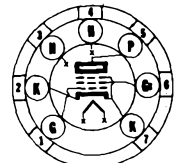

7BD-0-0

## PHYSICAL SPECIFICATIONS

Base.....	Miniature Button 7-Pin
Bulb.....	T-5 $\frac{1}{2}$
Maximum Overall Length.....	1 $\frac{3}{4}$ "
Maximum Seated Height.....	1 $\frac{1}{2}$ "
Mounting Position.....	Any

**RATINGS**

Heater Voltage AC or DC .....	6.3 Volts
Maximum Plate Voltage .....	180 Volts
Maximum Screen Supply Voltage .....	180 Volts
Maximum Plate Dissipation .....	1.7 Watts
Maximum Screen Dissipation .....	0.5 Watt
Maximum Positive Control DC Grid Voltage .....	0 Volts
Maximum Cathode Current .....	18 Ma.

**Direct Interelectrode Capacitances:**

	Shielded*	Unshielded
Grid to Plate .....	0.02	0.03 $\mu\text{f.}$
Input .....	4.0	4.0 $\mu\text{f.}$
Output .....	2.8	2.1 $\mu\text{f.}$

\*External shield connected to pins 2 and 7.

**TYPICAL OPERATION  
CLASS A<sub>1</sub> AMPLIFIER**

Heater Voltage .....	6.3 Volts
Heater Current .....	175 Ma.
Plate Voltage .....	28 Volts
Screen Grid Voltage .....	28 Volts
Control Grid Voltage .....	-1 Volt
Plate Resistance (approx.) .....	0.1 Megohm
Mutual Conductance .....	2,500 $\mu\text{mhos}$
Plate Current .....	2.7 Ma.
Screen Grid Current .....	1 Ma.
Control Grid Voltage for $I_b = 10 \mu\text{a.}$ .....	-4.5 Volts

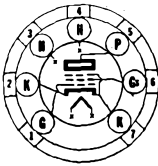

7BD-0-2 &amp; 7

**Sylvania Type 6AK5****RF AMPLIFIER PENTODE****PHYSICAL SPECIFICATIONS**

Base .....	Miniature Button 7 Pin
Bulb .....	T-5 $\frac{1}{2}$
Maximum Overall Length .....	1 $\frac{3}{8}$ "
Maximum Seated Height .....	1 $\frac{1}{2}$ "
Mounting Position .....	Any

**RATINGS**

Heater Voltage AC or DC .....	6.3 Volts
Heater Current .....	0.175 Ampere
Maximum Plate Voltage .....	180 Volts
Maximum Screen Volts .....	140 Volts
Maximum Plate Dissipation .....	1.7 Watts
Maximum Screen Dissipation .....	0.5 Watt
Maximum DC Heater-Cathode Voltage .....	90 Volts
Maximum Cathode Current .....	18 Ma.

**Direct Interelectrode Capacitances:\***

Grid to Plate .....	0.02 $\mu\text{f.}$ Max.
Input .....	4.0 $\mu\text{f.}$
Output .....	2.8 $\mu\text{f.}$

\*With a close fitting shield connected to the cathode.

# 6AK5 (Cont'd)

## TYPICAL OPERATION CLASS A<sub>1</sub> AMPLIFIER

Heater Voltage.....	6.3	6.3 Volts
Heater Current.....	175	175 Ma.
Plate Voltage.....	120	180 Volts
Screen Voltage.....	120	120 Volts
Cathode Resistor**.....	180	180 Ohms
Plate Resistance (approx.).....	0.30	0.50 Megohm
Mutual Conductance.....	5000	5100 $\mu$ mhos
Plate Current.....	7.5	7.7 Ma.
Screen Current.....	2.5	2.4 Ma.

\*\*Fixed Bias Operation is not recommended.

## APPLICATION

Sylvania Type 6AK5 is a high-frequency, high mutual conductance pentode of miniature style of construction. It is intended for use at frequencies up to approximately 400 megacycles and the dual cathode leads, when properly used, help to isolate input and output circuits, thereby permitting greater gain per stage.

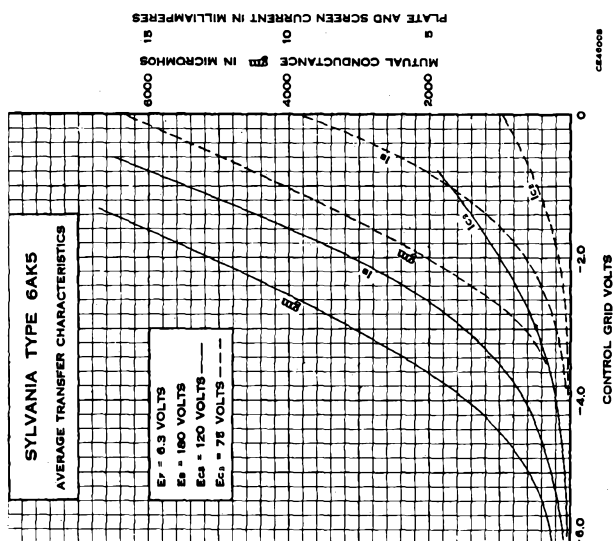
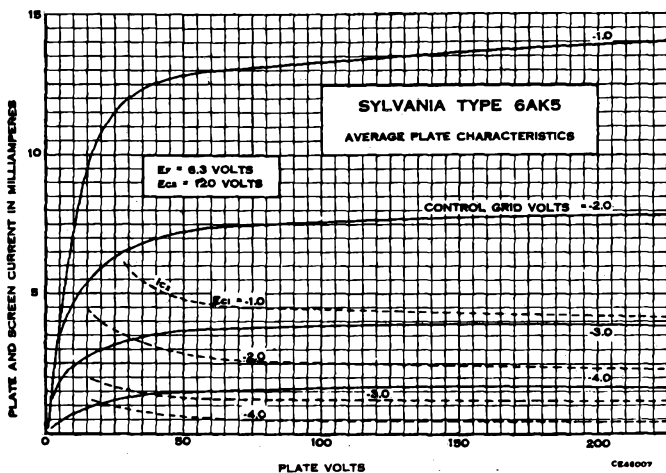

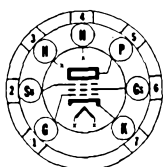

7BK-0-0



# Sylvania Type 6AK6

PENTODE POWER AMPLIFIER

## PHYSICAL SPECIFICATIONS

Base.....	Miniature Button 7-Pin
Bulb.....	T-5½"
Maximum Overall Length.....	2 1/8"
Maximum Seated Height.....	1 7/8"
Mounting Position.....	Any

## RATINGS

Heater Voltage AC or DC.....	6.3 Volts
Heater Current.....	150 Ma.
Maximum Plate Voltage.....	300 Volts
Maximum Screen Voltage.....	250 Volts
Maximum Plate Dissipation.....	2.75 Watts
Maximum Screen Dissipation.....	0.75 Watts
Maximum DC Heater-Cathode Voltage.....	100 Volts
<b>Direct Interelectrode Capacitances:*</b>	
Grid to Plate.....	0.12 μf.
Input.....	3.6 μf.
Output.....	4.2 μf.

\*Without external shield.

## TYPICAL OPERATION A.F. POWER AMPLIFIER

Heater Voltage.....	6.3 Volts
Heater Current.....	150 Ma.
Plate Voltage.....	180 Volts
Suppressor.....	Connected to Cathode at Socket
Screen Voltage.....	180 Volts
Grid Voltage.....	-9 Volts
Peak AF Grid Voltage.....	9 Volts
Zero Signal Plate Current.....	15 Ma.
Zero Signal Screen Current.....	2.5 Ma.
Plate Resistance.....	0.2 Megohm
Transconductance.....	2300 μmhos
Load Resistance.....	10,000 Ohms
Total Harmonic Distortion.....	10 %
Maximum Signal Power Output.....	1.1 Watts

## APPLICATION

Sylvania Type 6AK6 is a power amplifier pentode designed for use in compact light-weight radio equipment. It is similar in characteristics to Sylvania Type 6G6G.

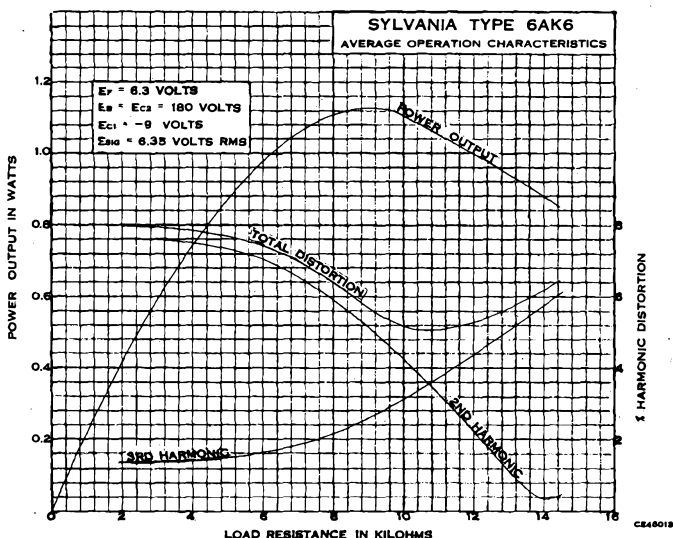

# 6AK6 (Cont'd)

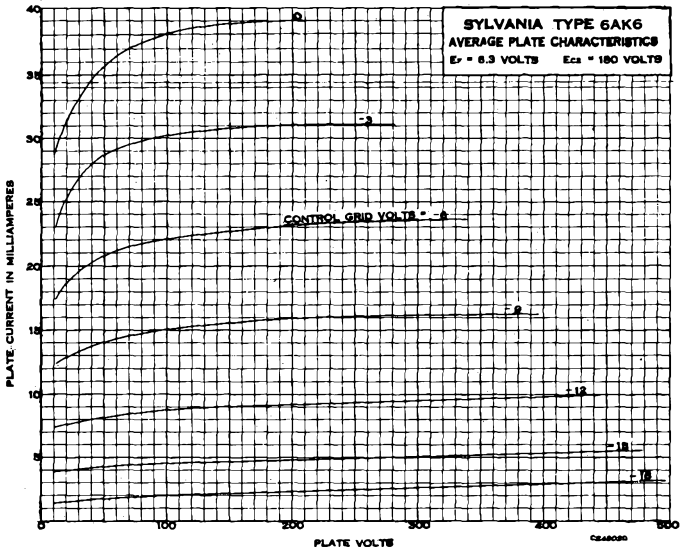

## 6AL5 Sylvania Type

DUODIODE

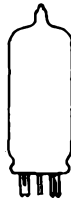

6BT-0-6

### PHYSICAL SPECIFICATIONS

Base.....	Miniature Button 7 Pin
Bulb.....	T5 1/2
Maximum Overall Length.....	1 3/4"
Maximum Seated Height.....	1 1/2"
Mounting Position.....	Any

### RATINGS

Heater Voltage AC or DC.....	6.3 Volts
Heater Current.....	0.3 Ampere
Maximum Peak Inverse Plate Voltage.....	330 Volts
Maximum Peak Plate Current per Plate.....	54 Ma.
Maximum DC Output Current per Plate.....	9.0 Ma.
Maximum DC Heater-Cathode Voltage.....	330 Volts

#### Direct Interelectrode Capacitances:

	Unshielded	Shielded*
Plate Input each Unit.....	2.5	3.2 $\mu$ f.
Coupling Plate to Plate.....	.068	.026 $\mu$ f.
Cathode Input each Unit.....	3.4	3.6 $\mu$ f.

\*With a 3/4" diameter shield (RMA Std. 316) connected to internal shield.

### TYPICAL OPERATION AS A HALF WAVE RECTIFIER

AC Voltage Per Plate (RMS).....	117 Volts
Minimum Effective Plate Supply Impedance.....	300 Ohms
DC Output Current Per Plate.....	9.0 Ma.

**APPLICATION**

Sylvania Type 6AL5 is a double diode of miniature type of construction. It is designed especially for high-frequency operation having a resonant frequency per unit of approximately 700 megacycles. Each diode unit is completely separate from the other and isolated by means of an internal shield thus permitting independent operation of each diode.

In ratio detector service, use of a series resistor to operate the heater at a voltage of 5.3 volts is recommended. This provides considerably lower hum output without loss of performance.

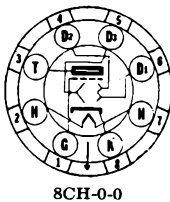
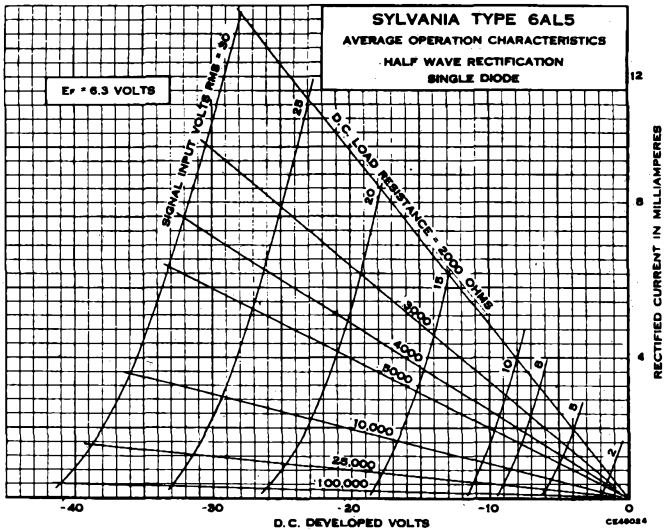
**Sylvania Type 6AL7<sup>GT</sup>****TUNING INDICATOR****PHYSICAL SPECIFICATIONS**

Base .....	Intermediate Shell 8 Pin Octal
Bulb .....	T-9
Maximum Overall Length .....	3 1/16"
Maximum Seated Height .....	2 1/2"
Mounting Position .....	Any

**RATINGS**

Heater Voltage .....	6.3 Volts
Maximum Target Voltage .....	365 Volts
Minimum Target Voltage .....	220 Volts
Maximum Heater-Cathode Voltage .....	90 Volts

**TYPICAL OPERATION****TUNING INDICATOR SERVICE**

Heater Voltage .....	6.3 Volts
Heater Current .....	150 Ma.
Target Voltage .....	315 Volts
Control Grid Voltage* .....	0 Volts
Deflection Electrode Voltages† .....	0 Volts
Deflection Sensitivity (Approx.) .....	1 mm per Volt
Control Grid Voltage for Fluorescent Cut-Off (Approx.) .....	-6.0 Volts
Cathode Bias Resistor (Approx.) .....	3300 Ohms

\*When not used for fluorescent control the grid should be connected to the cathode.

†The illustration shows the fluorescent areas controlled by the deflection electrodes connected to D1, D2 and D3 respectively.

# 6AL7GT (Cont'd)

## APPLICATION

Sylvania Type 6AL7GT is a tuning indicator tube using the principle of the cathode ray tube and designed for use with FM circuits. The fluorescent coating is applied to a mica screen and the relative values of the voltages applied to the deflection electrodes are indicated by the location and size of the illuminated area.

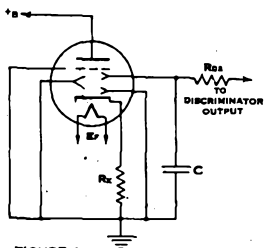

FIGURE 1

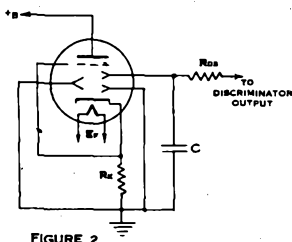

FIGURE 2

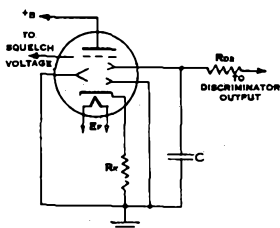

FIGURE 3  
SQUELCH VOLTAGE  
6 v. (APPROX) - OFF CHANNEL

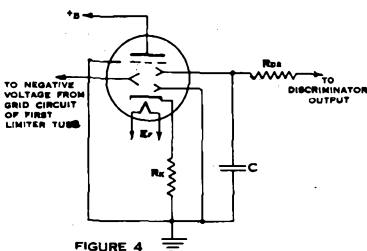

FIGURE 4

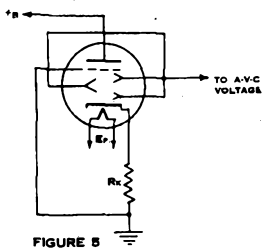
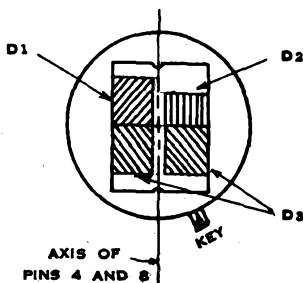

FIGURE 5



### COMMON CONDITIONS FOR ALL CIRCUITS

$E_r = 6.3$  VOLTS  
 $+B = 250$  VOLTS D-C APPROXIMATE  
 $R_r = 3200$  OHMS  
 $R_{sa} = 1.0$  MEGOHM  
 $C = 0.08$  MICROFARAD

### PATTERN RESPONSE IN VARIOUS CIRCUITS

CONTROL VOLTAGE SOURCE	SIGNAL	CIRCUIT (SEE FIGURE)	OFF CHANNEL (-)	ON CHANNEL OFF TUNE (-)	ON TUNE	ON CHANNEL OFF TUNE (+)	OFF CHANNEL (+)
DISCRIMINATOR	FM	1 AND 2					
DISCRIMINATOR AND SQUELCH	FM	3					
DISCRIMINATOR AND LIMITER	FM	4					
AVC	AM	5					

SYLVANIA RADIO TUBES



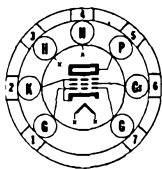

7BZ-0-0



# Sylvania Type 6AQ5

BEAM POWER AMPLIFIER

## PHYSICAL SPECIFICATIONS

Base.....	Miniature Button 7-Pin
Bulb.....	T-5 1/2"
Maximum Overall Length.....	2 5/8"
Maximum Seated Height.....	2 3/8"
Mounting Position.....	Any

## RATINGS

Heater Voltage AC or DC.....	6.3 Volts
Heater Current.....	450 Ma.
Maximum Plate Voltage.....	250 Volts
Maximum Screen Voltage.....	250 Volts
Maximum Plate Dissipation.....	12 Watts
Maximum Screen Dissipation.....	2 Watts
Maximum Peak Heater-Cathode Voltage.....	90 Volts
Maximum Grid-Circuit Resistance	
For Fixed Bias.....	0.1 Megohm
For Cathode Bias.....	0.5 Megohm

### Direct Interelectrode Capacitances:

	Shielded†	Unshielded
Grid to Plate.....	0.17	0.35 $\mu$ mf.
Input.....	8.0	7.6 $\mu$ mf.
Output.....	11.0	6.0 $\mu$ mf.

†With a 3/4" diameter shield (RMA Std. 316) connected to Cathode.

## TYPICAL OPERATION

### AF POWER AMPLIFIER - CLASS A<sub>1</sub>

Heater Voltage.....	6.3	6.3 Volts
Heater Current.....	450	450 Ma.
Plate Voltage.....	180	250 Volts
Screen Voltage.....	180	250 Volts
Control Grid Voltage.....	-8.5	-12.5 Volts
Peak AF Grid Voltage.....	8.5	12.5 Volts
Zero Signal Plate Current.....	29	45 Ma.
Maximum Signal Plate Current.....	30	47 Ma.
Zero Signal Screen Current (Approx.).....	3	4.5 Ma.
Maximum Signal Screen Current (Approx.).....	4	7 Ma.
Plate Resistance (Approx.).....	58,000	52,000 Ohms
Transconductance.....	3700	4100 $\mu$ mhos
Load Resistance.....	5500	5000 Ohms
Total Harmonic Distortion.....	8	8 %
Maximum Signal Power Output.....	2.0	4.5 Watts

### AF POWER AMPLIFIER - CLASS AB<sub>1</sub>\*

Plate Voltage.....	250 Volts
Screen Voltage.....	250 Volts
Control Grid Voltage.....	-15 Volts
Peak AF Grid to Grid Voltage.....	30 Volts
Zero Signal Plate Current.....	70 Ma.
Maximum Signal Plate Current.....	79 Ma.
Zero Signal Screen Current.....	5 Ma.
Maximum Signal Screen Current.....	13 Ma.
Plate Resistance (per tube).....	60,000 Ohms
Transconductance (per tube).....	3750 $\mu$ mhos
Effective Load Resistance (plate to plate).....	10,000 Ohms
Total Harmonic Distortion.....	5 %
Maximum Signal Power Output.....	10 Watts

\*Values are for two tubes.

## APPLICATION

Sylvania Type 6AQ5 is a beam power amplifier in the miniature style designed for use in compact AC or auto sets. Since it is identical to Type 6V6GT except that the highest rating is not recommended, the same characteristic curves may be used. These are shown with Sylvania Type 7C5.

# 6AQ6 Sylvania Type

DUODIODE HIGH-MU TRIODE

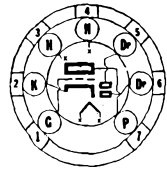

7BT-0-0

## PHYSICAL SPECIFICATIONS

Base.....	Miniature Button 7 Pin
Bulb.....	T5 1/2"
Maximum Overall Length.....	2 1/8"
Maximum Seated Height.....	1 3/8"
Mounting Position.....	Any

## RATINGS

Heater Voltage AC or DC.....	6.3 Volts
Heater Current.....	150 Ma.
Maximum Plate Voltage.....	300 Volts
Maximum Heater-Cathode Voltage.....	90 Volts

## TYPICAL OPERATION

### CLASS A<sub>1</sub> AMPLIFIER

Heater Voltage.....	6.3	6.3 Volts
Heater Current.....	150	150 Ma.
Plate Voltage.....	100	250 Volts
Grid Voltage.....	-1.0	-3.0 Volts
Amplification Factor.....	70	70
Plate Resistance.....	61000	58000 Ohms
Mutual Conductance.....	1150	1200 $\mu$ mhos
Plate Current.....	0.8	1.0 Ma.

## APPLICATION

Sylvania Type 6AQ6 is a double diode, high-mu triode of miniature construction. It is similar to type 6Q7 but has lower heater drain and lower internal capacitances. Its small size facilitates the design of small compact receivers.

Data for use in Resistance Coupled Amplifier Circuits may be found in the appendix under type 6Q7GT.

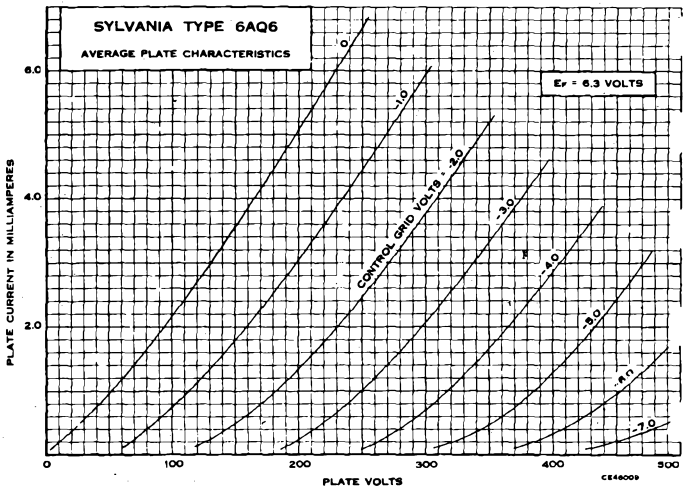

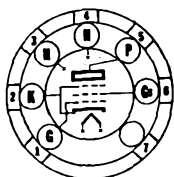

6CC-0-0

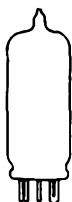

# Sylvania Type 6AR5

BEAM POWER AMPLIFIER

## PHYSICAL SPECIFICATIONS

Base .....	Miniature Button 7 Pin
Bulb .....	T-5½"
Maximum Overall Length .....	2 5/8"
Maximum Seated Height .....	2 3/8"
Mounting Position .....	Any

## RATINGS

Heater Voltage AC or DC .....	6.3 Volts
Maximum Plate Voltage .....	250 Volts
Maximum Screen Voltage .....	250 Volts
Maximum Plate Dissipation .....	8.5 Watts
Maximum Screen Dissipation .....	2.5 Watts
Maximum Heater-Cathode Voltage .....	90 Volts

## TYPICAL OPERATION

Heater Voltage AC or DC .....	6.3	6.3 Volts
Heater Current .....	400	400 Ma.
Plate Voltage .....	250	250 Volts
Screen Voltage .....	250	250 Volts
Grid Voltage* .....	-16.5	-18 Volts
Self-Bias Resistor .....	420	500 Ohms
Peak Signal Voltage .....	16.5	18 Volts
Plate Current (Zero Signal) .....	34	32 Ma.
Plate Current (Maximum Signal) .....	35	33 Ma.
Screen Current (Zero Signal) .....	5.7	5.5 Ma.
Screen Current (Maximum Signal) .....	10	10 Ma.
Plate Resistance (Approx.) .....	65,000	68,000 Ohms
Mutual Conductance .....	2,400	2,300 μmhos
Load Resistance .....	7,000	7,600 Ohms
Power Output .....	3.2	3.4 Watts
Total Harmonic Distortion .....	7	11 %

\*Maximum grid circuit resistance should not exceed 0.5 megohms for self-bias operation, or 0.1 megohm for fixed bias operation.

## APPLICATION

Sylvania Type 6AR5 is a miniature tube for use in locations where the space requirements do not permit use of the Types 7B5 or 6K6G, and which do not require the 315 volt rating. For curve data, reference should be made to Type 7B5.

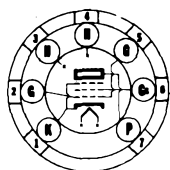

7CV-0-0



# Sylvania Type 6AS5

BEAM POWER AMPLIFIER

## PHYSICAL SPECIFICATIONS

Base .....	Miniature Button 7-Pin
Bulb .....	T-5½"
Maximum Overall Length .....	2 5/8"
Maximum Seated Height .....	2 3/8"
Mounting Position .....	Any

## RATINGS

Heater Voltage AC or DC .....	6.3 Volts
Maximum Plate Voltage .....	150 Volts
Maximum Screen Voltage .....	117 Volts
Maximum Plate Dissipation .....	5.5 Watts
Maximum Screen Dissipation .....	1.0 Watt
Maximum Heater-Cathode Voltage .....	90 Volts

### Direct Interelectrode Capacitances: (approx.)\*

Grid No. 1 (Control Grid) to Plate .....	0.6 μf.
Input .....	12 μf.
Output .....	6.2 μf.

\*With no external shield.

# 6AS5 (Cont'd)

## TYPICAL OPERATION CLASS A<sub>1</sub> AMPLIFIER

Heater Voltage.....	6.3 Volts
Heater Current.....	0.8 Ampere
Plate Voltage.....	150 Volts
Screen Voltage.....	110 Volts
Control Grid Voltage*.....	-8.5 Volts
Peak AF Grid Voltage.....	8.5 Volts
Plate Current (Zero Signal).....	35 Ma.
Plate Current (Maximum Signal).....	36 Ma.
Screen Current (Zero Signal).....	2 Ma.
Screen Current (Maximum Signal).....	6.5 Ma.
Mutual Conductance.....	5600 $\mu$ mhos
Load Resistance.....	4500 Ohms
Power Output (Maximum Signal).....	2.2 Watts
Total Harmonic Distortion.....	10 %

\*Maximum grid circuit resistance should not exceed 0.5 megohm for self bias operation, or 0.1 megohm for fixed bias operation.

## APPLICATION

Sylvania Type 6AS5, a miniature beam power amplifier, is used in the output stage of automobile and ac operated receivers. It delivers relatively large power output at low plate and screen voltages.

# 6AS6 Sylvania Type

PENTODE WITH SUPPRESSOR CONTROL

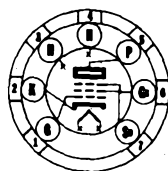

7CM-0-0

## PHYSICAL SPECIFICATIONS

Base.....	Miniature Button 7-Pin
Bulb.....	T-5 $\frac{1}{2}$
Maximum Overall Length.....	1 $\frac{1}{2}$ "
Maximum Seated Height.....	1 $\frac{1}{2}$ "
Mounting Position.....	Any

## RATINGS

Heater Voltage AC or DC.....	6.3 Volts
Heater Current.....	175 Ma.
Maximum Plate Voltage.....	180 Volts
Maximum Screen Voltage.....	140 Volts
Maximum Plate Dissipation.....	1.7 Watts
Maximum Screen Dissipation.....	0.75 Watt
Maximum Peak Heater-Cathode Voltage.....	90 Volts
Maximum Cathode Current.....	18 Ma.

### Direct Interelectrode Capacitances:

	Unshielded	Shielded*
Grid to Plate.....	0.025	0.02 $\mu$ f.
Input.....	3.9	4.0 $\mu$ f.
Output.....	2.2	3.0 $\mu$ f.

\*External shield connected to pin #2 (cathode.)

## TYPICAL OPERATION

Heater Voltage.....	6.3	6.3 Volts
Heater Current.....	175	175 Ma.
Plate Voltage.....	120	120 Volts
Screen Voltage.....	120	120 Volts
Suppressor Voltage.....	-3	0 Volts
Control Grid Voltage.....	-2	-2 Volts
Plate Current.....	3.6	5.2 Ma.
Screen Current.....	4.8	3.5 Ma.
Mutual Conductance, Control-Grid.....	1850	3200 $\mu$ mhos
Mutual Conductance, Suppressor Grid.....	810	470 $\mu$ mhos

## APPLICATION

Sylvania Type 6AS6 is a miniature pentode intended for low power applications at high and ultra-high frequencies. It can be used in delay circuits, mixers, gain controlled amplifiers, and gated amplifiers. The control grid and suppressor grid can be used as individual control elements.



8BD-0-0



# Sylvania Type 6AS7G

LOW MU DUOTRIODE

## PHYSICAL SPECIFICATIONS

Base.....	Medium Shell Octal 8 Pin
Bulb.....	ST-16
Maximum Overall Length.....	5 3/4"
Maximum Seated Height.....	4 3/4"
Mounting Position.....	Any

## RATINGS

Heater Voltage AC or DC.....	6.3 Volts
Heater Current.....	2.5 Amperes
Maximum Plate Voltage.....	250 Volts
Maximum Plate Dissipation per Plate.....	13 Watts
Maximum Peak Heater-Cathode Voltage.....	300 Volts
Maximum Peak Inverse Plate Voltage.....	1700 Volts
Maximum Plate Current.....	125 Ma.

## TYPICAL OPERATION

### AS A DIRECT COUPLED AMPLIFIER

Plate Supply Voltage.....	135 Volts
Grid Voltage.....	Obtained by Self-Bias Resistor
Self-Bias Resistor.....	250 Ohms
Plate Current.....	125 Ma.
Plate Resistance.....	280 Ohms
Mutual Conductance.....	7000 $\mu$ mhos
Amplification Factor.....	2.0

## APPLICATION

Sylvania Type 6AS7G is a low mu duo triode power amplifier designed for television service as a booster scanner. Fixed bias operation is not recommended and the grid circuit resistance should not exceed 1 megohm.

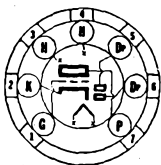

7BT-0-0



# Sylvania Type 6AT6

DUODIODE HIGH-MU TRIODE

## PHYSICAL SPECIFICATIONS

Base.....	Miniature Button 7 Pin
Bulb.....	T5 1/2
Maximum Overall Length.....	2 1/4"
Maximum Seated Height.....	1 1/4"
Mounting Position.....	Any

## RATINGS

Heater Voltage AC or DC.....	6.3 Volts
Heater Current.....	300 Ma.
Maximum Plate Voltage.....	300 Volts
Maximum Heater-Cathode Voltage.....	90 Volts

### Direct Interelectrode Capacitances:\*

Grid to Plate.....	2.1 $\mu$ f.
Input.....	2.3 $\mu$ f.
Output.....	1.1 $\mu$ f.
Diode No. 2 (Pin 5) to Grid.....	025 $\mu$ f. Max.

\*Without external shield.

## TYPICAL OPERATION

Heater Voltage.....	6.3	6.3 Volts
Heater Current.....	300	300 Ma.
Plate Voltage.....	100	250 Volts
Grid Voltage.....	-1.0	-3.0 Volts
Plate Current.....	0.8	1.0 Ma.
Amplification Factor.....	70	70
Plate Resistance.....	54000	58000 Ohms
Mutual Conductance.....	1300	1200 $\mu$ mhos

Data for use in Resistance Coupled Amplifier Circuits may be found in the appendix under type 6Q7GT.

# 6AT6 (Cont'd)

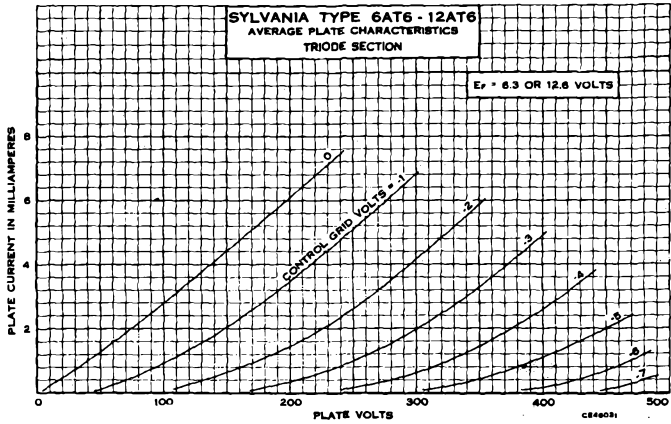

## 6AU5<sup>GT</sup> Sylvania Type

**BEAM POWER AMPLIFIER  
TELEVISION SCANNER**

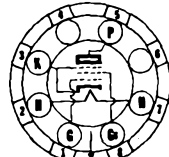

6CK-0-0

### PHYSICAL SPECIFICATIONS

Base .....	Intermediate Octal 6-Pin
Bulb .....	T-9
Maximum Overall Length .....	3 1/8"
Maximum Seated Height .....	2 3/4"
Mounting Position .....	Any

### RATINGS

Heater Voltage (AC or DC) .....	6.3 Volts
Heater Current .....	1.25 Amperes
Maximum Plate Voltage .....	450 Volts
Maximum Screen Voltage .....	200 Volts
Maximum Plate Dissipation .....	10 Watts
Maximum Peak Heater-Cathode Voltage .....	±180 Volts

#### Direct Interelectrode Capacitances\*

Grid to Plate .....	0.5 $\mu\text{f.}$
Input .....	11.3 $\mu\text{f.}$
Output .....	7.0 $\mu\text{f.}$

\*Without external shield.

## TYPICAL OPERATION

## HORIZONTAL DEFLECTION AMPLIFIER\*\*

Heater Voltage (AC or DC).....	6.3 Volts
Heater Current.....	1.25 Amperes
Plate Voltage.....	450 Volts
Screen Voltage.....	167 Volts
Peak Positive-Surge Plate Voltage.....	4500 Volts
Peak Positive Grid Signal (Sawtooth).....	85 Volts
Peak Negative Grid Signal (Sawtooth).....	15 Volts
Plate Current.....	71 Ma.
Screen Current.....	6 Ma.
Developed High Voltage.....	12.0 K Volts

\*\*Circuit used for these data is that given for Type 6BQ6GT.

†This voltage consists of 325 volts from DC power supply plus boost from the damper circuit.

## APPLICATION

Sylvania Type 6AU5GT is a beam power amplifier designed especially for use as a horizontal scanner in television receivers using magnetic deflection. For typical circuit see deflection amplifier circuit given for Type 6BQ6GT which uses a "fly-back" type high voltage supply.

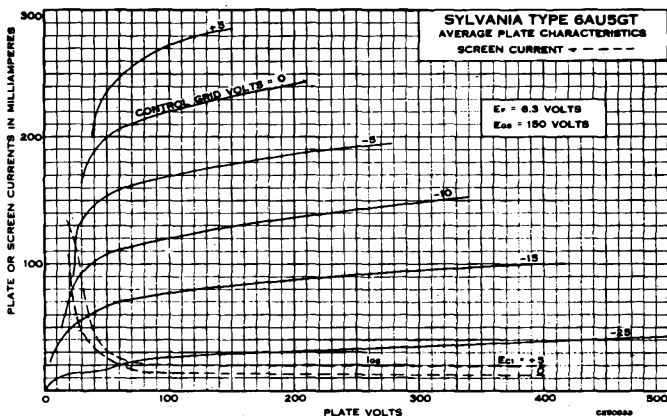

# 6AU6 Sylvania Type

SHARP CUT-OFF RF PENTODE

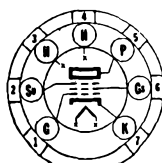

7BK-0-2

## PHYSICAL SPECIFICATIONS

Base.....	Miniature Button 7 Pin
Bulb.....	T5 1/2
Maximum Overall Length.....	2 1/8"
Maximum Seated Height.....	1 1/8"
Mounting Position.....	Any

## RATINGS

Heater Voltage AC or DC.....	6.3 Volts
Heater Current.....	300 Ma.
Maximum Plate Voltage.....	300 Volts
Maximum Screen Voltage.....	150 Volts
Maximum Screen Supply Voltage.....	300 Volts
Maximum Plate Dissipation.....	3 Watts
Maximum Screen Dissipation.....	0.65 Watt
Minimum Control Grid Voltage.....	0 Volt
Maximum Heater-Cathode Voltage.....	90 Volts

### Direct Interelectrode Capacitances:\*

Grid to Plate.....	0.0035 $\mu$ f. Max.
Input.....	5.5 $\mu$ f.
Output.....	5.0 $\mu$ f.

\* Without external shield.

## TYPICAL OPERATION

Heater Voltage.....	6.3	6.3	6.3 Volts
Heater Current.....	300	300	300 Ma.
Plate Voltage.....	100	250	250 Volts
Suppressor Grid.....		Connect to Cathode at Socket	
Screen Voltage.....	100	125	150 Volts
Control Grid Voltage.....	-1.0	-1.0	-1.0 Volt
Cathode Resistor.....	150	100	68 Ohms
Plate Resistance (Approximate).....	0.5	1.5	1.0 Megohm
Mutual Conductance.....	3900	4500	5200 $\mu$ mhos
Control Grid Voltage at 10 $\mu$ a. Plate.....	-4.2	-5.5	-6.5 Volts
Plate Current.....	5.0	7.6	10.6 Ma.
Screen Current.....	2.1	3.0	4.3 Ma.

## APPLICATION

Sylvania Type 6AU6 is a sharp cut-off pentode of miniature construction. It has high mutual conductance and low interelectrode capacitances. These characteristics combined with high plate resistance make it suitable for many RF and IF applications. The miniature type of construction lends itself readily to applications in compact light-weight equipment.

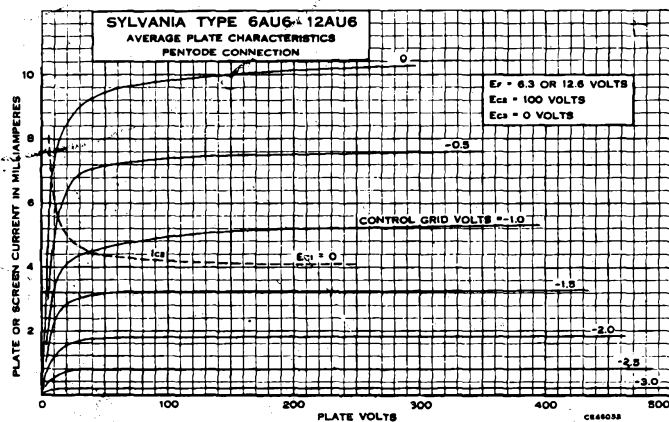



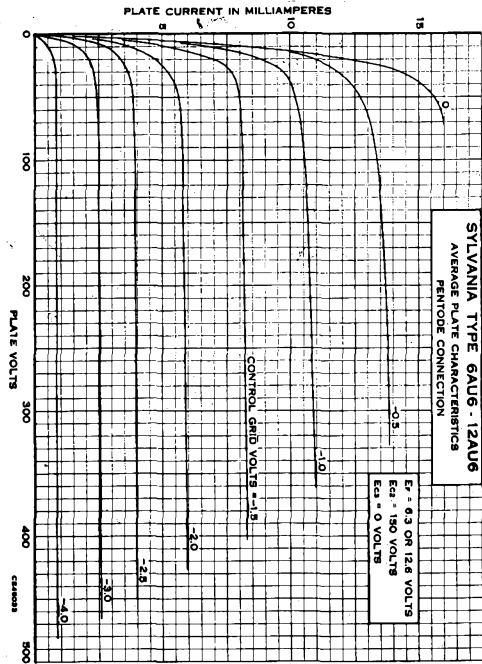
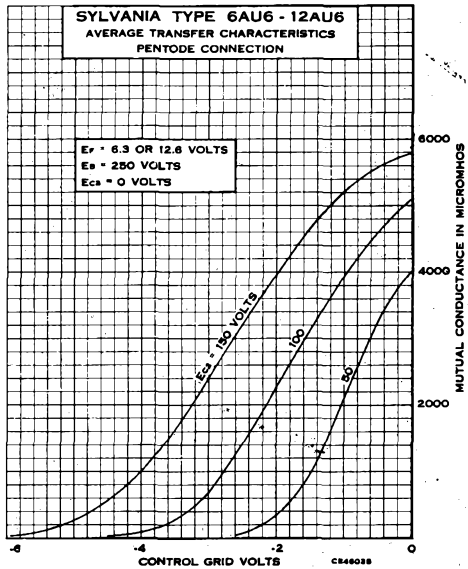
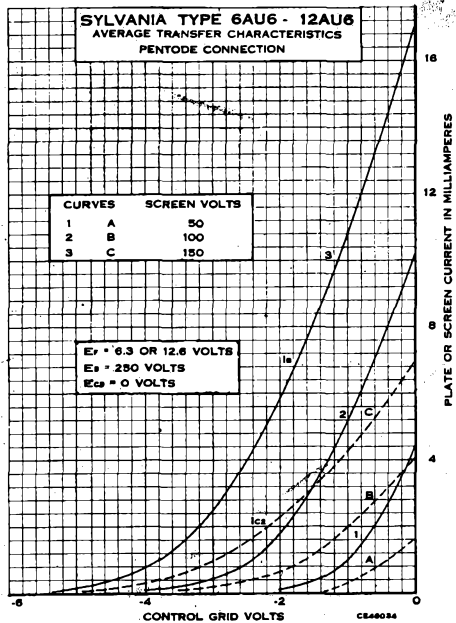

# 6AV5<sup>GT</sup> Sylvania Type

BEAM POWER AMPLIFIER  
TELEVISION SCANNER

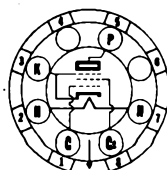

6CK-0-0

## PHYSICAL SPECIFICATIONS

Base .....	Intermediate Octal 6-Pin
Bulb .....	T-9
Maximum Overall Length .....	3 $\frac{1}{16}$ "
Maximum Seated Height .....	2 $\frac{3}{4}$ "
Mounting Position .....	Any

## RATINGS

Heater Voltage (AC or DC) .....	6.3 Volts
Heater Current .....	1.2 Amperes
Maximum Plate Supply Voltage .....	550 Volts
Maximum Screen Voltage .....	200 Volts
Maximum Peak Positive-Surge Plate Voltage* .....	5500 Volts
Maximum Negative Control Grid Voltage .....	100 Volts
Maximum Peak Negative-Surge Control Grid Voltage* .....	400 Volts
Maximum DC Plate Current .....	100 Ma.
Maximum Screen Dissipation .....	2.5 Watts
Maximum Plate Dissipation .....	11 Watts
Maximum Control Grid Circuit Resistance # .....	1 Megohm
Maximum Peak Heater-Cathode Voltage .....	180 Volts

\*Absolute maximum value which must not be exceeded under any condition of operation. The duration of the voltage pulse should not exceed 15% of one horizontal scanning cycle. In a 525 line, interlaced two to one, 30 frame per second television system, 15% of one vertical scanning cycle is 10 microseconds.

# As a protection against loss of excitation and resulting loss of developed bias a cathode resistor or other suitable device must be employed.

## TYPICAL OPERATION\*\*

### HORIZONTAL DEFLECTION AMPLIFIER

Heater Voltage (AC or DC) .....	6.3 Volts
Heater Current .....	1.2 Amperes
Plate Voltage† .....	460 Volts
Screen Voltage .....	136 Volts
Peak Positive-Surge Plate Voltage .....	136 Volts
Peak Positive Grid Signal (Sawtooth) .....	4400 Volts
Peak Negative Grid Signal (Sawtooth) .....	65 Volts
Plate Current .....	35 Volts
Screen Current .....	78 Ma.
Developed High Voltage .....	7 Ma.
	12.0 K Volts

\*\*Circuit used for these data is that given for Type 6BQ6GT.

†This voltage consists of 325 volts from DC power supply plus boost from the damper circuit.

## APPLICATION

Sylvania Type 6AV5GT is a beam power amplifier designed especially for use as a horizontal scanner tube in television receivers using magnetic deflection. The typical operating conditions shown above may be obtained by using the circuit given for Type 6BQ6GT. This provides sufficient scan for use with a Sylvania Type 16TP4 picture tube.

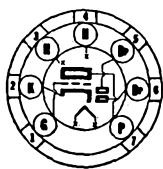
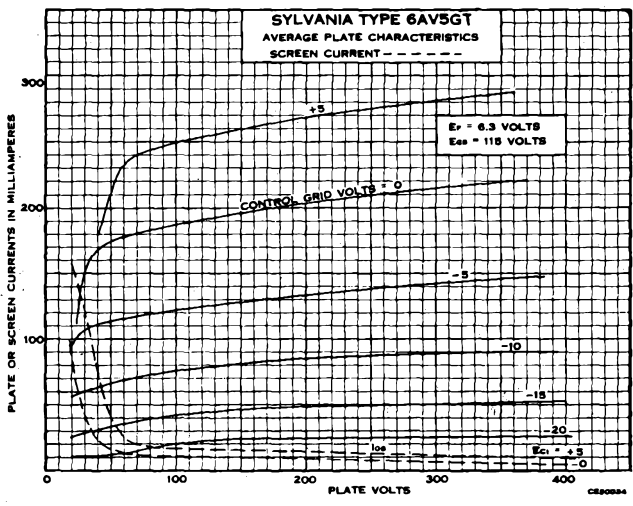

7BT-0-0



**Sylvania Type 6AV6**

**DUODIODE TRIODE**

**PHYSICAL SPECIFICATIONS**

Base.....	Small Button Miniature 7 Pin
Bulb.....	T-5 $\frac{1}{2}$
Maximum Overall Length.....	2 $\frac{1}{8}$ "
Maximum Seated Height.....	1 $\frac{1}{8}$ "
Mounting Position.....	Any

**RATINGS**

Heater Voltage AC or DC.....	6.3 Volts
Heater Current.....	300 Ma.
Maximum Plate Voltage (Triode Unit).....	300 Volts
Maximum Peak Heater-Cathode Voltage.....	90 Volts
Maximum Diode Plate Current per diode.....	1.0 Ma.

# 6AV6 (Cont'd)

## TYPICAL OPERATION TRIODE UNIT - CLASS A<sub>1</sub> AMPLIFIER

Heater Voltage.....	6.3	6.3 Volts
Heater Current.....	300	300 Ma.
Plate Voltage.....	100	250 Volts
Grid Voltage.....	-1	-2 Volts
Amplification Factor.....	100	100
Plate Resistance.....	80,000	62,500 Ohms
Transconductance.....	1250	1600 $\mu$ mhos
Plate Current.....	0.5	1.2 Ma.

## APPLICATION

Sylvania Type 6AV6 is a high  $\mu$  diode triode in the miniature style. It is very similar in characteristics to lock-in Type 7B4 and the resistance coupled data given in appendix will be substantially correct for this type also. Type 12AV6 is the 150 Ma. equivalent for use in AC-DC sets.

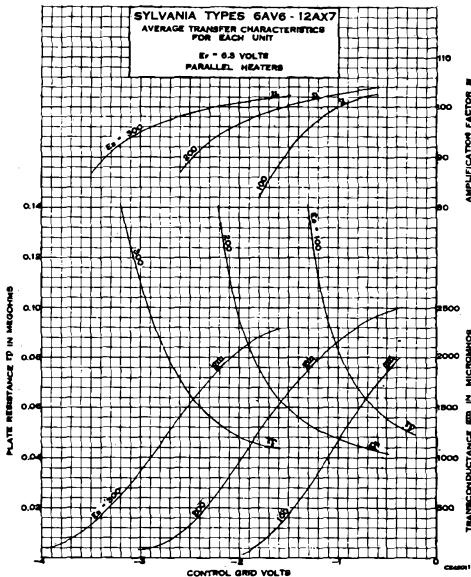
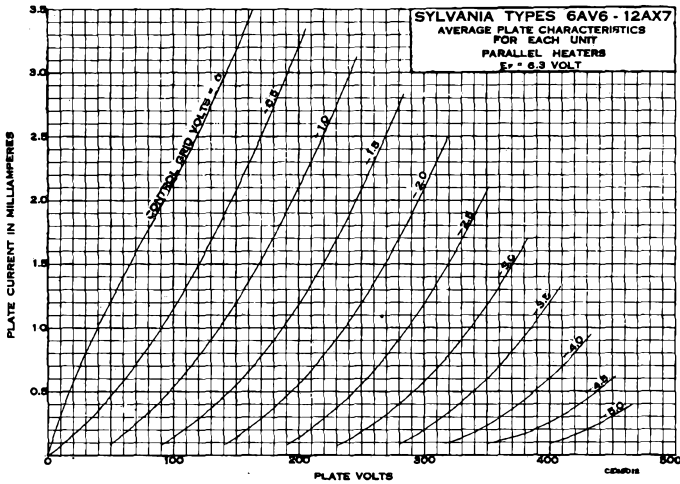

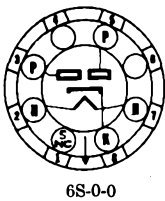

6S-0-0

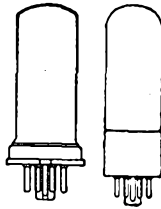

# Sylvania Type 6AX5<sup>GT</sup>

FULL-WAVE RECTIFIER

## PHYSICAL SPECIFICATIONS

Base .....	Intermediate Octal 6-Pin
Bulb .....	T-9
Maximum Overall Length .....	3 5/8"
Maximum Seated Height .....	2 3/4"
Mounting Position .....	Any

## RATINGS

Heater Voltage AC or DC .....	6.3 Volts
Heater Current .....	1.2 Amperes
Maximum Peak Inverse Plate Voltage .....	1250 Volts
Maximum Peak Heater-Cathode Voltage .....	450 Volts
Maximum Peak Plate Current (per plate) .....	375 Ma.

## TYPICAL OPERATION

### CONDENSER INPUT TO FILTER

AC Voltage per Plate (RMS) .....	350	450 Volts
Plate Supply Impedance per Plate .....	50	105 Ohms
Filter Input Capacitor .....	10	10 $\mu$ f.
DC Output Voltage at Input to Filter (approx.)		
At Half-Load Current of 62.5 Ma. ....	395	... Volts
40 Ma. ....		540 Volts
At Full-Load Current of 125 Ma. ....	350	... Volts
80 Ma. ....		490 Volts

### CHOKE INPUT TO FILTER

AC Voltage per Plate (RMS) .....	350	450 Volts
Filter Input Choke .....	10	10 Henrys
DC Output Voltage at Input to Filter (approx.)		
At Half-Load Current of 75 Ma. ....	270	... Volts
62.5 Ma. ....		365 Volts
At Full-Load Current of 150 Ma. ....	250	... Volts
125 Ma. ....		350 Volts

## APPLICATION

Sylvania Type 6AX5GT is a full-wave rectifier featuring the unipotential cathode. It is designed for use in ac operated receivers and automobile receivers.



7Q-0-0



# Sylvania Type 6AX6<sup>G</sup>

FULL WAVE RECTIFIER

## PHYSICAL SPECIFICATIONS

Base .....	Medium Octal 7-Pin
Bulb .....	ST-14
Maximum Overall Length .....	4 5/8"
Maximum Seated Height .....	4 1/8"
Mounting Position .....	Any

## RATINGS

Heater Voltage AC or DC .....	6.3 Volts
Maximum Peak Inverse Voltage (per plate)	
Rectifier Operation .....	1250 Volts
Damper Operation* .....	2000 Volts
Maximum Heater-Cathode Voltage	
Heater Negative With Respect to Cathode .....	450 Volts
Heater Positive With Respect to Cathode .....	100 Volts
Maximum Peak Plate Current per Plate .....	600 Ma.
Maximum DC Output Current per Plate .....	125 Ma.

\*Duration of voltage pulse not to exceed 15% of each scanning cycle. In the 525 line, 30 frame television system 15% of one scanning cycle is 10 microseconds.

# 6AX6<sup>G</sup> (Cont'd)

## TYPICAL OPERATION

### FULL WAVE RECTIFIER — CONDENSER INPUT

Heater Voltage AC or DC.....	6.3 Volts
Heater Current.....	2.5 Amperes
AC Plate Voltage per Plate (RMS).....	350 Volts
DC Output Current.....	250 Ma.
Total Effective Plate Supply Impedance per Plate (Min.).....	145 Ohms
DC Output Voltage at Input to Filter (approx.)	
At 1/2 Load (125 Ma.).....	395 Volts
At Full Load (250 Ma.).....	350 Volts

## APPLICATION

Sylvania Type 6AX6G is a full wave rectifier featuring the coated unipotential cathode. It is suitable for damper-diode service in television deflection circuits or as a rectifier in conventional power supply applications.

# 6B4G Sylvania Type

## POWER AMPLIFIER TRIODE

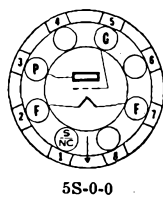

## PHYSICAL SPECIFICATIONS

Base.....	Medium Octal 8 Pin
Bulb.....	ST16
Maximum Overall Length.....	5 5/16"
Maximum Seated Height.....	4 3/4"
Mounting Position.....	Any

## RATINGS

Filament Voltage.....	6.3 Volts
Filament Current.....	1.0 Ampere
Maximum Plate Voltage.....	325 Volts

### Direct Interelectrode Capacitances:\*

Grid to Plate.....	16 $\mu$ f.
Input.....	7 $\mu$ f.
Output.....	5 $\mu$ f.

\*Without external shield.

## TYPICAL OPERATION AS AMPLIFIER

	Class A One Tube	Push Pull Class AB Fixed Bias	Two Tubes Self Bias
Filament Voltage.....	6.3	6.3	6.3 Volts
Filament Current.....	1.0	1.0	1.0 Ampere
Plate Voltage.....	250	325	325 Volts
Grid Voltage*.....	-45	-63	Volts
Self-Bias Resistor.....	750		850 Ohms
Plate Current (Per Tube).....	60	40	40 Ma.
Plate Resistance.....	800		Ohms
Mutual Conductance.....	5250		$\mu$ mhos
Amplification Factor.....	4.2		
Total Load Resistance.....	2500	3000	5000 Ohms
Power Output.....	3.2	15	10 Watts
Harmonic Distortion.....	5.0	2.5	5.0 Per Cent

\*Measured from filament center tap when operated on AC.

## APPLICATION

Sylvania 6B4G is a power amplifier triode, identical to Type 6A3 in electrical characteristics, and is used in the output stage of a-c operated receivers and public address systems.

Any of the conventional methods may be used for the input coupling provided that the resistance added in the grid return is not excessive. The d-c resistance in this circuit should be less than 0.5 megohm for a self-bias arrangement; with fixed bias the limit is 50,000 ohms. If the above values are exceeded, the bias voltage may be reduced as a result of grid current. This condition will cause excessive plate current to flow which, in turn, may cause damage to the tube or output transformer.

SYLVANIA RADIO TUBES

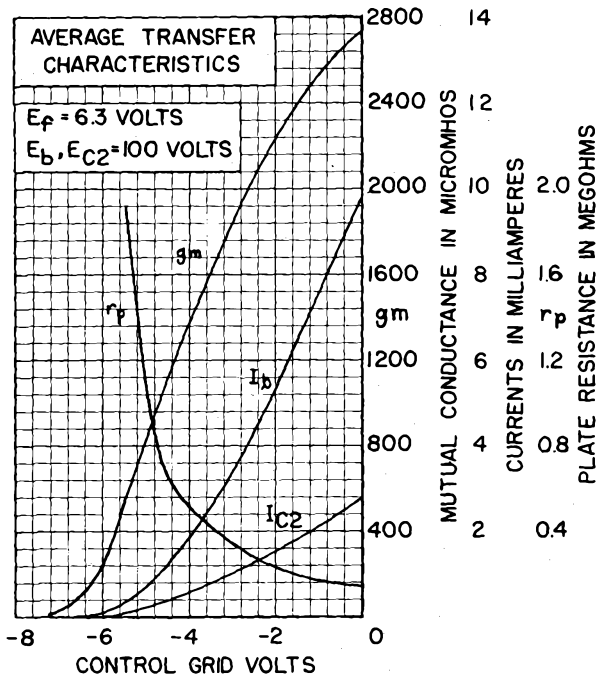

# Sylvania Type 6BA5

## PENTODE VOLTAGE AMPLIFIER

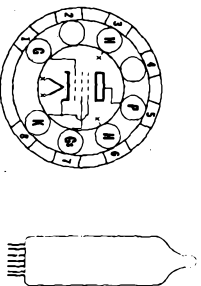

8DY-0-0

### PHYSICAL SPECIFICATIONS

Base.....	Flexible Leads
Bulb.....	1-3
Maximum Overall Bulb Length.....	1.375"
Minimum Lead Length.....	1.500"
Mounting Position.....	Any

### RATINGS

Heater Voltage AC or DC.....	6.3 Volts
Maximum Plate Voltage.....	150 Volts
Maximum Screen Voltage.....	140 Volts
Maximum Plate Dissipation.....	0.7 Watt
Maximum Heater-Cathode Voltage.....	0.3 Watt
Maximum Grid Circuit Resistance (cathode bias).....	90 Vols
	1 Megohm

### Direct Inter-electrode Capacitances:

	Unshielded	Shielded*
Grid to Plate.....	0.1	0.065 $\mu$ mf.
Input.....	3.2	3.4 $\mu$ mf.
Output.....	1.6	3.6 $\mu$ mf.

\*External shield of 0.405" diameter connected to cathode.

### TYPICAL OPERATION

#### CLASS A<sub>1</sub> AMPLIFIER

Heater Voltage.....	6.3 Volts
Heater Current.....	150 Ma.
Plate Voltage.....	100 Volts
Screen Voltage.....	100 Volts
Cathode Bias Resistor.....	270 Ohms
Plate Current.....	5.2 Ma.
Screen Current.....	2 Ma.
Mutual Conductance.....	2,150 $\mu$ mhos
Plate Resistance.....	175,000 Ohms
Control Grid Bias Voltage for I <sub>b</sub> = 10 $\mu$ A.....	-13.5 Volts

For use in resistance coupled circuits, see data in appendix.



# 6BA5 (Cont'd)

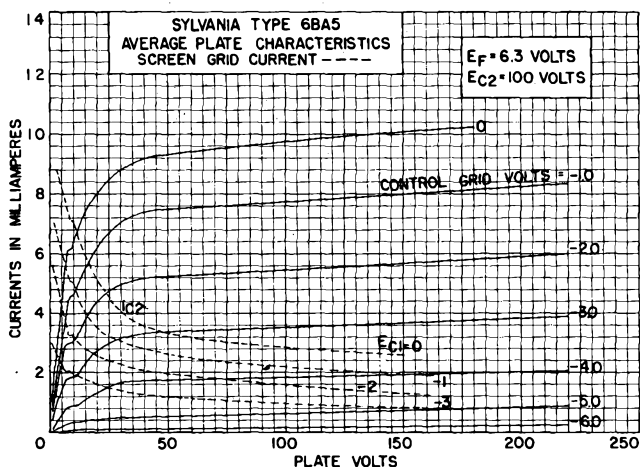

## 6BA6 Sylvania Type

REMOTE CUT-OFF RF PENTODE

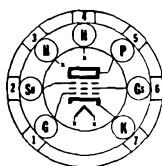

7BK-0-2

### PHYSICAL SPECIFICATIONS

Base .....	Miniature Button 7 Pin
Bulb .....	T-5 1/2
Maximum Overall Length .....	2 1/8"
Maximum Seated Height .....	1 7/8"
Mounting Position .....	Any

### RATINGS

Heater Voltage AC or DC .....	6.3 Volts
Heater Current .....	0.30 Ampere
Maximum Plate Voltage .....	300 Volts
Maximum Screen Voltage .....	125 Volts
Maximum Screen Supply Voltage .....	300 Volts
Maximum Plate Dissipation .....	3 Watts
Maximum Screen Dissipation .....	0.6 Watt
Minimum Control Grid Voltage .....	0 Volt
Maximum Heater-Cathode Voltage .....	90 Volts

#### Direct Interelectrode Capacitances:\*

Grid to Plate .....	0.0035 $\mu$ f. Max.
Input .....	5.5 $\mu$ f.
Output .....	5.0 $\mu$ f.

\*Without external shield.

### TYPICAL OPERATION

Heater Voltage .....	6.3	6.3 Volts
Heater Current .....	0.30	0.30 Ampere
Plate Voltage .....	100	250 Volts
Suppressor Grid .....	Connected to Cathode at Socket	
Screen Voltage .....	100	100 Volts
Self-Bias Resistor .....	68	68 Ohms
Plate Resistance (Approximate) .....	0.25	1.0 Megohms
Mutual Conductance .....	4300	4400 $\mu$ mhos
Grid Voltage at $G_m = 40 \mu$ mhos .....	-20	-20 Volts
Plate Current .....	10.8	11 Ma.
Screen Current .....	4.4	4.2 Ma.

**APPLICATION**

Sylvania Type 6BA6 is a remote cut-off pentode of miniature construction. The remote cut-off characteristics allow smooth control of gain by changing grid bias voltage thus assuring satisfactory performance in a-v-c controlled circuits. Its small size and high mutual conductance together with low interelectrode capacitances make this tube suitable for compact, light weight equipment.

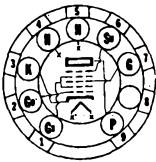
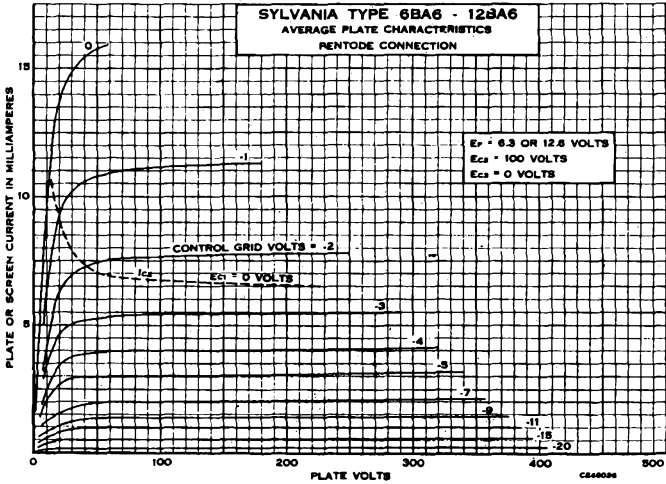

8CT-0-6&8



**Sylvania Type 6BA7**

**HEPTODE CONVERTER**

**PHYSICAL SPECIFICATIONS**

Base.....	Small-Button 9 Pin
Bulb.....	T-6 $\frac{1}{2}$
Maximum Overall Length.....	2 $\frac{3}{4}$ "
Maximum Seated Height.....	2 $\frac{3}{4}$ "
Mounting Position.....	Any

**RATINGS**

Heater Voltage AC or DC.....	6.3 Volts
Heater Current.....	300 Ma.
Maximum Plate Voltage.....	300 Volts
Maximum Screen Voltage.....	100 Volts
Maximum Screen Supply Voltage.....	300 Volts
Maximum Plate Dissipation.....	2.0 Watts
Maximum Screen Dissipation.....	1.5 Watts
Maximum Total Cathode Current.....	22 Ma.
Maximum Signal Grid Voltage	
Negative Bias.....	100 Volts
Positive Bias.....	0 Volts
Maximum Heater-Cathode Voltage.....	90 Volts

<b>Direct Interelectrode Capacitances: (Without Shield)</b>	
Grid G to Plate.....	0.19 $\mu$ f. Max.
Grid G to Go.....	0.1 $\mu$ f. Max.
Grid Go to Plate.....	0.05 $\mu$ f. Max.
RF Input.....	9.5 $\mu$ f.
Oscillator Input.....	6.7 $\mu$ f.
Mixer Output.....	8.3 $\mu$ f.
Grid Go to all Except Cathode.....	3.4 $\mu$ f.
Grid Go to Cathode.....	3.3 $\mu$ f.
Cathode to all Except Grid Go.....	4.0 $\mu$ f.

# 6BA7 (Cont'd)

## TYPICAL OPERATION CONVERTER (Separate Excitation\*)

Heater Voltage.....	6.3	6.3 Volts
Heater Current.....	300	300 Ma.
Plate Voltage.....	100	250 Volts
Suppressor and Internal Shield**.....	Connected directly to ground	
Screen Voltage.....	100	100 Volts
Control Grid Voltage.....	-1	-1 Volts
Oscillator Grid (Go) Resistor.....	20,000	20,000 Ohms
Plate Resistance (Approx.).....	0.5	1.0 Megohm
Conversion Transconductance.....	900	950 $\mu$ mhos
Conversion Transconductance (Approx.) at Signal Grid Volts=-20.....	3.5	3.5 $\mu$ mhos
Plate Current.....	3.6	3.8 Ma.
Screen Current.....	10.0	10.0 Ma.
Oscillator Grid Current.....	0.35	0.35 Ma.
Total Cathode Current.....	14.2	14.2 Ma.

Note: The transconductance between grid Go and screen connected to plate (not oscillating) is approximately 8000  $\mu$ mhos under the following conditions: signal applied to grid G at zero bias; screen and plate at 100 volts; grid G grounded. Under the same conditions, the plate current is 32.0 Ma. and the amplification factor is 16.5.

\*The characteristics shown with separate excitation correspond very closely with those obtained in a self-excited oscillator circuit operating with zero bias.

\*\*Internal shield (pins 6 and 8) connected directly to ground.

## APPLICATION

Sylvania Type 6BA7 is a high gain heptode converter of the miniature style, designed for use in FM broadcast service. A separate connection is provided for direct grounding of the suppressor. The short internal leads which are a feature of miniature construction, make the Type 6BA7 applicable for oscillator-mixer service in the 88-108 mc band. The Type 6BA7 has characteristics similar to those of the metal Type 6SB7-Y.

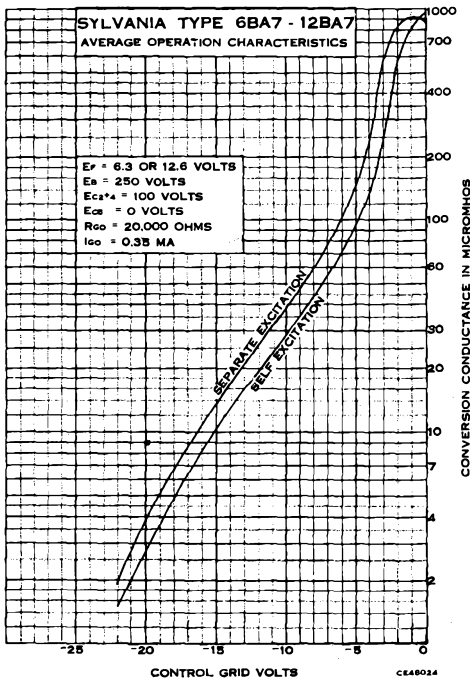



7BD-0-2 & 7



# Sylvania Type 6BC5

SHARP CUTOFF RF PENTODE

## PHYSICAL SPECIFICATIONS

Base .....	Miniature Button 7-Pin
Bulb .....	T5 $\frac{1}{2}$
Maximum Overall Length .....	2 $\frac{1}{8}$ "
Maximum Seated Height .....	1 $\frac{7}{8}$ "
Mounting Position .....	Any

## RATINGS

Heater Voltage (AC or DC) .....	6.3 Volts
Maximum Plate Voltage .....	300 Volts
Maximum Screen Supply Voltage .....	300 Volts
Maximum Plate Dissipation .....	2.0 Watts
Maximum Screen Dissipation .....	0.5 Watts
Maximum Heater Cathode Voltage .....	90 Volts

### Direct Interelectrode Capacitances:

Pentode Connection	Shielded*	Unshielded
Grid to Plate .....	0.020	0.030 $\mu$ mf. Max.
Input .....	6.6	6.5 $\mu$ mf.
Output .....	3.1	1.8 $\mu$ mf.
Triode Connection**		
Grid to Plate .....	2.5	2.5 $\mu$ mf.
Input .....	4.0	3.9 $\mu$ mf.
Output .....	4.3	3.0 $\mu$ mf.

\*With  $\frac{3}{16}$ " diameter shield (RMA Std. 316) connected to Pin 7.

\*\*For triode connection tie screen grid to plate.

## TYPICAL OPERATION

Heater Voltage .....	6.3	6.3	6.3 Volts
Heater Current .....	300	300	300 Ma.
Plate Voltage .....	100	125	250 Volts
Screen Voltage .....	100	125	250 Volts
Cathode Resistor .....	180	100	180 Ohms
Mutual Conductance .....	4900	6100	5700 $\mu$ mhos
Plate Current .....	4.7	8.0	7.5 Ma.
Screen Current .....	1.4	2.4	2.1 Ma.
Plate Resistance (approx.) .....	0.6	0.5	0.8 Megohm
Control Grid Voltage (approx.) for $I_b = 10 \mu$ a. ....	-5	-6	-8 Volts

Heater Voltage .....	6.3	6.3 Volts
Heater Current .....	300	300 Ma.
Plate Voltage .....	250	180 Volts
Grid Voltage .....	2.6	4.9 Volts
Cathode Resistor .....	820	330 Ohms
Mutual Conductance .....	4400	6000 $\mu$ mhos
Plate Current .....	6.0	8.0 Ma.
Plate Resistance (approx.) .....	.009	.006 Megohm
Amplification Factor .....	40	42

## APPLICATION

Sylvania Type 6BC5 is a high mutual conductance sharp cut-off RF pentode of miniature construction. It may be used up to 400 megacycles and is particularly useful in television receivers where a slightly higher gain than that obtained with the similar Type 6AG5 is desired. The two cathode leads may be used to provide separate RF returns in circuits requiring this feature.

# 6BC5 (Cont'd)

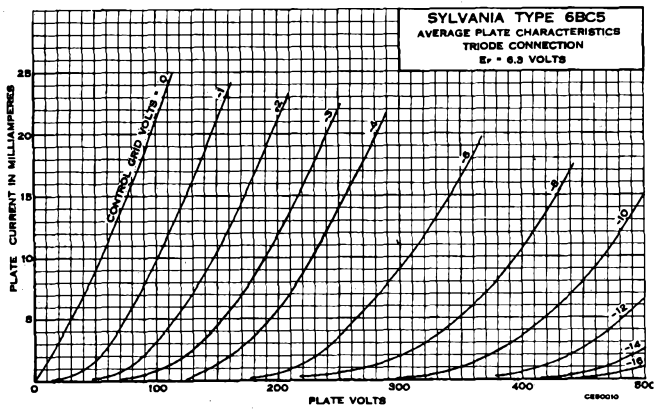
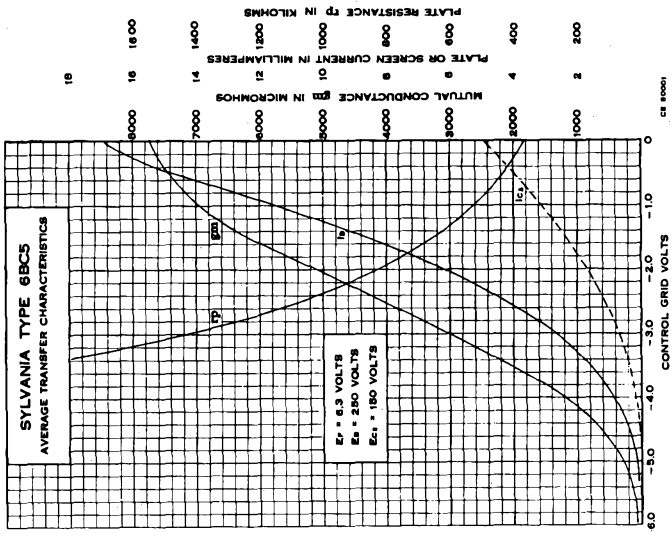
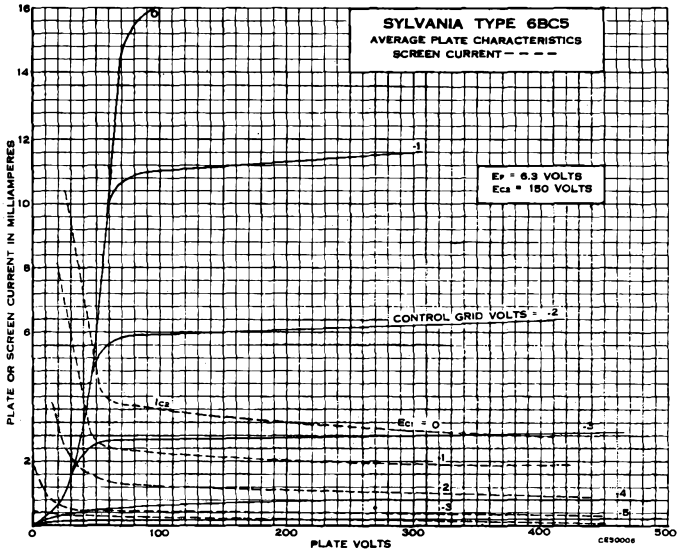

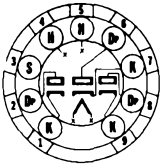

9AX-0-3



# Sylvania Type 6BC7

TRIPLE DIODE

## PHYSICAL SPECIFICATIONS

Base .....	Small Button 9-Pin
Bulb .....	T-6 $\frac{1}{2}$
Maximum Overall Length .....	2 $\frac{3}{16}$ "
Maximum Seated Height .....	1 $\frac{15}{16}$ "
Mounting Position .....	Any

## RATINGS

Heater Voltage AC or DC .....	6.3 Volts.
Heater Current .....	450 Ma.
Maximum Diode Operation Current per Plate .....	12 Ma.
Maximum Peak Heater-Cathode Voltage .....	200 Volts

### Direct Interelectrode Capacitances: (Unshielded)

Plate of Diode # 1 to All Other Elements .....	3.5 $\mu$ mf.
Plate of Diode # 2 to All Other Elements .....	5.5 $\mu$ mf.
Plate of Diode # 3 to All Other Elements .....	3.5 $\mu$ mf.

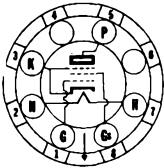

6CK-0-0

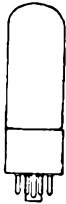

# Sylvania Type 6BD5<sup>GT</sup>

TELEVISION DEFLECTION AMPLIFIER

## PHYSICAL SPECIFICATIONS

Base .....	Intermediate Octal 6-Pin
Bulb .....	T-9
Maximum Overall Length .....	3 $\frac{7}{8}$ "
Maximum Seated Height .....	3 $\frac{5}{16}$ "
Mounting Position .....	Vertical†

†Horizontal operation permitted if pins 2 and 7 are in a vertical plane.

## RATINGS

Heater Voltage (AC or DC) .....	6.3 Volts
Maximum Plate Voltage .....	325 Volts
Maximum Screen Voltage .....	325 Volts
Maximum Plate Dissipation .....	10 Watts
Maximum Cathode Current .....	100 Ma.
Maximum Peak Positive Surge Plate Voltage* .....	4000 Volts
Maximum Peak Negative Surge Control Grid Voltage .....	200 Volts
Maximum Screen Dissipation .....	3.0 Watts
Maximum Control Grid Circuit Resistance .....	1.0 Megohm
Maximum Peak Cathode Current .....	300 Ma.
Maximum Heater to Cathode Voltage .....	135 Volts

\*The duration of the voltage pulse must not exceed 10 microseconds or 15% of the pulse recurrence period, whichever is smaller.

## TYPICAL OPERATION DEFLECTION AMPLIFIER

Heater Voltage .....	6.3 Volts
Heater Current .....	0.9 Ampere
Plate and Screen Grid Supply Voltage .....	310 Volts
Peak Positive Surge Plate Voltage (approx.) .....	2500 Volts
Peak Control Grid Surge Voltage (approx.) .....	50 Volts
Cathode Current .....	90 Ma.
Mutual Conductance** .....	

\*\*The mutual conductance is 5000  $\mu$ mhos when measured with 200 volts on plate and screen, and -12 volts on the control grid.

# 6BD5GT (Cont'd)

## APPLICATION

Sylvania Type 6BD5GT is a beam pentode tube adapted for use as a deflection amplifier tube in television sets. A typical circuit is shown below. The use of this tube and circuit provides full horizontal scanning for a 50° 12 inch picture tube with 11,000 volts anode supply. The stem and basing arrangement permit the use of this tube under the peak voltage condition found in this type of service.

For curve data, reference should be made to type 6L6G, to which type 6BD5GT is similar up to its wattage ratings.

### HORIZONTAL DEFLECTION AMPLIFIER

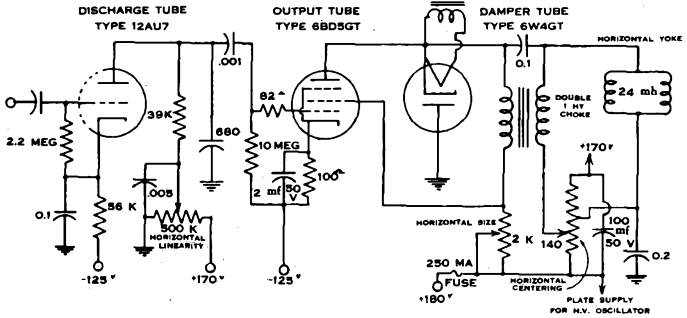

## 6BD6 Sylvania Type

REMOTE CUT-OFF RF PENTODE

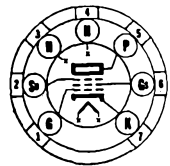

7BK-0-2

## PHYSICAL SPECIFICATIONS

Base .....	Miniature Button 7 Pin
Bulb .....	T-5 1/2
Maximum Overall Length .....	2 1/8"
Maximum Seated Height .....	1 7/8"
Mounting Position .....	Any

## RATINGS

Heater Voltage AC or DC .....	6.3 Volts
Heater Current .....	300 Ma.
Maximum Plate Voltage .....	300 Volts
Maximum Screen Voltage .....	125 Volts
Maximum Plate Dissipation .....	4.0 Watts
Maximum Screen Dissipation .....	0.4 Watts
Maximum Cathode Current .....	14 Ma.
Maximum Heater-Cathode Voltage .....	90 Volts

### Direct Interelectrode Capacitances:

	Shielded	Unshielded
Grid to Plate .....	0.005	0.004 $\mu$ f. Max.
Input .....	4.3	4.3 $\mu$ f.
Output .....	5.0	5.0 $\mu$ f.

## TYPICAL OPERATION

Heater Voltage.....	6.3	6.3 Volts
Heater Current.....	300	300 Ma.
Plate Voltage.....	100	250 Volts
Screen Voltage.....	100	100 Volts
Control Grid Voltage.....	-1	-3 Volts
Plate Current.....	13	9 Ma.
Screen Current.....	5	3.5 Ma.
Plate Resistance.....	0.12	0.7 Megohm
Transconductance.....	2350	2000 $\mu$ mhos
Grid Voltage (approx.) for 10 $\mu$ mhos.....	-35	-35 Volts

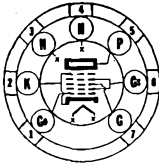

7CH-0-0



## Sylvania Type 6BE6

## HEPTODE CONVERTER

## PHYSICAL SPECIFICATIONS

Base.....	Miniature Button 7 Pin
Bulb.....	T5 $\frac{1}{2}$
Maximum Overall Length.....	2 $\frac{1}{8}$ "
Maximum Seated Height.....	1 $\frac{1}{8}$ "
Mounting Position.....	Any

## RATINGS

Heater Voltage AC or DC.....	6.3 Volts
Heater Current.....	300 Ma.
Maximum Plate Voltage.....	300 Volts
Maximum Screen Voltage.....	100 Volts
Maximum Screen Supply.....	300 Volts
Maximum Plate Dissipation.....	1.0 Watt
Maximum Screen Dissipation.....	1.0 Watt
Maximum Cathode Current.....	14.0 Ma.
Minimum Control Grid Voltage.....	0 Volt
Maximum Heater-Cathode Voltage.....	90 Volts

## Direct Interelectrode Capacitances:\*

Grid 3 to Plate.....	0.30 $\mu$ mf. Max.
Mixer Input.....	7.0 $\mu$ mf.
Mixer Output.....	8.0 $\mu$ mf.
Oscillator Input.....	5.5 $\mu$ mf.
Grid 1 to Grid 3.....	0.15 $\mu$ mf. Max.
Grid 1 to Plate.....	0.05 $\mu$ mf. Max.
Grid 1 to Cathode.....	3.0 $\mu$ mf.
Cathode to all except Grid 1.....	15.0 $\mu$ mf.

\*Without external shield.

## TYPICAL OPERATION

## (SEPARATE EXCITATION)\*

Heater Voltage.....	6.3	6.3 Volts
Heater Current.....	300	300 Ma.
Plate Voltage.....	100	250 Volts
Screen Voltage.....	100	100 Volts
Control Grid Voltage.....	-1.5	-1.5 Volts
Plate Current.....	2.6	2.6 Ma.
Screen Current.....	7.5	7.5 Ma.
Oscillator Grid Current.....	0.5	0.5 Ma.
Total Cathode Current.....	10.6	10.6 Ma.
Oscillator Grid Resistor.....	20000	20000 Ohms
Plate Resistance (Approximate).....	0.4	1.0 Megohms
Conversion Transconductance.....	455	475 $\mu$ mhos
Conversion Transconductance, Eg3=-30 Volts..	10 App.	10 App. $\mu$ mhos

\*Data for self excitation in a zero bias circuit corresponds very closely to that for separate excitation.

## APPLICATION

Sylvania Type 6BE6 is a miniature style heptode converter. It is similar in application to Type 6SA7GT and lock-in Type 7Q7. Operation data as given are for separate excitation but corresponds very closely to that obtained with self excitation. The small size of this tube lends itself readily to the design of light-weight compact equipment.



SYLVANIA RADIO TUBES

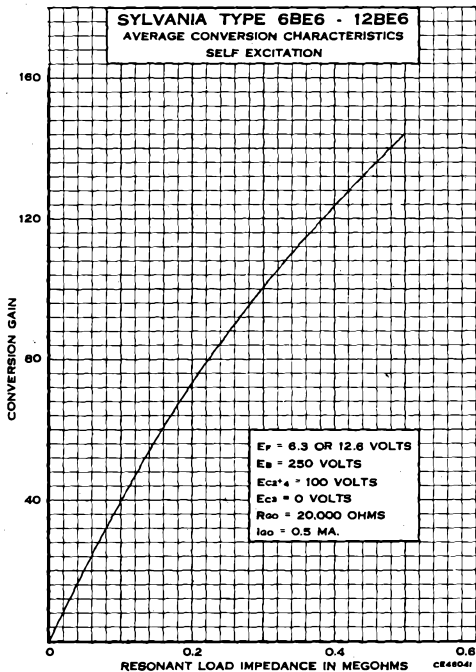

# 6BE6 (Cont'd)

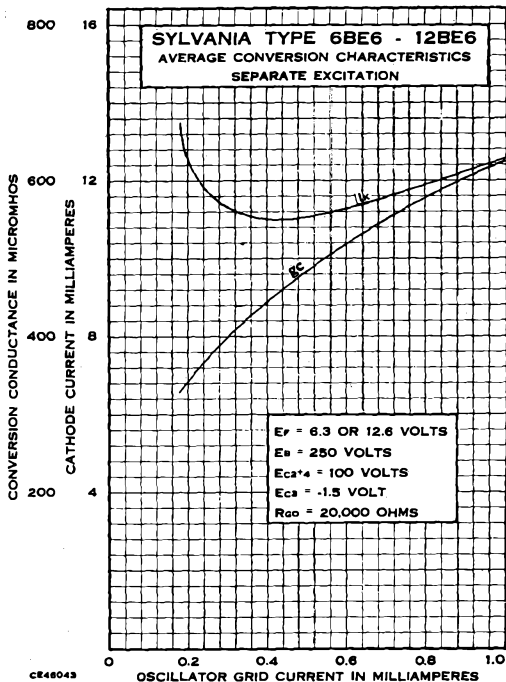



7BZ-0-0



## Sylvania Type 6BF5

BEAM POWER AMPLIFIER

### PHYSICAL SPECIFICATIONS

Base.....	Miniature Button 7-Pin
Bulb.....	T-5½"
Maximum Overall Length.....	2½"
Maximum Seated Height.....	2½"
Mounting Position.....	Any

### RATINGS

#### VERTICAL DEFLECTION AMPLIFIER OPERATION

Heater Voltage AC or DC.....	6.3 Volts
Maximum Plate Voltage.....	250 Volts
Maximum Screen Voltage.....	250 Volts
Maximum Plate Dissipation.....	5 Watts
Maximum Screen Dissipation.....	1.25 Watts
Maximum Heater-Cathode Voltage.....	100 Volts
Maximum Plate Peak to Peak Pulse Component.....	+700 Volts
Maximum Control Grid Resistor.....	2.2 Megohms
Minimum Cathode Bias Resistor.....	820 Ohms
Maximum Plate Duty Cycle.....	7% of Vertical Repetition Rate

#### Direct Interelectrode Capacitances: Unshielded

	Pentode	Triode Connected
Grid #1 to Plate.....	0.65	7.5 μmf.
Input.....	14	7 μmf.
Output.....	6	6 μmf.

### TYPICAL OPERATION

#### VERTICAL DEFLECTION AMPLIFIER (TRIODE CONNECTION)

Heater Voltage.....	6.3 Volts
Heater Current.....	1.2 Amperes
Plate Voltage.....	225 Volts
Screen (Tie to Plate)	
Cathode Bias Resistor.....	1200 Ohms
Control Grid Input Potential Peak to Peak Sawtooth (approx.)....	40 Volts
Negative Control Grid Peaking Component (approx.).....	56 Volts
DC Plate Current.....	20 Ma.
Plate Peak Positive Pulse Component (approx.).....	500 Volts
Plate Peak to Peak Sawtooth Component.....	140 Volts
Sweep Height for 16" Tube with 53° Deflection Angle and 14 KV Anode Voltage.....	11½ Inches
Mutual Conductance.....	4200 μmhos
Amplification Factor.....	6.7

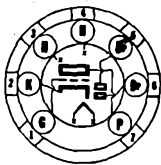

7BT-0-0



## Sylvania Type 6BF6

DUODIODE TRIODE

### PHYSICAL SPECIFICATIONS

Base.....	Miniature Button 7 Pin
Bulb.....	T-5½"
Maximum Overall Length.....	2½"
Maximum Seated Height.....	1½"
Mounting Position.....	Any

### RATINGS—Triode Unit

Heater Voltage AC or DC.....	6.3 Volts
Heater Current.....	300 Ma.
Maximum Plate Voltage.....	300 Volts
Maximum Plate Dissipation.....	2.5 Watt
Maximum Peak Heater-Cathode Voltage.....	90 Volts

#### Direct Interelectrode Capacitances:—Triode Unit

	Shielded	Unshielded
Grid to Plate.....	2.0	2.0 μmf.
Grid to Cathode.....	1.8	1.8 μmf.
Plate to Cathode.....	1.4	1.1 μmf.

# 6BF6 (Cont'd)

## TYPICAL OPERATION TRIODE UNIT - CLASS A<sub>1</sub> AMPLIFIER

Heater Voltage.....	6.3 Volts
Heater Current.....	300 Ma.
Plate Voltage.....	250 Volts
Grid Voltage.....	-9 Volts
Amplification Factor.....	16
Plate Resistance.....	8500 Ohms
Transconductance.....	1900 $\mu$ mhos
Plate Current.....	9.5 Ma.
Load Resistance.....	10,000 Ohms
Total Harmonic Distortion.....	6.5 %
Power Output.....	300 Mw

Data for use in Resistance Coupled Amplifiers may be obtained by referring to type 7E6 in the appendix.

# 6BF7 Sylvania Type

DUOTRIODE

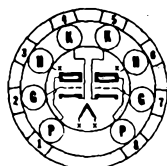

8DG-0-0

## PHYSICAL SPECIFICATIONS

Base.....	Flexible Leads
Bulb.....	T-3
Maximum Bulb Overall Length.....	1 1/2"
Minimum Lead Length.....	1 1/2"
Mounting Position.....	Any

## RATINGS

Heater Voltage AC or DC.....	6.3 Volts
Maximum Plate Voltage.....	110 Volts
Maximum Plate Dissipation (each section).....	1.0 Watt
Maximum Heater-Cathode Voltage.....	90 Volts

### Direct Interelectrode Capacitances:

	Unshielded	Shielded
Grid to Plate (each section).....	1.5	1.5 $\mu$ fd.
Input (each section).....	2.0	2.0 $\mu$ fd.
Output (section #1).....	0.28	1.6 $\mu$ fd.
(section #2).....	0.30	2.0 $\mu$ fd.
Grid to Grid.....	0.009	0.008 $\mu$ fd.
Plate to Plate.....	0.75	0.55 $\mu$ fd.

\*External shield 0.405" diameter connected to cathode.

## TYPICAL OPERATION

Heater Voltage AC or DC.....	6.3 Volts
Heater Current.....	300 Ma.
Plate Voltage.....	100 Volts
Cathode Bias Resistor.....	100 Ohms
Plate Current.....	8.0 Ma.
Amplification Factor.....	35
Mutual Conductance.....	4,800 $\mu$ mhos
Plate Resistance.....	7,000 Ohms
Control Grid Voltage for $I_b = 10\mu$ a.....	-7.5 Volts

For use in resistance coupled circuits, see data in appendix.

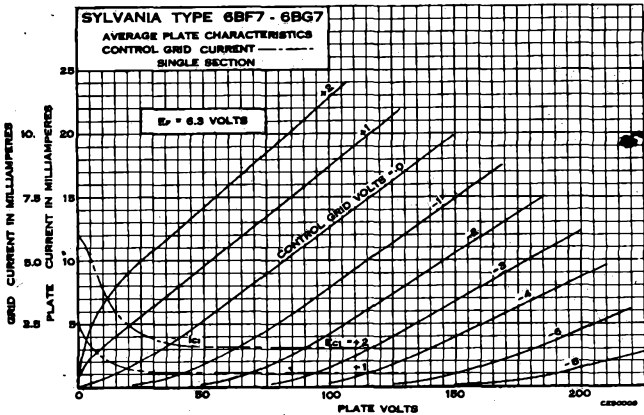
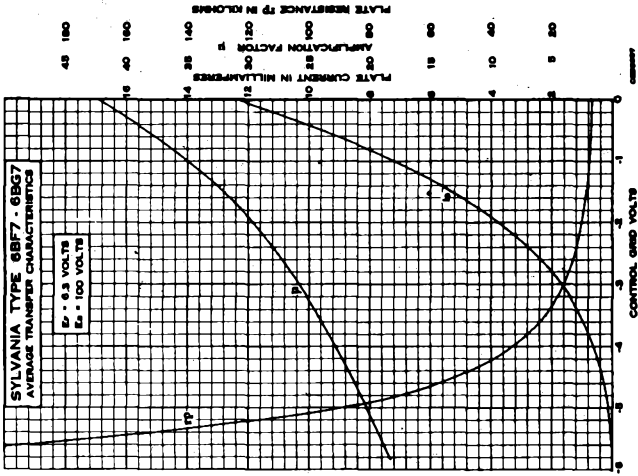

## Sylvania Type 6BG6-G

BEAM POWER AMPLIFIER

### PHYSICAL SPECIFICATIONS

Base .....	Medium-Shell Octal 6 Pin
Bulb .....	ST-16
Cap. ....	Miniature
Maximum Overall Length .....	5 11/16"
Maximum Seated Height .....	5 1/8"
Mounting Position .....	Vertical, Base Up or Down Horizontal, with Plane of Pins 2 and 7 Vertical

# 6BG6-G (Cont'd)

## RATINGS

Heater Voltage AC or DC.....	6.3 Volts
Heater Current.....	0.9 Ampere
Maximum Plate Voltage.....	700 Volts
Maximum Peak Positive Surge Plate Voltage*	6000 Volts
Maximum Screen Voltage**.....	350 Volts
Maximum Negative Control Grid Voltage.....	50 Volts
Maximum Peak Negative Surge Control Grid Voltage*	400 Volts
Maximum DC Plate Current.....	100 Ma.
Maximum Screen Input.....	3.2 Watts
Maximum Plate Dissipation.....	20 Watts
Maximum Heater-Cathode Voltage.....	135 Volts
Maximum Control Grid Circuit Resistance.....	1.0 Megohm

\*The duty cycle of the voltage pulse must not exceed 15% of one scanning cycle and its duration must be limited to 10 microseconds.

\*\*Preferably obtained from plate voltage supply through a series dropping resistor of sufficient magnitude to limit the screen grid input to the rated maximum value for wide variation in screen current.

### Direct Interelectrode Capacitances:\*

Grid to Plate.....	.65 $\mu$ f. Max.
Input.....	12.0 $\mu$ f.
Output.....	6.5 $\mu$ f.

\*With no external shield.

## TYPICAL OPERATION DEFLECTION AMPLIFIER

DC Supply Voltage, Plate and Screen.....	400 Volts
Peak Positive Surge Plate Voltage (Approx.).....	4000 Volts
Peak Negative Surge Control Grid Voltage.....	-100 Volts
Plate Current.....	70 Ma.
Screen Current.....	6 Ma.
Control Grid Current.....	25 $\mu$ a
Transconductance (approx.).....	6000 $\mu$ mhos

## APPLICATION

Sylvania Type 6BG6-G is a beam power amplifier designed for use as the driver tube in the horizontal deflection amplifier of television circuits using electro-magnetic deflection. A possible circuit is shown on the following page.

### HORIZONTAL DEFLECTION CIRCUIT

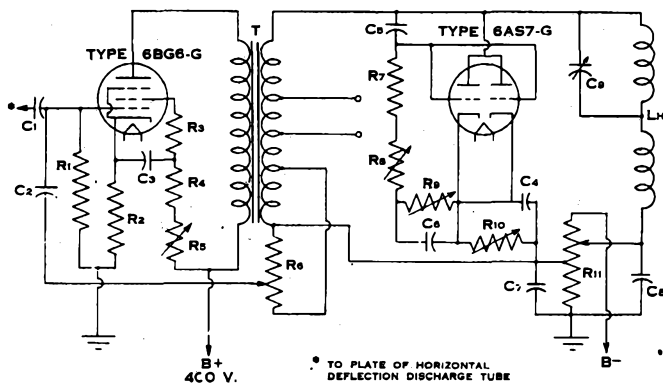

C1: 0.01  $\mu$ f, 400 DC working volts  
 C2: 150  $\mu$ f, 400 DC working volts  
 C3 C4: 4  $\mu$ f, 450 DC working volts (electrolytic)  
 C5: 30  $\mu$ f, 1500-volt surge  
 C6: 0.02  $\mu$ f, 400 DC working volts  
 C7 C8: 100  $\mu$ f, 10 DC working volts  
 C9: Balancing Capacitor, 25 to 75  $\mu$ f, 800-volt surge  
 LH: Horizontal Deflecting Yoke, Teletron Type No. DY-15, or equivalent  
 R1: 500,000 ohms, 1/2 watt  
 R2: 100 ohms, 2 watts  
 R3: 100 ohms, 1/2 watt  
 R4: 8000 ohms, 4 watts

R5: Width Control, 50,000 ohms, 5 watts  
 R6: Feaking Amplitude and Linearity Control, 5000 ohms, wire wound, 2 watts  
 R7: 50,000 ohms, 1 watt  
 R8: Linearity Control, 25,000 ohms, 1 watt  
 R9: Linearity Control, 100,000 ohms, 1 watt  
 R10: Linearity Control, 1000 ohms, 5 watts  
 R11: Centering Control, 20 ohms, tapped at 10 ohms  
 T: Horizontal Deflection Transformer, Teletron Type No. YT-111H, or equivalent

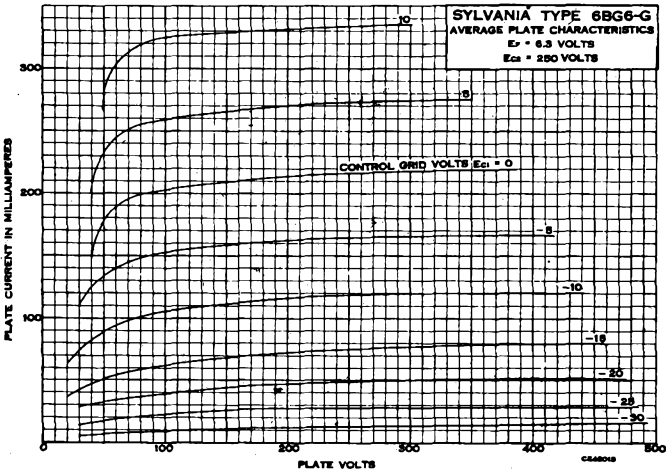
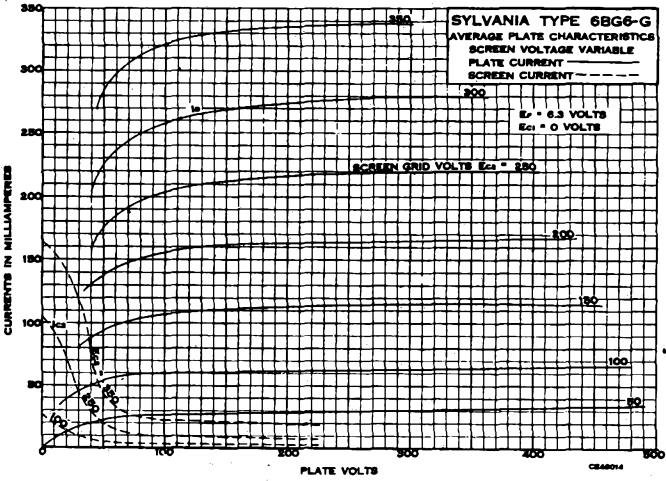

# 6BG7 Sylvania Type

DUOTRIODE

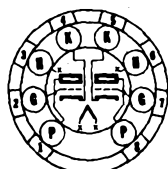

8DG-0-0

## PHYSICAL SPECIFICATIONS

Base .....	Subminiature Button 8-Pin
Bulb .....	T-3
Maximum Overall Length .....	1 3/4"
Maximum Seated Height .....	1 1/2"
Mounting Position .....	Any

For other data, refer to corresponding Type 6BF7 which is identical except for lead length.

# 6BH6 Sylvania Type

SHARP CUT-OFF RF PENTODE

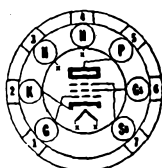

7CM-0-7

## PHYSICAL SPECIFICATIONS

Base .....	Small-Button Miniature 7 Pin
Bulb .....	T-5 1/2
Maximum Overall Length .....	2 1/8"
Maximum Seated Height .....	1 7/8"
Mounting Position .....	Any

## RATINGS

Heater Voltage AC or DC .....	6.3 Volts
Heater Current .....	150 Ma.
Maximum Plate Voltage .....	300 Volts
Maximum Screen Voltage .....	150 Volts
Maximum Screen Supply Voltage .....	300 Volts
Maximum Control Grid Voltage .....	
Negative bias value .....	50 Volts
Positive bias value .....	0 Volts
Maximum Plate Dissipation .....	3.0 Watts
Maximum Screen Dissipation .....	0.5 Watts
Maximum Heater-Cathode Voltage .....	90 Volts

### Direct Interelectrode Capacitances:\*

Grid to Plate .....	0.0035 $\mu$ f. Max.
Input .....	5.4 $\mu$ f.
Output .....	4.4 $\mu$ f.

\*With no external shield.

## TYPICAL OPERATION

### CLASS A<sub>1</sub> AMPLIFIER

Heater Voltage .....	6.3	6.3 Volts
Heater Current .....	150	150 Ma.
Plate Voltage .....	100	250 Volts
Suppressor .....	Connected to cathode at socket	
Screen Voltage .....	100	150 Volts
Control Grid Voltage .....	-1	-1 Volt
Plate Current .....	3.6	7.4 Ma.
Screen Current .....	1.4	2.9 Ma.
Control Grid Bias (approx.) for 10 $\mu$ a Plate Current .....	-5	-7.7 Volts
Plate Resistance .....	0.7	1.4 Megohms
Transconductance .....	3400	4600 $\mu$ mhos

## APPLICATION

Sylvania Type 6BH6 is a sharp cut-off RF pentode of miniature construction. It has a 150 Ma. heater which makes it useful in AC/DC receivers, and in mobile equipment requiring low heater drain.



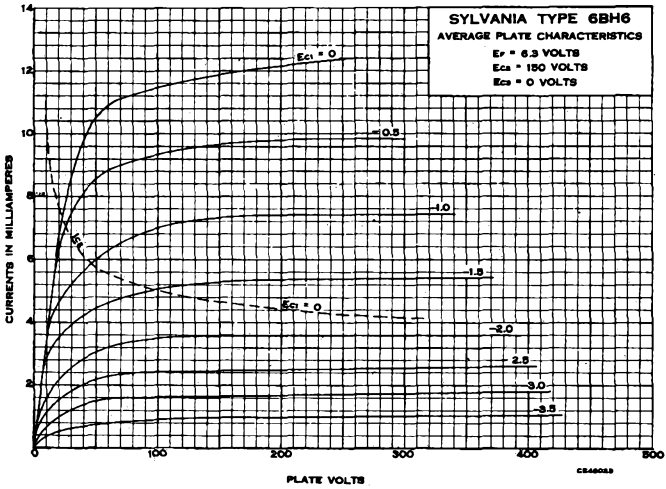
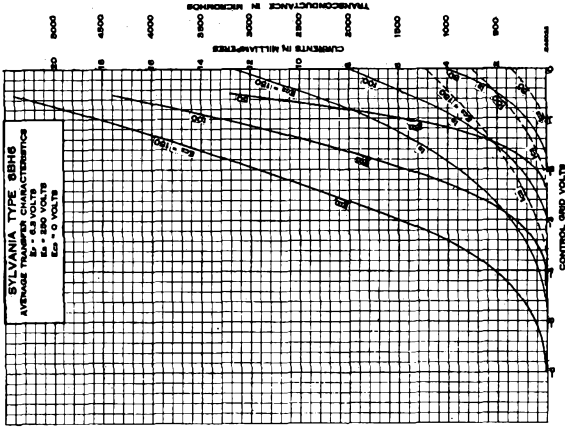

**Sylvania Type 6BJ6**  
 REMOTE CUT-OFF RF PENTODE

**PHYSICAL SPECIFICATIONS**

Base .....	Miniature Button 7 Pin
Bulb .....	T-5 1/2"
Maximum Overall Length .....	2 1/8"
Maximum Seated Height .....	1 1/8"
Mounting Position .....	Any

# 6BJ6 (Cont'd)

## RATINGS

Heater Voltage AC or DC.....	6.3 Volts
Heater Current.....	150 Ma.
Maximum Plate Voltage.....	300 Volts
Maximum Screen Voltage.....	125 Volts
Maximum Screen Supply Voltage.....	300 Volts
Maximum Plate Dissipation.....	3.0 Watts
Maximum Screen Dissipation.....	0.6 Watts
Maximum Control Grid Voltage	
Negative bias.....	50 Volts
Positive bias.....	0 Volts
Maximum Peak Heater-Cathode Voltage.....	90 Volts

### Direct Interelectrode Capacitances:\*

Grid to Plate.....	0.0035 $\mu$ f. Max.
Input.....	4.5 $\mu$ f.
Output.....	5.0 $\mu$ f.

\*Without external shield.

## TYPICAL OPERATION

### CLASS A<sub>1</sub> AMPLIFIER

Heater Voltage.....	6.3	6.3 Volts
Heater Current.....	150	150 Ma.
Plate Voltage.....	100	250 Volts
Screen Voltage.....	100	100 Volts
Control Grid Voltage.....	-1	-1 Volt
Suppressor.....	Connected to cathode at socket	
Control Grid Bias (Approx.)		
for 15 $\mu$ hos Transconductance.....	-20	-20 Volts
Plate Current.....	9.0	9.2 Ma.
Screen Current.....	3.5	3.3 Ma.
Transconductance.....	3650	3800 $\mu$ hos
Plate Resistance (Approx.).....	0.25	1.3 Megohms

## APPLICATION

Sylvania Type 6BJ6 is a remote cut-off pentode of miniature construction designed for use in sets requiring 150 Ma. heater current. It is similar in application to Sylvania Type 6BA6.

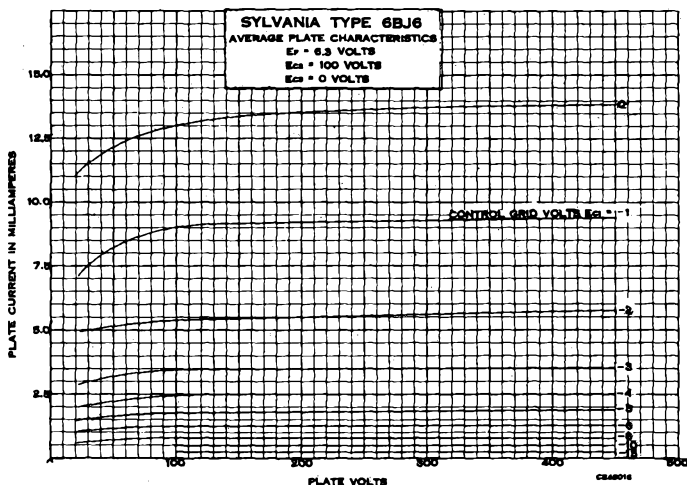

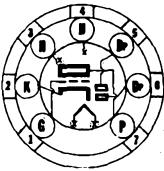
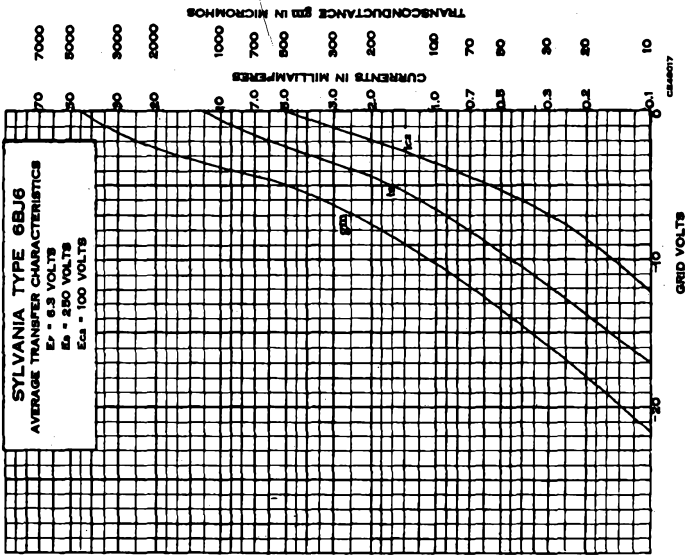

7BT-0-2

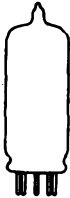
**Sylvania Type 6BK6**

DUO-DIODE HIGH-MU TRIODE

**PHYSICAL SPECIFICATIONS**

Base.....	Miniature Button 7 Pin
Bulb.....	T5 $\frac{1}{2}$
Maximum Overall Length.....	2 $\frac{5}{8}$ "
Maximum Seated Height.....	2 $\frac{3}{8}$ "
Mounting Position.....	Any

**RATINGS**

Heater Voltage (AC or DC).....	6.3 Volts
Heater Current.....	300 Ma.
Maximum Plate Volts.....	300 Volts
Average Diode Current per Diode at 10 Volts DC.....	4.0 Ma.
Maximum Heater Cathode Voltage.....	$\pm 90$ Volts
Maximum Diode Current for Continuous Operation.....	1.0 Ma.
Maximum Positive Grid Voltage.....	0 Volts

**Direct Interelectrode Capacitances:**

	Shielded*	Unshielded
Either Diode Plate to Cathode.....	1.0	1.0 $\mu$ mf.
Diode Plate No. 1 to Grid.....	01	.013 $\mu$ mf.

\*With a  $\frac{3}{8}$ " diameter shield (RMA Std. No. 316) connected to cathode.**TYPICAL OPERATION**

Heater Voltage (AC or DC).....	6.3	6.3 Volts
Heater Current.....	300	300 Ma.
Plate Voltage.....	100	250 Volts
Grid Voltage.....	-1.0	-2.0 Volts
Amplification Factor.....	100	100
Plate Resistance.....	80,000	62,500 Ohms
Mutual Conductance.....	1250	1600 $\mu$ mhos
Plate Current.....	0.5	1.2 Ma.

# 6BK6 (Cont'd)

## APPLICATION

Sylvania Type 6BK6 is a miniature duo-triode high- $\mu$  triode having characteristics very similar to type 6AV6, except for the improved diode characteristics. The improved diode permeance gives better rectification efficiency at low signals and the improved diode shielding reduces undesirable audio coupling between diode and triode.

Data for use in Resistance Coupled Amplifier Circuits may be found in the appendix.

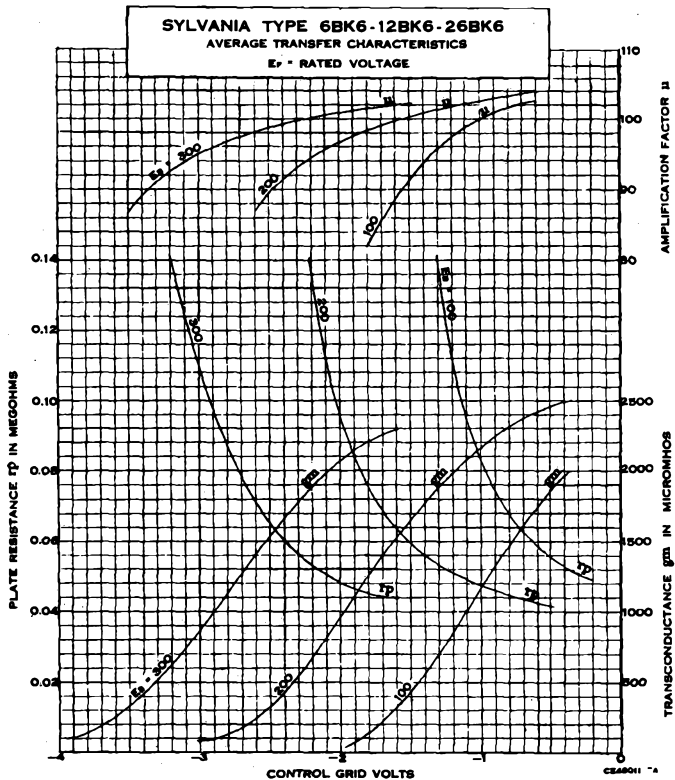
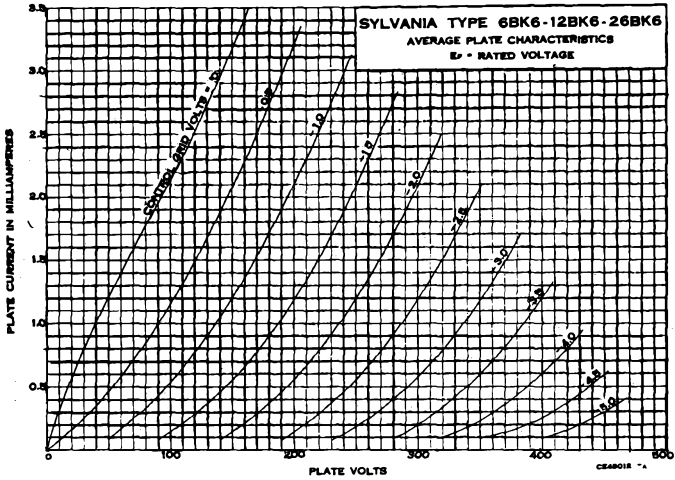

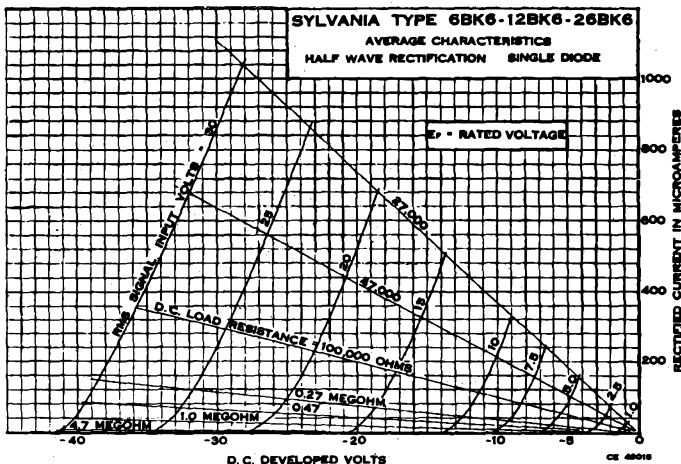

## Sylvania Type 6BL7<sup>GT</sup>

DUOTRIODE

### PHYSICAL SPECIFICATIONS

Base.....	Short Intermediate Shell 8 Pin Octal
Bulb.....	T-9
Maximum Overall Length.....	3 <sup>5</sup> / <sub>16</sub> "
Maximum Seated Height.....	2 <sup>3</sup> / <sub>4</sub> "
Mounting Position.....	Any

### RATINGS

Heater Voltage (AC or DC).....	6.3 Volts
Heater Current.....	1.5 Amperes
Maximum Plate Supply Voltage.....	600 Volts
Maximum Plate Voltage.....	500 Volts
Maximum Peak Plate Voltage*.....	2000 Volts
Maximum Peak Negative Grid Voltage.....	-500 Volts
Maximum Cathode Current per Section.....	60 Ma.
Maximum Plate Dissipation per Section**.....	10 Watts
Maximum Peak Heater-Cathode Voltage.....	±200 Volts
Maximum Grid Circuit Resistance.....	4.7 Megohms

\*The duration of the voltage pulse should not exceed 15 % of one vertical scanning cycle. In a 525 line, interlaced two to one, 30 frame per second television system, 15 % of one vertical scanning cycle is 2.5 milliseconds.

\*\*Total dissipation for both sections is limited to 12 watts.

#### Direct Interelectrode Capacitances:

	Shielded #	Unshielded
Section 1—Grid to Plate.....	4.2	4.2 $\mu$ f.
Input.....	5.0	4.4 $\mu$ f.
Output.....	3.4	1.1 $\mu$ f.
Section 2—Grid to Plate.....	4.0	4.0 $\mu$ f.
Input.....	5.0	4.8 $\mu$ f.
Output.....	3.2	1.2 $\mu$ f.
Coupling—Grid to Grid.....	0.1	1.11 $\mu$ f.
Plate to Plate.....	1.2	1.5 $\mu$ f.

\* With a 1<sup>5</sup>/<sub>16</sub>" diameter tube shield (RMA Std. #308) connected to cathode of section under test.

# 6BL7GT (Cont'd)

## TYPICAL OPERATION CLASS A<sub>1</sub> AMPLIFIER—SINGLE SECTION

Heater Voltage.....	6.3 Volts
Heater Current.....	1.5 Amperes
Plate Voltage.....	250 Volts
Grid Voltage.....	-9.0 Volts
Plate Current.....	40 Ma.
Amplification Factor.....	15
Mutual Conductance.....	7000 $\mu$ mhos
Plate Resistance.....	2150 Ohms
Grid Voltage for $I_b = 25 \mu$ a (approx.).....	-25 Volts
Grid Voltage for $I_b = 50 \mu$ a at $E_b = 600$ Volts (approx.).....	-60 Volts

## AS A VERTICAL DEFLECTION AMPLIFIER SINGLE SECTION SCANNING A TYPE 16TP4 AT 14 KV.

Plate Supply Voltage.....	350 Volts
Peak Positive Plate Voltage.....	1030 Volts
Plate Voltage (Pulse Component).....	510 Volts
Plate Voltage, Peak to Peak (Sawtooth).....	340 Volts
Cathode Bias Resistor.....	2800 Ohms
Signal Voltage (Negative Peaking Component).....	20 Volts
Signal Voltage, Peak to Peak (Sawtooth).....	45 Volts
Average Plate Current.....	10.2 Ma.
Plate Current, Peak to Peak.....	40 Ma.
Plate Input.....	3.3 Watts
Plate Dissipation.....	2.2 Watts
Retrace Time.....	250 $\mu$ seconds

## PARALLELED SECTIONS FOR HIGH EFFICIENCY WITH A TYPE 16TP4 AT 14 KV.

Plate Supply Voltage.....	300 Volts
Peak Positive Plate Voltage.....	1020 Volts
Plate Voltage (Pulse Component).....	540 Volts
Plate Voltage, Peak to Peak (Sawtooth).....	360 Volts
Cathode Bias Resistor.....	2600 Ohms
Signal Voltage (Negative Peaking Component).....	22 Volts
Signal Voltage, Peak to Peak (Sawtooth).....	43 Volts
Average Plate Current.....	10.2 Ma.
Plate Current, Peak to Peak.....	40 Ma.
Plate Input.....	2.8 Watts
Plate Dissipation.....	1.6 Watts
Retrace Time.....	220 $\mu$ seconds

## APPLICATION

Sylvania Type 6BL7GT is a high mutual conductance duotriode designed for use as a vertical deflection amplifier in television receivers. The high current available at low voltage provides the power necessary to deflect wide angle picture tubes, such as Sylvania Type 16TP4, when operated at their maximum (14 Kv.) second anode voltage. For certain applications where the plate supply voltage must be kept low and the highest efficiency obtained, the parallel connection of the two sections may be used. A separate triode will then be required for the sawtooth generator.

Circuit diagrams illustrating each use are shown on a following page together with the recommended components. Wave forms obtained at different points in the circuit are shown in Fig. 3 as obtained in the circuit of Fig. 1.

The operating efficiency of the Sylvania Type 6BL7GT is greater at low plate supply voltages for the reason that the power required for scanning is constant and the lowest plate supply voltage necessary to provide this power is, therefore, the condition of lowest power loss.

FIGURE 1

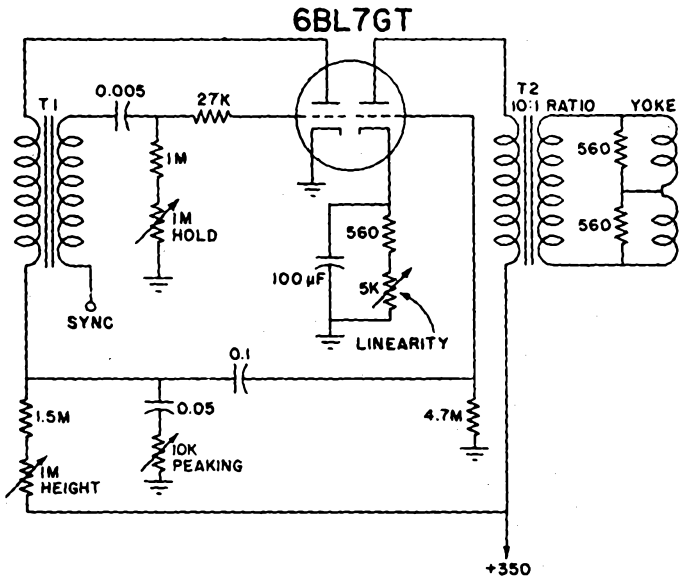

TYPICAL VERTICAL DEFLECTION CIRCUIT USING A SINGLE SECTION OF TYPE 6BL7GT IN THE OUTPUT CIRCUIT. THE SECOND SECTION IS USED FOR THE SAWTOOTH GENERATOR.

FIGURE 2

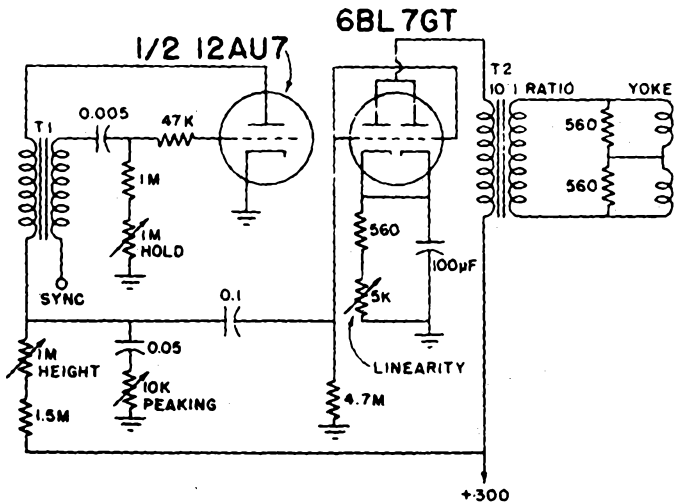

TYPICAL VERTICAL DEFLECTION CIRCUIT USING BOTH SECTIONS OF TYPE 6BL7GT IN PARALLEL IN THE OUTPUT CIRCUIT.

# 6BL7GT (Cont'd)

The data given for higher voltages, however, are useful in showing the reserve power available for conservative design, for picture tubes requiring greater deflection power, and for flexibility in the choice of supply voltage.

The use of the boost voltage from the horizontal scanning circuit may permit the use of a lower supply voltage in the receiver.

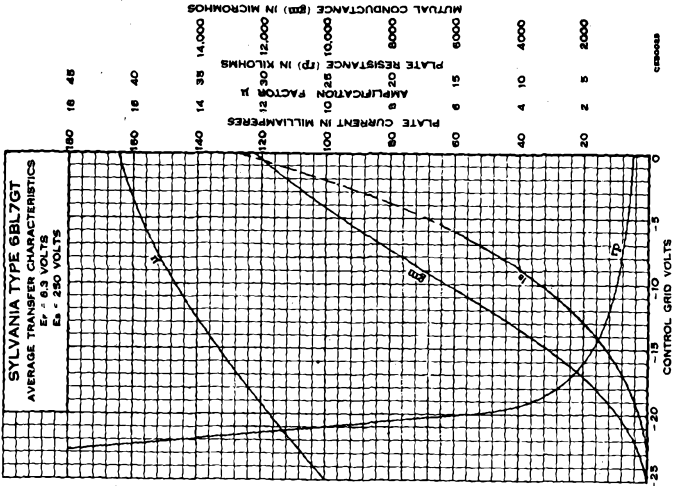
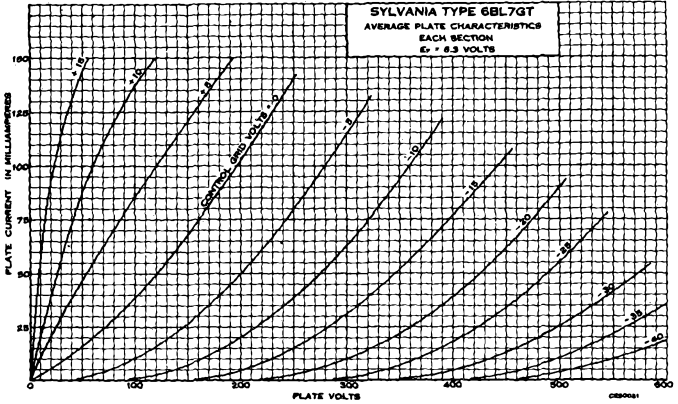
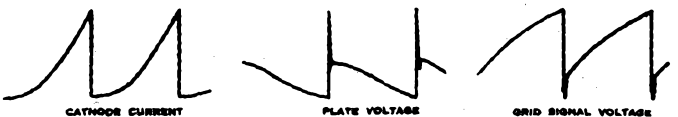
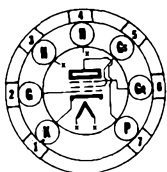

FIGURE 3







7DF-0-1

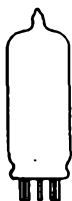

# Sylvania Type 6BN6

## GATED BEAM DISCRIMINATOR

### PHYSICAL SPECIFICATIONS

Base .....	Miniature Button 7 Pin
Bulb .....	T-5 1/2"
Maximum Overall Length .....	2 5/8"
Maximum Seated Height .....	2 3/8"
Mounting Position .....	Any

### RATINGS

Heater Voltage .....	6.3 Volts
Maximum Plate Voltage .....	135 Volts
Maximum Screen Voltage .....	100 Volts
Maximum Total Cathode Current .....	10 Ma.
Maximum Peak Positive Grid Voltage .....	45 Volts

### TYPICAL OPERATION

Heater Voltage .....	6.3 Volts
Heater Current .....	300 Ma.
Plate Voltage (Supply) .....	80 Volts
Screen Voltage .....	60 Volts
Control Grid Voltage obtained by cathode bias resistor Cathode Bias Resistor* .....	200-400 Ohms
Plate Current .....	0.23 Ma.
Screen Current .....	5.0 Ma.
Plate Load Resistor .....	68000 Ohms

\*Bias Voltage -1.3 approx. Fixed bias operation not recommended.

### APPLICATION

Sylvania Type 6BN6 is a gated beam tube in miniature construction designed especially for use in FM limiter-discriminator circuits. It may also be used as a sync separator and square wave generator. Type 6BN6 represents a considerable departure from the construction and characteristics of a conventional pentode. Due to the use of a sharply focused electron beam, the first control grid has a step shaped control characteristic, the plate current rising abruptly from zero to a sharply defined maximum as the grid voltage changes from negative to positive. The second control grid has similar properties. If made strongly negative it cuts the plate current off, or over a range of potentials in the vicinity of zero it controls the height of the plate current maximum, but if made more positive it loses all control of the plate current, which cannot exceed a certain level.

In the limiter discriminator application the first control grid is biased near the midpoint of its characteristic and passes current during the positive half cycle of signal, the peak amplitude of the current being limited to a definite value. After passing through the second accelerator the pulsed current produces a current in the second control grid by space charge coupling. If an LC circuit tuned to the signal frequency is connected to the second control grid, a voltage at signal frequency is produced which lags the signal voltage on grid 1, by about 90 degrees. The voltage on the second control grid, or quadrature grid, then controls the width of the plate current pulses to the plate, so that the average plate current is proportional to the frequency deviation of the signal, and the audio signal may be recovered from a load resistor in the plate circuit.

# 6BN6 (Cont'd)

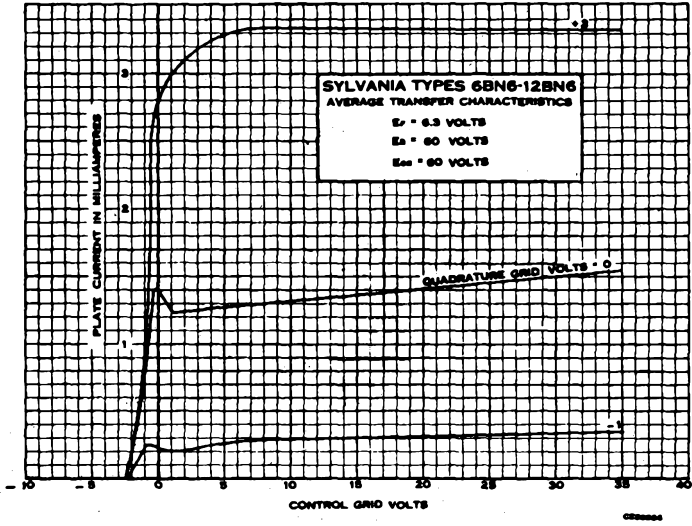

# Sylvania Type 6BQ6<sup>GT</sup>

BEAM POWER AMPLIFIER



6AM-0-0



## PHYSICAL SPECIFICATIONS

Base .....	Intermediate Octal 7 Pin
Bulb .....	T-9
Cap .....	Miniature
Maximum Overall Length .....	3 7/8"
Maximum Seated Height .....	3 3/8"
Mounting Position .....	Any

## RATINGS

Heater Voltage (AC or DC) .....	6.3 Volts
Maximum Plate Voltage .....	550 Volts
Maximum Peak Positive Surge Plate Voltage .....	5,000 Volts
Maximum Screen Voltage .....	200 Volts
Maximum Negative Control Grid Voltage .....	50 Volts
Maximum Peak Negative Surge Control Grid Voltage .....	100 Volts
Maximum DC Plate Current .....	100 Ma.
Maximum Screen Dissipation .....	2.5 Watts
Maximum Plate Dissipation .....	10 Watts
Maximum Control Grid Circuit Resistance .....	0.5 Megohms
Maximum Peak Heater-Cathode Voltage .....	180 Volts

Ratings are based on use in typical television service in which the duty cycle of the voltage pulse must not exceed 15% on one scanning cycle or 10 microseconds whichever is smaller.

### Direct Interelectrode Capacitances†

Grid to Plate .....	0.95 $\mu$ f.
Input .....	14 $\mu$ f.
Output .....	9.5 $\mu$ f.

†With no external shield.

## AVERAGE CHARACTERISTICS

Heater Voltage .....	6.3 Volts
Heater Current .....	1.2 Amperes
Plate Voltage .....	250 Volts
Screen Voltage .....	150 Volts
Control Grid Voltage .....	-22.5 Volts
Plate Current .....	55 Ma.
Screen Current .....	2.1 Ma.
Mutual Conductance .....	5,500 $\mu$ mhos

## TYPICAL OPERATION

### HORIZONTAL DEFLECTION AMPLIFIER

Plate and Screen Supply Voltage .....	275	300	325 Volts
Peak Positive Surge Plate Voltage .....	4000	4000	4,000 Volts
Peak Positive Grid Signal (Sawtooth) .....	50	50	50 Volts
Peak Negative Grid Signal (Sawtooth) .....	50	50	50 Volts
Cathode Bias Resistor .....	100	100	100 Ohms
Plate Current .....	85	85	83 Ma.
Screen Current .....	9	7	5 Ma.
Developed High Voltage .....	12.0	12.0	12.0 K Volts

## APPLICATION

Sylvania Type 6BQ6<sup>GT</sup> is a beam power amplifier designed for use as a driver tube in the horizontal deflection amplifier for television circuits using electro-magnetic deflection. The plate being brought out to the top cap permits the use of high surge voltages. A typical circuit is shown on the following page.

# 6BQ6<sup>GT</sup> (Cont'd)

## TYPICAL DEFLECTION AMPLIFIER CIRCUIT WITH "FLY BACK" TYPE HIGH VOLTAGE SUPPLY

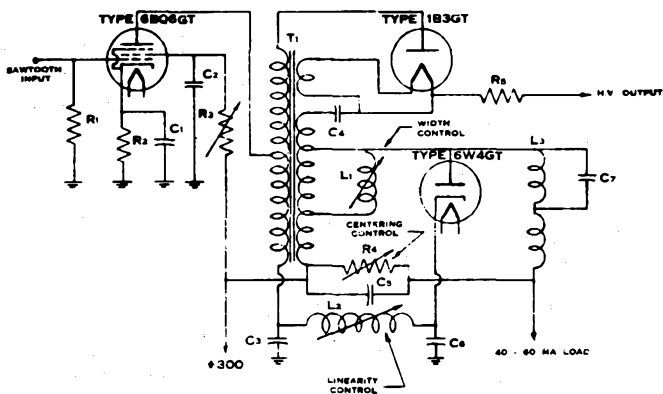

### PARTS LIST

C <sub>1</sub> = 0.25 $\mu$ f.	R <sub>1</sub> = .470 Megohm
C <sub>2</sub> = 0.25 $\mu$ f.	R <sub>2</sub> = 100 Ohms
C <sub>3</sub> = 0.03 $\mu$ f.	R <sub>3</sub> = 0.03 Megohm
C <sub>4</sub> = 500 $\mu$ f.	R <sub>4</sub> = 500 Ohms
C <sub>5</sub> = 0.5 $\mu$ f.	R <sub>5</sub> = .470 Megohm
C <sub>6</sub> = 0.05 $\mu$ f.	
C <sub>7</sub> = 56 $\mu$ f.	
T <sub>1</sub> = G.E. Transformer #77J1-5 or Equivalent	
L <sub>1</sub> , L <sub>2</sub> = G.E. Variable Inductor #77J4 or Equivalent	
L <sub>3</sub> = G.E. Yoke #77J11 or Equivalent	

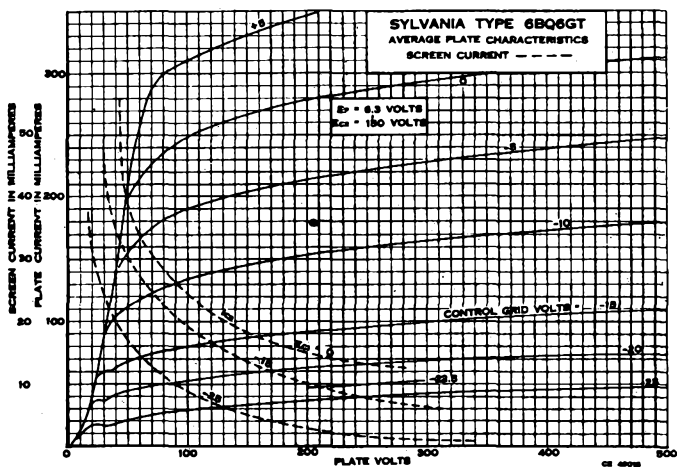

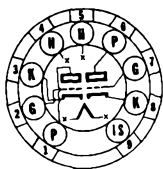

9AJ-0-9



# Sylvania Type 6BQ7

MEDIUM MU DUOTRIODE

## PHYSICAL SPECIFICATIONS

Base.....	Small Button 9 Pin
Bulb.....	T-6 1/2"
Maximum Overall Length.....	2 3/8"
Maximum Seated Height.....	1 1/8"
Mounting Position.....	Any

## RATINGS

Heater Voltage AC or DC.....	6.3 Volts
Maximum Plate Voltage.....	250 Volts
Maximum Plate Dissipation.....	2 Watts
Maximum Cathode Current.....	20 Ma.
Maximum Peak Heater-Cathode Voltage.....	200 Volts

### Direct Interelectrode Capacitances (Shielded):

	Section #1	Section #2
Grid to Plate.....	1.15	1.15 $\mu$ f.
Input.....	2.55	$\mu$ f.
Input (Grounded Grid).....		4.75 $\mu$ f.
Output.....	1.30	$\mu$ f.
Output (Grounded Grid).....		2.40 $\mu$ f.

## TYPICAL OPERATION

### CLASS A<sub>1</sub> AMPLIFIER

Plate Voltage.....	150 Volts
Cathode Bias Resistor.....	220 Ohms
Plate Current.....	9 Ma.
Amplification Factor.....	35
Plate Resistance.....	5,800 Ohms
Mutual Conductance.....	6,000 $\mu$ mhos

## APPLICATION

Sylvania Type 6BQ7 is a miniature type medium-mu duotriode designed for use in low-noise, vhf amplifiers.

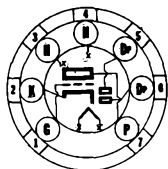

7BT-0-2

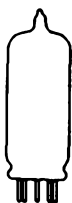

# Sylvania Type 6BU6

DUO-DIODE TRIODE

## PHYSICAL SPECIFICATIONS

Base.....	Small Button 7 Pin
Bulb.....	T-5 1/2"
Maximum Overall Length.....	2 3/8"
Maximum Seated Height.....	2 3/8"
Mounting Position.....	Any

## RATINGS

Heater Voltage.....	6.3 Volts
Maximum Plate Voltage.....	300 Volts
Maximum Positive dc Control Grid Voltage.....	0 Volts
Maximum Heater-Cathode Voltage.....	$\pm$ 90 Volts
Average Diode Current per Diode at 10 Volts dc.....	4.0 Ma.
Average Diode Current per Plate for Continuous Operation.....	1.0 Ma.

### Direct Interelectrode Capacitances:

	Shielded*	Unshielded
Either Diode Plate to Cathode.....	1.0	1.0 $\mu$ f.
Diode Plate # 1 to Grid.....	.01	.013 $\mu$ f. Max.

\*With a 3/4" diameter shield (RMA Std. No. 316) connected to cathode.

# 6BU6 (Cont'd)

## TYPICAL OPERATION CLASS A<sub>1</sub> AMPLIFIER

Heater Voltage (AC or DC).....	6.3	6.3 Volts
Heater Current.....	300	300 Ma.
Plate Voltage.....	100	250 Volts
Grid Voltage.....	-3.0	-9.0 Volts
Self Bias Resistor.....	770	950 Ohms
Plate Current.....	3.9	9.5 Ma.
Plate Resistance.....	11,000	8,500 Ohms
Mutual Conductance.....	1500	1900 $\mu$ mhos
Amplification Factor.....	16.5	16
Load Resistance.....	.....	10,000 Ohms
Power Output.....	.....	300 Mw.
Total Harmonic Distortion.....	.....	6.5 %

## APPLICATION

Sylvania Type 6BU6 is a miniature duo-diode triode having characteristics very similar to Type 6BF6, except for the improved diode characteristics. The improved diode perveance gives better rectification efficiency at low signals and the improved diode shielding reduces undesirable audio coupling between diode and triode.

A diode load curve may be found by referring to Type 6BK6. Design data for use in resistance coupled circuits may be found in the appendix.

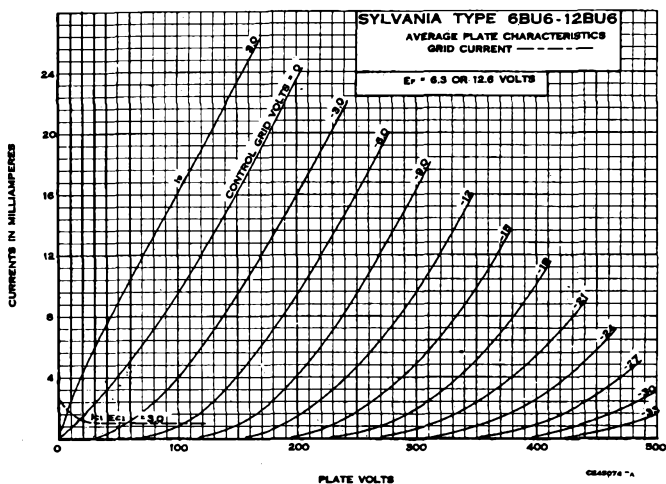

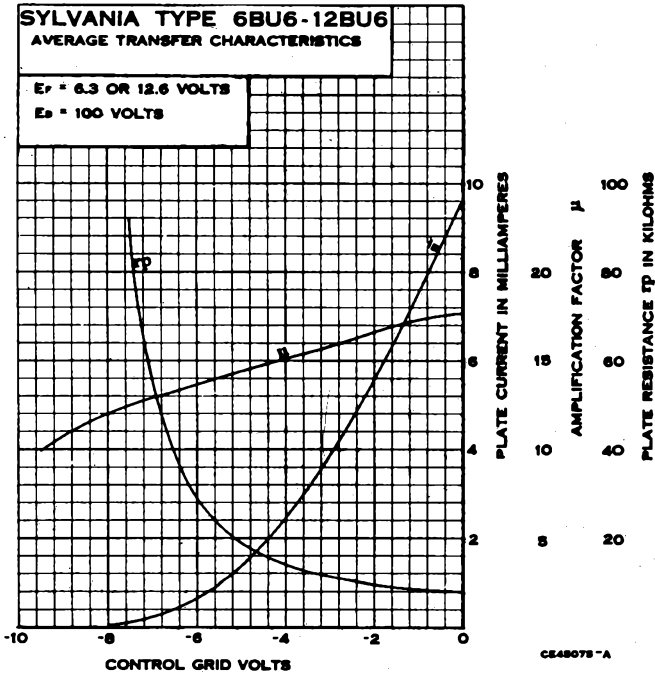
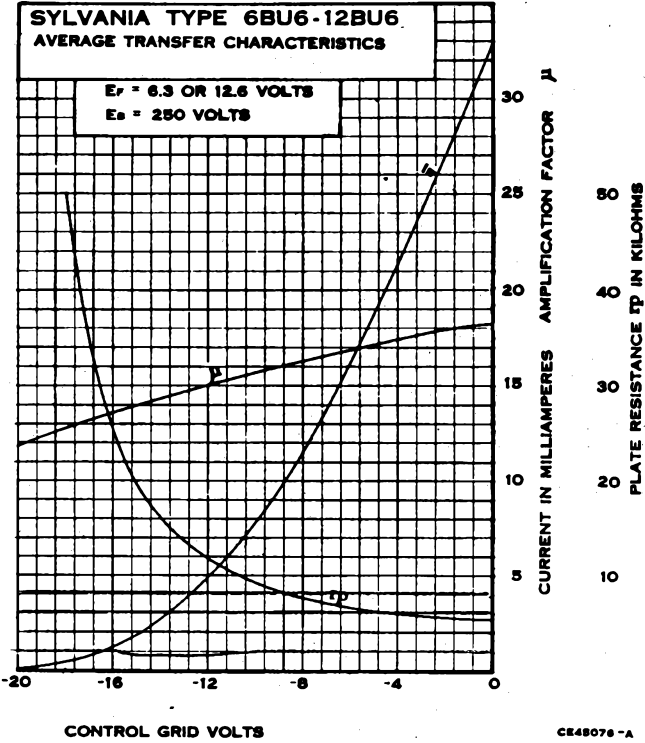

# 6BY5G Sylvania Type

**FULL-WAVE RECTIFIER**

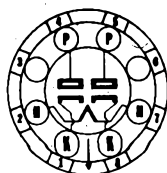

6CN-0-0

## PHYSICAL SPECIFICATIONS

Base .....	Medium Octal 7 Pin
Bulb .....	ST-14
Maximum Overall Length .....	4 5/8"
Maximum Seated Height .....	4 1/16"
Mounting Position .....	Any

## RATINGS

Heater Voltage AC or DC .....	6.3 Volts
Maximum Peak Inverse Voltage .....	
Rectifier Service .....	1,400 Volts
Damper Service* .....	3,000 Volts
Maximum Heater-Cathode Voltage .....	
Heater Negative With Respect to Cathode .....	450 Volts
Heater Positive With Respect to Cathode .....	100 Volts
Maximum DC Output Current .....	175 Ma.
Maximum Peak Plate Current .....	525 Ma.
Tube Voltage Drop (Tube Conducting 175 Ma. Each Plate) .....	32 Volts

\*Duration of voltage pulse not to exceed 15% of one scanning cycle. In the 525 line, 30 frame television system 15% of one scanning cycle is 10 microseconds.

## TYPICAL OPERATION

### FULL WAVE RECTIFIER, CONDENSER-INPUT FILTER

Heater Voltage .....	6.3 Volts
Heater Current .....	1.6 Amperes
AC Plate Supply Voltage (each plate) RMS .....	375 Volts
Filter Input Capacitance .....	8 $\mu$ f.
Effective Plate Supply Impedance per Plate .....	100 Ohms
DC Output Voltage .....	380 Volts
DC Output Current .....	175 Ma.

## APPLICATION

Sylvania Type 6BY5G is a duodiode with separate uni-potential cathodes. It is suitable for damper-diode service in television deflection circuits or as a rectifier in conventional power supply applications.

# 6C4 Sylvania Type

**HIGH FREQUENCY POWER TRIODE**

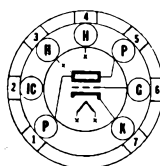

6BG-0-0

## PHYSICAL SPECIFICATIONS

Base .....	Miniature Button 7 Pin
Bulb .....	T5 1/2
Maximum Overall Length .....	2 1/8"
Maximum Seated Height .....	1 1/8"
Mounting Position .....	Any

## RATINGS

Heater Voltage AC or DC .....	6.3 Volts
Heater Current .....	150 Ma.
Maximum Plate Voltage .....	300 Volts
Maximum Plate Current .....	25 Ma.
Maximum Plate Dissipation .....	3.5 Watts
Maximum DC Grid Current .....	8.0 Ma.
Maximum Heater-Cathode Voltage .....	90 Volts

### Direct Interelectrode Capacitances:\*

Grid to Plate .....	1.4 $\mu$ f.
Input .....	1.8 $\mu$ f.
Output .....	2.5 $\mu$ f.

\*With close fitting shield connected to cathode.



## TYPICAL OPERATION

Heater Voltage.....	6.3 Volts
Heater Current.....	150 Ma.

CLASS A<sub>1</sub> AMPLIFIER

Plate Voltage.....	100	250 Volts
Grid Voltage**.....	0	-8.5 Volts
Self-Bias Resistor.....		775 Ohms
Amplification Factor.....	19.5	17
Plate Resistance.....	6250	7700 Ohms
Mutual Conductance.....	3100	2200 $\mu$ mhos
Plate Current.....	11.8	10.5 Ma.

## CLASS C POWER AMPLIFIER AND OSCILLATOR\*\*\*

Plate Voltage.....	300 Volts
Grid Voltage**.....	-27 Volts
DC Plate Current.....	25 Ma.
DC Grid Current (Approximate).....	7.0 Ma.
Driving Power (Approximate).....	0.35 Watt
Power Output (Approximate).....	5.5 Watt

\*\*Maximum grid circuit resistance should not exceed 0.25 megohm with fixed bias or 1.0 megohm with cathode resistor bias.

\*\*\*Approximately 2.5 watts can be obtained at 150 megacycles as an oscillator with a grid resistor of 10,000 ohms and maximum rated input.

## APPLICATION

Sylvania Type 6C4 is a miniature type high-frequency triode. It is intended for use at high frequencies as an oscillator or power amplifier. Good power output, at reasonable efficiencies, is obtainable from this tube at frequencies in the order of 150 megacycles.

For use in resistance coupled circuits, see data in appendix.

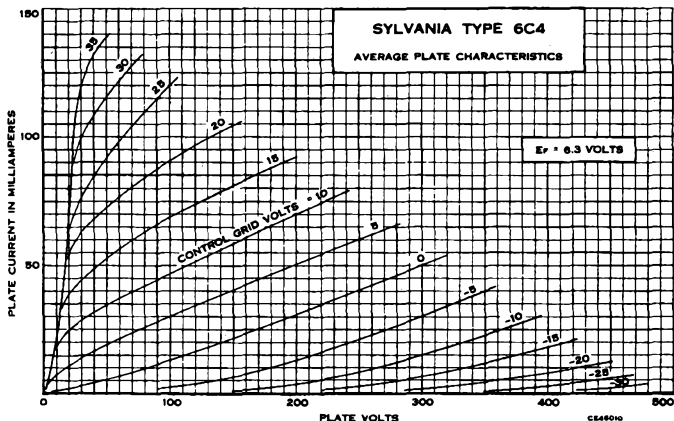

6Q-1-1

Sylvania Type 6C5<sup>GT</sup>

MEDIUM-MU TRIODE

## PHYSICAL SPECIFICATIONS

Base.....	6C5 Small Wafer Octal 6 Pin	6C5GT Small Wafer Octal 6 Pin Metal Sleeve
Bulb.....	Metal 8-3	T9
Maximum Overall Length.....	2 3/4"	3 1/4"
Maximum Seated Height.....	2 1/4"	2 3/4"
Mounting Position.....	Any	Any

# 6C5GT (Cont'd)

## RATINGS

Heater Voltage AC or DC.....		6.3 Volts
Heater Current.....		0.3 Amperes
Maximum Plate Voltage.....		250 Volts
Minimum Grid Voltage.....		0 Volt
Maximum Plate Dissipation.....		2.5 Watts
Maximum Heater-Cathode Voltage.....		90 Volts

<b>Direct Interelectrode Capacitances:</b>	<b>6C5**</b>	<b>6C5GT*</b>
Grid to Plate.....	2.0	2.2 $\mu$ f.
Input.....	3.0	4.4 $\mu$ f.
Output.....	11	12 $\mu$ f.

\*With 1 $\frac{1}{4}$ " diameter shield (RMA Std. 308) connected to cathode.

\*\*With metal shell connected to cathode.

## TYPICAL OPERATION

### CLASS A AMPLIFIER

Heater Voltage.....	6.3 Volts
Heater Current.....	0.3 Amperes
Plate Voltage.....	250 Volts
Grid Voltage**.....	-8 Volts
Plate Current.....	8 Ma.
Plate Resistance.....	10000 Ohms
Mutual Conductance.....	2000 $\mu$ mhos
Amplification Factor.....	20

\*\*The DC resistance in the grid circuit should not exceed 1.0 megohm.

For use in resistance coupled circuits see data in appendix.

# 6CB6 Sylvania Type

SHARP CUTOFF RF PENTODE

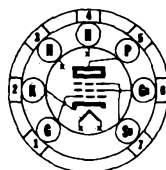

7CM-0-7

## PHYSICAL SPECIFICATIONS

Base.....	Miniature Button 7 Pin
Bulb.....	T-5 $\frac{1}{2}$
Maximum Overall Length.....	2 $\frac{1}{8}$ "
Maximum Seated Height.....	1 $\frac{1}{2}$ "
Mounting Position.....	Any

## RATINGS

Heater Voltage (AC or DC).....	6.3 Volts
Maximum Plate Voltage.....	300 Volts
Maximum Screen Voltage.....	150 Volts
Maximum Heater-Cathode Voltage.....	$\pm$ 90 Volts
Maximum Plate Dissipation.....	2.0 Watts
Maximum Screen Dissipation.....	0.5 Watts

<b>Direct Interelectrode Capacitances:*</b>	
Grid to Plate.....	0.020 $\mu$ f. Max.
Input.....	6.3 $\mu$ f.
Output.....	1.9 $\mu$ f.

\*With no external shield.

## TYPICAL OPERATION

### CLASS A<sub>1</sub> AMPLIFIER

Heater Voltage.....	6.3 Volts
Heater Current.....	300 Ma.
Plate Voltage.....	200 Volts
Screen Voltage.....	150 Volts
Cathode Bias Resistor.....	180 Ohms
Plate Resistance (approx.).....	0.6 Megohm
Mutual Conductance.....	6200 $\mu$ mhos
Plate Current.....	9.5 Ma.
Screen Current.....	2.8 Ma.
Grid Voltage (approx.) for Ib = 10 $\mu$ amps.....	-8 Volts

## APPLICATION

Sylvania Type 6CB6 is a sharp cutoff pentode of the miniature construction designed for television use as an amplifier operating in the vicinity of 40 megacycles. It may also be used as an rf amplifier in vhf television tuners. An added feature is the separate connection for the suppressor grid and internal shield.

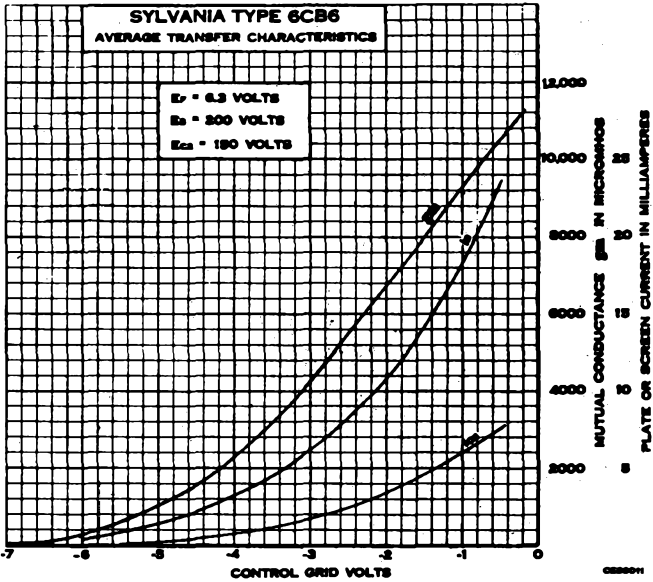
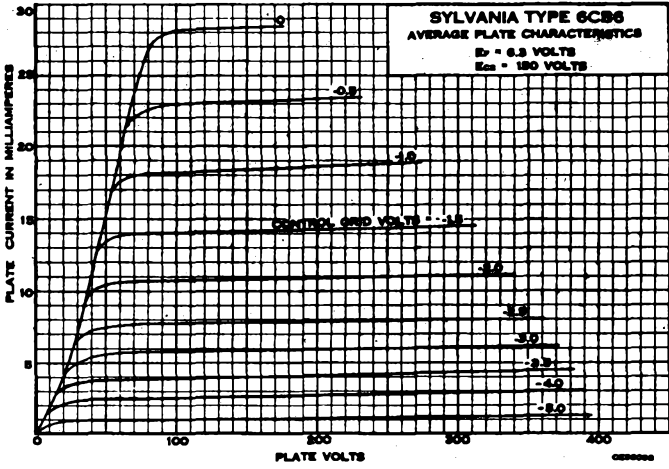

# 6CD6G Sylvania Type

**BEAM POWER AMPLIFIER  
TELEVISION SCANNER**

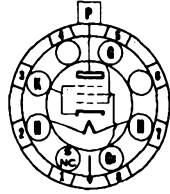

5BT-0-0

## PHYSICAL SPECIFICATIONS

Base.....	Medium Octal 6 Pin
Bulb.....	ST-16
Cap.....	Small
Maximum Overall Length.....	5- <sup>16</sup> / <sub>16</sub> "
Maximum Seated Height.....	5 <sup>1</sup> / <sub>8</sub> "
Mounting Position.....	Vertical*

\*Horizontal operation permitted if pins 2 and 7 are in a vertical plane.

## RATINGS

Heater Voltage (AC or DC).....	6.3 Volts
Heater Current.....	2.5 Amperes
Maximum Plate Voltage.....	700 Volts
Maximum Peak Positive-Pulse Plate Voltage**.....	6000 Volts
Maximum Peak Negative-Pulse Plate Voltage**.....	-1500 Volts
Maximum Screen Voltage.....	175 Volts
Maximum Negative Control Grid Voltage.....	50 Volts
Maximum Peak Negative Pulse Control Grid Voltage.....	150 Volts
Maximum DC Plate Current.....	170 Ma.
Maximum Screen Dissipation.....	3 Watts
Maximum Plate Dissipation.....	15 Watts
Maximum Control Grid Circuit Resistance.....	1 Megohm
Maximum Peak Heater-Cathode Voltage.....	±135 Volts

\*\*The duration of the pulse should not exceed 15% of one horizontal scanning cycle. In a 525 line, interlaced two to one, 30 frame per second television system, 15% of one horizontal scanning cycle is 10 microseconds.

### Direct Interelectrode Capacitances:\*

Grid to Plate.....	1.0 $\mu$ f. Max.
Input.....	2.6 $\mu$ f.
Output.....	10 $\mu$ f.

\* With no external shield.

## TYPICAL OPERATION

### HORIZONTAL DEFLECTION AMPLIFIER FOR TYPE 19AP4

Heater Voltage.....	6.3 Volts
Heater Current.....	2.5 Amperes
Plate Voltage* #.....	430 Volts
Screen Voltage.....	165 Volts
Cathode Bias Resistor.....	270 Ohms
Grid Signal Voltage (Peak to peak sawtooth components).....	50 Volts
Grid Signal Voltage (Negative peaking component).....	35 Volts
Plate Dissipation.....	9.6 Watts
Plate Current.....	112 Ma.
Screen Current.....	14 Ma.
Peak-Positive-Pulse Output Voltage.....	3400 Volts
Cathode Current (Peak to peak).....	470 Ma.
High Voltage Available for Picture Tube Anode.....	12 Kv.

\* # This voltage consists of 250 volts from the DC power supply plus 180 volts boost from the damper circuit.

## APPLICATION

Sylvania Type 6CD6G is a beam power tube designed for use in the horizontal output deflection circuits of television receivers. A typical circuit is shown on the following page for use with Sylvania Type 19AP4 and 250 volts supply.

HORIZONTAL DEFLECTION CIRCUIT

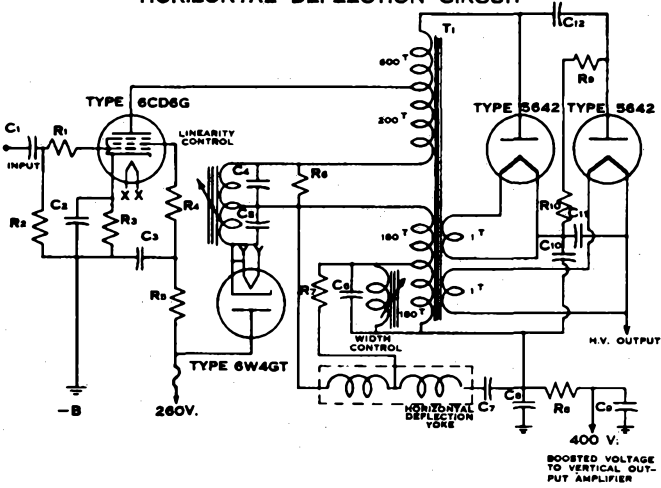

PARTS LIST

- |  |   |
|--|---|
| C <sub>1</sub> = 0.001 $\mu$ f. 500 V. | R <sub>1</sub> = 100 Ohm $\frac{1}{2}$ Watt |
| C <sub>2</sub> = 2 $\mu$ f. 50 V.      | R <sub>2</sub> = 470 K $\frac{1}{2}$ Watt   |
| C <sub>3</sub> = 0.05 $\mu$ f. 400 V.  | R <sub>3</sub> = 270 Ohm 5 Watt             |
| C <sub>4</sub> = 0.03 $\mu$ f. 600 V.  | R <sub>4</sub> = 100 Ohm $\frac{1}{2}$ Watt |
| C <sub>5</sub> = 0.1 $\mu$ f. 600 V.   | R <sub>5</sub> = 6.8 K 2 Watt               |
| C <sub>6</sub> = 1200 $\mu$ f. 1000 V. | R <sub>6</sub> = 1 K 1 Watt                 |
| C <sub>7</sub> = 0.22 $\mu$ f. 200 V.  | R <sub>7</sub> = 1 K $\frac{1}{2}$ Watt     |
| C <sub>8</sub> = 10 $\mu$ f. 450 V.    | R <sub>8</sub> = 1 K $\frac{1}{2}$ Watt     |
| C <sub>9</sub> = 10 $\mu$ f. 450 V.    | R <sub>9</sub> = 1.5 Meg. 2 Watt            |
| C <sub>10</sub> = 500 $\mu$ f. 10 Kv.  | R <sub>10</sub> = 1.5 Meg. 2 Watt           |
| C <sub>11</sub> = 500 $\mu$ f. 10 Kv.  |   |
| C <sub>12</sub> = 500 $\mu$ f. 10 Kv.  |   |

T<sub>1</sub> = Horizontal Output and H. V. Transformer  
 L<sub>1</sub> = Deflection Yoke 14 mh

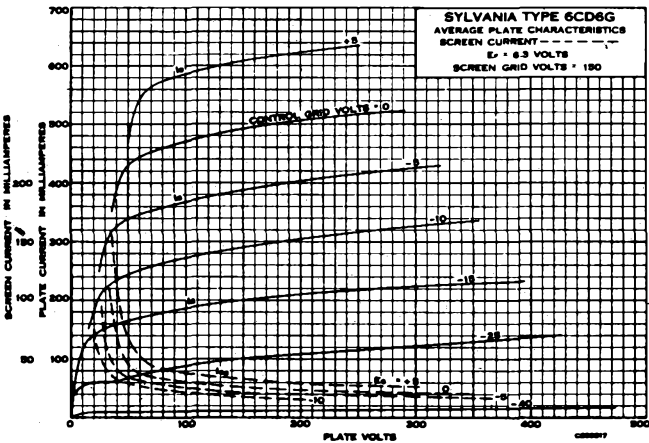

# 6D4 Sylvania Type

**GAS TRIODE**

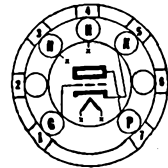

5AY-0-0

## PHYSICAL SPECIFICATIONS

Base.....	Miniature Button 7 Pin
Bulb.....	T5 1/2
Maximum Overall Length.....	2 1/8"
Maximum Seated Height.....	1 1/8"
Mounting Position.....	Any

## RATINGS

Heater Voltage AC or DC.....	6.3 Volts
Heater Current.....	250 Ma.
Minimum Heating Time*.....	30 Seconds
Maximum Voltage Between Elements.....	450 Volts
Peak Cathode Current.....	100 Ma.
Average Cathode Current (30 seconds maximum).....	25 Ma.
Tube Voltage Drop at 25 Ma. (Approximate).....	16 Volts
Maximum Heater-Cathode Voltages.....	-100 Volts +25 Volts

\*Heater voltage must be applied before application of anode voltage so that the cathode reaches operating temperature.

## TYPICAL OPERATION

Heater Voltage.....	6.3	6.3 Volts
Heater Current.....	0.25	250 Ma.
Anode Voltage.....	50	125 Volts
Approximate Grid Voltage to Start Conduction....	-6.0	-12.0 Volts

## APPLICATION

Sylvania Type 6D4 is a gas triode of miniature construction. It may be used as a relay control tube or as a relaxation oscillator. The miniature construction lends itself readily to use in compact light weight equipment.

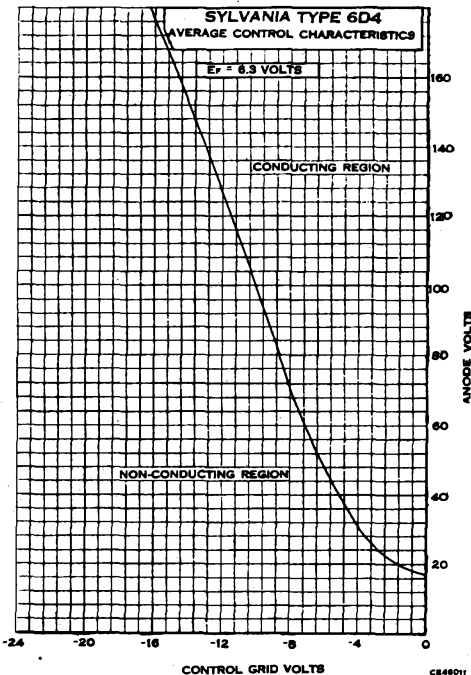

SYLVANIA RADIO TUBES



6R-0-0



# Sylvania Type 6E5

## ELECTRON RAY INDICATOR TUBE

### PHYSICAL SPECIFICATIONS

Base.....	Small 6 Pin
Bulb.....	T9
Maximum Overall Length.....	4 $\frac{1}{4}$ "
Maximum Seated Height.....	3 $\frac{3}{4}$ "
Mounting Position.....	Any

### RATINGS

Heater Voltage AC or DC.....	6.3 Volts
Heater Current.....	0.3 Ampere
Maximum Plate Supply Voltage.....	250 Volts
Maximum Target Voltage.....	250 Volts
Minimum Target Voltage.....	100 Volts
Maximum Heater-Cathode Voltage.....	90 Volts

### TYPICAL OPERATION

Heater Voltage.....	6.3	6.3	6.3 Volts
Plate Supply Voltage.....	100	200	250 Volts
Target Supply Voltage.....	100	200	250 Volts
Plate Current (Triode Unit)*.....	0.19	0.19	0.24 Ma.
Target Current (Approximate)*.....	1.0	3.0	4.0 Ma.
Grid Voltage (Triode Unit) † Approximate.....	0.0	0.0	0.0 Volt
Grid Voltage (Triode Unit) ‡ Approximate.....	-3.3	-6.5	-8.0 Volts
Triode Plate Resistor.....	0.5	1.0	1.0 Megohm

\*With triode grid voltage of zero volts.

†For shadow angle of 90 degrees.

‡For shadow angle of zero degrees.

### APPLICATION

Sylvania Type 6E5 consists of a triode, which functions as a d-c amplifier, and an electron ray device. This latter consists of a portion of the heated cathode as a source of the electrons which are attracted to the target by the positive potential on it. The shaded or unlighted sector is produced by the shadow of a control electrode which is attached to the plate of the triode.

This tube is designed primarily for use as a visible tuning indicator of the electron ray type. It contains a round conical plate or "Target" which fluoresces during operation, and is viewed through the top of the bulb. The visible indication is in the form of a fluorescent lighted sector covering about three-quarters of the area of the target when no voltage is applied to the control grid of the tube. When a negative voltage is applied to the control grid, the edges of the lighted portion close in over the previously unlighted or shaded 90° sector with a fan-like movement until the voltage is increased to a value such that the shaded portion is eliminated and the entire top surface of the target becomes uniformly illuminated.

If the control grid is made negative, the plate and therefore the electron ray-control electrode become more positive with respect to the cathode due to decreasing the voltage drop in the resistor which is connected externally between the target and the plate. As this control element becomes more positive its shadow on the target is reduced and the edges of the lighted portion close in as mentioned above.

In actual circuit use the varying negative voltage for controlling the shadow may be obtained from some point in the a-v-c circuit, thus giving an indication of resonance when the unlighted portion of the target is at minimum.

The principal difference between Type 6E5 and Type 6U5/6G5 is in the plate current cut-off characteristics, which are -8 volts and -22 volts respectively. Where difficulty is experienced due to complete closing of the shadow of the 6E5 it is recommended that the 6U5/6G5 be used. If no difficulty exists due to closing of the shadow from only a portion of the a-v-c voltage being used, increased indications on weak signals may be obtained by using a Type 6U5/6G5 and applying the total a-v-c voltage. Type 6U5/6G5 may be used to replace the 6E5 in nearly all present applications, and in general no circuit changes will be necessary.

# 6F5<sup>GT</sup> Sylvania Type

HIGH-MU TRIODE

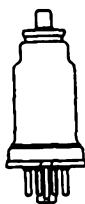

5M-1-0 (6F5)  
5M-0-0 (6F5GT)

## PHYSICAL SPECIFICATIONS

	6F5	6F5GT
Base.....	Small Wafer Octal 7 Pin	Intermediate Octal 7 Pin
Bulb.....	8-4	T-9
Cap.....	Miniature	Miniature
Maximum Overall Length....	3 1/4"	3 3/8"
Maximum Seated Height....	2 3/4"	2 3/4"
Mounting Position.....	Any	Any

## TYPICAL OPERATION

### CLASS A AMPLIFIER

	6F5	6F5GT
Heater Voltage.....	6.3	6.3 Volts
Heater Current.....	300	300 Ma.
Plate Voltage.....	100	250 Volts Max.
Grid Voltage*.....	-1	-2 Volts
Plate Current*.....	0.4	0.9 Ma.
Plate Resistance.....	85000	66000 Ohms
Mutual Conductance.....	1150	1500 μmhos
Amplification Factor.....	100	100
Heater-Cathode Voltage.....	90	90 Volts Max.

\*These are rating values only and not operating points with coupling resistor.

For resistance coupled circuits use data given for type 7B4.

# 6F6<sup>GT</sup> Sylvania Type

POWER AMPLIFIER PENTODES



7S-1-0 (6F6)  
7S-0-0 (6F6GT)

## PHYSICAL SPECIFICATIONS

	6F6	6F6G	6F6GT
Base.....	Small Wafer Octal 7 Pin	Medium Octal 7 Pin	Intermediate Octal 7 Pin
Bulb.....	8-6	ST14	T9
Maximum Overall Length....	3 1/4"	4 3/8"	3 5/8"
Maximum Seated Height....	2 1/4"	4 1/4"	2 3/4"
Mounting Position.....	Any	Any	Any

## TYPICAL OPERATION

### SINGLE TUBE—CLASS A<sub>1</sub> AMPLIFIER

	Pentode	Triode*
Heater Voltage.....	6.3	6.3 Volts
Heater Current.....	0.7	0.7 Amperes
Plate Voltage.....	250	250 Volts
Screen Voltage.....	250	250 Volts
Grid Voltage.....	-16.5	-20 Volts
Peak A-F Signal Voltage.....	16.5	20 Volts
Plate Current (Zero Signal).....	34	31 Ma.
Plate Current (Maximum Signal).....	36	34 Ma.
Screen Current (Zero Signal).....	6.5	7 Ma.
Screen Current (Maximum Signal).....	10.5	13 Ma.
Plate Resistance (Approximate).....	80000	78000
Mutual Conductance.....	2500	2500
Amplification Factor.....	.....	6.8
Load Resistance.....	7000	7000
Power Output.....	3.2	4.8
Total Harmonic Distortion.....	8	9
Maximum Heater-Cathode Voltage.....	90	90



## PUSH-PULL AMPLIFIER

	Class A <sub>1</sub>		Class AB <sub>2</sub>	
	Pentode	Pentode	Triode*	Triode*
Heater Voltage.....	6.3	6.3	6.3	6.3 Volts
Heater Current.....	0.7	0.7	0.7	0.7 Amperes
Plate Voltage.....	315	375	350	350 Volts
Screen Voltage.....	285	250	.....	Volts
Grid Voltage.....	-24	-26	-38	Volts
Peak A-F Grid to Grid Voltage.....	48	82	123	Volts
Plate Current (Zero Signal).....	62	34	48	Ma.
Plate Current (Maximum Signal).....	80	82	92	Ma.
Screen Current (Zero Signal).....	12	5	.....	Ma.
Screen Current (Maximum Signal).....	19.5	19.5	.....	Ma.
Load Resistance (Plate to Plate).....	10000	10000	6000	Ohms
Power Output.....	11	18.5	13	Watts
Total Harmonic Distortion.....	4	3.5	2	Per Cent
Maximum Heater-Cathode Voltage.....	90	90	90	Volts

\*With screen grid tied to plate.

## APPLICATION

For single tube Class A amplifier service either transformer or impedance input-coupling devices are recommended. The 6F6 and 6F6G may also be resistance coupled from either the detector tube or the first audio stage if diode detection is used. If resistance coupling is employed the grid resistor must not exceed 500,000 ohms. This value can be utilized only when the output tube is operated entirely self-biased. When used with a fixed bias, or partially so, the resistor should not exceed 250,000 ohms.



7S-0-0



## Sylvania Type 6G6G

## POWER AMPLIFIER PENTODE

## PHYSICAL SPECIFICATIONS

Base.....	Small Octal 7 Pin
Bulb.....	ST12
Maximum Overall Length.....	4 1/2"
Maximum Seated Height.....	3 3/4"
Mounting Position.....	Any

## RATINGS

Heater Voltage AC or DC.....	6.3 Volts
Heater Current.....	0.150 Ampere
Maximum Plate Voltage.....	180 Volts
Maximum Screen Voltage.....	180 Volts
Maximum Plate Dissipation.....	2.75 Watts
Maximum Screen Dissipation.....	0.75 Watt
Maximum Heater-Cathode Voltage.....	90 Volts

## TYPICAL OPERATION

CLASS A<sub>1</sub> AMPLIFIER

	Triode*		Pentode	
	Triode*	Pentode	Triode*	Pentode
Heater Voltage.....	6.3	6.3	6.3	6.3 Volts
Heater Current.....	0.15	0.15	0.15	0.15 Ampere
Plate Voltage.....	180	135	180	180 Volts
Screen Voltage.....	.....	135	180	180 Volts
Grid Voltage.....	-12	-6	-9	Volts
Peak A-F Signal Voltage.....	12	6	9	Volts
Plate Current (Zero Signal).....	11	11.5	15.0	Ma.
Screen Current (Zero Signal).....	.....	2.0	2.5	Ma.
Plate Resistance.....	4750	17000	175000	Ohms
Mutual Conductance.....	2000	2100	2300	μmhos
Amplification Factor.....	9.5	360	400	
Load Resistance.....	12000	12000	10000	Ohms
Power Output.....	0.25	0.6	1.1	Watts
Total Harmonic Distortion.....	5	7.5	10	Per Cent

\*With screen grid tied to plate.

# 6H6<sup>GT</sup> Sylvania Type

DUODIODES



7Q-1-1 (6H6)  
7Q-0-1 (6H6GT)

## PHYSICAL SPECIFICATIONS

	6H6	6H6GT
Base.....	Small Wafer Octal 7 Pin	Intermediate Octal 7 Pin
Bulb.....	Metal 8-5	T9
Maximum Overall Length.....	1 3/4"	3 5/8"
Maximum Seated Height.....	1 3/8"	2 5/8"
Mounting Position.....	Any	Any
<b>Direct Interelectrode Capacitances:*</b>		
Plate No. 1 to Cathode.....	3.0	3.1 $\mu$ f.
Plate No. 2 to Cathode.....	3.4	4.0 $\mu$ f.
Coupling—Plate No. 1 to Plate No. 2 ..	0.1	0.1 $\mu$ f. Max.

\*With close-fitting tube shield on Type 6H6GT or shell of 6H6 connected to cathode.

## TYPICAL OPERATION

Heater Voltage.....	6.3 Volts
Heater Current.....	0.30 Ampere
AC Voltage Per Plate (RMS).....	150 Volts Max.
DC Output Current.....	8 Ma. Max.

# 6J5<sup>GT</sup> Sylvania Type

MEDIUM-MU TRIODES

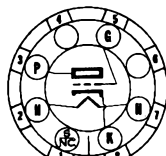

6Q-1-0

## PHYSICAL SPECIFICATIONS

	6J5	6J5GT
Base.....	Small Wafer Octal 6 Pin	Small Wafer Metal Sleeve Octal 6 Pin
Bulb.....	Metal 8-3	T9
Maximum Overall Length.....	2 5/8"	3 3/8"
Maximum Seated Height.....	2 1/8"	2 3/8"
Mounting Position.....	Any	Any

## RATINGS

Heater Voltage AC or DC.....	6.3 Volts
Heater Current.....	300 Ma.
Maximum Plate Voltage.....	300 Volts
Minimum Grid Voltage.....	0 Volt
Maximum Plate Dissipation.....	2.5 Watts
Maximum Heater Cathode Voltage.....	90 Volts.

	6J5	6J5GT
<b>Direct Interelectrode Capacitances:*</b>		
Grid to Plate.....	3.4	3.8 $\mu$ f.
Input.....	3.4	4.2 $\mu$ f.
Output.....	3.6	5.0 $\mu$ f.

\*With standard RMA tube shield for Type 6J5GT or shell of 6J5 connected to cathode.

## TYPICAL OPERATION

### CLASS A AMPLIFIER

Heater Voltage.....	6.3	6.3 Volts
Heater Current.....	300	300 Ma.
Plate Voltage.....	90	250 Volts
Grid Voltage**.....	0	-8 Volts
Plate Current.....	10.0	9.0 Ma.
Plate Resistance (Approximate).....	6700	7700 Ohms
Mutual Conductance (Approximate).....	3000	2600 $\mu$ mhos
Amplification Factor.....	20	20

\*\*The DC Resistance in the Grid Circuit should not exceed 1.0 Megohm.

## APPLICATION

In general the applications and operating conditions of these types will parallel those for Lock-In Type 7A4.



7BF-0-0



# Sylvania Type 6J6

DUO TRIODE

## PHYSICAL SPECIFICATIONS

Base.....	Miniature Button 7 Pin
Bulb.....	T5 1/2
Maximum Overall Length.....	2 3/4"
Maximum Seated Height.....	1 3/4"
Mounting Position.....	Any

## RATINGS

Heater Voltage AC or DC.....	6.3 Volts
Heater Current.....	0.45 Ampere
Maximum Plate Voltage.....	300 Volts
Maximum Grid Voltage.....	-40 Volts
Maximum Plate Current (Per Plate).....	15 Ma.
Maximum Grid Current (Per Unit).....	8.0 Ma.
Maximum Plate Dissipation (Per Unit).....	1.5 Watts
Maximum Heater-Cathode Voltage.....	100 Volts
<b>Direct Interelectrode Capacitances: Without Shield (Approx. each Unit)</b>	
Grid to Plate.....	1.6 $\mu$ f.
Input.....	2.2 $\mu$ f.
Output.....	0.4 $\mu$ f.

## TYPICAL OPERATION CLASS A<sub>1</sub> AMPLIFIER

(Per Section except as noted)

Plate Voltage.....	100 Volts
Self-Bias Resistor*.....	50 Ohms
Amplification Factor.....	38
Plate Resistance.....	7100 Ohms
Mutual Conductance.....	5300 $\mu$ mhos
Plate Current.....	8.5 Ma.

\*Value is for both units operating as specified. Under rated maximum conditions total grid circuit resistance should not exceed 0.5 megohm. Fixed bias operation is not recommended.

## CLASS C OSCILLATOR OR RF AMPLIFIER (Push-Pull)

Plate Voltage.....	150 Volts
Grid Voltage†.....	-10 Volts
Plate Current.....	30 Ma.
Grid Current (Approximate).....	16 Ma.
Driving Power (Approximate).....	0.35 Watt
Power Output (Approximate).....	3.5 Watts

†Obtained by grid resistor of 625 ohms or cathode resistor of 220 ohms.

## MIXER

Plate Voltage.....	150 Volts
Cathode-Bias Resistor*.....	820 Ohms
Oscillator Peak Voltage.....	3 Volts
Plate Resistance.....	10,200 Ohms
Conversion Transconductance.....	1900 $\mu$ mhos
Plate Current.....	4.8 Ma.

\*Under rated maximum conditions total grid circuit resistance should not exceed 0.5 megohm. Fixed bias operation is not recommended.

## APPLICATION

Sylvania Type 6J6 is intended as a high frequency oscillator, amplifier or mixer. Power outputs in the order of 3.5 watts are obtainable as a class C amplifier at moderate frequencies. With grids in push-pull and plates in parallel this tube will operate as a mixer at frequencies as high as 600 megacycles.

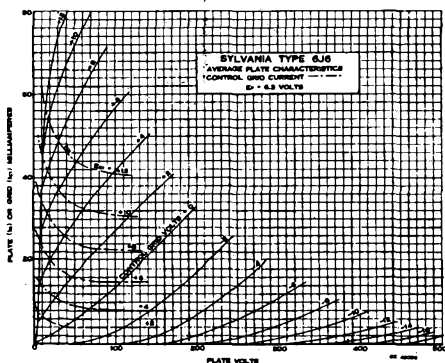

# 6J7<sup>GT</sup> Sylvania Type

SHARP CUT-OFF RF PENTODES

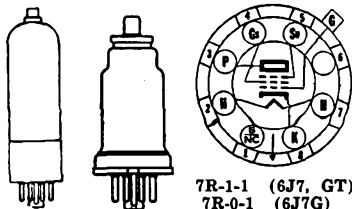

## TYPICAL OPERATION

	Triode		Pentode	
Heater Voltage.....	6.3	6.3	6.3	6.3 Volts
Heater Current.....	0.3	0.3	0.3	0.3 Ampere
Plate Voltage.....	180	250	100	250 Volts
Grid Voltage*.....	-5.3	-8	-3	-3 Volts
Screen Voltage.....	Tie to Plate	100	100	100 Volts
Suppressor.....	Tie to Plate	Tie to Cathode		
Plate Current.....	5.3	6.5	2.0	2.0 Ma.
Screen Current.....	.....	.....	0.5	0.5 Ma.
Plate Resistance.....	0.011	0.01	1.0	>1.0 Megohms
Mutual Conductance.....	1800	1900	1185	1225 amhos
Amplification Factor.....	20	20	.....	.....
Grid Voltage for Current Cut-Off.....	.....	.....	-7	-7 Volts

\*The d-c resistance in grid circuit should not exceed 1.0 megohm.

# 6J8G Sylvania Type

TRIODE HEPTODE CONVERTER

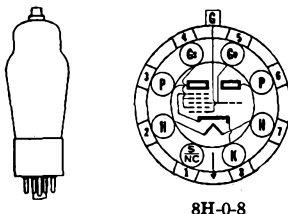

## PHYSICAL SPECIFICATIONS

Base.....	Small Octal 8 Pin
Bulb.....	ST-12
Cap.....	Miniature
Maximum Overall Length.....	4 <sup>15</sup> / <sub>16</sub> "
Maximum Seated Height.....	3 <sup>39</sup> / <sub>64</sub> "
Mounting Position.....	Any

## RATINGS

Heater Voltage.....	6.3 Volts
Heater Current.....	0.30 Ampere

The other characteristics of this tube have been substantially duplicated in Lock-In type 7J7 and further information may be obtained by reference to this type.

# 6K4 Sylvania Type

HIGH FREQUENCY TRIODE

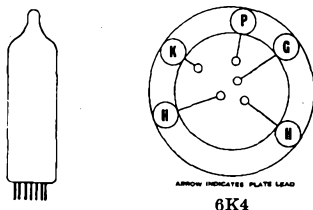

## PHYSICAL SPECIFICATIONS

Base.....	Flexible Leads
Bulb.....	T-3
Maximum Bulb Length.....	1 <sup>1</sup> / <sub>2</sub> "
Minimum Lead Length.....	1 <sup>1</sup> / <sub>4</sub> "
Mounting Position.....	Any

## RATINGS

Heater Voltage AC or DC.....	6.3 Volts
Maximum Plate Voltage.....	250 Volts
Maximum Heater to Cathode Voltage.....	90 Volts
Maximum Plate Dissipation (open air).....	3.0 Watts
Maximum Cathode Current.....	20.0 Ma.

Direct Interelectrode Capacitances:

	Shielded*	Unshielded
Grid to Plate.....	2.4	2.4 $\mu\text{f.}$
Input.....	2.4	2.4 $\mu\text{f.}$
Output.....	3.8	0.8 $\mu\text{f.}$

\*With a .405" diameter shield connected to cathode.

TYPICAL OPERATION

Heater Voltage.....	6.3	6.3 Volts
Heater Current.....	150	150 Ma.
Plate Voltage.....	100	200 Volts
Grid Voltage* Obtained from Self Bias Resistor of.....	150	680 Ohms
Plate Current.....	13.0	11.5 Ma.
Transconductance.....	5500	3450 $\mu\text{mh}$ s
Amplification Factor.....	20	16
Plate Resistance.....	3640	4650 Ohms
Grid Voltage for Plate Current Cut-Off to 10 $\mu\text{a.}$ .....	-14	-30 Volts

\*Provides an operating bias of approximately 2.0 and 8.0 volts respectively. Maximum grid circuit resistance should not exceed 1/2 megohm. Fixed bias operation is not recommended.

APPLICATION

Sylvania Type 6K4 is designed for use in high frequency applications requiring a very small, light-weight tube, highly resistant to shock and vibration.

At frequencies of around 500 Mc., an output of approximately 3/4 Watt may be obtained when used in a suitable circuit.

Data for use as a resistance coupled amplifier may be found in the appendix.

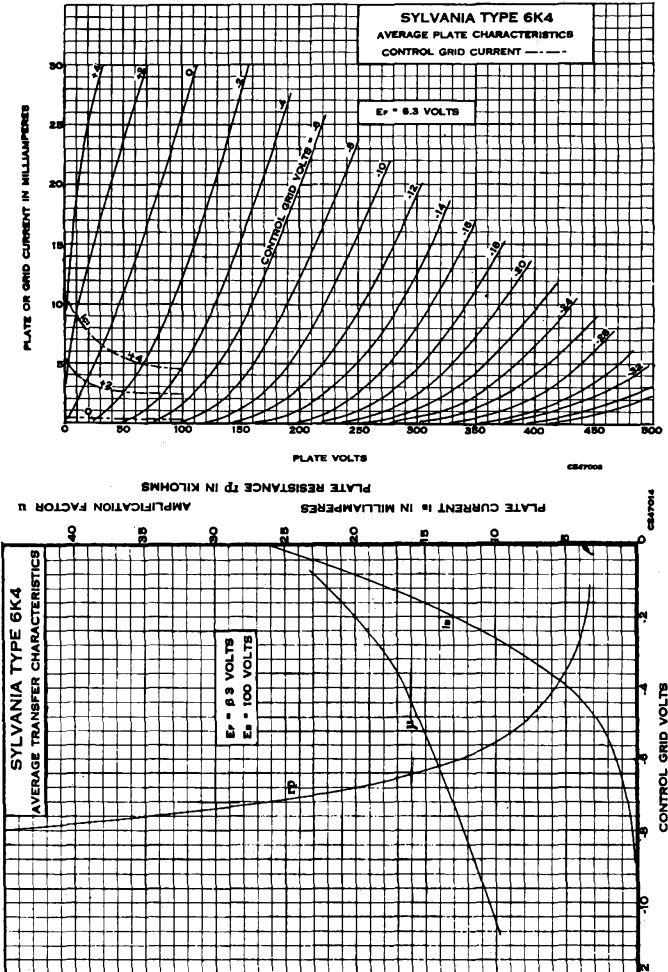

# 6K4 (Cont'd)

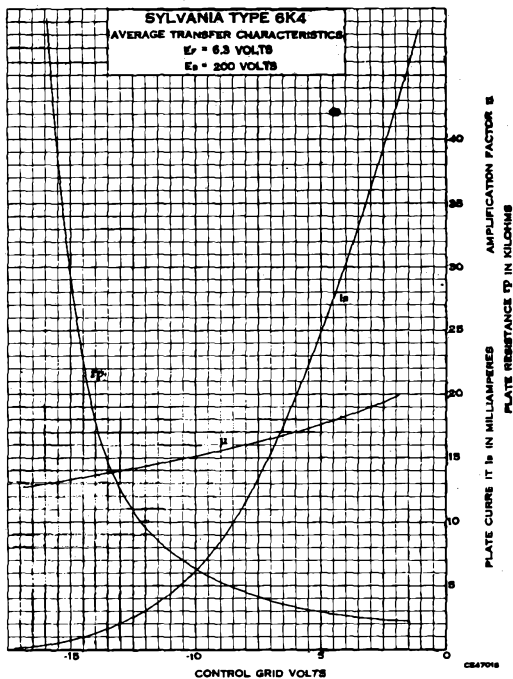

# 6K5<sup>GT</sup> Sylvania Type

HIGH-MU TRIODE

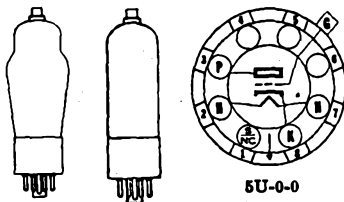

## PHYSICAL SPECIFICATIONS

Base.....	Small Octal 7 Pin
Bulb.....	T9 or ST12
Cap.....	Miniature
Maximum Overall Length.....	4 <sup>15</sup> / <sub>16</sub> "
Maximum Seated Height.....	3 <sup>19</sup> / <sub>32</sub> "
Mounting Position.....	Any
<b>Direct Interelectrode Capacitances:*</b>	
Grid to Plate.....	2.0 $\mu$ f.
Input.....	2.4 $\mu$ f.
Output.....	3.6 $\mu$ f.

## TYPICAL OPERATION CLASS A AMPLIFIER

Heater Voltage.....	6.3	6.3 Volts
Heater Current.....	0.3	0.3 Ampere
Plate Voltage.....	100	250 Volts
Grid Voltage*	-1.5	-3 Volts
Plate Current*	0.35	1.1 Ma.
Plate Resistance (Approximate).....	78000	50000 Ohms
*Mutual Conductance (Approximate).....	900	1400 $\mu$ mhos
Amplification Factor.....	70	70
Maximum Heater-Cathode Voltage.....	90	90 Volts

\*These are rating values only and not operating points with coupling resistor.

Data for use in Resistance Coupled Amplifier Circuits may be found in the appendix under Type 6Q7GT.



7S-0-0



# Sylvania Type 6K6<sup>GT</sup>

POWER OUTPUT PENTODE

## PHYSICAL SPECIFICATIONS

Base .....	Intermediate Octal 7 Pin
Bulb .....	T9
Maximum Overall Length .....	3 <sup>5</sup> / <sub>8</sub> "
Maximum Seated Height .....	2 <sup>1</sup> / <sub>4</sub> "
Mounting Position .....	Any

## RATINGS

Heater Voltage AC or DC .....	6.3 Volts
Heater Current .....	0.4 Ampere
Maximum Plate Voltage .....	315 Volts
Maximum Screen Voltage .....	285 Volts
Maximum Plate Dissipation .....	8.5 Watts
Maximum Screen Dissipation .....	2.8 Watts
Maximum Heater-Cathode Voltage .....	90 Volts

## TYPICAL OPERATION

Heater Voltage .....	6.3	6.3	6.3 Volts
Heater Current .....	0.4	0.4	0.4 Ampere
Plate Voltage .....	100	250	315 Volts
Grid Voltage .....	-7	-18	-21 Volts
Screen Voltage .....	100	250	250 Volts
Plate Current (Zero Signal) .....	9.0	32.0	25.6 Ma.
Plate Current (Maximum Signal) .....	9.5	33.0	28.0 Ma.
Screen Current (Zero Signal) .....	1.6	5.5	4.0 Ma.
Screen Current (Maximum Signal) .....	3.0	10.0	9.0 Ma.
Plate Resistance .....	104000	68000	75000 Ohms
Mutual Conductance .....	1500	2300	2100 $\mu$ hos
Peak Signal Voltage (a-f) .....	7	18	21 Volts
Load Resistance .....	12000	7600	9000 Ohms
Power Output .....	0.35	3.4	4.5 Watts
Total Harmonic Distortion .....	11	11	15 Percent

## APPLICATION

Sylvania 6K6GT is an efficient power amplifier pentode of the indirectly heated cathode type. This tube is the "G" type equivalent of Type 41. It has a 6.3 volt heater and is adaptable to a-c, and automobile service.

Type 6K6GT may be used either singly or in push-pull combination. If a single tube is employed in the output stage, using self-bias, the self-biasing resistor should be properly bypassed. For the push-pull arrangement the value of this resistor is one-half that required for a single tube.

Transformer or impedance coupling devices are to be recommended. If it is desired to use resistance coupling, the grid resistor (with self-bias) should be limited to 1.0 megohm provided the heater voltage never exceeds about 7 volts. With fixed bias the maximum allowable resistance for the grid resistor is 0.1 megohm.

The recommended load resistance should be used if possible in order to keep the second harmonic at a minimum. If, however, two tubes are used in push-pull Class A, somewhat lower third harmonic in the output may be obtained by employing a lower load for both tubes than normal since the second harmonics will cancel with the push-pull arrangement.

For curve data reference should be made to type 7B5.

# 6K7<sup>GT</sup> Sylvania Type

REMOTE CUT-OFF RF PENTODES

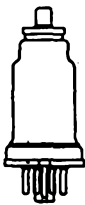

7R-1-0 (6K7)  
7R-0-8 (6K7G)  
7R-1-8 (6K7GT)

## PHYSICAL SPECIFICATIONS

	6K7	6K7G	6K7GT
Base.....	Small Wafer Octal 7 Pin	Small Octal 7 Pin	Small Wafer Metal Sleeve Octal 7 Pin
Bulb.....	Metal 8-4	ST12	T9
Cap.....	Miniature	Miniature	Miniature
Maximum Overall Length....	3 1/4"	4 1/2"	3 1/4"
Maximum Seated Height....	2 3/8"	3 3/8"	2 1/4"
Mounting Position.....	Any	Any	Any

## RATINGS

Heater Voltage AC or DC.....			6.3 Volts
Heater Current.....			0.3 Amperes
Maximum Plate Voltage.....			300 Volts
Maximum Screen Supply Voltage.....			300 Volts
Maximum Screen Voltage.....			125 Volts
Maximum Plate Dissipation.....			2.75 Watts
Maximum Screen Dissipation.....			.35 Watts
Minimum External Grid Bias.....			0 Volt
Maximum Heater-Cathode Voltage.....			90 Volts
Direct Interelectrode Capacitances:*			
Grid to Plate.....	.005	.007	.005 μf. Max.
Input G1 to (F+K+G2+G3).....	7	5	4.6 μf.
Output P to (F+K+G2+G3).....	12	12	12 μf.

\*With standard RMA tube shield on Type 6K7G and 6K7GT or shell of 6K7 connected to cathode.

## TYPICAL OPERATION

### CLASS A<sub>1</sub> AMPLIFIER

Heater Voltage.....	6.3	6.3	6.3 Volts
Heater Current.....	300	300	300 Ma.
Plate Voltage.....	100	250	250 Volts
Screen Voltage.....	100	100	125 Volts
Grid Voltage.....	-1.0	-3	-3 Volts
Suppressor.....		Tie to Cathode	
Plate Current.....	9.5	7.0	10.5 Ma.
Screen Current.....	2.7	1.7	2.6 Ma.
Plate Resistance (Approx.).....	.15	0.8	0.6 Megohm
Mutual Conductance.....	1650	1450	1650 μmhos
Grid Bias for Mutual Conductance= 2 μmhos.....	-38.5	-42.5	-52.5 Volts

# 6K8<sup>GT</sup> Sylvania Type

TRIODE HEXODE CONVERTERS

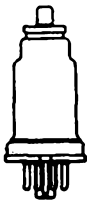

8K-1-0 (6K8)  
8K-0-8 (6K8G)  
8K-1-8 (6K8GT)

## PHYSICAL SPECIFICATIONS

	6K8	6K8G	6K8GT
Base.....	Small Wafer Octal 8 Pin	Small Octal 8 Pin	Small Wafer Metal Sleeve Octal 8 Pin
Bulb.....	Metal 8-2	ST12	T9
Cap.....	Miniature	Miniature	Miniature
Maximum Overall Length....	3 1/4"	4 1/2"	3 1/4"
Maximum Seated Height....	2 3/8"	3 3/8"	3"
Mounting Position.....	Any	Any	Any



**RATINGS**

Heater Voltage.....	6.3 Volts
Heater Current.....	0.3 Ampere
Maximum Hexode Plate Voltage.....	300 Volts
Maximum Hexode Screen Supply Voltage.....	300 Volts
Maximum Hexode Screen Voltage.....	150 Volts
Maximum Hexode Plate Dissipation.....	.75 Watt
Maximum Hexode Screen Dissipation.....	.7 Watt
Maximum Oscillator Anode Voltage.....	125 Volts
Maximum Oscillator Anode Dissipation.....	0.75 Watt
Maximum Total Cathode Current.....	16 Ma.
Minimum External Signal Grid Bias Voltage.....	0 Volt
Maximum Heater-Cathode Voltage.....	90 Volts

**Direct Interelectrode Capacitances:\***

	6K8	6K8G, 6K8GT
Grid G to Hexode Plate (P).....	0.03	0.08 $\mu$ f. Max.
Grid G to Oscillator Plate.....	0.02	0.05 $\mu$ f. Max.
Grid G to Oscillator Grid (Go).....	0.2	0.2 $\mu$ f. Max.
Oscillator Grid (Go) to Oscillator Plate.....	1.1	1.8 $\mu$ f.
Oscillator Grid (Go) to Mixer Plate.....	0.1	0.15 $\mu$ f. Max.
Signal Input (G to all other Electrodes).....	6.6	4.6 $\mu$ f.
Oscillator Input (Go to all other Electrodes except Oscillator Plate).....	6.0	6.5 $\mu$ f.
Oscillator Output (P to all other Electrodes except Grid Go).....	3.2	3.4 $\mu$ f.
Mixer Output (P to all other Electrodes).....	3.5	4.8 $\mu$ f.

\*With standard RMA tube shield on Type 6K8G, GT or shell of 6K8 connected to cathode.

**TYPICAL OPERATION  
AS A CONVERTER**

Heater Voltage.....	6.3	6.3 Volts
Heater Current.....	0.30	0.30 Ampere
Hexode Plate Voltage.....	100	250 Volts
Hexode Screen Voltage.....	100	100 Volts
Hexode Control-Grid Voltage.....	-3	-3 Volts
Oscillator Anode Voltage.....	100	100 Volts
Oscillator Grid Resistor.....	50000	50000 Ohms
Hexode Plate Current.....	2.3	2.5 Ma.
Hexode Screen Current.....	6.2	6.0 Ma.
Oscillator Plate Current.....	3.8	3.8 Ma.
Oscillator Grid and Hexode No. 1 Grid Current.....	0.15	0.15 Ma.
Cathode Current.....	12.5	12.5 Ma.
Hexode Plate Resistance (Approximate).....	0.4	0.6 Megohm
Conversion Conductance.....	325	350 $\mu$ hos
Hexode Control-Grid Voltage at -6 Volts.....	125	140 $\mu$ hos
Hexode Control-Grid Voltage at -10 Volts.....	43	45 $\mu$ hos
Hexode Control-Grid Voltage at -30 Volts (Approximate).....	2	2 $\mu$ hos

**6L5G Sylvania Type**

MEDIUM-MU TRIODES



6Q-0-0

**PHYSICAL SPECIFICATIONS**

Base.....	Small Octal 6 Pin
Bulb.....	ST12
Maximum Overall Length.....	4 1/8"
Maximum Seated Height.....	3 1/8"
Mounting Position.....	Any
Direct Interelectrode Capacitances:*	
Grid to Plate.....	2.8 $\mu$ f.
Input.....	2.8 $\mu$ f.
Output.....	5.0 $\mu$ f.

\*With standard RMA tube shield.

**TYPICAL OPERATION**

Heater Voltage.....	6.3	6.3 Volts
Heater Current.....	150	150 Ma.
Plate Voltage.....	100	250 Volts Max.
Grid Voltage.....	-3	-9 Volts
Plate Current.....	4.0	8.0 Ma.
Plate Resistance.....	10000	9000 Ohms
Mutual Conductance.....	1500	1900 $\mu$ hos
Amplification Factor.....	15	17
Heater-Cathode Voltage.....	90	90 Volts Max.

For use in resistance coupled circuits, see data in appendix.

**6L6** Sylvania Type  
**6L6G** Sylvania Type  
**6L6GA** Sylvania Type

**BEAM POWER AMPLIFIERS**

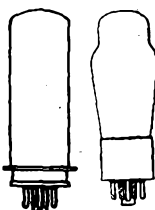

7S-1-0 (6L6)  
 7S-0-0 (6L6G, GA)

**PHYSICAL SPECIFICATIONS**

	6L6	6L6G	6L6GA
Base.....	Small Water Octal 7 Pin	Medium Octal 7 Pin	Medium Octal 7 Pin
Bulb.....	Metal 10-1	ST16	ST14
Maximum Overall Length.....	4 5/8"	5 5/8"	4 5/8"
Maximum Seated Height.....	3 3/4"	4 3/4"	4 1/4"
Mounting Position.....	Any	Any	Any

**RATINGS**

	Triode	Single Tube	Push-Pull
Heater Voltage.....	6.3	6.3	6.3 Volts
Heater Current.....	0.9	0.9	0.9 Amperes
Maximum Plate Voltage.....	300	350	360 Volts
Maximum Screen Voltage.....	Tie to Plate	250	270 Volts
Maximum Plate Dissipation.....	12	18.5	19.0 Watts
Maximum Screen Dissipation.....	.....	2.7	2.5 Watts
Maximum Heater-Cathode Voltage...	90	90	90 Volts

**TYPICAL OPERATION**

**CLASS A<sub>1</sub> AMPLIFIER SINGLE TUBE**

Heater Voltage.....	6.3	6.3	6.3 Volts
Plate Voltage.....	250	300	350 Volts
Screen Voltage.....	250	200	250 Volts
Grid Voltage.....	-14	-12.5	-18 Volts
Peak A-F Signal Voltage.....	14	12.5	18 Volts
Plate Current (Zero Signal).....	72	48	54 Ma.
Plate Current (Maximum Signal).....	79	55	66 Ma.
Screen Current (Zero Signal).....	5	2.5	2.5 Ma.
Screen Current (Maximum Signal).....	7.3	4.7	7.0 Ma.
Mutual Conductance.....	6000	5300	5200 μmhos
Plate Resistance.....	22500	35000	33000 Ohms
Load Resistance.....	2500	4500	4200 Ohms
Power Output.....	6.5	6.5	10.8 Watts
Total Harmonic Distortion.....	10	11	15 Per Cent

**PUSH-PULL AMPLIFIER, PENTODE CONNECTION**

	Class A <sub>1</sub>		Class AB <sub>1</sub>		Class AB <sub>2</sub>	
Heater Voltage.....	6.3	6.3	6.3	6.3	6.3	6.3 Volts
Plate Voltage.....	250	270	360	360	360	360 Volts
Screen Voltage.....	250	270	270	270	225	270 Volts
Grid Voltage.....	-16	-17.5	-22.5	-22.5	-18	-22.5 Volts
Peak A-F Grid to Grid Voltage.....	32	35	45	45	52	72 Volts
Plate Current*.....	120	134	88	88	78	88 Ma.
Plate Current**.....	140	155	132	140	142	205 Ma.
Screen Current*.....	10	11	5	*5	3.5	5 Ma.
Screen Current**.....	16	17	15	11	11	16 Ma.
Mutual Conductance.....	5500	5700	.....	.....	.....	..... μmhos
Plate Resistance.....	24500	23500	.....	.....	.....	..... Ohms
Load Resistance.....	5000	5000	6600	3800	6000	3800 Ohms
Power Output.....	14.5	17.5	26.5	18	31	47 Watts
Total Harmonic Distortion.....	2	2	2	2	2	2 Percent

\*Zero Signal.

\*\*Maximum Signal.

**TRIODE OPERATION**

**CLASS A<sub>1</sub> AMPLIFIER Single Tube**

Heater Voltage.....	6.3	6.3 Volts
Plate Voltage.....	300	250 Volts
Screen Voltage.....	Tie to Plate	
Grid Voltage.....	-27	-20 Volts
Peak A-F Signal Voltage.....	27	20 Volts
Plate Current (Zero Signal).....	41	40 Ma.
Plate Current (Maximum Signal).....	48	44 Ma.
Plate Resistance.....	1700	1700 Ohms
Mutual Conductance.....	4700	4700 μmhos
Amplification Factor.....	8	8
Load Resistance.....	5000	5000 Ohms
Power Output.....	2.4	1.4 Watts
Total Harmonic Distortion.....	5.6	5.0 Per Cent

**APPLICATION**

Sylvania Types 6L6 and 6L6G are power amplifier tubes designed for use in the output stage of radio receivers, particularly in those designed to have a reserve of power capability.

**SYLVANIA RADIO TUBES**

# 6L6 6L6G (Cont.) 6L6GA

The tubes provide high power output, power sensitivity and efficiency.

The design principles, responsible for the above features, involve the use of directed electron beams. These effects are produced by arranging the tube elements in such a manner that potential fields are set up which confine the electrons into beams of high density. Efficient suppressor action is produced by the space-charge effects formed between the screen and plate. Very little power is taken by the screen.

The second harmonic distortion is intentionally high in order to reduce the third and higher order harmonics to a minimum. Elimination of the second harmonic distortion can be obtained by using these tubes in a push-pull arrangement. If only one tube is used in a resistance coupled circuit, second harmonics can be reduced by generating out-of-phase second harmonics in preceding audio stages or by degeneration.

The Number "1" used in conjunction with the terms Class A and Class AB indicates that no grid current flows during any part of the input cycle. Likewise, the Number "2" indicates that grid current does flow during some part of the input cycle.

The heater voltage rating for Types 6L6 and 6L6G is 6.3 volts. Precautions should be taken to prevent the heater voltage from exceeding a maximum value of 7.0 volts during line voltage fluctuations. A minimum potential difference between heater and cathode should be maintained.

The maximum plate and screen dissipation must not be exceeded. Provision should be made for line voltage changes, especially when fixed-bias operation is employed.

Transformer or impedance coupling devices are recommended and the resistance introduced in the grid circuit should be kept as low as possible. For fixed bias this resistance should not exceed 0.1 megohm. The maximum grid circuit resistance when self-bias is employed may be 0.25 megohm if the heater voltage does not exceed 7.0 volts. See first note above.

For Class AB operation the driver stage should be designed so as to be capable of supplying the required peak power with low distortion to the grids of the output stage.

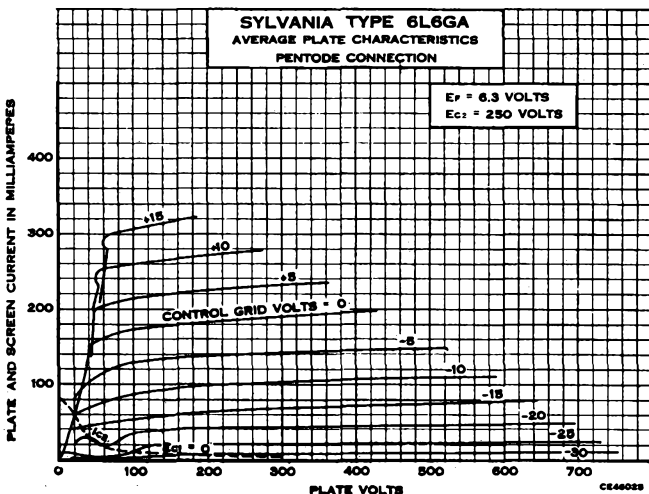

# 6L6A (Cont'd)

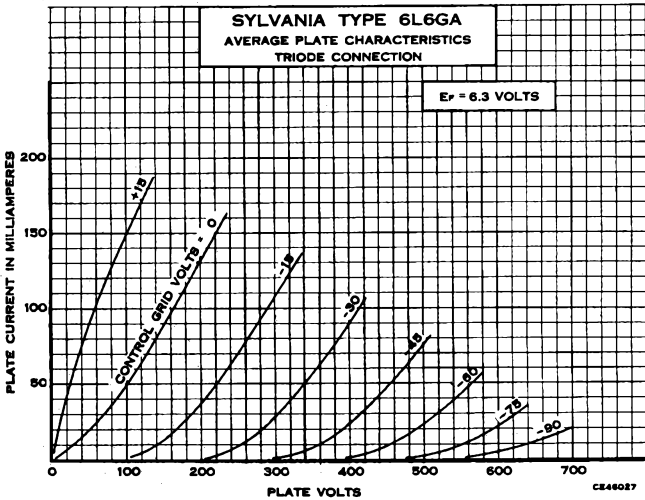
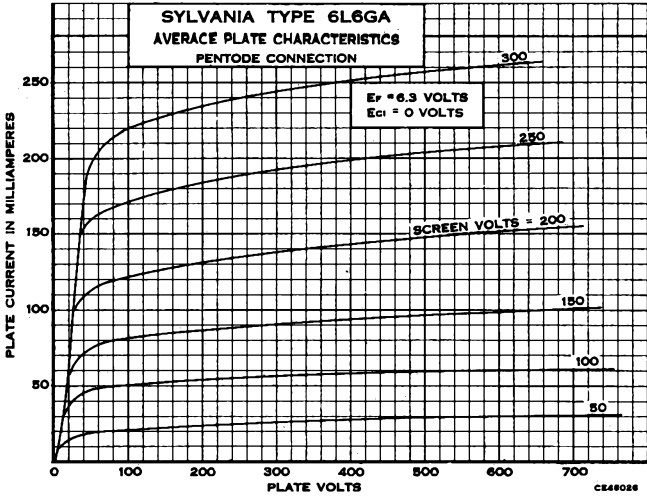

## 6L7, G Sylvania Type

HEPTODE CONVERTER, AMPLIFIER

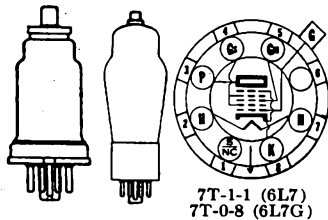

### PHYSICAL SPECIFICATIONS

	6L7	6L7G
Base.....	Small Wafer Octal 7 Pin	Small Octal 7 Pin
Bulb.....	Metal 8-4	ST12
Cap.....	Miniature	Miniature
Maximum Overall Length.....	3 1/8"	4 15/16"
Maximum Seated Height.....	2 1/4"	3 39/64"
Mounting Position.....	Any	Any

## RATINGS

	Mixer	Amplifier
Heater Voltage AC or DC.....	6.3	6.3 Volts
Heater Current.....	0.3	0.3 Ampere
Maximum Plate Voltage.....	300	300 Volts
Maximum Screen Voltage.....	150	100 Volts
Maximum Plate Dissipation.....	1.0	1.5 Watts
Maximum Screen Dissipation.....	1.5	1.0 Watts
Maximum Heater-Cathode Voltage.....	90	90 Volts

## TYPICAL OPERATION—MIXER

Heater Voltage.....	6.3	6.3 Volts
Plate Voltage.....	250	250 Volts
Screen Voltage (Gs).....	100	150 Volts
Control Grid Voltage (G).....	-3	-6 Volts
Modulator Grid Voltage (Gm).....	-10	-15 Volts
Peak Oscillator Voltage applied to Grid Gm (Min.).....	12	18 Volts
Plate Current.....	2.4	3.3 Ma.
Screen Current.....	7.1	9.2 Ma.
Plate Resistance.....	Greater than 1	Megohm
Conversion Conductance.....	375	350 $\mu$ hos
Control Grid Voltage for Conversion Conductance of 5 Micromhos.....	-30	-45 Volts

CLASS A<sub>1</sub> AMPLIFIER

Heater Voltage.....	6.3	6.3 Volts.
Plate Voltage.....	250	250 Volts
Screen Voltage (Gs).....	100	100 Volts
Control Grid Voltage (G).....	-3	-3 Volts
Control Grid Voltage (Gm).....	-3	-3 Volts
Plate Current.....	5.3	Ma.
Screen Current.....	6.5	Ma.
Plate Resistance (Approximate).....	0.6	Megohm
Amplification Factor.....	670	
Mutual Conductance.....	1100	$\mu$ hos
At -6 Volts Bias on Grids G and Gm.....	475	$\mu$ hos
At -10 Volts Bias on Grids G and Gm.....	75	$\mu$ hos
At -15 Volts Bias on Grids G and Gm (Approximate).....	5	$\mu$ hos

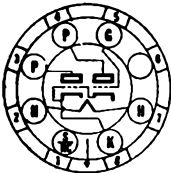

7AU-0-0



## Sylvania Type 6N6G

### DIRECT COUPLED POWER AMPLIFIER

## PHYSICAL SPECIFICATIONS

Base.....	Medium Octal 7 Pin
Bulb.....	ST14
Maximum Overall Length.....	4 $\frac{3}{4}$ "
Maximum Seated Height.....	4 $\frac{1}{4}$ "
Mounting Position.....	Any

## RATINGS

Heater Voltage AC or DC.....	6.3 Volts
Heater Current.....	0.8 Ampere
Maximum Output Plate Voltage.....	300 Volts
Maximum Input Plate Voltage.....	300 Volts
Maximum Heater-Cathode Voltage.....	90 Volts

### TYPICAL OPERATION

#### CLASS A AMPLIFIER

Heater Voltage.....	6.3 Volts
Heater Current.....	0.8 Ampere
Plate Voltage (Output).....	300 Volts
Plate Voltage (Input).....	300 Volts
Grid Voltage (Input).....	0 Volt
Plate Current (Output).....	42 Ma.
Plate Current (Input).....	9 Ma.
Plate Resistance.....	24000 Ohms
Mutual Conductance†.....	2400 $\mu$ hos
Amplification Factor.....	58
Load Resistance.....	7000 Ohms
Power Output*.....	4.0 Watts
Power Output**.....	6.5 Watts

†Input grid—output plate Mutual Conductance.

\*15 volts (r-m-s) signal; total distortion 5%.

\*\*Input grid begins to draw grid current; total distortion 10%.

# 6N7<sup>GT</sup> Sylvania Type

DUO TRIODE POWER AMPLIFIERS

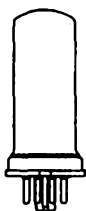

8B-1-0 (6N7)  
8B-0-0 (6N7GT)

## PHYSICAL SPECIFICATIONS

	6N7	6N7GT
Base.....	Small Wafer Octal 8 Pin	Intermediate Octal 8 Pin
Bulb.....	Metal 8-6	T9
Maximum Overall Length.....	3 1/4"	3 3/16"
Maximum Seated Height.....	2 1/4"	2 3/4"
Mounting Position.....	Any	Any

## RATINGS

Heater Voltage AC or DC.....	6.3 Volts
Heater Current.....	0.8 Ampere
Maximum Plate Voltage.....	300 Volts
Maximum Dynamic Peak Plate Current (per Plate).....	125 Ma.
Maximum Average Plate Dissipation (per Plate).....	5.5 Watts
Maximum Heater-Cathode Voltage.....	90 Volts

## TYPICAL OPERATION

### CLASS AB<sub>2</sub> POWER AMPLIFIER

(Values are for both sections unless otherwise specified)

	Ideal	Typical
Heater Voltage.....	6.3	6.3 Volts
Heater current.....	0.8	0.8 Ampere
Grid Impedance at 400 Cycles.....	0	516 † Ohms
Plate Supply Impedance.....	0	1000 Ohms
Plate Voltage (Zero Signal).....	300	300 Volts
Grid Voltage (DC).....	0	0 Volt
Peak Signal Voltage (per Grid).....	29	41 Volts
Plate Current (per Plate Zero Signal).....	17.5	17.5 Ma.
Plate Current (per Plate Maximum Signal).....	35	35 Ma.
Peak Grid Current (per Grid Maximum Signal).....	20	22 Ma.
Load Resistance (Plate to Plate).....	8000	8000 Ohms
Power Output.....	10	10 Watts
Total Harmonic Distortion.....	4	8 Per Cent

†The 516 ohms impedance shown consists of 500 ohms resistance and 50 mh. inductance.

### CLASS A DRIVER

(Both grids and both plates connected together at the socket)

Heater Voltage.....	6.3	6.3 Volts
Heater Current.....	0.8	0.8 Ampere
Plate Voltage.....	250	294 Volts
Grid Voltage.....	-5	-6 Volts
Plate Current.....	6	7 Ma.
Plate Resistance.....	11300	11000 Ohms
Mutual Conductance.....	3100	3200 amhos
Amplification Factor.....	35	35

For use in resistance coupled circuits see data in appendix.

# 6P5<sup>GT</sup> Sylvania Type

MEDIUM-MU TRIODE

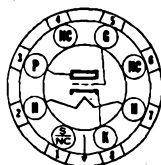

6Q-U-U

## PHYSICAL SPECIFICATIONS

Base.....	Intermediate Octal 6 Pin
Bulb.....	T9
Maximum Overall Length.....	3 3/16"
Maximum Seated Height.....	2 3/4"
Mounting Position.....	Any

### TYPICAL OPERATION CLASS A AMPLIFIER

Heater Voltage.....	6.3	6.3 Volts
Heater Current.....	300	300 Ma.
Plate Voltage.....	100	250 Volts
Grid Voltage.....	-5	-13.5 Volts
Plate Current.....	2.5	5 Ma.
Plate Resistance.....	12000	9500 Ohms
Mutual Conductance.....	1150	1450 $\mu$ mhos
Amplification Factor.....	13.8	13.8
Heater-Cathode Voltage.....	90	90 Volts Max.

### BIASED DETECTOR

Heater Voltage.....	6.3	6.3 Volts
Plate Voltage.....	100	250 Volts Max.
Grid Voltage (Approximate).....	-8	-20 Volts
Plate Current—Adjust to 0.2 ma. with no a-c input signal.		

### GRID LEAK DETECTOR

Heater Voltage.....	6.3 Volts
Plate Voltage.....	45 Volts
Grid Leak.....	1 to 5 Megohms
Grid Condenser.....	0.00025 $\mu$ f.



7V-1-8 (6Q7)  
7V-0-8 (6Q7G)  
7V-1-8 (6Q7GT)

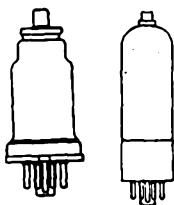

## Sylvania Type 6Q7GT

DUODIODE HIGH-MU TRIODE

### PHYSICAL SPECIFICATIONS

	6Q7	6Q7G	6Q7GT
Base.....	Small Wafer Octal 7 Pin	Small Octal 7 Pin	Small Wafer Metal Sleeve Octal 7 Pin
Bulb.....	Metal 8-4	ST12	T9
Cap.....	Miniature	Miniature	Miniature
Maximum Overall Length.....	3 $\frac{3}{4}$ "	4 $\frac{15}{16}$ "	3 $\frac{5}{8}$ "
Maximum Seated Height.....	2 $\frac{3}{4}$ "	3 $\frac{3}{4}$ "	2 $\frac{3}{4}$ "
Mounting Position.....	Any	Any	Any

### TYPICAL OPERATION

Heater Voltage.....	6.3	6.3 Volts
Heater Current.....	300	300 Ma.
Plate Voltage.....	100	250 Volts
Grid Voltage*.....	-1.0	-3 Volts
Plate Current*.....	0.8	1.0 Ma.
Plate Resistance.....	58000	58000 Ohms
Mutual Conductance.....	1200	1200 $\mu$ mhos
Amplification Factor.....	70	70
Heater-Cathode Voltage.....	90	90 Volts Max.

\*These are rating values only and not operating points with coupling resistor.  
For resistance coupled circuit data, see the appendix.



7V-1-1 (6R7)  
7V-0-8 (6R7GT)

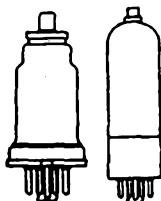

## Sylvania Type 6R7GT

DUODIODE MEDIUM-MU TRIODE

### PHYSICAL SPECIFICATIONS

	6R7	6R7GT
Base.....	Small Wafer Octal 7 Pin	Intermediate Octal 7 Pin
Bulb.....	Metal 8-4	T9
Cap.....	Miniature	Miniature
Maximum Overall Length.....	3 $\frac{3}{4}$ "	3 $\frac{5}{8}$ "
Maximum Seated Height.....	2 $\frac{3}{4}$ "	2 $\frac{3}{4}$ "
Mounting Position.....	Any	Any

# 6R7<sup>GT</sup> (Cont'd)

## TYPICAL OPERATION

Heater Voltage.....	6.3 Volts
Heater Current.....	0.30 Ampere
Plate Voltage.....	250 Volts
Grid Voltage.....	-9 Volts
Plate Current.....	9.5 Ma.
Plate Resistance.....	8500 Ohms
Mutual Conductance.....	1900 $\mu$ hos
Amplification Factor.....	16
Undistorted Power Output.....	285 Mw.
Maximum Heater-Cathode Voltage.....	90 Volts

For resistance coupled circuit data, see appendix.

# 6S4 Sylvania Type

MEDIUM MU TRIODE

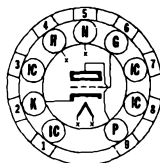

9AC-0-0

## PHYSICAL SPECIFICATIONS

Base.....	Small Button 9 Pin
Bulb.....	T-6 $\frac{1}{2}$
Maximum Overall Length.....	2 $\frac{5}{8}$ "
Maximum Seated Height.....	2 $\frac{3}{8}$ "
Mounting Position.....	Any

## RATINGS

Heater Voltage (AC or DC).....	6.3 Volts
Maximum Plate Voltage.....	500 Volts
Maximum Peak Plate Voltage*.....	2000 Volts
Maximum Grid Voltage DC.....	-50 Volts
Maximum Peak Negative Pulse Grid Voltage.....	-200 Volts
Maximum Cathode Current.....	30 Ma.
Maximum Plate Dissipation.....	7.5 Watts
Maximum Peak Heater-Cathode Voltage.....	$\pm$ 200 Volts
Maximum Grid Circuit Resistance.....	2.2 Megohm
Minimum Cathode Bias Resistance.....	220 Ohms

\*The duration of the voltage pulse must not exceed 15% of one scanning cycle. In typical television service this is 2.5 milliseconds.

## TYPICAL OPERATION VERTICAL DEFLECTION AMPLIFIER#

Heater Voltage.....	6.3 Volts
Heater Current.....	0.6 Ampere
Plate Voltage.....	450 Volts
Cathode Bias Resistor.....	820 Ohms
Grid Input Voltage (peak to peak of sawtooth).....	60 Volts
(negative peaking component).....	48 Volts
Plate Current.....	18 Ma.
Plate Output Voltage (peak positive pulse component).....	800 Volts
(peak to peak of sawtooth).....	350 Volts

## CLASS A<sub>1</sub> AMPLIFIER

Plate Voltage.....	250 Volts
Grid Voltage.....	-8.0 Volts
Plate Current.....	26 Ma.
Mutual Conductance.....	4500 $\mu$ hos
Amplification Factor.....	16
Plate Resistance.....	3600 Ohms

#For operation in a television receiver using a vertical deflection output transformer with a step-down ratio of approximately 11 to 1 to match the vertical deflection yoke coils having an inductance of approximately 40 mh.

## APPLICATION

Sylvania Type 6S4 is a medium-mu triode in the miniature construction having characteristics designed for use as a vertical deflection amplifier in television receivers. When used with well designed components and adequate power supply, sufficient drive is available for use with 16" picture tubes such as Sylvania Type 16TP4 at its maximum anode voltage.



## TYPICAL VERTICAL DEFLECTION CIRCUIT FOR SYLVANIA TYPE 16TP4 PICTURE TUBE

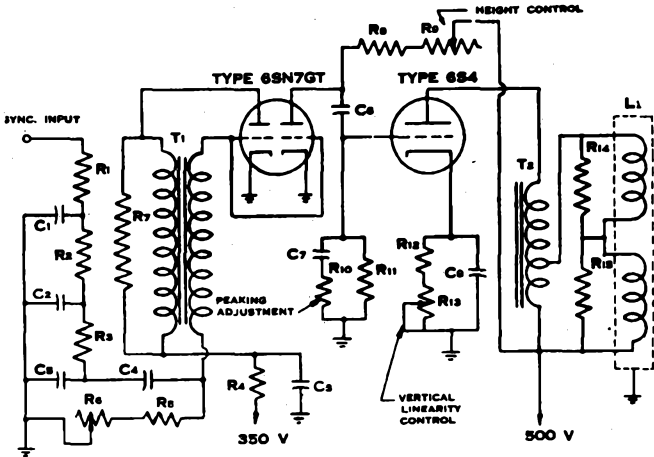

C1 C2 C4 C5: 0.005  $\mu\text{f.}$ , 400 v  
 C3: 4  $\mu\text{f.}$ , 400 v, electrolytic  
 C6: 0.1  $\mu\text{f.}$ , 600 v  
 C7: 0.05  $\mu\text{f.}$ , 600 v  
 C8: 100  $\mu\text{f.}$ , 50 v, electrolytic  
 L1: Vertical Coils of 70°  
 Deflection Yoke  
 R1 R2 R3: 8200 Ohms, 0.5 watt  
 R4: 0.1 megohm, 0.5 watt  
 R5 R8: 1.0 megohm, 0.5 watt  
 R6: Potentiometer, 1.0 megohm,  
 0.5 watt  
 R7: 10,000 ohms, 0.5 watt  
 R9: Potentiometer, 3.0 megohms,  
 1 watt

R10: Potentiometer, 5000 ohms,  
 0.5 watt (see Note)  
 R11: 2.2 megohms, 0.5 watt  
 R12: 820 ohms, 1 watt  
 R13: Potentiometer, 3000 ohms,  
 1 watt, wire wound  
 R14 R15: 560 ohms, 0.5 watt  
 T1: Vertical Blocking Oscillator  
 Transformer, Stancor A-8121  
 or equivalent  
 T2: Vertical-Deflection-Output  
 Transformer, Stancor A-8116  
 (using two windings) or RCA-  
 222T1 (Autotransformer)

Note: Fixed Resistance may be used after needed value for vertical peaking control has been determined with rheostat.

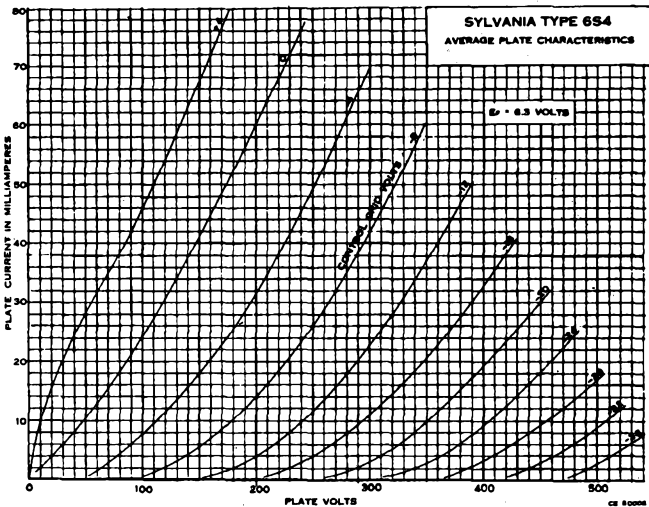

# 6S7, G Sylvania Type

REMOTE CUT OFF RF PENTODES

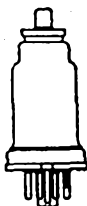

7R-1-1 (6S7)  
7R-0-8 (6S7G)

## PHYSICAL SPECIFICATIONS

	<b>6S7</b>	<b>6S7G</b>
Base.....	Small Wafer Octal 7 Pin	Small Octal 7 Pin
Bulb.....	Metal 8-4	ST12
Cap.....	Miniature	Miniature
Maximum Overall Length.....	3 1/8"	4 1/2"
Maximum Seated Height.....	2 3/4"	3 3/4"
Mounting Position.....	Any	Any

## TYPICAL OPERATION AMPLIFIER (CLASS A)

Heater Voltage.....	6.3	6.3 Volts
Heater Current.....	0.150	0.150 Ampere
Plate Voltage.....	135	250 Volts Max.
Grid Voltage.....	-3	-3 Volts Min.
Screen Voltage.....	67.5	100 Volts Max.
Suppressor.....		Tie to Cathode
Plate Current.....	3.7	8.5 Ma.
Screen Current.....	0.9	2.0 Ma.
Plate Resistance (Approximate).....	1.0	1.0 Megohm
Mutual Conductance.....	1250	1750 μmhos
Grid Voltage for 10 μmhos.....	-25	-38.5 Volts
Heater-Cathode Voltage.....	90	90 Volts Max.

# 6S8<sup>GT</sup> Sylvania Type

TRIPLE DIODE-TRIODE



8CB-0-2

## PHYSICAL SPECIFICATIONS

Base.....	Intermediate Octal 8 Pin
Bulb.....	T-9
Cap.....	Miniature
Maximum Overall Length.....	3 5/8"
Maximum Seated Height.....	3 1/4"
Mounting Position.....	Any

## RATINGS

Heater Voltage.....	6.3 Volts
Heater Current.....	300 Ma.
Maximum Plate Voltage.....	300 Volts
Maximum Plate Dissipation.....	0.5 Watts
Maximum Heater-Cathode Voltage.....	90 Volts

### Direct Interelectrode Capacitances:

Triode grid to any diode plate.....	005 μμf. Max
Diode input (approx. each).....	1 μμf.

## TYPICAL OPERATION

Heater Voltage.....	6.3	6.3 Volts
Heater Current.....	300	300 Ma.
Plate Voltage.....	100	250 Volts
Grid Voltage.....	-1.0	-2.0 Volts
Plate Current.....	0.4	0.9 Ma.
Mutual Conductance.....	900	1100 μmhos
Plate Resistance.....	110,000	91,000 Ohms
Amplification Factor.....	100	100

Reference should be made to Type 7B6 for curves and resistance coupled data.



8AD-1-6  
6SA7GT



8R-1-0  
6SA7

# Sylvania Type 6SA7<sup>GT</sup>

## HEPTODE CONVERTER

### PHYSICAL SPECIFICATIONS

	6SA7	6SA7GT
Base.....	Small Wafer Octal 8 Pin	Intermediate Octal 8 Pin
Bulb.....	Metal 8-1	T9
Maximum Overall Length....	2 3/4"	3 3/4"
Maximum Seated Height....	2 1/4"	2 3/4"
Mounting Position.....	Any	Any

#### Direct Interelectrode Capacitances:\*

	6SA7*	6SA7GT**
Grid G to all other Electrodes (Signal Input) ..	9.5 $\mu$ f.	9.5 $\mu$ f.
Plate to all other Electrodes (Mixer Output) ..	12 $\mu$ f.	9.5 $\mu$ f.
Grid Go to all other Electrodes.....	7 $\mu$ f.	8.0 $\mu$ f.
Grid G to Plate.....	0.13 $\mu$ f. Max.	0.5 $\mu$ f.
Grid Go to Grid G.....	0.15 $\mu$ f. Max.	0.4 $\mu$ f.
Grid Go to Plate.....	0.06 $\mu$ f. Max.	0.4 $\mu$ f.
Grid Go to all other Electrodes except K.....	4.4 $\mu$ f.	5.0 $\mu$ f.
Grid Go to K.....	2.6 $\mu$ f.	3.5 $\mu$ f.
K to all other Electrodes except Grid Go.....	5 $\mu$ f.	20 $\mu$ f.

\*With shell connected to cathode.

\*\*With 1 3/4" diameter shield (RMA Std. 308) connected to cathode.

### TYPICAL OPERATION

	Self-Excitation†		Separate Excitation	
Heater Voltage.....	6.3	6.3	6.3	6.3 Volts
Heater Current.....	300	300	300	300 Ma.
Plate Voltage.....	100	250	100	250 Volts
Control Grid Voltage				
(Grid G).....	0	0	-2	-2 Volts
Screen Voltage (Grid Ga)....	100	100	100	100 Volts
Grid No. 5 and Shell				
Voltage.....	0	0	0	0 Volt
Oscillator Grid Resistor				
(Grid Go).....	20000	20000	20000	20000 Ohms
Plate Current.....	3.2	3.4	3.3	3.5 Ma.
Screen Grid Current.....	8	8	8.5	8.5 Ma.
Oscillator Grid Current.....	0.5	0.5	0.5	0.5 Ma.
Plate Resistance (Approx.)....	0.5	0.8	0.5	1.0 Megohm
Conversion Transconductance	425	450	425	450 $\mu$ mhos
Control Grid Voltage				
(2 $\mu$ mhos Conv. Cond.)....	-35	-35	-35	-35 Volts
Max. Heater Cathode Voltage	90	90	90	90 Volts

†Values shown are approximate and are for a Hartley circuit with a feedback of approximately 2 volts peak in the cathode circuit.

### APPLICATION

Sylvania Types 6SA7, GT are single-ended pentagrid converters for service similar to other pentagrid converter types. The oscillator section is designed to operate in a Hartley circuit with the cathode connected to a tap on the oscillator coil. The mutual conductance between grid Go and grid Gs tied to the plate (not oscillating) is approximately 4500  $\mu$ mhos when grids Go, G and the shell are at zero volts, with grid Gs and plate at 100 volts. Characteristics for self-excitation in a Hartley circuit are shown above. Other application notes may be obtained by referring to Type 7Q7.

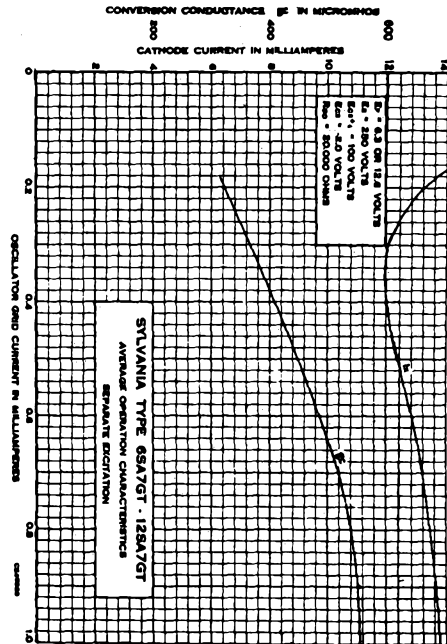
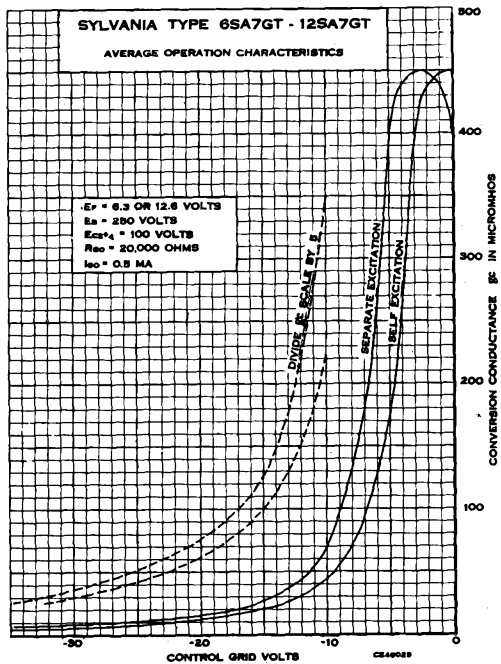
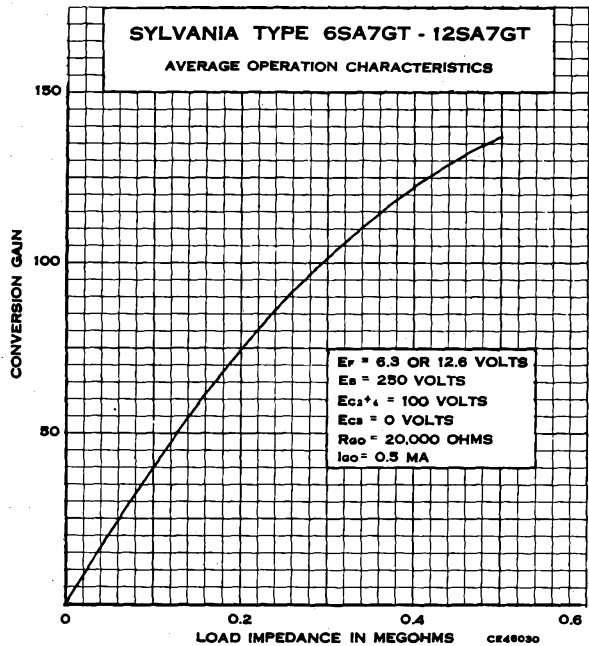



8R-1-0

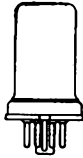

# Sylvania Type 6SB7Y

## HEPTODE CONVERTER

### PHYSICAL SPECIFICATIONS

Base.....	Micanol Small Wafer	Octal 8 Pin
Bulb.....		Metal 8-1
Maximum Overall Length.....		2 5/8"
Maximum Seated Height.....		2 1/8"
Mounting Position.....		Any

### RATINGS

Heater Voltage AC or DC.....	6.3 Volts
Heater Current.....	300 Ma.
Maximum Plate Voltage.....	300 Volts
Maximum Screen Voltage.....	100 Volts
Maximum Screen Supply Voltage.....	300 Volts
Maximum Plate Dissipation.....	2.0 Watts
Maximum Screen Dissipation.....	1.5 Watts
Maximum Total Cathode Current.....	22 Ma.
Maximum Control Grid Voltage Range.....	-100 to +0 Volts
Maximum Heater-Cathode Voltage.....	90 Volts

#### Direct Interelectrode Capacitances:

Grid G to all other electrodes (signal input)*.....	9.6 $\mu$ f.
Plate to all other electrodes (Mixer output)*.....	9.2 $\mu$ f.
Grid Go to all other electrodes (oscillator input)*.....	7.3 $\mu$ f.
Grid G to plate*.....	0.13 $\mu$ f. Max.
Grid G to Grid Go*.....	0.16 $\mu$ f. Max.
Grid Go to plate*.....	0.06 $\mu$ f. Max.
Grid Go to all except cathode.....	3.8 $\mu$ f.
Grid Go to cathode.....	3.4 $\mu$ f.
Cathode to all except Go.....	4.5 $\mu$ f.

\*With shell connected to cathode.

### TYPICAL OPERATION

	Separate Excitation*		Self Excitation for 88-108 Mc.
Heater Voltage.....	6.3	6.3	6.3 Volts
Heater Current.....	300	300	300 Ma.
Plate Voltage.....	100	250	250 Volts
Screen Voltage.....	100	100	... Volts
Screen Supply Voltage.....	...	...	250 Volts
Screen Dropping Resistor.....	...	...	12,000 Ohms
Control Grid Voltage.....	-1.0	-1.0	0 Volts
Oscillator Grid Resistor.....	20,000	20,000	22,000 Ohms
Plate Resistance.....	0.5	1.0	... Megohm
Conversion Transconductance†.....	900	950	... $\mu$ mhos
Conversion Transconductance† at $E_g = -20$ .....	3.5	3.5	... $\mu$ mhos
Signal Frequency.....	...	...	88 108 Mc.
Oscillation Frequency.....	...	...	98.7 118.7 Mc.
Plate Current.....	3.6	3.8	6.8 6.5 Ma.
Screen Current.....	10.2	10.0	12.6 12.5 Ma.
Oscillator Grid Current.....	0.35	0.35	0.13 0.14 Ma.

\*Substantially the same characteristics may be obtained as a self excited oscillator by reducing the grid voltage to 0 volts.

†The oscillator mutual conductance is approximately 8000 micromhos with  $E_{g0} = 0$ ,  $E_{g3} = E_p = 100$  volts,  $E_g = 0$ .

### APPLICATION

Sylvania Type 6SB7Y is very similar to Type 6SA7GT except for increased oscillator strength and conversion conductance which provide improved performance at high frequencies.

# Sylvania Type 6SC7

## HIGH-MU DUO TRIODE



8S-1-0

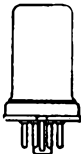

### PHYSICAL SPECIFICATIONS

Base.....	Small Wafer	Octal 8 Pin
Bulb.....		Metal 8-1
Maximum Overall Length.....		2 5/8"
Maximum Seated Height.....		2 1/8"
Mounting Position.....		Any

# 6SC7 (Cont'd)

## TYPICAL OPERATION CLASS A AMPLIFIER (ONE TRIODE)

Heater Voltage AC or DC.....	6.3 Volts
Heater Current.....	300 Ma.
Plate Voltage.....	250 Volts Max.
Grid Voltage.....	-2.0 Volts
Plate Current.....	2.0 Ma.
Plate Resistance.....	53000 Ohms
Mutual Conductance.....	1325 $\mu$ mhos
Amplification Factor.....	70
Heater-Cathode Voltage.....	90 Volts Max.

## TYPICAL OPERATION AS PHASE INVERTER

Plate Supply Voltage.....	90	300 Volts
Plate Current per Section.....	0.15	0.65 Ma.
Plate Load Resistor (per Plate).....	0.25	0.25 Megohm
Self-Bias Resistor.....	3750	1675 Ohms
Grid Resistor for Following Tubes.....	0.5	0.5 Megohm
Voltage Amplification (At 5 volts RMS Output)....	30	42
Peak Output Voltage (RMS)*.....	18	110 Volts

\*At start of grid current.

## APPLICATION

Sylvania Type 6SC7 is a double triode amplifier in the single-ended construction. It is so designed that it is specially adaptable for phase inverter service. For resistance coupling data reference should be made to Type 7F7.

# 6SD7<sup>GT</sup> Sylvania Type

SEMI-REMOTE CUT-OFF

RF AMPLIFIER



8N-1-5

## PHYSICAL SPECIFICATIONS

Base.....	Small Wafer Octal 8 Pin, Metal Sleeve
Bulb.....	T9
Maximum Overall Length.....	3 $\frac{3}{8}$ "
Maximum Seated Height.....	2 $\frac{3}{4}$ "
Mounting Position.....	Any

## RATINGS

Heater Voltage AC or DC.....	6.3 Volts
Heater Current.....	0.300 Ampere
Maximum Plate Voltage.....	300 Volts
Maximum Screen Supply Voltage.....	300 Volts
Maximum Screen Voltage.....	125 Volts
Maximum Plate Dissipation.....	4 Watts
Maximum Screen Dissipation.....	0.4 Watt
Maximum Heater-Cathode Voltage.....	90 Volts
Direct Interelectrode Capacitances:*	
Grid to Plate.....	0.0035 $\mu$ f. Max.
Input.....	9.0 $\mu$ f.
Output.....	7.5 $\mu$ f.

\*Shell and internal shield connected to cathode.

## TYPICAL OPERATION CLASS A<sub>1</sub> AMPLIFIER

Heater Voltage.....	6.3	6.3 Volts
Heater Current.....	0.300	0.300 Ampere
Plate Voltage.....	100	250 Volts
Screen Voltage.....	100	100 Volts
Control Grid Voltage.....	-2	-2 Volts
Self-Bias Resistor.....	260	255 Ohms
Suppressor Voltage.....	0	0 Volt
Plate Resistance (Approximate).....	0.25	1.0 Megohm
Mutual Conductance.....	3350	3600 $\mu$ mhos
Control Grid Voltage for 20 $\mu$ mhos.....	-11	-11 Volts
Plate Current.....	5.7	6.0 Ma.
Screen Current.....	2.0	1.9 Ma.



8N-1-5



# Sylvania Type 6SE7<sup>GT</sup>

SHARP CUT-OFF RF PENTODE

## PHYSICAL SPECIFICATIONS

Base.....	Small Wafer Octal 8 Pin Metal Sleeve
Bulb.....	T9
Maximum Overall Length.....	3 <sup>3</sup> / <sub>16</sub> "
Maximum Seated Height.....	2 <sup>3</sup> / <sub>4</sub> "
Mounting Position.....	Any

## RATINGS

Heater Voltage AC or DC.....	6.3 Volts
Heater Current.....	0.300 Ampere
Maximum Plate Voltage.....	300 Volts
Maximum Screen Supply.....	300 Volts
Maximum Screen Voltage.....	125 Volts
Maximum Plate Dissipation.....	4.0 Watts
Maximum Screen Dissipation.....	0.4 Watt
Minimum External Control Grid Voltage.....	0 Volt
Maximum Heater-Cathode Voltage.....	90 Volts

**Direct Interelectrode Capacitances:\***

Grid to Plate.....	0.005 $\mu$ f. Max.
Input.....	8.0 $\mu$ f.
Output.....	7.5 $\mu$ f.

\*With 1<sup>5</sup>/<sub>16</sub>" diameter shield (RMA Std. M8-308) connected to cathode.

## TYPICAL OPERATION

### CLASS A<sub>1</sub> AMPLIFIER

Heater Voltage.....	6.3	6.3 Volts
Heater Current.....	0.300	0.300 Ampere
Plate Voltage.....	100	250 Volts
Screen Voltage.....	100	100 Volts
Grid Voltage.....	-1	-1.5 Volts
Plate Resistance (Approximate).....	0.1	1.0 Megohm
Mutual Conductance.....	3000	3100 $\mu$ mhos
Control Grid Voltage for Cut Off.....	-5	-5 Volts
Plate Current.....	5.5	4.5 Ma.
Screen Current.....	2.4	1.5 Ma.
Self-Bias Resistor.....	125	250 Ohms

Suppressor Connected to Cathode.



6AB-1-0 (6SF5)  
6AB-0-0 (6SF5GT)

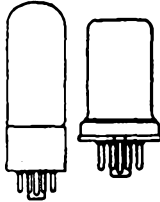

# Sylvania Type 6SF5<sup>GT</sup>

HIGH-MU TRIODE

## PHYSICAL SPECIFICATIONS

Base.....	6SF5 Small Wafer Octal 6 Pin Metal 8-1	6SF5GT Intermediate Octal 6 Pin T9
Bulb.....	2 <sup>5</sup> / <sub>8</sub> "	3 <sup>3</sup> / <sub>16</sub> "
Maximum Overall Length.....	2 <sup>1</sup> / <sub>4</sub> "	2 <sup>3</sup> / <sub>4</sub> "
Maximum Seated Height.....	Any	Any

**Direct Interelectrode Capacitances:\***

Grid to Plate.....	6SF5*	6SF5GT**
Input.....	2.4	2.6 $\mu$ f.
Output.....	4.0	4.2 $\mu$ f.
	3.6	3.8 $\mu$ f.

\*With shell connected to cathode.

\*\*With 1<sup>5</sup>/<sub>16</sub>" diameter shield (RMA Std. M8-308) connected to cathode.

# 6SF5<sup>GT</sup> (Cont'd)

## TYPICAL OPERATION CLASS A AMPLIFIER

Heater Voltage.....	6.3 Volts
Heater Current.....	0.3 Amperes
Plate Voltage.....	250 Volts Max.
Grid Voltage.....	-2 Volts
Plate Current.....	0.9 Ma.
Plate Resistance.....	66000 Ohms
Mutual Conductance.....	1500 $\mu$ mhos
Amplification Factor.....	100
Heater-Cathode Voltage.....	90 Volts Max.

For additional application notes and curve data refer to Type 7B4.

# 6SF7 Sylvania Type

DIODE RF PENTODE

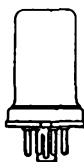

7AZ-1-1

## PHYSICAL SPECIFICATIONS

Base.....	Small Wafer	Octal 8 Pin
Bulb.....		Metal 8-1
Maximum Overall Length.....		2 5/8"
Maximum Seated Height.....		2 1/8"
Mounting Position.....		Any

## RATINGS

Heater Voltage AC or DC.....	6.3 Volts
Heater Current.....	300 Ma.
Maximum Plate Voltage.....	300 Volts
Maximum Screen Supply Voltage.....	300 Volts
Maximum Screen Voltage.....	100 Volts
Maximum Plate Dissipation.....	3.5 Watts
Maximum Screen Dissipation.....	0.5 Watt
Minimum Control Grid Bias.....	0 Volt
Minimum Diode Current at 10 Volts DC.....	0.8 Ma.
Maximum Continuous Diode Current.....	1.0 Ma.
Maximum Heater-Cathode Voltage.....	90 Volts

### Direct Interelectrode Capacitances:\*

Grid to Plate.....	0.004 $\mu$ f. Max.
Input.....	5.5 $\mu$ f.
Output.....	6.0 $\mu$ f.
Pentode Grid to Diode Plate.....	0.002 $\mu$ f. Max.
Pentode Plate to Diode Plate.....	1.3 $\mu$ f.

\*With shell connected to cathode.

## TYPICAL OPERATION CLASS A<sub>1</sub> AMPLIFIER

Heater Voltage.....	6.3	6.3 Volts
Heater Current.....	300	300 Ma.
Plate Voltage.....	100	250 Volts
Screen Voltage.....	100	100 Volts
Grid Voltage.....	-1	-1 Volts
Self-Bias Resistor.....	65	65 Ohms
Plate Resistance (Approximate).....	0.2	0.7 Megohm
Mutual Conductance.....	1975	2050 $\mu$ mhos
Control Grid Voltage for 10 $\mu$ mhos.....	-35	-35 Volts
Plate Current.....	12.0	12.4 Ma.
Screen Current.....	3.4	3.3 Ma.

Refer to data on Type 7B6 for diode characteristics.





8BK-1-1

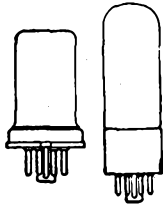

# Sylvania Type 6SG7GT

SEMI-REMOTE CUT-OFF RF PENTODE

## PHYSICAL SPECIFICATIONS

	6SG7 Small Wafer Octal 8 Pin Metal 8-1 Any	6SG7GT Small Wafer Octal 8 Pin Metal Sleeve T9 3 3/4" 2 3/4" Any
Base .....	Octal 8 Pin	8 Pin Metal Sleeve
Bulb .....	Metal 8-1	T9
Maximum Overall Length .....	2 3/8"	3 3/4"
Maximum Seated Height .....	2 1/8"	2 3/4"
Mounting Position .....	Any	Any

## RATINGS

Heater Voltage AC or DC .....	6.3 Volts
Heater Current .....	300 Ma.
Maximum Plate Voltage .....	300 Volts
Maximum Screen Supply .....	300 Volts
Maximum Screen Voltage .....	200 Volts
Maximum Plate Dissipation .....	3 Watts
Maximum Screen Dissipation .....	0.6 Watt
Minimum External Control Grid Bias .....	0 Volt
Maximum Heater-Cathode Voltage .....	90 Volts

### Direct Interelectrode Capacitances:

	6SG7*	6SG7GT**
Grid to Plate .....	0.003	.0035 $\mu$ f. Max.
Input .....	8.5	8.5 $\mu$ f.
Output .....	7.0	7.0 $\mu$ f.

\*Shell connected to cathode.

\*\*With 1 3/8" diameter tube shield (RMA Std. 308) connected to cathode.

## TYPICAL OPERATION

### CLASS A<sub>1</sub> AMPLIFIER

Heater Voltage .....	6.3	6.3	6.3 Volts
Heater Current .....	300	300	300 Ma.
Plate Voltage .....	100	250	250 Volts
Screen Voltage .....	100	125	150 Volts
Control Grid Voltage .....	-1	-1	-2.5 Volts
Self-Bias Resistor .....	90	60	190 Ohms
Plate Resistance (Approximate) .....	0.25	0.9	> 1.0 Megohm
Mutual Conductance .....	4100	4700	4000 $\mu$ mhos
Plate Current .....	8.2	11.8	9.2 Ma.
Screen Current .....	3.2	4.4	3.4 Ma.
Control Grid Voltage for 40 $\mu$ mhos .....	-11.5	-14.0	-17.5 Volts



8BK-1-1

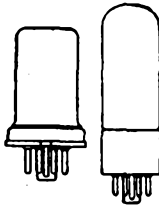

# Sylvania Type 6SH7GT

SHARP CUT-OFF RF PENTODE

## PHYSICAL SPECIFICATIONS

	6SH7 Small Wafer Octal 8 Pin Metal 8-1 Any	6SH7GT Small Wafer Octal 8 Pin Metal Sleeve T9 3 3/4" 2 3/4" Any
Base .....	Octal 8 Pin	8 Pin Metal Sleeve
Bulb .....	Metal 8-1	T9
Maximum Overall Length .....	2 3/8"	3 3/4"
Maximum Seated Height .....	2 1/8"	2 3/4"
Mounting Position .....	Any	Any

# 6SH7<sup>GT</sup> (Cont'd)

## RATINGS

Heater Voltage AC or DC.....	6.3 Volts
Heater Current.....	0.300 Ampere
Maximum Plate Voltage.....	300 Volts
Maximum Screen Supply.....	300 Volts
Maximum Screen Voltage.....	150 Volts
Maximum Plate Dissipation.....	3.0 Watts
Maximum Screen Dissipation.....	0.7 Watt
Minimum External Control Grid Bias.....	0 Volt
Maximum Heater Cathode Voltage.....	90 Volts

### Direct Interelectrode Capacitances:

	<b>6SH7*</b>	<b>6SH7GT**</b>
Grid to Plate.....	0.003	0.004 $\mu$ f. Max.
Input.....	8.5	8.5 $\mu$ f.
Output.....	7.0	7.0 $\mu$ f.

\*With shell connected to cathode.

\*\*With 1 $\frac{3}{8}$ " diameter shield (RMA Std. M8-308) connected to cathode.

## TYPICAL OPERATION

### CLASS A<sub>1</sub> AMPLIFIER

Heater Voltage.....	6.3	6.3 Volts
Heater Current.....	0.300	0.300 Ampere
Plate Voltage.....	100	250 Volts
Screen Voltage.....	100	150 Volts
Control Grid Voltage.....	-1	-1 Volts
Self-Bias Resistor.....	135	65 Ohms
Plate Resistance (Approximate).....	0.35	0.9 Megohm
Mutual Conductance.....	4000	4900 $\mu$ mhos
Grid Bias for 10 $\mu$ a. Plate Current.....	-4.0	-5.5 Volts
Plate Current.....	5.3	10.8 Ma.
Screen Current.....	2.1	4.1 Ma.

# 6SJ7<sup>GT</sup> Sylvania Type

SHARP CUT-OFF RF PENTODE



8N-1-1 (6SJ7)  
8N-1-5 (6SJ7GT)

## PHYSICAL SPECIFICATIONS

	<b>6SJ7</b>	<b>6SJ7GT</b>
Base.....	Small Wafer Octal 8 Pin	Small Wafer Metal Sleeve Octal 8 Pin
Bulb.....	Metal 8-1	T9
Maximum Overall Length.....	2 $\frac{3}{8}$ "	3 $\frac{1}{2}$ "
Maximum Seated Height.....	2 $\frac{1}{4}$ "	2 $\frac{1}{2}$ "
Mounting Position.....	Any	Any

### Direct Interelectrode Capacitances:\*

	<b>6SJ7*</b>	<b>6SJ7GT**</b>
Grid to Plate.....	0.005	0.005 $\mu$ f. Max.
Input.....	6.0	6.3 $\mu$ f.
Output.....	7.0	7.5 $\mu$ f.

\*Shell connected to cathode.

\*\*With 1 $\frac{3}{8}$ " diameter shield (RMA std. 308) connected to cathode.

## TYPICAL OPERATION

### CLASS A<sub>1</sub> AMPLIFIER PENTODE CONNECTION

Heater Voltage.....	6.3	6.3 Volts
Heater Current.....	0.3	0.3 Ampere
Plate Voltage.....	100	250 Volts Max.
Grid Voltage.....	-3	-3 Volts
Screen Voltage.....	100	100 Volts Max.
Suppressor.....	Tie to Cathode	
Plate Current.....	2.9	3.0 Ma.
Screen Current.....	0.9	0.8 Ma.
Plate Resistance (Approximate).....	0.7	1.0 Megohm
Mutual Conductance.....	1575	1650 $\mu$ mhos
Heater-Cathode Voltage.....	90	90 Volts Max.

**TRIODE CONNECTION**

Heater Voltage.....	6.3	6.3 Volts
Heater Current.....	0.3	0.3 Ampere
Plate Voltage.....	180	250 Volts Max.
Grid Voltage.....	-6.0	-8.5 Volts
Amplification Factor.....	19	19
Plate Resistance.....	8200	7600 Ohms
Mutual Conductance.....	2300	2500 $\mu$ mhos
Plate Current.....	6.0	9.2 Ma.

**APPLICATION**

Sylvania Types 6SJ7, GT are single-ended r-f pentode tubes having a sharp cut-off characteristic and designed for applications similar to those for Sylvania Type 6J7. Characteristics for this tube are also very similar to Type 7C7, but are not identical. For additional information on circuit application refer to Type 7C7. Resistance coupled circuit data may be found in the appendix.

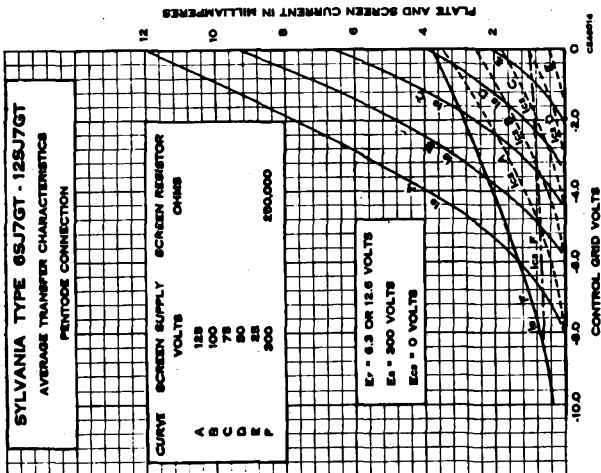
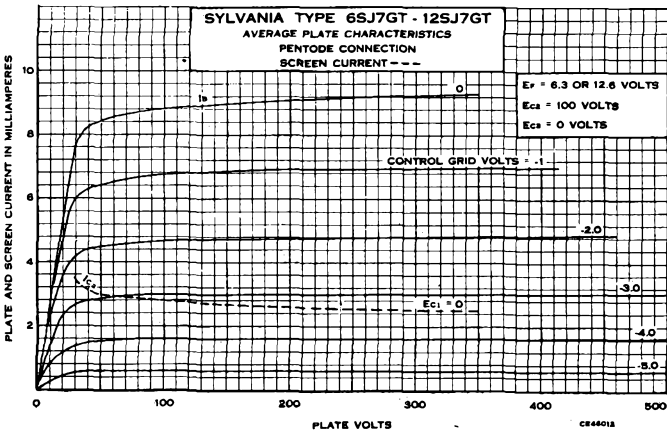

# SYLVANIA RADIO TUBES

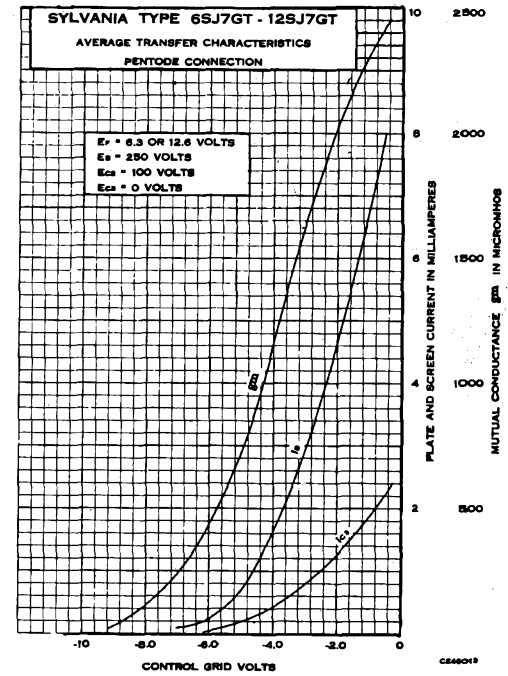
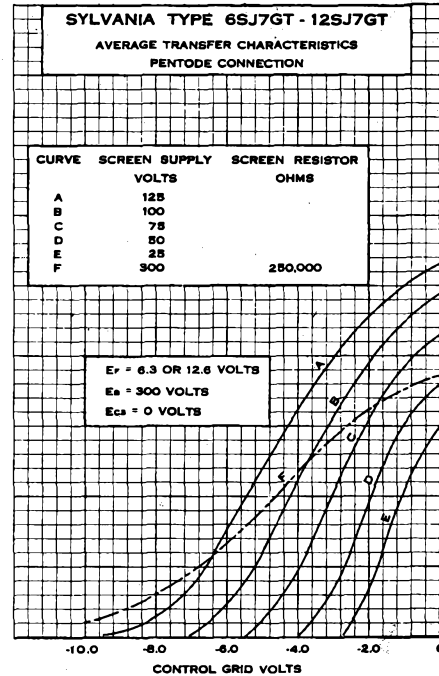
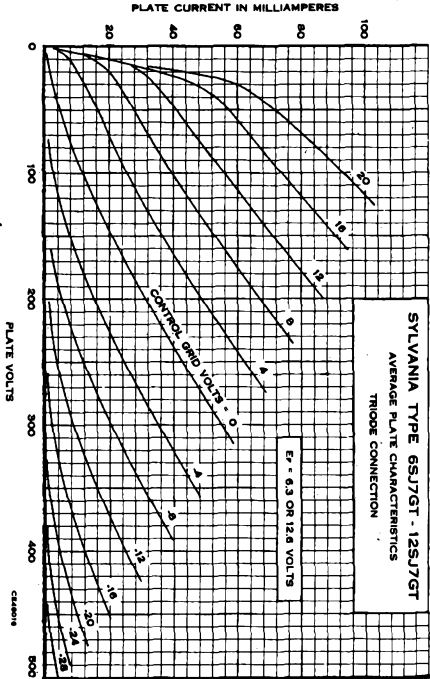

6SJ7GT (Cont'd)



8N-1-1 (6SK7)  
8N-1-5 (6SK7GT)

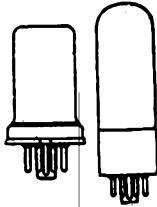

## Sylvania Type 6SK7<sup>GT</sup>

REMOTE CUT-OFF RF PENTODE

### PHYSICAL SPECIFICATIONS

Base.....	6SK7 Small Wafer Octal 8 Pin Metal 8-1	6SK7GT Small Wafer Metal Sleeve Octal 8 Pin T9
Bulb.....		
Maximum Overall Length.....	2 3/4"	3 1/4"
Maximum Seated Height.....	2 1/4"	2 3/4"
Mounting Position.....	Any	Any

#### Direct Interelectrode Capacitances:\*

Grid to Plate.....	6SK7* 0.003 $\mu$ f. Max.	6SK7GT** 0.005 $\mu$ f. Max.
Input.....	6.0 $\mu$ f.	6.5 $\mu$ f.
Output.....	7.0 $\mu$ f.	7.5 $\mu$ f.

\*With shell connected to cathode.

\*\*With 1 3/8" diameter shield (RMA Std. M8-308) connected to cathode.

### TYPICAL OPERATION

Heater Voltage.....	6.3	6.3 Volts
Heater Current.....	0.30	0.30 Ampere
Plate Voltage.....	100	250 Volts Max.
Grid Voltage.....	-1.0	-3 Volts Min.
Screen Voltage.....	100	100 Volts Max.
Suppressor.....	Tie to Cathode	
Plate Current.....	13.0	9.2 Ma.
Screen Current.....	4.0	2.6 Ma.
Plate Resistance (Approximate).....	0.12	0.8 Megohm
Mutual Conductance.....	2350	2000 $\mu$ hos
Amplification Factor.....	475	1600 Approx.
Grid Voltage (10 $\mu$ hos Mutual Cond.).....	-35	-35 Volts
Heater-Cathode Voltage.....	90	90 Volts Max.



8BD-0-0



## Sylvania Type 6SL7<sup>GT</sup>

HIGH-MU DUO TRIODE

### PHYSICAL SPECIFICATIONS

Base.....	Intermediate Octal 8 Pin
Bulb.....	T9
Maximum Overall Length.....	3 1/4"
Maximum Seated Height.....	2 3/4"
Mounting Position.....	Any

### TYPICAL OPERATION\*

Heater Voltage.....	6.3 Volts
Heater Current.....	0.300 Ampere
Plate Voltage.....	250 Volts
Grid Voltage.....	-2.0 Volts
Self-Bias Resistor.....	870 Ohms
Plate Current.....	2.3 Ma.
Plate Resistance.....	44000 Ohms
Mutual Conductance.....	1600 $\mu$ hos
Amplification Factor.....	70
Maximum Heater-Cathode Voltage.....	90 Volts

\*Values are for one section except for heater.

# 6SN7<sup>GT</sup> Sylvania Type

MEDIUM-MU DUO TRIODE

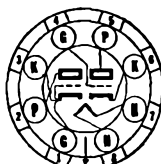

8BD-0-0

## PHYSICAL SPECIFICATIONS

Base.....	Intermediate Octal 8 Pin
Bulb.....	T9
Maximum Overall Length.....	3 $\frac{3}{8}$ "
Maximum Seated Height.....	2 $\frac{3}{4}$ "
Mounting Position.....	Any

## RATINGS

Heater Voltage AC or DC.....	6.3 Volts
Heater Current.....	0.60 Ampere

Direct Interelectrode Capacitances:\*

	Triode 1 $\frac{1}{2}$	Triode 2 $\frac{1}{2}$
Grid to Plate.....	3.8	4.0 $\mu$ mf.
Input.....	2.8	3.0 $\mu$ mf.
Output.....	0.8	1.2 $\mu$ mf.

\*Without shield.

$\frac{1}{2}$ Triode No. 1 connects to pins 4, 5 and 6. Triode No. 2 is connected to pins 1, 2 and 3.

## TYPICAL OPERATING CONDITIONS AND CHARACTERISTICS

### CLASS A<sub>1</sub> AMPLIFIER (PER SECTION)

Heater Voltage.....	6.3	6.3	Volts
Heater Current.....	0.6	0.6	Ampere
Plate Voltage.....	90	250	Volts
Grid Voltage.....	0	-8	Volts
Self Bias Resistor.....	0	900	Ohms
Plate Current.....	10	9.0	Ma.
Plate Resistance.....	6700	7700	Ohms
Mutual Conductance.....	3000	2600	$\mu$ mhos
Amplification Factor.....	20	20	

For resistance coupled data, refer to Type 7A4 in appendix.

# 6SQ7<sup>GT</sup> Sylvania Type

DUODIODE HIGH-MU TRIODE

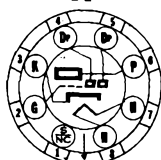
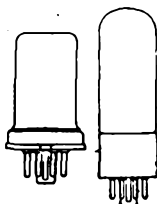

8Q-1-1 (6SQ7)  
8Q-1-3 (6SQ7GT)

## PHYSICAL SPECIFICATIONS

	6SQ7 Small Wafer Octal 8 Pin Metal 8-1	6SQ7GT Small Wafer Metal Sleeve Octal 8 Pin
Base.....		T9
Bulb.....		3 $\frac{3}{8}$ "
Maximum Overall Length.....	2 $\frac{5}{8}$ "	2 $\frac{3}{4}$ "
Maximum Seated Height.....	2 $\frac{1}{4}$ "	Any
Mounting Position.....	Any	

Direct Interelectrode Capacitances:\*

Grid to Plate.....	1.6	1.8 $\mu$ mf.
Input.....	3.2	4.2 $\mu$ mf.
Output.....	3.0	3.4 $\mu$ mf.

\*With shell connected to cathode for type 6SQ7G. Without shield for type 6SQ7GT.

## TYPICAL OPERATION

### CLASS A AMPLIFIER (TRIODE UNIT)

Heater Voltage.....	6.3	6.3 Volts
Heater Current.....	300	300 Ma.
Plate Voltage.....	100	250 Volts
Grid Voltage.....	-1	-2 Volts
Plate Current.....	0.5	1.1 Ma.
Plate Resistance.....	110,000	85,000 Ohms
Mutual Conductance.....	925	1175 $\mu$ mhos
Amplification Factor.....	100	100
Maximum Heater-Cathode Voltage.....	90	90 Volts

Except for capacitances the electrical characteristics and circuit applications are the same as those for Sylvania Type 7B6 and reference can be made to that type for any necessary information.



8-Q-1-1 (6SR7)  
8Q-0-3 (6SR7GT)

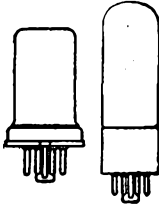

## Sylvania Type 6SR7<sup>GT</sup>

DUODIODE MEDIUM-MU TRIODE

### PHYSICAL SPECIFICATIONS

Base.....	6SR7 Small Wafer Octal 8 Pin Metal 8-1	6SR7GT Small Wafer 8 Pin Metal Shell T9
Bulb.....	2 5/8"	3 1/4"
Maximum Overall Length.....	2 1/4"	2 3/4"
Maximum Seated Height.....	Any	Any
Mounting Position.....		

### RATINGS AND OPERATION

Heater Voltages AC or DC.....	6.3 Volts
Heater Current.....	0.300 Ampere



8N-1-0



## Sylvania Type 6SS7

REMOTE CUT-OFF RF PENTODE

### PHYSICAL SPECIFICATIONS

Base.....	Small Wafer	Octal 8 Pin
Bulb.....	2 5/8"	Metal 8-1
Maximum Overall Length.....	2 1/4"	
Maximum Seated Height.....	2 1/4"	
Mounting Position.....	Any	

### RATINGS

Heater Voltage AC or DC.....	6.3 Volts
Heater Current.....	150 Ma.
Maximum Plate Voltage.....	300 Volts
Maximum Screen Supply Voltage.....	300 Volts
Maximum Screen Voltage.....	100 Volts
Minimum Grid Voltage.....	0 Volt
Maximum Plate Dissipation.....	2.25 Watts
Maximum Screen Dissipation.....	0.35 Watt
Maximum Heater-Cathode Voltage.....	90 Volts

### TYPICAL OPERATION

#### CLASS A<sub>1</sub> AMPLIFIER

Heater Voltage.....	6.3	6.3 Volts
Heater Current.....	150	150 Ma.
Plate Voltage.....	100	250 Volts
Screen Voltage.....	100	100 Volts
Grid Voltage.....	-1.0	-3.0 Volts
Suppressor.....	Connected to Cathode	
Plate Resistance (Approximate).....	0.12	1.0 Megohm
Mutual Conductance.....	1930	1850 μmhos
Grid Voltage for 10 μmhos.....	-35	-35 μmhos
Plate Current.....	12.2	9.0 Ma.
Screen Current.....	3.1	2.0 Ma.

# 6ST7 Sylvania Type

DUODIODE TRIODE



8Q-1-0

## PHYSICAL SPECIFICATIONS

Base.....	Small Wafer Octal 8 Pin.
Bulb.....	Metal 8-1
Maximum Overall Length.....	2 3/4"
Maximum Seated Height.....	2 1/8"
Mounting Position.....	Any

## RATINGS

Heater Voltage AC or DC.....	6.3 Volts
Heater Current.....	0.15 Ampere
Maximum Plate Voltage.....	250 Volts
Maximum Plate Dissipation.....	2.5 Watts
Maximum Heater-Cathode Voltage.....	90 Volts

## TYPICAL OPERATION

### CLASS A<sub>1</sub> AMPLIFIER

Heater Voltage.....	6.3 Volts
Heater Current.....	0.15 Ampere
Plate Voltage.....	250 Volts
Grid Voltage.....	-9.0 Volts
Self-Bias Resistor.....	950 Ohms
Amplification Factor.....	16
Plate Resistance.....	8500 Ohms
Mutual Conductance.....	1900 μmhos
Plate Current.....	9.5 Ma.

Reference should be made to Type 7E6 for further data.  
For diode information, refer to Lock-In Type 7B6.

# 6T8 Sylvania Type

TRIPLE DIODE TRIODE

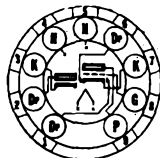

9E-0-3 & 7

## PHYSICAL SPECIFICATIONS

Base.....	Small Button 9 Pin
Bulb.....	T-61 1/2
Maximum Overall Length.....	2 3/4"
Maximum Seated Height.....	1 15/16"
Mounting Position.....	Any

## RATINGS

Heater Voltage AC or DC.....	6.3 Volts
Heater Current.....	450 Ma.
Maximum Plate Voltage.....	300 Volts
Maximum Plate Dissipation.....	1.0 Watt
Maximum Heater-Cathode Voltage.....	90 Volts
Maximum Diode Current per Plate.....	5.0 Ma.
Direct Interelectrode Capacitances:*	
Grid to each diode plate.....	0.035 μf. Max.
Diode input (pins 1 or 6).....	3.8 μf.
Diode input (pin 2).....	4.5 μf.

\*With no external shield.

## TYPICAL OPERATION

Heater Voltage AC or DC.....	6.3	6.3 Volts
Heater Current.....	450	450 Ma.
Plate Voltage.....	100	250 Volts
Grid Voltage.....	-1.0	-3.0 Volts
Plate Current.....	0.8	1.0 Ma.
Amplification Factor.....	70	70
Mutual Conductance.....	1300	1200 μmhos
Plate Resistance.....	54,000	58,000 Ohms

## APPLICATION

Sylvania Type 6T8 is a triple diode triode designed for use in FM-AM sets. When used as a ratio detector it is recommended that pins 1 and 2 be used as the diodes.

For curve data reference should be made to Type 6AQ6, and resistance coupled data may be found in the appendix under Type 6Q7GT.



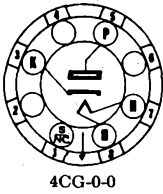

4CG-0-0



## Sylvania Type 6U4<sup>GT</sup>

HALF WAVE RECTIFIER

### PHYSICAL SPECIFICATIONS

Base.....	Intermediate Octal 6 Pin
Bulb.....	T-9
Maximum Overall Length.....	3 3/8"
Maximum Seated Height.....	2 15/16"
Mounting Position.....	Any

### RATINGS

Heater Voltage AC or DC.....	6.3 Volts
Heater Current.....	1.2 Amperes
Maximum Peak Inverse Plate Voltage	
Television Damper Service*.....	3850 Volts
Conventional Rectifier Service.....	1375 Volts
Maximum Peak Plate Current.....	660 Ma.
Maximum DC Output Current.....	138 Ma.
Maximum Hot-Switching Transient Plate	
Current for Duration of 0.2 Second Maximum.....	3.85 Amperes
Maximum Peak Heater-Cathode Voltage (Conventional Rectifier)	
Heater Negative With Respect to Cathode.....	500 Volts
Heater Positive With Respect to Cathode.....	110 Volts
Maximum Peak Heater-Cathode Voltage (Television Damper)	
Heater Negative With Respect to Cathode*.....	3850 Volts
Heater Positive With Respect to Cathode.....	110 Volts
Tube Voltage Drop at 250 Ma. DC.....	21 Volts

\*Duration of voltage pulse not to exceed 15% of one scanning cycle. In the 525 line, 30 frame television system 15% of one scanning cycle is 10 microseconds.

### TYPICAL OPERATION HALF WAVE RECTIFIER

Heater Voltage.....	6.3 Volts
AC Plate Voltage (RMS).....	350 Volts
Filter-Input Capacitor.....	20 $\mu$ f.
Total Effective Plate-Supply Impedance.....	145 Ohms
DC Output Current.....	125 Ma.
DC Output Voltage.....	335 Volts

### APPLICATION

Sylvania Type 6U4GT is a half wave rectifier featuring the unipotential cathode and a high peak heater-cathode rating, eliminating the necessity for a low-capacitance heater isolation transformer in television horizontal deflection circuits using a high-impedance yoke with direct coupling.

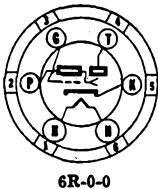

6R-0-0



## Sylvania Type 6U5

ELECTRON RAY INDICATOR TUBE

### PHYSICAL SPECIFICATIONS

Base.....	Small 6 Pin
Bulb.....	T9
Maximum Overall Length.....	4 1/8"
Maximum Seated Height.....	3 3/4"
Mounting Position.....	Any

### RATINGS

Heater Voltage AC or DC.....	6.3 Volts
Heater Current.....	300 Ma.
Maximum Plate Supply Voltage.....	285 Volts
Maximum Target Voltage.....	285 Volts
Minimum Recommended Target Voltage.....	125 Volts
Maximum Heater-Cathode Voltage.....	90 Volts

# 6U5 (Cont'd)

## TYPICAL OPERATION

Heater Voltage.....	6.3	6.3	6.3 Volts
Heater Current.....	300	300	300 Ma.
Plate Supply Voltage.....	100	200	250 Volts
Target Supply Voltage.....	100	200	250 Volts
Plate Current (Triode Unit)*.....	0.19	0.19	0.24 Ma. Max.
Target Current (Approximate)*.....	1.0	3.0	4.0 Ma.
Grid Voltage (Triode Unit)† (Approx.)..	0.0	0.0	0.0 Volt
Grid Voltage (Triode Unit)†† (Approx.)..	-8.0	-18.5	-22.0 Volts
Triode Plate Resistor.....	0.5	1.0	1.0 Megohm

\*With triode grid voltage of zero volts.

†For shadow angle of 90 degrees.

††For shadow angle of zero degrees.

The discontinued Type 6T5 had characteristics identical with the 6U5, but the visual indication was annular instead of fan-shaped. The 6U5 should be used as the replacement tube for Type 6T5, Type 6H5 and Type 6G5.

## 6U6<sup>GT</sup> Sylvania Type

BEAM POWER AMPLIFIER



7S-0-0

## PHYSICAL SPECIFICATIONS

Base.....	Intermediate Octal 7 Pin
Bulb.....	T9
Maximum Overall Length.....	3 <sup>5</sup> / <sub>16</sub> "
Maximum Seated Height.....	2 <sup>3</sup> / <sub>4</sub> "
Mounting Position.....	Any

## TYPICAL OPERATION

Heater Voltage AC or DC.....	6.3	6.3 Volts
Heater Current.....	0.75	0.75 Ampere
Plate Voltage.....	110	200 Volts
Screen Voltage.....	110	135 Volts
Grid Voltage.....	-10.0	-14.0 Volts
Plate Current.....	44.0	55.0 Ma.
Screen Current.....	4.0	3.0 Ma.
Mutual Conductance.....	5600	6200 μmhos
Load Resistance.....	2000	3000 Ohms
Power Output.....	2.0	5.5 Watts
Maximum Heater-Cathode Voltage.....	90	90 Volts

## 6U7G Sylvania Type

REMOTE CUT-OFF RF PENTODE



7R-0-8

## PHYSICAL SPECIFICATIONS

Base.....	Small Octal 7 Pin
Bulb.....	ST-12 Long
Cap.....	Miniature
Maximum Overall Length.....	4 <sup>7</sup> / <sub>8</sub> "
Maximum Seated Height.....	4 <sup>5</sup> / <sub>16</sub> "
Mounting Position.....	Any

**RATINGS**

Heater Voltage AC or DC.....	6.3 Volts
Heater Current.....	0.3 Ampere
Maximum Plate Voltage.....	300 Volts
Maximum Screen Voltage.....	100 Volts
Maximum Screen Supply Voltage.....	300 Volts
Grid Bias Voltage (Minimum External).....	0 Volt
Maximum Plate Dissipation.....	2.25 Watts
Maximum Screen Dissipation.....	25 Watts
Maximum Heater-Cathode Voltage.....	90 Volts

**TYPICAL OPERATION**

**CLASS A AMPLIFIER**

Heater Voltage.....	6.3	6.3 Volts
Heater Current.....	0.30	0.30 Ampere
Plate Voltage.....	100	250 Volts
Grid Voltage.....	-3	-3 Volts
Screen Voltage.....	100	100 Volts
Suppressor.....	Tie to Cathode	
Plate Current.....	8.0	8.2 Ma.
Screen Current.....	2.2	2.0 Ma.
Plate Resistance (Approximate).....	0.25	0.8 Megohm
Mutual Conductance.....	1500	1600 $\mu$ mhos
Grid Bias for Mutual Conductance= $2 \mu$ mhos.....	-50	-50 Volts

**Sylvania Type 6V6<sup>GT</sup>**

**BEAM POWER AMPLIFIER**



7S-1-0 (6V6)  
7S-0-0 (6V6GT)

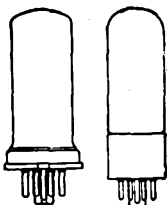

**PHYSICAL SPECIFICATIONS**

	<b>6V6</b>	<b>6V6GT</b>
Base.....	Small Wafer Octal 7 Pin	Intermediate Octal 7 Pin
Bulb.....	Metal 8-6	T9
Maximum Overall Length.....	3 1/4"	3 5/8"
Maximum Seated Height.....	2 11/16"	2 3/4"
Mounting Position.....	Any	Any

**RATINGS**

Heater Voltage AC or DC.....	6.3 Volts
Heater Current.....	0.45 Ampere
Maximum Plate Voltage.....	315 Volts
Maximum Screen Voltage.....	285 Volts
Maximum Plate Dissipation.....	12 Watts
Maximum Screen Dissipation.....	2 Watts
Maximum Heater-Cathode Voltage.....	90 Volts

**APPLICATION**

For further data, curves, etc., reference should be made to corresponding Lock-In type 7C5 which is identical in electrical characteristics.

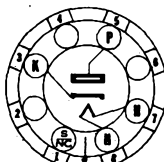

4CG-0-0



**Sylvania Type 6W4<sup>GT</sup>**

**HALF-WAVE RECTIFIER**

**PHYSICAL SPECIFICATIONS**

Base.....	6 Pin Octal
Bulb.....	T-9
Maximum Overall Length.....	3 5/8"
Maximum Seated Height.....	2 3/4"
Mounting Position.....	Any

# 6W4<sup>GT</sup> (Cont'd)

## RATINGS

Heater Voltage AC or DC.....	6.3 Volts
Heater Current.....	1.2 Amperes
Tube Drop at 250 Ma. DC.....	21 Volts
Maximum Peak Inverse Plate Voltage	
For Television Damper Service*	3500 Volts
For Conventional Rectifier Service.....	1250 Volts
Maximum Peak Plate Current.....	600 Ma.
Hot Switching Plate Current for Duration of 0.2 Second Max.....	3.5 Amperes
Maximum DC Plate Current.....	125 Ma.
Maximum Peak Heater-Cathode Voltage	
Heater Negative with respect to Cathode*#.....	2100 Volts
Heater Positive with respect to Cathode.....	100 Volts
Heater to Cathode Capacitance (Max.).....	7.0 $\mu$ f.

\*This rating is applicable where the duty cycle of the voltage pulse does not exceed 15% of one television scanning cycle and its duration is limited to 10 microseconds.

#DC component of heater-cathode voltage should not exceed 450 volts.

## TYPICAL OPERATION

	Half-Wave	Full-Wave 2 Tubes
Heater Voltage.....	6.3	6.3 Volts
Heater Current.....	1.2	2.4 Amperes
RMS Plate Voltage Per Plate.....	350	350 Volts
Filter Input Capacitance.....	20	20 $\mu$ f.
Total Minimum Effective Plate Supply Impedance.....	145	145 Ohms
DC Output Current.....	125	250 Ma.
Voltage Regulation (Half Load to Full Load) approx.....	55	40 Volts

## APPLICATION

Sylvania Type 6W4GT is a high-vacuum half-wave rectifier, with low voltage drop. It is designed specially for use as a damper diode in television circuits.

When used for rectifier service the output voltage at any load within the tube rating may be obtained from the curve given below.

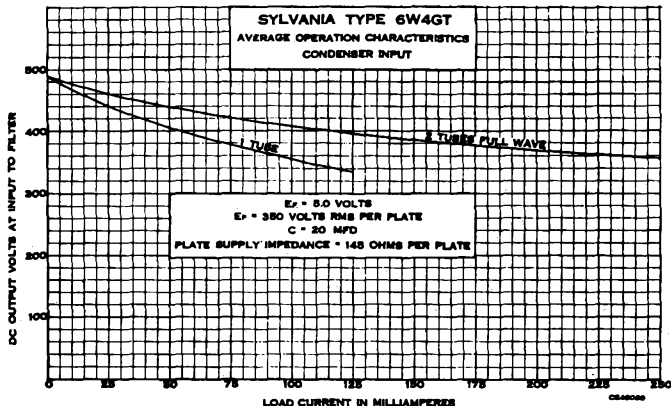

# 6W6<sup>GT</sup> Sylvania Type

BEAM POWER AMPLIFIER  
TELEVISION SCANNER



78-0-0

## PHYSICAL SPECIFICATIONS

Base.....	Intermediate Octal 7 Pin
Bulb.....	T-9
Maximum Overall Length.....	3 1/4"
Maximum Seated Height.....	2 1/4"
Mounting Position.....	Any

### RATINGS

Heater Voltage (AC or DC).....	6.3 Volts
Maximum Plate Voltage.....	300 Volts
Maximum Screen Supply Voltage.....	300 Volts
Maximum Screen Voltage*.....	150 Volts
Maximum Plate Dissipation.....	10 Watts
Maximum Screen Dissipation.....	1.25 Watts
Maximum Peak Positive-Pulse Plate Voltage*.....	1000 Volts
Maximum Grid Bias Voltage.....	-50 Volts
Maximum Peak Negative-Pulse Grid Voltage*.....	-200 Volts
Maximum Heater-Cathode Voltage.....	200 Volts

\*Screen voltage may exceed this value providing the screen dissipation is kept within the rating specified by JETEC Standard J5-C4.

\*The duration of the pulse should not exceed 15% of one vertical scanning cycle. In a 525 line, interlaced two to one, 30 frame per second television system 15% of one vertical scanning cycle is 2.5 milliseconds.

### TYPICAL OPERATION

#### CLASS A<sub>1</sub> AMPLIFIER

Heater Voltage.....	6.3	6.3 Volts
Heater Current.....	1.2	1.2 Amperes
Plate Voltage.....	110	200 Volts
Screen Grid Voltage.....	110	125 Volts
Control Grid Voltage.....	-7.5	... Volts
Cathode Bias Resistor.....	...	180 Ohms
Peak AF Grid Signal.....	7.5	8.5 Volts
Plate Resistance (Approx.).....	13,000	28,000 Ohms
Mutual Conductance.....	8000	8000 $\mu$ hos
Plate Current (Zero Signal).....	49	46 Ma.
Plate Current (Maximum Signal).....	50	47 Ma.
Screen Current (Zero Signal).....	4.0	2.2 Ma.
Screen Current (Maximum Signal).....	10.0	8.5 Ma.
Load Resistance.....	2000	5000 Ohms
Total Harmonic Distortion (Approx.).....	10	10 %
Power Output.....	2.1	3.8 Watts

#### VERTICAL DEFLECTION AMPLIFIER (Triode Connection)

Plate Voltage.....	300 Volts
Control Grid Voltage (Negative Peaking Component).....	35 Volts
Control Grid Voltage (Sawtooth Peaking Component).....	65 Volts
Plate Current.....	10.2 Ma.
Cathode Bias Resistance.....	4,000 Ohms
Maximum Control Grid Circuit Resistance.....	3.3 Megohms
Plate Voltage (Pulse Component).....	480 Volts
Plate Voltage (Sawtooth Component).....	320 Volts
Retrace Time.....	220 $\mu$ seconds

### APPLICATION

Sylvania Type 6W6GT is a beam pentode amplifier rated for use as a vertical scanning output amplifier in television sets using Sylvania Type 16TP4 at an anode voltage up to 14,000 volts.

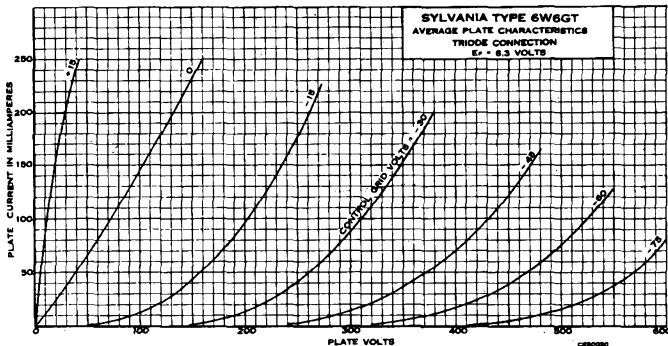

# 6W6<sup>GT</sup> (Cont'd)

## TYPICAL VERTICAL DEFLECTION CIRCUIT

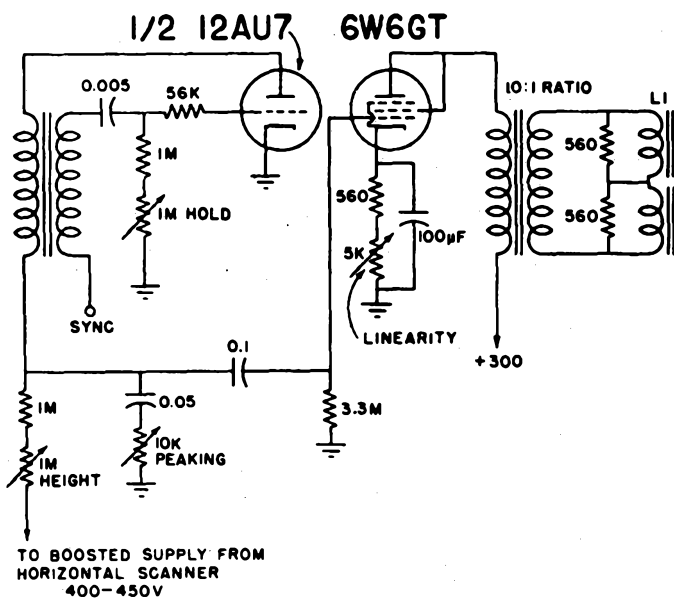

# 6W7G Sylvania Type

SHARP CUT-OFF R.F. PENTODE



7R-0-8

## PHYSICAL SPECIFICATIONS

Base.....	Small Octal 7 Pin
Bulb.....	ST12
Cap.....	Miniature
Maximum Overall Length.....	4 1/2"
Maximum Seated Height.....	3 3/8"
Mounting Position.....	Any

Sylvania Type 6W7G is a sharp cut-off pentode similar to type 6J7G but having a 150 ma. heater rating. For data concerning operation, reference should be made to Lock-In type 7C7.

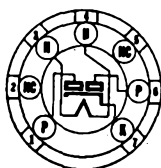

5BS-0-0



# Sylvania Type 6X4

FULL-WAVE RECTIFIER

## PHYSICAL SPECIFICATIONS

Base.....	Miniature Button 7 Pin
Bulb.....	T-5 1/2"
Maximum Overall Length.....	2 3/4"
Maximum Seated Height.....	2 3/8"
Mounting Position.....	Any

## RATINGS

Heater Voltage AC or DC.....	6.3 Volts
Heater Current.....	0.6 Ampere
Maximum Peak Inverse Voltage.....	1250 Volts
Maximum Peak Plate Current.....	210 Ma.
Maximum DC Output Current.....	70 Ma.
Maximum Peak Heater-Cathode Voltage.....	450 Volts

## TYPICAL OPERATION

	Condenser to Filter	Choke Input to Filter
AC Plate-to-Plate Supply Voltage RMS.....	650	900 Volts
Filter Input Condenser.....	4	ufd.
Total Effective Plate-Supply Impedance per Plate.....	150	Ohms
Minimum Filter Input Choke.....	70	8 Henries
DC Output Current.....		70 Ma.

## APPLICATION

Sylvania Type 6X4 is a miniature cathode type full-wave rectifier designed for use in compact sets requiring a rectifier of this rating. Characteristics are the same as for Sylvania Type 6X5GT, to which reference would be made for curve data.



6S-1-0 (6X5)  
6S-0-0 (6X5GT)

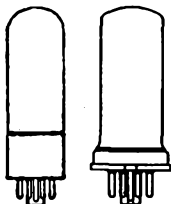

# Sylvania Type 6X5GT

FULL-WAVE RECTIFIER

## PHYSICAL SPECIFICATIONS

	6X5	6X5GT
Base.....	Small Wafer Octal 6 Pin	Intermediate Octal 6 Pin
Bulb.....	Metal 8-6	T9
Maximum Overall Length.....	3 1/4"	3 3/8"
Maximum Seated Height.....	2 1/8"	2 3/4"
Mounting Position.....	Vertical	Any

## RATINGS

Heater Voltage AC or DC.....	6.3 Volts
Heater Current.....	0.6 Ampere
Maximum Peak Inverse Voltage.....	1250 Volts
Maximum DC Heater-Cathode Voltage.....	450 Volts
Tube Voltage Drop (70 Ma. per Plate).....	22 Volts
Maximum Peak Plate Current.....	210 Ma.

## TYPICAL OPERATION

### CONDENSER INPUT TO FILTER

AC Voltage per Plate (RMS).....	325 Volts Max.
DC Output Current.....	70 Ma. Max.
Plate Supply Impedance (per Plate)*.....	150 Ohms Min.

\*Additional Impedance may be required when a filter of more than 40 Mfd. is used.

# 6X5GT (Cont'd)

## CHOKE INPUT TO FILTER

AC Voltage per Plate.....	450 Volts Max.
DC Output Current.....	70 Ma. Max.
Input Choke Value.....	10 Henrys Min.

Note: For rectifier curve data see next page.

## APPLICATION

Sylvania Type 6X5 and 6X5GT are designed for use as rectifiers for auto-radio receivers or for a-c operated receivers where the demand for rectified current is low. They are similar to the Type 7Y4 except for heater current rating and therefore usable in similar applications.

In order to obtain satisfactory output and regulation, careful consideration should be given to proper filtering. Filter circuits of the condenser-input or the choke-input type are applicable.

The d-c output will be considerably greater with a condenser-input filter than when the other type is used. Also, it will be true that higher peak plate currents will be encountered. The first condenser in the filter circuit, therefore, should not be too large in capacitance. It is not likely that the a-c input voltage will be a pure sine wave form so that the instantaneous peak values may be considerably greater than 1.4 times the r-m-s value. The voltage ratings of the condensers must be such as to handle the maximum peak values encountered.

When used with a vibrator and transformer combination as a source of a.c., considerable care must be taken in the transformer design, as well as the filter design, to avoid exceeding any of the maximum ratings.

TYPE 6X5, 6X5G, 84/824

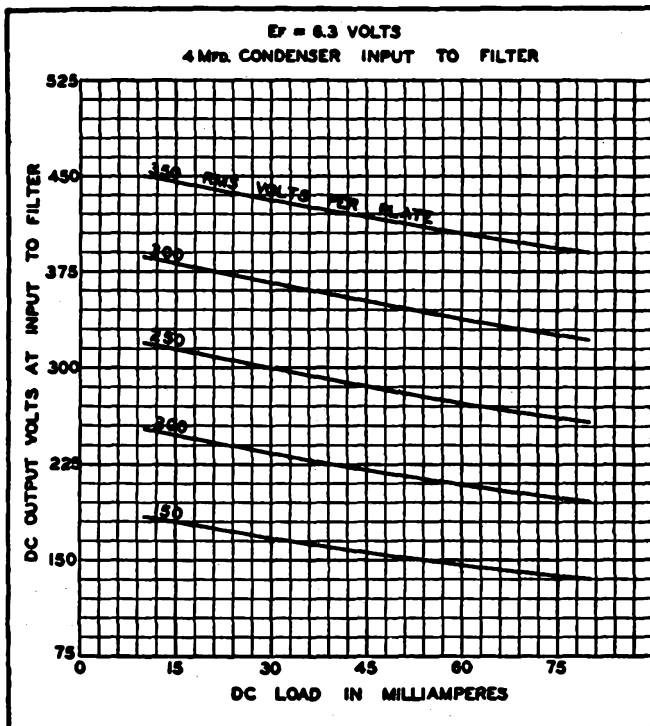



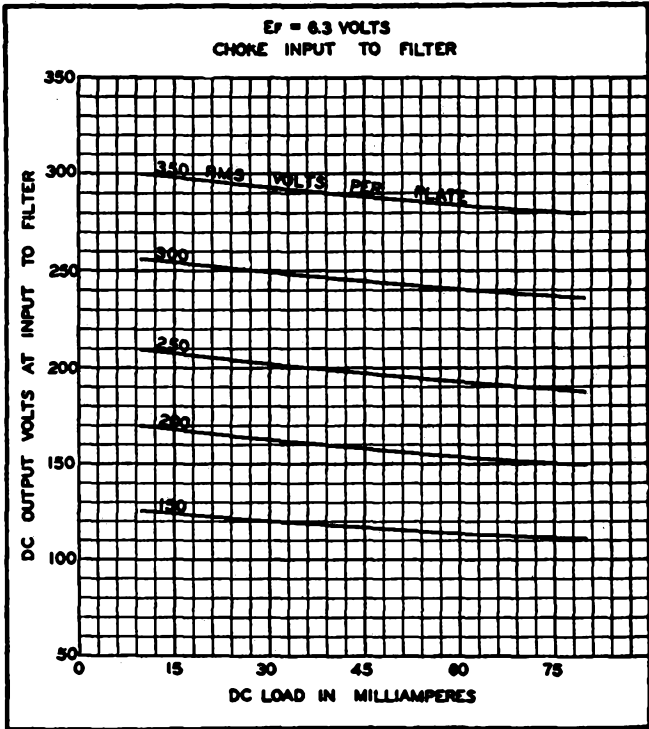

7S-0-0

**Sylvania Type 6Y6G**

BEAM POWER AMPLIFIER

**PHYSICAL SPECIFICATIONS**

Base.....	Medium Octal 7 Pin
Bulb.....	ST14
Maximum Overall Length.....	4 5/8"
Maximum Seated Height.....	4 1/4"
Mounting Position.....	Any

**RATINGS**

Heater Voltage AC or DC.....	6.3 Volts
Heater Current.....	1.25 Ampere
Maximum Plate Voltage.....	200 Volts
Maximum Screen Voltage.....	135 Volts
Maximum Plate Dissipation.....	12.5 Watts
Maximum Screen Dissipation.....	1.75 Watts
Maximum Heater-Cathode Voltage.....	90 Volts

**TYPICAL OPERATION**

Heater Voltage.....	6.3	6.3 Volts
Heater Current.....	1.25	1.25 Ampere
Plate Voltage.....	135	200 Volts
Screen Voltage.....	135	135 Volts
Grid Voltage.....	-13.5	-14.0 Volts
Peak Signal Voltage (A-F).....	13.5	14.0 Volts
Plate Current (Zero Signal).....	58	61 Ma.
Plate Current (Maximum Signal).....	60	66 Ma.
Screen Current (Zero Signal).....	3.5	2.2 Ma.
Screen Current (Maximum Signal).....	11.5	9.0 Ma.
Plate Resistance.....	9300	18300 Ohms
Mutual Conductance.....	7000	7100 $\mu$ mhos
Load Resistance.....	2000	2600 Ohms
Power Output.....	3.6	6.0 Watts
Total Harmonic Distortion.....	10	10 Per Cent

# 6ZY5G Sylvania Type

FULL-WAVE RECTIFIER

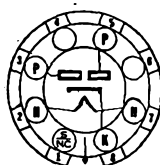

6S-0-0

## PHYSICAL SPECIFICATIONS

Base.....	Small Octal 6 Pin
Bulb.....	ST12
Maximum Overall Length.....	4 1/4"
Maximum Seated Height.....	3 1/4"
Mounting Position.....	Any

## TYPICAL OPERATION

	Choke Input	Condenser Input
Heater Voltage.....	6.3	6.3 Volts
Heater Current.....	0.300	0.300 Ampere
AC Plate Supply Voltage (RMS Per Plate).....	450	325 Volts
Maximum DC Output Current.....	40	40 Ma.
Maximum DC Heater-Cathode Voltage.....	450	450 Volts
Plate Supply Impedance Per Plate.....		250 Ohms Min.
Input Choke.....	(Min.) 13.5 Henrys	

# 7A4 Sylvania Type

MEDIUM-MU TRIODE

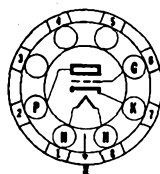
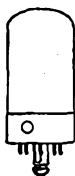

5AC-L-0

## PHYSICAL SPECIFICATIONS

Base.....	Lock-In 8 Pin
Bulb.....	T-9
Maximum Overall Length.....	2 15/16"
Maximum Seated Height.....	2 1/4"
Mounting Position.....	Any

## RATINGS

Heater Voltage (Nominal) AC or DC.....	7.0 Volts
Maximum Plate Voltage.....	300 Volts
Maximum Plate Dissipation.....	2.5 Watts
Minimum External Grid Bias Voltage.....	0 Volt
Maximum Heater-Cathode Voltage.....	90 Volts

### Direct Interelectrode Capacitances:\*

Grid to Plate.....	4.0 $\mu$ f.
Grid to Cathode.....	3.4 $\mu$ f.
Plate to Cathode.....	3.0 $\mu$ f.

\*With 1/4" diameter shield (RMA Std. 308) connected to cathode.

## TYPICAL OPERATION

### CLASS A AMPLIFIER

Heater Voltage.....	6.3	6.3 Volts
Heater Current.....	300	300 Ma.
Plate Voltage.....	90	250 Volts
Grid Voltage.....	0	-8 Volts
Self-Bias Resistor.....	0	900 Ohms
Plate Current.....	10	9 Ma.
Plate Resistance (Approximate).....	6700	7700 Ohms
Mutual Conductance.....	3000	2600 $\mu$ mhos
Amplification Factor.....	20	20

## APPLICATION

Sylvania Type 7A4 is a medium-mu triode designed for use as an oscillator, detector or amplifier. It is quite similar to types 6J5GT but gives improved performance especially at the higher frequencies, due to the lock-in type of construction. This construction results in shorter leads, lower capacitances, and lower base losses. This tube may be used successfully to about 225 mc. as an oscillator. For higher frequencies, types 7E5/1201 or 7F8 should be considered.

Tabulated data for resistance coupled operation will be found in the appendix.

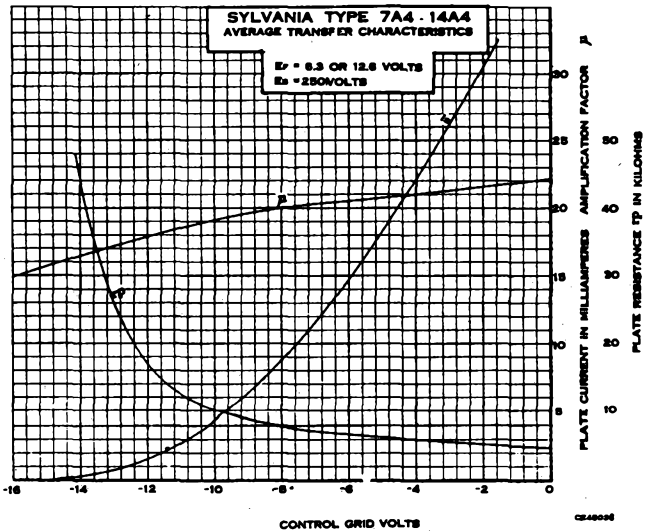
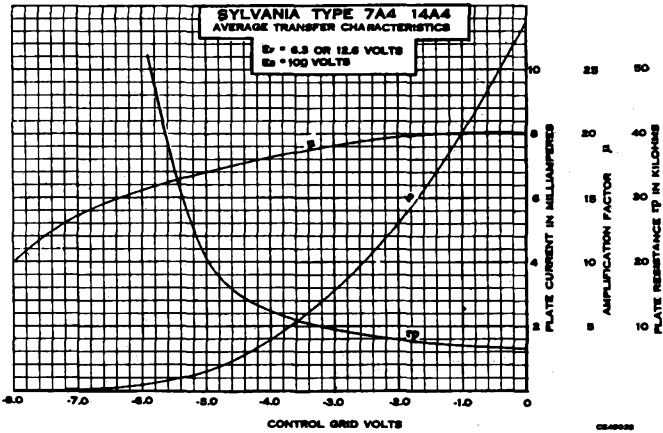
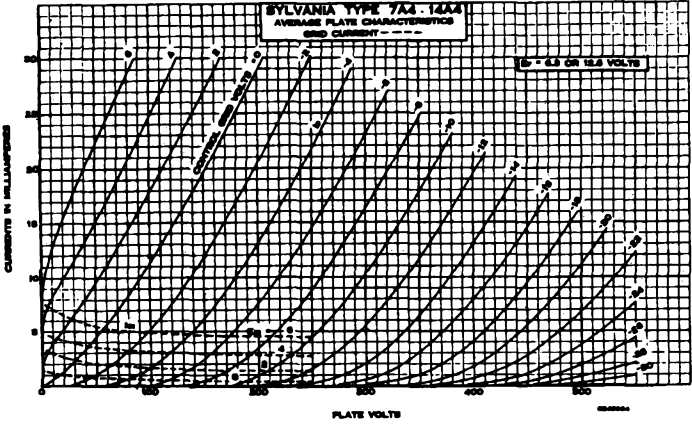

# 7A5 Sylvania Type

BEAM POWER AMPLIFIER

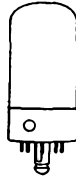

6AA-L-0

## PHYSICAL SPECIFICATIONS

Base .....	Lock-In 8 Pin
Bulb .....	T-9
Maximum Overall Length .....	3 5/8"
Maximum Seated Height .....	2 3/8"
Mounting Position .....	Any

## RATINGS

Heater Voltage AC or DC (Nominal) .....	7.0 Volts
Maximum Plate Voltage .....	125 Volts
Maximum Screen Voltage .....	125 Volts
Maximum Plate Dissipation .....	5.5 Watts
Maximum Screen Dissipation .....	1.2 Watts
Maximum Heater-Cathode Voltage .....	90 Volts

## TYPICAL OPERATION

Heater Voltage .....	6.3	6.3 Volts
Heater Current .....	0.75	0.75 Amperes
Plate Voltage .....	110	125 Volts
Screen Voltage .....	110	125 Volts
Grid Voltage .....	-7.5	Volts**
Self-Bias Resistor .....	175	190 Ohms
Plate Current (Zero Signal) .....	40.0	44.0 Ma.
Plate Current (Maximum Signal) .....	41.0	45.0 Ma.
Screen Current (Zero Signal) .....	3.0	3.3 Ma.
Screen Current (Maximum Signal) .....	7.0	9.5 Ma.
Mutual Conductance .....	5800	6000 $\mu$ mhos
Plate Resistance .....	16000	17000 Ohms
Load Resistance .....	2500	2700 Ohms
Power Output .....	1.5	2.2 Watt
Total Harmonic Distortion .....	10	10 Per Cent

\*\*Obtained by self-bias resistor. Fixed bias operation at maximum ratings is not recommended.

## APPLICATION

Sylvania Type 7A5 is a Lock-In type beam power amplifier designed to operate at plate voltages of about 110 volts. Except for heater ratings, it is similar to type 35A5. The curve data given for type 35A5 is applicable for the 110 volt condition.

Grid circuit resistance should not exceed 0.1 megohm for fixed bias operation or 0.5 megohm for self-bias operation.

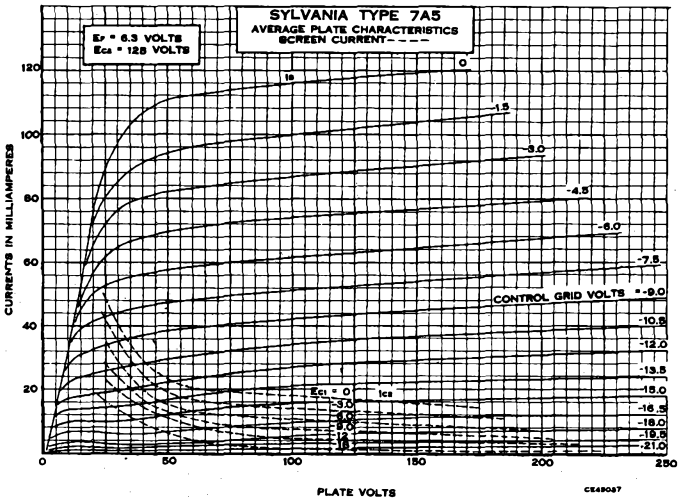

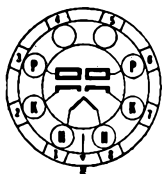

7AJ-L-5

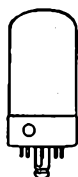

# Sylvania Type 7A6

DUODIODE

## PHYSICAL SPECIFICATIONS

Base.....	Lock-In 8 Pin
Bulb.....	T-9
Maximum Overall Length.....	2 1/8"
Maximum Seated Height.....	2 1/4"
Mounting Position.....	Any

## RATINGS

Heater Voltage AC or DC (Nominal).....	7.0 Volts
Maximum RMS Plate Voltage.....	150 Volts
Maximum Heater-Cathode Voltage.....	330 Volts
Maximum Peak Current Per Plate.....	45 Ma.
Maximum DC Output Current Per Plate.....	8.0 Ma.
Average Voltage Drop Per Plate at 16 Ma.....	11.0 Volts

### Direct Interelectrode Capacitances:\*

Plate 1 to Cathode 1 (pins 6 and 7).....	2.0 $\mu$ f.
Plate 2 to Cathode 2 (pins 2 and 3).....	2.6 $\mu$ f.
Plate 1 to Plate 2 (pins 3 and 6).....	0.1 $\mu$ f. Max.

\*With 1/8" diameter shield (RMA Std. 308) connected to cathode

## TYPICAL OPERATION

Heater Voltage.....	6.3 Volts
Heater Current.....	150 Ma.
AC Voltage per Plate (RMS).....	150 Volts
DC Output Current.....	8.0 Ma.

## APPLICATION

Sylvania Type 7A6 is a Lock-In type duodiode. It has separate cathodes and is similar to Type 6H6GT. The shielding between diode units permits each section to be used independently of the other and the lock-in construction gives good high-frequency characteristics. Type 7C4, however, should be considered for extremely high-frequency applications.

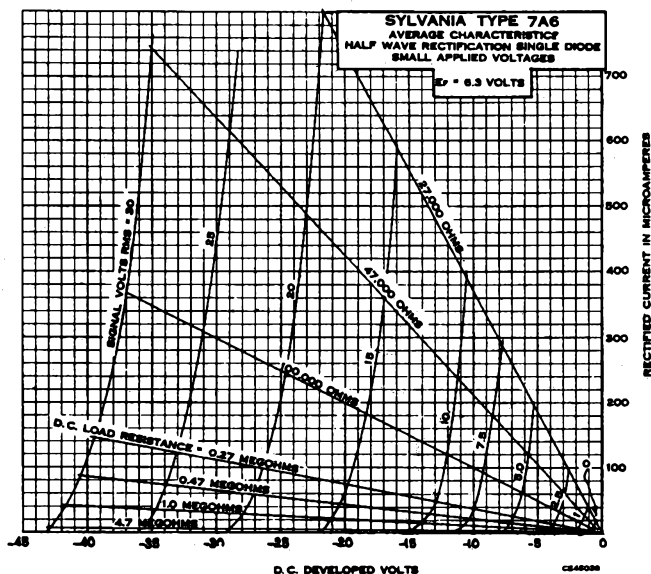

# 7A6 (Cont'd)

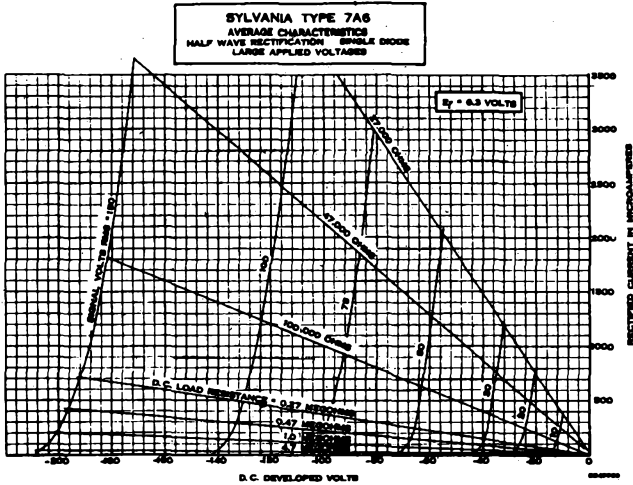

## 7A7 Sylvania Type

REMOTE CUT-OFF RF PENTODE

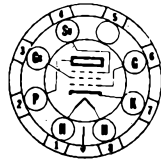
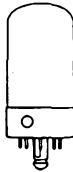

8V-L-5

### PHYSICAL SPECIFICATIONS

Base.....	Lock-In 8 Pin
Bulb.....	T-9
Maximum Overall Length.....	2 <sup>15</sup> / <sub>16</sub> "
Maximum Seated Height.....	2 <sup>1</sup> / <sub>4</sub> "
Mounting Position.....	Any

### RATINGS

Heater Voltage (Nominal) AC or DC.....	7.0 Volts
Maximum Plate Voltage.....	300 Volts
Maximum Screen Voltage.....	125 Volts
Maximum Plate Dissipation.....	4.0 Watts
Maximum Screen Dissipation.....	0.4 Watt
Minimum External Grid Bias Voltage.....	0 Volt
Maximum Heater-Cathode Voltage.....	90 Volts

#### Direct Interelectrode Capacitances:\*

Grid to Plate.....	0.003 $\mu$ f. Max.
Input; Grid to (F+K+G <sub>2</sub> +G <sub>3</sub> ).....	5.5 $\mu$ f.
Output; Plate to (F+K+G <sub>2</sub> +G <sub>3</sub> ).....	7.0 $\mu$ f.

\*With 1<sup>5</sup>/<sub>16</sub>" diameter shield (RMA Std. 308) connected to Cathode.

### TYPICAL OPERATION

Heater Voltage.....	6.3	6.3 Volts
Heater Current.....	300	300 Ma.
Plate Voltage.....	100	250 Volts
Screen Voltage.....	100	100 Volts
Grid Voltage.....	-1.0	-3 Volts
Self-Bias Resistor.....	60	260 Ohms
Suppressor.....		Connect to Cathode
Plate Current.....	13.0	9.2 Ma.
Screen Current.....	4.0	2.6 Ma.
Plate Resistance.....	0.12	0.8 Megohm
Mutual Conductance.....	2350	2000 $\mu$ mhos
Grid Voltage for Mutual Conductance of 10 $\mu$ mhos.....	-35	-35 Volts

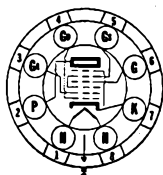

8U-L-7

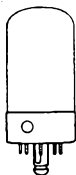

# Sylvania Type 7A8

## OCTODE CONVERTER

### PHYSICAL SPECIFICATIONS

Base.....	Lock-In 8 Pin
Bulb.....	T-9
Maximum Overall Length.....	2 <sup>15</sup> / <sub>16</sub> "
Maximum Seated Height.....	2 <sup>1</sup> / <sub>4</sub> "
Mounting Position.....	Any

### RATINGS

Heater Voltage AC or DC (Nominal).....	7.0 Volts
Maximum Plate Voltage.....	300 Volts
Maximum Screen Supply Voltage.....	300 Volts
Maximum Screen Voltage.....	100 Volts
Maximum Oscillator Anode Supply.....	300 Volts
Maximum Oscillator Anode Voltage.....	200 Volts
Maximum Plate Dissipation.....	1.0 Watt
Maximum Screen Dissipation.....	0.3 Watt
Maximum Oscillator Anode Dissipation.....	0.75 Watt
Maximum Cathode Current.....	13.0 Ma.
Minimum Signal Grid Voltage.....	0 Volt
Maximum Heater-Cathode Voltage.....	90 Volts

#### Direct Interelectrode Capacitances:\*

Grid G to Plate.....	0.15 $\mu$ f. Max.
Grid G to Grid Ga.....	0.3 $\mu$ f. Max.
Grid G to Grid Go.....	0.15 $\mu$ f. Max.
Grid G to Grid Ga.....	0.60 $\mu$ f.
Grid G to all Electrodes (r-f Input).....	7.5 $\mu$ f.
Grid Ga to all Electrodes except Go (Osc. Output).....	3.4 $\mu$ f.
Grid Go to all Electrodes except Ga (Osc. Input).....	3.8 $\mu$ f.
Plate to all Electrodes (Mixer Output).....	9.0 $\mu$ f.

\*With 1<sup>5</sup>/<sub>16</sub>" diameter shield (RMA Std. 308) connected to cathode.

### TYPICAL OPERATION

Heater Voltage.....	6.3	6.3 Volts
Heater Current.....	150	150 Ma.
Plate Voltage.....	100	250 Volts
Control Grid (G) Voltage.....	-3.0	-3.0 Volts
Screen (Gs) Voltage.....	75	100 Volts
Anode Grid (Ga) Voltage.....	100	250 Volts**
Oscillator Grid Resistor (Go).....	50000	50000 Ohms
Plate Current.....	1.8	3.0 Ma.
Screen Grid Current.....	2.7	3.2 Ma.
Anode Grid Current.....	2.8	4.2 Ma.
Oscillator Grid Current.....	0.2	0.4 Ma.
Self-Bias Resistor.....	400	280 Ohms
Plate Resistance.....	650000	700000 Ohms
Conversion Conductance.....	375	550 $\mu$ mhos
Control Grid Voltage for 2 $\mu$ mhos Conv. Cond.....	-22.5	-30 Volts

\*\*Applied through 20,000 ohm dropping resistor.

### OSCILLATOR CHARACTERISTICS NON-OSCILLATING CONDITION

Anode Grid Current (Ga).....	10 Ma.
Mutual Conductance (Ga to Go).....	1600 $\mu$ mhos
Amplification Factor (Ga to Go).....	65

Measurements taken with a plate voltage of 250 volts, anode grid voltage of 180 volts, screen voltage of 100 volts, with oscillator grid at 0.0 volt.

### APPLICATION

Sylvania Type 7A8 is a single-ended oscillator-mixer tube of lock-in design for service in AC, AC-DC and auto receivers. Compact size, short leads and good shielding are some of the features of this tube. Application and operation are similar to the older types of oscillator-mixer tubes. The addition of a suppressor grid in Type 7A8 serves to increase the plate resistance for improved performance, particularly when operated at low plate supply voltages.

# 7A8 (Cont'd)

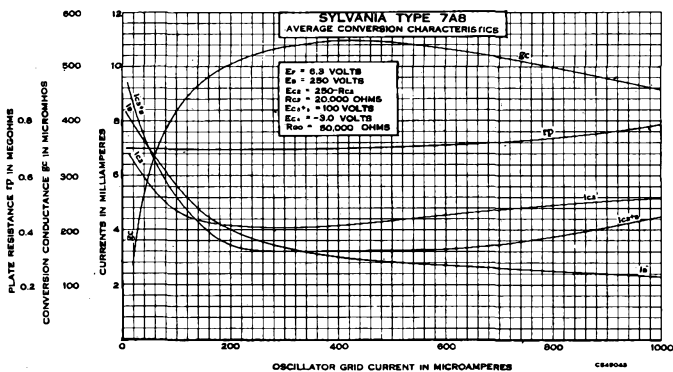
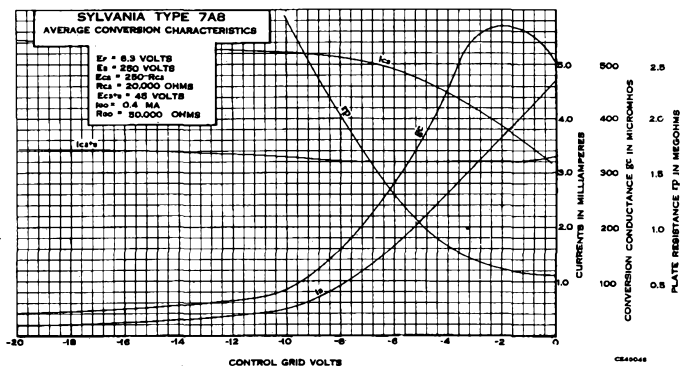
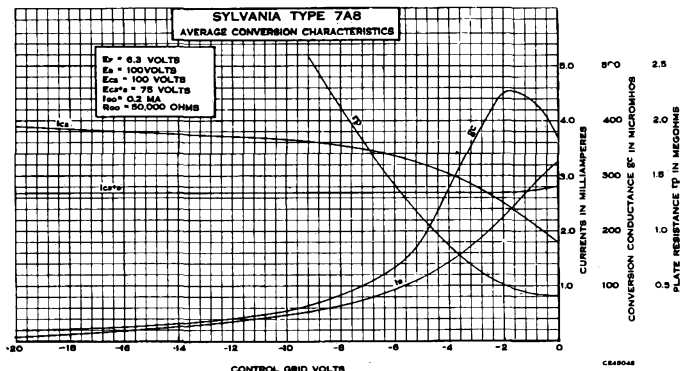



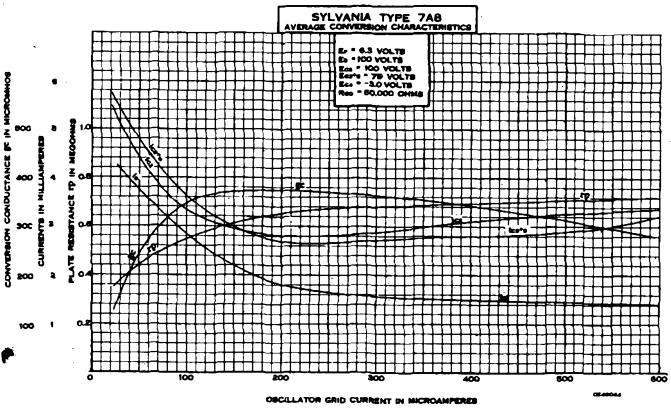

8V-L-5

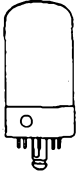

## Sylvania Type 7AD7

TELEVISION AMPLIFIER PENTODE

### PHYSICAL SPECIFICATIONS

Base.....	Lock-In 8 Pin
Bulb.....	T-9
Maximum Overall Length.....	3 5/8"
Maximum Seated Height.....	2 5/8"
Mounting Position.....	Any

### RATINGS

Heater Voltage (Nominal).....	7.0 Volts
Heater Voltage AC or DC.....	6.3 Volts
Maximum Plate Voltage.....	300 Volts
Maximum Screen Voltage.....	300 Volts
Maximum Grid Voltage.....	0 Volts
Maximum Plate Dissipation.....	10 Watts
Maximum Screen Dissipation.....	1.2 Watts
Maximum Heater-Cathode Voltage.....	90 Volts

**Direct Interelectrode Capacitances:\***

Grid to Plate.....	0.030 $\mu\text{f.}$ Max.
Input.....	11.5 $\mu\text{f.}$
Output.....	7.5 $\mu\text{f.}$

\*With 1 5/16" diameter shield (RMA Std. 308) connected to cathode.

### TYPICAL OPERATION

#### CLASS A<sub>1</sub> AMPLIFIER

Heater Voltage.....	6.3 Volts
Heater Current.....	0.600 Ampere
Plate Voltage.....	300 Volts
Screen Voltage.....	150 Volts
Grid Voltage*.....	-3 Volts
Self Bias Resistor.....	68 Ohms
Suppressor.....	Connected to cathode
Plate Current (Zero Signal).....	28 Ma.
Screen Current (Zero Signal).....	7.0 Ma.
Plate Resistance.....	300,000 Ohms
Mutual Conductance.....	9500 $\mu\text{mhos}$

\*Obtained preferably by self bias resistor. Maximum grid circuit resistance should not exceed 1.0 megohm for self bias condition; 0.25 megohm for fixed bias condition.

# 7AD7 (Cont'd)

## CLASS A<sub>1</sub> TELEVISION AMPLIFIER

Heater Voltage.....	6.3 Volts
Heater Current.....	0.600 Ampere
Plate Supply Voltage.....	300 Volts
Screen Voltage.....	125 Volts
Grid Voltage.....	-3.0 Volts
Self Bias Resistor.....	68 Ohms
Signal Voltage (Peak to Peak).....	4.0 Volts
Suppressor.....	Connected to cathode
Plate Current (Zero Signal).....	25.0 Ma.
Screen Current (Zero Signal).....	6.0 Ma.
Maximum Signal Voltage Output (Peak to Peak).....	135 Volts

## APPLICATION

Sylvania Type 7AD7 is a high transconductance pentode amplifier designed for voltage amplification of a broad band of frequencies such as required for television service.

This is the first Lock-In tube having characteristics suitable for this purpose. It is, however, very similar to Type 6AG7 which, although having slightly higher theoretical gain, does not have the ruggedness, low capacitance, and high production advantages of the Lock-In construction.

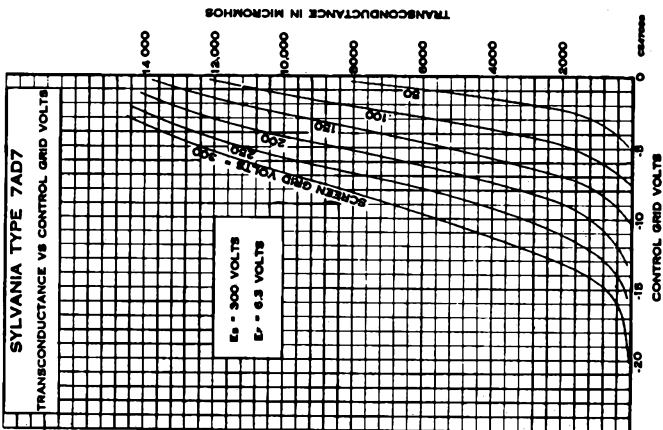
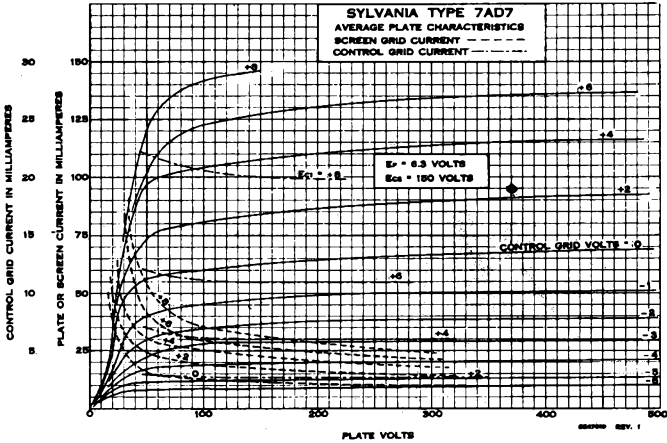

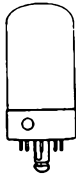
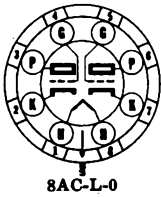
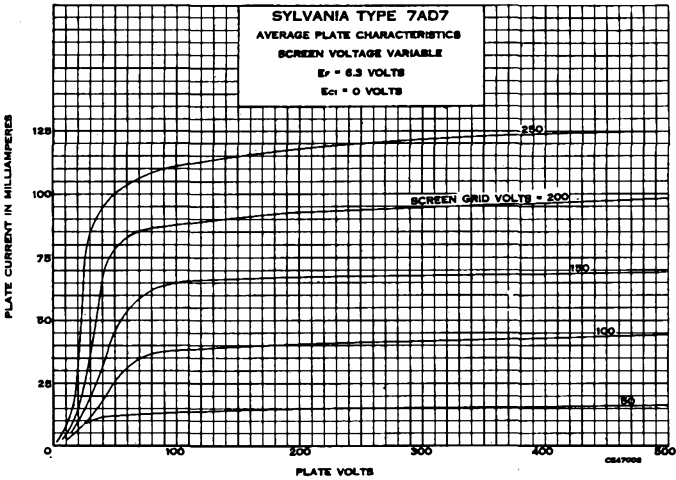

## Sylvania Type **7AF7**

**DOUBLE TRIODE AMPLIFIER**

### PHYSICAL SPECIFICATIONS

Base.....	Lock-In 8 Pin
Bulb.....	T-9
Maximum Overall Length.....	2 <sup>35</sup> / <sub>64</sub> "
Maximum Seated Height.....	2 <sup>1</sup> / <sub>4</sub> "
Mounting Position.....	Any

### RATINGS

Heater Voltage AC or DC (Nominal).....	7.0 Volts
Maximum Plate Voltage.....	300 Volts
Maximum Plate Dissipation (Per Plate).....	2.5 Watts
Minimum External Grid Bias.....	0 Volt
Maximum Heater-Cathode Voltage.....	90 Volts

#### Direct Interelectrode Capacitances:\*

Grid to Plate (Per Section).....	2.3 $\mu$ f.
Input (Per Section).....	2.2 $\mu$ f.
Output (Per Section).....	1.6 $\mu$ f.
Grid 1 to Grid 2.....	0.20 $\mu$ f. Max.
Plate 1 to Plate 2.....	0.60 $\mu$ f. Max.
Grid 1 to Plate 2.....	0.06 $\mu$ f. Max.
Grid 2 to Plate 1.....	0.10 $\mu$ f. Max.

\*Measured without shield.

### TYPICAL OPERATION

#### CLASS A<sub>1</sub>

#### PER SECTION EXCEPT HEATER

Heater Voltage (AC or DC).....	6.3	6.3	6.3 Volts
Heater Current.....	300	300	300 Ma.
Plate Voltage.....	100	100	250 Volts
Grid Voltage.....	0	-3	-10 Volts
Self-Bias Resistor.....		600	1100
Plate Current.....	10.8	5.0	9.0 Ma.
Mutual Conductance.....	2600	1900	2100 $\mu$ mhos
Amplification Factor.....	17	16	16
Plate Resistance.....	6600	8400	7600 Ohms

# 7AG7 Sylvania Type

SHARP CUT-OFF RF PENTODE

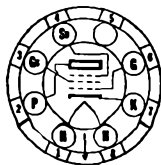

8V-L-5

## PHYSICAL SPECIFICATIONS

Base.....	Lock-In 8 Pin
Bulb.....	T-9
Maximum Overall Length.....	2 <sup>5</sup> / <sub>16</sub> "
Maximum Seated Height.....	2 <sup>1</sup> / <sub>4</sub> "
Mounting Position.....	Any

## RATINGS

Heater Voltage AC or DC (Nominal).....	7.0 Volts
Maximum Plate Voltage.....	300 Volts
Maximum Screen Voltage.....	300 Volts
Maximum Plate Dissipation.....	2.0 Watts
Maximum Screen Dissipation.....	0.75 Watt
Minimum Control Grid Voltage.....	-1.0 Volt
Maximum Heater-Cathode Voltage.....	90 Volts

### Direct Interelectrode Capacitances:\*

Grid to Plate.....	.005 $\mu$ f. Max.
Input.....	7.0 $\mu$ f.
Output.....	6.0 $\mu$ f.

\*With 1<sup>3</sup>/<sub>8</sub>" diameter shield (RMA Std. 308) connected to cathode.

## TYPICAL OPERATION

Heater Voltage.....	6.3	6.3 Volts
Heater Current.....	150	150 Ma.
Plate Voltage.....	100	250 Volts
Screen Voltage.....	100	250 Volts
Suppressor.....	Connected to cathode at socket	
Control Grid Bias.....	-1.0	* Volts
Self-Bias Resistor.....	480	250 Ohms
Plate Current.....	1.6	6.0 Ma.
Screen Current.....	0.5	2.0 Ma.
Mutual Conductance.....	2600	4200 $\mu$ hos
Plate Resistance.....	.710	>1.0 Megohm
Control Grid Voltage for 10 $\mu$ a. Plate Current.....	-3.5	-10.0 Volts

\*Bias voltage developed is approximately 2.0 volts. Fixed bias operation is not recommended.

## APPLICATION

Sylvania Type 7AG7 is a high efficiency, sharp cut-off pentode designed for either AC or AC-DC service. The high screen voltage rating permits a design which has high input impedance. For this reason, higher gains may be obtained in the television and frequency modulation bands than with other tubes having somewhat higher mutual conductance.

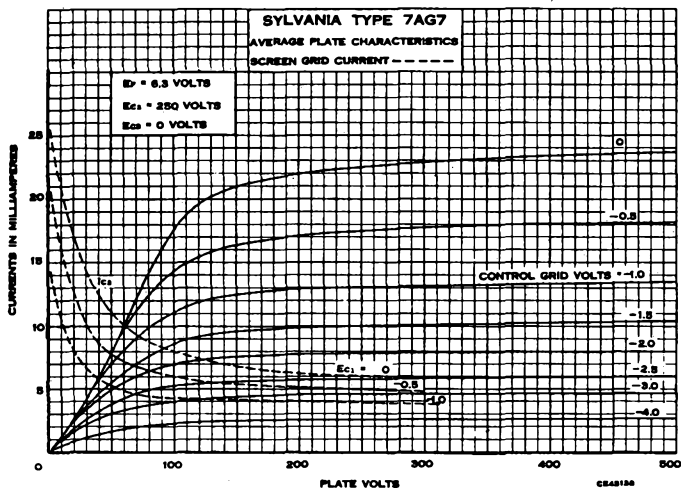

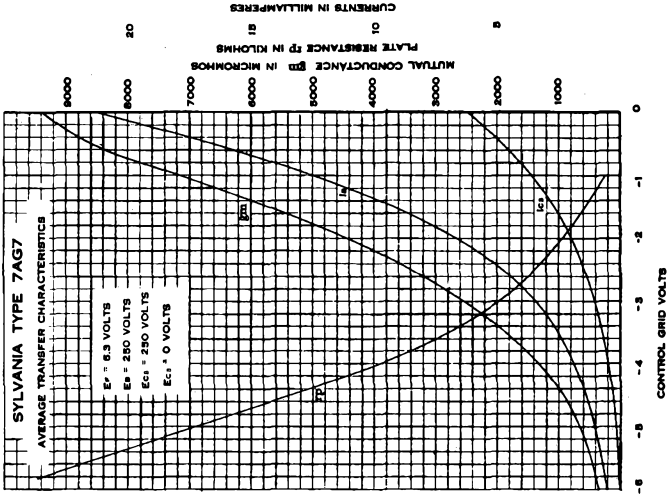

8V-L-5

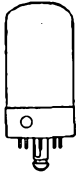

## Sylvania Type **7AH7**

SEMI-REMOTE CUT-OFF  
RF PENTODE AMPLIFIER

### PHYSICAL SPECIFICATIONS

Base.....	Lock-In 8 Pin
Bulb.....	T-9
Maximum Overall Length.....	2 <sup>35</sup> / <sub>16</sub> "
Maximum Seated Height.....	2 <sup>1</sup> / <sub>8</sub> "
Mounting Position.....	Any

### RATINGS

Heater Voltage (Nominal) AC or DC.....	7.0 Volts
Maximum Plate Voltage.....	300 Volts
Maximum Screen Voltage.....	300 Volts
Maximum Plate Dissipation.....	2.0 Watts
Maximum Screen Dissipation.....	0.7 Watt
Minimum External Negative Control Grid Voltage.....	1.0 Volt
Maximum Heater-Cathode Voltage.....	90 Volts

#### Direct Interelectrode Capacitances:\*

Grid to Plate.....	.005 $\mu$ f.
Input.....	7.0 $\mu$ f.
Output.....	6.5 $\mu$ f.

\*With 1<sup>5</sup>/<sub>16</sub>" diameter shield (RMA Std. 308) connected to cathode.

### TYPICAL OPERATION

#### CLASS A<sub>1</sub> AMPLIFIER

Heater Voltage.....	6.3 Volts
Heater Current.....	150 Ma.
Plate Voltage.....	250 Volts
Screen Voltage.....	250 Volts
Suppressor.....	Connected to Cathode at Socket
Grid Voltage**.....	Obtained by 250 ohms self-bias resistor
Plate Current.....	6.8 Ma.
Screen Current.....	1.9 Ma.
Mutual Conductance.....	3300 $\mu$ mhos
Plate Resistance.....	1.0 Megohm
Grid Voltage for Mutual	
Conductance of 35 $\mu$ mhos.....	-20 Volts (Approx.)

\*\*Bias voltage is approximately 2.0 volts but fixed bias is not recommended.

# 7AJ7 Sylvania Type

SHARP CUT-OFF PENTODE

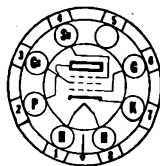
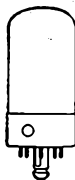

8V-L-5

## PHYSICAL SPECIFICATIONS

Base.....	Lock-In 8 Pin
Bulb.....	T-9
Maximum Overall Length.....	2 <sup>35</sup> / <sub>64</sub> "
Maximum Seated Height.....	2 <sup>1</sup> / <sub>2</sub> "
Mounting Position.....	Any

## RATINGS

Heater Voltage AC or DC (Nominal).....	7.0 Volts
Maximum Plate Voltage.....	300 Volts
Maximum Screen Voltage.....	100 Volts
Maximum Screen Supply Voltage.....	300 Volts
Maximum Plate Dissipation.....	1.0 Watt
Maximum Screen Dissipation.....	0.1 Watt
Minimum External Grid Bias.....	0 Volt
Maximum Heater-Cathode Voltage.....	90 Volts

### Direct Interelectrode Capacitances:\*

Grid to Plate.....	.007 $\mu$ f. Max.
Input.....	6.0 $\mu$ f.
Output.....	6.5 $\mu$ f.

\*With 1<sup>3</sup>/<sub>16</sub>" diameter shield (RMA Std. 308) connected to cathode.

## TYPICAL OPERATION

### CLASS A<sub>1</sub> AMPLIFIER

Heater Voltage AC or DC.....	6.3	6.3 Volts
Heater Current.....	300	300 Ma.
Plate Voltage.....	100	250 Volts
Screen Voltage.....	100	100 Volts
Control Grid Voltage.....	-1.0	-3.0 Volts
Self Bias Resistor.....	130	1000 Ohms
Suppressor Grid and Pin No. 5.....	Connected to Cathode	
Plate Current.....	5.7	2.2 Ma.
Screen Current.....	1.8	0.7 Ma.
Plate Resistance (Approx.).....	.400	1.0 Megohm
Mutual Conductance.....	2275	1575 $\mu$ hos
Grid Bias for Plate Current Cut-Off.....	-8.5	-8.5 Volts

Data for use in Resistance Coupled Amplifiers may be obtained by referring to type 7C7 in the appendix.

# 7AK7 Sylvania Type

PENTODE WITH SUPPRESSOR CONTROL



8V-L-0

## PHYSICAL SPECIFICATIONS

Base.....	Lock-In 8 Pin
Bulb.....	T-9
Maximum Overall Length.....	3 <sup>5</sup> / <sub>8</sub> "
Maximum Seated Height.....	2 <sup>5</sup> / <sub>8</sub> "
Mounting Position.....	Any

## RATINGS

Heater Voltage (Nominal) AC or DC.....	7.0 Volts
Maximum Plate Voltage.....	200 Volts
Maximum Screen Voltage.....	100 Volts
Maximum Plate Dissipation.....	8.5 Watts
Maximum Screen Dissipation.....	2.5 Watts
Maximum Heater-Cathode Voltage.....	90 Volts

### Direct Interelectrode Capacitances:\*

Control Grid to Plate.....	0.7 $\mu$ f.
Control Grid Input.....	12.0 $\mu$ f.
Output.....	9.5 $\mu$ f.
Suppressor Grid to Plate.....	4.0 $\mu$ f.

\*With 1<sup>3</sup>/<sub>16</sub>" diameter shield (RMA Std. 308) connected to cathode

**TYPICAL OPERATION**

Heater Voltage.....	6.3	6.3	6.3 Volts
Heater Current.....	0.8	0.8	0.8 Ampere
Plate Voltage.....	150	150	150 Volts
Screen Voltage.....	90	90	90 Volts
Control Grid Voltage.....	0	-11	0 Volts
Suppressor Grid Voltage.....	0	0	-9.5 Volts
Mutual Conductance.....	5500	.....	..... $\mu$ mhos
Plate Resistance (Approx.).....	11,500	.....	..... Ohms
Plate Current.....	40	2.0 Max.	2.0 Max. Ma.
Screen Current.....	21	0.45	43 Max. Ma.

**APPLICATION**

Sylvania Type 7AK7 is a sharp cut-off amplifier pentode of lock-in construction designed and rated for use with an additional control voltage on the suppressor. For use as a "gating" tube the watts dissipation rating of the screen may approximate 4.0 watts momentarily, providing the dissipation averaged over any one second interval does not exceed the rating.

Since normal use of this tube will require fixed bias operation, the maximum grid circuit resistance should not exceed .1 megohm.

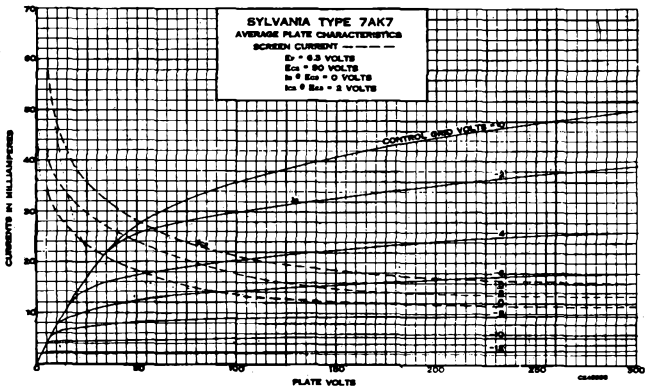
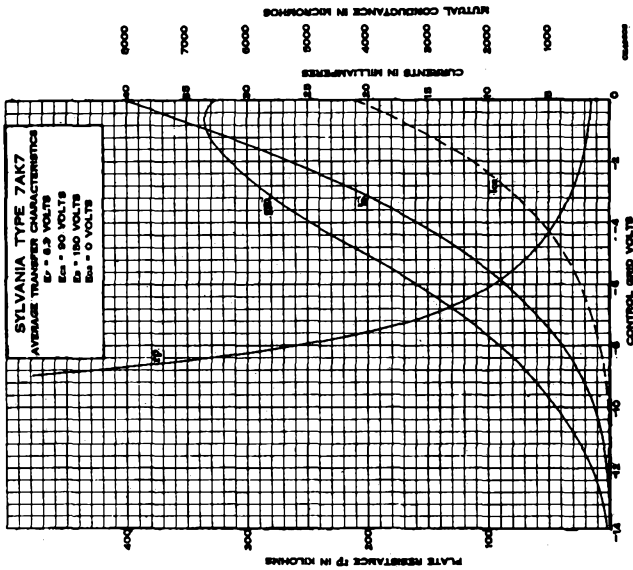

# 7B4 Sylvania Type

HIGH-MU TRIODE

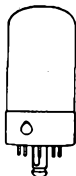

5AC-L-0

## PHYSICAL SPECIFICATIONS

Base.....	Lock-In 8 Pin
Bulb.....	T-9
Maximum Overall Length.....	2 <sup>15</sup> / <sub>16</sub> "
Maximum Seated Height.....	2 <sup>1</sup> / <sub>4</sub> "
Mounting Position.....	Any

## RATINGS

Heater Voltage (Nominal) AC or DC.....	7.0 Volts
Maximum Plate Voltage.....	300 Volts
Maximum Heater-Cathode Voltage.....	90 Volts

## TYPICAL OPERATION

### CLASS A<sub>1</sub> AMPLIFIER

Heater Voltage.....	6.3	6.3 Volts
Heater Current.....	300	300 Ma.
Plate Voltage.....	100	250 Volts
Grid Voltage.....	-1	-2 Volts
Plate Current.....	0.4	0.9 Ma.
Plate Resistance (Approximate).....	85000	66000 Ohms
Mutual Conductance (Approximate).....	1150	1500 μmhos
Amplification Factor.....	100	100

## APPLICATION

Sylvania Type 7B4 is a single-ended high-mu triode having electrical characteristics and applications similar to those for Type 6F5G.

The lock-in construction employed in Type 7B4 provides compactness, suitable shielding, and the lock-in feature. For a-c service the 7-volt heater rating corresponds to a 130-volt line condition. It is also the nominal voltage for automotive receiver service. For household receivers, ratings marked Max. are design centers for a line voltage of 117 volts. For automotive service the design centers are 90% of the values indicated using a battery terminal voltage of 6.6 volts.

For data on resistance coupling circuits, refer to table in appendix.

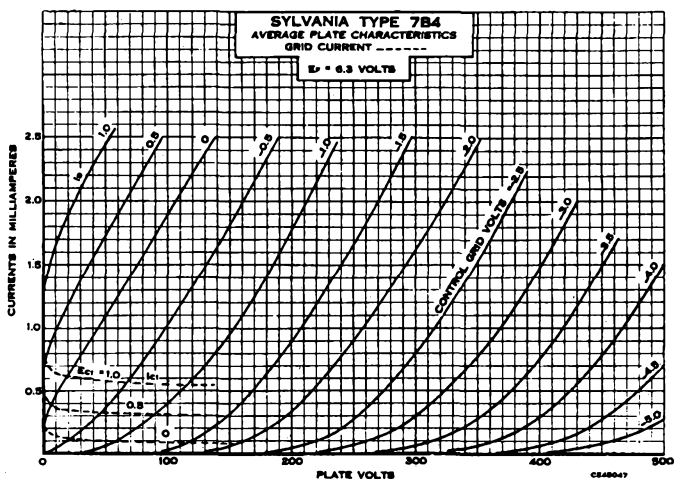



**SYLVANIA TYPE 7B4**  
**AVERAGE TRANSFER CHARACTERISTICS**

$E_p = 6.3$  VOLTS  
 $E_c = 100$  VOLTS

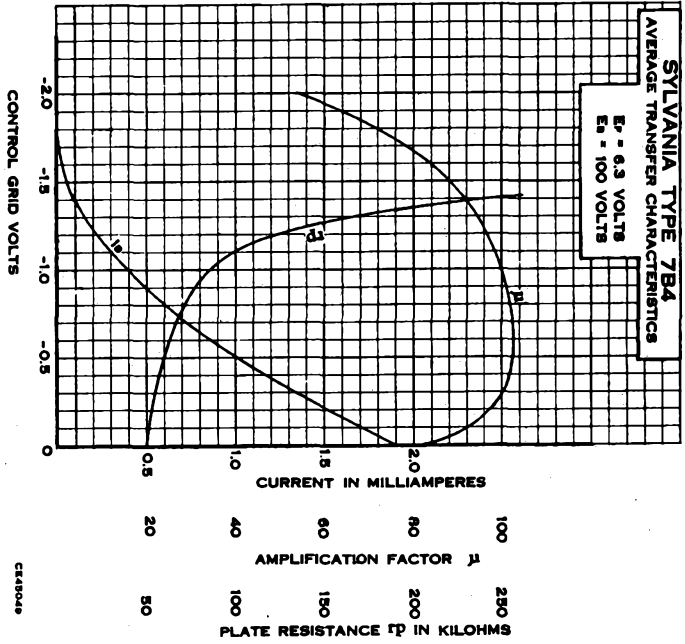

AMPLIFICATION FACTOR  $\mu$

PLATE RESISTANCE  $r_p$  IN KILOHMS

CS4504B

SYLVANIA RADIO TUBES

(Cont'd) **7B4**

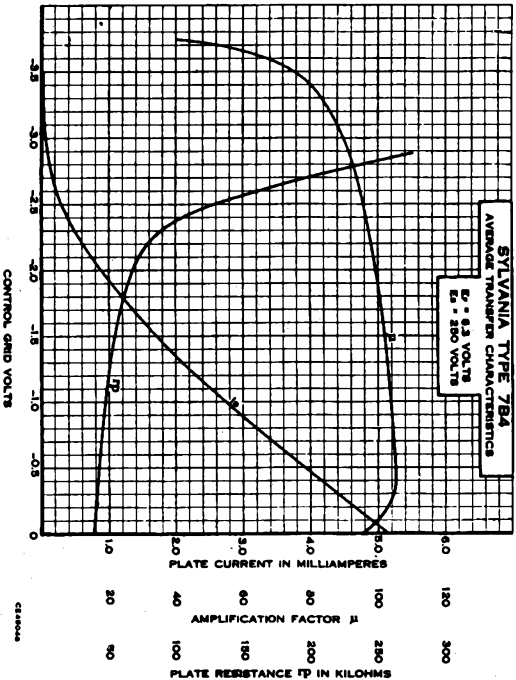

# 7B5 Sylvania Type

POWER OUTPUT PENTODE

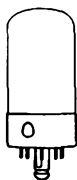

6AE-L-0

## PHYSICAL SPECIFICATIONS

Base.....	Lock-In 8 Pin
Bulb.....	T-9
Maximum Overall Length.....	3 $\frac{1}{4}$ "
Maximum Seated Height.....	2 $\frac{1}{2}$ "
Mounting Position.....	Any

## RATINGS

Heater Voltage AC or DC (Nominal).....	7.0 Volts
Maximum Plate Voltage.....	315 Volts
Maximum Screen Voltage.....	285 Volts
Maximum Plate Dissipation.....	8.5 Watts
Maximum Screen Dissipation.....	2.8 Watts
Maximum Heater-Cathode Voltage.....	90 Volts

### Direct Interelectrode Capacitances:\*

Grid to Plate.....	0.8 $\mu$ f.
Input.....	7.4 $\mu$ f.
Output.....	8.0 $\mu$ f.

\*With 1 $\frac{1}{8}$ " diameter shield (RMA Std. 308) connected to cathode.

## TYPICAL OPERATION

### SINGLE-TUBE CLASS A<sub>1</sub> AMPLIFIER

Heater Voltage.....	6.3	6.3	6.3 Volts
Heater Current.....	400	400	400 Ma.
Plate Voltage.....	100	250	315 Volts
Screen Voltage.....	100	250	250 Volts
Grid Voltage§.....	-7.0	-18	-21 Volts
Self-Bias Resistor.....	650	500	700 Ohms
Peak Signal Voltage.....	7.0	18	21 Volts
Plate Current (Zero Signal).....	9.0	32.0	25.5 Ma.
Plate Current (Maximum Signal).....	9.0	33.0	28.0 Ma.
Screen Current (Zero Signal).....	1.6	5.5	4.0 Ma.
Screen Current (Maximum Signal).....	3.0	10.0	9.0 Ma.
Plate Resistance (Approximate).....	104000	68000	75000 Ohms
Mutual Conductance.....	1500	2300	2100 $\mu$ mhos
Load Resistance.....	12000	7600	9000 Ohms
Power Output.....	0.35	3.4	4.5 Watts
Total Harmonic Distortion.....	11	11	15 Per Cent

§The DC resistance in the grid circuit should not exceed 0.5 Meg.

## APPLICATION

Sylvania Type 7B5 is a power output pentode of lock-in design. It is suitable for use in automobile and A-C operated receivers with the lock-in design providing ruggedness and compact size.

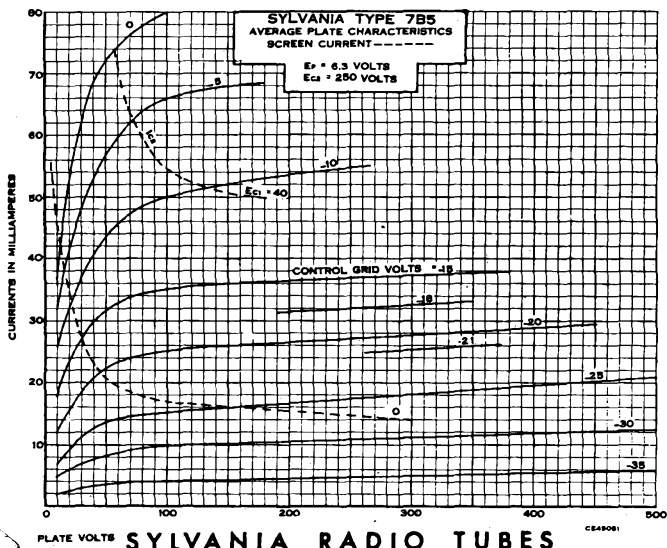

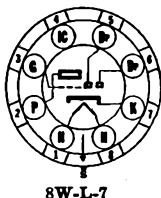
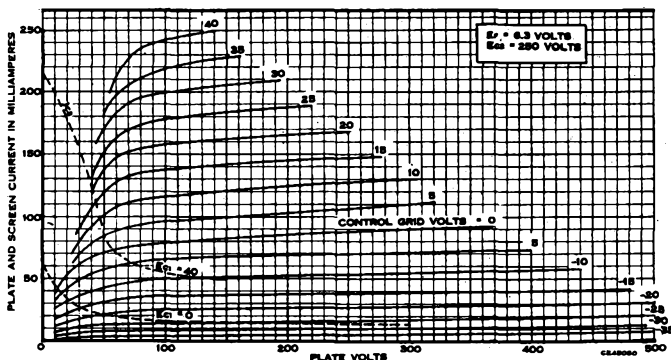
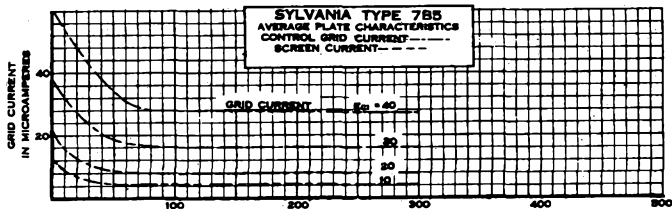

8W-L-7



## 7B6 Sylvania Type

DUODIODE HIGH-MU TRIODE

### PHYSICAL SPECIFICATIONS

Base.....	Lock-In 8 Pin
Bulb.....	T9
Maximum Overall Length.....	2 <sup>15</sup> / <sub>16</sub> "
Maximum Seated Height.....	2 <sup>1</sup> / <sub>4</sub> "
Mounting Position.....	Any

### RATINGS

Heater Voltage AC or DC (Nominal).....	7.0 Volts
Maximum Plate Voltage.....	300 Volts
Maximum Heater-Cathode Voltage.....	90 Volts
Maximum Diode Drop at 0.8 Ma.....	10 Volts
Maximum Diode Current per Plate (Continuous).....	1.0 Ma.

#### Direct Interelectrode Capacitances:\*

Grid to Plate.....	1.6 $\mu$ f.
Input.....	3.0 $\mu$ f.
Output.....	2.4 $\mu$ f.
Grid to Diode 1.....	0.01 $\mu$ f.
Grid to Diode 2.....	0.04 $\mu$ f.

\*With 1<sup>3</sup>/<sub>8</sub>" diameter shield (RMA Std. 308) connected to cathode.

### TYPICAL OPERATION

Heater Voltage.....	6.3	6.3 Volts
Heater Current.....	0.3	0.3 Ampere
Plate Voltage.....	100	250 Volts
Grid Voltage.....	-1	-2 Volts
Plate Current.....	0.4	0.9 Ma.
Plate Resistance.....	110000	91000 Ohms
Mutual Conductance.....	900	1100 $\mu$ mhos
Amplification Factor.....	100	100

## APPLICATION

Sylvania Type 7B6 is a duodiode high-mu triode suitable for detector audio amplifier service in AC or auto receivers. For AC-DC receivers, the Types 7C6 or 14B6, having lower heater current ratings, should prove more satisfactory.

The diodes are independent of each other and of the triode unit except that the cathode structure is common to all. Type 7K7 or 7X7 should be considered if it is necessary to have more complete separation between the various sections.

Resistance coupled amplifier data will be found in the table in the appendix.

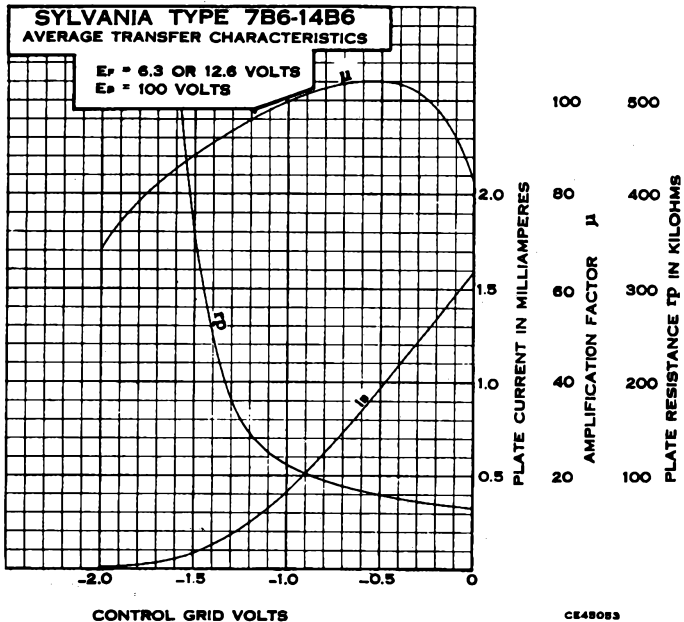
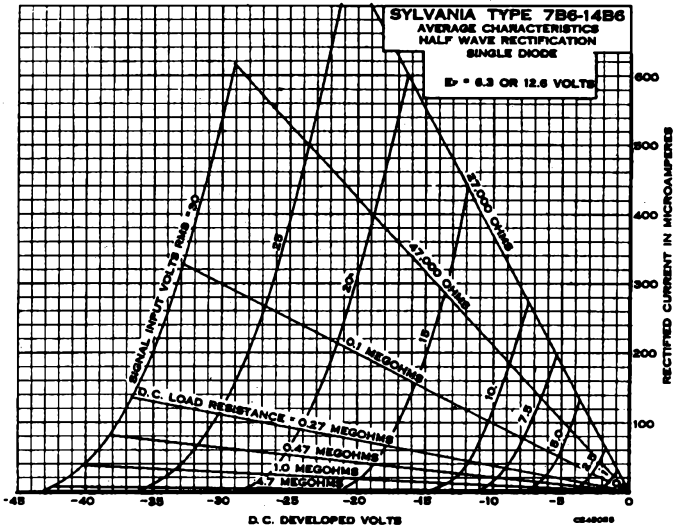

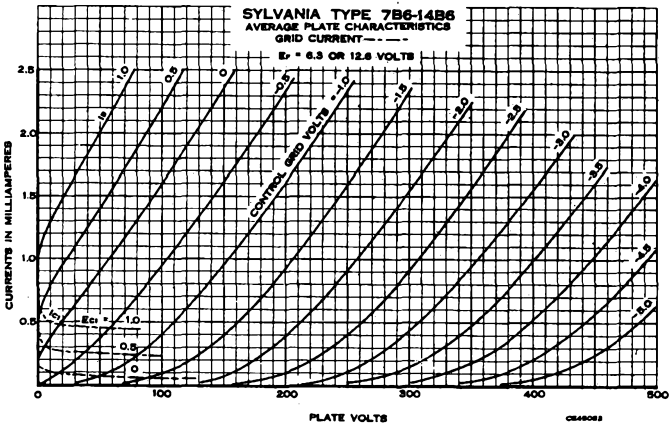
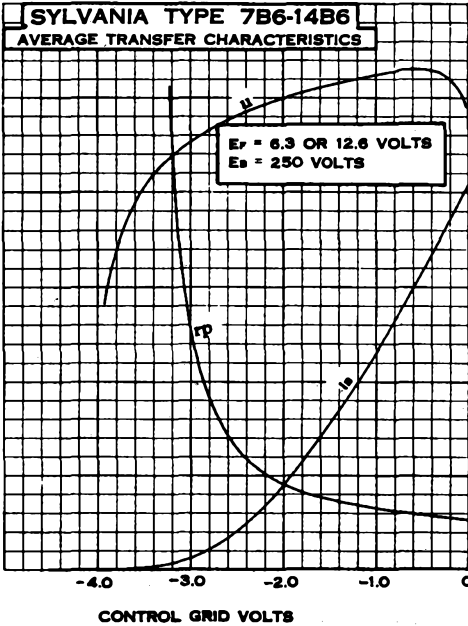

# 7B7 Sylvania Type

REMOTE CUT-OFF RF PENTODE

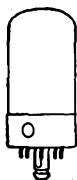

8V-L-5

## PHYSICAL SPECIFICATIONS

Base.....	Lock-In 8 Pin
Bulb.....	T9
Maximum Overall Length.....	2 1/2"
Maximum Seated Height.....	2 3/4"
Mounting Position.....	Any

## RATINGS

Heater Voltage (Nominal) AC or DC.....	7.0 Volts
Maximum Plate Voltage.....	300 Volts
Maximum Screen Voltage.....	100 Volts
Maximum Plate Dissipation.....	2.25 Watts
Maximum Screen Dissipation.....	0.25 Watt
Minimum External Grid Bias Voltage.....	0 Volt
Maximum Heater-Cathode Voltage.....	90 Volts

### Direct Interelectrode Capacitances:\*

Grid to Plate.....	0.004 $\mu$ f. Max.
Input; Grid to (F + K + Gs + Su).....	5.0 $\mu$ f.
Output; Plate to (F + K + Gs + Su).....	6.0 $\mu$ f.

\*With 1 1/4" diameter shield (RMA Std. 308) connected to cathode.

## TYPICAL OPERATION

Heater Voltage.....	6.3	6.3 Volts
Heater Current.....	150	150 Ma.
Plate Voltage.....	100	250 Volts
Screen Voltage.....	100	100 Volts
Grid Voltage.....	-3	-3 Volts
Self-Bias Resistor.....	300	300 Ohms
Suppressor.....	Connect to Cathode	
Plate Current.....	8.2	8.5 Ma.
Screen Current.....	1.8	1.7 Ma.
Plate Resistance.....	0.3	0.75 Megohm
Mutual Conductance.....	1675	1750 $\mu$ mhos
Grid Voltage for Mutual Conductance of 10 $\mu$ mhos.....	-40	-40 Volts

## APPLICATION

Sylvania Type 7B7 is a single-ended triple grid remote cut-off amplifier of lock-in design suitable for r-f or i-f service in a-c, ac-dc and auto receivers.

All of the grids terminate a base pins, thus providing an r-f amplifier tube without a top cap. An internal cage-like shield connected to pin Number 5 is used to obtain a small grid to plate capacity.

The electrical characteristics and applications of Type 7B7 are very similar to those for Type 7A7. Reference may be made to this type for application notes.

For a-c service the 7-volt heater rating corresponds to a 130-volt line condition.

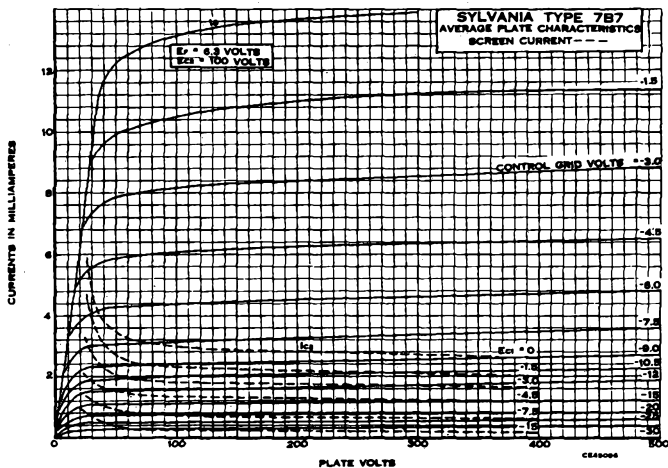

SYLVANIA RADIO TUBES

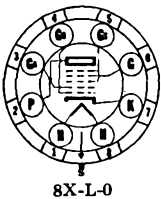
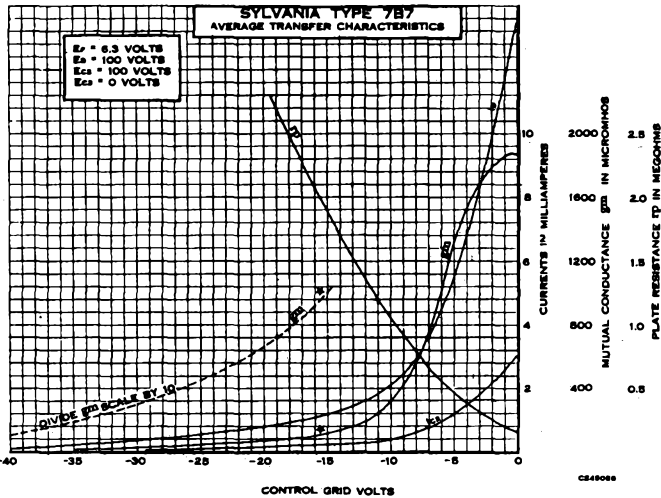
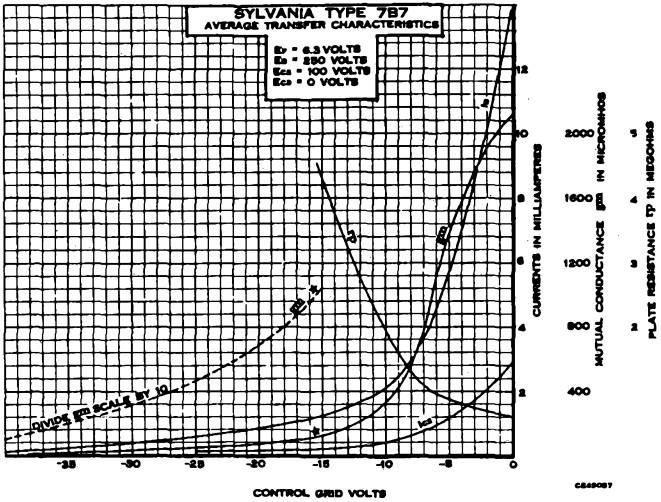

8X-L-0



## Sylvania Type 7B8

HEPTODE CONVERTER

### PHYSICAL SPECIFICATIONS

Base.....	Lock-In 8 Pin
Bulb.....	T9
Maximum Overall Length.....	2 1/4"
Maximum Seated Height.....	2 1/4"
Mounting Position.....	Any



# 7B8 (Cont'd)

## RATINGS

Heater Voltage AC or DC (Nominal).....	7.0 Volts
Maximum Plate Voltage.....	300 Volts
Maximum Screen Voltage.....	100 Volts
Maximum Screen Supply.....	300 Volts
Maximum Anode Grid Voltage.....	200 Volts
Maximum Anode Grid Supply.....	300 Volts
Maximum Plate Dissipation.....	1.0 Watt
Maximum Screen Dissipation.....	0.3 Watt
Maximum Anode Grid Dissipation.....	0.75 Watt
Maximum Cathode Current.....	14 Ma.
Minimum Signal Grid Bias.....	0 Volt
Maximum Heater-Cathode Voltage.....	90 Volts

### Direct Interelectrode Capacitances:\*

Grid G to Plate.....	0.2 $\mu$ f. Max.
Grid G to Grid Ga.....	0.3 $\mu$ f. Max.
Grid G to Grid Go.....	0.2 $\mu$ f., Max.
Grid Go to Grid Ga.....	0.9 $\mu$ f.
Grid G to all Electrodes (R-F Input).....	10.0 $\mu$ f.
Grid Ga to all Electrodes except Go (Osc. Output).....	3.4 $\mu$ f.
Grid Go to all Electrodes except Ga (Osc. Input).....	5.0 $\mu$ f.
Plate to all Electrodes (Mixer Output).....	9.0 $\mu$ f.

\*With 1 $\frac{1}{8}$ " diameter shield (RMA Std. 308) connected to cathode.

## TYPICAL OPERATION

Heater Voltage.....	6.3	6.3 Volts
Heater Current.....	300	300 Ma.
Plate Voltage.....	100	250 Volts
Screen Voltage.....	50	100 Volts
Anode Grid Voltage.....	100	250** Volts
Control Grid (G) Voltage.....	-1.5	-3.0 Volts
Oscillator Grid (Go) Resistor.....	50000	50000 Ohms
Plate Current.....	1.1	3.5 Ma.
Screen Grid Current.....	1.3	2.7 Ma.
Anode Grid Current.....	2.0	4.0 Ma.
Oscillator Grid Current.....	0.25	0.4 Ma.
Self-Bias Resistor.....	360	300 Ohms
Plate Resistance.....	0.6	0.36 Megohm
Conversion Conductance.....	360	550 $\mu$ mhos
Control Grid Voltage (Approximate)		
For 6 $\mu$ mhos Conversion Conductance.....		-35 Volts
For 3 $\mu$ mhos Conversion Conductance.....	-20	..... Volts

\*\*Applied through 20,000 ohm dropping resistor.

The oscillator section, not oscillating, has a Gm of 1150  $\mu$ mhos, a mu of 75 at an anode grid current of 4.0 ma. when Ep = 250 Volts; Ega = 100 Volts; Egs = 55 Volts; Eg = 2.0 Volts and Ego = -1.0 Volt.

## APPLICATION

Sylvania Type 7B8 is a lock-in converter tube designed for use in AC or auto receivers. For AC-DC service, Type 14B8 with lower heater current rating will usually prove more satisfactory.

Electrically, Type 7B8 is similar to the older oscillator mixer tubes. Conventional circuits and design are readily adaptable for use with this compact rugged tube. As is usual with converter tubes, it is well to ascertain that the maximum cathode current does not exceed the rated limit under any encountered operating condition.

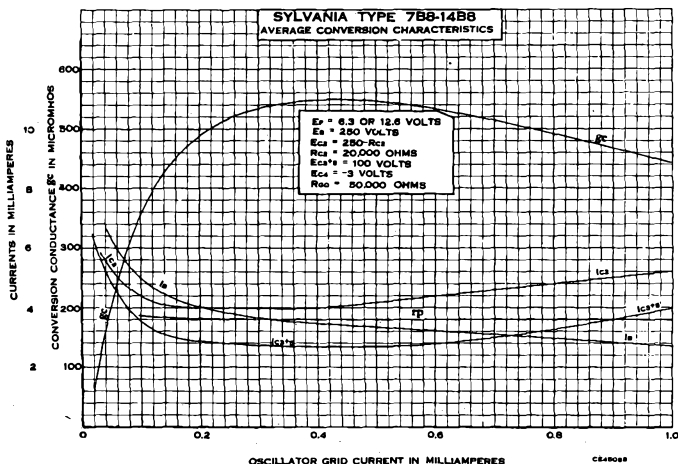

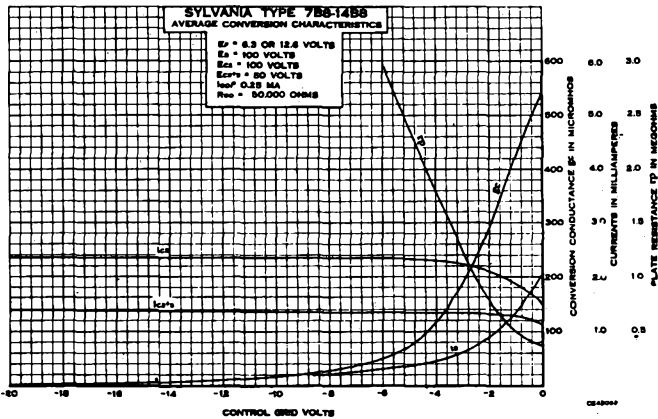
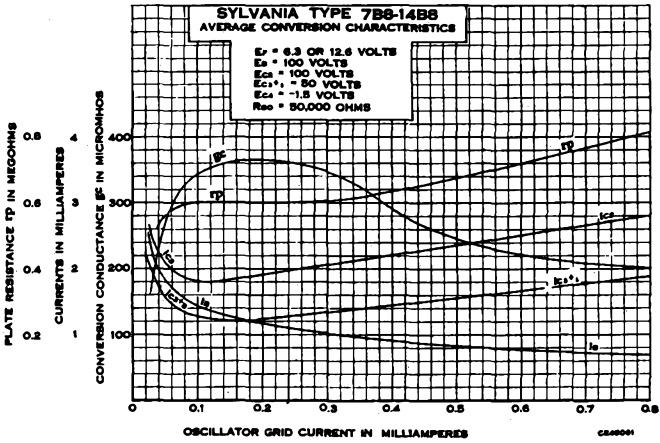
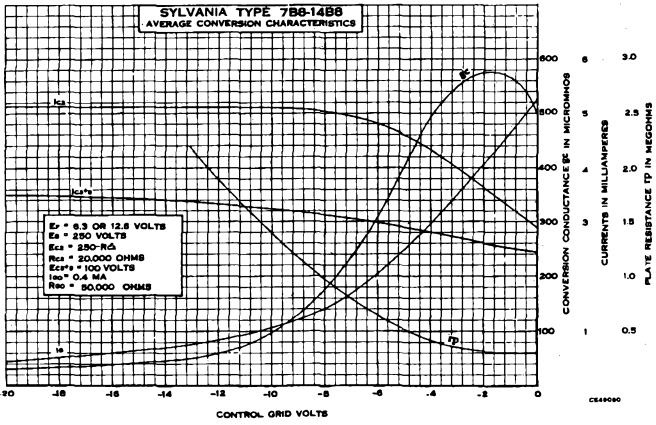

# 7C5 Sylvania Type

## BEAM POWER AMPLIFIER



6AA-L-0

### PHYSICAL SPECIFICATIONS

Base.....	Lock-In 8 Pin
Bulb.....	T9
Maximum Overall Length.....	3 5/8"
Maximum Seated Height.....	2 5/8"
Mounting Position.....	Any

### RATINGS

Heater Voltage AC or DC (Nominal).....	7.0 Volts
Maximum Plate Voltage.....	315 Volts
Maximum Screen Voltage.....	285 Volts
Maximum Plate Dissipation.....	12 Watts
Maximum Screen Dissipation.....	2 Watts
Maximum Heater-Cathode Voltage.....	90 Volts

#### Direct Interelectrode Capacitances:\*

Grid to Plate.....	0.4 $\mu$ f.
Input.....	9.5 $\mu$ f.
Output.....	9.0 $\mu$ f.

\*With 1 3/4" diameter shield (RMA Std. 308) connected to cathode.

### TYPICAL OPERATION

#### CLASS A<sub>1</sub> AMPLIFIER (ONE TUBE)

Heater Voltage.....	6.3	6.3	6.3 Volts
Heater Current.....	450	450	450 Ma.
Plate Voltage.....	180	250	315 Volts
Screen Voltage.....	180	250	225 Volts
Grid Voltage.....	-8.5	-12.5	-13.0 Volts
Self-Bias Resistor.....	260	250	360 Ohms
Peak Input Signal.....	8.5	12.5	13.0 Volts
Plate Current (Zero Signal).....	29	45	34 Ma.
Plate Current (Maximum Signal).....	30	47	35 Ma.
Screen Current (Zero Signal).....	3.0	4.5	2.2 Ma.
Screen Current (Maximum Signal).....	4.0	7.0	6.0 Ma.
Plate Resistance.....	58000	52000	77000 Ohms
Mutual Conductance.....	3700	4100	3750 $\mu$ mhos
Load Resistance.....	5500	5000	8500 Ohms
Power Output.....	2.0	4.5	5.5 Watts
Total Harmonic Distortion.....	8	8	12 Per Cent

#### CLASS AB<sub>1</sub> AMPLIFIER (PUSH-PULL)

(Values are for two tubes)

Heater Voltage.....	6.3	6.3 Volts
Heater Current.....	.90	.90 Ampere
Plate Voltage.....	250	285 Volts
Screen Voltage.....	250	285 Volts
Grid Voltage.....	-15	-19 Volts
Self-Bias Resistor.....	200	260 Ohms
Peak Input Signal (Grid to Grid).....	30	38 Volts
Plate Current (Zero Signal).....	70	70 Ma.
Plate Current (Maximum Signal).....	79	92 Ma.
Screen Current (Zero Signal).....	5	4 Ma.
Screen Current (Maximum Signal).....	13	13.5 Ma.
Plate Resistance.....	60000	65000 Ohms
Mutual Conductance.....	3750	3600 $\mu$ mhos
Load Resistance (Plate to Plate).....	10000	8000 Ohms
Power Output.....	10.0	14.0 Watts
Total Harmonic Distortion.....	5	3.5 Per Cent

### APPLICATION

Sylvania Type 7C5 is a beam power amplifier which provides high power output, power sensitivity, and efficiency with a low percentage of third and higher order harmonics. The electrical characteristics and applications are identical with those for Types 6V6 and 6V6G. The Type 7C5 should prove very desirable in applications where heater and plate current drain must be maintained at a minimum.

The lock-in construction provides compactness, suitable shielding and the special lock-in feature. For a-c service the 7-volt heater rating corresponds to a 130-volt line condition.

When fixed bias is employed the resistance in the grid circuit should not be greater than 0.1 megohm. With cathode bias the grid circuit resistance must not exceed 0.5 megohm.

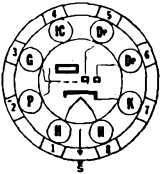
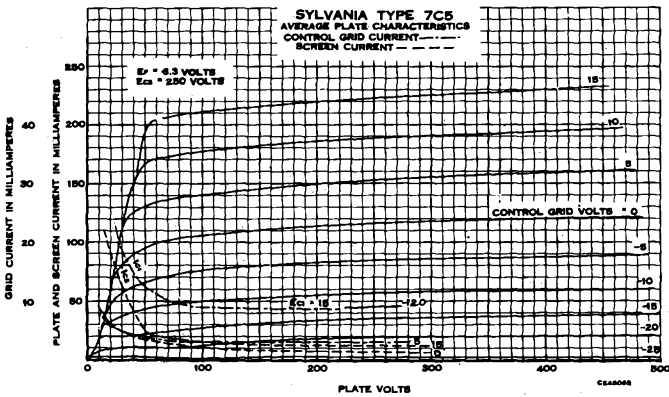

8W-L-7

**Sylvania Type 7C6**

DUODIODE HIGH-MU TRIODE

**PHYSICAL SPECIFICATIONS**

Base.....	Lock-In 8 Pin
Bulb.....	T-9
Maximum Overall Length.....	2 <sup>5</sup> / <sub>16</sub> "
Maximum Seated Height.....	2 <sup>3</sup> / <sub>4</sub> "
Mounting Position.....	Any

**RATINGS**

Heater Voltage AC or DC (Nominal).....	7.0 Volts
Maximum Plate Voltage.....	300 Volts
Maximum Diode Drop at .8 Ma.....	10 Volts
Maximum Diode Current per Plate (Continuous).....	1.0 Ma.
Maximum Heater-Cathode Voltage.....	90 Volts

**TYPICAL OPERATION**

Heater Voltage.....	6.2	6.3 Volts
Heater Current.....	150	150 Ma.
Plate Voltage.....	100	250 Volts
Grid Voltage*.....	0.0	-1.0 Volt
Plate Current*.....	1.0	1.3 Ma.
Plate Resistance*.....	0.1	0.1 Megohm
Mutual Conductance*.....	850	1000 $\mu$ mhos
Amplification Factor*.....	85	100

\*These are rating values only and not operating points with coupling resistor. Refer to tabulated data on page 49 for this information.

**APPLICATION**

Sylvania Type 7C6 is a single-ended duodiode high-mu triode having electrical characteristics quite similar to those for Type 75, except for the heater ratings.

The diodes are substantially the same as those employed in other Sylvania duodiode high-mu triode types and therefore are suitable for conventional circuit applications. Diode curves are given under Type 7B6.

# 7C6 (Cont'd)

The triode section should not be employed with fixed bias. A high value of grid resistor is required and the triode operated essentially under zero bias conditions. With a plate supply voltage of 250 volts, the plate load resistor should be approximately 0.25 megohm. For special applications this value may be varied to suit the conditions.

Resistance coupled data is given in the appendix.

It will be noted from the base diagram that the cathode is connected to two contact pins, Numbers 4 and 7. Pin Number 4 is used as a mount support for the cathode, therefore, the potential of Pins 4 and 7 is the same.

The lock-in construction provides compactness, suitable shielding and the special lock-in feature. For a-c service the 7-volt heater rating corresponds to a 130-volt line condition.

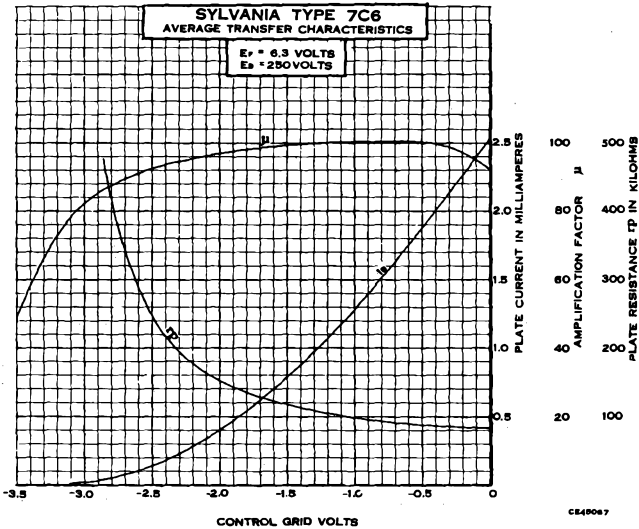
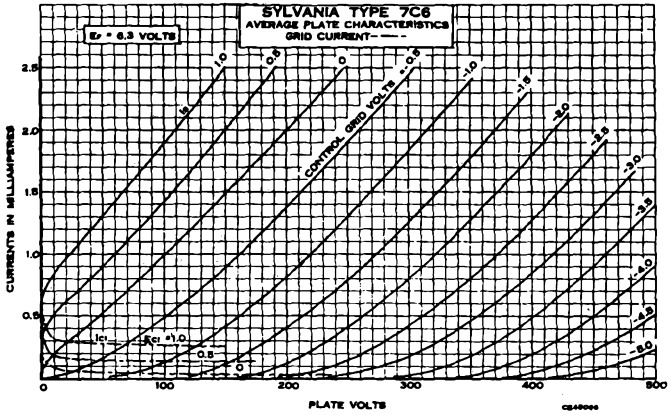

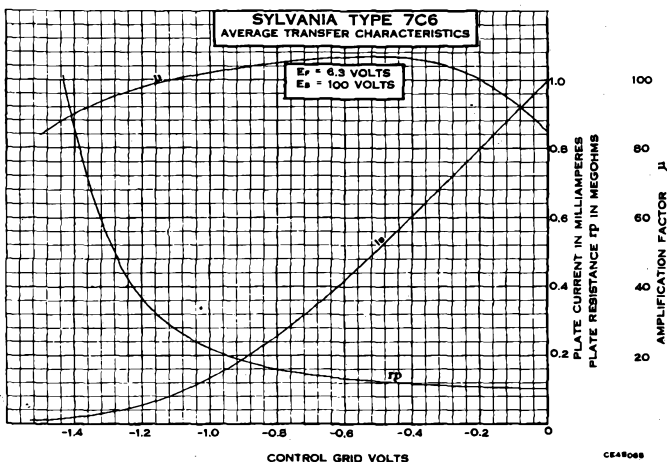

## Sylvania Type 7C7

### SHARP CUT-OFF RF PENTODE

### PHYSICAL SPECIFICATIONS

Base.....	Lock-In 8 Pin
Bulb.....	T-9
Maximum Overall Length.....	2 <sup>1</sup> / <sub>2</sub> "
Maximum Seated Height.....	2 <sup>1</sup> / <sub>4</sub> "
Mounting Position.....	Any

### RATINGS

Heater Voltage AC or DC (Nominal).....	7.0 Volts
Maximum Plate Voltage.....	300 Volts
Maximum Screen Voltage.....	100 Volts
Maximum Screen Supply.....	300 Volts
Maximum Plate Dissipation.....	1.0 Watt
Maximum Screen Dissipation.....	0.1 Watt
Minimum Grid Bias.....	0 Volt
Maximum Heater-Cathode Voltage.....	90 Volts

#### Direct Interelectrode Capacitances:\*

Grid to Plate (G1 to P).....	0.004 $\mu$ f. Max.
Input; G1 to (F+K+Gs+Su+Shield).....	5.5 $\mu$ f.
Output; P to (F+K+Gs+Su+Shield).....	6.5 $\mu$ f.

\*With 1<sup>5</sup>/<sub>16</sub>" diameter shield (RMA Std. 308) connected to cathode.

### TYPICAL OPERATION

Heater Voltage.....	6.3	6.3 Volts
Heater Current.....	150	150 Ma.
Plate Voltage.....	100	250 Volts Max.
Screen Voltage.....	100	100 Volts Max.
Grid Voltage.....	-3	-3 Volts Min.
Self-Bias Resistor.....	1350	1200 Ohms
Suppressor Grid.....	Connect to	Cathode
Plate Current.....	1.8	2.0 Ma.
Screen Current.....	0.4	0.5 Ma.
Plate Resistance (Approximate).....	1.2	2 Megohms
Mutual Conductance.....	1225	1300 $\mu$ mhos

### APPLICATION

Sylvania Type 7C7 is a sharp cut-off pentode with a low heater current rating. In other respects it is similar to the older Type 6J7GT. Design data for use in resistance coupled circuits appears in the appendix.

# 7C7 (Cont'd)

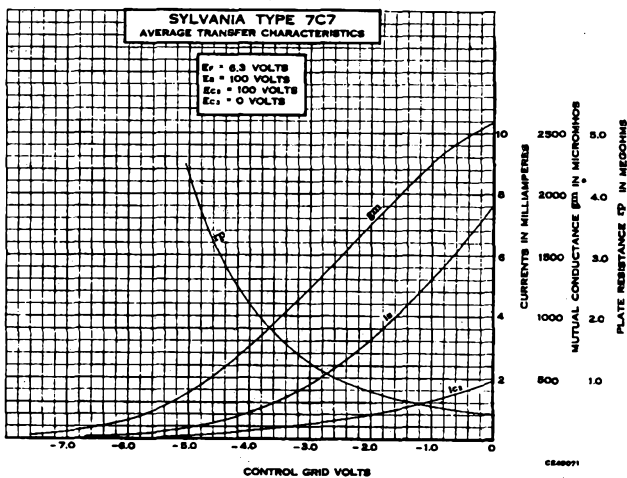
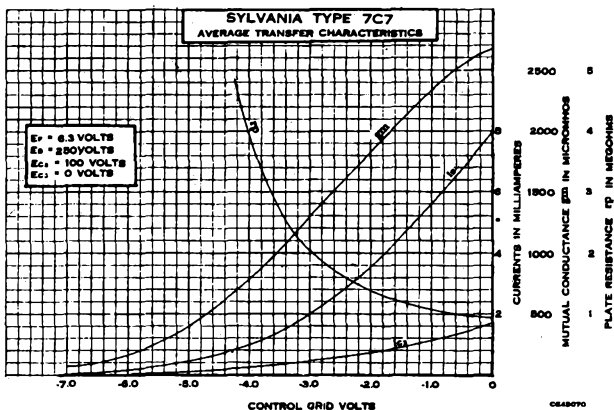
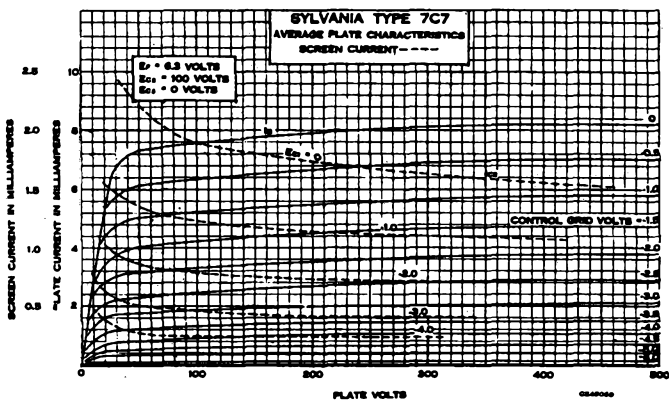

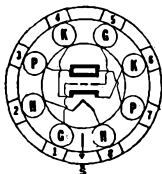

8BN-L-0

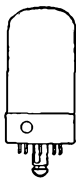

# Sylvania Type 7E5

## HIGH-FREQUENCY TRIODE

### PHYSICAL SPECIFICATIONS

Base.....	Lock-In 8 Pin
Bulb.....	T9
Maximum Overall Length.....	2 <sup>5</sup> / <sub>16</sub> "
Maximum Seated Height.....	2 <sup>1</sup> / <sub>4</sub> "
Mounting Position.....	Any

### RATINGS

Heater Voltage AC or DC (Nominal).....	7.0 Volts
Maximum Plate Voltage.....	250 Volts
Maximum Plate Current.....	16 Ma.
Maximum Grid Current.....	6 Ma.
Maximum Plate Dissipation.....	4 Watts
Maximum Heater-Cathode Voltage.....	90 Volts

#### Direct Interelectrode Capacitances:\*

Grid to Plate.....	1.5 $\mu$ f.
Input.....	3.6 $\mu$ f.
Output.....	2.8 $\mu$ f.

\*With 1<sup>5</sup>/<sub>16</sub>" diameter shield (RMA Std. 308) connected to cathode.

### TYPICAL OPERATION

#### CLASS A<sub>1</sub> AMPLIFIER

Heater Voltage.....	6.3 Volts
Heater Current.....	0.150 Ampere
Plate Voltage.....	180 Volts
Grid Voltage.....	-3.0 Volts
Plate Current.....	5.5 Ma.
Mutual Conductance.....	3000 $\mu$ mhos
Plate Resistance.....	12000 Ohms
Amplification Factor.....	36

#### UHF OSCILLATOR—750 Mc.‡

Heater Voltage.....	6.3	6.3 Volts
Plate Voltage.....	200	250 Volts
Plate Current.....	11	13 Ma.
Grid Resistor.....	10000	2000 Ohms
Developed Bias.....	2.5	3.5 Volts

‡Half-wave four-line oscillator in which line shortening, due to the tube, is approximately 45% of a half-wave length.

#### UHF OSCILLATOR OR POWER AMPLIFIER—300 Mc.\*

Heater Voltage.....	6.3 Volts
Plate Supply Voltage§.....	150 Volts
Plate Current.....	16 Ma.
Grid Current.....	6.0 Ma.
Grid Resistor (Approximate).....	1700 Ohms
Power Output.....	0.20 Watt

§Supplied through 3000 ohm dropping resistor.

#### LOCAL OSCILLATOR FOR 300 Mc. MIXER DRIVING\*

Heater Voltage.....	6.3 Volts
Plate Supply Voltage§.....	90 Volts
Plate Current.....	7.8 Ma.
Grid Voltage.....	-7.0 Volts
Grid Resistor.....	3000 Ohms
Mixer Developed Bias‡.....	-5.3 Volts

§Supplied through 3000 ohm dropping resistor.

\*Quarter wave four-line oscillator in which the line shortening is approximately 30% of a quarter wave length.

‡Developed bias across 35,000 ohm grid leak of UHF triode mixer tuned to 324 megacycles.

### APPLICATION

Sylvania Type 7E5 is a cathode type triode of Lock-In construction designed for ultra-high frequency applications. This tube can be used as a signal source or local oscillator to frequencies of 750 megacycles when used in a double ended transmission line circuit. This type of operation is facilitated by a symmetrical arrangement of double grid and plate leads. These connections are brought out to the Lock-In single ended base from opposite ends of their respective element structures. Useful power output can be obtained at frequencies of 400 megacycles and lower, but below approximately 200 megacycles the use of other types, such as Sylvania Type 7A4, are recommended.

For use in resistance coupled circuits, see data in appendix.



# 7E6 Sylvania Type

DUODIODE MEDIUM-MU TRIODE

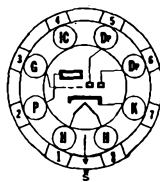
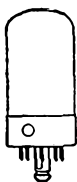

8W-L-7

## PHYSICAL SPECIFICATIONS

Base.....	Lock-In 8 Pin
Bulb.....	T9
Maximum Overall Length.....	2 <sup>3</sup> / <sub>4</sub> "
Maximum Seated Height.....	2 <sup>1</sup> / <sub>4</sub> "
Mounting Position.....	Any

## RATINGS

Heater Voltage AC or DC (Nominal).....	7.0 Volts
Maximum Plate Voltage.....	300 Volts
Maximum Plate Dissipation.....	2.5 Watts
Maximum Diode Drop at .8 Ma.....	10 Volts
Maximum Continuous Diode Current per Plate.....	1.0 Ma.
Maximum Heater-Cathode Voltage.....	90 Volts

### Direct Interelectrode Capacitances:\*

Grid to Plate.....	1.5 $\mu$ f.
Input.....	3.0 $\mu$ f.
Output.....	2.4 $\mu$ f.
Grid to Diode 1.....	0.01 $\mu$ f. Max.
Grid to Diode 2.....	0.04 $\mu$ f. Max.

\*With 1<sup>3</sup>/<sub>4</sub>" diameter shield (RMA Std. 308) connected to cathode.

## TYPICAL OPERATION

Heater Voltage.....	6.3	6.3 Volts
Heater Current.....	300	300 Ma.
Plate Voltage.....	100	250 Volts
Grid Voltage§.....	-3	-9 Volts
Self-Bias Resistor.....	770	950 Ohms
Plate Current.....	3.9	9.5 Ma.
Plate Resistance.....	11000	8500 Ohms
Mutual Conductance.....	1500	1900 $\mu$ mhos
Amplification Factor.....	16.5	16

§DC resistance in the grid circuit should not exceed 1.0 megohm under maximum rated conditions.

## APPLICATION

Sylvania Type 7E6 is a Lock-In duodiode triode having medium-mu characteristics. It is intended for use in conjunction with transformer coupled circuits although resistance coupling data are given in appendix. The diode section is the same as that in Type 7B6 and reference should be made to that type for curves.

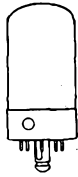
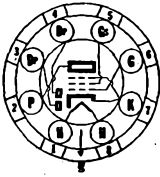

# Sylvania Type 7E7

DUODIODE RF PENTODE

SAE-L-7

## PHYSICAL SPECIFICATIONS

Base.....	Lock-In 8 Pin
Bulb.....	T9
Maximum Overall Length.....	2 <sup>3</sup> / <sub>4</sub> "
Maximum Seated Height.....	2 <sup>1</sup> / <sub>4</sub> "
Mounting Position.....	Any

## RATINGS

Heater Voltage AC or DC (Nominal).....	7.0 Volts
Maximum Plate Voltage.....	300 Volts
Maximum Screen Voltage.....	100 Volts
Maximum Screen Supply.....	300 Volts
Maximum Plate Dissipation.....	2.0 Watts
Maximum Screen Dissipation.....	0.3 Watt
Minimum Grid Bias.....	0 Volts
Maximum Diode Drop at 0.8 Ma.....	10 Volts
Maximum Continuous Diode Current per Plate.....	1.0 Ma.
Maximum Heater-Cathode Voltage.....	90 Volts

### Direct Interelectrode Capacitances:\*

Grid to Plate.....	.005 $\mu$ f. Max.
Input.....	4.6 $\mu$ f.
Output.....	5.5 $\mu$ f.
Grid to Diode 1.....	.013 $\mu$ f. Max.
Grid to Diode 2.....	.003 $\mu$ f. Max.

\*With 1<sup>3</sup>/<sub>4</sub>" diameter shield (RMA Std. 308) connected to cathode.

## TYPICAL OPERATION RF OR IF AMPLIFIER

Heater Voltage.....	6.3	6.3 Volts
Heater Current.....	300	300 Ma.
Plate Voltage.....	100	250 Volts
Screen Voltage.....	100	100 Volts
Grid Voltage.....	-1.0	-3.0 Volts
Self-Bias Resistor.....	80	330 Ohms
Plate Current.....	10.0	7.5 Ma.
Screen Current.....	2.7	1.6 Ma.
Plate Resistance (Approximate).....	0.15	0.7 Megohm
Mutual Conductance.....	1600	1300 $\mu$ mhos
Grid Voltage for 2 $\mu$ mhos Mutual Conductance... ..	-36	-42.5 Volts

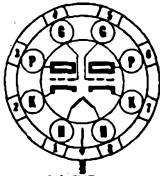

# Sylvania Type 7F7

HIGH-MU DUO TRIODE

8AC-L-0

## PHYSICAL SPECIFICATIONS

Base.....	Lock-In 8 Pin
Bulb.....	T9
Maximum Overall Length.....	2 <sup>3</sup> / <sub>4</sub> "
Maximum Seated Height.....	2 <sup>1</sup> / <sub>4</sub> "
Mounting Position.....	Any

## RATINGS

Heater Voltage AC or DC (Nominal).....	7.0 Volts
Maximum Plate Voltage.....	300 Volts
Maximum Plate Dissipation per Plate.....	1.0 Watt
Minimum Grid Voltage.....	0 Volt
Maximum Heater-Cathode Voltage.....	90 Volts

### Direct Interelectrode Capacitances:\*

Grid to Plate.....	1.6 $\mu$ f.
Input.....	2.4 $\mu$ f.
Output.....	2.0 $\mu$ f.
Grid 1 to Grid 2.....	0.2 $\mu$ f. Max.
Plate to Plate.....	1.0 $\mu$ f. Max.

\*With 1<sup>3</sup>/<sub>4</sub>" diameter shield (RMA Std. 308) connected to cathode.

# 7F7 (Cont'd)

## TYPICAL OPERATION CLASS A AMPLIFIER PER SECTION

Heater Voltage.....	6.3	6.3 Volts
Heater Current.....	300	300 Ma.
Plate Voltage.....	100	250 Volts
Grid Voltage.....	-1.0	-2.0 Volts
Plate Current.....	.65	2.3 Ma.
Plate Resistance.....	62000	44000 Ohms
Mutual Conductance.....	1125	1600 $\mu$ mhos
Amplification Factor.....	70	70

## APPLICATION

Sylvania Type 7F7 is a double triode high-mu amplifier tube of Lock-In construction. It is designed for use as a resistance coupled amplifier or phase inverter. All elements except the common heater are brought out separately allowing each triode section to operate independently of the other. Resistance coupling data are given in the appendix.

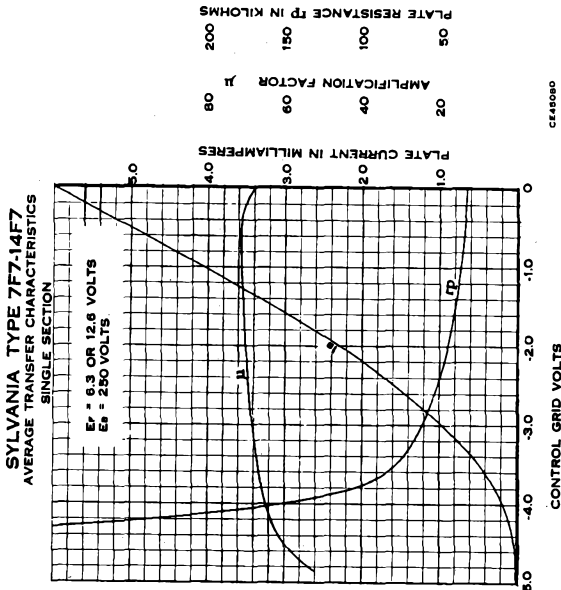
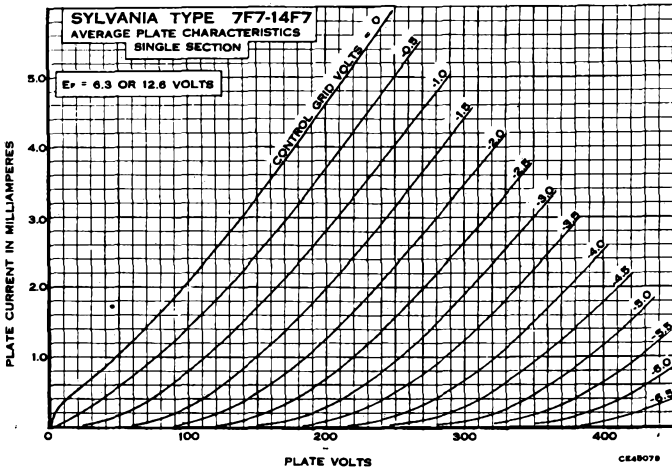

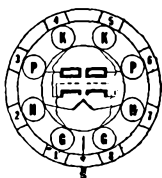

8BW-L-0



# Sylvania Type 7F8

DOUBLE TRIODE

## PHYSICAL SPECIFICATIONS

Base.....	Lock-In 8 Pin
Bulb.....	T9
Maximum Overall Length.....	2 3/4"
Maximum Seated Height.....	1 1/4"
Mounting Position.....	Any

## RATINGS

Heater Voltage AC or DC (Nominal).....	7.0 Volts
Maximum Plate Voltage.....	300 Volts
Maximum Plate Dissipation (Total both sections).....	3.5 Watts
Minimum External Grid Bias Voltage.....	0 Volt
Maximum Heater-Cathode Voltage.....	90 Volts

### Direct Interelectrode Capacitances:\*

Grid to Plate.....	1.2 $\mu$ f.
Input.....	2.8 $\mu$ f.
Output.....	1.4 $\mu$ f.
Grid to Grid.....	0.1 $\mu$ f. Max.
Plate to Plate.....	0.5 $\mu$ f. Max.
Heater to Cathode (External shield connected to ground).....	2.8 $\mu$ f.

\*With 1 3/8" diameter shield (RMA Std. 308) connected to cathode.

## TYPICAL OPERATION

Per Section except Heater

Heater Voltage (AC or DC).....	6.3 Volts
Heater Current.....	300 Ma.
Plate Voltage.....	250 Volts
Self-Bias Resistor.....	500 Ohms
Plate Current.....	6.0 Ma.
Mutual Conductance.....	3300 $\mu$ mhos
Amplification Factor.....	48
Grid Voltage for 10 $\mu$ a. DC Plate Current (Approx.).....	-11.0 Volts
Maximum Grid Circuit Resistance.....	0.5 Megohm

## APPLICATION

Sylvania Type 7F8 is a high mutual conductance double triode designed for use at frequencies up to 300 or 400 megacycles. With proper care each section may be used separately to effect tube and space savings since all elements except heater are separate.

Design data for use in resistance coupled circuits may be found in the appendix.

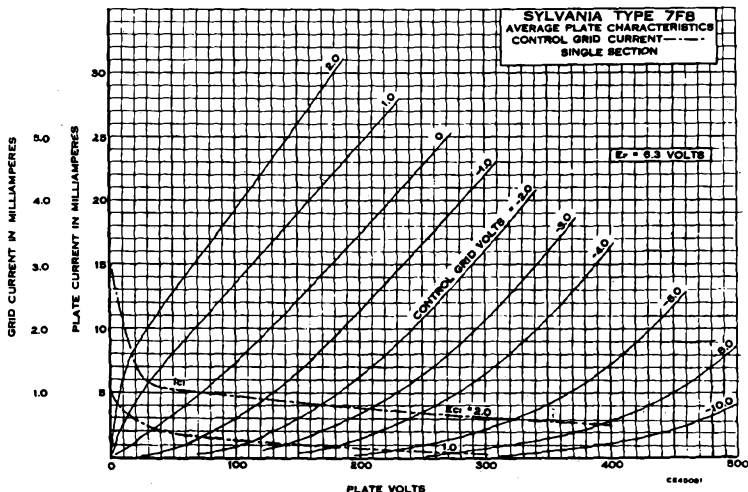

# 7F8 (Cont'd)

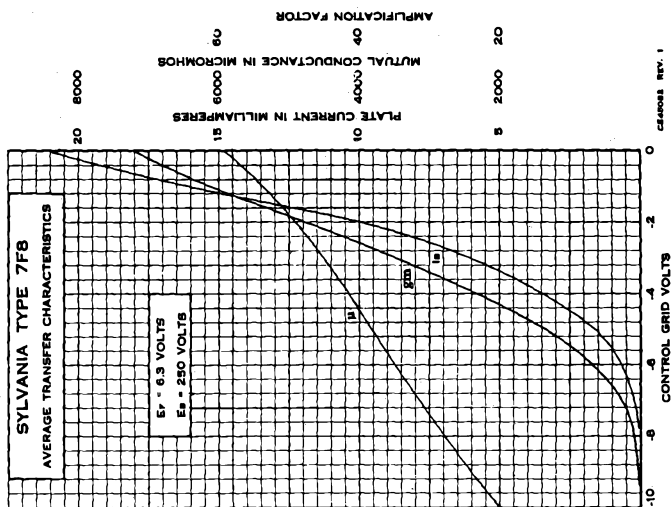

## 7G7 Sylvania Type

SHARP CUT-OFF RF PENTODE

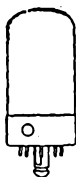

8V-L-5

### PHYSICAL SPECIFICATIONS

Base.....	Lock-In 8 Pin
Bulb.....	T9
Maximum Overall Length.....	2 15/16"
Maximum Seated Height.....	2 1/4"
Mounting Position.....	Any

### RATINGS

Heater Voltage (Nominal) AC or DC.....	7.0 Volts
Maximum Plate Voltage.....	300 Volts
Maximum Screen Voltage.....	100 Volts
Maximum Screen Supply Voltage.....	300 Volts
Maximum Plate Dissipation.....	1.5 Watts
Maximum Screen Dissipation.....	0.3 Watt
Maximum Heater-Cathode Voltage.....	90 Volts

#### Direct Interelectrode Capacitances:\*

Grid to Plate.....	0.006 $\mu$ mf. Max.
Input: G to (F+K+Gs+Su+Internal Shield).....	9.0 $\mu$ mf.
Output: P to (F+K+Gs+Su+Internal Shield).....	7.0 $\mu$ mf.

\*With 1 3/8" diameter shield (RMA Std. 308) connected to cathode.

### TYPICAL OPERATION

Heater Voltage.....	6.3 Volts
Heater Current.....	450 Ma.
Plate Voltage.....	250 Volts
Suppressor Voltage.....	Tie to Cathode
Screen Voltage.....	100 Volts
Grid Voltage.....	-2 Volts
Self-Bias Resistor.....	250 Ohms
Plate Current.....	6.0 Ma.
Screen Current.....	2.0 Ma.
Plate Resistance (Approximate).....	0.8 Megohm
Mutual Conductance.....	4500 $\mu$ mhos
Grid Voltage for Cathode Current Cut-off (Approx.).....	-7 Volts



8BV-L-0



# Sylvania Type 7G8

SHARP CUT-OFF DOUBLE TETRODE

## PHYSICAL SPECIFICATIONS

Base.....	Lock-In 8 Pin
Bulb.....	T9
Maximum Overall Length.....	2 <sup>3</sup> / <sub>4</sub> "
Maximum Seated Height.....	1 <sup>3</sup> / <sub>4</sub> "
Mounting Position.....	Any

## RATINGS

Heater Voltage AC or DC (Nominal).....	7.0 Volts
Maximum Plate Voltage.....	300 Volts
Maximum Screen Supply.....	300 Volts
Maximum Screen Voltage.....	100 Volts
Maximum Plate Dissipation (Per Section).....	1.5 Watts
Maximum Screen Dissipation (Per Section).....	0.1 Watt
Minimum Control Grid Bias.....	0 Volt
Maximum Heater-Cathode Voltage.....	90 Volts

### Direct Interelectrode Capacitances:\*

Grid to Plate.....	0.15 $\mu$ mf. Max.
Input.....	3.40 $\mu$ mf.
Output.....	2.60 $\mu$ mf.

\*With 1<sup>5</sup>/<sub>16</sub>" diameter shield (RMA Std. 308) connected to cathode. Measurements made on each section.

## TYPICAL OPERATION

### CLASS A<sub>1</sub> AMPLIFIER (Per Section except Heater)§

Heater Voltage.....	6.3 Volts
Heater Current.....	300 Ma.
Plate Voltage.....	250 Volts
Screen Voltage.....	100 Volts
Grid Voltage.....	-2.5 Volts
Self-Bias Resistor.....	470 Ohms
Plate Current.....	4.5 Ma.
Screen Current.....	0.8 Ma.
Mutual Conductance.....	2100 $\mu$ mhos
Plate Resistance.....	225000 Ohms
Grid Voltage for 10 $\mu$ a. Plate Current.....	-11 Volts

§To assure operation of one section only, at least 40 volts negative must be applied to the grid of the section not operating.

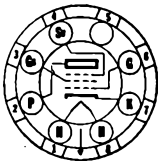

8V-L-5

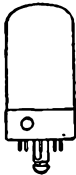

# Sylvania Type 7H7

SEMI-REMOTE CUT-OFF RF

PENTODE

## PHYSICAL SPECIFICATIONS

Base.....	Lock-In 8 Pin
Bulb.....	T9
Maximum Overall Length.....	2 <sup>3</sup> / <sub>4</sub> "
Maximum Seated Height.....	2 <sup>1</sup> / <sub>4</sub> "
Mounting Position.....	Any

## RATINGS

Heater Voltage AC or DC (Nominal).....	7.0 Volts
Maximum Plate Voltage.....	300 Volts
Maximum Screen Voltage.....	150 Volts
Maximum Screen Supply Voltage.....	300 Volts
Maximum Plate Dissipation.....	2.5 Watts
Maximum Screen Dissipation.....	0.5 Watt
Minimum External Grid Bias Voltage.....	0 Volt
Maximum Heater-Cathode Voltage.....	90 Volts

### Direct Interelectrode Capacitances:\*

Grid to Plate.....	0.004 $\mu$ mf. Max.
Input.....	8.0 $\mu$ mf.
Output.....	7.0 $\mu$ mf.

\*With 1<sup>5</sup>/<sub>16</sub>" diameter shield (RMA Std. 308) connected to cathode

# 7H7 (Cont'd)

## TYPICAL OPERATION CLASS A<sub>1</sub> AMPLIFIER

Heater Voltage (AC or DC).....	6.3	6.3 Volts
Heater Current.....	300	300 Ma.
Plate Voltage.....	100	250 Volts
Screen Voltage.....	100	150 Volts
Grid Voltage.....	-1.5	..... Volts
Self-Bias Resistor.....	150	180 Ohms
Suppressor and Internal Shield	Connect to Cathode	
Plate Current.....	7.5	10.0 Ma.
Screen Current.....	2.6	3.2 Ma.
Plate Resistance.....	0.35	0.8 Megohm
Mutual Conductance.....	4000	4000 $\mu$ ms
Grid Voltage for Mutual Conductance of 35 $\mu$ ms (Approximate).....	-12	-19 Volts

## APPLICATION

Sylvania Type 7H7 is a semi-remote cut-off pentode suitable for RF or television service. It is similar to Type 6AB7 except for lower heater current and slightly lower mutual conductance. The Lock-In construction provides ruggedness, suitable shielding and short leads so necessary in high-frequency circuits. The high mutual conductance helps to compensate for the low gain associated with high-frequency and wide-band amplifier designs.

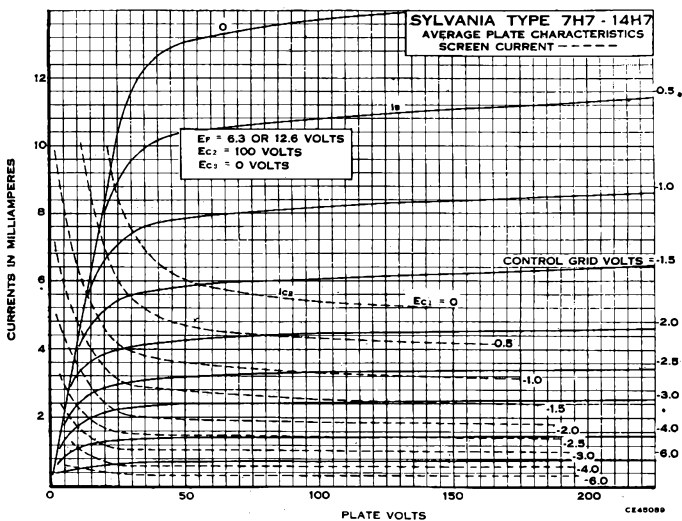
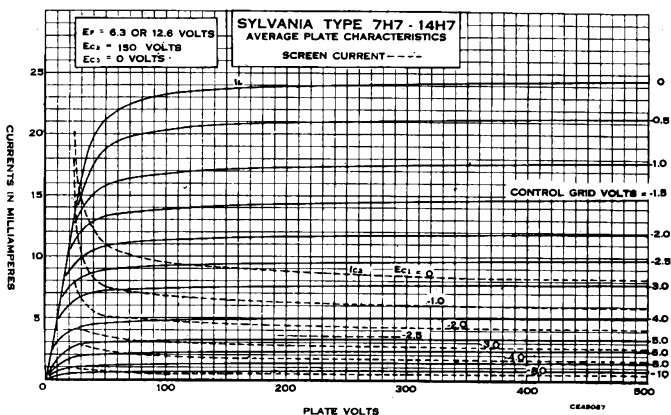

# SYLVANIA RADIO TUBES

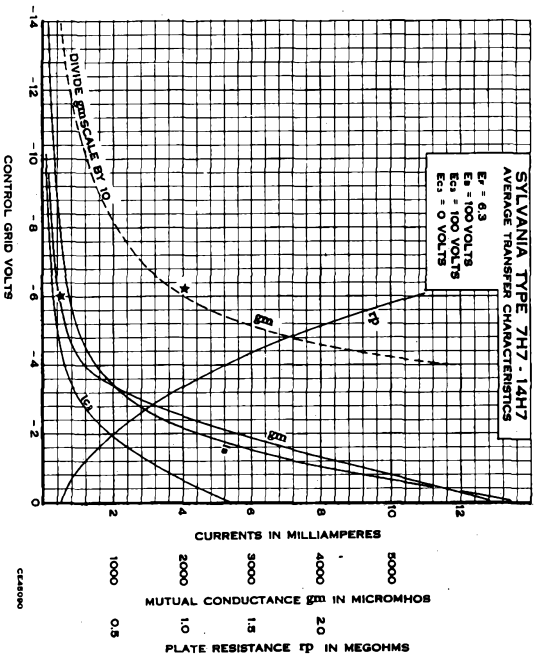



**SYLVANIA TYPE 7H7 - 14H7**  
**AVERAGE TRANSFER CHARACTERISTICS**

$E_p = 6.3$  OR  $12$  VOLTS  
 $E_b = 250$  VOLTS  
 $E_{c1} = 150$  VOLTS  
 $E_{c2} = 0$  VOLTS

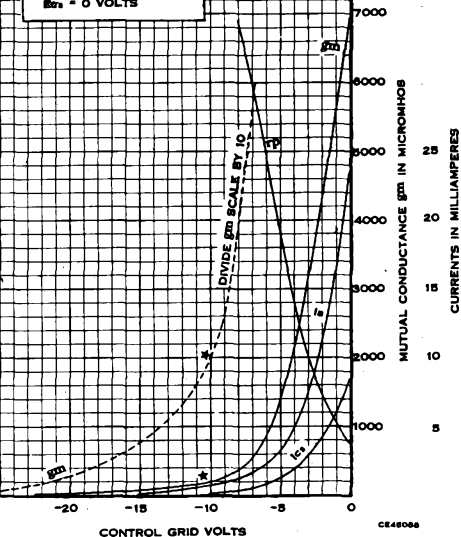

CE48086

(Cont'd) **7H7**

# 7J7 Sylvania Type

TRIODE HEPTODE CONVERTER

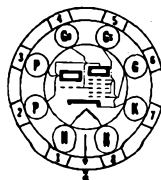
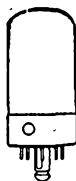

8BL-L-7

## PHYSICAL SPECIFICATIONS

Base.....	Lock-In 8 Pin
Bulb.....	T-9
Maximum Overall Length.....	2 <sup>3</sup> / <sub>4</sub> "
Maximum Seated Height.....	2 <sup>1</sup> / <sub>4</sub> "
Mounting Position.....	Any

## RATINGS

Heater Voltage (Nominal) AC or DC.....	7.0 Volts
Maximum Heptode Plate Voltage.....	300 Volts
Maximum Heptode Screen Voltage.....	100 Volts
Maximum Heptode Screen Supply Voltage.....	300 Volts
Minimum Heptode Control Grid (G) Voltage.....	0 Volt
Maximum Triode Plate Voltage.....	150 Volts
Maximum Triode Plate Supply Voltage.....	300 Volts
Maximum Triode Plate Dissipation.....	1.25 Watts
Maximum Total Cathode Current.....	14 Ma.
Maximum Heater-Cathode Voltage.....	90 Volts
<b>Direct Interelectrode Capacitances:*</b>	
Grid G to Heptode Plate.....	0.03 $\mu$ f. Max.
Grid G to Oscillator Plate.....	0.1 $\mu$ f. Max.
Grid G to Grid Go.....	0.3 $\mu$ f. Max.
Grid Go to Oscillator Plate.....	0.9 $\mu$ f.
Grid G to All Other Electrodes (r-f input).....	4.6 $\mu$ f.
Oscillator Plate to All Electrodes Except Grid Go (Oscillator Output).....	3.2 $\mu$ f.
Oscillator Grid to All Electrodes Except Oscillator Plate (Oscillator Input).....	7.5 $\mu$ f.
Heptode Plate to All Electrodes (Mixer Output).....	7.5 $\mu$ f.

\*With 1<sup>3</sup>/<sub>4</sub>" diameter shield (RMA Std. M8-308) connected to cathode.

## TYPICAL OPERATION

Heater Voltage.....	6.3	6.3 Volts
Heater Current.....	300	300 Ma.
Plate Voltage (Heptode).....	100	250 Volts
Oscillator Plate Voltage (Triode).....	100	250** Volts
Screen Voltage (Heptode).....	100	100 Volts
Control Grid Voltage (Heptode Grid G).....	-3	-3 Volts
Oscillator Grid Resistor (Triode).....	50000	50000 Ohms
Plate Current (Heptode).....	1.5	1.4 Ma.
Screen Current (Heptode).....	2.6	2.8 Ma.
Oscillator Plate Current (Triode).....	3.2	5.0 Ma.
Oscillator Grid Current (Triode).....	0.3	0.4 Ma.
Plate Resistance (Heptode).....	0.5	1.5 Megohms
Conversion Conductance.....	280	290 $\mu$ mhos
Conversion Conductance (Ec <sub>1</sub> = -20).....	2	2 $\mu$ mhos
Total Cathode Current.....	7.7	9.6 Ma.

\*\*Applied through 20000 ohms series resistance properly by-passed.

## TRIODE CHARACTERISTICS

Heater Voltage.....	6.3 Volts
Plate Voltage.....	150 Volts
Grid Voltage.....	-3 Volts
Plate Current.....	6.6 Ma.
Plate Resistance.....	10700 Ohms
Mutual Conductance (Approximate).....	1400 $\mu$ mhos
Amplification Factor (Approximate).....	15

# 7K7 Sylvania Type

DUODIODE HIGH-MU TRIODE

(Separate Diode Cathode)

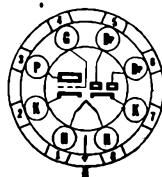

8BF-L-7

## PHYSICAL SPECIFICATIONS

Base.....	Lock-In 8 Pin
Bulb.....	T-9
Maximum Overall Length.....	2 <sup>3</sup> / <sub>4</sub> "
Maximum Seated Height.....	2 <sup>1</sup> / <sub>4</sub> "
Mounting Position.....	Any

## RATINGS

Heater Voltage AC or DC (Nominal)	7.0 Volts
Maximum Plate Voltage	300 Volts
Maximum Diode Drop for 1.5 Ma. (Per Diode)	10 Volts
Maximum Heater-Cathode Voltage	90 Volts
Maximum Plate Dissipation	1 Watt
Minimum External Grid Bias	0 Volt

## Direct Interelectrode Capacitances:\*

Grid to Plate	1.7 $\mu$ f.
Input	2.4 $\mu$ f.
Output	2.0 $\mu$ f.
Diode 1 to Grid 1	0.25 $\mu$ f. Max.
Diode 2 to Grid 1	0.25 $\mu$ f. Max.
Diode Cathode to Diode 1	2.0 $\mu$ f. Max.
Diode Cathode to Diode 2	2.0 $\mu$ f. Max.

\*With 1 $\frac{1}{4}$ " diameter shield (RMA Std. 308) connected to cathode.

## TYPICAL OPERATION AS AMPLIFIER—CLASS A

Heater Voltage AC or DC	6.3 Volts
Heater Current	300 Ma.
Plate Voltage	250 Volts
Grid Voltage	-2.0 Volts
Amplification Factor	70
Plate Resistance (Approximate)	44000 Ohms
Mutual Conductance	1600 $\mu$ mhos
Plate Current	2.3 Ma.

Resistance coupled amplifier data appears under Type 7F7 in the appendix.



8V-L-5



## Sylvania Type 7L7

SHARP CUT-OFF RF PENTODE

## PHYSICAL SPECIFICATIONS

Base	Lock-In 8 Pin
Bulb	T-9
Maximum Overall Length	2 $\frac{1}{2}$ "
Maximum Seated Height	2 $\frac{1}{4}$ "
Mounting Position	Any

## RATINGS

Heater Voltage (Nominal) AC or DC	7.0 Volts
Maximum Plate Voltage	300 Volts
Maximum Screen Voltage	125 Volts
Maximum Screen Supply Voltage	300 Volts
Maximum Plate Dissipation	4.0 Watt
Maximum Screen Dissipation	0.4 Watt
Minimum Grid Bias Voltage	0 Volt
Maximum Heater-Cathode Voltage	90 Volts

## Direct Interelectrode Capacitances:\*

Grid to Plate	0.01 $\mu$ f. Max.
Input: G to (F+K+Gs+Su+Internal Shield)	8.0 $\mu$ f.
Output: P to (F+K+Gs+Su+Internal Shield)	6.5 $\mu$ f.

\*With 1 $\frac{1}{4}$ " diameter shield (RMA Std. 308) connected to cathode and base shell.

## TYPICAL OPERATION

CLASS A<sub>1</sub> AMPLIFIER

Heater Voltage	6.3	6.3 Volts
Heater Current	300	300 Ma.
Plate Voltage	100	250 Volts
Screen Voltage	100	100 Volts
Grid Voltage	-1	-1.5 Volt
Suppressor	Tied to Cathode	
Self-Bias Resistor	125	250 Ohms
Plate Current	5.5	4.5 Ma.
Screen Current	2.4	1.5 Ma.
Plate Resistance (Approximate)	0.1	1.0 Megohm
Mutual Conductance	3000	3100 $\mu$ mhos
Grid Voltage for Cathode Current Cut-off	-6	-6 Volts Approx.

# 7N7 Sylvania Type

MEDIUM-MU DUOTRIODE



8AC-L-0

## PHYSICAL SPECIFICATIONS

Base.....	Lock-In 8 Pin
Bulb.....	T-9
Maximum Overall Length.....	3 3/4"
Maximum Seated Height.....	2 5/8"
Mounting Position.....	Any

## RATINGS

Heater Voltage AC or DC (Nominal).....	7.0 Volts
Maximum Plate Voltage.....	300 Volts
Maximum Plate Dissipation per Section.....	2.5 Watts
Maximum Heater-Cathode Voltage.....	90 Volts
Minimum Grid Voltage.....	0 Volt

### Direct Interelectrode Capacitances:\*

	T1†	T2†
Grid to Plate.....	3.0	3.0 μf.
Input.....	3.4	2.9 μf.
Output.....	2.0	2.4 μf.
Plate 1 to Plate 2.....	0.34	μf.
Grid 1 to Grid 2.....	0.40	μf.
Grid 1 to Plate 2.....	0.08	μf.
Grid 2 to Plate 1.....	0.06	μf.

\*With 1 3/4" diameter shield (RMA Std. 308) connected to cathode.

†Triode No. 1 connected to pins 5, 6 and 7; Triode No. 2 to pins 2, 3 and 4.

## TYPICAL OPERATION

### CLASS A<sub>1</sub> AMPLIFIER

Heater Voltage (AC or DC).....	6.3	6.3 Volts
Heater Current.....	0.600	0.600 Amperes
Plate Voltage.....	90	250 Volts
Grid Voltage.....	0	-8 Volts
Self-Bias Resistor.....	0	900 Ohms
Plate Current.....	10.0	9.0 Ma.
Plate Resistance.....	6700	7700 Ohms
Mutual Conductance.....	3000	2600 μmhos
Amplification Factor.....	20	20

### PHASE INVERTER

Plate Supply Voltage.....	100	250 Volts
Grid Voltage.....	-2.25	-5.5 Volts
Plate Current per Section.....	1.5	2.4 Ma.
Plate Resistor.....	30000	50000 Ohms
Self-Bias Resistor.....	750	1150 Ohms
Maximum Output Voltage (RMS).....	20	65 Volts

The 7N7 is identical to two Type 7A4 tubes and reference is made to that type for curves, and to the appendix for resistance coupled data

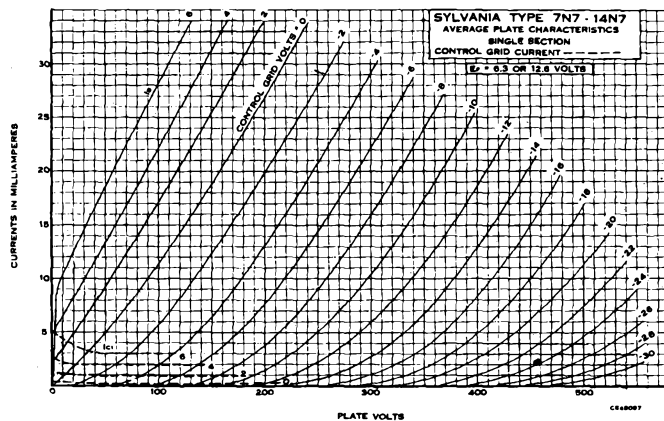

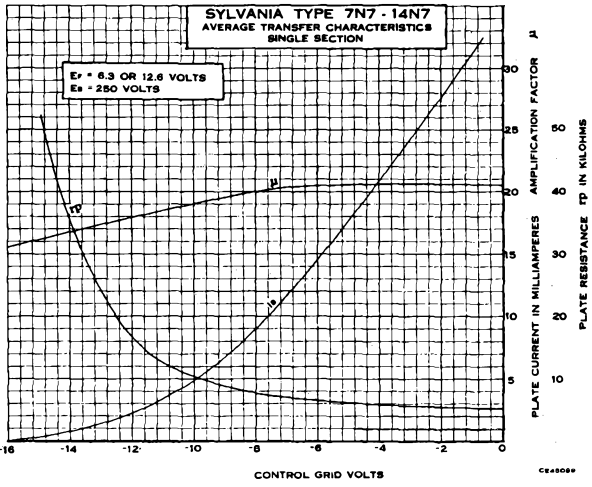
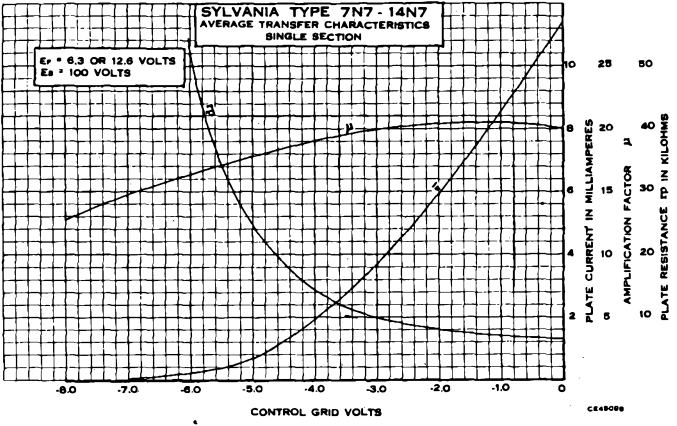

8AL-L-0

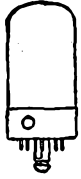

**Sylvania Type 7Q7**

**HEPTODE CONVERTER**

**PHYSICAL SPECIFICATIONS**

Base.....	Lock-In 8 Pin
Bulb.....	T-9
Maximum Overall Length.....	2 25/64"
Maximum Seated Height.....	2 1/4"
Mounting Position.....	Any

## RATINGS

Heater Voltage (Nominal) AC or DC.....	7.0 Volts
Maximum Plate Voltage.....	300 Volts
Maximum Screen Voltage.....	100 Volts
Maximum Screen Supply Voltage.....	300 Volts
Maximum Plate Dissipation.....	1.0 Watt
Maximum Screen Dissipation.....	1.0 Watt
Maximum Total Cathode Current.....	14 Ma.
Minimum Signal-Grid External Bias Voltage (with self-excited oscillator).....	0 Volt
Maximum Heater-Cathode Voltage.....	90 Volts

### Direct Interelectrode Capacitances:\*

Grid G to Plate.....	0.15 $\mu$ f. Max.
Grid G to Go.....	0.20 $\mu$ f. Max.
Grid Go to Plate.....	0.15 $\mu$ f. Max.
Signal Input.....	9.0 $\mu$ f.
Oscillator Input.....	7.0 $\mu$ f.
Mixer Output.....	9.0 $\mu$ f.
Grid Go to All Except Cathode.....	5.0 $\mu$ f.
Grid Go to Cathode.....	2.2 $\mu$ f.
Cathode to all Except Go.....	6.0 $\mu$ f.

\*With 1 $\frac{1}{8}$ " diameter shield (RMA Std. 308) connected to cathode.

## TYPICAL OPERATION

### CONVERTER (SEPARATELY EXCITED)

Heater-Voltage.....	6.3	6.3 Volts
Heater Current.....	300	300 Ma.
Plate Voltage.....	100	250 Volts
Screen Voltage.....	100	100 Volts
Control Grid Voltage** (G).....	-2	-2 Volts
Self-Bias Resistor.....	160	160 Ohms
Suppressor Grid and Shield Voltage.....	0	0 Volt
Oscillator Grid Resistor (Go).....	20000	20000 Ohms
Plate Resistance (Approximate).....	0.5	1.0 Megohm
Oscillator Grid Current.....	0.5	0.5 Ma.
Plate Current.....	3.3	3.5 Ma.
Screen Current (Gs).....	8.5	8.5 Ma.
Total Cathode Current.....	12.3	12.5 Ma.
Conversion Conductance at Ec3 = -2.....	525	550 $\mu$ mhos
Conversion Conductance at Ec3 = -6.....	275	300 $\mu$ mhos
Conversion Conductance at Ec3 = -10.....	65	70 $\mu$ mhos
Conversion Conductance at Ec3 = -35 (Approx.).....	2	2 $\mu$ mhos

\*\*Characteristics for self excitation are similar to those given for separate excitation except the control grid (Grid G bias voltage is 0 volt).

Note: With Grid Gs connected to plate (100 volts) and signal applied to Grid Go (0 volt bias), the Mutual Conductance is 4500  $\mu$ mhos, plate current 27 Ma. amplification factor 13. Grid G is connected to ground during this test.

## APPLICATION

Sylvania Type 7Q7 is a pentagrid converter having electrical characteristics quite similar to those for Type 6SA7. The Lock-In construction embodied in this type provides compactness, suitable shielding and the lock-in feature. For a-c service the 7-volt heater rating corresponds to a 130-volt line condition. It is also the nominal voltage for automotive receiver service. Ratings marked Max. and Min. are design centers for a line voltage of 117 volts. For automotive service the design centers are 90% of the values indicated, using a battery terminal voltage of 6.6 volts.

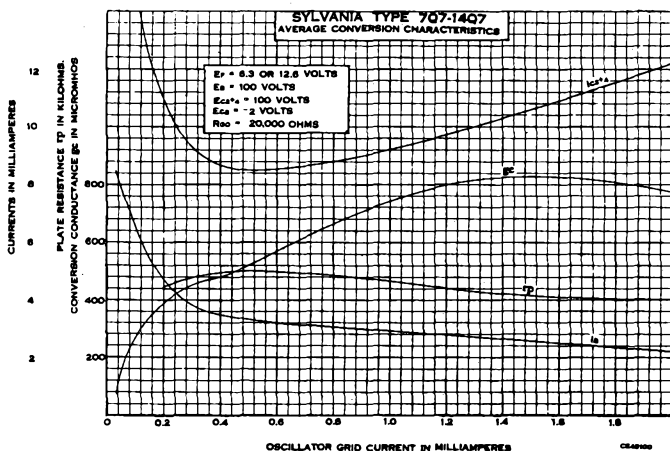

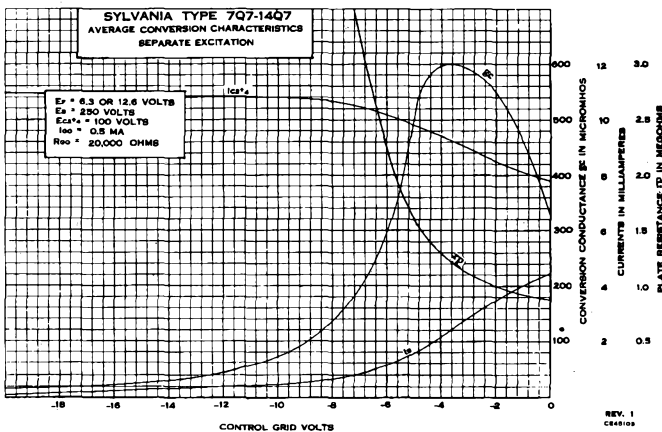
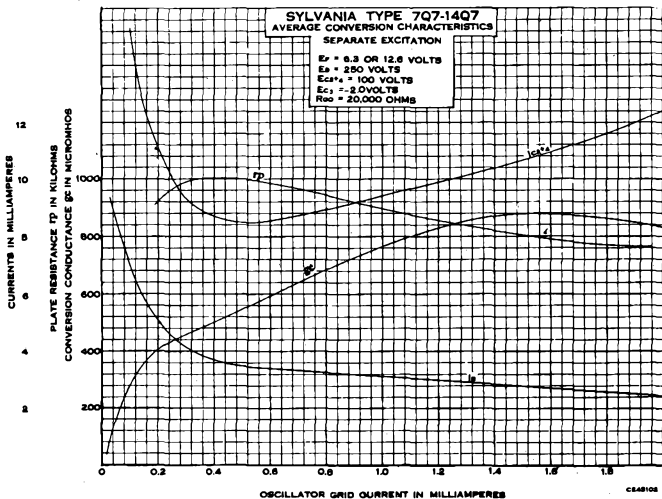
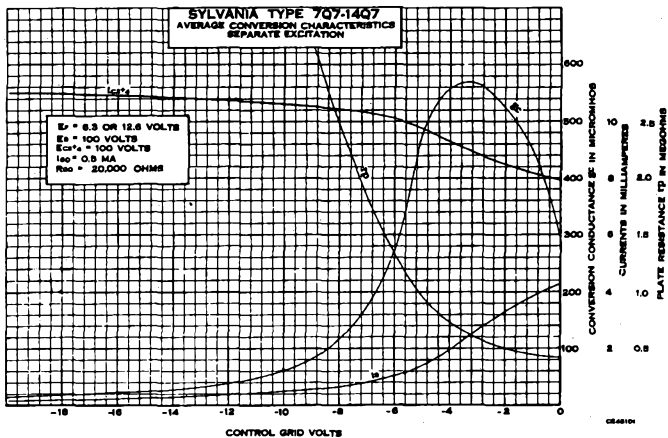

# 7R7 Sylvania Type

DUODIODE PENTODE

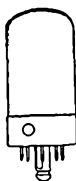

8AE-L-7

## PHYSICAL SPECIFICATIONS

Base.....	Lock-In 8 Pin
Bulb.....	T-9
Maximum Overall Length.....	2 <sup>3</sup> / <sub>8</sub> "
Maximum Seated Height.....	2 <sup>1</sup> / <sub>2</sub> "
Mounting Position.....	Any

## RATINGS

Heater Voltage AC or DC (Nominal).....	7.0 Volts
Maximum Plate Voltage.....	300 Volts
Maximum Screen Voltage.....	100 Volts
Maximum Screen Supply Voltage.....	300 Volts
Maximum Plate Dissipation.....	2.0 Watts
Maximum Screen Dissipation.....	0.25 Watt
Minimum External Grid Bias.....	0 Volt
Maximum Heater-Cathode Voltage.....	90 Volts
Maximum Diode Drop for .8 Ma.....	10 Volts
Maximum Diode Current per Plate (continuous).....	1.0 Ma.

### Direct Interelectrode Capacitances:\*

Grid to Plate.....	0.004 $\mu$ f. Max.
Input.....	5.6 $\mu$ f.
Output.....	5.3 $\mu$ f.
Diode 1 to Grid 1.....	.005 $\mu$ f. Max.
Diode 2 to Grid 1.....	.002 $\mu$ f. Max.

\*With 1<sup>5</sup>/<sub>16</sub>" diameter shield (RMA Std. 308) connected to cathode.

## TYPICAL OPERATION

Heater Voltage AC or DC.....	6.3	6.3	6.3	6.3 Volts
Heater Current.....	300	300	300	300 Ma.
Plate Voltage.....	100	100	250	250 Volts
Screen Voltage.....	100	100	100	100 Volts
Grid Voltage.....	-2.0	-1.0	-2.0	-1.0 Volts
Self-Bias Resistor.....	450	130	450	130 Ohms
Plate Current.....	3.4	5.5	3.5	6.2 Ma.
Screen Current.....	1.0	2.2	1.0	1.6 Ma.
Plate Resistance (Approx.).....	0.5	0.35	1.8	1.0 Megohm
Mutual Conductance.....	2100	3000	2200	3200 $\mu$ mhos
Grid Bias for 10 $\mu$ mhos.....	-20	-20	-20	-20 Volts

## APPLICATION

Applications of this tube will be similar to those of other high gain pentodes. The lower capacitance together with shielding and high mutual conductance make this tube suitable for many RF and wide band amplifier services. For diode characteristics, refer to curves for Type 7B6.

Data for use in resistance coupled circuits can be found in the appendix.

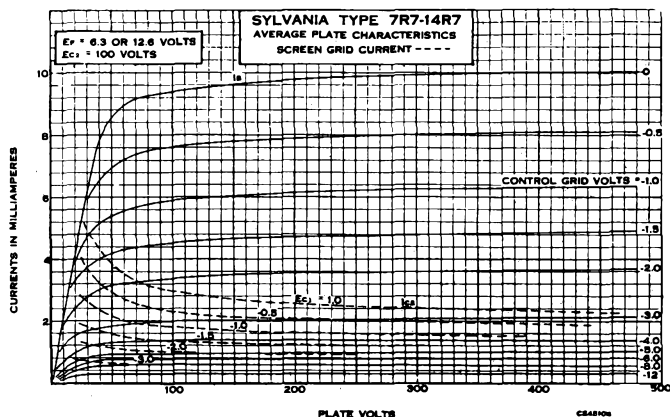



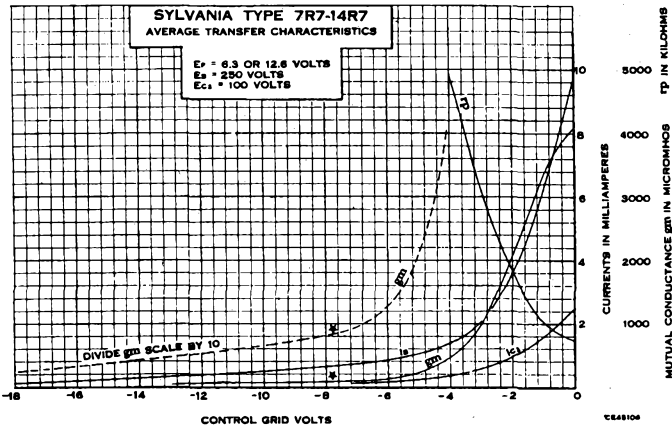
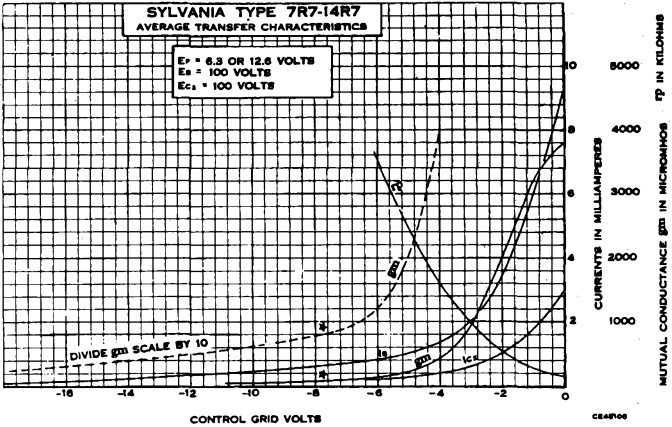

8BL-L-7

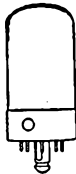

**Sylvania Type 7S7**  
TRIODE HEPTODE CONVERTER

**PHYSICAL SPECIFICATIONS**

Base.....	Lock-In 8 Pin
Bulb.....	T-9
Maximum Overall Length.....	2 1/4"
Maximum Seated Height.....	2 1/4"
Mounting Position.....	Any

## RATINGS

Heater Voltage AC or DC (Nominal).....	7.0 Volts
Maximum Heptode Plate Voltage.....	300 Volts
Maximum Heptode Screen Voltage.....	100 Volts
Maximum Heptode Screen Supply.....	300 Volts
Minimum Heptode Control Grid Voltage.....	0 Volt
Maximum Heptode Plate Dissipation.....	0.6 Watt
Maximum Heptode Screen Dissipation.....	0.4 Watt
Maximum Triode Plate Voltage.....	175 Volts
Maximum Triode Plate Supply Voltage.....	300 Volts
Maximum Triode Plate Dissipation.....	1.0 Watt
Maximum Total Cathode Current.....	14 Ma.
Maximum Heater-Cathode Voltage.....	90 Volts

### Direct Interelectrode Capacitances:\*

Heptode Grid G to Plate.....	0.03 $\mu$ f. Max.
Heptode Grid G to Triode Plate.....	0.10 $\mu$ f. Max.
Heptode Grid G to Grid Go.....	0.35 $\mu$ f. Max.
Triode Grid Go to Triode Plate.....	1.0 $\mu$ f.
Input (Signal).....	5.0 $\mu$ f.
Output (Mixer).....	8.0 $\mu$ f.
Input (Oscillator).....	7.0 $\mu$ f.
Output (Oscillator).....	3.5 $\mu$ f.

\*With 1 $\frac{1}{4}$ " diameter shield (RMA Std. 308) connected to cathode.

## TYPICAL OPERATION

Heater Voltage.....	6.3	6.3 Volts
Heater Current.....	300	300 Ma.
Heptode Plate Voltage.....	100	250 Volts
Heptode Screen Voltage.....	100	100 Volts
Oscillator Plate Voltage (Triode).....	100	250 $\frac{1}{2}$ Volts
Heptode Control Grid Voltage.....	-2	-2 Volts
Self-Bias Resistor.....	240	195 Ohms
Oscillator Grid Resistor.....	50000	50000 Ohms
Heptode Plate Current.....	1.9	1.8 Ma.
Heptode Screen Current.....	3.0	3.0 Ma.
Oscillator Plate Current (Triode).....	3.0	5.0 Ma.
Oscillator Grid Current (Triode).....	0.3	0.4 Ma.
Heptode Plate Resistance.....	0.5	1.25 Megohms
Conversion Conductance.....	500	525 $\mu$ mhos
Conversion Conductance (Heptode Grid -21 Volts).....	2	2 $\mu$ mhos
Total Cathode Current.....	8.2	10.2 Ma.

†Applied through a 20,000 ohm dropping resistor properly by-passed.

## TRIODE CHARACTERISTICS

Heater Voltage.....	6.3 Volts
Plate Voltage.....	100 Volts
Grid Voltage.....	0 Volts
Plate Current.....	6.5 Ma.
Plate Resistance.....	11000 Ohms
Mutual Conductance.....	1650 $\mu$ mhos
Amplification Factor.....	18

## APPLICATION

Sylvania Type 7S7 is a triode heptode tube designed for converter service. The triode section serves as the oscillator and is internally coupled to the heptode which serves as the mixer. This construction provides minimum frequency drift compared to other conversion methods. Type 7S7 is similar to Type 7J7 except for improved triode characteristics and higher conversion conductance.

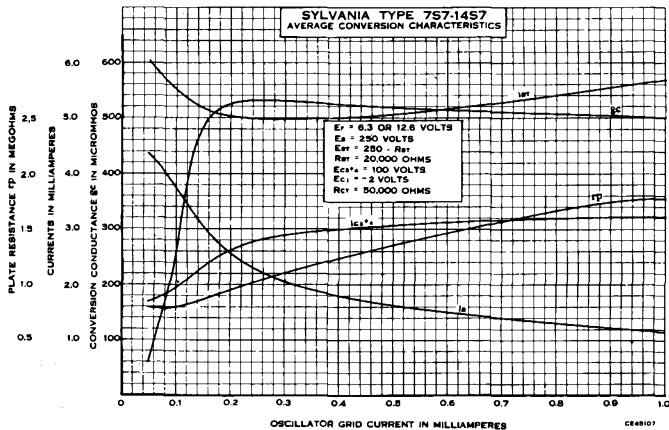

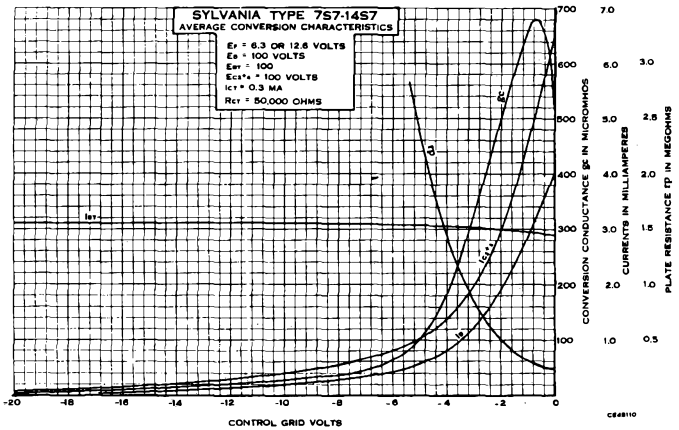
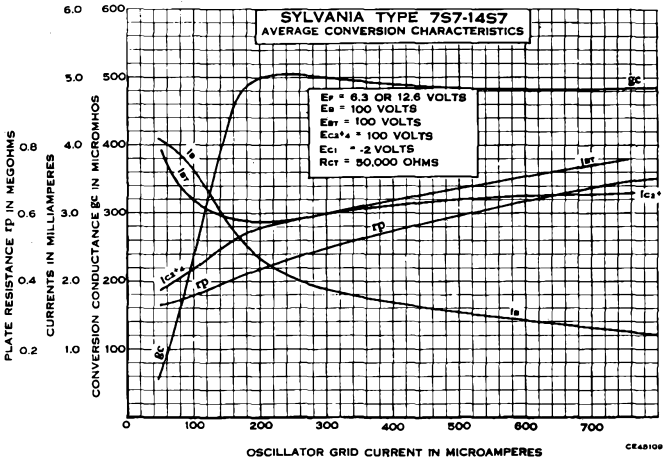
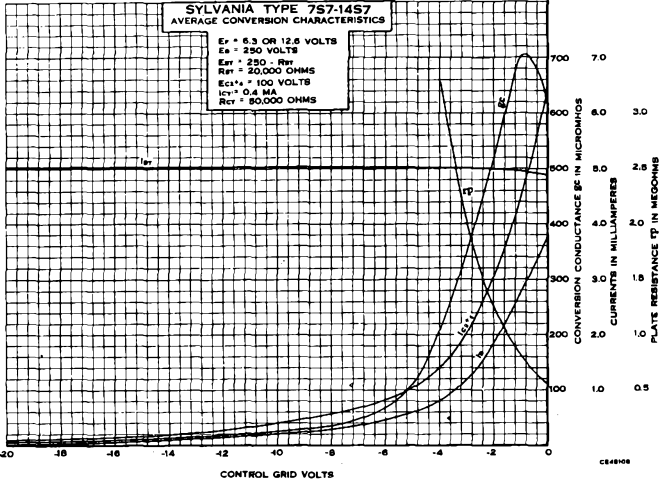

# 7V7 Sylvania Type

SHARP CUT-OFF RF PENTODE

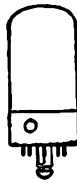

8V-L-5

## PHYSICAL SPECIFICATIONS

Base.....	Lock-In 8 Pin
Bulb.....	T-9
Maximum Overall Length.....	2 <sup>35</sup> / <sub>64</sub> "
Maximum Seated Height.....	2 <sup>1</sup> / <sub>4</sub> "
Mounting Position.....	Any

## RATINGS

Heater Voltage AC or DC (Nominal).....	7.0 Volts
Maximum Plate Voltage.....	300 Volts
Maximum Screen Voltage.....	150 Volts
Maximum Screen Supply Voltage.....	300 Volts
Maximum Plate Dissipation.....	4.0 Watts
Maximum Screen Dissipation.....	0.8 Watt
Minimum Self-Bias Resistor.....	160 Ohms
Maximum Heater-Cathode Voltage.....	90 Volts

### Direct Interelectrode Capacitances:\*

Grid to Plate.....	0.002 $\mu$ f. Max.
Input.....	9.5 $\mu$ f.
Output.....	6.5 $\mu$ f.

\*With 1<sup>5</sup>/<sub>16</sub>" diameter shield (RMA Std. 308) connected to cathode.

## TYPICAL OPERATION

	§Condition 1	§Condition 2
Heater Voltage AC or DC.....	6.3	6.3 Volts
Heater Current.....	450	450 Ma.
Plate Voltage.....	300	300 Volts
Screen Supply Voltage.....	150	300 Volts
Screen Series Resistor.....		40000 Ohms
Suppressor (Grid 4) and Pin 5.....	0	0 Volt
Self-Bias Resistor.....	160	160 Ohms
Plate Current.....	10	10 Ma.
Screen Current.....	3.9	3.9 Ma.
Plate Resistance.....	0.3	0.3 Megohms
Mutual Conductance.....	5800	5800 $\mu$ mhos
Grid Voltage for 10 $\mu$ a. Plate Current.....	-8.0	-16 Volts

§Conditions 1 and 2 represent operation with fixed screen supply and with series resistor, respectively. Condition 2 gives an extended cut-off characteristic. When a screen supply in excess of 150 volts is used a series dropping resistor must be used to limit screen voltage to 150 volts when the plate current is at its rated value of 10 milliamperes.

## APPLICATION

Sylvania Type 7V7 is a cathode type pentode having low grid-plate capacity and high mutual conductance. It is identical to type 7W7 except for minor changes which make type 7W7 superior at high frequencies. The same curve data may be used for either type.

Due to the low bias requirement, self-bias should be used and grid circuit resistances should be limited to 0.25 megohm for fixed screen supply while series drop screen supplies permit a maximum grid circuit resistance of 0.5 megohm.

# 7W7 Sylvania Type

SHARP CUT-OFF RF PENTODE

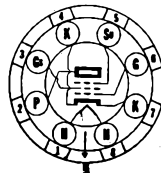
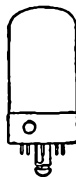

8BJ-L-5

## PHYSICAL SPECIFICATIONS

Base.....	Lock-In 8 Pin
Bulb.....	T-9
Maximum Overall Length.....	2 <sup>35</sup> / <sub>64</sub> "
Maximum Seated Height.....	2 <sup>1</sup> / <sub>4</sub> "
Mounting Position.....	Any

## RATINGS

Heater Voltage AC or DC (Nominal).....	7.0 Volts
Maximum Plate Voltage.....	300 Volts
Maximum Screen Voltage.....	150 Volts
Maximum Plate Dissipation.....	4.0 Watts
Maximum Screen Dissipation.....	0.8 Watt
Maximum Heater-Cathode Voltage.....	90 Volts

### Direct Interelectrode Capacitances\*:

Grid to Plate.....	0.002 $\mu$ f. Max.
Input.....	9.5 $\mu$ f.
Output.....	7.0 $\mu$ f.

\*With  $1\frac{1}{16}$ " diameter shield (RMA Std. 308) connected to cathode.

## TYPICAL OPERATION

	§Condition 1	§Condition 2
Heater Voltage AC or DC.....	6.3	6.3 Volts
Heater Current.....	450	450 Ma.
Plate Voltage.....	300	300 Volts
Screen Supply.....	150	300 Volts
Screen Series Resistor.....		40000 Ohms
Suppressor.....	Connected to Cathode	
Self-Bias Resistor.....	160	160 Ohms
Plate Current.....	10.0	10.0 Ma.
Screen Current.....	3.9	3.9 Ma.
Plate Resistance.....	0.3	0.3 Megohm
Mutual Conductance.....	5800	5800 $\mu$ mhos
Grid Voltage for 10 $\mu$ a. Plate Current Approx. ....	-8.0	-16 Volts

§Conditions 1 and 2 represent operation with fixed screen supply and with series screen dropping resistor respectively. Note that condition 2 gives an extended cut-off characteristic giving better control of gain when bias gain control is used. When a screen supply voltage in excess of 150 volts is used, a series screen dropping resistor must be employed to limit screen voltage to 150 volts with plate current at rated value of 10 ma.

## APPLICATION

Sylvania Type 7W7 is a cathode type RF pentode of Lock-In construction having high mutual conductance with exceptionally low grid-plate capacity. These characteristics make this tube especially well suited for use in broad-band amplifiers, and in high-frequency applications.

Degeneration due to common coupling in the cathode circuit can be reduced with this tube by proper use of the two cathode leads. It has been found that as an RF amplifier at 75 megacycles or higher, optimum input and output resistance can be obtained by returning input circuits to pin No. 4, and output circuits, including heater and screen, to pin No. 7.

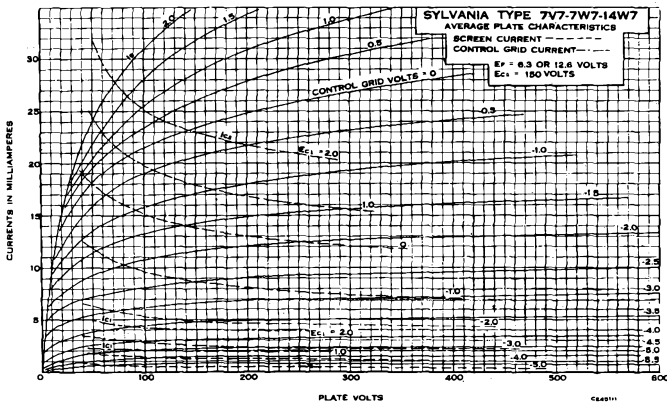

# 7W7 (Cont'd)

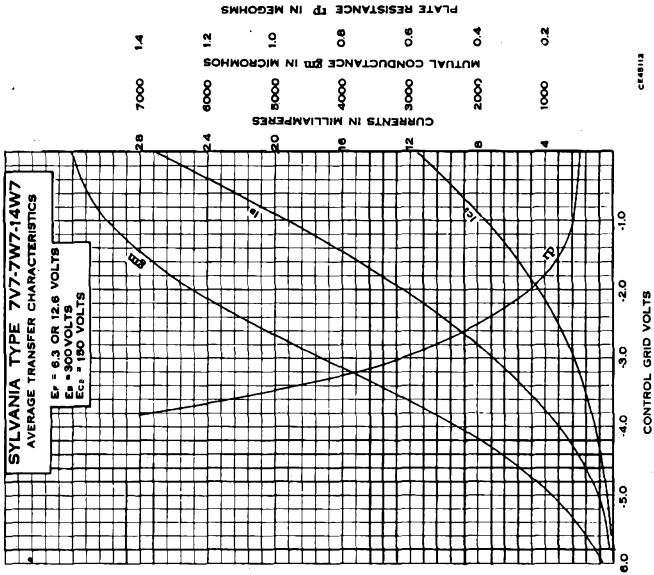

## 7X6 Sylvania Type

FULL-WAVE RECTIFIER

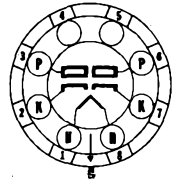
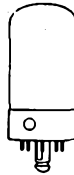

7AJ-L-0

### PHYSICAL SPECIFICATIONS

Base.....	Lock-In 8 Pin
Bulb.....	T-9
Maximum Overall Length.....	3 5/8"
Maximum Seated Height.....	2 5/8"
Mounting Position.....	Any

### RATINGS

Heater Voltage AC or DC (Nominal)..... 7.0 Volts

### TYPICAL OPERATION

Heater Voltage.....	6.3 Volts
Heater Current.....	1.2 Amperes

For other rating, operation and application data, refer to Sylvania Type 50X6.



8BZ-L-4



## Sylvania Type 7X

DUODIODE HIGH-MU TRIODE

### PHYSICAL SPECIFICATIONS

Base.....	Lock-In 8 Pin
Bulb.....	T-9
Maximum Overall Length.....	3 $\frac{1}{2}$ "
Maximum Seated Height.....	2 $\frac{5}{8}$ "
Mounting Position.....	Any

### RATINGS

Heater Voltage AC or DC (Nominal).....	7.0 Volts
Maximum Plate Voltage.....	300 Volts
Maximum Heater-Cathode Voltage.....	90 Volts
Diode Current at 5 Volts (Minimum).....	1.0 Ma.

### TYPICAL OPERATION

Heater Voltage.....	6.3	6.3 Volts
Heater Current.....	300	300 Ma.
Plate Voltage.....	100	250 Volts
Grid Voltage.....	0	-1.0 Volt
Amplification Factor.....	85	100
Mutual Conductance.....	1000	1500 $\mu$ mhos
Plate Resistance.....	85000	67000 Ohms
Plate Current.....	1.2	1.9 Ma.

### APPLICATION

Sylvania Type 7X7 is a double diode high-mu triode. It differs from other duodiode triodes by having diode No. 2 a completely separate unit except for the common heater. This difference allows this tube to be used in applications which require complete separation of the diode units.

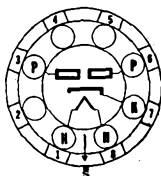

5AB-L-0



## 7Y4 Sylvania Type

FULL WAVE RECTIFIER

### PHYSICAL SPECIFICATIONS

Base.....	Lock-In 8 Pin
Bulb.....	T-9
Maximum Overall Length.....	2 $\frac{1}{2}$ "
Maximum Seated Height.....	2 $\frac{1}{4}$ "
Mounting Position.....	Any

### RATINGS

Heater Voltage (Nominal) AC or DC.....	7.0 Volts
Maximum RMS Plate Voltage Condenser Input.....	325 Volts
Maximum RMS Plate Voltage Choke Input.....	450 Volts
Maximum Peak Inverse Voltage.....	1250 Volts
Maximum DC Heater-Cathode Voltage.....	450 Volts
Maximum Peak Plate Current.....	210 Ma.
Maximum DC Output Current.....	70 Ma.
DC Voltage Drop at 70 Ma. Per Plate.....	22 Volts

### TYPICAL OPERATION

	Condenser Input	Choke Input
Heater Voltage.....	6.3	6.3 Volts
Heater Current.....	500	500 Ma.
RMS Plate Voltage.....	325	450 Volts
DC Output Current.....	70	70 Ma.
Plate Supply Impedance* (Minimum per Plate).....	150	..... Ohms
Minimum Input Choke Value.....		10 Henrys

\*When greater than 40  $\mu$ fd input filter condenser is used it may be necessary to increase minimum plate supply impedance.

# 7Y4 (Cont'd)

## APPLICATION

Sylvania Type 7Y4 is a full-wave cathode heater type rectifier tube of Lock-In construction. It is designed for service in small auto and AC receivers. It is similar to the older 6X5GT and 84 but is smaller physically and is considerably more rugged due to the Lock-In construction. Conventional circuits such as used with the older types, are entirely suitable for use with this tube.

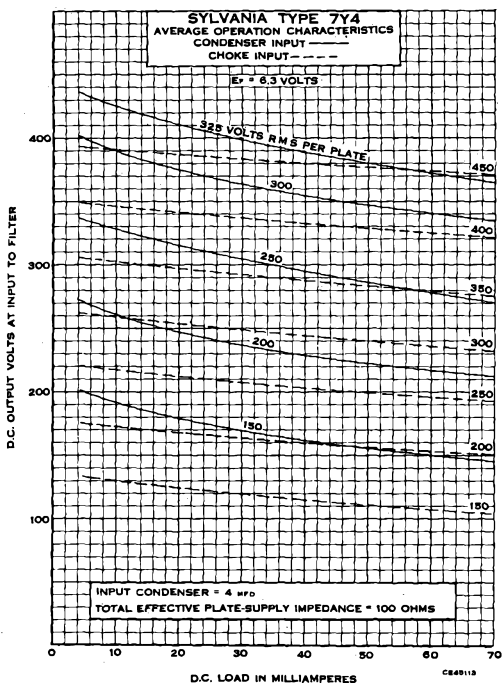

## 7Z4 Sylvania Type

DUODIODE RECTIFIER

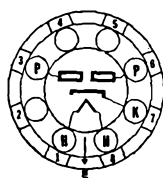

5AB-L-0

## PHYSICAL SPECIFICATIONS

Base.....	Lock-In 8 Pin
Bulb.....	T-9
Maximum Overall Length.....	3 5/8"
Maximum Seated Height.....	2 5/8"
Mounting Position.....	Any

## RATINGS

Heater Voltage AC or DC (Nominal).....	7.0 Volts
Maximum AC Plate Voltage (RMS Per Plate) Condenser Input..	325 Volts
Maximum AC Plate Voltage (RMS Per Plate) Choke Input.....	450 Volts
Maximum Peak Inverse Voltage.....	1250 Volts
Maximum DC Heater-Cathode Voltage.....	450 Volts
Maximum Steady State Peak Plate Current Per Plate.....	300 Ma.
DC Voltage Drop at 100 Ma. Per Plate.....	40 Volts
Maximum DC Output Current.....	100 Ma.



### TYPICAL OPERATION

<b>Condenser Input to Filter</b>	
Heater Voltage AC or DC.....	6.3 Volts
Heater Current.....	0.900 Ampere
AC Plate Voltage (RMS per Plate).....	325 Volts
DC Output Current.....	100 Ma.
Plate Supply Impedance (Per Plate)§.....	75 Ohms
<b>Choke Input to Filter</b>	
Heater Voltage.....	6.3 Volts
Heater Current.....	0.900 Ampere
AC Plate Voltage (RMS Per Plate).....	450 Volts
DC Output Current.....	100 Ma.
Minimum Value of Input Choke.....	6 Henrys
§When a filter condenser larger than 40 mfd. is used, additional plate supply impedance may be required.	

### APPLICATION

Sylvania Type 7Z4 is a full-wave cathode type rectifier of Lock-In construction providing a rugged, compact tube. This tube is designed for rectifier service in AC or auto receivers which require a greater load current than can be supplied by type 7Y4. The increased tube drop gives an additional safety factor with power supplies of low impedance. Conventional circuits may be used.

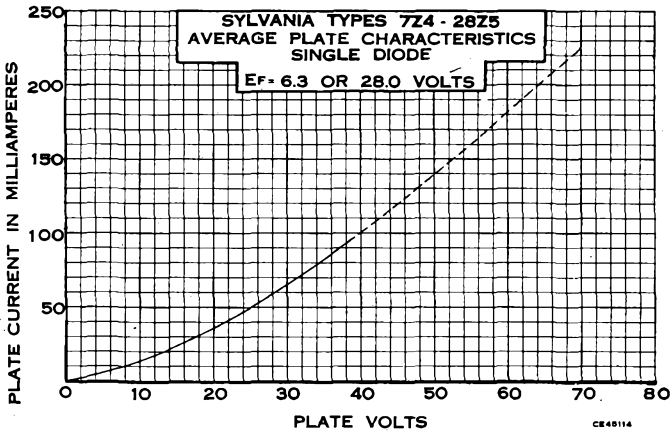

CE48114

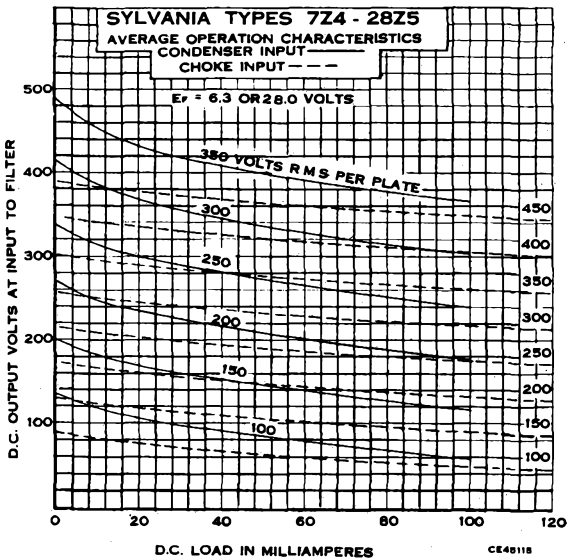

CE48115

# 12A8<sup>GT</sup> Sylvania Type

PENTAGRID CONVERTER

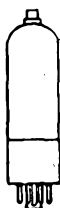

8A-1-0

## RATINGS AND OPERATION

Heater Voltage AC or DC..... 12.6 Volts  
 Heater Current..... 150 Ma.

For other ratings, operation and application data, refer to corresponding Type 6A8GT which is identical except for heater ratings.

# 12AL5 Sylvania Type

DUODIODE

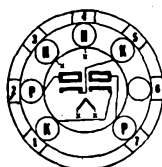

6BT-0-6

## RATINGS AND OPERATION

Heater Voltage..... 12.6 Volts  
 Heater Current..... 150 Ma.

For other rating, operation, and application data, refer to corresponding Type 6AL5.

# 12AT6 Sylvania Type

DUODIODE HIGH-MU TRIODE

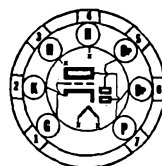

7BT-0-0

## RATINGS AND OPERATION

Heater Voltage AC or DC..... 12.6 Volts  
 Heater Current..... 150 Ma.

For other rating operation and application data, refer to corresponding Type 6AT6.

# 12AT7 Sylvania Type

DUOTRIODE

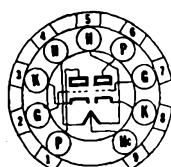

9A-0-0

## PHYSICAL SPECIFICATIONS

Base.....	Small Button 9 Pin
Bulb.....	T-6 3/4
Maximum Overall Length.....	2 3/4"
Maximum Seated Height.....	1 1/4"
Mounting Position.....	Any

### RATINGS EACH TRIODE UNIT

	Series	Parallel
Heater Voltage.....	12.6	6.3 Volts
Heater Current.....	150	300 Ma.
Maximum Heater-Cathode Voltage.....	90	90 Volts
Maximum Plate Voltage.....	300	300 Volts
Maximum Plate Dissipation.....	2.5	2.5 Watts

**Direct Interelectrode Capacitances:\***

	Triode No. 1†	Triode No. 2†
<b>Grounded Cathode Operation</b>		
Grid to Plate.....	1.5	1.5 $\mu$ f.
Input.....	2.2	2.2 $\mu$ f.
Output.....	0.5	0.4 $\mu$ f.
Grid to Grid.....	.005	$\mu$ f. Max.
Plate to Plate.....	0.4	$\mu$ f. Max.
Heater to Cathode.....	2.4	2.4 $\mu$ f.
<b>Grounded Grid Operation</b>		
Plate to Cathode.....	0.2	0.2 $\mu$ f.
Input.....	4.6	4.6 $\mu$ f.
Output.....	1.8	1.8 $\mu$ f.

†Triode 1 has the plate connected to Pin No. 6.

### TYPICAL OPERATION CLASS A<sub>1</sub> AMPLIFIER - EACH TRIODE UNIT

Heater Voltage.....	12.6 or 6.3	Volts
Heater Current.....	150 or 300	Ma.
Plate Voltage.....	100 180	250 Volts
Grid Voltage.....	-1 -1	-2 Volts
Cathode Bias Resistor.....	270 90	200 Ohms
Plate Resistance (Approx.).....	15,000 9,400	10,900 Ohms
Mutual Conductance.....	400 6600	5500 $\mu$ mhos
Amplification Factor.....	60 62	60
Plate Current.....	3.7 11.0	10.0 Ma.
Grid Voltage for $I_b = 10 \mu$ a (Approx.).....	-5 -8	-12 Volts

### APPLICATION

Sylvania Type 12AT7 is a miniature duotriode designed for use in compact equipment requiring a grounded-grid R.F. amplifier at frequencies up to 300 mc. The center tapped heater permits use on either 6.3 volt or series type heater circuits.

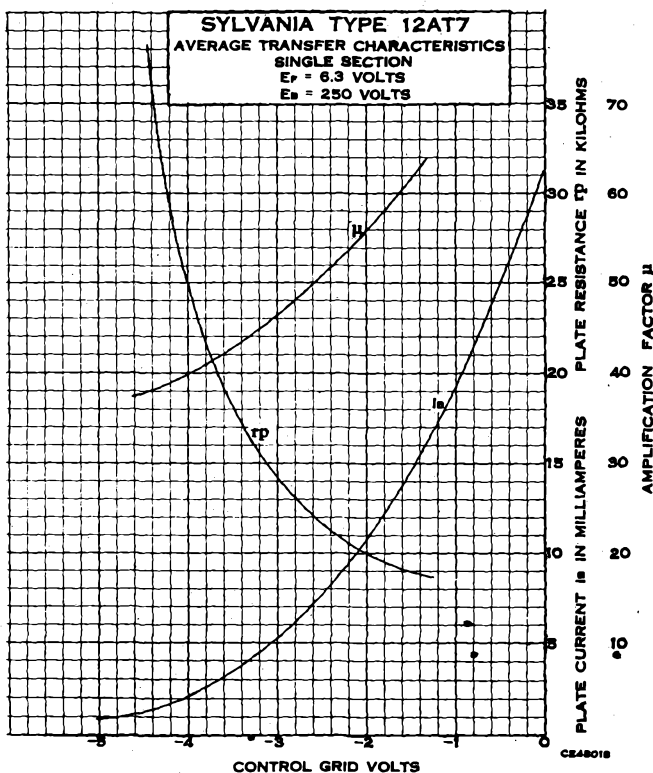

# 12AT7 (Cont'd)

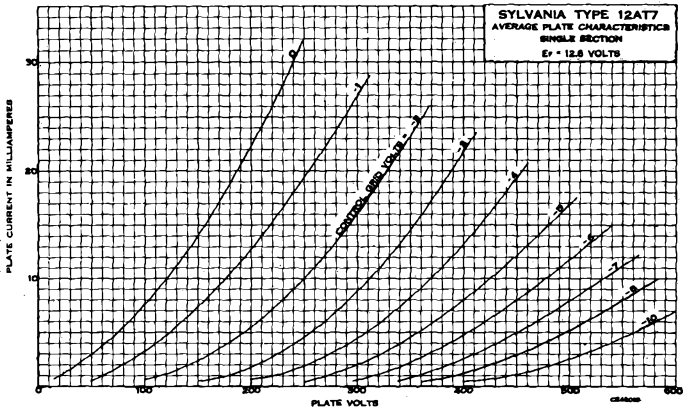

## 12AU6 Sylvania Type

SHARP CUT-OFF RF PENTODE

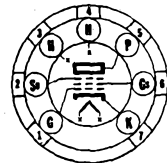

7BK-0-2

### RATINGS AND OPERATION

Heater Voltage..... 12.6 Volts  
 Heater Current..... 150 Ma.

For other rating, operation, and application data, refer to corresponding Type 6AU6.

## 12AU7 Sylvania Type

DUOTRIODE

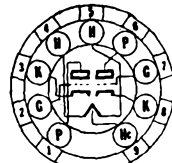

9A-0-0

### PHYSICAL SPECIFICATIONS

Base..... Small Button 9-Pin  
 Bulb..... T-6<sup>1</sup>/<sub>2</sub>  
 Maximum Overall Length..... 2<sup>3</sup>/<sub>8</sub>"  
 Maximum Seated Height..... 1<sup>13</sup>/<sub>8</sub>"  
 Mounting Position..... Any

### RATINGS (Each Triode)

	Series	Parallel
Heater Voltage AC or DC.....	12.6	6.3 Volts
Heater Current.....	150	300 Ma.
Maximum Plate Voltage.....	300	300 Volts
Maximum Plate Dissipation.....	2.75	2.75 Watts
Maximum Cathode Current.....	20	20 Ma.
Maximum Peak Heater-Cathode Voltage.....	180	180 Volts
Maximum Grid-Circuit Resistance		
For Cathode Bias.....	1.0	1.0 Megohm
For Fixed Bias.....	0.25	0.25 Megohm

**Direct Interelectrode Capacitances:\***

	<b>Triode No. 1</b>	<b>Triode No. 2</b>
Grid to Plate.....	1.5	1.5 $\mu\text{f.}$
Grid to Cathode.....	1.6	1.6 $\mu\text{f.}$
Plate to Cathode.....	0.50	0.35 $\mu\text{f.}$

\*Without external shield.

Note:—Triode No. 1 has the plate connected to pin No. 6.

**TYPICAL OPERATION**  
**CLASS A<sub>1</sub> AMPLIFIER**

<b>Heater Voltage</b>		
Series.....	12.6	12.6 Volts
Parallel.....	6.3	6.3 Volts
<b>Heater Current</b>		
Series.....	150	150 Ma.
Parallel.....	300	300 Ma.
Plate Voltage.....	100	250 Volts
Grid Voltage.....	0	-8.5 Volts
Amplification Factor.....	19.5	17
Plate Resistance.....	6250	7700 Ohms
Transconductance.....	3100	2200 $\mu\text{mhos}$
Plate Current.....	11.8	10.5 Ma.

**APPLICATION**

Sylvania Type 12AU7 is a double triode in the T6 $\frac{1}{2}$  miniature construction providing enough terminals to permit the center tap of the heater being brought out. This makes possible the parallel connection for use in AC sets or a series connection for use in 150 Ma. AC-DC service.

For curve and resistor coupled amplifier data reference should be made to Type 6C4.

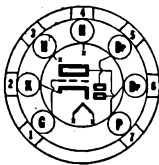

7BT-0-0



**Sylvania Type 12AV6**

**DUODIODE TRIODE**

**RATINGS AND OPERATION**

Heater Voltage AC or DC.....	12.6 Volts
Heater Current.....	150 Ma.

For other data refer to corresponding Type 6AV6, which is identical except for heater ratings.

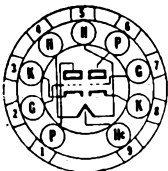

9A-0-0



**Sylvania Type 12AV7**

**DUOTRIODE**

**PHYSICAL SPECIFICATIONS**

Base.....	Small Button 9 Pin
Bulb.....	T-6 $\frac{1}{2}$
Maximum Overall Length.....	2 $\frac{3}{8}$ "
Maximum Seated Height.....	1 $\frac{15}{16}$ "
Mounting Position.....	Any

# 12AV7 (Cont'd)

## RATINGS

	Series	Parallel
Heater Voltage AC or DC.....	12.6	6.3 Volts
Heater Current.....	225	450 Ma.
Maximum Plate Voltage.....	300	300 Volts
Maximum Plate Dissipation (each section).....	2.7	2.7 Watts
Maximum Negative DC Control Grid Voltage.....	-50	-50 Volts
Maximum Heater-Cathode Voltage.....	90	90 Volts
<b>Direct Interelectrode Capacitances:</b>	<b>Unshielded With Shield # 315</b>	
Grid to Plate (each section).....	1.9	1.9 $\mu$ f.
Input (each section).....	3.1	3.2 $\mu$ f.
Output (section #1).....	0.5	1.3 $\mu$ f.
(section #2).....	0.4	1.6 $\mu$ f.
Heater to Cathode (each section).....	3.8	4.0 $\mu$ f.
Grounded Grid		
Input (each section).....	6.9	7.0 $\mu$ f.
Output (section #1).....	2.0	2.8 $\mu$ f.
(section #2).....	2.0	3.2 $\mu$ f.
Plate to Cathode (each section).....	0.24	0.23 $\mu$ f.

NOTE:—Triode No. 1 has the plate connected to pin No. 6.

## TYPICAL OPERATION

### CLASS A<sub>1</sub> AMPLIFIER (Each Section)

Heater Voltage		
Series.....	12.6	12.6 Volts
Parallel.....	6.3	6.3 Volts
Heater Current		
Series.....	225	225 Ma.
Parallel.....	450	450 Ma.
Plate Voltage.....	100	150 Volts
Plate Current.....	9.0	18 Ma.
Cathode Bias Resistor.....	120	56 Ohms
Plate Resistance.....	6,100	4,800 Ohms
Mutual Conductance.....	6,100	8,500 $\mu$ mhos
Amplification Factor.....	37	41
Control Grid Voltage (approx.) for $I_b = 10 \mu$ a.....	-9	-12 Volts

# 12AW6 Sylvania Type

SHARP CUT-OFF PENTODE

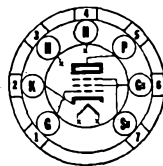

7CM-0-7

## PHYSICAL SPECIFICATIONS

Base.....	Miniature Button 7-Pin
Bulb.....	T-5 1/2"
Maximum Overall Length.....	2 1/8"
Maximum Seated Height.....	1 1/8"
Mounting Position.....	Any

## RATINGS

	Triode*	Pentode
Heater Voltage.....	12.6	12.6 Volts
Heater Current.....	150	150 Ma.
Maximum Plate Voltage.....	300	300 Volts
Maximum Screen Voltage.....		150 Volts
Maximum Screen Supply Voltage.....		300 Volts
Maximum Control Grid Voltage		
Negative.....	50	50 Volts
Positive.....	0	0 Volts
Maximum Plate Dissipation.....	2.5	2 Watts
Maximum Screen Dissipation.....		0.5 Watt
Maximum Peak Heater-Cathode Voltage.....	90	90 Volts

\*Screen grid tied to plate and suppressor grid tied to cathode.

### Direct Interelectrode Capacitances:\*

Grid to Plate.....	0.025 $\mu$ f.
Input.....	6.5 $\mu$ f.
Output.....	1.5 $\mu$ f.

\*\*With no external shielding.

### TYPICAL OPERATION CLASS A<sub>1</sub> AMPLIFIER

PENTODE CONNECTION			
Heater Voltage.....	12.6	12.6	12.6 Volts
Heater Current.....	150	150	150 Ma.
Plate Voltage.....	100	125	250 Volts
Suppressor Voltage.....		Connected to cathode at socket.	
Screen Voltage.....	100	125	150 Volts
Cathode Bias Resistor.....	100	100	200 Ohms
Plate Resistance (Approx.).....	0.3	0.5	0.8 Megohm
Transconductance.....	4750	5100	5000 $\mu$ mhos
Grid Voltage for Plate Current of 10 $\mu$ a.....	-5	-6	-8 Volts
Plate Current.....	5.5	7.2	7 Ma.
Screen Current.....	1.6	2.1	2 Ma.

TRIODE CONNECTION		
Heater Voltage.....	12.6	12.6 Volts
Heater Current.....	150	150 Ma.
Plate Voltage.....	180	250 Volts
Cathode Bias Resistor.....	350	825 Ohms
Plate Resistance.....	7900	11,000 Ohms
Amplification Factor.....	45	42
Transconductance.....	5700	3800 $\mu$ mhos
Plate Current.....	7.0	5.5 Ma.

### APPLICATION

Sylvania Type 12AW6 is a miniature sharp cut-off pentode designed for use in compact AC-DC sets. This type is the same as Type 6AG5 except for the heater voltage and the separation of the suppressor and cathode leads. For curve data reference should be made to Type 6AG5.

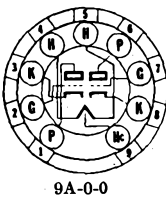

## 12AX7 Sylvania Type

HIGH MU DUOTRIODE

### PHYSICAL SPECIFICATIONS

Base.....	Small Button 9-Pin
Bulb.....	T-6 $\frac{1}{2}$ "
Maximum Overall Length.....	2 $\frac{3}{8}$ "
Maximum Seated Height.....	1 $\frac{15}{16}$ "
Mounting Position.....	Any

### RATINGS\*\*

	Series	Parallel
Heater Voltage AC or DC.....	12.6	6.3 Volts
Heater Current.....	150	300 Ma.
Maximum Plate Voltage.....	300	300 Volts
Maximum Plate Dissipation.....	1	1 Watt
Maximum Grid Voltage		
Negative Bias Value.....	50	50 Volts
Positive Bias Value.....	0	0 Volts
Maximum Peak Heater-Cathode Voltage		
Heater negative with respect to cathode.....	180	180 Volts
Heater positive with respect to cathode.....	180	180 Volts

#### Direct Interelectrode Capacitances:\*

	Triode No. 1†	Triode No. 2†
Grid to Plate.....	1.7	1.7 $\mu$ mf.
Grid to Cathode.....	1.6	1.6 $\mu$ mf.
Plate to Cathode.....	0.46	0.34 $\mu$ mf.

†Triode No. 1 and Triode No. 2 have their plates connected to pins 6 and 1 respectively.

\*Without external shield.

# 12AX7 (Cont'd)

## TYPICAL OPERATION\*\* CLASS A<sub>1</sub> AMPLIFIER

Heater Voltage.....	6.3	6.3 Volts
Heater Current.....	300	300 Ma.
Plate Voltage.....	100	250 Volts
Grid Voltage.....	-1	-2 Volts
Amplification Factor.....	100	100
Plate Resistance.....	80,000	62,500 Ohms
Transconductance.....	1250	1600 $\mu$ mhos
Plate Current.....	0.5	1.2 Ma.

\*\*Values are for each unit.

## APPLICATION

Sylvania Type 12AX7 is a high mu duotriode for use as a voltage amplifier or phase inverter in portable or compact radio equipment. The use of the 9 pin base allows connection to be made to the center tap of the heater permitting operation in parallel on 6 volt supplies or in series for AC-DC service. For typical curves and resistance coupled amplifier data, reference should be made to Sylvania Type 6BK6.

# 12AY7 Sylvania Type

MEDIUM-MU DUOTRIODE

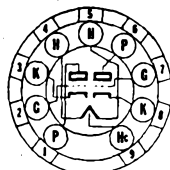

9A-0-0

## PHYSICAL SPECIFICATIONS

Base.....	Miniature Button 9 Pin
Bulb.....	T-61 $\frac{1}{2}$ "
Maximum Overall Length.....	2 $\frac{3}{16}$ "
Maximum Seated Height.....	1 $\frac{15}{16}$ "
Mounting Position.....	Any

## RATINGS

	Series	Parallel
Heater Voltage.....	12.6	6.3 Volts
Heater Current.....	0.15	0.3 Ampere
Maximum Plate Voltage.....	300	300 Volts
Maximum Plate Dissipation.....	1.5	1.5 Watts
Maximum Cathode Current.....	10	10 Ma.
Maximum Heater-Cathode Voltage.....	90	90 Volts

### Direct Interelectrode Capacitances\*

Grid to Plate.....	1.3 $\mu$ mf.
Input.....	1.3 $\mu$ mf.
Output.....	0.6 $\mu$ mf.

\*Without external shield.

## TYPICAL OPERATION

### CLASS A AMPLIFIER (Each Section)

Plate Voltage.....	250 Volts
Grid Voltage.....	-4.0 Volts
Plate Current.....	3.0 Ma.
Amplification Factor.....	40
Mutual Conductance.....	1750 $\mu$ mhos

### RESISTANCE COUPLED AMPLIFIER (Each section)

Heater Voltage** (AC or DC).....	6.3 Volts
Plate Supply Voltage.....	150 Volts
Plate Load Resistor.....	20,000 Ohms
Cathode Resistor.....	2700 Ohms
Cathode bypass Capacitor.....	40 $\mu$ f.
Grid Resistor.....	0.1 Megohm
Voltage Gain.....	12.5

\*\*For minimum hum tie pin #9 to negative B supply.



**APPLICATION**

Sylvania Type 12AY7 is a medium- $\mu$  duotriode which is designed for use as an af amplifier. It is a low noise, low microphonic tube having a center tapped heater which permits operation from either 6.3 volt or 12.6 volt heater supply. It is recommended that the 12.6 volt connection be used to assure the low-hum operation for which Type 12AY7 was developed.

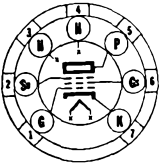

7BK-0-0



**Sylvania Type 12BA6**

**REMOTE CUT-OFF RF PENTODE**

**RATINGS AND OPERATION**

Heater Voltage AC or DC..... 12.6 Volts  
Heater Current..... 150 Ma.

For other rating, operation and application data, refer to corresponding Type 6BA6.



8CT-0-6 & 8



**Sylvania Type 12BA7**

**HEPTODE CONVERTER**

**RATINGS AND OPERATION**

Heater Voltage AC or DC..... 12.6 Volts  
Heater Current..... 150 Ma.

For other data, refer to corresponding Type 6BA7, which is identical except for heater ratings.

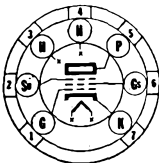

7BK-0-2



**Sylvania Type 12BD6**

**REMOTE CUT-OFF RF PENTODE**

**RATINGS AND OPERATION**

Heater Voltage..... 12.6 Volts  
Heater Current..... 150 Ma.

For other data, refer to corresponding Type 6BD6 which is identical except for heater ratings.

# 12BE6 Sylvania Type

HEPTODE CONVERTER

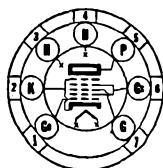

7CH-0-0

## RATINGS AND OPERATION

Heater Voltage AC or DC.....	12.6 Volts
Heater Current.....	150 Ma.

For other rating, operation and application data, refer to corresponding Type 6BE6.

# 12BF6 Sylvania Type

DUO-DIODE TRIODE

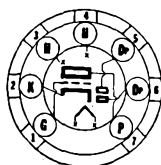

7BT-0-0

## RATINGS AND OPERATION

Heater Voltage AC or DC.....	12.6 Volts
Heater Current.....	150 Ma.

For other data refer to corresponding Type 6BF6 which is identical except for heater ratings. Curves and resistance coupled amplifier data may be found by reference to Type 7E6.

# 12BH7 Sylvania Type

MEDIUM-MU DUOTRIODE

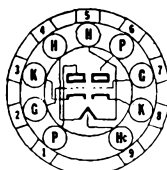

9A-0-0

## PHYSICAL SPECIFICATIONS

Base.....	Small Button 9 Pin
Bulb.....	T-6 $\frac{1}{2}$
Maximum Overall Length.....	2 $\frac{3}{8}$ "
Maximum Seated Height.....	2 $\frac{3}{8}$ "
Mounting Position.....	Any

## RATINGS\*

### CLASS A<sub>1</sub> AMPLIFIER

Heater Voltage AC or DC	
Series.....	12.6 Volts
Parallel.....	6.3 Volts
Maximum Plate Voltage.....	300 Volts
Maximum Plate Dissipation (Each Unit).....	3.5 Watts
Maximum Cathode Current (Each Unit).....	20 Ma.
Maximum Peak Heater-Cathode Voltage.....	180 Volts
Maximum Grid Circuit Resistance	
For Self Bias.....	2.5 Megohms
For Fixed Bias.....	1.0 Megohm

**VERTICAL DEFLECTION AMPLIFIER**

Maximum DC Plate Voltage.....	500 Volts
Maximum Peak Positive Pulse Plate Voltage*.....	1500 Volts
Maximum DC Negative Grid Voltage.....	50 Volts
Maximum Peak Negative Pulse Grid Voltage*.....	220 Volts
Maximum Cathode Current (Each Unit).....	20 Ma.
Maximum Plate Dissipation (Each Unit)*.....	5 Watts
Maximum Peak Heater-Cathode Voltage.....	180 Volts
Maximum Grid Circuit Resistance	
For Self Bias.....	2.5 Megohms
For Fixed Bias.....	1.0 Megohm

\*Values given are for each section.  
# Absolute maximum value not to be exceeded under any condition of operation

**Direct Interelectrode Capacitances:**

	Triode No. 1*		Triode No. 2*	
	†	††	†	††
Grid to Plate.....	2.4	2.4	2.4	2.4 $\mu\text{mf.}$
Input.....	3.0	3.0	3.0	3.0 $\mu\text{mf.}$
Output.....	2.0	0.8	2.6	0.8 $\mu\text{mf.}$

†With a  $\frac{1}{8}$ " diameter shield (RMA Stdrs. 315) connected to cathode of unit under test.  
††Without external shield.  
\*Triode No. 1 and Triode No. 2 have their plates connected to pins 6 and 1 respectively.

**TYPICAL OPERATION****CLASS A<sub>1</sub> AMPLIFIER\***

Heater Voltage.....	12.6	or	6.3 Volts
Heater Current.....	300	or	600 Ma.
Plate Voltage.....	85		250 Volts
Grid Voltage.....	0		10.5 Volts
Amplification Factor.....	21		17
Mutual Conductance (Each Unit).....	6200		3100 $\mu\text{mhos}$
Plate Current (Each Unit).....	20		11.5 Ma.

**VERTICAL DEFLECTION AMPLIFIER**

Heater Voltage.....	12.6	or	6.3 Volts
Plate Voltage.....			350 Volts
Cathode Bias Resistor (Variable).....			560 Ohms
Signal Voltage			
Peak to Peak Sawtooth Component (approx.).....			25 Volts
Negative Peaking Component.....			32 Volts
Plate Current.....			16 Ma.
Peak Positive-Pulse Output Voltage.....			670 Volts
Peak to Peak Sawtooth Output Voltage.....			230 Volts

\*Values given are for each section.

**APPLICATION**

Sylvania Type 12BH7 is a duotriode designed for use as a vertical deflection amplifier in television receivers using picture tubes which require wide deflection angles.

The 12BH7 may also be used in Class A<sub>1</sub> amplifier applications.

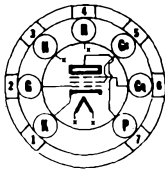

7DF-0-1

**Sylvania Type 12BN6****GATED BEAM DISCRIMINATOR****RATINGS AND OPERATION**

Heater Voltage AC or DC.....	12.6 Volts
Heater Current.....	150 Ma.

For other data, refer to corresponding Type 6BN6 which is identical except for heater ratings.

# 12F5<sup>GT</sup> Sylvania Type

HIGH-MU TRIODE



5M-0-0

## RATINGS AND OPERATION

Heater Voltage AC or DC..... 12.6 Volts  
Heater Current..... 150 Ma.

For other data, refer to corresponding Type 6F5 or 6F5GT which is identical, except for heater ratings.

# 12H6 Sylvania Type

TWIN DIODE

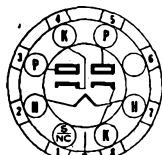

7Q-1-1

## RATINGS AND OPERATION

Heater Voltage AC or DC..... 12.6 Volts  
Heater Current..... 150 Ma.

For other data, refer to corresponding Type 6H6 which is identical except for heater ratings.

# 12J5<sup>GT</sup> Sylvania Type

MEDIUM-MU TRIODE



6Q-0-0

## RATINGS AND OPERATION

Heater Voltage AC or DC..... 12.6 Volts  
Heater Current..... 150 Ma.

For other data, refer to corresponding Type 6J5GT which is identical except for heater ratings.

# 12J7<sup>GT</sup> Sylvania Type

SHARP CUT-OFF RF PENTODE



7R-1-1

## RATINGS AND OPERATION

Heater Voltage AC or DC..... 12.6 Volts  
Heater Current..... 150 Ma.

For other data, refer to corresponding Type 6J7GT which is identical except for heater ratings.



7R-1-8

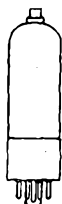

## Sylvania Type 12K7<sup>GT</sup>

REMOTE CUT-OFF RF PENTODE

### RATINGS AND OPERATION

Heater Voltage AC or DC..... 12.6 Volts  
 Heater Current..... 150 Ma.

For other data, refer to corresponding Type 6K7GT which is identical except for heater ratings.

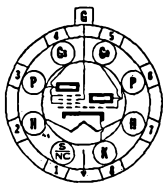

8K-1-8

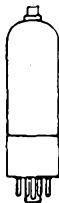

## Sylvania Type 12K8<sup>GT</sup>

TRIODE HEXODE CONVERTER

### RATINGS AND OPERATION

Heater Voltage AC or DC..... 12.6 Volts  
 Heater Current..... 150 Ma.

For other data, refer to corresponding type 6K8GT which is identical except for heater ratings.



7V-1-8



## Sylvania Type 12Q7<sup>GT</sup>

DUODIODE HIGH-MU TRIODE

### RATINGS AND OPERATION

Heater Voltage AC or DC..... 12.6 Volts  
 Heater Current..... 150 Ma.

For other data, refer to corresponding Type 6Q7GT which is identical except for heater ratings.



8CB-0-2



## Sylvania Type 12S8<sup>GT</sup>

TRIPLE DIODE TRIODE

### RATINGS AND OPERATION

Heater Voltage AC or DC..... 12.6 Volts  
 Heater Current..... 150 Ma.

For other data refer to corresponding Type 6S8GT which is identical except for heater ratings.

# 12SA7<sup>GT</sup> Sylvania Type

PENTAGRID CONVERTER



8AD-1-6  
12SA7GT



8R-1-0  
12SA7

## RATINGS AND OPERATION

Heater Voltage AC or DC..... 12.6 Volts  
Heater Current..... 150 Ma.

For other data, refer to corresponding Type 6SA7GT which is identical except for heater ratings.

# 12SC7 Sylvania Type

DOUBLE TRIODE AMPLIFIER



8S-1-0

## RATINGS AND OPERATION

Heater Voltage AC or DC..... 12.6 Volts  
Heater Current..... 150 Ma.

For other data, refer to corresponding Type 6SC7 which is identical except for heater ratings.

# 12SF5<sup>GT</sup> Sylvania Type

HIGH-MU TRIODE



6AB-0-0

## RATINGS AND OPERATION

Heater Voltage AC or DC..... 12.6 Volts  
Heater Current..... 150 Ma.

For other data, refer to corresponding Type 6SF5GT which is identical except for heater ratings.

# 12SF7 Sylvania Type

DIODE REMOTE CUT-OFF RF PENTODE



7AZ-1-0

## RATINGS AND OPERATION

Heater Voltage AC or DC..... 12.6 Volts  
Heater Current..... 150 Ma.

For other data, refer to corresponding Type 6SF7 which is identical except for heater ratings.



8BK-1-1

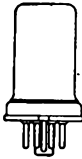

# Sylvania Type 12SG7

SEMI-REMOTE CUT-OFF RF PENTODE

## RATINGS AND OPERATION

Heater Voltage AC or DC..... 12.6 Volts  
Heater Current..... 150 Ma.

For other data, refer to corresponding Type 6SG7 which is identical except for heater ratings.



8BK-1-0 (12SH7)  
8BK-1-1 (12SH7GT)

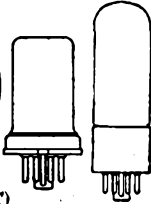

# Sylvania Type 12SH7<sup>GT</sup>

SHARP CUT-OFF RF PENTODE

## RATINGS AND OPERATION

Heater Voltage AC or DC..... 12.6 Volts  
Heater Current..... 150 Ma.

For other data, refer to corresponding Type 6SH7GT, which is identical except for heater ratings.



8N-1-1 (12SJ7)  
8N-1-5 (12SJ7GT)

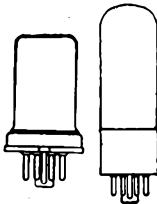

# Sylvania Type 12SJ7<sup>GT</sup>

SHARP CUT-OFF RF PENTODE

## RATINGS AND OPERATION

Heater Voltage AC or DC..... 12.6 Volts  
Heater Current..... 150 Ma.

For other data, refer to corresponding Type 6SJ7GT, which is identical except for heater ratings.



8N-1-1 (12SK7)  
8N-1-5 (12SK7GT)

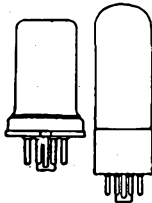

# Sylvania Type 12SK7<sup>GT</sup>

REMOTE CUT-OFF RF PENTODE

## RATINGS AND OPERATION

Heater Voltage AC or DC..... 12.6 Volts  
Heater Current..... 150 Ma.

For other data, refer to corresponding Type 6SK7GT which is identical except for heater ratings.

# 12SL7<sup>GT</sup> Sylvania Type

DOUBLE TRIODE AMPLIFIER

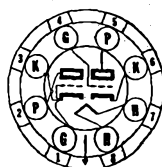

8BD-0-0

## RATINGS AND OPERATION

Heater Voltage AC or DC..... 12.6 Volts  
Heater Current..... 150 Ma.

For other data, refer to corresponding Type 6SL7GT which is identical except for heater ratings.

# 12SN7<sup>GT</sup> Sylvania Type

DOUBLE TRIODE AMPLIFIER



8BD-0-0

## RATINGS AND OPERATION

Heater Voltage AC or DC..... 12.6 Volts  
Heater Current..... 300 Ma.

For other data, refer to corresponding Type 6SN7GT which is identical except for heater ratings.

# 12SQ7<sup>GT</sup> Sylvania Type

DUODIODE HIGH-MU TRIODE



8Q-1-3

## RATINGS AND OPERATION

Heater Voltage AC or DC..... 12.6 Volts  
Heater Current..... 150 Ma.

For other data, refer to corresponding Type 6SQ7GT which is identical except for heater ratings.

# 12SR7 Sylvania Type

DUODIODE MEDIUM-MU TRIODE

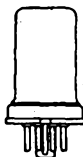

8Q-1-1

## RATINGS AND OPERATION

Heater Voltage AC or DC..... 12.6 Volts  
Heater Current..... 150 Ma.

For other data, refer to corresponding Type 6SR7 which is identical except for heater ratings.



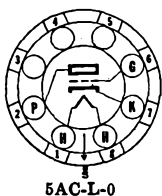

5AC-L-0

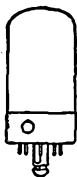

# Sylvania Type 14A4

MEDIUM-MU TRIODE

## PHYSICAL SPECIFICATIONS

Base.....	Lock-In 8 Pin
Bulb.....	T-9
Maximum Overall Length.....	2 <sup>35</sup> / <sub>16</sub> "
Maximum Seated Height.....	2 <sup>1</sup> / <sub>4</sub> "
Mounting Position.....	Any

## RATINGS

Heater Voltage AC or DC (Nominal).....	14.0 Volts
--	------------

## OPERATION

Heater Voltage AC or DC.....	12.6 Volts
Heater Current.....	150 Ma.

For other rating, operation and application data, refer to Sylvania Lock-In Type 7A4.

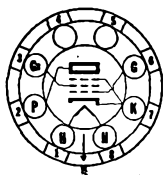

6AA-L-0

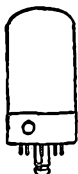

# Sylvania Type 14A5

BEAM POWER AMPLIFIER

## PHYSICAL SPECIFICATIONS

Base.....	Lock-In 8 Pin
Bulb.....	T-9
Maximum Overall Length.....	2 <sup>35</sup> / <sub>16</sub> "
Maximum Seated Height.....	2 <sup>1</sup> / <sub>4</sub> "
Mounting Position.....	Any

## RATINGS

Heater Voltage AC or DC (Nominal).....	14.0 Volts
Maximum Plate Voltage.....	300 Volts
Maximum Screen Voltage.....	300 Volts
Maximum Plate Dissipation.....	7.5 Watts
Maximum Screen Dissipation.....	1.5 Watts
Maximum Heater-Cathode Voltage.....	90 Volts

### Direct Interelectrode Capacitances:\*

Grid to Plate.....	0.4 $\mu$ f.
Input.....	6.8 $\mu$ f.
Output.....	7.0 $\mu$ f.

\*With 1<sup>5</sup>/<sub>16</sub>" diameter shield (RMA Std. 308) connected to cathode.

## TYPICAL OPERATION

### CLASS A<sub>1</sub> AMPLIFIER

Heater Voltage AC or DC.....	12.6 Volts
Heater Current.....	150 Ma.
Plate Voltage.....	250 Volts
Screen Voltage.....	250 Volts
Grid Voltage $\ddagger$ .....	-12.5 Volts
Self-Bias Resistor.....	370 Ohms
Peak AF Signal Voltage.....	12.5 Volts
Plate Current Zero Signal.....	30 Ma.
Plate Current Maximum Signal.....	32 Ma.
Screen Current Zero Signal.....	3.5 Ma.
Screen Current Maximum Signal.....	5.5 Ma.
Plate Resistance.....	70000 Ohms
Mutual Conductance.....	3000 $\mu$ mhos
Load Resistance.....	7500 Ohms
Power Output.....	2.8 Watts
Total Harmonic Distortion.....	7 Per Cent

$\ddagger$ The DC resistance in the grid circuit under rated maximum condition should never exceed 0.5 megohm for self bias, and 0.1 megohm for fixed bias operation.

# 14A7 Sylvania Type

REMOTE CUT-OFF RF PENTODE

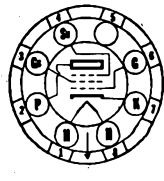
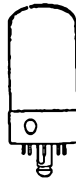

8V-L-5

## PHYSICAL SPECIFICATIONS

Base.....	Lock-In 8 Pin
Bulb.....	T-9
Maximum Overall Length.....	2 <sup>35</sup> / <sub>32</sub> "
Maximum Seated Height.....	2 <sup>1</sup> / <sub>4</sub> "
Mounting Position.....	Any

## RATINGS

Heater Voltage AC or DC (Nominal).....	14.0 Volts
--	------------

## OPERATION

Heater Voltage AC or DC.....	12.6 Volts
Heater Current.....	150 Ma.

For other rating, operation and application data, refer to Sylvania Lock-In Type 7A7.

# 14AF7 Sylvania Type

TWIN TRIODE AMPLIFIER

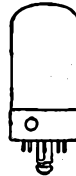

8AC-L-0

## PHYSICAL SPECIFICATIONS

Base.....	Lock-In 8 Pin
Bulb.....	T-9
Maximum Overall Length.....	2 <sup>35</sup> / <sub>32</sub> "
Maximum Seated Height.....	2 <sup>1</sup> / <sub>4</sub> "
Mounting Position.....	Any

## RATINGS

Heater Voltage AC or DC (Nominal).....	14.0 Volts
--	------------

## OPERATION

Heater Voltage AC or DC.....	12.6 Volts
Heater Current.....	150 Ma.

For other rating, operation and application data, refer to Sylvania Lock-In Type 7AF7.

# 14B6 Sylvania Type

DUODIODE HIGH-MU TRIODE

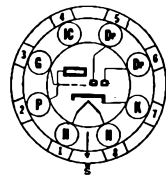
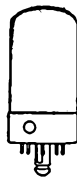

8W-L-7

## PHYSICAL SPECIFICATIONS

Base.....	Lock-In 8 Pin
Bulb.....	T-9
Maximum Overall Length.....	2 <sup>35</sup> / <sub>32</sub> "
Maximum Seated Height.....	2 <sup>1</sup> / <sub>4</sub> "
Mounting Position.....	Any

## RATINGS

Heater Voltage AC or DC (Nominal).....	14.0 Volts
--	------------

## OPERATION

Heater Voltage AC or DC.....	12.6 Volts
Heater Current.....	150 Ma.

For other rating, operation and application data, refer to Sylvania Lock-In Type 7B6.

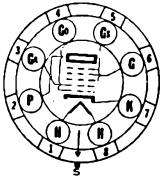

8X-L-0

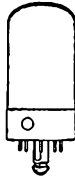

# Sylvania Type 14B8

PENTAGRID CONVERTER

## PHYSICAL SPECIFICATIONS

Base.....	Lock-In 8 Pin
Bulb.....	T-9
Maximum Overall Length.....	2 <sup>25</sup> / <sub>32</sub> "
Maximum Seated Height.....	2 <sup>1</sup> / <sub>4</sub> "
Mounting Position.....	Any

## RATINGS

Heater Voltage AC or DC (Nominal).....	14.0 Volts
--	------------

## OPERATION

Heater Voltage AC or DC.....	12.6 Volts
Heater Current.....	150 Ma.

For other rating, operation and application data, refer to Sylvania Lock-In Type 7B8.



6AA-L-0



# Sylvania Type 14C5

BEAM POWER AMPLIFIER

## PHYSICAL SPECIFICATIONS

Base.....	Lock-In 8 Pin
Bulb.....	T-9
Maximum Overall Length.....	3 <sup>5</sup> / <sub>32</sub> "
Maximum Seated Height.....	2 <sup>5</sup> / <sub>8</sub> "
Mounting Position.....	Any

## RATINGS

Heater Voltage AC or DC (Nominal).....	14.0 Volts
--	------------

## OPERATION

Heater Voltage AC or DC.....	12.6 Volts
Heater Current.....	225 Ma.

For other rating, operation and application data, refer to Sylvania Lock-In Type 7C5.



8V-L-5



# Sylvania Type 14C7

SHARP CUT-OFF RF PENTODE

## PHYSICAL SPECIFICATIONS

Base.....	Lock-In 8 Pin
Bulb.....	T-9
Maximum Overall Length.....	2 <sup>25</sup> / <sub>32</sub> "
Maximum Seated Height.....	2 <sup>1</sup> / <sub>4</sub> "
Mounting Position.....	Any

# 14C7 (Cont'd)

## RATINGS

Heater Voltage AC or DC (Nominal)	14.0 Volts
Maximum Plate Voltage	300 Volts
Maximum Screen Voltage	100 Volts
Maximum Screen Supply Voltage	300 Volts
Maximum Plate Dissipation	1.0 Watt
Maximum Screen Dissipation	0.1 Watt
Minimum External Grid Bias	0 Volt
Maximum Heater-Cathode Voltage	90 Volts

### Direct Interelectrode Capacitances:\*

Grid to Plate	0.004 $\mu$ f. Max.
Input	6.0 $\mu$ f.
Output	6.5 $\mu$ f.

\*With 1 $\frac{1}{8}$ " diameter shield (RMA Std. 308) connected to cathode.

## TYPICAL OPERATION CLASS A<sub>1</sub> AMPLIFIER

Heater Voltage	12.6	12.6 Volts
Heater Current	150	150 Ma.
Plate Voltage	100	250 Volts
Screen Voltage	100	100 Volts
Control Grid Voltage	-1.0	-3.0 Volts
Self-Bias Resistor	130	1000 Ohms
Suppressor Grid and Pin No. 5	Connected to Cathode	
Plate Current	5.7	2.2 Ma.
Screen Current	1.8	0.7 Ma.
Plate Resistance (Approximate)	.400	1.0 Megohm
Mutual Conductance	2275	1575 $\mu$ mhos
Grid Bias for Approx. Plate Current Cut-Off	-8.5	-8.5 Volts

Data for use in Resistance Coupled Amplifiers may be obtained by referring to type 7C7 in appendix.

# 14E6 Sylvania Type

DUODIODE MEDIUM-MU TRIODE

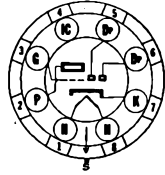
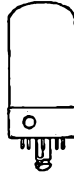

8W-L-7

## PHYSICAL SPECIFICATIONS

Base	Lock-In 8 Pin
Bulb	T-9
Maximum Overall Length	2 $\frac{3}{4}$ "
Maximum Seated Height	2 $\frac{1}{4}$ "
Mounting Position	Any

## RATINGS

Heater Voltage AC or DC (Nominal)	14.0 Volts
-----------------------------------	------------

## OPERATION

Heater Voltage AC or DC	12.6 Volts
Heater Current	150 Ma.

For other rating, operation and application data, refer to Sylvania Lock-In Type 7E6. For diode load curve data, refer to that for Type 7B6.

# 14E7 Sylvania Type

DUODIODE PENTODE

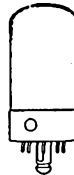

8AE-L-7

## PHYSICAL SPECIFICATIONS

Base	Lock-In 8 Pin
Bulb	T-9
Maximum Overall Length	2 $\frac{3}{4}$ "
Maximum Seated Height	2 $\frac{1}{4}$ "
Mounting Position	Any

## RATINGS

Heater Voltage AC or DC (Nominal)	14.0 Volts
-----------------------------------	------------

## OPERATION

Heater Voltage AC or DC	12.6 Volts
Heater Current	150 Ma.

For other rating, operation and application data, refer to Sylvania Lock-In Type 7E7.

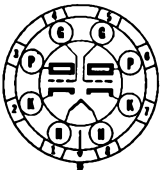

8AC-L-0



# Sylvania Type 14F7

HIGH-MU DUO TRIODE

## PHYSICAL SPECIFICATIONS

Base.....	Lock-In 8 Pin
Bulb.....	T-9
Maximum Overall Length.....	2 <sup>35</sup> / <sub>64</sub> "
Maximum Seated Height.....	2 <sup>1</sup> / <sub>4</sub> "
Mounting Position.....	Any

## RATINGS

Heater Voltage AC or DC (Nominal).....	14.0 Volts
--	------------

## OPERATION

Heater Voltage AC or DC.....	12.6 Volts
Heater Current.....	150 Ma.

For other rating, operation and application data, refer to Sylvania Type 7F7.



8BW-L-0

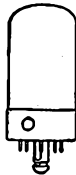

# Sylvania Type 14F8

DOUBLE TRIODE

## PHYSICAL SPECIFICATIONS

Base.....	Lock-In 8-Pin
Bulb.....	T-9
Maximum Overall Length.....	2 <sup>9</sup> / <sub>16</sub> "
Maximum Seated Height.....	1 <sup>3</sup> / <sub>4</sub> "
Mounting Position.....	Any

## RATINGS

Heater Voltage AC or DC (Nominal).....	14.0 Volts
--	------------

## TYPICAL OPERATION

Heater Voltage AC or DC.....	12.6 Volts
Heater Current.....	150 Ma.

For other rating, operation and application data, refer to Sylvania Type 7F8.



8V-L-5



# Sylvania Type 14H7

SEMI-REMOTE CUT-OFF RF PENTODE

## PHYSICAL SPECIFICATIONS

Base.....	Lock-In 8 Pin
Bulb.....	T-9
Maximum Overall Length.....	2 <sup>35</sup> / <sub>64</sub> "
Maximum Seated Height.....	2 <sup>1</sup> / <sub>4</sub> "
Mounting Position.....	Any

## RATINGS

Heater Voltage AC or DC (Nominal).....	14.0 Volts
--	------------

## OPERATION

Heater Voltage AC or DC.....	12.6 Volts
Heater Current.....	150 Ma.

For other rating, operation and application data, refer to Sylvania Lock-In Type 7H7.

# 14J7 Sylvania Type

TRIODE HEPTODE CONVERTER



8BL-L-7

## PHYSICAL SPECIFICATIONS

Base.....	Lock-In 8 Pin
Bulb.....	T-9
Maximum Overall Length.....	2 <sup>35</sup> / <sub>64</sub> "
Maximum Seated Height.....	2 <sup>1</sup> / <sub>4</sub> "
Mounting Position.....	Any

## RATINGS

Heater Voltage AC or DC (Nominal).....	14.0 Volts
--	------------

## OPERATION

Heater Voltage AC or DC.....	12.6 Volts
Heater Current.....	150 Ma.

For other rating, operation and application data, refer to Sylvania Lock-In Type 7J7.

# 14N7 Sylvania Type

MEDIUM-MU DUO TRIODE

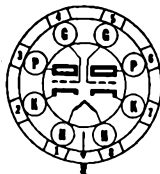
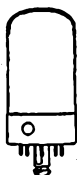

8AC-L-0

## PHYSICAL SPECIFICATIONS

Base.....	Lock-In 8 Pin
Bulb.....	T-9
Maximum Overall Length.....	2 <sup>35</sup> / <sub>64</sub> "
Maximum Seated Height.....	2 <sup>5</sup> / <sub>8</sub> "
Mounting Position.....	Any

## RATINGS

Heater Voltage AC or DC (Nominal).....	14.0 Volts
--	------------

## OPERATION

Heater Voltage AC or DC.....	12.6 Volts
Heater Current.....	300 Ma.

For other rating, operation and application data, refer to Sylvania Lock-In Type 7N7.

# 14Q7 Sylvania Type

PENTAGRID CONVERTER

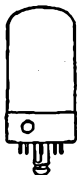

8AL-L-0

## PHYSICAL SPECIFICATIONS

Base.....	Lock-In 8 Pin
Bulb.....	T-9
Maximum Overall Length.....	2 <sup>35</sup> / <sub>64</sub> "
Maximum Seated Height.....	2 <sup>1</sup> / <sub>4</sub> "
Mounting Position.....	Any

## RATINGS

Heater Voltage AC or DC (Nominal).....	14.0 Volts
--	------------

## OPERATION

Heater Voltage AC or DC.....	12.6 Volts
Heater Current.....	150 Ma.

For other rating, operation and application data, refer to Sylvania Lock-In Type 7Q7.



8AE-L-7

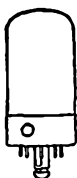

## Sylvania Type 14R7

DUODIODE PENTODE

### PHYSICAL SPECIFICATIONS

Base.....	Lock-In 8 Pin
Bulb.....	T-9
Maximum Overall Length.....	2 <sup>35</sup> / <sub>32</sub> "
Maximum Seated Height.....	2 <sup>1</sup> / <sub>4</sub> "
Mounting Position.....	Any

### RATINGS

Heater Voltage AC or DC (Nominal).....	14.0 Volts
--	------------

### OPERATION

Heater Voltage AC or DC.....	12.6 Volts
Heater Current.....	150 Ma.

For other rating, operation and application data, refer to Lock-In Type 7R7. For diode load current data, see Type 7B6.

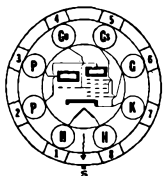

8BL-L-7

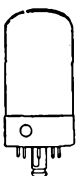

## Sylvania Type 14S7

TRIODE HEPTODE CONVERTER

### PHYSICAL SPECIFICATIONS

Base.....	Lock-In 8 Pin
Bulb.....	T-9
Maximum Overall Length.....	2 <sup>35</sup> / <sub>32</sub> "
Maximum Seated Height.....	2 <sup>1</sup> / <sub>4</sub> "
Mounting Position.....	Any

### RATINGS

Heater Voltage AC or DC (Nominal).....	14.0 Volts
--	------------

### OPERATION

Heater Voltage AC or DC.....	12.6 Volts
Heater Current.....	150 Ma.

For other rating, operation and application data, refer to Sylvania Lock-In Type 7S7.

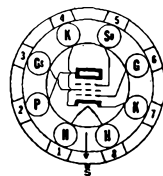

8BJ-L-5

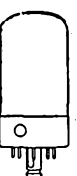

## Sylvania Type 14W7

SHARP CUT-OFF RF PENTODE

### PHYSICAL SPECIFICATIONS

Base.....	Lock-In 8 Pin
Bulb.....	T-9
Maximum Overall Length.....	2 <sup>35</sup> / <sub>32</sub> "
Maximum Seated Height.....	2 <sup>1</sup> / <sub>4</sub> "
Mounting Position.....	Any

### RATINGS

Heater Voltage AC or DC (Nominal).....	14.0 Volts
--	------------

### OPERATION

Heater Voltage AC or DC.....	12.6 Volts
Heater Current.....	225 Ma.

For other rating, operation and application data, refer to Sylvania Lock-In Type 7W7.

# 14X7 Sylvania Type

DUO-DIODE HI-MU TRIODE

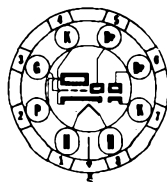
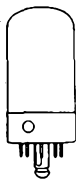

8BZ-L-4

## PHYSICAL SPECIFICATIONS

Base .....	Lock-In 8 Pin
Bulb .....	T-9
Maximum Overall Length .....	3 5/8"
Maximum Seated Height .....	2 5/8"
Mounting Position .....	Any

## RATINGS

Heater Voltage AC or DC (Nominal) .....	14.0 Volts
---	------------

## OPERATION

Heater Voltage AC or DC .....	12.6 Volts
Heater Current .....	150 Ma.

For other rating, operation and application data, refer to Sylvania Lock-In Type 7X7.

# 14Y4 Sylvania Type

DUODIODE RECTIFIER



5AB-L-0

## PHYSICAL SPECIFICATIONS

Base .....	Lock-In 8 Pin
Bulb .....	T-9
Maximum Overall Length .....	2 3/4"
Maximum Seated Height .....	2 1/4"
Mounting Position .....	Any

## RATINGS

Heater Voltage AC or DC (Nominal) .....	14.0 Volts
Maximum AC Plate Voltage (RMS per Plate, Condenser Input) .....	325 Volts
Maximum AC Plate Voltage (RMS, Choke Input) .....	450 Volts
Maximum Peak Inverse Voltage .....	1250 Volts
Maximum DC Heater-Cathode Voltage .....	450 Volts
Maximum Steady State Peak Plate Current Per Plate .....	210 Ma.
Tube Voltage Drop at 70 Ma. DC Per Plate .....	22 Volts
Maximum Output Current .....	70 Ma.

## TYPICAL OPERATION FULL WAVE RECTIFIER CONDENSER INPUT TO FILTER

Heater Voltage AC or DC .....	12.6 Volts
Heater Current .....	0.300 Ampere
AC RMS Voltage per Plate .....	325 Volts
DC Output Current .....	70 Ma.
Plate Supply Impedance per Plate § .....	150 Ohms Min.

## CHOKE INPUT TO FILTER

Heater Voltage .....	12.6 Volts
Heater Current .....	0.300 Amperes
AC Voltage Per Plate .....	450 Volts
DC Output Current .....	70 Ma.
Minimum Value of Input Choke .....	8 Henrys

§When filter condensers larger than 40  $\mu$ f are used it may be necessary to increase the specified plate supply impedance.

## APPLICATION

Sylvania Type 14Y4 is a full-wave cathode type rectifier of Lock-In construction, giving it desirable mechanical features. This tube is designed for service in aircraft or compact AC receivers. Operating conditions and characteristics are similar to those of Type 7Y4 except for heater rating. Conventional full or half-wave circuits may be used.



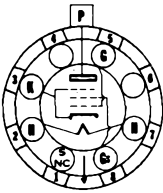

5BT-0-0



# Sylvania Type 19BG6G

BEAM POWER AMPLIFIER

## PHYSICAL SPECIFICATIONS

Base .....	Medium Octal 6 Pin
Bulb .....	ST-16
Maximum Overall Length .....	5 <sup>11</sup> / <sub>16</sub> "
Maximum Seated Height .....	5 <sup>1</sup> / <sub>8</sub> "
Mounting Position* .....	Vertical, Base Up or Down

\*Horizontal operation is permitted if the plane passing through pins 2 and 7 is vertical.

## RATINGS

Heater Voltage .....	18.9 Volts
Heater Current .....	300 Ma.

For other ratings operation and application data, refer to Sylvania Type 6BG6G.

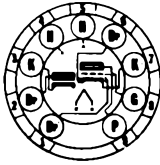

9E-0-0



# Sylvania Type 19C8

TRIPLE DIODE TRIODE

## PHYSICAL SPECIFICATIONS

Base .....	Small Button 9 Pin
Bulb .....	T-6 <sup>1</sup> / <sub>2</sub>
Maximum Overall Length .....	2 <sup>9</sup> / <sub>16</sub> "
Maximum Seated Height .....	1 <sup>15</sup> / <sub>16</sub> "
Mounting Position .....	Any

## RATINGS

Heater Voltage .....	18.9 Volts
Maximum Plate Voltage .....	250 Volts
Maximum Plate Dissipation .....	1.0 Watt
Maximum Diode Current per Plate .....	6.0 Ma.
Maximum Peak Heater-Cathode Voltage .....	200 Volts

Direct Interelectrode Capacitances: (approx. values—unshielded)

Plate of Diode #1 or #3 to All Other Elements .....	5.2 $\mu$ f.
Plate of Diode #2 to All Other Elements .....	4.0 $\mu$ f.
Plate of Diode #1 or #3 to Grid (Maximum) .....	0.0300 $\mu$ f.
Plate of Diode #2 to Grid (Maximum) .....	0.006 $\mu$ f.

## TYPICAL OPERATION

### CLASS A AMPLIFIER—TRIODE UNIT

Heater Voltage .....	18.9 Volts
Heater Current .....	150 Ma.
Plate Voltage .....	100 Volts
Control Grid Voltage .....	-1 Volt
Plate Resistance .....	80,000 Ohms
Mutual Conductance .....	1,250 $\mu$ mhos
Amplification Factor .....	100
Plate Current .....	0.5 Ma.

## APPLICATION

Sylvania Type 19C8 is a miniature type tube having a high- $\mu$  triode and three high-perveance diodes in the same envelope. The diode referred to as diode #2 has a separate cathode connection.

# 19J6 Sylvania Type

MEDIUM MU DUOTRIODE

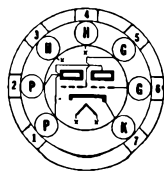

7BF-0-0

## PHYSICAL SPECIFICATIONS

Base.....	Miniature Button 7 Pin
Bulb.....	T-5 $\frac{1}{2}$
Maximum Overall Length.....	2 $\frac{1}{8}$ "
Maximum Seated Height.....	1 $\frac{7}{8}$ "
Mounting Position.....	Any

## RATINGS

Heater Voltage AC or DC.....	18.9 Volts
Heater Current.....	150 Ma.
Maximum Plate Voltage.....	300 Volts
Maximum Plate Dissipation.....	1.5 Watts
Maximum Peak Heater-Cathode Voltage.....	90 Volts

For other data, refer to Type 6J6, which has identical operating conditions.

# 19T8 Sylvania Type

TRIPLE DIODE TRIODE

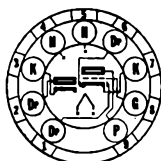

9E-0-3 & 7

## RATINGS AND OPERATION

Heater Voltage AC or DC.....	18.9 Volts
Heater Current.....	150 Ma.

For other data refer to corresponding Type 6T8 which is identical except for heater ratings.



7S-1-0 (25A6)  
7S-0-0 (25A6GT)

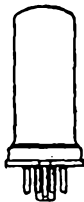

## Sylvania Type 25A6<sup>GT</sup>

POWER AMPLIFIER PENTODE

### PHYSICAL SPECIFICATIONS

	25A6	25A6GT
Base.....	Small Wafer 7 Pin	Intermediate Octal 7 Pin
Bulb.....	Metal 8-6	T-9
Maximum Overall Length.....	3 1/4"	3 5/8"
Maximum Seated Height.....	2 1/8"	2 3/4"
Mounting Position.....	Any	Any

### RATINGS

Heater Voltage AC or DC.....	25.0 Volts
Heater Current.....	300 Ma.
Maximum Plate Voltage.....	160 Volts
Maximum Screen Voltage.....	135 Volts
Maximum Plate Dissipation.....	5.3 Watts
Maximum Screen Dissipation.....	1.9 Watts
Maximum Heater-Cathode Voltage.....	90 Volts

### TYPICAL OPERATION

Heater Voltage AC or DC.....	25.0	25.0	25.0 Volts
Heater Current.....	300	300	300 Ma.
Plate Voltage.....	95	135	160 Volts
Screen Voltage.....	95	135	120 Volts
Grid Voltage.....	-15	-20	-18 Volts
Self-Bias Resistor.....	625	450	450 Ohms
Peak A-F Signal Voltage.....	15	20	18 Volts
Plate Current (Zero Signal).....	20	37	33 Ma.
Plate Current (Maximum Signal).....	22	39	36 Ma.
Screen Current (Zero Signal).....	4	8	6.5 Ma.
Screen Current (Maximum Signal).....	8	14	12 Ma.
Plate Resistance.....	45000	35000	42000 Ohms
Mutual Conductance.....	2000	2450	2375 μmhos
Load Resistance.....	4500	4000	5000 Ohms
Power Output.....	0.9	2	2.2 Watts
Total Harmonic Distortion.....	11	9	10 Per Cent

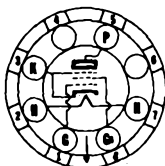

6CK-0-0



## Sylvania Type 25AV5<sup>GT</sup>

BEAM POWER AMPLIFIER

### RATINGS AND OPERATION

Heater Voltage AC or DC.....	25 Volts
Heater Current.....	300 Ma.

For other data, refer to corresponding Type 6AV5GT which is identical except for heater ratings.

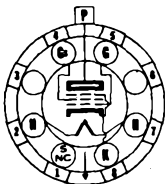

6AM-0-0

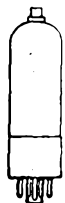

## Sylvania Type 25BQ6<sup>GT</sup>

BEAM POWER AMPLIFIER

### RATINGS AND OPERATION

Heater Voltage AC or DC.....	25 Volts
Heater Current.....	300 Ma.

For other data refer to corresponding Type 6BQ6GT which is identical except for heater ratings.

# 25C6G Sylvania Type

BEAM POWER AMPLIFIER

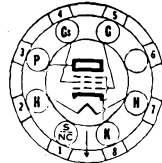

7S-0-0

## PHYSICAL SPECIFICATIONS

Base.....	Medium Octal 7 Pin
Bulb.....	ST14
Maximum Overall Length.....	4 3/8"
Maximum Seated Height.....	4 1/16"
Mounting Position.....	Any

## RATINGS

Heater Voltage AC or DC.....	25.0 Volts
Heater Current.....	300 Ma.

For other data on this type refer to type 6Y6 which is identical except for heater ratings.

# 25L6GT Sylvania Type

BEAM POWER AMPLIFIER

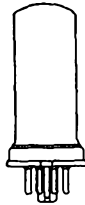

7S-1-0 (25L6)  
7S-0-0 (25L6GT)

## PHYSICAL SPECIFICATIONS

	25L6 Small Wafer Octal 7 Pin Metal 8-6	25L6GT Intermediate Octal 7 Pin
Base.....	Small Wafer Octal 7 Pin	Intermediate Octal 7 Pin
Bulb.....	Metal 8-6	T-9
Maximum Overall Length.....	3 1/4"	3 3/8"
Maximum Seated Height.....	2 11/16"	2 3/4"
Mounting Position.....	Any	Any

## TYPICAL OPERATION

### CLASS A<sub>1</sub> AMPLIFIER

	25L6	25L6GT
Heater Voltage.....	25.0	25.0 Volts
Heater Current.....	300	300 Ma.
Plate Voltage.....	110	200 Volts
Screen Voltage.....	110	125 Volts
Grid Voltage*.....	-7.5	** Volts
Peak AF Signal Voltage.....	7.5	8.5 Volts
Cathode Bias Resistor.....	140	180 Ohms
Plate Current, Zero Signal.....	49	46 Ma.
Plate Current, Maximum Signal.....	50	47 Ma.
Screen Current, Zero Signal.....	4	2.2 Ma.
Screen Current, Maximum Signal.....	10	8.5 Ma.
Plate Resistance.....	13,000	28,000 Ohms
Mutual Conductance.....	8000	8000 μmhos
Load Resistance.....	2000	4000 Ohms
Total Harmonic Distortion.....	10	10 %
Power Output.....	2.1	3.8 Watts

\*For fixed bias circuits the grid circuit resistance should not exceed 0.1 megohm; for self-bias operation 0.5 megohm should be the maximum.

\*\*Obtained by self-bias resistor. Fixed bias operation at maximum ratings is not recommended.

## APPLICATION

Sylvania 25L6 and 25L6G are power amplifiers intended especially for operation in the output stage of ac-dc and d-c receivers. These tubes provide high power output at the comparatively low plate and screen voltages which are available in such receivers.



4CG-0-0



## Sylvania Type 25W

HALF WAVE HIGH VACUUM RECTIFIER

### RATINGS AND OPERATION

Heater Voltage AC or DC ..... 25.0 Volts  
 Heater Current ..... 300 Ma.  
 For other rating, operation and application data refer to corresponding Type 6W4GT.

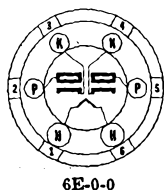

6E-0-0

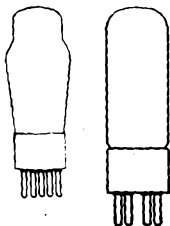

## Sylvania Type 25Z5

HIGH-VACUUM RECTIFIER

### PHYSICAL SPECIFICATIONS

Base ..... Small 6 Pin  
 Bulb ..... T9 or ST12  
 Maximum Overall Length ..... 4<sup>1</sup>/<sub>16</sub>"  
 Maximum Seated Height ..... 3<sup>3</sup>/<sub>16</sub>"  
 Mounting Position ..... Any

### RATINGS

Heater Voltage AC or DC ..... 25.0 Volts  
 Heater Current ..... 300 Ma.  
 Maximum DC Heater-Cathode Voltage ..... 350 Volts  
 Maximum Peak Inverse Voltage ..... 700 Volts  
 Tube Voltage Drop (150 Ma. Per Plate) ..... 22 Volts  
 Maximum Steady State Peak-Plate Current Per Plate ..... 450 Ma.

### TYPICAL OPERATION

#### VOLTAGE DOUBLER

Heater Voltage ..... 25.0 Volts  
 AC Plate Voltage Per Plate (RMS) ..... 117 Volts Max.  
 DC Output Current ..... 75 Ma. Max.  
 Maximum Steady State Peak Plate Current Per Plate ..... 450 Ma. Max.  
 Plate Supply Impedance (Minimum) ..... \* Ohms  
 \*Sufficient to limit the maximum steady-state peak plate current to value shown.  
 Additional impedance may be required when a filter of more than 40 mfd. is used.

#### HALF-WAVE RECTIFIER

Heater Voltage	25.0	25.0	25.0 Volts
A-C Plate Voltage per Plate (RMS)	117	150	235 <sup>1</sup> / <sub>2</sub> Volts
D-C Output Current per Plate	75 <sup>1</sup> / <sub>2</sub>	75 <sup>1</sup> / <sub>2</sub>	75 <sup>1</sup> / <sub>2</sub> Ma.
Plate Supply Impedance	15	40	100 Ohms

†Maximum.

# 25Z6<sup>GT</sup> Sylvania Type

HIGH-VACUUM RECTIFIER

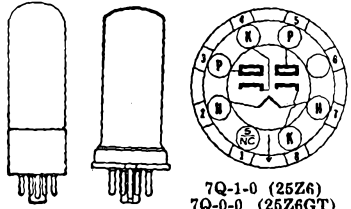

7Q-1-0 (25Z6)  
7Q-0-0 (25Z6GT)

## PHYSICAL SPECIFICATIONS

	25Z6	25Z6GT
Base.....	Small Wafer Octal 7 Pin	Intermediate Octal 7 Pin
Bulb.....	Metal 8-6	T-9
Maximum Overall Length.....	3 1/4"	3 5/8"
Maximum Seated Height.....	2 11/16"	2 3/8"
Mounting Position.....	Any	Any

## RATINGS

Heater Voltage AC or DC.....	25.0 Volts
Heater Current.....	300 Ma.
Maximum DC Heater-Cathode Voltage.....	350 Volts
Maximum Peak Inverse Voltage.....	700 Volts
Tube Voltage Drop (150 Ma. Per Plate).....	22 Volts
Maximum Steady State Peak Current Per Plate.....	450 Ma.

## TYPICAL OPERATION VOLTAGE DOUBLER

Heater Voltage.....	25.0 Volts
AC Plate Voltage Per Plate (RMS).....	117 Volts Max.
DC Output Current.....	75 Ma. Max.
Peak Plate Current*.....	450 Ma. Max.
Plate Supply Impedance (Minimum).....	* Ohms

\*Sufficient to limit the maximum steady-state peak plate current to value shown.  
Additional impedance may be required when a filter of more than 40 mfd. is used.

## HALF-WAVE RECTIFIER

Heater Voltage.....	25.0	25.0	25.0 Volts
AC Plate Voltage Per Plate (RMS).....	117	150	235 <sup>†</sup> Volts
DC Output Current Per Plate.....	75 <sup>†</sup>	75 <sup>†</sup>	75 <sup>†</sup> Ma.
Plate Supply Impedance.....	15	40	100 Ohms

<sup>†</sup>Maximum.

# 28D7 Sylvania Type

DOUBLE BEAM POWER AMPLIFIER

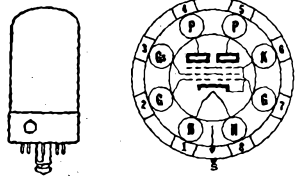

8BS-L-0

## PHYSICAL SPECIFICATIONS

Base.....	Lock-In 8 Pin
Bulb.....	T-9
Maximum Overall Length.....	3 5/8"
Maximum Seated Height.....	2 5/8"
Mounting Position.....	Any

## RATINGS

Heater Voltage.....	28 Volts
Heater Current.....	0.400 Ampere
Maximum Plate Voltage.....	100 Volts
Maximum Screen Voltage.....	67.5 Volts
Maximum Plate Dissipation (Per Section).....	3.0 Watts
Maximum Screen Dissipation (Per Section).....	0.5 Watts
Maximum Heater-Cathode Voltage.....	90 Volts

## TYPICAL OPERATION

### RESISTANCE COUPLED AMPLIFIER CLASS A<sub>2</sub>

	Self Bias	Fixed Bias
Heater Voltage.....	28.0	28.0 Volts
Heater Current.....	0.400	0.400 Ampere
Plate Voltage§.....	28.0	28.0 Volts
Screen Voltage.....	28.0	28.0 Volts
Grid Voltage.....		-3.5 Volts
Self-Bias Resistor.....	390	Ohms
Zero Signal Plate Current.....	9.0	12.5 Ma.
Maximum Signal Plate Current.....	6.5	8.1 Ma.
Zero Signal Screen Current.....	0.7	1.0 Ma.
Maximum Signal Screen Current.....	1.6	1.9 Ma.
Plate Resistance.....		4200 Ohms
Mutual Conductance.....		3400 μmhos
Peak AF Signal Voltage.....	4.9	4.9 Volts
Control Grid Resistor Per Section.....	0.5	0.2 Megohm
Load Resistance.....	4000	4000 Ohms
Power Output.....	80	100 Milliwatts
Total Harmonic Distortion.....	10	10 Per Cent

### PUSH-PULL RESISTANCE COUPLED CLASS A<sub>2</sub>

	Self Bias	Fixed Bias
Heater Voltage.....	28.0	28.0 Volts
Plate Voltage§.....	28.0	28.0 Volts
Screen Voltage.....	28.0	28.0 Volts
Grid Voltage.....		-3.5 Volts
Self-Bias Resistor.....	180	Ohms
Zero Signal Plate Current.....	18.5	25.0 Ma.
Maximum Signal Plate Current.....	14.5	19.0 Ma.
Zero Signal Screen Current.....	1.2	2.0 Ma.
Maximum Signal Screen Current.....	2.5	3.0 Ma.
Peak AF Signal Voltage (G to G).....	9.8	9.8 Volts
Control Grid Resistor (Per Section).....	0.5	0.2 Ohms
Load Resistance.....	6000	6000 Ohms
Total Harmonic Distortion.....	2.5	2.0 Per Cent
Power Output.....	175	225 Milliwatts

### TRANSFORMER COUPLED CLASS A<sub>2</sub>

Heater Voltage.....	28.0 Volts
Plate Voltage§.....	28.0 Volts
Screen Voltage.....	28.0 Volts
Grid Voltage.....	0 Volt
Self-Bias Resistor.....	0 Ohms
Zero Signal Plate Current.....	64.0 Ma.
Maximum Signal Plate Current.....	58.0 Ma.
Zero Signal Screen Current.....	4.0 Ma.
Maximum Signal Screen Current.....	17.0 Ma.
Peak AF Signal Voltage (G to G).....	17.8 Volts
Load Resistance (Plate to Plate).....	1500 Ohms
Total Harmonic Distortion.....	11.0 Per Cent
Power Output.....	600 Milliwatts

§The above characteristics may be realized provided the DC plate circuit resistance does not exceed 50 ohms per section.

## APPLICATION

Sylvania Type 28D7 is a double beam power output tube of Lock-In construction designed for low voltage operation. Comparatively large power outputs are obtainable with very low applied plate voltages. Power outputs of 150 milliwatts or more are readily obtainable using this type of tube in a push-pull circuit employing self-bias. However, each section may be used as desired, separately, parallel or push-pull. Whenever a source of separate bias can be provided, the useful plate voltage will be increased by the amount of the bias. In low voltage operation slight increases in plate voltage are important in giving improved performance. In some cases this bias can be obtained from an oscillator, making a separate battery for bias unnecessary.

# 28D7 (Cont'd)

The precautions usually recommended for satisfactory performance of output stages are especially important with Type 28D7. Grid resistors should not exceed values specified so as to minimize the effects of grid currents. A low- $\mu$  driver tube (20 or less) is more satisfactory than high- $\mu$  tubes for maintaining high output with low distortion. Greatest power output is provided by using another 28D7 with sections paralleled coupled to the output stage by means of a coupling transformer of 5.75:1 impedance ratio (primary to  $\frac{1}{2}$  secondary). Power outputs in the order of 600 milliwatts at 11% distortion are obtainable in this manner at plate voltages of 28 volts with Class A2 operating conditions. At 600 mw., driver power output of 80 mw. at 12.8 volts is required.

Additional information available on request.

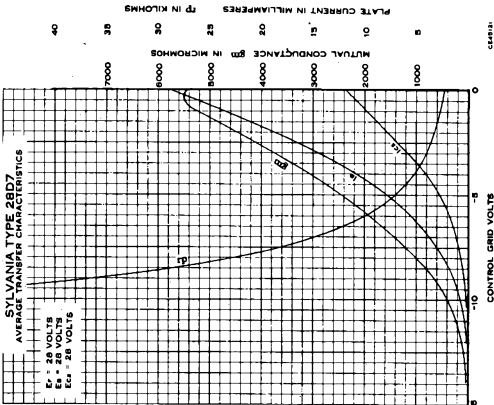
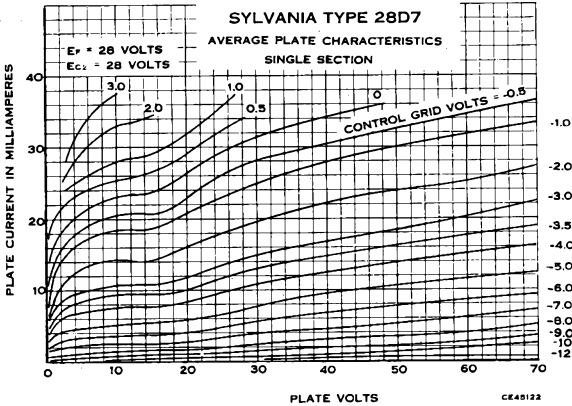

## 35A5 Sylvania Type

BEAM POWER AMPLIFIER

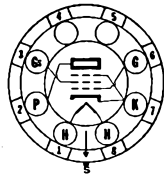
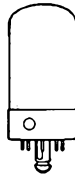

### PHYSICAL SPECIFICATIONS

Base.....	Lock-In 8 Pin
Bulb.....	T-9
Maximum Overall Length.....	3 5/8"
Maximum Seated Height.....	2 5/8"
Mounting Position.....	Any

SYLVANIA RADIO TUBES



## RATINGS

Heater Voltage AC or DC.....	35.0 Volts
Heater Current.....	150 Ma.
Maximum Plate Voltage.....	200 Volts
Maximum Screen Voltage.....	125 Volts
Maximum Plate Dissipation.....	8.5 Watts
Maximum Screen Dissipation.....	1.0 Watt
Maximum Heater-Cathode Voltage.....	90 Volts

## TYPICAL OPERATION

Heater Voltage AC or DC.....	35.0	35.0 Volts
Heater Current.....	150	150 Ma.
Plate Voltage.....	110	200 Volts
Screen Voltage.....	110	125 Volts
Grid Voltage*.....	-7.5	*** Volts
Peak Signal Voltage.....	7.5	8.0 Volts
Self-Bias Resistor.....	175	180 Ohms
Zero Signal Plate Current.....	40	43 Ma.
Maximum Signal Plate Current.....	41	43 Ma.
Zero Signal Screen Current.....	3.0	2.0 Ma.
Maximum Signal Screen Current.....	7.0	5.5 Ma.
Plate Resistance.....	14000	34000 Ohms
Mutual Conductance.....	5800	6100 $\mu$ mhos
Load Resistance.....	2500	5000 Ohms
Power Output.....	1.5	3.0 Watts
Total Harmonic Distortion.....	10	10 %

\*The maximum grid circuit resistance under fixed bias conditions should not exceed 0.1 megohm and for self-bias 0.5 megohm.

\*\*\*Obtained by self-bias resistor. Fixed bias operation at maximum ratings is not recommended.

## APPLICATION

Sylvania Type 35A5 is a beam power amplifier of Lock-In construction and is designed especially for use in the output stage of AC-DC and DC receivers. The heater ratings make this tube suitable for use with 150 Ma. tubes in receivers using series heater circuits. Electrically, this type is equivalent to Type 35L6GT.

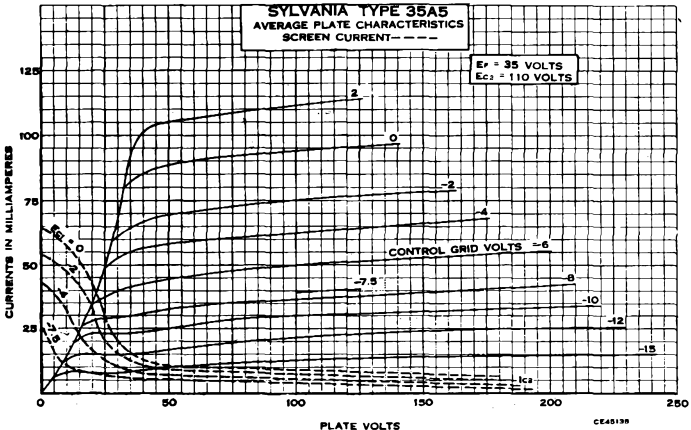

7BZ-0-0



## Sylvania Type 35B5

BEAM POWER AMPLIFIER

## PHYSICAL SPECIFICATIONS

Base.....	Miniature Button 7 Pin
Bulb.....	T-5 1/2"
Maximum Overall Length.....	2 5/8"
Maximum Seated Height.....	2 3/8"
Mounting Position.....	Any

# 35B5 (Cont'd)

## RATINGS

Heater Voltage AC or DC .....	35.0 Volts
Heater Current .....	150 Ma.
Maximum Plate Voltage .....	117 Volts
Maximum Screen Voltage .....	117 Volts
Maximum Plate Dissipation .....	4.5 Watts
Maximum Screen Dissipation .....	1.0 Watts
Maximum Peak Heater-Cathode Voltage .....	150 Volts
<b>Direct Interelectrode Capacitances:*</b>	
Control Grid to Plate .....	0.4 $\mu$ mf.
Input .....	11.0 $\mu$ mf.
Output .....	6.5 $\mu$ mf.
*With no external shield.	

## TYPICAL OPERATION

Heater Voltage .....	35.0 Volts
Heater Current .....	150 Ma.
Plate Voltage .....	110 Volts
Screen Voltage .....	110 Volts
Control Grid Voltage .....	-7.5 Volts
Peak Signal Voltage .....	7.5 Volts
Self-Bias Resistor .....	175 Ohms
Zero Signal Plate Current .....	40 Ma.
Maximum Signal Plate Current .....	41 Ma.
Zero Signal Screen Current .....	3.0 Ma.
Maximum Signal Screen Current .....	7.0 Ma.
Plate Resistance .....	14,000 Ohms
Mutual Conductance .....	5800 $\mu$ mhos
Load Resistance .....	2500 Ohms
Power Output .....	1.5 Watts
Total Harmonic Distortion .....	10 %

## APPLICATION

Sylvania Type 35B5 is a miniature output tube having the same characteristics as Sylvania Type 35A5 but for operation under the 110 volt condition only. For curve data reference should be made to Type 35A5.

# 35C5 Sylvania Type

BEAM POWER AMPLIFIER

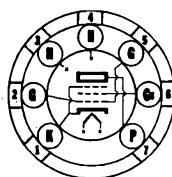

7CV-0-0

NOTE: With the exception of the base diagram given above the characteristics of Type 35C5 are identical with those given for Type 35B5 on this page.

# 35L6<sup>GT</sup> Sylvania Type

BEAM POWER AMPLIFIER



7S-0-0

## PHYSICAL SPECIFICATIONS

Base .....	Intermediate Octal 7 Pin
Bulb .....	T-9
Maximum Overall Length .....	3 $\frac{5}{16}$ "
Maximum Seated Height .....	2 $\frac{3}{4}$ "
Mounting Position .....	Any

**RATINGS**

Heater Voltage AC or DC.....	35.0	Volts
Heater Current.....	150	Ma.
Maximum Plate Voltage.....	200	Volts
Maximum Screen Voltage.....	125	Volts
Maximum Plate Dissipation.....	8.5	Watts
Maximum Screen Dissipation.....	1.0	Watt
Maximum Heater-Cathode Voltage.....	90	Volts

**TYPICAL OPERATION**

Heater Voltage.....	35.0	35.0	Volts
Heater Current.....	150	150	Ma.
Plate Voltage.....	110	200	Volts
Screen Voltage.....	110	125	Volts
Grid Voltage *.....	-7.5	**	Volts
Cathode Bias Resistor.....	175	180	Ohms
Peak Signal Voltage.....	7.5	8.0	Volts
Plate Current.....	40	43	Ma.
Maximum Signal Plate Current.....	41	43	Ma.
Screen Current (Approx.).....	3.0	2.0	Ma.
Maximum Signal Screen Current.....	7.0	5.5	Ma.
Plate Resistance (Approx.).....	14,000	34,000	Ohms
Mutual Conductance.....	5800	6100	$\mu$ mhos
Load Resistance.....	2500	5000	Ohms
Power Output.....	1.5	3.0	Watts
Total Harmonic Distortion.....	10.0	10.0	%

\*For fixed bias circuits the grid circuit resistance should not exceed 0.1 megohm; for self-bias operation 0.5 megohm should be the maximum.

\*\*Obtained by self-bias resistor. Fixed bias operation at maximum ratings is not recommended.

**APPLICATION**

Sylvania Type 35L6GT is a beam power amplifier tube designed for use as an output tube in AC-DC receivers. It is similar to type 25L6GT in application and equivalent to Lock-In types 35A5. Type 35L6GT is capable of delivering large power outputs at reasonable distortion levels with relatively low applied voltages. For curve data, refer to Lock-in Type 35A5.

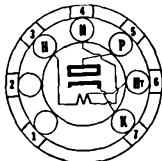

5BQ-0-0



**Sylvania Type 35W4**

**HALF-WAVE RECTIFIER**

**PHYSICAL SPECIFICATIONS**

Base.....	Miniature Button 7 Pin
Bulb.....	T-5 1/2
Maximum Overall Length.....	2 5/8"
Maximum Seated Height.....	2 3/8"
Mounting Position.....	Any

**RATINGS**

Heater Voltage AC or DC.....	35.0	Volts
Heater Current.....	150	Ma.
Maximum Peak Inverse Plate Voltage.....	330	Volts
Maximum Peak Plate Current.....	600	Ma.
Maximum DC Output Current.....		
With Panel Lamp (No shunting resistor).....	60	Ma.
(With shunting resistor).....	90	Ma.
Without Panel Lamp.....	100	Ma.
Maximum Voltage Panel Lamp Section (Panel Lamp Open).....	15	Volts
Maximum Peak Heater-Cathode Voltage.....	330	Volts
Tube Voltage Drop at 200 Ma. Plate Current.....	18	Volts

**TYPICAL OPERATION**

<b>With No. 40 or No. 47 Panel Lamps and 40 <math>\mu</math>f. Condenser Input Filter</b>					
Heater Voltage.....	32.0	32.0	32.0	32.0	Volts
Heater Current.....	150	150	150	150	Ma.
RMS Plate Supply.....	117	117	117	117	Volts
Min. Effective Plate Supply Impedance.....	15	15	15	15	Ohms
Panel Lamp Shunting Resistor.....	300	150	100	100	Ohms
DC Output Current.....	60	70	80	90	Ma.

# 35W4 (Cont'd)

With 40  $\mu$ f. Input Condenser and No Panel Lamp

Heater Voltage.....	35.0 Volts
Heater Current.....	150 Ma.
RMS Supply Voltage.....	117 Volts
Minimum Effective Plate Supply Impedance.....	15 Ohms
DC Output Current.....	100 Ma.
Maximum Value of Panel Lamp Shunting Resistor	
70 Ma. Output.....	800 Ohms
80 Ma. Output.....	400 Ohms
90 Ma. Output.....	250 Ohms

## APPLICATION

Sylvania Type 35W4 is a miniature style half-wave rectifier with tapped heater for panel lamp operation. It is similar in application to Type 35Z5GT and Lock-In Type 35Y4. Care should be taken in designing equipment for use with this tube to assure adequate ventilation as this tube, in common with other rectifiers, runs at quite high temperatures.

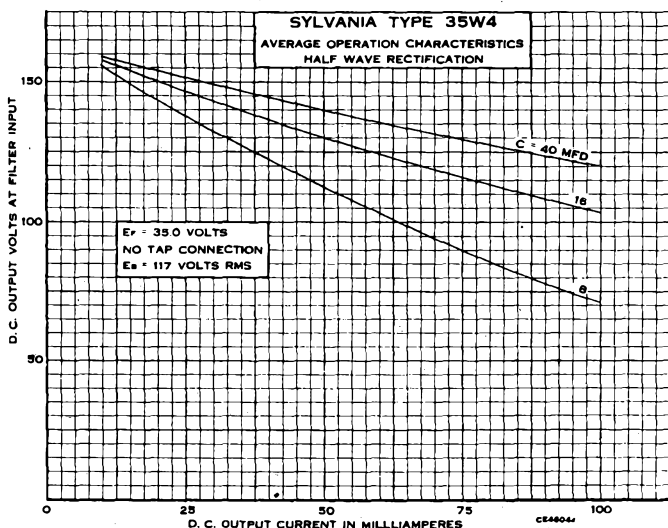

# 35Y4 Sylvania Type

HALF-WAVE RECTIFIER

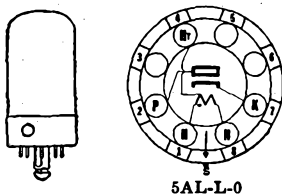

## PHYSICAL SPECIFICATIONS

Base.....	Lock-In 8 Pin
Bulb.....	T-9
Maximum Overall Length.....	3 3/4"
Maximum Seated Height.....	2 3/8"
Mounting Position.....	Any

## RATINGS

Heater Voltage AC or DC.....	35.0 Volts
Heater Current.....	150 Ma.
Maximum AC Plate Voltage (RMS).....	235 Volts
Maximum Peak Inverse Voltage.....	700 Volts
Maximum Steady State Peak Plate Current.....	600 Ma.
Maximum Peak Heater-Cathode Voltage.....	350 Volts
Maximum DC Output Current	
Without Panel Lamp.....	100 Ma.
With Panel Lamp and Shunting Resistor.....	90 Ma.
With Panel Lamp and No Shunting Resistor.....	60 Ma.

<b>Maximum Value of Panel Lamp Shunting Resistor</b>	
For 70 Ma. DC Output Current.....	800 Ohms
For 80 Ma. DC Output Current.....	400 Ohms
For 90 Ma. DC Output Current.....	250 Ohms
<b>Tapped Section Voltage (Between Pins 1 and 4)</b>	
With 0.150 Ampere flowing between Pins 1 and 8.....	7.5 Volts
<b>Maximum Voltage Across Tapped Section when</b>	
Panel Lamp Fails (RMS).....	15.0 Volts
Tube Voltage Drop at 200 Ma. DC Plate Current.....	18 Volts

**TYPICAL OPERATION**

**With 40 Mfd. Input Condenser and No. 40 or 47 Panel Lamp**

Heater Voltage (Pins 1 and 8)....	32.0	32.0	32.0	32.0	32.0 Volts
Heater Current (Pins 4 and 8)....	150	150	150	150	150 Ma.
<b>Voltage Across Tapped Section of</b>					
Heater (Pins 1 and 4).....	5.5	5.5	5.5	5.5	5.5 Volts
AC Plate Voltage.....	117	117	117	117	235 Volts
DC Output Current.....	60	70	80	90	60 Ma.
<b>Minimum Effective Plate Supply</b>					
Impedance.....	15	15	15	15	100 Ohms
Panel Lamp Shunt Resistor.....		300	150	100	.... Ohms

**With 40 Mfd. Input Condenser and No Panel Lamp**

Heater Voltage (Pins 1 and 8).....	35.0	35.0 Volts
Heater Current (Pins 4 and 8).....	150	150 Ma.
Voltage Across Tapped Section of Heater (Pins 1 and 4)...	7.5	7.5 Volts
AC Plate Voltage (RMS).....	117	235 Volts
DC Output Current.....	100	100 Ma.
Minimum Effective Plate Supply Impedance.....	15	100 Ohms

**APPLICATION**

Sylvania Type 35Y4 is a high-vacuum type rectifier tube of Lock-In construction designed for use in AC-DC receivers. Its heater ratings enable it to be used in series with other tubes in the 150-Ma. heater group. A heater tap has been brought out to pin No. 4 to provide for panel lamp operation. When so used, the rectifier plate should be connected to this tap so that rectifier plate current will also pass through the lamp. At higher dc load conditions, a shunt resistor on the panel lamp is essential.

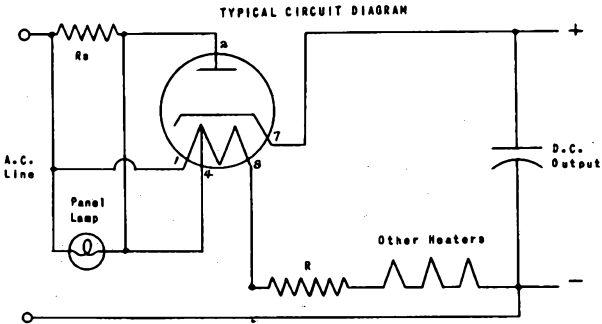

**Rs** Pilot Lamp Shunt Resistor

**R** Ballast Resistor

# 35Y4 (Cont'd)

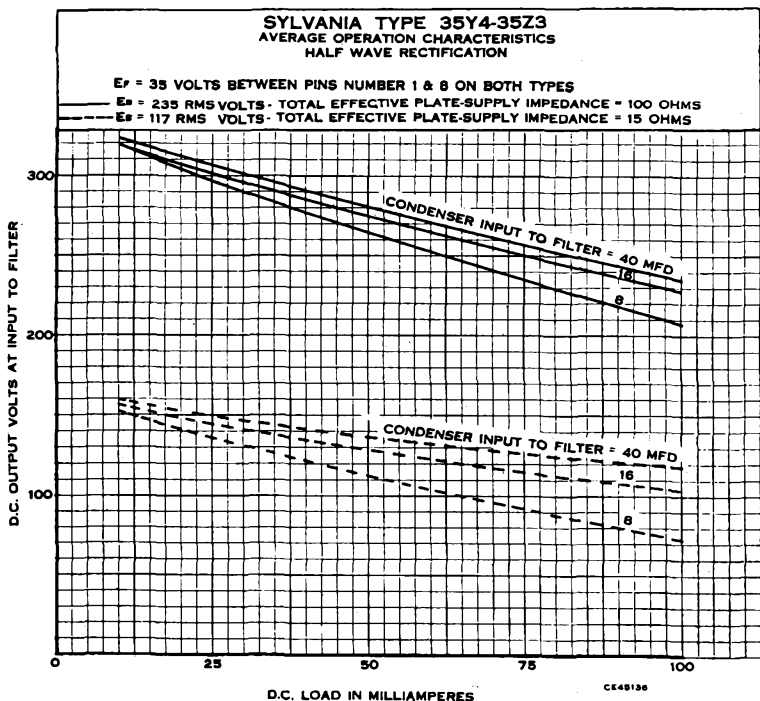

# 35Z3 Sylvania Type

HALF-WAVE RECTIFIER

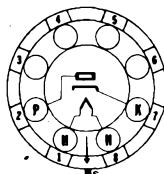

4Z-L-0

## PHYSICAL SPECIFICATIONS

Base.....	Lock-In 8 Pin
Bulb.....	T-9
Maximum Overall Length.....	3 3/8"
Maximum Seated Height.....	2 5/8"
Mounting Position.....	Any

## RATINGS

Heater Voltage AC or DC.....	35.0 Volts
Heater Current.....	150 Ma.
Maximum AC (RMS) Plate Voltage.....	235 Volts
Maximum Peak Heater-Cathode Voltage.....	350 Volts
Maximum Peak Inverse Voltage.....	700 Volts
Maximum Steady State Peak Plate Current.....	600 Ma.
Tube Voltage Drop at 200 Ma. DC Plate Current.....	18 Volts
Maximum DC Output Current.....	100 Ma.

## TYPICAL OPERATION HALF-WAVE RECTIFIER

Heater Voltage (AC or DC).....	35.0	35.0 Volts
Heater Current.....	150	150 Ma.
AC Plate Voltage RMS.....	117	235 Volts
Minimum Total Effective Plate Supply Impedance.....	15	100 Ohms
DC Output Current.....	100	100 Ma.

## APPLICATION

Sylvania Type 35Z3 is a high-vacuum half-wave rectifier of Lock-In construction, especially designed for use in compact AC-DC receivers. Characteristics are the same as those of 35Z4GT and 35Y4 except that the latter makes provision for the use of a pilot lamp.

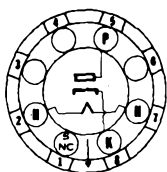

5AA-0-0



## Sylvania Type 35Z4

HALF-WAVE RECTIFIER

### PHYSICAL SPECIFICATIONS

Base.....	Intermediate Octal 6 Pin
Bulb.....	T-9
Maximum Overall Length.....	3 $\frac{3}{4}$ "
Maximum Seated Height.....	2 $\frac{3}{4}$ "
Mounting Position.....	Any

### TYPICAL OPERATION

Heater Voltage.....	35.0	35.0 Volts
Heater Current.....	150	150 Ma.
AC Plate Supply Voltage (RMS).....	117	235 Volts
Minimum Plate Supply Impedance.....	15	100 Ohms
DC Output Current.....	100	100 Ma.
Tube Voltage Drop at 200 Ma. DC Plate Current.....		18 Volts

### APPLICATION

Sylvania Type 35Z4GT is a half-wave high-vacuum rectifier tube designed for AC-DC receiver service. It is similar to type 35Z5GT and to Lock-In type 35Y4 except that it does not have the heater tap for use with a pilot light.



6AD-0-0



## Sylvania Type 35Z5<sup>GT</sup>

HALF-WAVE RECTIFIER

### PHYSICAL SPECIFICATIONS

Base.....	Intermediate Octal 6 Pin
Bulb.....	T-9
Maximum Overall Length.....	3 $\frac{3}{16}$ "
Maximum Seated Height.....	2 $\frac{3}{4}$ "
Mounting Position.....	Any

### TYPICAL OPERATION \* \*

#### CONDENSER INPUT

Heater Voltage.....	35.0 Volts
Heater Current.....	150 Ma.
AC Plate Voltage (RMS).....	125 Volts Max.
DC Output Current*.....	60 Ma. Max.
DC Output Current**.....	100 Ma. Max.
Maximum Peak Inverse Voltage.....	700 Volts
Maximum Peak Plate Current.....	600 Ma.
Series Plate Resistor.....	25 Ohms Min.
Tube Voltage Drop at 200 Ma.**.....	18 Volts
Maximum Peak Heater-Cathode Voltage.....	350 Volts

\*With rectified plate current through the panel lamp section of the heater shunted by a 6.3 volt, 0.150 ampere panel lamp, (Sylvania Panel Lamp S40 or S47).

\*\*Panel lamp not connected.

### APPLICATION

Sylvania Type 35Z5G is a half-wave high-vacuum rectifier designed for use in ac-dc and dc line operated receivers. The 35-volt heater is tapped to permit operation of a Sylvania S40 or S47 panel lamp across Pins 2 and 3. Conventional half-wave rectifier circuits are applicable.

A peak limiting resistor of at least 25 ohms must be used in series with the plate and a surge limiting resistor should be placed in series with the heaters of the other tubes in the heater circuit.

Reference should be made to the Lock-In equivalent Type 35Y4 for further data.

# 45Z3 Sylvania Type

HALF-WAVE HIGH-VACUUM  
RECTIFIER

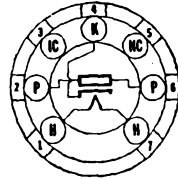

5AM-0-0

## PHYSICAL SPECIFICATIONS

Base.....	Miniature Button 7 Pin
Bulb.....	T-5 1/2
Maximum Overall Length.....	2 1/8"
Maximum Seated Height.....	1 7/8"
Mounting Position.....	Any

## RATINGS

Heater Voltage AC or DC.....	45 Volts
Heater Current.....	75 Ma.
Maximum Peak Inverse Voltage.....	350 Volts
Maximum Peak Plate Current.....	390 Ma.
Maximum Peak Heater-Cathode Voltage.....	330 Volts

## TYPICAL OPERATION

Heater Voltage.....	45 Volts
Heater Current.....	75 Ma.
RMS Plate Voltage.....	117 Volts
Minimum Effective Plate Supply Impedance.....	15 Ohms
Output Current DC*.....	65 Ma.

\*Condenser input filter.

# 50A5 Sylvania Type

BEAM POWER AMPLIFIER

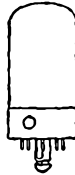

6AA-L-0

## PHYSICAL SPECIFICATIONS

Base.....	Lock-In 8 Pin
Bulb.....	T-9
Maximum Overall Length.....	3 5/8"
Maximum Seated Height.....	2 3/8"
Mounting Position.....	Any

## RATINGS

Heater Voltage AC or DC.....	50.0 Volts
Heater Current.....	0.150 Ampere
Maximum Plate Voltage.....	200 Volts
Maximum Screen Voltage.....	117 Volts
Maximum Plate Dissipation.....	10 Watts
Maximum Screen Dissipation.....	1.25 Watts
Maximum Heater-Cathode Voltage.....	90 Volts

## TYPICAL OPERATION

### CLASS A<sub>1</sub> AMPLIFIER

Heater Voltage AC or DC.....	50.0	50.0 Volts
Heater Current.....	0.150	0.150 Ampere
Plate Voltage.....	110	200 Volts
Screen Voltage.....	110	125 Volts
Grid Voltage*.....	-7.5	** Volts
Peak Signal Voltage.....	7.5	8.0 Volts
Self-Bias Resistor.....	175	180 Ohms
Zero Signal Plate Current.....	49	46 Ma.
Maximum Signal Plate Current.....	50	47 Ma.
Zero Signal Screen Current.....	4.0	2.2 Ma.
Maximum Signal Screen Current.....	10.0	8.5 Ma.
Plate Resistance.....	13,000	28,000 Ohms
Mutual Conductance.....	8000	8000 μmhos
Load Resistance.....	2000	4000 Ohms
Power Output.....	2.1	3.8 Watts
Total Harmonic Distortion.....	10	10 Percent

\*The maximum grid circuit resistance under fixed bias conditions should not exceed 0.1 megohm and for self-bias 0.5 megohm.

\*\*Obtained by self-bias resistor; fixed bias operation not recommended.



**APPLICATION**

Sylvania Type 50A5 is a beam power amplifier of Lock-In construction designed especially for use as an output tube in AC-DC receivers using other 150 ma. heater tubes operating in series heater circuits. The beam power construction gives high power output and good power sensitivity, at reasonable distortion levels. Transformer or impedance coupling is to be preferred for input circuits but resistance coupling methods are satisfactory provided the grid circuit resistance does not exceed 0.1 megohm with fixed bias or 0.5 megohms with self bias.

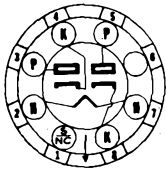
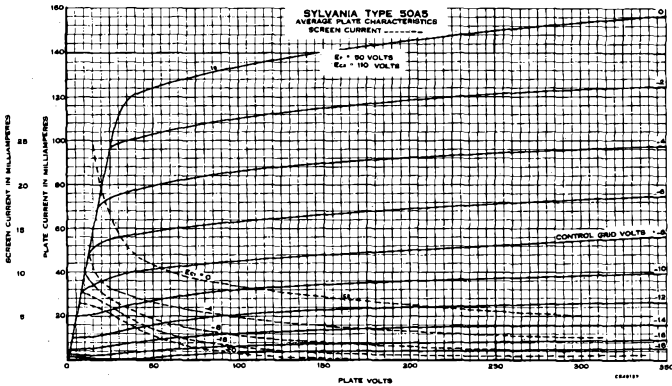

7Q-0-0



**Sylvania Type 50AX6G**

**FULL WAVE RECTIFIER**

**RATINGS AND OPERATION**

Heater Voltage AC or DC..... 50 Volts  
 Heater Current..... 300 Ma.

For other data, refer to corresponding Type 6AX6G which is identical except for heater ratings.

**50B5 Sylvania Type**

**BEAM POWER AMPLIFIER**

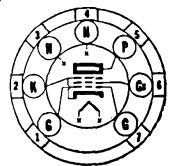
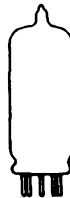

7BZ-0-0

**PHYSICAL SPECIFICATIONS**

Base..... Miniature Button 7 Pin  
 Bulb..... T-5 1/2  
 Maximum Overall Length..... 2 3/8"  
 Maximum Seated Height..... 2 3/8"  
 Mounting Position..... Any

**RATINGS**

Heater Voltage AC or DC..... 50 Volts  
 Heater Current..... 150 Ma.  
 Maximum Plate Voltage..... 135 Volts  
 Maximum Screen Voltage..... 117 Volts  
 Maximum Plate Dissipation..... 5.5 Watts  
 Maximum Screen Dissipation..... 1.25 Watts  
 Maximum Heater-Cathode Voltage..... 180 Volts

# 50B5 (Cont'd)

## TYPICAL OPERATION

Heater Voltage.....	50 Volts
Heater Current.....	150 Ma.
Plate Voltage.....	110 Volts
Screen Voltage.....	110 Volts
Control Grid Voltage.....	-7.5 Volts
Peak Signal Voltage.....	7.5 Volts
Zero Signal Plate Current.....	49 Ma.
Maximum Signal Plate Current.....	50 Ma.
Zero Signal Screen Current.....	4.0 Ma.
Maximum Signal Screen Current.....	8.5 Ma.
Plate Resistance (Approximate).....	10000 Ohms
Mutual Conductance.....	7500 $\mu$ mhos
Load Resistance.....	2500 Ohms
Total Harmonic Distortion.....	9.0 Percent
Maximum Signal Power Output.....	1.9 Watts

## APPLICATION

Sylvania Type 50B5 is a beam power output amplifier tube of miniature style of construction. It is similar in application to Type 35L6GT, 50L6GT and Lock-In Types 35A5 and 50A5. Grid circuit resistances should not exceed 0.5 megohm for self bias or 0.1 megohm for fixed bias. Due to the high temperature at which these tubes operate, adequate ventilation should be assured in equipment designed for their use.

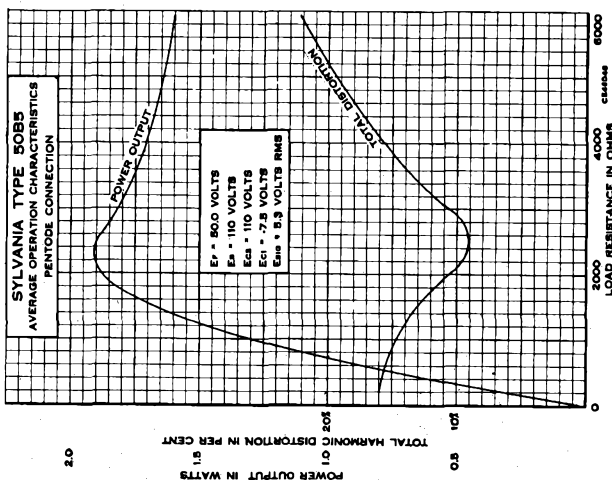
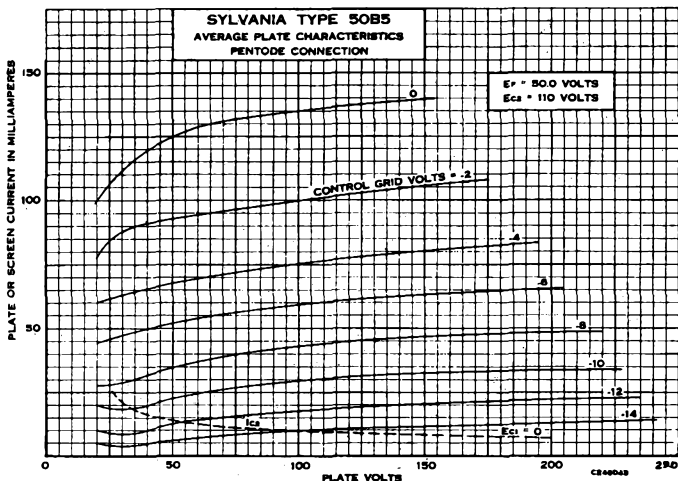

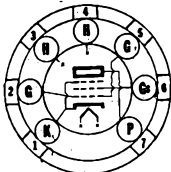

7CV-0-0



## Sylvania Type 50C5

BEAM POWER AMPLIFIER

NOTE: With the exception of the base diagram given above the characteristics of Type 50C5 are identical with those given for Type 50B5.



7S-0-0



## Sylvania Type 50C6G

BEAM POWER AMPLIFIER

### RATINGS AND OPERATION

Heater Voltage AC or DC..... 50.0 Volts  
 Heater Current..... 150 Ma.

For other data refer to corresponding Type 6Y6G which is identical except for heater ratings.



7S-0-0



## Sylvania Type 50L6GT

BEAM POWER AMPLIFIER

### PHYSICAL SPECIFICATIONS

Base..... Intermediate Octal 7 Pin  
 Bulb..... T-9  
 Maximum Overall Length..... 3<sup>5</sup>/<sub>16</sub>"  
 Maximum Seated Height..... 2<sup>3</sup>/<sub>4</sub>"  
 Mounting Position..... Any

### RATINGS

Heater Voltage AC or DC..... 50 Volts  
 Heater Current..... 150 Ma.  
 Maximum Plate Voltage..... 200 Volts  
 Maximum Screen Voltage..... 117 Volts  
 Maximum Plate Dissipation..... 10 Watts  
 Maximum Screen Dissipation..... 1.25 Watts  
 Maximum Heater Cathode Voltage..... 90 Volts

### TYPICAL OPERATION

#### CLASS A<sub>1</sub> AMPLIFIER

Heater Voltage.....	50	50 Volts
Heater Current.....	150	150 Ma.
Plate Voltage.....	110	200 Volts
Screen Voltage.....	110	125 Volts
Grid Voltage*.....	-7.5	** Volts
Self-Bias Resistor.....	140	180 Ohms
Peak AF Grid Signal.....	7.5	8.3 Volts
Plate Resistance (Approx.).....	13,000	28,000 Ohms
Mutual Conductance.....	8000	8000 μmhos
Zero Signal Plate Current.....	49	46 Ma.
Maximum Signal Plate Current.....	50	47 Ma.
Zero Signal Screen Current (Approx.).....	4.0	2.2 Ma.
Maximum Signal Screen Current (Approx.).....	10.0	8.5 Ma.
Load Resistance.....	2000	4000 Ohms
Power Output.....	2.1	3.8 Watts
Total Harmonic Distortion.....	10	10 Percent

\*Under rated maximum conditions, grid circuit resistance should not exceed 0.5 megohm for self-bias operation, and 0.1 megohm for fixed bias operation.

\*\*Obtained by self-bias resistor. Fixed bias operation not recommended.

### APPLICATION

Sylvania Type 50L6GT is a beam power output tube designed for use in series heater circuits with other tubes in the 150 Ma. heater group. It is very similar in characteristics to Sylvania Lock-In Type 50A5 and reference should also be made to that type for further application information.

SYLVANIA RADIO TUBES

# 50X6 Sylvania Type

HIGH-VACUUM RECTIFIER

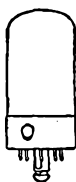

7AJ-L-0

## PHYSICAL SPECIFICATIONS

Base.....	Lock-In 8 Pin
Bulb.....	T-9
Maximum Overall Length.....	3 5/8"
Maximum Seated Height.....	2 5/8"
Mounting Position.....	Any

## RATINGS

Heater Voltage AC or DC 10%.....	50.0 Volts
Heater Current.....	150 Ma.
Maximum Inverse Plate Voltage.....	700 Volts
Maximum Steady State Peak Current Per Plate.....	450 Ma.
Maximum DC Output Current Per Plate.....	75 Ma.
Maximum Heater to Cathode Voltage.....	350 Volts
Tube Voltage Drop at 150 Ma. Per Plate.....	22 Volts

## TYPICAL OPERATION

### VOLTAGE DOUBLER

	Half Wave	Full Wave
Heater Voltage AC or DC.....	50	50 Volts
Heater Current.....	150	150 Ma.
AC Plate Voltage Per Plate RMS.....	117	117 Volts
Filter Input Condenser.....	16	16 Mfd.
Minimum Total Effective Plate Supply Impedance.....	30	15 Ohms
DC Output Current.....	75	75 Ma.

### HALF-WAVE RECTIFIER

#### Single Section — Condenser Input Filter

Heater Voltage AC or DC.....	50	50	50 Volts
Heater Current.....	150	150	150 Ma.
Plate Supply Voltage AC (RMS).....	117	150	235 Volts
Filter Input Condenser.....	16	16	16 Mfd.
Minimum Total Effective Plate Supply Impedance.....	15	40	100 Ohms
DC Output Current.....	75	75	75 Ma.

# 50Y6<sup>GT</sup> Sylvania Type

HIGH-VACUUM RECTIFIER

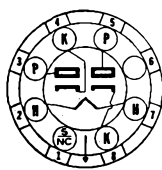
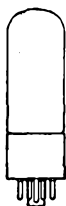

7Q-0-0

## RATINGS AND OPERATION

Heater Voltage AC or DC.....	50 Volts
Heater Current.....	150 Ma.

For other data refer to corresponding Type 25Z6GT which is identical except for heater ratings.



8AN-0-0



# Sylvania Type 50Y7<sup>GT</sup>

HIGH-VACUUM RECTIFIER DOUBLER

## PHYSICAL SPECIFICATIONS

Base.....	Intermediate Shell 8 Pin Octal
Bulb.....	T-9
Maximum Overall Length.....	3 <sup>5</sup> / <sub>16</sub> "
Maximum Seated Height.....	2 <sup>3</sup> / <sub>4</sub> "
Mounting Position.....	Any

## RATINGS

Heater Voltage AC or DC.....	50 Volts
Heater Current.....	150 Ma.
Maximum Peak Inverse Plate Voltage.....	700 Volts
Maximum AC Plate Voltage per Plate (RMS) Voltage Doubler Service.....	117 Volts
Half-Wave Rectifier.....	235 Volts
Maximum Steady State Peak Current per Plate.....	450 Ma.
Maximum Peak Heater-Cathode Voltage.....	350 Volts
Tapped Section Voltage (Pins 6 & 7).....	7.5 Volts
Tube Voltage Drop at 150 Ma. per Plate.....	22 Volts
Maximum DC Output Current per Plate.....	75 Ma.
Maximum DC Output Current per Plate with Panel Lamp.....	60 Ma.
with Shunt Resistor.....	65 Ma.

## TYPICAL OPERATION

### FULL-WAVE VOLTAGE DOUBLER

	No Panel Lamp	With No. 40 or No. 47 Panel Lamp
Heater Voltage.....	50	46 Volts
Plate Supply Voltage AC (RMS).....	117	117 Volts
DC Output Current.....	75	65 Ma.
Minimum Total Effective Plate Supply Resistance per Plate.....	15	15 Ohms
Panel Lamp Shunting Resistor.....		250 Ohms
Panel Lamp Voltage.....		5.5 Volts

### Half-Wave Rectifier per Section—No Panel Lamp

Heater Voltage.....	50	50	50 Volts
Heater Current.....	150	150	150 Ma.
Plate Supply Voltage AC (RMS).....	117	150	235 Volts
Filter Input Capacitance.....	16	16	16 $\mu$ f.
Minimum Total Effective Plate Supply Impedance.....	15	40	100 Ohms
DC Output Current.....	75	75	75 Ma.

### Half-Wave Rectifier per Section—With Panel Lamp

Heater Voltage.....	46	46	46 Volts
Heater Current (Pins 2 & 6).....	150	150	150 Ma.
Plate Supply Voltage AC (RMS).....	117	150	235 Volts
Filter Input Capacitance.....	16	16	16 $\mu$ f.
Minimum Total Effective Plate Supply Impedance.....	15	40	100 Ohms
DC Output Current.....	65	65	65 Ma.
Panel Lamp Voltage.....	5.5	5.5	5.5 Volts
Panel Lamp Shunting Resistor.....	250	250	250 Ohms

## APPLICATION

Sylvania Type 50Y7<sup>GT</sup> is a high-vacuum rectifier designed for voltage doubler or half-wave service in sets requiring a panel lamp.

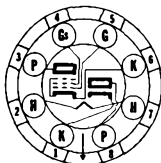

8AA-0-0



# Sylvania Type 70L7<sup>GT</sup>

RECTIFIER

BEAM POWER AMPLIFIER

## PHYSICAL SPECIFICATIONS

Base.....	Intermediate Octal 8 Pin
Bulb.....	T-9
Maximum Overall Length.....	3 <sup>1</sup> / <sub>16</sub> "
Maximum Seated Height.....	2 <sup>1</sup> / <sub>8</sub> "
Mounting Position.....	Any

# 70L7<sup>GT</sup> (Cont'd)

## RATINGS

Heater Voltage AC or DC.....	70.0 Volts
Heater Current.....	0.150 Ampere

### RECTIFIER UNIT

Maximum AC Plate Voltage (RMS).....	117 Volts
Maximum Peak Inverse Voltage.....	350 Volts
Maximum DC Heater-Cathode Voltage.....	175 Volts
Maximum Steady State Peak Plate Current.....	420 Ma.
Tube Voltage Drop at 140 Ma. applied DC.....	20 Volts

### AMPLIFIER UNIT

Maximum Plate Voltage.....	117 Volts
Maximum Screen Voltage.....	117 Volts
Maximum Plate Dissipation.....	5.0 Watts
Maximum Screen Dissipation.....	1.0 Watt
Maximum Heater-Cathode Voltage.....	90 Volts

## TYPICAL OPERATION

Heater Voltage.....	70 Volts
Heater Current.....	0.150 Ampere

### RECTIFIER UNIT

AC Plate Voltage.....	117 Volts
DC Output Current.....	70 Ma.
Minimum Effective Plate Supply Impedance.....	15 Ohms

### AMPLIFIER UNIT CLASS A<sub>1</sub>

Plate Voltage.....	110 Volts
Screen Voltage.....	110 Volts
Grid Voltage.....	-7.5 Volts
Self-Bias Resistor.....	175 Ohms
Peak AF Grid Voltage.....	7.5 Volts
Zero Signal Plate Current.....	40 Ma.
Maximum Signal Plate Current.....	43 Ma.
Zero Signal Screen Current (Nominal).....	3.0 Ma.
Maximum Signal Screen Current (Nominal).....	6.0 Ma.
Plate Resistance.....	15000 Ohms
Mutual Conductance.....	7500 μmhos
Load Resistance.....	2000 Ohms
Maximum Signal Power Output.....	1.8 Watts
Total Harmonic Distortion.....	10 Percent

## 80 Sylvania Type

FULL-WAVE RECTIFIER



4C-0-0

## PHYSICAL SPECIFICATIONS

Base.....	Medium 4 Pin
Bulb.....	ST14
Maximum Overall Length.....	4 1/16"
Maximum Seated Height.....	4 1/16"
Mounting Position.....	Vertical †

†Horizontal operation permitted if pins 1 & 2 are in a vertical plane.

## RATINGS

Filament Voltage AC.....	5.0 Volts
Filament Current.....	2.0 Amperes
Peak Inverse Voltage.....	1400 Volts Max.
Tube Voltage Drop (125 Ma. per Plate).....	60 Volts

## TYPICAL OPERATION CONDENSER INPUT TO FILTER

AC Voltage per Plate (RMS).....	350 Volts Max.
DC Output Current.....	125 Ma. Max.
Plate Supply Impedance per Plate.....	50 Ohms Min.

## CHOKE INPUT TO FILTER

AC Voltage per Plate (RMS).....	500 Volts Max.
DC Output Current.....	125 Ma. Max.
Input Choke Value.....	10 Henrys

SYLVANIA RADIO TUBES



4C-0-0



## Sylvania Type 82

FULL-WAVE MERCURY VAPOR  
RECTIFIERS

### PHYSICAL SPECIFICATIONS

	TYPE 82	TYPE 83
Base.....	Medium 4 Pin	Medium 4 Pin
Bulb.....	ST14	ST16
Maximum Overall Length.....	4 <sup>11</sup> / <sub>16</sub> "	5 <sup>5</sup> / <sub>16</sub> "
Maximum Seated Height.....	4 <sup>1</sup> / <sub>16</sub> "	4 <sup>3</sup> / <sub>4</sub> "
Mounting Position.....	Vertical—Base Down	Vertical—Base Down

### RATINGS

Filament Voltage AC.....	2.5	5.0 Volts
Filament Current.....	3.0	3.0 Amperes
Maximum Peak Inverse Voltage.....	1550	1550 Volts
Tube Voltage Drop (Approximate)...	15	15 Volts

### TYPICAL OPERATION

#### CONDENSER INPUT TO FILTER

AC Voltage per Plate (RMS).....	450	450 Volts Max.
DC Output Current.....	115	225 Ma. Max.
Peak Plate Current.....	0.5	1.0 Ampere Max.
Plate Supply Impedance per Plate.....	50	50 Ohms Min.
Condensed Mercury Temperature Operating Range.....	24° to 60°	20° to 60° Centigrade

#### CHOKE INPUT TO FILTER

AC Voltage per Plate (RMS).....	550	550 Volts Max.
DC Output Current.....	115	225 Ma. Max.
Peak Plate Current.....	0.5	1.0 Ampere Max.
Input Choke Value (Minimum).....	6	3 Henrys
Condensed Mercury Temperature Operating Range.....	24° to 60°	20° to 60° Centigrade



4AD-0-0



## Sylvania Type 83V

FULL-WAVE HIGH-VACUUM  
RECTIFIER

### PHYSICAL SPECIFICATIONS

Base.....	Medium 4 Pin
Bulb.....	ST14
Maximum Overall Length.....	4 <sup>11</sup> / <sub>16</sub> "
Maximum Seated Height.....	4 <sup>1</sup> / <sub>16</sub> "
Mounting Position.....	Any

### RATINGS

Heater Voltage AC.....	5.0 Volts
Heater Current.....	2.0 Amperes
Maximum Peak Inverse Voltage.....	1400 Volts
Tube Voltage Drop (175 Ma. per Plate).....	25 Volts

### TYPICAL OPERATION

#### CONDENSER INPUT TO FILTER

AC Voltage per Plate (RMS).....	375 Volts Max.
DC Output Current.....	175 Ma. Max.
Plate Supply Impedance per Plate.....	100 Ohms Min.

#### CHOKE INPUT TO FILTER

AC Voltage per Plate.....	500 Volts Max.
DC Output Current.....	175 Ma. Max.
Input Choke Value (Minimum).....	4.0 Henrys

# 117L7/M7<sup>GT</sup> Sylvania Type

**RECTIFIER**  
**BEAM POWER AMPLIFIER**

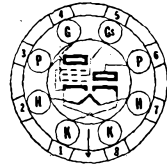

8A0-0-0

## PHYSICAL SPECIFICATIONS

Base.....	Intermediate Octal 8 Pin
Bulb.....	T-9
Maximum Overall Length.....	3 <sup>7</sup> / <sub>16</sub> "
Maximum Seated Height.....	2 <sup>3</sup> / <sub>8</sub> "
Mounting Position.....	Any

## RATINGS

Heater Voltage AC or DC.....	117 Volts
Heater Current.....	90 Ma.
Maximum Peak Inverse Voltage Rectifier Section.....	350 Volts
Maximum Peak Plate Current.....	450 Ma.
Maximum Peak Heater-Cathode Voltage.....	330 Volts

## AMPLIFIER SECTION

Maximum Plate Voltage.....	117 Volts
Maximum Screen Voltage.....	117 Volts
Maximum Plate Dissipation.....	6.0 Watts
Maximum Screen Dissipation.....	1.0 Watt

## TYPICAL OPERATION

Heater Voltage AC or DC.....	117 Volts
Heater Current.....	90 Ma.

## RECTIFIER SECTION CONDENSER INPUT FILTER

RMS Plate Voltage.....	117 Volts
DC Output Current.....	75 Ma.
Effective Plate Supply Impedance.....	15 Ohms

## AMPLIFIER SECTION

Plate Voltage.....	105 Volts
Screen Voltage.....	105 Volts
Grid Voltage.....	-5.2 Volts
Self-Bias Resistor.....	110 Ohms
Peak Signal Voltage.....	5.2 Volts
Zero Signal Plate Current.....	43 Ma.
Maximum Signal Plate Current.....	43 Ma.
Zero Signal Screen Current.....	4.0 Ma.
Maximum Signal Screen Current.....	5.5 Ma.
Plate Resistance (Approximate).....	17000 Ohms
Mutual Conductance.....	5300 $\mu$ mhos
Load Resistance.....	4000 Ohms
Total Harmonic Distortion.....	5 Percent
Maximum Signal Power Output.....	0.85 Watt

# 117N7<sup>GT</sup> Sylvania Type

**RECTIFIER**  
**BEAM POWER AMPLIFIER**

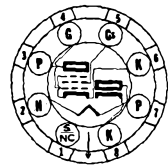

8AV-0-0

## PHYSICAL SPECIFICATIONS

Base.....	Intermediate Octal 8 Pin
Bulb.....	T-9
Maximum Overall Length.....	3 <sup>7</sup> / <sub>16</sub> "
Maximum Seated Height.....	2 <sup>3</sup> / <sub>8</sub> "
Mounting Position.....	Any

## RATINGS

Heater Voltage AC or DC.....	117 Volts
Heater Current.....	90 Ma.

## RECTIFIER SECTION

Maximum Peak Inverse Voltage.....	350 Volts
Maximum Peak Plate Current.....	450 Ma.
Maximum Peak Heater-Cathode Voltage.....	330 Volts

SYLVANIA RADIO TUBES



**AMPLIFIER SECTION**

Maximum Plate Voltage.....	117 Volts
Maximum Screen Voltage.....	117 Volts
Maximum Plate Dissipation.....	5.5 Watts
Maximum Screen Dissipation.....	1.0 Watt
Maximum Heater-Cathode Voltage.....	90 Volts

**TYPICAL OPERATION**

Heater Voltage.....	117 Volts
Heater Current.....	90 Ma.

**RECTIFIER SECTION, CONDENSER INPUT FILTER**

RMS Plate Voltage.....	117 Volts
DC Output Current.....	75 Ma.
Effective Plate Supply Impedance*	15 Ohms

**AMPLIFIER SECTION**

Plate Voltage.....	100 Volts
Screen Voltage.....	100 Volts
Grid Voltage.....	-6.0 Volts
Self-Bias Resistor.....	105 Ohms
Peak Signal Voltage.....	6.0 Volts
Zero Signal Plate Current.....	51 Ma.
Zero Signal Screen Current.....	5.0 Ma.
Plate Resistance.....	16000 Ohms
Load Resistance.....	3000 Ohms
Mutual Conductance.....	7000 $\mu$ mhos
Total Harmonic Distortion.....	6 Percent
Maximum Signal Power Output.....	1.2 Watts

\*When more than a 40 mf. filter condenser is used at the filter input more plate supply impedance than the minimum shown may be required.

§Grid circuit resistance should not exceed 0.25 megohm with fixed bias or 1.0 megohm with self bias.

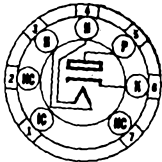

4CB-0-0

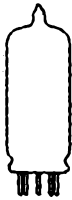
**Sylvania Type 117Z3****HALF-WAVE RECTIFIER****PHYSICAL SPECIFICATIONS**

Base.....	Miniature Button 7 Pin
Bulb.....	T-5 $\frac{1}{2}$
Maximum Overall Length.....	2 $\frac{5}{8}$ "
Maximum Seated Height.....	2 $\frac{3}{8}$ "
Mounting Position.....	Any

**RATINGS**

Heater Voltage (AC or DC).....	117 Volts
Heater Current.....	40 Ma.
Maximum AC Plate Voltage (RMS).....	117 Volts
Maximum Peak Heater to Cathode Voltage.....	
Cathode Positive.....	330 Volts
Cathode Negative.....	165 Volts
Maximum Peak Inverse Voltage.....	330 Volts
Maximum Steady State Peak Plate Current.....	540 Ma.
Tube Voltage Drop at 180 Ma. DC Plate Current.....	22.5 Volts
Maximum DC Output Current.....	90 Ma.
Maximum Plate Current Surge.....	1800 Ma.

**TYPICAL OPERATION**

Heater Voltage (AC or DC).....	117 Volts
Heater Current.....	40 Ma.
AC Plate Voltage (RMS).....	117 Volts
Output Current.....	90 Ma.
Minimum Total Effective Plate Supply Impedance.....	15 Ohms

**APPLICATION**

Sylvania Type 117Z3 is a miniature half-wave rectifier designed for use in portable and AC-DC receivers. The output is sufficient for operation of combination battery portables with the high efficiency 50 Ma tubes in series.

# 117Z3 (Cont'd)

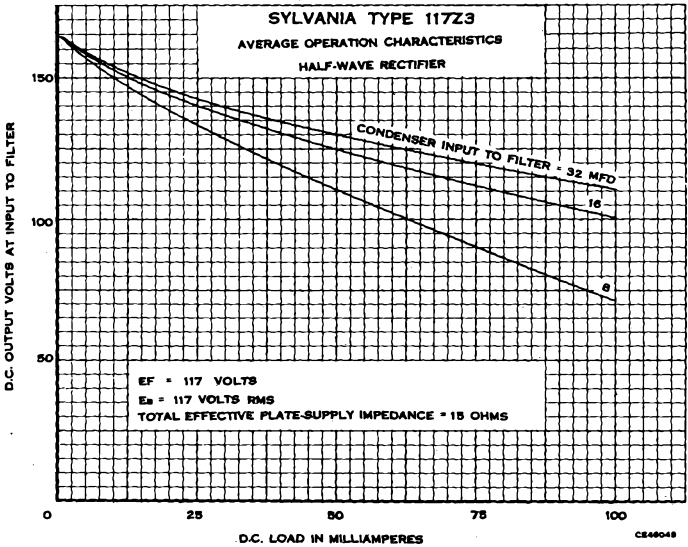

## 117Z6<sup>GT</sup> Sylvania Type

HIGH-VACUUM RECTIFIER

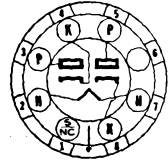

7Q-0-0

### PHYSICAL SPECIFICATIONS

Base .....	Intermediate Octal 7 Pin
Bulb .....	T-9
Maximum Overall Length .....	3 <sup>5</sup> / <sub>16</sub> "
Maximum Seated Height .....	2 <sup>3</sup> / <sub>4</sub> "
Mounting Position .....	Any

### RATINGS

Maximum Peak Inverse Plate Voltage .....	700 Volts
Maximum Peak Plate Current Per Plate .....	360 Ma.
Maximum DC Output Current Per Plate .....	60 Ma.
Maximum Peak Heater-Cathode Voltage .....	350 Volts
Average Tube Drop at 120 Ma. Output Current .....	15 Volts

### TYPICAL OPERATION

#### HALF-WAVE RECTIFIER WITH CONDENSER INPUT FILTER\*

Heater Voltage .....	117	117	117 Volts
Heater Current .....	75	75	75 Ma.
RMS Plate Supply Voltage .....	117	150	235 Volts
Input Filter Condenser .....	40	40	40 $\mu$ f.
Minimum Effective Plate Supply Impedance (Per Plate) .....	15	40	100 Ohms
DC Output Current (Per Plate) .....	60	60	60 Ma.

\*The sections may be used separately or in parallel.

#### VOLTAGE DOUBLER

	Half-Wave	Full-Wave
RMS Plate Supply Voltage Per Plate .....	117	117 Volts
Input Filter Condenser .....	40	40 $\mu$ f.
Minimum Effective Plate Supply Impedance Per Plate .....	30	15 Ohms
DC Output Current .....	60	60 Ma.

SYLVANIA RADIO TUBES



6Q-0-0  
884



5A-0-0  
885

Sylvania Type **884**

Sylvania Type **885**

GAS TRIODES

### PHYSICAL SPECIFICATIONS

Base.....	884 Small Octal 6 Pin	885 Small 5 Pin
Bulb.....	ST12	ST12
Maximum Overall Length.....	4 <sup>3</sup> / <sub>8</sub> "	4 <sup>3</sup> / <sub>16</sub> "
Maximum Seated Height.....	3 <sup>3</sup> / <sub>16</sub> "	3 <sup>3</sup> / <sub>16</sub> "
Mounting Position.....	Any	Any

### TYPICAL OPERATION

Heater Voltage.....	884 6.3	885 2.5 Volts
Heater Current.....	0.600	1.5 Ampere
Maximum Plate Voltage.....	300	300 Volts
Peak Breakdown Voltage.....	350	350 Volts
Peak Plate Current.....	300	300 Ma.
Average Plate Current (0-200 cycles per Sec.).....	3.0	3.0 Ma.
(200+cycles per Sec.).....	2.0	2.0 Ma.

Grid Resistor—1000 ohms per peak grid volt, should not exceed 500,000 ohms.

### APPLICATION

Sylvania Types 884 and 885 are gas triodes used chiefly as sweep circuit oscillators in oscilloscopes. Both types are identical except for heater ratings and base connections.

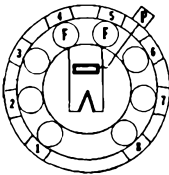

1247



Sylvania Type **1247**

HIGH FREQUENCY DIODE

### PHYSICAL SPECIFICATIONS

Base.....	Flexible Leads
Bulb.....	T-3
Top Connection.....	Flexible Lead
Maximum Overall Bulb Length.....	1 <sup>3</sup> / <sub>8</sub> "
Minimum Lead Length.....	1 <sup>1</sup> / <sub>4</sub> "
Mounting Position.....	Any

### RATINGS

Filament Voltage AC or DC $\pm 10\%$ .....	0.7 Volts
Maximum AC Plate Voltage RMS.....	300 Volts
Maximum Peak Inverse Volts.....	850 Volts
Maximum DC Plate Current.....	1.0 Ma.
Maximum Peak Plate Current.....	5.0 Ma.
Tube Voltage Drop at 100 $\mu$ a. (Approx.).....	0.7 Volts

#### Direct Interelectrode Capacitances:

Plate to filament shielded*.....	0.8 $\mu$ f.
Plate to filament unshielded.....	0.6 $\mu$ f.

\*With a 0.400" diameter shield connected to filament.

### TYPICAL OPERATION

Filament Voltage.....	0.7 Volts
Filament Current.....	65 Ma.
AC Plate Voltage RMS.....	300 Volts
DC Plate Current.....	0.4 Ma.

### APPLICATION

Sylvania Type 1247 is a filament type diode designed for use as the probe tube in vacuum tube voltmeters, such as the Sylvania Polymer, where its small size makes possible a probe which operates satisfactorily up to 300 Mc.

# 1273 Sylvania Type

NON-MICROPHONIC PENTODE

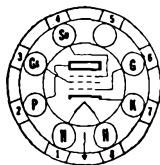
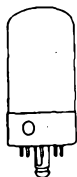

8V-L-5

## PHYSICAL SPECIFICATIONS

Identical to Type 7AJ7

## RATINGS

Identical to Type 7AJ7

Except Grid to Plate Capacitance, which is 0.004  $\mu$ f. Maximum.

## TYPICAL OPERATION

Identical to Type 7AJ7

## APPLICATION

Sylvania Type 1273 is a pentode amplifier designed specially for use in the first stages of high gain amplifiers where low microphonism and tube noise are essential. Reference should be made to Type 14C7 for curves, and to Type 7C7 for resistance coupled amplifier data.

# 1280 Sylvania Type

NON-MICROPHONIC PENTODE

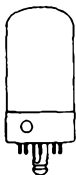

8V-L-5

## PHYSICAL SPECIFICATIONS

Identical to Type 14C7

## RATINGS

Identical to Type 14C7

## TYPICAL OPERATION

Identical to Type 14C7

## APPLICATION

Sylvania Type 1280 is a pentode amplifier designed specially for use in the first stages of high gain amplifiers requiring series operation of tubes and where low microphonism and minimum tube noise are essential. Reference should be made to Type 14C7 for curves, and to Type 7C7 for resistance coupled amplifier data.

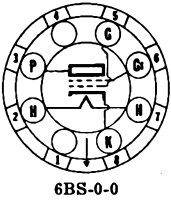

6BS-0-0

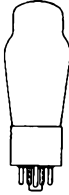

# Sylvania Type 2050 Sylvania Type 2051

GAS TETRODES

## PHYSICAL SPECIFICATIONS

Base.....	Small Octal 8 Pin
Bulb.....	ST12
Maximum Overall Length.....	4 1/8"
Maximum Seated Height.....	3 3/16"
Mounting Position.....	Any

## TYPICAL OPERATION

	2050	2051
Heater Voltage.....	6.3	6.3 Volts
Heater Current.....	0.6	0.6 Ampere
RMS Anode Voltage.....	400	220 Volts
Shield Grid Voltage.....	0	0 Volt
Peak Cathode Current.....	1000	375 Ma. Max.
Average Cathode Current.....	100	75 Ma. Max.
Control Grid Voltage (Approx. 180° out of phase with Plate Voltage).....	5.0	4.0 Volts
Peak Signal Voltage.....	5.0	4.0 Volts
Control Grid Circuit Resistance.....	1.0	1.0 Megom
Anode Circuit Limiting Resistance*.....	2000	2000 Ohms

\*Must be sufficient to limit anode current to maximum rating.  
The Above Ratings are absolute Maximums.

## APPLICATION

Sylvania Types 2050 and 2051 are gas tetrodes designed for remote circuit control applications. If DC anode supplies are used, provision must be made for interrupting anode supply circuit after each operation to restore grid control action.

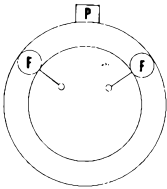

5642



# Sylvania Type 5642

HALF-WAVE RECTIFIER

## PHYSICAL SPECIFICATIONS

Base.....	Flexible Leads
Bulb.....	T-3
Maximum Bulb Length.....	2.160"
Minimum Lead Length.....	1 1/4"
Mounting Position.....	Any

## RATINGS

Filament Voltage (AC or DC).....	1.25 Volts
Maximum Peak Inverse Voltage.....	10,000 Volts
Maximum Peak Plate Current*.....	5 Ma.
Maximum Average Output Current.....	0.25 Ma.
Minimum Frequency of Supply Voltage.....	5.0 Kc
Direct Interelectrode Capacitances:*	
Filament to Plate.....	0.6 μf.

\*With no external shield.

## TYPICAL OPERATION

As a Pulse Type Rectifier Doubler in Television Scanning Circuits #

Filament Voltage.....	1.25 Volts
Filament Current (per tube).....	200 Ma.
Peak Plate Pulse Voltage from Scanning Section.....	8000 Volts
Output Current.....	150 $\mu$ a.
Output Voltage (two tubes in circuit shown).....	12,000 Volts

#The duration of the voltage pulse should not exceed 15% of one horizontal scanning cycle. In a 525 line, interlaced two to one, 30 frame per second television system, 15% of one horizontal scanning cycle is 10 microseconds.

## APPLICATION

Sylvania Type 5642 is a subminiature half-wave rectifier designed for use in high voltage power supplies where high efficiency and compactness are required. The use of a wired-in tube assists in avoiding socket insulation and leakage problems.

Leads should not be bent within 1/16" of the glass. Avoid soldering filament leads within 1/4" of the bulb, and the top (plate) lead should not be soldered within 1/8" of the glass.

The following circuit shows a typical application in a fly-back rectifier delivering 12,000 volts dc to the picture tube anode.

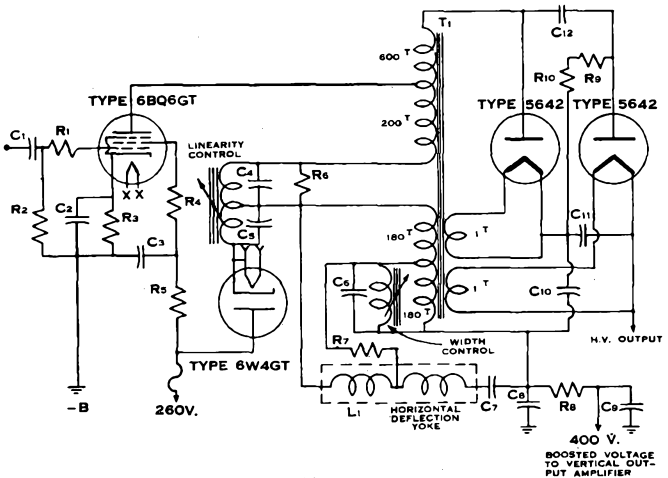

## PARTS LIST

C <sub>1</sub> = 0.001 $\mu$ f. 500 V.	R <sub>1</sub> = 100 Ohm 1/2 Watt
C <sub>2</sub> = 2 $\mu$ f. 50 V.	R <sub>2</sub> = 470 K 1/2 Watt
C <sub>3</sub> = 0.05 $\mu$ f. 400 V.	R <sub>3</sub> = 150 Ohm 5 Watt
C <sub>4</sub> = 0.03 $\mu$ f. 600 V.	R <sub>4</sub> = 100 Ohm 1/2 Watt
C <sub>5</sub> = 0.1 $\mu$ f. 600 V.	R <sub>5</sub> = 8200 Ohm 2 Watt
C <sub>6</sub> = 1200 $\mu$ f. 1000 V.	R <sub>6</sub> = 1 K 1 Watt
C <sub>7</sub> = 0.22 $\mu$ f. 200 V.	R <sub>7</sub> = 1 K 1/2 Watt
C <sub>8</sub> = 10 $\mu$ f. 450 V.	R <sub>8</sub> = 1 K 1/2 Watt
C <sub>9</sub> = 10 $\mu$ f. 450 V.	R <sub>9</sub> = 1.5 Meg. 2 Watt
C <sub>10</sub> = 500 $\mu$ f. 10 Kv.	R <sub>10</sub> = 1.5 Meg. 2 Watt
C <sub>11</sub> = 500 $\mu$ f. 10 Kv.	
C <sub>12</sub> = 500 $\mu$ f. 10 Kv.	
T <sub>1</sub> = Horizontal Output & H. V. Transformer	
L <sub>1</sub> = Deflection Yoke 14 mh	

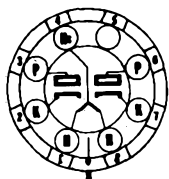

7CX-L-5



# Sylvania Type 5679

DUODIODE

## PHYSICAL SPECIFICATIONS

Identical to Type 7A6

### RATINGS

Identical to Type 7A6

### TYPICAL OPERATION

Identical to Type 7A6

### APPLICATION

Sylvania Type 5679 is a cathode type duodiode in which a center tap on the heater has been provided to permit balancing the sections. This adjustment is required in certain types of vacuum tube voltmeters, such as the Sylvania Polymeter. Reference should be made to Type 7A6 for curve data.

Additional series resistance may be required to limit the voltage across either section to the maximum of 3.5 volts under the highest line voltage condition.



8BD-0-0



# Sylvania Type 5691

HIGH-MU DUOTRIODE

## PHYSICAL SPECIFICATIONS

Base.....	Intermediate Octal 8 Pin
Bulb.....	T-9
Maximum Overall Length.....	2 7/8"
Maximum Seated Height.....	2 5/8"
Mounting Position.....	Any

### RATINGS

Heater Voltage AC or DC ( $\pm 5\%$ ).....	6.3 Volts
Heater Current.....	0.6 Ampere
Maximum Plate Voltage.....	275 Volts
Maximum Plate Supply Voltage.....	330 Volts
Maximum Plate Dissipation (per section).....	1 Watt
Control Grid Voltage:	
Negative Bias Range.....	-1 to -100 Volts
Negative Peak Value.....	-200 Volts
Maximum Control Grid Current.....	2 Ma.
Maximum Cathode Current (per section).....	10 Ma.
Maximum Heater-Cathode Voltage.....	100 Volts
Maximum Control Grid Circuit Resistance.....	2 Megohm

### Direct Interelectrode Capacitances: (Unshielded)

	Unit No. 1	Unit No. 2
Grid to Plate.....	3.6	3.6 $\mu\text{f.}$
Grid to Cathode.....	2.4	2.7 $\mu\text{f.}$
Plate to Cathode.....	2.3	2.6 $\mu\text{f.}$
Plate to Plate.....		3.2 $\mu\text{f.}$

## TYPICAL OPERATION

### CLASS A<sub>1</sub> AMPLIFIER

Heater Voltage.....	6.3 Volts
Heater Current.....	0.6 Ampere
Plate Voltage.....	250 Volts
Plate Current.....	2.3 Ma.
Amplification Factor.....	70
Plate Resistance.....	44,000 Ohms
Mutual Conductance.....	1,600 $\mu\text{mhos}$

### APPLICATION

Sylvania Type 5691 is a high-mu triode intended for industrial applications. It has exceptional uniformity and stability, resists shock and vibration, and is recommended for applications where a life of 10,000 hours is desirable. Within its ratings it is equivalent to Type 6SL7GT.

SYLVANIA RADIO TUBES

# 5692 Sylvania Type

MEDIUM-MU DUOTRIODE

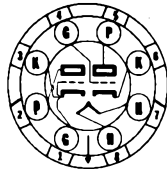

8BD-0-0

## PHYSICAL SPECIFICATIONS

Base.....	Short Intermediate Octal 8 Pin
Bulb.....	T-9
Maximum Overall Length.....	2 7/8"
Maximum Seated Height.....	2 1/16"
Mounting Position.....	Any

## RATINGS

Heater Voltage AC or DC ( $\pm 5\%$ ).....	6.3 Volts
Heater Current.....	0.6 Ampere
Maximum Plate Supply Voltage DC.....	330 Volts
Maximum Plate Voltage DC.....	275 Volts
Control Grid Voltage:	
Maximum Negative Bias Value.....	-1 to -100 Volts
Maximum Negative Peak Value.....	-200 Volts
Maximum DC Control Grid Current.....	2 Ma.
Maximum DC Cathode Current (per section).....	15 Ma.
Maximum Plate Dissipation (per section).....	1.75 Watts
Maximum Peak Heater to Cathode Voltage.....	100 Volts
Maximum Control Grid Circuit Resistance.....	2 Megohms

## APPLICATION

Sylvania Type 5692 is a medium-mu duo triode intended for industrial applications. It has exceptional uniformity and stability, resists shock and vibration, and is recommended for applications where a life of 10,000 hours is desirable. Within its ratings it is equivalent to Type 6SN7GT.

# 5693 Sylvania Type

SHARP CUT-OFF PENTODE

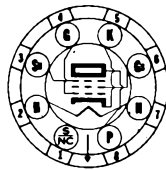
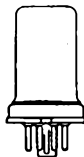

8N1-0

## PHYSICAL SPECIFICATIONS

Base.....	Small Wafer Octal 8 Pin
Bulb.....	Metal 8-1
Maximum Overall Length.....	2 5/8"
Maximum Seated Height.....	2 1/16"
Mounting Position.....	Any

## RATINGS

Heater Voltage AC or DC $\pm 5\%$ .....	6.3 Volts
Heater Current.....	300 Ma.
Maximum DC Plate Voltage.....	300 Volts
Maximum DC Plate Supply Voltage.....	330 Volts
Suppressor Grid Voltage.....	0 to -100 Volts
Maximum Screen Voltage.....	125 Volts
Control Grid Voltage:	
Negative Bias Range.....	-1 to -50 Volts
Negative Peak Value.....	-50 Volts
Maximum Cathode Current.....	10 Ma.
Maximum Plate Dissipation.....	2 Watts
Maximum Screen Dissipation.....	0.3 Watt
Maximum Peak Heater-Cathode Voltage.....	100 Volts
Maximum Control Grid Circuit Resistance.....	40 Megohms

## APPLICATION

Sylvania Type 5693 is a sharp cut-off pentode intended for industrial applications. It has exceptional uniformity and stability, resists shock and vibration, and is recommended for applications where a life of 10,000 hours is desirable. Within its ratings it is equivalent to Type 6SJ7.



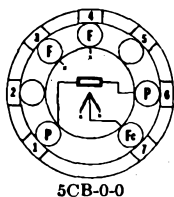

5CB-0-0



# Sylvania Type 5722

## NOISE GENERATING DIODE

### PHYSICAL SPECIFICATIONS

Base.....	Miniature Button 7 Pin
Bulb.....	T-5 $\frac{1}{2}$
Maximum Overall Length.....	2 $\frac{1}{8}$ "
Maximum Seated Height.....	1 $\frac{1}{8}$ "
Mounting Position.....	Vertical*

\*Horizontal operation permitted if Pins 1 and 2 are in a vertical plane.

### RATINGS

Maximum Filament Voltage.....	5.5 Volts
Minimum Filament Voltage.....	2.0 Volts
Filament Current at 4.9 Volts.....	1.6 Amperes
Maximum DC Plate Voltage.....	200 Volts
Maximum Plate Current.....	35 Ma.
Maximum Plate Dissipation	
Continuous Service.....	3.5 Watts
Intermittent Service.....	5.0 Watts
Maximum On Period in 50% Duty Cycle.....	5 Minutes

#### Direct Interelectrode Capacitances:\*

Plate to Filament.....	1.5 $\mu$ f.
------------------------	--------------

\*With no external shield.

### TYPICAL OPERATION

Sylvania Type 5722 is a tungsten filament diode designed for use as a noise generator at frequencies up to 400 or 500 mc. The filament center tap allows better RF grounding of the filament when used in the recommended circuit shown on a following page.

Since the tube has a tungsten filament the "shot effect" may be used as a standard noise source. If sufficient plate voltage is applied to obtain saturation, the noise factor (NF) may be obtained from the equation  $NF = 1 + \frac{R}{I}$  where R is the total generator resistance and I is the diode plate current in amperes. To convert to decibels  $NF_{db} = 10 \log_{10} 20 IR$ .

In use, the diode is coupled to the input of the amplifier under test and the filament voltage is increased until the noise output power is double that read without the diode. From the plate current reading and the generator resistance the noise factor can be calculated. Additional construction details may be obtained from the article "How Sensitive is Your Receiver," by Byron Goodman in the September 1947 issue of Q.S.T. and also "Coaxial Noise Diode" by H. Johnson, RCA Review, March 1947, Volume VIII, No. 1.

The useful life is dependent on the operating voltages since the usual causes of failure are burnout or vaporization of the tungsten filament.

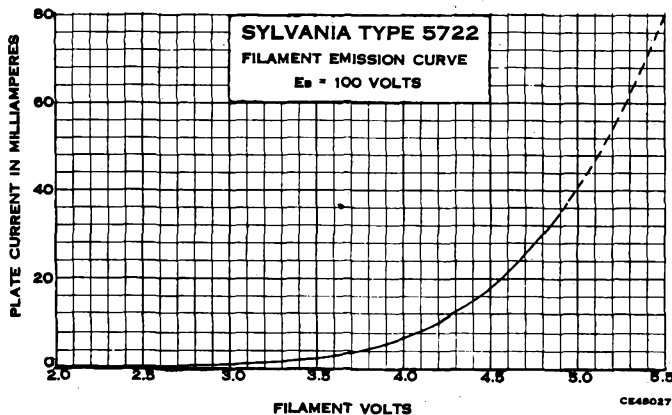

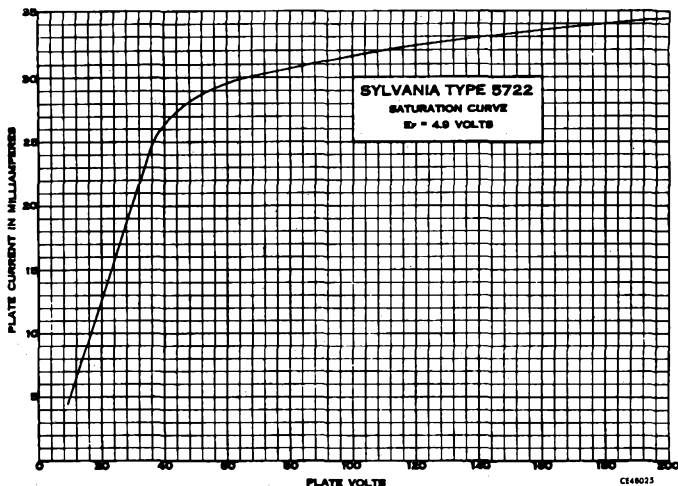

## RECOMMENDED CIRCUIT

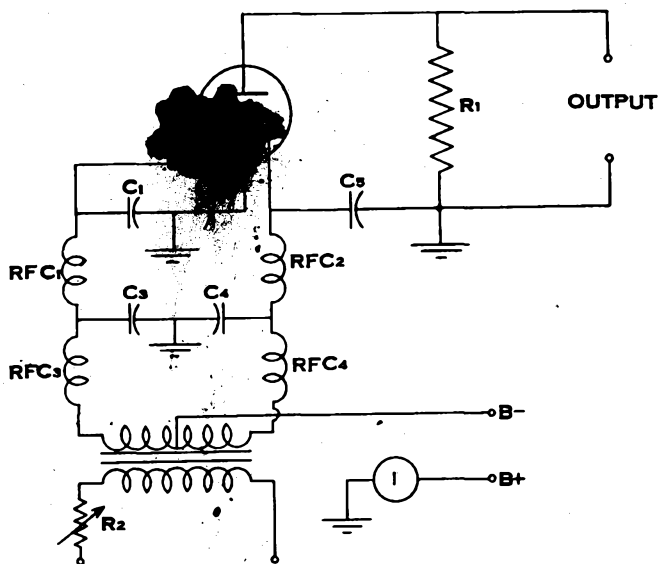

### PARTS LIST

C<sub>1</sub>  
 C<sub>2</sub>  
 C<sub>3</sub>  
 C<sub>4</sub>  
 C<sub>5</sub>

500  $\mu$ f

RFC<sub>1</sub>  
 RFC<sub>2</sub>

6 Turns #16 Enamel Wire on 3/16" Air Core

RFC<sub>3</sub>  
 RFC<sub>4</sub>

30 Turns #16 Enamel Wire on 3/8" O.D., 1/4" I.D. Bakelite Coil Form With Powdered Iron Core

R<sub>1</sub>  
 R<sub>2</sub>

50 to 300 Ohms as Required to Match Load  
 Filament Voltage Control

# APPENDIX

## FUNDAMENTAL ELECTRICAL LAWS

### OHM'S LAW

When a continuous current is flowing thru a given conductor, whose temperature is maintained constant, the ratio of the potential difference or voltage existing between the conductor terminals and the current carried by the conductor is a constant, no matter what the value of the current may be. The mathematical formulae for Ohm's Law may be expressed in the following forms:

$$R = \frac{E}{I} \quad I = \frac{E}{R} \quad E = IR$$

Where  $R$  = resistance expressed in ohms

$I$  = current expressed in amperes

$E$  = potential difference or voltage in volts

A practical example is given to illustrate the use of Ohm's Law:

If the screen current for a certain tube is 2 milliamperes (0.002 ampere) what value of resistance should be used to reduce the screen voltage to 90 volts from a supply voltage of 250 volts?

Solution: The required voltage drop across the resistor would be 250 — 90 or 160 volts.

$$\text{Therefore } R = \frac{E}{I} = \frac{160 \text{ volts}}{0.002 \text{ ampere}} = 80,000 \text{ ohms}$$

### POWER

Power is the time rate of doing work. Since energy is the ability to do work, power may also be defined as the time rate of expending energy. From the fundamental definitions of power, electromotive force and current it is easy to show that power may be computed from the following expression:

$$P = EI$$

If  $E$  is expressed in volts and  $I$  in amperes then the power  $P$  will be given in watts. Using values for  $E$  or for  $I$  from Ohm's Law, the above expression becomes either:

$$P = I^2 R \quad \text{or} \quad P = \frac{E^2}{R}$$

If the first equation for power is used, the wattage rating of the resistor used for reducing the screen voltage may be computed.

$$P = EI = 160 \text{ volts} \times 0.002 \text{ ampere} = 0.32 \text{ watt}$$

A 0.5 watt resistor should be employed.

### RESISTORS CONNECTED IN SERIES AND IN PARALLEL:

When two or more resistors are connected in series, so that the same current flows through each resistor, the total effective resistance ( $R_t$ ) of the network will be the sum of the separate resistances. Thus:

$$R_t = R_1 + R_2 + R_3 + \dots$$

If a number of resistors are connected in parallel so that the voltage drop is the same across each resistor, then the current in each resistor will be inversely proportional to the resistances. The total effective resistance ( $R_t$ ) of the network, will be given by:

$$1/R_t = 1/R_1 + 1/R_2 + 1/R_3 + \dots$$

For the case of two resistors in parallel:

$$R_t = \frac{R_1 R_2}{R_1 + R_2}$$

### CALCULATION OF CONDENSERS IN SERIES AND IN PARALLEL:

When a number of condensers are connected in series, the total effective capacity ( $C_t$ ) is computed from the relation:

$$1/C_t = 1/C_1 + 1/C_2 + 1/C_3 + \dots$$

For the case of two condensers connected in series this expression reduces to the form:

$$C_t = \frac{C_1 C_2}{C_1 + C_2}$$

The total capacity ( $C_t$ ) of any number of condensers connected in parallel is the sum of the separate capacities:

$$C_t = C_1 + C_2 + C_3 + \dots$$

### CALCULATION OF PROPER RESISTOR FOR SELF-BIASING:

From Ohm's Law

$$R = \frac{\text{Grid Bias in Volts} \times 1000}{\text{Total Cathode Current in Ma.} \times \text{Number of Tubes Involved}}$$

For triodes the total cathode current is equal to the plate current.

For tetrodes and pentodes the total cathode current is the sum of the plate and screen currents.

For pentagrid converters the plate, screen and oscillator anode currents must be added to obtain the total cathode current.

Example: What biasing resistor is required for two Type 6L6G tubes operated in push-pull Class A with 250 volts applied to the plates?

The following data are taken from the characteristics shown for Type 6L6G:

$$\begin{aligned} \text{Grid Bias} &= -16 \text{ Volts} \\ \text{Zero Signal Plate Current} &= 60.0 \text{ Ma. per tube} \\ \text{Zero Signal Screen Current} &= 5.0 \text{ Ma. per tube} \\ \text{Total Cathode Current} &= 65.0 \text{ Ma.} \end{aligned}$$

$$\text{Hence: } R = \frac{16 \times 1000}{65 \times 2} = \frac{16000}{130} = 125 \text{ ohms}$$

When over-biased operation is employed the recommended bias resistor values will be specified under Ratings or Circuit Application notes for the tube type involved.

# FUNDAMENTAL PROPERTIES OF VACUUM TUBES

The major operating characteristics of a vacuum tube can be expressed in terms of the amplification factor ( $\mu$ ), the dynamic plate resistance ( $R_p$ ) and the mutual conductance ( $G_m$ ). When these are known one can make quantitative calculations of the tube performance under many conditions.

The **Amplification Factor** is defined as the ratio of a small increment in plate voltage to the corresponding change in grid voltage necessary to maintain constant plate current. In other words, it is the ratio of the effectiveness of the grid and plate voltages in producing electrostatic forces at the surface of the cathode. The amplification factor depends upon the configuration of the electrode system, especially the grid structure, and the electrode voltages. Changes which cause the grid to more completely shield the plate from the cathode will increase the value of  $\mu$ .

The **dynamic Plate Resistance** may be defined as the ratio of a small change in plate voltage to the corresponding change in plate current produced. The value will depend upon the grid and plate voltages at the operating point under consideration. It will not be equal to the ratio of total plate voltage to total plate current. The dimensions and relative positions of the tube electrodes will largely determine the value of plate resistance.

The **Mutual Conductance** ( $G_m$ ), sometimes called control grid-plate transconductance ( $S_m$ ), is the ratio of the amplification factor to the plate resistance and represents the rate of change in plate current with respect to the change in grid voltage when the other voltages remain constant.

**Interelectrode Capacities:** The electrodes of a vacuum tube form a complicated electrostatic system, and each element may be considered as forming one plate of a small condenser. In a three-element tube the capacitance between the cathode and grid, between the grid and plate, and between the plate and cathode, are known as the interelectrode capacitances of the tube. Of these, the grid-plate capacity is generally the most important. The effect of these capacitances depends upon the relationship between their reactances and the associated external circuit impedances. Their effect is, therefore, a function of frequency and external load.

In multi-electrode tubes the number of separate interelectrode capacitances is larger than for a triode. Fortunately, only three of these direct interelectrode capacitances are of great importance in most applications. These are:

1. Grid-plate capacity ( $C_{gp}$ ).
2. Direct input capacity from control grid to cathode plus all other electrodes except output plate.
3. Direct output capacity from plate to cathode plus all other electrodes except the input grid.

## AMPLIFIER CLASSIFICATION

All radio receiving tubes except the rectifiers may be conveniently considered as amplifiers. Oscillators and detectors or frequency converters may be thought of as special cases of amplifiers in which use is made of the non-linear relations between the input voltages and output currents of the tube under consideration.

There are three major classes of amplifier service. Definitions describing these have been standardized by the Institute of Radio Engineers.

## **Class A Amplifier**

A Class A, or Class A1, amplifier is one in which the grid bias and signal voltages are such that plate current in the tube, or in each tube of a push-pull stage flows at all times.

This is accomplished by operating at the center point of the plate current vs. grid voltage curve and using signal voltages which do not drive the grid into either the positive region or into the sharp bend near cut-off voltage.

## **Class A2 Amplifier**

A Class A2 amplifier is the same as a Class A1 amplifier except that the signal may drive the grid into the positive region. This is accomplished by operating at a lower bias than the center point which would have been selected for class A operation.

## **Class B Amplifier**

A Class B amplifier is an amplifier in which the grid bias is approximately equal to the cut-off value, so that the plate current is approximately zero when no signal voltage is applied and so that plate current in the tube or in each tube of a push-pull stage, flows for approximately one-half of each cycle when an alternating grid voltage is applied.

An important characteristic is that the grid circuit draws appreciable power which prevents it from being used with ordinary resistance coupled driver tubes.

## **Class AB1 Amplifier**

A Class AB1 amplifier permits greater output to be obtained from small tubes, but requires push-pull operation to reduce distortion. It is characterized by operation at a higher bias than for Class A and uses a signal large enough to drive the grid into the cut-off region but not into the positive region.

## **Class AB2 Amplifier**

A Class AB2 amplifier is the same as a Class AB1 above except that additional bias may be used, and the signal drives the grid into both the cut-off and grid current regions.

## **Class C Amplifier**

A Class C amplifier is one in which the tubes operate at a bias much greater than cut-off voltage so that plate power is drawn only on the peaks of the signal voltage. It is not used in audio amplifiers because the distortion is too high but is the most efficient circuit for R. F. power amplifiers where the harmonics can be reduced by use of resonant circuits.

# DEFINITIONS

## OF COMMON RADIO TERMS

**Anode Current:** The total current passing to or from an anode. In vacuum tube terminology this is called plate current. Symbol  $I_b$ .

**Cathode Current:** The total space current passing to or from the emitter. This should not be confused with filament current in filament type tubes. Symbol  $I_k$ .

**Conversion Transconductance:** (Formerly called Conversion Conductance). The ratio of the desired beat frequency component of the plate current to the signal voltage applied to the grid. It is expressed in micromhos. Symbol  $G_c$ .

**Coupling:** The mutual relationship between circuits permitting a transfer of energy between them.

**Degeneration:** The result of a portion of the output signal appearing in the input circuit of a vacuum tube so as to reduce gain. It is sometimes introduced to stabilize the circuit and to improve the response. It may be called negative or inverse feedback.

**Demodulation:** The process of separating the modulation component from the carrier. It is commonly called detection.

**Diode:** A vacuum tube having two elements. It is usually used as a rectifier or detector. A duo diode is two diodes in one envelope; one element may or may not be common to both diodes.

**Distortion:** The change in wave form produced by the transmission device or amplifier.

**Discriminator:** A circuit which produces a DC voltage proportional in value and polarity to the variations in the applied frequency about the mean frequency, or which converts frequency modulated signals directly into audio frequency signals.

**Electron Emission:** The liberation of electrons from a surface into the surrounding space. If accomplished under the influence of heat it is called Thermionic Emission. If due to the impact of other electrons, it is called Secondary Emission. When emission occurs from a grid from any cause, it is called Grid Emission.

**Fidelity:** The degree of accuracy of reproduction of the original signal.

**Filter:** A selective network or circuit designed to pass a certain frequency or band of frequencies and reject all others.

**Frequency Deviation:** The amount of instantaneous carrier frequency shift from the mean frequency due to modulation in frequency modulated transmitters.

**Frequency Modulation:** A method of transmitting intelligence by means of varying the frequency of a transmitter about the mean frequency in accordance with the signal it is desired to transmit.

**Gain:** The ratio of output to input signal. It may be expressed in terms of power or voltage. Conversion gain is the ratio of intermediate frequency output to signal frequency input.

**Heptode:** A seven element vacuum tube containing an anode, cathode and five other electrodes, usually grids. It is chiefly used as a converter or mixer.

**Hexode:** A six element vacuum tube containing an anode, cathode and four other electrodes, usually grids. It is chiefly used as a converter or mixer.

**Limiter:** A circuit designed to prevent a signal from exceeding a pre-determined amplitude. The stage in a FM receiver used to remove any amplitude changes in the received signal.

**Load Resistance:** The total effective resistance in the plate circuit external to the tube.

**Modulation:** The process of varying the amplitude, phase, or frequency of a carrier in accordance with a signal. **Cross modulation** is an undesired process whereby the carrier of a desired signal combines with the modulation from an undesired signal. It usually occurs within the receiving device.

**Modulation Factor:** The ratio of half the difference between the maximum and minimum amplitudes of a modulated carrier to the average value. It is usually expressed in percent and called **modulation percentage**.

**Octode:** An eight element vacuum tube containing an anode, cathode and six other elements usually grids. It is usually used as a converter or mixer.

**Oscillator:** A vacuum tube device for generating alternating current. In superhetrodyne receivers it is the portion of the circuit generating the local signal required to beat with the incoming signal to produce the intermediate frequency.

**Peak Inverse Voltage:** The maximum instantaneous recurring voltage developed in the opposite direction to that in which an electron tube is designed to pass current. In half-wave rectifiers the value may be 2.8 times the rms value of AC plate voltage.

**Peak Plate Current:** The instantaneous maximum recurring current flowing in an anode or plate circuit.

**Pentagrid Converter:** A vacuum tube having five grids. It is usually used as an oscillator-mixer in a superhetrodyne receiver.

**Pentode:** A five element vacuum tube having an anode, a cathode and three grids.

**Perveance:** This is a figure of merit often used for diodes to express the ability to rectify high frequency current with low voltage drop. It corresponds roughly to  $1/R$  in a linear conductor, but in a non-linear conductor such as a vacuum tube which does not follow Ohm's Law the corresponding characteristic is called **Perveance**. **High Perveance:** means optimum design for both low capacitance and low diode voltage drop for currents within the tube rating.

**Phase Modulation:** A method of modulating a carrier by shifting the phase of the carrier with respect to the non-modulated carrier.

**Pip:** A strong short pulse appearing on the screen of a cathode ray tube. It is often used as a marker.

**Plate:** The common name of the principal anode element in a vacuum tube.



**Power Amplifier:** An amplifier designed to deliver power as distinguished from a voltage amplifier.

**Power Output:** The useful power developed in the output device or circuit. It is usually limited by permissible distortion.

**Pulse:** A single disturbance, such as half a square wave. Grid pulsing is a method of controlling a circuit by introducing a pulse into the grid circuit. Plate Pulsing is the same as grid pulsing except the pulse is introduced into the plate circuit.

**Reactance Tube:** A vacuum tube with operating conditions so chosen that the tube appears as an inductance or capacitance which can be varied by means of changes in the control voltage.

**Rectifier:** A device for converting alternating current into direct current by permitting much more current to flow in one direction than the other. A half-wave rectifier permits current flow only during one half of the cycle. A full-wave rectifier permits current flow from both halves of the cycle.

**Regulation:** The ratio between a reference voltage and change of voltage caused by the load. It is usually expressed in percent.

**Ripple Voltage:** The alternating component of the DC voltage after rectification or from a generator.

**Selectivity:** The ability of a circuit to choose between desired and undesired signals on adjacent frequencies.

**Sensitivity:** Is the term used to denote the ratio between input signal and output power. Generally expressed as microvolts per watt.

**Side Bands:** Those frequencies adjacent to, and associated with a carrier.

**Space Charge:** A cloud of electrons between elements of a vacuum tube.

**Space Current:** The current consisting entirely of the electron flow from the cathode to the anode and other positive elements in a vacuum tube.

**Trigger Circuit:** A circuit having two stable operating conditions readily changed from one to the other by a small change in operating conditions.

**Triode:** A three element vacuum tube having an anode, cathode and a control electrode.

**Voltage Gain:** The ratio of the voltage developed in the plate circuit to the grid voltage necessary to produce it.

Voltage Gain per stage may be obtained from the formula:

$$\text{Gain} = \frac{\mu \times Z_P}{Z_P + R_P} = \frac{G_M \times R_P \times Z_P}{(Z_P + R_P) \times 10^6}$$

Where  $G_m$  is in micromhos;  $R_p$  and  $Z_p$  in ohms

# GENERAL TUBE AND CIRCUIT INFORMATION

Efficient tube performance requires that careful attention be given to proper installation and to circuit considerations. Numerous suggestions regarding tube ratings, voltage supplies for the various tube elements, volume controlling, shielding and filtering are discussed below. This information applies in a general way to all tube types and represents practical and approved methods employed in modern radio receivers. Additional instructions and precautions pertaining to a particular tube may be found under the Circuit Application for that type. Minor deviations from the information given may sometimes be desirable in special circuit designs, although in general it will be advisable to follow the recommendations.

## INTERPRETATION OF RECEIVING TUBE RATINGS

Interpretation of tube ratings published in this manual are in accordance with RMA standards. The ratings shall be interpreted according to the conditions outlined in the following paragraphs.

### Cathode

The heater or filament voltage is given as a normal value unless otherwise stated. This means that transformers or resistances in the heater or filament circuit should be designed to operate the heater or filament at rated value for full-load operating conditions under average supply-voltage conditions. A reasonable amount of leeway is incorporated in the cathode design so that moderate fluctuations of heater or filament voltage downward will not cause marked falling off in response; also, moderate voltage fluctuations upward will not reduce the life of the cathode to an unsatisfactory degree.

### 1.4 Volt Battery Tube Types

**Dry Battery Operation:** The 1.4 volt line of battery tubes is designed to be operated from a dry cell battery rated at a terminal potential of 1.5 volts. In no case should the voltage across any 1.4 volt section of filament exceed 1.6 volts. In the case of series operation, shunting resistors may be required to obtain this condition.

**Operation from other Power Sources:** When other power supply sources are used the voltage drop across each 1.4 volt section should have a nominal value of 1.3 volts and should be maintained within a range of 1.25 and 1.4 volts at normal line voltage and for tubes of rated filament current. In the case of series operation shunting resistors may be required to obtain this condition. This assumes a normal line voltage of 117 volts, and a normal storage battery terminal voltage of 2.0 volts per cell.

### 2.0 Volt Battery Tube Types

The 2.0 volt line of tubes is designed to be operated with 2.0 volts across the filament. In all cases the operating voltage range should be maintained within the limits of 1.8 volts to 2.2 volts.

### Plate and Screen

In the case of plate voltage and screen voltage, however, recommended maximum values are given. The interpretation of this maximum value depends on the power source, as follows:

**A-C or D-C Power Line:** The maximum ratings of plate and screen voltages and dissipations given on the tube type data sheets are Design Maximums. For equipment designed for

use in the United States on nominal power-line services of 105 to 125 volts, satisfactory performance and serviceability may be anticipated, provided the equipment is designed so as not to exceed these Design Maximums at a line voltage of 117 volts.

**Automobile Storage Batteries:** When a tube is used in automobile receivers and other equipment operated from automobile storage batteries, consideration should be given to the larger percentage range over which the battery voltage varies as compared with the power-line voltage. The average voltage value of automobile batteries has been established as 6.6 volts. Automobile battery operated equipment should be designed so that when the battery voltage is 6.6 volts, the plate voltage, the plate dissipation, the screen voltage, the screen dissipation, and the rectifier load current will not exceed 90% of the respective recommended Design Maximum values given in the data for each tube type.

**"B" Batteries:** Equipment operated from "B" batteries should be designed so that under no condition of battery voltage will the plate voltage, the plate dissipation, the screen voltage, and the screen dissipation ever exceed the recommended respective maximum values shown in the data for each type by more than 10%.

### **Other Electrodes**

When a tube is of the multigridd type, the voltages applied to the additional positive electrodes will be governed by the considerations stated under Plate and Screen.

### **Typical Operation**

For many receiving tubes, the data show typical operating conditions in particular services. These typical operating values are given to show concisely some guiding information for the use of each type. They are not to be considered as ratings, because the tube can be used under any suitable conditions within its rating limitations.

## **VOLTAGE SUPPLIES**

The B-voltage supply includes voltage for the operation of plate circuits, screen circuits, and sometimes for bias circuits. The principal methods for obtaining each in various kinds of receivers will be described.

In battery receivers used in locations remote from power supply lines, B batteries are usually employed for the plate voltage. The screen voltage may be tapped off at the appropriate voltage; or for some cases a series dropping resistor and shunt filter condenser is applicable. Bias voltage was formerly obtained from separate batteries. However, with certain 1.4 volt battery types, such batteries are unnecessary since the tubes may be operated with no initial bias other than that developed across the a-v-c diode resistor.

For all other receivers screen voltages are obtained either by using a voltage divider or a series dropping resistor from the positive supply lead.

Grid bias is usually then supplied by means of an adequately by-passed resistor placed in the cathode circuit, or if a more stable bias is required, by means of a resistor in the negative lead of the plate supply and also adequately by-passed. Since this resistor carries the total plate supply load current, bias developed in this manner is much less affected by individual tube and circuit variations. As an economy measure a speaker field or filter choke having the proper resistance can be substituted for this resistor. In this case, resistance capacity filter circuits will be necessary to prevent hum voltage from appearing in the bias circuits, since the choke or speaker field will then often become part of the filter circuit.

In the cathode or "self-biased" circuit it is essential, except in push-pull circuits or where degeneration is desired, that the cathode resistor be by-passed with sufficient capacity so that no appreciable a-c impedance exists between cathode and grid return. With the other method of C-bias mentioned, adequate filtering must be used in order to keep at a minimum any power supply hum which might be applied to the tube grids.

For a-c operated receivers a step-up power transformer and rectifier tube are used to supply pulsating d.c. to an appropriate filter system, the output of which is essentially pure d.c. This supply can then be utilized for the recommended plate, screen and bias voltages.

In ac-dc radio sets the line voltage is applied directly across a rectifier tube and the associated filter system without using a power transformer. Whenever operation above 117 volts is required, a resistor of 50 to 100 ohms should be inserted in series with the rectifier plates to prevent damage to the tube or filter condenser. In many modern sets a filter capacity of 30 mf or more has been used which requires the addition of a peak current limiting resistor to prevent damage to the rectifier tube. The proper value will be found specified for each type under the various conditions of load. Except in circuits designed for voltage doubling, the rectified voltage will be relatively low and somewhat below the peak value of the impressed line voltage supply.

The r.f., converter and power output tubes suitable for use in this type of receiver are indicated by the inclusion of a rating of 100 volts for both plate and screen. The characteristics under these conditions show very little reduction in the mutual conductance but a great decrease in the plate resistance due to the plate and screen being at the same potential. The effect of this on performance can be estimated from the gain formula on page 14. The reasons for it can be seen from any of the plate characteristic curves and is discussed in the section on the Use of Curve Data.

Receivers operated directly on d.c. employ a hum or commutator-ripple filter that is connected across the line, the positive side being used for the plate supply voltage.

Automobile receivers utilize either a motor generator designed to deliver high d-c voltage, or a vibrator-transformer with a suitable rectifier and filter system to supply the set with B voltages. Either method depends upon the car storage battery as the primary source.

## HEATER VOLTAGE SUPPLIES

To obtain satisfactory performance it is important that proper voltages be supplied to the heaters or filaments at all times. The life of the tubes will be greatly shortened if excessive voltages are applied because the active or electron emitting material will be evaporated at a faster rate than required. If, on the other hand, the voltages are too low, the operating temperature of the cathode or filament will be inadequate to supply sufficient emission for proper operation.

The following sources of filament power supply are generally used:

- Dry batteries
- "Air Cell" batteries
- Storage batteries
- Direct Current 32 volt farm lighting power
- Alternating Current power line

The voltage delivered by dry batteries falls off during life so that it is necessary to provide a rheostat or ballast tube in order that constant voltage may be supplied to the tubes during the life of the batteries.

The voltage delivered by an "air cell" battery remains quite constant until final exhaustion, when it drops very rapidly. A fixed series resistor used in connection with this battery supply device will usually prove entirely satisfactory.

Exceptions to the two preceding paragraphs exist when 1.4 volt battery tubes are employed. These types will operate directly from a suitable 1.5 volt dry battery without the use of a series dropping resistor or ballast tube since the filament design provides satisfactory performance over the useful range normally encountered during the life of the battery. Single cell "air cells" also provide satisfactory operation without the use of a fixed series resistor since the constant terminal battery voltage is within the normal operating range for these tubes.

The voltage delivered by a storage battery varies widely, depending upon the condition of charge. If 5 volt tubes are employed, it will be necessary to employ a rheostat to reduce the voltage at the socket terminals to 5 volts. If 6.3 volt heater type tubes are employed, it will be unnecessary to use a series resistor unless the voltage range exceeds the normal value by more than 10%.

Receivers designed to operate on 115 volt d-c lines usually employ tubes connected in series, and with sufficient fixed resistance introduced the heater current is kept normal with 117 volts applied. Under normal line voltage variations from 105 volts to 130 volts no additional adjustable resistors will be necessary.

The universal type of receiver so common at the present time employs the series filament method of connection described in the previous paragraph. In general, no special precautions are necessary to take care of line voltage fluctuations.

Receivers designed for use on a-c power lines of a specified frequency employ step-down transformers to supply the proper filament voltages. If extremely high line voltages are encountered it may be desirable to incorporate an added resistor to reduce the voltage applied to the primary to a nominal value.

## VOLUME CONTROL CONSIDERATIONS

The method employed in older type receivers to control the volume was that of varying the screen voltage applied to the tubes. Later, with the advent of remote cut-off tubes, the system of C-bias variation was universally adopted. The bias voltage was obtained either from a potentiometer across the negative portion of the bleeder, or by inserting a variable resistance in the common cathode lead of several tubes when manual control of sensitivity was desired.

Most modern receivers employ automatic volume control. The function of the a-v-c circuit is to properly regulate the bias applied to the control grids of the r-f, converter and i-f tubes so that, in-so-far as the inherent limitations of the receiver permit, a nearly constant signal will be delivered to the input of the second detector. This is accomplished by utilizing the rectified voltage developed across the load resistor in the diode circuit for the control voltage impressed on the grids of the amplifier tubes. The diode current flowing through the resistor will place the cathode end at positive potential and the opposite end at negative potential. The negative voltage for biasing the grids is obtained from the negative end of this resistor. The value of the resistor should be such that for a given signal the drop in voltage across it will be sufficient to bias the tubes being controlled to a sensitivity consistent with the volume desired. An increase in the r-f signal input will raise the voltage drop, thereby applying more bias to the control tubes. This will decrease the receiver sensitivity and

maintain the receiver output at normal volume. On the other hand, a decrease in r-f signal input reduces the voltage drop and thus lowers the bias on the control tubes. This increases the receiver sensitivity and automatically maintains the volume constant.

With sharp cut-off tubes the cut-off voltage may be extended by feeding the screen through a series resistor from the full B-voltage source. The tube will then act somewhat similar to a remote cut-off type where the volume is controlled by varying the C-bias. The extended cut-off feature thus obtained is intermediate in magnitude between sharp and remote cut-off tubes. Such service is not recommended where the signal voltage is apt to be large since the sharpness of the knee of the dynamic characteristic is not materially reduced. In no case will the dynamic curve become similar to the characteristic of true remote cut-off tubes.

## SHIELDING

In order to obtain stable amplification which will be comparable with the theoretical limit it is essential that ample consideration be given to proper shielding. This is especially necessary in high gain circuits.

Each receiver layout will present different shielding problems. These become more complicated in small compact radios. Much can be done to minimize the necessity for shielding by using a layout scheme such that critical feed-back points are separated as far from each other as is conveniently possible. Over-all feed-back from the output tube to the antenna circuit should always be avoided.

## FILTERING

There are two major classes of filters, the high frequency and the low frequency types. In the former, very good condensers having low resistance and inductance components are required. Electrolytic condensers are not generally satisfactory for high frequency work.

At low frequencies it is necessary to consider the peak voltage that may be impressed on the condensers, since this is considerably greater than the d-c voltage measured across them. If considerable power is to be delivered from the filter an inductance-capacity filter should be used. Whenever the load current from the filter is not excessive, a resistance-capacity filter can be used. This type is more economical and requires less space.

AVC filter systems usually employ resistance and capacity networks. Careful consideration must be given to the time constant. If this is made too long, a sudden disturbance such as static may cause the receiver to become inoperative for a noticeable period of time. When the constant is too short, low frequency degeneration and modulation distortion may occur. A suitable value for the time constant is of the order of one-tenth second.

Screen circuits usually require more careful filtering than the plate circuits, since the screen grid has a control effect quite similar to any other grid in the tube. Instability and general interaction between circuits often result from inadequately filtered screen grids.

C-bias filtering has been discussed in detail under Voltage Sources. The usual circuit elements involved are series resistors and low-voltage shunt condensers.

## LOCK-IN TYPE TUBES

Sylvania Lock-Ins are small "all-glass" tubes without the familiar bakelite base. The contact pins are sealed into the glass bottom, thus eliminating soldered connections. This type of construction permits single-ended operation, as no top cap connections are present, and provides compactness, suitable shielding, and a special lock-in feature. Numerous types are especially suitable for use in UHF applications because of low lead inductances, low inter-electrode capacitances, and low dielectric losses. The lower portion of the tube is fitted with a metal shell and guide pin. This unit acts as a shield and makes possible the lock-in feature by employing a groove around the bottom of the locating pin which fits into a catch on the socket.

The locking arrangement holds the tubes in the sockets securely, assuring good contact at all times. Removal of these tubes from the sockets may be somewhat difficult when done by a direct upward pull. With a slight off-side pressure, the socket lock is released and the tube is readily removed.

These tubes are not directly interchangeable with other designs of receiving tubes because of the socket requirements. In many instances the electrical characteristics and applications are similar to other well known types. Adequate information is supplied under the various lock-in types shown elsewhere in this Manual.

## METAL TUBES

Metal tubes are somewhat smaller than the regular types of glass tubes. The bulb or shell diameter is one inch except at the base where the maximum diameter is one and five-sixteenths inches. The shell is all metal and the lead wires are brought out through the "header", which seals the shell at the bottom. The shell is connected to a base pin and operates at ground potential to eliminate any danger of electric shocks. The over-all length of the tube is reduced and an octal base is provided.

The octal base has provisions for eight pins uniformly spaced. Where fewer than eight pins are required, they are omitted and the spacing of the remaining pins is unchanged. The pin numbering is in accordance with the RMA standard numbering system. In this system, numbers are assigned to each of the eight possible pin positions. Numbering begins at the shell connection, which is always the first pin to the left of the locating lug when the base is viewed from the bottom with the lug toward the observer. The direction of numbering is clockwise on the basis of possible pin position.

## G, GT AND GT/G TUBES

Tubes are often classified according to their general design and construction. Lock-In and metal types have been briefly described. The so-called "regular" glass types are characterized by the style of glass envelope and particularly by the standard bakelite base equipped with four, five, six or seven pins as required, and the absence of any locating base lug.

G type tubes are glass tubes which are, in most cases, identical or very similar in operating characteristics to many of the regular types. The bases are of octal design with a bakelite locating lug while the top caps, if required, are of the miniature style. In these respects the G tubes resemble metal tubes.

A smaller version of the G tube is the GT style designed for use where tubes of this size are desired. For most GT types the characteristics are essentially the same as for the G type equivalent. All GT tubes are equipped with octal bases and a tubular bulb is employed. The suffix GT is derived from the base used on G types and tubular T style bulb. Reduction in physical size is secured through the use of a shorter stem.

Because of the similarity in characteristics between G tubes and the corresponding GT types it is usually possible to interchange GT for G tubes and vice versa if space permits. Consequently, many G types have been discontinued as such, the GT style adopted, and the tubes bulb-etched GT/G.

Two kinds of octal bases are employed on GT and GT/G types. Rectifier and output types are equipped with an all bakelite base as on G tubes. Converters, r-f and i-f types have metal shell bases, that is, a combination of a bakelite wafer to which is fastened a metal shell which is cemented to the glass bulb. The metal shell serves as a part of the shielding and is connected to pin No. 1. This arrangement often permits GT/G or GT tubes to be substituted for equivalent metal types. Slight realignment of tuned circuits may be required to secure correct performance. If additional shielding is necessary on GT/G tubes an external shield can be slipped over the metal shell. Other GT/G types may have one or the other style of base described above, this being optional with the manufacturer.

## MINIATURE TUBES

One of the recent trends in radio tube manufacture is the reduction in size of the tube required for given performance. The group of tubes known as miniatures are good examples of the results which may be obtained in a small T-5½ bulb. Many of these types are particularly useful at high frequencies because of the short leads and the absence of the old style phenolic insulation. Some well-known types of this design are Types 12AU6, 12AT6, 12BA6, 12BE6, 35W4 and 50B5.

## BATTERY TUBES

There are two general groups of battery tubes: the group designed for 2-volt operation and the newer group of 1.4 volt types. The former are now employed primarily for replacement purposes and their characteristics are quite well known. The latter both in GT/G and Lock-In construction are widely used in all forms of battery receivers and several special features are outlined below.

The 1.4 volt group of battery tubes is of particular interest because of the economy afforded in power supply requirements and the reduction in space which is possible. These tubes have been designed especially for economical operation, non-microphonic action and long life. With the exception of the output types, the tubes are designed for zero bias operation, thus simplifying circuit applications and reducing couplings to some extent.

Since these tubes are of the directly heated filament type there may be some small variation in contact potential which, in some instances, may result in slight variation in sensitivity between tubes of the same type if the grid return is made directly to minus filament. It is recommended that a resistance of at least 0.5 megohm, suitably by-passed, be connected between the grid return and minus filament. If these tubes are employed so that a-v-c voltage is applied to the grids, the resistors used for isolation and diode load will be sufficient.



Since the filament wire employed in these tubes is extremely small in diameter, some precautions may be necessary to prevent filament vibrations resulting mainly from acoustic and mechanical feed-back from the speaker to the tubes and chassis. Therefore, it is preferable not to mount the speaker directly on the chassis. A further point to bear in mind is the fact that the permanent magnet of the speaker produces a strong magnetic field which may influence the electron stream in tubes that are in close proximity to the magnet. With moderate care in lay-out this difficulty can be readily avoided.

## TUBE AND BASE DIAGRAM SYMBOLS

A —Anode	IS —Internal Shield
Dp —Diode Plate	J —Jumper
F —Filament	K —Cathode
Fc —Filament Center Tap	NC—No Connection
G —Control Grid	P —Plate
Ga —Anode Grid	Rc —Ray Control
Gm—Modulator Grid	S —Metal Shell
Go —Oscillator Grid	SA—Starter Anode
Gs —Screen Grid	Su —Suppressor Grid
H —Heater	T —Target
Hc —Heater Center Tap	XS—External Shield
Ht—Heater Tap	□ —Top Cap
Ic —Internal Connection	→ —Locating Pin

The symbols listed above are those employed in connection with the tube and base diagrams accompanying the characteristics on individual types of Sylvania tubes shown in the following section of this Technical Manual. All base diagrams are illustrated as viewed from bottom of base and numbers are in accordance with the RMA standard numbering system. Basing diagrams are purely symbolic and are not to be interpreted as exact representations of tube structure.

## BASE CONNECTION DIAGRAMS

The Radio and Television Manufacturer's Association have standardized on an improved method of designating the base connections. Formerly every minor change of shielding, really required a new drawing but now the location of the shielding elements is indicated by two following numbers (or letters) according to the following rules:

- (1) The first group of 2 or 3 digits, one figure and one or more letters, indicates the basing arrangements as far as the more important elements are concerned. This is the same group formerly given in the manual.
- (2) Following the dash separating it from the preceding group is a single numeral indicating the base pin to which is connected any external shielding such as base shielding or shell of metal tubes. The letter "L" means locking lug as on lock-in type tubes.

- (3) Following the second dash is a figure (or figures) indicating to which pin any internal shielding is connected. In case connection is made to two pins both numbers appear, connected by the symbol &.

Examples are: Type 6SK7GT, basing symbol 8N-1-5 which means base diagram number 8N with base shield connected to Pin No. 1 and internal shield to pin No. 5. Type 7E6 basing symbol 8W-L-7 which means base diagram 8W with base shield connected to locking lug and internal shield connected to pin No. 7.

## CATHODE RAY TUBES

Sylvania manufactures a line of television picture tubes and general purpose cathode ray tubes for a wide variety of initial equipment and renewal applications. Technical characteristics of the more popular types are provided in this tube manual. If additional data are required, write the Technical Publications Section, Sylvania Electric Products Inc., Emporium, Pennsylvania.

In radio servicing, as in any other work, certain precautions must be observed in order to work safely. With television receiver servicing the major dangers are from possible high voltage shock or injury from flying glass if a tube is carelessly or accidentally broken. To avoid shock we recommend taking no chances or short cuts; turn the power off and discharge the condenser before making changes. Be sure the interlocks and high voltage insulation in the set are in order. Also, use a dry linoleum or rubber mat to stand on and keep one hand in your pocket when making adjustments in a live set.

To avoid injury from broken glass it is recommended that gloves and goggles be worn when handling the larger picture tubes (over 5 inches in diameter) and that tubes not in a set be kept in their cartons. Be careful not to scratch the tube with tools or let it roll off the table. Worn out tubes should be disposed of by breaking the tip to let air in, making them safe for handling since only high vacuum makes implosion possible.

**WARNING:** X-ray radiation shielding may be necessary to protect against possible danger of personal injury from prolonged exposure at close range if this tube is operated at higher than the manufacturer's Maximum Rated Anode Voltage or 16,000 volts, whichever is less.

Some types have an external conductive coating on the glass shell. This coating should be grounded as a precaution against dangerously high potentials being developed on the coating.

The anode voltage is applied to the shell of the metal cone type tubes, making it necessary for such types to be operated only within an enclosure to prevent accidental contact or grounding.

# TUBE DIMENSIONS

It will be noted that with each tube type there appears a tube outline drawing showing the style of bulb and base employed. In the tabulations of characteristics the type of bulb is specified by a symbol and the style of base is also listed. Whenever it is desired to know the tube dimensions pertaining to any particular tube, reference may be made to the complete group of tube outlines on pages 24 to 28 which show all important dimensions.

## ST-12 STYLE

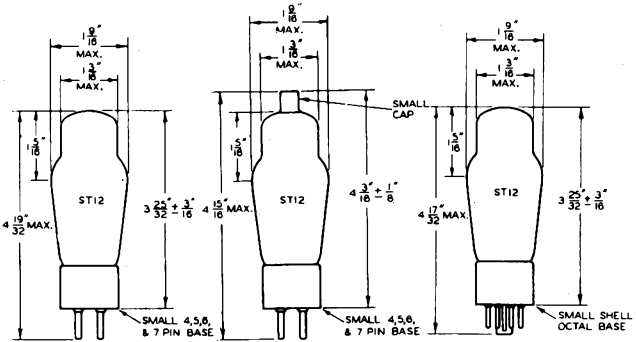

12-1

12-2

12-3

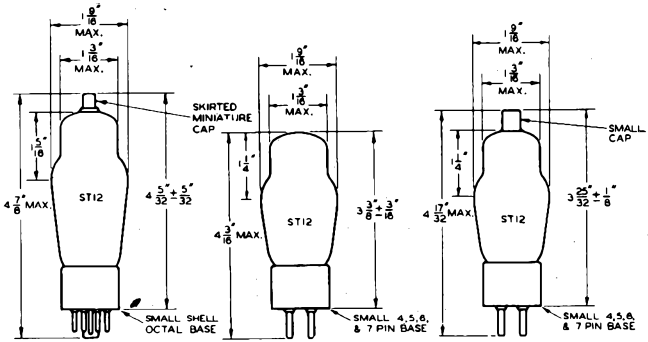

12-4

12-5

12-6

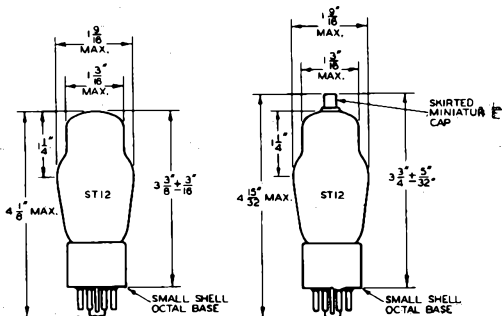

12-7

12-8

# TUBE DIMENSIONS

## LARGER ST STYLES

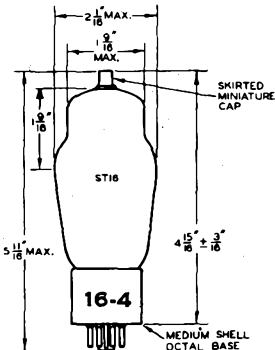
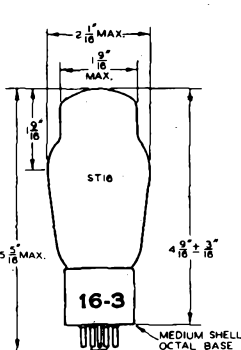
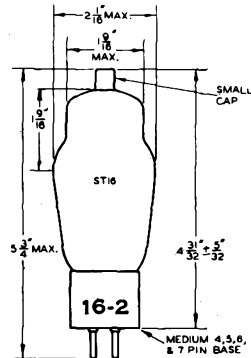
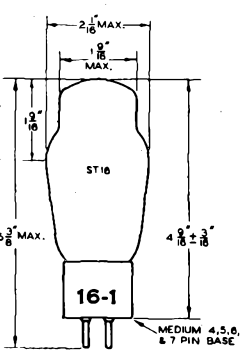
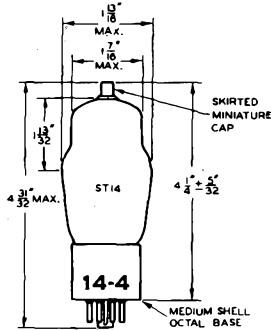
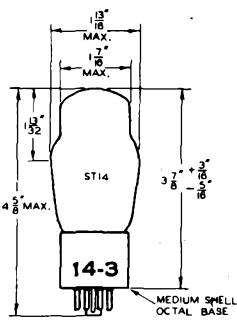
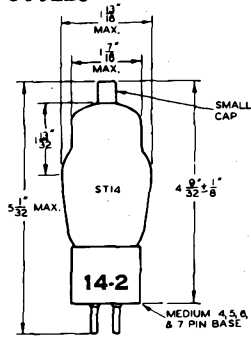
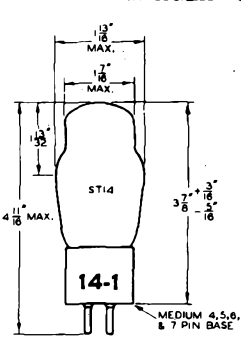

# TUBE DIMENSIONS

## T 9 STYLE

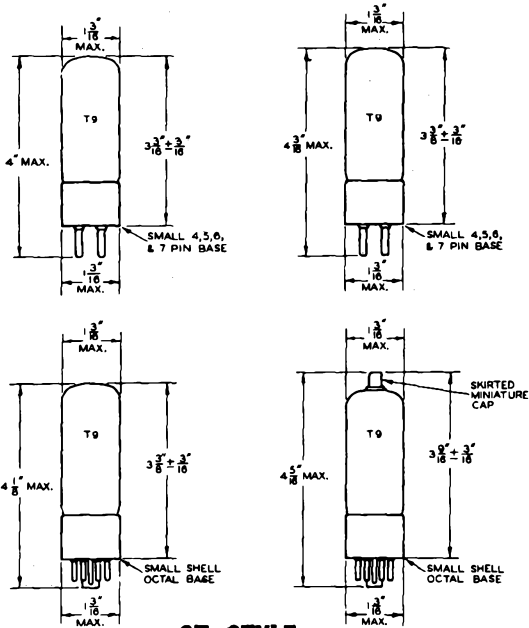

## GT STYLE

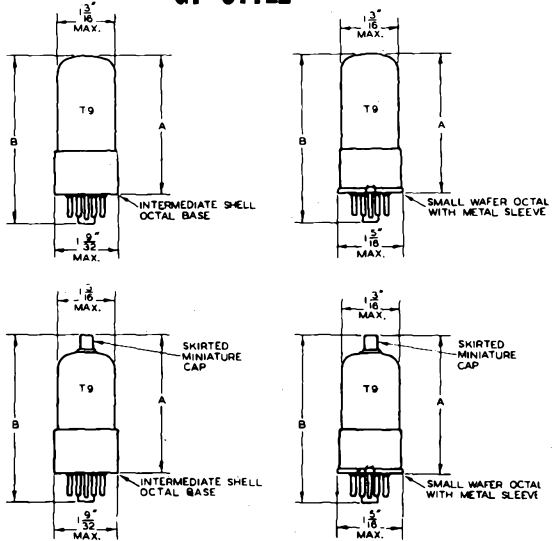

DIMENSIONS "A" AND "B" ARE GIVEN AS SEATED HEIGHT AND OVERALL LENGTH RESPECTIVELY FOR EACH INDIVIDUAL TYPE.

# TUBE DIMENSIONS

## LOCK-IN STYLE

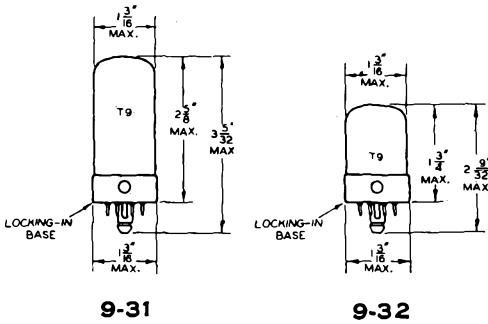
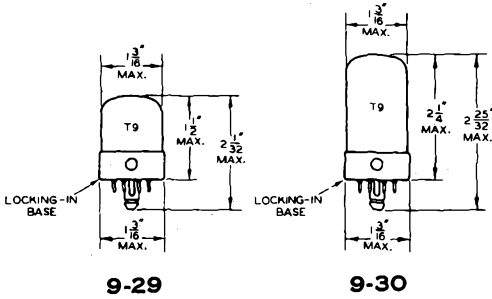

## MINIATURE STYLE

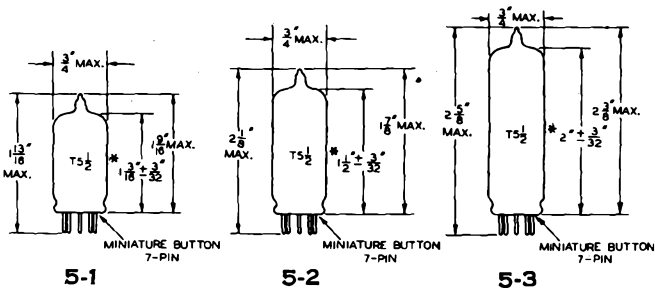

\* MEASURED FROM BASE SEAT TO BULB-TOP LINE  
AS DETERMINED BY RING GAUGE OF  $\frac{1}{16}$ " I.D.

The construction of the T6½ type is comparable to that of the T5½ types 5-2 and 5-3. The major differences are the bulb diameters and bases, the T6½ having a 9 pin base and a 7/8" maximum bulb diameter.

# TUBE DIMENSIONS

## METAL STYLE

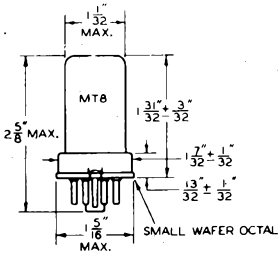

8-1

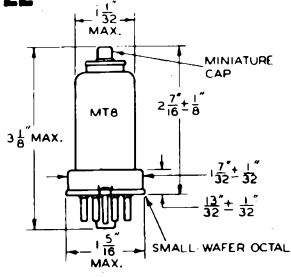

8-2

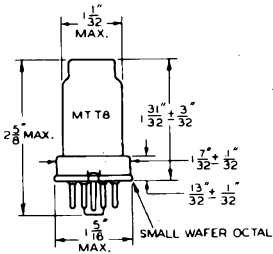

8-3

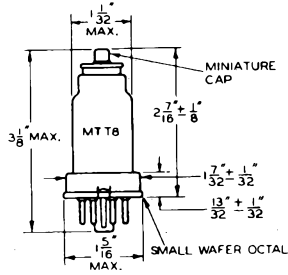

8-4

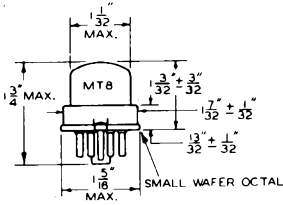

8-5

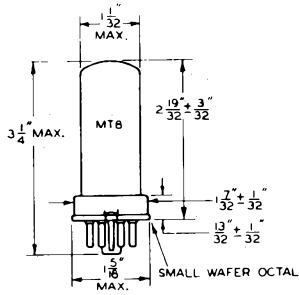

8-6

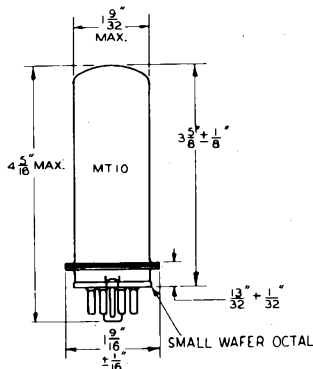

10-1

## USE OF CURVES

In general, curves are used to determine the proper operating point which will give a required characteristic. Audio amplifier tubes should be operated on the linear portion of the tube characteristic while detectors on the contrary should be operated on a non-linear portion. There are many curves which may be taken on tubes, but engineers have selected the following ones as being generally useful.

**Plate Characteristic**—This is the name given to the curve taken with plate current plotted along the vertical axis and plate voltage along the horizontal axis. A number of lines are generally shown, for different grid bias voltages at regular intervals over the range of probable use. In a screen grid tube there may be a number of plate families required, one for each recommended value of screen voltage.

On power tubes the plate characteristic may be used to determine the approximate power output for conditions not listed by the manufacturer. Let us take the type 7A4 as an example. Power output of this tube is not normally required so is not included in the characteristics, but suppose that a small amount of power were required from a triode of this nature, the procedure would be as follows:—Since the tube, when operated at 250 volts on the plate and —8 volts bias, draws 9 ma. this would seem to be a safe operating current. (For other plate voltages the bias voltage is generally taken

as  $.68 \times E_b$  Make a mark on the —8 volt curve above 250

volts on the plate voltage scale. The next step is to get a load line. If the load impedance is known, a line is drawn through the selected operating point such that the ratio of the voltage as read at the point of intersection with the horizontal axis to the current at the point of intersection on the vertical axis gives the desired value of load resistance. This is best done by arbitrarily selecting a value of current, say 20 ma., and if 20,000 ohms load is required the voltage intercept which gives this

$$\text{will be } E = I \times R = \frac{20}{1000} \times 20,000 = 400$$

Then join 20 ma. with 400 volts. This does not give the desired load line because it does not pass through the required operating point. All lines parallel to this, however, have the same ratio of intercepts on the axes and so another line is drawn parallel to it but passing through the selected operating point.

From this line we can now read the instantaneous value of current for any instantaneous value of signal applied to the grid. If operation is limited to the negative region the peak signal cannot exceed 8 volts and the tube current will swing from  $15\frac{1}{2}$  ma. at 0 grid volts to  $3\frac{1}{2}$  ma. at —16 grid volts. The voltages at these points are read if the value of power output is required. These read about 125 and 355 respectively and the power output is:

$$\frac{\text{Change in current} \times \text{Change in voltage}}{8} \text{ watts}$$

$$\frac{12}{1000} \times \frac{230}{8} = .345 \text{ watts or } 345 \text{ milliwatts}$$



## USE OF CURVES (Cont'd)

If more signal is available or if there is less signal, the end points selected may be different and the power correspondingly increased or decreased. If necessary to estimate the % 2nd. Harmonic Distortion, this is obtained from:

$$\frac{\text{Avg. Current} - \text{Current at Operating Point}}{\text{Change in Current}} \times 100$$

$$\frac{(9\frac{1}{2} - 9)}{12} \times 100 = 4.15\%$$

In cases where the best value of load is not known several lines may be drawn and the best one used.

Although a triode was selected as an example the procedure for use of a load line for a pentode is the same providing the distortion is kept to a reasonably low value.

The plate resistance for conditions not given in the rating or on other curves, may be taken approximately as the slope of the tangent to the plate current curve at the point required. The dynamic plate resistance is usually higher than that obtained in this way. It can be seen from the shape of the curves why the selectivity obtained with RF pentodes at 100 volts plate and screen is not as good as that obtained under the 250 volt condition. The plate resistance acts like a resistor shunted across the tuned plate circuit.

**Transfer Characteristic**—is the name given to the curve showing Mutual Conductance, Plate Current, Plate Resistance or Amplification Constant plotted on the vertical scale and grid bias on the horizontal axis. Its main uses are in determining the operating range for tubes used with AVC voltage, and the selection of the best point for operating a grid biased detector or a converter. Servicemen may need this in selecting a tube with the proper cut-off characteristic for use in a given circuit.

The instantaneous plate currents found by adding or subtracting a value of peak signal voltage from the operating center can also be used in those cases where the impedance of the plate load is negligible. Examples of such cases are pentode broad-band amplifiers and relay operation where the load impedance is low compared to the tube plate resistance.

**Conversion Characteristic**—These are given only for converter type tubes and are shown in two different ways: Characteristics vs. oscillator grid current, and characteristics vs. control grid volts. The first of these is important in selecting the oscillator strength for operation over a required frequency range. Since no practical circuit has the same oscillator grid current at all frequencies it is necessary to compromise for best overall performance. The other curve against control grid volts is used similarly to the transfer characteristic in showing the desired range of AVC voltage to be applied.

**Diode Load Curve**—This may be used in designing AVC systems or vacuum tube voltmeters. Taking the curves given under type 7B6 as an example, the load current may be found for any applied signal voltage and any of several values of DC load resistance. With 25 volts RMS applied signal and 0.1 meg. load resistance, for example the load current will be 270 ua. and the developed bias 26.8 volts.

# RESISTANCE COUPLED AMPLIFIER DATA

On the following pages are given the necessary data for the construction of resistance coupled amplifiers using the types of tubes commonly employed for this purpose. The data are necessarily quite condensed but with the aid of the five reference diagrams and the equations given on the following page for determining the size by-pass and coupling condensers, any serviceman should be able to build a good amplifier or check the design of one under repair.

Notice that data are given for use under all the B supply voltages commonly used with a given type. Values of gain are given for two different values of applied signal; the first a typical small signal likely to be found for the type and the second is the maximum which can be used without exceeding the 5% distortion limit.

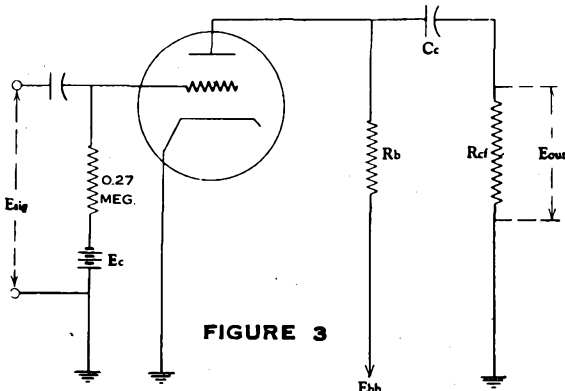
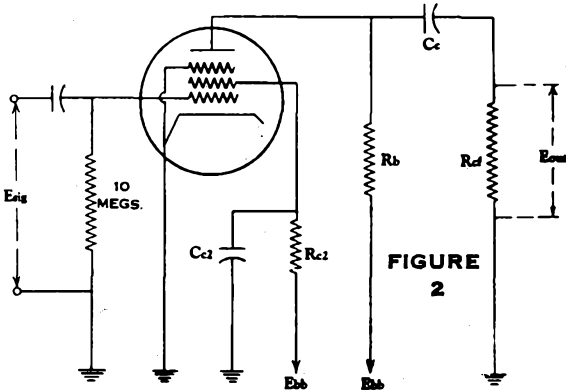
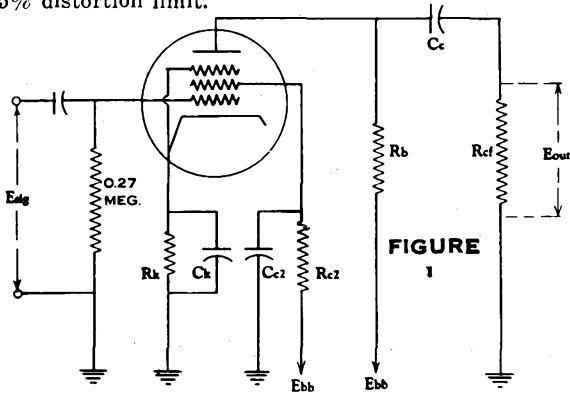

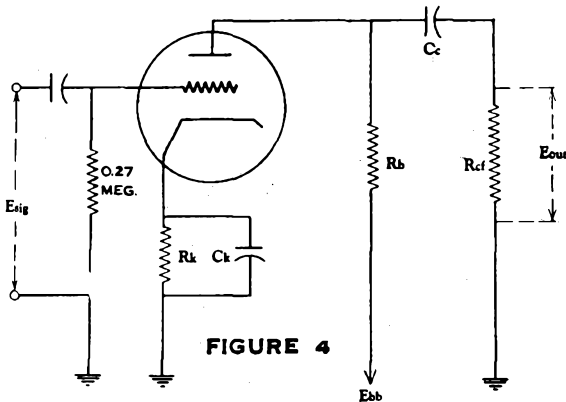

FIGURE 4

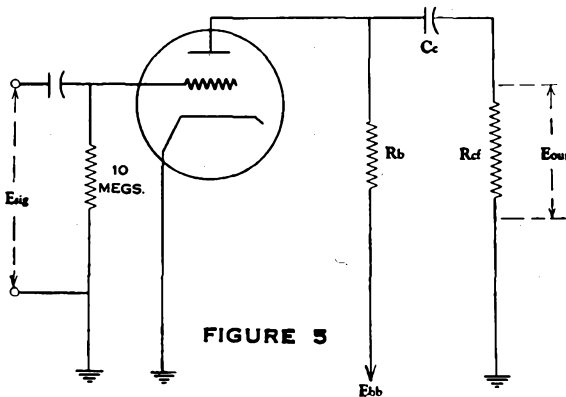

FIGURE 5

## SYMBOLS USED

Symbol	Function	Unit
Rb	Plate Load Resistor.....	Megohms
Rc2	Screen Dropping Resistor.....	Megohms
Rcf	Grid Resistor of following Tube.....	Megohms
Ebb	Plate Supply Voltage.....	Volts
Eb	Plate Voltage at Plate.....	Volts
Ec or Ecl	Grid to Neg. Fil. Voltage.....	Volts
Ec2	Screen Grid Voltage.....	Volts
Esig	Input Signal.....	RMS Volts
Eout	Output to following Grid.....	RMS Volts
Ib	Plate Current.....	Ma.
Ic2	Screen Grid Current.....	Ma.
Cc	Coupling Condenser.....	mfd.
Cc2	Screen By-pass Condenser.....	mfd.

Values of capacity are not specified since these are dependent mostly on the frequency characteristic required in each individual case.

For low frequency limit =  $f_1$

$$C_c = \frac{1.6 \times 10^6}{f_1 R_{cf}} \text{ mfd.}$$

$$C_k = \frac{1.6 \times 10^6}{f_1 R_k} \text{ mfd.}$$

$$C_{c2} = \frac{1.6 \times 10^6}{f_1 R_{c2}} \text{ mfd.}$$

Some text books show a more complicated method for calculating these by-pass condensers, but this method is quite rapid and gives conservative values. The loss due to incomplete by-passing will be less than 1% except for the cathode by-pass where it will be about 3%. The size condenser may be halved where economy is essential unless stages are cascaded and highest quality is required.

# RESISTANCE COUPLED AMPLIFIER DATA

Zero Bias Operation

26

SYLVANIA RADIO TUBES

IIC5 Sylvania Type

Rb	Ebb - 45 VOLTS									Ebb - 67.5 VOLTS									Ebb - 90 VOLTS																																			
	0.27			0.47			1.0			0.27			0.47			1.0			0.27			0.47			1.0																													
	1.0			1.8			3.9			1.0			1.8			3.9			1.0			1.8			3.9																													
Rc <sub>1</sub>	0.47			1.0			4.7			1.0			4.7			10			0.47			1.0			4.7			1.0			4.7			10			0.47			1.0			4.7			1.0			4.7			10		
Rc <sub>f</sub>	0.47	1.0	4.7	1.0	4.7	10	2.2	4.7	10	0.47	1.0	4.7	1.0	4.7	10	2.2	4.7	10	0.47	1.0	4.7	1.0	4.7	10	2.2	4.7	10	0.47	1.0	4.7	1.0	4.7	10	2.2	4.7	10	0.47	1.0	4.7	1.0	4.7	10	2.2	4.7	10									
I <sub>b</sub>	.080	.080	.080	.050	.050	.050	.025	.025	.025	.145	.145	.145	.087	.087	.087	.045	.045	.045	.22	.22	.22	.13	.13	.13	.065	.065	.065	.22	.22	.22	.13	.13	.13	.065	.065	.065	.22	.22	.22	.13	.13	.13	.065	.065	.065									
E <sub>b</sub>	23.4	23.4	23.4	21.5	21.5	21.5	20.0	20.0	20.0	28.3	28.3	28.3	26.6	26.6	26.6	22.5	22.5	22.5	30.5	30.5	30.5	29.0	29.0	29.0	29.0	29.0	29.0	25.0	25.0	25.0	25.0	25.0	25.0	25.0	25.0	25.0	25.0	25.0	25.0	25.0	25.0	25.0	25.0	25.0	25.0									
I <sub>c<sub>1</sub></sub>	.0232	.0232	.0232	.0146	.0146	.0146	.0077	.0077	.0077	.041	.041	.041	.025	.025	.025	.013	.013	.013	.061	.061	.061	.036	.036	.036	.0187	.0187	.0187	.061	.061	.061	.036	.036	.036	.0187	.0187	.0187	.061	.061	.061	.036	.036	.036	.0187	.0187	.0187									
E <sub>c<sub>1</sub></sub>	21.8	21.8	21.8	18.7	18.7	18.7	15.0	15.0	15.0	26.5	26.5	26.5	22.5	22.5	22.5	16.8	16.8	16.8	29.0	29.0	29.0	25.0	25.0	25.0	17.0	17.0	17.0	29.0	29.0	29.0	25.0	25.0	25.0	17.0	17.0	17.0	29.0	29.0	29.0	25.0	25.0	25.0	17.0	17.0	17.0									
E <sub>aig</sub>	0.05	0.05	0.05	0.05	0.05	0.05	0.05	0.05	0.05	0.1	0.1	0.1	0.1	0.1	0.1	0.1	0.1	0.1	0.1	0.1	0.1	0.1	0.1	0.1	0.1	0.1	0.1	0.1	0.1	0.1	0.1	0.1	0.1	0.1	0.1	0.1	0.1	0.1	0.1	0.1	0.1	0.1												
E <sub>out</sub>	1.55	1.94	2.25	2.15	2.75	2.85	2.80	3.25	3.50	4.10	5.0	5.7	5.5	6.8	7.0	7.1	8.2	8.65	4.9	6.0	6.9	6.65	8.35	8.7	9.0	10.4	11.0	6.9	8.35	8.7	9.0	10.4	11.0	6.65	8.35	8.7	9.0	10.4	11.0															
Gain	31.0	38.8	45.0	43.0	55.0	57.0	56.0	65.0	70.0	41.0	50.0	57.0	55.0	68.0	70.0	71.0	82.0	86.5	49.0	60.0	69.0	66.5	83.5	87.0	90.0	104	110	69.0	83.5	87.0	90.0	104	110	66.5	83.5	87.0	90.0	104	110															
% Distortion	2.10	1.90	1.20	2.00	1.70	1.60	2.90	2.40	2.0	1.80	1.30	1.60	1.70	2.0	2.1	2.30	2.50	2.70	.80	1.40	2.0	1.70	3.10	3.50	3.0	3.30	3.60	2.0	1.70	3.10	3.50	3.0	3.30	3.60																				
E <sub>aig</sub> (1)	0.13	0.17	0.19	0.12	0.15	0.15	0.1	0.11	0.11	0.26	0.28	0.30	0.21	0.23	0.24	0.15	0.17	0.17	0.34	0.34	0.34	0.28	0.28	0.28	0.18	0.18	0.17	0.34	0.34	0.34	0.28	0.28	0.28	0.18	0.18	0.17																		
E <sub>out</sub>	3.95	6.0	7.55	5.0	7.40	7.6	5.60	6.50	6.90	9.85	12.6	15.2	10.4	13.9	14.8	10.0	12.8	13.4	14.4	17.5	20.0	16.5	20.3	21.0	15.1	17.4	17.6	20.0	16.5	20.3	21.0	15.1	17.4	17.6																				
Gain	30.4	35.3	39.7	41.6	49.3	50.6	56.0	59.0	62.7	37.9	45.0	50.6	49.6	60.3	61.8	66.8	75.3	78.8	42.4	51.5	58.9	59.0	72.5	75.0	84.0	96.8	103.5	58.9	59.0	72.5	75.0	84.0	96.8	103.5																				
% Distortion	4.90	4.60	4.70	4.60	4.90	4.60	4.70	4.80	4.70	4.80	4.60	4.80	4.50	4.50	4.90	4.40	4.90	4.60	4.40	4.50	5.0	4.60	4.50	4.80	4.70	4.90	4.80	5.0	4.60	4.50	4.80	4.70	4.90	4.80																				

Note (1) Maximum signal for 5.0% distortion.

FOR CIRCUIT SEE FIGURE 2

# RESISTANCE COUPLED AMPLIFIER DATA

Zero Bias Operation

SYLVANIA RADIO TUBES 27

Sylvania Type 1LD5

Rb <sup>r</sup>	Ebb = 45 VOLTS									Ebb = 67.5 VOLTS									Ebb = 90 VOLTS								
	0.27			0.47			1.0			0.27			0.47			1.0			0.27			0.47			1.0		
	1.5			2.7			5.6			1.5			2.7			5.6			1.5			2.7			5.6		
Rc <sub>f</sub>	0.47	1.0	4.7	1.0	4.7	10.0	2.2	4.7	10.0	0.47	1.0	4.7	1.0	4.7	10.0	2.2	4.7	10.0	0.47	1.0	4.7	1.0	4.7	10.0	2.2	4.7	10.0
Ib (i)	0.066	0.066	0.066	0.043	0.043	0.043	0.023	0.023	0.023	0.125	0.125	0.125	0.077	0.077	0.077	0.04	0.04	0.04	0.189	0.189	0.189	0.114	0.114	0.114	0.059	0.059	0.059
Eb	27.2	27.2	27.2	24.8	24.8	24.8	22.0	22.0	22.0	33.7	33.7	33.7	31.3	31.3	31.3	27.5	27.5	27.5	39.0	39.0	39.0	36.4	36.4	36.4	31.0	31.0	31.0
Ic <sub>f</sub>	0.0142	0.0142	0.0142	0.009	0.009	0.009	0.0048	0.0048	0.0048	0.0259	0.0259	0.0259	0.0159	0.0159	0.0159	0.0082	0.0082	0.0082	0.0385	0.0385	0.0385	0.023	0.023	0.023	0.012	0.012	0.012
Ec <sub>f</sub>	23.7	23.7	23.7	20.7	20.7	20.7	18.1	18.1	18.1	28.6	28.6	28.6	24.5	24.5	24.5	21.6	21.6	21.6	32.2	32.2	32.2	27.9	27.9	27.9	22.8	22.8	22.8
Ea <sub>lg</sub>	0.05	0.05	0.05	0.05	0.05	0.05	0.05	0.05	0.05	0.1	0.1	0.1	0.1	0.1	0.1	0.1	0.1	0.1	0.1	0.1	0.1	0.1	0.1	0.1	0.1	0.1	0.1
Eout	1.46	1.75	2.10	2.0	2.54	2.62	2.47	2.97	3.24	4.05	4.82	5.50	5.45	6.8	7.05	6.85	8.4	8.9	4.9	5.7	6.75	6.65	8.45	8.75	8.55	10.4	10.8
Gain	29.2	35.0	42.0	40.0	50.8	52.4	49.5	59.4	64.8	40.5	48.2	55.0	54.5	68.0	70.5	68.5	84.0	89.0	49.0	57.0	67.5	66.5	84.5	87.5	85.5	104.0	108.0
% Distortion	2.2	1.9	1.5	2.4	2.0	1.7	3.1	2.2	2.1	2.3	1.8	1.6	3.1	2.3	2.2	4.0	3.2	2.8	1.1	0.9	0.7	2.0	1.2	1.2	2.4	1.7	1.7
Ea <sub>lg</sub> (s)	0.11	0.11	0.12	0.09	0.1	0.1	0.07	0.08	0.08	0.17	0.18	0.20	0.14	0.16	0.17	0.11	0.13	0.13	0.24	0.27	0.28	0.19	0.22	0.22	0.15	0.17	0.18
Eout	3.06	3.80	4.75	3.5	4.83	5.03	3.37	4.66	4.93	6.50	8.35	10.3	7.36	10.1	11.1	7.47	10.6	10.9	10.9	14.3	17.1	11.9	16.9	17.5	12.4	16.3	18.2
Gain	27.8	34.5	39.6	39.0	48.3	50.3	48.2	58.4	61.6	38.2	46.3	51.5	52.5	63.2	65.4	68.0	81.6	84.0	45.4	53.0	61.1	62.7	77.0	79.6	82.8	96.0	101.0
% Distortion	4.7	4.2	4.6	4.5	4.7	4.5	4.3	4.7	4.3	4.7	4.8	4.9	4.9	4.7	4.9	4.6	4.9	4.7	4.7	4.7	4.8	4.7	4.8	4.7	4.9	4.8	5.0

Note (1) Grid return to pin No. 8.  
 Note (2) Maximum signal for 5.0% distortion.

FOR CIRCUIT SEE FIGURE 2

# RESISTANCE COUPLED AMPLIFIER DATA

## Fixed Bias Operation

Rb	Ebb = 45 VOLTS						Ebb = 67.5 VOLTS						Ebb = 90 VOLTS					
	0.047		0.10		0.27		0.047		0.10		0.27		0.047		0.10		0.27	
Rcf	0.10	0.27	0.10	0.47	0.27	0.47	0.10	0.27	0.10	0.47	0.27	0.47	0.10	0.27	0.10	0.47	0.27	0.47
Ib	0.30	0.282	0.20	0.174	0.086	0.082	0.50	0.46	0.31	0.273	0.14	0.132	0.70	0.64	0.45	0.38	0.199	0.187
Ec	0.7	-0.8	-0.6	-0.8	-0.7	-0.8	-1.2	-1.4	-1.1	-1.4	-1.0	-1.2	-1.8	-2.1	-1.5	-2.0	-1.5	-1.7
Eb	30.9	32.3	25.0	27.6	21.8	22.9	44	45.9	36.5	40.2	34.7	31.9	57.1	60.0	45.0	52.0	36.2	39.5
Esig	0.10	0.10	0.10	0.10	0.10	0.10	0.5	0.5	0.5	0.5	0.5	0.5	0.5	0.5	0.5	0.5	0.5	0.5
Eout	0.68	0.74	0.74	0.86	0.83	0.92	3.7	3.95	4.05	4.6	4.7	5.05	3.94	4.2	4.32	4.76	5.0	5.2
Gain	6.8	7.4	7.4	8.6	8.3	9.2	7.45	7.9	8.1	9.2	9.4	10.1	7.9	8.4	8.65	9.5	10.0	10.4
% Distortion	0.7	0.7	0.5	0.9	0.8	0.9	2.5	2.1	2.9	2.3	3.3	3.1	1.7	1.4	1.7	1.3	2.4	2.2
Esig (1)	0.50	0.56	0.42	0.56	0.50	0.56	0.85	0.99	0.78	0.99	0.7	0.85	1.27	1.48	1.06	1.41	1.06	1.2
Eout	3.33	4.1	3.1	4.85	4.22	5.2	6.3	7.8	6.3	9.1	6.6	8.6	10.0	12.4	9.15	13.4	10.6	12.5
Gain	6.66	7.32	7.4	8.65	8.44	9.3	7.42	7.88	8.1	9.2	9.4	10.1	7.88	8.4	8.65	9.5	10.0	10.4
% Distortion	4.4	4.5	4.1	4.6	5.0	5.0	4.6	4.9	5.0	5.0	4.8	5.0	4.7	5.0	4.7	5.0	5.0	5.0

Note (1) Peak signal equal to bias. Optimum bias chosen for 5% maximum distortion. Grid return to pin No. 8.

FOR CIRCUIT SEE FIGURE 3

# RESISTANCE COUPLED AMPLIFIER DATA

Zero Bias Operation

SYLVANIA RADIO TUBES

29

Rb	Ebb = 45 VOLTS (See Note 2)									Ebb = 67.5 VOLTS									Ebb = 90 VOLTS								
	0.27			0.47			1.0			0.27			0.47			1.0			0.27			0.47			1.0		
	0.47	1.0	4.7	1.0	4.7	10.0	2.2	4.7	10.0	0.47	1.0	4.7	1.0	4.7	10.0	2.2	4.7	10.0	0.47	1.0	4.7	1.0	4.7	10.0	2.2	4.7	10.0
Rcf	0.0075	0.0075	0.0075	0.0064	0.0064	0.0064	0.005	0.005	0.005	0.03	0.03	0.03	0.0242	0.0242	0.0242	0.0168	0.0168	0.0168	0.071	0.071	0.071	0.053	0.053	0.053	0.032	0.032	0.032
Ib	43	43	43	42	42	42	40	40	40	59.4	59.4	59.4	56.1	56.1	56.1	50.7	50.7	50.7	70.8	70.8	70.8	65.1	65.1	65.1	58.0	58.0	58.0
Eb	.03	.03	.03	.03	.03	.03	.03	.03	.03	0.05	0.05	0.05	0.05	0.05	0.05	0.05	0.05	0.05	0.1	0.1	0.1	0.1	0.1	0.1	0.1	0.1	0.1
Eout	.168	.200	.234	.270	.336	.350	.405	.465	.490	0.77	0.91	1.03	1.08	1.26	1.29	1.37	1.52	1.60	2.2	2.55	2.8	3.0	3.4	3.5	3.65	3.95	4.05
Gain	5.6	6.7	7.8	9.0	11.2	11.7	13.5	15.5	16.3	15.4	18.2	20.6	21.6	25.2	25.8	27.4	30.4	32.0	22.0	25.5	28.0	30.0	34.0	35.0	36.5	39.5	40.5
% Distortion	5.1	5.0	4.9	4.5	4.2	3.8	3.9	3.7	3.6	3.5	3.3	2.9	3.2	2.9	2.8	2.6	2.3	2.2	2.7	2.4	2.1	2.5	2.1	2.0	2.6	2.3	2.1
Esig (1)	.03	.03	.03	.03	.04	.04	.05	.05	.05	0.07	0.08	0.08	0.08	0.09	0.10	0.09	0.10	0.11	0.17	0.18	0.20	0.17	0.19	0.20	0.16	0.18	0.19
Eout	.168	.200	.234	.270	.445	.465	0.67	0.76	0.81	1.07	1.44	1.63	1.7	2.24	2.50	2.43	2.97	3.45	3.60	4.45	5.40	4.89	6.20	6.65	5.66	6.80	7.45
Gain	5.6	6.7	7.8	9.0	11.1	11.6	13.4	15.2	16.2	15.3	18.0	20.4	21.3	24.9	25.0	27.0	29.7	31.4	21.2	24.7	27.0	28.7	32.6	33.2	35.4	37.8	39.2
% Distortion	5.1	5.0	4.9	4.5	5.2	5.1	5.2	5.0	4.9	4.7	4.7	4.6	4.7	4.5	4.8	4.5	4.5	4.7	4.6	4.3	4.7	4.5	4.5	4.7	4.5	4.65	4.7

Note (1) Maximum signal for 5.0% Distortion. Note (2) Operation at Ebb = 45 volts is not recommended. Above 45 volt data is shown only to assist in determining end of life performance with 67.5 volt supply. For 45 volt supply type 1LD5 is recommended.

FOR CIRCUIT SEE FIGURE 5

Sylvania Type

1LH4  
1H5G  
1B8GT  
3A8GT

# RESISTANCE COUPLED AMPLIFIER DATA

Zero Bias Operation

1LN5  
IN5GT  
3A8GT  
Sylvania Type

Rb	Ebb = 45 VOLTS									Ebb = 67.5 VOLTS									Ebb = 90 VOLTS								
	0.27			0.47			1.0			0.27			0.47			1.0			0.27			0.47			1.0		
	1.2			2.2			4.7			1.2			2.2			4.7			1.2			2.2			4.7		
Rc1	0.47			1.0			4.7			0.47			1.0			4.7			0.47			1.0			4.7		
Rc2	1.2			2.2			4.7			1.2			2.2			4.7			1.2			2.2			4.7		
Rc3	0.47	1.0	4.7	1.0	4.7	10	2.2	4.7	10	0.47	1.0	4.7	1.0	4.7	10	2.2	4.7	10	0.47	1.0	4.7	1.0	4.7	10	2.2	4.7	10
Ib	0.060	0.060	0.060	0.038	0.038	0.038	0.018	0.018	0.018	0.123	0.123	0.123	0.075	0.075	0.075	0.036	0.036	0.036	0.187	0.187	0.187	0.112	0.112	0.112	0.056	0.056	0.056
Eb	28.8	28.8	28.8	27.2	27.2	27.2	27.0	27.0	27.0	34.3	34.3	34.3	32.3	32.3	32.3	31.5	31.5	31.5	39.5	39.5	39.5	37.3	37.3	37.3	34.0	34.0	34.0
Ic1	0.0149	0.0149	0.0149	0.0095	0.0095	0.0095	0.005	0.005	0.005	0.029	0.029	0.029	0.0176	0.0176	0.0176	0.009	0.009	0.009	0.044	0.044	0.044	0.026	0.026	0.026	0.0134	0.0134	0.0134
Ec1	27.1	27.1	27.1	24.1	24.1	24.1	21.5	21.5	21.5	32.7	32.7	32.7	28.8	28.8	28.8	25.3	25.3	25.3	37.2	37.2	37.2	32.8	32.8	32.8	27.0	27.0	27.0
Esig	0.05	0.05	0.05	0.05	0.05	0.05	0.05	0.05	0.05	0.05	0.05	0.05	0.05	0.05	0.05	0.05	0.05	0.05	0.1	0.1	0.1	0.1	0.1	0.1	0.1	0.1	p.1
Eout	1.58	1.96	2.25	2.15	2.80	2.90	2.85	3.40	3.65	2.28	2.80	3.30	3.2	4.17	4.33	4.28	5.1	5.5	5.5	6.9	8.0	7.9	10.0	10.2	10.3	12.1	12.8
Gain	31.6	39.2	45.0	43.0	56.0	58.0	57.0	68.0	73.0	45.7	56.0	66.0	64.0	83.3	86.6	85.6	102.0	110.0	55.0	69.0	80.0	79.0	100	102	103	121	128
% Distortion	2.9	2.6	2.6	4.0	3.0	2.8	3.8	3.3	3.2	2.0	1.8	1.7	2.3	1.9	1.8	2.6	2.1	2.0	2.2	1.8	1.5	2.6	1.9	1.8	3.2	3.0	3.0
Esig (i)	0.09	0.09	0.09	0.07	0.08	0.08	0.06	0.07	0.07	0.13	0.15	0.17	0.11	0.13	0.14	0.09	0.1	0.11	0.21	0.23	0.25	0.17	0.19	0.19	0.13	0.14	0.14
Eout	2.75	3.45	4.0	3.0	4.45	4.60	3.40	4.68	4.90	5.65	8.00	10.2	6.7	10.0	10.9	7.4	9.6	10.9	10.8	14.4	17.8	12.5	17.2	17.9	12.9	16.1	17.0
Gain	30.6	38.3	44.4	42.8	55.6	57.5	56.6	66.9	70.0	43.5	53.3	60.0	61.0	77.0	77.8	82.3	96.0	99.0	51.5	62.5	71.2	73.5	90.5	94.2	99.0	115	121
% Distortion	5.0	4.7	4.5	4.4	4.8	4.7	4.6	5.0	4.8	4.6	4.7	4.8	4.8	4.5	4.9	4.6	4.5	5.0	5.0	4.9	4.8	4.9	4.7	4.6	4.9	4.9	4.9

Note (1) Maximum signal for 5.0% distortion.

FOR CIRCUIT SEE FIGURE 2



# RESISTANCE COUPLED AMPLIFIER DATA

Zero Bias Operation

	Ebb - 45 VOLTS									Ebb - 67.5 VOLTS									Ebb - 90 VOLTS								
	0.27			0.47			1.0			0.27			0.47			1.0			0.27			0.47			1.0		
Rb	0.27			0.47			1.0			0.27			0.47			1.0			0.27			0.47			1.0		
Rc <sub>1</sub>	0.68			1.2			2.2			0.68			1.2			2.2			0.68			1.2			2.2		
Rc <sub>f</sub>	0.47	1.0	4.7	1.0	4.7	10	2.2	4.7	10	0.47	1.0	4.7	1.0	4.7	10	2.2	4.7	10	0.47	1.0	4.7	1.0	4.7	10	2.2	4.7	10
I <sub>b</sub>	.072	.072	.072	.043	.043	.043	.023	.023	.023	.134	.134	.134	.078	.078	.078	.041	.041	.041	.20	.20	.20	.116	.116	.116	.06	.06	.06
E <sub>b</sub>	25.6	25.6	25.6	24.8	24.8	24.8	22.0	22.0	22.0	31.3	31.3	31.3	30.8	30.8	30.8	26.5	26.5	26.5	35.9	35.9	35.9	35.5	35.5	35.5	30.0	30.0	30.0
I <sub>c<sub>1</sub></sub>	.042	.042	.042	.025	.025	.025	.0146	.0146	.0146	.07	.07	.07	.0421	.0421	.0421	.024	.024	.024	.101	.101	.101	.06	.06	.06	.034	.034	.034
E <sub>c<sub>1</sub></sub>	16.5	16.5	16.5	15.0	15.0	15.0	12.9	12.9	12.9	20.0	20.0	20.0	17.0	17.0	17.0	14.6	14.6	14.6	21.3	21.3	21.3	18.0	18.0	18.0	15.0	15.0	15.0
E <sub>sig</sub>	0.05	0.05	0.05	0.05	0.05	0.05	0.05	0.05	0.05	0.1	0.1	0.1	0.1	0.1	0.1	0.1	0.1	0.1	0.1	0.1	0.1	0.1	0.1	0.1	0.1	0.1	0.1
E <sub>out</sub>	1.64	1.94	2.30	2.05	2.67	2.80	2.77	3.27	3.58	4.58	5.5	6.45	6.08	7.8	8.1	7.85	9.25	9.8	5.5	6.67	8.0	7.5	10.0	10.4	10.0	11.4	12.2
Gain	32.8	38.8	46.0	41.0	53.4	56.0	55.5	65.5	71.7	45.8	55.0	64.5	60.8	78.0	81.0	78.5	92.5	98.0	55.0	66.7	80.0	75.0	100	104	100	114	122
% Distortion	2.70	2.40	3.30	3.00	2.80	2.80	3.10	2.80	2.50	2.60	2.10	1.70	4.20	3.60	3.00	3.80	3.00	2.80	1.60	1.20	1.20	2.40	1.70	1.70	2.40	2.50	2.90
E <sub>sig</sub> (1)	0.09	0.10	0.11	0.08	0.09	0.09	0.07	0.09	0.09	0.16	0.18	0.20	0.12	0.15	0.15	0.12	0.13	0.14	0.24	0.26	0.27	0.17	0.19	0.20	0.16	0.16	0.16
E <sub>out</sub>	2.85	3.75	4.97	0.13	4.76	4.90	3.83	5.65	6.05	7.0	9.6	11.9	7.2	11.1	11.5	9.3	11.3	12.8	12.5	1.59	19.4	12.3	17.7	19.0	14.9	17.2	18.4
Gain	31.7	37.5	45.2	39.1	52.8	54.5	54.8	62.7	67.2	43.7	53.2	59.5	60.0	74.0	76.6	77.5	87.0	91.5	52.0	61.2	71.9	72.3	93.1	95.0	93.1	107	115
% Distortion	4.60	4.70	4.50	5.00	4.70	4.50	4.20	4.90	4.60	4.70	4.70	4.80	5.00	4.90	4.80	4.80	4.50	4.70	4.90	4.90	4.90	5.0	4.30	4.70	4.50	4.70	4.90

Note (1) Maximum signal for 5.0% Distortion.

FOR CIRCUIT SEE FIGURE 2

## RESISTANCE COUPLED AMPLIFIER DATA

Zero Bias Operation

ISS  
1U5  
Sylvania Type

Rb	Ebb - 45 VOLTS									Ebb - 67.5 VOLTS									Ebb - 90 VOLTS								
	0.27			0.47			1.0			0.27			0.47			1.0			0.27			0.47			1.0		
Rc <sub>s</sub>	1.0			1.8			3.9			1.0			1.8			3.9			1.0			1.8			3.9		
Rc <sub>f</sub>	0.47	1.0	4.7	1.0	4.7	10	2.2	4.7	10	0.47	1.0	4.7	1.0	4.7	10	2.2	4.7	10	0.47	1.0	4.7	1.0	4.7	10	2.2	4.7	10
I <sub>b</sub>	.080	.080	.080	.050	.050	.050	.025	.025	.025	.145	.145	.145	.087	.087	.087	.045	.045	.045	.22	.22	.22	.13	.13	.13	.065	.065	.065
E <sub>b</sub>	23.4	23.4	23.4	21.5	21.5	21.5	20.0	20.0	20.0	28.3	28.3	28.3	26.6	26.6	26.6	22.5	22.5	22.5	30.5	30.5	30.5	29.0	29.0	29.0	25.0	25.0	25.0
I <sub>c<sub>s</sub></sub>	.0232	.0232	.0232	.0146	.0146	.0146	.0077	.0077	.0077	.041	.041	.041	.025	.025	.025	.013	.013	.013	.061	.061	.061	.036	.036	.036	.0187	.0187	.0187
E <sub>c<sub>s</sub></sub>	21.8	21.8	24.8	18.7	18.7	18.7	15.0	15.0	15.0	26.5	26.5	26.5	22.5	22.5	22.5	16.8	16.8	16.8	29.0	29.0	29.0	25.0	25.0	25.0	17.0	17.0	17.0
E <sub>sig</sub>	0.05	0.05	0.05	0.05	0.05	0.05	0.05	0.05	0.05	0.1	0.1	0.1	0.1	0.1	0.1	0.1	0.1	0.1	0.1	0.1	0.1	0.1	0.1	0.1	0.1	0.1	0.1
E <sub>out</sub>	1.55	1.94	2.25	2.15	2.75	2.85	2.80	3.25	3.50	4.10	5.0	5.7	5.5	6.8	7.0	7.1	8.2	8.65	4.9	6.0	6.9	6.65	8.35	8.7	9.0	10.4	11.0
Gain	31.0	38.8	45.0	43.0	55.0	57.0	56.0	65.0	70.0	41.0	50.0	57.0	55.0	68.0	70.0	71.0	82.0	86.5	49.0	60.0	69.0	66.5	83.5	87.0	90.0	104	110
% Distortion	2.10	1.90	1.20	2.00	1.70	1.60	2.90	2.40	2.0	1.80	1.30	1.60	1.70	2.0	2.1	2.30	2.50	2.70	.80	1.40	2.0	1.70	3.10	3.50	3.0	3.30	3.60
E <sub>sig</sub> (1)	0.13	0.17	0.19	0.12	0.15	0.15	0.1	0.11	0.11	0.26	0.28	0.30	0.21	0.23	0.24	0.15	0.17	0.17	0.34	0.34	0.34	0.28	0.28	0.28	0.18	0.18	0.17
E <sub>out</sub>	3.95	6.0	7.55	5.0	7.40	7.6	5.60	6.50	6.90	9.85	12.6	15.2	10.4	13.9	14.8	10.0	12.8	13.4	14.4	17.5	20.0	16.5	20.3	21.0	15.1	17.4	17.6
Gain	30.4	35.3	39.7	41.6	49.3	50.6	56.0	59.0	62.7	37.9	45.0	50.6	49.6	60.3	61.8	66.8	75.3	78.8	42.4	51.5	58.9	59.0	72.5	75.0	84.0	96.8	103.5
% Distortion	4.90	4.60	4.70	4.60	4.90	4.60	4.70	4.80	4.70	4.80	4.60	4.80	4.50	4.50	4.90	4.40	4.90	4.60	4.40	4.50	5.0	4.60	4.50	4.80	4.70	4.90	4.80

Note (1) Maximum signal for 5.0% distortion.

FOR CIRCUIT SEE FIGURE 2

# RESISTANCE COUPLED AMPLIFIER DATA

Zero Bias Operation

Sylvania Type 1U4

Rb	Ebb = 45 VOLTS (See Note 2)									Ebb = 67.5 VOLTS									Ebb = 90 VOLTS								
	0.27			0.47			1.0			0.27			0.47			1.0			0.27			0.47			1.0		
	1.0									1.0									1.0								
Rc1	1.0			1.5			3.3			1.0			1.5			3.3			1.0			1.5			3.3		
Rc2	0.47	1.0	4.7	1.0	4.7	10.0	2.2	4.7	10.0	0.47	1.0	4.7	1.0	4.7	10.0	2.2	4.7	10.0	0.47	1.0	4.7	1.0	4.7	10.0	2.2	4.7	10.0
Ib	.048	.048	.048	.034	.034	.034	.0175	.0175	.0175	.101	.101	.101	.070	.070	.070	.035	.035	.035	.156	.156	.156	.11	.11	.11	.054	.054	.054
Eb	12.14	32.14	32.14	29.12	29.12	29.12	28.5	28.5	28.5	40.2	40.2	40.2	34.6	34.6	34.6	32.5	32.5	32.5	47.9	47.9	47.9	38.3	38.3	38.3	36.0	36.0	36.0
Ic1	.0165	.0165	.0165	.012	.012	.012	.006	.006	.006	.033	.033	.033	.0235	.0235	.0235	.0115	.0115	.0115	.049	.049	.049	.036	.036	.036	.017	.017	.017
Ec1	28.5	28.5	28.5	27.0	27.0	27.0	25.2	25.2	25.2	34.5	34.5	34.5	32.25	32.25	32.25	29.6	29.6	29.6	41.0	41.0	41.0	36.0	36.0	36.0	33.5	33.5	33.5
Esig	.05	.05	.05	.05	.05	.05	.04	.04	.05	.05	.05	.05	.05	.05	.05	.05	.05	.05	.05	.05	.05	.05	.05	.05	.05	.05	.05
Eout	1.46	1.75	2.10	2.00	2.55	2.68	2.25	2.52	3.45	2.3	2.75	3.3	3.3	4.25	4.45	4.35	5.2	5.55	2.92	3.60	4.25	4.20	5.40	5.60	5.70	6.80	7.40
Gain	28.3	35	42	40	51	53.6	56.3	63.1	69.0	46	55	66	66	85.0	89	87	104	111	58.4	72.0	85.0	84.0	108	112	113	136	148
% Distortion	3.4	3.4	3.9	4.2	4.3	4.0	4.1	4.4	4.9	2.0	2.0	2.0	2.3	2.3	1.9	3.8	3.6	3.3	1.4	1.2	1.3	1.3	1.1	0.9	2.5	2.2	1.8
Esig (1)	.06	.06	.06	.05	.05	.06	.04	.04	.05	.10	.11	.11	.09	.10	.10	.06	.07	.07	0.13	0.15	0.15	0.13	0.15	0.16	0.09	0.09	0.11
Eout	1.70	2.08	2.50	2.00	2.55	3.20	2.25	2.52	3.45	4.45	5.9	7.0	5.8	8.35	8.60	5.20	7.15	7.6	7.35	10.3	12.0	10.4	15	16.5	10	11.8	15.1
Gain	28.3	34.8	41.7	40	51	53.4	56.3	63.1	69.0	44.5	53.5	63.5	64.5	83.5	86.0	86.8	102	108	56.5	68.8	80	80	100	103	111	131	138
% Distortion	4.4	4.3	4.5	4.2	4.3	4.9	4.1	4.4	4.9	4.6	5.0	4.8	4.8	4.9	4.1	4.6	5.0	4.6	4.4	5.0	4.8	4.8	4.9	5.0	4.9	4.4	4.6

Note (1) Maximum signal for 5.0% distortion. Note (s) Operation at Ebb = 45 volts is not recommended. Above 45 volts data is shown only to assist in determining end of life performance with 67.5 volt supply.

FOR CIRCUIT SEE FIGURE 2

# RESISTANCE COUPLED AMPLIFIER DATA

Zero Bias Operation

Rb	Ebb = 100 Volts						Ebb = 250 Volts							
	0.10		0.27		0.47		0.1		0.27		0.47			
Ref	0.27	0.47	0.27	0.47	1.0	0.47	1.0	0.27	0.47	0.27	0.47	1.0	0.47	1.0
Rk	...	...	...	...	...	...	...	...	...	...	...	...	...	...
Ib	0.39	0.39	0.192	0.192	0.192	0.124	0.124	1.48	1.48	0.65	0.65	0.65	0.40	0.40
Ec	...	...	...	...	...	...	...	...	...	...	...	...	...	...
Eb	61.0	61.0	48.2	48.2	48.2	41.7	41.7	102.0	102.0	74.5	74.5	74.5	62.0	62.0
Esig	0.1	0.1	0.1	0.1	0.1	0.1	0.1	0.1	0.1	0.1	0.1	0.1	0.1	0.1
Eout	3.60	3.80	3.70	4.00	4.30	3.90	4.35	4.85	5.20	5.05	5.40	5.60	5.20	5.60
Gain	36.0	38.0	37.0	40.0	43.0	39.0	43.5	48.5	52.0	50.5	54.0	56.0	52.0	56.0
% Dist.	2.0	1.9	2.3	1.7	1.3	1.9	1.4	0.4	0.4	0.8	0.7	0.6	0.8	0.6
Esig (1)	0.21	0.23	0.19	0.24	0.28	0.22	0.29	0.72	0.75	0.56	0.67	0.78	0.60	0.78
Eout	7.4	8.4	6.7	9.3	11.0	8.2	11.5	30.5	33.0	25.0	31.5	38.0	27.5	37.5
Gain	35.2	36.5	35.2	38.8	39.3	37.2	39.7	42.4	44.0	44.6	47.0	48.7	45.8	48.1
% Dist.	4.9	5.0	4.8	4.9	5.0	4.8	5.0	4.8	4.9	5.0	5.0	4.9	5.0	5.0

(1) Maximum Signal For 5.0% Distortion

FOR CIRCUIT SEE FIGURE 5

Self Bias Operation

Rb	Ebb = 100 Volts						Ebb = 250 Volts							
	0.10		0.27		0.47		0.10		0.27		0.47			
Ref	0.27	0.47	0.27	0.47	1.0	0.47	1.0	0.27	0.47	0.27	0.47	1.0	0.47	1.0
Rk	3300	3300	5600	6800	6800	10,000	10,000	1200	1200	2700	2700	3300	3900	4700
Ib	0.340	0.340	0.175	0.168	0.168	0.112	0.107	1.20	1.20	0.550	0.550	0.510	0.345	0.324
Ec	-1.122	-1.122	-0.980	-1.142	-1.142	-1.120	-1.070	-1.440	-1.440	-1.485	-1.485	-1.682	-1.345	-1.522
Eb	66.0	66.0	52.7	54.7	54.7	47.4	49.7	130.0	130.0	101.5	101.5	112.3	88.0	97.7
Esig	0.1	0.1	0.1	0.1	0.1	0.1	0.1	0.1	0.1	0.1	0.1	0.1	0.1	0.1
Eout	3.40	3.60	3.45	3.80	4.10	3.70	4.05	4.60	4.70	4.6	4.9	4.95	4.90	5.05
Gain	34.0	36.0	34.5	38.0	41.0	37.0	40.5	46.0	47.0	46.0	49.0	49.5	49.0	50.5
% Dist.	2.2	2.0	2.4	1.9	1.6	2.0	1.4	0.6	0.6	0.9	0.7	0.6	0.8	0.6
Esig (1)	0.21	0.22	0.20	0.23	0.24	0.22	0.27	0.53	0.53	0.53	0.53	0.68	0.46	0.59
Eout	6.90	7.80	7.05	8.60	9.70	8.15	10.7	23.5	24.0	24.0	25.2	33.0	22.3	29.5
Gain	32.8	34.4	35.2	37.4	40.4	37.0	39.6	44.3	45.3	45.3	47.6	48.5	48.4	50.0
% Dist.	5.0	4.9	4.9	4.8	4.2	4.9	4.3	3.1	2.9	4.9	4.0	4.2	3.8	3.7

(1) At Grid Current Point, Less Than 1/4 Microampere Grid Current Through 0.27 Megohm Grid Resistor.

FOR CIRCUIT SEE FIGURE 4

## RESISTANCE COUPLED AMPLIFIER DATA

Self Bias Operation

	Ebb = 100 VOLTS										
Rb	.047			.1			.27			.47	
Rc2	.22			.39			1.0			1.8	
Ref	.047	.10	.27	.10	.27	.47	.27	.47	1.0	.47	1.0
Rk	680	680	680	1500	1500	1500	3300	3300	3300	5600	5600
Ib	1.13	1.13	1.13	.61	.61	.61	.265	.265	.265	.158	.158
Ic2	.280	.280	.280	.167	.167	.167	.074	.074	.074	.043	.043
Ec1	-0.96	-0.96	-0.96	-1.17	-1.17	-1.17	-1.12	-1.12	-1.12	-1.12	-1.12
Ec2	38.4	38.4	38.4	35.0	35.0	35.0	26.0	26.0	26.0	22.6	22.6
Eb	46.9	46.9	46.9	39.0	39.0	39.0	28.5	28.5	28.5	25.7	25.7
E sig.	0.1	0.1	0.1	0.1	0.1	0.1	0.1	0.1	0.1	0.1	0.1
E out	4.2	5.7	6.7	5.4	7.7	8.3	7.6	9.0	10.5	8.5	10.5
Gain	42	57	67	54	77	83	76	90	105	85	105
% Dist.	3.3	2.7	2.1	2.9	2.0	1.6	2.0	2.1	3.0	2.0	2.3
E sig. (1)	0.15	0.17	0.20	0.14	0.20	0.22	0.16	0.8	0.20	0.15	0.17
E out	6.2	9.2	12.8	7.5	14.4	17.0	11.5	15.7	20.7	12.6	17.7
Gain	41.3	54.1	64.0	53.5	72.0	77.5	72.0	87.2	103	84.0	104
% Dist.	4.8	5.0	5.0	4.7	4.9	5.0	4.6	4.6	4.5	4.7	4.6

	Ebb = 150 VOLTS										
Rb	.047			.1			.27			.47	
Rc2	.22			.47			1.2			2.2	
Ref	.047	.10	.27	.10	.27	.47	.27	.47	1.0	.47	1.0
Rk	470	470	470	1000	1000	1000	2200	2200	2200	3900	3900
Ib	1.86	1.86	1.86	.97	.97	.97	.41	.41	.41	.24	.24
Ic2	.460	.460	.460	.234	.234	.234	.101	.101	.101	.057	.057
Ec1	-1.09	-1.09	-1.09	-1.20	-1.20	-1.20	-1.13	-1.13	-1.13	-1.16	-1.16
Ec2	48.9	48.9	48.9	40.0	40.0	40.0	28.9	28.9	28.9	24.5	24.5
Eb	62.6	62.6	62.6	53.0	53.0	53.0	39.1	39.1	39.1	37.0	37.0
E sig.	0.1	0.1	0.1	0.1	0.1	0.1	0.1	0.1	0.1	0.1	0.1
E out	5.2	6.9	8.4	7.2	9.8	10.7	10.4	12.1	14.2	11.7	14.8
Gain	52	69	84	72	98	107	104	121	142	117	148
% Dist.	2.2	1.7	1.0	2.3	1.6	1.2	2.4	1.4	1.0	2.4	1.4
E sig. (1)	0.22	0.26	0.31	0.17	0.23	0.25	0.17	0.20	0.22	0.16	0.19
E out	11.2	17.0	24.0	11.9	21.6	25.0	17.2	23.2	29.5	18.5	26.8
Gain	50.8	65.4	77.5	70.0	93.9	100	101	116	134	115	141
% Dist.	4.9	4.9	5.0	4.8	4.9	4.8	4.9	4.8	4.8	4.9	5.0

Note (1) For self bias operation this is taken at the grid current point with less than 1/2 Microampere grid current.

FOR CIRCUIT SEE FIGURE 1

# RESISTANCE COUPLED AMPLIFIER DATA

Self Bias Operation  
Single Section of Types 6BF7 or 6BG7

Rb	Ebb = 100 VOLTS						Ebb = 250 VOLTS					
	0.047		0.1		0.27		0.047		0.1		0.27	
Rcf	0.1	0.27	0.1	0.47	0.27	0.47	0.1	0.27	0.1	0.47	0.27	0.47
Rk	1200	1500	2200	2700	6800	8200	680	820	1200	1800	3900	4700
Ib	1.12	1.04	0.61	0.58	0.24	0.226	3.23	3.07	1.75	1.57	0.67	0.63
Ec	-1.34	-1.56	-1.34	-1.57	-1.64	-1.85	-2.20	-2.52	-2.10	-2.83	-2.61	-2.96
Eb	47.4	51.1	39.0	42.0	35.1	39.0	98.0	106.7	75.0	93.0	69.0	80.0
Esig	0.1	0.1	0.1	0.1	0.1	0.1	0.5	0.5	0.5	0.5	0.5	0.5
Eout	1.95	1.90	1.85	2.0	1.91	1.88	11.0	11.2	10.8	11.2	9.9	10.0
Gain	19.5	19.0	18.5	20.0	19.1	18.8	22.0	22.4	21.6	22.4	19.8	20.0
% Distortion	.56	.42	.54	.35	.31	.37	1.4	1.2	1.8	.89	1.1	.71
Esig (1)	0.43	0.60	0.44	0.58	0.63	0.79	1.07	1.31	0.97	1.52	1.34	1.62
Eout	8.2	11.4	8.0	11.6	11.8	14.5	23.4	28.8	20.8	33.2	26.5	32.3
Gain	19.0	19.0	18.2	20.0	18.7	18.4	21.8	21.9	21.4	21.9	19.8	20.0
% Distortion	4.1	4.9	4.5	4.0	4.8	4.9	5.0	4.7	4.5	4.7	4.9	4.6

Note (1) For self bias operation this is taken at the grid current point with less than 1/2 microampere grid current.

FOR CIRCUIT SEE FIGURE 4

## RESISTANCE COUPLED AMPLIFIER DATA

Self Bias Operation

Rb	Ebb = 100 VOLTS								Ebb = 250 VOLTS							
	0.1		0.27		0.47		1.0		0.1		0.27		0.47		1.0	
	0.27	0.47	0.27	0.47	1.0	0.47	1.0	0.27	0.47	0.27	0.47	1.0	0.47	1.0	0.27	0.47
R <sub>cf</sub>	4700	5600	8200	10,000	10,000	12,000	15,000	1800	1800	3300	3300	3900	4700	5600		
I <sub>b</sub>	.23	.204	.132	.117	.117	.092	.08	.84	.84	.45	.45	.41	.30	.28		
E <sub>c</sub>	-1.08	-1.143	-1.03	-1.17	-1.17	-1.10	-1.2	-1.51	-1.51	-1.49	-1.49	-1.59	-1.41	-1.57		
E <sub>b</sub>	77.0	79.6	64.4	68.4	68.4	56.8	62.4	166.	166.	128.	128.	139.	109.	118.5		
E <sub>sig.</sub>	0.1	0.1	0.1	0.1	0.1	0.1	0.1	0.1	0.1	0.1	0.1	0.1	0.1	0.1	0.1	0.1
E <sub>out</sub>	3.6	3.8	4.2	4.35	5.0	4.7	5.2	5.4	5.7	6.1	6.6	6.9	6.6	7.1		
Gain	36.0	38.0	42.0	43.5	50.0	47.0	52.0	54.0	57.0	61.0	66.0	69.0	66.0	71.0		
% Dist.	3.4	3.4	3.6	3.2	2.6	3.2	2.6	0.3	....	0.5	0.2	0.2	0.4	0.2		
E <sub>sig.</sub> (1)	.14	.14	.11	.14	.17	.13	.17	.5	.5	.41	.45	.54	.38	.48		
E <sub>out</sub>	5.0	5.2	4.6	6.0	8.3	6.1	8.5	26.5	28.5	24.5	29.0	37.0	25.0	33.5		
Gain	35.7	37.2	41.8	42.9	48.8	46.9	50.0	53.0	52.0	59.8	64.4	68.5	65.8	69.8		
% Dist.	5.0	5.1	4.1	4.9	5.1	4.4	5.0	5.0	4.4	4.95	4.4	4.8	4.1	4.2		

(1) At grid current point, less than 1/2 Microampere grid current through 0.27 megohm grid resistor.

FOR CIRCUIT SEE FIGURE 4

Zero Bias Operation

Sylvania Type 6BK6

Rb	Ebb = 100 VOLTS								Ebb = 250 VOLTS							
	0.1		0.27		0.47		1.0		0.1		0.27		0.47		1.0	
	0.27	0.47	0.27	0.47	1.0	0.47	1.0	0.27	0.47	0.27	0.47	1.0	0.47	1.0	0.27	0.47
R <sub>cf</sub>	....	....	....	....	....	....	....	....	....	....	....	....	....	....	....	....
I <sub>b</sub>	.255	.255	.146	.146	.146	.100	.100	1.16	1.16	.57	.57	.57	.355	.355		
E <sub>c</sub>	....	....	....	....	....	....	....	....	....	....	....	....	....	....		
E <sub>b</sub>	74.5	74.5	60.6	60.6	60.6	53	53	134.	134.	123.	123.	123.	83.	83.		
E <sub>sig.</sub>	0.1	0.1	0.1	0.1	0.1	0.1	0.1	0.1	0.1	0.1	0.1	0.1	0.1	0.1	0.1	0.1
E <sub>out</sub>	3.9	4.2	4.35	5.0	5.5	4.85	5.7	6.0	6.3	6.6	7.2	7.7	7.3	8.0		
Gain	39	42	43.5	50	55	48.5	57	60	63	66	72	77	73	80		
% Dist.	3.0	2.7	3.4	2.6	2.0	2.9	2.0	....	....	....	....	....	0.3	....		
E <sub>sig.</sub> (1)	.14	.15	.13	.15	.18	.14	.18	.52	.56	.43	.5	.57	.42	.53		
E <sub>out</sub>	5.3	6.1	5.6	7.2	9.3	6.7	8.5	28.5	32.0	26.5	33.0	40.5	29.0	39.0		
Gain	37.9	40.7	43	48	51.7	47.8	47.2	54.8	57.1	61.6	66	71.1	69.	73.6		
% Dist.	4.8	4.8	4.8	4.7	4.9	4.7	4.8	4.8	5.0	4.9	5.0	4.9	4.8	4.8		

(1) Maximum signal for 5.0% distortion.

FOR CIRCUIT SEE FIGURE 5

## RESISTANCE COUPLED AMPLIFIER DATA

Self Bias Operation

Rb	Ebb = 100 VOLTS						Ebb = 250 VOLTS					
	0.047		0.1		0.27		0.047		0.1		0.27	
	0.1	0.27	0.1	0.47	0.27	0.47	0.1	0.27	0.1	0.47	0.27	0.47
Ref	1800	2200	2700	3900	6800	8200	1500	1800	2200	3300	5600	8200
Ib	1.07	1.0	0.62	0.56	0.256	0.240	2.85	2.69	1.63	1.46	0.661	0.60
Ec	-1.93	-2.2	-1.67	-2.18	-1.74	-1.97	-4.27	-4.84	-3.59	-4.82	-3.70	-4.92
Eb	49.6	53.0	38	44	31	35.2	116	123.8	87	104	71.8	88
Esig	0.5	0.5	0.5	0.5	0.5	0.5	1.0	1.0	1.0	1.0	1.0	1.0
Eout	5.3	5.4	5.6	5.8	5.7	5.8	11.2	11.8	11.8	12.4	12.1	12.2
Gain	10.6	10.8	11.2	11.6	11.4	11.6	11.2	11.8	11.8	12.4	12.1	12.2
% Distortion	1.2	1.9	2.0	1.8	2.2	1.8	1.3	1.2	1.8	1.3	1.8	1.3
Esig (°)	1.02	1.24	0.87	1.23	0.97	1.10	2.80	3.25	2.23	3.27	2.40	3.32
Eout	10.6	13.2	9.5	14.2	11.0	12.8	31.2	38.0	26.0	40.4	28.5	40.6
Gain	10.4	10.6	10.9	11.5	11.3	11.6	11.1	11.7	11.7	12.3	12.1	12.2
% Distortion	4.5	4.9	4.7	4.8	4.9	4.3	4.5	4.6	4.4	4.5	4.5	4.9

Note (1) For self bias operation this is taken at the grid current point with less than  $\frac{1}{2}$  microampere grid current.

FOR CIRCUIT SEE FIGURE 4



# RESISTANCE COUPLED AMPLIFIER DATA

Self Bias Operation

Rb	Ebb - 100 VOLTS						Ebb - 250 VOLTS					
	0.047		0.1		0.27		0.047		0.1		0.27	
	0.1	0.27	0.1	0.47	0.27	0.47	0.1	0.27	0.1	0.47	0.27	0.47
Rcf	0.1	0.27	0.1	0.47	0.27	0.47	0.1	0.27	0.1	0.47	0.27	0.47
Rk	1200	1200	2200	2700	6800	8200	1000	1000	1500	1800	4700	6800
Ib	1.22	1.22	.66	.628	.259	.246	3.2	3.2	1.78	1.72	.684	.63
Ec	1.465	1.465	1.45	1.695	1.76	2.02	3.2	3.2	2.67	3.10	3.21	4.28
Eb	42.7	42.7	34	37.2	30	33.6	150.5	150.5	72	78	65	80
Eaig	0.5	0.5	0.5	0.5	0.5	0.5	1.0	1.0	1.0	1.0	1.0	1.0
Eout	6.25	6.6	6.35	6.75	6.3	6.3	13.5	14.1	13.8	14.3	13.4	13.2
Gain	12.5	13.2	12.7	13.5	12.6	12.6	13.5	14.1	13.8	14.3	13.4	13.2
% Distortion	4.0	3.6	4.3	2.9	3.0	2.5	3.3	3.1	3.8	2.8	2.5	2.0
Esig (1)	0.65	0.65	0.57	0.77	0.71	0.98	1.70	1.70	1.34	1.70	1.80	2.52
Eout	8.1	8.6	7.2	10.4	8.9	12.4	23.0	24.0	18.5	24.5	24.1	33.1
Gain	12.5	13.2	12.6	13.5	12.5	12.6	13.5	14.1	13.8	14.3	13.4	13.1
% Distortion	4.8	4.4	4.8	4.6	4.6	5.0	4.9	4.6	5.0	5.0	4.9	5.0

(1) At grid current point, less than 1/2 microampere grid current.

FOR CIRCUIT SEE FIGURE 4

## RESISTANCE COUPLED AMPLIFIER DATA

Self Bias Operation

Rb	Ebb = 100 VOLTS						Ebb = 250 VOLTS					
	0.047		0.1		0.27		0.047		0.1		0.27	
	0.1	0.27	0.1	0.47	0.27	0.47	0.1	0.27	0.1	0.47	0.27	0.47
Rk	1800	2200	2700	3900	6800	8200	1800	1800	2700	3900	6800	8200
Ib	0.98	0.90	0.58	0.51	0.24	0.227	2.50	2.50	1.45	1.28	0.60	0.57
Ecl	-1.765	-1.98	-1.565	-1.99	-1.63	-1.86	-4.50	-4.50	-3.92	-4.99	-4.08	-4.67
Eb	54	57.7	42	49	35.2	38.7	132.5	132.5	105	122	88	96
Esig	0.5	0.5	0.5	0.5	0.5	0.5	1.0	1.0	1.0	1.0	1.0	1.0
Eout	5.75	6.0	6.15	6.65	6.5	6.7	12.6	13.45	13.2	14.25	13.6	14.1
Gain	11.5	12.0	12.3	13.3	13.0	13.4	12.6	13.45	13.2	14.25	13.6	14.1
% Distortion	2.0	1.7	2.4	1.7	2.3	1.9	1.5	1.2	1.9	1.3	1.9	1.6
Esig (1)	0.92	1.1	0.8	1.1	0.86	1.0	3.07	3.07	2.5	3.3	2.58	3.0
Eout	10.55	12	9.8	14.6	11.1	13.3	38.4	41.2	32.6	46.8	35.0	42.0
Gain	11.5	12.0	12.25	13.3	12.9	13.3	12.5	13.4	13.05	14.2	13.55	14.0
% Distortion	4.0	4.0	4.1	4.1	4.5	4.1	5.0	4.0	5.0	4.8	5.0	5.0

Note (1) At grid current point, less than 1/4 microampere grid current.

FOR CIRCUIT SEE FIGURE 4

# RESISTANCE COUPLED AMPLIFIER DATA

## Self Bias Operation

Rb	Ebb = 100 VOLTS						Ebb = 200 VOLTS					
	0.047		0.10		0.27		0.047		0.10		0.27	
	0.10	0.27	0.10	0.47	0.27	0.47	0.10	0.27	0.10	0.47	0.27	0.47
Rcf	1200	1500	2200	3300	8200	10,000	680	820	1500	2200	5600	6800
Rk	1.35	1.28	0.715	0.64	0.26	0.244	3.10	2.96	1.53	1.41	0.56	0.535
Ib	-1.62	-1.92	-1.57	-2.11	-2.13	-2.44	-2.11	-2.43	-2.29	-3.10	-3.14	-3.64
Ec	36.5	39.8	28.5	36.0	29.8	34.1	54.2	61.0	47.0	59.5	49.0	55.8
Eb	0.5	0.5	0.5	0.5	0.5	0.5	1.0	1.0	1.0	1.0	1.0	1.0
Esig	6.3	6.35	6.1	6.2	5.8	5.85	14.0	14.2	13.2	13.2	12.1	12.1
Eout	12.6	12.7	12.2	12.4	11.6	11.7	14.0	14.2	13.2	13.2	12.1	12.1
Gain	3.1	2.6	3.4	2.1	2.3	1.8	4.3	3.5	4.0	2.3	2.4	2.0
% Distortion	0.66	0.89	0.62	1.00	1.00	1.21	1.01	1.25	1.14	1.69	1.71	2.05
Esig <sup>(1)</sup>	8.3	11.3	7.6	12.4	11.6	14.2	14.1	17.7	15.0	22.3	20.6	24.7
Eout	12.6	12.7	12.2	12.4	11.6	11.7	14.0	14.2	13.2	13.2	12.1	12.1
Gain	4.8	4.7	4.3	4.5	5.0	5.0	4.5	4.8	4.8	4.7	4.8	4.7
% Distortion												

Note (1) Maximum signal at grid current point less than 1/2 microampere.

FOR CIRCUIT SEE FIGURE 4

# RESISTANCE COUPLED AMPLIFIER DATA

## Self Bias Operation

Rb	Ebb = 100 VOLTS						Ebb = 250 VOLTS					
	.047		0.10		0.27		.047		0.10		0.27	
	0.10	0.27	0.1	0.47	.27	.47	.10	.27	.10	.47	.27	.47
Rk	2200	2700	3300	5600	10,000	12,000	1800	2200	2700	4700	8200	10,000
Ib	1.0	.92	.59	.48	.227	.213	2.70	2.49	1.54	1.27	.60	.56
Ec	2.20	2.48	1.95	2.68	2.27	2.56	4.86	5.48	4.16	5.96	4.92	5.6
Eb	53	56.7	41	52	38.6	42.5	123	133	96	123	88	99
Esig	0.50	.50	.50	.50	.50	.50	1.0	1.0	1.0	1.0	1.0	1.0
Eout	5.7	6.10	6.0	6.3	6.25	6.65	12.4	12.8	12.9	13.4	13.4	13.9
Gain	11.40	12.20	12.0	12.6	12.5	13.30	12.40	12.80	12.90	13.40	13.40	13.90
% Distortion	1.8	1.6	1.8	1.6	2.0	1.4	1.3	1.2	1.7	1.2	1.6	1.2
Esig <sup>(1)</sup>	1.2	1.4	1.00	1.55	1.10	1.45	3.20	3.64	2.60	4.0	3.10	3.50
Eout	13.7	17.0	12.0	19.5	13.7	19.1	39.2	46.5	33.4	53.5	41.6	48.5
Gain	11.40	12.15	12.0	12.6	12.5	13.15	12.3	12.75	12.75	13.35	13.40	13.85
% Distortion	4.60	5.0	4.5	5.1	5.0	4.90	4.5	4.5	4.4	5.0	5.1	4.6

Note (1) At grid current point, less than 1/4 microampere grid current.

FOR CIRCUIT SEE FIGURE 4

## RESISTANCE COUPLED AMPLIFIER DATA

Self Bias Operation  
Single Section of Type 6N7GT

Rb	Ebb = 100 VOLTS						Ebb = 250 VOLTS					
	0.047		0.1		0.27		0.047		0.1		0.27	
Rof	0.10	.27	.10	.47	.27	.47	.10	.27	.10	.47	.27	.47
Rk	1800	1800	2700	3300	6800	6800	1000	1200	1500	1800	3300	3900
Ib	.81	.81	.51	.469	.225	.225	2.36	2.21	1.45	1.36	.64	.61
Ec	1.46	1.46	1.38	1.55	1.53	1.53	2.36	2.65	2.18	2.45	2.11	2.38
Eb	61.9	61.9	49	53.1	39.2	39.2	139	146	105	114	77	85.5
Eaig	.10	.10	.10	.10	.10	.10	.50	.50	.50	.50	.50	.50
Eout	1.74	1.93	1.93	2.2	2.23	2.38	10.0	10.9	10.9	12.5	12.8	13.0
Gain	17.4	19.3	19.3	22.0	22.3	23.8	20.0	21.8	21.8	25.0	25.6	26.0
% Distortion	1.2	1.0	1.3	1.0	1.3	1.1	1.8	1.8	2.6	2.2	2.7	2.4
Eaig (1)	.40	.40	.30	.50	.42	.42	1.20	1.40	1.00	1.22	.90	1.1
Eout	6.85	7.65	5.76	10.9	9.34	10.0	23.8	30.4	21.8	30.5	23.0	28.8
Gain	17.1	19.1	19.2	21.8	22.0	23.8	19.8	21.7	21.8	25.0	25.6	26.2
% Distortion	4.7	3.7	3.7	4.8	5.0	4.2	4.5	4.9	4.8	4.7	4.7	5.0

Note (1) At grid current point, less than 1/2 microampere grid current.

FOR CIRCUIT SEE FIGURE 4

6Q7GT  
 6T8  
 19T8  
 6AQ6  
 6AT6  
 6K5G  
 6SZ7  
 12AT6

Sylvania Type

# RESISTANCE COUPLED AMPLIFIER DATA

## Self Bias Operation

Rb	Ebb = 100 VOLTS							Ebb = 250 VOLTS						
	0.1		0.27		0.47			0.1		0.27		0.47		
	0.27	0.47	0.27	0.47	1.0	0.47	1.0	0.27	0.47	0.27	0.47	1.0	0.47	1.0
Rcf	0.27	0.47	0.27	0.47	1.0	0.47	1.0	0.27	0.47	0.27	0.47	1.0	0.47	1.0
Rk	3300	3300	5600	5600	6800	8200	10,000	1800	2200	3300	3900	4700	5600	6800
*Ib	.288	.288	.161	.161	.146	108	.099	.95	.88	.476	.46	.425	.31	.29
Ec	.95	.95	.9	.9	.99	.89	.99	1.71	1.94	1.57	1.79	2.0	1.73	1.97
Eb	71.2	71.2	56.5	56.5	60.6	49.2	53.5	155	162	121.5	125.8	135.2	104.4	113.7
Esig.	0.1	0.1	0.1	0.1	0.1	0.1	0.1	0.1	0.1	0.1	0.1	0.1	0.1	0.1
Eout	3.53	3.82	4.1	4.53	4.73	4.63	4.9	4.23	4.4	4.9	5.2	5.4	5.3	5.7
Gain	35.3	38.2	41.	45.3	47.3	46.3	49.	42.3	44.	49.	52.	54.	53.	57.
% Dist.	.55	0.9	1.6	1.2	1.1	1.5	1.2	.3	.3	.25	.3	.3	.2	.25
Esig. (1)	.23	.24	.19	.2	.25	.19	.25	.79	.89	.63	.77	.91	.71	.86
Eout	8.	8.9	7.75	8.93	11.8	8.7	12.2	33.3	38.5	30.8	39.6	49.	37.5	48.6
Gain	34.8	37.1	40.8	44.6	47.2	45.8	48.8	42.2	43.3	48.9	51.4	53.9	52.8	56.6
% Dist.	3.6	3.4	3.95	3.4	4.15	3.9	4.6	3.67	4.28	3.4	4.3	4.75	4.8	4.95

Note (1) For self bias operation this is taken at the grid current point with less than  $\frac{1}{2}$  Microampere grid current.

FOR CIRCUIT SEE FIGURE 4

## Zero Bias Operation

Rb	Ebb = 100 VOLTS							Ebb = 250 VOLTS						
	0.1		0.27		0.47			0.1		0.27		0.47		
	0.27	0.47	0.27	0.47	1.0	0.47	1.0	0.27	0.47	0.27	0.47	1.0	0.47	1.0
Rcf	0.27	0.47	0.27	0.47	1.0	0.47	1.0	0.27	0.47	0.27	0.47	1.0	0.47	1.0
Rk	.....	.....	.....	.....	.....	.....	.....	.....	.....	.....	.....	.....	.....	.....
Ib	0.325	0.325	0.17	0.17	0.17	0.1125	0.1125	1.35	1.35	0.65	0.65	0.65	0.385	0.385
Ec	.....	.....	.....	.....	.....	.....	.....	.....	.....	.....	.....	.....	.....	.....
Eb	67.5	67.5	54.1	54.1	54.1	47.1	47.1	115	115	74.5	74.5	74.5	69	69
Esig.	0.1	0.1	0.1	0.1	0.1	0.1	0.1	0.1	0.1	0.1	0.1	0.1	0.1	0.1
Eout	3.7	3.8	4.35	4.6	4.83	4.6	5.2	4.5	4.75	5.2	5.8	5.8	5.7	6.2
Gain	37.0	38.0	43.5	46.0	48.3	46.0	52.0	45.0	47.5	52.0	58.0	58.0	57.0	62.0
% Dist.	0.806	0.72	1.58	1.17	0.88	1.56	0.985	0.583	0.61	0.53	0.65	0.65	0.5	0.64
Esig. (1)	0.26	0.28	0.21	0.24	0.28	0.21	0.26	0.9	0.96	0.76	0.87	0.97	0.74	0.88
Eout	8.8	9.8	8.25	10.5	12.5	9.2	12.5	37.0	41.7	36.5	44.2	53.0	39.3	50.0
Gain	33.8	35.0	39.3	43.7	44.6	43.8	48.1	41.2	43.4	48.0	50.8	54.6	53.1	56.8
% Dist.	4.71	4.9	4.96	4.79	4.96	4.8	4.78	4.8	4.88	4.86	4.96	4.88	4.85	4.89

Note (1) Maximum signal for 5.0% Distortion.

FOR CIRCUIT SEE FIGURE 5

# RESISTANCE COUPLED AMPLIFIER DATA

Self Bias Operation

	Ebb - 100 VOLTS							Ebb - 250 VOLTS						
	0.1		0.27			0.47		0.1		0.27			0.47	
Rb														
Rc <sub>2</sub>	0.39		1.2			1.8		0.39		1.2			2.2	
Rc <sub>f</sub>	0.27	0.47	0.27	0.47	1.0	0.47	1.0	0.27	0.47	0.27	0.47	1.0	0.47	1.0
Rk	1200	1200	2700	2700	2700	4700	4700	560	560	1200	1200	1200	1800	1800
I <sub>b</sub>	0.645	0.645	0.259	0.259	0.259	0.165	0.165	1.77	1.77	0.675	0.675	0.675	0.402	0.402
I <sub>c<sub>2</sub></sub>	0.18	0.18	0.068	0.068	0.068	0.045	0.045	0.50	0.50	0.183	0.183	0.183	0.102	0.102
E <sub>c<sub>1</sub></sub>	0.99	-0.99	0.882	-0.882	-0.882	-0.99	-0.99	-1.27	-1.27	-1.03	-1.03	-1.03	-0.908	-0.908
E <sub>c<sub>2</sub></sub>	29.8	29.8	18.5	18.5	18.5	19.0	19.0	55	55	30.5	30.5	30.5	25.5	25.5
E <sub>b</sub>	35.5	35.5	30.2	30.2	30.2	22.5	22.5	73	73	67.8	67.8	67.8	61.2	61.2
E <sub>aig</sub>	0.1	0.1	0.1	0.1	0.1	0.1	0.1	0.1	0.1	0.1	0.1	0.1	0.1	0.1
E <sub>out</sub>	6.85	7.8	8.2	10.2	12.5	10.2	13.1	10.2	11.5	13.6	17.9	21.6	19.5	25.6
Gain	68.5	78.0	82	102	125	102	131	102	115	136	179	216	195	256
% Distortion	0.6	0.7	3.4	2.6	2.3	2.8	3.2	0.7	0.8	2.2	1.8	1.5	3.1	2.4
E <sub>aig</sub> ( <sup>1</sup> )	0.2	0.2	0.14	0.14	0.14	0.13	0.13	0.5	0.5	0.25	0.25	0.25	0.15	0.15
E <sub>out</sub>	13.15	14.9	11.1	13.9	17.2	12.8	16.6	47	54	33	41.8	50	28	37
Gain	65.8	74.5	79.4	99.5	123	98.5	128	94	108	132	167.5	200	187	247
% Distortion	3.0	2.9	5.1	4.3	3.7	4.6	5.0	4.2	5.0	5.2	4.4	4.7	4.5	3.7

Note (<sup>1</sup>) At grid current point, less than  $\frac{1}{4}$  microampere grid current.

FOR CIRCUIT SEE FIGURE 1

**7A4 Sylvania Type**  
**7N7**  
**6F8G**  
**6J5GT**  
**6SN7GT**  
**12SX7GT**

## RESISTANCE COUPLED AMPLIFIER DATA

Self Bias Operation  
 Type 7A4 or Single Section of Type 7N7

Rb	Ebb - 100 VOLTS						Ebb - 250 VOLTS					
	0.047		0.10		0.27		0.047		0.10		0.27	
	0.1	0.27	0.1	0.47	0.27	0.47	0.1	0.27	0.1	0.47	0.27	0.47
Rcf	1800	2200	3300	4700	8200	10,000	1500	2200	2700	3900	6800	8200
Ib	1.05	0.97	0.57	0.50	0.24	0.22	2.79	2.4	1.49	1.31	0.61	0.58
Ec	-1.89	-2.13	-1.90	-2.35	-1.93	-2.19	-4.18	-5.28	-4.03	-5.11	-4.15	-4.74
Eb	50.6	54.4	43.0	50.0	36.5	40.9	119	137	101	119	85	94
Esix	0.5	0.5	0.5	0.5	0.5	0.5	1.0	1.0	1.0	1.0	1.0	1.0
Eout	6.6	7.1	6.8	7.4	7.3	7.4	14.8	15.0	15.2	16.2	15.9	16.2
Gain	13.2	14.2	13.6	14.8	14.6	14.8	14.8	15.0	15.2	16.2	15.9	16.2
% Distortion	1.9	1.8	2.4	2.0	2.0	1.7	1.4	1.4	1.8	1.3	1.6	1.3
Esig (1)	0.95	1.13	0.95	1.3	0.95	1.20	2.70	3.50	2.55	3.10	2.64	3.05
Eout	12.5	15.5	12.9	19.2	13.7	17.7	39.9	52.5	38.4	53.0	42.0	49.4
Gain	13.1	13.9	13.6	14.7	14.4	14.7	14.7	15.0	15.0	16.1	15.9	16.2
% Distortion	3.9	4.2	4.9	4.7	4.4	4.5	4.1	4.9	4.9	4.6	4.7	4.5

Note (1) For self bias operation this is taken at the grid current point with less than 1/2 microampere grid current.

FOR CIRCUIT SEE FIGURE 4



# RESISTANCE COUPLED AMPLIFIER DATA

Zero Bias Operation

Self Bias Operation

Rb	Ebb - 100 VOLTS							Ebb - 250 VOLTS						
	0.1		0.27			0.47		0.1		0.27			0.47	
Rcf	0.27	0.47	0.27	0.47	1.0	0.47	1.0	0.27	0.47	0.27	0.47	1.0	0.47	1.0
Rk	...	...	...	...	...	...	...	...	...	...	...	...	...	...
Ib	0.223	0.223	0.126	0.126	0.126	0.89	0.89	1.1	1.1	0.54	0.54	0.54	0.34	0.34
Ec	...	...	...	...	...	...	...	...	...	...	...	...	...	...
Eb	77.7	77.7	66.0	66.0	66.0	58.2	58.2	140	140	104	104	104	90	90
Eaig	0.1	0.1	0.1	0.1	0.1	0.1	0.1	0.1	0.1	0.1	0.1	0.1	0.1	0.1
Eout	3.85	4.15	4.32	4.9	5.45	5.0	5.8	6.0	6.3	7.0	7.5	8.2	7.7	8.5
Gain	38.5	41.5	43.2	49.0	54.5	50.0	58.0	60.0	63.0	70.0	75.0	82.0	77.0	85.0
% Dist.	4.6	4.3	5.0	4.2	3.3	4.5	3.4	0.8	0.8	1.1	1.0	0.9	1.3	1.1
Eaig (1)	0.1	0.11	0.1	0.11	0.14	0.1	0.14	0.46	0.46	0.35	0.40	0.48	0.36	0.45
Eout	3.85	4.55	4.32	5.35	7.4	5.0	7.84	25.3	26.0	22.5	28.0	35.3	25.1	34.2
Gain	38.5	41.4	43.2	48.6	53.0	50.0	56.0	55.0	56.5	64.4	70.0	74.0	70.0	76.0
% Dist.	4.6	4.9	5.0	4.7	5.0	4.5	5.0	4.8	4.7	4.9	4.8	4.8	5.0	4.8

Note (1) Maximum signal for 5% Distortion.

FOR CIRCUIT SEE FIGURE 5

Rb	Ebb - 100 VOLTS							Ebb - 250 VOLTS						
	0.1		0.27			0.47		0.1		0.27			0.47	
Rcf	0.27	0.47	0.27	0.47	1.0	0.47	1.0	0.27	0.47	0.27	0.47	1.0	0.47	1.0
Rk	3900	3900	5600	5600	6800	8200	10,000	1500	800	2700	2700	2700	3900	4700
Ib	0.22	0.22	0.144	0.144	0.13	0.10	0.091	0.84	0.76	0.443	0.443	0.443	0.295	0.271
Ec	-0.86	-0.86	-0.81	-0.81	-0.88	-0.82	-0.91	-1.26	-1.37	-1.19	-1.19	-1.19	-1.15	-1.27
Eb	78	78	61.1	61.1	64.9	53	57.2	166	174	131	131	131	111.5	123
Eaig	0.1	0.1	0.1	0.1	0.1	0.1	0.1	0.1	0.1	0.1	0.1	0.1	0.1	0.1
Eout	4.25	4.3	4.8	5.35	5.62	5.4	6.4	5.65	5.8	6.5	7.15	7.65	7.3	7.65
Gain	42.5	43.0	48.0	53.5	56.2	54.0	64.0	56.5	58.0	65.0	71.5	76.5	73.0	76.5
% Dist.	4.1	4.1	4.3	3.7	3.2	4.1	3.6	0.9	0.9	1.0	1.0	1.0	1.3	1.2
Eaig (1)	0.12	0.12	0.1	0.1	0.13	0.1	0.15	0.47	0.54	0.39	0.39	0.39	0.33	0.45
Eout	5.1	5.15	4.8	5.35	7.25	5.4	9.0	26.5	30.5	24.5	27.5	29.2	23.5	34.0
Gain	42.5	43.0	48	53.5	55.8	54.0	60.0	56.4	56.5	63.0	70.5	75.0	71.3	75.5
% Dist.	5.1	5.0	4.3	3.7	4.6	4.1	5.0	4.5	5.3	5.1	4.2	3.9	5.2	5.3

Note (1) For self bias operation this is taken at the grid current point with less than 1/2 microampere grid current.

FOR CIRCUIT SEE FIGURE 4

**7B6** Sylvania Type  
**2A6**  
**6B6G**  
**6S8GT**  
**6SQ7GT**  
**75**

# RESISTANCE COUPLED AMPLIFIER DATA

Zero Bias Operation

Self Bias Operation

48 SYLVANIA RADIO TUBES

Rb	Ebb = 100 VOLTS							Ebb = 250 VOLTS						
	0.1		0.27			0.47		0.1		0.27			0.47	
Rcf	0.27	0.47	0.27	0.47	1.0	0.47	1.0	0.27	0.47	0.27	0.47	1.0	0.47	1.0
Rk	...	...	...	...	...	...	...	...	...	...	...	...	...	...
Ib	0.228	0.228	0.132	0.132	0.132	0.09	0.09	1.0	1.0	0.52	0.52	0.52	0.34	0.34
Ec	...	...	...	...	...	...	...	...	...	...	...	...	...	...
Eb	77.2	77.2	64.4	64.4	64.4	57.7	57.7	150	150	110	110	110	90	90
Esig	0.1	0.1	0.1	0.1	0.1	0.1	0.1	0.1	0.1	0.1	0.1	0.1	0.1	0.1
Eout	3.3	3.55	3.95	4.48	5.05	4.63	5.4	4.63	5.0	5.6	6.1	6.7	6.43	7.15
Gain	33.0	35.5	39.5	44.8	50.5	46.3	54.0	46.3	50.0	56.0	61.0	67.0	64.3	71.5
% Dist.	3.0	2.9	3.8	3.2	2.6	3.6	2.6	0.8	0.7	0.9	0.8	0.7	0.8	0.7
Esig <sup>(1)</sup>	0.15	0.16	0.12	0.14	0.17	0.13	0.17	0.55	0.6	0.5	0.57	0.65	0.5	0.6
Eout	4.73	5.4	4.65	6.12	8.3	5.9	8.8	23.4	26.6	25.5	31.8	39.0	29.5	39.5
Gain	31.5	33.8	38.7	43.8	49.0	45.4	51.7	42.5	44.5	51.0	56.0	60.0	59.0	66.0
% Dist.	4.9	5.0	4.9	4.8	5.0	5.0	5.0	4.7	4.9	5.0	4.9	4.9	5.0	5.0

Note (1) Maximum Signal for 5.0% Distortion

FOR CIRCUIT SEE FIGURE 5

Rb	Ebb = 100 VOLTS							Ebb = 250 VOLTS						
	0.1		0.27			0.47		0.1		0.27			0.47	
Rcf	0.27	0.47	0.27	0.47	1.0	0.47	1.0	0.27	0.47	0.27	0.47	1.0	0.47	1.0
Rk	3900	3900	5600	6800	6800	8200	10,000	1800	1800	2700	3300	3900	3900	4700
Ib	0.214	0.214	0.138	0.126	0.126	0.095	0.086	0.725	0.725	0.43	0.395	0.365	0.288	0.261
Ec	-0.835	-0.835	-0.774	-0.857	-0.857	-0.78	-0.86	-1.31	-1.31	-1.16	-1.30	-1.42	-1.12	-1.25
Eb	78.6	78.6	62.8	66.0	66.0	55.3	59.6	177.5	177.5	134	143.5	151.5	114.5	124.5
Esig	0.1	0.1	0.1	0.1	0.1	0.1	0.1	0.1	0.1	0.1	0.1	0.1	0.1	0.1
Eout	3.3	3.5	4.1	4.5	5.0	4.9	5.2	4.37	4.78	5.50	5.92	6.13	6.24	6.75
Gain	33.0	35.0	41.0	45.0	50.0	49.0	52.0	43.7	47.8	55.0	59.2	61.3	62.4	67.5
% Dist.	2.7	2.6	3.2	3.0	2.5	3.1	2.6	0.8	0.7	0.8	0.8	0.7	0.8	0.7
Esig <sup>(1)</sup>	0.16	0.16	0.10	0.17	0.17	0.12	0.19	0.55	0.55	0.40	0.53	0.61	0.40	0.53
Eout	5.15	5.5	4.1	7.1	8.2	5.75	9.7	23.9	26.0	21.8	31.2	37.0	25.0	36.0
Gain	32.2	34.4	41.0	43.0	48.1	48.0	51.0	43.5	47.4	54.5	59.0	60.6	62.4	67.5
% Dist.	4.5	4.0	3.2	5.0	4.5	4.0	5.0	4.5	4.0	3.3	4.0	4.5	3.3	3.8

Note (1) For self bias operation this is taken at the grid current point with less than 1/4 Microampere grid current.

FOR CIRCUIT SEE FIGURE 4

# RESISTANCE COUPLED AMPLIFIER DATA

Zero Bias Operation

Self Bias Operation

SYLVANIA RADIO TUBES

Rb	Ebb = 100 VOLTS								Ebb = 250 VOLTS							
	0.1		0.27			0.47			1.0		0.27			0.47		
	0.27	0.47	0.27	0.47	1.0	0.47	1.0	0.27	0.47	0.27	0.47	1.0	0.47	1.0		
Rcf	0.27	0.47	0.27	0.47	1.0	0.47	1.0	0.27	0.47	0.27	0.47	1.0	0.47	1.0		
Rk	...	...	...	...	...	...	...	...	...	...	...	...	...	...		
Ib	0.174	0.174	0.108	0.108	0.108	0.078	0.078	0.84	0.84	0.47	0.47	0.47	0.32	0.32		
Ec	...	...	...	...	...	...	...	...	...	...	...	...	...	...		
Eb	82.6	82.6	70.8	70.8	70.8	63.4	63.4	166	166	123	123	123	100	100		
Eaig	0.1	0.1	0.1	0.1	0.1	0.1	0.1	0.1	0.1	0.1	0.1	0.1	0.1	0.1		
Eout	2.75	3.02	3.67	4.25	4.77	4.68	5.37	3.95	4.32	5.2	5.8	6.25	6.0	6.75		
Gain	27.5	30.2	36.7	42.5	47.7	46.8	53.7	39.5	43.2	52.0	58.0	62.5	60.0	67.5		
% Dist.	3.3	3.1	4.3	3.5	2.9	3.9	2.9	0.6	0.5	0.7	0.6	0.5	0.6	0.5		
Eaig (1)	0.14	0.15	0.12	0.14	0.15	0.12	0.15	0.55	0.55	0.5	0.53	0.6	0.48	0.58		
Eout	3.7	4.45	4.22	5.5	6.9	5.35	7.7	19.8	21.9	23.6	27.9	34.0	27.4	37.0		
Gain	26.4	29.6	35.0	39.2	46.0	44.5	51.4	36.0	39.8	47.2	52.6	56.6	57.0	63.9		
% Dist.	4.6	5.0	5.0	4.9	5.0	4.8	5.0	5.0	4.8	5.0	4.8	4.9	5.0	5.0		

Note (1) Maximum Signal for 5% Distortion.

Rb	Ebb = 100 VOLTS								Ebb = 250 VOLTS							
	0.1		0.27			0.47			0.1		0.27			0.47		
	0.27	0.47	0.27	0.47	1.0	0.47	1.0	0.27	0.47	0.27	0.47	1.0	0.47	1.0		
Rcf	0.27	0.47	0.27	0.47	1.0	0.47	1.0	0.27	0.47	0.27	0.47	1.0	0.47	1.0		
Rk	4700	4700	6800	6800	6800	10,000	10,000	1800	1800	2700	3300	3900	3900	4700		
Ib	0.156	0.156	0.104	0.104	0.104	0.073	0.073	0.60	0.60	0.38	0.34	0.32	0.258	0.24		
Ec	-0.734	-0.734	-0.707	-0.707	-0.707	-0.73	-0.73	-1.08	-1.08	-1.03	-1.12	-1.25	-1.01	-1.13		
Eb	84.4	84.4	71.9	71.9	71.9	65.7	65.7	190	190	147	158	163.5	129	137		
Eaig	0.1	0.1	0.1	0.1	0.1	0.1	0.1	0.1	0.1	0.1	0.1	0.1	0.1	0.1		
Eout	2.64	2.9	3.51	4.13	4.65	4.35	5.15	3.7	4.05	5.1	5.35	5.85	5.9	6.52		
Gain	26.4	29.0	35.1	41.3	46.5	43.5	51.5	37.0	40.5	51.0	53.5	58.5	59.0	65.2		
% Dist.	3.4	3.3	3.4	3.0	2.6	3.7	1.9	1.0	0.9	1.0	0.9	0.5	0.9	0.7		
Eaig (1)	0.15	0.15	0.12	0.12	0.12	0.14	0.14	0.55	0.55	0.4	0.53	0.60	0.40	0.50		
Eout	3.95	4.3	4.16	4.9	5.35	6.0	7.15	19.8	22.0	19.4	28.0	34.0	22.8	32.3		
Gain	26.4	28.6	34.7	40.7	44.5	43.0	51.0	36.0	40.0	47.5	52.9	57.0	57.0	64.6		
% Dist.	5.0	4.7	4.3	3.7	3.5	5.0	4.0	5.0	4.5	3.7	4.8	4.6	3.6	3.6		

Note (1) For self bias operation this is taken at the grid current point with less than 1/4 Microampere grid current.

FOR CIRCUIT SEE FIGURE 5

FOR CIRCUIT SEE FIGURE 4

7C7 Sylvania Type  
 6C6  
 6J7GT  
 6W7G  
 7A17  
 14C7  
 1273  
 1280  
 954  
 57

## RESISTANCE COUPLED AMPLIFIER DATA

Self Bias Operation

Rb	Ebb = 100 VOLTS							Ebb = 250 VOLTS						
	0.1		0.27			0.47		0.1		0.27			0.47	
	0.47		1.2			1.8		0.47		1.2			2.2	
R <sub>cf</sub>	0.27	0.47	0.27	0.47	1.0	0.47	1.0	0.27	0.47	0.27	0.47	1.0	0.47	1.0
R <sub>k</sub>	1000	1000	2200	2200	2200	3900	3900	470	470	1000	1000	1000	1500	1500
I <sub>b</sub>	0.62	0.62	0.27	0.27	0.27	0.168	0.168	1.76	1.76	0.75	0.75	0.75	0.44	0.44
I <sub>c<sub>2</sub></sub>	0.145	0.145	0.064	0.064	0.064	0.465	0.465	0.41	0.41	0.177	0.177	0.177	0.10	0.10
E <sub>c<sub>1</sub></sub>	-0.765	-0.765	-0.735	-0.735	-0.735	-0.622	-0.622	-1.02	-1.02	-0.927	-0.927	-0.927	-0.81	-0.81
E <sub>c<sub>2</sub></sub>	31.9	31.9	23.3	23.3	23.3	16.3	16.3	57.2	57.2	37.5	37.5	37.5	30	30
E <sub>b</sub>	38	38	27.2	27.2	27.2	21	21	74	74	47.5	47.5	47.5	43.5	43.5
E <sub>sig</sub>	0.1	0.1	0.1	0.1	0.1	0.1	0.1	0.1	0.1	0.1	0.1	0.1	0.1	0.1
E <sub>out</sub>	7.0	8.05	8.0	10.0	12.0	9.8	12.5	10.6	12.0	13.0	17.0	20.4	18.8	24.5
Gain	70.0	80.5	80	100	120	98	125	106	120	130	170	204	188	245
% Distortion	2.7	2.4	3.7	2.7	2.3	3.2	1.9	1.6	1.4	1.5	1.6	2.4	2.0	2.8
E <sub>sig</sub> (1)	0.18	0.18	0.14	0.14	0.14	0.14	0.14	0.4	0.4	0.27	0.27	0.27	0.18	0.18
E <sub>out</sub>	12.3	13.9	10.8	13.8	16.7	13.2	17.0	40.3	45.2	33.0	41.6	49.5	32	41.5
Gain	68.5	77.2	77.2	98.7	119	94.5	121.5	101	113	122	154	183.5	178	230
% Distortion	4.7	4.1	5.5	4.6	3.8	4.9	5.0	4.3	4.4	5.0	5.0	5.9	4.3	4.9

\* Note (1) For self bias operation this is taken at the grid current point with less than 1/4 microampere grid current.

FOR CIRCUIT SEE FIGURE 1

# RESISTANCE COUPLED AMPLIFIER DATA

## Self Bias Operation

Rb	Ebb = 100 VOLTS						Ebb = 250 VOLTS					
	0.047		0.1		0.27		0.047		0.1		0.27	
	0.1	0.27	0.1	0.47	0.27	0.47	0.1	0.27	0.1	0.47	0.27	0.47
Rk	1000	1200	1800	2200	4700	4700	560	680	820	1200	2700	2700
Ib	1.06	1.00	0.59	0.56	0.248	0.248	3.05	2.95	1.74	1.60	0.67	0.67
Ec	-1.06	-1.20	-1.06	-1.23	-1.17	-1.17	-1.71	-2.00	-1.43	-1.92	-1.81	-1.81
Eb	50.2	53	41	44	33	33	107	111.5	76	90	69	69
Esig	0.1	0.1	0.1	0.1	0.1	0.1	0.1	0.1	0.1	0.1	0.1	0.1
Eout	2.15	2.22	2.12	2.34	2.20	2.30	2.56	2.55	2.60	2.69	2.48	2.59
Gain	21.5	22.2	21.2	23.4	22.0	23.0	25.6	25.5	26.0	26.9	24.8	25.9
% Distortion	1.6	1.2	1.6	1.2	1.2	1.2	0.8	0.6	0.8	0.7	0.9	0.9
Esig (1)	0.29	0.39	0.20	0.40	0.39	0.39	0.82	1.00	0.64	0.96	0.78	0.78
Eout	6.25	8.65	4.25	9.30	8.55	8.95	21.0	25.5	16.6	25.8	19.3	20.2
Gain	21.5	22.2	21.2	23.2	21.9	23.0	25.6	25.5	26.0	26.9	24.8	25.9
% Distortion	4.3	4.9	3.0	4.4	4.8	4.0	5.0	5.0	4.7	4.9	5.0	4.8

Note (1) For self bias operation this is taken at the grid current point with less than 1/8 Microampere grid current.

FOR CIRCUIT SEE FIGURE 4

6BF6  
6R7GT  
6SR7GT  
6S17  
12BF6  
12SW7  
26C6

# RESISTANCE COUPLED AMPLIFIER DATA

Self Bias Operation

Rb	Ebb - 100 VOLTS						Ebb - 250 VOLTS					
	0.047		0.1		0.27		0.047		0.1		0.27	
	0.1	0.27	0.1	0.47	0.27	0.47	0.1	0.27	0.1	0.47	0.27	0.47
Rcf	0.1	0.27	0.1	0.47	0.27	0.47	0.1	0.27	0.1	0.47	0.27	0.47
Rk	1800	2200	2700	3900	6800	8200	1500	1800	2200	3300	5600	8200
Ib	1.07	1.0	0.62	0.56	0.256	0.240	2.85	2.69	1.63	1.46	0.661	0.60
Ec	-1.93	-2.2	-1.67	-2.18	-1.74	-1.97	-4.27	-4.84	-3.59	-4.82	-3.70	-4.92
Eb	49.6	53.0	38	44	31	35.2	116	123.8	87	104	71.8	88
Esig	0.5	0.5	0.5	0.5	0.5	0.5	1.0	1.0	1.0	1.0	1.0	1.0
Eout	5.3	5.4	5.6	5.8	5.7	5.8	11.2	11.8	11.8	12.4	12.1	12.2
Gain	10.6	10.8	11.2	11.6	11.4	11.6	11.2	11.8	11.8	12.4	12.1	12.2
% Distortion	2.1	1.9	2.0	1.8	2.2	1.8	1.3	1.2	1.8	1.3	1.8	1.3
Esig (1)	1.02	1.24	0.87	1.23	0.97	1.10	2.80	3.25	2.23	3.27	2.40	3.32
Eout	10.6	13.2	9.5	14.2	11.0	12.8	31.2	38.0	26.0	40.4	28.5	40.6
Gain	10.4	10.6	10.9	11.5	11.3	11.6	11.1	11.7	11.7	12.3	12.1	12.2
% Distortion	4.5	4.9	4.7	4.8	4.9	4.3	4.5	4.6	4.4	4.5	4.5	4.9

Note (1) For self bias operation this is taken at the grid current point with less than 1/2 microampere grid current

FOR CIRCUIT SEE FIGURE 4

# RESISTANCE COUPLED AMPLIFIER DATA

Self Bias Operation—All Values Per Single Section

Zero Bias Operation—All Values Per Single Section

SYLVANIA RADIO TUBES

Rb	Ebb = 100 VOLTS								Ebb = 250 VOLTS							
	0.10		0.27			0.47			0.10		0.27			0.47		
	0.27	0.47	0.27	0.47	1.0	4.7	1.0	0.27	0.47	0.27	0.47	1.0	0.47	1.0		
Rcf	0.27	0.47	0.27	0.47	1.0	4.7	1.0	0.27	0.47	0.27	0.47	1.0	0.47	1.0		
Rk	3300	3300	5600	5600	6800	6800	8200	1800	2200	3300	3900	3900	4700	5600		
Ib	0.30	0.30	0.169	0.169	0.152	0.1240	0.112	0.917	0.83	0.475	0.44	0.44	0.312	0.29		
Ec	-0.99	-0.99	-0.948	-0.948	-1.03	-0.844	+0.92	-1.65	-1.83	-1.57	-1.72	-1.72	-1.47	-1.62		
Eb	70	70	54.3	54.3	59.9	41.7	47.3	158.3	167	122	131	131	103	113.5		
Esig	0.1	0.1	0.1	0.1	0.1	0.1	0.1	0.1	0.1	0.1	0.1	0.1	0.1	0.1		
Eout	3.2	3.23	3.7	4.15	4.5	4.28	4.65	4.0	4.1	4.5	5.0	5.25	5.25	5.55		
Gain	32.0	32.3	37.0	41.5	45.0	42.8	46.5	40.0	41.0	45.0	50.0	52.5	52.5	55.5		
% Dist.	1.3	1.3	1.8	1.5	1.4	1.8	1.4	0.6	0.5	0.6	0.5	0.4	0.5	0.4		
Esig (1)	0.33	0.33	0.21	0.21	0.34	0.2	0.3	0.87	1.03	0.83	0.97	0.97	0.77	0.90		
Eout	10.3	10.4	7.7	8.6	14.8	8.5	13.5	33.6	41.5	36.3	46.6	48.8	38.8	48.5		
Gain	31.2	31.5	36.6	41.0	43.5	42.5	45.0	38.6	40.2	43.7	48.0	50.4	50.4	54.0		
% Dist.	4.9	4.8	4.0	3.1	5.0	3.4	4.4	4.0	4.8	4.5	4.8	3.8	3.9	3.7		

Note (1) For self bias operation this is taken at the grid current point with less than  $\frac{1}{2}$  Microampere grid current.

FOR CIRCUIT SEE FIGURE 4

Rb	Ebb = 100 VOLTS						Ebb = 250 VOLTS							
	0.1		0.27		0.47		0.1		0.27		0.47			
	0.27	0.47	0.27	0.47	1.0	0.47	1.0	0.27	0.47	1.0	0.47	1.0		
Rcf	0.27	0.47	0.27	0.47	1.0	0.47	1.0	0.27	0.47	1.0	0.47	1.0		
Rk	...	...	...	...	...	...	...	...	...	...	...	...		
Ib	0.40	0.40	0.202	0.202	0.202	0.13	0.13	1.36	1.36	0.64	0.64	0.64	0.40	0.40
Ec	...	...	...	...	...	...	...	...	...	...	...	...		
Eb	60.0	60.0	45.5	45.5	45.5	38.6	38.6	114	114	77.0	77.0	77.0	62.0	62.0
Esig	0.1	0.1	0.1	0.1	0.1	0.1	0.1	0.1	0.1	0.1	0.1	0.1	0.1	0.1
Eout	3.4	3.6	3.95	4.35	4.7	5.1	4.95	4.1	4.32	4.7	5.1	5.5	5.25	5.75
Gain	34.0	36.0	39.5	43.5	47.0	51.0	49.5	41.0	43.2	47.0	51.0	56.0	52.5	57.5
% Dist.	1.1	1.0	1.1	1.0	1.0	1.0	0.9	0.4	0.4	0.5	0.4	0.4	0.4	0.4
Esig (1)	0.33	0.34	0.25	0.3	0.34	0.25	0.32	1.0	1.07	.86	.97	1.09	.83	1.03
Eout	10.3	11.2	9.25	11.8	14.7	10.4	14.7	37.0	41.5	37.3	45.4	53.6	40.0	53.0
Gain	31.2	33.0	37.0	39.4	43.4	41.6	46.0	37.0	38.8	43.4	46.8	49.3	48.3	51.5
% Dist.	5.0	4.8	4.9	5.0	5.0	5.0	5.0	4.9	5.0	5.0	5.0	4.8	5.0	5.0

Note (1) Maximum signal for 5.0% Distortion.

FOR CIRCUIT SEE FIGURE 5

53

Sylvania Type 7F7  
 6AQ7GT  
 6SL7GT  
 6SC7  
 6SU7GT  
 7K7

## RESISTANCE COUPLED AMPLIFIER DATA

Self Bias—Single Section

Rb	Ebb = 100 VOLTS						Ebb = 250 VOLTS					
	0.047		0.1		0.27		0.047		0.1		0.27	
	0.1	0.27	0.1	0.47	0.27	0.47	0.1	0.27	0.1	0.47	0.27	0.47
Rcf	0.1	0.27	0.1	0.47	0.27	0.47	0.1	0.27	0.1	0.47	0.27	0.47
Rk	1000	1200	1800	2200	4700	4700	390	470	820	1000	2200	2200
Ib	0.90	0.84	0.51	0.48	0.22	0.22	3.0	2.86	1.58	1.50	0.66	0.66
Ec	-0.90	-1.01	-0.92	-1.05	-1.03	-1.03	-1.17	-1.34	-1.29	-1.50	-1.45	-1.45
Eb	57.7	60.5	49	52	40.5	40.5	109	115	92	100	72	72
Esig	0.1	0.1	0.1	0.1	0.1	0.1	0.1	0.1	0.1	0.1	0.1	0.1
Eout	2.65	2.65	2.65	3.0	2.85	3.0	3.38	3.82	3.56	3.65	3.40	3.60
Gain	26.5	26.5	26.5	30.0	28.5	30.0	33.8	38.2	35.6	36.5	34.0	36.0
% Distortion	2.1	1.8	2.3	1.6	1.7	1.5	1.1	0.9	1.0	0.7	0.8	0.7
Esig <sup>(1)</sup>	0.18	0.26	0.17	0.30	0.24	0.24	0.4	0.55	0.50	0.70	0.60	0.60
Eout	4.74	6.8	4.45	8.8	6.7	7.1	13.5	21.0	17.8	25.5	20.4	21.6
Gain	26.3	26.2	26.2	29.4	28.0	29.6	33.8	38.2	35.6	36.4	34.0	36.0
% Distortion	3.7	4.8	3.6	4.7	4.3	3.7	4.0	4.6	4.6	4.9	4.5	4.2

Note (1). For self bias operation this is taken at the grid current point with less than 1/4 microampere grid current.

FOR CIRCUIT SEE FIGURE 4



# RESISTANCE COUPLED AMPLIFIER DATA

## Self Bias Operation

	Ebb = 100 VOLTS							Ebb = 250 VOLTS						
	0.1		0.27			0.47		0.1		0.27			0.47	
Rb														
Rc <sub>1</sub>	0.39		1.0			1.8		0.39		1.0			1.8	
Rc <sub>f</sub>	0.27	0.47	0.27	0.47	1.0	0.47	1.0	0.27	0.47	0.27	0.47	1.0	0.47	1.0
Rk	1200	1200	2700	2700	2700	4700	4700	470	470	1000	1000	1200	1800	1800
I <sub>b</sub>	0.61	0.61	0.271	0.271	0.271	0.163	0.163	1.75	1.75	0.75	0.75	0.74	0.44	0.44
I <sub>ca</sub>	0.173	0.173	0.076	0.076	0.076	0.044	0.044	0.49	0.49	0.212	0.212	0.207	0.121	0.121
Ec <sub>1</sub>	-0.94	-0.94	-0.938	-0.938	-0.938	-0.974	-0.974	-1.05	-1.05	-0.962	-0.962	-1.14	-1.01	-1.01
Ec <sub>2</sub>	32.5	32.5	23.5	23.5	23.5	20.5	20.5	59	59	38	38	43	32.1	32.1
Eb	39	39	26.9	26.9	26.9	23.4	23.4	75	75	47.5	47.5	50	43	43
Ea <sub>ig</sub>	0.1	0.1	0.1	0.1	0.1	0.1	0.1	0.1	0.1	0.1	0.1	0.1	0.1	0.1
E <sub>out</sub>	7.8	8.9	8.0	10.2	12.2	9.6	12.5	13.6	15.5	15.4	19.8	22.0	19.5	25.5
Gain	78	89	80	102	122	96	125	136	155	154	198	220	195	255
% Distortion	4.6	4.3	5.0	3.8	3.0	5.2	3.9	2.2	2.1	2.8	2.1	2.0	3.0	3.1
Ea <sub>ig</sub> (°)	0.11	0.11	0.1	0.1	0.1	0.1	0.1	0.22	0.22	0.15	0.15	0.2	0.14	0.14
E <sub>out</sub>	8.55	9.8	8.0	10.2	12.2	9.6	12.5	29	33	22.5	28.0	41.5	26.4	34.5
Gain	77.8	89	80	102	122	96	129	132	150	150	187	207.5	189	246.5
% Distortion	5.1	4.6	5.0	3.8	3.0	5.2	3.9	4.8	4.3	4.5	3.8	5.0	4.7	4.4

Note (1). For self bias operation this is taken at the grid current point with less than  $\frac{1}{2}$  microampere grid current.

FOR CIRCUIT SEE FIGURE 1

## OBSOLETE AND SELDOM ENCOUNTERED TYPES

Type	Construction		Class	Use	Emitter			Plate Volts	Screen Volts	Neg. Grid Volts	Plate Current Ma.	Screen Current Ma.	Plate ① Resistance Ohms	Amp. ② Factor	Power Output Mw.	Suggested Replacement Type
	Style	Base Diag.			Type	Volts	Amp.									
01A	ST-14	4D	Triode	Det. Amp.	Fil.	5.0	0.25	90 135	..... .....	4.5 9.0	2.5 3.0	..... .....	11,000 10,000	8.0 8.0	.....	
0A2	Min.	5B0	Diode	Voltage Reg.	Cold K	.....	.....	Starting Voltage=155, Operating Voltage=150, Operating Current=5 to 30 Ma.								
0B2	Min.	5B0	Diode	Voltage Reg.	Cold K	.....	.....	Starting Voltage=115, Operating Voltage=105, Operating Current=5 to 30 Ma.								
0Y4	Metal	4BU	Gas Diode	H-W Rect.	Cold K	.....	.....	117 A.C. Volts Per Plate, RMS, 75 Ma. Max., 40 Ma. Min. Output Current								
0Z3	.....	5N	Gas Rect.	F.W. Rect.	Cold K	.....	.....	350 V. RMS Per Plate, 75 Ma. Max. DC Output. 0Z4								
0Z4A	T-7	4R	Gas Duodiode	F.W. Rect.	Ionic	.....	.....	300 A.C. Volts Per Plate, RMS, 110 Ma. Max., 30 Ma. Min. Output Current								
1, KR1	ST-12	4G	Diode	H.W. Rect.	Cath.	6.3	0.30	350 V. RMS Plate, 50 Ma. DC Output. 1V								
1A3	Min.	5AP	Diode	Det.	Cath.	1.4	0.15	Single Diode, Cathode Type for H.F. Use.								
1A4	ST-12	4K	Tetrode	R.F. Amp.	Fil.	2.0	0.06	90 180	67.5 67.5	3.0 3.0	2.2 2.3	0.9 0.8	600,000 1.0 Meg.	720 750	..... .....	1A4P, 1A4T
1A4P	ST-12	4M	Pentode	R.F. Amp.	Fil.	2.0	0.06	135 180	67.5 67.5	3.0 3.0	2.2 2.3	0.9 0.8	1 Meg. 1 Meg.	625 725	..... .....	
1A4T	ST-12	4K	Tetrode	R.F. Amp.	Fil.	2.0	0.06	135 180	67.5 67.5	3.0 3.0	2.2 2.2	0.7 0.7	350,000 600,000	625 650	..... .....	
1A6	ST-12	6L	Heptode	Converter	Fil.	2.0	0.06	135 180	67.5 67.5	3.0 3.0	1.8 1.5	2.1 2.0	400,000 500,000	275▽ 300▽	G <sub>2</sub> =135 V. at 2.0 Ma.■ G <sub>2</sub> =180 V. at 2.5 Ma.■	
1AB5	Lock-In	5BF	Pentode	R.F. Amp.	Fil.	1.2 1.2	0.13 0.13	90 150	90 150	0 1.5	3.5 6.8	0.8 2.0	275,000 120,000	1,100 1,350	..... .....	
1B4	ST-12	4K	Tetrode	R.F. Amp.	Fil.	2.0	0.06	90 180	67.5 67.5	3.0 3.0	1.6 1.7	0.7 0.6	1.0 Meg.♦ 1.5 Meg.♦	600 650	..... .....	1B4P 1B4T
1B4/951	ST-12	4K	Tetrode	R.F. Amp.	Fil.	2.0	0.06	Same as Type 1B4. 1B4 P or T								
1B4P	ST-12	4M	Pentode	R.F. Amp.	Fil.	2.0 2.0	0.06 0.06	135 180	67.5 67.5	3.0 3.0	1.6 1.7	0.7 0.6	1.5 Meg. 1.5 Meg.	580 650	..... .....	

① Load Resistance for Power Output Tubes.

② Mutual Conductance for Tetrodes, Pentodes, Etc.

▽ Conversion Conductance.

♦ Approximate.

▲ Plate to Plate.

■ Through 20,000 Ohms.

# Per Tube or Section—No Signal.

‡ Plate and Target Supply.

# RESISTANCE COUPLED AMPLIFIER DATA

## Self Bias Operation

Rb	Ebb = 100 VOLTS							Ebb = 250 VOLTS						
	0.1		0.27			0.47		0.1		0.27			0.47	
Rc <sub>1</sub>	0.39		1.0			1.8		0.39		1.0			1.8	
Rc <sub>f</sub>	0.27	0.47	0.27	0.47	1.0	0.47	1.0	0.27	0.47	0.27	0.47	1.0	0.47	1.0
Rk	1200	1200	2700	2700	2700	4700	4700	470	470	1000	1000	1200	1800	1800
I <sub>b</sub>	0.61	0.61	0.271	0.271	0.271	0.163	0.163	1.75	1.75	0.75	0.75	0.74	0.44	0.44
Ic <sub>1</sub>	0.173	0.173	0.076	0.076	0.076	0.044	0.044	0.49	0.49	0.212	0.212	0.207	0.121	0.121
Ec <sub>1</sub>	-0.94	-0.94	-0.938	-0.938	-0.938	-0.974	-0.974	-1.05	-1.05	-0.962	-0.962	-1.14	-1.01	-1.01
Ec <sub>2</sub>	32.5	32.5	23.5	23.5	23.5	20.5	20.5	59	59	38	38	43	32.1	32.1
Eb	39	39	26.9	26.9	26.9	23.4	23.4	75	75	47.5	47.5	50	43	43
E <sub>sig</sub>	0.1	0.1	0.1	0.1	0.1	0.1	0.1	0.1	0.1	0.1	0.1	0.1	0.1	0.1
E <sub>out</sub>	7.8	8.9	8.0	10.2	12.2	9.6	12.5	13.6	15.5	15.4	19.8	22.0	19.5	25.5
Gain	78	89	80	102	122	96	125	136	155	154	198	220	195	255
% Distortion	4.6	4.3	5.0	3.8	3.0	5.2	3.9	2.2	2.1	2.8	2.1	2.0	3.0	3.1
E <sub>sig</sub> (1)	0.11	0.11	0.1	0.1	0.1	0.1	0.1	0.22	0.22	0.15	0.15	0.2	0.14	0.14
E <sub>out</sub>	8.55	9.8	8.0	10.2	12.2	9.6	12.5	29	33	22.5	28.0	41.5	26.4	34.5
Gain	77.8	89	80	102	122	96	129	132	150	150	187	207.5	189	246.5
% Distortion	5.1	4.6	5.0	3.8	3.0	5.2	3.9	4.8	4.3	4.5	3.8	5.0	4.7	4.4

Note (1). For self bias operation this is taken at the grid current point with less than  $\frac{1}{2}$  microampere grid current.

FOR CIRCUIT SEE FIGURE 1

## OBSOLETE AND SELDOM ENCOUNTERED TYPES

Type	Construction		Class	Use	Emitter			Plate Volts	Screen Volts	Neg. Grid Volts	Plate Cur- rent Ma.	Screen Cur- rent Ma.	Plate ① Resistance Ohms	Amp. Factor ②	Power Output Mw.	Suggested Replacement Type
	Style	Base Diag.			Type	Volts	Amp.									
01A	ST-14	4D	Triode	Det. Amp.	Fil.	5.0	0.25	90 135	..... .....	4.5 9.0	2.5 3.0	.....	11,000 10,000	8.0 8.0	.....	
0A2	Min.	5B0	Diode	Voltage Reg.	Cold K	.....	.....	Starting Voltage=155, Operating Voltage=150, Operating Current=5 to 30 Ma.								
0B2	Min.	5B0	Diode	Voltage Reg.	Cold K	.....	.....	Starting Voltage=115, Operating Voltage=105, Operating Current=5 to 30 Ma.								
0Y4	Metal	4BU	Gas Diode	H-W Rect.	Cold K	.....	.....	117 A.C. Volts Per Plate, RMS, 75 Ma. Max., 40 Ma. Min. Output Current								
0Z3	.....	5N	Gas Rect.	F.W. Rect.	Cold K	.....	.....	350 V. RMS Per Plate, 75 Ma. Max. DC Output.								0Z4
0Z4A	T-7	4R	Gas Duodiode	F.W. Rect.	Ionic	.....	.....	300 A.C. Volts Per Plate, RMS, 110 Ma. Max., 30 Ma. Min. Output Current								
1, KR1	ST-12	4G	Diode	H.W. Rect.	Cath.	6.3	0.30	350 V. RMS Plate, 50 Ma. DC Output.								1V
1A3	Min.	5AP	Diode	Det.	Cath.	1.4	0.15	Single Diode, Cathode Type for H.F. Use.								
1A4	ST-12	4K	Tetrode	R.F. Amp.	Fil.	2.0	0.06	90 180	67.5 67.5	3.0 3.0	2.2 2.3	0.9 0.8	600,000 1.0 Meg.	720 750	..... .....	1A4P, 1A4T
1A4P	ST-12	4M	Pentode	R.F. Amp.	Fil.	2.0	0.06	135 180	67.5 67.5	3.0 3.0	2.2 2.3	0.9 0.8	1 Meg. 1 Meg.	625 725	..... .....	
1A4T	ST-12	4K	Tetrode	R.F. Amp.	Fil.	2.0	0.06	135 180	67.5 67.5	3.0 3.0	2.2 2.2	0.7 0.7	350,000 600,000	625 650	..... .....	
1A6	ST-12	6L	Heptode	Converter	Fil.	2.0	0.06	135 180	67.5 67.5	3.0 3.0	1.8 1.5	2.1 2.0	400,000 500,000	275▼ 300▼	G <sub>2</sub> =135 V. at 2.0 Ma.■ G <sub>2</sub> =180 V. at 2.5 Ma.■	
1AB5	Lock-In	5BF	Pentode	R.F. Amp.	Fil.	1.2	0.13	90 150	90 150	0 1.5	3.5 6.8	0.8 2.0	275,000 120,000	1,100 1,350	..... .....	
1B4	ST-12	4K	Tetrode	R.F. Amp.	Fil.	2.0	0.06	90 180	67.5 67.5	3.0 3.0	1.6 1.7	0.7 0.6	1.0 Meg.♦ 1.5 Meg.♦	600 650	..... .....	1B4P 1B4T
1B4/951	ST-12	4K	Tetrode	R.F. Amp.	Fil.	2.0	0.06	Same as Type 1B4.								1B4 P or T
1B4P	ST-12	4M	Pentode	R.F. Amp.	Fil.	2.0	0.06	135 180	67.5 67.5	3.0 3.0	1.6 1.7	0.7 0.6	1.5 Meg. 1.5 Meg.	560 650	..... .....	

① Load Resistance for Power Output Tubes.

② Mutual Conductance for Tetrodes, Pentodes, Etc.

▼ Conversion Conductance.

♦ Approximate.

▲ Plate to Plate.

■ Through 20,000 Ohms.

# Per Tube or Section—No Signal.

§ Plate and Target Supply.

## OBSOLETE AND SELDOM ENCOUNTERED TYPES—Cont.

Type	Construction		Class	Use	Emitter			Plate Volts	Screen Volts	Neg. Grid Volts	Plate Current Ma.	Screen Current Ma.	Plate ① Resistance Ohms	Amp. ② Factor	Power Output Mw.	Suggested Replacement Type	
	Style	Base Diag.			Type	Volts	Amp.										
1B5/25S	ST-12	6M	Duodi Tri.	Det. Amp.	Fil.	2.0	0.06	135	....	3.0	0.8	....	35,000	20	....		
1B7GT	GT	7Z	Heptode	Conv.	Fil.	1.4	0.10	90	45	0	1.5	1.3	350,000	350▼	G <sub>2</sub> =90 V. at 1.6 Ma.	1A7GT	
1C6	ST-12	6L	Heptode	Converter	Fil.	2.0	0.12	135	67.5	3.0	1.3	2.5	600,000	300▼	G <sub>2</sub> =135 V. at 3.1 Ma.■		
						2.0	0.12	180	67.5	3.0	1.5	2.0	700,000	325▼	G <sub>2</sub> =180 V. at 4.0 Ma.■		
1C7G	ST-12	7Z	Heptode	Converter	Fil.	2.0	0.12	Same as 1C6.									
1D5G	ST-12	5R	Tetrode	R.F. Amp.	Fil.	2.0	0.06	180	67.5	3.0	2.3	0.7	600,000	750	....	1D5GP, 1D5GT	
1D5GP	ST-12	5Y	Pentode	R.F. Amp.	Fil.	2.0	0.06	135	67.5	3.0	2.2	0.9	1 Meg.	625	....		
						2.0	0.06	180	67.5	3.0	2.3	0.8	1 Meg.	725	....		
1D5GT	ST-12	5R	Tetrode	R.F. Amp.	Fil.	2.0	0.06	135	67.5	3.0	2.2	0.7	350,000	625	....		
						2.0	0.06	180	67.5	3.0	2.2	0.7	600,000	650	....		
1D7G	ST-12	7Z	Heptode	Converter	Fil.	2.0	0.06	135	67.5	3.0	1.8	2.1	400,000	275▼	G <sub>2</sub> =135 V. at 2.0 Ma.■		
						2.0	0.06	180	67.5	3.0	1.5	2.0	500,000	300▼	G <sub>2</sub> =180 V. at 2.5 Ma.■		
1D8	T-9	8AJ	Diode Triode	Det. Amp.	Fil.	1.4	0.1	45	....	0	....	....	77,000	25	....		
			Pentode	Pwr. Amp.	....	....	....	....	45	45	4.5	1.6	0.3	43,500	25		....
					....	....	....	....	90	90	9.0	5.0	1.0	20,000	650		35
1E4	T-9	5S	Triode	Det. Amp.	Fil.	1.4	0.05	Same Characteristics as Type 1LE3.									
1E5G	ST-12	5R	Tetrode	R.F. Amp.	Fil.	2.0	0.06	180	67.5	3.0	1.7	0.6	....	650	....	1E5GP, 1E5GT	
1E5GP	ST-12	5Y	Pentode	R.F. Amp.	Fil.	2.0	0.06	135	67.5	3.0	1.6	0.7	1.5 Meg.	560	....		
						2.0	0.06	180	67.5	3.0	1.7	0.6	1.5 Meg.	650	....		
1E5GT	ST-12	5R	Tetrode	R.F. Amp.	Fil.	Same as Type 1E5G.									1E5GP		
1E7GT	ST-12	8C	Pentode	Pwr. Amp.	Fil.	2.0	0.24	90	90	3.0	3.8	1.1	340,000	1,150	110		
				Push pull Max. Signal	2.0	0.24	135	135	4.5	7.5	2.2	260,000	1,425	290			
					2.0	0.24	135	135	7.5	10.5♦	3.5♦	24,000‡	....	575			

① Load Resistance for Power Output Tubes.

② Mutual Conductance for Tetrodes, Pentodes, Etc.

▼ Conversion Conductance.

♦ Approximate.

‡ Plate to Plate.

§ Through 20,000 Ohms.

# Per Tube or Section—No Signal.

‡ Plate and Target Supply.

## OBSOLETE AND SELDOM ENCOUNTERED TYPES—Cont.

Type	Construction		Class	Use	Emitter			Plate Volts	Screen Volts	Neg. Grid Volts	Plate Cur- rent Ma.	Screen Cur- rent Ma.	Plate ① Resistance Ohms	Amp. ② Factor	Power Output Mw.	Suggested Replacement Type	
	Style	Base Diag.			Type	Volts	Amp.										
1F4	ST-14	5K	Pentode	Pwr. Amp.	Fil.	2.0 2.0	0.12 0.12	90 135	90 135	3.0 4.5	4.0 8.0	1.1 2.4	20,000 16,000	1,400 1,700	110 310		
1F5G	ST-14	6X	Pentode	Pwr. Amp.	Fil.	2.0	0.12	Same as 1F4.									
1F6	ST-12	6W	Duodi Pent.	R.F. Amp.	Fil.	2.0	0.06	180	67.5	1.5	2.2	0.7	1 Meg.♦	650	....		
1F7G	ST-12	7AD	Duodi Pent.	R.F. Amp.	Fil.	2.0	0.06	Same as 1F6.									
1F7GV	ST-12	7AF	Duodi Pent.	R.F. Amp.	Fil.	2.0	0.06	Same as 1F7G except diodes placed one above the other.									
1G5G	ST-14	6X	Pentode	Pwr. Amp.	Fil.	2.0 2.0 2.0	0.12 0.12 0.12	90 124 135	90 124 135	6.0 11.0 13.5	8.7 10.7 9.7	3.0 4.3 3.6	8,500 8,000 9,000	1,500 1,500 1,550	250 600 550		
1H4G	ST-12	5S	Triode	Amp.	Fil.	2.0 2.0 2.0	0.06 0.06 0.06	90 135 180	.... .... ....	4.5 9.0 13.5	2.5 3.0 3.1	.... .... ....	11,000 10,300 10,300	9.3 9.3 9.3	.... .... ....		
1H6G	ST-12	7AA	Duodi Tri.	Amp.	Fil.	2.0	0.06	135	....	3.0	0.8	....	35,000	20	....		
1J5G	ST-14	6X	Pentode	Pwr. Amp.	Fil.	2.0	0.12	135	135	16.5	7.0	1.8	13,500	1,000	450		
1J6G	ST-12	7AB	Duo Tri.	Pwr. Amp.	Fil.	2.0 2.0 2.0	0.24 0.24 0.24	135 135 135	.... .... ....	0 3.0 6.0	24 26 30	.... .... ....	10,000‡ 10,000‡ 10,000‡	.... .... ....	2,200♦ 2,000♦ 1,600♦		
1N6G	T-9	7AM	Diode Pent.	Pwr. Amp.	Fil.	1.4	0.05	90	90	4.5	3.1	0.6	25,000	800	100		
1Q6	T-3	8CO	Diode Pent.	Det. Amp.	Fil.	1.25 1.25	0.04 0.04	30 67.5	30 67.5	0 0	0.33 1.60	0.09 0.40	500,000 400,000	330 600	.... ....		
1R4	Lock-In	4AH	H.F. Diode	Detector	Cath.	1.4	0.15	117 V. RMS			1.0		Resonant Frequency 1,500 Mc.				
1SA6GT	GT	6BD	Pentode	R.F. Amp.	Fil.	1.4	0.05	45 67.5 90	45 67.5 90	0 0 0	1.1 2.4 2.45	0.3 0.7 0.68	700,000 600,000 800,000	750 950 970	.... .... ....	1N5GT	
1SB6GT	GT	6BE	Di. Pent.	Det. Amp.	Fil.	1.4	0.05	45 90	45 67.5	0 0	0.6 1.45	0.16 0.38	900,000 700,000	500 665	.... ....	1LD5	
1V	ST-12	4G	Diode	H.W. Rect.	Cath.	6.3	0.30	350 V. RMS Plate, 45 Ma. DC Output.								76	

① Load Resistance for Power Output Tubes.

② Mutual Conductance for Tetrodes, Pentodes, Etc.

♦ Conversion Conductance.

◆ Approximate.

‡ Plate to Plate.

¶ Through 20,000 Ohms.

§ Per Tube or Section—No Signal.

‡ Plate and Target Supply.

## OBSOLETE AND SELDOM ENCOUNTERED TYPES—Cont.

Type	Construction		Class	Use	Emitter			Plate Volts	Screen Volts	Neg. Grid Volts	Plate Current Ma.	Screen Current Ma.	Plate ① Resistance Ohms	Amp. ② Factor	Power Output Mw.	Suggested Replacement Type	
	Style	Base Diag.			Type	Volts	Amp.										
2A3	ST-16	4D	Triode	Pwr. Amp.	Fil.	2.5	2.5	250 300	..... .....	45.0 62.0	60 40 per tube	..... .....	2,500 3,000‡	4.2 .....	3,500 15,000	2A3H	
2A3H	ST-16	4D	Triode	Pwr. Amp.	Cath.	2.5	2.5	Same as Type 2A3.								2A3	
2A4G	ST-12	5S	Gas Triode	Relay Tube	Fil.	2.5	2.5	Instantaneous Forward or Inverse Anode Volts=200, Peak Anode Amps.=1.25, Average Anode Current=0.1 Amp. Max., Avg. Time=45 sec. Cold Starting Time=2 sec.									
2A5	ST-14	6B	Pentode	Pwr. Amp.	Cath.	2.5	1.75	250 285	250 285	16.5 20.0	34 38	6.5 7.0	7,000 7,000	..... .....	3,200 4,800		
2A6	ST-12	6G	Duodi Tri.	Det. Amp.	Cath.	2.5	0.80	250	.....	2.0	0.9	.....	91,000	100	.....		
2A7, 2A7S	ST-12	7C	Heptode	Converter	Cath.	2.5	0.80	Same Characteristics as Types 6A7 or 6A8G.									
2B7, 2B7S	ST-12	7D	Diode Pent.	Det. Amp.	Cath.	2.5	0.80	100 250	100 100	3.0 3.0	5.8 6.0	1.7 1.5	300,000 800,000	950 1,000	..... .....		
2C4	T-5½	5AS	Gas Triode	Control Tube	Fil.	2.5	0.65	350	.....	50	5	Voltage Drop = 16 Volts					
2D21	T-5½	7BN	Gas Tetrode	Relay Tube	Cath.	6.3	0.6	400	.....	5	Average Cathode Current = 100 Ma. Max., Averaged over any 30 sec. interval						
2E5	T-9	6R	Elect. Ray	Indicator	Cath.	2.5	0.80	Same Characteristics as Type 6E5.									
2S/4S	ST-12	5D	Duo Diode	Det.	Cath.	2.5	1.35	Approximate 40 Ma. Per Plate, 50 Ma. DC Output.									
2V3G	ST-12	4Y	Diode	H.W. Rect.	Fil.	2.5	5.0	6000 V. RMS Plate, 2 Ma. DC Output.								2X2A	
2W3GT	GT	4X	Diode	H.W. Rect.	Fil.	2.5	1.50	350 V. RMS Plate, 55 Ma. DC Output, Cond. Filter Input.									
2Z2/G84	ST-12	4B	Diode	H.W. Rect.	Fil.	2.5	1.50	350 V. RMS Plate, 50 Ma. DC Output.									
G2/2S	.....	5D	Duo Diode	Det.	Cath.	2.5	1.75	.....	.....	.....	.....	.....	.....	.....	.....	2S/4S	
3A5	Min.	7BC	Duo. Tri.	Amp.	Fil.	1.4 2.8	0.22 0.11	90 135	..... .....	2.5 20.0	3.7 30.0	.....	8,300 Push-Pull Class C R.F. Amp.	15 2,000	.....		
3B5GT	GT	7AQ	Beam Amp.	Amp.	Fil.	1.4 2.8	0.10 0.05	45 67.5	45 67.5	4.5 7.0	4.4 6.7	0.3 0.5	8,000 5,000	1,400 1,500	70 180		
3B7	Lock-In	7BE	Duotriode	Osc. Amp.	Fil.	2.8	0.11	135	Class AB <sub>2</sub>		0	22.0	.....	16,000‡	20	1,500	
4A6G	ST-12	8L	Duo Tri.	Pwr. Amp.	Fil.	1.4 4.0	0.22 0.06	180 90	Class C		0	25.0	R.F. Pwr. Amp. 2800 mw. at 25 mc., 1400 mw. at 125 mc.		.....		
													Class P to P Load B Amp. 8,000	20	1,000		

① Load Resistance for Power Output Tubes.  
 ② Mutual Conductance for Tetrodes, Pentodes, Etc.  
 † Conversion Conductance.

♦ Approximate.  
 ‡ Plate to Plate  
 § Through 20,000 Ohms.

# Per Tube or Section—No Signal.  
 § Plate and Target Supply.

## OBSOLETE AND SELDOM ENCOUNTERED TYPES—Cont.

Type	Construction		Class	Use	Emitter			Plate Volts	Screen Volts	Neg. Grid Volts	Plate Current Ma.	Screen Current Ma.	Plate ① Resistance Ohms	Amp. ② Factor	Power Output Mw.	Suggested Replacement Type
	Style	Base Diag.			Type	Volts	Amp.									
G4/4S	.....	5D	Duo. Di.	Det.	Cath.	2.5	1.0	.....	.....	.....	.....	.....	.....	.....	.....	2S/4S
5T4	Metal	5T	Duo Di.	F.W. Rect.	Fil.	5.0	2.0	450 V. RMS Per Plate, 225 Ma. DC Output, Cond. Input Filter. 550 V. RMS Per Plate, 225 Ma. DC Output, Choke Input Filter.							5U4G	
5X3	ST-14	4C	Duodiode	Rect.	Fil.	5.0	2.0	400 AC V. Per Plate, RMS, 110 Ma. Output Current. Choke or Cond. Input to Filter. 1275 AC V. Per Plate, RMS, 30 Ma. Output Current. Choke or Cond. Input to Filter.								
KR5	ST-16	5B	Pentode	Pwr. Amp.	Fil.	6.3	0.30	135	135	9.0	14	2.5	9,500	1,900	700	6A4/LA
6A3	ST-16	4D	Triode	Pwr. Amp.	Fil.	6.3	1.00	250	.....	45.0	60.0	.....	2,500	4.2	3,200	
						6.3	1.00	325	.....	68.0	40.0%	Fixed Bias	3,000	.....	15,000	
						6.3	1.00	325	.....	.....	40.0%	Self Bias 850 Ohms	5,000	.....	10,000	
6A4/LA	ST-14	5B	Pentode	Pwr. Amp.	Fil.	6.3	0.30	100	100	6.5	9.0	1.6	11,000	1,200	310	
						.....	.....	180	180	12.0	22.0	3.9	8,000	2,200	1,400	
6A6	ST-14	7B	Duo. Tri.	Pwr. Amp.	Cath.	6.3	0.8	300	.....	0	35.0	Per Plate	8,000	Max. Signal	10,000	6N7G
						.....	.....	250	.....	5.0	6.0	.....	11,300	35	.....	
						.....	.....	294	.....	6.0	7.0	.....	11,000	35	.....	
6A7S	ST-12	7C	Heptode	Converter	Cath.	6.3	0.30	Same as Type 6A7.							6A7	
6AB5/6N5	T-9	6R	Electron Ray	Indicator	Cath.	6.3	0.15	135§ Series Plate Resistor 0.25 Meg., Target Current 2.0 Ma., Grid Bias = 10 for 0° Shadow.								
6AB6G	ST-12	7AU	Duo Tri.	Pwr. Amp.	Cath.	6.3	0.50	250	Inp. Tri.	0	5.0	.....	.....	.....	.....	6N6G
								250	Outp. Tri.	.....	34.0	.....	8,000	.....	3,500	
6AB7/1853	Metal	8N	Pentode	Amp.	Cath.	6.3	0.45	300	200	3.0	12.5	3.2	700,000	5,000	.....	

① Load Resistance for Power Output Tubes.  
 ② Mutual Conductance for Tetrodes, Pentodes, Etc.  
 ▼ Conversion Conductance.

◆ Approximate.  
 † Plate to Plate.  
 ‡ Through 20,000 Ohms.

§ Per Tube or Section—No Signal.  
 ¶ Plate and Target Supply.



## OBSOLETE AND SELDOM ENCOUNTERED TYPES—Cont.

Type	Construction		Class	Use	Emitter			Plate Volts	Screen Volts	Neg. Grid Volts	Plate Current Ma.	Screen Current Ma.	Plate ① Resistance Ohms	Amp. ② Factor	Power Output Mw.	Suggested Replacement Type								
	Style	Base Diag.			Type	Volts	Amp.																	
6AD5GT	GT	6Q	Triode	Amp.	Cath.	6.3	0.30	250	.....	2.0	0.9	.....	66,000	100	.....									
6AD6G	T-9	7AG	Electron Ray	Indicator	Cath.	6.3	0.15	100§	Ray Control Volts=45 for 0° Shadow, = -23 Volts for 135° Shadow. Ray Control Volts=75 for 0° Shadow, = -50 Volts for 135° Shadow.															
6AD7G	ST-14	8AY	Tri. Pent.	Tri. Amp. Pent. Amp.	Cath.	6.3	0.85	250									.....	25	3.7	.....	19,000*	6	.....	
6AE5GT	GT	6Q	Triode	Amp.	Cath.	6.3	0.30	95	.....	15.0	7.0	.....	7,000	2,500	3,200									
6AE6G	ST-12	7AH	Duo Plate Tri.	Remote Cut-Off Sharp Cut-Off	Cath.	6.3	0.15	250	.....	1.5	6.5	.....	25,000	25	.....									
					.....	6.3	0.15	250	.....	35.0	0.01	.....	35,000	33	.....									
					.....	6.3	0.15	250	.....	1.5	4.5	.....	.....	.....	.....									
					.....	6.3	0.15	250	.....	9.5	0.01	.....	.....	.....	.....									
6AE7GT	GT	7AX	Duo. Tri.	Amp.	Cath.	6.3	0.50	250	.....	13.5	5.0	.....	9,300	14	.....	Per Section (Driver for P.P.6AC5GT=250 V. 10 Ma., 6AC5GT Plate Ma.=76. Output 9.5 Watts with 10,000 Ohms Load.)								
6AF5G	ST-12	6Q	Triode	Amp.	Cath.	6.3	0.30	180	.....	18.0	7.0	.....	4,900	7.4	.....									
6AF6G	T-9	7AG	Twin Elec. Ray	Indicator	Cath.	6.3	0.15	100§	Ray Control Volts=60* for 0° Shadow, ♦Zero Volts for 100° Shadow. 135§ Ray Control Volts=81* for 0° Shadow, ♦Zero Volts for 100° Shadow. 250§ Ray Control Volts=155* for 0° Shadow, ♦Zero Volts for 100° Shadow.															
6AH5G	ST-16	6AP	Beam Amp.	Amp.	Cath.	6.3	0.90	350									250	18.0	54.0	2.5	4,200	5,200	10,800	6L6G
6AH7GT	GT	8BE	Duotriode	Amp. (per unit)	Cath.	6.3	0.30	100									.....	3.6	3.7	.....	10,300	16	.....	
6AL6G	ST-16	6AM	Beam Amp.	Pwr. Amp.	Cath.	6.3	0.90	180	.....	6.5	7.6	.....	8,400	16	.....									
								Same as 6L6G.								6L6G								
6AN6	Min.	7BJ	Quadruple Di.	Rectifier	Cath.	6.3	0.20	75 Volts RMS Per Plate, 8 Ma. D-C Output Per Plate.																
6AQ7GT	GT	8CK	Duodiode Tri.	Det. Amp.	Cath.	6.3	0.30	250	.....	2.0	2.3	.....	44,000	70	.....									
6B5	ST-14	6AS	Duo Tri.	Pwr. Amp.	Cath.	6.3	0.80	300	Inp. Tri. Outp. Tri.	0	8.0	.....	.....	.....	.....	.....								
								300									.....	45.0	.....	7,000	.....	4,000		

① Load Resistance for Power Output Tubes.  
 ② Mutual Conductance for Tetrodes, Pentodes, Etc.  
 ▼ Conversion Conductance.

◆ Approximate.  
 † Plate to Plate.  
 ‡ Through 20,000 Ohms.

\* Per Tube or Section—No Signal.  
 † Plate and Target Supply.

## OBSOLETE AND SELDOM ENCOUNTERED TYPES—Cont.

Type	Construction		Class	Use	Emitter			Plate Volts	Screen Volts	Neg. Grid Volts	Plate Current Ma.	Screen Current Ma.	Plate ① Resistance Ohms	Amp. ② Factor	Power Output Mw.	Suggested Replacement Type		
	Style	Base Diag.			Type	Volts	Amp.											
6B6G	ST-12	7V	Duodi Tri.	Det. Amp.	Cath.	6.3	0.30	250	....	20	0.9	....	91,000	100	....	6Q7GT		
6B7, 6B7S	ST-12	7D	Duodi Pent.	R.F. or I.F. Amp.	Cath.	6.3	0.30	100	100	3.0	5.8	1.7	300,000	950	....			
					Cath.	6.3	0.30	250	125	3.0	9.0	2.3	600,000	1,125	....			
6B8GT	GT	8E	Duodi Pent.	Det. Amp.	Cath.	6.3	0.30	Characteristics Same as Type 6B7.										
6C6	ST-12	6F	Pentode	Amp.  As Triode	Cath.	6.3	0.30	100	100	3.0	2.0	0.50	1 Meg. >1 Meg.	1,185	....	77		
					Cath.	6.3	0.30	250	100	3.0	2.0	0.50		1,225	....			
					....	6.3	0.30	180	....	5.3	5.3	....		11,000	....			
					....	6.3	0.30	250	....	8.0	6.5	....		10,000	....			
6C7	ST-12	7G	Duodi Tri.	Det. Amp.	Cath.	6.3	0.30	250	....	9.0	4.5	....	16,000	20	....	6SR7GT		
6C8G	ST-12	8G	Duo Tri.	Amp. Inv.	Cath.	6.3	0.30	250	....	4.5	3.2	....	22,500	36	....			
6D5G	....	6Q	Triode	Pwr. Amp.	Cath.	6.3	0.70	275	....	40	31	....	7,200	4.7	1,400			
6D6	ST-12	6F	Pentode	Amp.	Cath.	6.3	0.30	100	100	3.0	8.0	2.2	250,000*	1,500	....	78		
					Cath.	6.3	0.30	250	100	3.0	8.2	2.0	800,000*	1,600	....			
6D7	ST-12	7H	Pentode	Amp.	Cath.	6.3	0.30	Same as 6C6.									6C6	
6D8G	ST-12	8A	Heptode	Converter	Cath.	6.3	0.15	135	67.5	3.0	1.5	1.7	600,000	325 <sup>▼</sup>	G <sub>2</sub> =135 V. at 1.8 Ma. G <sub>2</sub> =250 V. at 4.5 Ma. <sup>■</sup>	7A8		
					Cath.	6.3	0.15	250	100	3.0	3.5	2.6	400,000	550 <sup>▼</sup>				
6E6	ST-14	7B	Duotriode	Pwr. Amp.	Cath.	6.3	0.60	180	....	20.0	11.5	....	15,000 <sup>‡</sup>	6.0	750			
					Cath.	6.3	0.60	250	....	27.5	18.0	....	14,000 <sup>‡</sup>	6.0	1,600			
6E7	ST-12	7H	Pentode	Amp.	Cath.	6.3	0.30	Same as 6D6.										6D6
6F7, 6F7S	ST-12	7E	Tri. Pent.	Amp.	Cath.	6.3	0.30	100	(Tri.) 100	3.0	3.5	....	16,200	8.5	....			
6F8G	ST-12	8G	Duo Tri.	Amp. Inv.	Cath.	6.3	0.60	250	....	8.0	9.0	....	7,700	20	....	6SN7GT		
6G5/6H5	T-9	6R	Elect. Ray	Indicator	Cath.	6.3	0.30	....	....	0-22	....	....	....	....	....	6U5/6G5		
6H4GT	GT	5AF	Diode	Rect.	Cath.	6.3	0.15	100	....	....	4.0	....	....	....	....	7A6		
6H5	T-9	6R	Elect. Ray	Indicator	Cath.	6.3	0.30	Same as 6G5/6H5.										6U5/6G5

① Load Resistance for Power Output Tubes.

② Mutual Conductance for Tetrodes, Pentodes, Etc.

▼ Conversion Conductance.

♦ Approximate.

‡ Plate to Plate.

■ Through 20,000 Ohms.

\* Per Tube or Section—No Signal.

‡ Plate and Target Supply.

## OBSOLETE AND SELDOM ENCOUNTERED TYPES—Cont.

Type	Construction		Class	Use	Emitter			Plate Volts	Screen Volts	Neg. Grid Volts	Plate Current Ma.	Screen Current Ma.	Plate ① Resistance Ohms	Amp. ② Factor	Power Output Mw.	Suggested Replacement Type
	Style	Base Diag.			Type	Volts	Amp.									
6J4	Min.	7BQ	Triode	Amp.	Cath.	6.3	0.4	150	....	Self	15.0	....	4,500	55	200 Ohm	Cath. Bias Resistor
6P7G	ST-12	7U	Pent. Tri.	Amp.	Cath.	6.3	0.30	Same as 6F7.								6F7
6Q6, 6Q6G	....	6Y	Diode Tri.	Det. Amp.	Cath.	6.3	0.15	250	....	3.0	1.2	....	....	65	....	6T7G
6Q6G/6T7G	....	7V	Duodi Tri.	Det. Amp.	Cath.	6.3	0.15	250	....	3.0	1.2	....	....	65	....	6T7G
6R6G	ST-12	6AW	Pentode	R.F. Amp.	Cath.	6.3	0.30	250	100	3.0	7.0	1.7	800,000*	1,450	....	....
6SV7	Metal	7AZ	Diode Pent.	.....	Cath.	6.3	0.30	100	100	1.0	3.7	1.4	700,000	2,600	....	....
						6.3	0.30	150	150	1.0	7.5	2.8	1.5 Meg.	3,600	....	....
6T5	ST-12	6R	Elect. Ray	Indicator	Cath.	6.3	0.30	250§	....	0-22	3.0	....	....	....	....	6U5/6G5
6T7G	ST-12	7V	Duodiode Tri.	Det. Amp.	Cath.	6.3	0.15	100	....	1.5	0.3	....	95,000	65	....	....
								250	....	3.0	1.2	....	62,000	65	....	....
6T7G/6Q6G	ST-12	7V	Duodi Tri.	Det. Amp.	Cath.	6.3	0.15	250	....	3.0	1.2	....	62,000	65	....	6T7G
6V7G	ST-12	7V	Duodi-Triode	Det. Amp.	Cath.	6.3	0.3	Same Characteristics as Type 85.								....
6W5G	ST-12	6S	Duo Diode	F.W. Rect.	Cath.	6.3	0.90	325 V. RMS Per Plate, 90 Ma. DC Output, Cond. Input Filter. 450 V. RMS Per Plate, 90 Ma. DC Output, Choke Input Filter.								6X5G
6Y3G	ST-12	4AC	Diode	H.W. Rect.	Cath.	6.3	0.70	5000 A.C. Volts Per Plate RMS 7.5 Ma. Output Current.								2X2A
6Y5	ST-12	6J	Duo Diode	F.W. Rect.	Cath.	6.3	0.80	350 V. RMS Per Plate, 50 Ma. DC Output.								6X5G
6Y5V	ST-12	6J	Duo Diode	F.W. Rect.	Cath.	6.3	0.80	350 V. RMS Per Plate, 60 Ma. DC Output.								6X5G
6Y7G	ST-12	8B	Duo Triode	Class B Amp.	Cath.	6.3	0.6	Same Characteristics as Type 79.								....
6Z3	....	4G	Diode	H.W. Rect.	Cath.	6.3	0.30	350 V. RMS Plate, 50 Ma. DC Output.								1V
6Z4, 6Z4/84	ST-12	5D	Duo Diode	F.W. Rect.	Cath.	6.3	0.50	350 V. RMS Per Plate, 60 Ma. DC Output, Cond. Input Filter.								6X5G
6Z5, 6Z5/12Z5	ST-12	6K	Duo Diode	F.W. Rect.	Cath.	6.3	0.80	230 V. RMS Per Plate, 60 Ma. DC Output.								6X5G
						12.6	0.40									....
6Z7G	ST-12	8B	Duo Triode	Class B Amp.	Cath.	6.3	0.3	135	....	0	60	....	....	9,000	2,500	....
								180	....	0	60	....	....	12,000	4,200	....
6ZY5G	ST-12	6S	Duo Diode	F.W. Rect.	Cath.	6.3	0.30	325 V. RMS Per Plate, 40 Ma. DC Output, Cond. Input Filter.								6X5G or 14Y4
7A7LM	Metal	8V	Pentode	Amp.	Cath.	6.3	0.30	250	100	3.0	8.6	2.0	800,000*	2,000	....	7A7

① Load Resistance for Power Output Tubes.  
 ② Mutual Conductance for Tetrodes, Pentodes, Etc.  
 ▼ Conversion Conductance.

♦ Approximate.  
 † Plate to Plate.  
 ‡ Through 20,000 Ohms.

# Per Tube or Section—No Signal.  
 § Plate and Target Supply.

## OBSOLETE AND SELDOM ENCOUNTERED TYPES—Cont.

Type	Construction		Class	Use	Emitter			Plate Volts	Screen Volts	Neg. Grid Volts	Plate Current Ma.	Screen Current Ma.	Plate <sup>①</sup> Resistance Ohms	Amp. <sup>②</sup> Factor	Power Output Mw.	Suggested Replacement Type
	Style	Base Diag.			Type	Volts	Amp.									
7AB7	Lock In	8B0	Pentode	Amp.	Cath.	6.3	0.15	250	100	2.0	4.0	1.3	500,000	1,800	....	
7B5LT	T-9	6AE	Pentode	Pwr. Amp.	Cath.	6.3	0.40	250 315	250 250	18.0 21.0	32.0 25.5	5.5 4.0	7,600 9,000	2,300 2,100	3,400 4,500	7B5
7B6LM	Metal	8W	Duodi Tri.	Det. Amp.	Cath.	6.3	0.30	100 250	....	1.0 2.0	0.4 0.9	....	110,000 91,000	100 100	....	7B6
7B8LM	Metal	8X	Heptode	Converter	Cath.	6.3	0.30	100 250	50 100	1.5 3.0	1.1 3.5	1.3 2.7	600,000 360,000	360 <sup>▼</sup> 550 <sup>▼</sup>	G <sub>2</sub> =100 V. at 2.0 Ma. <sup>■</sup> G <sub>2</sub> =250 V. at 4.0 Ma. <sup>■</sup>	7B8
7C4	Lock-In	4AH	H.F. Diode	Detector	Cath.	6.3	0.15	117 V. RMS			5.0	Resonant Frequency 900 Mc.				
7C5LT	T-9	6AA	Beam Amp.	Pwr. Amp.	Cath.	6.3	0.45	250 315	250 225	12.5 13.0	45.0 34.0	4.5 2.2	5,000 8,500	4,100 3,750	4,500 5,500	7C5
7T7	Lock-In	8V	Pentode	Amp.	Cath.	6.3	0.30	100	100	1.0	5.3	2.1	350,000	4,000	....	
						6.3	0.30	250	150	1.0	10.8	4.1	900,000	4,900	....	
10	ST-16	4D	Triode	Pwr. Amp.	Fil.	7.5	1.25	250 350 425	....	23.5 32.0 40.0	10.0 16.0 18.0	....	13,000 11,000 10,200	8.0 8.0 8.0	400 900 1,600	
WD11	T-8	4F	Triode	Det. Amp.	Fil.	1.1	0.25	45 Det. + Fil. 0.25 to 5.0 Meg. Grid Leak. 90 Amp. 4.5   2.5			....	15,500	6.6	....		
WX12	T-10	4D	Triode	Det. Amp.	Fil.	1.1	0.25	Same as WD11.								
12A, 112A	ST-14	4D	Triode	Det. Amp.	Fil.	5.0	0.25	90 135	.... ....	4.5 9.0	5.0 6.2	.... ....	5,400 5,100	8.5 8.5	35 130	
12A5	ST-12	7F	Pentode	Pwr. Amp.	Cath.	12.6	0.30	100 180	100 180	15.0 25.0	19.0 48.0	6.0 14.0	4,500 3,300	1,700 2,400	800 3,400	
12A6	Metal	7AC	Beam Amp.	Pwr. Amp.	Cath.	12.6	0.15	250	250	12.5	30	3.5	7,500	3,000	3,400	
12A6GT	T-9	7AC	Beam Amp.	Pwr. Amp.	Cath.	12.6	0.15	Same as 12A6.								

① Load Resistance for Power Output Tubes.

② Mutual Conductance for Tetrodes, Pentodes, Etc.

▼ Conversion Conductance.

◆ Approximate.

♣ Plate to Plate.

■ Through 20,000 Ohms.

\* Per Tube or Section—No Signal.

♠ Plate and Target Supply.

## OBsolete AND SELDOM ENCOUNTERED TYPES—Cont.

Type	Construction		Class	Use	Emitter			Plate Volts	Screen Volts	Neg. Grid Volts	Plate Current Ma.	Screen Current Ma.	Plate ① Resistance Ohms	Amp. ② Factor	Power Output Mw.	Suggested Replacement Type
	Style	Base Diag.			Type	Volts	Amp.									
12A7	ST-12	7K	Diode Pent.	Rect. Amp.	Cath.	12.6	0.30	125 V. RMS 135	135	13.5	30 Ma. 9.0	DC Output (Rect.) 2.5	13,500	975	550	
12AH7GT	GT	8BE	Duotriode	Amp.	Cath.	12.6	0.15	100 180	.....	3.6 7.6	3.7 .....	.....	10,300 8,400	16 16	.....	
12B7	Lock In	8V	Pentode	Amp.	Cath.	12.6	0.15	Same as Lock In Type 14A7.								14A7
12B8GT	GT	8T	Triode Pentode	Tri. Amp. Pent. Amp.	Cath.	12.6	0.30	90 90	..... 90	0.0 3.0	2.8 7.0	..... 2.0	37,000 200,000	90 1,800	.....	6AT6 6BA6
12C8	Metal	8E	Duodi Pent.	Det. Amp.	Cath.	12.6	0.15	See Type 6B8.								
12L8GT	GT	8BU	Duo Pentode	Pwr. Amp.	Cath.	12.6	0.15	110 180	110 180	5.5 9.0	6.1% 13.0%	1.3% 2.8%	14,000% 10,000%	1,680% 2,150%	300% 1,000%	
12Z3	ST-12	4G	Diode	H.W. Rect.	Cath.	12.6	0.30	235 V. RMS Per Plate, 55 Ma. DC Output, Condenser Input Filter.								
12Z5	.....	7L	Duo Diode	Rect. Doub.	Cath.	12.6	0.30	225 V. RMS Per Plate, 60 Ma. DC Output, Condenser Input Filter.								
13	.....	4C	Duo Diode	F.W. Rect.	Fil.	5.0	.....	.....								80
14Z3	.....	4G	Diode	H.W. Rect.	Cath.	14.0	0.30	250 V. RMS Plate, 60 Ma. DC Output.								12Z3
15	ST-12	5F	Pentode	Amp.	Cath.	2.0	0.22	135	67.5	1.5	1.85	0.3	800,000	750	.....	
16, 16B	.....	4B	Diode	H.W. Rect.	Fil.	7.5	.....	.....								81
18	ST-14	6B	Pentode	Pwr. Amp.	Cath.	14.0	0.30	See Type 6F6G.								
19	ST-12 GT	6C	Duo Tri.	Pwr. Amp.	Fil.	2.0	0.26	135	.....	0	10.0	.....	10,000♠	.....	2,100	
						2.0	.....	135	.....	3.0	3.4	.....	10,000♠	.....	1,900	
						2.0	.....	135	.....	6.0	0.2	.....	10,000♠	.....	1,600	
20	T-8	4D	Triode	Pwr. Amp.	Fil.	3.3	0.132	90	.....	16.5	2.8	.....	9,600	3.5	50	
						135	.....	22.5	6.0	.....	6,500	3.5	130			
22	ST-14	4K	Tetrode	Amp.	Fil.	3.3	0.132	135	67.5	1.5	3.7	1.3	250,000	500	.....	
22AC	.....	5E	Tetrode	Amp.	Cath.	2.5	1.75	250	90	3.0	4.0	1.7	.....	1,050	.....	24A

① Load Resistance for Power Output Tubes.  
 ② Mutual Conductance for Tetrodes, Pentodes, Etc.  
 ▼ Conversion Conductance.

♠ Approximate.  
 ♠ Plate to Plate.  
 ♠ Through 20,000 Ohms.

♠ Per Tube or Section—No Signal.  
 § Plate and Target Supply.

## OBSOLETE AND SELDOM ENCOUNTERED TYPES—Cont.

Type	Construction		Class	Use	Emitter			Plate Volts	Screen Volts	Neg. Grid Volts	Plate Cur- rent Ma.	Screen Cur- rent Ma.	Plate ① Resistance Ohms	Amp. ② Factor	Power Output Mw.	Suggested Replacement Type	
	Style	Base Diag.			Type	Volts	Amp.										
24A, 24S	ST-14	5E	Tetrode	R.F. Amp.	Cath.	2.5 2.5	1.75 1.75	180 250	90 90	3.0 3.0	4.0 4.0	1.7 1.7	400,000 600,000	1,000 1,050	.....		
25, 25S	.....	6M	Duodi Tri.	Det. Amp.	Fil.	2.0	0.06	135	.....	3.0	1.0	.....	.....	20	.....	1B5/25S	
25A7GT	GT	8F	Di. Pent.	H.W. Rect. Pwr. Amp.	Cath.	25.0 25.0	0.30 0.30	117 100	A-C Volts 100	Per Plate 15.0	RMS, 75 Ma. 20.5	Output Current, 4.0	.....	4,500	1,800	770	
25AC5GT	GT	6Q	Triode	Pwr. Amp. Dyn. Coup. Amp.	Cath.	25.0 25.0	0.30 0.30	110 165	.....	+15 Bias from 6AE5GT Driver	45.0 46.0	.....	15,200 2,000	58 .....	2,000		
25B5	ST-12	6D	Duo Tri.	Pwr. Amp.	Cath.	25.0	0.30	See Type 25N6G.									
25B6G	ST-14	7S	Pentode	Pwr. Amp.	Cath.	25.0	0.30	105 200	105 135	16.0 23.0	48.0 62.0	2.0 1.8	1,700 2,500	4,800 5,000	2,400 7,100	25A6GT	
25B8	T-9	8T	Triode Pentode	Tri. Amp. Pent. Amp.	Cath. Cath.	25 .....	0.15 .....	100 100	..... 100	1.0 3.0	0.6 7.6	..... 2.0	75,000 185,000	112 370	.....		
25D8GT	.....	8AF	Di. Tri. Pent.	Det. Amp.	Cath.	25.0	0.15	100 100	..... 100	1.0 3.0	.5 8.5	..... 2.7	.....	100 1,900	(Tri.) (Pent.)	12AV6 and 12BD6	
25N6G	ST-12	7W	Duo Tri.	Pwr. Amp.	Cath.	25.0	0.30	110 180	110* 100*	0 0	45 46	7.0* 5.8*	2,000 4,000	.....	2,000 3,800		
25Y5	ST-12	6E	Duo Diode	Rect. Doub.	Cath.	25.0	0.30	117 V. RMS Per Plate, 75 Ma. DC Output, Per Plate. 235 V. RMS Plate, 75 Ma. DC Output Per Plate.								25Z5	
KR25	.....	6B	Pentode	Pwr. Amp.	Cath.	2.5	1.75	250	250	16.5	3.4	6.5	7,000	2,200	3,000	2A5	
26	ST-14	4D	Triode	Amp.	Fil.	1.5	1.05	90 180	..... .....	7.0 14.5	2.9 6.2	.....	8,900 7,300	8.3 8.3	.....		
26A6	T-5½	7BK	Pentode	R.F. Amp.	Cath.	26.5	0.07	26.5 250	26.5 250	..... .....	1.7 10.5	0.7 4.0	250,000 1,000,000	.....	.....		
26A7	T-9	8BU	Duo Pent.	Pwr. Amp.	Cath.	26.5	0.6	26.5	26.5	4.5	20	2.0	1,500	5,500*	200		
26C6	T-5½	7BT	Duodi, Tri.	Det. Amp.	Cath.	26.5	0.07	Same Characteristics as Type 7E6.									

- ① Load Resistance for Power Output Tubes.  
 ② Mutual Conductance for Tetrodes, Pentodes, Etc.  
 ▼ Conversion Conductance.

- ◆ Approximate.  
 † Plate to Plate.  
 ■ Through 1,000 Ohms.

- \*Screen Listings refer to Input Triode.  
 ‡ Per Tube or Section—No Signal.  
 § Plate and Target Supply.

## OBSOLETE AND SELDOM ENCOUNTERED TYPES—Cont.

Type	Construction		Class	Use	Emitter			Plate Volts	Screen Volts	Neg. Grid Volts	Plate Current Ma.	Screen Current Ma.	Plate Resistance Ohms	Amp. Factor	Power Output Mw.	Suggested Replacement Type		
	Style	Base Diag.			Type	Volts	Amp.											
26D6	T-5½	7CH	Heptode	Converter	Cath.	26.5	0.07	26.5 100 250	26.5 100 100	0.5 1.5 1.5	0.45 2.8 3.0	1.6 8.0 7.8	..... 500,000 1,000,000	270 455 475	.....			
27, 27S	ST-12	5A	Triode	Amp.	Cath.	2.5	1.75	90	.....	6.0	3.0	.....	10,000	9.0	.....			
						2.5	1.75	135	.....	9.0	4.7	.....	9,000	9.0	.....			
						2.5	1.75	180	.....	13.5	5.0	.....	9,000	9.0	.....			
						2.5	1.75	250	.....	21.0	5.2	.....	9,250	9.0	.....			
						2.5	1.75	250	.....	30.0*	Adjust Bias for 0.2 Ma. Plate Current Without Signal.							
27HM	.....	5A	Triode	Amp.	Cath.	2.5	1.75	180	.....	13.5	5.0	.....	9,600	13	.....	56		
28Z5	Lock-In	6BJ	Double Diode	F.W. Rect.	Cath.	28.0	0.24	325	A-C Volts Per Plate, RMS, 100 Ma. Output Current, Condenser Input to Filter.									
						28.0	0.24	450	A-C Volts Per Plate, RMS, 100 Ma. Output Current, 6h Choke Input to Filter.									
KR28	.....	5D	Duo Diode	F.W. Rect.	Cath.	6.3	0.50	350 V. RMS, 50 Ma. DC Output.										84, 6Z4
30	ST-12	4D	Triode	Amp.	Fil.	2.0	0.06	90	.....	4.5	2.5	.....	11,000	9.3	.....			
						2.0	0.06	135	.....	9.0	3.0	.....	10,300	9.3	.....			
						2.0	0.06	180	.....	13.5	3.1	.....	10,300	9.3	.....			
31	ST-12	4D	Triode	Pwr. Amp.	Fil.	2.0	0.13	135	.....	22.5	8.0	.....	7,000	3.8	185			
						2.0	0.13	180	.....	30.0	12.3	.....	5,700	3.8	375			
32	ST-14	4K	Tetrode	R.F. Amp.	Fil.	2.0	0.06	135	67.5	3.0	1.7	0.4	950,000	640	.....			
						2.0	0.06	180	67.5	3.0	1.7	0.4	1.2 Meg.	650	.....			
						2.0	0.06	180	67.5	6.0*	Adjust Bias for 0.2 Ma. Plate Current Without Signal.							
32L7GT	GT	8Z	Diode Beam Amplifier	Rectifier	Cath.	32.5	0.30	125 RMS Volts Per Plate, 60 Ma. Output Current, Condenser Input to Filter.										
						.....	32.5	0.30	110	110	7.5	40.0	3.0	2,600	6,000	1,000		
33	ST-14	5K	Pentode	Pwr. Amp.	Fil.	2.0	0.26	135	135	13.5	14.5	3.0	7,000	1,450	700			
						2.0	0.26	180	180	18.0	22.0	5.0	6,000	1,700	1,400			
34	ST-14	4M	Pentode	R.F. Amp.	Fil.	2.0	0.06	67.5	67.5	3.0	2.7	1.1	400,000	560	.....			
						2.0	0.06	135	67.5	3.0	2.8	1.0	600,000	600	.....			
						2.0	0.06	180	67.5	3.0	2.8	1.0	1 Meg.	620	.....			
35/51, 35S/51S	ST-14	5E	Tetrode	R.F. Amp.	Cath.	2.5	1.75	180	90	3.0	6.3	2.5	300,000	1,020	.....			
						2.5	1.75	250	90	3.0	6.5	2.5	400,000	1,050	.....			

① Load Resistance for Power Output Tubes.

② Mutual Conductance for Tetrodes, Pentodes, Etc.

▼ Conversion Conductance.

◆ Approximate.

♠ Plate to Plate.

♣ Through 20,000 Ohms.

\* Per Tube or Section—No Signal.

§ Plate and Target Supply.

# OBSOLETE AND SELDOM ENCOUNTERED TYPES—Cont.

Type	Construction		Class	Use	Emitter			Plate Volts	Screen Volts	Neg. Grid Volts	Plate Current Ma.	Screen Current Ma.	Plate ① Resistance Ohms	Amp. ② Factor	Power Output Mw.	Suggested Replacement Type
	Style	Base Diag.			Type	Volts	Amp.									
35A5LT	T-9	5AA	Beam Pwr.	Amp.	Cath.	35.0	0.15	110	110	7.5	40	3.0	2,500	5,800	1,500	35A5
35Z3LT	T-9	4Z	Diode	H.W. Rect.	Cath.	35.0	0.15	235 V. RMS Plate, 100 Ma. DC Output.								35Z3
35Z6G	ST-14	7Q	Duo Diode	Doub. Rect.	Cath.	35.0	0.30	117 V. RMS Plate, 110 Ma. DC Output.								
36, 36A	ST-12	5E	Tetrode	R.F. Amp.	Cath.	6.3	0.30	100	55	1.5	1.8	Not	550,000	850	.....	.....
						6.3	0.30	135	67.5	1.5	2.8	over 1/2	475,000	1,000		
						6.3	0.30	180	90	3.0	3.1	Plate	500,000	1,050		
						6.3	0.30	250	90	3.0	3.2	Cur.	550,000	1,080		
						6.3	0.30	250	20 to 25	6.0*	Adjust Bias for .1 Ma. Plate Current Without Signal.					
37, 37A	ST-12	5A	Triode	Amp.	Cath.	6.3	0.30	90	.....	6.0	2.5	.....	11,500	9.2	.....	.....
						6.3	0.30	135	.....	9.0	4.1	.....	10,000	9.2		
						6.3	0.30	180	.....	13.5	4.3	.....	10,200	9.2		
						6.3	0.30	250	.....	18.0	7.5	.....	8,400	9.2		
38, 38A	ST-12	5F	Pentode	Pwr. Amp.	Cath.	6.3	0.30	100	100	9.0	7.0	1.2	15,000	875	270	.....
						6.3	0.30	135	135	13.5	9.0	1.5	13,500	925	550	
						6.3	0.30	180	180	18.0	14.0	2.4	11,600	1,050	1,000	
						6.3	0.30	250	250	25.0	22.0	3.8	10,000	1,200	2,500	
39, 39/44, 39A	ST-12	5F	Pentode	R.F. Amp.	Cath.	6.3	0.30	90	90	3.0	5.6	1.6	375,000	960	.....	.....
						6.3	0.30	180	90	3.0	5.8	1.4	750,000	1,000	.....	
						6.3	0.30	250	90	3.0	5.8	1.4	1 Meg.	1,050	.....	
40	ST-14	4D	Triode	Amp.	Fil.	5.0	0.25	135	.....	1.5	0.2	.....	150,000	30	.....	.....
40Z5/45Z5GT	GT	6AD	Diode	H.W. Rect.	Cath.	45	0.15	Characteristics same as Type 35Y4.								.....
41	ST-12	6B	Pentode	Pwr. Amp.	Cath.	6.3	0.40	Characteristics same as Type 6K6GT and 7B5.								.....
42	ST-14	6B	Pentode	Pwr. Amp.	Cath.	6.3	0.65	Characteristics same as Type 6F6G.								.....
43	ST-14	6B	Pentode	Pwr. Amp.	Cath.	25.0	0.30	Characteristics same as Type 25A6GT.								.....
44	.....	5F	Pentode	Amp.	Cath.	6.3	0.30	See Type 39 or 39/44.								39/44
45	ST-14	4D	Triode	Pwr. Amp.	Fil.	2.5	1.5	180	.....	31.5	31.0	.....	2,700	3.5	830	.....
						2.5	1.5	250	.....	50.0	34.0	.....	3,900	3.5	1,600	
						2.5	1.5	275	.....	56.0	36.0	.....	4,600	3.5	2,000	
45A	.....	4D	Triode	Pwr. Amp.	Fil.	2.5	1.50	325	.....	68	43	.....	3,200	3.5	3,000	45

① Load Resistance for Power Output Tubes.  
 ② Mutual Conductance for Tetrodes, Pentodes, Etc.  
 ▼ Conversion Conductance.

◆ Approximate.  
 † Plate to Plate.  
 \* Through 20,000 Ohms.

‡ Per Tube or Section—No Signal.  
 § Plate and Target Supply.



## OBSOLETE AND SELDOM ENCOUNTERED TYPES—Cont.

Type	Construction		Class	Use	Emitter			Plate Volts	Screen Volts	Neg. Grid Volts	Plate Current Ma.	Screen Current Ma.	Plate Resistance Ohms	Amp. Factor	Power Output Mw.	Suggested Replacement Type
	Style	Base Diag.			Type	Volts	Amp.									
46	ST-16	5C	Dual Grid Triode	Pwr. Amp.	Fil.	2.5	1.75	250	Tie Gs to P	33.0	22.0	....	6,400	5.6	1,250	
				(Class B)	.....	2.5	1.75	300	Tie Gs to G	0	150 Peak per tube	5,200	2 Tubes	16,000		
				(Class B)	.....	2.5	1.75	400	Tie Gs to G	0	200 Peak per tube	5,800	2 Tubes	20,000		
47	ST-16	5B	Pentode	Pwr. Amp.	Fil.	2.5	1.75	250	250	16.5	31.0	6.0	7,000	2,500	2,700	2A5
48	ST-16	6A	Tetrode	Pwr. Amp.	Cath.	30.	0.40	95 125	95 100	20.0 22.5	52 52	12.0 12.0	1,500 1,500	3,900 3,900	2,000 3,000	
49	ST-14	5C	Dual Grid Tri.	Class A Amp. Class B Amp.	Fil.	2.0	0.12	135 180	Gs to P Gs to G	20 0	6.0 4.0	.... 2 tubes	11,000 12,000	4.7 ....	170 3,500	
50	ST-16	4D	Triode	Pwr. Amp.	Fil.	7.5	1.25	300	....	54.0	35.0	....	4,600	3.8	1,600	
						7.5	1.25	350	....	63.0	45.0	....	4,100	3.8	2,400	
						7.5	1.25	400	....	70.0	55.0	....	3,670	3.8	3,400	
						7.5	1.25	450	....	84.0	55.0	....	4,350	3.8	4,600	
50Z7G	ST-12	8AN	Duo Diode	F.W. Rect.	Cath.	50	0.15	117 V. RMS Per Plate, 65 Ma. DC Output.								
EF50	Lock-In	9C	Pentode	R.F. Amp.	Cath.	6.3	0.3	250	250	....	10	3.1	600,000	....	....	
HZ50	.....	4G	Diode	H.W. Rect.	Cath.	12.6	0.30	250 V. RMS Plate, 60 Ma. DC Output.								12Z3
51, 51S	ST-14	5E	Tetrode	Amp.	Cath.	2.5	1.75	See Type 35, 35/51.								35
52	ST-14	5C	Dual Grid Tri.	Class A Amp. Class B Amp.	Fil.	6.3	0.30	110	....	0	43	....	2,000	5.2	1,500	6A4/LA
						....	....	180	2 Tube	0	3.0	....	10,000	....	5,000	
53	ST-14	7B	Duo. Tri.	Pwr. Amp.	Cath.	2.5	2.0	Characteristics same as Type 6N7GT.								
55	ST-12	6G	Duodi Tri.	Det. Amp.	Cath.	2.5	1.0	Characteristics same as Type 6V7G.								
55S	ST-12	6G	Duodi Tri.	Det. Amp.	Cath.	2.5	1.00	250	....	20	8.0	....	7,500	8.3	350	55
56, 56S	ST-12	5A	Triode	Amp. Det.	Cath.	2.5	1.0	250	....	13.5	5.0	....	9,500	13.8	....	
						....	2.5	1.0	250	....	20.0	♦	Adjust Bias for 0.2 Ma. Plate Current Without Signal.			
56AS	ST-12	5A	Triode	Amp.	Cath.	6.3	0.40	250	....	13.5	5.0	....	9,500	13.8	....	76

① Load Resistance for Power Output Tubes.

② Mutual Conductance for Tetrodes, Pentodes, Etc.

▼ Conversion Conductance.

♦ Approximate.

‡ Plate to Plate.

■ Through 20,000 Ohms.

\* Per Tube or Section—No Signal.

‡ Plate and Target Supply.

## OBSOLETE AND SELDOM ENCOUNTERED TYPES—Cont.

Type	Construction		Class	Use	Emitter			Plate Volts	Screen Volts	Neg. Grid Volts	Plate Current Ma.	Screen Current Ma.	Plate <sup>①</sup> Resistance Ohms	Amp. <sup>②</sup> Factor	Power Output Mw.	Suggested Replacement Type
	Style	Base Diag.			Type	Volts	Amp.									
57, 57S	ST-12	6F	Pentode	Amp. Det.	Cath. .....	2.5 2.5 2.5	1.0 1.0 1.0	100 250 250†	100 100 100	3.0 3.0 4.3*	2.0 2.0	0.5 0.5	1 Meg. 1 Meg.	1,185 1,225	..... .....	..... .....
													Adjust Bias for 0.1 Ma Plate Current Without Signal.			
57AS	ST-12	6F	Pentode	Amp.	Cath.	6.3	0.40	250	100	3.0	2.0	0.5	1 Meg.	1,225	.....	6C6
58, 58S	ST-12	6F	Pentode	Amp.	Cath.	2.5 2.5	1.0 1.0	100 250	100 100	3.0 3.0	8.0 8.2	2.2 2.0	250,000 800,000	1,500 1,600	..... .....	.....
58AS	ST-12	6F	Pentode	Amp.	Cath.	6.3	0.40	250	100	3.0	8.2	2.0	800,000	1,600	.....	6D6-78
59	ST-16	7A	Pentode	Pwr. Amp. Triode  Triode— Class B Triode— Class B	Cath. ..... ..... .....	2.5 2.5 2.5 2.5	2.0 2.0 2.0 2.0	250 250 300 400	250 Tie Gs to P Tie Gs to G and Su to P	18.0 28.0 0 0	35.0 26.0 10.0% 13.0%	9.0 ..... ..... .....	6,000 5,000 4,600‡ 6,000‡	2,500 2,600 ..... .....	3,000 1,250 15,000 (2 tubes) 20,000 (2 tubes)	.....
59B	.....	7M	Pentode	Pwr. Amp.	Fil.	2.5	2.0	250	250	18.0	35.0	9.0	6,000	.....	3,000	(See Type 59)
64, 64A	.....	5E	Tetrode	Amp.	Cath.	6.3	0.40	180	90	3.0	3.1	1.5	500,000	1,050	.....	36
65, 65A	.....	5E	Tetrode	Amp.	Cath.	6.3	0.40	180	90	3.0	4.5	1.3	750,000	1,000	.....	39/44
67, 67A	.....	5A	Triode	Det. Amp.	Cath.	6.3	0.40	180	.....	13.5	4.3	.....	10,200	9.2	.....	37
68, 68A	.....	5E	Pentode	Pwr. Amp.	Cath.	6.3	0.40	135	90	13.5	14	3.0	7,500	1,400	650	38
70A7GT	T-9	8AB	Di. Beam Amp.	H.W. Rect. Pwr. Amp.	Cath. .....	70.0 .....	0.15 .....	125 V. RMS 110	110	Plate, 7.5	60 Ma. 40	Output, 3.0	2,500	5,800	1,500	70L7GT
71	ST-14	4D	Triode	Pwr. Amp.	Fil.	5.0	0.50	180	.....	40.5	20	.....	4,800	3	790	71A
71A	ST-14	4D	Triode	Pwr. Amp.	Fil.	5.0 5.0 5.0	0.25 0.25 0.25	90 135 180	..... ..... .....	16.5 27.0 40.5	10.0 17.3 20.0	..... ..... .....	3,000 3,000 4,800	3 3 3	125 400 790	.....
71B	ST-14	4D	Triode	Pwr. Amp.	Cath.	5.0	0.125	180	.....	40.5	20	.....	4,800	3	790	71A

① Load Resistance for Power Output Tubes.

② Mutual Conductance for Tetrodes, Pentodes, Etc.

▼ Conversion Conductance.

◆ Approximate.

‡ Plate to Plate.

▪ Through 20,000 Ohms.

† Applied through 250,000 Ohms.

§ Per Tube or Section—No Signal.

‡ Plate and Target Supply.

## OBSOLETE AND SELDOM ENCOUNTERED TYPES—Cont.

Type	Construction		Class	Use	Emitter			Plate Volts	Screen Volts	Neg. Grid Volts	Plate Current Ma.	Screen Current Ma.	Plate Resistance Ohms	Amp. Factor	Power Output Mw.	Suggested Replacement Type	
	Style	Base Diag.			Type	Volts	Amp.										
75, 75S	ST-12	6G	Duodi Tri.	Det. Amp.	Cath.	6.3	0.30	250	....	2.0	0.9	....	91,000	100	....		
76	ST-12	5A	Triode	Amp.	Cath.	6.3	0.30	100	....	5.0	2.5	....	12,000	13.8	....		
						6.3	0.30	250	....	13.5	5.0	....	9,500	13.8	....		
						6.3	0.30	250	....	20.0*	Adjust Bias for 0.2 Ma. Plate Current Without Signal.						
77	ST-12	6F	Pentode	Amp.	Cath.	6.3	0.30	100	60	1.5	1.7	0.4	600,000*	1,100	....		
						6.3	0.30	250	100	3.0	2.3	0.5	>1.0 Meg.	1,250	....		
78	ST-12	6F	Pentode	Amp.	Cath.	6.3	0.30	90	90	3.0	5.4	1.3	300,000	1,275	....		
						6.3	0.30	180	75	3.0	4.0	1.0	1 Meg.	1,100	....		
						6.3	0.30	250	100	3.0	7.0	1.7	800,000	1,450	....		
						6.3	0.30	250	125	3.0	10.5	2.6	600,000	1,650	....		
79	ST-12	6H	Duo Tri.	Pwr. Amp.	Cath.	6.3	0.60	250	Class B	0	21.0	Both Triodes	14,000‡	....	8,000	6N7	
80M	....	4C	Duo Di. M.V.	F.W. Rect.	Fil.	5.0	2.00	450 V. RMS Per Plate, 125 Ma. DC Output.								80	
81, 81M	ST-16	4B	Diode	H.W. Rect.	Fil.	7.5	1.25	700 A-C Volts Per Plate, RMS, 85 Ma. Output Current. Condenser Input to Filter.									
82V	....	....	....	....	....	....	....	....								82	
84/6Z4	ST-12	5D	Duodiode	F.W. Rect.	Cath.	6.3	0.50	325	A-C Volts Per Plate, RMS, 60 Ma. Output Current. Condenser Input to Filter.								
						6.3	0.50	450	A-C Volts Per Plate, RMS, 60 Ma. Output Current. 10h Choke Input to Filter.								
G84	....	4B	Diode	H.W. Rect.	Fil.	2.5	1.50	350 V. RMS Plate, 50 Ma. DC Output.								2Z2/G84	
G84/2Z2	....	4B	Diode	H.W. Rect.	Fil.	2.5	1.50	350 V. RMS Plate, 50 Ma. DC Output.								2A6	
85	ST-12	6G	Duodi Tri.	Det. Amp.	Cath.	6.3	0.30	Characteristics same as Type 6V7G.								6V7G	
85AS	ST-12	6G	Duodi Tri.	Det. Amp.	Cath.	6.3	0.30	250	....	9.0	4.5	....	16,000	20	....	85	
88	....	4C	Duo Diode	F.W. Rect.	Fil.	5.0	2.00	450 V. RMS Per Plate, 125 Ma. DC Output.								83V	
89	ST-12	6F	Pwr. Amp. Triode	Triode Class B	Cath.	6.3	0.40	180	180	18.0	20.0	3.0	8,000	1,550	1,500		
						6.3	0.40	180	Gs+Su to P	20.0	17.0	....	7,000	4.7	300		
						6.3	0.40	180	Tie Su to P	0	3.0	....	9,400‡	Tie Gs to G	3,500 (2 tubes)		
89Y	....	....	....	....	....	....	Same as Type 89. Has low-loss base.										

① Load Resistance for Power Output Tubes.  
 ② Mutual Conductance for Tetrodes, Pentodes, Etc.  
 † Conversion Conductance.

♦ Approximate.  
 ‡ Plate to Plate.  
 \* Through 20,000 Ohms.

‡ Per Tube or Section—No Signal.  
 § Plate and Target Supply.

## OBSOLETE AND SELDOM ENCOUNTERED TYPES—Cont.

Type	Construction		Class	Use	Emitter			Plate Volts	Screen Volts	Neg. Grid Volts	Plate Current Ma.	Screen Current Ma.	Plate ① Resistance Ohms	Amp. ② Factor	Power Output Mw.	Suggested Replacement Type	
	Style	Base Diag.			Type	Volts	Amp.										
VR90/30	ST-12	4AJ	Diode	Voltage Reg.	Cold K	....	....	See Type OB3.								OB3	
95	.....	6B	Pentode	Pwr. Amp.	Cath.	2.5	1.75	315	315	22.0	42	8.0	7,000	2,300	5,000	2A5	
96	.....	4G	Diode	H.W. Rect.	Cath.	10.0	0.50	350 V. RMS Plate, 100 Ma. DC Output.							1V		
98	.....	.....	.....	.....	.....	.....	.....	.....	.....	.....	.....	.....	.....	.....	.....	84	
V99	T-8	4E	Triode	Det. Amp.	Fil.	3.3	.063	90	.....	4.5	2.5	.....	15,500	6.6	.....		
X99	T-9	4D	Triode	Det. Amp.	Fil.	3.3	.063	Same as V99.									
VR105/30	ST-12	4AJ	Diode	Voltage Reg.	Cold K	.....	.....	See Type OC3.								OC3	
117P7GT	GT	8AV	Diode Beam Amp.	H.W. Rect. Pwr. Amp.	Cath.	117.0	0.09	117 V. RMS Plate, 105   105		75 Ma. DC Output. 43   4.0		4,000	5,300	850			
117Z4GT	GT	5AA	Diode	H.W. Rect.	Cath.	117	0.04	117 V. RMS Plate, 90 Ma. DC Output.									
143D	.....	.....	Diode	H.W. Rect.	.....	.....	.....	.....	.....	.....	.....	.....	.....	.....	.....	2X2	
VR150/30	ST-12	4AJ	Diode	Voltage Reg.	Cold K	.....	.....	See Type OD3.								OD3	
182B/482B	ST-14	4D	Triode	Pwr. Amp.	Fil.	5.0	1.25	250	.....	35.0	20	.....	4,500	5.0	1,350	71A or 45	
183/483	ST-14	4D	Triode	Pwr. Amp.	Fil.	5.0	1.25	250	.....	65.0	20	.....	4,500	3.0	1,800	71A or 45	
210T	ST-16	4D	Triode	Pwr. Amp.	Fil.	7.5	1.25	Standard Type 10 with Ceramic Base, See Type 10 Characteristics.									
288	.....	.....	.....	.....	.....	.....	.....	.....	.....	.....	.....	.....	.....	.....	.....	83V	
401	.....	4D	Triode	Det. Amp.	Cath.	3.0	1.35	90	.....	3.0	5.0	.....	9,500	9.5	.....	27	
482A	.....	4D	Triode	Pwr. Amp.	Fil.	5.0	0.80	200	.....	45.0	18	.....	4,500	2.0	1,500	71A	
482B	.....	4D	Triode	Pwr. Amp.	Fil.	5.0	1.25	250	.....	35.0	18	.....	4,500	5.0	1,500	182B/482B	
483	.....	4D	Triode	Pwr. Amp.	Fil.	5.0	1.25	250	.....	65.0	20	.....	4,500	3.0	2,000	183/483	
484	.....	5A	Triode	Det. Amp.	Cath.	2.8	1.60	180	.....	9.0	6.0	.....	9,300	12.5	.....	485	
485	ST-12	5A	Triode	Det. Amp.	Cath.	3.0	1.25	180	.....	9.0	5.8	.....	8,900	12.5	.....	27	
585	.....	4D	Triode	Pwr. Amp.	Fil.	7.5	1.25	450	.....	84.0	55	.....	4,350	3.8	4,600	50	

① Load Resistance for Power Output Tubes.  
 ② Mutual Conductance for Tetrodes, Pentodes, Etc.  
 ▼ Conversion Conductance.

◆ Approximate.  
 † Plate to Plate.  
 ‡ Through 20,000 Ohms.

\* Per Tube or Section—No Signal.  
 † Plate and Target Supply.

## OBSOLETE AND SELDOM ENCOUNTERED TYPES—Cont.

Type	Construction		Class	Use	Emitter			Plate Volts	Screen Volts	Neg. Grid Volts	Plate Current Ma.	Screen Current Ma.	Plate ① Resistance Ohms	Amp. ② Factor	Power Output Mw.	Suggested Replacement Type
	Style	Base Diag.			Type	Volts	Amp									
586	.....	4D	Triode	Pwr. Amp.	Fil.	7.5	1.25	450	.....	84.0	55	.....	4,350	3.8	4,600	50
P861	.....	5D	Duo Diode	F.W. Rect.	Cath.	6.3	0.50	225 V. RMS Per Plate, 50 Ma. DC Output.			.....	.....	.....	.....	84	
864	T-9	4D	Triode	Amp.	Fil.	1.1	0.25	90 135	.....	4.5 9.0	2.9 3.5	.....	13,500 12,700	8.2 8.2	.....	.....
879	ST-12	4AB	Diode	H.W. Rect.	Cath.	2.5	1.75	Now known as 2X2A.			.....	.....	.....	.....	2X2A	
950	.....	5K	Pentode	Pwr. Amp.	Fil.	2.0	0.125	135	135	16.5	5.5	2.0	13,500	950	575	33
951	.....	4K	Tetrode	Amp.	Fil.	2.0	0.60	180	67.5	3.0	1.7	0.4	1.2 Meg.	650	.....	1B4P
1201	Lock In	8BN	Triode	Osc. Amp.	Cath.	6.3	0.15	See Type 7E5.			.....	.....	.....	.....	.....	
1203A	Lock In	4AH	H.F. Diode	Det.	Cath.	6.3	0.15	See Type 7C4.			.....	.....	.....	.....	.....	
1204	Lock In	8BO	Pentode	Amp.	Cath.	6.3	0.15	See Type 7AB7.			.....	.....	.....	.....	.....	
1206	Lock In	8BV	Duo Tetrode	R.F. Amp.	Cath.	6.3	0.30	See Type 7G8.			.....	.....	.....	.....	.....	
1221	ST-12	6F	Pentode	Amp.	Cath.	6.3	0.30	Non Microphonic, See 6C6.			.....	.....	.....	.....	.....	
1223	ST-12	7R	Pentode	Amp.	Cath.	6.3	0.30	Non Microphonic, See 6C6.			.....	.....	.....	.....	.....	
1229	ST-12	4K	Tetrode	.....	Fil.	2.0	0.06	Special Type 32. Made for Low Grid Current Applications.			.....	.....	.....	.....	.....	
1231	Lock In	8V	Pentode	Amp.	Cath.	6.3	0.45	300	150	200 Ohms	10.0	2.5	700,000	5,500	(Cath. Resistor)	.....
1232	Lock In	8V	Pentode	Amp.	Cath.	6.3	0.45	See Type 7G7.			.....	.....	.....	.....	.....	
1265	ST-12	4AJ	Diode	Voltage Reg.	Cold K	.....	.....	Starting Voltage=135, Operating Voltage=90, Operating Current=5 to 30 Ma.			.....	.....	.....	.....	.....	
1266	T-9	4AJ	Diode	Voltage Reg.	Cold K	.....	.....	Similar to Type OB3/VR-90-30, Except Regulating at 70 Volts.			.....	.....	.....	.....	.....	
1267	T-9	4V	Gas Triode	Relay Tube	Cold K	.....	.....	Similar to Type OA4G.			.....	.....	.....	.....	OA4G	
1275	ST-16	4C	Duodiode	Rect.	Fil.	5.0	1.75	Similar to Type 5Z3.			.....	.....	.....	.....	.....	
1276	ST-16	4D	Triode	Amp.	Fil.	4.5	1.14	Similar to Type 6B4G.			.....	.....	.....	.....	.....	
1291	Lock In	7BE	Duo Triode	Osc. Amp.	Fil.	1.4 2.8	.220 .110	See Type 3B7.			.....	.....	.....	.....	.....	

① Load Resistance for Power Output Tubes.  
 ② Mutual Conductance for Tetrodes, Pentodes, Etc.  
 ▼ Conversion Conductance.

♦ Approximate.  
 † Plate to Plate  
 ■ Through 20,000 Ohms.

# Per Tube or Section—No Signal.  
 § Plate and Target Supply.

# OBSOLETE AND SELDOM ENCOUNTERED TYPES—Cont.

Type	Construction		Class	Use	Emitter			Plate Volts	Screen Volts	Neg. Grid Volts	Plate Current Ma.	Screen Current Ma.	Plate ① Resistance Ohms	Amp. ② Factor	Power Output Mw.	Suggested Replacement Type	
	Style	Base Diag.			Type	Volts	Amp.										
1293	T-9	4AA	Triode	Oscillator	Fil.	1.4 1.4	0.11 0.11	90 90	.....	0 20	5.2 13.25	(120 Mc. Oscillator, Rg=10,000 Ohms)	15				
1294	Lock In	4AH	H.F. Diode	Det.	Cath.	1.4	.150	See Type 1R4.									
1299	Lock In	6BA	Beam Amp.	Pwr. Amp.	Fil.	1.4 2.8	.220 .110	See Type 3D6.									
1612	Metal	7T	Heptode	Mixer Amp.	Cath.	6.3	0.30	Non Microphonic, See 6L7.									
1626	ST-12	6Q	Triode	Osc. Amp.	Cath.	12.6	0.25	250	.....	.....	25 max.....	.....	5	4,000			
1629	T-9	7AL	Electron Ray	Indicator	Cath.	12.6	0.15	Same as Type 6E5.									
9001	T-5½	7BD	Pentode	Det. Amp.	Cath.	6.3	0.15	90 250	90 100	3 3	1.2 2.0	0.5 0.7	1,000,000 1 Meg. Min	..... 1,400	.....		
9002	Min.	7BS	Triode	Amp.	Cath.	6.3	0.15	250	.....	7.0	6.3	.....	11,400	25	.....		
9003	Min.	7BD	Pentode	R.F. Amp.	Cath.	6.3	0.15	250	100	3.0	6.7	2.7	700,000	1,800	.....		
9006	T-5½	6BH	UHF Diode	Rect.	Cath.	6.3	0.15	270 V. RMS Plate, 5 Ma. DC Output.									
AD	.....	4G	Diode	H.W. Rect.	Cath.	6.3	0.30	350 V. RMS Plate, 50 Ma. DC Output.									1V
AF	.....	4C	Duo Diode	F.W. Rect.	Fil.	2.5	3.00	500 V. RMS Per Plate, 125 Ma. DC Output.									82
AG	.....	4C	Duo Diode	F.W. Rect.	Fil.	5.0	3.00	500 V. RMS Per Plate, 250 Ma. DC Output.									83
AX	.....	4D	Triode	Det. Amp.	Fil.	5.0	0.25	135	.....	9.0	.....	.....	20,000	8	55	01A	
B	.....	4E	Triode	Det. Amp.	Fil.	3.3	0.063	90	.....	4.5	2.5	.....	15,500	6.6	.....	V99	
BA	.....	4J	Duo Diode	F.W. Rect.	Cold K	.....	.....	350 V. RMS Per Plate, 350 Ma. DC Output.									
BH	.....	4J	Duo Diode	F.W. Rect.	Cold K	.....	.....	350 V. RMS Per Plate, 125 Ma. DC Output.									0Z4
BR	.....	4H	Diode	H.W. Rect.	Cold K	.....	.....	300 V. RMS Plate, 50 Ma. DC Output.									0Z4
D½	.....	4B	Diode	H.W. Rect.	Fil.	7.5	1.25	700 V. RMS Plate, 85 Ma. DC Output.									81
D1	.....	4C	Duo Diode	F.W. Rect.	Fil.	5.0	2.00	350 V. RMS Per Plate, 125 Ma. DC Output.									80
DE1	.....	5A	Triode	Det. Amp.	Cath.	2.5	1.75	250	.....	21.0	5.2	.....	34,000	9	300	27	
E	.....	4D	Triode	Pwr. Amp.	Fil.	3.3	0.132	135	.....	22.5	6.5	.....	6,500	3.3	110	20	
G	.....	4D	Triode	Amp.	Fil.	5.0	0.25	180	.....	3.0	0.2	.....	150,000	30	.....	40	

① Load Resistance for Power Output Tubes.

② Mutual Conductance for Tetrodes, Pentodes, Etc.

▼ Conversion Conductance.

◆ Approximate.

♣ Plate to Plate.

♠ Through 20,000 Ohms.

\* Per Tube or Section—No Signal.

‡ Plate and Target Supply.

## OBSOLETE AND SELDOM ENCOUNTERED TYPES—Cont.

Type	Construction		Class	Use	Emitter			Plate Volts	Screen Volts	Neg. Grid Volts	Plate Cur- rent Ma.	Screen Cur- rent Ma.	Plate ① Resistance Ohms	Amp. ② Factor	Power Output Mw.	Suggested Replacement Type
	Style	Base Diag.			Type	Volts	Amp.									
H	.....	4D	Triode	Det. Amp.	Fil.	5.0	0.25	45	.....	0	1.5	.....	31,500	20	.....	01A
H2-10	.....	4AB	.....	.....	.....	.....	.....	.....	.....	.....	.....	.....	.....	.....	.....	2X2/879
LA	.....	5B	Pentode	Pwr. Amp.	Fil.	6.3	0.30	180	180	12.0	22	3.9	8,000	2,200	1,400	6A4
PZ	.....	5B	Pentode	Pwr. Amp.	Fil.	2.5	1.75	250	250	16.5	31	6.0	7,000	2,500	2,700	47
PZH	.....	6B	Pentode	Pwr. Amp.	Cath.	2.5	1.75	250	250	16.5	34	6.5	7,000	2,200	3,000	2A5
RE1	.....	.....	.....	.....	.....	.....	.....	.....	.....	.....	.....	.....	.....	.....	.....	80
RE2	.....	.....	.....	.....	.....	.....	.....	.....	.....	.....	.....	.....	.....	.....	.....	81
S02	.....	.....	.....	.....	.....	.....	.....	.....	.....	.....	.....	.....	.....	.....	.....	50
Wunderlich A Auto	.....	6N	Dual Grid	Det.	Cath.	6.3	0.40	250	.....	16.5	7.0	.....	10,200	9.2	.....	
Wunderlich A	.....	5H 6N	Dual Grid	Det.	Cath.	2.5	1.00	250	.....	16.5	7.0	.....	10,200	9.2	.....	
Wunderlich B	.....	6P	Special	Det.	Cath.	2.5	1.00	250	.....	.....	17.0	.....	.....	.....	.....	
X6030	Lock In	X6030	Diode	Noise Diode	Fil.	3.0m	0.6	90 250 1400	.....	.....	4.0 3.0 0.535	.....	.....	.....	.....	.....
XXB	Lock In	7BW	Duo Triode	Amp.	Fil.	1.4	0.10	90	.....	0	4.5	.....	11,200	14.5	.....	
XXD	Lock In	8AC	Duo Triode	Amp.	Cath.	12.6	0.15	See Type 14AF7/XXD.								
XXFM	Lock In	8BZ	Duodi Tri.	Det. Amp.	Cath.	6.3	0.30	See Type 7X7.								
XXL	Lock In	5AC	Triode	Amp.	Cath.	6.3	0.30	100 250	..... .....	0 8.0	10.0 8.0	..... .....	7,000 8,700	25 20	..... .....	7A4

① Load Resistance for Power Output Tubes.

② Mutual Conductance for Tetrodes, Pentodes, Etc.

▼ Conversion Conductance.

◆ Approximate.

♠ Plate to Plate.

♣ Through 20,000 Ohms

\* Per Tube or Section—No Signal.

§ Plate and Target Supply.

# BASE DIAGRAMS FOR SELDOM ENCOUNTERED TYPES

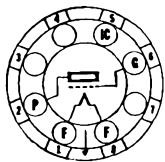

4AA

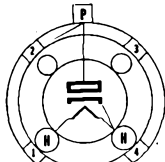

4AB

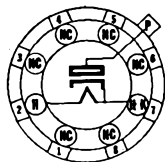

4AC

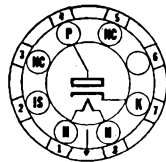

4AH



4AJ

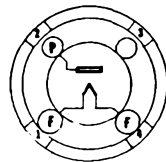

4B

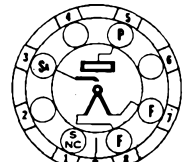

4BU

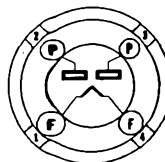

4C



4D

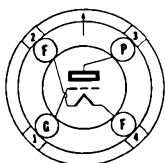

4E

## 4F

- 1 F
- 2 P
- 3 F
- 4 G

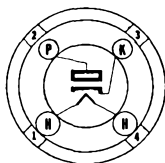

4G

## 4H

- 1 K
- 2 J
- 3 J
- 4 A

## 4J

- 1 A1
- 2 K
- 3 NC
- 4 A2

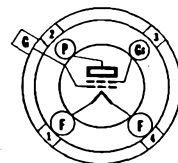

4K



4M

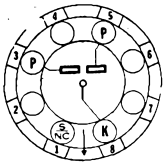

4R

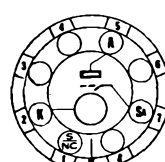

4V

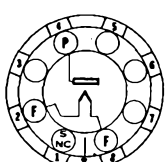

4X

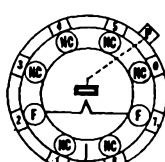

4Y

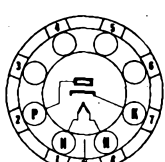

4Z

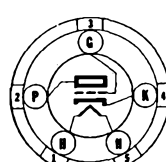

5A

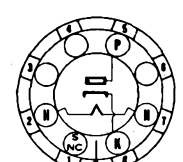

5AA



5AC



## BASE DIAGRAMS FOR SELDOM ENCOUNTERED TYPES—Cont.

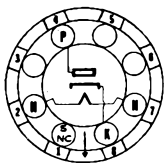

5AF

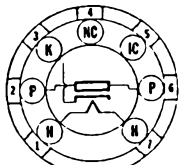

5AP

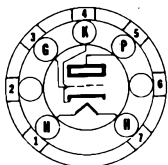

5AS

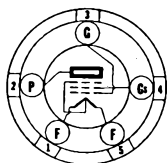

5B

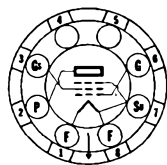

5BF

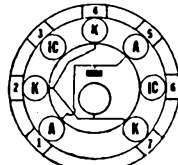

5BO

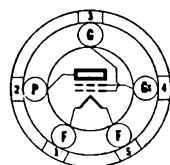

5C

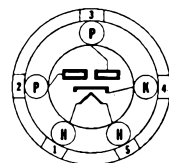

5D

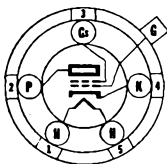

5E

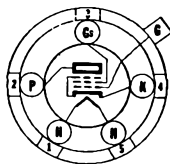

5F

### 5H

- 1 H
- 2 G
- 3 P
- 4 G
- 5 H
- Cap K

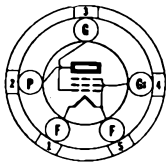

5K

### 5N

- 1 J
- 2 A
- 3 A
- 4 K
- 5 J



5R

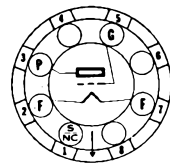

5S

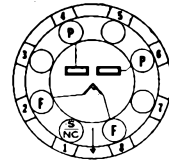

5T

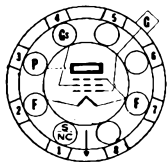

5Y

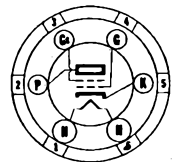

6A



6AA



6AD



6AE



6AF

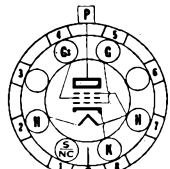

6AM

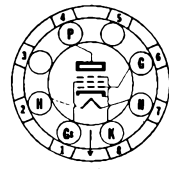

6AP

## BASE DIAGRAMS FOR SELDOM ENCOUNTERED TYPES—Cont.

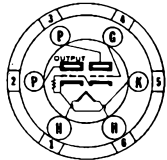

6AS



6AW

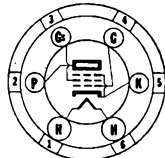

6B

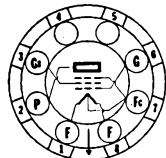

6BA



6BD



6BE

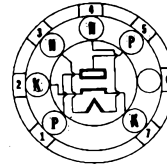

6BH

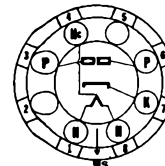

6BJ

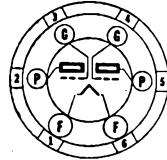

6C

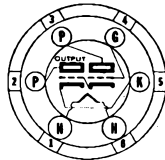

6D

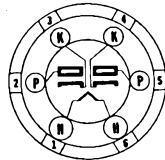

6E

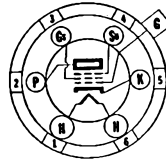

6F

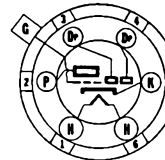

6G

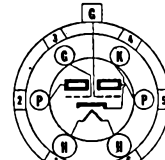

6H

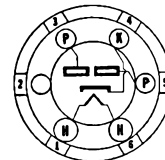

6J

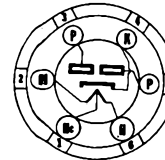

6K

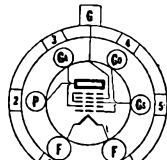

6L

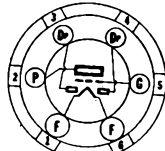

6M

**6N**

- |   |   |
|---|---|
| 1 | H |
| 2 | P |
| 3 | G |
| 4 | G |
| 5 | K |
| 6 | H |

**6P**

- |     |    |
|-----|----|
| 1   | H  |
| 2   | P  |
| 3   | G  |
| 4   | G  |
| 5   | K  |
| 6   | H  |
| Cap | Gs |



6Q

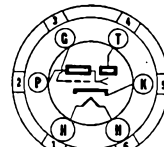

6R



6S

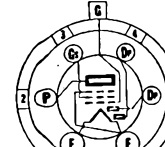

6W

# BASE DIAGRAMS FOR SELDOM ENCOUNTERED TYPES—Cont.



6X

6Y  
 1 NC  
 2 HP  
 3 PNC  
 4 D  
 5 NC  
 6 H  
 7 K  
 8 K  
 Cap G

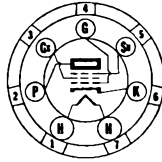

7A



7AA

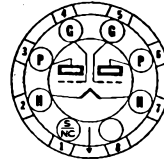

7AB

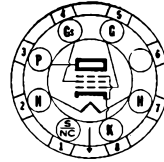

7AC

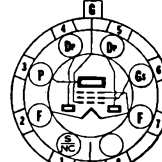

7AD



7AF



7AG

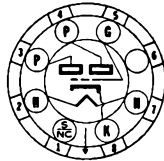

7AH

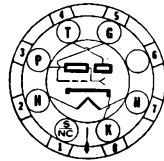

7AL

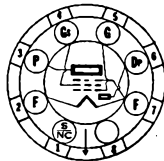

7AM

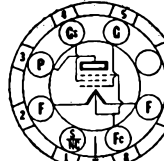

7AQ

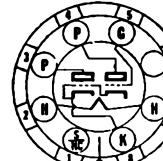

7AU



7AX



7AZ



7B

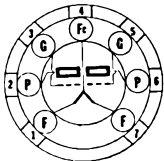

7BC

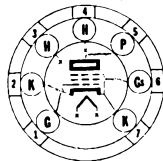

7BD

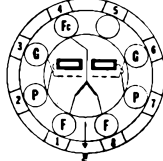

7BE

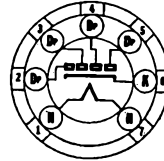

7BJ

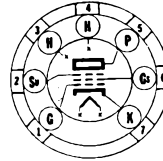

7BK

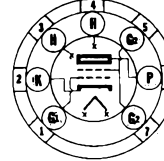

7BN

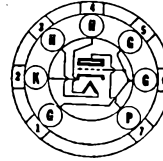

7BQ

## BASE DIAGRAMS FOR SELDOM ENCOUNTERED TYPES—Cont.

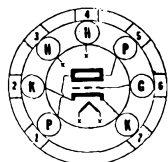

7BS

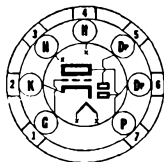

7BT.

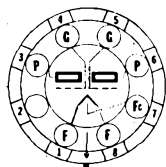

7BW

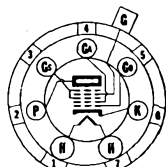

7C

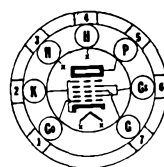

7CH.



7D

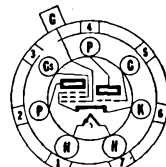

7E



7F

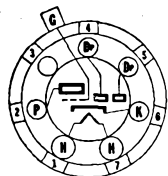

7G

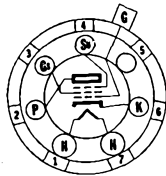

7H

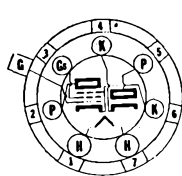

7K

## 7L

- |   |    |
|---|----|
| 1 | H  |
| 2 | P2 |
| 3 | K2 |
| 4 | Hc |
| 5 | K1 |
| 6 | P1 |
| 7 | H  |

## 7M

- |   |    |
|---|----|
| 1 | F  |
| 2 | P  |
| 3 | Ga |
| 4 | G  |
| 5 | SU |
| 6 | NC |
| 7 | F  |

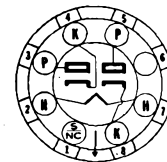

7Q



7R

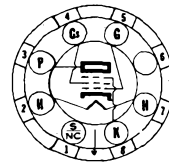

7S



7T



7U

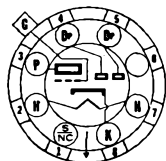

7V

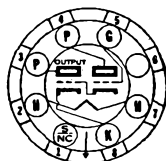

7W

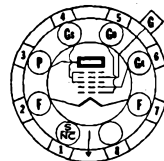

7Z

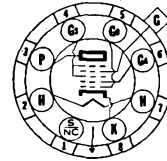

8A

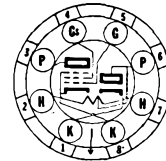

8AB

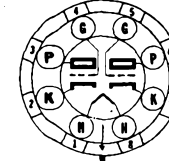

8AC

# BASE DIAGRAMS FOR SELDOM ENCOUNTERED TYPES—Cont.

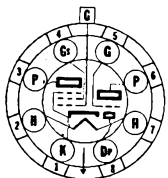

8AF



8-AJ

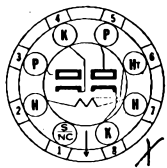

8AN



8AV

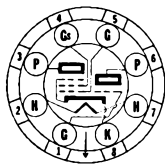

8AY

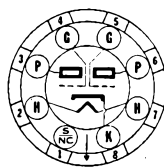

8B

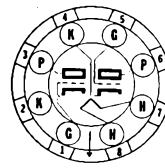

8BE

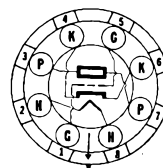

8BN



8BO

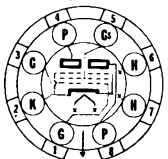

8BU

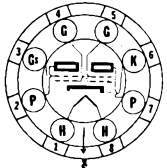

8BV



8BZ



8C

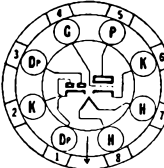

8CK

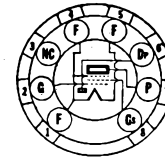

8CO

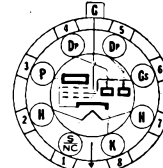

8E

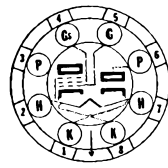

8F

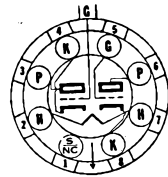

8G



8L



8N

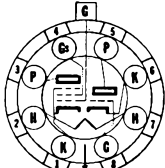

8T

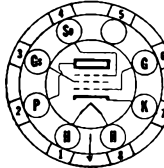

8V

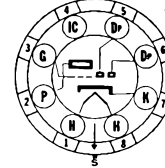

8W

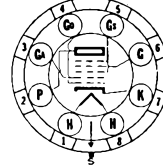

8X

## BASE DIAGRAMS FOR SELDOM ENCOUNTERED TYPES



8Z



9C

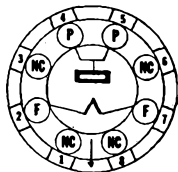

X6030

# SYLVANIA PANEL LAMPS

A complete line of Sylvania Panel Lamps, especially designed for radio dials, tuning meters, flash-tuning arrangements, and the like, is now available. A market for some types of these lamps will also be found in flashlights, parking lights, auto panel boards, record players, pin-ball machines, and wherever a miniature lamp of this style is required.

The early types of panel lamps were used primarily as on-or-off indicators in radio receivers. Present-day panel lamps must be constructed to withstand speaker vibrations, have noise-free operation, current drain within the required limit (particularly when used in ac-dc receivers and battery receivers), and to provide shadowless illumination. Sylvania radio panel lamps have been constructed for all these requirements.

The replacement of panel lamps should be made with lamps having the same type number. This is particularly true in tuning meters, battery, and ac-dc receiver replacements. Sylvania Type S47 is the same as other lamps marked 40A. Lamps marked 49A may be replaced with Sylvania Type S49. Type S292 is mainly for use in 2.5 volt receivers where the line voltage is high and when regular 2.5 volt lamps will not give satisfactory life.

The filament wires of all standard panel lamps are mounted through a small colored glass bead located above the bulb press. If the markings on the lamp to be replaced are not legible, the bead color may be used as identification, since the color identifies the lamp type. The bead color of each lamp is shown in the tabulated data below, and it will be noted that in some cases the bead colors identify more than one particular type of lamp. In these cases other means of identification will be required, such as comparison of bulb, base, and circuit voltage.

## CHARACTERISTICS

Type No.	Circuit Volts	Design		Bead Color	Bulb Style	Miniature Base	Usual Service	Type No.
		Volts	Amp.					
S40	6-8	6.3	0.15	Brown	T-3 1/4	Screw	Radio Dials	S40
S41	2.5	2.5	0.50	White	T-3 1/4	Screw	Radio Dials	S41
S42	3.2	3.2	0.35	Green	T-3 1/4	Screw	Radio Dials	S42
S43	2.5	2.5	0.50	White	T-3 1/4	Bayonet	Radio Dials and Tuning Meters	S43
S44	6-8	6.3	0.25	Blue	T-3 1/4	Bayonet	Radio Dials and Tuning Meters	S44
S45	3.2	3.2	0.35	White	T-3 1/4	Bayonet	Radio Dials	S45
S46	6-8	6.3	0.25	Blue	T-3 1/4	Screw	Radio Dials and Tuning Meters	S46
*S47	6-8	6.3	0.15	Brown	T-3 1/4	Bayonet	Radio Dials	*S47
S48	2.0	2.0	0.06	Pink	T-3 1/4	Screw	Battery Set Dials	S48
*S49	2.0	2.0	0.06	Pink	T-3 1/4	Bayonet	Battery Set Dials	*S49
S50	6-8	7.5	0.20	White	G-3 1/2	Screw	Auto Sets Flash Lights	S50
S51	6-8	7.5	0.20	White	G-3 1/2	Bayonet	Auto Sets, Auto Panels	S51
S55	6-8	6.5	0.40	White	G-4 1/2	Bayonet	Auto Sets, Parking Lights	S55
S292	2.9	2.9	0.17	White	T-3 1/4	Screw	Radio Dials	S292
S292A	2.9	2.9	0.17	White	T-3 1/4	Bayonet	Radio Dials Coin Machines	S292A
S1455	18.0	18.0	0.25	Brown	G-5	Screw	Coin Machines	S1455
S1455A	18.0	18.0	0.25	Brown	G-5	Bayonet	Coin Machines	S1455A

\*Sylvania Types S47 and S49 are interchangeable with Types 40A and 49A, respectively, in other brands.

# SYLVANIA BALLAST TUBES AND PLUG-IN RESISTORS

Ballast Tubes and Plug-in Resistors form two divisions based upon differences in construction and regulating characteristics. The first group is employed mainly in battery operated receivers to maintain substantially constant current over a considerable range of battery voltage variation. The second group is used in ac-dc receivers and 32-volt sets where the voltage drop required may cover a wide range. Such a resistor tube affords some amount of regulation, but the characteristic is not as flat as for regulators intended for use in battery receivers. These should be operated as closely as possible to the standard current ratings in order to realize the most efficient performance.

The tubes for use in battery sets are designed to permit the operation of 2-volt types from a 3-volt battery source which may consist of two banks of dry cells in parallel, the banks being connected in series. The supply voltage varies from about 3.4 volts to 2.2 volts during the life of the batteries. For this range of supply voltage the types listed below will maintain the socket terminal voltage between 1.8 and 2.2 volts. During the major part of battery life the socket voltage remains very close to the rated value of 2.0 volts.

Due to the confusion in ballast and resistor tube type numbers there has been considerable misunderstanding as to the correct type of tube to be used for replacement purposes in receivers. All the Sylvania ballast tubes listed will replace any ballast tubes having the same type numbers. Furthermore, Sylvania ballast tubes will also replace any ballast tubes for similar service, regardless of designating type numbers, providing the filament current load is identical and the basing arrangement is the same. The same is true for the Sylvania resistor types employed in ac-dc service provided that, in addition, the average voltage drop is also the same.

To determine the filament current load in series with the ballast tube it is necessary to include the total filament current drain of the receiver tubes plus the current drain of the dial light if the latter is employed. For example, a set using a Type 19, a Type 30, and 3 Type 34 tubes has a normal filament current drain of 500 milliamperes. The correct ballast tube would be a Type 1A1.

## CHARACTERISTICS

Type	Use	Ma. Average Load Voltage Current Drop*		Bulb	Base
1A1/5E1	Battery	500	1.0	ST-12	4-A
1B1	Battery	360	1.0	ST-12	4-A
1C1	Battery	745	1.0	ST-12	4-A
1D1	Battery	240	1.0	ST-12	4-A
1E1	Battery	480	1.0	ST-12	4-A
1F1	Battery	720	1.0	ST-12	4-A
1G1	Battery	420	1.0	ST-12	4-A
1J1	Battery	620	1.0	ST-12	4-A
1K1	Battery	550	1.0	ST-12	4-A
1R1G	Battery	540	1.0	ST-12	4-T
1T1G	Battery	560	1.0	ST-12	4-T
1X1	Battery	780	1.0	ST-12	4-T
1Y1	Battery	540	1.0	ST-12	4-A
1Z1	Battery	900	1.0	ST-12	4-A
2	DC or AC-DC	300	9.0	S-14	4-A
3	DC or AC-DC	300	128.0	ST-16	4-A
4	DC or AC-DC	400	115.0	ST-16	4-A
4A1	Battery	300	4.0	ST-12	4-A
5	DC or AC-DC	460	115.0	ST-16	4-A
6	Battery	685	1.0	ST-12	4-A
7	DC or AC-DC	300	176.0	ST-16	4-A
8	DC or AC-DC	300	132.0	ST-16	4-A
9	DC or AC-DC	300	50.0	ST-16	4-A
46A1	DC or AC-DC	400	46.1	ST-12	2-S
46B1	DC or AC-DC	300	46.1	ST-12	2-S

\*The voltage drop shown is for average operation and may vary according to the supply voltage.

## BASE VIEWS

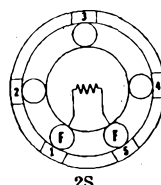
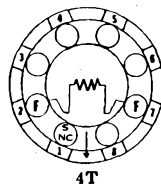
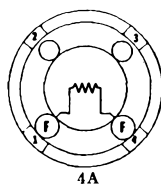



# SYLVANIA ELECTRIC PRODUCTS INC.

## PRODUCT DIRECTORY

### RADIO TUBE DIVISION

Emporium, Pennsylvania

Receiving Tubes • Test Equipment

### TELEVISION PICTURE TUBE DIVISION

Seneca Falls, New York

Cathode Ray Tubes • Television Picture Tubes

### RADIO & TELEVISION DIVISION

254 Rano Street, Buffalo 7, New York

Radio Receivers • Television Receivers

### ELECTRONICS DIVISION

70 Forsyth Street, Boston 15, Massachusetts

Specialized Electronics Equipment • Germanium and Silicon Diodes — Magnetrons — Thyratrons — TR Tubes

### PHOTOFLASH DIVISION

Broad Street, Montoursville, Pennsylvania

Photoflash Lamps • Photoflood Lamps

### LIGHTING DIVISION

60 Boston Street, Salem, Massachusetts

Fluorescent & Incandescent Lamps • Sign Tubing  
Lamp Fixtures & Accessories

### TUNGSTEN & CHEMICAL DIVISION

Towanda, Pennsylvania

Tungsten Products • Fluorescent Chemicals

### PARTS DIVISION

208 East Street, Warren, Pennsylvania

Wire Parts, Welds • Plastics

*For information on specific products, address inquiries to the appropriate division.*

### SYLVANIA PLANTS, LABORATORIES, AND OFFICES LOCATED IN—

Alexandria, Va.

Altoona, Pa.

Atlanta, Ga.

Bayside, L. I., N. Y.

Boston, Mass.

Brookville, Pa.

Buffalo, N. Y.

Chicago, Ill.

Cincinnati, Ohio

Cleveland, Ohio

Danvers, Mass.

Dayton, Ohio

Detroit, Mich.

Drummondville, P. Q., Canada

Emporium, Pa.

Flushing, N. Y.

Huntington, W. Va.

Ipswich, Mass.

Kansas City, Mo.

Kew Gardens, L. I., N. Y.

Los Angeles, Calif.

Mill Hall, Pa.

Mineola, L. I., N. Y.

Montoursville, Pa.

Montreal, P. Q., Canada

New York, New York

Ottawa, Ohio

Philadelphia, Pa.

Salem, Mass.

San Francisco, Calif.,

Seattle, Wash.

Seneca Falls, N. Y.

Shawnee, Okla.

St. Marys, Pa.

Towanda, Pa.

Warren, Pa.

Washington, D. C.

Williamsport, Pa.

# *Let Sylvania Help You . . .*

Besides this Technical Manual, Sylvania Electric has a large assortment of Sales and Service helps for Radio and Television Service Men. Most of these are free for the asking.

Semi-technical literature, such as Characteristics Sheets, Service Hints Booklets, TV Tube Complement Book and Radio and Television Instruction Courses are in constant demand by successful servicemen, electronics schools and manufacturers.

Sylvania News, a monthly publication, features a separate Technical Section, items of trade interest and service helps.

Window and Door Decals, Window Displays, price literature, direct mail helps, newspaper mats . . . in fact, complete local advertising campaigns prepared by a nationally famous advertising agency and coordinated with Sylvania's national campaigns are available.

Practically all of the above helps are available at nominal or no cost.

Business Record Books, Job Record Cards, Service Forms, Personalized Stationery, Billheads and Business Cards, Tools, Service Kits, and many other aids can be purchased at manufacturer's cost through the cooperation of Sylvania Electric Products, Inc.

Ask your Sylvania Distributor for complete information, or write:

Advertising Department,  
Sylvania Electric Products, Inc.,  
Emporium, Pa.



# SYLVANIA REFERENCE BOOKS

## SERVICING RADIO AND TELEVISION WITH A VACUUM TUBE VOLTMETER

A valuable aid to every technician, whether he services radio, television, or sound equipment. It's a 48-page book packed with information, schematics, and block diagrams that will help you get maximum utility from your vacuum tube voltmeter and aid you in reducing servicing time per job.

**\$1.00**

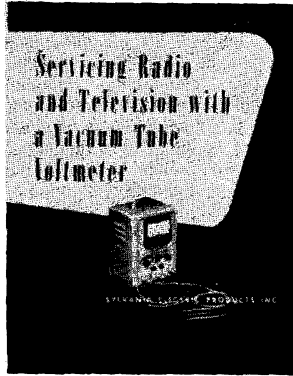

## TUBE SUBSTITUTION MANUAL

This 40-page book gives substitution data for over 300 popular radio and television tubes, tabulated in convenient, easy-to-read listings in the six major categories. Included are extensive sections on television receiving types and television picture tube types. There is also a complete classification chart which lists tube types by categories according to their principal function. Other data includes tube adapter wiring diagrams and an important article on substitutions in a series filament type receiver.

**No Charge**

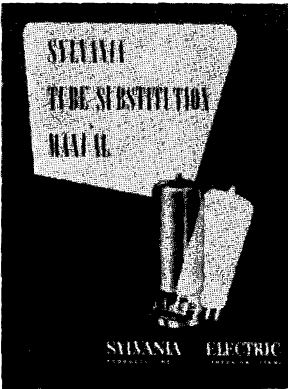

## 40 USES FOR GERMANIUM DIODES

Here's the most complete collection of uses for germanium diodes ever published. Includes radio and television receiver circuits, transmitter circuits, many test and control circuits and dozens of plans for handy electronic gadgets.

**25¢**

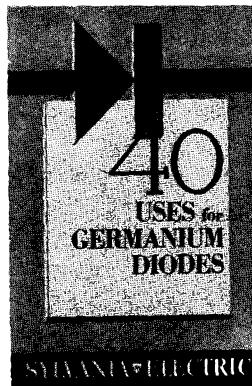

# SYLVANIA REFERENCE BOOKS

## SERVICING TV RECEIVERS

The biggest "little" book ever printed for the television serviceman. Contains page after page of handy reference for the causes and corrections for faulty reception in TV receiving sets. Profusely illustrated, complete with circuit diagrams, that save guessing and suggestions that save time and make more money, quicker, for you! Handy pocket size, 5" x 7".

\$2.00



## HOW TO SERVICE RADIOS WITH AN OSCILLOSCOPE

Complete 72-page book that gives you step-by-step instructions for using the oscilloscope in testing and servicing radio receivers, audio amplifiers and transmitters. Thoroughly illustrated, and written in a language that you (and we) can understand. Makes your work more interesting and accurate.

\$1.00

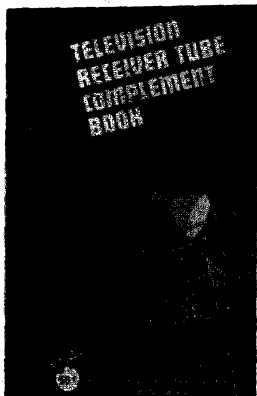
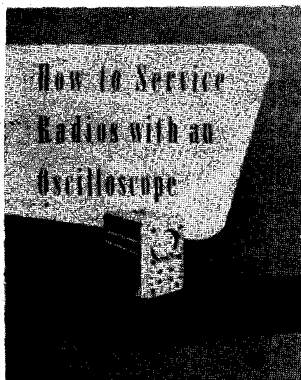

## TELEVISION RECEIVER TUBE COMPLEMENT BOOK

The most complete, authentic book of its type ever published. Gives complete tube complement of all current television receiver models. Includes list of manufacturer's names and addresses, replacement charts and usage table. It's an absolute "must" on your shelf for successful servicing of any television receiver, one of the many Sylvania services designed to help you give more dependable service.

50¢