

**SERIES OF BOOKS  
ON  
ELECTRONIC TUBES**

THE SERIES OF BOOKS ON ELECTRONIC TUBES INCLUDES:

- Book I "Fundamentals of Radio-Valve Technique"  
Book II "Data and Circuits of Receiver and Amplifier Valves"  
Book III "Data and Circuits of Receiver and Amplifier Valves", 1st Suppl.  
Book IIIA "Data and Circuits of Receiver and Amplifier Valves", 2nd Suppl.  
Book IIIB "Data and Circuits of Receiver and Amplifier Valves", 3rd Suppl.  
Book IIIC "Data and Circuits of Television Receiving Valves"  
Book IV "Application of the Electronic Valve in Radio Receivers and Amplifiers",  
Volume 1  
Book V Ditto, Volume 2  
Book VII "Transmitting Valves"  
Book VIIIA "Television Receiver Design" 1  
Book VIIIB "Television Receiver Design" 2  
Book IX "Electronic Valves in Pulse Technique"  
Book X "Analysis of bistable Multivibrator Operation"  
Book XI "U.H.F. tubes for communication and measuring equipment"  
Book XII "Tubes for computers"  
Book XIII "Industrial Rectifying Tubes"

Book IIIB and XIII are in preparation

BOOK XI

**U.H.F. TUBES FOR COMMUNICATION  
AND MEASURING EQUIPMENT**

Distributors for United Kingdom and Eire:  
CLEAVER-HUME PRESS Ltd.,  
31 Wright's Lane, Kensington, London W. 8

**U.H.F. TUBES  
FOR COMMUNICATION AND  
MEASURING EQUIPMENT**

621.385.1.029.63

**BY**

**MEMBERS OF  
PHILIPS ELECTRON TUBE DIVISION**

**\***

**P H I L I P S ' T E C H N I C A L L I B R A R Y**

All rights reserved by  
N.V. Philips' Gloeilampenfabrieken, Eindhoven (Holland)  
Printed in the Netherlands

Published 1956  
All data in this book are given without prejudice  
to patent rights of the above Company

## PREFACE

*The use of electronic apparatus operating at frequencies of 300 Mc/s and higher is steadily extending in an ever widening field of applications.*

*Radio and radar for communication and navigation are vital elements of modern sea- and air-traffic and have greatly increased its efficiency and safety. Public services, e.g. police, fire, and medical departments largely depend on mobile transmitting and receiving equipment for rapid and effective action in emergencies. Balloon sondes have very much helped to increase the accuracy of weather forecasting, and at present, seamen, airmen and farmers all over the world are relying upon these forecasts in making vital decisions.*

*In all these applications the use of radio waves in the decimeter and centimeter ranges is imperative for various reasons, such as the overcrowding of longer wave ranges and the small power supply available in mobile and portable equipment.*

*To further add to the possibilities offered by conventional tubes with their relatively simple and reliable design and their well-known circuit technique even at the wavelengths required for use in the decimetric wave range, various improvements were introduced in these tubes. The use of centimetric waves, however, made it necessary to develop tube types which differ fundamentally from conventional tubes both in design and construction.*

*In this book the tube range for U.H.F. and S.H.F. waves is described in detail. In addition, some applications of tubes for the measurement of the noise factor at these high frequencies are dealt with.*





## CONTENTS

INTRODUCTION . . . . .	I
SUBMINIATURE U.H.F. TRIODE DC 70 . . . . .	3
Technical data . . . . .	3
U.H.F. TRIODE EC 80 FOR GROUNDED-GRID CIRCUITS . . . . .	5
Technical data . . . . .	6
H.F. section of a receiver for 300 to 400 Mc/s with the tubes EC 80, EC 80 and EC 81 . . . . .	10
U.H.F. OSCILLATOR TRIODE EC 81 . . . . .	13
Technical data . . . . .	14
Simple U.H.F. oscillator with the EC 81 . . . . .	19
Oscillator with two tubes EC 81 in push-pull for approx. 440 Mc/s . . . . .	22
Simple oscillator with the EC 81 for use in balloon sondes at 395 Mc/s . . . . .	23
U.H.F. DISC-SEAL TRIODE EC 55 . . . . .	27
Technical data . . . . .	27
Oscillator with the EC 55 operating between 730 and 1350 Mc/s . . . . .	30
S.H.F. DISC-SEAL TRIODES EC 56 and EC 57 . . . . .	33
General data of the EC 56 and EC 57 (tentative data) . . . . .	34
Technical data of the EC 56 (tentative data) . . . . .	35
Technical data of the EC 57 (tentative data) . . . . .	35
REFLEX-KLYSTRONS 2K25 and 723 A/B . . . . .	41
Technical data of the 2K25 . . . . .	45
Technical data of the 723 A/B . . . . .	46
STANDARD NOISE SOURCES K81A, K50A and K51A . . . . .	48
Standard noise diode K81A . . . . .	52
Technical data . . . . .	52
Gas discharge noise tubes . . . . .	54
Tubes K50A and K51A . . . . .	56
Technical data of the K50A . . . . .	57
Technical data of the K51A . . . . .	58



# INTRODUCTION

The wavelengths for transmitting signals are steadily becoming shorter, which is due to the following reasons:

- (1) The longer wavebands, which are suitable for broadcasting and telecommunication, are becoming more and more crowded.
- (2) Apart from this overcrowding, television and frequency-modulated transmitters would occupy such wide bands with their broad frequency spectrum that the available space in the medium and long wavebands would scarcely be sufficient for a single transmitter.
- (3) In radar techniques the use of extremely short wavelengths is required with a view to their specific properties, such as the possibility of producing narrow beams, thereby being reflected against small surfaces.

The new problems which arose by the urge to apply ever decreasing wavelengths were solved most satisfactorily by electronic engineering, by means of improvements and new designs of electron tubes.

The highest frequency at which conventional tubes still operate is determined by the following factors:

- (1) Transit time effects. These effects become noticeable at frequencies at which the duration of one cycle of the alternating voltage is no longer large compared with the time required by an electron to travel from the cathode to the anode. At these frequencies the mutual conductance of the tube decreases, the input circuit is heavily damped, and the signal-to-noise ratio deteriorates.
- (2) Undesired couplings caused by the capacitances, selfinductances and mutual inductances of the electrodes and their connections.
- (3) Losses that increase with the frequency, such as dielectric losses occurring in the glass envelope and dissipative losses produced in the electrodes, and their connections; at very short wavelengths the latter losses predominate.

The most obvious method of reducing the influence of transit time effects consists in decreasing the interelectrode spacings. The clearance between the cathode and grid is particularly important, because in this space the velocity of the electrons is fairly small, as a result of which the time required by the electrons to cover this distance is relatively long. By mounting the cathode and grid close to each other, the mutual conductance of the tube is increased. It is true that the capacitance between these electrodes is also increased in this way, but the total

result is an improvement of the tube properties as far as short-wave operation is concerned.

A reduction of undesired couplings and losses can be obtained by shortening the connections between the electrodes and their terminals. In some of the types described in this book (the EC 80, EC 81 and K 81 A) the electrode system is mounted on a glass disc into which the contact pins have been fused, which offers the possibility of minimizing the distance between the electrodes and the external circuit. The subminiature type DC 70 is provided with connecting leads which are fused into the glass disc and can be soldered directly to the wiring.

At frequencies exceeding approximately 500 Mc/s these tubes become unsuitable, and recourse must be taken to disc-seal triodes. In these tubes (the EC 55, EC 56 and EC 57) the concentric electrode system has been replaced by flat, equidistant electrodes. In this way extremely small interelectrode distances can be obtained, such as are required for minimizing the transit times. The electrode connections are formed by metal discs which protrude through the glass envelope into which they are fused, thus ensuring very small selfinductances. These discs are so arranged that they can easily be included in coaxial or waveguide systems. The EC 55 can be used on decimetric waves; the EC 56 and EC 57 are suitable for wavelengths down to 7.5 cm (4000 Mc/s).

By ingeniously taking advantage of the transit time effect, it has been found possible to construct electron tubes which are suitable for use on centrimetric and even on millimetric waves, namely tubes with velocity modulation. To this category belong, amongst others, the klystrons; the so-called reflex-klystrons are designed for use as oscillators. In this book two types are described, namely the reflex-klystrons 2 K 25 and the 723 A/B, which are suitable for use in the 3 cm band.

The noise figure of a receiver gives very important information regarding its quality and can be measured even at metric waves by means of the vacuum diode K 81 A, used as a standard noise source. For noise measurements on centrimetric waves it is, however, necessary to use gas-discharge tubes, such as the K 50 A and the K 15 A, which have been designed for use on the 3 cm and on the 10 cm bands respectively.

# SUBMINIATURE U.H.F. TRIODE DC 70

The DC 70 is a directly heated triode intended for purposes of transmitting and receiving at ultra high frequencies. It can for instance be used as an oscillator, amplifier, super-regenerative detector or mixer in walkie-talky equipment, balloon sondes, Citizens Radio or professional equipment, etc. When the tube is used as an oscillator, the output obtainable at 500 Mc/s ( $\lambda = 60$  cm) is about 450 mW.

The filament voltage of the DC 70 is 1.25 V at a current of 0.2 A. Being a directly heated tube, its mutual conductance is high (3.4 mA/V at an anode current of 12 mA); the amplification factor amounts to 14.

The DC 70 is provided with leads which pass through the base and are to be soldered directly to the wiring of the circuit. For this reason no tube socket is used.

The small dimensions and battery operation make the DC 70 specially suitable for use in portable equipment. The tube can be mounted in all positions.

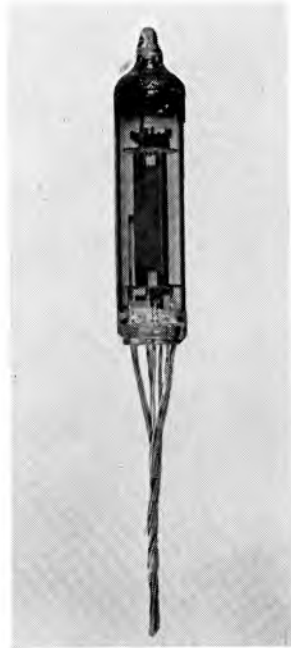

89514

Fig. 1. Photograph of the DC 70 (actual size).

## TECHNICAL DATA

### FILAMENT DATA

Heating: direct by battery

Filament voltage . . . . .  $V_f = 1.25$  V

Filament current . . . . .  $I_f = 0.20$  A

### CAPACITANCES (measured with external shield and with leads marked n.c. left unconnected)

Anode to grid . . . . .  $C_{ag} = 1.4$  pF

Grid to filament . . . . .  $C_g = 1.3$  pF

Anode to filament . . . . .  $C_a = 1.9$  pF

### MOUNTING POSITION: any

Note: Direct soldered connections to the leads of the tube must be at least 5 mm from the seal, and any bending of the tube leads must be at least 1.5 mm from the seal.

ELECTRODE ARRANGEMENT

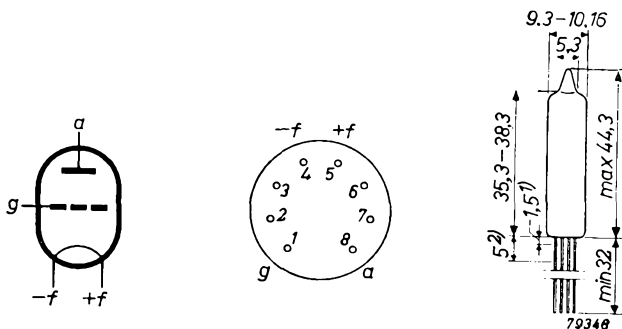

Fig. 2. Electrode arrangement, electrode connections and maximum dimensions in mm.

TYPICAL CHARACTERISTICS

Anode voltage . . . . .	$V_a = 150$ V
Grid voltage . . . . .	$V_g = -4.5$ V
Anode current . . . . .	$I_a = 12$ mA
Mutual conductance . . . . .	$S = 3.4$ mA/V
Amplification factor . . . . .	$\mu = 14$

OPERATING CHARACTERISTICS AS AN OSCILLATOR AT 500 Mc/s

Anode voltage . . . . .	$V_a = 150$ V
Cathode current . . . . .	$I_k = 20$ mA
Output power . . . . .	$W_o = 0.45$ W

LIMITING VALUES

Anode voltage . . . . .	$V_a = \text{max. } 150$ V
Anode dissipation . . . . .	$W_a = \text{max. } 2.4$ W
Cathode current . . . . .	$I_k = \text{max. } 20$ mA
Grid current . . . . .	$I_g = \text{max. } 5$ mA
Filament voltage . . . . .	$V_f = \text{max. } 1.35$ V (absolute maximum)

# U.H.F. TRIODE EC 80 FOR GROUNDED-GRID CIRCUITS

The EC 80 is an indirectly heated triode designed for use at ultra high frequencies. As an amplifier the tube can be used up to 500 Mc/s. The amplification factor and the mutual conductance are high ( $\mu = 80$  and  $S = 12 \text{ mA/V}$ ), while the noise of the tube is very small (noise figure about 8 dB at 300 Mc/s with a bandwidth of 4.5 Mc/s).

These properties make the EC 80 suitable for a number of applications on decimetric waves, for example in Citizens Radio and professional equipment, radio links, measuring equipment, etc. etc. Due to its high mutual conductance and low noise the EC 80 will also be of great use in a number of applications at lower frequencies. We mention, for instance, broad-band amplifiers, I.F. stages following a crystal mixing stage, etc. The EC 80 is specially intended for use as an amplifier and mixer in grounded-grid circuits. In these circuits the grid, instead of the cathode, is the common electrode of the input and output circuits. In fig. 4 the basic diagram of a grounded-grid amplifier is shown; in such a circuit an appropriately constructed grid will act as a screen between anode and cathode, making a separate screen grid superfluous. In spite of the ultra high frequencies, it will therefore be possible to use triodes instead of pentodes in these circuits with good results.

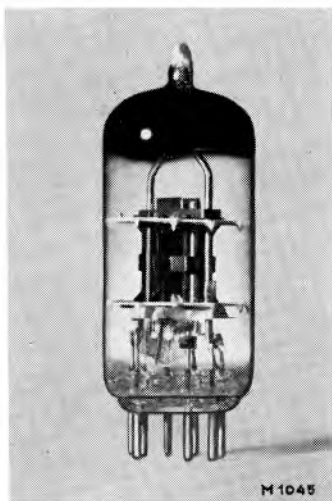

Fig. 3. Photograph of the EC 80 (actual size).

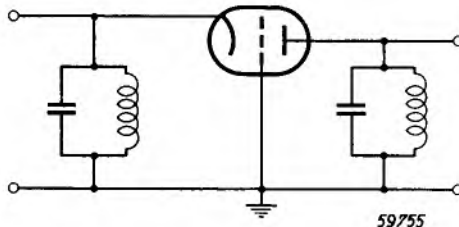

Fig. 4. Triode in grounded-grid circuit. The d.c. sources have been omitted.

Owing to the absence of the so-called partition noise inherent in a pentode, the total noise of a triode is much smaller than that of a pentode. This explains the favourable behaviour with respect to noise of the triode EC 80 in grounded-grid circuits.

In order to reduce the effects of troublesome capacitances, self-inductances and resistances, the measures described in the Introduction have been taken. In this connection special attention must be drawn to the self-inductance of the grid lead. This lead being common to both the input and the output circuits, self-inductance will tend to cause instability. In the case of the EC 80 this has been avoided by connecting the grid to four pins in parallel. If the corresponding socket contacts are connected to earth, the self-inductance of the grid lead and the tendency to instability will be reduced to a minimum.

Whereas the gain of a tube at lower frequencies is only slightly influenced by the input and output impedances of the tube, this is no longer the case on decimetric waves. Due to the influence of transit-time effects, resistance and self-inductance of the connecting leads, etc., these input and output impedances are reduced in such a way that their influence on the gain becomes very great, and as a result, the control of amplifying tubes will require power. Therefore, instead of speaking in terms of voltage amplification, as normally is done at lower frequencies, we will have to take into consideration the power gain. The definition of this quantity is as follows:

*The power gain of an amplifier is the optimum ratio between the output power and the power available at the input.*

As the power gain is dependent upon the width of the frequency band to be amplified, it is always necessary to mention the bandwidth of the amplifier. As a first approximation the product of power gain and bandwidth has a constant value, so that the gain at any bandwidth can be calculated if the gain at a certain bandwidth is known.

The noise of a receiver or an amplifier is defined by *the noise figure F*, representing the available signal-to-noise power ratio at the input, divided by the signal-to-noise power ratio available at the output. Here both the noise and the signal are expressed as power, taken over the bandwidth of the amplifier, whilst the noise properties of the input power source are expressed in terms of a resistor at room temperature.

As may be seen from the operating data of the EC 80 mentioned under Technical Data, the *power gain G* at a frequency of 300 Mc/s and a bandwidth of 4.5 Mc/s is about 15 dB and the *noise figure F* about 8 dB (see also fig. 8).

## TECHNICAL DATA

### HEATER DATA

Heating: indirect with a.c. or d.c.; parallel supply

Heater voltage . . . . .  $V_f = 6.3$  V

Heater current . . . . .  $V_f = 0.48$  A



**ELECTRODE ARRANGEMENT**

To ensure stability of functioning in grounded-grid circuits, the four grid contacts must be connected to earth.

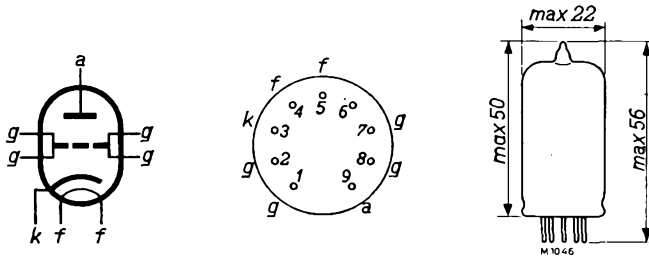

Fig. 5. Electrode arrangement, electrode connections and maximum dimensions in mm (noval base).

**CAPACITANCES (measured with the tube cold and with grounded grid)**

Input capacitance . . . . .	$C_{(g+6)(k+f)}$	$= 5.1 \text{ pF}^1)$
Input capacitance . . . . .	$C_{(g+f+6)k}$	$= 9.3 \text{ pF}^1)$
Capacitance between anode and cathode . . . . .	$C_{ak}$	$< 0.075 \text{ pF}$
Capacitance between anode and cathode plus heater	$C_{a(k+f)}$	$< 0.08 \text{ pF}$
Output capacitance . . . . .	$C_{a(g+6)}$	$= 3.4 \text{ pF}^1)$
Output capacitance . . . . .	$C_{a(g+f+6)}$	$= 3.4 \text{ pF}^1)$
Capacitance between cathode and heater . . . . .	$C_{kf}$	$< 8 \text{ pF}$

**TYPICAL CHARACTERISTICS**

Anode voltage . . . . .	$V_a$	$= 250 \text{ V}$
Cathode bias resistor . . . . .	$R_k$	$= 100 \Omega$
Anode current . . . . .	$I_a$	$= 15 \text{ mA}$
Mutual conductance . . . . .	$S$	$= 12 \text{ mA/V}$
Amplification factor . . . . .	$\mu$	$= 80$

**OPERATING CHARACTERISTICS (grounded grid)**

Power gain at 300 Mc/s (bandwidth 4.5 Mc/s) . . . . .	$G$	$= \text{appr. } 15 \text{ dB}$
Noise figure at 300 Mc/s (bandwidth 4.5 Mc/s) . . . . .	$F$	$= \text{appr. } 8 \text{ dB}$

**LIMITING VALUES**

Anode voltage in cold condition . . . . .	$V_{ao}$	$= \text{max. } 550 \text{ V}$
Anode voltage . . . . .	$V_a$	$= \text{max. } 300 \text{ V}$
Anode dissipation . . . . .	$W_a$	$= \text{max. } 4 \text{ W}$
Cathode current . . . . .	$I_k$	$= \text{max. } 15 \text{ mA}$
Grid current start ( $I_g = +0.3 \mu\text{A}$ ) . . . . .	$V_g$	$= \text{max. } -1.3 \text{ V}$
External resistance between heater and cathode . . . . .	$R_{fk}$	$= \text{max. } 20 \text{ k}\Omega$
Voltage between heater and cathode . . . . .	$V_{fk}$	$= \text{max. } 100 \text{ V}$

<sup>1)</sup> 6 denotes pin No. 6.

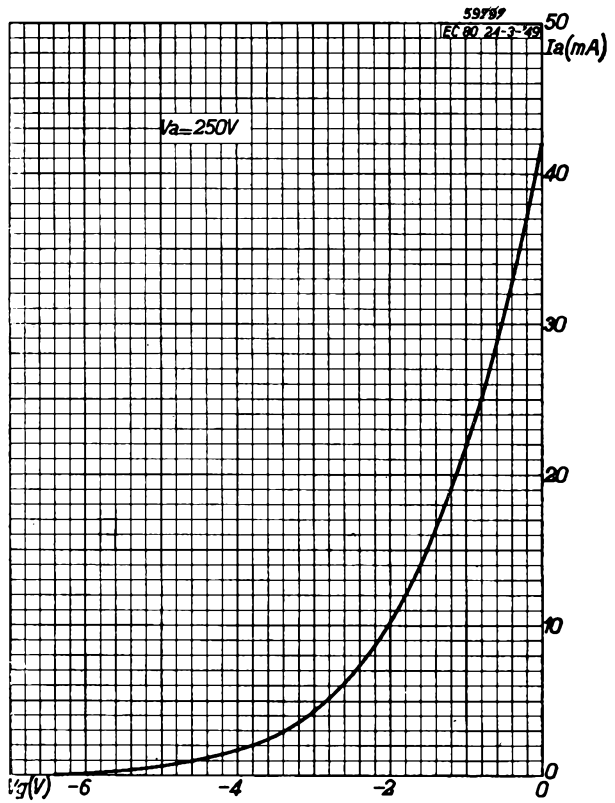

Fig. 6.  $I_a/V_g$  characteristic of the EC 80 at an anode voltage of 250 V

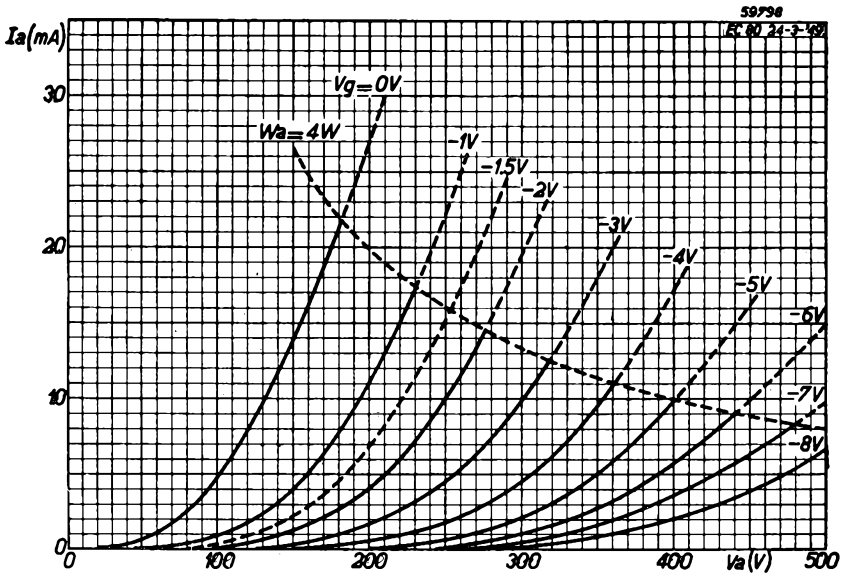

Fig. 7.  $I_a/V_a$  characteristic of the EC 80. The maximum admissible anode dissipation is indicated by the dashed line  $W_a = 4W$ .

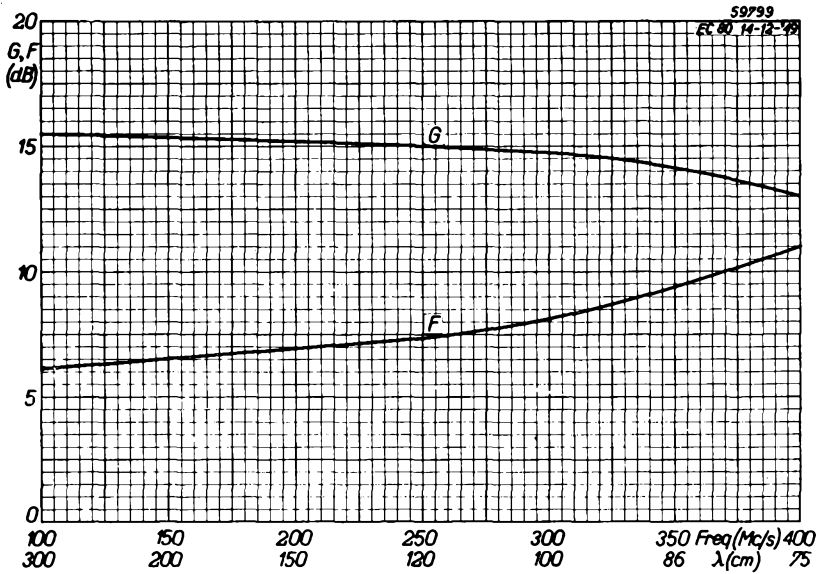

Fig. 8. Power gain  $G$  and noise figure  $F$  of the EC 80 as a function of the frequency  $f$  and wavelength  $\lambda$ .

## BASE AND SOCKET

The EC 80 is provided with the standard noval base, and can therefore be mounted in a socket of normal construction. However, at the very high frequencies at which the tube is used, the material of the socket must answer high requirements. The socket type 5908/46 is recommended.

Its small dimensions and normal operating voltage make the EC 80 specially suitable for use in fixed, as well as in mobile equipment. The tube can be mounted in all positions; if, however, shocks are to be expected, or if the tube is not mounted in an upright position, it is recommended that the tube be supported.

In order to ensure stable functioning of the EC 80, it is recommended to use a cathode resistor for obtaining the negative grid bias (see e.g. fig. 10a with resistors  $R_2$  and  $R_7$  of  $100 \Omega$ ).

## H.F. SECTION OF A RECEIVER FOR 300 to 400 Mc/s WITH THE TUBES EC 80, EC 80 and EC 81

Figs 9 and 10 show a photograph and the circuit diagram of the H.F. section of a receiver using two tubes type EC 80, as an amplifier and a mixer respectively, in a grounded-grid circuit, and an EC 81 as a local oscillator. The H.F. circuits are not normal L.C. circuits as shown in the simplified circuit diagram of fig. 10a, but coaxial line circuits (see figs 9 and 10b). These have a short-circuiting plunger which is adjustable for tuning purposes. The frequency range of the receiver runs from 300 to 400 Mc/s (100 to 75 cm), whilst the bandwidth is 5 Mc/s. The power gain of the H.F. stage is about 12 dB and the noise figure about 8 dB. The mixer is connected as a triode. It is, however, also possible to use it as a diode (grid connected to anode). In the circuit given, both the amplified aerial signal and the locally generated voltage are applied to the cathode.

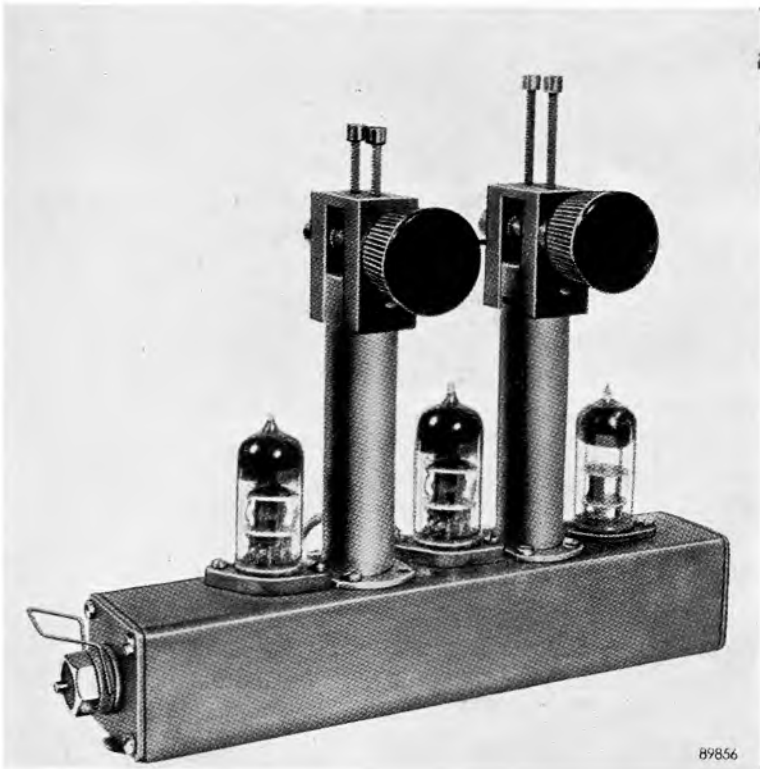

*Fig. 9. H.F. section of a receiver for 300 to 400 Mc/s ( $\lambda = 100$  to 75 cm). Mounted on the chassis are two tubes EC 80 (H.F. amplifier and mixer), one tube EC 81 (local oscillator) and two variable coaxial line circuits.*

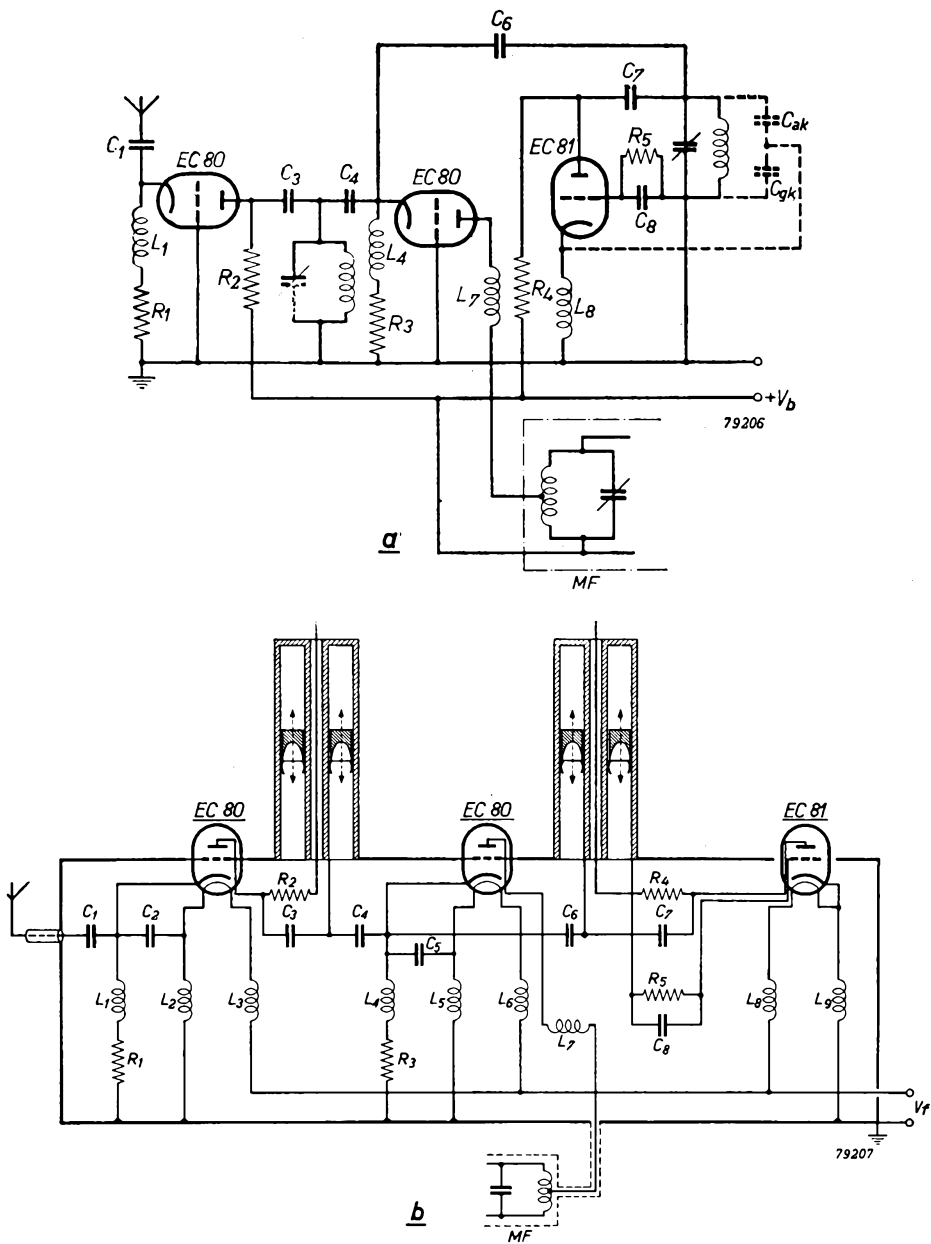

Fig. 10. Circuit diagram of the H.F. section of the receiver of fig. 9; (a) in simplified form, (b) complete. The first EC 80 tube functions as a U.H.F. amplifier in grounded-grid circuit, the second one as a triode mixer in grounded-grid circuit. The EC 81 tube operates as an oscillator.  $R_2$  and  $R_7$  of  $100 \Omega$  each are resistors for automatic positive cathode voltage (with respect to the grid connected to earth).  $R_5$  and  $R_{11}$  are anode resistors of  $1000 \Omega$  each.  $R_{12}$  is the oscillator grid leak of  $10\,000 \Omega$ .  $C_1$ ,  $C_2$ ,  $C_3$ ,  $C_5$ ,  $C_7 = 100 \text{ pF}$ .  $C_4 = 5.6 \text{ pF}$ .  $C_6 = 2 \text{ pF}$ .  $C_8 = 56 \text{ pF}$ . The oscillator (EC 81) functions as a Colpitts oscillator by means of the interelectrode capacitances  $C_{nk}$  and  $C_{ok}$  (dotted in fig. 10a).

The aerial can be matched to the input of the first EC 80 amplifying tube by properly selecting the length of the connecting lead. The self-inductance of this lead together with the input capacitance of the tube will then give the right transformer ratio for maximum input power.

The capacitor  $C_4$  is not only a separating capacitor, but forms at the same time, with the input capacitance of the second EC 80 tube, a voltage divider, matching the low input resistance of the next stage to the higher output resistance of the preceding stage. The local oscillator of the receiver is equipped with the tube EC 81.

The oscillator circuit consists of the coaxial line circuit shown at the right, with a short-circuiting plunger, by means of which the frequency can be adjusted. The oscillator functions as a Colpitts oscillator with the aid of the interelectrode capacitances  $C_{ak}$  and  $C_{gk}$ , as is indicated by the dotted capacitors in fig. 10a. The frequency range of the oscillator is about 300-400 Mc/s (100 to 75 cm). The frequency drift during the heating time of the tube is only 50 000 c/s. The oscillator voltage is applied to the cathode of the mixer tube EC 80 via the capacitor  $C_6$ , and is sufficiently high for obtaining optimum conversion gain. The heater and cathode leads of the tubes have been provided with H.F. chokes ( $L_1$  to  $L_9$ ). The wire length of these chokes is about 23 cm. The anode leads have been decoupled by feeding them through the inner conductor of the transmission lines.

The receiver can be tuned by means of two knobs. Each knob adjusts the plunger of a coaxial line circuit via a rack and pinion. The tuning frequency can be indicated by a pointer moving along a calibrated scale, thus facilitating the operation of the receiver.

# U.H.F. OSCILLATOR TRIODE EC 81

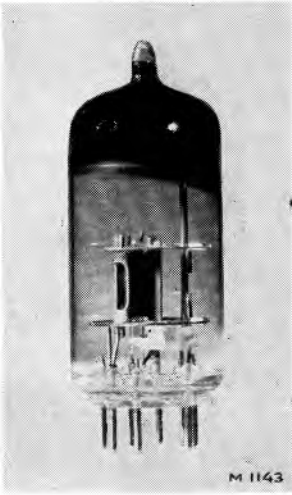

Fig. 11. Photograph of the tube EC 81 (actual size).

The EC 81 is an indirectly heated triode designed for oscillator service at ultra high frequencies, the maximum frequency being about 1200 Mc/s ( $\lambda = 25$  cm). At 750 Mc/s ( $\lambda = 40$  cm) an output of 1.1 watts can be obtained: at 500 Mc/s ( $\lambda = 60$  cm) 2.9 watts and at 300 Mc/s ( $\lambda = 1$  m) 4.2 watts. If higher output power is required, two tubes can be connected in push-pull. The mutual conductance of the EC 81 is high ( $S = 5.5$  mA/V); the amplification factor is 16.

The EC 81 is an excellent oscillator for a great number of applications, such as in transmitters, as a local oscillator in receivers for Citizens Radio and professional equipment, in beam transmitters for radio links, in balloon sondes and measuring equipment, etc.

The generation of ultra-high frequencies with the EC 81 has become possible by taking the measures described in the Introduction. The capacitances between the various electrodes have been made very small, thanks to the exceedingly small dimensions of the electrode system. This has been achieved by shaping the anode in a special way, so as to combine small capacitance with a high heat dissipation.

The operating characteristics of the EC 81 are given below, under various conditions with reference to the constancy of the supply voltage.

In the first place, the data and maximum values under normal operating conditions are given.

In this case the maximum admissible anode dissipation is 3.5 watts. The heater can be fed from a 6.3 volts supply source if a resistor of 3 ohms is connected in series. At a frequency of 750 Mc/s an output of 0.6 watts can be obtained.

In the second place, operating data and maximum values are given under absolute maximum conditions. The maximum admissible value of the anode dissipation is then 5 watts, the anode voltage 300 volts, and the cathode current 30 mA. It must be stressed that these values should never be exceeded under any usual condition of supply voltage variation, load variation, or manufacturing tolerances in the equipment itself.

When the tube is operated with the maximum cathode current of 30 mA, it will be necessary to feed the heater from a supply source of 6.3 volts, the fluctuations

of which do not exceed  $\pm 3\%$ . In that case the output obtainable at 750 Mc/s is 1.1 watts.

### TECHNICAL DATA

#### HEATER DATA

Heating: indirect by a.c. or d.c.; parallel supply

Heater voltage . . . . .  $V_f = 6.3 \text{ V}^1)$

Heater current . . . . .  $I_f = 0.2 \text{ A}$

#### CAPACITANCES (measured with tube cold)

Input capacitance . . . . .  $C_g = 1.8 \text{ pF}$

Output capacitance . . . . .  $C_a = 0.7 \text{ pF}$

Capacitance between grid and anode . . . . .  $C_{ag} = 1.6 \text{ pF}$

Capacitance between grid and heater . . . . .  $C_{gf} < 0.25 \text{ pF}$

Capacitance between cathode and heater . . . . .  $C_{kf} = 2.3 \text{ pF}$

#### ELECTRODE ARRANGEMENT

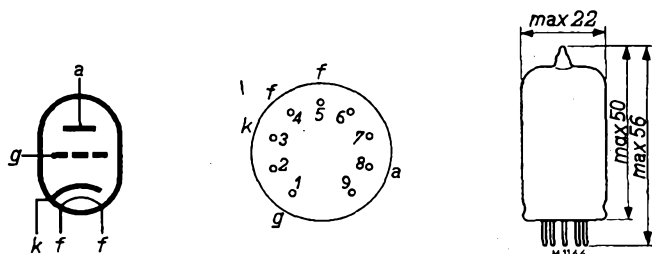

Fig. 12. Electrode arrangement, electrode connections and maximum dimensions in mm (noval base).

#### TYPICAL CHARACTERISTICS

Anode voltage . . . . .	$V_a = 120$	150 V
Grid voltage . . . . .	$V_g = -2$	-2 V
Anode current . . . . .	$I_a = 20$	30 mA
Mutual conductance . . . . .	$S = 4.0$	5.5 mA/V
Amplification factor . . . . .	$\mu = 16$	16

#### OPERATING CHARACTERISTICS AS OSCILLATOR

##### NORMAL OPERATING CONDITIONS (ANODE VOLTAGE NOT STABILIZED)

##### Limiting values

Anode voltage . . . . .	$V_a = \text{max.}$	275 V
Anode dissipation . . . . .	$W_a = \text{max.}$	3.5 V
Cathode current . . . . .	$I_k = \text{max.}$	20 mA

<sup>1)</sup> When using a heater voltage of 6.3 volts, the fluctuations of the voltage must not exceed  $\pm 3\%$ . In this case the absolute value of the cathode current amounts to 30 mA. When the heater voltage fluctuations exceed 3%, a resistor of 3 ohms must be connected in series with the heater. In this case the maximum admissible cathode current is 20 mA.



Heater supply voltage . . . . .	$V_{bf}$	=	6.3	V
Heater series resistor . . . . .	$R_f$	=	3	$\Omega$
Frequency . . . . .	$f$	=	750	375 Mc/s
Anode voltage . . . . .	$V_a$	=	220	275 V
Anode current . . . . .	$I_a$	=	18.6	17.2 mA
Grid current . . . . .	$I_g$	=	1.5	2.8 mA
Input power . . . . .	$W_{ia}$	=	4.1	4.7 W
Output power . . . . .	$W_o$	=	0.6	2.1 W

NORMAL OPERATING CONDITIONS (ANODE VOLTAGE STABILIZED)

Limiting values

Anode voltage	} (absolute maxima)	}	$V_a$	= max. 300 V $\pm$ 1%
Anode dissipation			$W_a$	= max. 5 W <sup>2)</sup>
Cathode current			$I_k$	= max. 20 mA

Heater supply voltage . . . . .	$V_{bf}$	=	6.3	V
Heater series resistor . . . . .	$R_f$	=	3	$\Omega$
Frequency . . . . .	$f$	=	750	375 Mc/s
Anode voltage . . . . .	$V_a$	=	290	300 V
Anode current . . . . .	$I_a$	=	19.6	18.6 mA
Grid current . . . . .	$I_g$	=	0.4	1.5 mA
Input power . . . . .	$W_{ia}$	=	5.7	5.6 W
Output power . . . . .	$W_o$	=	0.7	2.2 W

OPERATING CONDITIONS (HEATER AND ANODE VOLTAGE STABILIZED)

Limiting values (absolute maxima)

Anode voltage	} (absolute maxima)	}	$V_a$	= max. 300 V $\pm$ 1%
Anode dissipation			$W_a$	= max. 5 W <sup>2)</sup>
Cathode current			$I_k$	= max. 30 mA

Heater voltage . . . . .	$V_f$	=	6.3 <sup>3)</sup>	V
Frequency . . . . .	$f$	=	750	375 Mc/s
Anode voltage . . . . .	$V_a$	=	220	300 V
Anode current . . . . .	$I_a$	=	27.7	26.3 mA
Grid current . . . . .	$I_g$	=	2.3	4.0 mA
Input power . . . . .	$W_{ia}$	=	6.1	7.9 W
Output power . . . . .	$W_o$	=	1.1	3.8 W

<sup>2)</sup> This value must be adjusted for each tube separately.

<sup>3)</sup> See note on page 14.

LIMITING VALUES

*Absolute maxima*

Anode voltage in cold state . . . . .	$V_{ao}$ = max.	550 V
Anode voltage . . . . .	$V_a$ = max.	300 V
Anode dissipation . . . . .	$W_a$ = max.	5 W
Cathode current . . . . .	$I_k$ = max.	30 mA
Grid bias . . . . .	$V_g$	= max. 100 V
Grid current start . . . . .	$V_g$ ( $I_g = 0.3 \mu A$ )	= max. -1.3 V
Grid current . . . . .	$I_g$	= max. 7.5 mA
External resistance between grid and cathode	$R_g$	= max. 1 M $\Omega$
External resistance between cathode and heater	$R_{fk}$	= max. 20 k $\Omega$
Voltage between cathode and heater	$V_{fk}$	= max. 100 V

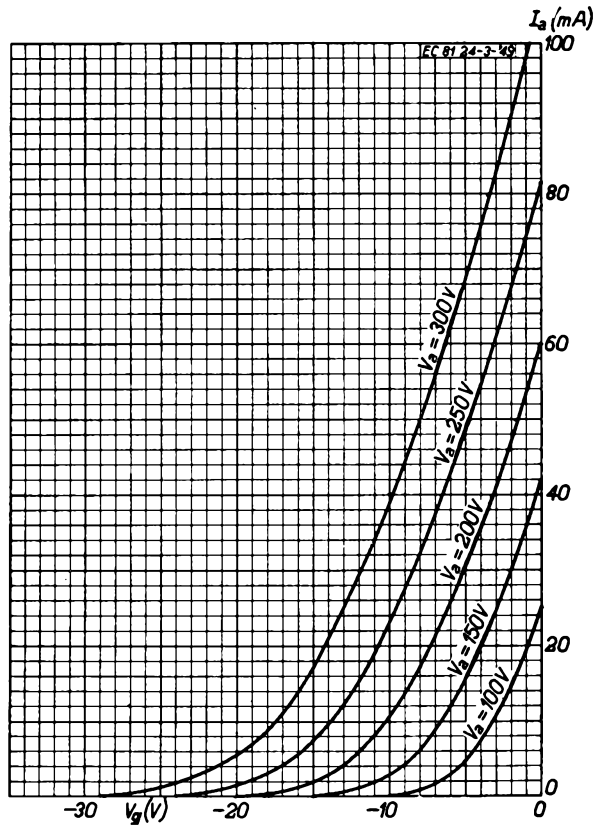

Fig. 13.  $I_a|V_a$  characteristics of the EC 81.

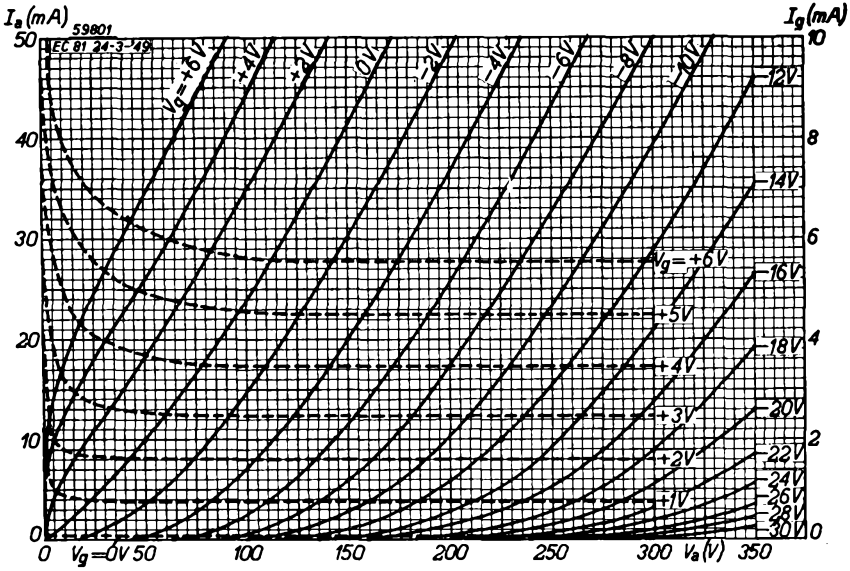

Fig. 14.  $I_a/V_a$  characteristics (drawn) and  $I_g/V_a$  characteristics (dashed) of the EC 81.

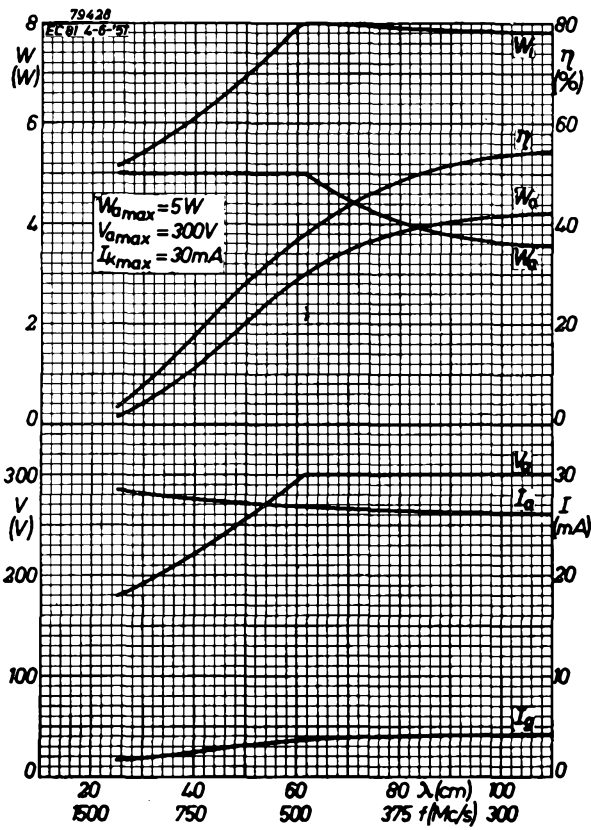

Fig. 15. Operating characteristics of the EC 81 as an oscillator. The output power ( $W_o$ ), the anode dissipation ( $W_a$ ), the anode input power ( $W_i$ ), the anode voltage ( $V_a$ ), the anode current ( $I_a$ ) and the grid current ( $I_g$ ) are plotted as functions of the frequency  $f$  and the wavelength  $\lambda$ . The maximum values of the anode voltage (300 V), the anode dissipation (5 W) and the cathode current (30 mA) are absolute maximum ratings.

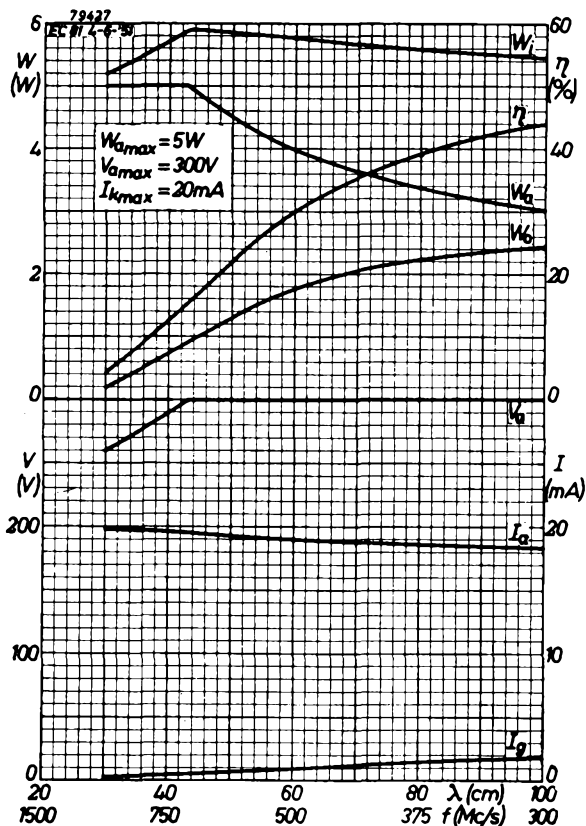

Fig. 16. As fig. 15, the anode voltage and dissipation being maximum, but with reduced cathode current. The maximum values of the anode voltage (300 V) and the anode dissipation (5 W) are absolute maximum ratings, that of the cathode current (20 mA) is a design-centre rating.

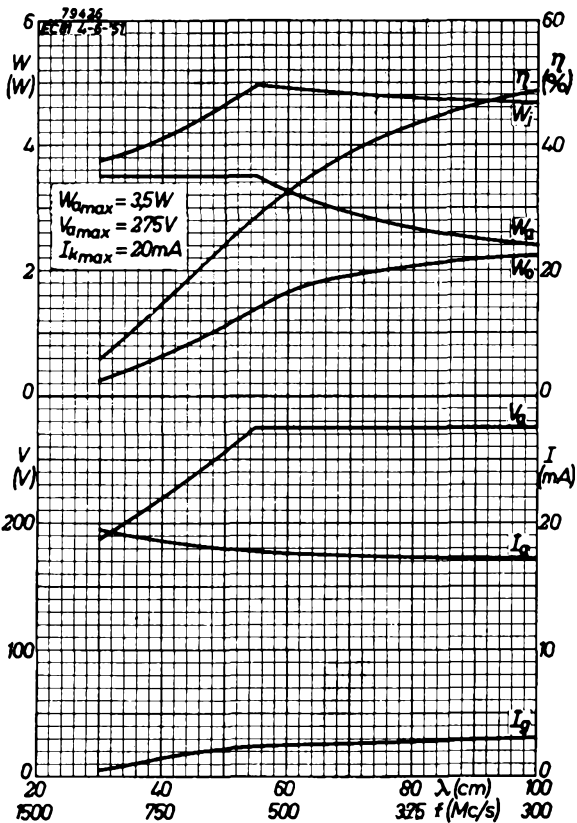

Fig. 17. As fig. 15, under normal operating conditions. The maximum values of the anode voltage (275 V), the anode dissipation (3.5 W) and the cathode current (20 mA) are design-centre ratings.

## BASE AND SOCKET

The EC 81 is provided with a standard noval base. Owing to the very high frequencies at which the tube can be used, the material of the socket must answer very high requirements. The tube socket type 5908/46 is recommended. In order to diminish as far as possible the capacitances between the various electrode leads, it is recommended to remove the unused contacts of the socket. At the highest frequencies the tube must be used without socket. The small dimensions and the normal operating voltages make the EC 81 specially suitable for use in fixed and mobile equipment. The tube can be mounted in all positions; if, however, shocks have to be expected, or if the tube is not used in an upright position, it is recommended that the tube be supported.

In order to obtain sufficient cooling, the tube must be installed in such a way that air can circulate freely around it. This is of special importance if the tube is used with its maximum admissible anode dissipation.

## SIMPLE U.H.F. OSCILLATOR WITH THE EC 81

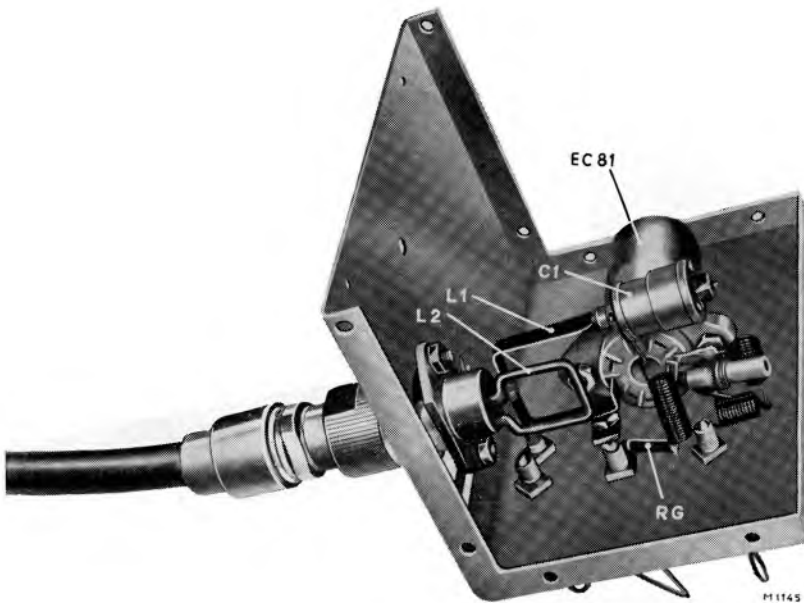

Fig. 18. Photograph of a compact and simple construction of an oscillator with the EC 81 tube (frequency = 470 Mc/s.  $\lambda = 64$  cm).

In figs 18 and 19, a compact and simple construction of an oscillator with the EC 81 is shown. The coil of the oscillator circuit is made of a bent strip ( $L_1$ ), the tuning capacitor ( $C_1$ ) is a normal trimming capacitor. The results obtained with this oscillator at a frequency of 470 Mc/s are shown in figs 20 to 22.

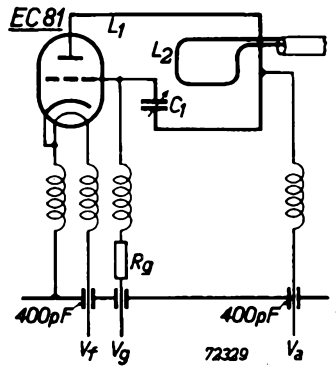

Fig. 19. Circuit diagram of the oscillator of fig. 18. For the value of the grid leak, see fig. 20-22.

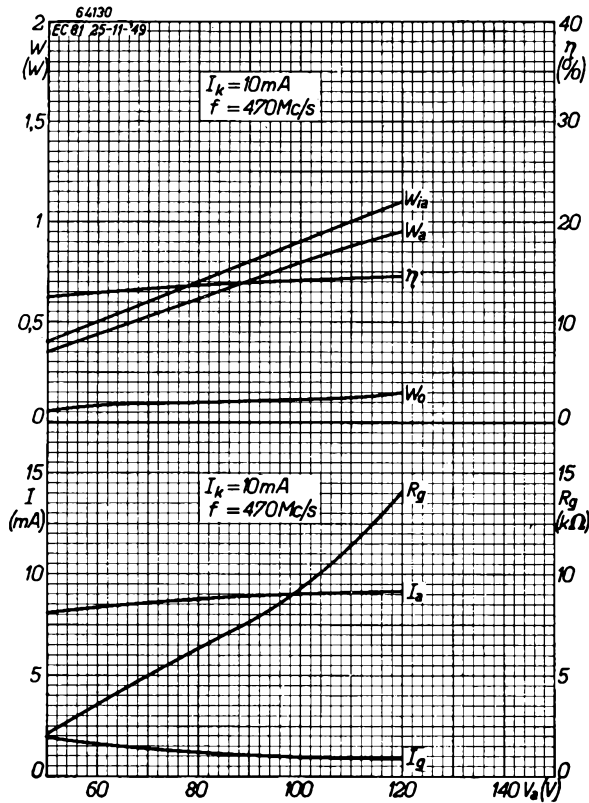
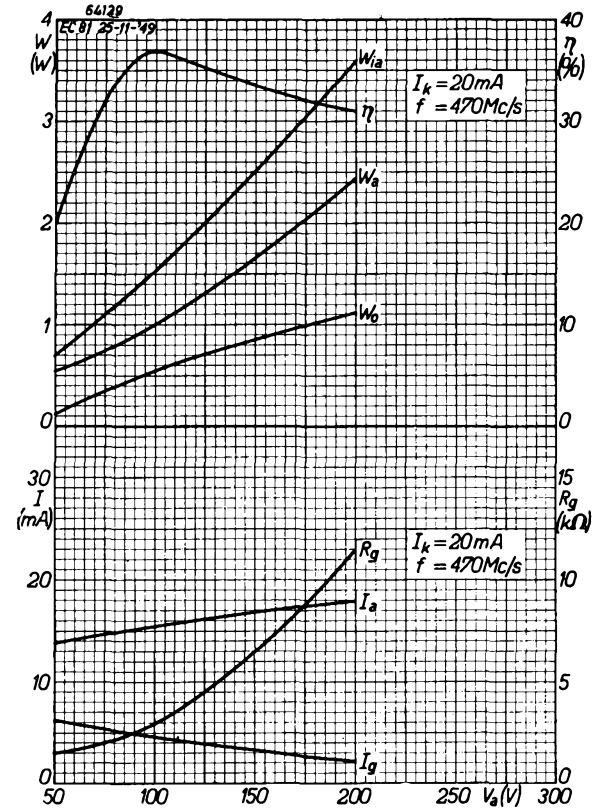
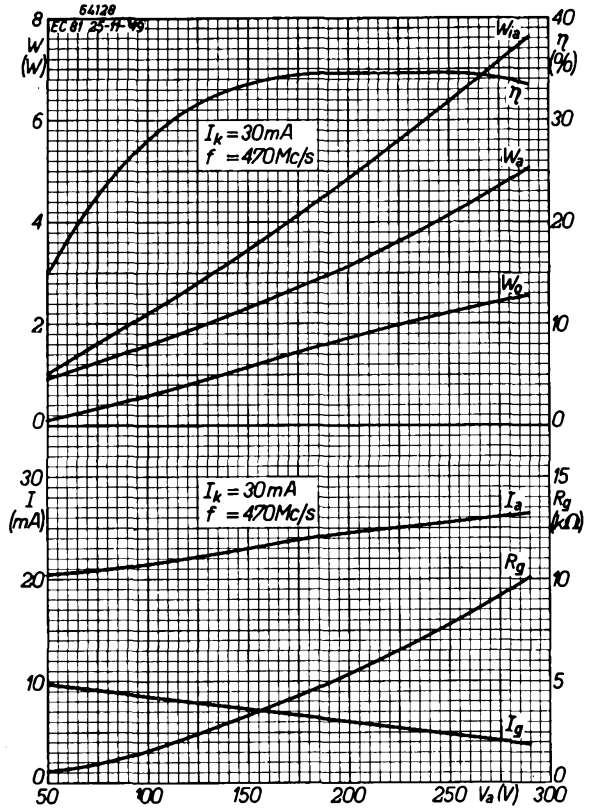

Fig. 22. As fig. 20, but at a cathode current of 10 mA.



Figs 20 and 21. Operating characteristics of the EC 81 as an oscillator at 470 Mc/s, measured in the arrangement according to figs 18 and 19. The power output ( $W_o$ ), the anode dissipation ( $W_a$ ), the anode input power ( $W_{ia}$ ), the efficiency ( $\eta$ ), the anode current ( $I_a$ ), the grid current ( $I_g$ ) and the optimum value of the grid leak ( $R_g$ ) are plotted as functions of the anode voltage at a cathode current of 30 mA (fig. 20) and 20 mA (fig. 21). (The absolute maximum ratings of the anode voltage, the anode dissipation and the cathode current are 300 V, 5 W and 30 mA respectively).

Simple U.H.F. oscillator with the EC 81



## OSCILLATOR WITH TWO TUBES EC 81 PUSH-PULL FOR APPROX. 440 Mc/s

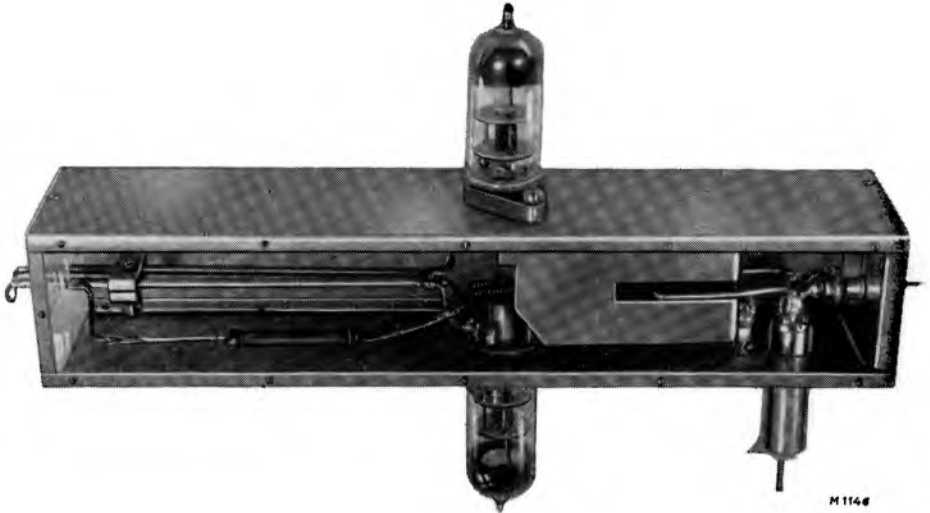

*Fig. 23. Photograph of a push-pull oscillator with two EC 81 tubes for a frequency of 440 Mc/s. The obtainable output power is 7 W.*

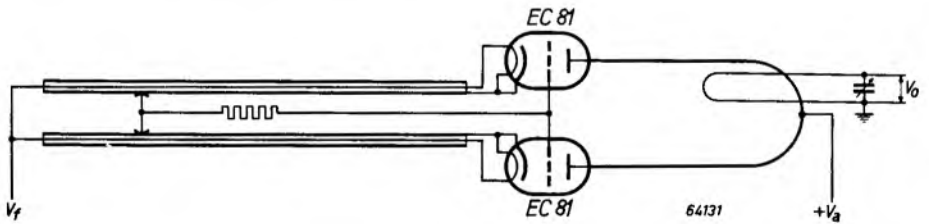

*Fig. 24. Circuit diagram of the oscillator of fig. 23.*

In figs 23 and 24 a push-pull oscillator with two tubes type EC 81 is shown. The oscillator circuit is a bent metal plate connected between the anodes. This oscillator is intended for use with impulse modulation at 440 Mc/s, and is capable of delivering an output power of 7 watts.

## SIMPLE OSCILLATOR WITH THE EC 81 FOR USE IN BALLOON SONDES AT 395 Mc/s

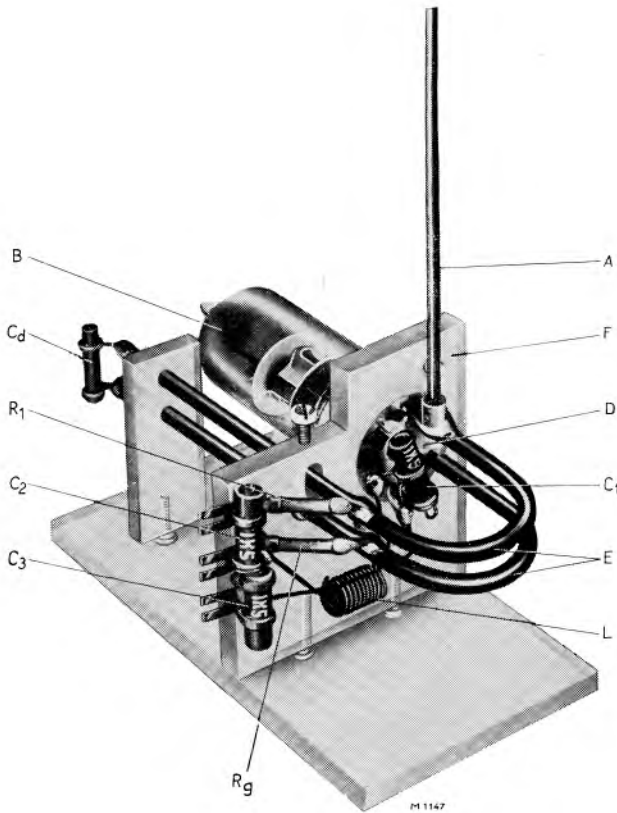

*Fig. 25. Photograph of a simple oscillator with a EC 81 for use in balloon sondes.*

In figs 25 and 26 are shown the mechanical set-up and the circuit diagram of an oscillator with the tube EC 81 operating at a frequency of 395 Mc/s, designed for use in balloon sondes.

The oscillator circuit, inserted between the anode and the grid, consists of a parallel-wire transmission line, half-a-wavelength long, which acts like an open circuit (parallel-resonant circuit). Its length is reduced at one side by the anode-grid capacitance of the tube, and for the sake of symmetry it is shortened at the other side by a dummy capacitor  $C_d$ .



*Simple oscillator with the EC 81 for use in balloon sondes at 395 Mc/s*

---

<i>B</i>	Tube . . . . .	EC 81
<i>F</i>	Frame . . . . .	perspex or hardpaper
<i>D</i>	Socket . . . . .	ceramic without shield base (type 5908/03)
<i>E</i>	Lecher system . . . . .	2 × brass rod or brass tube 3 mm diameter distance      10 mm length        130 mm bent around 20 mm diameter

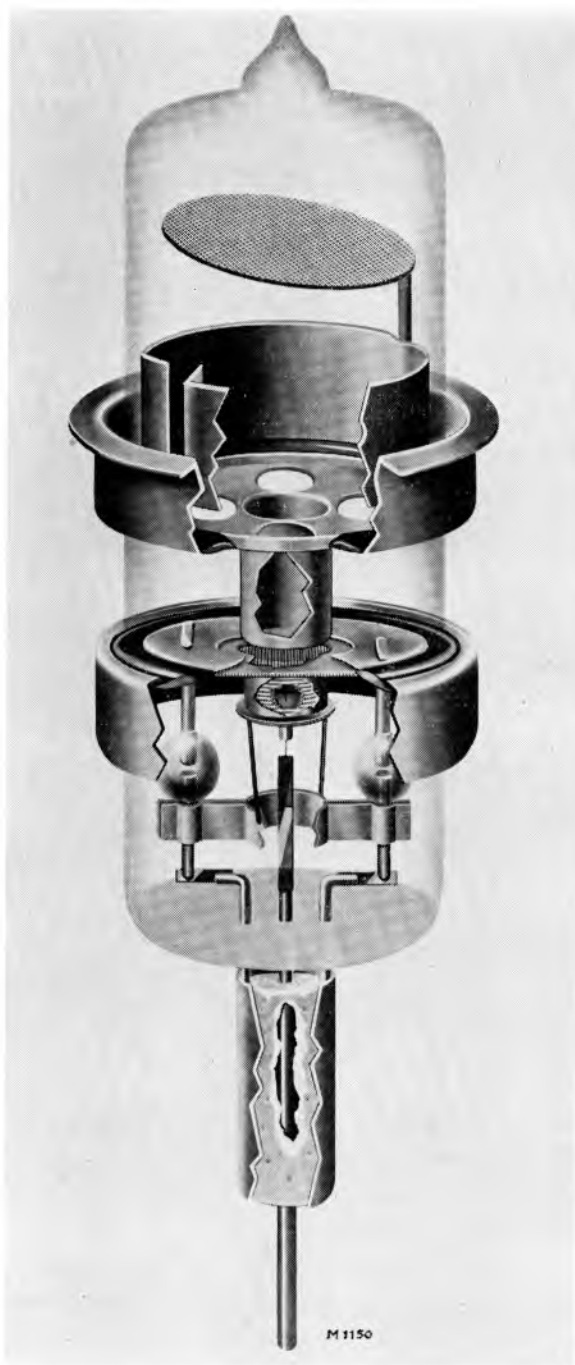

*Fig. 28. Greatly enlarged representation of the EC 55.*

# U.H.F. DISC-SEAL TRIODE EC 55

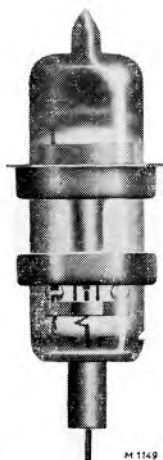

Fig. 27. Photograph of the EC 55 (actual size).

The EC 55, a disc-seal triode, has been developed for use in receivers and small transmitting installations working in the ultra-high frequency band. The mutual conductance amounts to 6 mA/V at an anode current of 20 mA, and the amplification factor is 30.

The applications of the EC 55 are manifold both in transmitting and receiving. In receivers, the tube can be used as a high-frequency amplifier and local oscillator, and in transmitters as a self-excited, controlled and impulse-modulated transmitting tube.

The EC 55 is mainly intended for use in coaxial line circuits, for which purpose the electrode connections have been given a special shape. When the tube is used as an oscillator in a coaxial line circuit, the output power with an anode input of 10 watts is about 2.8 W at 1000 Mc/s ( $\lambda = 30$  cm), about 1.4 W at 2000 Mc/s ( $\lambda = 15$  cm) and about 0.5 W at 3000 Mc/s ( $\lambda = 10$  cm).

The resistance and self-inductance of the electrode leads have been reduced to a minimum, thanks to the copper discs fused into, and protruding beyond the envelope. The outer parts of these discs have been shaped in a special way, permitting the tube to be easily inserted in coaxial line circuits. The grid is composed of stretched wires, to prevent buckling due to heating, thus keeping frequency drift to a minimum. Moreover, the grid and the disc to which it has been attached, function as a screen between the anode and the cathode, so that the coupling between the input and output circuits is very small.

Cooling of the anode is achieved mainly by thermal conduction to the line circuit. In order to limit the anode seal temperature, and also its rate of change, it is necessary for the mass of metal in close thermal contact with the anode disc to be not less than 60 grammes of brass or its equivalent.

## TECHNICAL DATA

### HEATER DATA

Heating: indirect by a.c. or d.c.: parallel supply

Heater voltage . . . . .  $V_f = 6.3 \text{ V} \pm 5\%$

Heater current . . . . .  $I_f = 0.4 \text{ A}$

CAPACITANCES (measured with tube cold)

Capacitance between grid and cathode . . . . .	$C_g = 1.8 \text{ pF}$
Capacitance between grid and anode . . . . .	$C_{ag} < 1.3 \text{ pF}$
Capacitance between anode and cathode . . . . .	$C_a = 0.03 \text{ pF}$

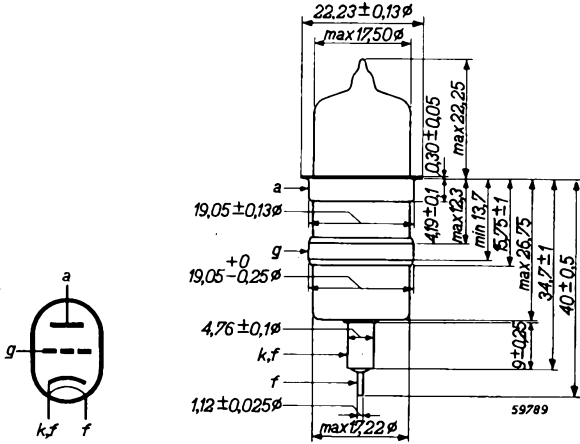

Fig. 29. Electrode arrangement, electrode connections and maximum dimensions in mm.

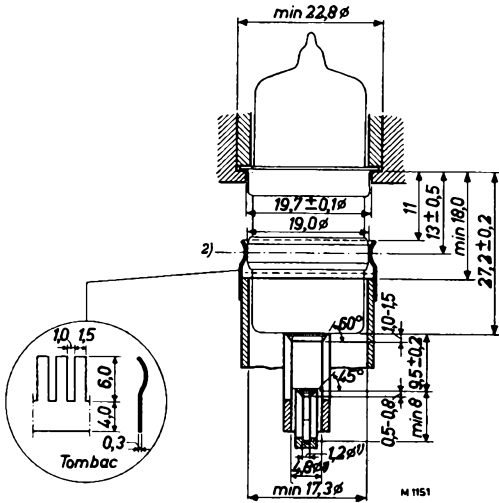

Fig. 30. Eccentricity. Distance between axes of the electrodes:

- g-a max. 0.38 mm;
- k-a max. 0.38 mm;
- f-k max. 0.12 mm.

- 1) In order to make good contact, these sockets should be split.
- 2) Line of contact.

TYPICAL CHARACTERISTICS

Anode voltage . . . . .	$V_a = 250 \text{ V}$
Grid bias . . . . .	$V_g = -3.5 \text{ V}$
Anode current . . . . .	$I_a = 20 \text{ mA}$
Mutual conductance . . . . .	$S = 6 \text{ mA/V}$
Amplification factor . . . . .	$\mu = 30$

LIMITING VALUES (absolute maxima)

Anode voltage . . . . .	$V_a = \text{max. } 350 \text{ V}$
Anode dissipation . . . . .	$W_a = \text{max. } 10 \text{ W}$
Cathode current . . . . .	$I_k = \text{max. } 40 \text{ mA}$
Anode seal temperature . . . . .	$T = \text{max. } 140 \text{ }^\circ\text{C}$
Grid dissipation . . . . .	$W_g = \text{max. } 0.1 \text{ W}$
Grid voltage . . . . .	$-V_g = \text{max. } 50 \text{ V}$

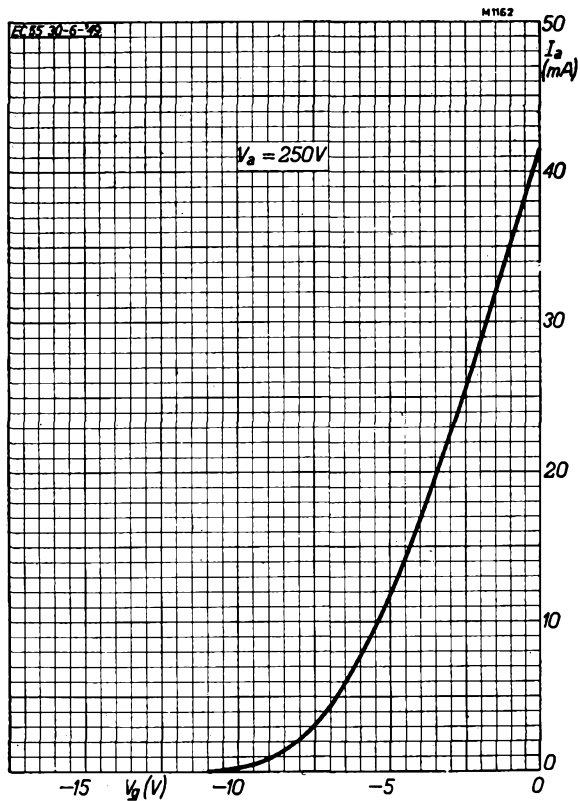

Fig. 31.  $I_a/V_g$  characteristic of the EC 55 at an anode voltage of 250 V.



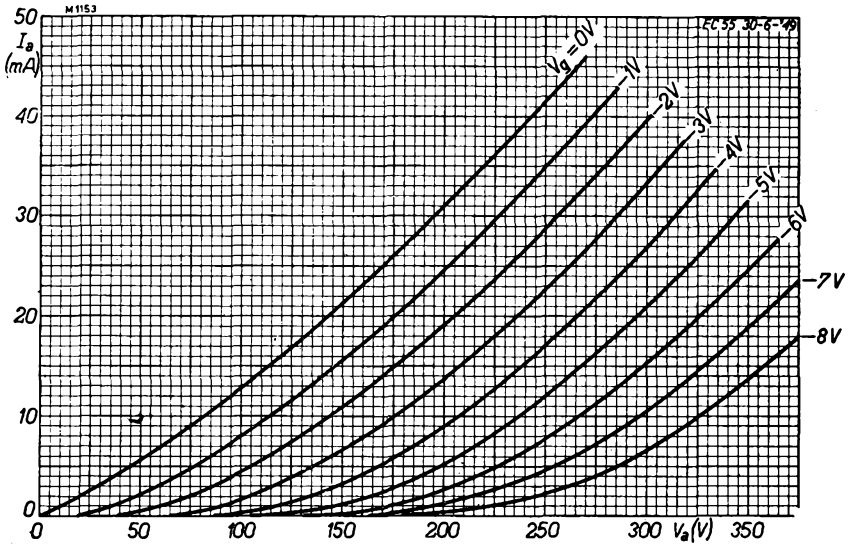

Fig. 32.  $I_a/V_a$  characteristics of the EC 55.

## OSCILLATOR WITH THE EC 55 OPERATING BETWEEN 730 and 1350 Mc/s

A practical oscillator with the tube EC 55 and its assembly are shown in figs 33 to 35. The anode-grid and grid-cathode circuits are coaxial lines, the grid tube being common to both circuits. The circuits are tuned by means of movable shorting plungers. In this way every desired value of the imaginary portion of the admittance between grid and anode (grid and cathode) can be adjusted.

This circuit arrangement is known as the grid separation circuit or grounded anode circuit, and is outlined in fig. 9. To achieve oscillation, capacitive feedback is applied by means of a probe, which is screwed in the outer wall of the anode tube and "peeps" towards the cathode through an opening in the grid tube.

The oscillation frequency is mainly determined by the grid-anode circuit. The optimum value of the feedback depends on the position of the shorting plunger in the cathode-grid circuit and the value of the capacitance between cathode and anode. The cathode, grid and anode having different voltages, have to be insulated from each other against direct voltage. This is done by inserting separating capacitors in the moving bridges. It is also possible to use a separating capacitor near the anode, in order to keep the outer wall at earth potential.

The heater lead is fed through the cathode tube and is decoupled by two capacitors in order to avoid parasitic oscillations.

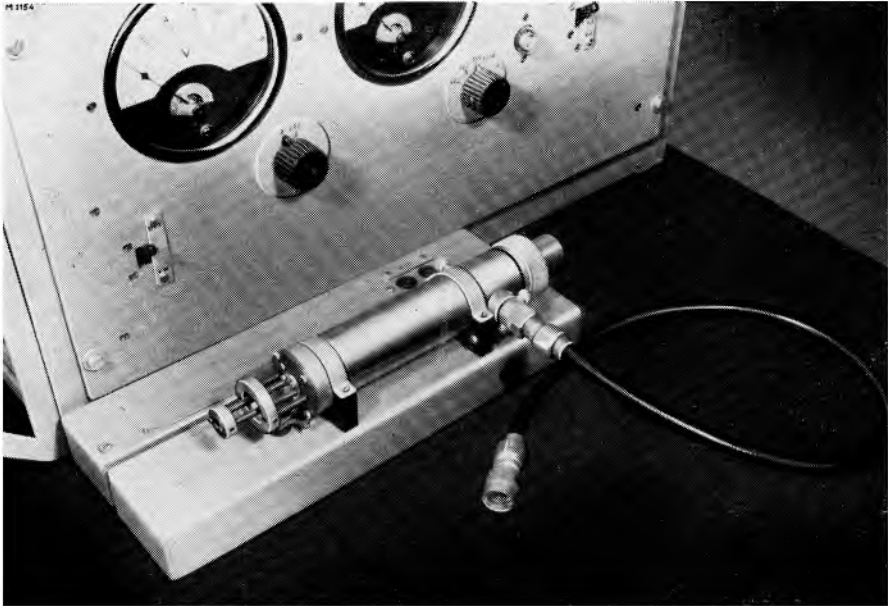

*Fig. 33. Photograph of an oscillator with the EC 55; frequency range from 730-1350 Mc/s.*

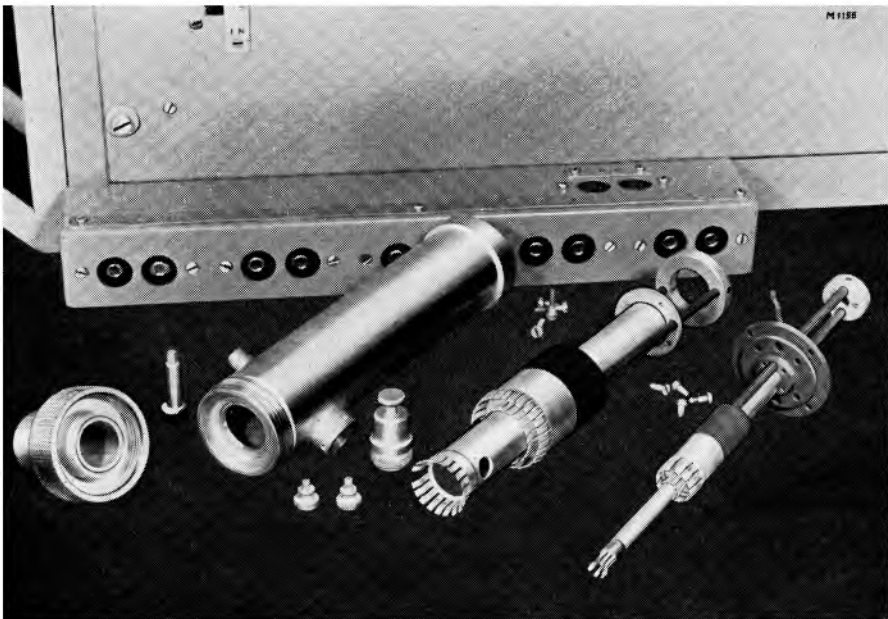
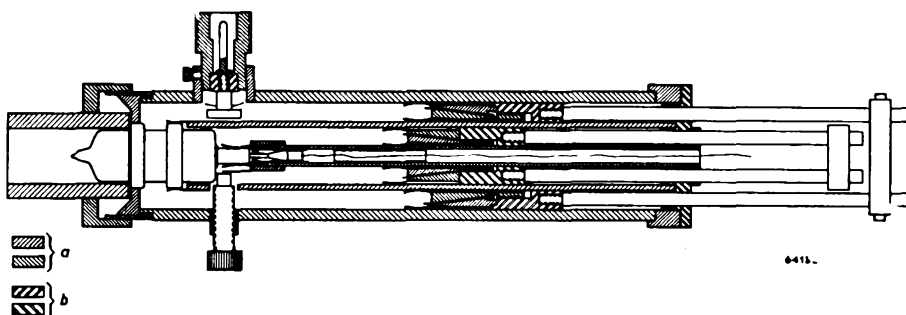

*Fig. 34. Photograph of the parts of the coaxial line circuit of the oscillator of fig. 33.*

The oscillator operates in the so-called  $\frac{1}{4}$ - $\frac{1}{4}$  mode, i.e. the length of both the two coaxial lines is about  $\frac{1}{4}$  of a wavelength.

The material used for the cylinders and flanges is brass; phosphorous bronze is used for the contact springs. After assembling and soldering of the parts, the resonators have been silver-plated. The assembly of the circuits can be seen clearly in figs 33 and 34.

The rods operating the shorting plungers are made from insulating material, in order to avoid parasitic effects upsetting the tuning itself. Conducting rods would also have some radiation due to leakage from the tuned circuit, thus introducing additional losses.



*Fig. 35. Cross section through the oscillator of fig. 33.  
a = metal; b = insulation.*

The feedback is applied by means of a screw, effecting a capacitive coupling between anode and cathode. The capacitive coupling of the output to the anode-grid circuit can be adjusted by moving the cable connector in its socket.

The oscillator can be adjusted between 730 and 1350 Mc/s (wavelength 41-22 cm). The upper frequency is limited by the outer plunger being blocked by the capacitive coupling between anode and cathode; the lower frequency is limited by the length of the system.

The above-mentioned circuit has also been used as an impulse-modulated oscillator, for which purpose negative pulses with a duration of 4  $\mu$ sec were applied to the cathode. The duty cycle was about 0.016, the oscillator frequency 1000 Mc/s. It showed that the EC 55 is able to supply H.F. pulses with a peak output power of about 225 watts (average value during each pulse about 165 W) and an efficiency of 36%. These results were obtained with an anode voltage pulse of about 1300 volts peak value (average value during each pulse about 950 volts), an anode current pulse of about 435 mA (average value during each pulse) and an average anode dissipation of 4.5 watts.

## S.H.F. DISC-SEAL TRIODES EC 56 and EC 57



Fig. 36. Photograph of the tubes EC 56 and EC 57 (actual size).

The EC 56 and EC 57 are indirectly heated disc-seal triodes, intended for use as oscillators or broad-band amplifiers in microwave relay stations at frequencies up to about 4000 Mc/s.

Both types are mechanically identical; they only differ in electrical properties.

Special features of these tubes are:

- a. low operating voltages, obtained with a common power supply;
- b. high efficiency compared with klystrons operating at the same frequency.

Owing to their special construction, the tubes are very suitable for insertion in coaxial lines and waveguide circuits, in which the grid serves as a separation between the anode and cathode circuit.

The grid disc is threaded to ensure solid mounting and good r.f. contact. Consequently

ly the tube should be screwed into its circuit.

The application of a planar 'L'-cathode allows a great current density. The clearance between the grid and the heated cathode is  $40 \mu$  approx. The cathode is directly connected with the corresponding disc, which provides the cathode r.f. connection.

The EC 56 is suitable for use as a general-purpose low-level amplifier, delivering a max. output of 1 watt approx. at 4000 Mc/s, at a bandwidth of 50 Mc/s. At frequencies up to about 2500 Mc/s, the EC 56 can be used advantageously as a low-noise pre-amplifier.

The EC 57 is specially intended for use as a power amplifier, as such delivering a power output of 3 watts approx. at 4000 Mc/s, at a bandwidth of 50 Mc/s.

The combined use of the EC 56 and EC 57 provides the possibility of constructing microwave link systems in the 4000 Mc/s band, the EC 57 being used as an output tube and the EC 56 as its driver. A two-stage amplifier of this kind has a low level gain (100 mW output power) of 29 dB (25 dB resp.) at an overall flat transmission bandwidth of 35 Mc/s (50 Mc/s resp.) between the 0.1 dB points. When the output is increased to 1.5 watt (1 watt resp.), the total gain drops to about 25 dB (21 dB resp.) and the bandwidth is slightly increased.

## GENERAL DATA OF THE EC 56 and EC 57 (tentative data)

Heating: indirect by a.c. or d.c.; parallel supply only

Heater voltage . . . . .	6.3 V <sup>1)</sup>
Heater current . . . . .	0.65 A

### CAPACITANCES

*Inter-electrode capacitances*

Anode to grid . . . . .	1.6 pF
Anode to cathode . . . . .	20 mpF
Grid to cathode . . . . .	2.2 pF

### MAXIMUM RATINGS (absolute maxima)

Anode voltage at zero anode current . . . . .	500 V
Anode voltage . . . . .	300 V
Anode dissipation . . . . .	10 W
Cathode current	{ EC 56 . . . . . 35 mA { EC 57 . . . . . 70 mA
Grid current . . . . .	
Grid positive bias . . . . .	0 V
Grid negative bias . . . . .	-50 V
Heater to cathode voltage (cathode positive) . . . . .	50 V
Anode seal temperature . . . . .	200 °C <sup>2)</sup>
Grid seal temperature . . . . .	75 °C <sup>2)</sup>
Cathode seal temperature . . . . .	75 °C <sup>2)</sup>

### INSULATION *k<sub>f</sub>*

Heater-cathode current with a heater-cathode voltage of 50 V and a heater voltage of 6.3 V is maximum 100  $\mu$ A.

### INVERSE GRID CURRENT

At a heater voltage of 6.3 V and an anode dissipation of 10 W, the inverse grid current is maximum 0.6  $\mu$ A.

DIMENSIONS: See outline

### BASE CONNECTIONS

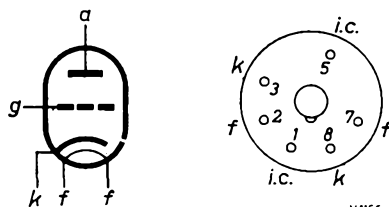

Fig. 37. Electrode arrangement and base connections (modified octal base).

<sup>1)</sup> <sup>2)</sup> See page 35.

## TECHNICAL DATA of the EC 56 (tentative data)

### Typical characteristics as amplifier

Anode voltage . . . . .	180 V
Anode current . . . . .	30 mA
Grid voltage . . . . .	-3.5 V
Mutual conductance . . . . .	16 mA/V
Amplification factor . . . . .	35

### Operating conditions as amplifier at 4000 Mc/s

Anode supply voltage . . . . .	220 V
Grid supply voltage . . . . .	+40 V
Cathode bias resistor . . . . .	<sup>3)</sup>
Anode current . . . . .	30 mA
Bandwidth (between half-power points) . . . . .	100 50 Mc/s <sup>4)</sup>
Power gain at 1 mW output power . . . . .	13 17 dB
Output power at 8 dB power gain . . . . .	0.6 1.2 W

## TECHNICAL DATA of the EC 57 (tentative data)

### Typical characteristics at amplifier

Anode voltage . . . . .	180 V
Anode current . . . . .	60 mA
Grid voltage . . . . .	-1.8 V
Mutual conductance . . . . .	19 mA/V
Amplification factor . . . . .	35

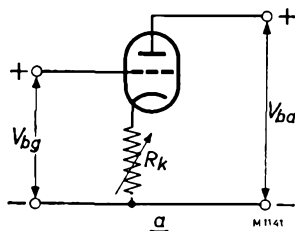

Fig. 38. Recommended d.c. circuit for the EC 56 and EC 57.

<sup>1)</sup> To prolong the life of the tube, the maximum variation of the heater voltage should be less than  $\pm 2\%$  (absolute limits).

<sup>2)</sup> Low velocity air flow may be required.

<sup>3)</sup> To obtain good stability, a variable resistor of maximum 2000 ohms is necessary. It should be adjusted so as to obtain the desired anode current. In this way negative direct current feedback is introduced (see fig. 38).

<sup>4)</sup> The given bandwidth is obtained by adjusting the coupling between the anode circuit and the output waveguide. The anode circuit impedance, referred to the output waveguide, presents a voltage standing-wave ratio, which varies from 3 to 15, depending on the tube and the bandwidth.

Operating conditions as amplifier at 4000 Mc/s

Anode supply voltage . . . . .					220 V
Grid supply voltage . . . . .					+40 V
Cathode bias resistor . . . . .					<sup>3)</sup>
Anode current . . . . .	45		60		mA
Bandwidth (between half-power points)	100	50	100	50	<sup>4)</sup>
Power gain at 1 mW output .. . . .	13.8	17.5	14.0	17.6	dB
Output power at 8 dB power gain . . .	1.2	2.4	1.6	3.2	W

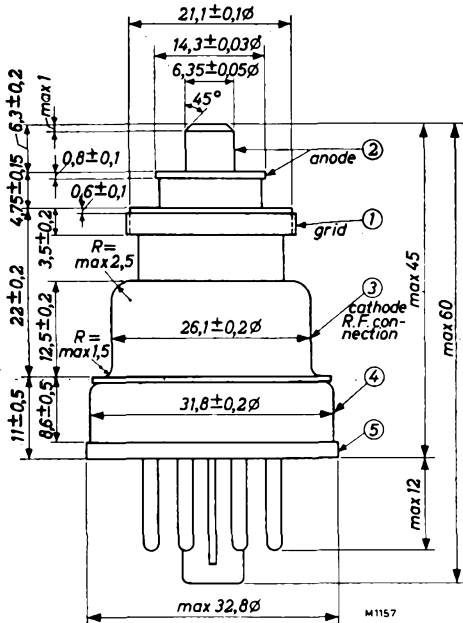

Fig. 39. Dimensional drawing\*); dimensions in mm.

Data of thread of the grid disc:

32 turns per inch; thread angle 60°

minor diameter:	21.22	+ 0 mm	- 0.15 mm
major diameter:	22.2	+ 0 mm	- 0.15 mm
effective diameter:	21.68	+ 0 mm	- 0.09 mm

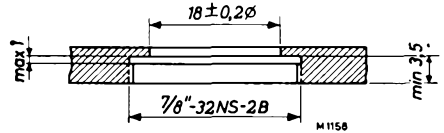

Fig. 40. Recommended mount\*); dimensions in mm.

Data of thread:

32 turns per inch; thread angle 60°

minor diameter:	21.51	+ 0 mm	- 0.15 mm
major diameter:	min 22.23		
effective diameter:	21.83	+ 0 mm	- 0.12 mm

<sup>3)</sup> <sup>4)</sup> See page 35.

\*) The following points should be considered with respect to the maximum eccentricities, referring to the figures 1 to 5 within the small circles in fig. 39.

(1) The eccentricities are given with respect to the axis of the threaded hole shown in fig. 40, the grid disc of the tube being screwed firmly against the flange (with inner diameter of 17 mm).

(2) Maximum eccentricity of the anode 0.15 mm.

(3) Maximum eccentricity of the cathode R.F. connection 0.20 mm.

(4) The tolerance of the eccentricity of the base is such that this base fits into a hole with a diameter of 32.5 mm, provided this hole is correctly centred with respect to the axis of the hole specified in fig. 40.

(5) The tolerance of the eccentricity of the base flange is such that this base flange fits into a hole with a diameter of 33.5 mm, provided this hole is correctly centred with respect to the axis of the hole specified in fig. 40.

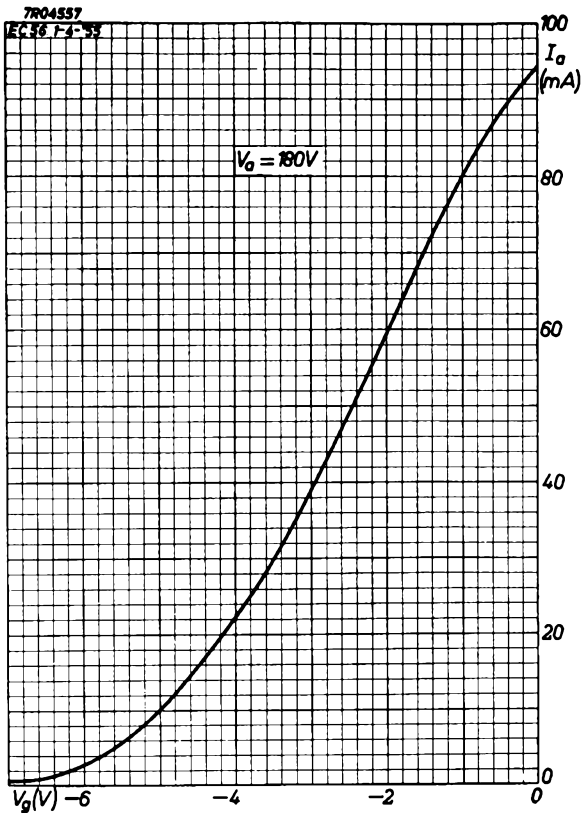

Fig. 41.  $I_a/V_g$  characteristic of the EC 56 at an anode voltage of 180 V.



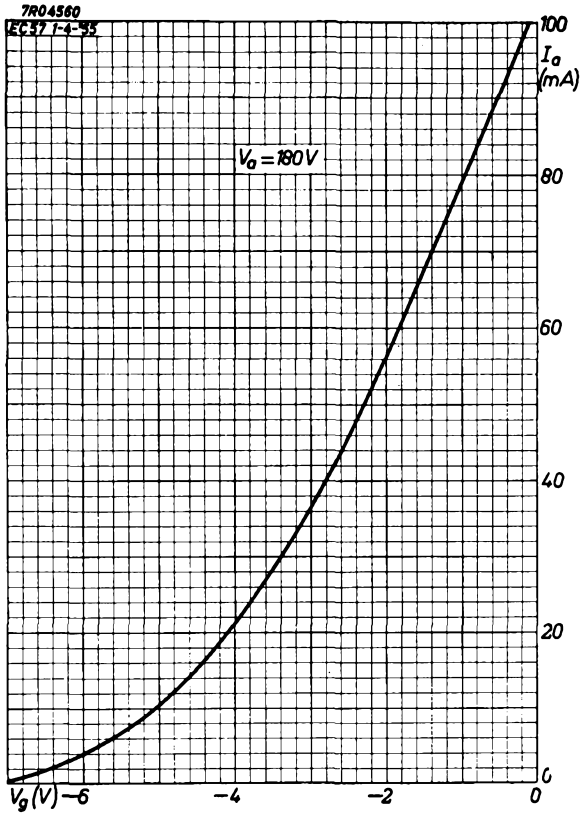

Fig. 42.  $I_a/V_a$  characteristic of the EC 57 at an anode voltage of 180 V.

Technical data

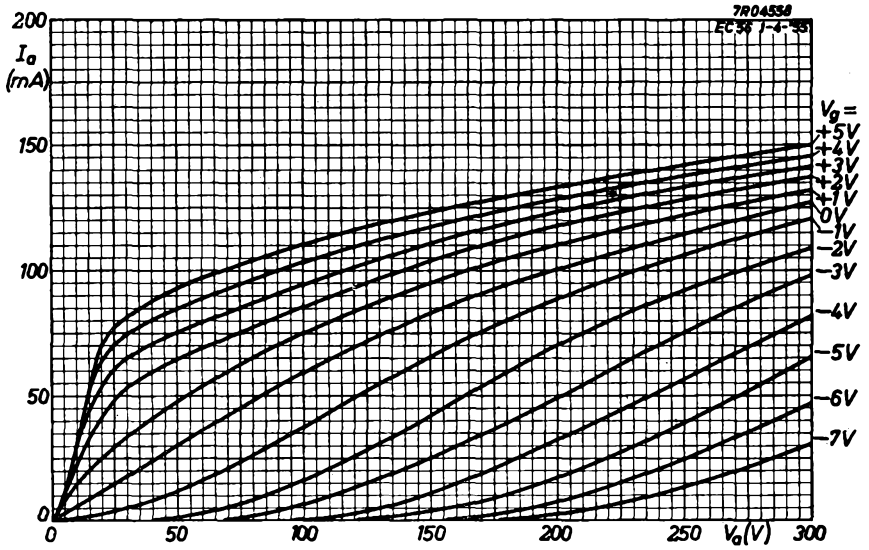

Fig. 43.  $I_c/V_c$  characteristics of the EC 56.

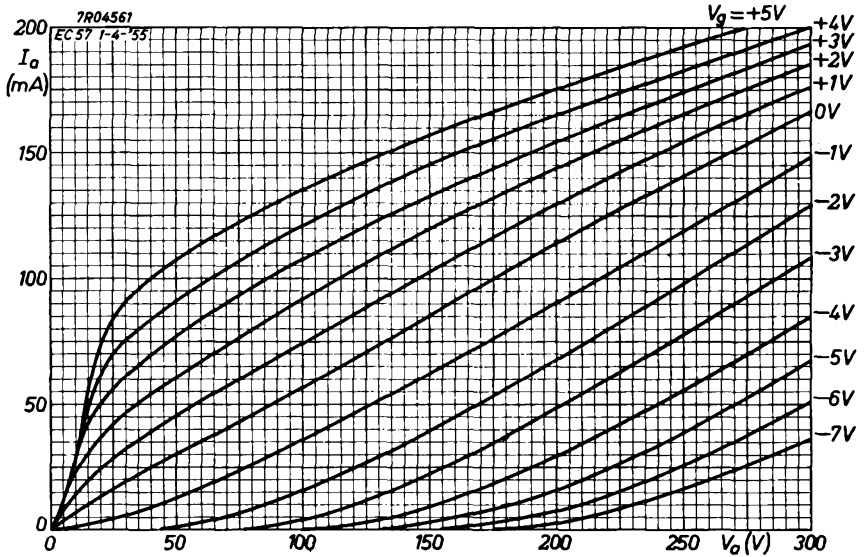

Fig. 44.  $I_a/V_a$  characteristics of the EC 57.

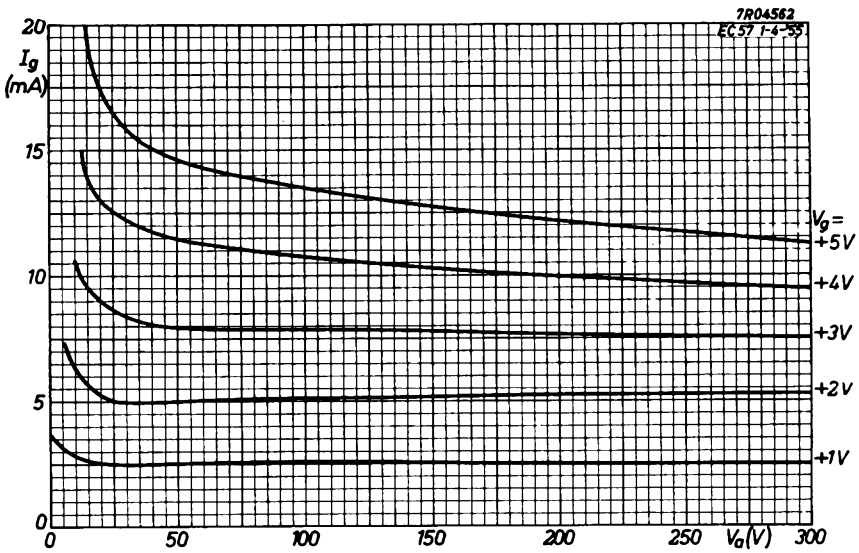

Fig. 45.  $I_a/V_a$  characteristics of the EC 57.

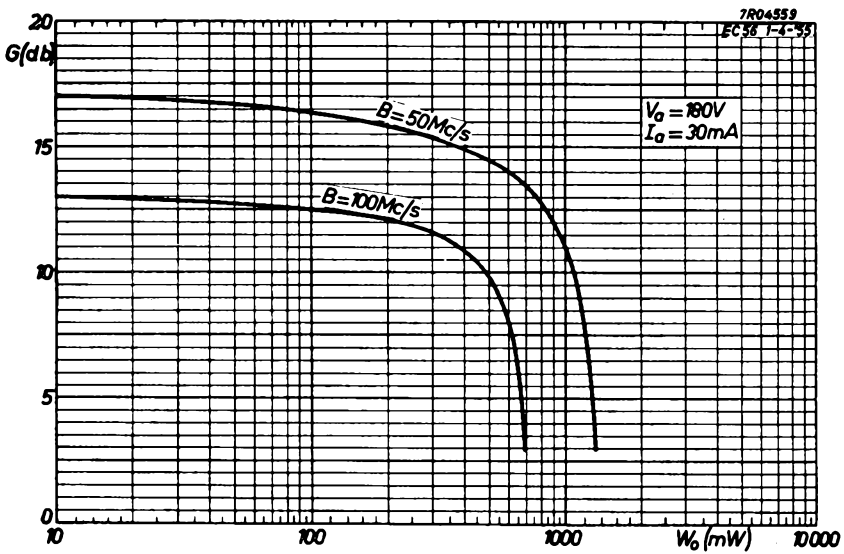

Fig. 46. Power gain  $G$  of the EC 56 as a function of the output power  $W_o$  with the bandwidth  $B$  as parameter at an anode current  $I_a = 30 mA$ .

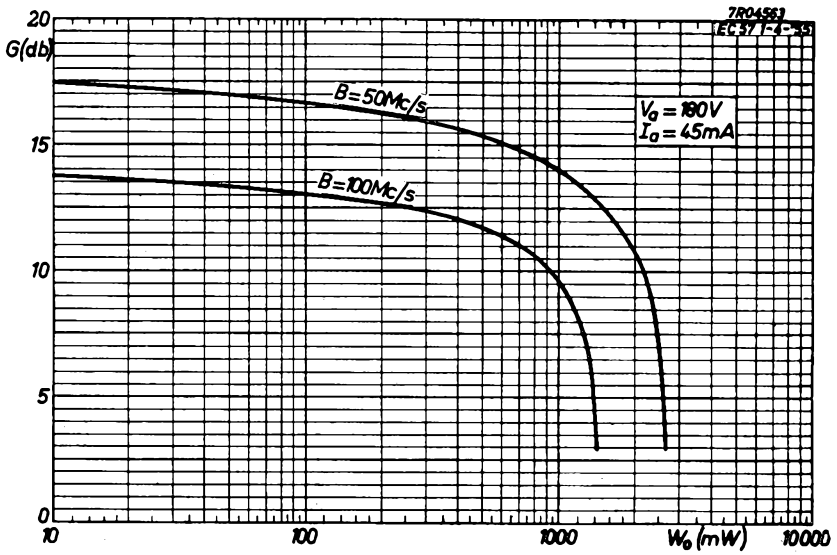

Fig. 47. Power gain  $G$  of the EC 57 as a function of the output power  $W_o$  with the bandwidth  $B$  as parameter at an anode current  $I_a = 45$  mA.

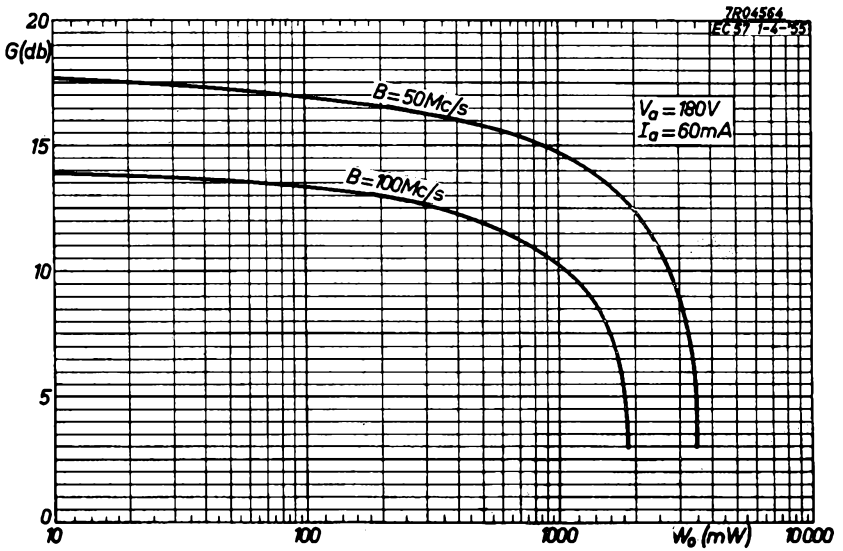

Fig. 48. Power gain  $G$  of the EC 57 as a function of the output power  $W_o$  with the bandwidth  $B$  as parameter at an anode current  $I_a = 60$  mA.

# REFLEX KLYSTRONS 2 K 25 and 723 A/B

The 2K25 and 723A/B (see fig. 49) are indirectly heated tunable reflex klystrons with internal cavity, intended for use as local oscillators in radar receivers, spectrum analyzers and test equipment.

The construction of both types is identical. They only differ in the frequency range covered and the power output.

Fig. 50 shows a cross section of the tube which displays the electrode arrangement. The electron gun consists of the cathode  $k$ , the focusing screen  $sc$  and the accelerator grid  $g_1$ . The screen is internally connected to the cathode. The three grids, of which the numbers 2 and 3 are part of the cavity resonator, are directly connected to the metal envelope, which is earthed and

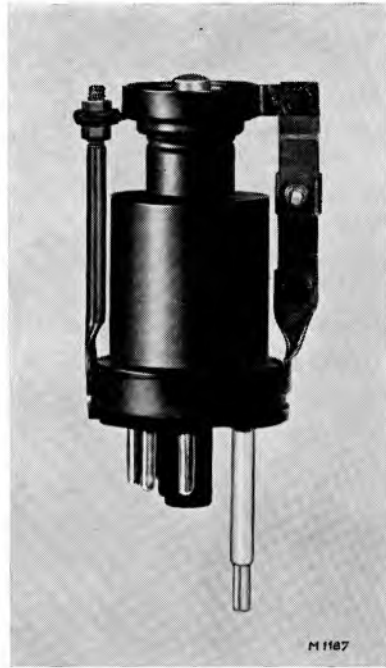

Fig. 49. Photograph of the tubes 2K25 and 723A/B (actual size).

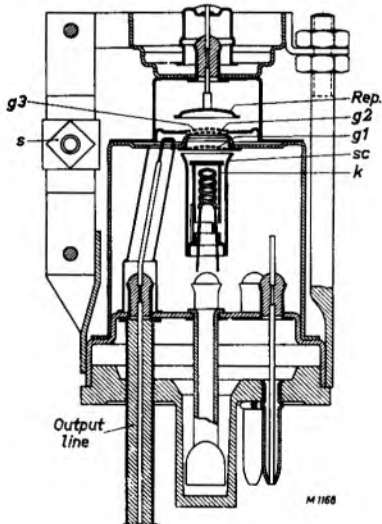

Fig. 50. Cross section of the 2K25 and 723 A/B.

has a potential of 300 V positive with respect to the cathode.

Mechanical tuning is accomplished by moving the membrane-shaped upper part of the resonant cavity by means of the setting screw  $s$ , thus varying the capacitive element of the resonator. For proper frequency adjustment, the screw should be turned alternately above and below the desired frequency with gradually decreasing deviation <sup>1)</sup>.

In order to compensate frequency variations due to temperature changes, part of

<sup>1)</sup> To avoid mechanical defects, the cavity should not be tuned to frequencies beyond the specified frequency band.

the tuning mechanism is made of invar. The relative frequency shift thus obtained is less than 0.2 Mc/s per degree centigrade.

Electronic tuning is possible by varying the negative voltage applied to the repeller, which is connected to the top cap.

The coaxial output line protruding through the base is inductively coupled to the resonator by means of a loop. At the lower side of this line the inner conductor projects beyond the outer and acts like an aerial.

For good wide-band performance the tube should be inserted in a suitable mount. The mount recommended, shown in fig. 51, consists of a section of 3 cm waveguide (outside dimensions  $1' \times \frac{1}{2}'$ ) short-circuited at one side, into which the aerial of the tube penetrates.

The outer conductor of the output line should reach to the inner side of the waveguide. A good r.f. contact between the outer conductor and the guide is accomplished by a wave trap (fig. 52).

The tube socket, the hole of which corresponding to pin No. 4 of the base has been drilled in order to pass the coaxial output line, is fixed rigidly to the waveguide, to ensure proper installation.

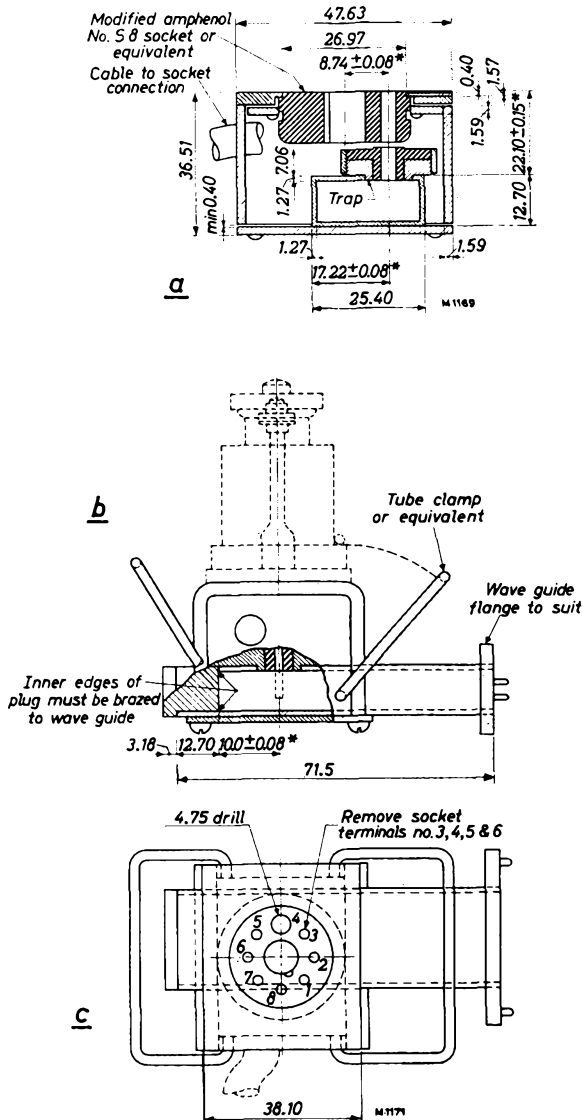

Fig. 51. Recommended mount.  
 (a) cross section,  
 (b) side view,  
 (c) top view.

The tube should be fixed firmly in the socket by clamps which make contact at the lower platform of the tube only.

Fig. 53 shows a typical graph of output power and frequency shift versus repeller voltage. The mechanical tuning is adjusted to 9300 Mc/s.

For use as a continuous oscillator, mode 'A' is recommended, the output coupling being designed for this purpose.

The values of the output power shown in fig. 53 are those delivered in a load presenting a unity standing-wave ratio in the waveguide. When the guide is not correctly terminated, output and frequency deviations will generally occur. These phenomena are shown in fig. 54, a so-called 'Rieke diagram', in which loci of constant power and frequency are drawn according to certain values of the amplitude and phase angle of the reflection coefficient which also corresponds to the standing-wave ratios indicated

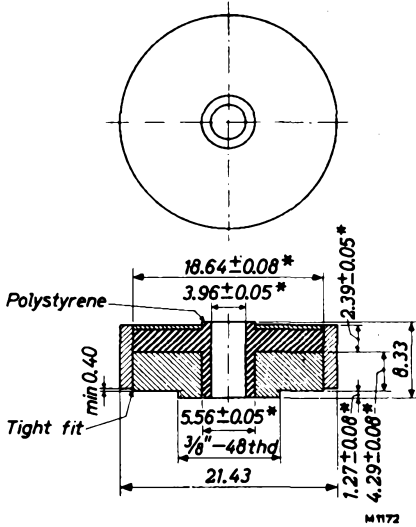

Fig. 52. Wave trap.

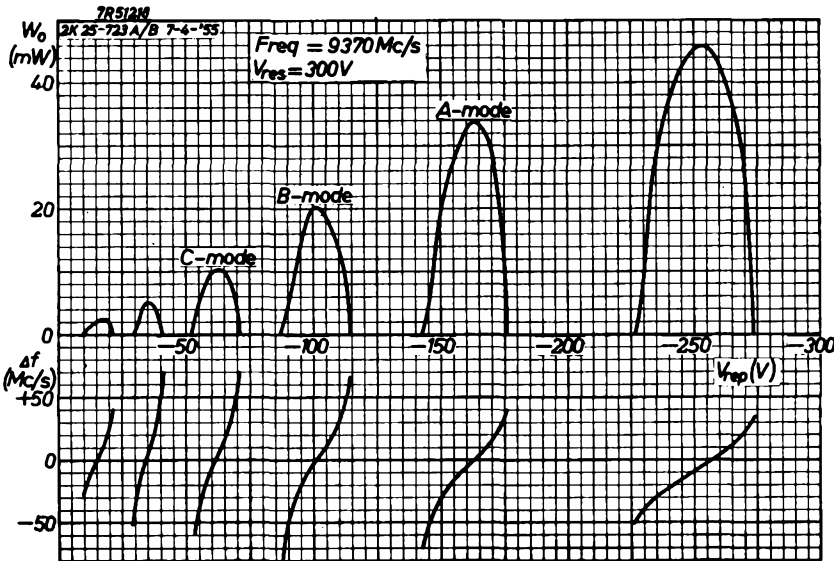

Fig. 53. Power output  $W_0$  and frequency shift  $\Delta f$  as functions of the repeller voltage.

in the diagram. The minimum standing-wave ratio at which oscillation stops, is called 'sink margin'. The 2K25 and 723A/B are designed to have a minimum sink margin of 8 dB and 4 dB respectively.

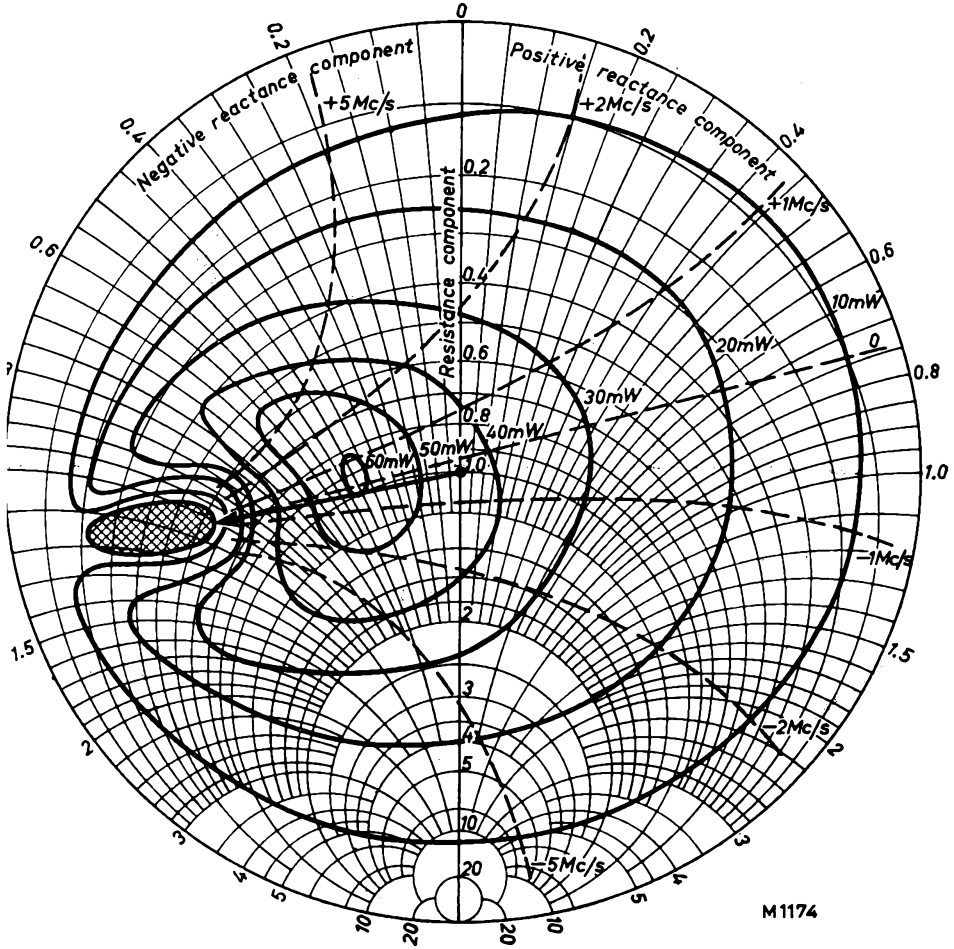

Fig. 54. Typical Rieke diagram. The drawn curves are loci of constant power, and the dashed curves loci of constant frequency deviation. The sink margin is indicated by an arrow point. Within the hatched area no oscillations occur.

#### REMARKS

In order to prevent undesired frequency modulation, care should be taken to employ well stabilized repeller and resonator voltages, and the connecting leads should be shielded.

It may happen that the waveguide is not terminated in a matched load, which causes frequency instability. When, however, very good frequency stability is



required, an attenuator of 6 dB may be inserted in the guide between the aerial and the load.

The resistance of the repeller voltage supply should not exceed 150 kΩ.

To prevent sudden cooling due to air-blow, the whole tube may be shielded. Care should be taken not to exceed the permissible temperature of the output line, and not to introduce parasitic resonant circuits outside the tube.

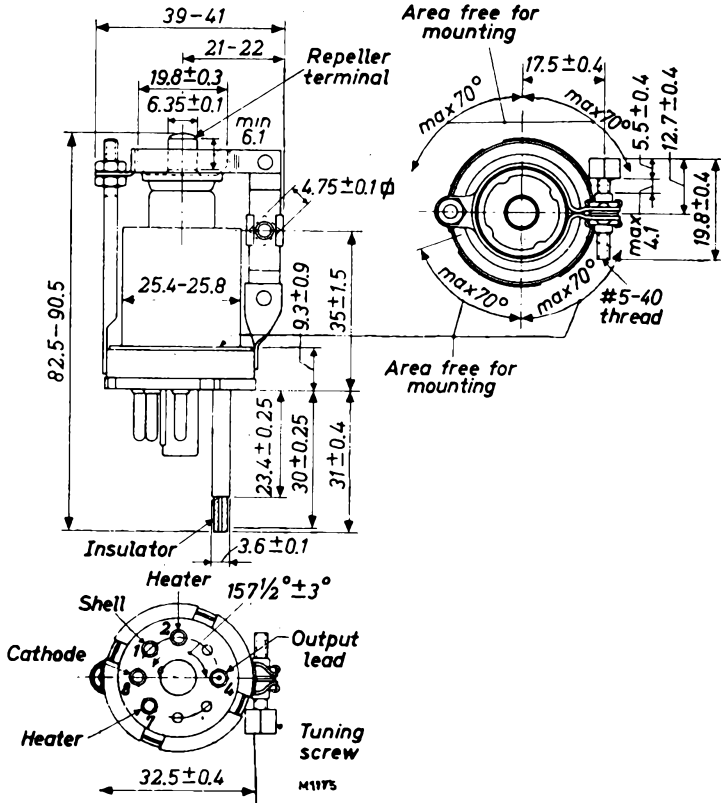

Fig. 55. Dimensional drawing; dimensions in mm.

## TECHNICAL DATA of the 2 K 25

### HEATER DATA

Heating: indirect by a.c. or d.c.; parallel supply

Heater voltage . . . . .  $V_f = 6.3 \text{ V} \pm 8\%$

Heater current . . . . .  $I_f = 0.44 \text{ A}$

## Reflex klystrons 2 K 25 and 723 A/B

MOUNTING POSITION: any

ELECTRODE ARRANGEMENT

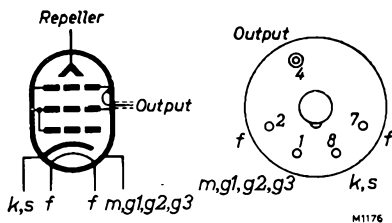

Fig. 56. Electrode arrangement and base connections.

TYPICAL OPERATING CONDITION: (frequency 8500-9660 Mc/s, mode A)

D.C. resonator voltage . . . . .	$V_{res} =$	300 V
D.C. repeller voltage range . . . . .	$V_{rep} =$	-85 to -200 V <sup>1)</sup>
D.C. resonator current . . . . .	$I_{res} =$	25 mA
Half-power electronic tuning frequency change $\Delta f$ . . . . .	$=$	35 Mc/s <sup>2)</sup>
Power output . . . . .	$W_o =$	25 mW

LIMITING VALUES (absolute maxima)

D.C. resonator voltage . . . . .	$V_{res} =$ max.	330 V
D.C. repeller voltage neg. . . . .	$-V_{rep} =$ max.	400 V
D.C. repeller voltage pos. . . . .	$V_{rep} =$ max.	0 V
D.C. resonator current . . . . .	$I_{res} =$ max.	37 mA
Voltage between cathode and heater . . . . .	$V_{kf} =$ max.	50 V
Temperature of coaxial output line . . . . .	$T =$ max.	70 °C

## TECHNICAL DATA of the 723 A/B

The reflex klystron type 723 A/B is specially designed for operation at 9370 Mc/s. Its frequency range is smaller than that of the 2K25; viz. 8702-9548 Mc/s.

### HEATER DATA

Heating: indirect by a.c. or d.c.: parallel supply

Heater voltage . . . . .  $V_f = 6.3 \text{ V} \pm 8\%$

Heater current . . . . .  $I_f = 0.44 \text{ A}$

<sup>1)</sup> Adjusted for maximum power output at the given operating frequency.

<sup>2)</sup> Change in frequency between the two half-power points when the repeller voltage is varied above and below the point of maximum power output corresponding to the given frequency.

TYPICAL OPERATING CONDITIONS: (frequency 9370 Mc/s, mode A)

D.C. resonator voltage . . . . .	$V_{res} =$	300 V
D.C. repeller voltage range . . . . .	$V_{rep} =$	-130 to -185 V <sup>1)</sup>
D.C. resonator current . . . . .	$I_{res} =$	25 mA
Half-power electronic tuning frequency range $\Delta f =$		40 Mc/s <sup>2)</sup>
Power output . . . . .	$W_o =$	30 mW

MOUNTING POSITION: any

ELECTRODE ARRANGEMENT

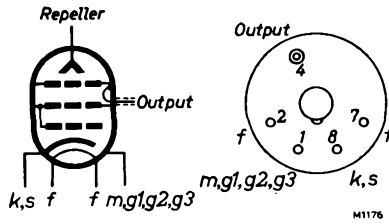

Fig. 57. Electrode arrangement and base connections.

LIMITING VALUES (absolute maxima)

D.C. resonator voltage . . . . .	$V_{res} = \text{max.}$	330 V
D.C. repeller voltage neg. . . . .	$-V_{rep} = \text{max.}$	400 V
D.C. repeller voltage pos. . . . .	$V_{rep} = \text{max.}$	0 V
D.C. resonator current . . . . .	$I_{res} = \text{max.}$	37 mA
Voltage between cathode and heater . . . . .	$V_{kf} = \text{max.}$	50 V
Temperature of coaxial output line . . . . .	$T = \text{max.}$	70 °C

<sup>1)</sup> Adjusted for maximum power output at the given operating frequency.

<sup>2)</sup> Change in frequency between the two half-power points when the repeller voltage is varied above and below the point of maximum power output corresponding to the given frequency.

# STANDARD NOISE SOURCES

## K 81A, K 50A and K 51A

In the performance of short wave apparatus, such as television and radar equipment, noise plays an important part. This is attributable to the inherent noise of the receivers and amplifiers used. An important property of amplifiers and receivers is the 'noise factor', which defines their noise properties under given conditions.

There are two main methods of determining the noise factor. The first is the one employing a standard signal generator. This method is rather time-consuming and inaccurate, since it necessitates absolute measurements of power and effective bandwidth. The other method is to employ a standard noise source, such as hot resistors, saturated diodes and gas discharge tubes. Since it would be necessary to heat resistors to 29000 °K for measuring a noise factor of 100, which may often be required, their use is, however, restricted.

Saturated diodes are only available for measurements at frequencies up to about 1000 Mc/s. However, at such frequencies it is hardly possible to effect good matching between the diode and its circuit. The K 81 A noise diode is designed for use at frequencies up to 300 Mc/s.

Specially designed gas discharge tubes have proved to possess properties that make them very suitable for use as standard noise sources at microwaves. The K 50 A and K 51 A are intended for use in the 3 cm and the 10 cm band respectively.

### NOISE

Noise originates from the arbitrary motion of electrons in solids, liquids and gases. The electron motion may be due to temperature (thermal agitation- or Johnson noise) or to phenomena occurring in gas discharges (collisions of the electrons and the ions) or in vacuum tubes (shot noise, partition noise, induced grid noise).

It can be proved that the mean square noise voltage  $v_n^2$  at the terminals of a resistor equals  $4kTBR$ , where  $k$  is Boltzmann's constant ( $1.38 \times 10^{-23}$  Joule/°C),  $T$  the absolute temperature of the resistor,  $B$  the effective bandwidth of the frequency range considered and  $R$  the resistance of the resistor.

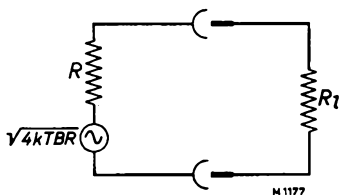

Fig. 58. Representation of a resistor as a noise source.

Accordingly, a resistor may be considered as a noise source of which the e.m.f. is  $\sqrt{4kTBR}$  and whose internal resistance is  $R$ , which is assumed to be noise-free (fig. 58).

The maximum obtainable power from this

noise source is dissipated in a load resistor  $R_l$ , which is equal to  $R$ . This so-called 'available noise power' is thus:

$$W_{na} = \frac{v_n^2}{4R} = \frac{4kTB}{4R} = kTB \dots\dots\dots (1)$$

The available noise power is therefore directly proportional to the absolute temperature  $T$ . Analogous to the noise from a resistor, the noise originating from a non-thermal noise source may be expressed in terms of the 'noise temperature', i.e. the temperature of a resistor that would deliver the same amount of noise as the non-thermal noise source.

**THE NOISE FACTOR OF A POWER AMPLIFIER**

For the sake of simplicity only the noise factor of a power amplifier will be discussed. The discussion is, however, also valid for any other four-terminal network.

Fig. 59 shows the block diagram of a power amplifier and the adjacent circuits. The input of the amplifier is matched to the driver, which has an internal resistance ' $R$ ' and is thus equal to the input resistance of the amplifier.



Fig. 59. Block diagram of a power amplifier and adjacent circuits.

The available noise power at the input is  $kT_0B$ ,  $T_0$  being the noise temperature of the driver.

The term 'available gain' is introduced, being the ratio of the available output power and the available power at the input of the amplifier.

If the available signal power at the input of the amplifier is assumed to be  $S$ , and the available gain of the amplifier to be  $G$ , the available signal power at the output is  $GS$  and the available noise power

$$W_n = GkT_0B + W_i, \dots\dots\dots (2)$$

where  $W_i$  is the inherent noise power of the amplifier available at the output.

The noise factor of the amplifier is defined as the ratio of the available signal-to-noise ratio at the input and the available signal-to-noise ratio at the output of the amplifier, hence:

$$N = \frac{S/kT_0B}{GS/W_n} = \frac{W_n}{GkT_0B}, \dots\dots\dots (3)$$

or:

$$N = \frac{GkT_0B + W_i}{GkT_0B}$$

The last expression shows that the noise factor may also be defined as the ratio of the noise power actually available at the output to the noise power that would be available at the output if the amplifier were noiseless.

From (3) it follows that:

$$W_n = NGkT_0B ; \dots\dots\dots (4)$$

since:

$$W_n = GkT_0B + W_i = NGkT_0B,$$

$$W_i = (N - 1) GkT_0B . \dots\dots\dots (5)$$

THE SATURATED DIODE AS A STANDARD NOISE SOURCE

The operation of a diode as a noise source is based on the following principle. When the diode is saturated, all electrons emitted by the cathode will reach the anode. The number of electrons emitted during a time interval  $\Delta t$ , i.e. the charge transferred during this time interval, is not constant but fluctuates around a statistical average value due to the thermal movement of the electrons in the cathode. The charge transmitted per unit time corresponds to the direct anode current  $I_a$ , and on this average value a fluctuating current is superimposed. This effect is termed the shot effect. The mean square of the noise current within a frequency band  $B$  is given by:

$$i_n^2 = 2e \cdot I_a \cdot B , \dots\dots\dots (6)$$

in which  $e$  denotes the charge of an electron, i.e.  $1.6 \times 10^{-19} C$ .

Since the individual electrons do not influence each other, this expression is applicable to the entire frequency spectrum, but at extremely high frequencies the influence of the transit time effect becomes more and more noticeable and reduces the shot effect.

When a current  $I_a + i_n$  passes through a resistance  $R_a$  included in the anode circuit of the diode, a noise voltage drop  $v_n = i_n \cdot R_a$  will be produced in addition to the voltage drop caused by the direct anode current. So long as the influence of the internal resistance of the diode is negligible compared with that of  $R_a$ , i.e. when  $R_i \gg R_a$  (which will always be the case when the diode is saturated, since  $\partial v_a / \partial i_a = \infty$ ), the resistance  $R_a$  may be considered as a noise source with an e.m.f.  $v_n$  and an internal resistance  $R_a$ . The noise voltage source may be represented by the equivalent diagram shown in fig. 60.

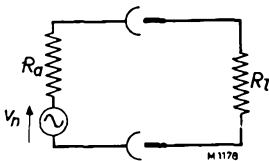

Fig. 60. Equivalent diagram of a saturated diode as a noise source.

The available noise power of this noise source is given by:

$$W_{na} = \frac{i_n^{-2} \cdot R_a}{4} \dots\dots\dots (7)$$

From (6) and (7) it follows that:

$$W_{na} = \frac{e \cdot I_a \cdot B \cdot R_a}{2} = 8 I_a \cdot B \cdot R_a \cdot 10^{-20} \dots\dots\dots (8)$$

The essential formulae having been given, we will now investigate the way in which the noise generator should be set up in order to be used as a standard noise source, and the requirements to be satisfied in order to obtain reliable results.

The requirement is imposed on the circuit that the internal resistance of the generator should be real and that no appreciable attenuation should be caused by the circuit at high frequencies. In order to ensure that the internal resistance

of the generator is real, the capacitance introduced by the tube and the circuit may be neutralized by an inductance shunted across the tube. In this way a parallel tuned resonant circuit is obtained, which is heavily damped by the anode load resistance  $R_a$  (usually 60  $\Omega$  or 300  $\Omega$ ).

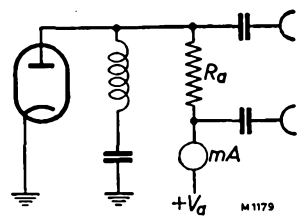

Fig. 61. Basic circuit of a noise generator equipped with a noise diode.

Fig. 61 shows the basic circuit of a noise generator equipped with a noise diode. The noise factor is measured in the following way.

As shown in fig. 62, the amplifier to be tested is connected to the noise generator. The anode load resistance  $R_a$  of the generator should be equal to the input resistance of the amplifier.



Fig. 62. Block diagram of the measuring set-up.

First the heater current of the diode remains switched off and a meter indicating the relative power output is connected to the output terminals of the amplifier. After a record has been made of the reading of this meter, which indicates a value corresponding to a power output  $W_n = NGkT_0B$  (according to eq. (4)), the heater current of the diode is switched on and carefully adjusted to the value at which the output meter indicates twice the original power. The additional noise output power due to the energized diode is  $GW_{na}$  and exactly equal to the initial power  $NGkT_0B$ .

Hence:

$$GW_{na} = NGkT_0B, \dots\dots\dots (9)$$

which gives:

$$N = \frac{W_{na}}{kT_0B} = \frac{8 \cdot I_a B R_a \cdot 10^{-20}}{kT_0B}$$

When  $T_0$  is 288 °K:

$$N = 20 I_a R_a, \dots\dots\dots (10)$$

where  $I_a$  is expressed in mA and  $R_a$  in kΩ.

When the milliammeter incorporated in the anode circuit has been calibrated accordingly, the noise factor can be read directly, or it can be calculated by means of eq. (10).

### STANDARD NOISE DIODE K 81 A

The K 81 A is a directly heated diode equipped with a novel base, intended for use as a standard noise source at frequencies up to 300 Mc/s. Owing to the small distance between the filament and the anode, the transit time is reduced to a large extent. In order to realize small self-inductances of the electrode leads, both the extremities of the filament and the anode are each connected to three pins of the base.

The filament is fairly thick, so that it can be fed from a 2 volts battery. The thermal inertia consequent upon this thickness is sufficient to prevent fluctuations in the saturation current when an a.c. supply is used. In this case the filament voltage should be very well stabilized. As a result of the diode's high internal resistance, the anode voltage need not be stabilized.

When a load resistor of 50 ohms is employed, a noise factor of 20 (13 dB) can be measured without exceeding the maximum admissible anode current and anode dissipation. When the load resistor is enlarged, it is possible to measure higher noise factors.

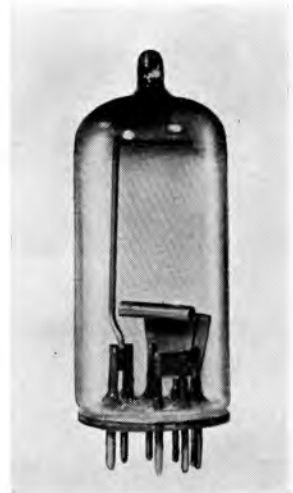

Fig. 63. Photograph of the K81A (actual size).

### TECHNICAL DATA

Heating: direct by a.c. or d.c.

#### CAPACITANCES

Capacitance between filament and anode . . . . .  $C_{af} = 2.2 \text{ pF}$



MOUNTING POSITION: any  
 ELECTRODE ARRANGEMENT

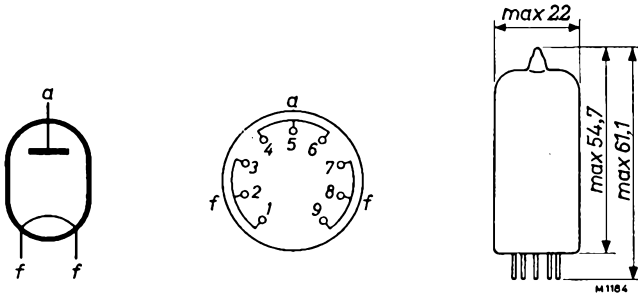

Fig. 64. Electrode arrangement, electrode connections and maximum dimensions in mm (noval base).

TYPICAL CHARACTERISTICS

Filament voltage . . . . .	$V_f =$	1.85 V
Filament current . . . . .	$I_f =$	2.5 A
Anode voltage . . . . .	$V_a =$	100 V
Anode current . . . . .	$I_a =$	15 mA

LIMITING VALUES

Filament voltage . . . . .	$V_f = \text{max.}$	2 V
Anode voltage . . . . .	$V_a = \text{max.}$	150 V
Anode current . . . . .	$I_a = \text{max.}$	20 mA
Anode dissipation . . . . .	$W_a = \text{max.}$	3 W

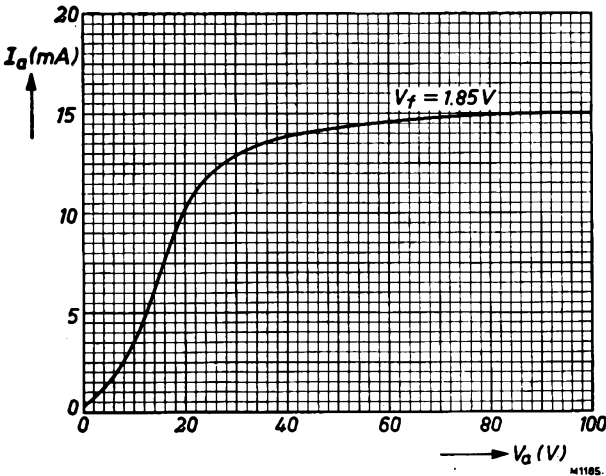

Fig. 65.  $I_a/V_a$  characteristic of the 8B1A at a heater voltage of 1.85 V.

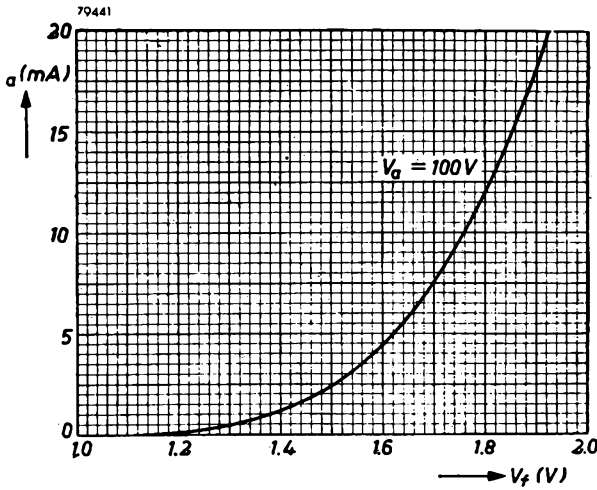

Fig. 66.  $I_a/V_f$  characteristic of the K81A at an anode voltage of 100 V.

### PRACTICAL CIRCUIT

Fig. 67 shows the circuit diagram of a typical set-up for noise measurements with the K 81 A at 50 Mc/s. The h.f. section is mounted in a closed metal box. The filament and anode voltages are applied via low-pass filters, which prevent the noise originating in the power supply from entering the circuit.

The anode-filament capacitance and the parasitic capacitances are compensated by the self-inductance  $L$ .

$P$  represents a coaxial output plug to which a coaxial cable with a characteristic impedance of 50 or 75 ohms should be connected, depending on the load resistor used.

### CHARACTERISTIC DATA

$$L = 3 \text{ H (approx.)}$$

$$C = 5000 \text{ pF}$$

$$C' = 1000 \text{ pF}$$

$$R_a = 50 \text{ or } 75 \Omega$$

$$V_a = 90 - 150 \text{ V}$$

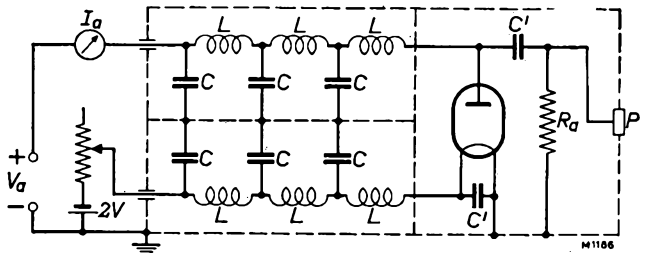

Fig. 67. Practical set-up for noise measurements at 50 Mc/s with the K81A.

### GAS-DISCHARGE NOISE TUBES

The collisions between electrons and atoms and the mutual collisions of the electrons in a gas discharge give rise to an arbitrary motion of these electrons, the mean square velocity of which is of such a magnitude that an appreciable

amount of noise is produced. It is possible to determine the noise temperature (or electron temperature), which may amount to a few tens of thousands of degrees Kelvin, depending on the type of gas, its pressure, etc.

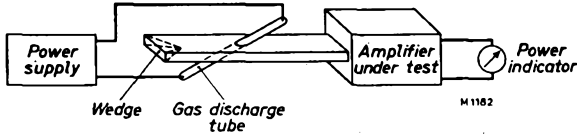

Fig. 68. Outline of a microwave set-up for noise measurements.

In fig. 68 an outline is shown of a typical microwave set-up for measuring the noise factor of an amplifier. In order to achieve wide-band matching, the gas-discharge tube penetrates the broad faces of the waveguide at an inclination of about  $10^\circ$ . The dissipating wedge, situated at the rear of the tube, provides a reflection-free termination when the tube is not ignited, damping then being small. The input of the amplifier is matched to the waveguide: the output terminals of the amplifier, which has an available gain  $G$ , are connected to a measuring instrument, indicating the relative output power  $a \cdot W$ ,  $a$  generally being unknown.

A method of measuring the noise factor is as follows:

First the gas-discharge tube remains unenergized. The available noise power at the input of the amplifier is now  $kT_0B$ , where  $T_0$  is the temperature of the wedge, which is mostly assumed to be at room temperature. The available noise output of the amplifier is  $W_n = GkT_0B + W_i$ , according to (2). The reading of the power indicator, being  $a(GkT_0B + W_i)$ , is recorded.

Then the gas-discharge tube is switched on. The available noise power at the input of the amplifier now amounts to  $kT_nB$ ,  $T_n$  being the noise temperature of the tube. At the output of the amplifier a noise power of  $GkT_nB + W_i$  is available. The corresponding reading on the power indicator, being  $a(GkT_nB + W_i)$ , is divided by the actual reading. This ratio, which is called  $Y$ , thus becomes:

$$Y = \frac{a(GkT_nB + W_i)}{a(GkT_0B + W_i)} = \frac{GkT_nB + W_i}{GkT_0B + W_i}$$

Since, according to eq. (5):

$$W_i = (N - 1) GkT_0B$$

$$Y = \frac{GkT_nB + (N - 1) GkT_0B}{GkT_0B + (N - 1) GkT_0B}$$

or:

$$Y = \frac{T_n + (N - 1)T_0}{T_0 + (N - 1)T_0}$$

whence:

$$N = \frac{T_n/T_0 - 1}{Y - 1} \dots\dots\dots(11)$$

Since  $Y$  and  $T_n$  are known quantities, the noise factor  $N$  can be calculated from eq. (11).

As can be seen, the bandwidth  $B$  of the amplifier does not appear in (11), which makes this method more attractive than that using a standard signal generator, in which this is the case.

### TUBES K 50 A and K 51 A

The K 50 A and the K 51 A are directly heated, neon-filled gas-discharge tubes for use as standard noise sources in the 3 cm and 10 cm wave bands respectively. They have been designed to be inserted in corresponding waveguides. In fig. 69 an outline of the recommended test mounts is drawn, in which the tubes, when adjusted as specified, are properly matched.

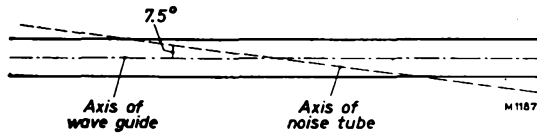

Fig. 69. Outline of the recommended test mount.

High stability is obtained owing to the rare-gas filling of the tubes; within wide limits the noise level is independent of the ambient temperature.

The ignition voltage of the tubes is about 6000 V, and the arc voltages amount to 165 and 140 V respectively. If a special starting device is used, it is not necessary to have a high-tension power supply. The recommended circuit is shown on page 59. The resistor  $R$  is designed so as to obtain the desired anode current.

In order to ignite the tube, the switch  $S$  is closed, which causes a rather large current to flow through the coil. When this current is interrupted by the switch being opened, a high voltage is induced in the coil, which is sufficient to ignite the tube.

For the tubes to function reliably, the following precautions should be taken:

- a. The anode side of the tube should point in the direction of the device under test.
- b. The tube should not touch the microwave part of the mount.
- c. When using the tube in on-off conditions, it should be remembered that the tube represents a small damping when not ignited. In this condition the waveguide at the rear of the tube should be terminated in a matched load, or a dissipative attenuator of at least 30 dB should be inserted in the waveguide between the tube and the device under test.

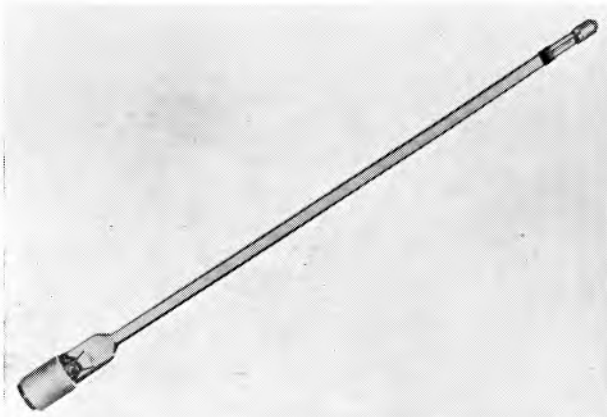

09516

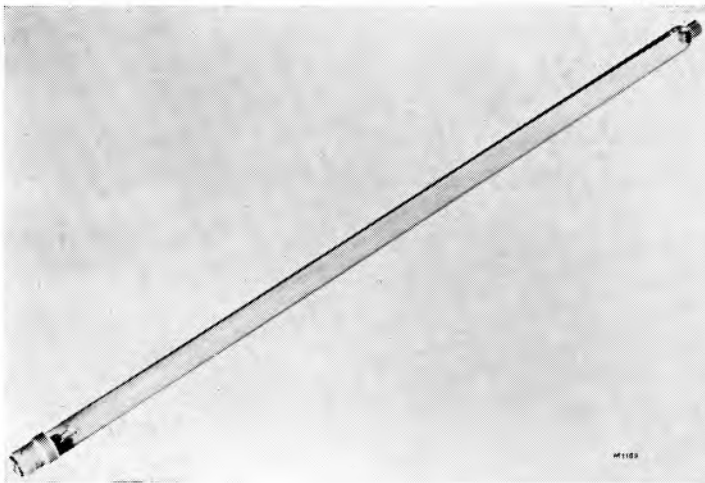

01103

Figs 70 and 71. Photographs of the K50A (above) and K51A (below).

## TECHNICAL DATA of the K 50 A

Heating: directly by a.c.: parallel supply

Heater voltage . . . . .	2 V
Heater current . . . . .	2 A
Heating time . . . . . min.	15 sec

### DESIGN VALUE

Ignition voltage . . . . . approx. 6000 V <sup>1)</sup>

<sup>1)</sup> For recommended circuit, see fig. 74.

The inductance of 8 H should be capable of producing the minimum value of the ignition voltage. This value is only valid if some ambient illumination is present. Hence, in darkness, the presence of a small light source (about 2 W) is necessary.

TYPICAL CHARACTERISTICS

Anode voltage . . . . .	approx. 165 V
Anode current . . . . .	125 mA
Noise level in test mount (see fig. 69) . . . . .	19.3 dB <sup>2)</sup>

LIMITING VALUES

Anode current . . . . .	min. 50 mA
	max. 150 mA
Ambient temperature . . . . .	min. -55 °C
	max. +75 °C

The K 50 A is intended to be used in a waveguide RG-52U or equivalent. The VSWR introduced by the tube in operation is less than 1.1<sup>3)</sup>.

It is recommended that the noise tube and the microwave part of the mount are not touching (minimum diameter of pipe: 7.5 mm).

TECHNICAL DATA of the K 51 A

Heating: directly by a.c.; parallel supply

Heater voltage . . . . .	2 V ± 7.5%
Heater current . . . . .	3.5 A
Heating time . . . . .	min. 15 sec

DESIGN VALUE

Ignition voltage . . . . .	min. 6000 V <sup>1)</sup>
----------------------------	---------------------------

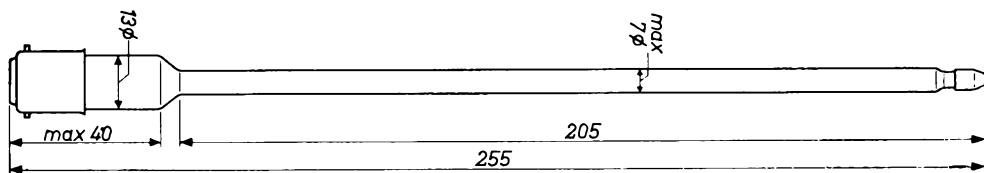

Fig. 72. Dimensions in mm of the K50A.

<sup>1)</sup> For recommended circuit, see fig. 74.

The inductance of 8 H should be capable of producing the minimum value of the ignition voltage. This value is only valid if some ambient illumination is present. Hence, in darkness, the presence of a small light source (about 2 W) is necessary.

<sup>2)</sup> With respect to 300 °K. Change in noise level over 200 hours of operation is negligible.

<sup>3)</sup> The tube can also be used in other types of waveguides. Care should then be taken not to exceed the minimum VSWR of 1.1. For this reason a matching transformer may be required.

TYPICAL CHARACTERISTICS

Anode voltage . . . . .	approx. 140 V
Anode current . . . . .	200 mA
Noise level in test mount (see fig. 69) . . . . .	19.1 dB <sup>1)</sup>

LIMITING VALUES

Anode current . . . . .	min. 100 mA
	max. 300 mA
Ambient temperature . . . . .	min. -55 °C
	max. +75 °C

The K 51 A is intended to be used in a waveguide RG-48U or equivalent. The VSWR introduced by the tube in operation is less than 1.1<sup>2)</sup>.

It is recommended that the noise tube and the microwave part of the mount are not touching (minimum diameter of pipe: 17 mm).

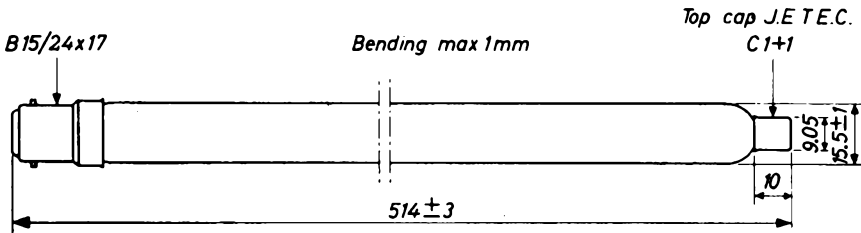

Fig. 73. Dimensions in mm of the K51A.

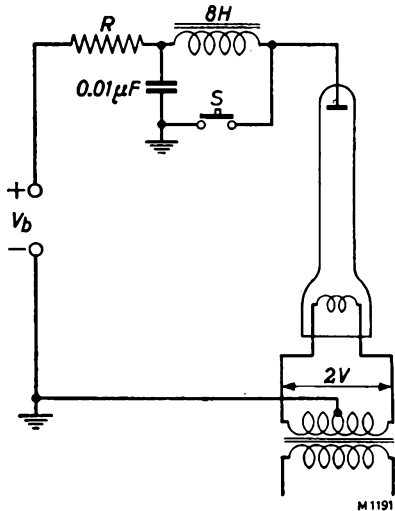

Fig. 74. Recommended ignition circuit for the K 50 A and K 51 A.

K 50 A  $V_b = 500$  V,  $R = 2700 \Omega$ .  
 K 51 A  $V_b = 350$  V,  $R = 1000 \Omega$ .

<sup>1)</sup> With respect to 300 °K. Change in noise level over 200 hours of operation is negligible.

<sup>2)</sup> The tube can also be used in other types of waveguides. Care should then be taken not to exceed the minimum VSWR of 1.1. For this reason a matching transformer may be required.

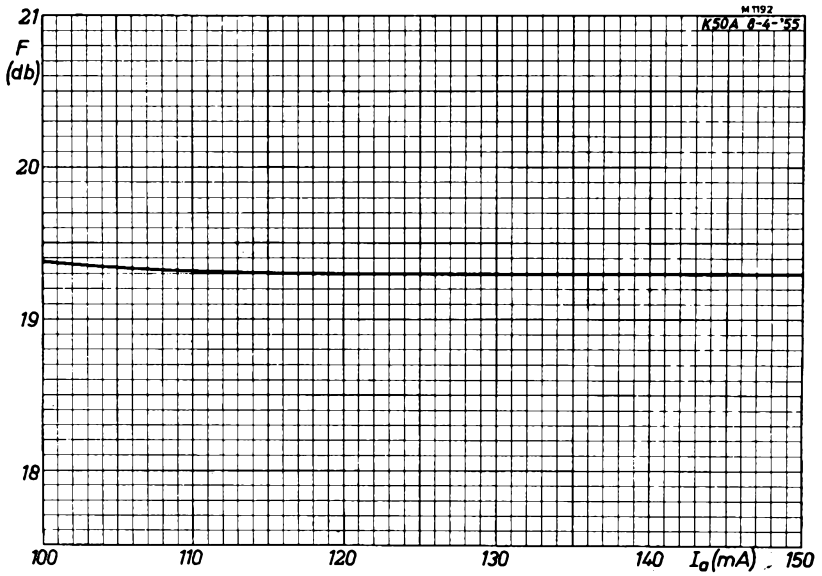

Fig. 75. Noise level (F) of the K50A with respect to 300 °K as a function of the anode current.

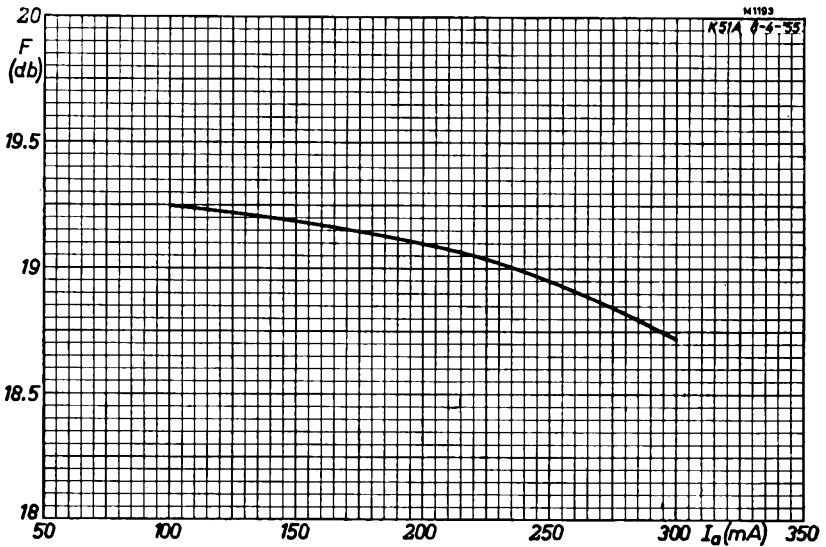

Fig. 76. Noise level (F) of the K51A with respect to 300 °K as a function of the anode current.



## PHILIPS' TECHNICAL LIBRARY

Philips' Technical Library comprises 4 series of books:

- a. Electronic Valves
- b. Light and Lighting
- c. Miscellaneous
- d. Popular series

Series a, b and c in cloth binding 6" × 9", gilt. The dimensions of the popular series, coloured "integral" binding, are 5¾" × 8¼".

Most of these books are published in 4 languages: English, French, German and Dutch.

### a. Series on ELECTRONIC TUBES

- Book I "Fundamentals of Radio-Valve Technique", by J. Deketh  
Book II "Data and Circuits of Receiver and Amplifier Valves"  
Book III "Data and Circuits of Receiver and Amplifier Valves", 1st Suppl.  
Book IIIA "Data and Circuits of Receiver and Amplifier Valves", 2nd Suppl.,  
by N. S. Markus and J. Otte  
Book IIIB "Data and Circuits of Receiver and Amplifier Valves", 3rd Suppl.,  
by N. S. Markus and J. Vink  
Book IIIC "Data and Circuits of Television Receiving Valves", by J. Jager  
Book IV "Application of the Electronic Valve in Radio Receivers and Amplifiers",  
Volume I, by B. G. Dammers, J. Haantjes, J. Otte and H. van Suchtelen  
Book V Ditto, Volume 2  
Book VII "Transmitting Valves", by P. J. Heyboer and P. Zijlstra  
Book VIIIA "Television Receiver Design" 1, by A. G. W. Uitjens  
Book VIIIB "Television Receiver Design" 2, by P. A. Neeteson  
Book IX "Electronic Valves in Pulse Technique" by P. A. Neeteson  
Book X "Analysis of bistable Multivibrator Operation", by P. A. Neeteson  
Book XI "U.H.F. Tubes for Communication and Measuring Equipment"  
Book XII "Tubes for Computers"  
Book XIII "Industrial Rectifying Tubes"

*Book IIIB and XIII are in active preparation.*

### b. Series "LIGHT AND LIGHTING"

1. "Physical Aspects of Colour", by P. J. Bouma
2. "Gas Discharge Lamps", by J. Funke and P. J. Oranje
3. "Fluorescent Lighting", by Prof. C. Zwicker c.s.
4. "Artificial Light and Architecture", by L. C. Kalff (size 7" × 11")
5. "Artificial Light and Photography", by G. D. Rieck and L. H. Verbeek (size 7" × 11")
6. "Manual for the Illuminating Engineer on Large Size Perfect Diffusors", by H. Zijl
7. "Calculation and Measurement of Light", by H. A. E. Keitz
8. "Lighting Practice", Volumes I, II and III, by Joh. Jansen
9. "Illuminating Engineering Course", by H. Zijl

*Book 4 in German only. The English edition of book 8 is in preparation.*

c. Series "MISCELLANEOUS"

- a. "Television", by Fr. Kerkhof and W. Werner
- b. "Low-Frequency Amplification", by N. A. J. Voorhoeve
- c. "Metallurgy and Construction", by E. M. H. Lips
- d. "Strain Gauges", by Prof. J. J. Koch
- e. "Introduction to the study of Mechanical Vibrations", by G. W. v. Santen
- f. "Data for X-Ray Analysis" I, by W. Parrish and B. W. Irwin (size 8.2" × 11.6"), paper bound
- g. "Data for X-Ray Analysis" II, by W. Parrish, M. G. Ekstein and B. W. Irwin (size 8.2" × 11.6"), paper bound
- b. "X-Rays in Dental Practice", by G. H. Hepple
- i. "Industrial Electronics Handbook", by R. Kretzmann
- j. "Introduction to TV-Servicing", by H. L. Swaluw and J. v. Woerd
- k. "From the Electron to the Superhet", by J. Otte, Ph. F. Salverda and C. J. van Willigen
- l. "How Television works", by W. A. Holm
- m. "The Cathode Ray Oscilloscope", by J. Czech
- n. "Industrial Electronics Circuits", by R. Kretzmann
- o. "Medical X-Ray Technique", by G. J. van der Plaats and L. Penning
- p. "Electrical Discharges in Gases", by F. M. Penning
- q. "Tube Selection Guide", compiled by Th. J. Kroes

*Books l, o and p are in active preparation.*

d. "POPULAR SERIES"

Our "Popular Series" is intended to meet the growing demand for works on technical subjects written in a way that can be readily understood by the less advanced reader. Popular as used here does not mean superficial, but intelligible to a wider public than is catered for by the other more specialized books in Philips Technical Library.

1. "Remote Control by Radio", by A. H. Bruinsma
2. "Electronic Valves for L. F. Amplification", by E. Rodenhuis
4. "Battery Receiving Valves", by E. Rodenhuis
5. "Germanium Diodes", by S. D. Boon
6. "Introduction to the Cathode Ray Oscilloscope", by Harley Carter
7. "From Microphone to Ear", by G. Slot
8. "Valves for A. F. Amplifiers", by E. Rodenhuis
9. "Robot Circuits", by A. H. Bruinsma

*Books 4 and 9 are in preparation.*

PHILIPS JOURNALS

- a. Philips Technical Review
- b. Philips Research Reports
- c. Philips Telecommunication Review
- d. Philips Serving Science and Industry
- e. Medicamundi
- f. Electronic Applications