

1969

**The
RADIO-ELECTRONIC**

**M
A
S
T
E
R**



Division of
Cox Broadcasting Corp.

Catalog of
ELECTRONIC
PARTS,
INSTRUMENTS
AND
EQUIPMENT
Sold through
Distributors

COMPANION TO
eem
ELECTRONIC ENGINEERS MASTER

33rd Edition

PRINTED IN U S A

1969

33rd Edition



Price:
\$10.00

THE RADIO ELECTRONIC MASTER

OFFICIAL CATALOG
OF ELECTRONIC PARTS,
INSTRUMENTS & EQUIPMENT
SOLD THROUGH DISTRIBUTORS

THE RADIO ELECTRONIC MASTER

1969 — 33rd EDITION

FOREWORD

The RADIO-ELECTRONIC MASTER is the Official Buying Guide and Reference Book for electronic parts, instruments and equipment sold by distributors.

IMPORTANT

While most distributors maintain a large and varied stock, they do not represent that they necessarily stock all manufacturers' products cataloged in this MASTER.

Prices are furnished for information only — they are not offered as quotations.

WHERE LIST PRICES ARE SHOWN, TRADE DISCOUNTS APPLY IN MOST CASES . . .
PHONE OR WRITE YOUR DISTRIBUTOR FOR LATEST PRICES AND DELIVERY.

Participating manufacturers reserve the right to make changes in specifications, to change prices or withdraw items without notice.

While every precaution has been taken to insure accuracy in content, the publisher cannot be responsible for manufacturers' claims and representations; nor can any guarantee be made against the possibility of error or omission.

When ordering, please mention The MASTER, 33rd EDITION, also page number on which the item appears and specific catalog or code number, if any. This will help to expedite the filling of your order and lessen the chance of error.

Copyright **UNITED TECHNICAL PUBLICATIONS, INC • 1968**
Division of Cox Broadcasting Corporation

No part of this book may be reproduced
without express permission of the publishers.

Library of Congress Catalog Card No. 39-15586

PRINTED IN U.S.A.

GENERAL INDEX

A	Page
ADC PRODUCTS	507-511
ATA ELECTRONICS, INC.	988
AVA ELECTRONICS & MACHINE CORP.	512
Absorbers, Shock (See Mounts, Shock & Vibration)	
ACME ELECTRIC CORP.	989, 1421
Adapters (See Connectors; Plugs; Sockets; etc.)	
Add-A-Rack Cabinets	142
Add-A-Strip Power Strips	539
Adhesives (All Types)	432-436
Adjustoroid Variable Toroids	483
Admiral Headsets	77
Adventurer Transceivers	51
Aerofilm Capacitors	261, 262
Aeroglaze Resistors	1137
Aeromet Resistors	1137
AEROVOX CORP., DISTRIBUTOR DIV.	
Capacitors	254-287
Filters	833
Resistors	1136, 1137
Air Cleaners & Filters (Shielded & Unshielded).....	144
AIRCO SPEER ELECTRONIC COMPONENTS	
Jeffers Molded Inductors	446, 447
JC Precision Resistors	1139-1141
PEC Precision Electronic Components Ltd.	1209
Air Filtering & Ventilating Panels, Shielded & Unshielded (See Air Cleaners & Filters)	
AKRO-MILS	
Alarms & Alarm Systems.....	36, 796, 797, 807, 964, 965, 1311
AL-Cab Cabinets	181
ALCO ELECTRONIC PRODUCTS INC (Alcoswitch)	
Knobs, Terminal Strips	817
Pilot Lights	506
Switches	1304, 1305
ALLIED CONTROL COMPANY, INC.	1037-1044
Alligator Clips (See Clips, Alligator)	
ALPHA WIRE CORP. (See Loral Distributor Products)	
Alphlex Lacing Cords & Tapes.....	1642
Alphlex Plastic Tubing	1643, 1644
Alphlex Zipper Tubing	1642
Ambassador Wireless Intercoms	54
American Beauty Soldering Irons.....	1374, 1375
AMERICAN COMMUNICATIONS CORP.	34-39
AMERICAN ELECTRICAL HEATER CO.	1374, 1375
AMERICAN RADIO RELAY LEAGUE (ARRL)	1027
Ammeters (See Meters, Ampere)	
Amp-Clamp A-C Ammeter Adapters.....	924
AMPEREX ELECTRONIC CORP.	
Capacitors	306
Resistors	1138
Semiconductors	1270, 1271
Tubes	1560, 1561
AMPERITE CO., INC.	
Relays	1034, 1035
Tubes	1562, 1563
AMPHENOL DISTRIBUTING DIV., THE BUNKER-RAMO CORP.	
Connectors	513-525
Instruments	857
Switches	1306, 1307
Wire	1622, 1623
Amplifiers	
A-F	38, 40-44, 45, 47, 59, 60, 62, 63, 66, 74, 123, 1271, 1482
Antenna	22, 25
Control	63, 66, 1271, 1780
Distribution	22, 25, 28, 256
I-F	471
Line	22
Linear	1482
Magnetic	1434, 1435, 1547, 1552
Master Antenna (See Amplifiers, Distribution)	
Microphone (See Amplifiers, A-F)	
Mixing	38
Photozell	964
Power	44-47, 57, 64, 66, 68, 74, 123, 505
Public Address	38, 40-44, 57, 58, 59, 60, 62-64, 66, 67, 123
Recording (See Amplifiers, A-F)	
Resolver (See Amplifiers, Servo)	
Servo	63
Telephone	1782
Video	1271
AMPROBE INSTRUMENT, DIV. SOSS MFG. CO.	854, 855
Analyzers	
A-F	857
Antenna	887
Capacitor (See Testers, Capacitor)	
Circuit (See Testers, Signal Tracing)	
Crystal	815
Distortion (See Analyzers, A-F)	

SCR	887
Transistor (See Testers, Transistor)	
Anniversary Soldering Tips	1414
Annunciators	34, 35
Antenna Couplers (See Couplers, Antenna)	
Antenna Dummy Loads (See Dummy Loads)	
Antenna Feed Systems	29
Antenna Filters (See Filters, Antenna)	
Antenna Rotators	24
Antenna Towers & Supports.....	29, 1780
Antennas	
Airborne	32
Automobile	31-33
Broadcasting (Commercial)	31
Citizen Band	31-33
Direction Finding	31
F-M & TV	22-24, 26, 107, 766, 1785
Ground Plane	31, 32
Log Periodic	22-24
Mobile	31, 32
Phased Array	23, 24, 31
Telescopic	31-33
Anti-Static Compounds & Coatings (See Coatings, Anti-Static)	
Arc Lamp Power Supplies (See Power Supplies, Arc Lamp)	
ARCO ELECTRONIC INC. (See Loral Distributor Products)	
ARCOLECTRIC SWITCH CO., LTD.	1303
Arcolytic Capacitors	303
Argonaut Speakers	75
ARGOS PRODUCTS CO., INC.	75, 76
Arresters	
Electrical Surge (Also See Suppressors, Arc; Protectors, Surge)	988, 1589
Lightning	1589, 1785
ASTATIC CORPORATION, THE	78, 79
Astra Speakers	76
Astro-Com Telephone Amplifiers	1782
Astro-Com Transmitters	1782
ASTRODYNE, INC.	1272
Astrolite Indicator Lights	977
ATLAS SOUND DIV, AMERICAN TRADING & PRODUCTION CORP.	80-83
Atom Capacitors	378, 379
Attenuators	
Audio	121, 1220, 1254, 1262, 1265
Coaxial	37, 610
Fixed	28, 610, 1254
Impedance Matching	28, 610, 1220, 1254, 1262, 1265
R-F	37, 1254, 1265
Variable	1220, 1265
Audible Warning Devices (See Alarms & Alarm Systems — Also See Bells, Buzzers, Gongs, Sirens & Aural Warning Devices)	
AUDIO DEVICES, INC.	125-127
Audio Equipment (See Amplifiers; Microphones; Speakers; etc.)	
Audiorecording Discs	125
Audiophile Speakers	76
Audiopoint Recording Styli	125
Audiotape Magnetic Recording Tape	126, 127
Audiotex Hi-Fi & Stereo Accessories.....	128
AUDIOTEX MFG. CO. (See GC Electronics)	
Automatic Checkout Equipment (See Test Equipment, Automatic Checkout)	
Autopass Capacitors	260
Autotransformers (See Transformers, Autotransformer)	
AUTOTRON, INC.	956-962
Avikrimp Terminals	771
Axiom Resistors	1205

B

B-Lite Indicator Lights	981
Baffles, Speaker (See Enclosures, Speaker)	
Balancing Equipment (Dynamic)	901
Ballast Tubes (See Tubes, Ballast)	
Baluns (See Transformers, Matching)	
Band Director Speakers	75
Banshee Speakers	81
Bantam Jacks	507
Bantam Patch Cords	508
Bars, Shorting	675, 684-686
Bases, Antenna (See Mounts, Antenna)	
Batteries	
Carbon Zinc	1007-1009
Dry, Flashlight, Transistor, etc.....	990, 991, 993
Lead Acid	1006-1008
Manganese Alkaline	992, 993, 1015-1017
Mercury	992, 983, 1006, 1007, 1008, 1009, 1015
Nickel Alkaline	1005-1007
Nickel Cadmium	991-993, 1006
Photoflash	993, 1007, 1008
Silver Cadmium	1007, 1008

GENERAL INDEX (Continued)

	Page	Page
Capacitance Comparators (See Bridges, Capacitance)	922	
Capacitor Leakage Indicators (See Testers, Capacitor)		
Capacitors, Chip (for Microcircuits)	281, 338, 427	
Capacitors, Fixed		
Bathub	260, 267, 273, 409	
Ceramic	275-280, 282-284, 301, 302, 312-314, 316, 323, 337, 338, 411-413, 610	
Ceramic Disc	282, 301, 302, 307-311, 313, 322, 414-419	
Telephone	1634-1636, 1638, 1661-1663, 1665, 1737, 1738, 1759-1761, 1788	
Circuit Board Mounting	254, 255, 257, 258, 260, 262-264, 266, 267, 275, 277, 278, 280, 282, 285, 286, 288, 289, 293, 296, 301-304, 306, 319, 323, 328-331, 334, 335, 337-340, 342, 343, 376, 406, 407, 415-418, 424, 427	
Decade	867	
Electrolytic (All Types)	254-260, 279, 303, 304, 306, 317, 328-331, 339, 340, 343, 344, 346-350, 357-386, 421-423, 425-428, 702, 1509	
Feedthru	283, 316, 409, 410	
Film	306, 341, 344, 400, 402-408	
Glass	260, 319, 344, 386	
High Capacitance, Low Voltage	254, 255, 257-259, 263, 264, 281, 303, 304, 306, 307, 310, 317, 319, 322, 323, 332, 339, 340, 346-348, 357-385, 379, 419, 424-427	
High Voltage	245, 265, 266, 271-274, 276-279, 282, 286, 293, 297, 298, 301, 302, 310, 312-315, 323, 344, 345, 352, 353, 355, 374, 375, 386-394, 397-402, 405, 406, 408, 414-419, 1014	
High Temperature	262, 264, 266-268, 270, 275, 280, 286, 291, 293, 297, 306, 336, 337, 340-342, 350, 354, 362, 364, 367, 385-387, 389, 390, 393, 394, 396-401, 409, 412, 426, 428	
Fixed, Mica	285-293, 352, 353, 404, 405, 420	
Miniature & Subminiature	257-264, 266, 267, 275, 277-280, 282, 283, 285, 286, 289-292, 294, 296, 301-304, 306, 308, 310, 313, 319, 322, 323, 330, 331, 333, 335-343, 351, 354, 357-365, 370, 380-382, 387-394, 402, 407, 411, 412, 414-419, 422-424, 426-428, 472, 473	
Mylar	262, 269, 296-298, 341, 345, 461	
Mylar, Metallized	263-265, 269, 306, 341, 461	
Oil	265, 266, 273, 274, 344, 354, 355, 386, 399, 409	
Paper	260, 265, 269, 271, 272, 297, 298, 341, 354, 355, 386-394, 396-403, 405-407, 410	
Paper, Metallized	267-72, 303, 304, 341, 400, 401, 403, 407	
Photoflash	260, 265	
Polycarbonate, Metallized	264, 306, 341	
Polystyrene	316, 341	
Silvered Mica	285, 286, 289, 293-295, 351, 420	
Tantalum	322, 333-336, 339, 342, 343, 357-373, 421-428	
TFE	306, 340, 341	
Temperature Compensating	284, 302, 307-309, 312, 313, 412, 416-418	
Capacitors, Overvoltage Protected	281	
Capacitors, Variable		
Air	300, 320-322, 326, 327, 472, 473	
Ceramic	299, 306, 322, 323	
Film	306	
Glass	324	
High Temperature	324	
HV (Lab Type)	321, 326	
Mica	299, 300	
Padder	300, 473	
Piston (See Capacitors, Variable Trimmer, All Types)		
Quartz	324	
TFE	326	
Temperature Compensating	306	
Trimmer (All Types)	299, 300, 306, 314, 320, 321, 324, 326, 327, 472, 473	
Capri Light Controls	810	
Caps		
Connector	418, 487, 520-522, 524, 528, 575, 678	
Forms & Tapes, Heat Shrinkable (Also See Tubing, Heat Shrinkable)		
Grid & Plate (See Clips & Caps, Grid & Plate)		
Lens, Indicator Light	966-973, 977-984	
Wire-Splicing (See Splicers, Wire, Butt & Cap Types)		
Captain Flashlights	1003, 1137	
Carbofilm Resistors	1136	
Card Holders, Circuit Boards (See Racks, Circuit Board)		
Cardiline Microphones	85	
Cardmatic Tube Testers	874	
Cards		
Linear Function (with Discrete Components)	1271	
Linear Function (with IC's)	1278	
Logic (with Discrete Components)	954	
Carillon Amplifiers	47	
CARTER MOTOR COMPANY	995	
Cartridges & Cassettes, Tape	100, 125	
Cartridges, Microphone	62, 79, 199	
Cartridges, Phono		
Ceramic	78	
Crystal	78	
Magnetic	78	
Cases		
Instrument & Equipment	166, 175, 198, 230, 242, 767-769	
Equipment, Meter (Portable)	148, 150, 151, 165, 181, 183, 218, 244, 693, 818, 827, 917	
Instrument, Meter (Stationary)	150, 151, 165, 181, 183, 218, 244, 245, 752, 818, 827	
Cases, Relay (See Cans, Relay)		
Cases, Shielded (See Containers, Shielded)		
Cassettes, Tape (See Cartridges & Cassettes, Tape)		
Casters & Wheels	144, 223, 252, 193, 199, 221	
Cat Transformers	1550	
CATV Systems & Equipment	38	
Cells, Electrolytic (E-Cells), Timing (See Timers, Electronic Cell)		
Cells, Photoconductive	955, 957, 964, 1286, 1586	
Cellulose Wire	1668	
CENTRALAB ELECTRONICS DIV., GLOBE-UNION INC.		
Capacitors	307-317	
Potentiometers	1210-1215	
Switches	1320-1328	
Cera-Mite Capacitors	414, 415, 417	
Cerafil Molded Ceramic Capacitors	275	
Ceralam Capacitors	275, 280, 281	
Cerod Capacitors	411	
Ceramics (See Insulation Parts, Ceramic)		
Chambers, Vacuum	505	
CHANNELLOCK, INC.	1380, 1381	
Chargers, Battery	988, 1001, 1023, 1026, 1207	
Chassis, Circuit Board Mounting	180	
Chassis Marking Kits (See Kits, Marking, Dial, Instrument, Equipment, etc.)		
Chassis, Metal	148, 151-153, 166, 180-182, 222, 245, 246, 218, 219	
Chass Slides (See Slides, Cabinet, Chassis & Drawer)		
Check-out Systems, Automatic (See Test Equipment, Check-out)		
Checkers (See Analyzers; Testers)		
Chemicals		
Anti-Static (See Coatings, Anti-Static)		
Degreasing (See Cleaners & Solvents)		
Fungicidal (See Coatings, Fungicidal)		
Wire Stripping	432	
Chem-Oil Lubricating Oil	431	
CHEMTRONICS INC.	430, 431	
Chestsets (See Handsets, Chestsets & Operator Sets)		
CHICAGO MINIATURE LAMP WORKS	974	
Chief Headsets	77	
Chief Intercom Systems	74	
CINCH MFG. CO., DIST. DIV.	540-550	
Chips, Capacitor (See Capacitors, Chip)		
Chokes		
A-F (See Coils, A-F)		
Filter	460-462, 1191, 1449, 1453, 1455, 1464, 1465, 1496, 1497, 1509, 1524-1526, 1535, 1538, 1541, 1551, 1556, 1558, 1559	
R-F	450-461, 463, 1455, 1191	
Swinging	1425, 1464, 1465, 1482, 1496, 1497, 1535, 1551, 1556, 1558	
Chro Bar Generators	897	
Chronographs (See Recorders, Timing)		
Circuit Analyzers (See Testers, Signal Tracing)		
Circuit Board Racks (See Racks, Circuit Board)		
Circuit Breakers	1207, 1351	
Circuitracer Circuit Testers	862	
Circuit Testers (See Testers, Signal Tracing)		
Circuits		
Encapsulated	323	
Hybrid, Thin-Film	1270	
Integrated, Metal Oxide Semiconductor (Mos)	1278	
Integrated, Silicon Monolithic	947-949	
Integrated, Silicon Monolithic, Unpackaged Chips	1270	
Logic & Computer (See Cards, Logic; Circuits, Hybrid; Circuits, Integrated)		
Multilayer (See Printed Circuits, Multilayer)		
Printed with Components (See Cards, LI Near Function)		
Thin-Film (See Circuits, Hybrid, Thin-Film)		
CLAIREX ELECTRONICS INC.	955	
Clamps & Clips, Cable (Also See Wire & Cable)	512, 678, 704, 711, 840, 848, 853, 1763, 1768, 1771	
Clamps, Component	488, 580, 1377, 1380, 1395, 1403, 1419	
Claro-Dec Decade Boxes	1225	
Clarodial Dials	1222	
CLAROSTAT MFG. CO., INC.		
Resistors	1142-1145	
Potentiometers	1216-1225	
Classic Motors	995	
Classic Speakers	94	
Clean Room Equipment & Supplies	1402	
Cleaners & Solvents	103, 105, 127, 128, 429, 430, 432-437, 443, 604, 1207	
Cleaners, Mechanical, Magnetic Tape	103, 128	
Cleaners & Filters, Air (See Air Cleaners & Filters)		
Cleap Connectors	712	
CLEVITE CORP. (See Burgess Battery)		
Clip Insulators (See Insulators, Test & Battery Clip)		
Clipper Chokes	1486	
Clipper Foot Switches	1346	
Clips		
Alligator	558, 568, 569, 591, 592, 596, 605, 629, 634, 635, 641, 642, 688, 985	
Battery	568-570, 590-592, 689	

GENERAL INDEX (Continued)

	Page
Cordlite Light Extensions	1698
Cordlite Reels	1699
Cordmaster Switches	724
Cords & Tapes, Lacing.....	683, 1642, 1720, 1763
Cords	
Lacing (See Cords & Tapes, Lacing)	
Line & Set, Extension.....	697, 733, 735, 755, 766, 794, 1392, 1407, 1669, 1690-1699, 1722, 1741, 1756, 1757, 1784-1786
Line, Lamp (See Cable, Multiconductor)	
Line, Resistance	1741
Patch	37, 106, 107, 510, 606, 607, 622, 623, 630-632, 638-642, 681-683, 687, 696, 718, 733-735, 737, 738, 751
Power (See Cable, Power)	
Retractable	631, 676, 697, 735, 1638, 1665, 1670, 1691-1693, 1695, 1719, 1758, 1759, 1764, 1784, 1785
Speaker Extension (See Cable, Audio)	
Twin Lead (See Cable, Multiconductor)	
Corona Testers (See Testers, Corona)	
CORNING ELECTRONICS DIV. OF CORNING GLASS WORKS	
Capacitors	319
Resistors	1146
Corrib Resistors	1192
Counters	
Digital	927
Frequency	927
Photoelectric	956-958, 962
Preset	798, 799
Couplers	
Antenna	25-28, 30, 38, 766, 1785
Directional	28, 38, 766
Multi-Set (See Couplers, Antenna)	
Couplings, Shaft, Rigid & Flexible.....	486, 698, 1221, 1241, 1242, 1244, 1245
Covers	
Chassis	65, 166, 180-182, 245, 246, 752
Jack (See Jack Covers)	
Protective	62, 104, 520, 524, 688, 689, 693, 761, 827, 849, 1234, 1236, 1241, 1256, 1780
Cradle Clip Cable Clamp	1768
Cramolin Coatings & Cleaners.....	429
Crimping Machines & Tools (See Tools, Crimping)	
Cross-Lock Terminals	701
Crystal Analyzers (See Analyzers, Crystal)	
Crystal Filters (See Filters, Crystal)	
Crystal Oscillators (See Oscillators, Crystal-Controlled)	
Crystal Ovens (See Ovens, Crystal & Component)	
Crystals	
Frequency Control	814, 816
Piezoelectric	816
Quartz	816, 1276
Crystek Crystals	816
CUTLER HAMMER	1314-1317
Cutters	
Hole, Hand Operated	1389
Wire, Automatic (See Wire Measuring & Cutting Machines)	
Wire, Hand (See Wire Cutters, Hand Operated)	
D	
D-Holder Lamp Holders	979
DABURN ELECTRONICS & CABLE CDRP.	
Hardware, etc.	834
Insulators, etc.	944
Jacks, Plugs, etc.	554-558
Heat Dissipators	1273
Switches	1318, 1319
Tubing, Wire, etc.	1742-1764
Daflex Fiberglass Tubing	1742-1745
Daffon Heat Shrinkable Tubing.....	1743, 1744
DALE ELECTRONICS, INC.	1147-1151
Dalite Wire	1753
Dampers, Structural, Chassis, Panel, etc. (See Mounts, Shock & Vibration)	
Dandee Capacitors	256
DATAK CORP., THE	820
Datalite Indicator Lights	966, 967
DAVIES MOLDING CO., HARRY	818, 819
DEARBORN WIRE & CABLE CO.	1765
Decade Boxes	
Capacitance	287, 867, 901
Inductance	287, 867, 1553
Resistance	287, 858, 901, 1144, 1191, 1225
Decalcomania (Also See Labels, Pressure Sensitive).....	712, 820
Deci-Cap Capacitors	337
Deci-Ductor Inductors	475
Decoders	
Audio Tone	884, 1343
Telemetry (See Decoders, Audio Tone)	
Decontaminants (See Cleaners & Solvents)	
Deflection Yokes, Coils & Assemblies (See Yokes, Deflection)	

	Page
Degreasing Chemicals (See Cleaners & Solvents)	
Delay Lines	
Distributed, Constant (Fixed)	322
Distributed, Constant (Variable)	322
Lumped-Constant (Electrically Variable)	322
Lumped-Constant (Fixed)	322
Delays, Time (Excluding Delay Lines).....	800, 801, 802-804, 813, 694
DELCO RADIO DIV. GENERAL MOTORS CORP.	1274, 1275
Deluxe Outlet Boxes	757
Demagnetizers	127, 128, 136
De-Ox-Id Contact Cleaner	432
DESCO MFG. CO.	
Test Probes	862, 863
Miniature Tools	1382
Designer Series Cabinets	162, 163
De-Snower Antenna Amplifiers	25
De-Snower Preamplifiers	28
Desoldering Tools & Equipment (See Soldering Accessories; Soldering Equipment; Soldering Guns, etc.)	
Detectors	
A-F (See Detectors, Frequency)	
Corona (See Testers, Corona)	
F-M (See Detectors, Frequency)	
Fire & Smoke, Electronic (See Fire Detection & Fighting Equipment)	
Frequency	807, 901, 1060
Light Intensity (See Meters, Light, Non-photographic)	
Null (See Indicators, Null)	
Phase-Sensitive	1060
R-F (See Detectors, Frequency)	
Video	901
Voltage	1024, 1060
Determohm Resistance Boxes	1191
Diagonal Cutters (See Wire Cutters, Hand Operated)	
Dial Locks (See Locks, Dial & Shaft)	
Dialco Indicator Lights	966-973
DIALIGHT CORP.	966-973
Dials	
Instrument, Metal, Plastic, etc.	472, 499, 502, 705, 818, 821, 825, 826, 1267
Turns-Counting	705, 825, 826, 1222, 1262, 1359
Dielectric Coolants (See Coolants, Circuit & Component)	
Dies & Taps	712, 1384, 1386, 1398
Differentials, Mechanical (See Gears & Gear Mechanisms)	
Difilm Capacitors	400, 404-406
Digital Display Devices (See Readouts & Readout Devices — Also See Tubes, Readout)	
Digital Voltmeters (See Meters, Volt, Digital)	
Dim-Lighter Light Controls	810
Dimmers (See Controls, Photoelectric)	
Diode Testers (See Testers, Diode)	
Diodes	
Avalanche	1292, 1293
Dual	1159, 1270, 1276, 1277
Germanium	694, 1270, 1276, 1284-1286
Limiting	1289
Microwave Detector	694, 1276, 1601
Microwave Mixer	1276, 1601
Photoelectric	1284-1286
Selenium (See Rectifiers, Selenium)	
Silicon	1270, 1276, 1284-1286, 1289, 1296, 1300, 1301
Tunnel	1284-1286
Varactor	1270
Video Detector (See Diodes, Microwave Detector)	
Zener	1270, 1276, 1289, 1296
Directional Couplers (See Couplers, Directional)	
Director Wireless Intercoms	54
Discriminators	1436, 1437
Disc Packs, Magnetic	125
Display Systems, Data	34, 35
Display, Numeric (See Readouts & Readout Devices — Also See Tubes, Readout)	
Dissipators, Heat (See Heat Sinks — Also See Transistor & Diode Heat Dissipators; Tube Heat Dissipators)	
Distortion Analyzers (See Analyzers, A-F)	
Distortion Indicators (See Analyzers, A-F)	
Distribution Systems, Frequency	22, 26, 27, 28
Dividers	
Power	1460
Voltage (Also See Transformers, Voltage-Dividing)	1165, 1186
Dividohm Resistors	1186
Dixie Headsets	77
Dollies & Instrument Carts (See Carts, Instrument)	
Dolphin Lanterns	993
Doors, Cabinet, Metal (See Cabinets & Accessories, Metal)	
Dope, Coil (See Insulating Compounds, Coil Dope)	
Double-Wipe Switches	728
DOW-KEY COMPANY	1036

GENERAL INDEX (Continued)

	Page
Gamma Ray Tube (See Tubes, Radiation Detection)	
GARRARD, DIV. OF BRITISH INDUSTRIES CO.	130
Gaskets (See Seals)	
Gaskets, Shielding, R-F (See Shields, R-F)	
GATES ELECTRONICS CO., INC.	998-1002
Gauges	
Ionization	1618
Lead Bending	1395
Pirani	1618
Gears & Gear Mechanisms (Precision)	485
Geiger-Mueller Tubes (See Tubes, Geiger-Mueller)	
Gemlite Indicator Lights	977
GENERAL CONTROL CO.	1329
GENERAL ELECTRIC CO., ELECTRONIC COMPONENTS SALES DIV.	
Lamps	975
Panel Meters, Meter Relays	868-873
Power Supplies, Batteries	1010-1013
Semiconductors	1276
Soldering Irons	1390, 1391
Transformers	1446, 1447
Tubes	1564-1588
GENERAL TIME CORP.	798, 799
Generators	
A-M/F-M	876
Audio	857, 897
Color TV	857, 876, 888, 889, 895-897
Cross Hatch	857, 876, 895, 897
F-M	875, 896
F-M & F-M/Stereo	857, 895
Line & Vector	888
Low Frequency	895, 897
Marker	815, 876, 897, 899
R-F	815, 876, 888, 895, 896
Signal, Standard Type	876, 895, 896
Sine-Wave	857, 895, 897
Spectrum (See Generators, Sweep)	
Square-Wave	857, 897
Sweep	876, 896
Tone	815
TV Signal	876, 895, 896
TV Synch	894, 895
Germanium Semiconductors (See Diodes; Transistors)	
Gibraltar Distribution Amplifiers	28
Glass-K Capacitors	319
Glo-Bar Thermistors	1152
Glo-Dot Pilot Lights	984
Glues (See Adhesives)	
GOTHAM AUDIO CORP.	1448
Grand Prix Cabinets	142
Greases (Also See Lubricants)	1207
GREENLEE TOOL COMPANY	1389
Greenohm V Resistors	1142, 1143, 1145
GRIFFITH PLASTIC PRODUCTS CO.	821
Grilles, Metal/Plastic	146, 205, 206
Grilles, Speaker	247
Grommets	493, 699, 841, 835, 849, 851, 1769
Ground Rods (See Rods & Clamps, Ground)	
GUARDIAN ELECTRIC MFG. CO.	1054-1060
Guides, Circuit Board	438
Guns, Soldering (See Soldering Guns)	

H

Hi-Lite Indicator Lights.....	983
Hallmark Speakers	75
HAMLIN INC.	1330
HAMMARLUND MFG. CO. INC., THE, SUB. ELECTRONIC ASSISTANCE CORP. 320, 321	
HAMMEL RIGLANDER & CO., INC.	1394
Hamswitch Switches	1356
Hand Tools (See Specific Types — Also See Tools as Modified)	
Handi-VOM Volt-Ohm-Milliamperere Meters	918
Handiscope Oscilloscopes	922
Handles for Cabinets, Circuit Boards, Racks, etc.....	154, 186, 221, 223, 252, 253, 488, 746
Handsets, Chestsets & Operator Sets.....	37, 88, 115
Hardware, Antenna (See Clamps; Ground Rods; Mounts; etc. — Also See Antenna Towers & Supports)	
Hardware (See Bolts, Brackets, Clamps, Fasteners, Terminals; etc.)	
Harnesses, Wire (See Cable Assemblies)	
HARREL INC.	806
HART-ADVANCE RELAY DIV., OAK ELECTRO/NETICS CORP.	1045-1052
HAYDEN BOOK CO., INC.	1028, 1029
Headers, Relay & Transformer	587
Headers, Transistor & Diode	587
Headphones & Headsets.....	58, 74, 114, 115, 505, 605, 712
Heads	
Erase	132-135, 695
Magnetic Drum, Memory	133
Recording/Playback, Audio & Stereo	132-135

Heat Dissipators (See Transistor & Diode Heat Dissipators; Tube Heat Dissipators — Also See Heat Sinks, Soldering)	
Heat Guns, Production	1397, 1414, 1743
Heat Shrinkable Elastomers (See Caps, Forms & Tapes, Heat Shrinkable — Also See Tubing, Heat Shrinkable)	
Heat Shrinkable Plastics (See Caps, Forms & Tapes, Heat Shrinkable — Also See Tubing, Heat Shrinkable)	
Heat Sinks, Soldering	1380, 1388, 1395, 1419
HEINTZ & KAUFMAN LTD.	1590, 1591
Hercules Foot Switches	1347
HEXACON ELECTRIC COMPANY	1392, 1393
Hexclad Soldering Tips	1393
Hi-D Jax Phone Jacks	715
HI-G INDUSTRIAL PRODUCTS, RELAY CO. OF AMERICA, INC.	1062, 1063
Hi-Lite Picture Tubes.....	1595
HICKOK ELECTRICAL INSTRUMENT CO., THE	874-876
Hide-A-Lite Indicator Lights	974
Hinges (See Fasteners)	
Hipermalloy Transformers	1555
HIPOTRONICS, INC.	
Power Supplies	1014
Testing Equipment	878-880
Transformers	880
Hippo-Clip Battery Clips	591
Holders	
Battery (See Retainers, Battery — Also See Connectors, Battery)	
Brush (See Brushes & Brush Assemblies)	
Excluding Retainers (See Holders; Sockets)	
Fuse (See Clips & Holders, Fuse; Panels, Fuse)	
Lamp (See Sockets, Lamp & Lamp Assemblies)	
Tube (See Retainers, Tube)	
Hole Cutters (See Cutters, Hole)	
Hoods, CRT Viewing (See Viewing Hoods, Cathode-Ray Tube)	
Hook Switch Switches	729
Horns, Speaker	52, 53, 74, 84, 90
Hot Shot Batteries	1006
Housings	
Instrument & Meter (See Cabinets; Cases)	
Metal (See Cabinets; Cases)	
Metal, Small (See Cans)	
Speaker (See Enclosures, Speaker)	
Humdinger Potentiometers	1144
HUNTER TOOLS DIV., HUNTER INDUS.	1395
HURST MFG. CO., INC.	951
Hy-Cap Capacitors	337
Hypass Capacitors	410
Hypercon Capacitor Discs	419

I

IRC, DIV. OF TRW INC., DIST. PRODUCTS	
Electrical Tapes	946
Resistors	1155-1166
Potentiometers	1228-1258
Semiconductors	1277
Switches	1331-1335
ITT CANNON ELECTRIC	551
Iceberg Outlet Ships	764
ICORE ELECTRO-PLASTICS INC.	1770
Igniters, Arc Lamp (See Power Supplies, Arc Lamp)	
Ignitor Batteries	1006
Illumination Indicators (See Meters, Light)	
ILLINOIS TOOL WORKS (See Licon Div.)	
Impedance Comparators (See Bridges, Impedance)	
IMPERIAL (See GC Electronics)	
Imperial Panel Consoles	145
Imperial Soldering Irons	1407
In-Dus-Tronic Tools	1378
Indicator Lights (See Lights, Dial, Panel, etc.)	
Indicators	
Capacitor Leakage (See Testers, Capacitor)	
Circuit Condition, On/Off, etc. (Electromechanical)	865, 976, 977, 985
Computer Type (See Lights; Dials — Also See Readouts & Readout Devices)	
Data Display (See Lights; Dials — Also See Readouts & Readout Devices; Tubes, Readout)	
Distortion (See Analyzers, A-F)	
Elapsed Time	798, 799, 812, 872, 885
Electromechanical (See Indicators, Circuit Condition, On/Off)	
Fire (See Fire Detection & Fighting Equipment)	
Frequency (See Meters, Frequency)	
Illumination (See Meters, Light)	
Liquid Level	807
Null	867
Numeric Readout (See Readouts & Readout Devices)	
Phase	854
R-F (See Meters, Frequency)	
Shaft Speed (See Tachometers, Electronic)	
Smoke & Combustion, Electronic (Also See Fire Detection & Fighting Equipment)	

GENERAL INDEX (Continued)

	Page
Line Radiator Speakers	90
Line-O-Lite Pilot Lights	984
Lincers, Tube Shield (See Shields, Tube)	
Lite-Line Cabinets	165
LITTELFUSE INC., SUB. OF TRACOR INC.	1348-1354
Littel-Jax Phone Jacks	715
Littel-Key Switches	727
Littel-Lite Switches	723
Littel-Plug Phone Plugs	719
Littel-Switch Switches	723
Little Champ Pliers	1381
Little Dandy Soldering Irons	1374
Little Devil Resistors	1188, 1190
Little Jim Flashlights	1005
Little-Lytic Capacitors	381
LITTON INDUSTRIES	
Triad Div.	1530-1544
USECO Div.	740-747
Lo-Cap Switches	727
Loc-Fit Terminals	742
Lock-Jaw Adhesives	436
Locators, Cable & Line Fault	878, 879
Locators, Open-Short	878, 879
Locks, Dial & Shaft	154, 503, 487, 698, 746
Logic Circuits (See Cards, Logic; Modules, Logic; Circuits, Integrated)	
Long John Outlet Boxes	763
LORAL DISTRIBUTOR PRODUCTS	
Alpha Wire — Wire & Cables	1624-1646
Arco Electronics — Capacitors, Elmenco, ArcoLytic	288-305
Lorcap Capacitor Discs	301, 302
Loudspeakers (See Speakers)	
Louvers, Vents & Windows, for Equip. (See Cabinets & Accessories, Metal)	
Lubricants (Also See Greases)	103, 105, 128, 429-437, 604, 1207
Lug-Plug Phone Plugs	719
Lugs (See Terminals, Lug)	
LUTRON ELECTRONICS CO., INC.	808-810
M	
Machines	
Crimping (See Tools, Crimping)	
Shock Testing (See Testers, Shock)	
Solderability Testing	1399
Soldering (See Soldering Equip.)	
MAGNECRAFT ELECTRIC CO.	1072-1083
Magnetic Shields & Materials (See Shields, Magnetic)	
Magnetrons (See Tubes, Magnetron)	
Magnets, Permanent	1330
Magnifiers, Bench Top & Head Band	1402
Magnifying Glasses, Inspection (Also See Lamps, Magnifying)	1402
MALLORY DISTRIBUTOR PRODUCTS CO.	
Capacitors	328-336
Batteries	1015
Potentiometers	1264, 1265
Signals	807
Switches	1356, 1357
Marine Core Cable	1623
Mark II A-C to D-C Converters	995
Mark-T Cabinets	147
Marker Strips (See Strips, Marker & Fanning)	
Markers, Dry Transfer (See Dry Transfer Letters — Also See Drafting Symbols; Labels, Pressure-Sensitive)	
Markers, Identification (See Labels; Nameplates)	
Markers, R-F (See Generators, Marker)	
Markers, Terminal (See Kits, Marking)	
Markers, Wire, Tab & Sleeve (See Wire Markers)	
Marketch Etching Solution	822
Marking Inks (See Inks, Marking)	
Markit Transfer Letters & Symbols	822
Marksman Soldering Guns	1413
Mask-N-Glas Anti-Static Spray	430
MASTER APPLIANCE CORP.	1397
Master Antenna TV Systems & Equipment	22, 25, 27, 28, 38, 39, 512
Master Headsets	77
Master Intercoms	505
Masts, Antenna (See Antenna Towers & Supports)	
Mat Transformers	1552
Mat Magnetic Amplifiers	1552
Matcherator Transformers	22
Max-C Trimmer Capacitors	324
Megohm Insulation Testers	930
MEMCOR DIV., LTV ELECTROSYSTEMS INC., COMPONENTS OPERATION	1168-1175, 1266, 1267
MERCURY ELECTRONIC CORP.	889
METAL WORKS INC.	167-179
Meter Cases (See Cases, Equipment)	
Meter Controllers (See Relays, Meter)	
Meter Shunts (See Shunts, Meter)	

	Page
Meters	
Ampere, A-C	864, 865, 871, 893, 902-904, 908, 911-918, 921, 923, 930, 931, 933-935
Ampere, D-C	505, 855, 864, 865, 869, 870, 872, 873, 881, 889, 893, 902-904, 906, 909, 910, 914, 915, 917, 918, 921, 923, 924, 930-932, 934, 935, 937-940
Ampere, R-F	907, 910, 934
Ampere, True Rms	892
Ampere-Hour	867
Audio Level	904, 923
Cable Testing (See Testers, Cable)	
Capacitance	875
Decible Indicating	904, 907, 911, 917, 918, 921, 940
Dynamometer (See Dynamometers)	
Edge-wise	965, 872, 890, 891, 902, 903, 909, 931, 934
Elapsed Time (See Indicators, Elapsed Time)	
Events-Per-Unit-Time (See Counters, Mechanical, etc.)	
Field Strength	28, 857, 903
Flutter & Wow	1448
Frequency	861, 882-884, 892, 893, 904, 912-914, 915, 930
Galvanometer	907, 910
Kilovolt	859, 878-881, 889-904, 932, 937-939
Light (Non Photographic)	903
Megohm	505, 858, 866, 878, 880, 889, 892, 893, 904, 927, 930, 935, 937-940
Microampere	855, 869, 871-873, 881, 893, 902, 906, 909-911, 914-918, 921-924, 927, 930, 934, 935, 937, 940, 948, 949
Micro-Microampere (See Meters, Nanoampere)	
Micro-Microvolt (See Meters, Nanovolt)	
Milliampere	855, 864, 868, 869, 871-873, 875, 881, 889, 890, 902-904, 906-911, 914-918, 920, 921, 924, 927, 931, 933-937, 940
Milliohm	923, 924
Millivolt	855, 907, 909, 910, 915-917, 920, 924, 927, 932, 934, 935, 940
Miniature	909, 930, 985
Multitester	854, 855, 875, 880, 892, 904, 917-921, 936-939
Nanoampere	927
Nanovolt	880
Null	867, 935
Ohm	859, 881, 903, 904, 917-921, 924, 927, 936-940
Panel (D'Arsonval Movement)	861, 864, 865, 868-872, 890, 891, 902, 903, 906-908, 910-913, 930-935
Permeameter	881
Pocket	854, 881, 903, 918, 937-939, 985
Pyrometer	855, 886, 914
Q	867
Recording	855
R-F	907, 910
S-Units	903
Snap-Around	854, 917, 936
Tachometer (See Tachometers, Electronic)	
Temperature, Dial-Type (Contacting)	903, 917, 920, 923
Thermocouple	886, 914
Time Delay Rate	799
Time Interval (See Timers, Interval)	
Vacuum Tube Volt (VTVM)	888, 889, 892, 919, 923, 937, 940
Vibration	930
Volt	505, 855, 857, 865, 867, 868, 870-873, 889, 893, 903, 904, 906-909, 910-918, 920, 921, 924, 931-940, 985
Volt, Differential (See Meters, Volt)	
Volt, Digital (DVM) & Accessories	927
Volt, R-F	935
Volt, True Rms	892, 912, 913
Volt-Ammeter	505, 854, 855, 889, 893, 899, 917, 918, 920, 937-940
Volt-Ohm	505, 875, 889, 892, 893, 899, 904, 917-921, 935-940
VU	62, 65, 103, 903, 907, 911, 933
Watt	908, 910, 921, 923, 933, 935
Metfilm Capacitors	402
Metohm Resistors	1204
Metro Color Antennas	24
Micro-Hex Connectors	665
Micro-Jax Phone Jacks	715
Micro-Man Manipulators	1402
Micro Mite Chokes	150
Micro Plug Phone Plugs	719
Micro Ribbon Connectors	546
Microcircuits (See Circuits, Integrated; Circuits, Hybrid)	
Microphones	
Aircraft Type	85, 112, 113, 116
Carbon	88, 116
Cardioid	78, 85, 86, 88, 98, 99, 109, 110, 117, 122, 505
Ceramic	78, 79, 87, 88, 116
Contact	605
Crystal	62, 78, 79, 87
Differential	88
Dynamic	37, 62, 78, 79, 85-88, 98, 99, 109-111, 116, 117, 122, 505, 605
Handsets, Headsets (See Headsets)	
Lapel	78, 79, 85, 87
Lavalier	38, 78, 85, 87, 98, 109, 117, 122
Magnetic	113
Noise-Cancelling	79, 85, 88, 99-112, 113, 117
Pressure	116

GENERAL INDEX (Continued)

	Page		Page
Paracyl Antennas	24	Rheostat (See Rheostats)	
PARAGON ELECTRIC CO., INC.	856	Servo-Set	1223, 1228
Paralog Antennas	23, 24	Trimmer, Carbon Ceramic	1258
Parapro Antennas	24	Trimmer, Carbon Composition	1138, 1210, 1211, 1214, 1216, 1217, 1223, 1225, 1232, 1235, 1236, 1247, 1249, 1250, 1253, 1257-1259, 1263
PARKER INSTRUMENT CORP.	890, 891	Trimmer, Ceramic-Metal (Cermet)	1209
PAR-METAL PRODUCTS DIV. OF EON CORP.	184-221	Trimmer, Wirewound	1144, 1150, 1151, 112, 1218, 1221-1223, 1225, 1237, 1248-1250, 1254, 1257-1259, 1264, 1265
Patch Boards (See Boards, Plug-In; Boards, Programming)		Wirewound	1210, 1212, 1215, 1218, 1221, 1223, 1224, 1226, 1227, 1231, 1232, 1235, 1237-1240, 1245, 1247-1249, 1251, 1252, 1255, 1257, 1259-1261, 1264, 1265
Patch Cords (See Cords, Patch)		POTTER & BRUMFIELD	
Pathfinder Antennas	23	Relays	1089-1102
Pathfinder Public Address Equipment	66-69	Switches	1360, 1361
Patio Speakers	75	Pow' Riveter Riveting Tools	1406
Pedaline Foot Switches	1071	Power-Line Amplifiers	123
Permafoam Coaxial Cables	1722	Power-Stat Variable Transformers	1025
Permohm Cable	1667	Powerdial Controls	808
PETERSEN RADIO CO., INC.	814, 815	Power Outlet Boxes (See Boxes, Power Outlet)	
Phase Indicator (See Indicators, Phase)		Power Supplies	
PHILMORE MFG. CO., INC.	505	A-C Output — 60 CPS	986, 989, 997, 1020, 1023, 1026, 1521
Phones (See Headphones & Headsets)		A-C Output — 400 CPS	989, 1020, 1521
Phonograph Parts & Accessories	104, 105, 128, 432, 557, 572, 573, 734, 1782	A-C Output — Other Than 60 or 400 CPS	989, 1020, 1021
Phonographs	41, 57-60, 62, 66	D-C Output — Other than 60 or 400 CPS Input	989, 999, 1012, 1018
Photo Mod Lamp Assemblies	955	60 or 60/400 CPS Input, Up to 30 VDC Output, Voltage Regulated	22, 881, 989, 994, 996-999, 1000-1002, 1012, 1019-1022, 1023
Photocells & Phototubes (See Cells, Photoconductive, etc — Also See Tubes, Photomultiplier)		60 or 60/400 CPS Input, Up to 100 VDC Output, Voltage Regulated	888, 989, 990, 994, 996, 999-1002, 1012, 1019, 1022, 1023
Photoelectric Equipment (See Alarms; Controls; Counters; etc.)		60 or 60/400 CPS Input, Up to 1,000 VDC Output, Voltage Regulated	888, 989, 994, 996, 998, 999-1002, 1012, 1014, 1019, 1022, 1023
Photometers (See Meters, Light)		60 or 60/400 CPS Input, Up to 10,000 VDC Output, Voltage Regulated	989, 994, 998, 1014, 1018, 1020, 1021, 1023
Photomultipliers (See Tubes, Photomultiplier)		60 or 60/400 CPS Input, Up to 50,000 VDC Output, Voltage Regulated	994, 1014, 1018, 1020, 1021
Pick-A-Shaft Controls	1218	60 or 60/400 CPS Input, Up to 500,000 VDC Output, Voltage Regulated	1021
Pickup Cartridges (See Cartridges, Phono)		60 or 60/400 CPS Input, Unregulated D-C Output	989, 994, 1000, 1014, 1019, 1020, 1021
Pickups, Telephone (For Recording)	136	400 CPS Input Only, D-C Output, Voltage Regulated	989
Picoline Delay Lines	322	400 CPS Input Only, D-C Output, Voltage Unregulated	989
Piggy-Back Snap Switch Modules	721, 722	60 or 400 CPS Input, D-C Output, Current Regulated	989, 994, 1019, 1022
Pilot Lamps (See Lamps, Dial & Pilot)		28 VDC Input, Up to 10,000 VDC Output, Voltage Regulated	1021
Pin Straighteners, Tube	1386	28 VDC Input, Over 10,000 VDC Output, Voltage Regulated	1021
Pins, Electrically Conductive	669	Arc Lamp	989
Pip Transformers	1548	Electroplating Equipment	999, 1001, 1002
PLASTIC CAPACITORS, INC.		Energy Storage	989
Capacitors	344, 345	integrated Circuit	989
Power Supplies	1018	Lab, Multiple Output	989, 996, 997, 1023
Plasti-Grip Terminals	702	Operational	989, 999, 1019, 1020
Plastics, Heat Shrinkable (See Caps, Forms & Tapes, Heat Shrinkable — Also See Tubing, Heat Shrinkable)		Programmable	989
Plates		Programmable, High-Speed	989
Instructional (See Nameplates)		R-F	989, 994, 1021
Names (See Nameplates)		Switch-Over Automatic (Self-Contained Battery)	994
Silk Screen (See Nameplates)		Powerhouse Megaphones	52
Switch Mounting	27, 30, 721, 725, 826	Powerkote Coils	1521
Pliers	1378, 1380, 1381, 1384, 1386, 1394, 1395, 1403, 1404, 1406, 1410, 1411, 1419	Powerlytic Capacitors	383, 384
Pliobond Cement	432	Powermate Antennas	25
Plug Adapters	37, 106, 128, 515, 516, 532-535, 556, 557, 562, 574, 577, 595, 598, 606, 608-615, 618-620, 622, 623, 638, 639, 668, 669, 678-680, 683-687, 697, 714, 717, 719, 734-736, 787	Powr-Rib Resistors	1192
Plug & Jack Sets	106, 557, 560, 576, 577, 606, 607, 616, 617, 629-641, 716, 717, 719, 732, 734, 736, 1785	Powerstat Motor Speed Controls	1523
Plug Caps & Shells	515, 516, 624, 731	Powerstat Variable Transformers	1520, 1522, 1523
Plug-In Module Enclosures	587, 616-618, 624-628, 711, 751	Preamplifiers	
Plugboard Plug-In Boards	438	Audio	45
Plugs, Button-Hole	508, 599, 840	Microphone	42, 43, 63, 64, 66, 68
Plugs, Electrical (All Types)	106, 107, 128, 305, 508, 510, 515, 516, 518-524, 526-528, 531-535, 540, 541, 546, 547, 551, 556-558, 561-566, 571-573, 576-578, 595-598, 603, 605, 606, 608, 609, 616-623, 630, 631, 634-636, 638-642, 660, 668, 669, 672, 673, 675, 678-681, 684-687, 697, 701, 702, 712, 714, 716-719, 730-738, 751, 771, 786, 787, 793, 849, 1369	R-F	25, 28
Plugs & Receptacles, Line Cord	518, 679, 730, 732, 1369	Transistor	1435
Plugs, Fused	606	PRECISION ELECTRONIC COMPONENTS LTD. (PEC)	
Pointers, Dial	686	AN AFF. OF AIRCO SPEER ELECTRONIC COMPONENTS	1209
Poly-Pedance Transformers	1486	PREMAX PRODUCTS DIV. OF CHISHOLM-ROYER CO., INC.	32, 33
Polycap Capacitors	261	PREMIER METAL PRODUCTS CO.	223-253
Polychromatran Transformers	1487	Prem-O-Cube Cabinets	230
Polyfoam Cable	1623	Prem-O-Kool Fans & Blowers	250, 251
POMONA ELECTRONICS CO., INC.	606-645	Prem-O-Rak Cabinet Racks	224, 226-228, 233, 234
Posts		Premier Microphones	79
Binding	524, 530, 531, 558, 560, 564, 566-568, 579, 586, 598-600, 605, 606, 609-614, 619, 621, 674, 675, 680, 684, 685, 687, 694, 714, 1509	Press-Fit Receptacles	646
Harness Board	530, 567-579, 674, 675	Press-Fit Spacer/Bushings	646
Spring Binding	530, 558-579, 606, 619, 621, 674, 675	Pres-Fit Terminals	647-650, 651-660, 661, 662
Potentiometer Testers (See Testers, Potentiometer)		Pressgrip Terminals	661
Potentiometers		Pressure Indicators (See Gauges, Pressure)	
Carbon Ceramic	1257	Pressurization Equipment, Cable (See Cable Pressure Equipment)	
Carbon Film	1151, 1210	Prestige Versa-Cabinets	142
Ceramic-Metal (Cermet)	1209, 1255, 1260, 1261	Princess Soldering Irons	1409
Composition	1209-1211, 1213, 1214, 1216, 1217, 1221, 1223, 1224, 1235, 1245, 1247, 1253, 1255, 1256, 1263	Printed Circuit Etchants	435
Conductive Plastic	1227	Printed Circuits, Multilayer	1271
Deposited Carbon	1138, 1224, 1225, 1230-1232, 1234, 1237, 1249, 1251, 1259	Printing, Dry Transfer (See Kits, Marking, Dial, Instrument, Equip., etc.)	
(Lab Type)	1222, 1223	Probes	
Metal Film	1151, 1255	Crystal	900
Metal, Glazed (See Potentiometers, Ceramic-Metal)		High-Voltage	534, 570, 607, 637, 677, 900, 923, 941, 1386, 1388
Non-Linear (See Potentiometers, as Modified)		R-F	900, 901, 923, 941
		Temperature (Also See Thermocouples)	806
		Test Lead	533-535, 557-559, 570, 595-597, 607, 614, 636, 637, 660, 668, 671, 677, 687, 692, 856, 862, 892, 900, 901, 923, 941, 983, 1386

GENERAL INDEX (Continued)

	Page	Page
Resistors (continued)		
Miniature & Subminiature ..1137, 1140, 1144, 1148, 1153, 1160, 1162, 1167, 1174, 1176, 1182, 1183, 1187-1190, 1193, 1200-1202, 1204, 1205		
Negative Temperature Coefficient ..1138, 1177		
Non-Inductive ..1146-1149, 1153, 1185, 1196, 1198, 1199, 1259		
Plug-In ..609, 1166		
Positive Temperature Coefficient ..1138		
Power ..1142, 1143, 1146-1149, 1152, 1153, 1164-1167, 1169-1175, 1179, 1181-1187, 1192, 1198, 1199, 1205, 1206, 1266, 1267		
Printed Circuit Mounting ..1138, 1139, 1141, 1144, 1148, 1159, 1160, 1162, 1167, 1176, 1182, 1188-1190, 1205, 1259		
Rheostat (See Rheostats)		
Standards (See Standards, Resistance)		
Suppressor ..1191		
Surge ..1203		
Tapped ..1143, 1145, 1147, 1153, 1174, 1186, 1187, 1192, 1206, 1225, 1230		
Temperature Sensitive (See Thermistors)		
Tin Oxide ..1146		
Variable (See Potentiometers)		
Voltage-Sensitive ..1143-1203		
Wirewound ..1142, 1143, 1145, 1147-1149, 1153, 1157, 1158, 1160, 1162-1176, 1179-1187, 1192, 1195-1201, 1205-1207		
Retainers		
Battery ..580, 581		
Relay ..1044, 1090, 1091		
Transistor & Diode ..1273, 1279-1281		
Tube ..584, 694		
Retractable Cords (See Cords, Retractable)		
Rheostats ..1144, 1168, 1219, 1259-1262, 1264-1267, 1269		
Rib-Loc Indicator Lights ..986		
Rib-Loc Jacks ..576		
Rib-Loc Terminals ..579		
Rings, Retaining ..1221		
RISK INDUSTRIES, GEORGE		
Semiconductors ..1290, 1291		
Switches ..1362, 1363		
Riteohm Resistors ..1182, 1183		
Rivets ..839, 1406		
ROBERTSHAW CONTROLS CO. ACRO DIV. ..1364, 1365		
ROBBINS ELECTRONICS CORP. ..100-107		
Rob-O-Stat Record Cleaning Kits ..105		
Rockette Switches ..1315		
Rods & Clamps, Ground ..33, 512, 591, 1780		
Rods, Threaded ..698		
Rotators (See Antenna Rotators)		
Rough Rider Antennas ..22		
Royal Crest Circuit Tubes ..1621		
Rubber Guards, for Equipment (See Bumpers)		
Ruf-Koat Wrinkle Varnish ..432		
Rugged Seal Meter Relays ..916		
Rugged Seal Panel Meters ..913		
RUSSELL INDUSTRIES INC.		
Bumpers, Grommets ..835		
Dry Transfer Letters, Kits ..822		
Shielding Foil, Tape, Tubing ..1593		
RYE INDUSTRIES CORP. ..605		
S		
S-Coat Resistors ..1205		
Safari Lite Lanterns ..993		
Safe-T-Klip Alligator Clips ..985		
Safe-T-Kord Test Leads ..985		
Sal-Met Solder Flux ..436		
SAMS & CO. INC., HOWARD W. ..1030, 1031		
SANFORD MILLER CORP. ..1282, 1283, 1449		
SARKES TARZIAN, INC. ..1292-1296		
Savbit Solder ..1399		
SAXTON PRODUCTS INC. ..1774-1786		
Scale Expanders, Meter (See Multipliers, Meter)		
Scales & Reticles, Optical ..493		
SCHAUER MFG. CORP. ..1019, 1289		
SCHRACK ELECTRICAL SALES CORP. ..1124, 1125		
Scissors ..1376, 1378, 1395, 1403		
Scope Dollies (See Carts, Instrument & Equipment)		
Scopes (See Oscilloscopes)		
Scotch-Master Antenna Beams ..31		
SCR's (See Thyristors)		
SCR Firing Controls (See Controls, SCR)		
Screwdrivers ..435, 1381, 1382, 1385, 1386, 1388, 1395, 1396, 1398, 1403-1405, 1415-1418		
Screws (See Fasteners)		
Scrubbing Tools ..1417		
Scrublock Phone Tips ..534		
SEALCRO CORP. ..646-666		
Sealecro-Print Recorders ..855		
Sealecroboard Program Boards ..666		
Sealecroswitch Programming Switches ..666		
Sealers (See Coatings)		
Seals & Feedthrus, Environmental (See Feedthrus & Seals, Environmental)		
SECO ELECTRONICS CORP. ..887		
Seiyer Nose Plier Clamp ..1419		
Selective Calling Devices (See Comm. Systems, Selective Paging)		
Selsyns (See Motors, Synchronous)		
Semiconductors (See Diodes; Rectifiers; Transistors (Also See Circuits, Integrated))		
SENCORE INC. ..904		
Senior Multitester Meters ..904		
Senior Foot Switches ..1347		
Sentry Speaker Systems ..85		
Series 60 Cabinet Racks ..138-141		
Services, Assembly & Fabrication ..116, 159, 160, 223, 488, 684, 692, 989, 1194, 1421, 1466		
Services, Coating (All Types) ..223		
Servo Motors (See Motors, Servo)		
Shadow Cabinets ..149		
Shaft Couplings (See Couplings, Shaft)		
Shafts & Adapters, Flexible (Also See Couplings, Shaft) ..487, 698		
Shafts, Rigid (Also See Couplings, Shaft) ..698, 1219, 1221, 1230, 1233-1236, 1241-1245, 1247, 1256		
Shafts, Threaded ..698		
Shav-Pak Inverters ..988		
Shielded Jax Jack Shields ..715		
Shields		
Cathode-Ray Tube ..494-498		
Coil ..463, 473		
Electrostatic (See Shields, Tube)		
Heat (See Tube Heat Dissipators)		
Indicator Light ..595, 694		
Magnetic ..494-498		
R-F ..494-497		
Switch ..711, 725, 1319, 1335		
Tube ..497, 516, 548, 694, 793, 1281		
Wire (See Braid, Cable & Wire Shielding)		
Shock Mounts (See Mounts, Shock)		
Short Frame Phone Jacks ..716		
Shorting Bars (See Bars, Shorting)		
Sharty Duplex Aligners ..1388		
Shrinkable Plastics & Elastomers (See Caps, Forms & Tapes, Heat Shrinkable — Also See Tubing, Heat Shrinkable)		
Shunts, Meter ..854, 891, 932, 941, 1191		
SHURE BROS. INC. ..109-113		
SHURITE METERS ..902, 903		
SIGMA INSTRUMENTS, INC. ..1126-1135		
Signal Conditioners & Equipment ..1508		
Signal Tracers (See Testers, Signal Tracing)		
SIGNAL TRANSFORMER CO. ..1462-1471		
Silicon Semiconductors (See Diodes; Transistors)		
Siltab Silicon Rectifier Stacks ..1509		
Silverama Picture Tubes ..1594		
SIMPSON ELECTRIC CO. ..906-927		
Single-D Microphones ..86		
Sinks, Heat (See Transistor & Diode Heat Dissipators; Tube Heat Dissipators — Also See Heat Sinks, Soldering)		
SLAUGHTER CO. ..905		
Sleeves (See Tubing)		
Slides, Cabinet & Chassis ..151, 173, 193, 200, 221, 222, 248, 249, 252, 752		
Slim Jim Test Leads ..676		
Slim-Line Connectors ..730, 732		
Slo-Syn Motor Controllers ..954		
Slo-Syn Motors ..952, 953		
SMITH INC., HERMAN H. ..668-713		
Smitty Wrenches ..1395		
Smoke Indicators (See Fire Detection & Fighting Equipment)		
Smoothline Master Antenna TV Systems ..22		
Snap-Acting Switches ..709, 710		
Snap-Cap Capacitors ..330		
Snaprol Control Accessories ..1230, 1232, 1233, 1235-1237		
Snip-N-Fit Grommets ..1769		
Snips (See Wire Cutters)		
Socket Adapters ..30, 513, 514, 516, 607, 629, 643-645, 754, 1386		
Sockets		
Breadboard ..445, 588, 629, 643-645, 753		
Capacitor ..549		
Crystal ..694, 794		
Diode ..605, 1207		
Integrated Circuit ..549, 662, 753, 793		
Lamp & Lamp Assemblies ..506, 694, 739, 966-974, 976, 979, 980-983, 987, 1699		
Miniature & Subminiature (See Sockets, Diode; IC; Transistor)		
Relay ..515-517, 549, 607, 1044, 1063, 1084, 1085, 1090, 1091		
Test ..513, 560, 607, 643-645, 658, 659, 753, 754, 1207, 1386		
Transistor ..445, 549, 605, 629, 643-645, 662, 753, 794, 976, 977, 983, 1207		
Transmitting & Industrial Tube ..515, 517, 643-645		
Tube ..273, 445, 513-516, 548, 549, 643-645, 694, 753, 754, 793		
Turret ..753		
SOLA ELECTRIC DIV. OF SOLA BASIC INDUS.		
Power Supplies ..1022		
Transformers ..1472-1474		

GENERAL INDEX (Continued)

Switches (continued)	Page
Tap	1356, 1358, 1359
Thermally Actuated	801
Time Delay	1783, 1786
Timing (See Timers)	
Toggle	593, 706-711, 1053, 1304, 1305, 1312-1319, 1336-1340, 1365-1368, 1370, 1371
Trigger	1056, 1368
Switchlights (See Switches, Illuminated)	
SYLVANIA ELECTRIC PRODUCTS INC.	1600, 1601
Syncro-Lab Turntables	130
Systems, Temperature Control (See Controls, Temperature)	

T

T-Bar Relays & Switches.....	1053
Tabcap Filter Capacitors.....	1509
Tables, Laboratory (See Benches, Consoles, Stools, Tables, Lab & Shop)	
Tabpost Binding Posts	1509
Tabtran Rectifier Transformers & Chokes.....	1509
Tachometers	
Electrical (Non-Generating)	930, 995
Electrical (Self-Generating)	930, 995
Electronic, Indicating	930
Stroboscopic	905, 930
TALK-A-PHONE CO.	72-74
Tan-O-Mite Capacitors	342, 343
TANSITOR ELECTRONICS, INC.	421-428
Tantalex Capacitors	357-367, 370, 373
Tape-A-Letter Recording Tape	131
Tape Decks (See Tape Transports)	
Tape Erasers, Magnetic (See Erasers, Magnetic Tape Bulk)	
Tape-Programmed Testers (See Test Equipment, Automatic Checkout; Testers, Integrated Circuit)	
Tape Recording Accessories.....	100-104, 106, 127-129, 132-135, 430
Tapes	
Electrical Insulation	505, 946
Films & Foils, Pressure Sensitive.....	104
Heat Shrinkable (See Caps, Forms & Tapes, Heat Shrinkable)	
Recording, Magnetic (All Types).....	100, 101, 126, 127, 129, 131
Taps (See Dies & Taps)	
Teaching Machines	57
TECHNICAL APPARATUS BUILDERS DIV. POWER ALTERNATING DIRECT CORP.	1023, 1509
Technical Books	127, 1027-1033, 1161, 1276
Teksel Selenium Rectifier Stacks.....	1509
TELCO (See GC Electronics)	
Tel-Ohmike Capacitor Testers	929
Telephone Handsets (See Handsets)	
Telephone Systems (See Comm. Systems, Telephone)	
Telephones, Sound Powered (See Comm. Systems, Telephone)	
Television Equipment (See Antennas; Cameras; Coils; Monitors; Recorders, Video)	
Telever Switches	726
TELVAC INSTRUMENT CO. (ORYX)	1400-1403
TEMPLE SOUND EQUIPMENT CO., INC.	70, 71
Tem-Stat Temperature Controls	144
Temperature Controls (See Controls, Temperature)	
Temperature Indicators (See Meters, Temperature)	
Temperature Sensors (See Transducers, Temperature)	
Templates, Drafting (See Drafting Equipment)	
Tempodium Lecterns	71
TERADO CORPORATION	1026
Terminal Blocks (See Blocks, Terminal)	
Terminal Boards (See Boards, Terminal)	
Terminal Boards, Prepunched	582-585
Terminal Connectors, Butt & Line.....	679, 701, 750, 771, 783, 786, 788, 790, 1687
Terminal Strips (See Strips, Terminal)	
Terminals	
Feedthru	552, 553, 560, 579, 583, 584, 586, 646, 651-657, 661, 692, 740-745, 750
Hermetic (See Terminals, as Modified)	
Lug	554, 555, 558, 560, 568, 569, 584, 597, 600, 620, 629, 633, 634, 661, 675, 679, 700-703, 748, 771-785, 787, 789, 790, 792, 836, 844, 845, 849, 850, 1667, 1668, 1687
Miniature & Subminiature.....	579, 585, 588, 647-657, 661, 692, 701, 742-745, 750
Printed Circuit Board	552, 553, 579, 582, 583, 740-745
Self-Mounting, Punch Type	743
Solderless	444, 554, 582-584, 586, 692, 700-702, 748-750, 753, 771-790, 792, 844, 845, 1686
Standoff	489, 490, 552, 553, 560, 579, 588, 589, 603, 647-650, 657, 661, 692, 693, 740-742
Threaded	553, 692
Turret	531, 552, 553, 560, 579, 582-585, 646-657, 674, 690, 691, 740-745
Terminations, High Voltage	1014
Test Equipment	
Automatic Checkout	874, 905
Color TV	887, 889, 898, 901
Component Substituting	887, 901

Test Lead Probes (See Probes, Test Lead)	
Test Leads & Adapters.....	559, 570, 596, 606, 615, 622, 634, 635, 676, 677, 682, 683, 687, 856, 862, 923, 933, 941, 1386, 1764, 1785
Test Sets (See Testers)	
Test Sets, Multipurpose	505, 857, 878, 881, 886, 887, 889, 917, 929
Testers	
Battery	903, 923
Cable	858, 878, 879
Capacitor	858, 922, 929
Circuit (See Testers, Signal Tracing)	
Corona	878, 879
Diode	863, 888, 898, 1402
Electric Power (See Monitors, Power, A-C & D-C)	
Flutter (See Meters, Flutter & Wow)	
Ground Resistance (See Meters, Ohm)	
Hi-Pot (See Testers, Insulation Breakdown).....	858, 859, 866, 879, 905, 930
Leakage	858, 866, 879, 905
Multipurpose (See Test Sets, Multipurpose)	
Resistor	858, 1191
Shock	504
Signal Tracing	856, 857, 862
Solderability (See Machines, Solderability Testing).....	863, 876, 1207, 1386, 1395, 1405
Resistor	858, 1191
Shock	504
Signal Tracing	856, 857, 862
Solderability (See Machines, Solderability Testing).....	836, 876, 1207, 1386, 1395, 1405
Transistor	857, 863, 874, 875, 887-889, 898, 923, 942, 1207, 1402
Tube	857, 874, 875, 887-889, 942
Voltage Breakdown	859, 903, 854
TEXAS CRYSTALS	816
Thermo-O-Meter Temperature Meters	920
Therma-Link Transistor Retainers.....	1279
Therma-Rel Tube Heat Dissipators.....	1281
Thermistors	1138, 1152, 1203
Thermocouples, Elements & Accessories	886
Thermostats (See Switches, Thermally Actuated; Controls, Temperature)	
Thin-Finger Phone Plugs	571
Thinline Speakers	76
Thinistor Thin-Film Thermistors	1203
Thrift-Foam Transmission Cable	1722
Thyratrons (See Tubes, Thyatron)	
Thyristors (Includes Silicon Controlled Rectifiers).....	1276, 1284-1288, 1293, 1300, 1301, 1601
Ties, Wire & Cable (See Wire & Cable Ties)	
Tilt-A-View Cabinets	147
Timer Switches (See Switches, Time Delay)	
Timers	
Cycle	798-802, 804, 812, 813
Interval	757, 758, 761, 798, 799, 804, 872, 930
Programmed	757, 758, 761, 802, 805, 812
Reset	798-802, 804
Sequence	798, 799, 801, 802, 804, 956, 959, 960
Solid State	799
Thermal	801
Timing Switches (See Timers)	
Tini-Jax Phone Jacks	715
Tini-Plug Phone Plugs	719
Tiny Switch Switches	723
Tinylite Indicator Lights	977
Tip-O-Dyke Wire Cutters.....	1395
Titelite Indicator Lights	977
TODD ELECTRIC CO.	1524-1528
Tool Handle Insulators.....	1381, 1398
Tool Holders	1381, 1384, 1418
Tool Kits & Sets.....	589, 691, 700, 712, 1376, 1381, 1382, 1386, 1395, 1398, 1402, 1403, 1405, 1416-1418
Tools	
Alignment & Tuning.....	435, 1382, 1384, 1387, 1388, 1402, 1404, 1405
Crimping	512, 589, 700, 702, 749, 791, 795, 1685
Hand or Mechanical (See Cutters; Screwdrivers; Wrenches; etc.)	
Resistance Soldering (See Soldering Equipment, Resistance)	
Riveting, Hand Operated	1406
Soldering (See Specific Types)	
Swaging	589
Toroids (See Coils, Toroidal)	
Towers, Antenna (See Antenna Towers)	
Tracers, Signal (See Testers, Signal Tracing)	
Trans-Aire Blowers.....	144
Transceivers, Amateur, CB, Industrial & Marine.....	54, 72, 505
Transceivers, Single-Sideband	54
Transducers, Temperature	806
Transducers, Thermoelectric (See Transducers, Temperature)	
Transformers	
Audio	136, 1422-1425, 1427, 1448, 1450-1452, 1454, 1455, 1480-1489, 1514, 1515, 1530-1533, 1535-1539, 1546, 1547, 1550, 1551, 1555-1558
Autotransformer	899, 1421, 1440, 1441, 1456, 1457, 1466, 1467, 1475, 1502, 1528, 1533, 1534, 1536, 1538, 1556, 1559

GENERAL INDEX (Continued)

Tubing (continued)	Page
Plastic (Also See Tubing, Spaghetti)	943, 1643, 1645, 1646, 1707, 1709, 1710, 1742, 1770, 1773
Rubber, Natural & Synthetic	678
Shrinkable (See Tubing, Heat Shrinkable)	
Spaghetti	692, 834, 1386, 1643-1646, 1707, 1708, 1719, 1742-1745, 1770, 1773
Spiral Wrap	1764, 1768, 1770
TFE (Also See Tubing, Spaghetti).....	692, 1644, 1709, 1710, 1743, 1745, 1764, 1770, 1773
Zipper	1642
Tudor Cabinets	147
Tuners A-M & F-M (Mono & Stereo)	45
Tuners, TV & F-M	323
Tun-O-Lube Cleaning Lubricant Spray	430
Tun-O-Wash Tuner Degreasing Spray	431
TURNER MICROPHONE CO.	116, 117
Turntables, Recording & Transcription	130
Tweezers, Hand & Vacuum	1377, 1386, 1393, 1402, 1403, 1411
Twin-Foam Cable	1779
Twin-Jax Phone Jacks	717
Twin-TEX Reversible Panels	247
Twist-Lok Capacitors	374-376
Twisters, Wire (See Wire Twisters)	
Ultra-Compact A Line Transformers	1546

U

USECO DIV./LITTON INDUSTRIES	740-747
UNGAR DIV. OF ELDON INDUS., INC.	1407-1409
Uni-Tite Controls	1221
Unicircuit Integrated Circuits	947
Unicreme Capacitors	323
Unidyne Microphones	109-111
Unifline Speaker Columns	120
UNION CARBIDE CORP. CONSUMER PRODUCTS DIV.	1003-1009
Unisphere Microphones	110
Uniseal R-F Coils	465
UNITED ELECTRONICS CO.	1602
UNITED TRANSFORMER CORP. DIV. OF TRW INC.	1545-1559
UNIVERSITY SOUND, DIV. OF LTV, LING ALTEC INC.	118-123

V

VACO PRODUCTS CO.	
Terminals	748, 749
Tools	1404-1406
Vac-U-Seal Double/Diodes	1276
Vacombo Tool Kits	1406
Vacuum-Tube Voltmeters (See Meters, Vacuum-Tube Volt)	
VAM Variable Capacitors	322
Varactors (See Diodes, Varactor)	
Vari-Fine Motor Speed Controls	759
Variable-D Microphones	85, 86
Variac Transformers	1023
Variductor Coils	1554
Varipower Autotransformers	1556
Varistors (See Resistors, Voltage Sensitive)	
Varnish (See Insulating Compounds, Varnish)	
Veco-Vamp Meter Protectors	1203
Vectorbord Breadboards	750
Vectorconn Connectors	438
VECTOR ELECTRONICS, INC.	
Plugboards, Breadboard Kits	438, 439
Terminal Boards, Sockets & Access.	750-754
Velvet Voice Microphones	79
Velvetork R-F Coils	468
Versakrimp Terminals	771
Vibrakrimp Terminals	771
Vibration Mounts (See Mounts, Shock & Vibration)	
Vibrators (Frequency Converting).....	988, 1026, 1207
VICTORY ENGINEERING CORP.	1203
Vises (All Types)	1395
Video Analyzers (See Analyzers, Video)	
Vidicon Tubes (See Tubes, TV Camera Pickup)	
Viewing Hoods, Cathode-Ray Tube	488
VIGOR TOOL CO., DIV. B. JADOW & SONS INC.	1410, 1411
Vitamin-Q Capacitors	387-398
Vitrohm Resistors	1206
VOCALINE CO. OF AMERICA BRISTOL MOTOR & ELECTRONIC DIV.	812, 813
Voice Microphones	79
Volt-Pac Transformers	1446
Volt-Pac Voltage Regulators	1013
Voltage Regulators (See Regulators & Stabilizers, Voltage)	
Voltmeters (See Meters, Volt)	
Voltohmyst Meters	892, 893
Voltprobe Voltage Level Testers	854
Vufinder Antennas	23

W

	Page
WABER ELECTRONICS INC.	755-769
WALDOM ELECTRONICS, INC.	
Breadboards & Components	440-445
Connectors, Terminals, Sockets	771-795
Hardware	846-853
Knobs, Dials, Drives	823-827
Switches	1372
WALL MFG. CO.	1414
WALSCO (See GC Electronics)	
WARD LEONARD ELECTRIC CO.	1204-1206, 1269
Washers (See Fasteners)	
Wee-Ductor Shielded Coils	478
Wee V-L Adjustable Coils	482
Wee-Wee-Ductor Shielded Coils	477
Weldohm Wire	1668
WELLER ELECTRIC CORP.	1412, 1413
WESTINGHOUSE ELECTRIC CORP. ELECTRONIC TUBE DIV.	
Rectifiers	1300-1302
Tubes	1603-1620
WHARFEDALE, DIV. OF BRITISH INDUSTRIES CO.	124
Wheel-N-Rack Wire Racks	768
Whip Antennas (See Antennas, Mobile)	
Wide-Vue Bezels & Illumination Kits	908
Wide-Vue Panel Meters	906, 907, 912
Wire	
Antenna (All Types)	1666-1668, 1688, 1711, 1747, 1777-1779, 1784-1786, 1788
Bare, Aluminum	1669, 1778
Bare, Copper	1666, 1711, 1720, 1739, 1740, 1747, 1778
Bare, Copper-Clad	1666
Bare, Nickel-Chrome	1739
Braid (Excluding Shielding).....	1720, 1740, 1746, 1747
Braid, Shielding (See Braid, Cable & Wire Shielding)	
Enamel Insulated (See Wire, Hookup, Pushback)	
Fiberglass Insulated (See Wire, Glass Insulated)	
Flat Strip (See Cable, Flat)	
Glass Insulated	1624, 1625, 1629, 1641, 1679, 1680, 1712, 1714, 1730, 1731, 1734-1735, 1748, 1751, 1788
Guy	834, 1778, 1783, 1784
High Temperature	1666, 1676, 1678, 1716, 1735, 1736, 1739, 1750-1754, 1757, 1786, 1788
High Voltage	1623, 1675-1681, 1706, 1712, 1713, 1715, 1717, 1729-1731, 1733, 1735, 1748-1752, 1755, 1757, 1762, 1776, 1777, 1786, 1788
Hookup Pushback (All Types).....	1624-1627, 1629, 1641, 1660, 1666, 1670, 1676-1682, 1688, 1689, 1704, 1712, 1713, 1715, 1717, 1719, 1730-1735, 1739, 1747-1750, 1753, 1755, 1762, 1773-1778, 1784, 1786
Lead-in & Ground	1669, 1735, 1754, 1762, 1773, 1778
Litz	1666
Magnet	1666, 1688, 1711, 1739, 1747, 1781, 1786
Multiconductor (See Cable, Multiconductor)	
Plastic Insulated (See Wire, Hookup-Pushback)	
Semiconductor Lead	1751
Shielded	1624, 1627, 1660, 1675, 1679, 1681, 1686, 1689, 1712-1715, 1729, 1730, 1734, 1749, 1750, 1754, 1762, 1773-1776, 1784, 1790
TFE Insulated	1629, 1678, 1689, 1704, 1705, 1714, 1717, 1735, 1736, 1751, 1753, 1777, 1786
Test Lead	1406, 1638, 1670, 1675, 1717, 1719, 1735, 1740, 1758, 1762, 1776, 1786
Thermocouple	1788
Transmission (See Cable, Transmission Line)	
Wire & Cable Ties	698, 852, 853, 1763, 1764, 1767, 1768, 1771
Wire Cutters, Hand-Operated	749, 791, 1378, 1380, 1384, 1394, 1395, 1405, 1410, 1419, 1685
Wire Markers, All Types (Also See Strips, Markers & Fanning)	1769, 1771
Wire Shielding	1682, 1720, 1740, 1746
Wire Strippers, Hand Operated	749, 791, 1375, 1378, 1380, 1387, 1388, 1395, 1401, 1403, 1405, 1410, 1685
Wire Strippers, Thermal	1395, 1401
Wire Stripping Chemicals (See Chemicals, Wire Stripping)	
Wire Wrapping Tools & Accessories	1771
Wizardboard Circuit Boards	440, 441
WORKMAN ELECTRONIC PRODUCTS INC.	1207
WORNER ELECTRONIC DEVICES	964, 965
Wrapid Jacks	509
Wrenches	435, 698, 712, 725, 1378, 1381, 1382, 1384, 1386, 1388, 1395, 1398, 1405, 1406, 1419
WYCO METAL PRODUCTS	222

X-Y-Z

XCELITE INC.	1415-1419
XTradur Soldering Tips	1393
Yellow Jacket Capacitors	408
Yokes, Deflection, TV	1386, 1506
Zener Diodes (See Diodes, Zener)	
ZENITH SALES CORP.	1621
Zephyr Cabinet Racks	145



SMOOTH LINE

'82' CH. MATV

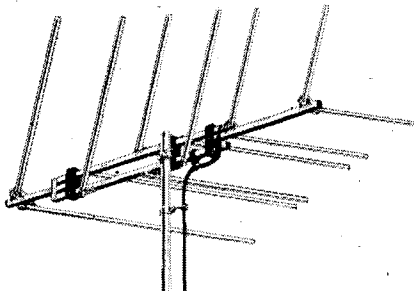

'ROUGH RIDER' SERIES MATV ANTENNAS

75 OHM OUTPUT

These antennas are a high quality version of the log periodic home TV antennas. They are made of heavy gold anodized aircraft aluminum and have heavy duty elements with double boom construction.

RR-FM-1000 thru RR-1008
LO BAND SINGLE CHANNEL List Price 37.50

RR-1007 thru RR-1013 HI BAND
SINGLE CHANNEL List Price 37.50

RR-1101 BROAD BAND VHF List Price 55.00
RR-1102 BROAD BAND VHF List Price 80.00
RR-1501 UHF List Price 32.50
RR-1502 UHF List Price 42.50

'SYSTEMS' ACCESSORIES

PROVIDER 2-(SL-6120) AMPLIFIED SPLITTER. Provides 2 VHF 75 ohm outputs from single 75 ohm input. 7.5 db gain. Features UHF by-pass with some amplification. List Price 35.00

PROVIDER 4-(SL-6140) AMPLIFIED SPLITTER. Provides 4 VHF 75 ohm outputs from single 75 ohm input. 3.5 db gain. Features UHF by-pass. List Price 40.00

SL-6120

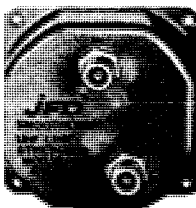
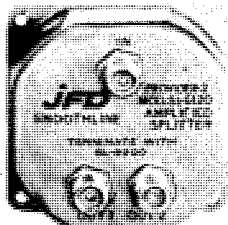

SL-6310

STRETCHER-(SL-6300) VHF LINE STRETCHER AMPLIFIER. 13.5 db gain. 75 ohm input and output. Featuring UHF by-pass and amplification. List Price 37.50

STRETCHER-(SL-6310) UHF LINE STRETCHER AMPLIFIER. 12 db gain. 75 ohm input and output. VHF by-pass. List Price 37.50

POWER SUPPLY-(SL-6514) 17 VDC SUPPLY for up to 5 SMOOTH-LINE accessories. Also powers V-3130 or U-3140 head end amplifiers. 75 ohm input and output. List Price 37.50

SL-6514

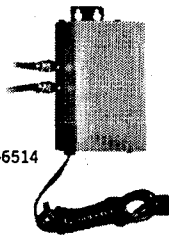

SL-6200

TERMINATOR-(SL-6200) 75 ohm LINE TERMINATOR. Power blocked. List Price 2.50

POWER BLOCK-(SL-6600) Blocks power on desired cables and outlets. 75 ohm impedance; passes UHF and VHF. List Price 3.75

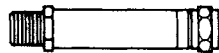

SL-6600

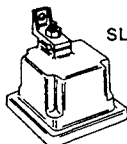

SL-6700

OUTDOOR HOUSING-(SL-6700) Weather-proofs all SMOOTHLINE accessories and amplifiers that have: 2 3/8" x 2 3/8" x 1" chassis. List Price 12.50

'82' CHANNEL TAPOFFS

U-5517

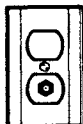

UNITAP-(U-5512 & U-5517) UNIVERSAL TV TAPOFF. U-5512 has 12 db isolation, U-5517 has 17 db isolation. Through loss: 1.0 U/V U-5512, 0.5 db U/V U-5517. Accepts all usual system coaxial cables. Back matched 75 ohm '82' channel outlet. List Price 4.38

P-5103

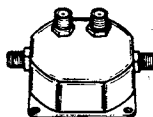

POSITAP-(P-5103) '82' CHANNEL TWO OUTLET SURFACE MOUNT TAPOFF. 17 db isolation; 1.5 db through loss. List Price 7.50



HEAD-END 'NOVERLOAD'® AMPLIFIERS

These units have the following unique features:
• ALL SOLID STATE FOR COOL RUNNING RELIABILITY
• OPTION OF SELF OR REMOTE POWERING
• SEPARATE HI BAND VHF, LO BAND VHF AND UHF BAND GAIN CONTROLS
• SEPARATE UHF/VHF INPUTS: COMBINED OUTPUT ON MODEL SL-3155

MODEL SL-3155 '82' CHANNEL HEAD-END AMPLIFIER List Price 199.00

MODEL V-3130 VHF HEAD-END AMPLIFIER List Price 99.00

MODEL U-3140 UHF HEAD-END AMPLIFIER List Price 180.00

'82' CHANNEL - UNISPLITS AND MATCHERS

8120

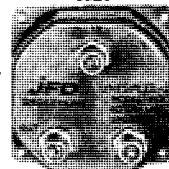

UNISPLIT 2-(Model-8120) '82' CHANNEL 2 WAY SPLITTER. 75 ohm impedance. 3.8 db splitting loss at VHF and 4.4 db at UHF. List Price 15.00

UNISPLIT 4-(Model-8140) '82' CHANNEL 4 WAY SPLITTER. 75 ohm impedance. 8.9 db through loss at VHF and 9.0 db through loss at UHF. List Price 20.00

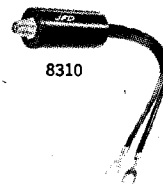

8310

SET-MATCH-(Model-8310) '82' CHANNEL. UHF, VHF, FM indoor 75 ohm/300 ohm Matching Transformer with coaxial cable fitting. List Price 2.95

8320

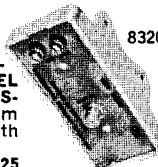

MATCHING TRANSFORMER-(Model-8320) '82' CHANNEL OUTDOOR MATCHING TRANSFORMER. 300 ohm/75 ohm Matching Transformer with coaxial cable fitting. List Price 5.25

8311

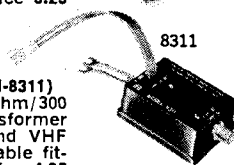

MATCHERATOR-(Model-8311) 2-WAY INDOOR 75 ohm/300 ohm Matching Transformer with separate UHF and VHF outputs and coaxial cable fitting. List Price 4.95

JERROLD**TV-FM ANTENNAS AND ROTOR****COLOR GUARD™****VHF-TV & FM ANTENNAS**

Maximum reception at minimum price. 300-ohm as well as Coloraxial models.

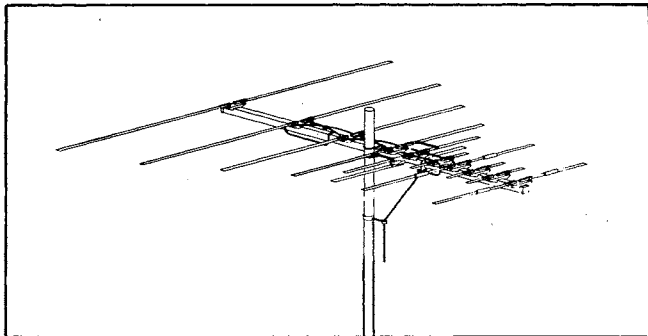

- | | | |
|----------------------|---|--------------|
| Model CG-13 | 4 element VHF, 300-ohm | List \$10.95 |
| Model CG-81 | 82-channel, 6 element, 300-ohm | List \$15.95 |
| Model CG-82 | 82-channel, 11 element, 300-ohm | List \$26.50 |
| Model CGX-16 | 5 element VHF Coloraxial | List \$12.95 |
| Model CGX-16K | Complete kit (CAX-16, 50-foot Coloraxial cable,
5-foot mast and mount) | List \$31.95 |
| Model CGX-81 | 82-channel, 6 element Coloraxial | List \$15.95 |
| Model CGX-82 | 82-channel, 11 element Coloraxial | List \$26.50 |

NEW!**DYNA ROTOR™**

The new Jerrold Dyna-Rotor is a revolutionary breakthrough in antenna rotator design, featuring a totally solid-state control circuit and a unique Dynamic Spline drive mechanism. The Dyna-Rotor is completely automatic—just set the control knob to the desired direction, and the antenna turns to the exact selected position—quickly, precisely. Antenna is synchronized with the control at all times; no re-synchronizing ever required. Positive mechanical lock prevents antenna from drifting off selected position, even in high winds. Fastest rotator available, the Dyna-Rotor turns the largest antennas a full 360° in less than 40 seconds. Control unit is attractively styled and completely silent in operation. Dial light indicates antenna is turning. In-line rotor cannot be jammed by ice loading; operates reliably at —20°F.

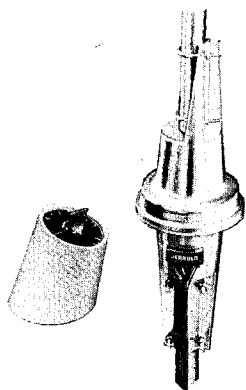

- | | | |
|---------------------|-------|--------------|
| Model JDR-77 | | List \$54.95 |
|---------------------|-------|--------------|

PARAPRO™**300/75-OHM UHF ANTENNAS**

Ideal add-ons to existing VHF antennas; no combiner required. PUX models have built-in matching transformer for 75-ohm Coloraxial installation; PAU models have 300-ohm outputs convertible to Coloraxial with STO-82 or STO-83 matching transformer (see p. 2).

- | | | |
|----------------------|-------------------------------|--------------|
| Model PUX-450 | Metropolitan area | List \$10.95 |
| Model PUX-700 | Difficult suburban area | List \$16.95 |
| Model PUX-900 | Fringe area | List \$28.95 |
| Model PAU-450 | Metropolitan area | List \$ 9.95 |
| Model PAU-700 | Difficult suburban area | List \$14.95 |
| Model PAU-900 | Fringe area | List \$25.95 |

PARACYL™**300-OHM UHF ANTENNAS**

Five models to cover every UHF-TV reception requirement from local to deep fringe areas.

- | | | |
|--------------------|-------------------------------|--------------|
| Model JUP-1 | Local area | List \$ 6.95 |
| Model JUP-2 | Suburban area | List \$10.95 |
| Model JUP-3 | Difficult suburban area | List \$29.95 |
| Model JUP-4 | Fringe area | List \$39.95 |
| Model JUP-5 | Deep fringe area | List \$54.50 |

metro color™**75/300-OHM ANTENNAS**

Ghost-killing antennas for strong signal areas.

- | | | |
|---------------------|------------------------|--------------|
| Model MCX-13 | VHF-TV & FM | List \$16.95 |
| Model MCX-82 | UHF, VHF-TV & FM | List \$29.95 |

FM ANTENNAS**PARALOG™****FM ANTENNAS**

The ultimate in FM antennas with all the features of the Paralog line but designed specifically for the FM band of frequencies. Extremely high front-to-back ratios and negligible minor lobes for the elimination of multipath interference. The exceptionally high gain (up to a realistic 11.6 dB on the FMP-16) delivers signals that let the tuner do its best—producing hiss-free, full FM reproduction. Flat response assures good reception on all channels—no gain drop-off at band extremities.

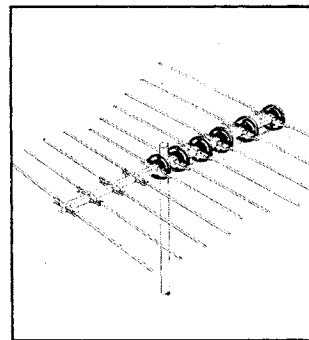

- | | | |
|---------------------|--------------------------|--------------|
| Model FMP-8 | 8 Element Paralog | List \$23.95 |
| Model FMP-10 | 10 Element Paralog | List \$29.95 |
| Model FMP-16 | 16 Element Paralog | List \$43.95 |

OTHER FM ANTENNAS

- | | | |
|--------------------|-------------------------------------|--------------|
| Model G677M | Golden Turnstile | List \$12.95 |
| Model FM-5 | 5 Element Yagi | List \$14.25 |
| Model FM-10 | 10 Element Yagi | List \$22.25 |
| Model G626A | "Lark" All-directional S-type | List \$ 8.95 |

JERROLD**TV-FM RECEPTION PRODUCTS****SPLITTERS/MIXERS**

Model FS-1314. 300-ohm VHF/UHF splitter for connecting the download of an all-channel antenna to the separate VHF and UHF terminals of the TV set. Low loss, high isolation.
List \$3.50

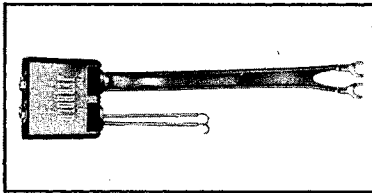

Model 1425C. For separating or combining high-band and low-band UHF-TV signals. 300-ohm input and output; weatherproof housing for antenna mounting**List \$5.66**

Model 1460C. All-channel splitter/mixer for separating or combining VHF and UHF signals. 300-ohm input and output; indoor or outdoor mounting. Used to combine separate VHF and UHF antennas into a single download**List \$4.95**

ANTENNA MATCHING TRANSFORMERS

Model MUV-374. An 82-channel, 300/75-ohm matching transformer for use with all-channel antennas. Mountable outdoors, matches 300-ohm antenna output to 75-ohm coaxial cable. AC passing. Complete with weatherboot, mast mounting, bracket and stainless steel strap.
List \$5.95

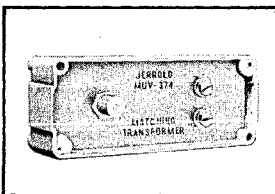

Model TO-374A. A VHF outdoor, mast-mounted transformer that matches 300-ohm VHF antenna to 75-ohm coaxial cable download. AC passing.
List \$4.95

INDOOR MATCHING TRANSFORMERS

Model T-380A. An all-channel (54 to 890 MHz) transformer-type splitting network for rear-of-set mounting. Matches 75-ohm coaxial cable to 300-ohm TV sets. Splits signal providing separate UHF and VHF antenna inputs to TV set. Input: 75 ohms, all-channel (54 to 890 MHz). Output: 300 ohms, individual VHF (54-216 MHz), UHF (470-890 MHz)**List \$7.95**

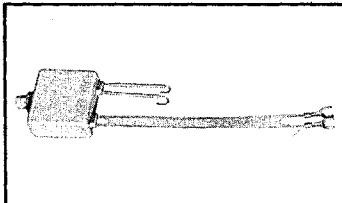
**NEW!**

Model FSX-1314. All-channel matching transformer and UHF/VHF separator unit mounts to rear of set. Similar to T-380A. Recommended for Coloraxial installations**List \$5.12**

Model T-378. Rugged, matching transformer for installation at the back of a TV receiver. High impact plastic case, has a type "F" fitting for a 75-ohm coaxial input, and special break-resistant twin-lead on the 300-ohm end. Features 60 Hz AC isolation. An F-59A connector is provided (VHF 54-216 MHz only)**List \$2.50**

Model T-372. A VHF 300/75-ohm matching transformer with a flat response across the frequency range of 54-216 MHz, and provides AC-DC isolation. For indoor surface mounting. Housed in blister can, with C-61 input connector. C-52 male connector provided**List \$5.00**

Model T-373. Flush-mounted version of Model T-372. B-59 cable bushing provided**List \$5.00**

INDOOR ANTENNAS

Jerrold's new JIN-Series antennas are designed to provide excellent indoor reception of all 82 VHF-TV and UHF-TV channels, plus FM and FM stereo. These attractively styled top-of-the-set antennas are engineered to deliver more brilliant, lifelike color pictures — excellent for black-and-white, too. Separate 300-ohm outputs for UHF and VHF terminals on the TV set. Twelve position selector switch provides optimum tuning.

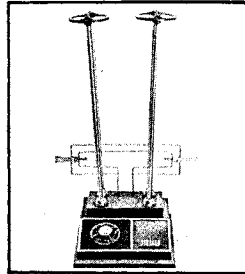

Model JIN-3 Deluxe indoor antenna (same as JIN-2) with 12 position switch selector tuning**List \$11.95**

Model JIN-4 Premium indoor antenna with folded twin double telescoping dipoles and double UHF loop with added tuning fins**List \$17.95**

COLORAXIAL™ CABLE

This is the heart of the Coloraxial installation—the reason for it all. All Jerrold Coloraxial CAC cable is guaranteed to have been factory sweep-tested to eliminate any flaws over its entire length. Each 50-, 75- or 100-foot length is complete with F-56A fittings attached, plus a weatherboot for the outdoor connection. Very easy to install—just screw fittings to connectors.

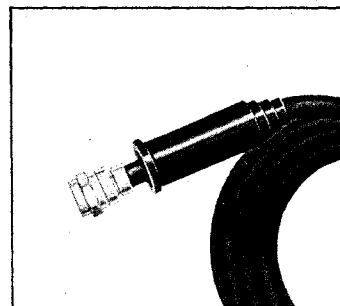

Model CAC-50 50-foot length of 82-channel coaxial cable. Fittings and weatherboot attached**List \$10.75**

Model CAC-75 75-foot length of 82-channel coaxial cable. Fittings and weatherboot attached**List \$14.50**

Model CAC-100 100-foot length of 82-channel coaxial cable. Fittings and weatherboot attached**List \$17.65**

VHF COLORAXIAL CONVERSION KIT MODEL CAT-2

With this kit, you can easily convert any existing antenna to Coloraxial. Kit consists of one TO-374A mast-mounting matching transformer for any 300-ohm antenna, and one T-378 set-mounting matching transformer. Complete with bracket and mounting strap for the outdoor transformer**List \$8.20**

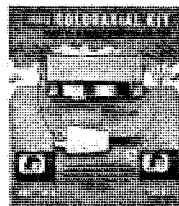

JERROLD

a GENERAL INSTRUMENT company

TV-FM DISTRIBUTION EQUIPMENT

© Copyright 1968 by the JERROLD ELECTRONICS CORPORATION. Specifications and prices subject to change without notice.

ATTENUATORS

Model A-18 Attenuator. DC-890 MHz precision switch-type. 75 ohms. VSWR 1.26. Power handling up to 500 milliwatts or .5 amp 0-18 dB in 6 dB stepsList \$12.95

PDL-In-Line Attenuators. Available in 1, 3, 6, 10 or 20 dB. Models 1, 3 and 6 are all-channel. Models 10 and 20 are VHF onlyList \$5.85

VHF Directional Couplers, Models DC-8, DC-12, DC-16. Model DC-8 (Insertion loss 1.5 dB—Tap loss 9 dB); DC-12 (1 dB-12 dB), DC-16 (.75 dB-16 dB). High isolation from tap to outputList \$14.30

82-Channel Directional Couplers, Model DC-12UV. Insertion loss: VHF, 1.75 dB \pm 0.5; UHF, 2.25 dB \pm 0.5. Tap loss: 10-54 MHz, 13.0 dB \pm 0.5; 54-216 MHz, 12.0 dB \pm 0.5; 470-890 MHz, 12.5 dB \pm 0.5. High isolation from tap to outputList \$14.30

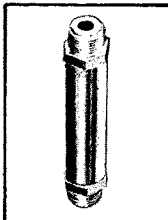
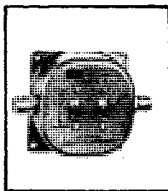
**CABLE CONNECTORS****FOR RG-59/U CABLE**

F-59 Male Cable Connector. For use with RG-59/U type cable. Mates with F-61A, F-81, A-61. 75-ohm use. Use Crimping Tool PL-602 or PL-659. Separate ferrule suppliedList \$6.60

**FOR CAC AND RG-6/U CABLE**

F-56 Male Cable Connector. For RG-6 cables at 75 ohms. Mates with F-61A, A-61, F-101 and AF-201. Separate ferrule suppliedList \$6.60

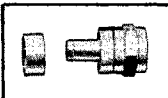

F-56A Male Cable Connector. Similar to type F-59A except for use with Jerrold CAC Cable. 75-ohm use. Built-on CAC size ferruleList \$6.60

**FOR RG-11/U CABLE**

FHC-404 Male Cable Connector. For RG-11 cable; mates with F-61AList \$2.10

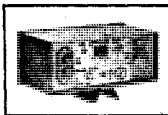
**UHF CONVERTERS**

Jerrold UV-Series Single Channel UHF to VHF Converters are designed for Master Antenna Systems, for metropolitan to deep fringe installations.

Model U3V*. For outdoor use. Used in metropolitan or strong signal areas. Impedance is 75- or 300-ohm input (specify when 75-ohm is desired), 75-ohm outputList \$191.50

Model U4V*. For outdoor use. Excellent for fringe areas. Impedance is 75- or 300-ohm input (specify when 75-ohm is desired), 75-ohm output. List \$236.90

Model U5V*. For indoor use, the U5V consists of a Converter-Amplifier Unit, Model 454T, mounted with an Oscillator/Power Supply, Model 464-SS—all solid-state—all in a single compact housing. It's the ideal indoor converter for metropolitan to deep-fringe installations. Specifications are the same as Model U4VList \$211.90

**"DESNOWER" PREAMPLIFIERS**

Model DSS*. "De-Snow" amplifiers are high-gain, single channel preamplifiers for use with cut-to-channel antennas in MATV systems....List \$143.00

NEW!

Model DSB-107. High output VHF preamplifier with built-in tunable FM trap. Output capability at +40 dBmV per channel, for 7 channels at -46 dB cross-modulation, sufficient to drive small distribution system. FM trap may be tuned to insert 10 dB attenuation on band 1.25 MHz wide within FM band. If no strong FM interference exists, trap can be tuned off FM band. Uses remote power supply, Model 107List \$109.50

*Specify channel or FM when ordering.

75-OHM LINE SPLITTERS

Model 1562-2 VHF, 2-way, Hybrid. B-59 fittings. Just push RG-59/U cable on and crimpList \$ 6.78

Model 1592 VHF, 2-way, Hybrid. "F" fittingsList \$11.90

Model 1514A VHF, 4-way, "F" fittingsList \$14.29

Model 1584 VHF, 4-way, Hybrid. "F" fittingsList \$17.60

Model G-1518-2 VHF, 8-way, "G" fittingsList \$29.50

Model 1502A UHF/VHF, 2-way, "F" fittingsList \$10.75

Model SCX-2 UHF/VHF, Outdoor, "F" fittingsList \$ 5.95

Model 1596 UHF/VHF, 2-way, Hybrid. "F" fittingsList \$12.38

Model 1597** UHF/VHF, 4-way, Hybrid, "F" fittingsList \$17.66

**Patent pending.

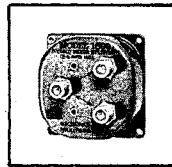
**SYSTEM AMPLIFIERS**

Jerrold's "Gibraltar" series TV/FM distribution system amplifiers are the result of unmatched experience in solid-state technology. Each model is performance-guaranteed through Jerrold's policy of using only minimum specifications.

Model 3440. Solid-state "Gibraltar" high-gain, low-noise, broadband VHF amplifier for small TV distribution systems. Capable of 12-channel operation. Handles up to 40 TV outlets. Flat response. Provision for both 300-ohm and 75-ohm input. Provides 22 dB minimum gain and better than +42 dBmV minimum output, TV and FM bands. Output impedance is 75 ohms for coaxial distributionList \$89.50

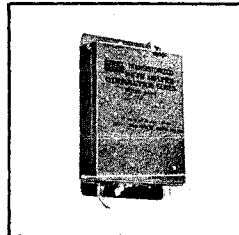

Model 3550. New solid-state, high-gain, broadband "Gibraltar" VHF amplifier for medium size distribution systems. Similar to Model 3440. Provides 33 dB minimum gain and better than +45.5 dBmV output, TV and FM band; 75-ohm input and output impedanceList \$109.50

Model 3660. Solid-state, high-gain, broadband "Gibraltar" amplifier for large TV distribution systems such as those in hotels, apartment houses, and schools. Provides 40 dB of gain and better than +50 dBmV output, TV and FM bands. Easily handles more than 100 sets. Capable of 12-channel operation. Flat response across all bands. Separate gain controls for high and low bands. Wall or 19-inch rack mounting. 75-ohm input and outputList \$216.00

Model 2880. Broadband, vacuum tube amplifier famous for its high output capability (+60 dBmV). One volt per channel for each 7 channels. Provides 41 dB of low band and 44 dB of high band gain. 75-ohm input and outputList \$392.85

Model 5330A. New improved solid-state broadband UHF amplifier featuring increased gain (28.0 dB avg.) and multi-channel output capability. Input and output high-pass filters ensure superior VHF signal rejection. 75-ohm input and outputList \$190.00

SIGNAL STRENGTH METER

Model AIM-718. Jerrold's new Signal Strength Meter is the first designed specifically for the installer. Solid-state all-channel (UHF/VHF/FM) direct-reading in dBmV. Completely portable, battery operated. Continuous coverage 54-216 MHz for VHF-TV/FM, 470 to 890 MHz for UHF-TV. Input impedance VHF/UHF 300-ohms. Comes equipped with 300/75 ohm 82 channel matching balun. Sensitivity: 20 μ V at 75 ohms, 40 μ V at 300 ohms. Accuracy: 3 dB on VHF, 6 dB on UHFList \$330.83



Mosley Electronics, Inc. TV/FM ANTENNA ACCESSORIES

75 OHM VHF/UHF COAX ACCESSORIES

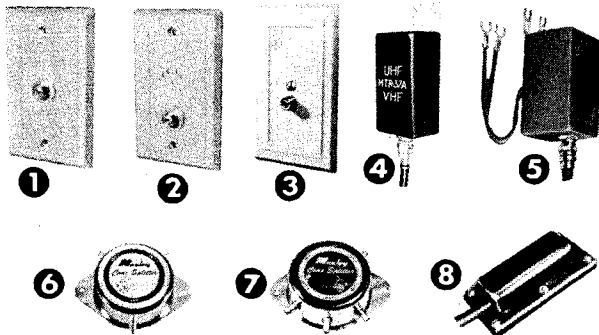

1 Single Lead-in Outlet

Model FCC-1PK single direct antenna coax lead-in receptacle, UHF/VHF, FM-Stereo reception for 75 ohm coax. Constant impedance, molded of polystyrene, Crimp-on ferrule for lead-in, "F" type coax connector attaches TV receiver lead to plate. Mount in F-8 plaster ring or F-9 mounting brackets. Solderless. MODEL FCC-1PK . . . Wall Plate w/connector, mtg. hdw.

2 Single Lead-in and Rotor Cable Outlet

Model FCC-145PK single direct antenna coax lead-in receptacle for UHF/VHF, FM-Stereo reception utilizing 75 ohm coax with 4 or 5 wire rotor cable plug. Use F-8 plaster ring or F-9 mounting brackets. Solderless. MODEL FCC-145PK . . . Wall Plate, connector, plug, mtg. hdw.

3 Single & Multiple Lead-in Wall Taps

MC-Series antenna Coax lead-in UHF/VHF, FM Wall Taps utilizing 75 ohm coaxial cable lead-in without rotor. Four models designed for simple, or more intricate, amplified distribution systems, Constant impedance, low insertion loss, low SWR. Connections made with crimp-on ferrules. "F" type coax connector provides secure TV lead connection to Wall Taps. Use F-8 plaster ring or standard electrical box. Complete instructions, 3 colors. Solderless.
MC-1 . . . No resistors, connector, mtg. hdw.
MC-12 . . . Same, but with 12 db. isolation
MC-17 . . . above with 17 db. isolation
MC-23 . . . above with 23 db. isolation

4 UHF or VHF Matching Transformer (indoor/outdoor)

Mounted on outdoor antenna, Model MTR-37A matches 300 ohm antenna to 75 ohm coax; mounted indoors, matches 75 ohm coax to 300 ohm UHF or VHF receiver terminals. Housing molded of polystyrene. Weather-proof. Hardware included. Solderless.
MODEL MTR-37A . . . matching transformer for 300/75 and 75/300. Mounting hardware.

5 UHF & VHF Input-Splitter/Matching Transformer

Model UV-2 for UHF/VHF and FM reception provides separate UHF/VHF antenna inputs to respective terminals. Incorporates features of MTR-37A to provide perfect match of 75 ohm coax lead-in to 300 ohm receiver terminals. High isolation, low loss. Molded polystyrene. Hardware included. Solderless. MODEL UV-2 . . . UHF/VHF Input-Splitter and Matching Transformer

6 UHF & VHF Coax Splitter (two-set)

Resistive type 75 ohm coax splitter for UHF/VHF or FM. Distributes TV/FM signal to two receivers to permit simultaneous operation without interaction; or mixes 2 single-channel antenna lines to one lead-in line. Low loss, high isolation. Combine to provide a number of lines for larger, amplified systems. Metal container mounts easily. Solderless. MODEL M-22 . . . 2-set Splitter, 3 crimp-on ferrules, mtg. hdw.

7 UHF & VHF Coax Splitter (four-set)

Model M-24 resistive type 75 ohm coax splitter for UHF/VHF and FM. Permits as many as 4 TV/FM receivers to operate simultaneously from one antenna; or mixes as many as 4 single-channel antenna lines into one receiver lead-in line. Low insertion loss, high isolation. May be combined to provide any number of lines for a large, amplified system. Solderless connections. Metal container mounts easily. MODEL M-24 . . . 4-set Splitter, 5 crimp-on ferrules, mtg. hdw.

8 Universal Roof-Thru/Wall-Thru

Weatherproof entrance accessory for all types of antenna and rotor lead-in line. Mounts on any sloped roof or on the wall of most non-brick structures with included hardware. Insect-proof housing molded of black Cycolac. Easy-to-install with built-on flange and rubber gasket. No roof cement needed. MODEL M-60 . . . Universal Roof-Thru/Wall-Thru

300 OHM UHF/VHF TWIN LEAD ACCESSORIES

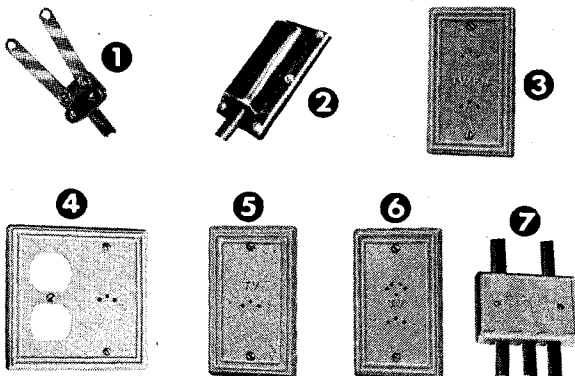

1 Connector for (300 ohm) transmission line to antenna

Y-TY connector eliminates wire breakage; secure connection of line at TV antenna. Aluminum straps attach to terminals. Grips line securely; positive contact, weatherproof connection. Solderless; polystyrene base.
MODEL 263-S . . . terminal distance 4" or less.
MODEL 263-L . . . for terminal distances 4" to 6".

2 Universal Roof-thru/Wall-thru

Weatherproof entrance accessory for all types of antenna and rotor lead-in line. Mounts on sloped roof or wall of non-brick structure. Hardware included. Insect-proof housing molded of Cycolac. Easy-to-install. Built-on flange and rubber gasket. MODEL M-60 . . . Universal Roof-Thru/Wall-Thru

3 TV/FM-Stereo Receptacle

Model WPS-11PKB for TV/FM-Stereo reception from one antenna. Resistor type two-set coupler built-in to isolate TV and FM for simultaneous reception without interaction. Use F-9 mounting brackets, or F-8 plaster rings. Low loss. 3 colors. Solderless.
MODEL LWPS-11PKB . . . receptacle, 2 plugs, mounting brackets

4 Combination AC/TV Antenna Receptacle

AC outlet cover plate and TV antenna lead-in receptacle. Serves two purposes; non-electrical TV antenna plug-in and AC connection. Mating plugs supplied. Metal barrier plate supplied. Fits over standard electrical boxes. 3 colors. Solderless.
MODEL AC-1PKB . . . receptacle, TV plug, hdw., barrier plate.
MODEL ACA-1PKB . . . above less barrier plate.
MODEL AC11PKB . . . Same as AC-1PKB with two TV plugs.
MODEL AC-145PKB . . . AC/TV and 4 or 5 wire rotor lead-in receptacle with TV plug, one rotor plug & hdw.
MODEL AC-245PKB . . . Above with 2 TV plugs.

5 Single TV Lead-in Receptacle

Model F-1 TV antenna receptacle for TV/FM. Constant impedance, low loss. Molded of polystyrene. Heavy-duty contacts. Use F-8 plaster ring or F-9 mounting brackets. 3 colors. Solderless.
MODEL F-1 . . . receptacle with mounting screws.
MODEL F-1PKB . . . above with plug, mounting brackets.

6 TV Lead-in and Four or Five Wire Rotor Receptacle

Model F-145PKB TV/FM antenna receptacle and 4 or 5 wire rotor cable lead-in. Constant impedance, low loss. Molded of polystyrene. Incorporating heavy-duty contacts. Use plaster ring or F-9 mounting brackets. 3 colors. Solderless. MODEL F-145PKB TV lead-in and 4 or 5 wire rotor receptacle, mounting screws, plug, rotor plug, mounting brackets.

7 Four-set Coupler for Cable Twin Lead

Designed for heavy-duty cable type twin lead — shielded and unshielded (or flat twin lead) — UHF/VHF B&W/Color TV and FM-Stereo. Resistive type printed circuit coupler permits up to 4 TV sets to operate simultaneously without interaction. Combine to provide any number of outlets. Ground frame adapter securely clamps cable and provides terminal for ground wire. Easy-to-install on baseboard, floor joists, or rafters with just a screwdriver. Molded of Antique Ivory polystyrene. Solderless.
MODEL BL-4PK . . . 4-set coupler with ground frame adapter
MODEL BL-4 . . . Same as above without ground frame adapter

PREMAX

ANTENNAS--MOUNTINGS--ACCESSORIES

SERIES C CENTER-LOADED MARINE ANTENNAS

A Center-Loaded Collapsible type Antenna, consisting of two telescoping, adjustable base sections on which the loading coil is mounted, with a tapered top whip section, giving a total extended length of about 19 feet. This Antenna collapses to a single unit with the whip section telescoping through the coil into the lower section, making a collapsed length of 7 feet. The sections are of seamless aluminum, polished or gold anodized, or stainless steel and the coil is wound on low-loss bakelite tubing and treated after assembly with weatherproof coating.

No.	Type	Base O.D.	Base I.D.	Wt. Lbs.	List Price
CLA-619	Aluminum	1.000"	.834"	5	\$60.00
CLS-1119	Stainless	1.000"	.900"	7	110.00
CLGA-619	Gold Anodized Aluminum	1.000"	.834"	5	65.00

SERIES B CENTER-LOADED ANTENNAS FOR MOBILE & MARINE USE

Center-Loaded Whip-Type Antennas consist of a standard base section or spring-type on which is mounted a special Premax coil. The top is a taper-ground stainless steel whip 8 ft. in length, giving a total overall height of 9 ft. Various coils are available or the standard .75-meter coil can be adapted by shorting out turns on the coil. Antennas can be used with any of the Standard Premax Mountings shown below, or will fit any 3/8" x 24-thread mounting.

NO.	FREQ.	PRICE
BXS-14	14,000 kc. (20M.)	\$25.00
BXS-23	2374 kc. (CAP)	26.00
BXS-31	3105 kc. (APT)	26.00
BXS-38	3800 kc. (75M)	26.00
BXS-43	4325 kc. (CAP)	26.00
BXS-46	4585 kc. (CAP)	26.00
BXM-25	2000 to 3000 kc. (Marine)	26.00

(Same as BXS but with Spring)

BSS-14	14,000 kc. (20M.)	42.00
BSS-23	2374 kc. (CAP)	45.00
BSS-31	3105 kc. (APT)	45.00
BSS-38	3800 kc. (75M.)	45.00
BSS-43	4325 kc. (CAP)	45.00
BSS-46	4585 kc. (CAP)	45.00
BSM-25	2000 to 3000 kc. (Marine)	45.00

SERIES B COILS

Premax also supplies the Series "B" coils in the standard frequencies above. Special frequencies available on request.

List Price\$15.00 ea.

MAST EXTENSIONS

Polished Stainless Mast Extensions—threaded 3/8" x 24 on both ends and supplied with stainless nuts and lockwashers. Available in 12", 18", 24", 30" and 36" lengths.

Prices range from \$6.50 to \$15.00 list each

SERIES C

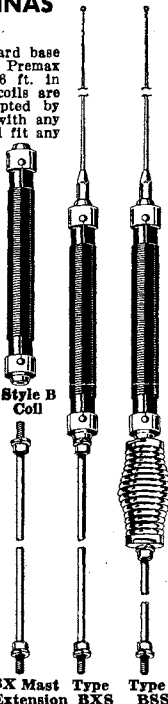

MOBILE VHF WHIPS

Style CD-11 Series—Permanent type. Porcelain insulator mounts thru 1/2" hole in rooftop.

Style CD-21 Series—Emergency type. Attaches by heavy duty suction cup.

NO.	FREQ.	PRICE
CD-112	108 to 120 mc.	\$6.00
CD-114	144 mc.	6.00
CD-115	152 to 162 mc.	6.00
CD-212	108 to 120 mc.	4.20
CD-214	144 mc.	4.20
CD-215	152 to 162 mc.	4.20

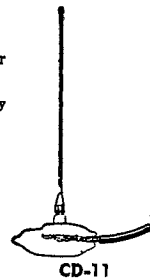

CD-11



CD-21

GROUND PLANE ANTENNAS FOR POINT-TO-POINT USE

For point-to-point installations, Premax has two VHF Antennas: The Style GP-3 which has elements of heavily-plated spring steel with skirt wires that can be bent down to any angle to match coax cable. Mounting is within a water-proof housing that fits standard 1/2" pipe. Cable carries down thru pipe.

NO.	FREQ.	USE	PRICE
GP-312	120 mc.	For aircraft and CAP.	\$12.00
GP-314	140 mc.	For 2 meter and CD.	12.00
GP-315	150 mc.	For police and taxi	12.00

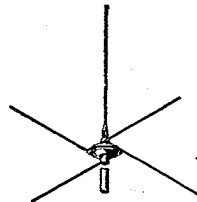

GP-3

PREMAX ADJUSTABLE GROUND PLANE ANTENNAS 20-60 mc

Another low-cost type Ground Plane Antenna is adjustable from 20 to 40 mc. or 40 to 60 mc. Standing wave ratio matching to 52-ohm line is 1.07 to 1.13 and to 72-ohm line is 1.27 to 1.23 depending on type of transformer cable. All-aluminum construction employing adjustable tubular elements.

GP-430	Adjustable 20-40 mc.	\$75.00
GP-450	Adjustable 40-60 mc.	60.00

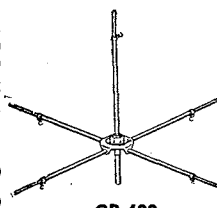

GP-400 Series

MOBILE MOUNTINGS FOR USE WITH WHIPS WITH 3/8"—24 MALE THREAD



Type CA

CA BUMPER MOUNTING

"Chain Style" — clamps on any bumper with 1/2" clearance; no drilling; theft-proof.

Price\$15.00



Type NA-1

TYPE NA-1

Bumper mounting with ceramic cone insulator and steel bracket.

Price\$14.00

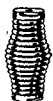

Type SA-2

SA-2 SPRING ADAPTOR

Stainless steel Spring Adaptor—can be attached to types R-2, R-3, L-1, CA and NA-1 to provide greater flexibility. Height 4 1/4", diameter 2 3/8".

Price\$16.00



Type RS-2

TYPE RS-2 COMBINATION

Similar to R-2 except has spring as shown under SA-2.

Price\$40.00

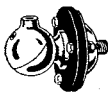

Type R-2

R-2 UNIVERSAL COAX TYPE MOUNTING

Solid Polished Aluminum split-ball can be adjusted to any angle. Has shielded coax connection and stainless hardware.

Price\$19.00



Type F

TYPE F

30° adjustable mounting for fender, cowl or gravel pan. Chrome-plated brass with phenolic insulation.

Price\$23.00



Type R-3

R-3 UNIVERSAL MOUNTING

Solid Polished Aluminum Swivel Ball. Heavy stainless steel back-up plate with grounding screws. Stainless steel hardware.

Price\$24.00



Type V

TYPE V

Thru-deck mounting designed for Style BX and BS Center-Loaded Marine Antennas. White porcelain cones with a maximum opening for 1-1/2" deck. Stud threaded 7/16"-24.

Price\$14.00

MINI-MOBILE ANTENNAS

Model CBMSF-27 25-50 MHz

New from Premax — Mini CB Spring and Chrome-plated Adjustable 30° Mounting for roof, fender or trunk. Overall height only 27". Stainless steel Whip, chrome-plated brass base with heavy phenolic insulator. Complete with 16' RG-58/U 50-OHM coaxial cable with connector and adapter.

Price\$37.00

Model CBMS-25

Same as CBMSF-27 but without Adjustable Mount.

Price\$22.50

Model CBF-24

Same as CBMSF-27 but without Spring.

Price\$32.50

CITIZENS BAND 27 MHz WHIP MOBILE ANTENNAS

Model CB-4 includes type RS-2 Mobile Mounting and Style VS-9108 Whip Antenna. Price\$53.50

Model CB-5

Same as above but with type S-2 Mobile Mounting and Style TS-8108 Whip Antenna. Price\$37.00

Model CB-3

Same as CB-4 but without spring. Price\$31.00

Price\$31.00

ALSO AVAILABLE: CITIZEN BAND BUMPER MOUNTINGS WITH FULLY ADJUSTABLE CHAIN TO FIT ANY BUMPER CONTOUR. AVAILABLE WITH OR WITHOUT SPRING.

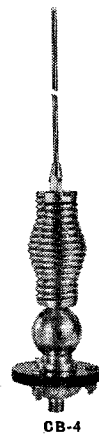

CB-4



CBMSF-27

PREMAX PRODUCTS, DIV. CHISHOLM-RYDER CO., INC.

AUDIO / VISUAL / SIGNAL SYSTEMS & PARTS FOR HOTELS — MOTELS — INSTITUTIONS

ROOM STATUS CONTROLS

ONLY ONE CONTROL WIRE REQUIRED PER ROOM!
LITERATURE AVAILABLE (SPECIFY NUMBER OF ROOMS).

Model 2L Typical Front Desk Board

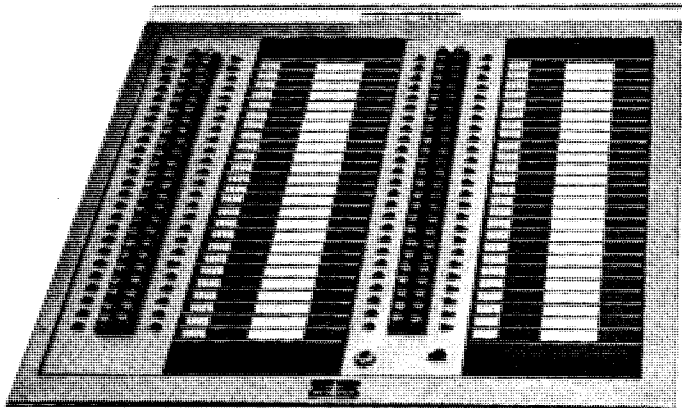

Room Plate



Model 2LMI Boards

Front Desk

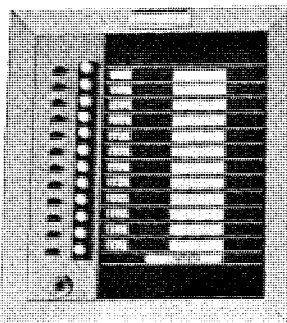

Cashier



Floor

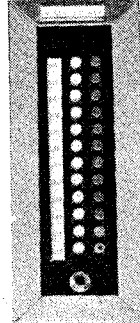

THESE SYSTEMS ARE PROTECTED BY
U. S. PATENTS 3,214,747 and 3,230,520

Model 2L — 2 Lights, 2 Switches per Room
Two lights, green for room available and red for checkout on consoles for front desk and housekeeper. Switches are on front desk board only, and not on housekeeper's board.

When guest checks in, desk moves switch putting out green light. No lights indicate occupied or rented room. When guest checks out, the room clerk throws other switch, putting on red light on his console and red light on housekeeper's board and a small light appears on the guest room panel.

When the maid enters the room, the light on the guest room panel indicates a checkout to her. She pushes in her signal plug to indicate she is working that room. This causes red light on front desk and housekeeper's consoles to blink. When maid is through with room she pushes her plug all the way in and removes it. This puts out all lights and turns on the green lights to indicate room is ready for sale.

Note: Once the maid enters the room and pushes in her plug, either or both the front desk and the housekeeper can give her verbal instructions in regard to the room. Two-way communication is available but not recommended.

(†) Net — Model 2L

- Front Office Board\$14.25 per room
- Housekeeper Board 9.25 per room
- Guest Room Plate 7.50 per room

Does not include cable or wires

NEW, MAID AND INSPECTRESS ROOM STATUS SYSTEM, Model 2LMI

This is a new light system that is equivalent to American's standard 4 light system. It not only shows when a room is ready for sale, occupied or a check out, but also the status of a

room when it is being cleaned or inspected. Front desk has one green light and switch per room, cashier has one red light and switch per room. These two boards can be combined for front desk operation. A combination information board with red and green lights for each room, but no switches is at the housekeeper's station, and for the inspectress, there are boards for each floor with a red and green light for every room on the floor.

OPERATION

When a guest checks out, cashier throws switch for the room, lighting red light on her board, also on housekeeper's board, and on floor board as information for inspectress and maid, and a small light on status plate in check out room. When maid sees this light on entering the room she immediately knows it is a check out. She pushes her plug into the maid jack on the room plate. This causes red lights to dim, for the room involved. At this time, the cashier, or housekeeper can give verbal instructions to the maid (one way communication). When maid is through, she removes her plug and all the lights for the room begin to blink, indicating that room has been cleaned.

Inspectress enters and checks the room. If it is acceptable, she pushes her plug into the maid's jack and removes it, causing the small light on the room panel and the red lights on the other boards to stop blinking and to burn steady. Upon seeing the small light on the room panel burn steady, the inspectress knows the room is a checkout. She pushes her plug into her jack on the room panel, causing the room plate light and the red lights on the other boards to go out, while at the same time lighting the green light on the front desk. Front desk now knows he has a room for rental.

Net — Model 2LMI

- Front Office Board..... \$13.75 per room
- Housekeeper Board 9.25 per room
- Cashier Board 8.75 per room
- Floor Board 10.75 per room
- Guest Room Plate..... 9.50 per room

Does not include wire or cable

(†) Priced per room, up to 100 rooms: less cable, Room Unit (where required). * All switching, signalling systems in these pages protected by Patent Nos. 3,214,747 & 3,230,520.

Single Light Maid Status System

Maid Call System "MC" is the use of the white light or maid's control light of Status Control System 4L as an independent, separate system. This system may be installed alone, and functions to notify the Front Office or Housekeeper when the room has been completed.

Operation:

- (1) On Check Out, Room Clerk turns on light on Guest Room Panel.
- (2) Light indicates to Maid that room is Check Out.
- (3) Light blinks at Front Office and/or Housekeeper's board when Maid inserts plug in room jack.
- (4) Light goes off when Maid removes plug.
- (5) Room Clerk now knows room is ready for Sale.

As with other systems, Front Office and Housekeeper are in direct communication (one way) with Maid in room.

(†) Net — Model MC

- Front Office Board.....\$8.75 per room
- Housekeeper Board..... 5.25 per room
- Guest Room..... 7.50 per room

Does not include wire or cable



A-P5-A Room Unit, includes Centralized Radio Controls plus jack and light for "blink light" Room Status and Maid Call. **Net \$15.00/room.**



AMERICAN COMMUNICATIONS CORPORATION

AMERICAN'S New TV-set THEFT ALARMS Pending Patents.

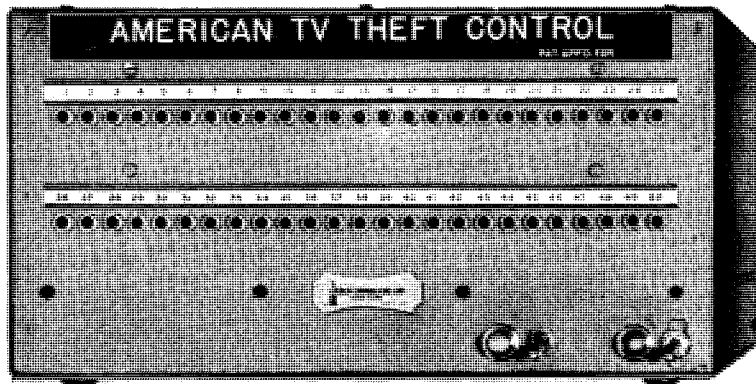

A-TA-B/50 TV-set Theft Alarm for Hotels.

AMERICAN'S TV-set Theft Alarm is now available in designs that meet the needs of occupancies of any size; in addition to the **Model B**, for hotels of 50 rooms or more, there is the new **Model C**, for motels of under 50 room units.

Both models operate to signal the front desk of any attempt to steal the television set it protects.

Installation may be made by any technician, following detailed instructions supplied with each System (Console, and Room Units). **Requires only one control wire per guest room.**

Operation: Equipment under protection (TV-set, appliance, etc.) is electronically protected. Any attempt to remove connection from wall outlet, or cut power cord, starts alarm signal. This signal is indicated at the Front Office as a flashing light, and loud buzz.

There is no alarm in the guest room to alert the thief, but the Front Office signal, once triggered, cannot be stopped until Front Office attendant has operated a Reset switch (which cancels buzz); a room indicator lamp remains lit, however, until house personnel has checked the guest room and restored the circuit to its normal alert condition.

Apartment House owners can now offer their tenants maximum security at negligible cost. Tenant is protected against an unlawful entry.

SPECIFICATIONS

No. A-TA-B/- TV-set Theft Alarm, including Front

Office Control Console, complete w/room lights, loud-sounding buzzer, alarm light, flasher, alarm reset and power on-off switches, solid state devices, and power supply; and, Room Kit (Conversion Cord, Conversion Outlet, one each per room). Control Console (A-TA-B/50) measures approx. 15" x 7 $\frac{3}{4}$ " x 9" deep; wt., approx. 30 lbs.; finish, gray crackle enameled steel. Operates on 115 V., 60 cy. A-C. **Net Price, A-TA-B/-, \$12.00/room.** Price is for a maximum of 50 rooms. Cable not included.

TV-3, SELF-CONTAINED TV THEFT ALARM. The TV-3 Theft Alarm mounts on the back of each TV set. Should anyone attempt to cut the power line, pull out the power plug or remove the Theft Alarm, an extremely shrill piercing alarm is set off. The alarm, which is audible throughout the entire building, will run for about an hour. Two options are available to the owner. Option 1 requires the management's presence to shut the alarm off. Option 2 — If the plug is re-inserted in the receptacle, the alarm will shut off by itself. This option allows for a test of the alarm.

The TV-3 is held in place by screws. No internal connections have to be made to the set. All that's required is to plug the TV set's power cord into the TV-3 and then plug the TV-3 into any power receptacle.

NOTE: If Power goes off, Alarm will not be set off.
Net: TV-3, \$14.00 Quantity discounts.

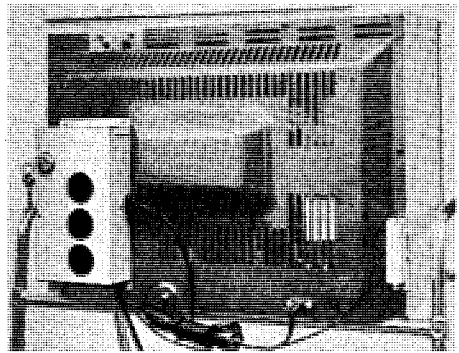

TV-3, SELF-CONTAINED TV THEFT ALARM.

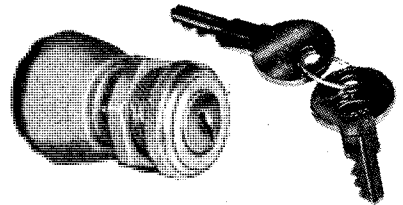

NEW, 2-POSITION KEY LOCK SWITCH

10 Amps., 110 Volt rated. Beautiful finish, keyed tumbler pin lock, installs on any electrical device. Key is removable for safety and security. 3/4" dia. threaded mounting bushing with mounting nut. Can mount on panel from 1/8" to 3/4" thick. Discounts in quantity. **\$2.25 ea.**

MINIATURE, COMPLETELY WATERPROOF SPEAKER

Miniature waterproof speaker for use in all types of equipment. Primarily designed for military use, but is adaptable for other applications. 8 ohms impedance. Rated at 3 watts. Supplied with mounting clamps. Dimensions: 1 3/4" square by 3/4" deep. Can be made smaller (1 1/2" square) or larger. **\$15.00 ea.**



No. A-TVB1 Bracket (left). Swivel wall-mounted support for 19" TV sets, particularly the Designer series, or equivalent, for hospitals, hotels, etc. Saves floor space. Set easily positioned for best viewing. **Net \$9.75.** (Other sizes to order.)



TV MOUNTS

No. A-TVS Roll-away TV Stand (right). Easily positioned under, for example, a hospital bed. Shelf holds set over bed. Hard-rubber casters, bolted 7/8-in. diam. steel tubing. Shipped KD. Bar holds pillow speaker cord or, as shown, TV Remote Control Cord. **Net \$25.49.**



PATIENT'S RADIO WALL-PLATE

Although designed for use by patients in hospitals, the No. A-RW1 Radio Wall-plate shown here, is a convenience wherever used. Operates by pull chain or Nylon cord. Has stepper switch and a jack. Switch has continuous rotation through "Off", 5 positions for selection of radio programs, and back to "Off", and so-on. Jack provides connection for pillow speaker.

No. A-RW1 Radio Wall-plate.

SPECIFICATIONS

No. A-RW1 Radio Wall-plate. Switch is pull-chain actuated, continuous rotation, single-pole, 5 positions and "Off". Either single-circuit or seize-type jack can be supplied, for PL-55 plug; specify which desired. Plate is stainless steel, 2 3/4" x 4 1/2" high; overall depth, from front of plate, 2 1/4". Fits standard outlet box. Bead chain or nylon cord. 3 ft long; cut to desired length. **Net Price, \$7.35**

No. A-RW2 Radio Wall-plate. Dual unit placed between two beds for two patients' use. Size: 4 3/8" x 4 3/8". **Net Price, \$12.85**

PILLOW SPEAKER/"MIKE"

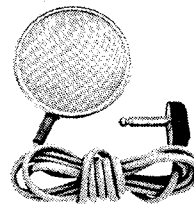

No. A-S/M Pillow Speaker, may serve also as Microphone! Ideal for hospital use: Water-resistant, stainless steel case, rugged construction, exceptional fidelity, has bedclothes clip and chain (not shown), and special flat-to-wall plug. Alnico magnet; available voice coil impedances: 3.2, 2,000, 5,000 and 10,000 ohms. Measures 7/8" x 3" dia. Cord is 10 ft. long (other lengths to order). **Net Price, \$10.50.** Quantity discounts.



AMERICAN COMMUNICATIONS CORPORATION

C.A.T.V. AND MASTER ANTENNA SYSTEM COMPONENTS

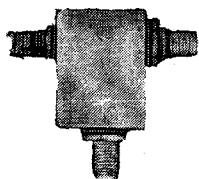

No. A-1601-1 Isolation Unit. A Single-unit TV line tap. Attenuation color codes per Note 1. Outdoor housing; 75 ohms. Net \$1.60.

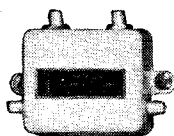

No. A-1602-2 Double-unit Line Tap, for 2 TV sets. (Notes 1, 3) Net \$2.90.

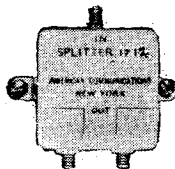

No. A-1712 Line Splitter, hybrid 2-way. Has 3 db forward attenuation. (Note 3) Net \$2.15.

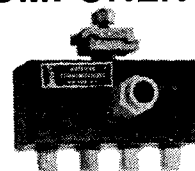

BACK MATCHED DIRECTIONAL COUPLERS WITH UP TO 6 HOUSE TAP-OFFS

A-C or D-C feed through, with complete tap isolation. 100% weatherproof, designed to mount on the strand. Low insulation loss and excellent response over entire 50 to 220 MC spectrum. Uses F61 house tap connectors. Input and output connectors are designed for up to 3/4" cables (per your order). Tap values available in 10-12-15-18-22-26 and 30 db attenuation. VSWR 1.2:1 max. with up to 20 db or better return loss.

(Net Prices)

Type	No. of House Tap-offs	F. or 308 Connectors	.412 Cable Connectors	.500 Cable Connectors	.750 Cable Connectors
DC2T	2	\$7.95	\$10.80	\$13.10	\$15.10
DC4T	4	9.50	12.10	15.08	17.08
DC6T	6	11.10	13.05	16.15	18.15

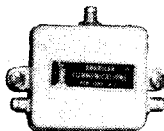

No. A-1601-2 Single-unit Line Tap. 75 ohms (Notes 1, 3) indoor housing. Net \$1.60.



No. A-CTVB Convenience TV Box, w/connector A-CH61. (Note 3) Net 77¢.

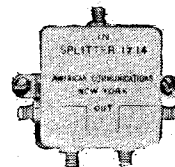

No. A-1714 Line Splitter, hybrid 4-way. Has 6 db forward attenuation. (Note 3) Net \$3.50.

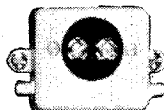

A-1601-3 Single-unit Line Tap, 75 ohms, screw terminals. (Note 3) Net \$1.60.

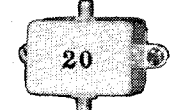

No. A-T/R-T Trunk/Riser Tap. Various db values of isolation. Creates Risers from Trunk Line. (Note 4) Net \$1.60.

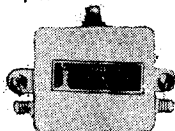

FM TAP OFF
American's FM TAP is used to connect an FM set to trunk line with minimum insert loss. The unit consists of a band pass filter for the FM band only, but allows TV spectrum to pass through. Supplied with three, C or F Fittings. Net \$2.25.

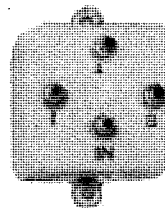

BACK MATCHED HYBRID DIRECTIONAL SPLITTERS

From 2-way to 6-way with VSWR of 1.2:1 max. and with either C or F fittings. Frequency Range of 50 to 220 MC @ 72 ohms impedance.

Type	Net	Type	Net
SP2 — 2-way.....	\$2.65	SP4 — 4-way.....	\$4.45
SP3 — 3-way.....	3.55	SP6 — 6-way.....	6.75

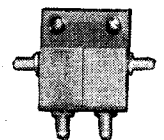

No. A-DBLA DB Line Attenuator Pad, for 2 TV sets. (Notes 1, 2) Net \$2.90.

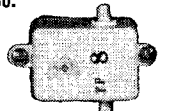

No. A-DBLA DB Line Attenuator Pad. 3-6-10-20-30. (Note 4) Net \$1.77.

(Note 1) Attenuation coded red, yellow, green, blue. (Note 3) Surface mount, in A-BC1 Accessory Box. (Note 2) On mounting bracket. (Note 4) Surface mount.

INSTANTANEOUS OR SIMULTANEOUS INTERPRETATION & TRANSLATION SYSTEMS

These systems are used wherever foreign groups assemble for meetings, conventions or governmental business. The system is similar to that used at the United Nations and other international conference halls.

There are usually five languages spoken for the purpose of interpretation.

The system comprises:

1. The initial pickup of the person addressing the audience.
2. Simultaneous transmission to the interpreters through headsets.
3. Each of the five interpreters, in his own language, translates what the speaker has said simultaneously to each separate seat in the auditorium.
4. At each seat there is a special switching device and air conduction head sets for the occupant, allowing him to hear either original address or any of the five interpretations.
5. The switching unit is installed in the seat arm or in the case of a temporary installation, tied to the lower arm.
6. Whenever portable equipment is used, the wires from the switching device are plugged into a specially designed floor molding, that is placed directly under and through the seats.

The system consists of the following equipment:

The Interpreter's Box, Model IB.....	\$135.00
Interpreter's Mixer-Amplifier, 25 W. solid state, Model IMA	160.00
Interpreter's Microphone, lavalier type, Model IM (not shown)	55.00
Seat Switching Unit, Model SSU.....	18.55
Air Conduction Headset, Model ACH.....	5.75
Molding Connection Box, built-in short circuit-proof networks, Model MCB	23.85
Special Wired Molding, lies flat on floor, with male and female plugs, 8 ft. section. Other lengths available (8 ft.)	12.50

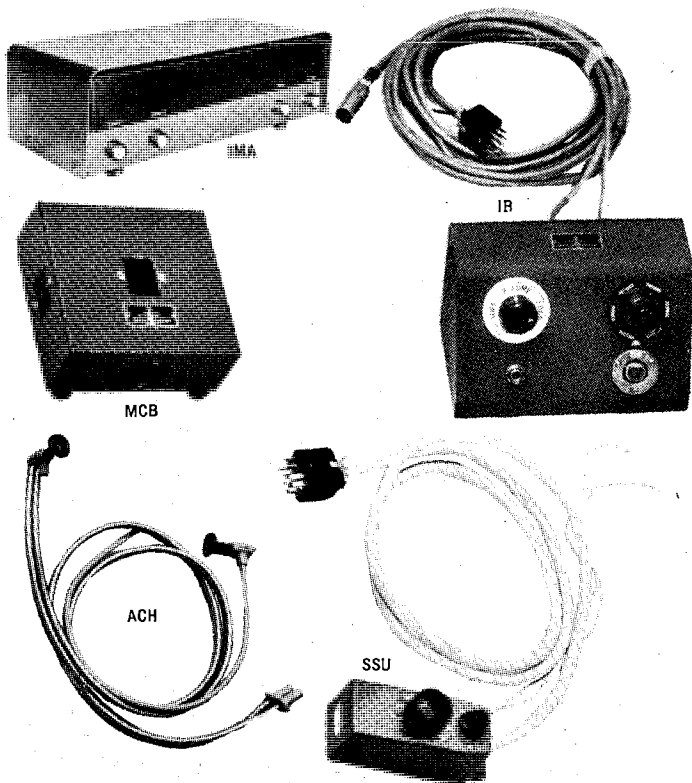

BOGEN SOUND SYSTEMS

FLEX-PAK[®] PA AMPLIFIERS

Combining operational flexibility, sound quality and dependability, Bogen professional amplifiers offer functions and features unmatched at any price, by any maker. Adaptable to a wide variety of applications once served only by custom designed, custom fabricated equipment, these amplifiers will accommodate virtually any audio signal source, providing a degree of intelligibility and control not previously obtainable in a single chassis amplifier. They include facilities for a host of accessories, engineered to satisfy specific require-

ments: two and four channel remote controllers, peak limiters, standby controllers for microphone or music channels; optional monitor and speaker units to allow checking of sound levels by both ear and eye; 600-ohm balanced line transformers; high-fidelity phono tops; plug-in microphone transformers, control locking plates, wall mounting kits and many more. All models include output jacks for driving tape recorders and booster amplifiers.

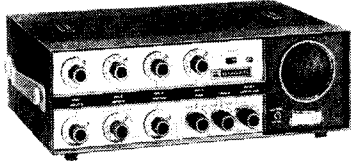

MX60A/MX30A/
MTX30B Shown with MMS-1

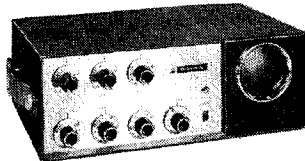

M330A/M60A Shown with MSK-1

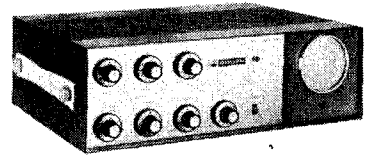

M120

	*MTX30B All Transistor	MX60A	MX30A	M330A	M60A	M120
POWER OUTPUT	30 w. @ 2% (Full pwr: 30 - 20,000 Hz)	60 w. @ 2% (Full pwr: 21 - 30,000 Hz ± 1 db)	30 w. @ 2% (Full pwr: 21-40,000 Hz $\pm 1\frac{1}{2}$ db)	30 w. @ 2%	60 w. @ 3%	120 w. @ 3%
PEAK POWER	50 watts	85 watts	50 watts	50 watts	100 watts	200 watts
POWER CONSUM.	60 watts	180 watts	125 watts	120 watts	160 watts	320 watts
FREQ. RESPONSE	± 1 db, 15-25,000 Hz	$\pm 1\frac{1}{2}$ db, 10-38,000 Hz	± 2 db, 10 - 40,000 Hz	± 2 db, 20-20,000 Hz	± 2 db, 20-20,000 Hz	± 1 db, 20-20,000 Hz
SENSITIVITY	Mic.: 2 MV (high imp); Mag.: 3 MV; Aux.: 0.3-v	Mic.: 3.5 MV (high imp); Mag.: 2 MV; Aux.: 0.15-v	Mic.: 3.5 MV (high imp); Mag.: 2 MV; Aux.: 0.15-v	Mic.: 6 MV; Mag.: 50 MV; Aux.: 0.3-v	Mic.: 9 MV; Mag.: 24 MV; Aux.: 0.4-v	Mic.: 9 MV; Mag.: 24 MV; Aux.: 0.4-v
GAIN	Mic.: 125 db; Mag.: 120 db; Aux.: 95 db	Mic.: 125 db; Mag.: 120 db; Aux.: 85 db	Mic.: 125 db; Mag.: 120 db; Aux.: 85 db	Mic.: 120 db; Mag.: 105 db; Aux.: 95 db	Mic.: 122 db; Mag.: 115 db; Aux.: 96 db	Mic.: 125 db; Mag.: 118 db; Aux.: 99 db
HUM and NOISE (below rated output)	Mic. - 70 db; Mag. - 65 db; Aux. - 85 db.	Mic. - 70 db	Mic. - 70 db	Mic. - 65 db; Aux. - 80 db	Mic. - 65 db; Aux. - 80 db	Mic. - 65 db; Mag. - 65 db; Aux. - 80 db
INPUTS	4 mic. (convert to low impedance with T200, T500 or T50 transformer); 2 mic. (high imp.); 2 mag. phono or tape playback heads; 2 aux. (high imp., high level); 1 600-ohm balanced telephone line with WMT1 transformer; 2 bridging. Note: 4 mics. and any two of the other nine inputs may be simultaneously mixed and faded.	4 mic. (convert to low impedance with T200, T500 or T50 transformer); 1 mic. (high imp. or mag. tape); 2 aux. (high imp. high level/fader); 1 600-ohm balanced telephone line with WMT1 transformer; 1 bridging input/output. Note: 6 inputs can be simultaneously mixed and faded.	4 mic. (convert to low impedance with T200, T500 or T50 transformer); 1 mic. (high imp. or mag. tape); 2 aux. (high imp. high level/fader); 1 600-ohm balanced telephone line with WMT1 transformer; 1 bridging input/output. Note: 6 inputs can be simultaneously mixed and faded.	3 mic. (convert to low impedance with T200, T500 or T50 transformer or 2 convert to mag.); 1 aux. channel (2 inputs/fader control); 1 600-ohm balanced telephone line with WMT1 transformer. Note: 4 inputs can be simultaneously mixed and faded.	3 mic. (convert to low impedance with T200, T500 or T50 transformer or 2 convert to mag.); 1 aux. channel (2 inputs/fader control); 1 600-ohm balanced telephone line with WMT1 transformer. Note: 4 inputs can be simultaneously mixed and faded.	3 mic. (convert to low impedance with T200, T500 or T50 transformer or 2 convert to mag.); 1 aux. channel (2 inputs/fader control); 1 600-ohm balanced telephone line with WMT1 transformer. Note: 4 inputs can be simultaneously mixed and faded.
OUTPUT IMPEDANCE	4, 8, 16 ohms, tape and booster jack, 25-v, balanced (21 ohms), 70-v, balanced (163 ohms)	4, 8, 16 and 83 ohms, balanced 25-v, line, balanced 70-v, line; tape/booster jack	4, 8, 16 and 163 ohms, balanced 25-v, line, balanced 70-v, line; tape/booster jack	4, 8, 16 ohms, balanced 25-v (16 ohms), 70-v (163 ohms); tape/booster jack	4, 8, 16 ohms, balanced 25-v (16 ohms), balanced 70-v (82 ohms); tape/booster jack	8, 16 ohms, bal'd 25-v (5 ohms), bal'd 70-v (41 ohms), bal'd 25-v center tap (1.25 ohms); tape/booster jack
CONTROLS	4 individual mic. (each with speech filter or wide-range switch) • 1 high imp. mic./mag. phono/tape head/aux.-fader control with speech filter switch • 1 high imp. mic./mag. phono/tape head/aux.-600 ohm line fader control with speech filter switch • master vol. • bass • treble • power switch • calibrated low freq. filter (variable) determines low freq. cut-off of all inputs • provision for remote control or precedence of all six inputs and master vol.	4 individual mic. (each with speech filter switch) • 1 mic. /mag./tape with speech filter switch • aux. 1/aux. 2 • master vol. • bass • treble • power switch • calibrated low freq. filter (variable) determines low freq. cut-off of all inputs • provision for remote control or precedence of all six inputs and master vol.	4 individual mic. (each with speech filter switch) • 1 mic. /mag./tape with speech filter switch • aux. 1/aux. 2 • master vol. • bass • treble • power switch • calibrated low freq. filter (variable) determines low freq. cut-off of all inputs • provision for remote control or precedence of all six inputs and master vol.	3 mic. • aux. 1/2 • master vol. • bass • treble • power switch • provision for remote control or precedence for mic.	3 mic. • aux. 1/2 • master vol. • bass • treble • power switch • provision for remote control or precedence for mic.	3 mic. • aux. 1/2 • master vol. • bass • treble • power switch • provision for remote control or precedence for mic.
TO NE CONTROL ACTION	Treble (10 KHz) + 12 db to -14 db; Bass (50Hz) + 15 db to -9 db	Treble (10 KHz) + 13 db to -15 db; Bass (50Hz) + 15 db to -10 db	Treble (10 KHz) + 13 db to -15 db; Bass (60Hz) + 15 db to -10 db	Treble (10 KHz) + 10.5 db to -14.5 db; Bass (50 Hz) + 13.5 db to -9 db	Treble (10 KHz) + 12 db to -15.5 db; Bass (50 Hz) + 15 db to -9.5 db	Treble (10 KHz) + 12 db to -14.5 db; Bass (50 Hz) + 15 db to -9.5 db
TRANSISTORS or TUBES	All Silicon 32-transistors, 3-diodes, 2-zener diodes	8 tubes: 3-12AX7A, 3-7247, 2-8417 plus 5-silicon rectifiers	8 tubes: 3-12AX7A, 3-7247, 2-7868 plus 5-silicon rectifiers	5 tubes: 2-7868, 1-7247, 2-6EU7 plus 2-silicon rectifiers and 1-bias silicon diode	5 tubes: 2-8417, 1-7247, 2-6EU7 plus 2-silicon rectifiers and 1-bias silicon diode	7 tubes: 4-8417, 1-7247, 2-6EU7 plus 3-silicon rectifiers
DIMENSIONS	16 $\frac{1}{2}$ " W, 12" D, 4 $\frac{3}{4}$ " H	16 $\frac{1}{2}$ " W, 12" D, 4 $\frac{3}{4}$ " H	16 $\frac{1}{2}$ " W, 12" D, 4 $\frac{3}{4}$ " H	14 $\frac{7}{8}$ " W, 9 $\frac{7}{8}$ " D, 5 $\frac{3}{4}$ " H	14 $\frac{7}{8}$ " W, 9 $\frac{7}{8}$ " D, 5 $\frac{3}{4}$ " H	16 $\frac{1}{2}$ " W, 12" D, 4 $\frac{3}{4}$ " H
SHIP. WEIGHT	28 lbs.	37 lbs.	29 lbs.	20 lbs.	28 lbs.	43 lbs.
NET EACH	\$250.50 (Zone 2: \$253.00)	\$217.50 (Zone 2: \$220.85)	\$172.50 (Zone 2: \$175.10)	\$123.00 (Zone 2: \$124.80)	\$154.50 (Zone 2: \$157.00)	\$205.50 (Zone 2: \$209.35)

* Operates on 105-125 VAC or 12-15 VDC - from -20°C to +70°C (158°F)

(SOLID STATE)

LEAR SIEGLER, INC.





BOGEN COMMUNICATIONS DIVISION

BOGEN SOUND SYSTEMS "CHS" SOLID STATE PA AMPLIFIERS

These new "CHS" p.a. amplifiers feature ruggedness, flexibility and dependable performance. Every day their systems-tested circuitry and unique features gain growing acclaim from users in professional sound studios, government, industry, churches and schools throughout the world.

The degree of reliability achieved through advanced, conservative solid-state design could not be realized with conventional tube amplifiers. . . so, Bogen created "CHS" . . . the popular-priced series of solid-state amplifiers to suit every p.a. need. Safe continuous operations from -20°C . (-4°F .) to $+65^{\circ}\text{C}$. (149°F .)

Unique features: optional panel-mounted preamp. provides 2 additional mic. inputs • hi or lo imp. mic. inputs (no transformer required) • all solid-state (CHS100, CHS50 are all-silicon) • automatic wave-soldered printed circuit boards • AC/DC operation (12 v. battery) with CHS35, CHS20 • provision for mic. precedence and remote vol. control.

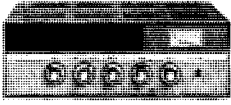
				
	CHS 100	CHS 50	CHS 35	CHS 20
POWER OUTPUT	100 W. @ 5%	50 W. @ 5%	35 W. @ 5%	20 W. @ 5%
PEAK POWER	200 W.	100 W.	70 W.	40 W.
FREQ. RESPONSE	40-20,000 Hz $\pm 2\text{db}$	40-20,000 Hz $\pm 2\text{db}$	60-15,000 Hz $\pm 2\text{db}$	50-15,000 Hz $\pm 2\text{db}$
SENSITIVITY	Mic. (Lo-imp.): 0.3 mv. Mic. (Hi-imp.): 4.0 mv. Aux.: 0.3 v. Bridging: 1.0 v.	Mic. (Lo-imp.): 0.5 mv. Mic. (Hi-imp.): 3.0 mv. Aux.: 0.2 v. Bridging: 1.0 v.	Mic. (Lo-imp.): 0.6 mv. Mic. (Hi-imp.): 4.0 mv. Aux.: 0.5 v. Bridging: 1.0 v.	Mic. (Lo-imp.): 0.6 mv. Mic. (Hi-imp.): 4.0 mv. Aux.: 0.5 v. Bridging: 1.0 v.
INPUTS (impedance)	2 Mic. (Hi or Lo imp. unbal.) Hi imp.: 100k ohms Lo imp.: 200 ohms Aux.: (2 inputs on fader): 300k ohms Bridging: Hi imp. (1.0 v.)	2 Mic. (Hi or Lo imp. unbal.) Hi imp.: 100k ohms Lo imp.: 200 ohms Aux.: (2 inputs on fader): 300k ohms Bridging: Hi imp. (1.0 v.)	2 Mic. (Hi or Lo imp. unbal.) Hi imp.: 100k ohms Lo imp.: 200 ohms Aux.: (2 inputs on fader): 300k ohms Bridging: Hi imp. (0.6 v.)	1 Mic. (Hi or Lo imp. unbal.) Hi imp.: 100k ohms Lo imp.: 200 ohms Aux.: (2 inputs on fader): 300k ohms Bridging: Hi imp. (1.0 v.)
CONTROLS	2 indiv. mic. (plus 2 on PMA-2 preamp.) 1 vol. (fader) for Aux. 1 and 2 Master Volume Bass Treble Power Switch Provision for remote control or mic. precedence (all inputs)	2 indiv. mic. (plus 2 on PMA-2 preamp.) 1 vol. (fader) for Aux. 1 and 2 Master Volume Bass Treble Power Switch Provision for remote control or mic. precedence (all inputs)	2 indiv. mic. (plus 2 on PMA-2 preamp.) 1 vol. (fader) for Aux. 1 and 2 Master Volume Bass Treble Power Switch Provision for remote control or mic. precedence (all inputs)	1 mic. (plus 2 on PMA-2 preamp.) 1 vol. (fader) for Aux. 1 and 2 Master Volume Bass Treble Power Switch Provision for remote control or mic. precedence (all inputs)
OUTPUT IMPEDANCE	2, 8, 16 ohms 25 v. bal. (c.t.) = 6 ohms 70 v. bal. = 49 ohms 2 quick-disconnect sockets and screw terminals Tape/Booster: 10k ohms 5.0 v. Bridging: Hi imp. at 0.5v.	4, 8, 16 ohms 25 v. bal. (c.t.) = 12 ohms 70 v. bal. = 100 ohms 2 quick-disconnect sockets and screw terminals Tape/Booster: 10k ohms 5.0 v. Bridging: Hi imp. at 0.5v.	4, 8, 16 ohms 25 v. = 16 ohms 70 v. = 143 ohms 2 quick-disconnect sockets and screw terminals Tape/Booster: 10k ohms 5.0 v. Bridging: Hi imp. at 0.5v.	4, 8, 16 ohms 25 v. = 31 ohms 70 v. = 250 ohms 2 quick-disconnect sockets and screw terminals Tape/Booster: 10k ohms 5.0 v. Bridging: Hi imp. at 0.5v.
TONE CONTROLS	Bass: +10db to -10db at 50 Hz Treble: +10db to -10db at 10 KHz	Bass: +10db to -10db at 50 Hz Treble: +11db to -12db at 10 KHz	Bass: +8db to -23db at 50 Hz Treble: +8db to -15db at 10 KHz	Bass: +8db to -19db at 50 Hz Treble: +12db to -15db at 10 KHz
HUM & NOISE (below rated output)	Mic.: 65db Aux.: 70db	Mic.: 67db Aux.: 70db	Mic.: 64db Aux.: 67db	Mic.: 66db Aux.: 70db
POWER CONSUMPTION	105-125 v. 50-60 Hz	105-125 v. 50-60 Hz	105-125 v. 50-60 Hz 12-15 VDC at 3A	105-125 v. 50-60 Hz 12-15 VDC at 2A
SEMI-CONDUCTORS	Total 14 All-silicon	Total 12 All-silicon	Total 11: 9 silicon 2 germanium	Total 10: 8 silicon 2 germanium
DIMENSIONS	5½"Hx10½"Dx15¼"W	5½"Hx10½"Dx15¼"W	5½"Hx10½"Dx15¼"W	5½"Hx10½"Dx15¼"W
SHIPPING WEIGHT	24 lbs.	21 lbs.	17 lbs.	15 lbs.
NET EACH	\$157.15 (Zone 2: \$159.20)	\$127.45 (Zone 2: \$129.35)	\$104.95 (Zone 2: \$106.50)	\$92.25 (Zone 2: \$93.60)

Accessories: PMA-2 Preamplifier — panel mounts to provide 2 additional high or low impedance microphone inputs (no transformers required for low impedance). Knobs come through front panel of amplifier.

Matching phono-top. Control-guard locking plate. Plug-in remote volume controllers. Rack panel mounting kits. Carrying cases. WMT-1 transformer—provides 500/600 ohm telephone line input for wired background music.

(SOLID STATE)

LEAR SIEGLER, INC.



BOGEN COMMUNICATIONS DIVISION

BOOSTER AMPLIFIERS

BOGEN SOUND SYSTEMS

Bogen's booster amplifiers embody the most advanced developments in design and techniques of construction. These units deliver maximum power from a small package. They are ideal for sound systems in industrial plants, airports, stadia, schools... wherever undistorted power is required. Note their exceptionally wide-range response characteristics. Built-in provision permits paralleling any number of power amplifiers to multiply power output. The models described on the preceding page are ideal preamplifiers for these boosters. The MO200A, MO100A, and MT100 units are unsurpassed for both PA and industrial uses. Their 115-volt output makes them adaptable to

unique applications. With a variable frequency audio generator input, they represent relatively inexpensive power sources — any frequency or voltage — capable of driving servos, motors, vibration (shake) tables, ultrasonic equipment. The unique all-silicon transistor model MT100 may be operated from a 12-16 VDC source as well as from 117 VAC. Highly flexible in combination, inputs of identical amplifiers can be paralleled; outputs can be wired in series or parallel to provide any reasonable voltage or power (except MBT60 outputs).

No cage is furnished with MO200A.

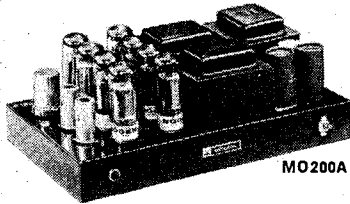

MO200A

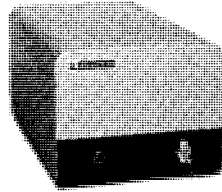
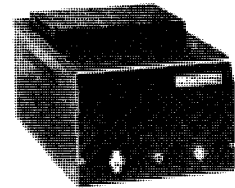
MO100A
MO30A
MBT60

MT100

	MO200A	MO100A	MO30A	ALL-SILICON TRANSISTOR	
				MBT60	MT100
POWER OUTPUT	200 w. at less than 2% distortion (Full power: 21-50,000 Hz ± 1 db at 5%)	100 w. at less than 2% distortion (Full power: 21-50,000 Hz ± 1 db at 5%)	30 w. at less than 2% distortion (Full power: 21-40,000 Hz $\pm 1\frac{1}{2}$ db at 5%)	60 w. rms at less than 3% distortion	100 w. rms at less than 1% distortion
FREQ. RESPONSE	8-50,000 Hz ± 1 db	8-50,000 Hz ± 1 db	10-40,000 Hz ± 2 db	12-20,000 Hz ± 1 db	15-35,000 Hz ± 1 db
OUTPUT IMPEDANCE	Bal. 8 ohms, bal. 25-v (3 ohms) C.T., bal. 70-v (25 ohms) C.T. and 115-v (86 ohms) (for industrial uses)	Bal. 16 ohms, bal. 25-v (6.25 ohms) C.T., bal. 70-v (49 ohms) C.T. and 115-v (132 ohms) (for industrial uses)	Bal. 4, 8, 16 ohms, bal. 25-v (21 ohms), bal. 70-v (163 ohms)	Bal. 2.5, 8 and 16 ohms, bal. 25-v (10.4 ohms) C.T., bal. 70-v (82 ohms)	16 ohms, bal. 25-v (6 ohms) C.T., bal. 70-v (49 ohms) C.T., and 115-v (132 ohms) bal. (for industrial uses)
INPUTS	High imped: 0.5 meg-ohms. Low imped: 500/600 ohms with T161 or T165B line transformer	High imped: 0.5 meg-ohms. Low imped: 500/600 ohms with T161 or T165B line transformer	High imped: 0.5 meg-ohms. Low imped: 500 ohms with T161 or T165B line transformer	High imped: 0.1 meg-ohms. Low imped: 500/600 ohms with TL600 transformer; 10,000 ohms with TL10K transformer	High imped: 0.1 meg-ohms. Low imped: 500/600 ohms with TL600 transformer; 10,000 ohms with TL10K transformer
SENSITIVITY	High imped: better than 2-v. Low imped: with T161 transformer, better than 0.5-v	High imped: better than 2-v. Low imped: with T161 transformer, better than 0.5-v	High imped: better than 2-v. Low imped: with T161 transformer, better than 0.5-v	High imped: 0.15-v. Low imped: with TL600 transformer, 0.04-v	High imped: 0.75-v. Low imped: with TL600 transformer, 0.2-v
HUM (below rated output)	-80 db	-80 db	-80 db	-78 db	-80 db
TUBES or TRANSISTORS	(10) tubes and (3) silicon rectifiers: 2-7247, 8-8417	(5) tubes and (3) silicon rectifiers: 1-7247, 4-8417	(3) tubes and (2) silicon rectifiers, (1) bias sil. diode: 1-7247, 2-7868	(7) all silicon transistors and (7) diodes	(14) all silicon transistors, (1) Zener diode and (2) silicon rectifiers
POWER CONSUM.	500 watts	250 watts	105 watts	115 watts 105-125 VAC, 50/60 Hz	215 watts 105-125 VAC, 50/60 Hz 12 A. at 16 VDC
DIMENSIONS	16" W, 11 $\frac{1}{2}$ " D, 6" H	8" W, 13" D, 6 $\frac{3}{4}$ " H	8" W, 13" D, 6 $\frac{3}{4}$ " H	8" W, 13" D, 6 $\frac{3}{4}$ " H	8" W, 13" D, 6" H
SHIP. WEIGHT	45 lbs.	33 lbs.	23 lbs.	18 lbs.	31 lbs.
NET EACH	\$262.50 (Zone 2: \$266.55)	\$150.00 (Zone 2: \$152.95)	\$96.00 (Zone 2: \$98.05)	\$120.00 (Zone 2: \$121.60)	\$240.00 (Zone 2: \$242.80)

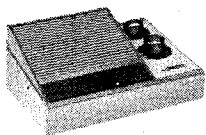
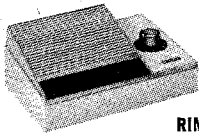
TIA-6
TIA-12

RIM-6



TSL-16



TQ-12A

INTERCOMS

Bogen intercoms include a wide variety of systems — each designed to answer a specific need.

SERIES "T" INTERCOMS — Fully transistorized, unlimited flexibility, high intelligibility, simple installation and unique styling. Permits multiple simultaneous conversations.

Equipment: TIA-6 Master Station: For systems up to 6 stations — all master or one master plus remotes. TIA-12 Master Station: For systems up to 12 stations. RIA-1 Remote Station: Can call only 1 pre-selected master and reply when called. TIM-12 Master Station: For intermix systems up to 12 masters and/or remotes. RIM-6 Selective Remote: Can call any of 6 pre-selected masters.

INTERNAL PHONE SYSTEMS — Extremely flexible telephone systems that provide simultaneous conversations without a costly central exchange. No switching, no dialing, no switchboard delay. **Equipment:** TSL-16. 1 ring button and 15 station selector buttons. TSL-B. 1 ring button and 7 station selector buttons. TRC. Phone-Page Adapter allows paging from TSL phones. TQ-1A for 2 station systems. TQ-6A phone for up to 7 station system. TQ-12A phone for up to 13 station system. TRA Phone-Page Adapter allows paging from TQ phones.

Request Catalog No. 429 for complete details and pricing of Bogen Intercom and Phone Systems.

BELL p/a / COMMERCIAL SOUND EQUIPMENT

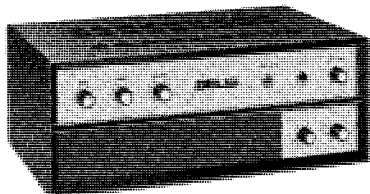

MOD SERIES
Models MOD-20 and MOD-45

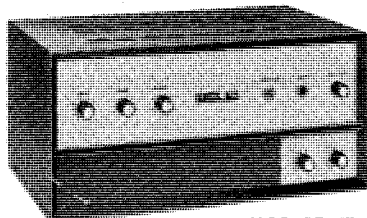

MOD SERIES
Models MOD-90 and MOD-200

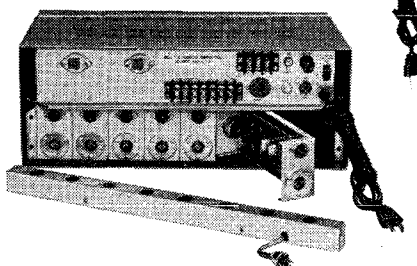

TRUE MODULAR AMPLIFIERS

FEATURES:

- 1 to 8 modular input preamps.
- Thousands of possible combinations.
- Hundreds of modular arrangements.
- Dozens of basic applications.

GENERAL:

The new Bell P/A MOD Series modular amplifiers incorporate the TPA Series in a unique package concept that makes possible a virtually unlimited number of applications. The new line provides unprecedented flexibility in modules. The new MOD amps are full fidelity, heavy duty construction, conservatively designed to meet the most extreme performance requirements within each power range. As in the TPA Series, Bell P/A's high standards of quality prevail throughout the new modular line.

INPUT MODULES:

Bell P/A MOD Series units are each equipped with one hi Z mic preamp (Model No. MMH-1) and one hi Z, high level, aux program preamp (Model No. PMH-1). Six other preamp modules* may be added, for a total of 8, to satisfy input requirements of nearly any installation. Modules are simple to install in field, requiring no special tools or wiring.

The "stacking" principle utilized in Bell P/A MOD Series permits unusual design flexi-

bility. Channel 1 (to extreme right, facing front of unit) is base channel, and all input modules are stacked to left. Special control modules, such as "priority paging" or "limiter" module, may be placed in any channel so as to mute or limit the gain of all inputs to the left of its position. In this way, it is possible to control from one to all seven other inputs.

When designing a system, it is recommended that MOD xx Basic be special-ordered with required input configuration. Completed unit will be shipped from factory, ready to operate.

* Input modules can be supplied with any standard audio input connector, on special order. For complete information on input modules and specifications, see individual module spec sheets.

*MMH-1	Mic Preamp, Hi Z (1 Megohm).....	\$30.00
MMH-2	Mic Preamp, Hi Z (Precedence Paging)	38.75
MMH-3	Mic Preamp, Hi Z (Vol Limiting).....	50.00
MML-1	Mic Preamp, Bal Lo Z (50-250 Ohms)	52.50
MMF-2	Mic Preamp, Bal Lo Z (Precedence Paging)	68.75
MML-3	Mic Preamp, Bal Lo Z (Vol Limiting)	75.00
PMH-1	Program Preamp, Hi Z High Level....	25.00
PMH-2	Program Preamp (Mag Phono)	30.00
PML-1	Program Preamp, Bal 600 Ohms	55.00
TGM-1	Tone Generator (Siren Alarm).....	65.00

SPECIFICATIONS — Modular Transistorized Amplifiers

	MOD-20	MOD-45	MOD-90	MOD-200
POWER OUTPUT:	20 W @ 5%	45 W @ 5%	90 W @ 5%	200 W @ 5%
REGULATION:	1 db @ 1000 Hz better than 3 db overall	1 db @ 1000 Hz better than 3 db overall	1 db @ 1000 Hz better than 3 db overall	1 db @ 1000 Hz better than 3 db overall
HUM & NOISE:	90 db below rated output	90 db below rated output	90 db below rated output	90 db below rated output
GAIN:	130 db mic 90 db program	130 db mic 90 db program	130 db mic 90 db program	130 db mic 90 db program
INPUT SENSITIVITY:	1 MV mic 100 MV program	1 MV mic 100 MV program	1 MV mic 100 MV program	1 MV mic 100 MV program
FREQUENCY RESPONSE:	20-20,000 Hz ± 1 db	20-20,000 Hz ± 1 db	20-20,000 Hz ± 1 db	20-20,000 Hz ± 1 db
OUTPUT IMPEDANCES:	4, 8, 16 Ω 41 (bal 25 V) Ω 333 (bal 70 V) Ω	4, 8, 16 Ω 21 (bal 25 V) Ω 167 (bal 70 V) Ω	4, 8, 16 Ω 10 (bal 25 V) Ω 80 (bal 70 V) Ω	4 (bal 25 V CT) Ω 8, 16, 32 (bal 70 V CT) Ω
POWER RESPONSE:	50-20,000 Hz, 15 W @ less than 2%	50-20,000 Hz, 30 W @ less than 2%	50-20,000 Hz, 60 W @ less than 2%	50-20,000 Hz, 150 W @ less than 2%
TONE CONTROL:	Treble, 12 db boost, 15 db cut 10,000 Hz Bass, 16 db boost, 14 db cut 50 Hz	Treble, 12 db boost, 15 db cut 10,000 Hz Bass, 16 db boost, 14 db cut 50 Hz	Treble, 12 db boost, 15 db cut 10,000 Hz Bass, 16 db boost, 14 db cut 50 Hz	Treble, 12 db boost, 15 db cut 10,000 Hz Bass, 16 db boost, 14 db cut 50 Hz
INPUTS:	Aux (hi Z hi level) bal 600 Ω w 32B263 trans. Plus 1 hi Z mic and 1 aux	Aux (hi Z hi level) bal 600 Ω w 32B263 trans. Plus 1 hi Z mic and 1 aux	Aux (hi Z hi level) bal 600 Ω w 32B263 trans. Plus 1 hi Z mic and 1 aux	Aux (hi Z hi level) bal 600 Ω w 32B263 trans. Plus 1 hi Z mic and 1 aux
TRANSISTORS:	19 transistors, (5 FET's), 7 diodes	21 transistors, (5 FET's), 7 diodes	20 transistors, (5 FET's), 7 diodes	22 transistors, (5 FET's), 7 diodes
POWER CONSUMPTION:	50 W, 120 V, 60 Hz	100 W, 120 V, 60 Hz	150 W, 120 V, 60 Hz	350 W, 120 V 60 Hz
DIMENSIONS:	6 $\frac{1}{4}$ " H, 16 $\frac{1}{4}$ " W, 8 $\frac{1}{2}$ " D	6 $\frac{1}{4}$ " H, 16 $\frac{1}{4}$ " W, 8 $\frac{1}{2}$ " D	7 $\frac{3}{4}$ " H, 16 $\frac{1}{4}$ " W, 10 $\frac{1}{4}$ " D	7 $\frac{3}{4}$ " H, 16 $\frac{1}{4}$ " W, 10 $\frac{1}{4}$ " D
WEIGHT:	19 lbs	20 lbs	25 lbs	32 lbs
LIST PRICE:	\$262.50 (Zone 2 — \$265.50)	\$312.50 (Zone 2 — \$315.50)	\$375.00 (Zone 2 — \$379.00)	\$475.00 (Zone 2 — \$479.00)

Request detailed spec sheets from your BELL P/A products distributor. Specs and prices subject to change without notice.

FANON

INTERCOMS FOR HOME AND BUSINESS

"FI" SERIES — DELUXE INTERCOM SYSTEM

- Solid state circuits
- Push-button operation
- New styling

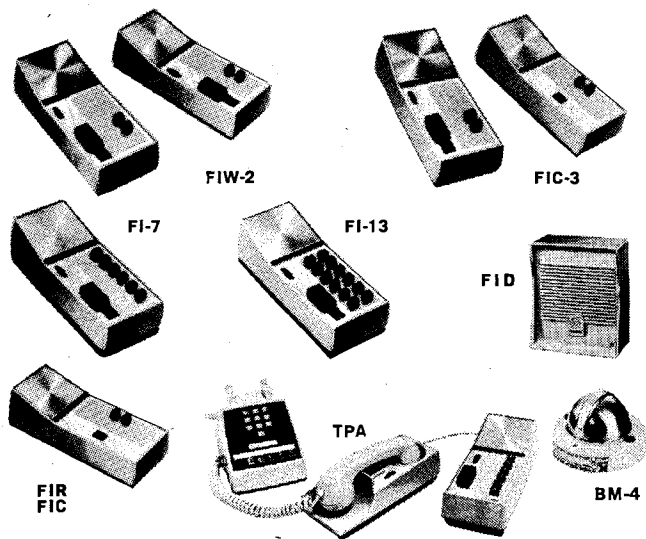

Refer to Catalog 15 for details

FIC-3	Trans. deluxe 2 station system with 50' cable Net 35.50
FIS	Transistorized deluxe staff station for FIC-3 Net 27.75
FIC	Additional indoor remote for FIC-3 Net 10.75
FID-3	Transistorized deluxe 2 station door intercom system with 50' cable Net 33.95
FID	Additional outdoor remote for "FI" series Net 7.65
FI-3	Transistorized deluxe master only Net 27.75
FI-7	Transistorized deluxe 7 station master for all-master or master to remote installation Net 30.95
FI-13	Transistorized deluxe 13 station master for all master or master to remote installation Net 42.95
FIR	Transistorized deluxe remote for FI-7, FI-13 Net 9.95
FIW-2	Transistorized deluxe 2 station, 2 channel wireless intercom system Net 59.95
FIW-1	Additional wireless intercom station for FIW-2 Net 30.75
TPA	Telephone amplifier accessory for "FI" masters Net 11.25
BM-3	Temperature fire-sensing device for FIC-3, FID-3, FI-3 Net 3.95
BM-4	Temperature and rate of rise fire detector for FIC-3, FID-3, FI-3 Net 7.75
PR-15	Paging and talkback relay accessory for FI-7, FI-13 master. Used with any PA system..... Net 19.95

MEGAPHONES

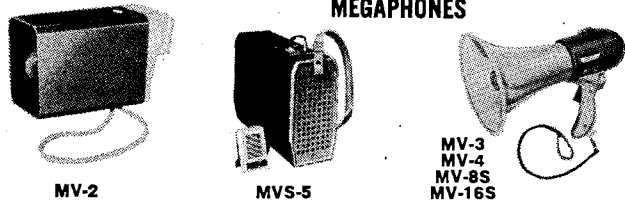

MV-2	Transistorized, 1 watt battery powered megaphone. Net 12.95
MV-3	Electric, battery powered megaphone. Net 29.95
MV-4	Transistorized, 4 watt battery powered megaphone. Net 44.95
MV-8S	Transistorized, 8 watt battery powered megaphone. Net 59.95
MV-16S	Transistorized, 16 watt battery powered megaphone with built-in siren alarm. Net 74.95
MVS-5	Transistorized, 8 watt portable P.A. system. Net 67.50
CL-16	Auto cigarette lighter adaptor cord for MV-16S. Net 4.50
MVR	Auto window rack holder for MVS-5. Net 3.00
STM-16	Mtg. bracket for MV-16S, MV-8S, MV-4, MV-3 .Net 11.95.

**TWO-STATION "PACKAGED" INTERCOMS
1600 SERIES — SOLID STATE INTERCOMS**

New economy series — Blister-packed for standard cartons

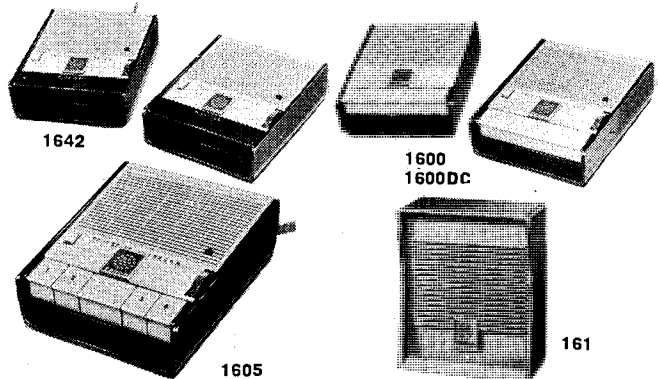

Refer to Catalog 16 for details

1600	Transistorized 2 station system w/built-in AC power supply and 50' cable Net 19.95
1600DC	Same as above less AC power supply..... Net 17.75
ES-16	Transistorized 2 station door intercom w/built-in AC power supply and 50' cable Net 19.95
ES-16DC	Same as above less A.C. power supply Net 17.75
PS-16	AC power supply for 1600DC and ES-16DC.... Net 5.25
1605	Single 5 station master for master to remote instal. Net 15.95
(BL)165Y	"Starter system" — one 1605 master two 162 remotes and two 2WP cable Net 29.95
161	Additional outdoor remote for above systems Net 5.25
162	Additional indoor remote for above systems Net 4.50
2WP	50' 2 conductor cable with plug terminations Net 2.00
2WP-100	100' 2 conductor cable with plug terminations Net 3.40
1642	Transistorized 2 station wireless intercom Net 29.95
1643	Additional single wireless station for 1642 Net 15.95

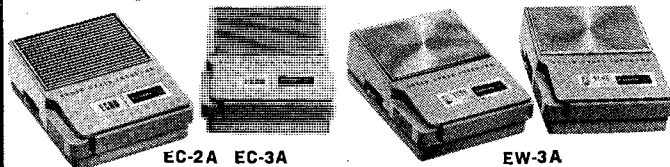

ECONOMY "ECHO" INTERCOMS

EC-2A	Transistorized battery operated two-station system with 50 ft. cable. Less battery Net 9.95
EC-3A	Transistorized, AC operated 2-station system Net 11.95
EW-3A	Transistorized, AC, 2-station wireless system Net 19.95

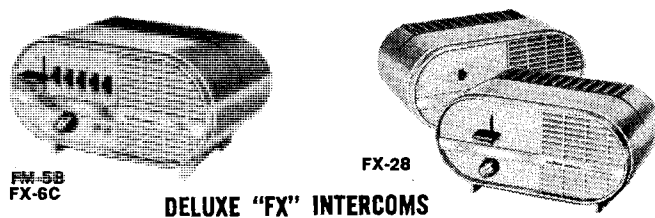

DELUXE "FX" INTERCOMS

FM-5B	Five station master for master-to-remote installations with "remote-to-remote" talking feature. Net 26.95
FX-6C	Six station master for all master or master-to-remote. Net 25.45
FX-2B	Deluxe two-station system with 50 ft. cable Net 26.95
FSB	Additional remote with 50 ft. cable for FX-2B Net 9.50
FCB	Remote for FM-5 and FX-6C Net 10.25

Refer to Catalog 1 for details

FANON

AMPLIFIERS, P.A. SYSTEMS, HORNS & SPEAKERS

Refer to Catalog 3D for details

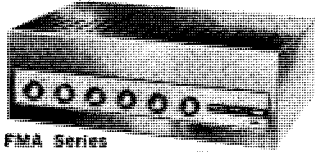

FMA Series



BC-350 with MH-3

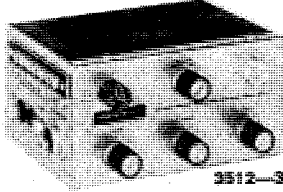

3512-3527

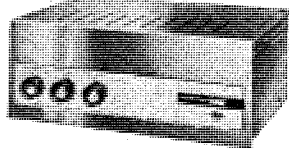

FMM-35AD

FMA-100	100 watt, POWER-FLEX P.A. amplifier.	Net 125.95
FMA-65	65 watt, POWER-FLEX P.A. amplifier.	Net 110.95
FMA-35	35 watt, POWER-FLEX P.A. amplifier.	Net 82.95
FMA-20	20 watt, POWER-FLEX P.A. amplifier.	Net 65.95
FMA-11	11 watt, POWER-FLEX P.A. amplifier.	Net 47.95
FMB-100	100 watt, POWER-FLEX booster amplifier. ...	Net 116.95
FMB-65	65 watt, POWER-FLEX booster amplifier.	Net 100.50
ARM	Above amplifiers mounted on 19" rack panel, add:	
BC-350	35 watt FM/AM receiver and P.A. amplifier ...	Net 179.95
MH-3	Metal cover for BC-350.	Net 14.95
ASC-10	Speaker area selector control.	Net 20.25
BMT	600 ohm balanced line transformer.	Net 20.95
CCP-1	Control cover for 100, 65 and 35 w. amplifiers	Net 7.50
LZT	Low impedance microphone transformer.	Net 17.25
MP-2	Two channel microphone preamplifier.	Net 21.75
PPC-1	Priority paging control.	Net 10.45
RMC-2	Remote microphone volume control.	Net 9.75
3600	Phono turntable, 117v AC.	Net 27.00
S-2	Systems case with two 12" speakers, cables, plugs.	Net 62.95
MM-4	4 channel microphone mixer.	Net 20.25
3512	12 watt, transistorized P.A. for 12v DC.	Net 52.50
3527	27 watt, transistorized P.A. for 12v DC.	Net 62.95
FMM-35AD	35 watt, transistorized P.A. for 12v DC or 117v AC.	Net 110.25
PS-27	117v AC power supply for 3512 and 3527.	Net 38.95
3612	Phono turntable for 12v DC.	Net 37.45

Refer to Catalog 11 for details

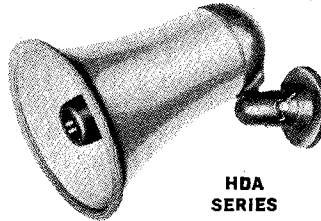

HDA SERIES

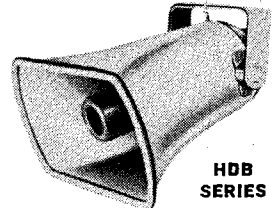

HDB SERIES

FANON PAGING AND TALKBACK SPEAKERS

HDA-5A-8	15 watt—swivel base—5¼" bell, 8 ohms	Net 7.45
HDA-5A-45	15 watt—swivel base—5¼" bell, 45 ohms	Net 7.90
HDA-5-8	15 watt—swivel base—6" bell, 8 ohms	Net 9.95
HDA-5-45	15 watt—swivel base—6" bell, 45 ohms	Net 10.40
HDA-6-8	15 watt—swivel base—6½" bell, 8 ohms	Net 13.30
HDA-6-45	15 watt—swivel base—6½" bell, 45 ohms	Net 13.75
HDA-10-8	30 watt—swivel base—10" bell, 8 ohms	Net 18.25
HDA-10-45	30 watt—swivel base—10" bell, 45 ohms	Net 18.75
HDB-8-8	25 watt—wide angle—8½x5½" bell, 8 ohms ..	Net 18.25
HDB-8-45	25 watt—wide angle—8½x5½" bell, 45 ohms	Net 18.75
HDB-12-8	30 watt—wide angle—11x6½" bell 8 ohms ...	Net 24.95
HDB-12-45	30 watt—wide angle—11x6½" bell, 45 ohms	Net 25.40

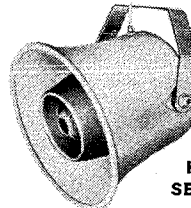

HFA SERIES

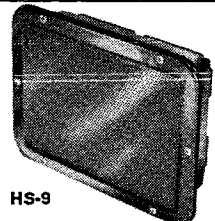

HS-9

FANON HI-FIDELITY AND SPECIAL PURPOSE

HFA-8	5 watt—swivel base—8" bell, 4 ohms	Net 13.75
HFA-12	10 watt—co-axial—12" bell, 8 ohms	Net 29.95
HS-9	10 watt—flush mount—6x9", 8 ohms	Net 16.60

"TRIUMPH" SERIES — SOLID STATE AMPLIFIERS

- Totally New Design
- Heavy Duty Performance
- Unmatched Flexibility
- Made in U.S.A.

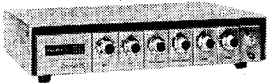

TRI-35

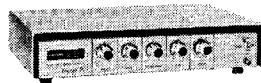

TRI-25



TRI-100



TMP-1
TML-1

TRI-15	15 watt, P.A. Amplifier	Net 56.95
TRI-25	25 watt, P.A. Amplifier	Net 65.95
TRI-35	35 watt, P.A. Amplifier	Net 82.95
TRI-50	50 watt, P.A. Amplifier	Net 109.95
TRI-100	100 watt, P.A. Amplifier	Net 129.95

OPTIONAL ADD-ON ACCESSORIES

ASC-10	Speaker Area Selector Control	Net 20.25
3600	Phono Turntable, 117 V AC	Net 27.00
S-2	Systems case with two 12" speakers, cables, plugs	Net 62.95
TLX-1	Low Impedance Microphone Adaptor.....	Net 10.50
TPP-1	Priority Paging Control	Net 6.75
TML-1	2 Channel Mic. Preamplifier, Low Imp.	Net 14.95
TMP-1	2 Channel Mic. Preamplifier, High Imp.	Net 14.95
TWM-1	500/600 ohm Balanced Line Adaptor	Net 7.50

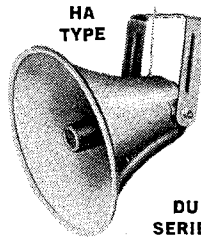

HA TYPE



DU SERIES

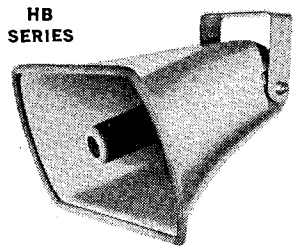

HB SERIES

FANON REFLEX TRUMPETS

HA-15	2½ ft. air column—15" bell	Net 16.60
HA-20	3½ ft. air column—20" bell	Net 19.95
HB-15	2½ ft. air column—15x 8" wide angle	Net 21.60
HB-20	3½ ft. air column—20x10" wide angle	Net 23.25

FANON HIGH POWER DRIVERS

DU-25	25 watt, deluxe weatherproof driver, 16 ohms.	Net 12.50
DU-35	35 watt, deluxe weatherproof driver, 16 ohms.	Net 16.60
DU-45	45 watt, deluxe weatherproof driver, 16 ohms.	Net 21.60
DU-60	60 watt, deluxe weatherproof driver, 16 ohms.	Net 26.60
DU-35T	35 watt with transformer, weatherproof 16 ohms.	Net 23.25
DU-60T	60 watt with transformer, weatherproof, 16 ohms	Net 32.25



Take it from Mickey Mantle†

"ON LAND... AT SEA... there's a new wonderful, exciting world of sound... at your command!"



POWERHOUSE MEGAPHONES

FEDTRO MEG-3600 DELUXE POWERHOUSE TRANSISTORIZED MEGAPHONE

• Waterproof • Impactproof • Rustproof

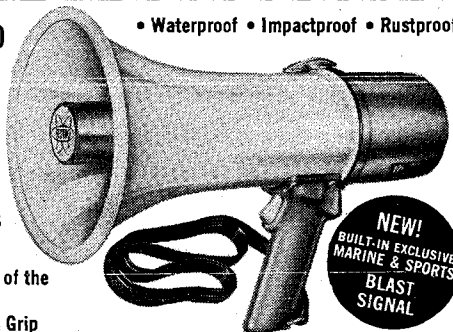

NEW!
BUILT-IN EXCLUSIVE MARINE & SPORTS BLAST SIGNAL

SPECIAL FEATURES

- Superior Power Range
- Tonal Quality and Clarity of the Highest Fidelity
- Perfectly Balanced Pistol Grip with Trigger Switch and Fingertip Volume Control
- All Aluminum Construction
- All Weather Durable Handy Carrying Strap
- Instant Battery Loading

- Special Blast Signal Stops and Starts the Action... Marine Signal... Boat Horn... Fog Horn... "Mayday" ... Designed to meet U.S. Coast Guard Distress Signalling Regulations

\$79.95*

magnificently finished in gleaming harmonious tones of brilliant red and lustrous ivory

*Suggested selling price. Slightly higher in Western states.

FEDTRO MEG-3300 DELUXE POWERHOUSE TRANSISTORIZED MEGAPHONE

• Waterproof • Impactproof • Rustproof

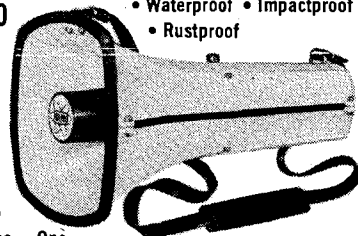

SPECIAL FEATURES

- Two Dynamic Microphones... One Built-In and Additional "Plug-In" Detachable Microphone
- Use 4 Ways:
• Over Shoulder • Trumpet Grip
• Thru Regular Mike
• Thru Detachable Mike
- Super Power Range
- Superior Clarity
- Perfect Tonal Quality

- Hi-Impact PVC Construction
- Fingertip Volume Control
- Adjustable Carrying Strap & Shoulder Cushion
- Instant Battery Loading

\$59.95*

*Suggested selling price. Slightly higher in Western states.

magnificently finished in gleaming harmonious tones of lustrous ivory and ebony black

FEDTRO MEG-1200 MICRO-MEG POWERHOUSE TRANSISTORIZED MEGAPHONE

• Waterproof • Impactproof • Rustproof

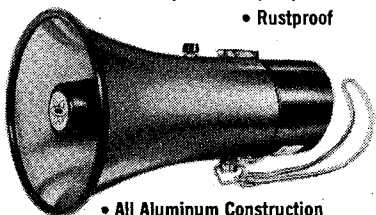

the ultimate in transistorized miniaturization

SPECIAL FEATURES

- Transistorized
- Miniaturized... only 8½ inches long
- Power Packed Amplification

- All Aluminum Construction
- Fingertip Volume Control
- Elegant Wrist-Strap Swivel Chain
- Noise-Cancelling Microphone

\$39.95*

*Suggested selling price. Slightly higher in Western states.

magnificently finished in gleaming harmonious tones of iridescent Imperial silver smartly trimmed with ebony black.

FEDTRO MEG-1000B POWERHOUSE TRANSISTORIZED MEGAPHONE

• Waterproof • Impactproof • Rustproof

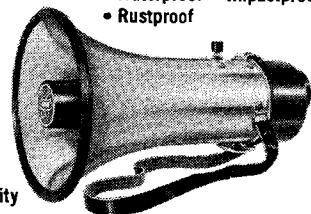

SPECIAL FEATURES

- All Aluminum Construction
- Superior Clarity and Tonal Quality
- Durable Handy Carrying Strap
- Instant Battery Loading
- Noise-Cancelling Microphone
- Fingertip Volume Control
- Power Packed Amplification

\$39.95

*Suggested selling price. Slightly higher in Western states.

magnificently finished in gleaming harmonious tones of brilliant red and elegant ebony black

POWERHOUSE
OFFICIAL MEGAPHONE
FOR THE
MEXICAN 1968
OLYMPIC GAMES



proven sound around the world®

© COPYRIGHT 1968 • FEDTRO INC. †MICKEY MANTLE ENDORSES ALL FEDTRO AUDIO PRODUCTS



take it
from **Mickey Mantle**†

**ENJOY NEW
WONDERFUL CONVENIENCE**

WIRELESS INTERCOMS! JUST PLUG IN... AND TALK!

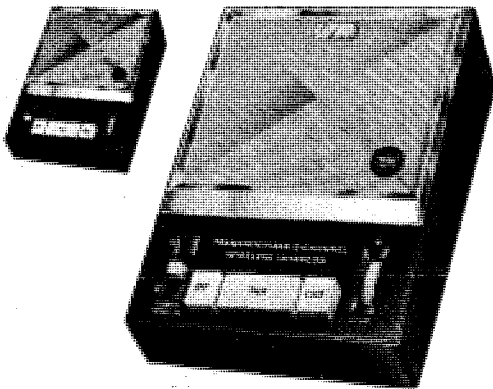

the **EXECUTIVE DELUXE**
the finest instrument of its kind in the world!

The most desirable, functional, elegant 2-channel, 2-station transistorized wireless intercom...magnificently packaged. Designed for the most discriminating taste. 2-channel selectivity permits private conversation between rooms of your choice. By merely the flick of a switch you can select and talk on either one of two "private lines". No wires to connect! No installation! Input: 100/120 Volt AC, 50/60 cycles, 4 watts. Carrier frequency: Channel "A"—200 KC $\pm 5\%$, Channel "B"—165 KC $\pm 5\%$.

MODEL INT-2C2W (Set of 2) \$59.95*

MODEL INT-SW2C (Extra Single Station) \$29.95*

*Suggested selling price.

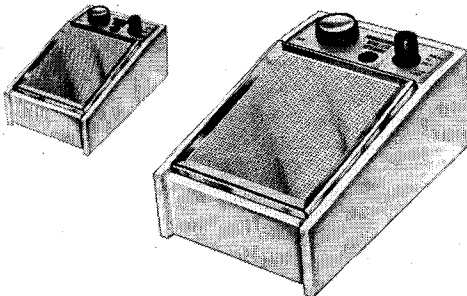

the **DIRECTOR**

Wonderful...effortless 2-way communication. A quality wireless intercom magnificently packaged. The set of 2 units are elegantly designed and superbly engineered for total efficiency. No wires to connect! No installation! Fully transistorized. As many stations as necessary can be added...three, four, five and up. Input: 100/120 Volt AC, 50/60 cycles, 3.5 watts. Carrier frequency: 200 KC $\pm 5\%$.

MODEL INT-2WR (Set of 2) \$39.95* *Suggested selling price.

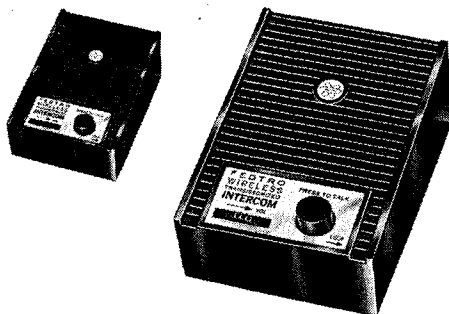

the **AMBASSADOR**
the lowest priced quality **WIRELESS!**

A fully transistorized wireless intercom, at a price that can't be beat. Nothing to connect! No wires, no installation. Just plug in...and talk. Wonderful 2-way communication between any 2 rooms, house to house, office to office...any two areas. Additional stations can be added as needed. Input: 100/120 Volts AC, 50/60 cycles, 3.5 watts. Carrier frequency: 200 KC $\pm 5\%$.

MODEL INT-2LPW (Set of 2) \$24.95*

*Suggested selling price.



proven sound around the world®

© COPYRIGHT 1968 • FEDTRO INC.

†MICKEY MANTLE ENDORSES ALL FEDTRO AUDIO PRODUCTS

PRICES

Prices in this MASTER should not be considered as final. INQUIRE ABOUT LATEST PRICES AND DELIVERY.

DISCOUNTS

Trade discounts apply in most cases where LIST PRICES are shown.

ORDERING

Since previous editions of the MASTER are frequently referred to, it is important, when ordering, to mention specifically the edition and page number, also the catalog number of each item. This will avoid possible confusion and delay.

INVENTORY

While most distributors maintain a large and varied stock, they do not represent that they stock all manufacturers' products shown in this MASTER catalog.

NEWCOMB

STEREO PHONOGRAPHS,
TRANSCRIPTION PLAYERS,
HEADPHONE LISTENING
CENTERS, TABLE RADIOS

R
SERIES

RS-1620V 4 speed, variable speed

RS-1620 4 speed, fixed speed

STEREOPHONIC

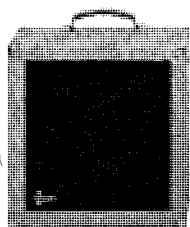

PORTABLE
COMBINATION
TRANSCRIPTION
PLAYER
P.A. SYSTEM

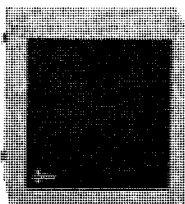

Newcomb RS-1620V stereophonic/monophonic portable combination transcription player/public address systems are simple to operate, durable, economical. Stereo or mono at the flip of a switch. Bi-Coupled output system delivers 10 watts peak per channel, 20 watts peak combined. Compatible cartridge is a turnover ceramic, plug-in type with jeweled styli. Rubber-matted turntable plays records to 17 1/4" masters. Tempo control +5% to -15%. Two mike inputs and left and right input jacks for radio or tape. On lighted, slanted panel are separate mixers for each mike and phono, voice filters, separate bass and treble tone controls ganged for both channels, but bass does not affect voice. Player unit measures 8" x 15 1/2" x 16 1/2". For use on 117 volts, 60 cycles a.c.

**20 WATTS
PEAK**

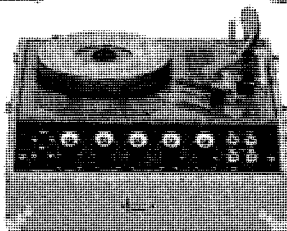

Shown with
Acra-Set tone
arm lifting
accessory
available
at additional
cost

	Variable Speed Model Number	Prof. Net	Fixed Speed Model Number	Prof. Net
With S-212 split case containing two 12" dual cone hi-fi drivers. Closed case: 16 3/4" x 16 1/4" x 13 1/8". 21 lbs.	RS-1620V-2	\$215.00	RS-1620-2	\$205.00
With S-212HF split case containing two 2-way systems — 12" woofers, 3 1/2" tweeters. Closed: 16 3/4" x 16 1/4" x 13 1/8", 23 lbs.	RS-1620V-HF2	\$239.00	RS-1620-HF2	\$229.00
With 2 C-100 2-way reproducers ea. in sep. encl. Each measures 10 1/4" x 14 3/4" x 20", 19 1/2 lbs.	RS-1624V-C2	\$309.50	RS-1620-C2	\$299.50

NEWCOMB HEADPHONES AND LISTENING CENTER ACCESSORIES

**MODEL
HDPB**
monophonic
headphones

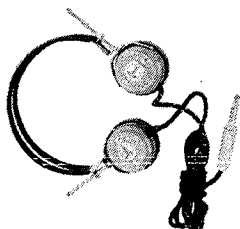

Good sound, rugged construction, low cost. HDPB phones are colored red and black, have 6' cords, standard phone plugs. Plated metal parts, plastic-covered spring headband. Vertical adjustment springs are tubular sleeves with large friction-contact area for maximum life. **NET \$4.60**

**MODEL
LCBBP**
listening
center

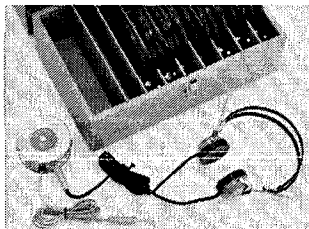

Kit includes an 8BP adapter, 8 sets of HDPB phones, compartmented carrying case. 14 1/4" x 8 1/2" x 7 3/4", 10 pounds. **NET \$67.30**

MODEL 8BP circular adapter

More convenient and space saving than panel-in-case type, the 8 BP free-standing adapter has 10' cord and phone jack for source connection, 8 jacks for HDPB phones, an additional jack for another adapter. **NET \$17.50**

**MODEL
HDPB**
stereophonic
headphones

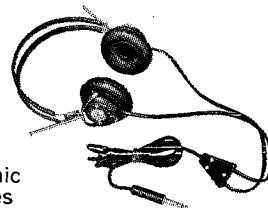

Economical, general purpose stereo phones with good response, colored red and black, have plastic-covered cables, plated hardware, standard stereo phone plugs, soft neoprene ear cushions that are comfortable on ears, form sound-tight seal. **NET \$7.75**

**MODEL
R-HDBBC**
listening
center

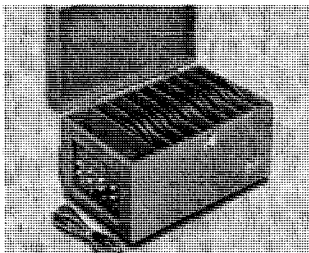

Eight sets of HDPB headphones in vinyl-covered compartmented case with 8 standard headphone jacks and 8 level controls in end panel; 10' source cord and output jack for additional adapter. 14 1/4" x 8 1/2" x 7 3/4", 11 pounds. **NET \$69.95**

**MODEL
R-HDBB**
listening
center

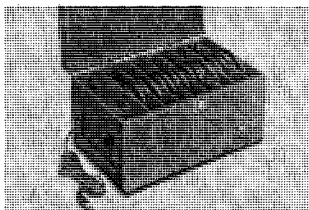

Kit with 8 HDPB phones, compartmented case with terminal panel at end containing 8 standard phone jacks, has 10' source connection cord, jack for additional kit, measures 14 1/4" x 8 1/2" x 7 3/4", 11 pounds. **NET \$59.55**

**MODEL
RHS-4C**
stereophonic
listening
center

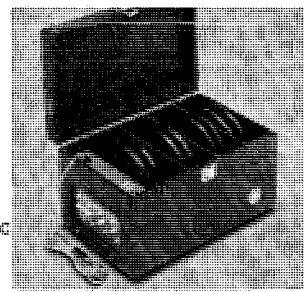

This deluxe kit contains 4 sets of HDPB phones in compartmented case that has connector panel at one end. There are 4 standard stereo phone jacks on panel and 8 level controls providing volume adjustment for each ear. 10' source cord and plug. Output jack for additional kit. 14 1/4" x 8 1/2" x 7 3/4", 10 pounds. **NET \$69.95**

TABLE MODEL RADIOS

AFM-1500
AM & FM



Highly sensitive, rendered very stable by a.f.c. and temperature-compensated oscillators, the AFM-1500 provides high fidelity sound through its 15 watts peak push-pull amplifier and 20 watt, 9" oval, dual-cone loudspeaker. It has a telescoping FM antenna, "Hi-Q" ferrite rod AM antenna, tuning eye, reference scale, large tuning knob, compensated volume control, external antenna terminals, jack for external speaker or headphones, jack for external amplifier, p.a. or tape recorder. 16 3/4" x 9 3/4" x 8 5/8", 20 1/4 lbs. 70 watts, 117 volts, 60 cycles a.c. **PROF. NET: \$164.50**

AM-500
AM

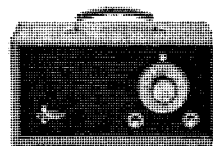

Trim, rugged, easy to carry, the AM-500 is an economical, continuous-duty transformer-powered radio with a 5 watts peak, inverse-feedback amplifier and 8" oval, dual-cone loudspeaker whose special tweeter cone gives improved distribution and high frequency response. It has a built-in "Hi-Q" antenna and terminals for external antenna. Pilot light index illuminates direct-driven dial. Same jacks as AFM-1500. Neat power cord storage on back of both 6 1/2" x 8" x 15 1/2", 10 lbs. 40 watts, 117 volts, 60 cycles a.c. **PROF. NET: \$59.95**

NEWCOMB

TR-1640 SERIES 40 WATT CERAMIC PICKUP STEREO JACK

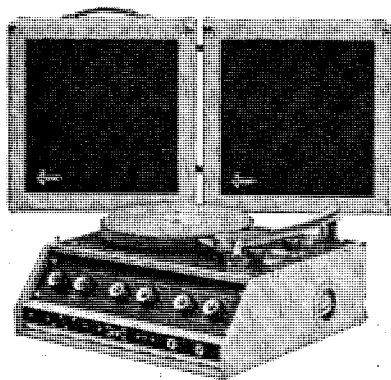

TR-1640 models provide impressive audience coverage at moderate cost. Motor is a heavy-duty, four-pole unit. Player is equipped with a plug-in, "power point" type, high fidelity ceramic cartridge with separate jeweled standard and microgroove styli, ultra-linear amplifier. It has a treble tone control for all channels, bass tone for phono, phono volume mixer, mike volume mixer, bass tone for mike, impedance switch for speakers, scratch filter switch. There are output jacks for 2 speakers, "Phono," "All," stereo. Inputs for one mike auxiliary.

	PROF. NET
MODEL TR-1640 in a single split case with one 12" 50-watt speaker, 36 lbs.	169.95
MODEL TR-1640-E2, two cases, includes one S-212, 51 lbs.	196.50
MODEL TR-1640-E4, three cases, one S-212, one S-212E, 72 lbs.	261.00
MODEL TR-1640-2, two cases, one S-212H, 51½ lbs.	209.50
MODEL TR-1640-4, three cases, one S-212H, one S-212E, 72½ lbs.	273.05
MODEL TR-1640-NE2, three cases two N12ET, 64 lbs.	261.00
MODEL TR-1640-NE4, five cases, four N12ET, 98 lbs.	390.00
MODEL TR-1640-NH2, three cases, two N12HT, 78 lbs.	331.00
MODEL TR-1640-NH4, five cases, four N12HT, 126 lbs.	530.00
MODEL TR-1640-CS2, three cases, two CS48, 74 lbs.	271.00
MODEL TR-1640-CS4, five cases, four CS48, 118 lbs.	410.00
MODEL TR-1640-SCS2, three cases, two SCS-412, 125 lbs.	411.00
MODEL TR-1640-SCS4, five cases, four SCS-412, 220 lbs.	690.00

Stereo compatible pickup safely plays stereo records monophonically.

TR-1640M SERIES 40 WATT MAGNETIC PICKUP

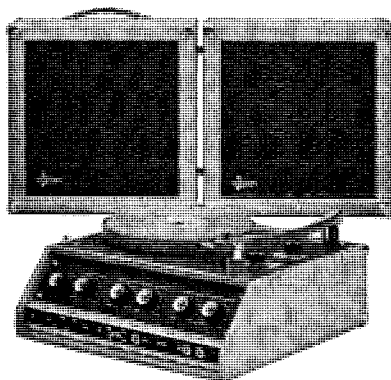

A more powerful music room model which handles with ease four speakers, the TR-1640M player unit has an ultra-linear output system, two-way crossover-network loud-speaker systems, and the GE variable reluctance cartridge. The phono circuit is converted to a second mike channel by flipping a selector switch. It has a treble tone control for all channels, phono volume mixer, phono bass tone control, mike bass tone, mike volume mixer, impedance switch for speakers, scratch filter. There are output jacks for 2 speakers, "Phono," and "All"; input jacks for 2 mikes and auxiliary.

	PROF. NET
MODEL TR-1640M-HF in a single split case with 2-way speaker system including a 12" 50-watt woofer, crossover and separate 3½" tweeter, 36½ lbs.	205.00
MODEL TR-1640M-E2, two cases, includes one S-212, 52 lbs.	220.00
MODEL TR-1640M-E4, three cases, one S-212, one S-212E, 73 lbs.	284.50
MODEL TR-1640M-HF2, two cases, one S-212HF, 54 lbs.	244.00
MODEL TR-1640M-HF4, three cases, one S-212HF, one S-212E, 75½ lbs.	309.50
MODEL TR-1640M-KN, two cases, one KN-200, 66 lbs.	288.25
MODEL TR-1640M-KN2, three cases, two KN-200, 101 lbs.	421.00
MODEL TR-1640M-NE2, three cases, two N12ET, 65 lbs.	284.50
MODEL TR-1640M-NE4, five cases, four N12ET, 99 lbs.	413.50
MODEL TR-1640M-NH2, three cases, two N12HT, 79 lbs.	354.50
MODEL TR-1640M-NH4, five cases, four N12HT, 127 lbs.	553.50
MODEL TR-1640M-NN2, three cases, two N12NT, 86 lbs.	394.50
MODEL TR-1640M-NN4, five cases, four N12NT, 141 lbs.	633.50
MODEL TR-1640M-CS2, three cases, two CS48, 75 lbs.	294.50
MODEL TR-1640M-CS4, five cases, four CS48, 119 lbs.	433.50
MODEL TR-1640M-SCS2, three cases, two SCS-412, 126 lbs.	434.50
MODEL TR-1640M-SCS4, five cases, four SCS-412, 221 lbs.	713.50

TR-1656M SERIES 56 WATT MAGNETIC PICKUP

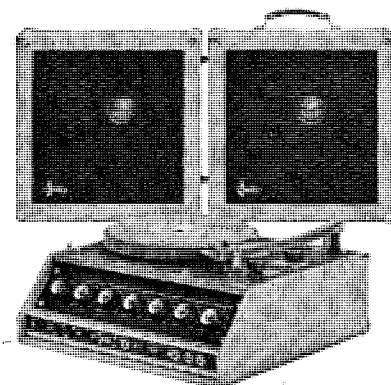

These fully integrated systems achieve phenomenal acoustic output. They include 56 watts peak output system, four-pole deluxe motor, GE variable reluctance cartridge. The phono channel converts to a third microphone channel by flipping a switch. First mike channel has separate bass attenuating control for voice clarity. Second mike is flat. Phono tone controls regulate third mike. There are a separate treble tone control for all channels, bass tone for phono, phono volume mixer, mike 2 mixer, mike 1 mixer, mike 1 bass tone, speaker impedance switch, scratch filter. Output jacks for 2 speakers, "Phono," and "All"; input jacks for 3 mikes and auxiliary.

	PROF. NET
MODEL TR-1656M-HF2, two cases, includes one S-212HF, 57 lbs.	288.50
MODEL TR-1656M-HF4, three cases, one S-212HF, one S-212HFE, 80 lbs.	377.00
MODEL TR-1656M-X2, two cases, one S-212X, 59 lbs.	311.00
MODEL TR-1656M-X4, three cases, one S-212X, one S-212XE, 84 lbs.	421.50
MODEL TR-1656M-NF2, two cases, one S-212NF, 63 lbs.	329.85
MODEL TR-1656M-NF4, three cases, one S-212NF, one S-212NFE, 92 lbs.	459.35
MODEL TR-1656M-KN2, three cases, two KN-200, 104 lbs.	465.85
MODEL TR-1656M-KN4, five cases, four KN200, 176 lbs.	731.35
MODEL TR-1656M-NE2, three cases, two N12ET, 68 lbs.	329.00
MODEL TR-1656M-NE4, five cases, four N12ET, 102 lbs.	458.00
MODEL TR-1656M-NH2, three cases, two N12HT, 82 lbs.	399.00
MODEL TR-1656M-NH4, five cases, four N12HT, 130 lbs.	598.00
MODEL TR-1656M-NN2, three cases, two N12NT, 89 lbs.	439.00
MODEL TR-1656M-NN4, five cases, four N12NT, 144 lbs.	678.00
MODEL TR-1656M-CS2, three cases, two CS48, 78 lbs.	339.00
MODEL TR-1656M-CS4, five cases, four CS48, 122 lbs.	478.00
MODEL TR-1656M-SCS2, three cases, two SCS-412, 129 lbs.	479.00
MODEL TR-1656M-SCS4, five cases, four SCS-412, 224 lbs.	758.00

DIMENSIONS OF NEWCOMB TR PLAYERS

Single speaker TR players form a single case with the speaker mounting used as the lid. They measure 16¾" x 16¼" x 13¼". In multiple-speaker models (except TRS-1680) the phono-

amplifier unit closed measures 16¾" x 16¼" x 8½". Speaker dimensions are given on facing page. Accessory speakers may be added to one- or two-speaker models at any time.

SPECIFICATIONS AND PRICES ARE SUBJECT TO CHANGE WITHOUT NOTICE.

NEWCOMB AUDIO PRODUCTS CO.

NEWCOMB

NEWCOMB

STEREOPHONIC SYSTEMS
MICROPHONES, ACCESSORIES

TR
SERIES



STEREOPHONIC
MONOPHONIC

TRS-1680 SERIES 80 WATT

It has three mike channels. The central mike puts the speaker or square dance caller in the middle, midway between the reproducers. There are separate treble, bass, and volume controls for phono or other reproduced sound. Each mike channel has its own, individual tone and volume controls. Mike tone controls are rotated for treble adjustment, pushed or pulled for bass. There is a blend control to provide any degree of stereo you wish. There are "Left" and "Right" inputs for radio, tape, or auxiliary; a scratch filter; "All" or "Phono" monitor jacks; jacks for two or four speakers with an impedance-matching switch. Turntable-amplifier unit DIMENSIONS: 9 1/4" x 17 3/8" x 18 5/8"; 43 lbs. POWER CONSUMPTION: 180 watts, 117 volts, 60 cycles a.c. A wide choice of reproducers to meet specific assignments is offered...

PROF.
NET

MODEL TRS-1680-NF2, two cases, includes one S-212NF, 72 lbs.	\$429.00
MODEL TRS-1680-NF4, three cases, two S212NF, 101 lbs.	\$558.50
MODEL TRS-1680-KN2, three cases, two KN-200, 113 lbs.	\$565.00
MODEL TRS-1680-KN4, five cases, four KN-200, 183 lbs.	\$830.50
MODEL TRS-1680-NH2, three cases, two N12HT, 91 lbs.	\$498.50
MODEL TRS-1680-NH4, five cases, four N12HT, 139 lbs.	\$697.50
MODEL TRS-1680-NN2, three cases, two N12NT, 98 lbs.	\$538.50
MODEL TRS-1680-NN4, five cases, four N12NT, 153 lbs.	\$777.50
MODEL TRS-1680-CS2, three cases, two CS48, 87 lbs.	\$438.50
MODEL TRS-1680-CS4, five cases, four CS48, 131 lbs.	\$577.50
MODEL TRS-1680-SCS2, three cases, two SCS-412, 138 lbs.	\$578.50
MODEL TRS-1680-SCS4, five cases, four SCS-412, 233 lbs.	\$857.50

Built with a great reserve of power for most uses — 40 watts peak per channel — the Newcomb TRS-1680 is perhaps the most complete and flexible portable sound system ever built. It reproduces stereo or mono with the turn of a knob. Stereo or mono tape or radio can be fed to the system. Live music and speech are reproduced either stereo- or monophonically.

ACRA-SET TONE ARM LIFTER AND

RECORD-
CUEING
DEVICE

MODEL A-1

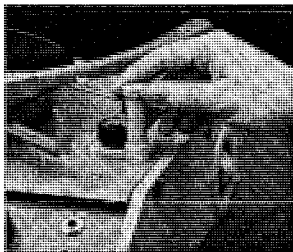

Acra-Set is an accessory available at additional cost for repeating passages and protecting records. You simply twist the knob on top to gently lift or lower tone arm. Lifter has a 100-division scale and a traveling stop with a pointer. It is simply installed by drilling a 3/16" hole which is readily located with a template. Holes are pre-drilled at the factory on current transcription players. Specify your model number when ordering; correct template and C-1 cue sheets will be supplied. PROF. NET: \$12.50

MODEL VU-1 PORTABLE VISUAL OUTPUT METER

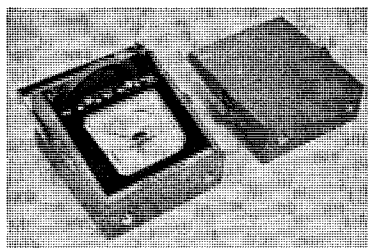

Model VU-1 Output Meter permits you to see that your voice is being amplified to the proper level, helps you make the most of your fine Newcomb TR system. Meter is high quality instrument with jeweled d'Arsonval movement and a scale calibrated in both db and volume units from 0 to 100 over the working range of the system. Also indicates overloading. Simple internal adjustment matches meter to any TR player; instructions are permanently mounted in lid. One end of the supplied patch cord connects player to "All" monitor jack, other end to "Input" on meter. Supplementary "All" monitor jack on meter. PROF. NET: \$29.95

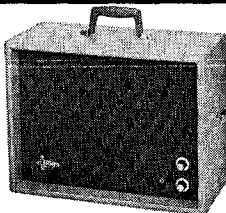

AMPLIFIED MUSIC MONITORS

With a Newcomb Amplified Monitor you can hear reproduced music without interference or feedback squeal from caller's or speaker's voice. Connected to

"Phono" channel of transcription player, monitor reproduces music only, not mike channels. Or, it may be connected to "All" jack to reproduce voice and music. It can also be used as a stereo channel with a TR-1625 or TR-1640.

MODEL M-12: 12" speaker; 10 watt amplifier; 17 3/8" x 13 3/8" x 7 1/2"; 17 1/4 lbs. PROF. NET: \$79.50

MODEL M-9: 9" oval, dual-cone speaker; 10 watt amplifier; 13 1/4" x 10 1/8" x 7"; 10 lbs. PROF. NET: \$69.50

PROTECTIVE CANVAS COVERS

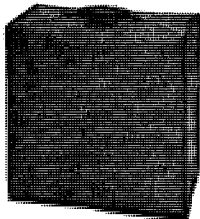

Made of tightly woven, fleece-lined, rubberized mackintosh covert, with stout zipper closure and flap that tucks under handle. Transparent slot for identification.

No. CA-102 for use with TR-1625, TR-1625M, TR-1640, TR-1640M amplifier sections only. PROF. NET: \$5.95

No. CA-103 for use with S-212 type split case speaker assemblies and all TR series systems with single speaker in case lid. PROF. NET: \$5.95

No. CA-104 for use with TRS-1680 amplifier section only. PROF. NET: \$5.95

No. CA-110 for use with KN-200 or K-400 reproducers. PROF. NET: \$6.63

No. CA-111 for use with C-100 or J-200 reproducers. PROF. NET: \$5.95

No. CA-119 for use with M-12 monitor. PROF. NET: \$5.95

No. CA-132 for use with M-9 monitor. PROF. NET: \$5.95

No. CA-136 for use with all N-12 series reproducers. PROF. NET: \$5.95

No. CA-137 for use with CS48 column speaker. PROF. NET: \$9.30

No. SCS-412 for use with SCS-412 column speaker. PROF. NET: \$12.63

MICROPHONES

Model N-30 Crystal Microphone with lavaliere cord, stand adapter, switch, and shielded plug.

PRO. NET 13.95

Model N-30D Desk Mounting for N-30 only.

PRO. NET 1.85

Model N-36

Dynamic

Professional

Quality

Microphone is the

perfectionist's

choice with any

TR system,

especially

intended for use

with TR-1640M,

TR-1656M and

TRS-1680 series

models. Supplied

with shielded

cord and plug and

on-off switch.

PRO. NET 50.00

Model N-23

Dynamic

Microphone of

very high quality

with switch and

shielded plug,

recommended for

general purpose

use with all

TR series systems.

PRO. NET 39.50

Model MS-23

Accessory Bag

of heavy plastic,

zippered, for

microphones, etc.,

can be attached

inside lid of

speaker case.

PRO. NET 2.10

Model PP-61

Stereo Conversion

Pickup Cartridge,

plug-in type

for any TR series

player equipped

with stereo output

jack and plug-in

ceramic cartridge.

PRO. NET 4.65

Model WC-64

Connecting Cable,

four feet long

with plugs for

connecting two

TR ceramic

models together

for stereo.

PRO. NET 4.65

SPECIFICATIONS AND PRICES ARE SUBJECT TO CHANGE WITHOUT NOTICE.

NEWCOMB AUDIO PRODUCTS CO.

NEWCOMB

NEWCOMB

MODULAR
PUBLIC ADDRESS
AMPLIFIERS

CUSTOM
SERIES K

70 COMBINATIONS FROM 14 UNITS

The modular concept makes it possible for you to get exactly the features you need without delay. Four chassis and four power units combine to form 15 basic assemblies. The VU meter may be added to 12 assemblies. 8 models (K4R assemblies with and without VU meter) become remote-control units with the addition of the RB4 accessory. All 35 may be rack panel mounted or covered for free-standing use. (UL requires that they be purchased with one or the other.)

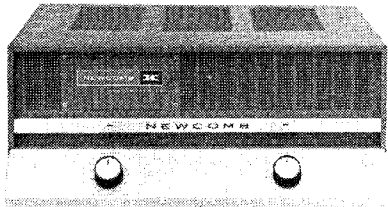

MODEL KB BOOSTER CHASSIS
WITH MODEL KCB COVER

SPECIFICATIONS — K3, K4R, K5 MIXER-PREAMPLIFIERS

All of the Newcomb Custom K mixer-preamplifier modules have space at the back of the chassis into which may be inserted either a Model 400, 600 or 1250 power amplifiers or the Model P power supply. Power is normally supplied to the front end by the power amplifier module; Model P is used when the preamp section is to be used as a separate mixer-control unit. Mixer models differ principally in the number of input channels. Each has one mike channel that is convertible by switch to use with a magnetic or ceramic phono pickup (preamp provides full RIAA response curve) or with a flat tuner or tape input. **Outputs:** 2 from each of two cathode followers, one before and one after the master control. Maximum output from followers: 10 volts into high impedance load. **Distortion:** less than 1/2%. D.C. on all filaments. **Frequency response:** ± 1 db 20-20,000 cycles. **Bass tone control range:** -18 db to +18 db. **Low frequency roll off:** 3 db at 100 cycles, -12 db at 20 cycles. **Treble tone control range:** -18 db to +18 db. **High frequency roll off:** 3 db at 5,000 cycles, -12 db at 20,000 cycles. **Microphone impedance:** 2 megohms convertible to low impedance by Newcomb-hum-free plug-in transformer. **Input volts required for 1 volt output from cathode followers:** Mikes, .0028 volts, gain 54° db, 2 megohms. **Magnetic,** .0022 volts, 100,000 ohms. Equalized to full RIAA curve. **Ceramic pickup,** .086 volts. Equalized to RIAA curve. **Tuner or Tape input (Aux.),** .34 volts, 1/2 meg., gain 6.4° db. *Gain stated is with 1 meg. output load. With 600 ohm output using TR-100 add 13 db. **Hum** below 10 volts output (inputs shorted): Mikes, -80 db. **Magnetic pickup,** -70 db. **Aux. input,** -80 db. **All controls off,** -100 db. Socket supplies power for VU-2T volume indicating meter. Note: K4R provides for remote control of all inputs. **Dimensions,** all models: 17" x 13 3/8" x 7 3/8" (height dimension includes KC cover). **Weight,** all models: 7 pounds. All microphone inputs require Cannon XL3-11C type connectors.

	Model K3	Model K4R	Model K5
Number of Channels and mixing controls	3	4	5
Number of Channels with voice filters	2	3	4
Tubes	two 6AB4 three 12AX7	three 6AB4 three 12AX7	four 6AB4 three 12AX7
LIST: (with tubes, without cover)	\$199.50	\$225.00	\$239.50



FOR SEPARATE MIXER-PREAMPLIFIER ONLY...

MODEL P POWER SUPPLY takes the place of the power amplifier in the space provided in the K3, K4R, and K5 preamp modules, and supplies power to them through an octal socket. (It is never included or unbalanced 600 ohm line. **Maximum 600 ohm output = 0 VU. Input power:** 117 volts, 60 cycles, 22 watts. **Wt.** 4 1/2 lbs. **List:** (with tubes) \$37.50.

AS SIMPLE TO SPECIFY AS THEY ARE TO ASSEMBLE

Model number of a basic assembly consists of a combination of preamp model number and power amplifier model number as follows:

Preamp Mixer ↓ / Power Amp →	Model 1250 125 watts	Model 600 60 watts	Model 400 40 watts	Model P Power Supply
Model K5 5 Channel	K5-1250 \$439.00	K5-600 \$399.00	K5-400 \$369.00	K5-P \$277.00
Model K4R 4 Channel	K4R-1250 \$424.50	K4R-600 \$384.50	K4R-400 \$354.50	K4R-P \$262.50
Model K3 3 Channel	K3-1250 \$399.00	K3-600 \$359.00	K3-400 \$329.00	K3-P \$237.00
Model KB Booster Chassis	KB-1250 \$237.00	KB-600 \$197.00	KB-400 \$167.00	Complete Mixer-Preamp Only

Specifications For Complete Mixer-Preamplifier Power Amplifier Assemblies	Mike Gain	133 db	130 db	128 db
Auxiliary Gain	85.4 db	82.4 db	80.4 db	
Hum, input shorted: Mike, -60 db below full output Magnetic pickup, -50 db below full output Auxiliary input, -60 db below full output All controls off, -80 db below full output				

List prices of combinations are shown without cover, rack mounting or VU meter.

SPECIFICATIONS — 400, 600, 1250 POWER AMPLIFIER MODULES

The power amplifier modules in Newcomb's Custom K Series are not usable alone; they must be installed in a K3, K4R, or K5 mixer-preamplifier chassis. If they are to be used simply as a booster amplifier, they can be mounted in a Model KB Booster Chassis. Circuits in all power amplifier modules are resistance-capacity coupled, screen-regulated, with fixed bias and inverse feedback. They include power supply for K3, K4R, and K5 preamps. All have an a.c. outlet and an external fuse post. All three models have some identical specifications: **Input impedance:** 1 megohm convertible to low impedance with hum-free plug-in line or bridging transformers. **Output impedances:** 4, 8, and 16 ohms to a terminal strip and two octal sockets; 25 and 70 volts balanced or unbalanced line to one octal socket. **Hum and noise:** 80 db below steady state power rating.

	Model 400	Model 600	Model 1250
POWER OUTPUT: steady state RMS at less than 5% T.H.D.	40 watts	60 watts	125 watts
POWER OUTPUT: at less than 1% T.H.D.	35 watts	50 watts	110 watts
PEAK POWER: (Note: Music power peak rating is higher)	80 watts	120 watts	250 watts
INPUT—1.2 V or 3 V required for maximum rated steady state power output			
GAIN: at 1 meg. 1.2 V input tap 3 V input tap	74 db 70 db	76 db 72 db	79 db 75 db
GAIN: at 600 ohms input using TR-100 and 1.2 V input tap 3 V input tap	61 db 57 db	63 db 59 db	66 db 62 db
FREQUENCY RESPONSE: ± 2 db 25-15,000 cps at all ± 0 db 20-20,000 cps at	35 watts 1 watt	50 watts 1 watt	110 watts 1 watt
POWER CONSUMPTION: 117 volts, 60 cycles a.c.	110 watts	145 watts	185 watts
TUBES: All models include 5 silicon rectifiers	one 7199 two 6B87 one 6CU5	one 7199 two 6L6GC one 6CU5	two 12AU7 two 6550 one 6CU5
WEIGHT:	16 1/2 lbs.	21 1/4 lbs.	30 1/2 lbs.
LIST: (with tubes)	\$129.50	\$159.50	\$199.50

FOR COMPLETE POWER AMPLIFIER ONLY

MODEL KB CHASSIS is the same size as the K3, K4R, and K5 preamp modules and accommodates Model 400, 600, or 1250 power amplifier modules when they are to be used as boosters. Model KB includes volume control, low frequency roll-off switch, power switch, and pilot lights. It has a lighted, slanted operating panel and factory-wired socket for Newcomb plug-in, hum-free transformers. **Dim.:** 17" x 13 3/8" x 7 3/8". **Wt.:** 5 lbs. (without cover). **List:** \$37.50.

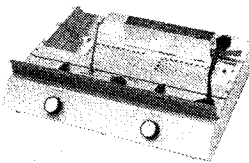

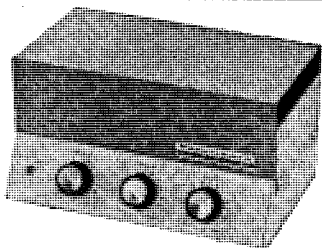
NEWCOMB**PATHFINDER**
PUBLIC ADDRESS EQUIPMENT**MODEL E-10B**

10 watt
amplifier
Low priced, deluxe,
full push-pull output

The Newcomb E-10B offers a surprising number of deluxe features for so compact and economical an amplifier. It has the slanted operating panel and control markers which distinguish all Pathfinder models. The E-10B has separate mixers for microphone and ceramic phono pickup (or radio or tape). Mike input is a standard 3-contact phone jack suitable for high or low impedance mike. The E-10B is wired for plug-in transformers for instant conversion for use with low impedance mike. Output impedances to socket are 4, 8, 16 ohms, plus 25 and 70 volt line taps. Output jack for recorder or booster amplifier. Unit has a wide-range treble tone control, 25,000 hour pilot light. UL approved.

SPECIFICATIONS: Power Output: 10 watts RMS, 20 watts peak at less than 5% distortion. Frequency Response: ± 2 db 30 through 15,000 cycles. Mike Gain: 118 db at 2 meg. .0055 volts delivers full power. Phono Gain: 79 db at 1 meg.; 33 volts delivers full power. Output To Tape Jack: Delivers 4.4 volts max. or 1 volt at $\frac{1}{2}$ watt output. Hum: Fundamental, 70 db below rated output. Power Response: ± 3 db, 70 through 13,000 cycles at 5% distortion. Size: $10\frac{1}{4}'' \times 6\frac{1}{2}'' \times 5\frac{3}{4}''$ high. Weight: 9 lbs. Power Consumption: 60 watts, 117 volts, 60 cycles. Tubes: 1-12AX7, 1-6AU6, 2-6V6, 1-6X4. LIST: (with tubes) \$75.00.

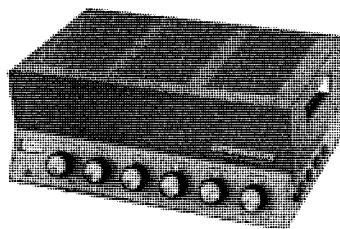
**MODEL E-5P**

5-channel
mixer
preamplifier

The Newcomb E-5P is a high performance, low-priced, multi-purpose mixer-preamplifier with 4 microphone channels (one convertible to magnetic phono), one high level channel with two inputs (chosen by selector switch) — one for ceramic phono pickup, the other for tape or radio. Master gain control. Each mike input jack is standard 3-contact phone jack. Each mike channel is wired for plug-in transformers for instant conversion to low impedance microphone usage. The E-5P has a VU meter with concealed sensitivity adjustment, outputs for tape, booster, and a.c., 25,000-hour pilot lamp. Operating panel is slanted for easy viewing and operating sitting or standing. Performance is excellent with individual mike input tubes for minimum crosstalk and d.c. on all filaments. UL approved.

SPECIFICATIONS: Cathode Follower Outputs: 6 volts at less than 2% into high impedance load. Volume Indicating Meter: Adjustable from 2 to 6 volts. Frequency Response: ± 2 db 30 through 20,000 cycles. Mike Inputs: 2 meg.; .0025 volts for 2 volts out. Ceramic Phono or Radio or Tape Input: 1 meg. .32 volts for 2 volts output. Magnetic Phono Input: .011 volts for 2 volts output. Hum: Fundamental, 80 db below 6 volts output. Size: $14\frac{1}{2}'' \times 8\frac{3}{8}'' \times 5''$ high. Weight: 11 $\frac{1}{2}$ lbs. Power Consumption: 31 watts 117 volts 60 cycles A.C. Tubes: 4-12AV6, 1-12AU6, 5-0C5, 1 power silicon rectifier. LIST: (with tubes) \$139.50.

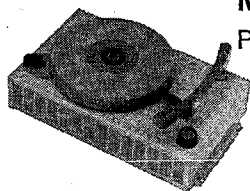
HIGH QUALITY, LOW PRICE PUBLIC ADDRESS AMPLIFIERS WITH MANY DELUXE FEATURES**MODEL P-4**
PHONO TOP

The Newcomb P-4 is a 4-speed record player that is designed to fit on top of the E-20, E-40 or E-75 Pathfinder amplifier.

It includes an automatic idler release on the power switch to prevent flat spots, a plug-in turnover-type dual-sapphire-styli ceramic cartridge, pickup hold-down screw and drop pad. Dimensions: $8\frac{5}{8}'' \times 14'' \times 5''$ high over all. Weight: 6 lbs. LIST: \$39.95.



All Newcomb Pathfinder power amplifiers and the E-5P preamplifier have slanted operating panels for convenient control in either a sitting or standing position. This feature is important, too, with rack mounted installations where units may be mounted near the floor as well as at eye level. All control knobs have white, rotatable reference markers for quick return to a pre-determined setting. All have a 25,000 hour pilot light. All are UL approved. Newcomb

public address amplifiers Models E-20, E-40, and E-75 all have the following features: Each has two microphone channels with mixer controls and one high level channel with mixer for ceramic phono pickup, radio or tape. Mike channels are wired for Newcomb plug-in transformers for instant conversion to use with low impedance microphones. High level control is compensated; as volume is reduced, bass is proportionately sustained. Mike not affected by this control. There are separate bass and treble master tone controls. Output taps on terminal strip and two sockets are for 25 volt balanced or unbalanced line plus 70 ohms unbalanced, and 16, 8, and 4 ohms. There is an output jack for recorder or booster and an a.c. output receptacle. Pathfinder equipment has a distinctive two-tone finish in soft tints of olive-gray and spruce.

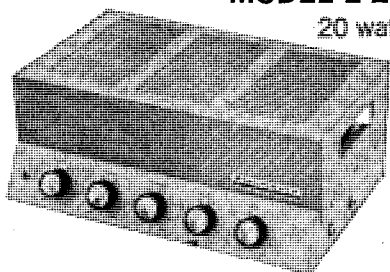
**MODEL E-20**
20 watt

SPECIFICATIONS: Power Output: 20 watts RMS, 40 watts peak at less than 5% distortion. Frequency Response: ± 2 db 30 through 15,000 cycles. Mike Gain: 122 db at 2 meg.; .005 volts delivers full power. Phono Gain: 83 db at 1 meg. .315 volts delivers full power. Output To Tape Jack: Delivers 6 volts max. or 1 volt at $\frac{1}{2}$ watt output. Hum: Fundamental, 70 db below rated output. Power Response: ± 3 db 50 through 20,000 cycles at 5% distortion. Size: $14\frac{1}{2}'' \times 9\frac{1}{2}'' \times 6\frac{3}{4}''$ high. Weight: 14 $\frac{1}{4}$ lbs. Power Consumption: 80 watts, 117 volts, 60 cycles A.C. Tubes: 1-12AX7, 1-6BR8, 2-EL-84, 1-5Y3. LIST: (with tubes) \$99.50.

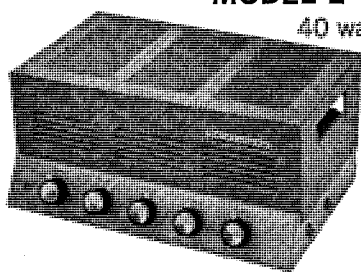
**MODEL E-40**
40 watt

SPECIFICATIONS: Power Output: 40 watts RMS, 80 watts peak at less than 5% distortion. Frequency Response: ± 2 db 30 through 15,000 cycles. Mike Gain: 125 db at 2 meg.; .005 volts delivers full power. Output To Tape Jack: Delivers 6 volts max. or 1 volt at 1 watt output. Hum: Fundamental, 70 db below rated output. Power Response: ± 2 db 40 through 20,000 cycles at 5% distortion. Size: $14\frac{1}{2}'' \times 9\frac{1}{2}'' \times 6\frac{3}{4}''$ high. Weight: 19 $\frac{1}{4}$ lbs. Power Consumption: 160 watts, 117 volts, 60 cycles A.C. Tubes: 1-12AX7, 1-6BR8, 4-EL84, 1-5U4. LIST: (with tubes) \$129.50

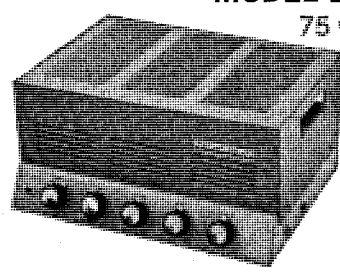
**MODEL E-75**
75 watt

SPECIFICATIONS: Power Output: 75 watts RMS, 150 watts peak at less than 5% distortion from a fixed bias, screen regulated, output system. Frequency Response: ± 2 db 30 through 15,000 cycles. Mike Gain: 128 db at 2 meg.; .005 volts delivers full power. Phono Gain: 88 db at 1 meg.; 3 volts delivers full power. Output To Tape Jack: Delivers 6 volts max. or 1 volt at 1.87 watts output. Hum: Fundamental, 70 db below rated output. Power Response: ± 2 db 50 through 20,000 cycles at 5% distortion. Size: $7'' \times 13\frac{1}{2}'' \times 14\frac{1}{2}''$. Weight: 26 lbs. Power Consumption: 185 watts, 117 volts 60 cycles. Tubes: 2-12AX7, 1-6C4, 2-7027A, 1-6V6GT, 3 power silicon rectifiers. LIST: (with tubes) \$189.50.

SPECIFICATIONS AND PRICES ARE SUBJECT TO CHANGE WITHOUT NOTICE.

NEWCOMB AUDIO PRODUCTS CO.**NEWCOMB**

NEWCOMB**PATHFINDER**
PUBLIC ADDRESS EQUIPMENT**MODEL E2-525G INDUSTRIAL PREAMPLIFIER**

Designed for industrial sound systems, the Newcomb E2-525G has 125 to 600 ohm balanced line output. Maximum output at 600 ohms = 10 volts line output. Inputs: one mike at 2 meg impedance, convertible to low impedance by means of Newcomb plug-in transformer (socket provided) · one high level crystal phono; one radio or tape. At 600 ohm line output: mike output of .0015 volts delivers 1 volt; phono input of .15 volts delivers 1 volt out. Frequency response: ± 2 db 30 to 15,000 cycles. Electronic remote switching turns mike on and music off when paging. Remote switching line may be unshielded 3-conductor cable up to several thousand feet long. No relays required. There are separate tone controls for mike and phono. Mike input socket is a standard 3-contact phone jack usable with low or high impedance microphones. Tubes: 1-6SF5, 1-6SN7, 1-6J5, 1-6X5, 25 watts, 117 volts, 60 cycles a.c. Dimensions: 19" x 5 1/4" x 6 1/2" deep. Weight: 9 lbs. **LIST: \$129.50.**

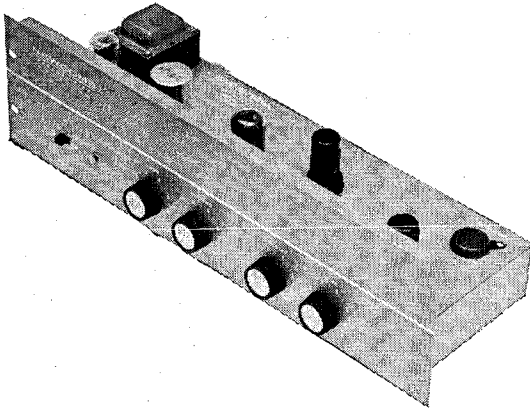
**PANELS FOR CABINET RACK****BLANK
PANELS**

Model Number	Dimensions	Weight lbs.	List
175G	1 3/4" x 19"	1 3/4	\$3.00
350G	3 1/2" x 19"	1 3/4	\$3.50
525G	5 1/4" x 19"	2 1/2	\$4.00
700G	7" x 19"	3	\$4.50
875G	8 3/4" x 19"	3 1/2	\$5.00
1050G	10 1/2" x 19"	4 1/4	\$5.50

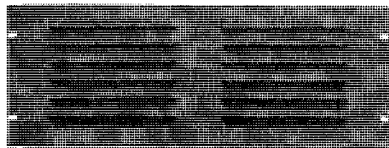
**LOUVERED
PANELS**

Model Number	Dimensions	Weight lbs.	List
L-525G	5 1/4" x 19"	2 1/2	\$5.00
L-700G	7" x 19"	3	\$5.75
L-875G	8 3/4" x 19"	3 1/2	\$6.50
L-1050G	10 1/2" x 19"	4 1/4	\$7.25

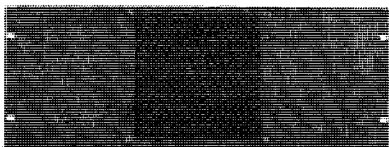
**MONITOR
PANEL**

MODEL 700MPG measures 7" x 19", has perforated metal grille, requires 6" speaker, weight 3 lbs. (See also radio panels.) **LIST: \$10.00.**

**LEVER KEY
PANELS**

All lever key panels have 1" slots 1" apart with 1/8" mounting holes. Each panel measures 3 1/2" x 19". Weight of each panel is 1 1/4 lbs.

Model No.	No. of slots	LIST	Name strip Model No.	LIST
LK-350-6G	6	\$5.00	SR-6	\$2.50
LK-350-8G	8	\$5.50	SR-8	\$2.60
LK-350-10G	10	\$6.00	SR-10	\$2.70
LK-350-12G	12	\$6.50	SR-12	\$2.80
LK-350-14G	14	\$7.00	SR-14	\$2.90
LK-350-16G	16	\$7.50	SR-16	\$3.00

CONNECTORS

MODEL PW-156 is an octal speaker plug for all Pathfinder models. **LIST: \$.45.**

MODEL PW-157 is a phono tap or radio input plug for all Pathfinder models. **LIST: \$.75.**

MODEL PW-144 is a three contact, shielded mike plug for all Pathfinder models. **LIST: \$1.75.**

**TX-10 SERIES STEREO TAPE RECORDERS**

Essentially a machine for the perfectionist, the TX-10 is probably the most foolproof and easiest-on-tape stereo recorder made. It takes any size reel — 3" to 10 1/2". Cybernetically engineered, tape transport is controlled with a single central joystick. It permits sound-on-sound recording, can be monitored before or after recording, has three heads, four-digit counter, stainless steel tape guides, hysteresis motor, differential braking, pointer-to-pointer illuminated meters which show both recording and playback levels. The TX-10 is a two-speed machine — 7 1/2 and 3 3/4 ips — selected by push button with speed-frequency correction. (15/7 1/2 ips machines available on special order). Response is ± 2 db 30-18,000 cps at 7 1/2 ips. There are separate "mike" and "line" inputs and mixing controls for each channel, a balance control, a ganged volume control, pilot light. It accepts Cannon XLR-3-12C male connectors and has easily accessible sockets for Newcomb plug-in transformers to permit use of low impedance microphones.

PROFESSIONAL USERS NET: \$750.00 unmounted.

CA-133 CARRYING CASE \$25.00.

SR-85 MOUNTING FRAME FOR HI-FI CABINETS \$10.00.

SR-86 FRAME FOR RACK MOUNTING in Newcomb Model 35-19 or 70-19 cabinet racks (cannot be used with door) **\$15.95**

SR-97 PAIR OF RACK BRACKETS FOR MOUNTING IN STANDARD 19" RACKS \$3.95.

MODEL SA-80B — 2 CHANNEL POWER AMPLIFIER WITH TONE, VOLUME AND BALANCE CONTROLS.

A stereo/mono amplifier designed especially for use with the TX-10, the Newcomb SA-80B amplifier puts out 40 peak watts per channel. Response: ± 1 db 20-20,000 cps. Distortion per channel at 20 watts rms less than 1%. Hum below -65 db. It has a balance control and ganged bass, treble, and volume controls. Output impedances per channel — 16, 8, and 4 ohms. 8 1/2" x 16 3/4" x 16 3/4", 32 pounds. **PROFESSIONAL NET \$199.50.**

SPECIFICATIONS AND PRICES ARE SUBJECT TO CHANGE WITHOUT NOTICE.

NEWCOMB AUDIO PRODUCTS CO.**NEWCOMB**

Temple sound columns

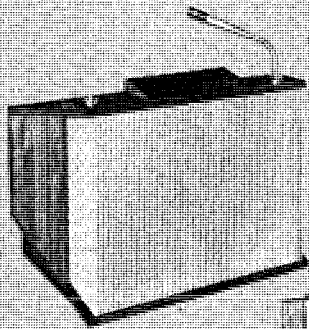

MODEL T-2
Table unit
Hand rubbed, oiled walnut finish.
Temperature Lathern



MODEL T-2B
Base unit for T-2

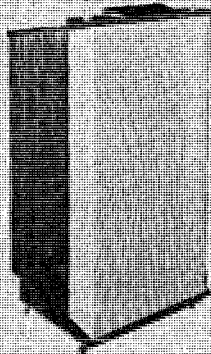

MODEL T-1
Floor unit
Hand rubbed, oiled walnut finish.

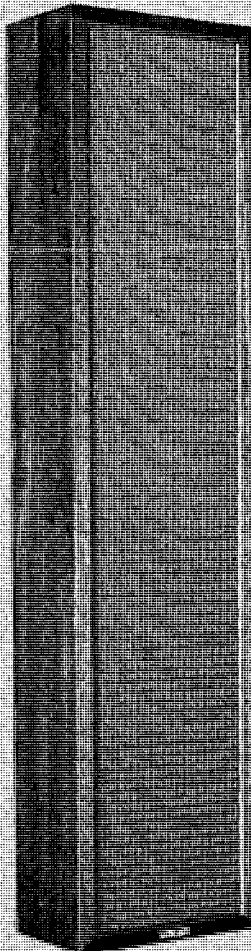

175 Watt

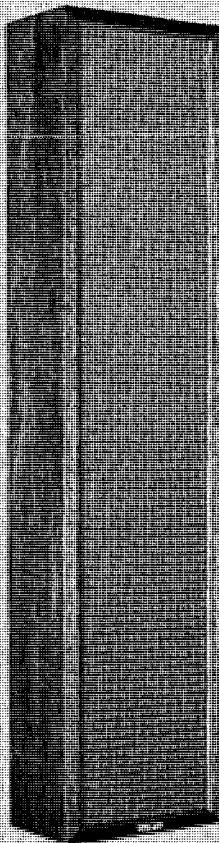

100 Watt

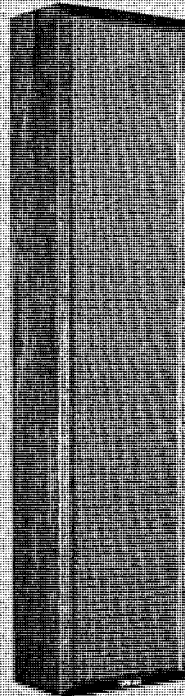

75 Watt

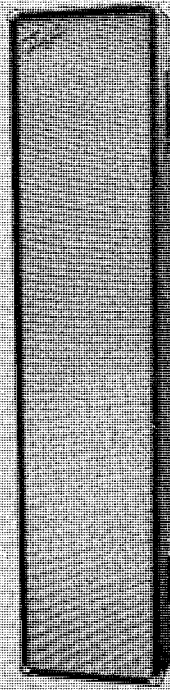

200 Watt Portable

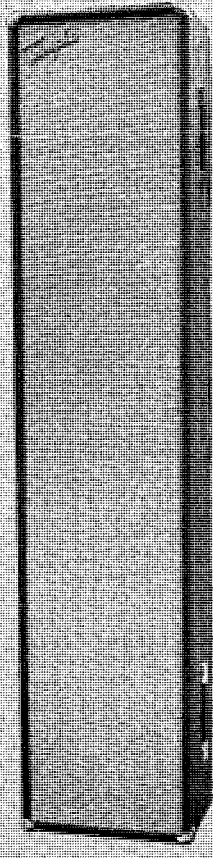

300 Watt Portable

The unchallenged leader with more than 60,000 field-proven installations! A complete line of sound columns from 18 watts to a precedent-shattering 300 watts; 20" to 84" in height; 13 attractive models in six different finishes; plus, rugged vinyl covered portables. Featuring "Forward-Additive" effect to provide uniform intensity and maximum intelligibility over a wide range. Important! Only Temple offers a custom design service to suit individual sound column requirements.

The Temple line also includes handsome, efficient roll-about lecterns that project sound realistically, directly from the speaker's rostrum. These practical models have many applications and feature our exclusive dual sound column design—speaker array may be oriented vertically and horizontally. *All products backed by our exclusive two year guarantee.*

S

THE MARK OF
SOUND SATISFACTION



TEMPLE SOUND EQUIPMENT CO., INC

TALK-A-PHONE WIRELESS AND HOME INTERCOM SYSTEMS

**TWO
WIRELESS
SYSTEMS**

Two high-quality wireless intercoms, featuring the exclusive TALK-A-PHONE "SONIC GATE" circuit. Provides communication where permanent or wired systems are not practical. For use in offices, factories, stores, homes, apartments, nurseries, farms, etc. Distinctively styled cabinets combine the look and feel of fine grained leather with the strength and rigidity of steel. Beautifully finished in charcoal gray with brushed chrome side panels. Each station has a translucent indicator which illuminates when "On." All stations must be connected to outlets on the same electric company service transformer. Built-in Ground Adapter provides greater sensitivity where electrical wiring is routed over long paths. U. L. Listed.

TALK-A-PHONE 12-STATION SELECTIVE WIRELESS* SYSTEM

- 6 Separate 2-Way Conversations Simultaneously
- Selective Paging with Reply • Push-Button Channel Selector
- Start a System with any number of Masters and Staffs

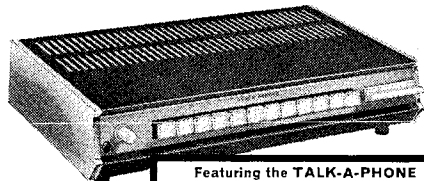

- No Installation
- No Wiring
- No Cables
- Just Plug-in and Talk

Featuring the TALK-A-PHONE "SONIC-GATE".

Your Voice Goes Through . . . Noise and Hum are Screened Out . . .

The Sonic Gate circuit effectively suppresses line noises and hum by 30 db while system is in actual operation, as well as when in Stand-By position.

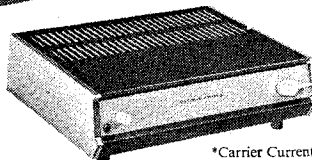
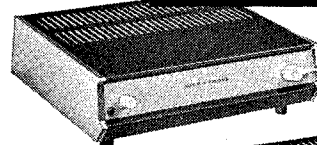

*Carrier Current

Provides selective communication. Each Master is equipped with a 6 or 12-channel selector; can converse with any other station selectively; can receive calls on any channel Master elects to use. As many as 6 separate conversations may be held simultaneously, with 12 Masters. Masters can talk with any station in system; can also set up conferences.

Wireless Staff Stations are for use where calls need not be originated, but where reply must be made. They are available for operation on any single channel desired—to match that of Master. They also can be used to receive Paging Calls from any Selective Wireless Master in the system . . . use as many Wireless Staffs as needed (all Staffs must operate on same channel for this

purpose). Two or more Wireless Staffs on the same channel will function as a 2-Station System (without Master); they can originate calls and reply to each other.

Start a system with any number of Masters and Staffs. Where up to 12 stations are used, each on a separate channel, Master can converse selectively with any channel. If more than 12 stations are used, channels must be shared; stations on same channel will receive all calls to that channel. To change location, merely pick up unit and move . . . no rewiring or new installation is necessary. All stations are equipped with the original TALK-A-PHONE UNI-TRANS feature, which permits continuous one-way transmission for periods when you wish to dictate or "listen-in."

TLCM-8912, 12-Station Selective Wireless Master. Complete with tubes and instructions, ready to use. Operates on 110-120 volts, AC or DC. Size 14" w x 8 3/4" d x 3 1/2" h. Shipping weight, 12 1/2 lbs. List Price Per Station \$188.00.Net **110.50**

TLCM-8906, 6-Station Selective Wireless Master. As above except for 6-Station Capacity. Shpg. Wt. 10 lbs. List Price Per Station \$167.00.Net **98.00**

Wireless Staff Stations. Receive and reply on a single channel only.

- T-LCS-901 Channel 1
- T-LCS-902 Channel 2
- T-LCS-903 Channel 3
- T-LCS-904 Channel 4
- T-LCS-905 Channel 5
- T-LCS-906 Channel 6

Complete with tubes and instructions, ready to use. Operates on 110-120 volts, AC or DC. Size, 10 1/2" w x 8 3/4" d x 3 1/2" h. Shipping weight, 7 lbs. List Price Per Station \$96.00.Net **56.40**

TALK-A-PHONE 2-STATION WIRELESS* SYSTEM

A complete system of 2 stations, ready to use. Simply place each unit where desired, plug each into nearest electrical outlet, and talk! Add more stations anytime. All stations will receive any messages transmitted from any point. Move units anywhere, plug into electrical outlet and use—no re-wiring or new installation necessary. The original TALK-A-PHONE UNI-TRANS is built in—provides continuous one-way transmission; ideal for dictation, or listening-in on baby. 110-120 V. AC-DC. Size, 10 1/2" w x 8 3/4" d x 3 1/2" h.

T-LC-33. Complete with tubes and instructions. Weight 16 lbs. List Price Per System \$167.00.Net **98.00**

T-LC-17. Additional Single Station. Weight 8 lbs. List Price Each \$83.50.Net **49.00**

CRADLEPHONE—Optional for all units above. Add H to model No. when ordering. List Price per Station add \$65.00.Net add **38.00**

TALK-A-PHONE All-Transistor HOME INTERCOM-RADIO SYSTEMS



HI-9 or HI-8



HI-9R or HI-29R

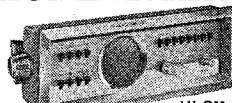

Housing Assembly with HI-17 or HI-16

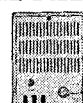

HI-4



HI-1

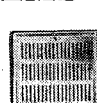

K-LR-2R

This TALK-A-PHONE Intercom System saves the housewife and homeowner miles of tiresome steps, hours of time . . . Makes home life easier, more comfortable and more enjoyable . . .

LISTEN-IN ON BABY, CHILDREN OR SICK ROOM . . . from any room in the house, day or night • **ANSWER OUTSIDE DOORS FROM ANY ROOM . . .** in any part of the house—without opening doors to strangers • **TALK FROM ROOM TO ROOM . . .** back and forth, upstairs or downstairs, any time, day or night • **YOUR FAVORITE RADIO PROGRAMS . . .** follow you throughout the house with the flick of a switch.

TALK-A-PHONE All-Transistor Home Intercom units are beautifully finished in gold, polished and satin silver tones. All Masters and Staff Stations are designed for flush mounting; or with optional Housing Assembly, these stations can be mounted on walls, cabinets, or set on tables, shelves, etc. Plaster Ring included for 8 and 16-Station units require 14 1/2" w, 43 3/4" h, 3 1/2" d wall opening. Front panel size: 15 1/4" w, 5 1/4" h. HI-4 requires 4 1/2" w, 6 1/2" h, 2" d wall opening. Front Panel size: 4 1/8" w x 7 3/8" h. Sub-Stations are designed for flush mounting only, do not need Plaster Ring. Requires 2" square wall opening, 2" deep. Front Panel size: 3 3/8" w, 5 3/8" h. Stations do not plug into electrical outlet. Operates from HI-PS Power Supply Unit or battery. Total capacity: up to 16 stations including Central Master. With full instructions.

CENTRAL MASTER STATIONS. Only one used per system. Contains the All-Transistor Amplifier (and radio when built-in). Place in any room. Master can call and converse with any other station (or stations) in system; can listen-in to any Station that user makes "non-private". If system has Model HI-9R Central Master (built-in radio), the Master and any Staff can listen to standard AM radio broadcasts. "Additional" Masters can be used in rooms where it is desired to listen to AM radio programs different from those tuned in at Central Master.

HI-9 Central Master Station. Without radio, less battery.Net Each **59.95**

HI-9R Central Master Station. With built-in radio. Less battery.Net Each **93.30**

HI-17 Central Master Station. Same as HI-9 except has total 16 station capacity. Without built-in radio.Net Each **89.00**

HI-29R Additional Master Station. With built-in radio. Less battery.Net Each **93.30**

HI-4 Staff Station. Provides same operation as Master. Can call 3 other stations. Can listen to radio of HI-9R.Net Each **19.95**

HI-8 Staff Station. Provides same operation as Master. Can call 8 other stations. Can listen to radio of HI-9R.Net Each **33.30**

HI-16 Staff Station. Provides same operation as Master. Can call 16 other stations. Can listen to radio of HI-9R.Net Each **61.00**

STAFF STATIONS. 4, 8 and 16-Station Capacity Staff Stations can be combined within the same system and used with choice of one 8-station capacity or one 16-station capacity Central Master Station. (When HI-9R is used, any HI-4, HI-8 and HI-16 staff, can listen to radio of HI-9R).

HI-SM HOUSING ASSEMBLY. For enclosing any 8 or 16-Station Capacity Master or Staff, to permit mounting on walls or cabinets, or placing on tables, shelves, etc. List Price Each \$21.00.Net Each **12.30**

HI-1 OUTDOOR SUB-STATION. For front and rear entrance applications. Complete with push-button for connection to regular house chime, bell or buzzer. Has illuminated nameplate. When caller rings bells, any Master or Staff may reply and converse with caller. Caller operates no controls.Net Each **17.25**

O-SM Surface Mounting Accessory for HI-1. Custom-styled metal casting of satin silver finish. Provides an attractive, coordinated base for mounting HI-1 on surface of wall. 3 3/8" x 5 1/8" x 5/8". List Price, Each, \$5.95.Net Each **3.50**

K-LR-2R ALTERNATE OUTDOOR SUB-STATION. For flush mounting. Requires wall opening 4 1/8" square, 2" deep. Stainless steel front panel measures 4 1/8" square. Complete with plaster ring. Without push button or illuminated nameplate. List Price, Each, \$25.50.Net Each **14.95**

Model K-SM Optional accessory for surface mounting K-LR-2R on wall. List Price, Each, \$7.60.Net Each **4.45**

Model K-SM-L Optional accessory for Surface mounting HI-4 Staff on wall. List Price, Each, \$8.75.Net Each **5.10**

HI-JB8 JUNCTION BOX for connecting Masters and Staffs up to a total of 8 stations. See #2 of "How to Determine Cable Needs." List Price, Each, \$8.95.Net Each **5.25**

HI-JB16 JUNCTION BOX Same as above except for up to 16 stations. List Price, Each, \$15.25.Net Each **8.95**

HI-PS POWER SUPPLY UNIT. One required per system (only when battery is not used). Plugs into any 120 volt, 60 cycle AC electrical outlet in basement, attic, etc. List Price, Each, \$29.50.Net Each **17.25**

BATTERY. Use any 9-volt dry battery, such as ignition or telephone battery; or six standard #6 dry cells in series—available from local sources. Note: When battery is used, power supply is not required.

HOW TO DETERMINE CABLE NEEDS

Masters and Staff Stations. Use #6226 cable in one of 2 ways: (1) Measure from 1st unit to 2nd unit only; from 2nd unit to 3rd unit only, etc., until last unit is reached—then total. Cable between last and 1st unit not needed. (2) Place a Common Junction Box (Model HI-JB) in attic, basement, closet, etc. Measure from each Master and Staff to Junction Box and total. Double length #6226 required for 16-Station units. Connect HI-4 to nearest 8 or 16-Station unit or to HI-JB with #6214 cable.

Outdoor Sub-Stations: Connect to nearest Master or Staff only with #6202 cable.

Battery or Power Supply Unit: Connect with #6202 cable to Master Stations only.

CABLE. For indoor or outdoor use.

Type No.	No. Pairs	Approx. O.D.	LIST, Per Ft.	NET, Per Ft.
6226	13	3/8"	76c	44c
6214	7	3/16"	39c	23c
6202	1	3/16"	8c	4 1/2c



TALK-A-PHONE CO.

All prices slightly higher west of Rockies—All prices and specifications subject to change without notice. Manufactured under exclusive TALK-A-PHONE Patents.

THE ALL-TRANSISTOR TALK-A-PHONE "CHIEF" AND "CHIEF REDI-POWER" INTERCOMMUNICATION SYSTEMS



"Has Everything . . . Does Everything"

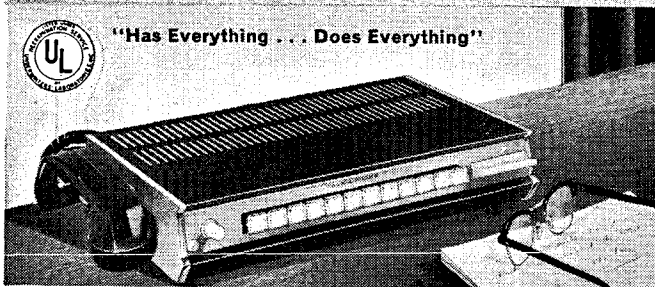

One Model Meets Every Requirement



Setting a high standard in quality, design and performance, the TALK-A-PHONE "CHIEF" and "CHIEF REDI-POWER" meets the intercom needs of office, factory, institution, or any other commercial or private application. "CHIEF" Master Stations of 6, 12, 20, 30, 40 or 50 station capacity can be intermixed with "CHIEF REDI-POWER" Masters of different capacities, together with Staff Stations and Horns within the same system in any desired combination. Masters can talk with any other Master or Staff . . . page . . . and can utilize other optional equipment shown as well. Staffs can answer any Master and can originate calls to one Master, or to two Masters selectively.

ONLY THE TALK-A-PHONE "CHIEF" AND "CHIEF REDI-POWER" GIVE YOU ALL THESE FEATURES

• **DISTINCTIVELY STYLED**—Less than 3-inches high. In cabinets that combine the look and feel of fine-grained leather with the strength and rigidity of steel. Attractively finished in charcoal gray and brushed chrome.

• **"PRIVATE" OR "NON-PRIVATE" MASTERS AND STAFFS**—Exclusive Dynasonic Design enables stations to perform "privately" (so no one can listen-in), or "non-privately" (for reply without use of controls). The same station can be "private" to one or more Masters and "non-private" to others.

• **INCOMING CALL CHIME**—A standard feature of Masters. Indicates that your station is being called. Caller talks, voice follows.

• **MONITORING SIGNAL**—A standard feature of Masters and Staffs. Visually indicates to a "non-private" station that it is being monitored.

• **BUSY SIGNAL**—A standard feature of Masters and Staffs. Visually indicates when station you call is "busy." All units have facility to override "busy signal" for important calls.

• **DYNASONIC SELECTOR**—An exclusive TALK-A-PHONE feature that permits intermixing of stations and variation of performance. Add to system at anytime without discarding original equipment.

• **MULTI-MAGIC STATION SELECTOR**—A patented, exclusive TALK-A-PHONE feature that enables selection of up to 30 stations with only 12 push buttons . . . 40 and 50 stations with 14 push buttons . . . in the same attractive cabinet style and size.

• **UNI-TRANS DICTATION CONTROL**—No need to operate or hold down controls when one-way transmission is desired or when Cradle Phone is used.

• **EXTERNAL RELAY CONTROL**—A standard feature of Masters. Enables Master to activate external relays for operating siren, gong, light, etc. Use in extremely high noise level areas to signal personnel, who can then communicate with caller from Master in quieter location or in sound booth. Operates simultaneously with chime within Master.

• **RECIPROCAL POWER SUPPLY**—Each Master operates on 120 volts, AC only, and should be plugged-in. Where no electrical outlet is available, up to 30% of the "Chief" Masters in the system can operate without being plugged-in.

• **NOISE-FREE VOICE RANGE POWER**—The rugged, all-transistor high-gain amplifier provides unsurpassed clarity and naturalness of tone. The exclusive, patented TALK-A-PHONE circuit enables performance without noise, hum or distortion when used with TALK-A-PHONE cable.

• **HI-POWER STAFF STATIONS AND HORNS**—For use with any TALK-A-PHONE Master where high volume at Staff locations is needed. Ideal for paging speakers. K-HP-3 provides more than twice the volume of universal Staff; K-C-20 provides about 4 times greater volume . . . more with REDI-POWER Masters.

• **WALL SWITCH**—Combine with TALK-A-PHONE Horn or Hi-Power Staff to add origination-of-call feature.

• **"LD" LONG DISTANCE**—(optional accessory on Masters). For use over cable lines of 2,000 ft., 5,000 ft., 10,000 ft. or more without loss of volume. Functions only between Masters with LD . . . not between an LD Master and Staff. Built-in at factory at additional cost.

• **CRADLE PHONE**—(optional accessory on Masters or Staffs). Has live microphone. Provides listening privacy and greater speaking convenience. Diminishes background noises in noisy areas. Eliminates use of controls in conversation between Masters. Cuts off incoming voice from loudspeaker when in use.

• **WALL MOUNTED CRADLE PHONE**—(optional accessory). For noisy areas and listening privacy. Use with K-HP-3, K-C-20 and K-S-101 or K-S-102. Speaker disconnects when in use.

• **RIGHT-OF-WAY RELAY**—(optional accessory). Use with "CHIEF REDI-POWER" Masters to page any group of stations with a single button. Paged stations can also be used for intercommunication. K-RW-10 capacity, 10 stations, K-RW-20 capacity, 20 stations. Connects to one Master, other Masters also utilize facilities.

• **POWER PAGING BOOSTER**—(optional accessory). Use with "CHIEF" Masters to page a group of speakers with a single button. 50 watts output. Requires its own paging speakers (K-C-20, K-HP-3). Provides paging facility only . . . paged stations cannot reply or originate calls through paging speakers. Connects to one Master, other Masters can also utilize facilities.

All "CHIEF" and "CHIEF REDI-POWER" Master Stations come complete with junction box and built-in power supply attached by 6' flexible cable. Master size: 14" w, 3 1/2" h, 8 3/4" d. For 120 volts, AC only. U.L. Listed.

K-C-4906 Master 6 station capacity. Wt. 13 lbs.
List Price Per Station \$167.00 Net **98.00**

K-C-4912 Master 12 station capacity. Wt. 14 lbs.
List Price Per Station \$188.00 Net **110.50**

K-C-4920 Master 20 station capacity. Wt. 17 lbs.
List Price Per Station \$223.00 Net **131.00**

K-C-4930 Master 30 station capacity. Wt. 20 lbs.
List Price Per Station \$258.00 Net **151.50**

K-C-4940 Master 40 station capacity. Wt. 23 lbs.
List Price Per Station \$293.00 Net **172.00**

K-C-4950 Master 50 station capacity. Wt. 26 lbs.
List Price Per Station \$328.00 Net **192.50**

How to Determine Cable Requirements. To inter-connect Master Stations, measure from first Master to second Master only, from second to third Master only, etc., until the last unit in the system is reached, and total. For K-C-4920 and K-CRP-5920, use two lengths of 6226 Cable; and for K-C-4930 and K-CRP-5930 use three lengths of 6226 Cable, etc. To connect K-C-41, K-C-42 or K-HP-3 Staff Stations, measure from Staff Station to the one Master to which Staff Station originates calls. To connect the K-C-42 Staff Station measure a separate length of cable from Staff Station to each Master Station to which Staff originates calls (for each K-C-41 or K-C-42, follow same procedure). Connect K-S-111 at any convenient point between remote speaker and Master Station.

All prices slightly higher west of the Rockies. All prices and specifications subject to change without notice. Manufactured under exclusive TALK-A-PHONE Patents.

TALK-A-PHONE Apartment House Intercom System. With 1 or 2 selective talking circuits; with 1 or 2 independent door opener buttons. Catalog available.

TALK-A-PHONE ALL-TRANSISTOR "CHIEF REDI-POWER" MASTERS

These units have all the operational features of the "CHIEF," plus the additional feature of built-in extra power (up to 30 watts) for use when and as needed. Provides additional volume for calling many stations at once, or noisy locations singly. Needs no separate power booster, which would eliminate return speech. Return speech is received at normal room volume. REDI-POWER Masters have a self-compensating amount of volume, whether you call 2, 10 or 20 stations simultaneously. Each station receives its pre-determined volume with no division of output as you call more stations at once. Use REDI-POWER Masters with "CHIEF" Masters and Staffs in same system. Add K-RW-10 or K-RW-20 and REDI-POWER Masters can page any group of stations with a single selector button. Paged stations can also be used for intercommunication. Operates on 120 volts, AC only. U.L. Listed.

K-CRP-5912 Redi-Power Master station 12 station capacity. Wt. 18 lbs.
List Price Per Station \$283.00 Net **166.00**

K-CRP-5920 Redi-Power Master 20 station capacity. Wt. 21 lbs.
List Price Per Station \$318.00 Net **186.50**

K-CRP-5930 Redi-Power Master 30 station capacity. Wt. 23 lbs.
List Price Per Station \$353.00 Net **207.00**



K-C-42, K-C-42M

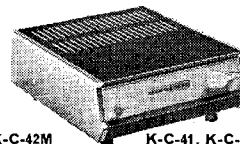

K-C-41, K-C-41M



K-C-41R

TALK-A-PHONE "CHIEF" UNIVERSAL STAFF STATIONS For use with any "CHIEF" or "CHIEF REDI-POWER" Master. Like Masters, Staff Stations can be connected "privately" or "non-privately", and can originate calls. When "non-private", calls can be answered at a distance from Staff without using controls. Persons at "non-private" Staffs may reply to all Masters in the system (whether directly connected to them or not). Connected "privately" no one can listen-in to Staff, but any Master can call. "Private" or "Non-Private" Staffs can originate calls to one or two "Private" Masters. Each Staff has "busy signal" and "monitoring signal" features. Staffs do not connect to an electrical outlet . . . are distinctively styled in modern cabinets that combine the look and feel of fine grained leather with the strength and rigidity of steel. Finished in charcoal gray and brushed chrome. Size: 7 1/2" w x 8 3/4" d x 2 1/2" h.

K-C-41 Staff Station for origination-of-call to one Master. Wt. 8 lbs.
List Price, Each \$44.30 Net **26.00**

K-C-41M. Same operation as K-C-41 and in cabinet of same style, color and size, but in grained baked enamel finish. Wt. 8 lbs. List Price, Each \$47.00 Net **21.10**

K-C-42 Staff Station for origination-of-call to two Masters. Wt. 8 lbs.
List Price, Each \$55.00 Net **32.20**

K-C-42M. Same operation as K-C-42 and in cabinet of same style, color and size, but in grained baked enamel finish. Wt. 8 lbs. List Price, Each \$47.00 Net **27.50**

K-C-42R. Same as K-C-42, but for flush wall mounting. Stainless Steel Front Panel, 4 1/2" x 7 1/2". Wall Opening: 4 1/2" w x 6 1/2" h x 2" d. Wt., 5 lbs.
List Price, Each \$47.00 Net **27.50**

K-C-41R. Flush mounted Staff Station for use with any of above Masters. Requires wall opening 4 1/2" W. x 6 1/2" H. Stainless steel front panel measures 4 1/2" W. x 7 1/2" H. Complete with plaster ring. List Price, Each \$36.00 Net each **21.10**

K-SM-L Optional accessory for surface mounting K-C-41R and K-C-42R on wall. List price, each \$8.75 Net each **5.10**

K-HP-3. Hi-Power Sub-Station for wall mounting in charcoal gray metal case. Wt. 8 lbs. List Price, Each \$34.25 Net **19.95**

K-HP-3V. Same as above, but with built-in volume control, adjustable to full output. List Price, Each \$42.50 Net **24.95**

K-C-20. Nine-inch weatherproof re-entrant horn. List Price, Each \$51.00 Net **29.95**

K-C-20V. Same as above, but with built-in weather resistant volume control, adjustable to full output. List Price, Each \$68.00 Net **39.95**

Optional Wall Mounting Brackets for Models K-C-41, K-C-41M, K-C-42 and K-C-42M are available. See description on preceding page.

Optional Equipment

Cradle Phone Available on all Models except K-C-41R, K-C-42R, K-HP-3 (V) and K-C-20(V). Add "H" to Model No. when ordering. Net add **38.00**

Model K-S-111 Wall Mounted Cradle Phone. List Price, Each \$75.00 Net **44.00**

LD Long Distance Feature Available on Master Stations. Add "LD" to Model No. when ordering. List Price, Each—\$22.50 Net add **12.95**

Model K-S-101 Wall Switch For origination of call to one Master through K-C-20, or K-HP-3, in Chief systems. List Price, Each \$15.00 Net **8.80**

K-S-102 WALL SWITCH. For origination of call to two Masters through K-C-20, or K-HP-3, in Chief systems. List Price, Each \$24.50 Net **14.40**

K-RW-10 Right-of-Way Relay. List Price, Each \$79.95 Net **47.00**

K-RW-20 Right-of-Way Relay. List Price, Each \$146.50 Net **86.00**

K-HP-50 Power Booster. List Price, Each \$160.00 Net **94.00**

CABLE. For indoor or outdoor use.

6206 Cable for connecting K-C-41, K-C-42, K-HP-3, K-C-20 with origination of call. List Price per Ft. 19c Net per Ft. **11c**

6214 Cable for inter-connecting K-C-4906 Masters. Net per Ft. **23c**

6226 Cable for inter-connecting K-C-4912, K-C-4920, K-C-4930, K-C-4940, K-C-4950, K-CRP-5912, K-CRP-5920 and K-CRP-5930 Masters. Net per Ft. **44c**

6902 Cable for connecting K-HP-3, K-C-20 without origination of call. List Price per Ft. 43c Net per Ft. **2 1/2c**

TALK-A-PHONE CO.

Argos

PRODUCTS COMPANY

- Quality Speaker-Baffle Combinations
- Wall Baffles
- High Fidelity Speaker Systems

SPEAKER-BAFFLE COMBINATIONS

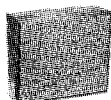

Prestige

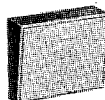

Thin line

Now there are four complete lines of Argos speaker-baffles. Each comes to you completely wired, ready to install. Prestige (PB series)—our finest, with handsome wood furniture finishes in Dusk Walnut and Antique Birch and cane grill. 8" speaker, 15 watts. Thin line Dual Cone (WB-408 series)—Slender, handsomely clad in blond or walnut wood-grained vinyl, almost undistinguishable from wood. 8" dual cone speaker, 10 watts, 8 ohms.

"Thinline Heavy-Duty" (WB-212 series) has 12" speaker with 10 oz. ceramic magnet. 18 watt capacity, 8 ohms impedance. Dimensions: 14 1/4" x 16 1/4" w. x 6 1/4" d. Blond or walnut vinyl-clad.

Thin line Low Level (WB-108 series) Has 8" speaker, 6 watts, 8 ohms, blond or walnut vinyl covering.

PB-508CS—Baffle with speaker. Ship. Wt. 5 1/2 lbs. (11" x 9 3/4" x 5 3/8") List Price \$19.90

PB-508CSL—Baffle, speaker, L pad. Ship. Wt. 5 1/2 lbs. List Price \$23.65

PB-508CST—Baffle, speaker, 70.7V.* transformer. Ship. Wt. 6 1/4 lbs. List Price \$24.90

PB-508CSLT—Baffle, speaker, L pad. 70.7-V.* transformer. Ship. Wt. 6 1/4 lbs. List Price \$27.90

PB-508C—Baffle only. Max. spkr. depth 4 1/4". Ship. Wt. of two 6 lbs. List Price each \$9.15

PB-512C—12" Prestige Baffle only, max. spkr. depth 6". Ship. Wt. of two 11 lbs. List Price each \$12.50

WB-408CS—Baffle with speaker. Ship. Wt. 5 lbs. (12 1/4" x 9 3/4" x 4 3/8") List Price \$16.60

WB-408CSL—Baffle, speaker, L pad. Ship. Wt. 5 lbs. List Price \$20.35

WB-408CST—Baffle, speaker, 70.7-V.* transformer. Ship. Wt. 5 1/2 lbs. List Price \$21.55

WB-408CSLT—Baffle, speaker, L pad. 70.7-V.* transformer. Ship. Wt. 5 1/2 lbs. List Price \$24.55

WB-212CS—Baffle with speaker. Ship. Wt. 9 3/4 lbs. List Price \$26.25

WB-212CSL—Baffle, speaker, L pad. Ship. Wt. 9 3/4 lbs. List Price \$29.95

WB-212CST—Baffle, speaker, and 70.7-V.* transformer. Ship. Wt. 10 1/4 lbs. List Price \$31.25

WB-212CSLT—Baffle, speaker, L pad. 70.7-V.* transformer. Ship. Wt. 10 1/4 lbs. List Price \$34.25

WB-212C—12" baffle only. Maximum speaker depth 4 3/8". Ship. Wt. 5 1/2 lbs. List Price \$10.63

WB-108CS—Baffle with speaker. Ship. Wt. 4 1/2 lbs. (12 1/4" x 9 3/4" x 4 3/8") List Price \$13.25

WB-108CSV—Baffle, speaker, volume control. Ship. Wt. 4 1/2 lbs. List Price \$16.65

WB-108CST—Baffle, speaker, 70.7-V.* transformer. Ship. Wt. 5 lbs. List Price \$18.25

WB-108CSVT—Baffle, speaker, volume control, 70.7-V.* transformer. Ship. Wt. 5 lbs. List Price \$20.60

WB-208C—8" Thinline Baffle only. Max. spkr. depth 3". Ship. Wt. 3 1/4 lbs. List Price \$7.75

*Also available w/25V. transformer at same price on special order. 12 unit minimum.

CORNER BAFFLES

CB-12D

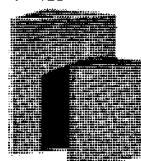

SCB-12D

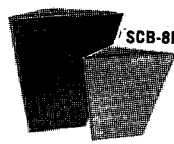

SCB-8D

Thinline Slanting Corner Baffle

Favorites for their mounting ease and over-all high quality. Argos corner baffles are now available in 3 series to fill every need. Corner location and bass reflex design provide excellent tone. All have quick clip-on front, are held to walls with Argos Speedy Mounting Clips. Coverings are wood-grained vinyl, walnut or blond, with cane grills.

Thinline Slanting Corner Speaker-Baffle combination

Heavy-duty PA performance in a thin, slanting baffle complete with 8" speaker, 15 watts, 8 ohms. Transformers and L-pads available on special order, min. 12 units. SCB-208S Ship. Wt. 6 lbs. List Price \$23.25

Slanting Corner Baffles

SCB-8D—Take 8" spkr. up to 5 1/2" deep. Internal volume: 680 cubic inches. Size: 15" H x 17 3/4" W x 9" D. Ship. Wt. 6 lbs. List Price \$15.75

SCB-12D—Takes 12" spkr. up to 6 1/2" deep. Volume: 1240 cubic inches. Size: 20" H x 20 3/4" W x 10 1/2" D. Ship. Wt. 8 lbs. List Price \$21.60

Regular Corner Baffles

CB-8D—Takes 8" spkr. up to 4 1/2" deep. Volume: 525 cubic inches. Size: 14" H x 12 1/4" W x 6 1/2" D. Ship. Wt. 4 1/2 lbs. List Price \$13.10

CB-12D—Takes 12" spkr. up to 6 3/4" deep. Volume: 1420 cubic inches. Size: 20" H x 17 3/4" W x 9" D. Ship. Wt. 8 1/2 lbs. List Price \$20.40

WALL BAFFLES

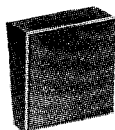

REGULAR

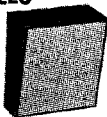

DELUXE

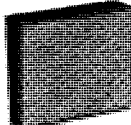

PROFESSIONAL

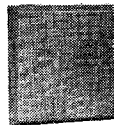

FLAIR

Argos offers 4 wall baffle lines to meet every need. All utilize Argos famous Speedy Mounting Clip for fastest installation:

Regular Wall Baffles (WB series) are the standard of the industry for quality. In blond or walnut wood-grained vinyl with cane grill.

Deluxe Wall Baffles (DWB series) are furniture finished wood in Antique Birch or Dusk Walnut.

Professional Wall Baffle (PWB) is a large cubic capacity baffle for use with 8" speakers only. In blond or walnut wood grained vinyl.

Flair Baffle (FMB) is a stylish new flush mounting wall or ceiling baffle with concealed mounting screws. In Dusk Walnut or Antique Birch furniture finished wood.

Model	Spkr. Cap.	Width, Depth, Inches	Height, Inches	Cubic Inches	Ship. Wt. Lbs.	List Price Each
WB-4/5D	4/5	6 1/2 x 6 3/4	4	100	2 3/4*	\$5.38
WB-6D	6	8 1/2 x 8 3/4 x 5	210	4 1/2*	6.50	
WB-6/9D	6/9	10 x 10 3/4 x 6 1/2	400	6 1/4*	7.75	
WB-8D	8	10 x 10 3/4 x 6 1/2	400	6 1/4*	7.75	
WB-10D	10	12 1/2 x 12 5/8 x 7 7/8	800	8*	10.00	
WB-12D	12	13 7/8 x 14 1/4 x 9 1/8	1180	11*	10.63	
DWB-8A	8	9 3/4 x 10 1/2 x 6 1/2	400	5 1/2*	10.00	
DWB-12A	12	13 3/8 x 14 x 9 1/8	1180	9*	14.00	
PWB-8C	8	16 1/4 x 14 x 6 1/4	1000	6	11.25	
FMB-8	8	11 3/8 sq. x 1 1/4"	—	2 1/4	9.25	

*Ship. Wt. of 2 in carton

Argos Decor/Oriented High Fidelity Speaker Systems

AHF-1 "ASTRA"

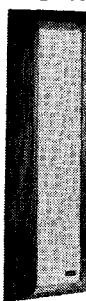

Tall, slender and elegant, "Astra" is first new speaker design in years. Contemporary styling is decoratively ideal for walls and unusual areas. Sound-column design uses scientific focusing principle to add extra projection to high tones. Ideal for stereo. 3 3/4" w x 10 1/2" h x 4" d. 4 speakers—2 Jensen woofers, 2 direct radiator tweeters. 50 to 17,000 cps response. Cabinet of genuine walnut with hand-rubbed oil finish. AHF-1 Ship. Wt. 15 lbs. Audiophile net, each \$49.95

The Solitaire—For Places Hi-Fi Could Never Go Before

A delight to see and hear, "Solitaire" offers extraordinary tonal brilliance, yet measures only 18" w x 12" h x 3 1/4" d. It's designed for desk, table, or wall to carry high fidelity music everywhere in home or office. Genuine walnut cabinet has hand-rubbed oil finish, grill cloth is neutral Belgian linen. Rests on its own miniature legs or hangs like a picture. Contains high-compliance Jensen woofer and separate direct-radiator tweeter give 50 to 17,000 cps. Stereo phased. Built-in volume control. SHF-1 Ship. Wt. 8 3/4 lbs. Audiophile net, each \$29.95

Argos finest—TX-400 For Areas That Demand Big Systems Performance.

Argos' incomparable craftsmanship is blended with the industry's most advanced speaker technology for the sophisticated high fidelity requirement. Three-way system employs 12" Jensen woofer, 8" solid-back mid-range and horn-loaded compression driver. Distortion-free response from 35-18,000 cps. Genuine 3/4" hand-rubbed, oiled walnut cabinet with Belgian linen grill cloth. Size: 25" x 14 3/4" x 9". Ship. Wt. 31 lbs. Audiophile net, each \$79.95



TX-400



TX-200



TX-5

TX-4E Enclosure. Same as enclosure for TX-400 except cut for 12" woofer, 8" mid-range and 3 1/2" tweeter. Wt. 23 lbs. Audiophile net, each \$39.95

New! TX-200—Where Space is Limited, But High Performance is Required.

Totally new dimension in high fidelity speaker system design—a genuine price breakthrough for such outstanding performance and craftsmanship. Features a high-compression driver matched to specially designed low resonance, high-compliance woofer. Undistorted response from 30-18,000 cps. Hand-rubbed 3/4" oiled walnut cabinet, imported Belgian linen grill cloth. Size: 18 7/8" x 11 1/8" x 7 7/8". Ship. Wt. 18 lbs. Audiophile net, each \$45.00

TX-1—For High Activity Areas Like Game Rooms.

Unequaled for pure value! Unit features a special 8" 45-cycle woofer and 3 1/2" tweeter. Response: 45-17,000 cps. Impedance: 8 ohms. Terminals marked for stereo phasing. Optional miniature legs. Walnut wood-grain vinyl finish. Size: 24" x 11" x 9". Ship. Wt. 18 lbs. Audiophile net, \$29.95

TX-1E. Enclosure only, wt. 15 lbs. Audiophile net, \$19.95

TX-2E. Enclosure, same as TX-1E except genuine hand-rubbed walnut. Ship. Wt. 19 1/2 lb. Audiophile net, \$29.95

TX-5—Popular Cube Shape Tastefully Fills "Nooks and Crannies"

Has sound fidelity normally associated with more costly and far larger high fidelity speaker systems. The 3/4" hand-rubbed oiled walnut cabinet is 12 3/8" x 13 3/8" x 10" deep. Has 8" woofer and a 3 1/4" tweeter. 50 to 17,000 cycles. Wired through crossover network to terminal strip, marked for stereo phasing. 8 ohms. TX-5—Wt. 16 lbs. Audiophile net, each \$32.50

RUGGEDIZED TUBE CADDIES™

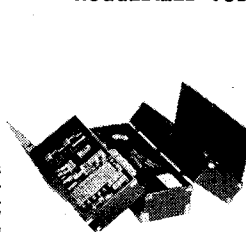

TC-600—Super 600 Tube Caddy.

The most rugged Tube Caddy ever built. Heavy 16 gauge steel runners protect the bottom and corners. Upper fold out sections and covers rest on floor when open. Has over 3300 cubic inches in volume. Holds countless tubes, tools, soldering gun, meters and accessories. New grey vinyl covering. Size: 24" x 16 1/2" x 8 1/2". Ship. Wt. 20 1/2 lbs. Net Price \$29.95

TC-500—Super Tube Caddy—A real man-size case with space for everything. Over 3300 cubic inches in volume. More durable than ever with extra bracing and more metal corners. New grey vinyl covering. Size: 24" x 16 1/2" x 8 1/2". Ship. Wt. 17 lbs. Net Price \$23.95

TC-400—Carry-All Tube Caddy—Most popular Tube Caddy ever made. Break-away design gives quick access to all sections. Holds up to 262 tubes... less with tools. New grey vinyl and more metal corners. Size: 21" x 15" x 8". Ship. Wt. 11 lbs. Net Price \$16.95

TC-200 Tube Caddy Junior—Smaller, easy-to-carry size for quick trips or as companion to other Argos Tube Caddies. Up to 143 tubes, less with tools. Grey vinyl covering. Size: 15 3/4" x 12 1/2" x 8". Ship. Wt. 8 lbs. Net Price \$10.95

Argos Products Co.

Copyright 1968 Argos Products Co.

ASTATIC Microphones, Accessories

NEW!

SETTING A NEW STANDARD OF PERFORMANCE, APPEARANCE, AND DEPENDABILITY.

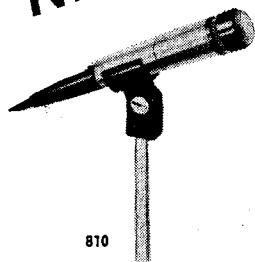

810

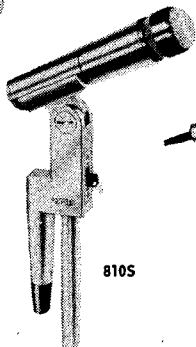

810S

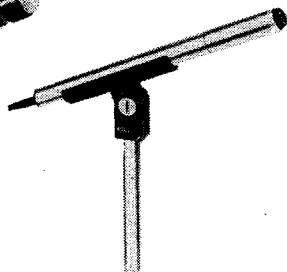

820

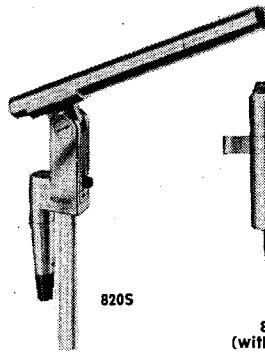

820S



840
(with clip)

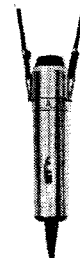

840S
(with Lavalier cord)

810 ULTRA CARDIOID

Exclusive Astatic "Sibrophase" system provides the greatest front-to-back ratio in the industry. Perfect cardioid polar pattern, wide range tailored response, multi impedance, modern styling, rugged construction. DuPont Mylar® diaphragms all serve to make these new microphones ideal for Public address, Broadcast and Recording, indoors or outdoors. Feedback, unwanted pickup, reverberation, "Pop" & "Blast" are problems of the past. **MODEL 810** for hand held or stand use has the new "Easy-On" swivel adaptor. **MODEL 810S** has an on-off switch built into the integral swivel mount. Both models are available in non-reflecting brushed satin chrome with black chrome trim, or in brushed satin gold to harmonize with entertainment or sacramental decor; come with broadcast type connector and 18 feet of shielded cable. **Front to Back Pickup:** 25db. **Output:** -50db at High Z, -54db at Low Z. **Frequency Response:** 40-15,000 Hz. **Impedance:** High Z, EIA 40,000 ohms; Low Z, EIA 150 ohms. **Size:** 5-9/16" x 1-5/16". **Weight:** (less cables) 810-9 ounces; 810S-18 ounces.

	List Price
Model 810—With "easy-on" adaptor.....	\$85.00
Model 810 Gold—As above with gold finish.....	\$90.00
Model 810S—With built-in on-off switch.....	\$89.00
Model 810S Gold—As above with gold finish.....	\$94.00

820 OMNIDIRECTIONAL PROBE

A dynamic, slim and modern probe with the ultimate versatility for all sound applications. Omnidirectional sensitivity allows sounds from all directions to come through with uniform volume and clarity. Ideal for choirs and vocal groups and other music or voice pickup where balanced sound is required. Grille screens and filters, and the Du Pont Mylar® "Pop" and "Blast" resistant diaphragm allow the 820 series to perform well indoors or outdoors. **MODEL 820** for hand held or stand use has the new "Easy-On" swivel adaptor, broadcast type connector. **MODEL 820S** has an on-off switch built into the integral swivel mount. Both models are available in non-reflecting brushed satin chrome with black chrome trim, or in brushed satin gold to harmonize with entertainment or sacramental decor, comes with 18 ft. of shielded cable. High or Low impedance can be selected by a simple, solderless, pin change. **Output:** -61db at High Z, -60db at Low Z. **Frequency Response:** 40-18,000 Hz. **Impedance:** High Z, EIA 40,000 ohms; Low Z, EIA 150 ohms. **Size:** 9" x 3/4". **Weight:** 820: 27 ounces with cable, 820S: 14.5 ounces without cable.

	List Price
Model 820—With "easy-on" adaptor.....	\$79.50
Model 820 Gold—As above with gold finish.....	\$84.50
Model 820S—With on-off switch built in.....	\$85.00
Model 820S Gold—As above with gold finish.....	\$90.00

840 LAVALIER

A dramatic little microphone, outstanding in performance whether worn or hand held, that can't be matched for applications requiring the microphone to move with the performer. Complete with the lapel clip and neck cord accessories — the 840 is engineered for maximum intelligibility despite chest cavity resonance. Response pattern can easily be converted for hand held use. DuPont Mylar® diaphragm provides long life, stable flexibility and "Pop" and "Blast" resistant features. Wide response range and uniform response pattern tailored for voice broadcasting, public address and lecturers. **MODEL 840S** has an on-off switch built into the microphone body. Both models come with 30 feet of super flexible 3/4" diameter cable and are available in non-reflecting brushed satin chrome, or in brushed satin gold. **Output** -59db. **Frequency Response:** 50-12,000 Hz as Lavalier, 50-16,000 Hz as Hand Held. **Impedance:** Low, 150 ohms. **Size:** 840: 2 3/4" x 3/4", 840S: 3 3/4" x 3/4". **Weight:** (without cables) 840: 1 1/4 ounces, 840S: 1 3/4 ounces. **Weight:** (with cables) 840: 5 1/2 ounces, 840S: 6 1/4 ounces.

	List Price
Model 840—With clips and neck cord.....	\$85.00
Model 840 Gold—As above with gold finish.....	\$90.00
Model 840S—With built-in, on-off switch.....	\$90.00
Model 840S Gold—As above with gold finish.....	\$95.00

MODEL 77 DYNAMIC CARDIOID

A most positive anti-feed microphone. Also available in gold finish. Unidirectional design has suspended cartridge; eliminates external shock mounts. Built-in impedance selector. **Front-to-Back Pick-up:** 18 db differential. **Output:** -48 db. **Frequency Response:** 30-15,000 cps. **Impedance:** Low-Z, 30-50 ohms; medium, 150-250 ohms; high, 40,000 ohms. **Shipping Weight:** Approximately 2 lbs., 6 oz., less stand.

Model 77—With on-off switch and provisions for locking in "on" position. List Price.....	\$82.50
Model 77 Gold Finish—List Price.....	\$92.50
Model 77-L—Head only for mounting on G Stand. List Price.....	72.50
Model 77-L Gold Finish—List Price.....	82.50
Model G-77—Includes G Stand and 8' cable. List Price.....	97.45

MODEL DN-50 "THE COMMENTATOR"

General Purpose. Unitary moving coil system, carefully proportioned acoustic circuit. **Response:** 50-10,000 cps. **Output:** DN-50, -51 db; DN-HZ, -52 db. Semi or non-directional. Opalescent gray and bright chrome finish. With 10' cable. **Size:** 6 7/8" h. 2 3/4" grill dia., 4 1/4" d. **Net Wt:** 1 lb. 12 oz. (mike only).

MODEL	DESCRIPTION	LIST
DN-50	50 OHM Impedance, 10 Foot Cable	\$33.50
GDN-50	50 OHM Impedance, with Grip-To-Talk Stand and 6 FT. of Shielded Cable.	52.70
UGS-DN50	Same as above but Balanced	57.70
DN-HZ	25,000 or more Impedance, 10 Foot Cable	39.70
GDN-HZ	Same as above, with Grip-To-Talk Desk Stand and 6 FT. of Shielded Cable.	59.90

See next page for description of Grip-To-Talk Stand.

SERIES 330 AND GOOSENECK SERIES 330-GS

330 Series

(See next page for matching stand)

Small, slim mikes with quality performance for various applications at real low price. Model 331 has momentary on, spring-return switch, furnished with hang-up bracket. Cable provides for audio and relay connections. All other models have slide switch with "lock-on" position complete with lavalier and stand adapter with 3/8"-27 thread. High impedance except Model 335L.

330-GS

Professional performing, all purpose gooseneck microphones for intercommunications, tape recording, amateur language laboratories and many other applications. Gooseneck is permanently attached, 13" in length. Complete with 7' single conductor, shielded cable (335L-GS, 2-cond. for balanced line).

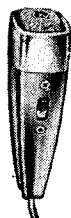

330 Series



330-GS Series

Model	Type	Output	Freq.	Body	Grille	Cap	Goose Neck	List
331	Ceramic	-58db	300- 7000	Black	Black	Chrome	—	\$17.90
332	Crystal	-54db	30-15000	Chrome	Black	Chrome	—	17.90
332GS	Crystal	-54db	30-15000	Chrome	Chrome	Chrome	Chrome	24.50
333	Ceramic	-58db	30-10000	Black	Black	Chrome	—	17.90
333GS	Ceramic	-58db	30-10000	Black	Black	Black	Chrome	24.50
335H	Dynamic	-56db	100-12000	T.V. Gray	Chrome	Chrome	—	26.50
335H-GS	Dynamic	-56db	100-12000	Chrome	Chrome	Chrome	Chrome	33.00
335L	Dynamic	-57db	100-12000	T.V. Gray	Chrome	Chrome	—	23.50
335L-GS	Dynamic	-57db	100-12000	Chrome	Chrome	Chrome	Chrome	30.00

ASTATIC PHONOGRAPH NEEDLES AND CARTRIDGES



For over 25 years Astatic has maintained its number one position as the world's leader in supplying the most complete line of phono-graph cartridges for O.E.M.'s and Distributors.

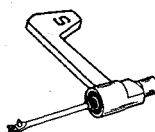

Needle for needle, Astatic always has the highest quality and the most complete line of needles. Regardless of the original manufacturer of the phono-graph, Astatic has the replacement needle for the cartridge on hand and ready for immediate delivery.



ATLAS SOUND



ATLAS SOUND PAGING AND TALK BACK SPEAKERS

HU and CJ models are equipped with the "Versalock" mounting bracket. Rigid, rugged, dependable bracket is completely adjustable on both a horizontal and vertical plane, affording "pin-point" directivity and simple secure mounting. HU horns are constructed of aluminum, while the CJ horns are molded of indestructible Fiberglass. Rugged diecastings and tough steel parts add strength. All are 100% weatherproof.

HU-24N Similar to HU-15N. Larger horn improves low frequency response, increases over-all efficiency. For paging and talk-back systems that are also required to reproduce music.

CJ-14N Wide angle speaker with rectangular horn opening for broad sound dispersion in horizontal plane while maintaining good vertical coverage.

EC-10 Lowest priced American-made speaker designed specially for low power systems requiring limited coverage. Gives improved results and high efficiency for intercom and other applications formerly using cone speakers.

Horn sections molded of new tough, all-weather, acrylic plastic. Handsome beige-brown color combination blends with any decor. Tough steel bracket is adjustable and makes mounting simple and secure. Unmatched where size, weight, appearance and high efficiency combined with low cost are factors.

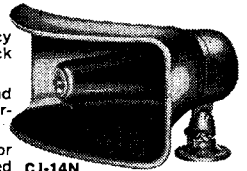

CJ-14N
CJ-30N



HU-12N

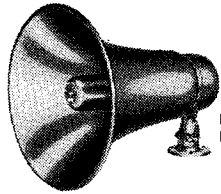

HU-15N
HU-24N

HU-15N The most popular all-purpose, trouble-free speaker of its type and size.

CJ-30N Similar to CJ-14N, except power handling capacity is increased. Larger, wide angle horn improves low frequency response.

TP-15N One high efficiency driver unit does the work of two for low cost bi-directional coverage in long corridors and outdoors. Universal bracket mounts dual horns at a 10° angle down or out from wall surface or pole.

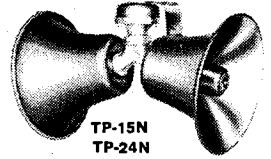

TP-15N
TP-24N

TP-24N Same as TP-15N but equipped with oversized horns for improved low frequency response. Excellent for bi-directional paging locations required to reproduce music.

The DeCor speakers described below are designed to simulate a lamp, handsomely styled for contemporary interiors. All horn parts, fully adjustable bracket and base-canopy, are finished in brushed satin aluminum. Base-canopy conceals wiring and matching transformer, if required. All mounting hardware included. May be used outdoors in sheltered location.

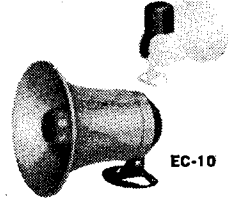

EC-10

DU-12N With driver type reproducer unit for high efficiency, directivity and intelligibility.

DC-5 With high efficiency weather-resistant 5" diameter cone speaker for pleasing reproduction of low level voice and music. Ideal for churches, conference halls, restaurants and similar quiet surroundings.

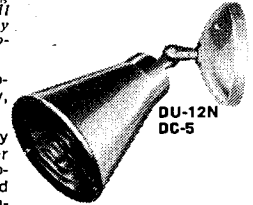

DU-12N
DC-5

MODEL	POWER	IMPEDANCE (specify)	FREQUENCY cps	SOUND LEVEL#	DISPERSION	DIMENSIONS	SHIPPING WEIGHT	NET PRICE
EC-10	6 Watts	8 or 45 ohms	400-13,000	112 db	125°	6 1/4" Bell dia. 6 3/8" deep	2 1/2 lbs.	8Ω \$15.15 45Ω \$16.65
*HU-12N	7.5 Watts	8 or 45 ohms	350-13,000	115 db	120°	7 1/2" Bell dia. 7 1/4" deep	3 1/2 lbs.	8Ω \$18.75 45Ω \$20.25
*HU-15N	25 Watts	8 or 45 ohms	250-13,000	123 db	100°	9 3/4" Bell dia. 8 3/4" deep	6 lbs.	8Ω \$22.95 45Ω \$24.45
HU-24N	25 Watts	8 or 45 ohms	200-13,000	124 db	95°	11 1/4" Bell dia. 12" deep	6 lbs.	8Ω \$25.80 45Ω \$27.30
CJ-14N	7.5 Watts	8 or 45 ohms	350-13,000	115 db	120° x 60°	5 1/2" high 9 1/2" wide 8" deep	3 1/2 lbs.	8Ω \$21.15 45Ω \$22.65
CJ-30N	25 Watts	8 or 45 ohms	250-13,000	121 db	120° x 60°	6" high 14" wide 11 1/4" deep	7 lbs.	8Ω \$27.80 45Ω \$29.10
TP-15N	25 Watts	8 or 45 ohms	250-13,000	120 db Each horn	100° Each horn	9 3/4" Bell dia. 16 1/2" long	7 1/2 lbs.	8Ω \$36.45 45Ω \$37.95
TP-24N	25 Watts	8 or 45 ohms	200-13,000	121 db Each horn	95° Each horn	11 1/4" Bell dia. 23" long	8 lbs.	8Ω \$40.80 45Ω \$42.30
DU-12N	7.5 Watts	8 or 45 ohms	350-13,000	115 db	110°	7" Bell dia. 14" long	4 lbs.	8Ω \$24.90 45Ω \$26.40
DC-5	6 Watts	8 ohms	120-7,000	105 db	—	7" Bell dia. 14" long	3 lbs.	8Ω \$15.75

Available with factory preassembled and prewired T-11 weatherproof line transformer. Model HU-12NT: Net Price: \$27.00. Model HU-15NT: Net Price \$29.85 # Measured at 4 ft. on axis rated power.

NEW! ATLAS SOUND SECTORAL HORNS

WCH-100 Extremely rugged cast aluminum sectoral horn for difficult environmental or atmospheric locations. Ideal for stadiums, factories, mills, industrial yards, etc. For use with any Atlas Sound driver or unit having 1 3/8"-18 thread. Unique mounting bracket permits adjustment in two planes. Dispersion: 120° x 50°. Dimensions: 18" high x 23" wide x 15" deep. Weight 17 lbs.

WCH-200 Same as WCH-100 except designed to accommodate flanged mounted drivers.

WCH-100 Net Price \$69.00
WCH-200 Net Price \$70.80

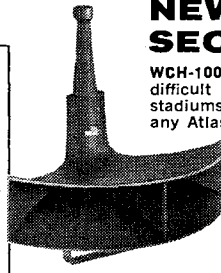

ATLAS SOUND Columair SOUND COLUMNS

(with exclusive EASY-MOUNT Universal Bracket)

In-line array of 6 frequency adjusted cone speakers. Configuration produces a sound pattern having a broad horizontal and narrow vertical distribution. Uniform sound intensity even at varying distances from the sound column. EASY-MOUNT swivel bracket permits optimum adjustment of critical beam pattern.

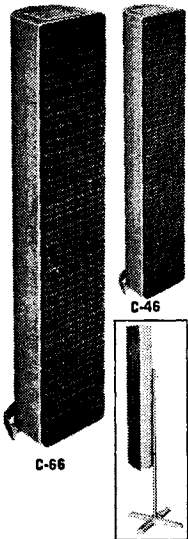

C-46

C-66

SPECIFICATIONS	C-46	C-66	WR-7
Speaker Array	Six, Four-Inch	Six, Six-Inch	
Frequency Range	200-10,000 Hz	125-10,000 Hz	70-15,000 Hz
*Power Capacity	20 Watts	40 Watts	15 Watts
**Vert. Distribution Angle	26-36 Degrees	22-32 Degrees	
**Hor. Distribution Angle	120-160 Degrees	120-160 Degrees	
Impedance (Total)	16 Ohms	16 ohms	8 ohms
Dimensions	28" x 5 1/4" x 5"	42" x 7 3/4" x 6"	18" x 8" x 5 1/2"
Net Weight	8 1/4 Lbs.	18 1/2 Lbs.	8 lbs.
Net Price	\$42.00	\$63.60	\$23.40

Model MK-1 Columair stand attachment kit..... Net Price \$1.70
Model SS-4 Speaker stand for Columair..... Net Price \$16.70

ATLAS SOUND EXPLOSION-PROOF HIGH EFFICIENCY SPEAKERS

Listed by Underwriters Laboratories for use in hazardous locations where explosive atmospheres exist. Highly efficient due to exclusive design of explosion barrier. CLASS 1 speakers for use in atmospheres containing ethyl ether, cyclopropane, gasoline, naphtha, benzene, butane, acetone, lacquer, natural gas, etc. CLASS 2 can be used in Class 1 conditions as well as in atmospheres containing dust of magnesium, coal, coke, flour, starch, grain, etc. Complete specifications in ATLAS SOUND catalog. Net Prices from \$82.20 to \$101.40



HLE-1-30
HLE-1-32

HLE-2-30
HLE-2-32

ATLAS SOUND HIGH POWER ELECTRONIC SIREN AND MOBILE SPEAKERS

HPC-75 For electronic siren applications and high power mobile power address use. Low silhouette public glass, cobra-flare horn gives wide dispersion. Rigid, one-piece cast bracket for fail-safe mounting. Weatherproof. Power: 75 watts. Impedance: 16 ohms. Response: 225-8,000 Hz. Dispersion: 120° x 160°. Dimensions 6" high x 14" wide x 11 1/4" deep. Shipping wt: 8 1/2 lbs. Net Price \$61.20

HPR-75 Same as HPC-75 except with round horn and 100° dispersion. Dimensions: 9" bell diameter, 8 3/4" deep. Wt: 7 lbs. Net Price \$54.00

HP-75 High power public address and electronic siren driver unit only. 1 3/8"-18 driver threads for use on any industry-standard horn. Power: 75 watts. Impedance: 16 ohms. Response: 125-8,000 Hz. Dimensions: 4 3/8" diameter, 3 3/4" deep including threads. Shipping wt: 4 3/4 lbs. Net Price \$36.00

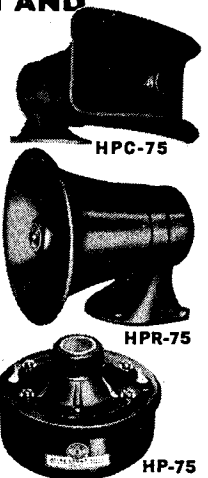

HPC-75

HPR-75

HP-75

ATLAS SOUND, Division of American Trading and Production Corporation, In Canada: Atlas Radio Corp. ATLAS SOUND... YOU CAN HEAR THE DIFFERENCE



ATLAS SOUND



ATLAS SOUND MICROPHONE DESK STANDS AND ACCESSORIES

DS-4 Highly polished molded phenolic base is light beige in color with chrome upright tube. The smooth base will not scratch or mar table tops. Upright tube can be easily removed from base. Base diameter 5", height of tube 4", thread size 5/8"-27. Shipping weight 1/2 lb. Net Price \$1.70

DS-5 Non-Adjustable Desk Stand Base cast iron, finished in black wrinkle. Base diameter 6", tube height 4" chrome finish. Shipping Weight 2 lbs. Net Price \$2.50

DS-7 Same as above but equipped with upright adjustable from 8 to 13 inches. Shipping Weight 3 lbs. Net Price \$4.15

DS-10 "Stream Liner" Desk Stand: Features "Rear Cable Exit". Bright chrome trim. Rubber bumpers. Shipping Weight 1 1/2 lbs. Net Price \$4.30

TS-8 Adjustable Banquet Stand. Low silhouette base. Upright adjustable from 14 1/2" to 26". In full super-chrome. Shipping Weight 5 1/2 lbs. . . Net Price \$7.70

DS-9 Professional Desk Stand. Handsome appearance of modern, low silhouette base and tapered upright, both finished in satin chrome, complements the finest microphones. Stable 8" diameter base protects against accidental microphone damage. 4" upright tube. 5 felt base pads (4 lbs.) Net Price \$6.00

DS-14 Desk stand is functionally and aesthetically suited to slim, elongated microphones. Black wrinkle finished base with protective felt pads and 3" polished chrome upright tube with 5/8"-27 thread. (2 lbs.) . . . Net Price \$3.20

SB-1 Dispatcher and Switchboard Mike Support. 12 inch long, flexible, chrome plated "goose neck" arm mounted on spring loaded swivel, can be swung aside when not in use. Feed thru hole located at the mike end of the "goose neck" so that mike cable can be concealed within flexible arm. Base casting is rear loaded so the base will not tip forward. Finish—Black wrinkle. Shipping Weight 13 lbs. Net Price \$12.65

SW-1 Gyromatic Swivel permits microphone to be adjusted to any angle. Locks in any position. Die cast finished in chrome Net Price \$3.85

LO-2 "Lock-On" accessory for instantaneous microphone attachment or removal without threading on or off any stand or support. One half of LO-2 remains fastened to the microphone, the other half stays on the stand. Excellent where microphones must often be removed. Positive lock holds microphone safely in hanging positions on booms, ceiling supports, stage battens. Chrome finish Net Price \$2.65

SO-1 "Snap-On" accessory. Identical to LO-2 but less locking feature. Spring loaded, ball bearing design for secure, safe microphone attachment and quick disconnect on any upright floor stand Net Price \$2.15

FS-1 Foot Switch for press-to-talk paging applications using any microphone with a single ended input. May also be hand operated on desks and switchboards. Easily rewired for press-to-open circuit application. . . . Net Price \$9.85

NS-1 "The Chesty" Neck Supported Mike Holder. Permits quick, simple "three way" adjustment. Mike is always in suitably "close talking" position reducing acoustic feedback problems. Wide comfortable chest support prevents rolling due to sudden movement. Cool and lightweight. 6 oz. Net Price \$4.70

GN "Goose Necks" can be attached to any microphone stand or fixture; ends have 5/8"-27 male and female threads—all finished in bright chrome, model numeral indicates overall length of "goose neck" in inches. Net Price GN-6 \$1.50, GN-13 \$2.00, GN-19 \$2.80

US-2 Multi-Purpose microphone support. For use with language laboratories, dispatcher desks, telephone switchboards, pulpits, etc. Boom arm vertical adjustment and rotation motion is spring loaded and will "float" the mike in desired position without requiring a locking adjustment. Microphone cable may be concealed within boom arm and will feed thru swivel assembly and base flange. A small opening is provided at microphone end of the boom for cable entry. Finished in "super-chrome". Boom arm length 12 3/4"; vertical adjustment of boom 180°; rotation 360°; base length 2 5/8" . . . Net Price \$6.65

BC-1 Bracket Clamp. Can be used with a boom arm, goose neck, etc. Chrome tube 6" long. Clamp can be removed and top flange screwed or bolted in position. 5/8"-27 thread Net Price \$2.80

CH-1 Cable Hanger. Fits all tubes 7/8" to 1 1/4" diameter. Mike cable can be quickly coiled and looped over the cable hanger when moving, storing or transporting the mike and stand. Finished in polished chromium. Net Price \$2.00

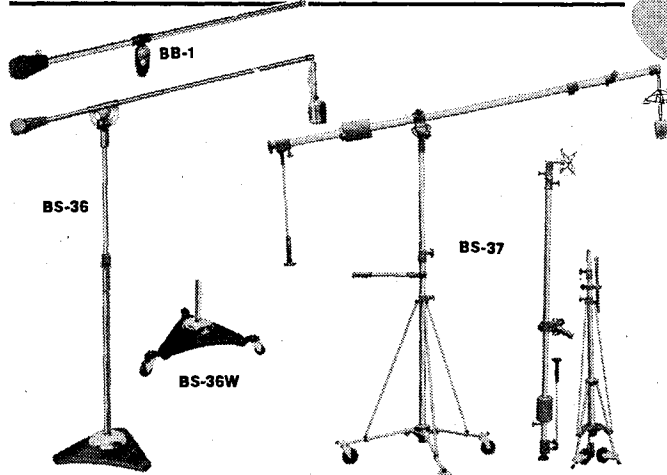
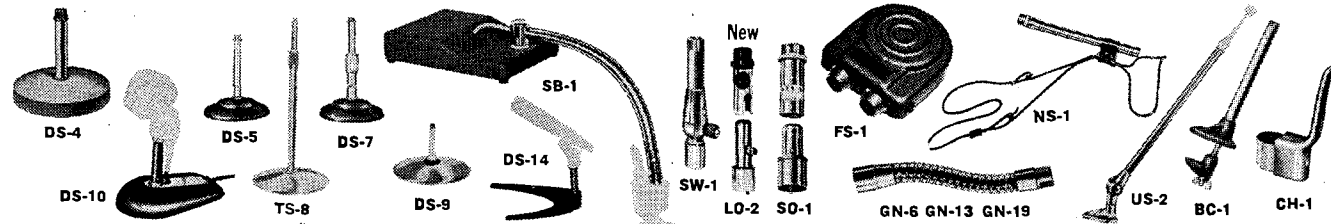

ATLAS SOUND STANDS

BB-1 "Baby Boom" Attachment. Versatile device can be attached to any floor stand. All swivel parts are precision die castings for smooth operation and secure positioning. Boom 31"—Chrome plated 5/8"-27 thread. Shipping weight 3 1/2 lbs Net Price \$6.20

BS-36 Professional Boom Stand with "Safety Air Lock Cushion" offers all advantages of "Floating Action" plus secure and dependable locking adjustment. Air Lock built into vertical section prevents any accidental or sudden slippage of the upright section. A gyromatic swivel joint is provided at the microphone end. Base casting equipped with shock absorbent chrome plated, "domes of silence". Boom length 62" (extension may be added). Vertical extension from 48" to 72".

All tubular sections super-chrome plated. Base finished in polished chrome and black wrinkle. Shipping weight 36 lbs. Net Price \$50.00

BS-36W Mobile Model. Identical to BS-36 except that base is supplied with ball bearing swivel casters, permitting entire stand to be wheeled to various positions in the studio. Shipping weight 40 lbs. Net Price \$56.65

BS-37 Porto Boom. For most exacting TV studio, sound motion picture application, etc., ideal for portable service. Fully collapsible to fit automobiles. Air check prevents any accidental collapse of the upright. Upright retracted 5 1/4 ft., extended 9 ft. Boom retracted 7 ft., extended 18 ft. All tubular sections aluminum processed in "Alumilite". Counter weight cast iron with bronze locking mechanism. Base casters 4" swivel type. Base spread 42" on radius. Shipping weight 73 lbs. Net Price \$516.65

ATLAS SOUND MICROPHONE ADAPTERS AND FITTINGS

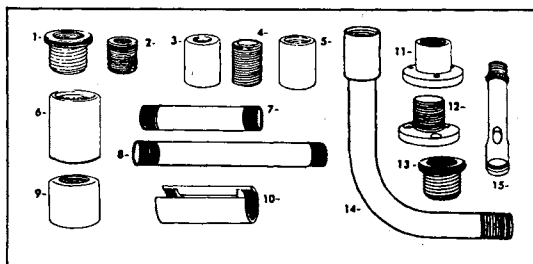

ATLAS SOUND,
Division of American Trading and Production Corporation,
In Canada: Atlas Radio Corp.
ATLAS SOUND . . . YOU CAN HEAR THE DIFFERENCE

Model	Description	Net Price
AD-1	1-5/8"-27 female to 1/2" pipe thread male (RCA Adapter)	.70
AD-2	2-1/8" pipe female to 5/8"-27 male	.50
AD-3	3-1/8" pipe female to 5/8"-27 female	.53
AD-4	4-3/4" long, 5/8"-27 male running thread	.40
AD-5	5-5/8"-27 female to 5/8"-27 female, coupling	.53
AD-6	6-7/8"-27 female to 7/8"-27 female, coupling	1.00
AD-7	7-3" long tube 5/8"-27 male each end	.67
AD-8	8-6" long tube 5/8"-27 male each end	.67
AD-9	9-7/8"-27 female to 5/8"-27 female	.73
AD-10	10-5/8"-24 female to 5/8"-27 female (W. E. Adapter)	1.10
AD-11	Flange, 5/8"-27 female. Base Diameter 1 3/4"	.73
AD-12	Flange, 5/8"-27 male. Base holes on 1 1/4" mounting centers	.73
AD-13	13-7/8"-27 male to 5/8"-27 female	.73
AD-14	Right angle bent tube: 5/8"-27 male and female each end	1.16
AD-15	Cable "Feed-Thru" adapter: 5/8"-27 male and female each end	1.10

Note: Thread sizes specified as 1/8" pipe is I.P.S. (Electrical fitting) Measures Approx. 3/8" dia. All adapters chrome plated.



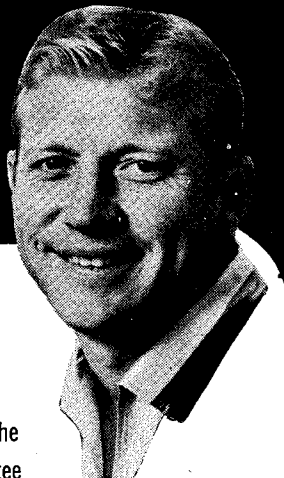

POWERHOUSE TRUMPET SPEAKERS

proven sound around the world®



Take it from Mickey Mantle†
 "FEDTRO...the proven sound of champions"

"proven sound around the world"® from the blistering humid depths of Equatorial Africa...to the frigid waters of the Arctic Seas, Fedtro Powerhouse Speakers are ruggedly constructed to guarantee optimum performance, even under the most brutal of climatic extremes.  Shockproof, rustproof, and totally weatherized, the entire Fedtro series is ideally suited for the most trying applications of Marine and Mobile use...Public Address, Paging and Talkback Systems. The diaphragm is constructed with a special resinification process, which permits it to withstand higher than 30% power input overloads.  Engineered and designed to afford the highest degree of clarity and intelligibility over the complete frequency spectrum, from the compact S-5RD to the mammoth S-16RD, there's a perfect Powerhouse available for your specific needs.  Greater efficiency...increased power output...higher intelligibility...and almost indestructible durability...all add up to why they are "proven sound around the world"®.



MODEL S-5RD

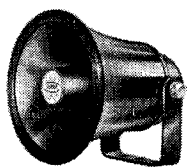

MODEL S-6RD

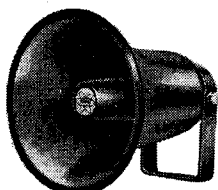

MODEL S-8RD

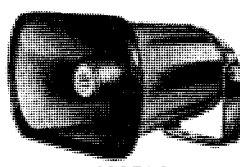

MODEL S-8BX

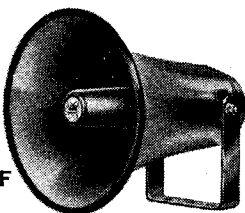

MODEL S-12RD

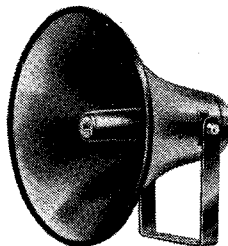

MODEL S-16RD

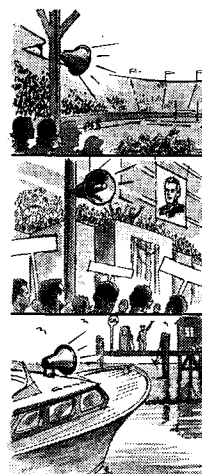

Ruggedly Constructed for Outdoor, Indoor, Marine and Mobile Use

- WATERPROOF ■ SHOCKPROOF
- RUSTPROOF ■ CORROSIONPROOF
- DYNAMIC 3-COLOR
- CUSTOM PACKAGING

FEDTRO POWERHOUSE TRUMPET SPEAKER SPECIFICATION CHART	Model No.	Power Rating		Voice Coil Impedance	Frequency Range	Bell Diameter (Horn Opening)	Overall Length	Net Weight
		Program	Peak					
	S-5RD	8 watts	12 watts	8 ohms	200 to 13,000 cps.	5 inches	5 inches	approx. 1 lb.
	S-6RD	10 watts	15 watts	8 ohms	200 to 13,000 cps.	6 inches	6½ inches	approx. 2 lbs.
	S-8RD	15 watts	25 watts	8 ohms	200 to 13,000 cps.	8 inches	8½ inches	approx. 2½ lbs.
	S-8BX	15 watts	25 watts	8 ohms	200 to 13,000 cps.	8 inches x 5 inches	8 inches	approx. 2.4 lbs.
	S-12RD	30 watts	65 watts	8 ohms	150 to 13,000 cps.	12 inches	13¼ inches	approx. 4.4 lbs.
	S-16RD	40 watts	75 watts	8 ohms	150 to 13,000 cps.	16 inches	13 inches	approx. 5.3 lbs.

GET MORE SOUND FOR YOUR DOLLAR WITH FEDTRO POWERHOUSE SPEAKERS!

SUPERIOR QUALITY...

... at the lowest prices in the industry



proven sound around the world®

© COPYRIGHT 1968 • FEDTRO INC.

†MICKEY MANTLE ENDORSES ALL FEDTRO AUDIO PRODUCTS



FOR FEDTRO POWERHOUSE TRANSISTORIZED MEGAPHONES, SEE PAGES 52 & 53
 FOR FEDTRO TRANSISTORIZED INTERCOMS, SEE PAGES 54 & 55

Electro-Voice®

MICROPHONES

Cardioid Dynamic Microphones

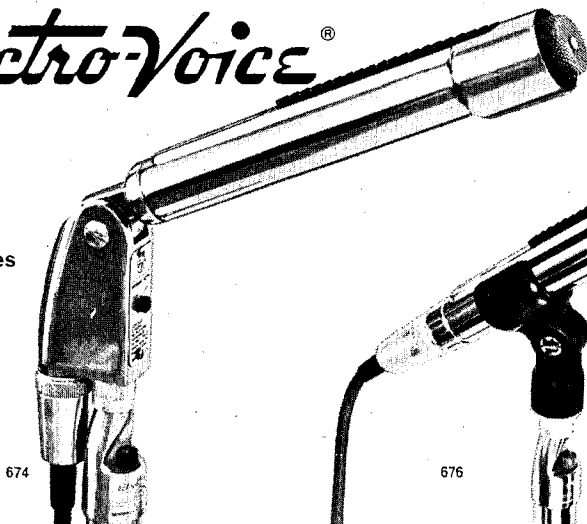

674

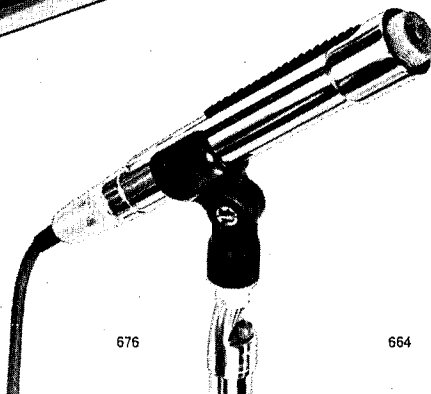

676

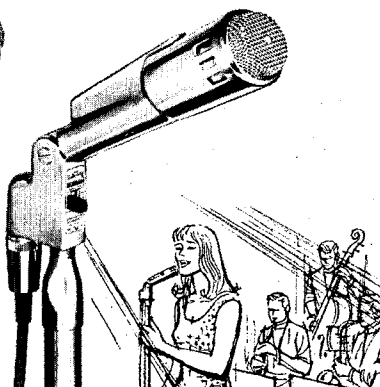

664

674: Radically new design brings truly professional quality to public address, recording, communications, and other general purpose microphone applications. An exclusive Continuously Variable-D® microphone† which assures uniform symmetrical cardioid pattern at all frequencies. Highest discrimination against feedback and unwanted sound. Exclusive three position switch offers controlled low-frequency attenuation to overcome rumble and feedback when microphone is used at a distance. Slim design permits full view of person speaking. Rugged high pressure die-cast construction. Dual Lo-Z and Hi-Z. E-V QC™4M cable connector allows easy change of impedance without tools by moving a single pin. Frequency response: 60–15,000 Hz. Output: –27 db. Satin chrome finish. Net \$53.40
APPLICATIONS: Public address/Base station communications/Quality tape recording in the home and in schools.

674A: Non-reflecting gray finish. Shipped wired for Lo-Z. Net \$53.40
 674G: Gold finish. Net \$56.70

676: Similar to 674, except less mounting stud and on/off switch. For use with stand mounting clamp (supplied) so microphone can easily be removed and used hand-held during performance. Very uniform polar pattern across audio spectrum. Three position bass tilt selector adjusts low frequency response to suit environment. Response: 60–15,000 Hz with low-frequency attenuation switch. Output: –57 db. Dual Lo-Z and Hi-Z. New E-V QC™4M cable connector allows easy change of impedance without tools by moving a single pin. Satin chrome finish. Net \$53.40

676A: Non-reflecting gray finish. Shipped wired for Lo-Z. Net \$53.40
 676G: Gold finish. Net \$56.70

664: Designed for quality tape recording, communications, and public address applications. Cardioid pattern at all frequencies, with Variable-D® feature†. Permits close talking without “booming” or bass attenuation. Provides better discrimination against unwanted sound. Blast filter minimizes wind effect. E-V Acoustalloy® diaphragm shielded from dust and magnetic particles. Response: 60 to 15,000 Hz. Output: –58 db. On/off switch. Dual Lo-Z and Hi-Z. E-V QC™4M cable connector allows easy change of impedance without tools by moving a single pin. Satin chrome finish. Net . . . \$53.40

664A: Non-reflecting gray finish. Shipped wired for Lo-Z. Net \$53.40
 664G: Gold finish. Net \$56.70

Unidirectional Line Microphone

644: Combination cardioid and distributed front opening* instrument, making it the most directional PA microphone available. Better than 2½ times working distance of pressure types with virtually no change in response. Extremely high rejection of noise from sides and rear, reducing reverberation and feedback. Narrow front angle of acceptance for best isolation. Very low response to wind noise and shock. Response is smooth from 40 to 10,000 Hz. Output: –53 db. Dual Lo-Z and Hi-Z, selected by moving one wire in cable connector. High pressure die cast case, satin chrome finish. Acceptance angle: 90°. Net \$69.30

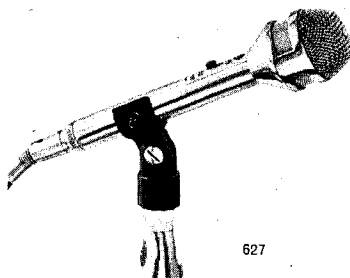
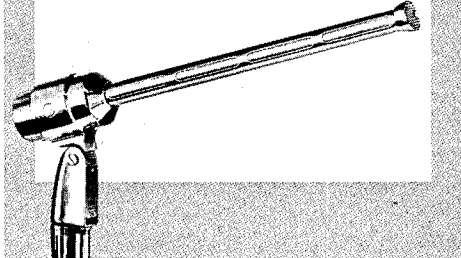

627

627: “Single-D” cardioid. Low frequency response varies with working distance. “Robust” sound enhanced when microphone is close to lips. Low frequency response to sounds more than two feet away is reduced, improving feedback control. Built in breath and pop filter. Acceptance angle: 150°. With on/off switch. Satin chrome finish. Response: 80 to 11,000 Hz. Output: –58 db. Hi-Z or Lo-Z, must be specified. Net \$37.80

APPLICATIONS: Auditorium/Music Instruction/Tape recording—home and school /Recording for special effects through use of unique low frequency characteristic.

627N: Same as 627 but with matte satin nickel finish. Net \$37.80

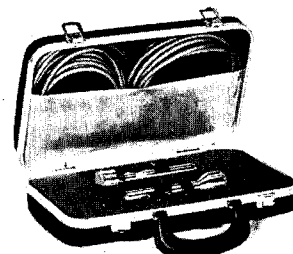

Convenient, Durable Carrying Cases

457: Deluxe double carrying case only. Holds two microphones and cables. Attractive instrument-type case with metal trim. Microphones are fully protected by contoured plastic interior that holds them snugly in place assuring protection from scratches, bumps, or other damage. Specify for 627, 631, 664, or 676 microphones. Net \$15.00

456: Single microphone carrying case only, has space for cable. Microphone nests in contoured foam plastic insert. Specify for 627, 631, 664, 674, or 676 microphone. Net \$5.40

* U.S. Patent No. 3,095,084
 † U.S. Patent No. 3,115,207

Electro-Voice®

COMMUNICATIONS AND PAGING MICROPHONES



602FTR: Transistorized noise cancelling dynamic mobile with built-in transistor amplifier. Provides level for direct replacement of carbon units. Maximum output: -43 db with 250 ohm load and 27 V supply. Output adjustable from exterior. Response: 100 to 5,000 Hz. Press-to-talk switch and coiled cord with phone plug at terminal end. Lo-Z, Net \$40.80



205STCKK: Noise cancelling, single button carbon for aircraft and emergency communications. FAA approved. Blast-proof, waterproof, and shock resistant. Output at ¼": -50 db. Lo-Z. Black phenolic case. Press-to-talk switch and coiled cord. Net \$31.50
205STCKKP: With PJ-068 phone plug. Net \$34.50



603TR: Transistorized noise cancelling mobile providing all dynamic advantages for direct replacement of carbon units. Built-in transistor amplifier matches level of carbon circuits. Output adjustable with internal potentiometer up to -44 db. Excellent for aircraft applications. Response: 200 to 4,000 Hz. Lo-Z. Press-to-talk switch and coiled cord. Magnetic hanger bracket furnished. Net \$88.20



602TR: Similar to 603TR but different case design. Uses conventional hanger bracket. Fixed output level: -48 db (carbon equiv.) Response: 100 to 5,000 Hz. FAA approved. Net \$58.50



600E: Dynamic mobile of rugged construction. Lo-Z has "open circuit" wiring for multiple paging installations. Hi-Z provides "straight through" circuit for VOX operations. Output level: -55 db. Response: 100 to 7,000 Hz, matched to high intelligibility requirements. Gray. With hang-up bracket. Specify Hi-Z or Lo-Z. Net \$24.60



602F: Similar to 602FTR, less transistor amplifier. For circuits designed for dynamic microphones. Output: -60 db. Hi-Z or balanced Lo-Z must be specified. Net \$36.30



714: Ceramic hand-held unit for paging, ham radio, and CB. Cyclocac case for long life and protection from shock. High impedance output: -55. Response tailored for high intelligibility: 100 to 7,000 Hz. DPDT switch. Coiled cord extends to 5'. Bracket included. Net \$10.50

717: Similar to 714, except cardioid pickup. Aperture on either side of diaphragm provides attenuation of sound arriving from rear and sides. Output: -55 db. Response: 100 to 7,000 Hz. Net \$12.30

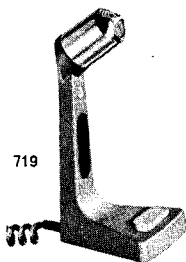

719: Ceramic base station unit for communications or paging. Switch for press-to-talk in base or move to upper part of stand for grip-to-talk use. Stand and head are die cast, nonreflecting gray and chrome plated, respectively. Hi-Z. Output: -58 db. Response: 70 to 7,000 Hz. Net \$17.40

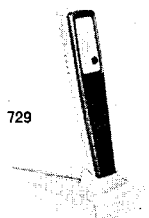

729: Ceramic cardioid reduces random noise, reverberation, and feedback. For PA, paging, home recording, and general communications. Excellent VOX operations. Tailored for single sideband. Output: -60 db. Response: 60 to 8,000 Hz. Hi-Z. 8½' cable. Stand adapter supplied. Net . . . \$15.30
729SR: With relay switch. Net \$16.80

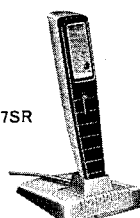

727: Omnidirectional, similar in appearance to 729. Withstands extremes of temperature and humidity. Hi-Z. Response: 60 to 8,000 Hz. Output: -55 db. Net \$12.60
727SR: With relay switch. Net \$14.70

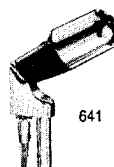

641: Modern two-tone dynamic microphone for public address, home recording, communications, electronic teaching aids, and paging systems. Integral on/off switch. Wide range response: 70 to 10,000 Hz. High output level: -57 db. 15' cable. Case is chrome plated die-cast zinc and gray high impact plastic. Hi-Z or balanced Lo-Z must be specified. Net . . . \$24.90

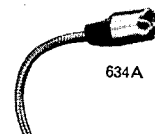

634A: Similar to 641 but without stand mounting stud or on/off switch. Fits any stand, boom, or goosneck with complete cable concealment. Ideal for electronic teaching aids, amateur and commercial communications, and paging systems. Hi-Z or balanced Lo-Z must be specified. Net . . . \$18.90



648: Extremely versatile paging, intercom, or talk-back microphone. Omnidirectional with Acoustalloy diaphragm. Non-reflecting gray. Does not include cable. Hi-Z or Lo-Z must be specified. Net \$35.40

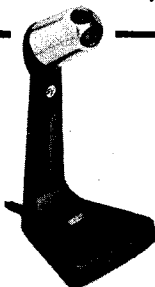

619TR: Unique base-station microphone with built-in transistor amplifier and speech compressor ideal when high value of average modulation (PEP) is important. Eliminates need for special clipper or compressor equipment and can be used with any impedance or input level. Rugged die-cast stand in non-reflecting gray with chrome die-cast head. Grip-to-talk switch in stand riser, compression meter in base. Response: 150 to 10,000 Hz. Output (at compression threshold) Hi-Z: -42 db; 3000 ohm: -44 db; 150 ohm: -58 db; maximum output with gain and compression controls at max.: -40 db. Net \$42.00



606: Differential dynamic is close talking, noise cancelling. Accepts sounds of close origin (¼") and rejects sounds of distant origin. Response: 100 to 5,000 Hz. Output at ¼": -55 db. Acoustalloy diaphragm. Has built-in connector and satin chrome finish. Hi-Z or balanced Lo-Z must be specified. 15' cable. Net \$33.00



625TRSKK: Transistorized noise cancelling handset for intercom and communications on aircraft or other applications demanding rejection of high level background noise. No changes required in carbon circuits. Phenolic case holds Lo-Z microphone and 150 ohm magnetic receiver. FAA approved. Response: 100 to 5,000 Hz. Output: -48 db (carbon equiv.). Five-conductor coiled cord. Net \$77.10
625SKK: Same as 625TRSKK but without transistor amplifier. For paging, intercom, and communications work. Output: -55 db. Net . . . \$53.40

ELECTRO-VOICE, INC. • Division of Gulton Industries, Inc.



Electro-Voice®

SOUND REINFORCEMENT LOUDSPEAKERS

MUSICASTER: High fidelity performance in compact, portable system. Aluminum diecast housing protects weatherproof cone speaker, extends bass response. Dual Radax cone radiates smooth highs through 120 degree angle. Provision for mounting 70.7 V line transformer inside. Frequency response: 60 to 13,000 Hz. Nominal impedance: 8 ohms. Power handling capacity: 30 watts program. Sound pressure level: 110 db. 21½" square, 8½" deep. Net \$72.00

MUSICASTER II: Same as above except added brilliance and wider coverage. Response: 60 to 18,000 Hz. Complete with crossover. Net \$90.00

M253: Multicellular horn (less driver) weatherproof for indoor or outdoor use. Dispersion essentially uniform (60° vertical, 120° horizontal). Two rows of five cells are jig assembled and covered with special black damping compound. Accepts any E-V driver with 1-3/8"-18 thread. Low frequency cutoff 300 Hz. Mounting hardware supplied. Driver-throat built in. 17½" h, 30½" w, 36½" d. Steel construction. Net \$189.00

LR7: Largest E-V Line Radiator. Low- and high-frequency response extended. Uses nine 5" by 7" speakers and two T35 VHF drivers for frequency range of 200 to 17,000 Hz. Crossover at 3500 Hz. Horizontal coverage 160°, vertical coverage 60°. Power handling capacity: 50 watts, impedance: 8 ohms. Non-resonant, curved* wood enclosure finished in Mesa Tan. Universal mounting brackets supplied. 60" h., 11" w., 14" d. Net \$195.00

LR4SA: Weatherproofed for outdoor or indoor installation. Extruded aluminum case is finished in Faun metallic. Electrical filters remove end speakers from circuit as frequencies increase, eliminating high frequency lobes at ends. Frequency response: 200 to 10,000 Hz. Impedance: 8 ohms. Power handling capacity: 40 watts program. Dispersion: 30° vertical, 160° horizontal. Sound pressure level: 116 db. 48-3/8" l., 6-5/8" w., 4-7/8" d. Universal mounting bracket and one Model 460 bracket for heavy-duty stand mounting supplied. Net \$99.90

LR2SA: Short version of LR4SA. Greater vertical dispersion (45°). Response: 200 to 10,000 Hz. Impedance: 8 ohms. Power handling capacity: 20 watts program. 24½" l., 6-5/8" w., 4-7/8" d. Two Model 460 brackets supplied. Net \$55.50

LR4A: Curved design* overcomes unwanted high frequency dispersion at ends, eliminates echo and feedback. Uses nine 3" x 5" and three 3½" cone speakers. 160° horizontal dispersion, 60° vertical dispersion. Frequency response: 200 to 10,000 Hz. Power handling capacity: 25 watts program. Nominal impedance: 8 ohms. 49" h., 7" w., 13" d. Mesa Tan wooden enclosure. Net \$94.80

*U.S. Patent No. 3,125,181

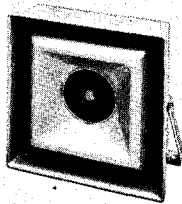

MUSICASTER

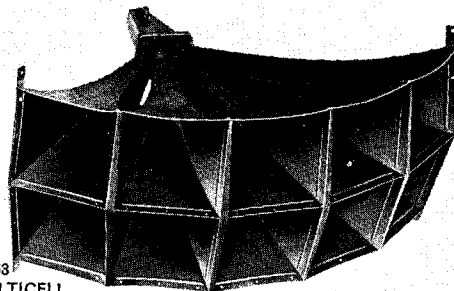

M253
MULTICELL

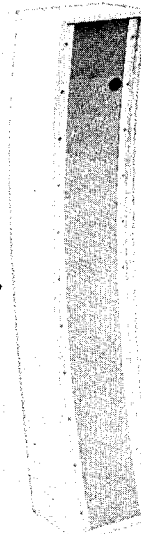
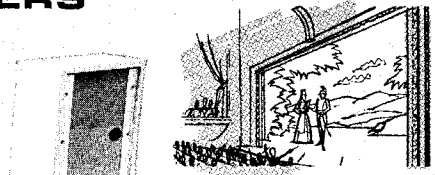

LR7

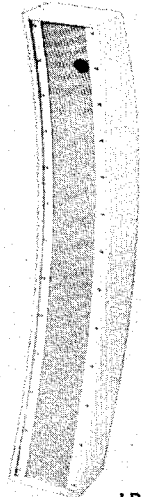

LR4A

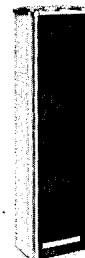

LR2SA

Paging Speakers

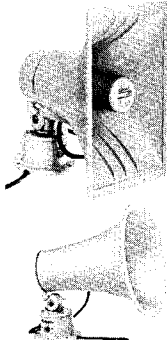

PA30AT-7: 30 watt projector with integral 70.7 V line transformer. Line power taps at 30, 15, 8, 4, and 2 watts. Rugged Implex horn. Smooth response for voice or music: 250 to 14,000 Hz. Universal swivel bracket. Power handling capacity: 30 watts. Dispersion: 120° x 90°. EIA sensitivity rating: 60 db. Sound pressure level: 127 db. 11½" h., 6½" w., 9¾" d. Net \$28.50

PA30AT-2: Same as above except integral transformer is 25 volts. Net \$28.50

PA30A: Same as PA30AT but no line transformer. Will accept model TR30. Nominal impedance: 8 ohms. 11" h., 6½" w., 8½" d. Net \$21.90

PA30A-45: Same as above but with 45 ohm voice coil for intercom systems. Net \$23.10

PA30RT-7: 30 watt reentrant projector with round spun-aluminum bell. Integral 70.7 V line transformer with power taps at 30, 15, 8, 4, and 2 watts, part of mounting base. Response: 250 to 14,000 Hz. Power handling capacity: 30 watts. Impedance: 8 ohms. Dispersion: 105°. EIA sensitivity rating: 60 db. Sound pressure level: 127 db. 12-1/8" h., 10¼" d., diameter, 10". Net \$30.60

PA30RT-2: Same as above except 25 volt transformer. Net \$30.60

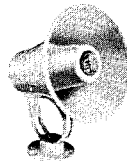

PA30R: Same as PA30RT but no line transformer. Will accept model TR30. Nominal impedance 8 ohms. Horn diameter 10", 9¾" deep. Net \$23.70

PA30R-45: Same as above but with 45 ohm voice coil. Net \$23.70

PA7: Reentrant projector constructed completely of Implex—virtually indestructible. Diaphragm design eliminates loading problems, provides clean reproduction. Handles 7½ watts over range of 400 to 13,000 Hz. 120° dispersion angle. Mounting bracket allows horn to be positioned at any angle. 6¾" diameter, 6" deep. Net \$18.75

PA7-45: Same as above but with 45 ohm voice coil. Net \$19.50

844A: Smooth response with better lows to provide natural paging without feedback. Handles 30 watts.

Rugged die-cast horn, field replaceable voice coil. Frequency response: 250 to 13,000 Hz. Power handling capacity: 30 watts program. Nominal impedance: 8 ohms, nominal dispersion: 90°. EIA sensitivity rating: 54 db. Sound pressure level: 123 db. 9-7/8" diameter, 7-7/8" deep. Net . . . \$22.95

847: Utilizes E-V CDP® principle. Wide angle speaker provides high articulation over uniform 120° x 90° area. Uses TWO diffraction horns. Power handling capacity: 25 watts. Frequency response: 250 to 10,000 Hz. Sound pressure level: 114 db. Impedance: 16 ohms. Fiberglass Mesa Tan horn. 11¼" l., 7¼" w., 10¼" deep. Net \$35.40

OXFORD TRANSDUCER
COMPANY Division of OXFORD ELECTRIC CORPORATION

*Quality Speakers
 for Every
 Application*

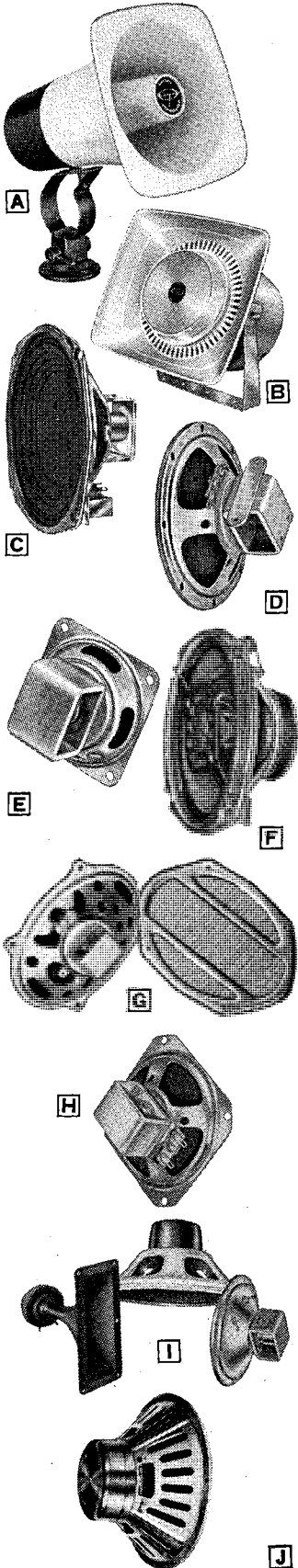

A OP SPECIALIST SERIES OP-4

Models OP-6 and OP-8 represent the most advanced weatherproof paging and talkback speakers. They incorporate new design innovations with new materials to provide the highest efficiency with the lowest distortion factors of any competitive units available.

B OH-10 WEATHERPROOF DUAL SPEAKER SOUND SYSTEM

A high efficiency co-axial speaker that reproduces music and voice with the fidelity of an expensive indoor high-fidelity speaker system yet, the OH-10 is rugged and completely weatherproof. Components are housed in die-cast aluminum inclosure which is designed to compliment every setting from the shopping center to the patio.

C SPEAKERS — COMMERCIAL SOUND

Oxford public address speakers are designed for higher output, with less power input. This maximum conversion efficiency in power and coverage permits a reduction in the number of speakers usually required in an installation. And, lower rated power amplifiers may be used with a substantial savings in cost.

D INTER-COM SPEAKERS

Oxford high efficiency Inter-com speakers are designed to give round, full and clear reproduction in the voice frequency range and at the same time suppress unwanted background noises. Even whispers will be reproduced with great clarity in areas with high background noise levels . . . shouts are reproduced without distortion.

E ALL WEATHER SPEAKERS

Oxford offers a complete line of All Weather speakers specifically designed for maximum operating performance regardless of weather conditions. They feature exclusive Oxford HYDRO-PRUF cones for full environmental protection. Special moisture protected voice coils prevent humidity damage. Extra heavy cadmium plating, inside and out, resists corrosion.

F CERAMIC SPEAKERS

Featuring shallow construction, these speakers are ideal for in-wall, stereo wing, picture frame, and other installations where space is at a premium. In addition to the standard models, Oxford also offers ceramic units with exclusive Oxford Hidden Magnet design. The magnet is mounted between the basket and the cone, permitting use of the dual cone for extended range while retaining the thin silhouette.

G EXACT REPLACEMENT AUTOMOTIVE RADIO SPEAKERS

A complete line is available, including exact replacement speakers, universal speakers, special units for custom automobiles, and speakers specifically designed for transistorized automobile radios.

H REPLACEMENT SPEAKERS

Oxford manufactures the most complete line of standard replacement speakers available for original equipment, including, phonographs, tape recorders, radios and television sets. The speaker sizes range from 2" through 15", in dimensions to insure a perfect installation.

I HIGH FIDELITY SPEAKERS

The Oxford line offers a full range of woofers, tweeters, extended range and co-axial speakers. They are all designed to reproduce the entire audio spectrum with true high fidelity so necessary for fine stereo reproduction. For the price conscious hi-fi equipment buyer, Oxford offers the most outstanding value.

J PROFESSIONAL MUSICAL INSTRUMENT SPEAKERS

As a "full line" loudspeaker manufacturer, Oxford also produces speakers for many "special purposes." The most popular of these is a series designed for use with electric musical instruments, such as guitars and electronic organs. It is only with a speaker designed for this particular application that the full quality of the instrument and performance can be appreciated.

Manufacturers, Write for Quotes on OEM Quantities.

OXFORD TRANSDUCER COMPANY

A Division of OXFORD ELECTRIC CORPORATION

REAR SEAT SPEAKER KITS

and Accessories

Featuring Oaktron's High Energy cup housing speakers. Solderless hookup — No special tools required for installation. Includes all necessary hardware.

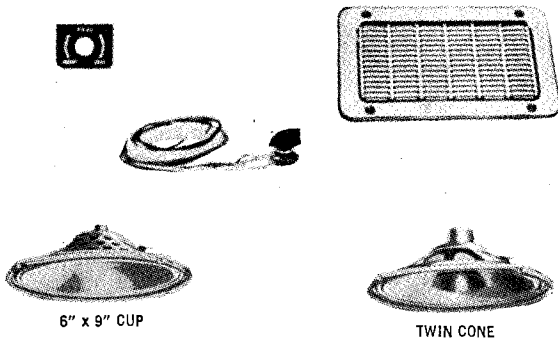

6" x 9" CUP

TWIN CONE

TWIN CONE SPEAKERS

Matched dual cones for true high fidelity sound reproduction.



6" x 9" TWIN CONE

12" ROUND TWIN CONE

Size and Shape	Part Number	Magnet Weight Ounces	Dia. Inches	VOICE COIL Impedance (Ohms)	Power in Watts	Max. Depth in Inches	Sugg. Dealer Price
8" Pin Cushion	8E8WC	2.18 cup	1	8	6	2 1/16	\$4.07
8" Pin Cushion	8F8W	3.16	3/4	8	8	3 1/16	4.43
8" Pin Cushion	8H8W	6.80	1	8	12	4	6.16
8" Pin Cushion	8HU8W	*10.00	1	8	12	3	6.03
12" Round	12H8W	6.80	1	8	12	5 1/2	8.21
6" x 9"	57E8U8W	*6.00	1	8	8	2 3/8	5.15
6" x 9"	69E8WC	2.18 cup	1	8	6	2 7/8	3.69
6" x 9"	68HU8W	*10.00	1	8	10	3 1/16	5.92

* Ceramic Magnet — all others Alnico 5

INTERCOM SPEAKERS

Size and Shape	Part No.	Magnet Weight Ounces	Dia. Inches	VOICE COIL Impedance (Ohms)	Power in Watts	Max. Depth in Inches	Sugg. Dealer Price
3 1/2" Square	35A45C	.53 cup	3/8	45	2	1 1/8	\$1.82
4" Square	4A45C	.53 cup	3/8	45	2	1 1/8	1.67
4" Square	4D45	1.47	3/8	45	3	2 1/8	2.27
5" Pin Cushion	5D45	1.47	3/8	45	3	2 1/8	2.36
8" Pin Cushion	8F45	3.16	3/4	45	8	3 1/16	4.27

TWEETER SPEAKERS

These speakers are true compression type, using totally enclosed baskets and molded curvilinear cones for maximum high frequency radiation, 8 ohm aluminum voice coils and Alnico 5 magnets—Blue luminescent enamel finish.

Size and Shape	Part Number	Impedance	Magnet Weight	V.C. Dia.	Power Watts	Frequency Response	Max. Depth in Inches	Sugg. Dealer Price
3" Square	3C8T	8 Ohms	1.00 oz.	3/8"	4	3000-16,000	1 1/16"	\$2.07
3 1/2" Square	35D8T	8 Ohms	1.47 oz.	3/8"	5	3000-16,000	2	2.36
4" Square	4D8T	8 Ohms	1.47 oz.	3/8"	5	3000-15,000	2 1/8"	2.36
5" Round	5D8T	8 Ohms	1.47 oz.	3/8"	5	2000-15,000	2 3/8"	2.47
4" x 6"	46D8T	8 Ohms	1.47 oz.	3/8"	6	2000-17,000	2 1/8"	2.75

SYSTEMS — HIGH FIDELITY

Matched Trio for Multi-Speaker Application

Size in Inches	Part Number	Impedance	Magnet Weight	V.C. Dia.	Power Watts	Frequency Response	Max. Depth in Inches	Sugg. Dealer Price
12 6x9 4x6 Harness with Crossover	ST-124	8 Ohms	12" Woofer 6.80 oz. 6"x9" Mid Range 3.16 oz. 4"x6" Tweeter 1.47 oz.	1" 3/4" 3/8"	12	35-15,000	5" 3" 2 1/2"	\$17.91

Model	Speaker	Grille	Control	Speaker	Max. Depth in Inches	Sugg. Dealer Price
RK57	5 x 7	Gray	3 Pos. Switch	57C3C	2 3/16	\$5.22
RK57C	5 x 7	Chrome	3 Pos. Switch	57C3C	2 3/16	5.51
RK57F	5 x 7	Gray	Fader	57C3C	2 3/16	5.44
RK57CF	5 x 7	Chrome	Fader	57C3C	2 3/16	5.72
AK69	6 x 9	Gray	3 Pos. Switch	69A3C	2 11/16	5.08
AK69C	6 x 9	Chrome	3 Pos. Switch	69A3C	2 11/16	5.36
AK69F	6 x 9	Gray	Fader	69A3C	2 11/16	5.29
AK69CF	6 x 9	Chrome	Fader	69A3C	2 11/16	5.58
RK69	6 x 9	Gray	3 Pos. Switch	69C3C	2 11/16	5.38
RK69C	6 x 9	Chrome	3 Pos. Switch	69C3C	2 11/16	5.69
RK69F	6 x 9	Gray	Fader	69C3C	2 11/16	5.62
RK69CF	6 x 9	Chrome	Fader	69C3C	2 11/16	5.90
WK69	6 x 9	} Twin Cone	Gray	69E8WC	2 7/8	6.41
WK69C	6 x 9		Chrome	69E8WC	2 7/8	6.70
WK69F	6 x 9		Gray	69E8WC	2 7/8	6.62
WK69CF	6 x 9	Chrome	Fader	69E8WC	2 7/8	6.91
MK69	} Multi-Impedance	Gray	3 Pos. Switch	69EMCF	2 1/4	6.66
MK69C		Chrome	3 Pos. Switch	69EMCF	2 1/4	6.95
MK69F		Gray	Fader	69EMCF	2 1/4	6.88
MK69CF		Chrome	Fader	69EMCF	2 1/4	7.16

ACCESSORIES:

Part No.	Description	Sugg. Dealer Price
FA-1	Fader Control with Presoldered Wire and Hardware	\$1.57
SW-1	Switch Control with Presoldered Wire and Hardware	1.35
CH57	5 x 7 Chrome Grille with Hardware	1.39
CH69	6 x 9 Chrome Grille with Hardware	1.39
GY57	5 x 7 Gray Grille with Hardware	1.10
GY69	6 x 9 Gray Grille with Hardware	1.10

Grills listed above supplied individually visual packed.

HIGH FIDELITY SPEAKERS

ALL OAKTRON HI-FIDELITY SPEAKERS ARE ENCLOSED IN A PLASTIC COVERING AND INDIVIDUALLY BOXED TO INSURE MAXIMUM PROTECTION.

COAXIAL SPEAKERS

Oaktron's coaxial type speakers are superbly engineered to produce a flat response over a wide range of frequencies. These speakers are finished in a glossy royal blue luminescent enamel and feature a unique cross over network, solid basket compression type tweeters, specially treated aluminum voice coils and Alnico 5 magnets. These features combined with Oaktron's superior workmanship offer the finest in coaxial speakers.

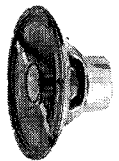

12" COAXIAL

Size in Inches	Part Number	Impedance	Magnet Weight	V.C. Dia.	Power Watts	Frequency Response	Max. Speaker Depth in Inches	Sugg. Dealer Price
8	CA-8	8 Ohms	8" Woofer 3.16 oz. 3" Tweeter .53 oz.	3/4"	8	60-14,000	4 1/2	\$ 8.55
8	CA-8-HD	8 Ohms	8" Woofer 6.80 oz. 3" Tweeter .53 oz.	1"	10	50-14,000	4 1/2	11.25
12	CA-12	8 Ohms	12" Woofer 6.80 oz. 3" Tweeter 1.00 oz.	3/4"	12	35-14,000	6 1/8	12.51
12	CA-12-HD	8 Ohms	12" Woofer 10.10 oz. 3 1/2" Tweeter 1.00 oz.	1 1/4"	20	25-14,000	6 1/8	16.65
15	CA-15	8 Ohms	15" Woofer 6.80 oz. 1 1/2" Tweeter 1.00 oz.	3/4"	14	30-13,000	7 1/8	17.28
15	CA-15-HD	8 Ohms	15" Woofer 10.10 oz. 5" Tweeter 1.00 oz.	1 1/4"	20	20-13,000	7 1/8	22.41
6x9	CA-69	8 Ohms	6x9" Woofer 2.15 oz. 3" Tweeter .53 oz.	3/4"	6	70-14,000	3 3/8	7.65
6x9	CA-69-HD	8 Ohms	6x9" Woofer 6.80 oz. 3" Tweeter .53 oz.	1"	10	60-14,000	4 3/8	10.26

CLASSIC SERIES

Twin cone speakers:

- Perfectly matched dual cones
- Smooth Response
- Heavy magnets
- Large voice coils

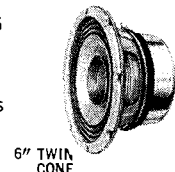

6" TWIN CONE

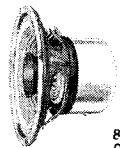

8" TWIN CONF

SAME GENERAL APPEARANCE AS COAXIAL SPEAKERS

Excellent woofer characteristics combined with a perfectly matched twin cone to complete a truly exceptional full range high fidelity speaker.

Size in Inches	Part Number	Impedance	Magnet Weight	V.C. Dia.	Power Watts	Frequency Response	Max. Speaker Depth in Inches	Sugg. Dealer Price
6	FE6W	8 Ohms	*6.00 oz.	1"	12	40-15,000	3 3/8	\$ 8.46
8	Free Edge Cone FE8KW	8 Ohms	10.10 oz.	1 1/2"	20	30-14,000	4 3/8	12.51
8	Free Edge FE-8W Twin Cone	8 Ohms	6.80 oz.	1"	12	40-16,000	4 1/2	9.98
12	FE12KW	8 Ohms	10.10 oz.	1 1/2"	20	25-13,000	5 3/8	14.85
15	FE15KW	8 Ohms	10.10 oz.	1 1/2"	20	20-13,000	7 1/8	20.52
6x9	FE-69UW Twin Cone	8 Ohms	*10.00 oz.	1"	10	35-16,000	3 3/8	7.65

*Chrome Finished Dust Cover.

*Ceramic Magnet.

QUAM *Quality Line* SPEAKERS

These speakers are engineered and manufactured solely for replacement, public address, high fidelity and outdoor applications. EIA standard dimensions. Fully dust-proofed. Baked gold enamel finish. EIA service guarantee. Only Quam speakers have the U shaped coil pot construction which provides an unbroken flux path of sufficient cross section to carry the full energy of the magnetic field.

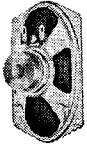

Fig. R

SPECIAL REPLACEMENT SPEAKERS FOR COLOR TV

MODEL No.	SIZE	FIGURE	MAGNET WEIGHT OR FIELD	POWER HANDLING WATTS	DEPTH	SHIP WT., LBS.	DEALER NET
35A2C*	3"x5"	R‡	1.1 oz. Alnico V	4	1-11/16	3/4	\$3.00
4A2C*	4"	R‡	1.1 oz. Alnico V	4	1-5/8	3/4	2.86
46A2C*	4"x6"	R‡	1.1 oz. Alnico V	4	1-11/16	1	3.14
52A2C*	5 1/4"	R‡	1.1 oz. Alnico V	5	1-7/8	1	3.27

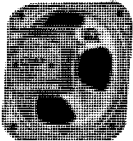

Fig. A

REPLACEMENT SPEAKERS Voice coil impedance 3.2 ohms ±10% except as noted.

22A06Z8**	2 1/4"	J	.45 oz. Alnico V	.25	1	1/4	\$2.85
22A06Z100**	2 1/4"	J	.45 oz. Alnico V	.25	1	1/4	3.15
25A07	2 1/2"	A	.65 oz. Alnico V	1.5	1-1/4	1/4	2.18
26A07	2"x6"	R	.65 oz. Alnico V	2	1-19/32	1/2	2.55
27A06Z12**	2 3/4"	J	.55 oz. Alnico V	.25	1	1/4	2.82
30A05	3"	I	.55 oz. Alnico V	2	1-3/16	1/2	1.89
3A05Z8**	3 1/2"	I	.55 oz. Alnico V	2	1-9/32	1/4	2.25
3A05*	3 1/2"	I	.55 oz. Alnico V	2	1-9/32	1/4	1.89
3A07*	3 1/2"	A	.55 oz. Alnico V	2.5	1-11/16	1/2	2.31
3A07Z20**	3 1/2"	I	.55 oz. Alnico V	2.5	1-33/64	1/2	2.58
35A05*	3"x5"	R	.55 oz. Alnico V	2	1-1/2	1/2	2.29
35A05Z8**	3"x5"	R	.55 oz. Alnico V	2	1-1/2	1/2	2.67
4A05*	4"	I	.55 oz. Alnico V	2.5	1-1/2	1/4	1.61
4A07*	4"	A	.65 oz. Alnico V	3	1-3/4	1/2	2.35
4A1	4"	A	1.0 oz. Alnico V	3	1-3/4	3/4	2.51
4A15	4"	A	1.47 oz. Alnico V	3	2-1/16	3/4	2.82
46A07*	4"x6"	E	.65 oz. Alnico V	3.5	1-15/16	3/4	2.85
46A1	4"x6"	E	1.0 oz. Alnico V	3.5	1-15/16	1	2.97
46A1Z10**	4"	A	1.0 oz. Alnico V	3	1-9/16	3/4	3.51
46A15	4"x6"	E	1.47 oz. Alnico V	3.5	2-1/4	1	3.30
410A2MT#	4"x10"	M	1.4 oz. Alnico V	6	2-11/16	1	5.97
410A2Z10§	4"x10"	M	1.4 oz. Alnico V	6	2-11/16	1	5.67
48A2*	4"x8"	M	1.4 oz. Alnico V	4.5	2-1/16	1	4.34
48A2Z20CT†	4"x8"	M	1.4 oz. Alnico V	4.5	2-1/16	1	4.95
410A2*	4"x10"	M	1.4 oz. Alnico V	6	2-11/16	1 1/4	4.88
5A05*	5"	I	.55 oz. Alnico V	3	1-11/16	1/2	1.91
5A07*	5"	C	.65 oz. Alnico V	3.5	2	3/4	2.58
5A1	5"	C	1.0 oz. Alnico V	3.5	2	1	2.73
5A1Z8**	5"	C	1.0 oz. Alnico V	3.5	2-5/16	1	3.03
5A15	5"	C	1.47 oz. Alnico V	3.5	2-5/16	1	3.03
52A1	5 1/4"	C	1.0 oz. Alnico V	4	2-1/16	1	2.88
52A1Z8**	5 1/4"	C	1.0 oz. Alnico V	4	1-7/8	1	3.09
52C10#	5 1/4"	N	10.0 oz. Ceramic	10	2-1/4	2-1/8	5.82
57A1	5"x7"	D	1.0 oz. Alnico V	5	2-3/8	1	3.03
57A15	5"x7"	D	1.47 oz. Alnico V	5	2-11/16	1	3.66
57A2MT#	5"x7"	D	1.2 oz. Alnico V	5	2-5/16	1	3.90
57A21	5"x7"	D	2.15 oz. Alnico V	5	2-61/64	1-1/4	4.05
58A15Z8	5"x8"	F	1.47 oz. Alnico V	5	2-3/4	1-1/4	4.26
6A1	6 1/2"	C	1.0 oz. Alnico V	5	2-5/8	1	3.18
6A15	6 1/2"	C	1.47 oz. Alnico V	5	2-5/8	1	3.45
6A31	6 1/2"	C	3.16 oz. Alnico V	6	3-11/64	1-3/4	4.56
69A1*	6"x9"	D	1.2 oz. Alnico V	6	2-3/4	1-1/4	3.27
69A1S*	6"x9"	D	1.2 oz. Alnico V	6	2-1/16	1	4.64
69A2*	6"x9"	D	1.4 oz. Alnico V	8	2-15/16	1-1/2	4.09
69A2MT#	6"x9"	D	1.4 oz.	8	2-15/16	1-1/4	5.04
69A2Z10§	6"x9"	D	1.4 oz.	8	2-15/16	1-1/4	4.77
69A3	6"x9"	D	3.2 oz. Alnico V	10	3-5/16	2	5.31
610A1Z8	6"x10"	F	1.2 oz. Alnico V	8	2-13/16	1-3/4	5.10
7A21*	7"	C	1.4 oz. Alnico V	6	2-31/32	1	4.35
8A1	8"	C	1 oz. Alnico V	6	3-1/2	1	3.81
8A21	8"	C	2.15 oz. Alnico V	7	3-13/32	1-1/2	4.41
8A31	8"	C	3.16 oz. Alnico V	9	3-21/32	2	5.22
10C5	10"	L	4.8 oz. Ceramic	9	3-17/32	2-1/4	7.08
12A31	12"	B	3.16 oz. Alnico V	10	4-19/32	3-3/4	7.17
12A6A	12"	B	6.8 oz. Alnico V	14	5-1/4	4-1/2	9.45

* Cup pot; very shallow construction.

** Impedance is designated by number following the letter "Z".

Ceramic magnet. • Dual cone.

† 20 ohms, center tapped

■ Multi-tap; 10-20-40 ohms

‡ Illustrates magnet construction; see same size standard speaker for basket shape.

§ 8-12 ohms

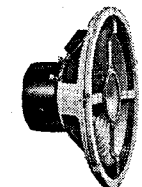

Fig. G

RCA**MICROPHONES
AND ACCESSORIES****POLYDIRECTIONAL RIBBON — 77DX**

The quality microphone standard of the broadcast industry, the RCA 77DX, is available in two models: one with a low-gloss finish for TV, the other a satin chrome finish for AM and FM. The 77DX offers a choice of unidirectional, bidirectional, or nondirectional pickup patterns which are easily changed by a selector switch. Three frequency-response variations on the basic pickup patterns may also be obtained, thus a total of nine different directional characteristics may be utilized. The 30- to 20,000-Hz frequency response of the 77DX makes it suitable for every high-fidelity broadcasting and recording application. Output impedance is factory connected for 250 ohms; however, it may be easily reconnected for a 30- or 150-ohm output impedance. This 77DX mounts on a standard 1/2-inch pipe thread, and comes with 30 feet of three-conductor shielded cable, less plug.

77DX Satin Chrome Finish\$290.00*
77DX-G Low Luster Gray Finish 275.00*

NONDIRECTIONAL DYNAMIC — BK-1A

Ideal for outdoor use or wherever constant handling is required, the BK-1A offers smooth response for both voice and music. The BK-1A is also an excellent unit for sports, panel shows, interviews, and remotes. It provides uniform response from 50 to 15,000 Hz. The swivel mounting of the BK-1A can be used to control directional characteristics. The vertical position is nondirectional; the horizontal position is semidirectional. The output impedance is 250 ohms, but 30- and 150-ohm connections are included. The BK-1A may be mounted on any type stand having 1/2-inch pipe thread and is perfect for use with the MA-06 desk stand. Thirty feet of three-conductor cable is supplied, less connector.

BK-1A\$86.00*

UNIAXIAL RIBBON — BK-5B

The BK-5B is a high quality ribbon instrument designed especially for use in high noise areas, as well as being suitable for general studio purposes. Maximum sensitivity of the BK-5B is in the major mechanical axis, and this produces an extremely directional cardioid pattern. Frequency response from 30 to 20,000 Hz permits using the BK-5B for all types of high fidelity voice and music pickups. The output is connected for 250 ohms, but may easily be changed to 30 or 150 ohms. It is supplied with thirty feet of three-conductor cable, less connector. A wind-screen is available for outdoor use. The BK-5B is supported by a fork mounting which has 1/8-inch pipe thread.

BK-5B\$158.00*

LAVALIER — BK-6B

The BK-6B is a lightweight microphone with excellent speech balance, ideal for remotes, interviews, and other applications where an inconspicuous microphone is needed. The 2.3-ounce unit is only 2 1/16 inches. Wide-range frequency response (60-15,000 Hz) permits using the microphone for all speech applications. The 250-ohm output impedance may be changed to 30 or 150 ohms by a simple change of cable connections. The small size and lanyard mounting make the BK-6B extremely versatile. Thirty feet of two-conductor shielded cable is supplied, less connector.

BK16B with lanyard and fastener\$86.00*

BIDIRECTIONAL RIBBON — BK-11A

In the studio or at indoor remotes, whether a simple interview program or full orchestra pickup, the bidirectional characteristics and excellent frequency response (20 to 20,000 Hz) make the BK-11A an extremely useful production tool. The output can be connected for 30-, 150-, and 250-ohm operation. A three-position switch permits selection of desired frequency ranges for voice and music. The BK-11A has been designed for use with the inexpensive MA-06 desk stand, and it can also be used with any standard 1/2-inch pipe thread desk or floor stand. Thirty feet of three-conductor cable is supplied without a connector.

BK-11A\$107.00*

SUBMINIATURE LAVALIER — BK-12A

The RCA BK-12A is a high-quality subminiature microphone weighing just 20 grams and measuring only 3/4" x 1 1/2". It has a wide-frequency response of 60 to 18,000 Hz, which has been tailored for proper speech balance. A line impedance voice coil permits use with 30- to 250-ohm unloaded inputs. The BK-12A is essentially nondirectional to 6,000 Hz, and as a result, ordinary errors in orientation have negligible effect upon response. It is supplied with lanyard, tie-clip holder, cable clip and 30 feet of two-conductor cable (less connector).

BK-12A\$95.00*

**HIGH-OUTPUT UNIDIRECTIONAL
RIBBON — KU-3A**

The KU-3A is a high-quality microphone for TV, motion picture and recording studio line pickup or wherever boom operation is used. It provides uniform response from 30 to 15,000 Hz. Output impedance is factory connected for 250 ohms; however, it may be easily connected for a 30- or 150-ohm output impedance. It is supplied with voice/music switch, resilient mounting and 12 feet of pigtail cable, less connector.

KU-3A\$675.00*

GENERAL PURPOSE DYNAMIC — SK-30/SK-31

Here is an excellent nondirectional, general-purpose microphone available as a low-impedance (SK-30) or high-impedance (SK-31) unit. It is rugged and lightweight with good response to voice and music (50-14,000 Hz). In addition to being hand held, it may be swivel mounted on a desk or floor stand or it may be mounted on a goose-neck stand. A 3/8-inch-27 thread swivel adaptor is available for floor or desk stand mounting. The microphone comes complete with 20 feet of shielded cable (less connector).

SK-30\$30.00*
SK-31\$31.00*

**NONDIRECTIONAL DYNAMIC —
SK-39B/40B (Low Z — High Z)**

Cue and talk-back applications are perfect for this inexpensive dynamic microphone. The SK-39B/40B is rugged and relatively insensitive to mechanical shock and wind. Frequency response is 60 to 10,000 Hz. It may be mounted on any 3/8-inch-27 fixture thread, and is supplied with 7 feet of three-conductor cable (less connector).

SK-39B/40B\$33.00*

NONDIRECTIONAL DYNAMIC — SK-45B

Ideal for talk-back, cue, and public address use, the rugged lightweight SK-45B microphone offers good voice reproduction. It may be connected for a 150- to 200-ohm balanced output or a 15,000-ohm output. Response is from 70 to 12,000 Hz. Mounting with any 3/8-inch-27 fixture thread permits the use of low cost stands. The SK-45B is supplied with 25 feet of two-conductor cable less connector.

SK-45B\$37.00*

BIDIRECTIONAL RIBBON — SK-46

The SK-46 is designed for high quality indoor use. It has excellent frequency response (40-15,000 Hz) and bidirectional pickup characteristics. Output impedance is 200 ohms, but it may be reconnected to produce a 15,000-ohm output. Dependable performance as well as attractive styling make the SK-46 an ideal choice for high fidelity applications. The SK-46 has a 3/8-inch-27 mounting thread and is supplied with 25 feet of two-conductor shielded cable (less connector).

SK-46\$54.95*

ACCESSORIES

Wind-screen — MA-25 — For use with BK-5B microphone\$16.50*

Boom Mount — MA-24 — Shock mounting to isolate BK-5B microphone from vibration\$36.50*

Holder — MA-07 — 5/8"-27 female thread. For use with BK-6B microphone\$3.35*

Adaptor — MA-08 — 5/8"-27 female fitting — 1/2" male pipe thread, to adapt a 3/8"-27 microphone to a 1/2" pipe thread stand\$.60*

Adaptor — MA-09 — 1/2" female pipe thread, 5/8"-27 male fitting, to adapt a 1/2" microphone to a 3/8"-27 stand\$ 3.75*

Desk Stand — MA-06 — 1/2" pipe fit-male, 4 3/8" dia., 1 3/8" high. For use with BK-1A and BK-11A microphones.\$ 7.75*

Desk Stand — MA-05 — 1/2" pipe fit-male, 4 1/2" wide, 6 3/8" long, 3/4" high or 1 3/4" (incl. Stem). Crinkle and chrome finish. 4 lbs. For use with 77DX and BK-5B microphones\$16.75*

Desk Stand — MA-01 — 3/8"-27 male thread, 7" to 11" chrome tube, 8" dia. Crinkle base. About 2 1/2 lbs. Use MA-08 Adaptor for 1/2" pipe thread microphone.\$ 5.20*

Banquet Stand — MA-02 — 3/8"-27 male thread, 13" to 25" chrome tube, 8" dia. Crinkle base. About 6 lbs. Use MA-08 Adaptor for 1/2" pipe thread microphone.\$ 5.85*

Floor Stand — MA-03 — 3/8"-27 male thread, 7 3/8" dia., 35" to 65" chrome tube, 12" dia. Crinkle base. Use MA-08 Adaptor for 1/2" pipe thread microphone.\$ 9.00*

Floor Stand (Deluxe) — MA-04 — 3/8"-27 male thread, 1 1/8" dia., 37" to 66" chrome tube. Triangular 17" dia. Crinkle base. Use MA-08 Adaptor for 1/2" pipe thread microphone.\$16.50*

Swivel Adaptor — MA-32 — For SK-30/SK-31 microphone. (Fits conventional 3/8"-27 thread floor and desk stands)\$ 3.40*

* Optional distributor resale price. All prices subject to change without notice.

Prices may be slightly higher in Alaska, Hawaii and the West.

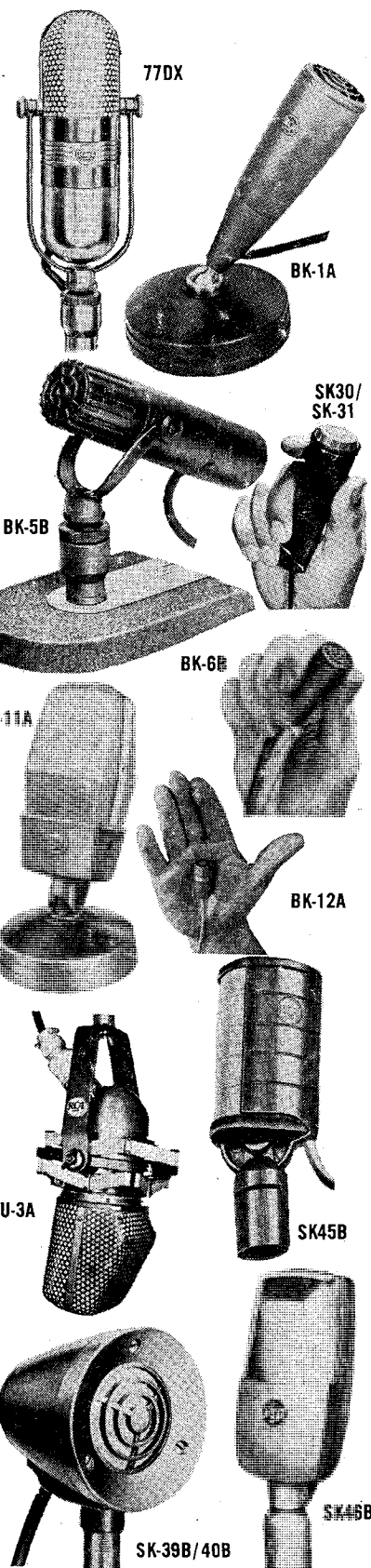

ROBINS® RECORDING TAPE

ROBINS ELECTRONICS CORP.

"BRAND FIVE" QUADRUPLE-PLAY 1/4 MIL SUPER-LONG RECORDING TIME

Four times more recording and playing time than standard thicknesses on the same reel, increases playing time of small recorders. Quality tensilized Mylar for greater strength.

Cat. No.	Reel Size	Length Feet	Playing Time per track in minutes at 3 3/4 ips	List
3C25MT	2 1/2"	500'	50 minutes	\$2.25
3C32MT	3 3/4"	1100'	1 hour 50 minutes	4.50
3D5MT	5"	2400'	4 hours	9.00
3D7MT	7"	4800'	8 hours	18.00

BRAND FIVE RECORDING CASSETTES

Superior Quality Recording Tape. Individually protected in an attractive and convenient permanent storage plastic Canister. Seals out dust and other foreign matter. Built-in "stops" prevent tape from developing slack and unwinding. Has transparent hinged top for identification.

Cat. No.	Record Time	List
2D30	30 min.	\$3.35
2D60	60 min.	4.15
2D90	90 min.	6.00
2D120	120 min.	7.80

BRAND FIVE RECORDING TAPE

The fifth oldest brand of recording tape in the world. Dependable quality. Features new improved dry synthetic lubricant to eliminate squeal, stop gumming of heads, and reduce head wear. Offers increased output, reduced distortion at same recording level, better frequency response for sharper, brighter recordings. Improved uniformity for lower modulation noise.

Cat. No.	Reel Size	Length Feet	Playing Time per track in minutes at 3 3/4 ips	Material	List
15D3	3"	150'	7 1/2	1.5 mil Acetate	\$ 1.80
15D5	5"	600'	30	Standard Play	1.65
15D7	7"	1200'	60	—	2.50
10D3	3"	225'	11	1. mil Acetate	1.00
10D5	5"	900'	45	—	2.05
10D7	7"	1800'	90	—	3.35
10D3M	3"	225'	11	1. mil Polyester	1.10
10D5M	5"	900'	45	—	2.60
10D7M	7"	1800'	90	—	4.50
5D3M	3"	300'	15	.5 mil Polyester	1.15
5D5M	5"	1200'	60	Double Play	3.15
5D7M	7"	2400'	120	—	5.52
5D3MT	3"	300'	15	.5 mil Tensilized Polyester	1.35
5D5MT	5"	1200'	60	—	4.90
5D7MT	7"	2400'	120	Double Play	8.05
5D3MS	3"	450'	22 1/2	.5 mil Polyester	\$1.50
5D32MS	3 3/4"	600'	30	Triple Play	1.95
5D5MS	5"	1800'	90	—	5.00
5D7MS	7"	3600'	180	—	8.85
5D3MTS	3"	450'	22 1/2	.5 mil Tensilized Polyester	1.65
5D5MTS	5"	1800'	90	—	6.65
5D7MTS	7"	3600'	180	Triple Play	11.15

"BRAND SEVEN"...ROBINS ENGINEERED TO PROFESSIONAL QUALITY RECORDING TAPE WITH EXCLUSIVE QUALITY FEATURES

Professional quality. Offers increased output, reduced distortion at same recording level, better frequency response for sharper, brighter recordings. Improved uniformity for lower modulation noise. Features improved dry synthetic lubricant. Calendered to achieve a smoother oxide surface for higher quality recording. Color-Coded Leader Tape and Aluminum Foil Sensing and Cueing Strips pre-spliced to beginning and end of tape on every reel. Attractive 4-color Library Box.

Cat. No.	Reel Size	Length Feet	Playing Time per track in minutes at 3 3/4 ips	Material	List
15E5	5"	600'	30	1.5 mil Acetate	\$2.35
15E7	7"	1200'	60	—	3.80
10E5	5"	900'	45	1. mil Acetate	3.75
10E7	7"	1800'	90	—	5.95
10E5M	5"	900'	45	1. mil Polyester	3.90
10E7M	7"	1800'	90	—	6.70
5E5M	5"	1200'	60	.5 mil Polyester	4.70
5E7M	7"	2400'	120	—	8.10
5E5MS	5"	1200'	60	.5 mil Polyester	6.25
5E7MS	7"	2400'	120	Double Play	11.00
5E32MTS	3 3/4"	600'	30	.5 mil Polyester	3.30
5E5MTS	5"	1800'	90	Tensilized	7.70
5E7MTS	7"	3600'	180	Triple Play	13.00

"BRAND SEVEN"...ROBINS ENGINEERED TO PROFESSIONAL QUALITY RECORDING TAPE

Cat. No.	Reel Size	Length Feet	Playing Time per track in minutes at 3 3/4 ips	Material	List
5E5MT	5"	1200'	60	.5 mil Polyester Tensilized	5.90
5E7MT	7"	2400'	120	Double Play	10.30



"BRAND FIVE" 1/4 mil tapes.

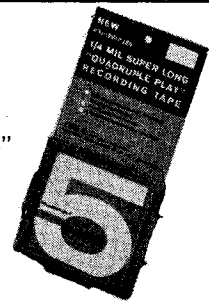

ROBINS BRAND CORRESPONDENCE TAPE

"BRAND FIVE" CASSETTES Packaged in new Dispenser Packs when ordered in increments of 12.

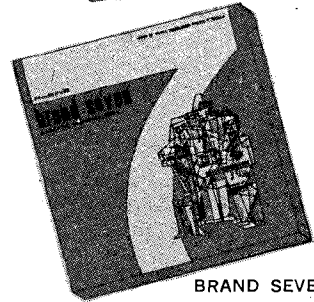

BRAND SEVEN TAPE

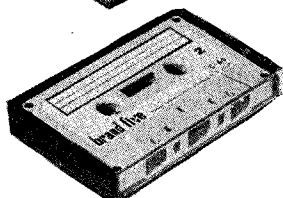
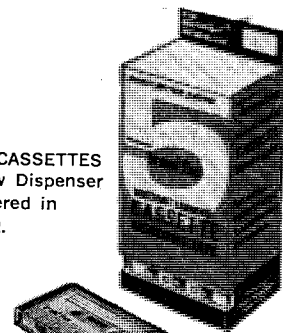

ROBINS® BRAND CORRESPONDENCE TAPE

Top quality recording tape in Impact-Resistant Plastic reusable Tape Mailing Canisters. Two-sided address cards included.

Cat. No.	Reel Size	Length Feet	Playing Time per track in minutes at 3 3/4 ips	Material	List
15H3	3"	150'	7 1/2	1.5 mil Acetate	\$1.05
10H3	3"	225'	11	1. mil Acetate	1.25
10H3M	3"	225'	11	1. mil Polyester	1.45
5H3M	3"	300'	16	.5 mil Polyester	1.65
5H3MS	3"	450'	22 1/2	.5 mil Polyester Triple Play	2.30
5H32MS	3 3/4"	600'	30	.5 mil Polyester Triple Play	2.75

SONORAMIC BRAND RECORDING CASSETTES

Packaged in convenient Self-Mailers.

Cat. No.	Record Time	List
2S30	30 minutes	\$2.65
2S60	60 minutes	3.35
2S90	90 minutes	4.50

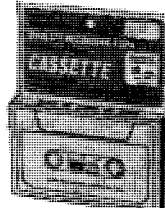

No. TC-3 IMPACT RESISTANT PLASTIC CASSETTE PERMANENT STORAGE CANISTERS. Package of 3. Built-in "stops" prevent tape from unwinding and becoming slack. Clear hinged cover for identification. List \$1.65

No. TCB-18 CASSETTE MAILERS. Package of 18. Cardboard. List \$1.65

ROBINS® TAPE ACCESSORIES

ROBINS ELECTRONICS CORP.

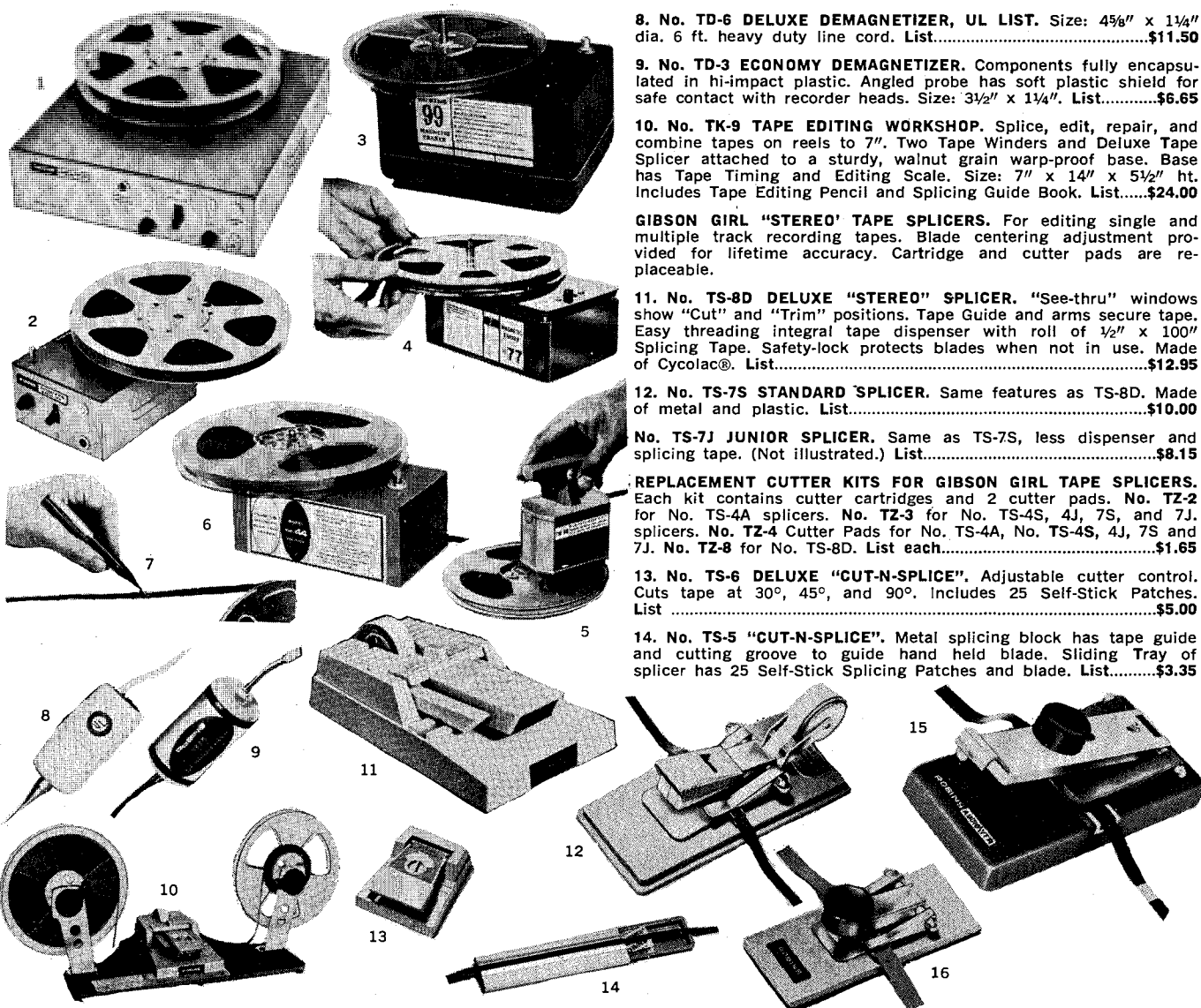

MAGNETIC BULK TAPE ERASERS FOR AUDIO, VIDEO, COMPUTER AND INDUSTRIAL RECORDING TAPE UP TO 1" WIDE. Erasure 50-90 db below saturation level. 115 V. 50-60 Hz. A.C. Safety features: overheat indicator, individually fused circuits.

1. No. TM-120. Accommodates reels to 17" dia. Duty cycle: 10 min. On/10 min. Off. Size 3 $\frac{3}{4}$ " x 12" x 14". With blower system. List\$200.00

2. No. TM-100. Accommodates reels to 10 $\frac{1}{2}$ " dia. Duty cycle: 5 min. On/15 min. Off. Size: 3 $\frac{3}{4}$ x 6" x 8". List.....\$100.00

3. No. TM-99 PROFESSIONAL BULK TAPE ERASER. UL LIST. For tapes to $\frac{1}{2}$ " wide on reels to 10 $\frac{1}{2}$ ". Erasure 3 to 6 db below normal erase head level. 110 V. 50-60 Hz. A.C. Size: 5 $\frac{1}{4}$ " x 6 $\frac{3}{4}$ " x 3 $\frac{3}{4}$ ". List\$47.50

4. TM-77 DELUXE ERASER. For $\frac{1}{4}$ " tape, reels to 7". Erasure 2 to 4 db below erase head level. 110 V. 50-60 Hz. A.C. Size: 2 $\frac{3}{8}$ " x 3 $\frac{3}{4}$ " x 6 $\frac{3}{4}$ ". List.....\$26.50

5. No. TM-88 HAND-HELD ERASER. For $\frac{1}{4}$ " tape, any size reel. Handle has momentary contact switch. Erasure below normal erase head level. Size: 4" x 2 $\frac{1}{4}$ " x 4 $\frac{1}{4}$ ". Wt. 2 lb. 4 oz. 4 amps 110 V. A.C. List\$17.50

6. No. TM-44 ECONOMY ERASER. For $\frac{1}{4}$ " tape, reels to 7". Erasure below normal erase head level. Size: 5 $\frac{1}{4}$ " x 2 $\frac{1}{8}$ " x 3 $\frac{3}{8}$ " 110 V. A.C. Duty cycle: 1 min. On/5 min. Off. List.....\$18.50

7. No. TM-2 MAGNETIC TAPE EDITING PEN. Removes single sounds, noise, etc. from recording when applied to tape. Fade-in, fade-out sounds. List.....\$2.10

HEAD DEMAGNETIZER. Removes signal damaging residual magnetism from recorder heads to improve sound fidelity. 110 V. 50-60 Hz. A.C.

8. No. TD-6 DELUXE DEMAGNETIZER, UL LIST. Size: 4 $\frac{5}{8}$ " x 1 $\frac{1}{4}$ " dia. 6 ft. heavy duty line cord. List.....\$11.50

9. No. TD-3 ECONOMY DEMAGNETIZER. Components fully encapsulated in hi-impact plastic. Angled probe has soft plastic shield for safe contact with recorder heads. Size: 3 $\frac{1}{2}$ " x 1 $\frac{1}{4}$ ". List.....\$6.65

10. No. TK-9 TAPE EDITING WORKSHOP. Splice, edit, repair, and combine tapes on reels to 7". Two Tape Winders and Deluxe Tape Splicer attached to a sturdy, walnut grain warp-proof base. Base has Tape Timing and Editing Scale. Size: 7" x 14" x 5 $\frac{1}{2}$ " ht. Includes Tape Editing Pencil and Splicing Guide Book. List.....\$24.00

GIBSON GIRL "STEREO" TAPE SPLICERS. For editing single and multiple track recording tapes. Blade centering adjustment provided for lifetime accuracy. Cartridge and cutter pads are replaceable.

11. No. TS-8D DELUXE "STEREO" SPLICER. "See-thru" windows show "Cut" and "Trim" positions. Tape Guide and arms secure tape. Easy threading integral tape dispenser with roll of $\frac{1}{2}$ " x 100" Splicing Tape. Safety-lock protects blades when not in use. Made of Cyclocac®. List.....\$12.95

12. No. TS-7S STANDARD SPLICER. Same features as TS-8D. Made of metal and plastic. List.....\$10.00

No. TS-7J JUNIOR SPLICER. Same as TS-7S, less dispenser and splicing tape. (Not illustrated.) List.....\$8.15

REPLACEMENT CUTTER KITS FOR GIBSON GIRL TAPE SPLICERS. Each kit contains cutter cartridges and 2 cutter pads. No. TZ-2 for No. TS-4A splicers. No. TZ-3 for No. TS-4S, 4J, 7S, and 7J. splicers. No. TZ-4 Cutter Pads for No. TS-4A, No. TS-4S, 4J, 7S and 7J. No. TZ-8 for No. TS-8D. List each.....\$1.65

13. No. TS-6 DELUXE "CUT-N-SPLICE". Adjustable cutter control. Cuts tape at 30°, 45°, and 90°. Includes 25 Self-Stick Patches. List\$5.00

14. No. TS-5 "CUT-N-SPLICE". Metal splicing block has tape guide and cutting groove to guide hand held blade. Sliding Tray of splicer has 25 Self-Stick Splicing Patches and blade. List.....\$3.35

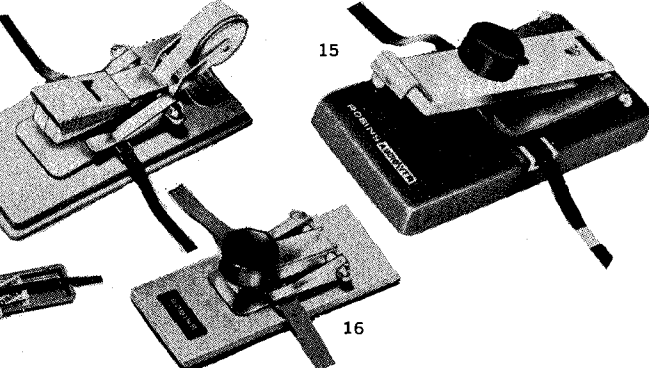

No. TS-3 "SEMI-PRO." Low cost splicer has tape guide with adhesive back, hand held blade for cut and trim operation, with blade cover. (Not illustrated.) List.....\$2.65

No. TS-2 "HOBBYIST". Low cost splicer. Adhesives backed tape guide fastens to recorder. Cutting blades supplied. (Not illustrated.) List\$1.30

15. "GIBSON GIRL" AUDIO/VIDEO TAPE SPLICERS. Heavy duty. Professional precision features are the accepted standard of the industry. Precision cut and "Gibson Girl" trim at sides of splices prevent adhesive of splicing tape from contacting critical parts of recorder. Long life replaceable blades and cutter pads. No. TS-250 for $\frac{1}{4}$ " tapes. No. TS-500 for $\frac{1}{2}$ " tapes, Sony, Concord, etc. systems. No. TS-1000 for 1" tape, Ampex Systems. Splicer with straight cut: No. TS-250S, No. TS-500S, and No. TS-1000S. List each.....\$85.00

16. AUDIO/VIDEO TAPE SPLICERS. Heavy duty. 25 self-stick Patches supplied. No. TSV-50 for $\frac{1}{2}$ " tape, Sony, Concord, etc. systems. No. TSV-100 for 1" tape, Ampex systems. List price each.....\$19.95

SPLICING TAPE. Special formula, Mylar. (Not illustrated.)

No. TST-235 $\frac{1}{4}$ " x 300". List.....\$1.15

No. TST-376 $\frac{3}{8}$ " x 275". List.....\$1.15

No. TST-501 $\frac{1}{2}$ " x 250". List.....\$1.15

No. TST-751 $\frac{3}{4}$ " x 150". List.....\$1.30

No. TT-234 $\frac{1}{4}$ " x 100". List......45

No. TT-375 $\frac{3}{8}$ " x 100". List......50

No. TT-500 $\frac{1}{2}$ " x 100". List......55

No. TST-233 Self-Stick Patches for No. TS-5, No. TS-6, and other splicers. Pkg. 75. List.....\$1.30

PATCHES FOR VIDEO SPLICERS. Pre-cut, self-stick.

No. TT-247 $\frac{1}{2}$ " Patches for No. TSV-50 splicer. Pkg. of 60. List.....\$1.65

No. TT-248 1" Patches for No. TSV-100 splicer. Pkg. of 48. List.....\$1.65

ROBINS® TAPE ACCESSORIES

ROBINS ELECTRONICS CORP.

25. COLOR-CODING TAPE LOG KIT. 240 self-stick Title Labels, 72 self-stick Tape Ends Tabs, 48 self-stick Numbered Tape Index Spots, 30 self-stick Tape Box Ends, (all in 6 colors), bound color-indexed Log Book and Simulated Feather Writing Pens. For cataloging tape library. No. TK-1 List.....\$8.30

No. TT-245 COLOR-CODE TAPE END TABS. Reinforced tape ends, prevents tape unwinding, facilitates threading. Pkg. of 72 in 6 colors. List\$1.15

No. TT-246 COLOR-CODED INDEX AND CUEING SPOTS FOR TAPES. Numbered 1 to 8. Index selections throughout reel. Pkg. of 48. 6 colors. List\$1.65

No. TL-5 COLOR-CODE TAPE BOX ENDS. 30 self-stick, textured book binding strips in 6 colors. Reinforces and hinges lids. (Not illustrated.) List\$2.50

No. TT-16 COLOR-CODE LEADER TAPES. Set of five 2½" reels, 100 ft. each Red, Blue, Green, Yellow and White Leader Tapes. Reinforces tape ends. Ideal for indexing between recorded sections on reels. (Not illustrated.) List.....\$4.15

LEADER TAPES IN CLEAR, WHITE, AND COLORS. 100 ft. x ¼" wide on 2½" reels. No. TT-100C Clear; No. TT-100W White; No. TT-100G Green; No. TT-100R Red. (Not illustrated.) List each.....\$1.25

No. TT-101 ECONOMY PROFESSIONAL SIZE WHITE LEADER TAPE. 1200 ft. 1.5 mil, on 7" reel. White coloration is fully impregnated in tape. No flaking. (Not illustrated.) List.....\$4.50

No. TL-240 COLOR-CODE TITLE LABELS. Pkg. of 240. ½" x 2" self-stick. Assorted colors. List.....\$1.75

26. No. TL-180 WHITE TITLE LABELS. ½" x 2", self-stick. Pkg. 180. List.....\$1.39

No. TB-15 CARDBOARD MAILERS. Pkg. of 15, for 3¼" tapes. List\$1.25

27. No. RMC-6 REUSABLE, IMPACT RESISTANT PLASTIC TAPE MAILING CANISTERS. Pkg. of 6. For 3¼" tapes. Includes 2-sided address cards. List.....\$1.65. **No. TMC-30 Pkg. 30.** 2-sided address cards for No. RMC-6 Canisters. List.....\$1.25

28. No. TC-3 CASSETTE PERMANENT STORAGE FILING CANISTERS. Impact resistant plastic. Built-in stops prevent tape from unwinding and becoming slack. Clear hinged cover provides instant identification. Pkg. of 3. List.....\$1.65

No. TCB-18 CARDBOARD CASSETTE MAILERS. Pkg. of 18. (Not illustrated.) List.....\$1.65

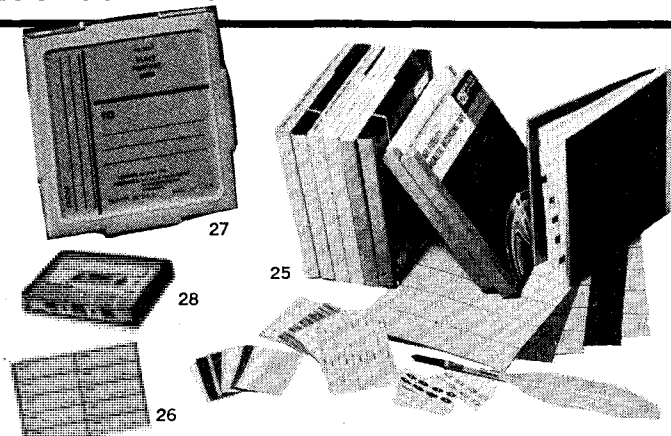

EMPTY TAPE REELS FOR EVERY RECORDING NEED. No. TR-36-6 Pkg. of 6-3" reels, 2 each: Red, Yellow, Blue. (Not illustrated. List\$1.30

5" COLOR-CODED REELS				7" COLOR-CODED REELS			
Cat. No.	Color	Pkg. Qty.	List	Cat. No.	Color	Pkg. Qty.	List
TR51-2B	Blue	2	\$1.30	TR71-2B	Blue	2	\$1.65
TR51-2G	Green	2	1.30	TR71-2G	Green	2	1.65
TR51-2R	Red	2	1.30	TR71-2R	Red	2	1.65
TR51-2Y	Yellow	2	1.30	TR71-2Y	Yellow	2	1.65

REEL MULTIPAKS				REELS IN BOXES			
TR	Reel Size	Qty.	List	TR	Reel Size	Qty.	List
TR20-6	2"	6	\$1.15	TRB-2	2"	1	.42
TR25-6	2½"	6	1.15	TRB-2.5	2½"	1	.42
TR30-6	3"	6	1.15	TRB-3	3"	1	.42
TR32-4	3¼"	4	1.15	TRB-3.2	3¼"	1	.45
TR40-4	4"	4	1.30	TR-50	5"	1	.65
TR50-2	5"	2	1.00	TR-70	7"	1	.75
TR70-2	7"	2	1.25	TRV-75	7" VTR Reel for ½" wide tape	1	2.50
TR74-2	7" Low Torque	2	2.15				
TR53-2	5" Low Torque	2	1.75				

EMPTY BOXES FOR TAPE			
TB	Size	Qty.	List
TB-5	5"	1	.39
TB-7	7"	1	.39

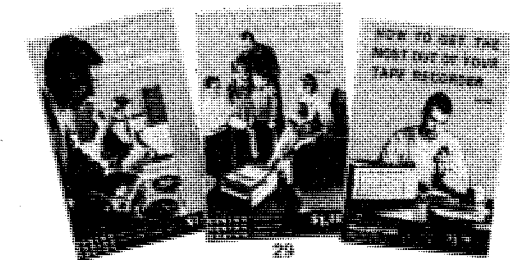

29. INFORMATIVE BOOKS FOR RECORDISTS: No. TE-24 "Tape Editing and Splicing Guide", List.....\$5.00. No. TE-48 "Television Tape Recording", List.....\$1.00. No. TE-96 "What You Should Know About Your Tape Recorder", List.....\$1.25. No. TE-127 "Tape Recording The Sounds Of Your Life", List.....\$1.59. No. TE-129 "How To Get The Most Out Of Your Recorder", List.....\$1.59.

COMPLETE AUDIO/VISUAL TAPE ACCESSORY KITS FOR LANGUAGE LABS, AUDIO/VISUAL DEPTS., BROADCAST AND RECORDING STUDIOS. No. TK-12 KIT. Contains: No. TM-99 UL listed Bulk Tape Eraser, No. TS-8D Deluxe Tape Splicer, 6 rolls of ½" x 100" Splicing Tape, No. TK-6 Head and Guide Cleaner and Lubricant, Tape Strobe and Light Kit, No. TD-6 UL listed Head Demagnetizer, Tape Threader, Tape Jockey Cloth, 180 Title Labels, 75 Tape Clips, and 150 cleaning "Swabbies". List.....\$83.50

No. TK-11 KIT. Contains: No. TM-77 Bulk Tape Eraser, No. TS-7S Tape Splicer, ¾" x 275" Splicing Tape, Head and Guide Cleaner and Lubricant, Tape Strobe and Light Kit, No. TD-3 Head Demagnetizer, Tape Threader, Tape Jockey Cloth, 180 Title Labels, and 75 Tape Clips. List.....\$50.00

ROBINS® PHONO AND RECORD ACCESSORIES

No. PK-20 COLOR-CODE RECORD LOG KIT. Catalog your record collection. 120 page Log Book, 80 self-stick Identification Labels for LP and 45 rpm records, 240 Album and Record Index Spots, (all in 5 colors), and Simulated Feather Writing Pen. List.....\$4.15

No. PL-80 COLOR-CODE OWNER IDENTIFICATION LABELS FOR LP AND 45 RPM RECORDS. Package of 80. Self-Stick. Imprinted "This Record is the Property Of —" Curved to fit label area of records. In 5 colors. List\$1.30

No. PL-5 COLOR-CODE ALBUM AND RECORD INDEX SPOTS. Package of 240, Self-Stick. 2 sets numbered 1 to 24, assorted in 5 colors. List\$1.15

No. PT-5 COLOR-CODE ALBUM REINFORCEMENT TAPE. Repair, reinforce, and Color-Code Albums. In 5 colors. Enough for 24 albums. List\$1.65

31. No. PJ-18 RECORD COVERS. Round bottom, plastic. Package of 18. List.....\$1.15

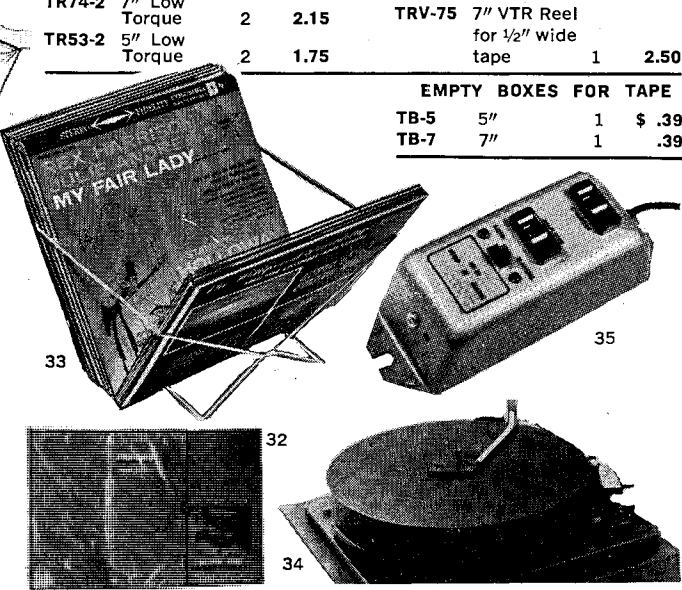

32. No. PJ-25 HEAVY DUTY ALBUM COVERS. Window-clear plastic. Package of 12. Has convenient thumb notches for easy insertion and removal of records. List.....\$1.65

33. No. PR-1 RECORD BROWSER. Compact, sturdy, metal brass plated rack. Fast, easy selection of records. For quantity of 12" records. List.....\$2.65

34. No. PC-6 AUTOMATIC END RECORD AND RECORD PROTECTOR. Covers records stacked on automatic changer. Drops as last records to continue protection from dust and grime. Sign off tells you when last record has played. Complete with jacket. List.....\$3.30

35. No. PS-3 AUTOMATIC SOLID-STATE HI-FI/STEREO SHUT-OFF. For domestic and imported equipment. Shuts off amplifier after last record has played. Prevents equipment "burn-up". Amplifier and phono plug in separately. Switch for manual operation. 6 ft. line cord. 110 V. A.C. Metal housing for wall or cabinet mount. Size: 6½" x 2¼" x 1¾" high. List.....\$11.50

ROBINS® PATCH CORDS AND ADAPTORS

ROBINS ELECTRONICS CORP.

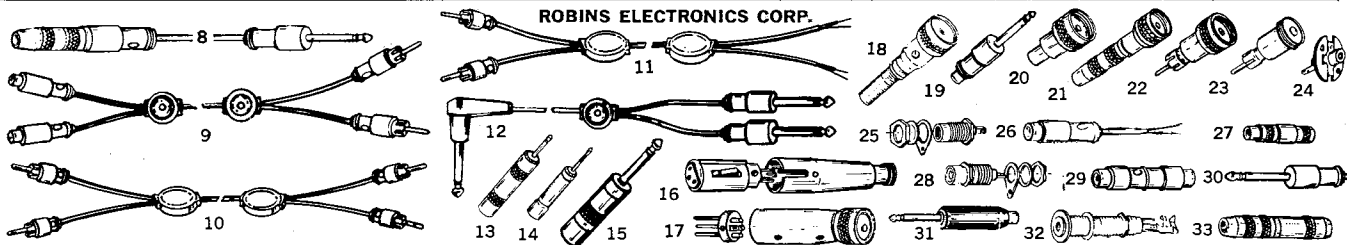

STEREO CABLE ASSEMBLIES

- 8. No. SJT-300. Phone Plug to Jack. 3-Cond. 25 ft. Shielded. Cable. List.....\$10.55
- 9. No. SMF-36. 2 Phono Plugs to 2 Phono Jacks. 36" Shielded. Cable. List.....\$3.30
- 10. No. SMM-36 36" Cable length. List.....\$3.45. No. SMM-72 72" Cable length. List.....\$4.05. No. SMM-120 120" Cable length. List.....\$4.85. 2 Phono Plugs at each end.
- 11. No. SMS-36 36" Cable length. List.....\$3.10. No. SMS-72 72" Cable length. List.....\$3.45. No. SMS-120 120" Cable length. List.....\$4.05. 2 Phono Plugs to Stripped and Tinned-Ends.
- 12. No. YXTT-144 Adaptor Cable, 2-Cond., 11 ft., 3-Cond. Right Angle Phone Plug to "Y" Junction. 2 Single Cond. 12" Cables from "Y" Junction to 2-Cond. Phone Plugs. Use to interconnect components where a 3-Cond. output is to be connected to 2 individual 2-Cond. inputs. List.....\$7.40

ADAPTORS

- 13. No. AA-66 Adapts Standard Phono Plug to "Tini-Jax" Phone Jack. List.....\$2.10
- 14. No. AA-68 Phono Jack Input to Micro Plug (.097 dia.) Output. List.....\$1.85
- 15. No. AA-70 2-Cond. "Tini-Jax" Input to standard Phone Plug Output. List.....\$1.95
- 16. No. AC-1 2-Cond. Input Connector (No. D-2), Output Connector, with unsoldered internal wire permitting connection to terminal. List.....\$3.45
- 17. No. AC-2 Female Microphone Connector to Input Connector. List.....\$3.45
- 18. No. B-1 Microphone Connector Female. List.....\$.90
- 19. No. BB-1 Microphone Connect. Double Female, connects 2 cables with male connectors. List.....\$1.70
- 20. No. BF-1 Phono Jack input to Female Microphone Connect. Output. O.D. 1/2". List.....\$1.55
- 21. No. BJ-1 2-Cond. Phone Jack input to Female Microphone Output. Removable Coupler Ring converts connector to male type. Body O.D. 1/2". List.....\$2.20
- 22. No. BP-1 Phono Plug to Female Microphone Connector. List.....\$1.40
- 23. No. DP-1 Phono Plug to Male Microphone Connector. List.....\$1.30
- 24. No. F-1 Phono Jack, 2-Conductor. Package of 5. List.....\$.85
- 25. No. F-2 Phono Jack for back of panel mount. 2-Cond. Package of 2. List.....\$1.05
- 26. No. F-3 2-Cond. long handle, Phono Jack to 3/8" Shielded Cable. Converts screw or solder terminals to standard Phono Jack. Mates with No. M-1 or No. M-2 Phono Plug. Package of 2. List.....\$2.00
- 27. No. F-4 Phono Extension Jack, removable handle, Cable Clamp. Package of 2. List.....\$1.60
- 28. No. F-5 RF Phono Jack, Nylon Insulated. 2-Cond. Front panel mount. Package of 2. List.....\$1.35
- 29. No. FF-1 Phono Plug to Phono Plug, Shielded. List.....\$1.20
- 30. No. FT-1 Phone Plug Output-Phono Jack Input. Shielded. List.....\$1.50
- 31. No. FTR-1 Phono-Adapter Female Phono Jack end of handle. Internal resistor circuit for connection between crystal phono pick-up, radio or TV set and input of tape recorder. Use as adaptor with magnetic phono by opening plug and twisting leads of resistor together. List.....\$2.15
- 32. No. J-1 Phone Jack w/long bushing. Mounts in panels to 1/4" thick. 2-Cond. Jack mates with "Littel Plugs." Ideal for microphone connection. List.....\$1.75
- 33. No. J-2 1/4" 2-Cond. Extension Phone Jack w/Solder Terminals. List.....\$2.15
- 34. No. J-3 Phone Jack, same as No. J-1, except 3-Cond. List.....\$2.00
- 35. No. J-4 Extension Jax, bakelite handle, 2-Cond. Screw terminals, Clamp. List.....\$1.47
- 36. No. J-5 Extension Jax, bakelite handle, 3-Cond. Screw terminals, Clamp. List Price.....\$1.95
- 37. No. JF-1 2-Cond. Phone Jack input to Phono Jack Output, Body O.D. 1/2". List.....\$2.05

MOLDED CABLE ASSEMBLIES

Cat. No.	Adaptor at One End Fig.	Adaptor at Other End Fig.	Cable Length in Inches	List
BS-120	MC	ST	120"	\$2.50
FF-72	PJ	PJ	120"	2.15
MC-120	PP	AC	120"	2.45
MF-18	PP	PJ	18"	1.35
MF-36	PP	PJ	36"	1.60
MF-72	PP	PJ	72"	1.95
MF-120	PP	PJ	120"	2.35
MJ-72	PP	PhJ	72"	3.15
MM-18	PP	PP	18"	1.10
MM-36	PP	PP	36"	1.30
MM-72	PP	PP	72"	1.65
MM-120	PP	PP	120"	2.15
MS-18	PP	ST	18"	.85
MS-36	PP	ST	36"	1.10
MS-72	PP	ST	72"	1.50
MS-120	PP	ST	120"	1.90
MT-72	PP	PJ	72"	2.40
MT-120	PP	PJ	120"	2.95
TC-72	PhP	AC	72"	2.10
TC-120	PhP	AC	120"	2.65
TF-72	PhP	PJ	72"	2.40
TJ-120	PhP	PhJ	120"	3.95
TS-72	PhP	ST	72"	1.95
TS-120	PhP	ST	120"	2.50
TT-72	PhP	PhP	72"	2.80
TT-120	PhP	PhP	120"	3.80
XJ-180	PP	SEJ	180"	6.00
XM-120	PhP	PP	120"	4.35

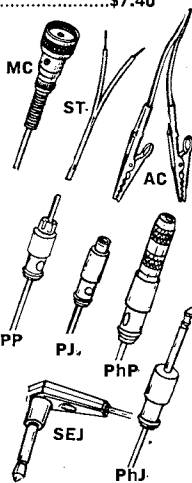

MC—Microphone Connector. ST—Stripped and Tinned Ends. AC—Alligator Clips. PP—Phono Plug. PJ—Phono Jack. PhP—Phone Plug. PhJ—Phone Jack. SEJ—Short Extension Jack.

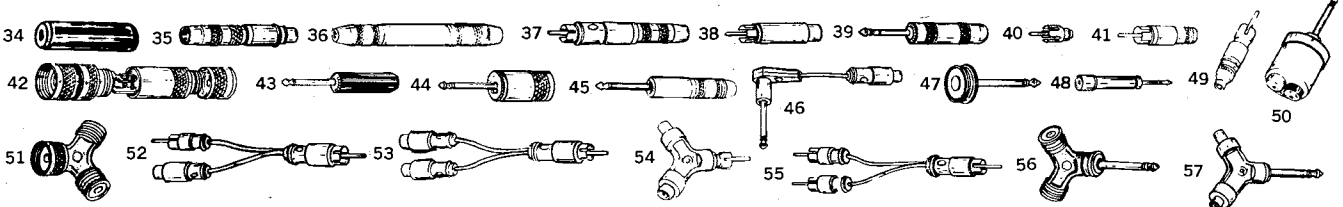

ADAPTORS

- 36. No. JJ-1 Coupler, 2-Cond. Phone Jack each end. List.....\$2.90
- 37. No. JJ-3 same as JJ-1, 3-Cond. List.....\$3.45
- 38. No. JM-2 Compact Adaptor. Phono Jack Input, Phono Plug Output, connects Ceramic Phono Cartridge to amplifier which was designed for magnetic cartridge. List.....\$3.65
- 39. No. JR-1 Standard 2-Cond. Phone Plug to 2-Cond. Short Extension Jack. List.....\$2.55
- 40. No. M-1 Phono Plug. Solder terminals. Package of 6. List.....\$.65
- 41. No. RF-1 RF Plug, 2-Cond. long handle, cable clamp, Nylon insulated. List.....\$.90
- 42. No. SC-1 Microphone Connection w/2 Screw Terminals. Single Contact, Female. 2-piece handle w/built-in cable clamp. Connection cable, stripped ends. List.....\$3.05
- 43. No. T-1 Phone Plug, 2-Cond. Solder terminals. List.....\$.80
- 44. No. T-1S Silent Phone Plug, 2-Cond. 1" length. Shielded handle. Circuit device, when plug is removed, shorts input of amplifier, prevents squeal. Ideal for use with musical instruments. List.....\$2.65
- 45. No. T-3 1/4" Phone Plug. 3-Cond. Solder terminals. Shielded metal handle. List.....\$2.20
- 46. No. TAF-1 Phone Plug. Right Angle, 2-Cond. w/long handle molded to 2" Shielded Cable. Adapts Phone Jack to Phono Plugs. List.....\$2.10
- 47. No. TD-1 Microphone input, male to Phone Plug Output. List.....\$1.40

- 48. No. TJF-1 2-Cond. "Tini-Plug" (3/8") Output to Phono Jack Input. List.....\$1.55
- 49. No. TJM-1 2-Cond. "Tini-Jack" Input to Phone Plug Output. O.D. 1/2". List.....\$1.75
- 50. No. TJT-1 Tip Jack Inputs to Phone Plug Output. List.....\$3.05
- "Y" ADAPTORS.** Convert Stereo Players to Mono. Use for Tap-in Meter Monitor connection and other applications. Requires on some tape recorders.
- 51. No. YBDD-1 Connects 2 cables (w/standard microphone connections) in parallel to one single connector. Light metal. List.....\$2.10
- 52. No. YFMM-1 Phono Plug to One Phono Plug and one Phono Jack, 4" Cable. List.....\$2.50
- 53. No. YMFF-1 Phono Plug connection in parallel to Phono Jacks. 4" Cable. List.....\$2.50
- 54. No. YMFF-2 Two Phono Jacks connections in parallel to standard Phono Plug. List.....\$2.15
- 55. No. YMMM-1 One Phono Plug connection in parallel to 2 Phono Plugs. 4" Cable. List.....\$2.60
- 56. No. YTTD-1 Two male Microphone connections. Connected in parallel to standard 2-Cond. Phone Plug. Completely shielded. List.....\$2.40
- 57. No. YTFF-1 Two Phono Jacks connections in parallel to 2-Cond. Phone Plug. List.....\$2.40
- FM INDOOR ANTENNA** — Folded dipole. Eliminates need for outdoor antenna in most locations. Improves FM reception over "built-in" set antennas. Easily concealed under rug or behind the set.
- No. MA-1. List.....\$2.50

*You can depend on your local
ELECTRONIC DISTRIBUTOR for ...*

- *Instant off-the-shelf delivery*
- *In-depth inventories*
- *Wide varieties*
- *Prompt service*
- *Technical assistance*
- *Availability of the latest products*
- *Speedy purchasing — one order does the job*

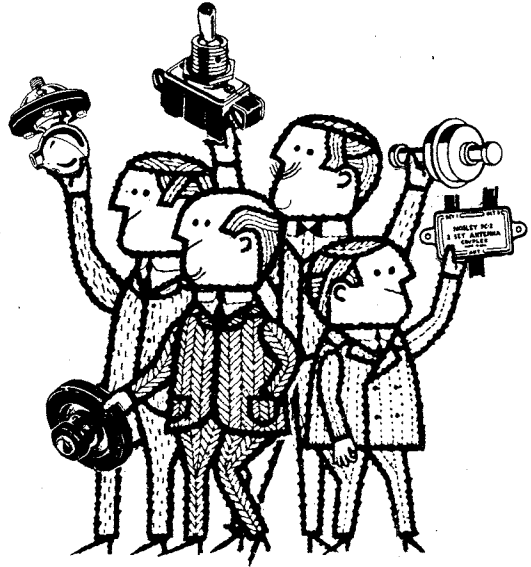

*Contact your local **ELECTRONIC DISTRIBUTOR**
for all your requirements!*

SHURE UNISPHERE & UNIDYNE "B" MICROPHONES

UNISPHERE I Microphones **MODELS 565 • 565S • 566**

Now! You can get all the superb feedback-control and uniform cardioid pickup pattern features that have made the Unidyne family of microphones world-renowned for solving difficult public-address problems—with the added problem-solving ability achieved through special filter assemblies that effectively control explosive breath sounds ("POP") and minimize wind noise in outdoor locations (eliminating the need for windscreens). The Unisphere I provides excellent reproduction of voice and music—can be effectively used outdoors and indoors.

Model 565 Unisphere I: For stand or hand usage. Includes an A25B swivel adapter. **List Price: \$95.00**

Model 565S Unisphere I: On-Off switch included as part of the swivel connector assembly. **List Price: \$100.00**

Model 566 Unisphere I: Features a built-in vibration-isolation shock mount. **List Price: \$140.00**

SPECIFICATIONS

Frequency Response: 50 to 15,000 Hz. (Model 566 is 40 to 15,000 Hz.)

Impedance and Output Level:

Models 565 and 565S: Dual: Low -57 db (0 db = 1 milliwatt per 10 microbars); .141 millivolts/microbar. High -54.5 db (0 db = 1 volt per microbar); 1.88 millivolts/microbar.

Model 566 Dual: Low (30 to 50 ohms) -55 db (0 db = 1 milliwatt per 10 microbars); .075 milli-

volts/microbar. Medium (250 ohms) -55 db. (0 db = 1 milliwatt per 10 microbars); .158 millivolts/microbars.

Cable:

Model 565 and 565S: 15-foot, three-conductor shielded with Amphenol MC4M Type Connector. Model 566: 18-foot, two-conductor shielded with Cannon XL-3-11 Type Connector.

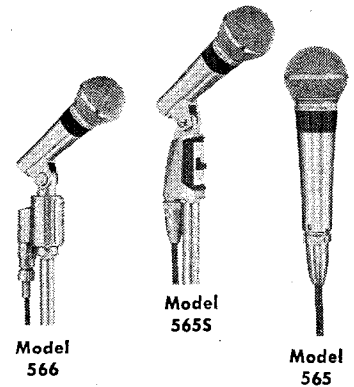

UNISPHERE A Microphones **MODELS 585SA • 585SB • 585SAV • 585SBV**

The Unisphere A Series of Microphones are economical unidirectional dynamic microphones featuring special filters that provide protection from wind and "pop" (explosive breath sounds). They also eliminate annoying loudspeaker "squeal" caused by feedback. These models are particularly suitable for use in locations where omnidirectional microphones may not operate properly because of poor acoustics or where wind creates a problem. The Model 585 Series comes complete with shock-mounted cartridge, On-Off switch, detachable cable, and a Model A25B swivel adapter.

The Model 585SAV and 585SBV are two of the most ingenious microphones ever designed because the volume control on the microphone case enables the user to change the loudness of the P.A. system at the microphone location. Ideal for applications where the amplifier controls are inaccessible or where the speaker or singer wants to control his own volume for dramatic effects.

Model 585SA Unisphere A: High impedance. **List Price: \$65.00**

Model 585SB Unisphere A: Low impedance. **List Price: \$58.00**

Model 585SAV Unisphere A: With adjustable volume control; High impedance. **List Price: \$72.50**

Model 585SBV Unisphere A: With adjustable volume control; Low impedance. **List Price: \$72.50**

SPECIFICATIONS

Frequency Response: 50 to 13,000 Hz.

Impedance and Output Level:

Models 585SA and 585SAV: High -56.5 db (0 db = 1 volt per microbar); 1.48 millivolts/microbar. Model 585SB and 585SBV: Low -56.5 db (0 db = 1 milliwatt per 10 microbars); .105 millivolts/microbar.

Cable:

Models 585SA and 585SAV: 15-foot, one-conductor, shielded with an Amphenol MC1F Type Connector.

Models 585SB and 585SBV: 15-foot, two-conductor shielded with an Amphenol MC2M type Connector.

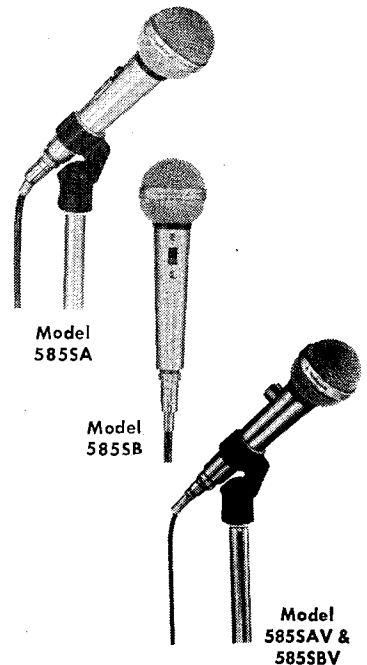

UNIDYNE B Microphones **MODELS 515SA • 515SB**

Lowest cost Unidyne, ever. Has the feedback suppression and uniform, symmetrical pick-up pattern features that have made Unidynes world famous. An excellent choice where budget is the prime consideration. Can be used on stand, or in hand. Built-in On-Off switch. Includes A25B swivel adapter.

Model 515SA Unidyne B: High Impedance. **List Price: \$40.00**

Model 515SB Unidyne B: Low Impedance. **List Price: \$35.00**

SPECIFICATIONS

Frequency Response: 80 to 13,000 Hz.

Impedance and Output Level: Model 515SA:

High -58 db (0 db = 1 volt per microbar); 1.25 millivolts/microbar. Model 515SB: Low

(25 to 200 ohm) -59 db (0 db = 1 milliwatt per 10 microbars); .089 millivolts/microbar.

Cable: Model 515SA: Non-detachable 15-foot, one-conductor shielded. Model 515SB: Non-detachable 15-foot, two conductor shield.

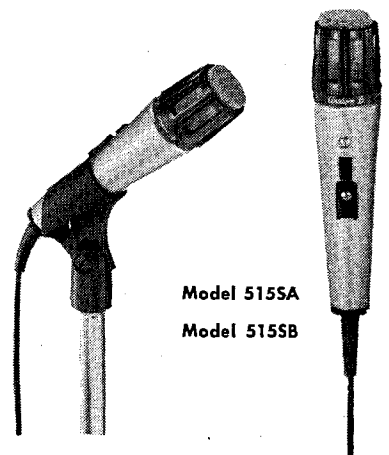

SHURE

MICROPHONE MIXERS

SHURE M68 AND M68FC MICROPHONE MIXER (TRANSISTORIZED—PORTABLE)



PRACTICAL—The Shure M68 Mixer is a practical, efficient and economical way of increasing the efficiency, usefulness and flexibility of public-address and paging systems, or tape recorders, by making it possible to use more than one microphone or other sound source. You can strategically place microphones so that everybody who should be heard will have a microphone close at hand. It is particularly useful where additional microphones are needed for panels or for audience Question-and-Answer sessions.

UNIQUE—This new mixer is unique in that it satisfies the needs of most public-address systems and serious tape recording enthusiasts, while being light enough to be portable, simple to operate and modest in cost. It is the **only** mixer which strikes a happy medium between the expensive heavy and complex permanent-installation type mixer and the extremely low-cost units of limited usefulness.

With the M68, each microphone (or other sound source) can be cut in or out of the system (and independently balanced for volume) with no loss in microphone output level. In addition to independent volume controls, a master volume control simultaneously controls the gain of all inputs. The M68 can, therefore, be used as a conveniently "at-hand" P.A. system volume control in situations where the regular amplifier is located some distance away.

VERSATILE—You can use high or low impedance microphones, in any mix, with any type amplifier without need for expensive line transformers.

You can tape record from multiple sound sources or record sound-on-sound with two recorders.

Frequency response is 30-20,000 Hz (cps). Underwriters Laboratory listed for use in commercial applications. Easily portable... 2 $\frac{5}{8}$ " x 11 $\frac{3}{8}$ " x 5 $\frac{3}{8}$ ", weighs only 4 lbs. 105-125 V. A.C. 50/60 cps.

Model M68 Mixer. Input connections are MALE Cannon XLR-3-14 type. (Uses XLR-3-11C type Mate.) **List Price: \$125.00**

Model M68FC Mixer. Input connections are FEMALE Cannon XLR-3-13 type. (Uses XLR-3-12C type Mate.) **List Price: \$135.00**

MICROPHONE MIXER ACCESSORIES

ATTACHE-TYPE CARRYING CASE — Makes M68 mixer, microphones and cables conveniently portable. **List Price: \$37.50**

A68B BATTERY POWER SUPPLY — Eliminates need for 115 V. A.C. hookup. **List Price: \$10.00**

A68L LOCKING PANEL — Prevents tampering with the controls. **List Price: \$8.00**

A68C OUTPUT CABLE KIT to connect mixer to any amplifier. **List Price: \$25.00**

A68S STACKING KIT to connect 2 or more M68's together for use with more than four microphones. **List Price: \$5.00**

A68SC INTERCONNECTING CABLE ONLY. **List Price: \$1.25**

A68R RACK PANEL KIT to mount mixer in a standard rack panel. **List Price: \$12.50**

SHURE

PROFESSIONAL NOISE CANCELLING MICROPHONES

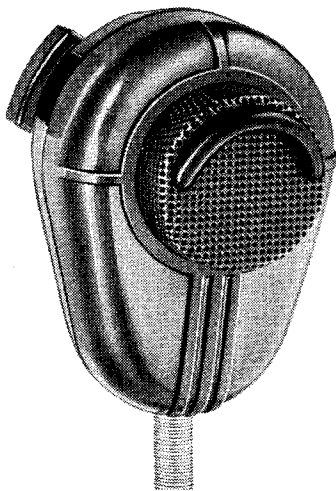

MODEL 488 "SONOBAR" . . .

A MAJOR BREAKTHROUGH IN MICROPHONE DESIGN

Stated by users to outperform and obsolete all others . . . its quality confirmed by extensive laboratory and field comparison tests! Provides highly intelligible speech communication where high volume background noise is found, such as airplanes, helicopters, motorcycles, trucks, fire engines, power boats, sporting events, drop forges, press-rooms, factories, canneries, mills, printing plants, etc. Incorporates the patented Shure Controlled Reluctance cartridge into a distance-discriminating microphone that effectively cancels background noise . . . gets the message through **EVEN WHEN THE SPEAKER CAN'T HEAR HIMSELF!** Correct placement for close-talk assured by convenient lipguard. Rugged, impact-resistant "Armo-Dur" case. Four versions available: 488A—high impedance; 488B—low impedance; and 488C and 488T—transistorized for direct replacement of carbon microphones (488T FAA Certified for Aircraft applications). All models equipped with coiled-cord and "million-cycle" push-to-talk, blade-type switches. With mounting bracket.

SPECIFICATIONS

Model	488A High Impedance	488B Low Impedance	488C Transistorized	488T Transistorized Aircraft
Frequency Response	(SPECIALLY TAILORED FOR BEST INTELLIGIBILITY) 200 to 4,000 Hz.			
Output Level (0 db = 1 volt per 100 microbar field)	.141 volts (—17 db)	.014 volts (—37 db)	0.45 volts (—7 db) using 6 volts d.c. and 500 ohm load	0.71 volts (—3 db) using 12 volts and 500 ohm load
Impedance	High: Recommended Load 100,000 ohms or more	150-250 ohms	Recommended Load 100 to 500 ohms	Recommended AC Load 100 to 800 ohms
Cable, 5 $\frac{1}{2}$ ' extended	Three-conductor (One-conductor shielded) cadmium copper coiled cord	Four-conductor (Two-conductor shielded) cadmium copper coiled cord	Four-conductor cadmium copper coiled cord	Three-conductor tinsel coiled cord with PJ 068—plug attached
Switch Mic Circuit Relay Circuit	Normally closed* Normally open	Normally open** Normally open	Normally open Normally open	Normally open Normally open
Dimensions and Weight	3 $\frac{3}{4}$ " HIGH x 2 $\frac{3}{8}$ " WIDE x 2 $\frac{1}{2}$ " DEEP; $\frac{3}{4}$ LB.			
List Price	\$57.50	\$57.50	\$62.50	\$72.50

*Provision for simple change to normally open

**Provision for simple change to normally closed

TRIMM / INC.

A SELECTED LISTING FROM OVER 2500 TRIMM-MANUFACTURED COMPONENTS.

HEADSETS: GENERAL PURPOSE, COMMERCIAL, MILITARY, AMATEUR, EDUCATIONAL, STEREO

Since 1922 TRIMM has manufactured a complete line of the finest electro-acoustic equipment and components. Engineered to fill the broadest applications; from the experimental crystal set to rugged field use, from industrial test equipment to home high-fidelity and stereo — these headsets are quality constructed and value priced.

ACME 24, 25, 27

A superior low-cost headset most suitable for Geiger counters, crystal sets, toys and radio systems. Black bakelite shell and cap. No. 24 has a black vinyl covered double headband and cotton tinsel conductor "Y" cord with pin tips. No. 25 headband is black enameled. No. 27 has a black enameled single headband and plastic covered stranded wire cord with pin tips.

REX 30, 32

Lowest cost BIPOlar type headset. Increased sensitivity. A 6 oz. lightweight for code training and institutional radio systems. Black bakelite shell and cap. Black vinyl covered headband. No. 32 has a single headband and plastic covered stranded wire with pin tips.

DEPENDABLE 70, 71, 72

Combines the best qualities of Acme and Rex; simple, rugged, sensitive and low cost. Ideal for electronic organs, code training and language labs. Black bakelite shell and cap, black vinyl covered headband, mercerized cotton tinsel "Y" cord and pin tips. No. 70 has double headband; No. 71 has plastic covered stranded wire cord; and No. 72 has single headband and single cord with pin tips.

STEREO

All models available for stereo use, ranging from the least expensive Acme to the top quality, extended range "L" headset. Stereo types have two different plug terminations. Those with "14" in code number have single 3-circuit plug such as No. 513 or No. 516; and those with "15" in code number have 2-circuit plugs, one red, other black.

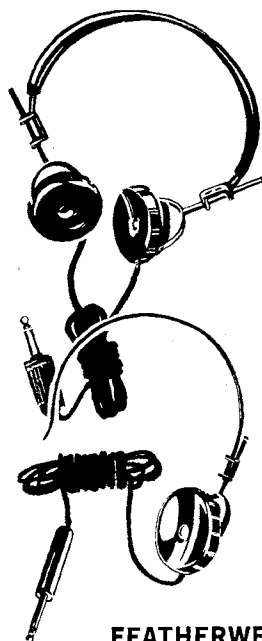

ACME

24-03	\$3.95	25-2K	\$3.65	With 511 plug	
25-03	3.50	24-4K	4.45	24-9-03	\$5.15
27-03*	2.10	25-4K	4.00	24-9-2K	5.20
24-15	4.00	27-1K*	2.25	25-9-2K	4.75
24-2K	4.10	27-2K*	2.45	27-9-03	3.20

STEREO

24-14-03	\$6.50	24-15-03	\$7.60
----------	--------	----------	--------

REX

30-03	\$4.70	30-3K	\$5.20	With 511 plug	
30-06	4.70	32-03*	2.65	30-9-03	\$5.80
30-2K	4.90	32-1K*	2.75	30-9-06	5.80
				30-9-2K	6.00
				32-9-03*	3.75

DEPENDABLE

70-03	\$5.35	70-3K	\$5.85	With 511 plug	
70-06	5.35	70-4K	6.15		
70-15	5.50	72-03*	3.60	70-9-03	\$6.45
70-2K	5.55	72-1K*	3.70	70-9-2K	6.65
71-2K	6.55	72-2K*	3.85	70-9-4K	7.25

STEREO

70-14-03	\$7.55	70-14-2K	\$8.35
70-15-03	8.75	70-15-2K	9.55

Headsets are listed by their model number and by their impedance or D.C. resistance; 3.2 ohms (03); 8 ohms (08); 600 ohms (06); 1500 ohms (15); 2000 ohms D.C. (2K); 2000 ohms (2M); 3000 ohms D.C. (3K); 4000 ohms D.C. (4K); 5000 ohms (5M); 12000 ohms (12M); 17000 ohms (17M); and 24000 ohms (24M). Single earphones (*). List prices included are for single purchases at retail. Consult your distributor for quantity discounts.

FEATHERWEIGHT 5 OZ.!

WORLD FAMOUS-PROVEN IN USE

100, 101, 102, 104, 106, 107

Highly recommended for amateur radio use, language training and electronic testing. Nos. 100 and 106 have a fully adjustable nickel plated single headband. Black bakelite shell and cap. Waterproof mercerized cotton tinsel conductor "Y" cord with pin tips. Nos. 104 and 107 have black vinyl covered double headband at no increase in price.

\$12.00 List With Pin Tips		\$14.00 List With 501 Plug	
100-03	100-2K	100-9-03	100-9-4K
104-03	104-2K	104-9-03	104-9-4K
100-06	100-4K	100-9-06	106-9
104-06	104-4K	104-9-06	107-9
100-15	106	100-9-2K	
104-15	107	104-9-2K	

With Pin Tips List \$12.50		With 501 Plug List \$14.50	
101-03	102-03	101-9-03	102-9-03
101-06	102-06	101-9-06	102-9-06
101-2K	102-2K	101-9-2K	102-9-2K

104-14-03	\$15.00	104-15-08	\$16.00
104-15-03	16.00	104-14-2K	15.00
104-14-08	15.00	104-15-2K	16.00



'L' HEADSET

IDEAL STEREO INSTRUMENT

HIGH SENSITIVITY

EXCEPTIONAL RESPONSE

No. 50, 56

Highest quality headset of conventional construction. Individually tuned acoustic cavities assures faithful sound reproduction. Top performance under all environmental conditions. Black bakelite shell and cap. No. 50 has black rubber covered double headband and waterproof nylon tinsel conductor, "Y" cord and No. 501 plug. No. 56 has a vinyl covered double headband with over-the-head molded neoprene cord and No. 501 plug.

STANDARD "L"

50-08	\$23.00	56-2M	\$27.65
56-08	27.65	50-5M	23.00
50-06	23.00	56-5M	27.65
56-06	27.65	50-12M	24.00
50-2M	23.00	56-12M	28.65

STEREO "L"

50-14-08	27.00	56-14-16	31.65
56-14-08	31.65	50-14-6M	28.00
50-14-16	27.00	56-14-6M	32.65
50-15-08	28.00	56-15-16	32.65
56-15-08	32.65	50-15-6M	29.00
50-15-16	28.00	56-15-6M	33.65

REPLACEMENT PARTS

For a nominal charge all TRIMM manufactured products can be restored to top working condition at the factory. Nearly any part that is required for manufacture is also available as a replacement part. In addition, worn or broken headset cords for almost any make can be made to order.

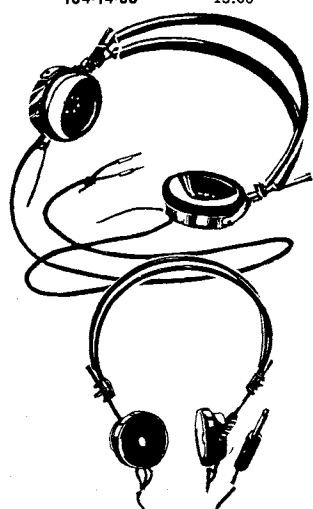

ARMY — NAVY 28, 29

Built for severe use. Satin chrome brass shell, black bakelite cap. Black rubber covered double headband with thumbscrew lock for yoke adjustment. Waterproof nylon tinsel conductor "Y" cord, pin tips or plug.

With Pin Tips		With 501 Plug	
28 (W) 600 ohm	\$20.00	28-9 (W) 600 ohm	\$21.65
29 (K) 20M ohm	20.00	29-9 (K) 20M ohm	21.65

COMMERCIAL 155, 156, 157, 158, AND 159

Very rugged TRIMM headset — yet very lightweight. Developed for marine and aircraft radio use. All types have black bakelite shell and cap; waterproof, tinsel conductor cord. No. 156 (600 ohm) and No. 157 (17M ohm) have rubber covered double headband with a "Y" cord and 501 plug. No. 158 (600 ohm) and No. 159 (17M ohm) same with pin tips on end of cord. No. 155 especially suited for educational use, has black vinyl covered headband, somewhat smaller than normal adult size and suitable for children. Complete with 501 plug.

155-03	\$13.50	156	\$15.75
155-06	13.50	157	15.75
155-2K	13.50	158	14.00
		159	14.00



MICROPHONES BY TURNER

SUBSIDIARY OF CONRAC CORPORATION

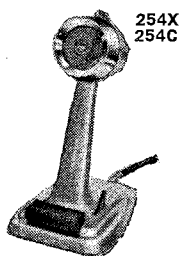

254X
254C

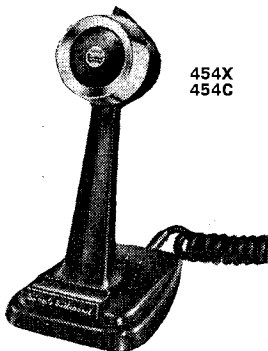

454X
454C

COMMUNICATIONS AND CITIZENS BAND MICROPHONES BASE STATION

MODEL 254X — It features push-to-talk front touch bar and locking on-off lever switch. May be wired for relay operation or electronic switching. Deluxe light grey hammertone finish. Output level: —48 db for more clear signal strength. Response: 100-8000 cps. 7' three-conductor (shielded) cable. Size is 7 $\frac{3}{4}$ " in height x 5 $\frac{1}{2}$ " in depth. Net price.....\$17.40

MODEL 254C — Same as 254X except with famous 21C ceramic interior. Output level: —54 db. Net price.....\$17.40

MODEL 454X — Designed for the voice range, it's extra hot. Output level: —48 db. Response: 300-3000 cps. Attractive telephone black finish. Your choice of VOX or PTT switch operation. Comes complete with 3-conductor (one shielded) coiled cord. Net price.....\$19.20

MODEL 454C — Same as Model 454X except has ceramic interior. Output level: —52 db. Net price.....\$19.20

MODEL +2

Revolutionary new microphone which allows manual control of output volume by a twist of a dial. Two transistor pre-amp built into the microphone for up to 50 times the output level of conventional ceramic base station microphones. World's best and most popular base station microphone. Exclusive touch-to-talk or lock on-off switching with a frequency response of 300-3,500 cps. Self contained 9 volt battery included. Net price..\$33.00



+ 2

REAR VIEW

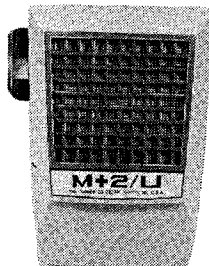

M + 2
JM + 2

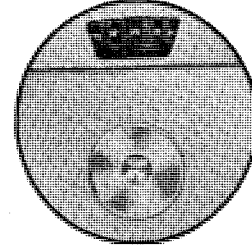

VOLUME CONTROL

MODEL M +2/U

Mobile companion to the +2 Model. 10 position output level control. Two transistor built-in pre-amp. Wired for relay switching. Net price.....\$23.70

MODEL JM +2/U

Same as M +2 except wired for sets that use electronic switching. Net Price...\$23.70

MOBILE

Model 360 is a small mobile type communications microphone, ceramic type designed to reduce size and weight to a minimum. Looks very good with the new small solid state sets. Also recommended for use with portable P.A. applications. Rugged cyclac case and heavy duty coiled cord. Response is 300-3000 cps; output level —54 db. Wired for relay switching. **Model J-360** is the same as Model 360 except wired for sets that use electronic switching.

MODEL 360, Net.....\$9.00
MODEL J-360, Net.....\$9.00

MODEL 360L — A new low impedance ceramic mike for the new solid state transistorized sets like III, 323 etc.....\$9.90

MODEL 350C — Most used as original equipment. This low-cost ceramic microphone with on-off switch is familiar to most mobile radio operators. More 350C microphones are used as original equipment on citizens band and marine transceivers than any other microphone. Extra-tough cyclac case. Rugged ceramic interior allows you to use the 350C in any climate. Complete with hanger button and standard dash bracket for easy mounting. Ideal for citizens band, amateur use, mobile rigs and paging. Wired for relay operation. Response: 80-7000 cps. Output level: —54 db. Net price.....\$9.00

Model +350 — is a transistorized dynamic mobile microphone in a dark gray 350 style case. It's an ideal replacement microphone for many sets using carbon microphones and will improve the intelligibility of your signal and provide consistent modulation. Silicon transistors are used for maximum dependability. Complete instructions are included. Response: 300-500 cps; Output level: —40 db at 12 v dc using 600 ohm load; Coiled cord: 3 conductor (1 shielded), Model +350. Net price.....\$20.58

MODEL 355C — Inexpensive mobile microphone with grip-to-talk switch. More comfortable to hold — more comfortable to use. The 355C features an output level of —50 db. It's extra hot for a high gain signal. Response: 80-7000 cps. Net price.....\$9.00

MODEL SR90D — The Model SR90D (pressure operated dynamic) features a slender die cast zinc alloy case with the Turner exclusive front hanger button. (Satin chrome finish.) Dynamic models are available in two impedances, hi or 200 ohms. Relay switching is standard. Three-conductor (one shielded) 11" retracted, 5' extended coiled cord on hi impedance models and 4-conductor (two shielded) on 200 ohm units. Output level: —52 db. at hi impedance. Response: 200-10,000 cps. Net price.....\$25.50

MODEL SR90R — Is equipped with a high quality telephone type carbon interior to give you maximum voltage output and high intelligibility as well. Same general appearance and features as Model SR90D. Output level: —40 db. Response: 200-4000 cps. Choose the Model SR90R wherever maximum output with a minimum of distortion is specified... taxicabs, police, etc. Net price.....\$19.20



350C
+350C



360



355C



SR90D
SR90R

CUSTOM INTERIORS

Turner has complete facilities for designing and manufacturing all kinds of special application microphone interiors, soft speakers for dictating machines, anything you need. Write for full information on this service.



UNIVERSITY® SOUND

A DIVISION OF LTV LING ALTEC, INC.

Drivers

MODEL ID-20 (20 watts) For speech and music systems requiring moderate sound power. Designed to deliver maximum output, the ID-20 is highly efficient, produces a clear, penetrating and distortion-free sound.

MODEL ID-30/ID-30T (30 watts) Exceptional for installations requiring single medium power units or multiple driver/horn combinations. These high quality drivers produce musical balance and speech penetration with a performance superior to higher cost competitive models. Tropicalized voice coil, completely weatherproof. Model ID-30T has a built-in line matching transformer tapped for impedances of 167/335/500/1000/2000/4000 ohms and 25 and 70 volt power taps at 30/20/10/5/2.5 watts.

MODEL ID-40/ID-40T (40 watts) Extended range, high quality and excellent efficiency produce an essentially uniform response and natural quality of speech and music reproduction. Moderately high power for penetrating through high ambient noise levels. Tropicalized voice coil and fully weatherproofed. Model ID-40T has a built-in line matching transformer tapped for impedances of 45/122/250/500/1000/2000 ohms and 25 and 70 volt power taps at 40/20/10/5/2.5 watts. ID-40T housing is rugged, die-cast aluminum with dural gland nut water tight cable entrance.

MODEL ID-60/ID-60T (60 watts) A premium high power compression driver. Wide range response, high efficiency and high quality construction for natural speech and music reproduction with maximum penetration in high noise areas. Rugged, weatherproof housing for trouble-free performance in any environmental application. Model ID-60T has high impact cyclocac outer case and built-in line matching transformer tapped for impedances of 16/80/165/500/1000/2000 ohms and 25 and 70 volt power taps at 60/30/20/10/5/2.5 watts.

MODEL ID-75 (75 watts) New, higher power in a compact case. Ideal for both Public Address and electronic siren applications. Peak efficiency, super power for effective penetration into exceptionally high noise areas.

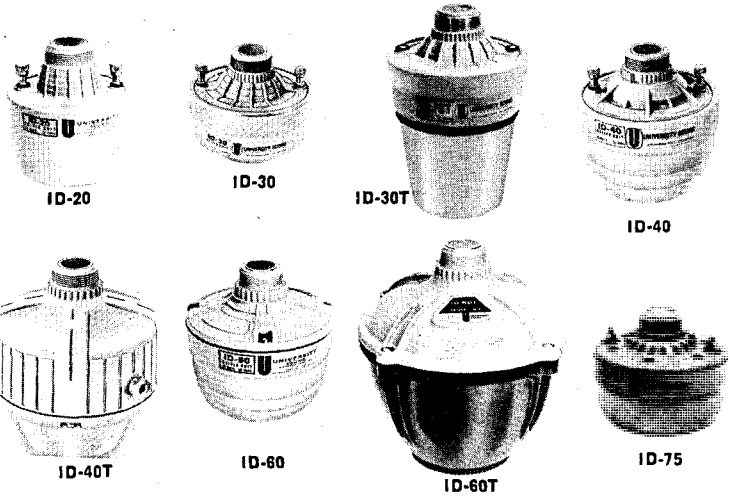

DRIVER MODEL	FREQUENCY RESPONSE	POWER RATING	VOICE COIL IMPEDANCE	DIMENSIONS (Overall)	SHIP. WT.	NET PRICE
ID-20	120-6500 Hz	20 watts	16 ohms	3 1/2" dia. 3 3/4" d.	2 1/2 lbs.	16.50
ID-30	85-7500 Hz	30 watts	16 ohms	4 1/8" dia. 3 3/4" d.	3 lbs.	19.50
ID-30T	85-7500 Hz	30 watts	variable*	4 1/8" dia. 6" d.	4 lbs.	28.87
ID-40	80-12000 Hz	40 watts	16 ohms	4 1/2" dia. 4 7/8" d.	4 1/4 lbs.	24.90
ID-40T	80-12000 Hz	40 watts	variable*	5" dia. 6 1/4" d.	5 1/4 lbs.	33.60
ID-60	70-12000 Hz	60 watts	16 ohms	4-11/16" dia. 5" d.	5 3/4 lbs.	34.50
ID-60T	70-12000 Hz	60 watts	variable*	6 3/4" dia. 6 3/4" d.	6 3/4 lbs.	42.54
ID-75*	150-7000 Hz	75 watts	16 ohms	4 1/4" dia. 3 3/4" d.	5 lbs.	35.40

*Also available in 8 ohms order as model ID-75-8.

Trumpets

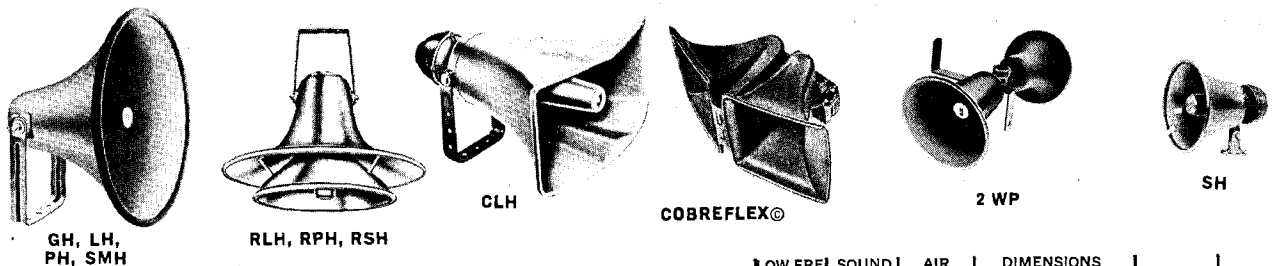

DIRECTIONAL MODELS GH, LH, PH, SMH For maximum noise penetration and distance of projected sound. Reflex design for highest conversion efficiency. Fully weatherproof, baked finish.

RADIAL MODELS RLH, RPH, RSH For uniform 360° overhead dispersion in high ceiling installations. Rugged construction, baked finish.

WIDE ANGLE COBREFLEX Patented twin folded exponential horns with two air columns in a single assembly. High efficiency and smooth radiation pattern. Can be used in cluster arrays. Rugged, fully weatherproof.

WIDE ANGLE MODEL CLH Patented design and construction. Wide angle bell and long air column for maximum low frequency response. Omnidirectional bracket for vertical and horizontal rotation to eliminate feedback and overshoot "dead spots". Can be used in cluster arrays. Rugged fiberglass horn.

HORN MODEL	LOW FREQUENCY CUT-OFF	SOUND DISTRIBUTION	AIR COLUMN LENGTH	DIMENSIONS (Overall)		SHIP. WT.	Net Price
				BELL LENGTH	BELL		
GH	85 Hz	65°	6 1/2 ft.	28"	31"	22 lbs.	55.77
LH	120 Hz	75°	4 1/2 ft.	19"	25 3/4"	16 1/2 lbs.	35.88
PH	150 Hz	85°	3 1/2 ft.	15 3/4"	20 3/8"	11 3/4 lbs.	26.14
SMH	200 Hz	95°	2 1/2 ft.	12"	16 1/4"	8 1/4 lbs.	21.60
RLH	120 Hz	360°	5 ft.	18 1/2"	28 1/4"	25 lbs.	48.60
RPH	140 Hz	360°	4 ft.	13 3/4"	25 1/4"	19 lbs.	37.26
RSH	180 Hz	360°	3 ft.	11"	19"	13 lbs.	34.98
COBREFLEX	200 Hz	120°x60°	2 1/2 ft.	10 1/4"	18 1/2"x9 1/4"	10 1/4 lbs.	27.60
CLH	120 Hz	120°x60°	4 1/2 ft.	20"	21 1/2"x11 1/2"	13 1/4 lbs.	33.00
SH	350 Hz	100°	1 1/2 ft.	7"	8 3/4"	2 3/4 lbs.	21.60
2WP	350 Hz	120° each horn	1 1/2 ft.	20 1/2"	8 1/2"	4 1/2 lbs.	21.60

Accessories

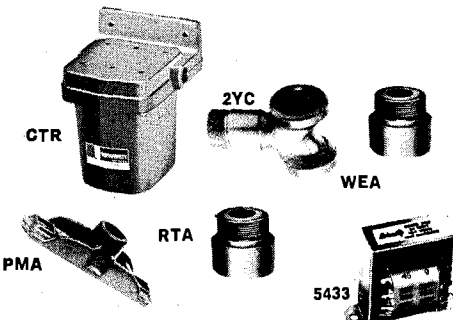

PMA ADAPTER Fits standard 1/2" dia. threaded pipe to any University "U" mounting bracket—for special applications requiring pipe mounting. Net \$2.97

RTA ADAPTER Fits University trumpets to Western Electric and RCA drivers having 1 7/16—16 threads. Shpg. wt., 1/2 lb. Net \$2.40

WEA ADAPTER Fits University drivers to Western Electric and RCA trumpets having 1 7/16—16 threads, Shpg. wt., 1/2 lb. Net \$1.89

MODEL 5433 TRANSFORMER 30 watt capacity. Use with ID-20, ID-30 or to feed a number of smaller paging speakers. Primary impedance: 45/165/200/250/500/1000

/2000 ohms. Secondary impedance: 4/8/16 ohms. 70 v. line power taps: 30/25/20/10/5/2.5 watts. Dimensions: 1 15/16" x 2 5/16" x 1 1/4". Mtg. hole centers: 2 3/8". Shpg. wt., 1 lb. Net \$5.46

MODEL CTR TRANSFORMER/JUNCTION HOUSING Die cast aluminum. Weatherproof. Houses models 5433, 5434, or other transformers up to 2 3/8" x 2 7/8" x 2 7/8". Adjustable slotted adapter mounts transformer with centers 1 1/2" to 2 7/8". Junction box for speaker lines. Bar strap for mounting to "U" brackets. Screws to wall. Also holds University paging speakers. Shpg. wt., 1 1/2 lbs. Net \$6.27

2YC CONNECTOR Allows use of two driver units on a single radial, directional, or wide-angle trumpet. Shpg. wt., 1 lb. Net \$8.97



Special Purpose Loudspeakers

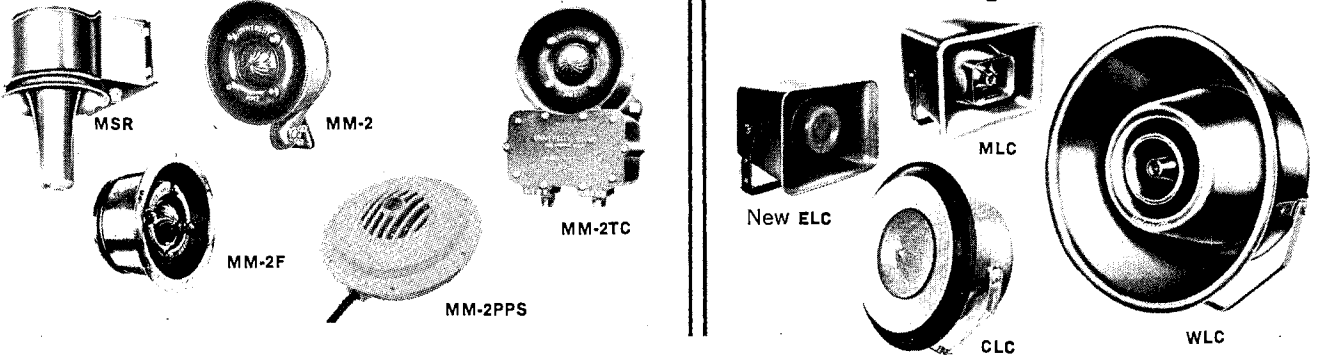

	Frequency Response	Power Rating (1)	Impedance (2)	Dispersion	Sound Pressure Level (3)	Dimensions	Shipping Weight	Net Price
ES-75	400-7,000 Hz	75 watts	16 ohms	90°	126 dB	9 1/2" h. x 8 3/4" w. x 10" l.	9 lb.	58.70
MSR	250-10,000 Hz	25 watts	16 ohms	360°	114 dB	10 3/4" h. x 6 7/16" w. x 8 1/4" d.	10 1/4 lb.	59.07
MSR-T			16 ohms (4)				11 1/4 lb.	67.81
MM-2	350-10,000 Hz	25 watts	16 ohms	150°	117 dB	6" dia. x 5" d.	5 1/4 lb.	37.29
MM-2F			16 ohms (4)			7 1/4" dia. x 3 3/4" d.		38.48
MM-2TC	350-10,000 Hz	25 watts	16 ohms	120°	117 dB	10" h. x 6 7/16" w. x 4 7/16" d.	8 3/4 lb.	56.38
MM-2TC-T			16 ohms (4)				9 3/4 lbs.	64.26
MM-2PPS	100-10,000 Hz	25 watts	16 ohms			7 3/16" dia. x 3 5/8" d.	5 1/4 lb.	46.50
MLC	150-15,000 Hz	15 watts	8 ohms	120°	117 dB	12 3/4" x 9 1/8" x 10 5/8"	10 lb.	39.95
CLC	55-14,000 Hz	30 watts	8 ohms	120°	118 dB	22 3/4" dia. x 12 3/4" d.	23 lb.	65.67
WLC	50-15,000 Hz	50 watts	8 ohms	90°	120 dB	33 1/2" dia. x 20" d.	68 lb.	185.80
ELC	150-11,500 Hz	15 watts	8 ohms	120°	114 dB	12 3/4" x 9 1/8" x 10 5/8"	9 lb.	32.95

1) Capacity in watts IPM (Music Power).
2) Voice coil impedance.

3) SPL reading taken 4 ft. on axis with "Full-Range" power input. Reduce by 6 dB each time distance is doubled. Reduce by 3dB if power input is halved; increase by 3dB when power input is doubled.
4) Matching transformer primary impedances: 45/165/200/250/500/1000/2000 ohms.

EXPLOSION PROOF DRIVERS

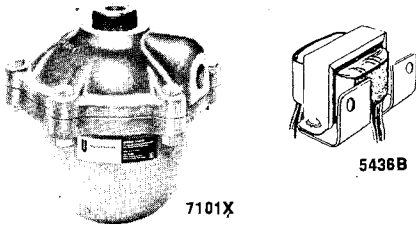

7101X, 7102X, 7105X are UL approved explosion-proof drivers, for use in 100%-safe systems where flammable liquids, gases, dust, etc., are present. The 7105X is approved for use in hydrogen-air atmospheres. In compliance with Government safety regulations, these units have provisions for mounting a line-matching transformer (optional*). 7101X is approved for Class I, Groups C & D. 7102X is approved for the same, plus Class II, Groups E, F & G. 7105X is approved for Class I, Groups B, C & D and Class II, Groups E, F & G. All units have 16 ohm voice coils. Frequency response is to 12,000 Hz and power capacity is 65 watts. Dimensions are 7 7/8" in dia., 7 3/8" long. Shipping weight is 14 lb. These UNIVERSITY explosion-proof drivers may be used with any UNIVERSITY trumpet, but are most often used and recommended for use with the UNIVERSITY SOUND Models PH, SMH and Cobreflex.

* University Model 5436B 65 watt transformer kit is complete with transformer, mounting bracket and hardware for installation inside the explosion-proof driver housing. Prices: Model 7101X \$77.26; Model 7102X \$84.15; Model 7105X \$130.80; Model 5436 B \$15.42.

Slim profile 3-way high fidelity speaker

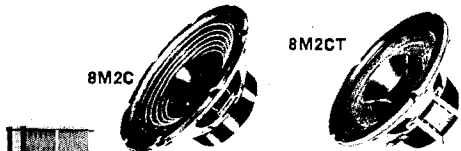

MODEL 8M2C 3-WAY SPEAKER A slim profile multi-speaker for public address and commercial sound applications. High quality, high efficiency performance for background music. Response to 50-20,000 Hz. Handles 15 watts of IPM. Model 8M2CT has built-in line matching transformer for 25 and 70 volt lines, tapped for 15/10/5/2.5/-1.25/.65 watts. Only 3" deep.
Net \$12.60
MODEL 8M2CT Same as 8M2C with transformer
Net \$14.97

UNILINE (TM) SOUND COLUMNS

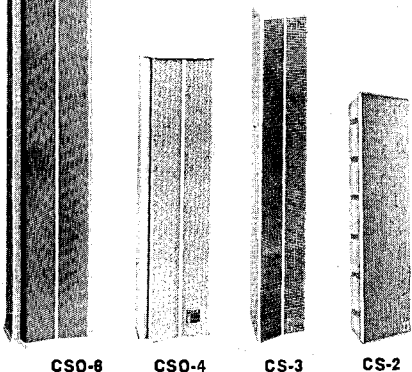

Model	CS-2	CS-3	CS0-4	CS0-6
Speakers	6 wide-range 5"	6-4"x6" Plus 2 Tweeters	2-8" plus 2-8" Dual Cone	4-8" plus 2-8" Dual Cone
Frequency Range	175-12,000 Hz	150-10,000 Hz	70-17,000 Hz	65-14,000 Hz
Power Capacity	30 watts IPM**	25 watts IPM	75 watts IMP	120 watts IPM
Impedance	8 ohms	16 ohms	8 ohms	16 ohms
S.P.L.*	102dB	107dB	114dB	117dB
Dispersion	Vertical 25° Horizontal 165°	20° 120°	18° 120°	16° 120°
Dimensions	31"x5"x5 1/2"	7 1/2"x8 3/4"x47 7/8"	11 7/8"x7 3/4"x41 3/8"	11 7/8"x7 3/4"x60 1/4"
Shipping Weight	14 lb.	33 lb.	40 lb.	63 lb.
Net Price	59.70	95.08	149.40	207.00

*10 ft. on axis, re .0002 dynes/cm², at rated power



UNIVERSITY® SOUND
A DIVISION OF LTV LING ALTEC, INC.

Dynamic Microphones

Broadcasting, Recording, Home Entertainment and General Purpose Applications

UNIVERSITY's new series of dynamic microphones embraces every possible need in the audio field. Widely acclaimed in the industry, each UNIVERSITY microphone is designed and engineered to maintain the same exacting quality standards for which UNIVERSITY is famous the world over. Each and every UNIVERSITY microphone, from the economically priced Model 2000 to the top of the line 5000 Series, is covered by UNIVERSITY's exclusive warranty to assure reliable trouble free operation for many years. To own the finest—choose UNIVERSITY!



NEW Model 5000 Shock-Mounted Super-Cardioid Dynamic New spherical shaped 5000 Series has a wide-angle pickup pattern with a precise taper characteristic that rejects all unwanted sound at the rear hemisphere of the unit. Rugged die-cast housing. For all applications—soundcasting, broadcasting, recording. 200 and 20,000 ohms. Response from 25 to 18,000 Hz. Output at 200 ohms -54 dB/1 mw/10 microbar; at 20,000 ohms 13 mv/10 microbar. 2 3/16" max. diameter. 9 5/8" max. length. 15' wired in 2 cond. shielded cable and SA-10 Stand Adapter supplied. Net \$51.60

Model 5020 Same as 5000 with detachable 15' cable and Amphenol Connector. Net \$56.95

Model 5050 Same as 5000 with swivel stand adaptor and 15' detachable cable. Net \$59.95

Model 8000 Attache' Cardioid Lavalier The 6000 is the world's smallest cardioid microphone. Its wide-range cardioid pickup pattern and inconspicuous appearance make it ideal for churches, night club, studio and remote broadcasting applications. It can be used as a lavalier, hand-held, mounted on a desk or floor stand, a boom or gooseneck fixture. Response is 50-15,000 Hz. Low impedance 50-500 ohms. Output at 150 ohms is -57 dB/1 mw/10 microbar. 1 1/6" diameter, 3 11/16" long. Supplied with lavalier neck cord, cable. Net Price \$39.75

Model 8000 Shock Mounted Cardioid Dynamic Highly directional wide angle pick-up pattern. Shock mounted for on-the-move applications. Ideal for church sound systems, industrial and commercial p.a. systems, and home tape recording. Response is 70-15,000 Hz. Impedance 250 and 20,000 ohms. Output at 250 ohms is -60 dB/1 mw/10 microbar; at 20,000 ohms is 8.5 mv/10 microbar. 1 3/4" diameter, 6 3/8" long. Equipped with 15', 3 cond. shielded cable and Cannon XLR-4-11-C connector. Supplied with stand adaptor. Net \$34.95

Model 8100 Same as Model 8000 with switch. Net \$37.95

Model 2000 Omni-directional Dynamic For general soundcasting and recording applications. Omni-directional pick-up pattern is ideal for groups and audience participation programs. Response is 50-14,000 Hz. Impedance 50 and 20,000 ohms. Output at 50 ohms is -50 dB/1 mw/10 microbar; at 20,000 ohms is 28 mv/10 microbar. 15' 3 cond. shielded cable is wired-in. 1 5/32" dia., 6" long. With SA-10 Stand Adaptor. Net \$26.85

Model 2040 Same as Model 2000 with switch and detachable 15' cable. Cannon Connector. Net \$30.60

Model 2050 Same as Model 2000 with switch and swivel stand adaptor, 15' detachable cable and Cannon Connector. Net \$33.45

MICROPHONE STANDS

Model DS-10 Desk Stand Heavy base sculptured stand may be used with any microphone. Standard 3/8-27 NPSM thread. 4 1/2" high x 7 7/8" wide x 4 5/8" deep. Black wrinkle finish. Net \$7.65

Model SA-10 Slide-on Stand Adaptor. Net \$2.85

Model DS-1 Desk Stand Contemporary design, slim profile desk stand with extruded aluminum base in black oxide finish. Perfectly balanced, will hold large microphones. Standard 3/8-27 thread. 6" x 4" x 3 3/4". Knurled locking washer. Net \$2.85

Model FS-7 Floor Stand A new concept in microphone stands. New fluted tubes are easy to adjust. Doesn't show hand marks, won't slip. Velvet action movement of upper tube, no twisting or turning. Positive lock clutch, jam-free one hand operation. Non-reflecting finish. Adjustable from 34" to 63". Black wrinkle base weighs 7 pounds and is 10" diameter. Natural satin fluted aluminum. Net \$10.77

Model FS-7B Blue Anodized. Net \$11.37

Model FS-7G Gold Anodized. Net \$11.37

Model FS-10 Floor Stand Same as Model FS-7 except for 10 pound, 12" diameter base. Natural Fluted aluminum. Net \$11.97

Model FS-10B Blue Anodized. Net \$12.57

Model FS-10G Gold Anodized. Net \$12.57

Wharfedale ACHROMATIC SPEAKER SYSTEMS



ACHROMATIC W90D

DELUXE SIX-SPEAKER, FOUR-WAY CONSOLE TABLE SPEAKER SYSTEM Exclusive Sand-filled Enclosure

The truly remarkable sound of the W90D is due both to the particularly high quality of its components and to the design used in putting them to best use. The fine furniture quality of the W90D cabinet will enhance any room setting. The front grille assembly is removable for facilitating decorative changes, if desired.

- Speakers: Woofer — One 12½" with 75 sq. in. Polystyrene piston radiator; One 12½" with conical cone; Midrange: two 5" acoustically isolated; Treble: Two Super 3" omnidirectional, mylar dome • Controls: treble, continuously variable; midrange, continuously variable • Minimum Power Required: 10 watts (per channel) IHF • System impedance: 4 to 8 ohms, Dimensions: 23¾" x 30" x 13½" (includes table top) Ship. Wt.: 100 lbs. • Finish: Oiled Walnut, Price: \$317.60.

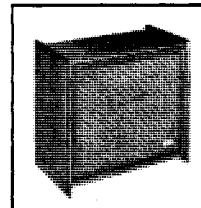
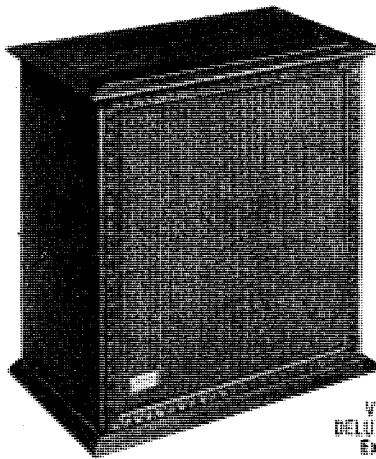

ACHROMATIC W70D

VERSATILE HI AND LOW BOY DELUXE FOUR-WAY SPEAKER SYSTEM Exclusive Sand-Filled Enclosure

The W70D incorporates the finest components available for multiple speaker systems. The versatile design permits use either as a "high boy" when placed on end, or as a "low boy" when placed on its side. The front grille is removable for decorative changes; nameplate is rotatable to accommodate different positions.

- Speakers: Woofer: 12½" extra heavy duty; Midrange: 8" upper bass/lower midrange; 5" upper midrange; Treble: Super 3" omnidirectional mylar dome tweeter • Controls: Individual continuously variable treble and midrange • Minimum Power Required: 10 watts (per channel) IHF • System Impedance: 4 to 8 ohms • Dimensions: 24" x 22¾" x 13½" (includes table top); Ship. Wt.: 73 lbs. • Finish: Oiled Walnut, Price \$199.95.

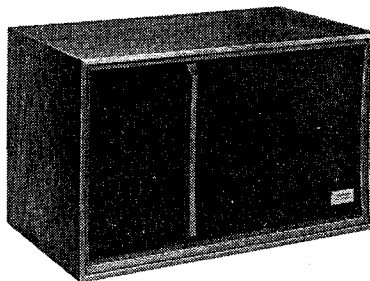

ACHROMATIC W60D

BOOKSHELF AND FLOOR-STANDING THREE-WAY SPEAKER SYSTEM Exclusive Sand-filled Enclosure

This latest version of the very popular W60 enjoys important benefits derived from its 3-way configuration and newly upgraded components. Removable grille.

- Speakers: Woofer: 12½" heavy duty woofer with 9½ lbs. magnet assembly; Midrange: 5" acoustically isolated; Treble: Super 3" omnidirectional mylar dome tweeter • Controls: individual continuously variable treble and midrange • Min. Power Required: 8 watts (per channel) IHF • System impedance: 4 to 8 ohms, Dimensions: 14¼" x 24" x 13" deep, Ship. Wt. 56 lbs. • Finish: Oiled Walnut, Price \$147.00.

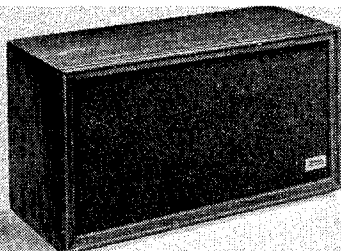

ACHROMATIC W40D **THREE-WAY BOOKSHELF SPEAKER SYSTEM WITH ACOUSTIC SUSPENSION**

The new W40D is a full three-way multiple speaker system yielding a carefully tailored, ultra-linear frequency response with minimum distortion. Using the acoustic suspension principle, the handsomely appointed cabinet is airtight and sturdily constructed. The front grille assembly is removable to facilitate decor changes, and the nameplate is rotatable to accommodate the speaker in either a vertical or horizontal position.

- Speakers: Woofer: Heavy duty 10"; Midrange: 5" acoustically isolated; Treble: Super 3" omnidirectional mylar dome tweeter • Control: Individual continuously variable treble and midrange • Min. Power Required: 8 watts (per channel) IHF • System Impedance: 4 to 8 ohms • Dimensions: 12½" x 23¼" x 10½" deep • Ship. Wt. 37 lbs. Finish: Oiled Walnut, Price \$105.85.

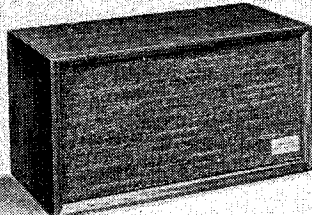

ACHROMATIC W30D **TWO-WAY COMPACT SPEAKER SYSTEM WITH ACOUSTIC SUSPENSION**

The new Model W30D solves the problems encountered by modern speaker systems intended for use with either tube or transistor amplifiers and receivers. It is suitable for use with any amplifier having an output of 4 to 8 ohms. The cabinet uses the acoustic suspension principle, with heavy, airtight construction for maximum performance. The grille assembly is removable to facilitate changes in cloth; nameplate is rotatable either vertically or horizontally.

- Speakers: Woofer: Heavy duty, long-throw 8" treble; 3" omnidirectional mylar dome tweeter • Control: Continuously variable treble • Minimum Power Required: 10 watts (per channel) IHF • System Impedance 4 to 8 ohms • Dimensions: 10" x 19" x 9¼" deep • Ship. Wt.: 20 lbs. Finish: Scuff resistant Oiled Walnut Vinyl • Price: \$64.65.

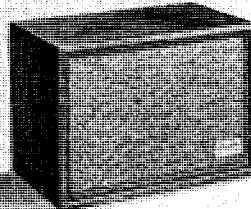

ACHROMATIC W20D **TWO-WAY MINORETTE SPEAKER SYSTEM WITH ACOUSTIC SUSPENSION**

Enthusiastically acclaimed in trade magazine test reports, the W20D Minorette sets its sights on sound above all... with dimensions and cost a secondary consideration. It features a sturdily constructed, handsomely appointed cabinet (acoustic suspension principle) with easily removed front grille. Small overall dimensions make it suitable for either stand-up or horizontal positioning with the position of the nameplate changeable, too. Ideal also for placement inside the speaker compartment of stereo "consoles."

- Speakers: Woofer: high-compliance 8"; Treble: 3" omnidirectional mylar dome tweeter • Control: continuously variable treble • Minimum Power Required: 10 watts (per channel) IHF • System Impedance: 4 to 8 ohms • Dimensions 9¾" x 14" x 8½" deep, Ship. Wt.: 14 lbs. Finish: Scuff resistant, Oiled Walnut Vinyl, Price: \$52.95.

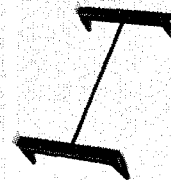

MODEL B67 UNIVERSAL MOUNTING BASE

Optional for the W60D and W90D Speaker Systems: Ship. Wt.: 2 lbs. Oiled Walnut, \$10.50

WHARFEDALE, Div. British Industries Corp.

PRICES AND SPECIFICATIONS SUBJECT TO CHANGE WITHOUT NOTICE

THE COMPLETE LINE OF PROFESSIONAL QUALITY audiotape

TRADE MARK

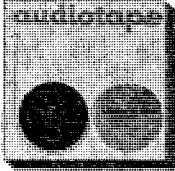
Description	Type No.	Length	Reel†	Suggested Resale	
 <p>STANDARD RECORDING on 1½-mil Acetate</p> <p>Meets the most exacting requirements of the professional, educational and home recordist at minimum cost. Known the world over for its matchless performance and consistent uniform quality. Formula 10, in the red box.</p>	151	150 ft.	3" Plastic Reel	\$0.42	
	151MB	150 ft.	3" Plastic Reel in Mailing Box	0.42	
	351	300 ft.	4" Plastic Reel	0.81	
	651	600 ft.	5" Plastic "C-Slot" Reel	1.35	
	851	850 ft.	5¾" Plastic Reel	1.77	
	1251	1200 ft.	7" Plastic "C-Slot" Reel	2.10	
	2551H	2500 ft.	NARTB Hub	4.71	
	2551R	2500 ft.	10½" Aluminum Reel	6.48	
	‡2551FS	2500 ft.	10½" Fiberglass Reel	6.48	
	5051H	5000 ft.	NARTB Hub	8.64	
	5051R	5000 ft.	14" Aluminum Reel	12.81	
<p>audiotape</p> <p>LONGER RECORDING on 1 mil Mylar*</p> <p>50% more recording time per reel. The strong, super-durable polyester film base assures trouble-free operation even under severe conditions of heat and humidity. Formula 10, in the orange box.</p>	261	225 ft.	3" Plastic in Self-Mailer Pkg.	0.60	
	961	900 ft.	5" Plastic "C-Slot" Reel	2.16	
	1261	1200 ft.	5¾" Plastic Reel	2.49	
	1861	1800 ft.	7" Plastic "C-Slot" Reel	3.72	
	2461	2400 ft.	8¼" Plastic Reel	5.65	
	3661H	3600 ft.	NARTB Hub	6.84	
	3661R	3600 ft.	10½" Aluminum Reel	8.61	
	‡3661FS	3600 ft.	10½" Fiberglass Reel	8.61	
	7261H	7200 ft.	NARTB Hub	14.40	
	7261R	7200 ft.	14" Aluminum Reel	18.00	
	<p>audiotape</p> <p>LONGER RECORDING on 1 mil Acetate</p> <p>50% more recording and playback time on low-cost 1-mil cellulose acetate base, affording maximum economy for applications where high strength is not required. Formula 10, in the blue box.</p>	941	900 ft.	5" Plastic "C-Slot" Reel	2.10
1241		1200 ft.	5¾" Plastic Reel	2.25	
1841		1800 ft.	7" Plastic "C-Slot" Reel	3.30	
3641H		3600 ft.	NARTB Hub	5.91	
3641R		3600 ft.	10½" Aluminum Reel	7.68	
‡3641FS		3600 ft.	10½" Fiberglass Reel	7.68	
7241H		7200 ft.	NARTB Hub	11.04	
7241R		7200 ft.	14" Aluminum Reel	15.21	
<p>audiotape</p> <p>DOUBLE RECORDING on ½ mil Mylar*</p> <p>Twice as much recording time per reel as standard plastic-base tape. Suitable for extended-play applications where tape tension is not excessive. Formula 10, in the tan box.</p>		331	300 ft.	3" Plastic Reel	0.82
		1231	1200 ft.	5" Plastic "C-Slot" Reel	2.10
		1831	1800 ft.	5¾" Plastic Reel	3.00
	2431	2400 ft.	7" Plastic "C-Slot" Reel	3.90	
	<p>audiotape</p> <p>DOUBLE RECORDING on "Tempered" Mylar*</p> <p>Twice as much recording time per reel as standard plastic-base tape, and is twice as strong as other double-length tapes. Will not stretch or break on any tape recorder—will not dry out or embrittle with age. Formula 10, in the maroon box.</p>	331T	300 ft.	3" Plastic in Self-Mailer Pkg.	0.96
1231T		1200 ft.	5" Plastic "C-Slot" Reel	3.27	
1831T		1800 ft.	5¾" Plastic Reel	4.05	
2431T		2400 ft.	7" Plastic "C-Slot" Reel	5.70	
4831T-R		4800 ft.	10½" Aluminum Reel	13.20	
‡4831T-FS		4800 ft.	10½" Fiberglass Reel	13.20	
<p>audiotape</p> <p>STANDARD RECORDING on 1½ mil Mylar*</p> <p>A premium-quality professional tape that provides the utmost in mechanical strength and immunity to temperature and humidity. Will not dry out or embrittle with age. Formula 10, in the green box.</p>		671	600 ft.	5" Plastic "C-Slot" Reel	1.59
	1271	1200 ft.	7" Plastic "C-Slot" Reel	2.55	
	2571H	2500 ft.	NARTB Hub	4.98	
	2571R	2500 ft.	10½" Aluminum Reel	6.72	
	‡2571FS	2500 ft.	10½" Fiberglass Reel	6.72	
	5071H	5000 ft.	NARTB Hub	9.99	
	5071R	5000 ft.	14" Aluminum Reel	14.70	
	<p>audiotape</p> <p>MASTER RECORDING on 1½ mil Acetate</p> <p>The finest, professional-quality recording tape. Base material 1½-mil acetate. Maximum fidelity, uniformity, frequency response and freedom from noise and distortion. . . . Plus low print-through. Formula 14, in red and gold box.</p>	651-M	600 ft.	5" Plastic "C-Slot" Reel	1.65
1251-M		1200 ft.	7" Plastic "C-Slot" Reel	2.58	
2551H-M		2500 ft.	NARTB Hub	5.55	
2551R-M		2500 ft.	10½" Aluminum Reel	7.32	
‡2551FS-M		2500 ft.	10½" Fiberglass Reel	7.32	
5051H-M		5000 ft.	NARTB Hub	10.17	
5051R-M		5000 ft.	14" Aluminum Reel	14.34	
<p>audiotape</p> <p>MASTER RECORDING on 1½ mil Mylar*</p> <p>Super-durable tape that meets highest standards of performance. Withstands extreme temperature and is virtually immune to humidity. . . . Plus low print-through. Formula 14, in the green and gold box.</p>		671-M	600 ft.	5" Plastic "C-Slot" Reel	1.92
		1271-M	1200 ft.	7" Plastic "C-Slot" Reel	3.06
	2571H-M	2500 ft.	NARTB Hub	6.60	
	2571R-M	2500 ft.	10½" Aluminum Reel	8.10	
	‡2571FS-M	2500 ft.	10½" Fiberglass Reel	8.10	

†COLORED PLASTIC REELS: Audiotape on 5" and 7" reels can be supplied on colored reels at no increase in price. To designate color (Red, Yellow, Green or Blue) add "RR" and "YR", and "GR" or "BR" to Type No. E.g.—Type 1251YR covers 1200 feet of plastic-base tape on Yellow Reel.

‡"FS" in Type No. indicates Fiberglass reel with solid hub and ¼" center hole.

*"Mylar" is the registered DuPont trade mark for its polyester film.



HI FI & STEREO ACCESSORIES FOR TAPE RECORDERS & PHONOGRAPHS, HOME & AUTO

CONNECTING CABLES

AMERICAN MADE

STANDARD AUDIO CABLES FOR
HI-FI - STEREO

- The Complete Line of Cables
- Durable Molded Assemblies
- Heavy-Duty, Low Resistance Wire
- Attractively Packaged

PART NO.	ILLUSTRATION	DESCRIPTION	LENGTH	LIST
30-400-S		Shielded Cable, Phono Pin Plugs on both ends.	18" Cable	1.30
30-402-S		Shielded Cable, Phono Pin Plugs on both ends.	36" Cable	1.42
30-404-S		Shielded Cable, Phono Pin Plugs on both ends.	72" Cable	1.73
30-406-S		Shielded Cable; Phono Pin Plugs on both ends.	12' Cable	2.28
	FOR STEREO HEADSET			
30-449-S		Molded On Three Conductor Phone Plug on one end of two conductor shielded cable, other end Molded On Three Conductor Phone Jack.	12' Cable	6.66
30-450-S		Shielded Cable, Phone Plug on one end, other end stripped and tinned.	72" Cable	2.05
30-451-S		Molded Shielded Cable with right angle Phone Plug on one end, other end stripped and tinned.	12' Cable	2.55

PLUGS, JACKS AND ADAPTORS

30-534		Combination clamp-type Phone Plug (solder connection) with removable shielded handle. Much easier to attach than the standard phono plug, and provides "finished appearance". *Pkg. of 2.	2	1.17
30-472		Adapter, Phono Pin Plug to Standard Phone Plug.	1	1.95
30-484		Standard Phone Plug, 2 conductor. Black Plastic Handle	1	1.00

NEW

Tape Cartridge
Player

HEAD- DEMAG

(Extra Long Tip for
Auto and Home

4 and 8 Track Players)

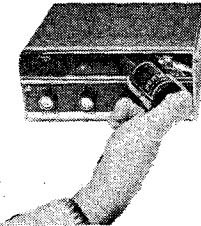

Demagnetizes player heads quickly and easily. Extra long tip will reach into tape cartridge players easily for demagnetizing tape player head, thus preserving full frequency response. Demagnetizer tip is coated with soft plastic to prevent damaging player head. Complete with momentary push-button switch and 6' cord. Nothing to wear out; will last a lifetime.

(Std. Ctn. 12 cards)

NO.30-112-2 List 12.95

HEAD LUBRICANT HEAD CLEANER

(The Perfect Treatment
for Maximum Efficiency)



Use Audiotex safe, efficient head cleaner to remove dirt and grease. Audiotex Recorder Head lubricant with silicone may be applied liberally to recorder head, leaves a light protective film to reduce friction. Cuts wow, flutter and tape squeals.

(Std. Ctn. 12 cards)

No. 30-124-1 Cleaner List 1.00

No. 30-124-2 Lubricant List 1.00

No. 30-124-3 Cleaner and Lubricant... List 1.95

DELUXE TAPE SPLICER

WITH BUILT-IN
SPLICING
TAPE DISPENSER

(Cuts and Splices
Tape Automatically)



The New Deluxe Audiotex Tape Splicer handles all sizes of splicing tape. Unique splicing tape dispenser simplifies operation. For professionally repairing and editing, splicer cuts recording tape diagonally and trims splicing tape with indented cut to eliminate the danger of adhesive coming in contact with the recorder heads.

No. 30-106 List 8.95



Walsco PHONO DRIVES

Part No.	I.D.	Inside Circum.	Used On	Net
1420-01	2-3/32	6-9/16	3/16 Wollensak T1600	.40
1428-02	29/32	2-27/32	1/8 Wollensak T1600	.37

High-Quality,
Abrasion-resistant
Neoprene
RUBBER TIRES

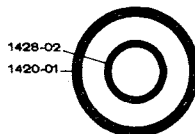

FABRIC
DRIVE BELTS

Part No.	I.D.	Inside Circum.	Width	Thickness	Used On	Net
1409-02	5-13/32	17	5/16	1/64	Pentron, Crescent Recorders	4.02
1409-03	3-29/32	12-1/4	5/16	1/64	Pentron, Crescent Recorders	3.12
1409-04	4-1/32	12-5/8	5/16	1/64	VM 700, 701, 710, 711, 714	3.12
1409-05	5-13/32	17	3/16	1/64	Webcor Recorders	3.12
1409-06	3-5/16	10-3/8	7/32	1/64	Telectro 880	2.08
1409-07	5-1/8	16-3/32	7/32	1/64	Telectro 880	2.08
1409-08	2-13/32	7-9/16	7/32	1/64	Telectro MR111, 556, 1960	2.00
1409-09	3-1/4	10-3/16	7/32	1/64	Telectro MR111, 556, 1960,	2.08
1409-10	3	9-13/32	7/32	1/64	Telectro and Knight	2.00
1409-11	3-19/32	11-5/16	7/32	1/64	Telectro and Knight	2.08
1409-12	2-1/2	7-13/16	7/32	1/64	Telectro	1.83
1409-13	4-31/32	15-1/16	5/32	1/64	Webcor	2.42
1499-16	3-5/16	10-3/8	3/16	1/64	Webcor	3.00



IDLER WHEEL - 2" O.D.

For use on G.E. model EA80X61.
Shaft dia. .1253".

No. 1499-35. Net 2.50



PRESSURE ROLLER 3/4" O.D.

For use with VM Model 700, 701,
710, 711, 714 tape recorders.

No. 1458. Net 1.75

WRITE FOR CATALOG #FR-69 FOR COMPLETE LISTINGS

5 SYNCHRO-LAB™ MODELS THAT GUARANTEE ABSOLUTELY CONSTANT SPEED

Garrard®

WORLD'S FINEST
AUTOMATIC TRANSCRIPTION TURNTABLES

Garrard's revolutionary SYNCHRO-LAB™ motor starts instantly at precise speed and maintains that speed regardless of voltage fluctuations. It powers all five Synchro-Lab Series turntables and incorporates the best features of both induction and synchronous motors. Instant start... constant speed.

SL 95 3-speed Automatic Transcription Turntable, \$129.50. For the finest music systems and most discriminating listeners. Features include:

- NEW advanced, one-piece, ultra low-mass tonearm with Afrormosia wood for low resonance • NEW anti-skating control calibrated in 1/2 grams and infinitely variable • NEW stylus force adjustment dial with detent stops of 1/4 grams
- NEW combined manual-cueing-pause control: single lever starts turntable, activates cueing, lifts and lowers arm gently to record • NEW Auto-Rise Safety platform for automatic play — disappears into unit for single play
- NEW interchangeable cartridge clip — no need for plug-in shells • NEW versatile automatic lever controls all automatic and manual functions
- NEW combined speed and record size selector • NEW full 12" turntable, kinetically matched to synchronous motor • NEW single play spindle rotates with record.



SL 75 3-speed Automatic Transcription Turntable, \$109.50. A brilliant combination of revolutionary new features, with new Synchro-Lab motor.

- NEW low mass, one-piece tonearm of twin-braced aluminum for extra rigidity and freedom from resonance • NEW interchangeable cartridge clip — no need for plug-in shells • NEW patented, adjustable anti-skating control, infinitely variable • NEW adjustable counterweight, suspended in resonance-absorbing plastic • NEW stylus pressure adjustment assembly with "optical" knob • NEW Auto-Rise Safety platform for automatic play; disappears into unit when not in use • NEW one-lever manual and cueing control starts turntable, activates cueing, lifts and lowers arm gently to record • NEW full 12" aluminum turntable • NEW combined speed and record size selector • NEW single play spindle rotates with record.

SL 65 4-speed Automatic Turntable, \$79.50. With the brilliant new SYNCHRO-LAB motor and a host of advanced features:

- Tubular, dynamically balanced tonearm • Resiliently mounted counterbalance weight • Automatic anti-skate assembly • Stylus pressure adjustment assembly with knurled "optical" type knob • Cueing and pause control • Lightweight, cutaway shell with new cueing pointer • Super-sensitive Du Pont Delrin® trip • Cast, balanced, oversized turntable • Interchangeable spindles; automatic intermix operation when desired.



New, Module SLx2

3-speed Automatic Turntable Complete With Handsome, Matching Base Coordinated Dust Cover and High Performance Magnetic Cartridge, \$69.50. With Synchro-Lab motor for an outstanding automatic record playing unit to complement the finest stereo components.

- Features include:
- Oversize balanced turntable with distinctive aluminum trim ring and safety groove mat • Ultra low mass, dynamically balanced tubular aluminum arm • Adjustable counterbalance • Built-in adjustable stylus pressure adjustment knob, calibrated from 0 to 5 grams • Single-lever cueing and pause control for both automatic and manual functions • Unique, swing-away overarm for single-record play • Synchro-Lab motor guarantees absolutely constant synchronous speed for perfect record reproduction.

SL 55 4-speed Automatic Turntable, \$59.50. With the Synchro-Lab motor. Unmatchable value in a synchronous-speed automatic turntable. Features include:

- Lightweight tubular tonearm with resiliently mounted counterbalance weight • Stylus pressure adjustment with gram markings • Manual cueing and pause control • Lightweight plug-in shell with cueing pointer • Oversized turntable with distinctive trim ring • Two spindles; automatic intermix operation when desired.

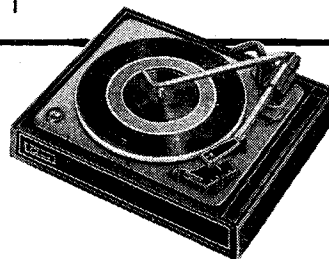

40 MK II 4-speed Automatic Turntable, \$44.50. The

- Model 40 MK II is undoubtedly the most widely-featured automatic in preselected music systems throughout the country. Its features include:
- Cast aluminum, counterbalanced tonearm • Simple, accessible stylus pressure adjustment • Lightweight cutaway shell with extended finger lift • Intermix automatic operation • Super-sensitive Du Pont Delrin® trip • 4-pole shaded "induction surge" motor • Oversized turntable • Two spindles; short for manual; center drop for automatic play when desired • Ultra-compact size fits easily into any record changer space.

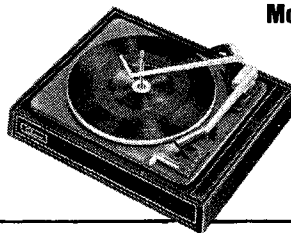

Model 30 4-speed Automatic Turntable, \$39.50.

- This excellent new model comes complete with a ceramic diamond stylus cartridge, as well as the finest quality and superior features:
- Simple accessible stylus pressure adjustment • NEW one-piece cast aluminum tonearm • Super-sensitive Du Pont Delrin® trip • Garrard-built motor • Intermix automatic operation • Ultra compact size • NEW oversized, weighted turntable • Two spindles; short for manual; center drop for automatic play when desired.

SP 20 4-speed Manual Record Playing Unit, \$37.50. An efficient, low-priced compact manual player, ideal for basic stereo music systems and quality audio visual applications.

- Semi-counterbalanced arm with adjustable stylus pressure • Interchangeable plug-in head • Garrard-built motor • Full size turntable • Du Pont Delrin® trip • Compact size.



Accessories: Coordinated bases including the new Power-Matic series; dust covers, mounting boards, automatic "45" spindles.



GARRARD, Div. British Industries Corp.

PRICES AND SPECIFICATIONS SUBJECT TO CHANGE WITHOUT NOTICE



MAGNETIC TAPE HEADS AND QUIK-KITS

Designed and manufactured to highest standards of excellence, Nortronics tape heads are used as "original" equipment by more than 80% of the nation's tape recorder manufacturers. Nortronics now offers a complete line of heads, available in a wide selection of track styles, functions and sizes in PROFESSIONAL, PREMIUM or STANDARD versions.

ABOUT THIS LISTING—The magnetic heads, hardware and accessories listed on these four pages is only a partial listing of the complete Nortronics line. For information on more than 1800 replacements and more than 1800 possible conversions, see your Nortronics Distributor. His comprehensive listings contain cross-reference data by: 1.) Manufacturer's Name and Model 2.) Recorder Manufacturer's Head Part Number and 3.) Head Manufacturer's Part Number.

REAR MOUNT HEADS—All heads listed below are No-Mount styles. Rear-Mount styles are also available, except on "Combos," and 3100 and 5800 Series, and may be ordered by simply adding 50 to last two digits of No-Mount model number. (i.e.: 1203 No-Mount becomes 1253 to indicate same head with Rear-Mount.) For Rear-Mount prices, see footnote under charts.

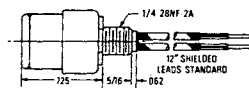

Record/Play and Record-Only Heads

APPLICATION NOTES:

1. High-impedance general-purpose record/play or playback-only head for vacuum-tube circuits. 2. Medium-impedance record/play head for vacuum-tube or transistor circuits. 3. Low-impedance record/play for transistor circuits. 4. Special low-impedance record-only for vacuum-tube or transistor circuits in duplicators and professional recorders. 5. Low-impedance record-only for vacuum-tube or transistor circuits. 6. For bias frequencies up to 750 KHz.

Head Description	Nortronics Model No.		Head Function	Application (See Notes)	1 KHz Inductance MHY	1 KHz Impedance OHMS	DC Resistance OHMS	Net Each (No Mount)
	No Mount	Case Style						
Standard 4-Track Stereo Hyperbolic Metal Face Laminated Cores	1000	B	Record/Play	1	800	5000	700	\$21.00
	1001	B	Record/Play	2	400	2500	390	21.00
	1002	B	Record/Play	3	100	650	90	21.00
Premium 4-Track Stereo Hyperbolic Metal Face Laminated Cores	1200	B	Record/Play	1	800	5000	700	\$28.20
	1201	B	Record/Play	2	400	2500	390	28.20
	1203	B	Record/Play	3	100	650	90	28.20
Standard 2-Track Stereo Hyperbolic Metal Face Laminated Cores	1800	B	Record/Play	1	800	5000	720	\$23.30
	1801	B	Record/Play	2	400	2500	410	23.30
	1802	B	Record/Play	3	100	650	130	23.30
Premium 2-Track Stereo Hyperbolic Metal Face Laminated Cores	2000	B	Record/Play	1	800	5000	720	\$30.30
	2001	B	Record/Play	2	400	2500	410	30.30
	2002	B	Record/Play	3	100	650	130	30.30
Premium 2-Track Mono Hyperbolic Metal Face Laminated Cores Track .040 Off Center	2600	B	Record/Play	1	800	5000	400	\$15.90
	2601	B	Record/Play	2	400	2500	165	15.90
	2602	B	Record/Play	3	100	650	70	15.90
Standard 2-Track Mono Hyperbolic Metal Face Laminated Cores	3000	G	Record/Play	1	800	5000	400	\$ 8.40
	3001	G	Record/Play	2	400	2500	165	8.40
	3002	G	Record/Play	3	100	650	70	8.40
2-Track Mono (Center Tr.) Cylindrical Metal Face Solid Cores	3100	G	Record/Play	1	1000	6300	625	\$ 8.40
	3101	G	Record/Play	2	400	2500	350	8.40
Premium 2-Track Mono Hyperbolic Metal Face Laminated Cores	3200	G	Record/Play	1	800	5000	400	\$15.90
	3201	G	Record/Play	2	400	2500	165	15.90
	3202	G	Record/Play	3	100	650	70	15.90
Premium Full-Track Hyperbolic Metal Face Laminated Cores	4100	B	Record/Play	5	250	1500	200	\$34.70
	4101	B	Record Only	5	55	330	125	34.70
Premium 4-Channel Hyperbolic Metal Face Laminated Cores	5601	B	Record Only	5	50	320	150	\$99.00
	5602	B	Record/Play	3	90	600	100	99.00
	5603	B	Record/Play	2	370	2200	690	99.00
Premium 3-Channel Hyperbolic Metal Face Laminated Cores	5701	B	Record/Play	3	340	2000	800	\$99.00
	5702	B	Record/Play	3	100	650	260	99.00
	5703	B	Record Only	5	50	400	260	99.00
Premium 8-Track Stereo Hyperbolic Metal Face Laminated Cores	5800	B	Record/Play	2	400	2500	700	\$15.00
	5810	B	Record Only	5	40	75	42	15.00
	5813	B	Record Only	5	50	400	225	21.00
Premium 8-Track 4-Channel Hyperbolic Metal Face Laminated Cores	5832	B	Record/Play	2	200	1400	500	\$1.00
	5833	B	Record/Play	3	100	700	250	81.00
	5834	B	Record Only	5, 6	50	400	250	81.00
	5835	B	Dup. Record	4, 6	10	80	60	81.00
	5836	B	Dup. Record	4, 6	2	20	16	81.00

*Note: For Rear Mount add \$1.50, except on 5650 and 5750 series add \$6.00.

Erase Heads

Head Description	Nortronics No Mount Model Nos.		Imped.	1 KHz Impd. MHY	60 KHz Impd. OHMS	Operating Erase Current MA	DC Resist. OHMS	60 KHz Operating Voltage VOLTS	Net Each†
	Standard "S" Case	Large "L" Case							
4-Track Stereo Erase Full Metal Face	1400	1400L	H	80	30,000	3-5	270	90-150	\$12.00
	1401	1401L	Med	10	2,800	10-15	40	28-42	12.00
	1402	—	Lo	0.13	40	80-140	2	3-6	12.00
2-Track Stereo Erase Full Metal Face	2200	2200L	H	8	25,000	4.5-7.0	205	100-150	\$12.00
	2201	2201L	Med	8	2,000	16-24	35	32-48	12.00
2-Track Mono Erase Full Metal Face	3600	3600L	H	8	25,000	4.5-7.0	205	100-150	\$ 8.00
	3601	3601L	Med	8	2,000	16-24	35	32-48	8.00
Full-Track Mono Erase Full Metal Face	4400	4400L	H	4.0	12,000	10-15	88	100-150	\$14.00
	4401	4401L	Med	3.6	1,000	32-48	25	32-48	14.00

*For 60 db erasure of saturated tape. Voltages shown are RMS. †For Rear Mount, add \$1.50.

Combo Heads

Head Description	Nortronics No Mount Model No.	Head Function	Equivalent Head Specification Reference	Net Each
4-Track Stereo "Combo" Metal Face	6000	Record/Play, Erase	1201, 1400	\$33.00
	6001	Record/Play, Erase	1203, 1400	33.00
	6002	Record/Play, Erase	1201, 1401	33.00
	6003	Record/Play, Erase	1000, 1402	33.00
6009	Record/Play, Erase	1009, 1401	33.00	
4-Track Stereo Z-Combo	6800	Record/Play, Erase	—	\$23.70
2-Track Stereo "Combo" Metal Face	6100	Record/Play, Erase*	2001, 2201	\$36.00
2-Track Mono "Combo" Metal Face, Center Track	6125	Record/Play, Erase	3000, 3600	\$21.00

Quik-Kit Mounting Hardware

Nortronics Quik-Kits consist of packaged hardware and complete instructions for installation of a Nortronics tape head on a recorder. Most Quik-Kits are universal in design to fit most recorders—special Quik-Kits are for use on recorders requiring a mount unique to that machine type only.

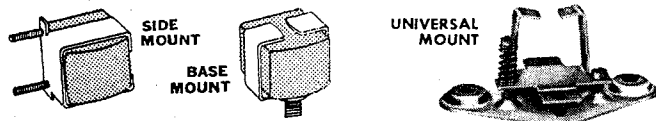

Quik-Kit	Description	Net
QK-18	Erase—Side Mount, "S" Cases	\$1.00
QK-19	Erase—Base Mount, "S" Cases	1.00
QK-20	R/P—Side Mount, "G" Cases	1.00
QK-21	R/P—Base Mount, "G" Cases	1.00
QK-35	Spec. Base Mt., "A"; "B" Cases	2.00
QK-38	Side Mount, "A"; "B" Cases	1.00
QK-66	Base Mount, "A"; "B" Cases	1.00
QK-76	Amplex Mounting Block	12.00
QK-74	Adjustable Head Mt. "B" Case	2.25
QK-77	Adjustable Head Mt. "G" Case	2.25
QK-78	Adjustable Head Mt. "S" Case	2.25

Quik-Kit	Description	Net
QK-100	Pentron R/P Mount	\$ 2.00
QK-102	Sony R/P Mount	1.75
QK-114	2—"B" Head Stereo Cart. Mt.	13.60
QK-115	2—"G" Head Mono Cart. Mt.	13.60
QK-117	2-1 "B" Stereo, 1 "G" Mono Cart. Mt.	13.60
QK-119	Sony R/P Strap Mount	1.00
QK-300	Pentron Erase Mount	3.00
QK-305	Sony Erase Mount	2.25
	L-Bracket Side Mts.	.50
	L-Bracket Side Mts.—R. Bend	.70
	L-Bracket Side Mts.—L. Bend	.70

Nortronics
COMPANY, INC.



**DIRECT REPLACEMENT HEADS FOR:
PROFESSIONAL MACHINES**

■ **Replacement Head Listing for Professional Machines**

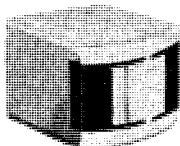

FULL TRACK R/P

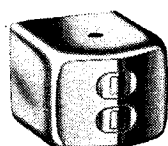

2-TRACK STEREO R/P

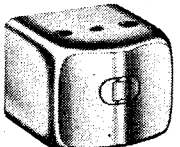

2-TRACK MONO R/P

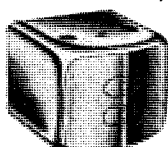

4-TRACK STEREO R/P

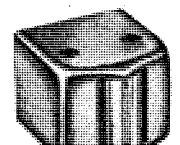

FULL TRACK ERASE

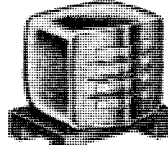

4 CHANNEL 1/2" R/P

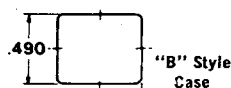
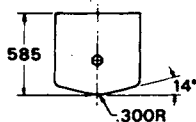

■ **Head Mounting Brackets for Professional Machines**

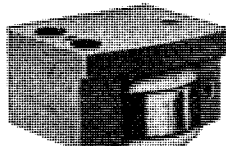

QK-76 with Nortronics Head original Ampex equipment... Net Each **\$12.00**

QK-76 contains all hardware and illustrated instructions necessary to adapt a Nortronics head to the shield cup of an Ampex head nest. Includes: precision cast aluminum block; spacers; screws; connector plug—all other parts necessary are utilized from the original Ampex equipment.

QK-35 is a special base-mount bracket kit for adapting Nortronics no-mount heads for replacement of Brush heads, or in any application requiring a large base-mounting stud. (Stud is 1/4" - 28 x 3/8")... Net Each **\$2.00**

■ **Tape Recording Accessories**

TAPE GUIDES

TG-7, Tape Guide Post. Vertically adjustable with tapped mounting hole in base. Chrome-Plated brass for long life... Net each **\$1.00**

TG-8, Tape Guide Plate. For Side-Mount heads and L-5, L-6 or L-7 bracket; gives additional guiding... Net each **\$.50**

CONTACTOR HEAD

Used with metal foil cueing (has 2 contactor shoes) CH3N/B—includes base mount... **\$8.00**

CH3R—rear-mount style... **\$9.50**

ALIGNMENT TAPE

AT-100 Azimuth and Amplifier Alignment Tape. A 7.5 IPS full track, direct oscillator master recording of frequencies from 40 to 10,000 Hertz for checking azimuth and NAB equalization. 1000 Hertz zero reference level tone included. Instructions are included... Net each **\$4.95**

CONNECTOR ASSEMBLIES

CC-70—18" plug and shielded insulated cable assembly for Nortronics heads (Except Mono Combo)... Net each **\$2.00**

CC-77—18" plug and shielded insulated cable assembly for Nortronics Mono Combo heads... Net each **\$2.00**

Manufacturer and Model Numbers	Original Function	Nortronics Head + Quik-Kit	Net, Less Quik-Kit	
AMPEX 300, 350, 351, 354, 400, 450 series PR-10, 600, 900, 1200, AG350, AG355 NOTE: On PR-10 600, 900 & 1200 series use QK-66 instead of QK-76 NOTE: QK-66 and/or QK-76 required only for initial replacement using Nortronics head. *351, 354, 400, 450 350 Full Track	Record Full Track*	8001 + 76	\$36.00	
	Play Full Track*	8000 + 76	36.00	
	Erase Full Track (1)*	8109 + 76	30.00	
	Erase Full Track (2)*	8106 + 76	30.00	
	Record 2-Track Stereo	8201 + 76	32.00	
	Play 2-Track Stereo	8200 + 76	32.00	
	Erase 2-Track Stereo (1)	8309 + 76	26.00	
	Erase 2-Track Stereo (2)	8304 + 76	26.00	
	Record 2-Track Mono	8401 + 76	22.00	
	Play 2-Track Mono	8400 + 76	22.00	
Erase 2-Track Mono (1)	8509 + 76	18.00		
Erase 2-Track Mono (2)	8504 + 76	18.00		
Record 4-Track Stereo	8604 + 76	30.00		
Play 4-Track Stereo	8600 + 76	30.00		
Erase 4-Track Stereo	8701 + 76	26.00		
Record Full Track	9103 + 76	42.00		
Play Full Track	9102 + 76	42.00		
Erase Full Track	9125 + 76	42.00		
(1) For all but 300, AG350 & AG355 (2) For 300 only NOTE: AG350 & AG355—Write for recommended Erase head listing.				
CROWN 701, 801, BX801, 1001, 1401	Play only or Record/Play, Full Track	8006 + 35	36.00	
	Record, Full Track	8001 + 35	36.00	
	Erase, Full Track	8102 + 35	30.00	
	Play only or Record/Play Stereo, 2-Track	8209 + 35	32.00	
	Record Stereo, 2-Track	8201 + 35	32.00	
	Erase Stereo, 2-Track	8304 + 38	26.00	
	Play only or Record/Play Mono, 2-Track	8403 + 35	22.00	
	Record Mono, 2-Track	8404 + 35	22.00	
	Erase Mono, 2-Track	8504 + 38	18.00	
	A51, A314	Play only Mono, 2-Track	8406 + 66	22.00
A54, A324, SP324	Play only Stereo, 4-Track	8601 + 66	30.00	
714C, 824, BX824, BX1024, 1424	Play only or Record/Play Stereo, 4-Track	8608 + 66	30.00	
	Record Stereo, 4-Track	8603 + 66	30.00	
	Erase Stereo, 4-Track	8701 + 38	26.00	
MAGRECORD 1021 *No QK required	Record, Full Track	8005 *	40.00	
	Play Mono, 2-Track (Optional)	8408 *	22.00	
	Erase, Full Track	8102 *	30.00	
	Play, Full Track	8006 *	36.00	
	1022 *No QK required	Record Stereo, 2-Track	8203 *	35.00
		Play Stereo, 2-Track	8202 *	35.00
		Erase Stereo, 2-Track	8302 *	26.00
	1020, 1024 *No QK required	Record Stereo, 4-Track	8602 *	30.00
		Play Stereo, 4-Track	8607 *	30.00
		Erase Stereo, 4-Track	8702 *	26.00
P60, P75, M90 M80	Record, Full Track	8001 + 35	36.00	
	Play, Full Track	8000 + 35	36.00	
	Erase, Full Track	8105 + 35	30.00	
R.C.A. RT21 *No QK required	Full Record	8002 *	68.00	
	Full Play	8003 *	54.00	
	Full Erase	8110 *	68.00	
	2-Track Stereo Record	8206 *	42.00	
	2-Track Stereo Play	8205 *	54.00	
	2-Track Stereo Erase	8307 *	48.00	
	270-2 SCULLY	2-Track Stereo Play	9200 + None	97.00
	270-4	4-Track Stereo Play	8620 + None	82.00
	280 (1/4")	Full Record	9101 + None	66.00
		Full Play	9100 + None	66.00
	Full Erase	9130 + None	66.00	
	2-Track Stereo Record	9201 + None	97.00	
	2-Track Stereo Play	9200 + None	97.00	
	2-Track Stereo Erase	9221 + None	97.00	
280 (1/2", 3-channel)	Record	9361 + None	164.00	
280 (1/2", 3-channel)	Play	9360 + None	164.00	
280 (1/2", 3-channel)	Erase	9370 + None	164.00	
282-4 (1/2", 4-channel)	Record	9461 + None	224.00	
282-4 (1/2", 4-channel)	Play	9460 + None	224.00	
282-4 (1/2", 4-channel)	Erase	9470 + None	224.00	

Note: All Scully replacements include mount.

†IMPORTANT—For prices of Quik-Kits, see listing on Page 1 of this section.



BIAS OSCILLATOR TRANSFORMERS

T70-T2—For Transistor circuits; with plug in terminals for p.c. board mounting. Supplies 40-120 V. at 60-110 KHz. With instructions. Net each **\$4.53**

T70-T6—Similar to T70-T2. Supplies 70 V. at 250-500 KHz for duplicators... Net each **\$9.00**

T60-T2—For transistor circuits. Features Ferroxcube E-cores for high Q, maximum efficiency and distortion-free waveform. Supplies 40-120 volts at 60-100 KHz. With instructions... Net each **\$4.50**

T60-F—For vacuum tube circuits, push-pull erase and bias power at operating frequencies from 70-100 KHz; output 150 volts rms tapped at 60 volts, for high and medium impedance erase heads. With instructions... Net each **\$4.50**

YOUR BEST AND MOST COMPLETE SOURCE FOR MAGNETIC TAPE HEADS



PRECISION **HI-FI** ACCESSORIES

Mixing Transformer - Stereo - Mono

Combines stereo channels into balanced mono output

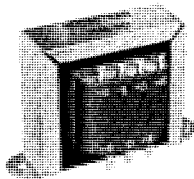

Model HM-90

- Add third speaker to fill "hole in the middle."
- Add mono extension speakers.
- Add and match any combination of mono and extension speakers.
- Assures exact impedance matching
- Simple hookup; connections made to numbered terminals.
- Power: 30 watts.
- Peak Power: 100 watts.
- Frequency Response (Power) 40 to 20,000 Hz.
- Impedance matching Range: ± 4 thru $\pm 16\Omega$.
- Finish: Vacuum Varnish impregnation.
- Size: $3\frac{3}{4}'' \times 2\frac{1}{2}'' \times 2\frac{3}{8}''$ hi: $3\frac{1}{4}''$ mtg. ctrs.
- Weight: 2 lbs.
- Model HM-90 User Net

Magnetic Tape Eraser - Model HD-11M

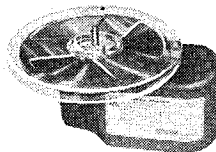

A heavy duty bulk tape demagnetizer. Develops high intensity field. Noise level reduced below level of standard erase heads. Restores up to $\frac{1}{2}''$ tape to like-new condition or better. Spindle mounting of reel prevents missed spots.

- Reel size range: 5" through $10\frac{1}{2}''$ (spindle removable for other sizes).
- Rating: 117 Volts AC, 5 Amps.
- Finish: Cast Epoxy
- Size: $7'' \times 3\frac{1}{2}'' \times 3\frac{1}{4}''$ H
- Weight: 9 lbs.
- HD-11M User Net: \$23.50
- Universal Use: May be used for Demagnetizing Record Playback-Erase Heads, and other metal objects.
- Accessory: Adapter Hub for use with N.A.B. $10\frac{1}{2}''$ reels. (Model HD-11AD—User Net \$2.30)

A Must for Stereo Recording.

(Most stereo recorders do not provide complete erasure facilities)

Tape Head Demagnetizer - Model HD-40M

For Tape Recording Heads

Reduce hum, noise and distortion caused by magnetized heads. Removes any residual permanent magnetism from the heads.



- Safeguards valuable tape libraries.
- Insures high frequency response.
- Special finish on pole piece prevents damaging recording head.
- Extended tapered pole piece for easy access.
- Ratings: 117 Volts AC, 1 Amp.
- Finish: High Impact molded epoxy
- Size: $4'' \times 1\frac{1}{4}''$ Diameter
- Weight: 7 ozs.
- Model HD-40M User Net: \$6.15

Magnetic Tape Eraser - Model HD-15

A compact tape demagnetizer that erases signals and noise instantly without rewinding. Removes background noise below level of new tape or sound film.

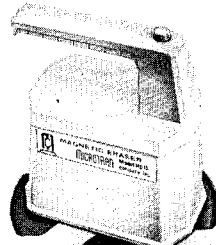

- Universal unit for any reel size.
- Demagnetizes guide posts, tools, watches, other metal objects, etc.
- Lightweight—hand held—easy to use.
- Tape Width Range: $\frac{1}{4}''$ and $\frac{1}{2}''$.
- Sound Film Range: 8, 16, and 35mm.
- Rating: 117 Volts 50/60 cycle, 4 amps.
- Finish: High impact plastic case.
- Size: $4\frac{3}{4}'' \times 2\frac{1}{2}'' \times 4\frac{3}{8}''$ H
- Line Cord: 8' with molded plug.
- Weight: $2\frac{1}{2}$ lbs.
- Model HD-15 User Net: \$11.95

Telephone Pick-up Coil - Model HP-61

For transcribing telephone conversations with tape recorder or dictation machine or making messages audible on amplifier. May also be used as probe for locating sources of hum.

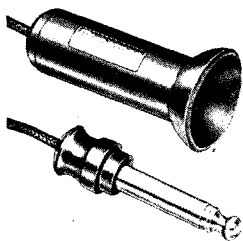

- Equalized Level: Local and distant conversations recorded with more constant signal level than base mounted units.
- Suction Cup: Mounting on telephone receiver.
- Universal Model: One unit suitable for all types of telephones.
- Plug-In Use: Supplied with 68" shielded cable, terminated with standard phone plug for mike input of recorder or amplifier.
- Finish: Optical Black.
- Size: Only $\frac{5}{8}''$ diameter x 2" long.
- Weight: $1\frac{1}{2}$ ounces.
- Model HP-61 User Net: \$6.15

Hum-Bucking Telephone Pick-up Coil Model HP-70

transcribing telephone conversations. Symmetrical pick-up coils eliminate high stray hum-pick up caused by fluorescent lights and appliances. For use with tape recorders or dictation machines or making messages audible on amplifier.

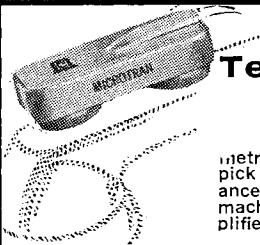

- Mounting: Double Suction cup.
- Cable Length: 5 feet.
- Termination: Tinned Leads.
- Shipping Weight: 2 ozs.
- Case: Hi impact plastic.
- Finish: Grey
- Size: $2\frac{1}{2}'' \times 1\frac{3}{8}'' \times 1\frac{1}{8}''$ H
- Model HP-70: User Net: \$6.95

In-Line Microphone Transformer Model M8027

Matches low-impedance mike to high impedance amplifier input. Minimizes loss on long cable runs. Mu metal and electrostatic shield suppresses hum. Simple in-line installation on microphone cable.



- Impedance Ratio: 1:400
- Pri. Imp.: 150 through 250 ohms.
- Sec. Imp.: 40,000 ohms nominal.
- Freq. Resp.: 50-20,000 cps ± 2 db.
- Cable: 20" shielded cable.
- Cable Termination: Tinned Leads.
- Color: Grey.
- Case: Hi impact plastic.
- Size: $2\frac{1}{4}'' \times 1\frac{1}{8}'' \times \frac{1}{8}''$ D
- Weight: 2 ozs.
- Model M8027 User Net \$9.00

Low Level Input Transformers

Broadcast fidelity — microphone transformers — 65 db mu-metal shielding



Fig. A—
Size: $2\frac{1}{8}'' \times 1\frac{1}{8}''$ D



Fig. B—
Size: $1\frac{1}{2}'' \times 1\frac{1}{8}'' \times \frac{1}{8}''$ D—M.C.— $1\frac{1}{2}''$

Part Number	Pri. Imp.	Sec. Imp.	Freq. Resp. ± 2 db	Figure	User Net
M8030*	200/50 C.T.	50,000	20-20,000	A	\$13.50
M8031	600 C.T./150	50,000	30-20,000	A	13.35
M8032†	250 C.T.	50,000	20-20,000	A	13.05
M8033†	50 C.T.	50,000	20-20,000	A	13.05
M1-S	50/250 C.T./600 C.T.	50,000	20-20,000	B	10.95

M8030-1 have 8 pins. M8032-3 have 9 pins.
*M8030 is designed as a replacement for Ampex No. 1733-1.
†M8032 and M8033 mates with sockets on many RCA amplifiers.



Write for CATALOG showing complete specifications



Series "60" Cabinet Racks

Scientifically designed to meet all requirements for human needs as well as component physical specifications; the most practical cabinet rack developed for either a single piece of equipment or a large instrumentation system. Very economical to the user, units are shipped fully assembled and ready for immediate use.

Basic frame welded in a solid unit composed of 14-gauge cold-rolled steel channels. Sides have "U" braces with perforated channels for fastening vertical adjustable mounting rails. Rails also support other types of equipment such as brackets, shelves, slides, etc. Eliminates need of drilling holes in the rack. Sides and rear door made of 16 gauge steel. Door may be mounted to open left or right. Vertical channel, 6" wide, welded to door to prevent vibration or whip. Two pairs of panel mounting rails are supplied; fully adjustable. Panels may be mounted in front and rear at the same time. Front rails drilled and tapped 10-32 W.E. spacing. Rear rails are drilled according to universal spacing.

All Series Sixty enclosures may be quickly combined with each other to create units of any desired width as shown in the Add-A-Rack series. In addition, such accessories as desk tops, turrets, drawers, slides, sloping panel supports and front door are easily installed.

Standard finishes are smooth baked enamel over a primer. For two-tone gray, specify by adding suffix **SG**. For two-tone blue, add suffix **SB** to order number. Standard Bud relay rack panels are available for the Series Sixty racks in light gray and light blue; when ordering, add suffix **SG** for gray; **SB** for blue.

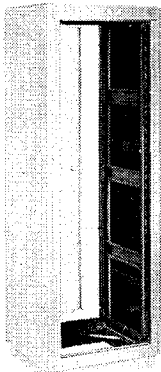

UPRIGHT CABINET RACKS

Completely assembled with sides, rear door and top. Standard units have plain sides and door; solid top. For greater ventilation, order units with louvered sides and/or rear door; both, with solid top. Width, 24 1/4", all units. Inside depth 20 1/4" clear on units with 22" outside depth; 23 3/4", all others. Top opening 18 1/2" w. x 17" d. on units with 22" outside depth; 18 1/2" w. x 20 1/2" d., all others. **Specify Color When Ordering:** Add suffix **SG** to number for gray; suffix **SB**, for blue.

Series shown below includes welded framework, plain sides, plain rear door and solid top

For 24" Panel Space				Common Dimensions for Both 24" & 19" Panel Space			For 19" Panel Space				Wgt. Lbs.		
Bud No. 60	Top Opening	Net Each Lots of			Height	Outside Depth	Panel Space	Bud No. 60	Top Opening	Net Each in Lots of			
		1-3	4-6	7-9						1-3	4-6	7-9	
2315	23 1/2" x 17"	\$140.30	\$126.30	\$112.25	29 5/8"	22"	21"	2300	18 1/2" x 17"	\$117.00	\$105.30	\$ 93.60	118
2316	23 1/2" x 17"	173.70	156.35	138.95	40 1/4"	22"	31 1/2"	2301	18 1/2" x 17"	134.70	130.20	115.80	156
2317	23 1/2" x 17"	193.00	173.70	154.40	50 5/8"	22"	42"	2302	18 1/2" x 17"	160.70	134.70	128.60	173
2318	23 1/2" x 17"	213.75	192.40	171.00	61 1/4"	22"	52 1/2"	2303	18 1/2" x 17"	178.50	160.70	142.80	197
2319	23 1/2" x 17"	238.00	214.20	190.40	69 7/8"	22"	61 1/4"	2304	18 1/2" x 17"	198.40	178.60	157.70	220
2320	23 1/2" x 17"	265.00	238.50	212.00	78 5/8"	22"	70"	2305	18 1/2" x 17"	220.40	198.40	176.40	235
2321	23 1/2" x 17"	289.00	260.10	231.20	87 3/4"	22"	78 3/4"	2306	18 1/2" x 17"	240.60	216.60	192.50	265
2322	23 1/2" x 20 1/2"	165.35	148.80	132.30	29 5/8"	25 1/2"	21"	2307	18 1/2" x 20 1/2"	138.10	124.30	110.50	156
2323	23 1/2" x 20 1/2"	192.00	172.80	153.60	40 1/4"	25 1/2"	31 1/2"	2308	18 1/2" x 20 1/2"	160.50	144.40	128.40	176
2324	23 1/2" x 20 1/2"	214.00	192.60	171.20	50 5/8"	25 1/2"	42"	2309	18 1/2" x 20 1/2"	178.30	160.40	142.60	185
2325	23 1/2" x 20 1/2"	237.00	213.30	189.60	61 1/4"	25 1/2"	52 1/2"	2310	18 1/2" x 20 1/2"	197.90	178.10	158.30	211
2326	23 1/2" x 20 1/2"	264.00	237.60	211.20	69 7/8"	25 1/2"	61 1/4"	2311	18 1/2" x 20 1/2"	219.90	197.90	176.00	240
2327	23 1/2" x 20 1/2"	293.00	263.70	234.40	78 5/8"	25 1/2"	70"	2312	18 1/2" x 20 1/2"	244.40	220.00	195.50	266
2328	23 1/2" x 20 1/2"	320.50	288.45	256.40	87 3/4"	25 1/2"	78 3/4"	2313	18 1/2" x 20 1/2"	266.70	240.00	213.40	267

Series shown below includes welded framework, louvered sides, plain rear door and solid top.

2615	23 1/2" x 17"	\$143.00	\$128.70	\$114.40	29 5/8"	22"	21"	2600	18 1/2" x 17"	\$119.00	\$107.10	\$ 95.20	118
2616	23 1/2" x 17"	179.00	161.10	143.20	40 1/4"	22"	31 1/2"	2601	18 1/2" x 17"	148.80	133.90	119.00	156
2617	23 1/2" x 17"	199.50	179.55	159.60	50 5/8"	22"	42"	2602	18 1/2" x 17"	166.30	149.70	133.10	173
2618	23 1/2" x 17"	229.00	206.10	183.20	61 1/4"	22"	52 1/2"	2603	18 1/2" x 17"	190.20	171.20	152.20	197
2619	23 1/2" x 17"	249.00	224.10	199.20	69 7/8"	22"	61 1/4"	2604	18 1/2" x 17"	207.00	186.30	165.80	220
2620	23 1/2" x 17"	275.50	247.95	220.40	78 5/8"	22"	70"	2605	18 1/2" x 17"	230.00	207.00	184.00	235
2621	23 1/2" x 17"	299.75	269.80	239.80	87 3/4"	22"	78 3/4"	2606	18 1/2" x 17"	249.90	224.90	199.90	265
2622	23 1/2" x 20 1/2"	169.00	152.10	135.20	29 5/8"	25 1/2"	21"	2607	18 1/2" x 20 1/2"	147.70	126.60	112.60	156
2623	23 1/2" x 20 1/2"	203.75	183.40	163.00	40 1/4"	25 1/2"	31 1/2"	2608	18 1/2" x 20 1/2"	169.90	152.90	135.90	176
2624	23 1/2" x 20 1/2"	227.00	204.30	181.60	50 5/8"	25 1/2"	42"	2609	18 1/2" x 20 1/2"	189.20	170.20	151.30	185
2625	23 1/2" x 20 1/2"	259.00	233.10	207.20	61 1/4"	25 1/2"	52 1/2"	2610	18 1/2" x 20 1/2"	216.50	194.70	173.20	211
2626	23 1/2" x 20 1/2"	272.00	244.80	217.60	69 7/8"	25 1/2"	61 1/4"	2611	18 1/2" x 20 1/2"	233.70	210.30	187.00	240
2627	23 1/2" x 20 1/2"	311.50	280.35	249.20	78 5/8"	25 1/2"	70"	2612	18 1/2" x 20 1/2"	259.50	233.60	207.60	266
2628	23 1/2" x 20 1/2"	340.00	306.00	272.00	87 3/4"	25 1/2"	78 3/4"	2613	18 1/2" x 20 1/2"	283.00	254.70	226.40	267

Series shown below includes welded framework, louvered sides, louvered rear door and solid top.

2715	23 1/2" x 17"	\$148.00	\$133.20	\$118.40	29 5/8"	22"	21"	2700	18 1/2" x 17"	\$121.50	\$109.30	\$ 97.20	118
2716	23 1/2" x 17"	184.00	165.60	147.00	40 1/4"	22"	31 1/2"	2701	18 1/2" x 17"	151.00	135.90	120.80	156
2717	23 1/2" x 17"	204.50	184.00	163.60	50 5/8"	22"	42"	2702	18 1/2" x 17"	169.00	152.20	135.30	173
2718	23 1/2" x 17"	234.00	210.60	187.00	61 1/4"	22"	52 1/2"	2703	18 1/2" x 17"	193.20	175.90	154.60	197
2719	23 1/2" x 17"	254.00	228.60	203.00	69 7/8"	22"	61 1/4"	2704	18 1/2" x 17"	210.30	189.30	168.30	220
2720	23 1/2" x 17"	280.50	252.50	224.40	78 5/8"	22"	70"	2705	18 1/2" x 17"	233.60	210.30	186.30	235
2721	23 1/2" x 17"	305.00	274.50	244.00	87 3/4"	22"	78 3/4"	2706	18 1/2" x 17"	253.80	228.40	203.00	265
2722	23 1/2" x 20 1/2"	174.00	156.60	139.00	29 5/8"	25 1/2"	21"	2707	18 1/2" x 20 1/2"	143.90	128.90	114.60	156
2723	23 1/2" x 20 1/2"	209.00	188.00	167.00	40 1/4"	25 1/2"	31 1/2"	2708	18 1/2" x 20 1/2"	172.90	155.60	138.30	176
2724	23 1/2" x 20 1/2"	232.00	208.80	185.60	50 5/8"	25 1/2"	42"	2709	18 1/2" x 20 1/2"	192.60	173.40	154.10	185
2725	23 1/2" x 20 1/2"	265.00	238.50	212.00	61 1/4"	25 1/2"	52 1/2"	2710	18 1/2" x 20 1/2"	214.20	192.80	171.30	211
2726	23 1/2" x 20 1/2"	277.00	249.30	221.60	69 7/8"	25 1/2"	61 1/4"	2711	18 1/2" x 20 1/2"	238.00	214.20	190.40	240
2727	23 1/2" x 20 1/2"	316.50	284.85	253.00	78 5/8"	25 1/2"	70"	2712	18 1/2" x 20 1/2"	264.40	237.90	211.50	266
2728	23 1/2" x 20 1/2"	345.00	310.50	276.00	87 3/4"	25 1/2"	78 3/4"	2713	18 1/2" x 20 1/2"	283.00	254.70	226.40	267

Series shown below includes welded framework, plain sides, louvered rear door and solid top.

2815	23 1/2" x 17"	\$142.00	\$127.80	\$113.60	29 5/8"	22"	21"	2800	18 1/2" x 17"	\$115.30	\$103.80	\$ 92.30	118
2816	23 1/2" x 17"	177.00	159.30	141.60	40 1/4"	22"	31 1/2"	2801	18 1/2" x 17"	142.80	128.50	114.20	156
2817	23 1/2" x 17"	195.50	175.95	156.40	50 5/8"	22"	42"	2802	18 1/2" x 17"	158.70	142.80	126.90	173
2818	23 1/2" x 17"	222.00	199.80	177.60	61 1/4"	22"	52 1/2"	2803	18 1/2" x 17"	180.30	162.30	144.20	197
2819	23 1/2" x 17"	245.50	220.95	196.40	69 7/8"	22"	61 1/4"	2804	18 1/2" x 17"	195.60	176.00	156.40	220
2820	23 1/2" x 17"	270.00	243.00	216.00	78 5/8"	22"	70"	2805	18 1/2" x 17"	217.20	195.50	173.70	235
2821	23 1/2" x 17"	296.50	266.85	237.20	87 3/4"	22"	78 3/4"	2806	18 1/2" x 17"	237.40	213.70	189.90	265
2822	23 1/2" x 20 1/2"	167.00	150.30	133.60	29 5/8"	25 1/2"	21"	2807	18 1/2" x 20 1/2"	135.70	122.10	108.60	156
2823	23 1/2" x 20 1/2"	199.00	179.00	159.00	40 1/4"	25 1/2"	31 1/2"	2808	18 1/2" x 20 1/2"	163.60	147.20	130.90	176
2824	23 1/2" x 20 1/2"	220.50	198.45	176.40	50 5/8"	25 1/2"	42"	2809	18 1/2" x 20 1/2"	181.90	163.70	145.50	185
2825	23 1/2" x 20 1/2"	248.00	223.00	198.40	61 1/4"	25 1/2"	52 1/2"	2810	18 1/2" x 20 1/2"	201.90	181.70	161.50	211
2826	23 1/2" x 20 1/2"	268.00	241.00	214.40	69 7/8"	25 1/2"	61 1/4"	2811	18 1/2" x 20 1/2"	224.40	201.90	179.50	240
2827	23 1/2" x 20 1/2"	302.00	271.80	241.60	78 5/8"	25 1/2"	70"	2812	18 1/2" x 20 1/2"	249.90	224.40	199.00	266
2828	23 1/2" x 20 1/2"	329.00	296.10	263.20	87 3/4"	25 1/2"	78 3/4"	2813	18 1/2" x 20 1/2"	272.10	244.90	217.70	267

SERIES SIXTY DESK TOP (FIG. F)

May be used in connection with any Series Sixty enclosure. Furnished completely assembled with wood-grained Formica surface. Fastens to panel mounting rails by two pre-drilled channels. Will support in excess of 200 lbs. Surface 24 1/4" wide, 19 1/2" deep, 3 1/4" high. Available in two colors. **Specify Color:** Add suffix **SG** for gray; **SB** for blue.

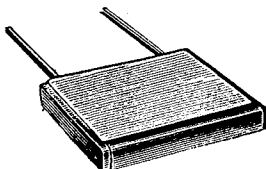

Bud No.	Fits Series Sixty	Support Channel	Wt., Lbs.	Ea., 1-3	Ea., 4-6	Ea., 7-8
60-2360	With 22" depth	2 1/4" long	22	\$38.30	\$34.50	\$30.70
60-2362	With 25 1/2" depth	2 3/4" long	23	37.20	33.50	29.80

F Desk Top



Series "60" Cabinet Racks

INCLINED PANEL CABINET RACKS

Completely assembled with Sides, Rear door and Solid Top. Racks for 24" Panels are 29¹/₁₆" wide and Racks for 19" Panels are 24¹/₁₆" wide. Both types are 50³/₈" high, have an outside Depth of 22" and a clear Inside Depth of 20¹/₄".

Series shown below includes Welded Framework, Plain Sides, Plain Rear Door and Solid Top.

Bud No. 60-	For 24" Panel Space				Common Dims. for Both 24" and 19" Panel Space		For 19" Panel Space				
	Top Opening	Net each in lots of			Inclined Panel Sp.	Vertical Panel Sp.	Bud No. 60-	Top Opening	Net each in lots of		
		1-3	4-6	7-9					1-3	4-6	7-9
2337	11 ³ / ₈ "x23 ¹ / ₂ "	\$220.50	\$198.45	\$176.40	10 ¹ / ₂ "	29 ³ / ₈ "	2330	11 ³ / ₈ "x18 ¹ / ₂ "	\$175.40	\$157.80	\$140.30
2338	10 ¹ / ₂ "x23 ¹ / ₂ "	\$234.00	\$270.60	\$187.20	15 ³ / ₈ "	24 ¹ / ₂ "	2331	10 ¹ / ₂ "x18 ¹ / ₂ "	\$185.80	\$167.30	\$148.70
2339	9 ³ / ₈ "x23 ¹ / ₂ "	\$234.00	\$210.60	\$187.20	17 ¹ / ₂ "	22 ³ / ₈ "	2332	9 ³ / ₈ "x18 ¹ / ₂ "	\$185.90	\$167.30	\$148.70

Series shown below includes Welded Framework, Louvred Sides, Plain Rear Door and Solid Top.

Bud No. 60-	For 24" Panel Space				Common Dims. for Both 24" and 19" Panel Space		For 19" Panel Space				
	Top Opening	Net each in lots of			Inclined Panel Sp.	Vertical Panel Sp.	Bud No. 60-	Top Opening	Net each in lots of		
		1-3	4-6	7-9					1-3	4-6	7-9
2637	11 ³ / ₈ "x23 ¹ / ₂ "	\$232.00	\$208.80	\$185.60	10 ¹ / ₂ "	29 ³ / ₈ "	2630	11 ³ / ₈ "x18 ¹ / ₂ "	\$185.20	\$166.70	\$148.20
2638	10 ¹ / ₂ "x23 ¹ / ₂ "	\$245.50	\$220.95	\$196.40	15 ³ / ₈ "	24 ¹ / ₂ "	2631	10 ¹ / ₂ "x18 ¹ / ₂ "	\$195.80	\$176.20	\$156.60
2639	9 ³ / ₈ "x23 ¹ / ₂ "	\$245.50	\$220.95	\$196.40	17 ¹ / ₂ "	22 ³ / ₈ "	2632	9 ³ / ₈ "x18 ¹ / ₂ "	\$195.80	\$176.20	\$156.60

Series shown below includes Welded Framework, Louvred Sides, Louvred Rear Doors and Solid Top.

Bud No. 60-	For 24" Panel Space				Common Dims. for Both 24" and 19" Panel Space		For 19" Panel Space				
	Top Opening	Net each in lots of			Inclined Panel Sp.	Vertical Panel Sp.	Bud No. 60-	Top Opening	Net each in lots of		
		1-3	4-6	7-9					1-3	4-6	7-9
2737	11 ³ / ₈ "x23 ¹ / ₂ "	\$237.00	\$213.30	\$189.60	10 ¹ / ₂ "	29 ³ / ₈ "	2730	11 ³ / ₈ "x18 ¹ / ₂ "	\$188.40	\$169.50	\$150.70
2738	10 ¹ / ₂ "x23 ¹ / ₂ "	\$250.50	\$225.45	\$200.40	15 ³ / ₈ "	24 ¹ / ₂ "	2731	10 ¹ / ₂ "x18 ¹ / ₂ "	\$199.50	\$179.50	\$159.60
2739	9 ³ / ₈ "x23 ¹ / ₂ "	\$250.50	\$225.45	\$200.40	17 ¹ / ₂ "	22 ³ / ₈ "	2732	9 ³ / ₈ "x18 ¹ / ₂ "	\$199.50	\$179.50	\$159.60

Series shown below includes Welded Framework, Plain Sides, Louvred Rear Door and Solid Top.

Bud No. 60-	For 24" Panel Space				Common Dims. for Both 24" and 19" Panel Space		For 19" Panel Space				
	Top Opening	Net each in lots of			Inclined Panel Sp.	Vertical Panel Sp.	Bud No. 60-	Top Opening	Net each in lots of		
		1-3	4-6	7-9					1-3	4-6	7-9
2837	11 ³ / ₈ "x23 ¹ / ₂ "	\$225.90	\$202.95	\$180.40	10 ¹ / ₂ "	29 ³ / ₈ "	2830	11 ³ / ₈ "x18 ¹ / ₂ "	\$179.10	\$161.10	\$143.20
2838	10 ¹ / ₂ "x23 ¹ / ₂ "	\$239.00	\$215.10	\$191.20	15 ³ / ₈ "	24 ¹ / ₂ "	2831	10 ¹ / ₂ "x18 ¹ / ₂ "	\$189.60	\$170.60	\$151.70
2839	9 ³ / ₈ "x23 ¹ / ₂ "	\$239.00	\$215.10	\$191.20	17 ¹ / ₂ "	22 ³ / ₈ "	2832	9 ³ / ₈ "x18 ¹ / ₂ "	\$189.60	\$170.60	\$151.70

ACCESSORIES LIST FOR INCLINED PANEL RELAY RACKS

FRONT DOORS

Front doors for Racks with 24" Panel Space are 23¹/₁₆" wide and for Racks with 19" Panel Space are 18¹/₁₆" wide

For 24" Panel Space									
Bud No. 60-	Plain			Louvred			Wgt. Lbs.	Fits Inclined Panel Rack with Top Opening	
	Net Each in Lots of			Net Each in Lots of					
	1-3	4-6	7-9	Bud No. 60-	1-3	4-6			
2353	\$27.00	\$24.30	\$21.60	2553	\$32.00	\$28.80	\$25.60	11 ³ / ₈ "x23 ¹ / ₂ "	
2354	25.00	22.50	20.00	2554	28.50	25.65	22.80	10 ¹ / ₂ "x23 ¹ / ₂ "	
2355	24.25	21.85	19.40	2555	27.50	24.75	22.00	9 ³ / ₈ "x23 ¹ / ₂ "	
For 19" Panel Space									
2350	\$21.10	\$19.00	\$16.90	2556	\$24.30	\$21.90	\$19.40	11 ³ / ₈ "x18 ¹ / ₂ "	
2351	19.70	17.70	15.70	2551	22.70	20.40	18.20	10 ¹ / ₂ "x18 ¹ / ₂ "	
2352	19.10	17.20	15.30	2552	22.00	19.80	17.60	9 ³ / ₈ "x18 ¹ / ₂ "	

REAR DOOR

Rear Doors for Racks with 24" Panel Space are 23¹/₁₆" wide and for Racks with 19" panel space are 18¹/₁₆" wide. One size fits all models regardless of height.

For 24" Panel Space								
Bud No. 60	Plain			Louvred			Wgt. Lbs.	
	Net Each in Lots of			Net Each in Lots of				
	1-3	4-6	7-9	Bud No. 60	1-3	4-6		
2392	\$35.00	\$31.50	\$28.00	4542	\$33.50	\$30.15	\$26.80	
For 19" Panel Space								
2342	\$23.30	\$21.00	\$18.60	2552	\$22.00	\$19.80	\$17.60	15 ¹ / ₂

SIDES

Fits all Inclined Panel Racks regardless of width

Bud No. 60	Plain Type			Louvred Type			Wgt. Lbs.	
	Net Per Pair in Lots of			Net Per Pair in Lots of				
	1-3	4-6	7-9	1-3	4-6	7-9		
2574	\$40.40	\$36.35	\$32.30	2594	\$44.70	\$40.20	\$35.80	11
2575	41.50	37.35	33.20	2595	46.00	41.40	36.80	9 ¹ / ₂
2576	42.10	37.90	33.70	2596	46.00	41.40	36.80	9

Specify "L" for left side or "R" for right side, determined when facing front of rack.

PERFORATED TOP

Top with 17" depth fits upright rack with overall depth of 22" and 20¹/₂" deep top fits rack with 25¹/₂" depth.

Bud No. 60	For 24" Panel Space				Bud No. 60	For 19" Panel Space				Wgt. Lbs.
	Net Each in Lots of					Net Each in Lots of				
	Width	1-3	4-6	7-9		Width	1-3	4-6	7-9	
2376	26 ¹ / ₁₆ "	\$ 9.00	\$8.10	\$7.20	2370	21 ¹ / ₁₆ "	\$6.80	\$6.20	\$5.50	6
2377	26 ¹ / ₁₆ "	10.00	9.00	8.00	2371	21 ¹ / ₁₆ "	7.20	6.50	5.70	7

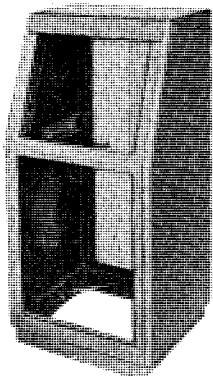

INCLINED PANEL RACK

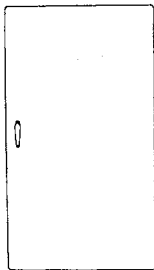

Plain Door

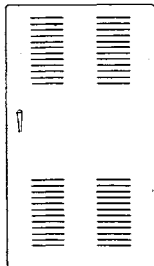

Louvred Door

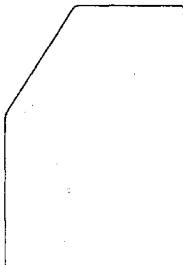

Plain Side

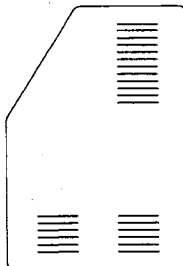

Louvred Side



Add-a-Rack and Cabinets

SERIES SIXTY ADD-A-RACKS

Each assembly consists of frame, top, bottom, rear door and cowlings; used as an add-on unit to join any of the Series 60 enclosures into a bank of two or more. One standard rack plus several Add-a-Racks make any desired number of racks combined for optimum width. Colors are same as Racks.

For 24" Panel Space

Bud No. 60	For Add-onto Rack No. 60	Plain Sides			Bud No. 60	For Add-onto Rack No. 60	Louvered Sides			Wgt. Lbs.
		Net Each in Lots of					Net Each in Lots of			
		1-3	4-6	7-9			1-3	4-6	7-9	
2515	2300, 2600	\$118.50	\$106.65	\$ 94.80	2915	2715, 2815	\$121.50	\$109.35	\$ 97.20	
2516	2301, 2601	139.50	125.55	111.60	2916	2716, 2816	143.00	128.70	114.40	
2517	2302, 2602	152.00	136.80	121.60	2917	2717, 2817	157.00	141.30	125.60	
2518	2303, 2603	166.00	149.40	132.80	2918	2718, 2818	171.00	153.90	136.80	
2519	2304, 2604	186.00	167.40	148.80	2919	2719, 2819	191.00	171.90	152.80	
2520	2305, 2605	207.00	186.30	165.60	2920	2720, 2820	213.00	191.70	170.40	
2521	2306, 2606	222.00	199.80	177.60	2921	2721, 2821	229.00	206.10	183.20	
2522	2307, 2607	133.00	119.70	106.40	2922	2722, 2822	134.50	121.05	107.60	
2523	2308, 2608	155.50	139.95	124.40	2923	2723, 2823	158.00	142.20	126.40	
2524	2309, 2609	170.50	153.45	136.40	2924	2724, 2824	174.50	157.05	139.60	
2525	2310, 2610	185.50	166.95	148.40	2925	2725, 2825	190.50	171.45	152.40	
2526	2311, 2611	207.00	186.30	165.60	2926	2726, 2826	213.00	191.70	170.40	
2527	2312, 2612	231.00	207.90	184.80	2927	2727, 2827	237.00	213.30	189.60	
2528	2313, 2613	256.00	230.85	205.20	2928	2728, 2828	262.00	235.80	209.60	
2537	2330, 2630	177.00	159.30	141.60	2937	2737, 2837	179.00	161.10	143.20	
2538	2331, 2631	189.00	170.10	151.20	2938	2738, 2838	194.00	174.60	155.20	
2539	2332, 2632	189.00	170.10	151.20	2939	2739, 2839	194.00	174.60	155.20	

For 19" Panel

Bud No.	For Add-onto Rack No. 60	Plain Sides			Bud No.	For Add-onto Rack No. 60	Louvered Sides			Wgt. Lbs.
		Net Each in Lots of					Net Each in Lots of			
		1-3	4-6	7-9			1-3	4-6	7-9	
2500	2300, 2600	\$ 95.00	\$ 85.50	\$ 76.00	2900	2700, 2800	\$ 93.90	\$ 84.50	\$ 75.20	92
2501	2301, 2601	111.30	100.20	89.00	2901	2701, 2801	114.50	103.00	91.60	113
2502	2302, 2602	121.90	109.70	97.60	2902	2702, 2802	125.40	112.90	100.30	115
2503	2303, 2603	133.20	119.90	106.50	2903	2703, 2803	137.00	123.30	109.60	145
2504	2304, 2604	148.80	133.90	119.00	2904	2704, 2804	153.00	137.70	122.40	148
2505	2305, 2605	165.70	149.20	132.60	2905	2705, 2805	170.50	153.50	136.40	152
2506	2306, 2606	178.00	160.20	142.40	2906	2706, 2806	183.00	164.70	146.40	158
2507	2307, 2607	106.30	95.70	85.00	2907	2707, 2807	107.40	96.65	85.90	120
2508	2308, 2608	124.60	112.10	99.70	2908	2708, 2808	126.20	113.60	100.95	132
2509	2309, 2609	136.00	122.40	108.80	2909	2709, 2809	139.60	125.70	111.70	138
2510	2310, 2610	148.50	133.60	118.80	2910	2710, 2810	152.20	137.00	121.80	142
2511	2311, 2611	166.00	149.40	132.80	2911	2711, 2811	170.10	153.10	136.10	164
2512	2312, 2612	184.90	166.40	147.90	2912	2712, 2812	189.70	170.70	151.70	168
2513	2313, 2613	204.60	184.10	163.70	2913	2713, 2813	209.80	188.80	167.80	172
2530	2330, 2630	141.60	127.50	113.30	2930	2730, 2830	143.00	128.70	114.40	119
2531	2331, 2631	151.10	135.90	120.80	2931	2731, 2831	154.40	139.05	123.60	119
2532	2332, 2632	151.10	135.90	120.80	2932	2732, 2832	154.40	139.00	123.60	125

PRESTIGE BALL CORNERED VERSA-CABINETS

A standard Prestige Versa-Cabinet consists of the framework, two ball cornered sides, perforated metal back, solid bottom plate and two supporting channels.

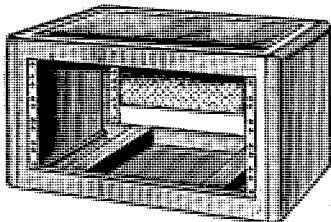

The front, back, top, and bottom may be quickly removed for access to interior for easy servicing.

Standard 19" panels may be attached to the top, bottom, front or back of cabinet to provide complete closure. Perforated top panel may also be used.

An opening is provided across bottom of back for cable leads, controls or knobs. Size of opening is 1 3/4" x 19". Bud Steel Panel PS 1250 or Aluminum Panel PA-1101 may be used to close opening if desired. Perforated back may be removed and a standard steel or aluminum panel may be used to close back opening entirely.

Sides are attached by means of holding flanges on the bottom of the frame and nut at top. Handles may be fastened to sides.

Cabinets may be fastened side-to-side in batteries of two or more or may be stacked one on another. Four rubber feet are regularly supplied.

Top may be closed by using PS-1256HG or PA-1107HG solid panels or by using PS-616HG or PS-815HG door panels or by PC-1710 perforated steel top panel.

Clear inside width—22 1/4". Overall width—23 3/16".

Clear inside depth—15". Overall depth—15 25/32".

Weight 28 to 35 lbs.

Finished in gray hammertone.

Bud No.	Height, Overall	Panel Space	Rear Panel	Net Each, Lots of		
				1-14	15-24	25-34
PC-1700	8 3/8"	5 1/4"	3 1/2"	\$33.10	\$29.80	\$26.50
PC-1701	10 3/8"	7 1/8"	5 3/4"	35.10	31.60	28.10
PC-1702	12 3/8"	8 3/4"	7"	36.00	32.40	28.80
PC-1703	14"	10 3/8"	8 3/4"	40.70	36.60	32.50
PC-1704	15 3/8"	12 3/4"	10 1/2"	42.80	38.60	34.30

PERFORATED STEEL TOP PLATE

Bud No.	Size, In.	Wt., Lbs.	Net Each, Lots of		
			1-14	15-24	25-34
PC-1710	12 1/4" x 19"	2 1/2"	\$3.50	\$3.20	\$2.80

GRAND PRIX CABINETS

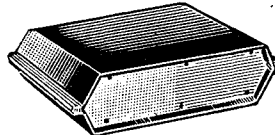

A concept in styling not elsewhere available in standard electronic cabinetry. Practical for audio equipment, also for medical and other electronic equipment and controls.

Engineered to make installation and servicing of contents easy. The upper and lower segments are held together by sturdy brushed aluminum extrusions.

Body and front and rear panels made of 20 gauge steel. Four rubber feet are furnished.

Choice of light gray hammertone body with matching panels or smooth dark gray body with smooth light gray panels. Please specify (HG) or (SG) when ordering.

Bud No.	Size, Inches H. x W. x D.	Wt., Lbs.	Net Each, Lots of		
			1-24	25-49	50-99
MD-1	4 3/8 x 19 1/2 x 10 1/2	7 1/4	\$15.20	\$13.70	\$12.20
MD-2	7 3/8 x 19 1/2 x 10 1/2	7 3/4	15.90	14.40	12.80
MD-3	4 3/8 x 12 3/8 x 8 3/4	7	12.30	11.00	9.80

FUTURA CABINETS

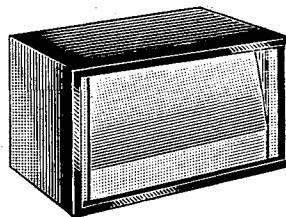

Front panels are held in place by body flanges eliminating the use of panel mounting screws.

Top and sides are formed of one piece of steel to which is fastened the base. Thus, the two parts may be quickly disassembled to expose the entire contents. Body and rear panel are of 20 gauge steel while front panels are 18 gauge. Four rubber feet attached to base. Chassis may be affixed to base, front or rear panels.

Choice of light gray hammertone body with smooth light gray panel or smooth dark blue body with smooth light blue panel. Please specify (HG) or (SB) when ordering.

Bud No.	Overall Size, In. W. x H. x D.	Uses Bud Chassis No.	Net Each, Lots of		
			1-24	25-49	50-99
MD-1960	13 x 7 x 8	CB-40	\$ 8.40	\$ 7.50	\$6.70
MD-1961	14 x 8 x 9	CB-997	8.90	8.00	7.10
MD-1962	16 x 8 x 9	CB-998	9.30	8.30	7.40
MD-1963	13 x 7 x 8	CB-40	9.80	8.80	7.80
MD-1964	14 x 8 x 9	CB-997	10.50	9.40	8.40
MD-1965	16 x 8 x 9	CB-998	11.10	10.00	8.90



Cabinet Racks, Accessories

DELUXE RELAY RACKS WITH ADD-A-RACK

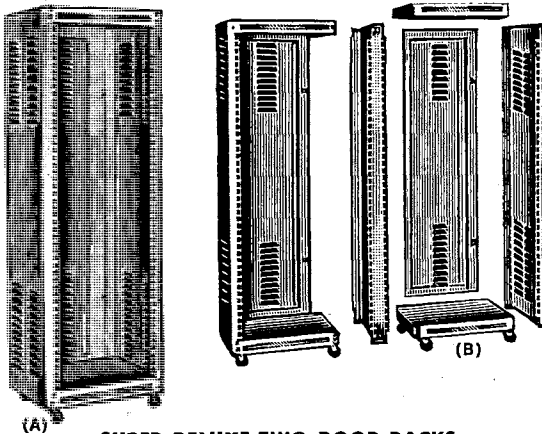

(A) Deluxe Relay Racks — High quality relay racks made of 16-gauge steel with $\frac{3}{16}$ " panel supports. Panel mounting supports are recessed so that no panel edges will be exposed. Both back and sides are fully louvered for best ventilation. Snap catches are positioned on the door. Rounded corners and red-lined chrome trim give streamlined appearance. Base constructed with four special supports so that casters may be applied directly to base for mobility. All standard panels fit these racks: 22" wide for 19" panels; 27" wide for 24" panels.

Super Deluxe Series Relay Racks are equipped with adjustable panel mounting supports permitting forward and backward adjustment of panels for more efficient use of space. Adjustable points are at 1" intervals for 9" to 15" clearance behind panels. Super Deluxe Racks are fitted with both front and rear doors, the rear to cover any equipment behind the panel while making it easily accessible. The front door, not louvered, conceals controls on the front panel.

(B) Add-A-Rack Series — Where relay racks are to be joined in series. Provides additional strength and improved appearance. Includes door, top, bottom and coupling unit, all that is needed to make a double relay rack out of a single Deluxe series.

All Racks Listed are shipped knocked-down with all necessary hardware and assembly instructions. Casters optional. When ordering specify finish. Add suffix "HG" for gray hammertone; suffix "G" for gray wrinkle; and suffix "B" for black wrinkle.

SUPER DELUXE TWO-DOOR RACKS WITH 19" WIDE PANEL SPACE

Bud No.	Height, Overall	Panel Space	Wt., Lbs.	Net Each, Lots of		
				1-9	10-14	15-19
CR-2174	42 $\frac{1}{8}$ "	36 $\frac{3}{4}$ "	102	\$ 75.10	\$ 67.60	\$60.10
CR-2171	47 $\frac{5}{8}$ "	42"	104	81.10	73.00	64.90
CR-2172	66 $\frac{5}{8}$ "	61 $\frac{1}{4}$ "	138	104.60	94.10	83.70
CR-2175	75 $\frac{5}{8}$ "	70"	150	112.50	101.30	90.00
CR-2173	82 $\frac{5}{8}$ "	77"	163	125.60	113.00	100.50

WITH 24" WIDE PANEL SPACE

Bud No.	Height, Overall	Panel Space	Wt., Lbs.	Net Each, Lots of		
				1-9	10-14	15-19
CR-2494	42 $\frac{1}{8}$ "	36 $\frac{3}{4}$ "	119	\$ 96.80	\$ 87.10	\$77.45
CR-2491	47 $\frac{5}{8}$ "	42"	122	108.70	97.80	87.00
CR-2492	66 $\frac{5}{8}$ "	61 $\frac{1}{4}$ "	160	141.60	127.50	113.30
CR-2495	75 $\frac{5}{8}$ "	70"	175	150.80	135.70	120.60
CR-2493	82 $\frac{5}{8}$ "	77"	190	169.50	152.60	135.60

ADD-A-RACK ASSEMBLIES

Includes door, top, bottom and coupling unit for add-on use with racks indicated.

Bud No.	For Use With Rack No.	Wt., Lbs.	Net Each, Lots of		
			1-9	10-14	15-19
AR-1778	CR-1774	70	\$ 56.50	\$ 50.90	\$ 45.20
AR-1775	CR-1771	74	60.10	54.00	48.00
AR-1776	CR-1772	100	74.60	67.20	59.70
AR-1779	CR-1780	107	78.90	71.00	63.20
AR-1777	CR-1773	113	91.80	82.60	73.40
AR-4274	CR-2474	82	58.30	52.50	46.65
AR-4271	CR-2471	87	65.80	59.20	52.65
AR-4272	CR-2472	117	82.50	74.25	66.00
AR-4275	CR-2475	125	84.00	75.60	67.20
AR-4273	CR-2473	132	98.90	89.00	79.10
AR-2278*	CR-2074	102	64.00	57.60	51.20
AR-2275*	CR-2071	86	72.30	65.10	57.80
AR-2276*	CR-2072	110	90.50	81.50	72.40
AR-2279	CR-2075	120	92.30	83.05	73.85
AR-2277*	CR-2073	130	110.20	99.20	88.20
AR-3278	CR-2484	100	82.70	74.45	66.15
AR-3275	CR-2481	119	92.40	83.20	73.90
AR-3276	CR-2482	129	115.80	104.20	92.70
AR-3279	CR-2485	140	117.70	105.95	94.15
AR-3277	CR-2483	152	139.30	125.40	114.40

*Gray hammertone standard; for black or gray wrinkle add 10% to price.

"TEM-STAT" TEMPERATURE CONTROLS

Prevents costly damage to electronic components in enclosed cabinets, boxes, etc. Bimetal sensing element responds quickly to gradual or sudden temperature changes and actuates whatever warning device you use: Activates a light, bell, blower or other device; or, shuts off current. Activates snap-action, heavy-duty, normally open switch contacts. High electrical ratings up to 300° F; fully adjustable temperature ranges. Screw terminals for easy attachment. U/L Listed. Small size. 2 $\frac{1}{2}$ " lg. x 1" w. x 1 $\frac{1}{2}$ " d., suitable for limited space applications. **U/L Rating:** 8 amps, full load.

Bud Model TS-15—For 80°-170° F range. Net Each... **\$530**
 Bud Model TS-16—For 150°-240° F range. Net Each... **\$530**

CASTERS

Bud No.	Height	Weight (Set of 4)	Net Each, Lots of		
			1-49	50-99	100-149
RC-7756	2 $\frac{3}{8}$ "	1 $\frac{1}{2}$ lbs.	\$1.10	\$1.00	.90
RC-7757	2"	1 lb.	.60	.55	.48
RC-7758	3 $\frac{1}{4}$ "	6 lbs.	2.70	2.40	2.20

DELUXE RELAY RACKS

17 $\frac{1}{8}$ " Overall Depth

WITH 19" WIDE PANEL SPACE

Bud No.	Height, Overall	Panel Space	Wt., Lbs.	Net Each, Lots of		
				1-9	10-14	15-19
CR-1774	42 $\frac{1}{8}$ "	36 $\frac{3}{4}$ "	82	\$57.50	\$51.80	\$46.00
CR-1771	47 $\frac{5}{8}$ "	42"	92	65.10	58.60	52.10
CR-1772	66 $\frac{5}{8}$ "	61 $\frac{1}{4}$ "	115	81.50	73.30	65.20
CR-1780	75 $\frac{5}{8}$ "	70"	125	83.60	75.20	67.90
CR-1773	82 $\frac{5}{8}$ "	77"	135	93.80	84.40	75.00

WITH 24" WIDE PANEL SPACE

Bud No.	Height, Overall	Panel Space	Wt., Lbs.	Net Each, Lots of		
				1-9	10-14	15-19
CR-2474	42 $\frac{1}{8}$ "	36 $\frac{3}{4}$ "	96	\$ 67.40	\$ 60.60	\$53.90
CR-2471	47 $\frac{5}{8}$ "	42"	108	76.00	68.40	60.80
CR-2472	66 $\frac{5}{8}$ "	61 $\frac{1}{4}$ "	135	96.30	86.70	77.00
CR-2475	75 $\frac{5}{8}$ "	70"	146	97.00	87.30	77.60
CR-2473	82 $\frac{5}{8}$ "	77"	158	114.00	102.60	91.20

EXTRA DEEP DELUXE RACKS

Same as above, except 22 $\frac{1}{8}$ " deep instead of 17 $\frac{1}{8}$ " deep. Gray hammertone finish standard; for black or gray wrinkle add 10% to price.

WITH 19" WIDE PANEL SPACE

Bud No.	Height, Overall	Panel Space	Wt., Lbs.	Net Each, Lots of		
				1-9	10-14	15-19
CR-2074	42 $\frac{1}{8}$ "	36 $\frac{3}{4}$ "	98	\$ 70.40	\$ 63.40	\$56.30
CR-2071	47 $\frac{5}{8}$ "	42"	102	79.60	71.60	63.70
CR-2072	66 $\frac{5}{8}$ "	61 $\frac{1}{4}$ "	137	99.70	89.70	79.80
CR-2075	75 $\frac{5}{8}$ "	70"	148	101.60	91.50	81.30
CR-2073	82 $\frac{5}{8}$ "	77"	159	118.40	106.60	94.70

WITH 24" WIDE PANEL SPACE

Bud No.	Height, Overall	Panel Space	Wt., Lbs.	Net Each, Lots of		
				1-9	10-14	15-19
CR-2484	42 $\frac{1}{8}$ "	36 $\frac{3}{4}$ "	115	\$ 94.70	\$ 85.20	\$75.80
CR-2481	47 $\frac{5}{8}$ "	42"	119	106.30	95.70	85.00
CR-2482	66 $\frac{5}{8}$ "	61 $\frac{1}{4}$ "	160	133.30	119.90	106.60
CR-2485	75 $\frac{5}{8}$ "	70"	173	135.60	122.00	108.50
CR-2483	82 $\frac{5}{8}$ "	77"	186	159.00	143.10	127.20

TRANS-AIRE BLOWER

Ideal for use where excessive heat is generated by equipment in an enclosed rack, cabinet or console. Brings in fresh air or exhausts heated air, enabling use as an exhaust or intake blower, depending upon mounting position. Unit will operate in any position—vertical or horizontal. May be mounted to rails of standard cabinet or rack. Use of Bud Chassis Supporting

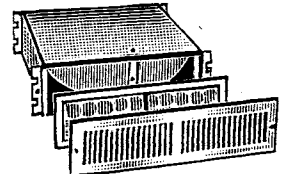

Angles SA-1349, SA-1350 or CE-2219 is recommended when blower is mounted in rack or cabinet. Motor is rubber mounted to reduce vibration. Operating noise factor reduced to minimum. Thermal overload protection to prevent overheating. Automatic reset. Oil impregnated, fiberglass disposable filter can be changed without removing unit from cabinet. Three sizes provide air displacement from 100 c.f.m. to 750 c.f.m. at 0° static pressure. Complete with filter, chrome-plated grille and 18" three-wire cord. All dimensional and technical data in table below. **Weight:** B-23 17 $\frac{1}{4}$ lbs., B-25 33 lbs., B-27 35 $\frac{1}{2}$ lbs.; replacement filter 1 lb.

BLOWERS

Bud No.	Panel Space	Depth	Air c.f.m.		Mot. hp	Net Each, Lots of		
			High	Low		1-9	10-14	15 Up
B23	3 $\frac{1}{2}$ "x19"	12"	200	100	1/20	\$67.40	\$60.70	\$53.90
B25	5 $\frac{1}{4}$ "x19"	14 $\frac{1}{2}$ "	500	250	1/6	77.10	69.40	61.70
B27	7" x19"	14 $\frac{1}{2}$ "	750	350	1/4	86.60	78.00	69.30

FILTERS FOR ABOVE BLOWERS

Bud No.	Unit	Net Each, Lots of		
		1-24	25-49	50-99
BF-24	Filter for use with B-23	\$1.50	\$1.40	\$1.20
BF-26	Filter for use with B-25	1.70	1.50	1.30
BF-28	Filter for use with B-27	1.80	1.65	1.45



Relay Racks and Panels

STANDARD RELAY RACK PANELS

Choice of $\frac{1}{8}$ " steel or $\frac{1}{8}$ " and $\frac{3}{16}$ " aluminum panels in both 19" and 24" widths. Specify color when ordering; use suffix B for black wrinkle; G for gray wrinkle; HG for gray hammertone; SB for smooth blue; SG for smooth gray. Aluminum panels: 5005 H-36 or 2024 T-3 alloy.

19" WIDE PANELS

Ht., In.	Bud No. PS-	$\frac{1}{8}$ " STEEL			Bud No. PA-	$\frac{1}{8}$ " ALUMINUM		
		1-49	50-99	100-149		1-49	50-99	100-149
1 1/4	1250	\$1.50	\$1.00	\$.90	1101	\$1.40	\$1.20	\$1.10
3 1/2	1251	1.30	1.10	1.05	1102	1.90	1.70	1.50
5 1/4	1252	1.80	1.60	1.40	1103	2.40	2.20	2.00
7	1253	1.90	1.70	1.50	1104	3.10	2.80	2.50
8 3/4	1254	2.40	2.20	2.00	1105	3.60	3.30	2.90
10 1/2	1255	3.30	2.90	2.60	1106	4.60	4.10	3.70
12 1/4	1256	3.60	3.30	2.90	1107	5.30	4.80	4.30
14	1257	4.00	3.60	3.20	1108	6.10	5.50	4.90
15 1/4	1258	4.40	4.00	3.50	1109	6.80	6.10	5.40
17 1/2	1259	4.80	4.40	3.90	1110	7.40	6.70	5.90
19 1/4	1260	5.50	5.00	4.40	1111	8.10	7.30	6.50
21	1261				1112	9.00	8.10	7.20

24" WIDE PANELS

1 1/4	3420	\$1.60	\$1.40	\$1.30	2401	\$ 2.00	\$ 1.80	\$1.60
3 1/2	3421	1.80	1.60	1.40	2402	2.60	2.40	2.10
5 1/4	3422	2.20	2.00	1.80	2403	3.50	3.20	2.80
7	3423	2.50	2.30	2.00	2404	4.10	3.70	3.30
8 3/4	3424	3.10	2.80	2.50	2405	5.20	4.70	4.10
10 1/2	3425	3.50	3.20	2.80	2406	6.30	5.70	5.10
12 1/4	3426	4.40	4.00	3.50	2407	7.10	6.40	5.70
14	3427	5.20	4.70	4.10	2408	8.60	7.70	6.90
15 1/4	3428	5.80	5.20	4.60	2409	9.20	8.30	7.30
17 1/2	3429	6.30	5.70	5.10	2410	9.70	8.70	7.70
19 1/4	3430	7.10	6.40	5.70	2411	10.60	9.50	8.50
21	3431	7.80	7.00	6.20	2412	11.70	10.50	9.40

3/16" 5005 H-36 ALUMINUM PANELS

Ht., In.	Standard 19" Wide Panels			Standard 24" Wide Panels				
	Bud No. PA-	1-49	50-99	100-149	Bud No. PA-	1-49	50-99	100-149
1 1/4	3101	\$ 2.00	\$ 1.80	\$ 1.60	2431	\$ 3.50	\$ 3.10	\$ 2.80
3 1/2	3102	2.90	2.60	2.30	2432	4.50	4.10	3.60
5 1/4	3103	3.80	3.40	3.00	2433	6.30	5.60	5.00
7	3104	4.80	4.30	3.80	2434	7.30	6.50	5.80
8 3/4	3105	5.60	5.00	4.50	2435	8.50	7.70	6.80
10 1/2	3106	7.00	6.30	5.60	2436	10.80	9.70	8.60
12 1/4	3107	8.10	7.30	6.50	2437	12.20	11.00	9.80
14	3108	9.00	8.10	7.20	2438	14.40	12.90	11.50
15 1/4	3109	10.50	9.40	8.40	2439	16.00	14.40	12.80
17 1/2	3110	11.60	10.40	9.20	2440	17.50	15.80	14.00
19 1/4	3111	12.60	11.30	10.00	2441	19.30	17.40	15.40
21	3112	13.80	12.40	11.00	2442	21.20	19.10	17.00

1/8" HARD ALUMINUM PANELS

Ht., In.	19" Wide Panels				24" Wide Panels			
	Bud PA-	1-49	50-99	100-149	Bud PA-	1-49	50-99	100-149
1 3/4	1131	\$ 1.70	\$1.50	\$1.40	4221	\$ 2.40	\$ 2.15	\$ 1.90
3 1/2	1132	2.10	1.90	1.70	4222	3.10	2.80	2.50
5 1/4	1133	2.90	2.60	2.30	4223	4.00	3.60	3.20
7	1134	3.70	3.30	2.90	4224	5.20	4.70	4.10
8 3/4	1135	4.10	3.70	3.30	4225	6.00	5.40	4.80
10 1/2	1136	5.30	4.70	4.20	4226	7.40	6.65	5.90
12 1/4	1137	6.00	5.40	4.80	4227	8.50	7.70	6.80
14	1138	7.00	6.30	5.60	4228	9.80	8.80	7.80
15 1/4	1139	7.60	6.80	6.10	4229	10.70	9.65	8.55
17 1/2	1140	8.20	7.40	6.50	4230	11.60	10.45	9.30
19 1/4	1141	8.90	8.00	7.10	4231	12.50	11.25	10.00
21	1142	10.10	9.10	8.10	4232	14.40	13.00	11.50

3/16" HARD ALUMINUM PANELS

1 3/4	3121	\$ 2.90	\$ 2.60	\$ 2.30	4280	\$ 4.60	\$ 4.15	\$ 3.70
3 1/2	3122	3.50	3.10	2.80	4281	5.60	5.05	4.50
5 1/4	3123	4.80	4.30	3.80	4282	7.20	6.50	5.75
7	3124	6.00	5.40	4.80	4283	9.20	8.30	7.35
8 3/4	3125	7.10	6.40	5.70	4284	10.80	9.70	8.65
10 1/2	3126	8.70	7.80	6.90	4285	13.30	12.00	10.65
12 1/4	3127	10.20	9.20	8.20	4286	15.50	13.95	12.40
14	3128	11.80	10.60	9.40	4287	18.00	16.20	14.40
15 1/4	3129	12.60	11.35	10.10	4288	19.40	17.45	15.50
17 1/2	3130	13.90	12.60	11.20	4289	21.20	19.10	16.95
19 1/4	3131	14.70	13.25	11.75	4290	22.80	20.50	18.25
21	3132	17.00	15.30	13.60	4291	26.20	23.60	20.95

FLANGED PANELS 19" WIDE

Made of 16 gauge steel with a $\frac{1}{2}$ " flange all around. Elongated hole is .250" x .500". Spacing of holes is same as standard panel notching. Specify color when ordering; add suffix G, gray wrinkle; B, black wrinkle; H, gray hammertone; SG, smooth light gray; SB, smooth light blue; CG, charcoal gray; S, sand.

Bud No.	Height Inches	Weight Lbs.	Net Each, Lots of		
			1-49	50-99	100-149
FPS-1230	1 3/4	1	\$1.40	\$1.20	\$1.10
FPS-1231	3 1/2	1 1/2	1.40	1.20	1.10
FPS-1232	5 1/4	2	1.60	1.40	1.30
FPS-1233	7	2 3/4	1.80	1.60	1.40
FPS-1234	8 3/4	3 1/4	2.20	2.00	1.80
FPS-1235	10 1/2	4	2.70	2.40	2.20
FPS-1236	12 1/4	4 1/2	3.20	2.90	2.60
FPS-1237	14	5	3.50	3.20	2.80
FPS-1238	15 1/4	5 1/2	4.00	3.60	3.20
FPS-1239	17 1/2	6 1/4	4.40	4.00	3.50
FPS-1240	19 1/4	6 3/4	4.80	4.40	3.90
FPS-1241	21	7 1/2	5.30	4.70	4.20

SURFACE SHIELD PANELS

Bright aluminum alloy 5005 H-36 panels have blemish-free mill finish. Covered on both sides with sturdy, pressure-sensitive, white paper; protects against damage and useful for marking for drilling, positioning, etc. Standard notched sizes.

STANDARD 19" WIDE PANELS

Ht., In.	Bud SFA-	$\frac{1}{8}$ " ALUMINUM			$\frac{3}{16}$ " ALUMINUM			
		1-49	50-99	100-149	1-49	50-99	100-149	
1 1/4	1831	\$1.20	\$1.10	\$.95	3161	\$ 2.10	\$ 1.90	\$ 1.70
3 1/2	1832	1.80	1.70	1.50	3162	3.00	2.70	2.40
5 1/4	1833	2.40	2.20	1.90	3163	3.90	3.50	3.10
7	1834	2.90	2.60	2.30	3164	4.80	4.40	3.90
8 3/4	1835	3.50	3.20	2.80	3165	5.80	5.20	4.60
10 1/2	1836	4.50	4.10	3.60	3166	6.70	6.00	5.30
12 1/4	1837	5.10	4.60	4.10	3167	8.40	7.60	6.70
14	1838	5.80	5.30	4.70	3168	9.60	8.70	7.70
15 1/4	1839	6.60	5.90	5.30	3169	10.80	9.70	8.60
17 1/2	1840	7.30	6.50	5.80	3170	11.90	10.70	9.50
19 1/4	1841	8.00	7.20	6.40	3171	13.00	11.70	10.40
21	1842	8.80	7.90	7.00	3172	14.20	12.80	11.40

STANDARD 24" WIDE PANELS

1 1/4	2451	\$ 2.20	\$ 2.00	\$ 1.80	3401	\$ 4.10	\$ 3.70	\$ 3.30
3 1/2	2452	3.00	2.70	2.40	3402	5.50	5.00	4.40
5 1/4	2453	3.80	3.40	3.00	3403	7.40	6.70	5.90
7	2454	4.90	4.40	3.90	3404	9.10	8.20	7.30
8 3/4	2455	5.80	5.20	4.60	3405	10.90	9.80	8.70
10 1/2	2456	7.30	6.50	5.60	3406	13.70	12.30	11.00
12 1/4	2457	8.20	7.40	6.50	3407	15.80	14.20	12.60
14	2458	9.50	8.60	7.60	3408	18.20	16.40	14.60
15 1/4	2459	10.80	9.70	8.60	3409	20.30	18.30	16.30
17 1/2	2460	11.70	10.60	9.40	3410	22.50	20.20	18.00
19 1/4	2461	12.90	11.60	10.40	3411	24.50	22.10	19.60
21	2462	14.10	12.70	11.30	3412	26.60	24.00	21.30

VENTILATED DOOR RACK PANELS

Perforated area in door provides adequate ventilation. Features a plunger type latch for positive locking and easy opening. Distance from hinged side of opening to bottom, $3\frac{1}{2}$ "; from lock side of opening to top, 1". Available in black or gray wrinkle finish or gray hammertone finish (specify when ordering). $\frac{1}{8}$ " steel, 19" long.

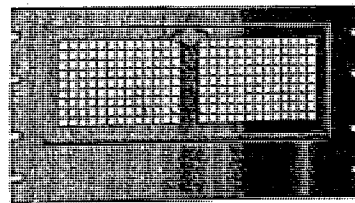

Bud No.	Height Overall	Door Size, Inches	Wt., Lbs.	Net Each, Lots of		
				1-24	25-49	50-99
PS-814	10 1/2"	15 3/8 x 6	6	\$10.10	\$9.10	\$8.10
PS-815	12 1/4"	15 3/8 x 7 1/2	7	10.80	9.70	8.60

NON-VENTILATED METAL DOOR PANELS

PS-615	10 1/2"	15 3/8 x 6	7 1/4	\$ 8.20	\$7.40	\$6.50
PS-616	12 1/4"	15 3/8 x 7 1/2	8 1/4	10.20	9.20	8.10

VENTILATING GRILLE PANELS

Substitute for solid panels for extra ventilation. Made of $\frac{1}{8}$ " steel with die-cut grille $13\frac{1}{2}$ " wide. Standard notching, 19" wide sizes. Specify black wrinkle (suffix B), gray wrinkle (suffix G), or gray hammertone (suffix HG).

Bud No.	Height, Overall	Grille Height	Wt., Lbs.	Net Each, Lots of		
				1-24	25-49	50-99
PS-808	5 1/4"	3 3/8"	2 1/2	\$4.00	\$3.60	\$3.20
PS-809	7"	4 7/8"	3 1/2	4.40	4.00	3.50
PS-810	8 3/4"	3 3/8"	5	5.30	4.70	4.20
PS-811	10 1/2"	5 7/8"	5 3/4	5.50	5.00	4.40
PS-812	12 1/4"	7 3/8"	6 1/4	6.00	5.40	4.80

* Allows $3\frac{1}{2}$ " space for chassis mounting.



Cases, Racks, Chassis

TRANSICASE PORTABLE INSTRUMENT CASES

Handsome, portable instrument case with unlimited applications. Contour design fabricated of .040" aluminum with flush-fitting aluminum panel. Foam-rubber lined lid protects instruments in case; mounted on two slide-off, bright nickel-plated hinges with toggle catches. Rubber feet at both base and back; metal plugs supplied to fill holes if rubber feet are not used. Bright nickel-plated handle. **Specify Color:** Add suffix **SB** for smooth blue; **SG**, for smooth gray enamel.

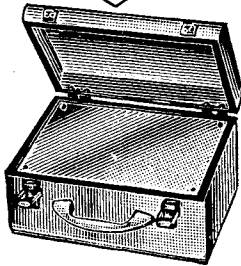

Bud No.	Inside Panel Size, Inches	Clear Internal Space		Internal Aperture	Overall Size, Inches W. x D. x H.	Wt., Lbs.	Net Each, Lots of		
		Below Panel	Above Panel				1-9	10-14	15-19
TC-300	8 1/16 x 5 11/16	4 15/32	1 15/32	8" x 5 1/4"	10 1/16 x 7 x 6	3 3/4	\$26.50	\$23.80	\$21.20
TC-301	10 3/8 x 7 3/4	4 15/32	1 15/32	9 1/16 x 7 1/2"	11 1/2 x 8 1/4 x 6	4 1/2	27.10	24.40	21.70
TC-302	11 1/2 x 7 15/16	5 25/32	1 15/32	10 15/16 x 7 31/32"	13 x 9 x 7 1/2	6	27.60	24.90	22.10
TC-303	15 3/8 x 7 15/16	5 25/32	1 15/32	14 1/4 x 7 31/32"	16 1/2 x 9 x 7 1/2	8	28.10	25.30	22.50
TC-304	19 x 7	7 1/2	1 15/32	18 1/4 x 7 1/2"	20 1/2 x 8 x 9	10	29.70	26.80	23.80

DELUXE CABINET RACKS

Rounded corners, red-lined chrome trim. There is a recessed, hinged door on the top with a snap catch. These racks are made of heavy gauge steel and are of sturdy construction. The five large sizes have a hinged rear door, while the small sizes have a welded panel in the rear. Adequate ventilation is assured by means of louvered sides and a 2 1/2 inch opening in the bottom of the back extends the entire width. "NO-SCRATCH" EXTENDED METAL FEET ARE EMBOSSED ON THE BOTTOM. In black wrinkle (add suffix "B" to number when ordering), gray wrinkle (suffix "G"), and hammertone gray (suffix "HG"). Size: 14 3/4" x 22" w. Fits 19" panels. Full size aluminum Relay Rack Panel supplied at no extra cost.

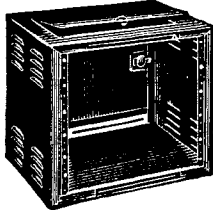

Bud No.	Height, Overall	Panel Space	Wt., Lbs.	Net Each, Lots of		
				1-14	15-24	25-34
CR-1726	8 5/8"	7"	24	\$18.90	\$16.90	\$15.00
CR-1741	10 1/4"	8 3/4"	28	20.10	18.10	16.10
CR-1740	12 1/4"	10 1/4"	31	23.50	21.60	18.80
CR-1742	14 1/4"	12 1/4"	32	24.10	21.70	19.30
CR-1733	15 1/4"	14"	35	32.70	29.50	26.20
CR-1743*	19 1/4"	17 1/2"	40	32.10	28.90	25.70
CR-1727*	22 1/4"	21"	43	34.40	31.00	27.50
CR-1744*	28 1/4"	26 1/4"	51	37.00	33.30	29.60
CR-1728*	33 1/4"	31 1/2"	58	39.30	35.40	31.50
CR-1745*	36 1/4"	35"	63	41.30	37.20	33.10

*These sizes have both top and rear doors.

HEAVY DUTY CABINET RACKS

Similar to our Deluxe Cabinet Rack except with greater depth and extra strength. These racks are shipped knocked down with all necessary assembly hardware. Panel mounting rails are an integral part of the sides. Removable rear door. Louvered sides and 2 1/2" x 17 7/8" opening in bottom or back assure adequate ventilation. Made of 16 gauge steel. Where it is advantageous to have a bank of these cabinet racks, an Add-a-Cab feature is provided. The method of assembly is the same as our Add-a-Rack series. Specify gray hammertone (HG), black wrinkle (B), or gray wrinkle (G). Size 17 7/8" dia x 22" w.

Bud No.	Height, Overall	Panel Space	Wt., Lbs.	Net Each, Lots of		
				1-14	15-24	25-34
CR-1736	24 1/2"	19 1/4"	50	\$31.30	\$28.20	\$25.10
CR-1737	31 1/2"	26 1/4"	57	33.70	30.30	26.90
CR-1738	40 1/2"	35"	70	40.10	36.10	32.10
ACR-1936	Add-A-Cab for CR-1736	42	31.10	28.00	24.90	
ACR-1937	Add-A-Cab for CR-1737	52	32.10	28.90	25.70	
ACR-1938	Add-A-Cab for CR-1738	57	39.50	35.50	31.60	

PORTACAB INSTRUMENT CABINETS

PORTACABS

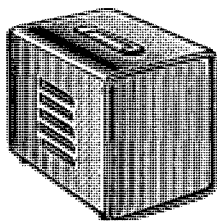

These attractive and versatile cabinets are desirable as housings for instrumentation requiring highly styled appearance. The body is of one piece .050 aluminum with contoured corners. Panel is .062 aluminum.

Flexible recessed handle permits easy portability as well as vertical stacking. Well louvered for adequate ventilation. Since louvers point inward, side-to-side placement of cabinets is possible without space loss. Welded back has opening.

Front panel mounting flanges 1/2" wide. Aluminum front panel is recessed 1/8". The perimeter of the panel follows the contour of the body. Four detachable rubber feet furnished. Gray hammertone finish only.

Bud No.	Size, inches W. x D. x H.	Wt., Lbs.	Bud Chassis	Net Each, Lots of		
				1-24	25-49	50-99
WA-1540	6 1/2 x 8 x 8	2 1/2	AC-402	\$10.70	\$ 9.60	\$ 8.60
WA-1541	8 1/2 x 12 x 9	3	AC-407	14.00	12.60	11.20
WA-1542	10 1/2 x 8 x 8	3 1/2	AC-406	12.50	11.20	10.00
WA-1543	11 1/2 x 18 x 11	6 1/2	AC-416	17.40	15.60	13.90
WA-1544	14 1/2 x 18 x 12	7 3/4	AC-420	20.00	18.00	16.00

MINIATURE UTILITY CABINETS

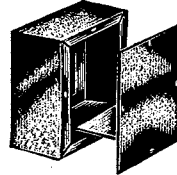

Ideal housing for construction of electronic devices using miniature tubes and transistorized circuitry. Front panel has a built-on chassis. Both front and rear panels are removable; fastened by self-tapping screws. Black wrinkle enamel finish.

Bud No.	Size, in. H. x W. x D.	Chassis W. x D., in.	Net Each, Lots of		
			1-49	50-99	100-149
C-1793	4 x 4 x 2	3 1/2 x 1 1/2"	\$1.60	\$1.40	\$1.30
C-1794	4 x 5 x 3	4 1/2 x 2 1/2"	1.90	1.70	1.50
C-1795	5 x 4 x 3	3 3/4 x 2 1/2"	2.00	1.80	1.60
C-1796	6 x 5 x 4	4 1/2 x 3 1/2"	2.10	1.90	1.70
C-1797	5 x 6 x 4	5 1/2 x 3 1/2"	2.40	2.10	1.90
C-1798	6 x 6 x 6	4 1/2 x 5 1/2"	2.90	2.60	2.30

*1" high. †1 1/2" high. ‡1 3/4" high.

STREAMLINED MULTI-PURPOSE CABINETS

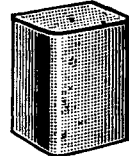

Attractive cabinet with curved corners; uses chassis No. CB-1625. Back is entirely open for ventilation. Finished in light gray wrinkle only.

Bud No.	Size, inches H. x W. x D.	Wt., Lbs.	Net Each, Lots of		
			1-49	50-99	100-149
C-1787	4 1/2 x 5 1/2 x 3 1/2	1	\$2.20	\$2.00	\$1.70
C-1788	6 1/2 x 5 1/2 x 3 1/2	1 1/2	2.20	2.00	1.70

MINIATURE SPEAKER CASES

Safe, convenient steel housing for 2" and 3" speakers. Black wrinkle finish only.

Bud No.	For Speaker	Net Each, Lots of		
		1-24	25-49	50-99
CS-1685	2"	\$1.90	\$1.70	\$1.55
CS-1686	3"	1.90	1.70	1.55

UNIVERSAL SLOPING PANEL CABINETS

Fully enclosed and shielded housing with one-piece detachable back and sides fastened to body with four self-tapping screws. Components may be mounted on back, bottom, sides or front. Will accommodate Bud Miniature Aluminum Chassis. Size: 4" d. x 4 1/4" h. Gray hammertone finish only.

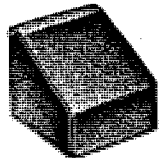

ALUMINUM MODELS

Aluminum alloy 5005 H-14.

Bud No.	Uses Chassis	Width	Wt., Lbs.	Net Each, Lots of		
				1-24	25-49	50-99
AC-1610	CB-1617	4"	1 1/2	\$2.30	\$2.00	\$1.80
AC-1611	CB-1618	5"	1 1/2	2.20	2.00	1.80
AC-1612	CB-1619	6"	3/4	2.40	2.10	1.90
AC-1613	CB-1620	7"	3/4	2.60	2.40	2.10

STEEL MODELS

C-1606	CB-1617	4"	3/4	\$1.80	\$1.60	\$1.40
C-1607	CB-1618	5"	3/4	1.90	1.70	1.50
C-1608	CB-1619	6"	1 1/8	2.00	1.80	1.60
C-1609	CB-1620	7"	1 1/8	2.40	2.10	1.90



Cabinets and Cases

STREAMLINED CABINETS

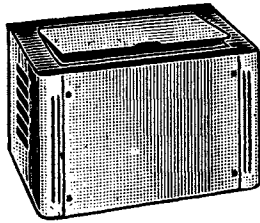

Ideal for housing devices not requiring excessive depth. Recessed, hinged cover with convenient finger lift for access. Panels fit flush with embossed, rounded corner fronts. Recommended for use with Bud Open End Chassis. Back opening 3½" h. provides for cables or rear controls; louvered sides provide ample ventilation. Size: 8¼" d. x 8" h., overall. Specify black wrinkle (suffix "B") or gray wrinkle (suffix "G") or gray hammertone (suffix "HG") finish.

Bud No.	Width, Overall	Panel Space	Wt., Lbs.	Net Each, Lots of		
				1-24	25-49	50-99
CD-1480	10½"	8" x 8"	5¾	\$ 6.90	\$ 6.20	\$ 5.50
CD-1481	12½"	8" x 10"	6	7.00	6.30	5.60
CD-1482	14½"	8" x 12"	6½	7.40	6.70	5.90
CD-1483	16½"	8" x 14"	7	7.90	7.10	6.30
CD-1484	18½"	8" x 16"	7½	8.60	7.70	6.90
CD-1485*	20½"	12" x 18"	15	17.50	15.70	14.00

*Depth is 12"; has ½" vertical chrome strip at corners.

INSTRUMENT AND RECEIVER CABINETS

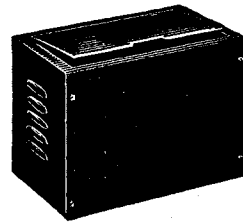

Economy version of the Streamlined Cabinet series. Recessed, hinged cover provides access to contents. Front panel is attached with self-tapping screws. Louvers provide ample ventilation. Bud Open End Chassis are suited for use with these units. Black wrinkle finish only.

Bud No.	Size, Inches H. x W. x D.	Wt., Lbs.	Net Each, Lots of		
			1-24	25-49	50-99
C-973	7 x 8 x 8	5	\$ 5.20	\$ 4.70	\$ 4.10
C-993	7 x 10 x 8	5½	5.90	5.30	4.70
C-994	7 x 12 x 8	5¾	6.20	5.60	4.90
C-995	7 x 14 x 8	6	6.50	5.90	5.20
C-1190	8 x 16 x 8	7	9.30	8.30	7.40
C-975	9 x 15 x 11	8	11.20	10.10	9.00
C-999	12 x 18 x 12	15	12.20	11.00	9.80

METAL UTILITY CABINETS

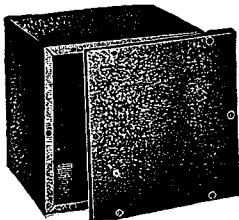

Highly useful housing for all types of electronic equipment such as mixers, monitors, frequency meters, etc. Both front and back panels are removable for easy accessibility.

STEEL CABINETS

Specify black wrinkle (suffix "B") or gray hammertone (suffix "HG") finish.

Bud No.	Size, Inches D. x W. x H.	Wt., Lbs.	Net Each, Lots of		
			1-49	50-99	100-149
CU-883	2 x 4 x 4	¾	\$1.40	\$1.20	\$1.10
CU-728	3 x 5 x 4	¾	1.50	1.40	1.20
CU-729	4 x 5 x 6	1¼	1.70	1.50	1.35
CU-1098	6 x 6 x 6	2½	2.60	2.40	2.10
CU-1099	5 x 6 x 9	3	2.90	2.60	2.30
CU-879	7 x 8 x 10	5	4.10	3.70	3.30
CU-1124	6 x 7 x 12	4	4.00	3.60	3.20
CU-880	8 x 10 x 10	5½	4.90	4.40	3.90
CU-881	8 x 11 x 12	6	5.40	4.90	4.30
CU-882	7 x 9 x 15	7½	5.50	5.00	4.40

NATURAL FINISH ALUMINUM CABINETS*

AU-1083	2 x 4 x 4	¾	\$1.60	\$1.40	\$1.30
AU-1028	3 x 5 x 4	¾	1.70	1.50	1.40
AU-1029	4 x 5 x 6	1¼	1.90	1.70	1.50
AU-1039	6 x 6 x 6	¾	2.70	2.40	2.20
AU-1040	5 x 6 x 9	1	3.10	2.80	2.50

GRAY HAMMERTONE ALUMINUM CABINETS*

AU-1083HG	2 x 4 x 4	¾	\$1.90	\$1.70	\$1.50
AU-1028HG	3 x 5 x 4	¾	2.10	1.90	1.70
AU-1029HG	4 x 5 x 6	1¼	2.20	2.00	1.80
AU-1039HG	6 x 6 x 6	¾	3.00	2.70	2.40
AU-1040HG	5 x 6 x 9	1	3.70	3.30	3.00

*Aluminum alloy 5005 H-14.

CARRYING CASES

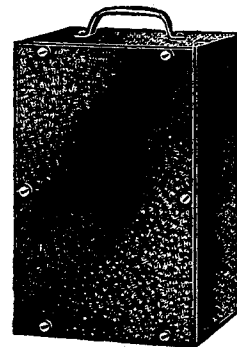

A versatile cabinet that accepts a variety of equipment. Removable front and back panels; handle may be attached to top. Available in sturdy steel or lightweight aluminum to suit your requirements.

STEEL CASES

Specify black wrinkle (suffix "B") or gray hammertone (suffix "HG") finish when ordering.

Bud No.	Size, Inches D. x W. x H.	Wt., Lbs.	Net Each, Lots of		
			1-24	25-49	50-99
CC-1095	5 x 6 x 9	3¼	\$3.70	\$3.30	\$3.00
CC-1091	5 x 9 x 6	3¾	3.70	3.30	3.00
CC-1096	6 x 7 x 12	4	5.20	4.70	4.10
CC-1092	6 x 12 x 7	4	5.20	4.70	4.10
CC-1097	7 x 7¾ x 15	5	5.80	5.20	4.60
CC-1100	8 x 10 x 10	5	5.90	5.30	4.70
CC-1093	7 x 15 x 9	5	7.20	6.50	5.70

NATURAL FINISH ALUMINUM CASES*

Bud No.	Size, Inches D. x W. x H.	Wt., Lbs.	Net Each, Lots of		
			1-24	25-49	50-99
ACC-2095	5 x 6 x 9	1½	\$3.80	\$3.40	\$3.00
ACC-2091	5 x 9 x 6	1½	3.80	3.40	3.00
ACC-2096	6 x 7 x 12	1½	5.80	5.20	4.60
ACC-2092	6 x 12 x 7	1½	5.80	5.20	4.60

GRAY HAMMERTONE ALUMINUM CASES*

Bud No.	Size, Inches D. x W. x H.	Wt., Lbs.	Net Each, Lots of		
			1-24	25-49	50-99
ACC-2095HG	5 x 6 x 9	1½	\$4.30	\$3.90	\$3.50
ACC-2091HG	5 x 9 x 6	1½	4.30	3.90	3.50
ACC-2096HG	6 x 7 x 12	1½	6.60	5.90	5.30
ACC-2092HG	6 x 12 x 7	1½	6.60	5.90	5.30

*Aluminum alloy 5005 H-14.



Chassis and Accessories

ALUMINUM CHASSIS BASES

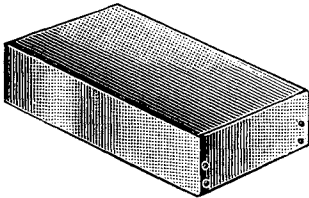

Each chassis is made from a single sheet of aluminum. All bases are welded on the latest type of welders by experienced operators. All corners are reinforced. Natural finish aluminum alloy 5005 H14. All four sides are folded at bottom for extra strength and rigidity. Now 63 sizes.

Bud No.	Width, in.	Lgth., in.	Ht., in.	Gauge	Net Each, Lots of		
					1-24	25-49	50-99
AC-1401*	2½	4½	1	18	\$1.20	\$1.10	\$.95
AC-1402*	3½	4½	1	18	1.20	1.10	.95
AC-1403*	3½	5½	1	18	1.20	1.10	.95
AC-1404*	4	5	2	18	1.40	1.30	1.10
AC-1405*	4	6	1½	18	1.40	1.30	1.10
AC-430	4	6	3	18	1.60	1.40	1.30
AC-431	4	6	2	18	1.40	1.30	1.10
AC-1406*	4	8	2	18	1.70	1.50	1.35
AC-432	4	17	3	16	2.90	2.60	2.30
AC-1407*	4½	8	1½	18	1.40	1.30	1.10
AC-402	5	7	2	18	1.50	1.40	1.20
AC-429	5	7	3	18	1.80	1.60	1.40
AC-1408*	5	9	1½	18	1.40	1.30	1.10
AC-1409*	5	9½	1½	18	1.50	1.40	1.20
AC-403	5	9½	2	18	1.70	1.50	1.35
AC-401	5	9½	2½	18	1.90	1.70	1.50
AC-421	5	9½	3	18	2.00	1.80	1.60
AC-404	5	10	3	18	2.00	1.80	1.60
AC-422	5	13	3	18	2.40	2.10	1.90
AC-1410*	5	13½	2½	18	1.90	1.70	1.50
AC-1411*	5½	5½	1	18	1.40	1.30	1.10
AC-1412*	5½	9½	1½	18	1.50	1.40	1.20
AC-1413*	6	8	2	18	1.70	1.50	1.35
AC-1414*	6	14	3	16	3.00	2.70	2.40
AC-433	6	17	3	16	3.40	3.00	2.70
AC-405	7	7	2	18	1.70	1.50	1.35
AC-406	7	9	2	18	1.80	1.60	1.40
AC-407	7	11	2	18	2.00	1.80	1.60
AC-408	7	12	3	18	2.40	2.20	2.00
AC-409	7	13	2	18	2.10	1.90	1.70
AC-1415*	7	15	2	16	2.70	2.40	2.20
AC-411	7	15	3	16	3.40	3.00	2.70
AC-1416*	7	17	2	16	3.10	2.80	2.50
AC-1417*	7	17	2½	16	3.20	2.90	2.60
AC-423	7	17	3	16	3.40	3.00	2.70
AC-1418*	8	10	2½	18	2.50	2.30	2.00
AC-1419*	8	12	2½	18	3.00	2.70	2.40
AC-424	8	12	3	16	3.00	2.70	2.40
AC-425	8	17	2	16	3.10	2.80	2.50
AC-412	8	17	3	16	3.50	3.10	2.80
AC-1420*	8½	15	3	16	3.30	2.90	2.60
AC-1421*	9	15	3	16	3.70	3.30	3.00
AC-413	10	12	3	16	3.40	3.00	2.70
AC-414	10	14	3	16	3.50	3.10	2.80
AC-415	10	17	2	16	3.40	3.00	2.70
AC-416	10	17	3	16	3.90	3.50	3.10
AC-427	10	17	4	14	5.60	5.00	4.50
AC-1422*	10	17	5	16	8.00	7.20	6.40
AC-1423*	10	23	3	14	5.80	5.20	4.60
AC-426	11	17	2	14	8.90	8.00	7.10
AC-417	11	17	3	14	4.90	4.40	3.90
AC-1424*	12	12	3	16	3.50	3.20	2.80
AC-1425*	12	17	2	16	4.50	4.10	3.60
AC-418	12	17	3	14	5.00	4.50	4.00
AC-419	13	17	2	14	4.40	4.00	3.50
AC-420	13	17	3	14	5.30	4.70	4.20
AC-428	13	17	4	14	6.50	5.90	5.20
AC-1426*	13	17	5	14	8.90	8.00	7.10
AC-1427*	14	17	3	14	6.30	5.60	5.00
AC-1428*	15	17	4	14	8.90	8.00	7.10
AC-1429*	16	17	6	14	12.10	10.90	9.60
AC-1430*	17	17	3	14	7.40	6.70	5.90
AC-1431*	17	17	4	14	10.50	9.40	8.40

*Denotes new size

CHASSIS MOUNTING BRACKETS

Mounts chassis to panels, essential when panel supports entire chassis weight. Heavy gauge steel 6½" high, cut away at bottom to mount flush to panel. Black enamel finish.

Bud No.	Depth, in.	Net Per Pair, Lots of		
		1-49	50-99	100-149
MB-458	8	\$1.50	\$1.40	\$1.20
MB-448	10	1.50	1.40	1.20
MB-459	11	1.70	1.50	1.30
MB-449	12	1.90	1.70	1.50
MB-460	13	1.90	1.70	1.50
MB-450*	10	2.20	2.00	1.80
MB-451*	13	2.40	2.10	1.90

*8½" high for chassis height of 4"

TRIANGULAR MOUNTING BRACKETS

Ideal for rigid support of shelves to take heavy loads. Heavy gauge steel with ¾" flange. Black enamel finish only.

Bud No.	Height, in.	Depth, in.	Wt., lbs.	Net Per Pair, Lots of		
				1-49	50-99	100-149
MB-1266	5	5	1	\$1.20	\$1.10	\$.95
MB-1267	7	7	1	1.40	1.20	1.10
MB-1268	9	9	1½	1.70	1.50	1.35

ALUMINUM BOTTOM PLATES

42 sizes to fit all Bud chassis. Made of 5005 H14 aluminum alloy. Natural finish. Plates have four embossed feet to prevent damage to surface on which they rest. Fit snugly on bottom of chassis.

Bud No.	Fits Chassis		1-49	50-99	100-149
	Width, in.	Length, in.			
BPA-1501*	2½	4½	\$.60	\$.55	\$.50
BPA-1502*	3½	4½	.70	.65	.55
BPA-1503*	3½	5½	.70	.65	.55
BPA-1504*	4	5	.70	.65	.55
BPA-1505*	4	6	.80	.70	.65
BPA-1506*	4	8	.90	.80	.70
BPA-1532*	4	17	.90	.80	.75
BPA-1507*	4½	8	1.00	.90	.80
BPA-1508*	5	7	.90	.80	.70
BPA-1590	5	9	.90	.80	.70
BPA-1591	5	10	.90	.80	.70
BPA-1509*	5	13	1.30	1.10	1.05
BPA-1510*	5	13½	1.30	1.20	1.10
BPA-1511*	5½	5½	.90	.80	.70
BPA-1512*	5½	9½	.90	.80	.75
BPA-1513*	6	8	1.00	.90	.80
BPA-1514*	6	14	1.30	1.10	1.05
BPA-1515*	6	17	1.60	1.40	1.30
BPA-1592	7	7	.90	.80	.70
BPA-1593	7	9	.90	.80	.70
BPA-1594	7	11	1.00	.90	.80
BPA-1595	7	12	1.10	1.00	.90
BPA-1596	7	13	1.30	1.15	1.05
BPA-1516*	7	15	1.40	1.30	1.15
BPA-1517*	7	17	1.40	1.30	1.15
BPA-1518*	8	10	1.40	1.20	1.10
BPA-1519*	8	12	1.70	1.50	1.35
BPA-1520*	8	17	1.70	1.50	1.35
BPA-1521*	8½	15	1.90	1.70	1.50
BPA-1522*	9	15	2.00	1.80	1.60
BPA-1523*	10	12	1.70	1.50	1.35
BPA-1524*	10	14	1.70	1.50	1.35
BPA-1597	10	17	1.70	1.50	1.35
BPA-1525*	10	23	1.90	1.70	1.50
BPA-1526*	11	17	2.40	2.10	1.90
BPA-1527*	12	12	1.90	1.70	1.50
BPA-1528*	12	17	2.20	2.00	1.80
BPA-1598	13	17	2.40	2.10	1.90
BPA-1529*	14	17	2.40	2.20	2.00
BPA-1530*	15	17	3.20	2.90	2.60
BPA-1531*	17	17	3.20	2.90	2.60

OPEN-END CHASSIS

Primarily intended to be used with the various sizes and styles of Bud metal cabinets, these chassis are ideal for any type of small built-up unit such as a record amplifier, code oscillator, etc. U-shaped construction is used with ends folded over ¾" for additional strength. This unit is natural finish aluminum alloy 5005 H-14.

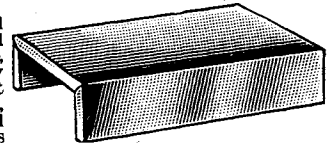

Bud No.	Size, Inches D. x W. x H.	Fits Cabinet Number	Net Each, Lots of		
			1-24	25-49	50-99
CB-38	7 x 6 x 2	C-1584	\$1.20	\$1.10	\$.90
CB-30	5 x 7 x 1½	C-973	1.20	1.10	.90
CB-41	7 x 7 x 1½	C-973	1.40	1.30	1.10
CB-39	7 x 8 x 2	C-1585	1.40	1.30	1.10
CB-996	5½ x 9 x 1½	C-993	1.40	1.20	1.10
CB-976	7½ x 9 x 1½	C-999, CD-1481	1.70	1.50	1.40
CB-40	7 x 10 x 2	C-1586	1.60	1.40	1.30
CB-997	7 x 11 x 1½	C-994, CD-1482	1.60	1.40	1.30
CB-998	7 x 13 x 1½	C-995, CD-1483	1.90	1.70	1.55

MINIATURE ALUMINUM CHASSIS



Small versions of above with ¼" flange on bottom for bottom plate or fastening. Ideal for limited space uses. Natural finish.

CB-1623	2½ x 2½ x 1¼	\$.40	\$.35	\$.32
CB-1624	1½ x 3½ x 1	CU-883	.50	.45	.40
CB-1625	3½ x 4½ x 2	C-1788	.60	.55	.50
CB-1626	2½ x 4½ x 1	CU-728	.60	.55	.50
CB-1627	3½ x 4½ x 1½	CU-729	.60	.55	.50
CB-1628	3 x 6½ x 1¼	C-1788	.70	.65	.55
CB-1629	5½ x 4½ x 1½	CU-1098	.70	.65	.55
CB-1617	4 x 3½ x 1	C-1606, C-1610	.50	.45	.40
CB-1618	4 x 4½ x 1	C-1607, C-1611	.60	.55	.50
CB-1619	4 x 5½ x 1	C-1608, C-1612	.70	.65	.55
CB-1620	4 x 6½ x 1	C-1609, C-1613	.70	.65	.55



Cabinet Hardware

BUD HANDLES

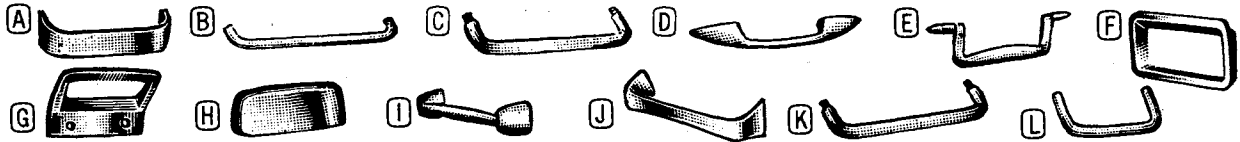

Fabricated from steel, brass or cast aluminum. Durable finish provides long wear and attractive appearance. Skin packed in pairs or bulk packed (priced singly) with all necessary mounting

hardware. Designed for rugged applications, they have unlimited use in electronic, electrical and other fields.

Bud No.	Fig.	Description	Net Per Pair, Lots of			Bulk Pack*: Net Each, Lots of		
			1-49	50-99	100-149	1-99	100-199	200-499
H-9100	A	1" x 1/4" chrome-plated solid brass; 4" x 1/2" mtg. ctrs.; 1" hand clearance; four 1/2" x 6-32 threaded screws	\$6.10	\$5.50	\$4.90	\$2.70	\$2.40	\$2.10
H-9101	A	Same, but 8" x 1/2" mtg. centers	9.40	8.50	7.50	4.30	3.90	3.50
H-9102	A	5/8" x 1/4" chrome-plated solid brass; 4" mtg. centers; 1" hand clearance; two 1/2" x 6-32 threaded screws	4.80	4.40	3.90	2.30	2.10	1.90
H-9103	A	Same, but has 6" mounting centers	5.60	5.00	4.50	2.70	2.40	2.10
H-9110	B	3/8" steel rod angular formed, chrome-plated; 6" mtg. ctrs.; 1 1/4" hand clearance; two 1/2" x 10-32 screws	4.30	3.90	3.50	1.70	1.55	1.35
H-9111	B	3/8" steel rod, chrome plated, 4" mtg. ctrs.; 1" hand clearance; two 1/2" x 10-32 threaded screws	2.30	2.10	1.90	1.10	1.00	.90
H-9112	B	6" mtg. center version of H-9111	2.70	2.40	2.20	1.20	1.10	.90
H-9113	B	8" mtg. center version of H-9111	3.00	2.70	2.40	1.30	1.20	1.05
H-9114	B	1/2" steel rod, chrome-plated; 8" mtg. centers; 1 1/2" hand clearance; two 1/2" x 1/4"-28 thd. screws	4.80	4.40	3.90	1.90	1.70	1.50
H-9115	C	3/8" steel rod, chrome-plated; 4" mtg. ctrs.; 1 1/4" hand clearance; two 1/4"-28 thd. nuts	3.70	3.30	2.90	1.50	1.40	1.20
H-9116	C	Same, but has 6" mtg. centers	4.10	3.70	3.30	1.70	1.55	1.35
H-9120	D	Silver-anodized die-cast aluminum; 4 3/4" inside, 5 3/4" outside mtg. centers; 1" hand clearance; four 1/2" x 6-32 threaded screws	5.40	4.90	4.30	2.50	2.30	2.00
H-9121	D	Same, except chrome plated alloy	6.80	6.10	5.40	3.20	2.90	2.60
H-9123	D	Similar to H-9120 but 4 1/2" mtg. centers; 1" hand clearance; two 1/2" x 10-32 thd. screws	3.50	3.20	2.80	1.60	1.40	1.30
H-9122	E	Silver-anodized die-cast aluminum; hinged on 1/4" steel pins with 2 hinge blocks; 6 1/2" inside, 7 1/2" outside mtg. centers; 1 1/2" hand clearance; four 3/8" x 10-32 threaded screws	9.20	8.30	7.30	4.30	3.90	3.50
H-9130	F	Silver-anodized die-cast aluminum; 3" mtg. centers; two 3/8" x 10-32 thd. screws; size 4 1/4" x 3"	7.50	6.80	6.00	3.60	3.30	2.90
H-9131	G	Silver-anodized die-cast aluminum; size, 4" x 2 1/4"; 2 1/4" mtg. centers; two 3/4" x 1/4"-28 thd. raised, counter-sunk screws and nuts	5.60	5.00	4.50	2.60	2.40	2.10
H-9140	H	Silver-anodized die-cast aluminum; 3 1/4" mtg. centers; 3/4" hand clearance; two 1/2" x 10-32 threaded screws	3.40	3.00	2.70	1.50	1.40	1.20
H-9150	I	Silver-anodized die-cast aluminum; 4" x 3/8" mtg. centers; 1 1/4" hand clearance; four 1/2" x 10-32 threaded screws	4.50	4.00	3.60	2.10	1.90	1.70
H-9151	J	Silver-anodized die-cast aluminum; 5 1/4" x 3/8" mtg. centers; 1 3/8" hand clearance; four 1/2" x 10-32 threaded screws	7.30	6.50	5.80	3.40	3.00	2.70
H-9152	J	Similar to above except 3 7/8" mtg. centers; 1 1/8" hand clearance; two 1/2" x 10-32 threaded screws	5.90	5.30	4.70	2.70	2.40	2.20
H-9160	K	Chrome-plated 3/8" steel rod; 3 1/2" mtg. centers; 1 1/4" hand clearance; two 1/4"-28 hex nuts	4.00	3.60	3.20	1.70	1.50	1.30
H-9161	K	Same, but with 5 1/4" mounting centers	4.50	4.10	3.60	1.70	1.55	1.35
H-9162	K	Same, but with 7" mounting centers	4.70	4.20	3.70	1.90	1.70	1.50
H-9163	K	Same, but with 8 3/4" mounting centers	4.80	4.40	3.90	1.90	1.70	1.50
H-9164	K	Same, but with 10 1/2" mounting centers	5.40	4.90	4.30	2.00	1.80	1.60
H-9165	K	Same, but with 12 1/2" mounting centers	5.90	5.30	4.70	2.20	2.00	1.80
H-9166	K	Chrome-plated 1/4" brass rod; 1 1/4" mtg. centers; 1" hand clearance; two 1/2" x 6-32 thd. screws	1.90	1.70	1.50	.90	.80	.70
H-9168	L	Same, but 3" mtg. centers; two 1/4" x 6-32 thd. screws	2.00	1.80	1.60	.90	.80	.70

*Number shown is for skin packed pairs. For bulk packed handles (priced singly), add suffix B to number (example: H-9100B).

SPEAKER ENCLOSURE HANDLES

Attach to any small housing or speaker enclosure to achieve portability. Made of aluminum tubing with etched finish.

Bud No.	Length, Inches	Mtg. Ctrs., Inches	Net Each, Lots of		
			1-49	50-99	100-149
UH-70A	5 3/8	4 3/8	\$3.50	\$4.45	\$4.43
UH-71A	3 3/4	3 1/4	.40	.36	.32

DOOR HANDLES, CATCH SETS

No. 9347: Fits flush with cabinet door; exposed parts chrome plated. Nos. 9196 and 9223: Lever-type handles are chrome plated with steel spindle and cam; fit Super Deluxe racks.

Bud No.	Description	Net Each, Lots of		
		1-49	50-99	100-149
H-9196	Non-locking handle	\$3.40	\$3.00	\$2.70
HL-9223	9196 with lock and key	6.30	5.60	5.00
H-9347	Flush-mount catch set	1.30	1.20	1.05

RUBBER FEET

No. F-7264A: Has recessed head with mounting stud; rubber portion 1 1/4" x 1 1/4" thick. No. F-8038: May be applied to any surface when glue coating is moistened with benzol base solution; 3/4" dia. x 1/8" thick. No. F-9653: Press-fit type for 1/4" hole.

Bud No.	Description	Net per 100, Lots of		
		1-49	50-99	100-149
F-7264A	High grade black rubber	\$10.00	\$9.00	\$8.00
F-8038**	Sponge rubber pad	2.40	2.16	1.92
F-9653	Top grade gray rubber	4.75	4.25	3.78

** Lots of 1-99, 100-199, 200-299

MOUNTING BRACKETS

Permit mounting of midget condensers, controls and other components in any position. Made of 3/4" wide, cadmium plated steel. Right-angle design with short side have two mounting holes; long side with 3/8" slot. No. AB-549 has additional 1/2" dia. hole centered on 3/8" slot.

Bud No.	Size	Wt. Per 100, Lbs.	Net Each, Lots of		
			1-99	100-199	200-299
AB-549	1 3/8" x 2"	2 1/4	\$11.20C	\$10.10C	\$8.95C
AB-550	1 3/8" x 2"	2	11.20C	10.10C	8.95C

ANGLES AND BRACKETS

Similar to above; made of 3/8" wide, nickel-plated brass. Right-angle design; Type 1 has single hole at end of each angle; Type 2 has two holes on long side; single hole on short side.

Bud No.	Size, Inches	Type	Wt. Per 100, Lbs.	Net Per 100, Lots of		
				1-99	100-199	200-299
AB-444	1/2" x 1/2"	1	1 1/2	\$ 5.20	\$ 4.70	\$ 4.15
AB-445	3/4" x 3/4"	1	1 1/2	5.85	5.25	4.70
AB-446	1" x 1"	1	2	7.50	6.75	6.00
AB-447	1 1/2" x 1 1/2"	1	2 1/2	10.00	9.00	8.00
AB-631	1" x 1 1/2"	1	1 1/2	6.35	5.70	5.10
AB-632	1 1/2" x 3/8"	1	1 1/2	7.85	7.05	6.30
AB-633	2" x 3/8"	2	1 1/2	10.35	9.30	8.30
AB-634	3" x 3/8"	2	2 1/2	12.70	11.40	10.15
AB-635	4" x 3/8"	2	3 3/4	15.90	14.30	12.70

DIAL LOCK

Dual purpose design functions as both dial lock and position indicator. Completely eliminates problems of dial slippage and accidental movement. Nickel-plated brass construction.

Bud No. DL-1947 Dial Lock—Net Each

1-99	100-199	200-299
.30	.27	.24



Imlok "Prototyper" Cabinets

INTERNAL EXTRUSIONS

Bud No.	Description	Net Each, Lots of		
		1-9	10-14	15-34
BI-2032	12 ft. long, 90° internal extrusion to fit BI-1028; has two panel retaining grooves; for unbraced spans up to 3 ft. long.	\$14.10	\$12.70	\$11.30
BI-2032-3	3 ft. length BI-2032	4.30	3.80	3.40
BI-2032-6	6 ft. length BI-2032	8.00	7.20	6.40
BI-2032-9	9 ft. length BI-2032	11.50	10.30	9.20
BI-2051	12 ft. long, 67½° internal extrusion to fit BI-1017 connector. For use in unbraced spans up to 3 ft.	13.50	12.20	10.80
BI-2051-3	3 ft. length BI-2051	4.10	3.60	3.20
BI-2051-6	6 ft. length BI-2051	7.85	7.05	6.30
BI-2051-9	9 ft. length BI-2051	11.00	9.90	8.80
BI-2091	12 ft. long, 60° internal extrusion; fits BI-1025 connector.	14.00	12.60	11.20
BI-2091-3	3 ft. length BI-2091	4.20	3.80	3.40
BI-2091-6	6 ft. length BI-2091	8.05	7.25	6.45
BI-2091-9	9 ft. length BI-2091	11.50	10.35	9.20
BI-2006	12 ft. long, 45° internal extrusion has two ½" flanges, one with panel-retaining groove. For flat-topped, sloping front cabinets.	12.00	10.80	9.60
BI-2006-3	3 ft. length BI-2006	3.60	3.30	2.90
BI-2006-6	6 ft. length BI-2006	6.90	6.20	5.50
BI-2006-9	9 ft. length BI-2006	9.90	8.90	7.90
BI-2071	12 ft. long, 30° internal extrusion; fits BI-1021 connector.	14.20	12.80	11.30
BI-2071-3	3 ft. length BI-2071	4.20	3.80	3.40
BI-2071-6	6 ft. length BI-2071	8.00	7.20	6.40
BI-2071-9	9 ft. length BI-2071	11.40	10.25	9.10
BI-2031	12 ft. long, 22½° internal extrusion; fits BI-1013 connector.	14.00	12.60	11.20
BI-2031-3	3 ft. length BI-2031	4.20	3.80	3.40
BI-2031-6	6 ft. length BI-2031	8.00	7.20	6.40
BI-2031-9	9 ft. length BI-2031	11.50	10.35	9.20

SPACER BAR AND TABLE-TOP EXTRUSIONS

BI-2008	12 ft. long, spacer bar extrusion used to subdivide panels or act as cross-bracing members.	\$12.80	\$11.50	\$10.30
BI-2008-3	3 ft. length BI-2008	3.80	3.40	3.10
BI-2008-6	6 ft. length BI-2008	7.30	6.50	5.80
BI-2008-9	9 ft. length BI-2008	10.50	9.40	8.40
BI-2009	12 ft. long, table-top extrusion for use at base of cabinet, as vertical member where double radius between cabinets is undesirable. Has flange with normal retaining groove; other is 1" deep to support table or bench top.	10.50	9.50	8.40
BI-2009-3	3 ft. length BI-2009	3.20	2.90	2.50
BI-2009-6	6 ft. length BI-2009	6.10	5.50	4.90
BI-2009-9	9 ft. length BI-2009	8.60	7.80	6.90

EXTERNAL SPACER BAR CONNECTORS

Bud No.	Description	Net Each, Lots of		
		1-14	15-24	25-34
BI-1011	This connector specially designed for use with 90° external heavy duty extrusion BI-2034. One leg fits this extrusion as well as all other 90° external extrusions. The other two legs fit BI-2008, 67½° external spacer bar connector; brace or sub-divide walls where BI-1016 is used at corners. One leg fits BI-2041; other two fit any spacer bar extrusion.	\$2.00	\$1.80	\$1.60
BI-1018	67½° external spacer bar connector; brace or sub-divide walls where BI-1016 is used at corners. One leg fits BI-2041; other two fit any spacer bar extrusion.	2.00	1.80	1.60
BI-1026	60° version of BI-1018. One leg fits BI-2081; other two fit any spacer bar extrusion.	2.00	1.80	1.60
BI-1007	45° version of BI-1018. One leg fits BI-2005, BI-2015 or BI-2025; other two fit any spacer bar extrusion.	2.40	2.20	1.90
BI-1022	30° version of BI-1018. One leg fits BI-2061 extrusion; other two fit any spacer bar extrusion.	2.00	1.80	1.60
BI-1014	22½° version of BI-1018. One leg fits BI-2021; other two fit any spacer bar extrusion.	2.00	1.80	1.60

INTERNAL CORNER CONNECTORS

BI-1028	90° internal connector gives an included angle of 90° for L-shaped structures. One leg fits BI-2032 extrusion; other two fit any 90° external extrusion, (BI-2004, BI-2014, BI-2024, BI-2034, BI-2054).	\$2.00	\$1.80	\$1.60
BI-1017	67½° internal connector used where two walls are to meet to include a 67½° angle. One leg fits BI-2051 extrusion; other two fit any 90° external extrusion.	2.00	1.80	1.60
BI-1025	60° version of BI-1017. One leg fits BI-2091; other two fit any 90° external extrusion.	2.00	1.80	1.60
BI-1006	45° version of BI-1017. One leg fits BI-2006; other two fit any 90° external extrusion. Helps make flat top, sloping front structure.	2.40	2.20	1.90
BI-1021	30° version of BI-1017. One leg fits BI-2071; other two fit any 90° external extrusion.	2.00	1.80	1.60
BI-1013	22½° version of BI-1017. One leg fits BI-2031; other two fit any 90° external extrusion.	2.00	1.80	1.60

INTERNAL SPACER BAR CONNECTORS

BI-1029	90° internal spacer connector permits bracing or sub-division of spans of BI-2032. One leg fits BI-2032 internal extrusion; other two fit BI-2008 spacer bar extrusion.	2.00	1.80	1.60
BI-1019	67½° internal spacer bar connector is companion to BI-1017 for sub-dividing or cross-bracing. One leg fits BI-2051; other two fit any spacer bar extrusion.	2.00	1.80	1.60
BI-1027	60° version of BI-1019 above; companion for BI-1025. One leg fits BI-2091; other two fit any spacer bar extrusion.	2.30	2.10	1.85
BI-1010	45° version of BI-1019; companion for BI-1006. One leg fits BI-2006; other two fit any spacer bar extrusion.	2.00	1.80	1.60
BI-1023	30° version of BI-1019; companion to BI-1021. One leg fits BI-2071; other two fit any spacer bar extrusion.	1.70	1.55	1.35
BI-1015	22½° version of BI-1019; companion to BI-1013. One leg fits BI-2031; other two fit any spacer bar extrusion.	2.00	1.80	1.60

CUTTING JIGS

Bud No.	Description	Net Each, Lots of		
		1-14	15-24	25-34
BI-3003	90° cutting jig permits easy mitering of any 90° external extrusion. Makes assembly quick, easy.	\$15.20	\$13.60	\$12.10
BI-3002	45° cutting jig for mitering any 45° external extrusion.	20.30	18.20	16.20



BI-1001



BI-1003

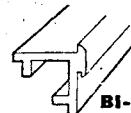

BI-2009

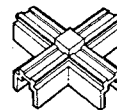

BI-1009

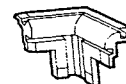

BI-1028

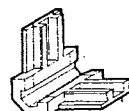

BI-1029

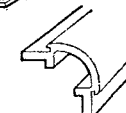

BI-2004

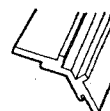

BI-2006

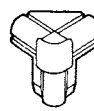

BI-1005

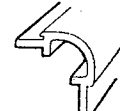

BI-2024

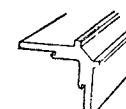

BI-2032

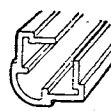

BI-2034

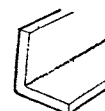

BI-2044

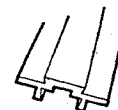

BI-2008

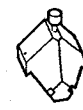

BI-3003



BI-4601



Slimline 901 Imlok®

CONNECTORS

Bud No.	Description	Net Each, Lots of		
		1-14	15-24	25-34
BIM. 902	90° external standard connector used for normal 90° external corners and for joining spacer bars to the various 90° external and bezel extrusions.	\$1.20	\$1.10	\$1.00
BIM. 901	90° external corner connector; a lighter duty model than BIM. 902; used with extrusions BIM. 801, BIM. 834, BIM. 835, BIM. 836 and BIM. 837; if one leg is removed use BIM. 818.	1.00	.90	.80
BIM. 90	90° external slotted connector replaces BIM. 902 if an unobstructed aperture is required on framework involving extrusions BIM. 802, BIM. 806, BIM. 810, BIM. 811 and BIM. 821.	2.10	1.90	1.70
BIM. 909	90° internal connector; extrusion BIM. 826 is fitted to one leg and the other two legs accept extrusions BIM. 802, BIM. 803, BIM. 806, BIM. 807 and BIM. 821.	1.80	1.60	1.50
BIM. 090	90° internal spacer bar connector enables spacer bars BIM. 810, BIM. 811 or BIM. 812 to be fitted to extrusion BIM. 826.	2.10	1.90	1.70
BIM. 990	90° cruciform connector; used to join spacer bars BIM. 810, BIM. 811, or BIM. 812 where they cross to divide large panel areas.	2.10	1.90	1.70
BIM. 915	15° external corner connector; used for 15° external corners when two 90° frame extrusions are BIM. 803 or BIM. 845; extrusion BIM. 601 is always fitted to third leg.	1.70	1.60	1.40
BIM. 91	15° external slotted connector replaces BIM. 915 when 90° extrusions are BIM. 802, BIM. 806, BIM. 807 or BIM. 821; also used for joining spacer bars to BIM. 601.	2.10	1.90	1.70
BIM. 951	15° internal corner connector for all 15° internal corner applications; extrusion BIM. 611 is fitted to one leg; the other two will accept BIM. 802, BIM. 803, BIM. 806, BIM. 807 or BIM. 821.	1.70	1.60	1.40
BIM. 015	15° internal spacer bar connector permits spacer bars BIM. 810, BIM. 811 or BIM. 812 to be fitted to 15° internal extrusion BIM. 611.	2.10	1.90	1.70
BIM. 945	45° external corner connector; used for 45° external corners when extrusion is either BIM. 803 or BIM. 845; must be used with extrusion BIM. 641.	1.70	1.60	1.40
BIM. 94	45° external slotted connector replaces BIM. 945 when extrusions are either BIM. 802, BIM. 806, BIM. 807 or BIM. 821; also used for joining spacer bars to extrusion BIM. 641.	2.10	1.90	1.70
BIM. 954	45° internal corner connector; used for all 45° internal corners with extrusion BIM. 651; two legs accept 90° extrusions.	2.10	1.90	1.70
BIM. 045	45° internal spacer bar connector; used in fitting spacer bars to extrusion BIM. 651.	2.10	1.90	1.70
BIM. 975	75° external corner connector; used for 75° external corners with either 90° extrusion BIM. 803 or BIM. 845; BIM. 681 is always the third extrusion.	2.10	1.90	1.70
BIM. 97	75° external slotted connector; used to replace BIM. 975 when 90° extrusions are BIM. 802, BIM. 806, BIM. 807 or BIM. 821; connects spacer bars to extrusion BIM. 681.	1.70	1.60	1.40
BIM. 957	75° internal corner connector; used for all 75° internal corners with extrusion BIM. 691 fitted to one leg; use BIM. 802, BIM. 803, BIM. 806, BIM. 807 or BIM. 821 on other two legs.	2.10	1.90	1.70
BIM. 075	75° internal spacer bar connector enables spacer bars to be fitted to extrusion BIM. 691.	1.80	1.60	1.50
BIM. 750	75° acute external corner connector; used with extrusions BIM. 803 or BIM. 845; always used with extrusion BIM. 682.	2.10	1.90	1.70
BIM. 75	75° acute external slotted connector replaces BIM. 750 when extrusions BIM. 802, BIM. 806, BIM. 807 or BIM. 821 are used; also joins spacer bars to extrusion BIM. 682.	2.10	1.90	1.70

ACCESSORIES

Bud No.	Description	Net Each, Lots of		
		1-14	15-24	25-34
BIM. 103	Tapped block 6-32 threaded for mounting panels with extrusions BIM. 801 and BIM. 810.	\$.90	\$.80	\$.70
BIM. 104	Tapped block 10-32 threaded for mounting panels with extrusions BIM. 801 and BIM. 810.	.90	.80	.70
BIM. 106	Adjustable mounting bracket may be positioned as required to allow standard rack panel mountings on extrusions BIM. 801, BIM. 802, BIM. 803, BIM. 806, BIM. 807, BIM. 810, BIM. 811, BIM. 812, BIM. 821 and BIM. 845.	.40	.38	.35
BIM. 108	90° external corner gusset may be fitted to connectors BIM. 90 and BIM. 901.	.30	.28	.25
BIM. 109L	Lift-off butt hinge, left hand; chrome plated.	1.50	1.40	1.20
BIM. 109R	Lift-off butt hinge, right hand; chrome plated.	1.50	1.40	1.20
BIM. 134	45° corner gusset with 3 drilled holes (one .44", two .22") plus 4 holes tapped 12-24. For 90° corners only.	1.20	1.10	1.00
BIM. 135	45° corner gusset with 3 drilled holes (one .44", two .22").	1.10	1.00	.90
BIM. 136	23°-67° corner gusset drilled and tapped for use in any 90° corner; may be fitted after framework is completed.	1.10	1.00	.95

Bud No.	Description	Net Each, Lots of		
		1-9	10-14	15-19
BIM. 110	Open hinge, cadmium plated steel, undrilled, 4-ft. length for use with deep recess extrusions.	\$ 4.70	\$ 4.20	\$ 3.80
BIM. 130	Pivot hinge block and collar designed for use with either flush fitting or recessed doors; chrome plated.	1.90	1.70	1.50
BIM. 137	Bracing extrusion for internal bracing at any desired angle; particularly useful for strengthening non-90° corners.	10.10	9.10	8.10

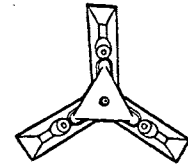

BIM. 902

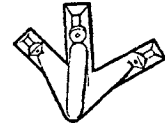

BIM. 909

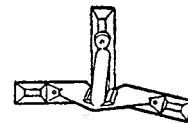

BIM. 915

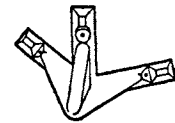

BIM. 954

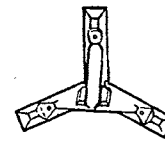

BIM. 975

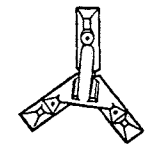

BIM. 750

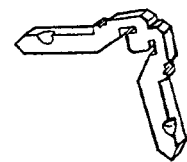

BIM. 075

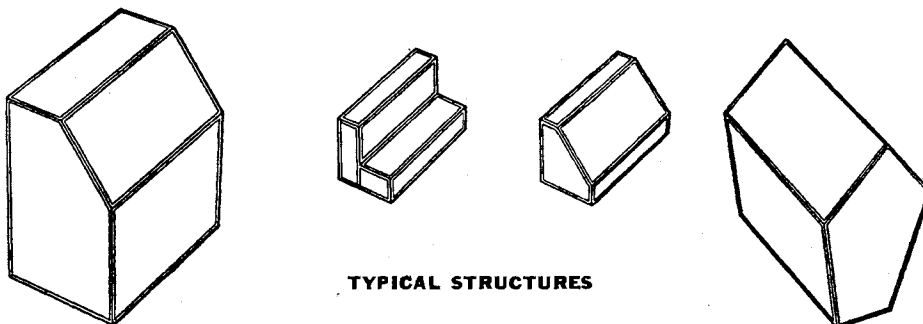

TYPICAL STRUCTURES



Specially Fabricated Products

Consult your local Authorized Bud Distributor about your special enclosure problems. In reality, he is an extension of the factory's engineering department and can recommend the proper design and size for your equipment. His advice will save you time and money.

These are the services we perform:

1. Modification of our standard products.
2. Specially punched panels, chassis and boxes.
3. Standard construction employing steel or aluminum.
4. Special construction employing the Imlok system of aluminum extrusions, castings and sheets.
5. Original designs based upon your circuitry requirements.

Bud can supply you with a pilot model or a production run. Our more than 35 years of experience in the electronic industry assures you that we can readily understand your problems and solve them economically. 112,000 sq. ft. of completely integrated plant facilities — from engineering, tooling and fabrication to painting, assembly and packaging insure quick delivery. Almost every type of industry, branches of the armed forces, the Space Agency and the Nuclear Energy Commission use Bud products.

Whenever a special sheet metal enclosure is required, call in your local Authorized Bud Distributor. He is anxious to cooperate with you.

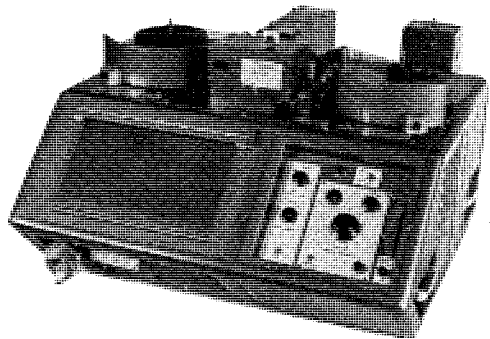
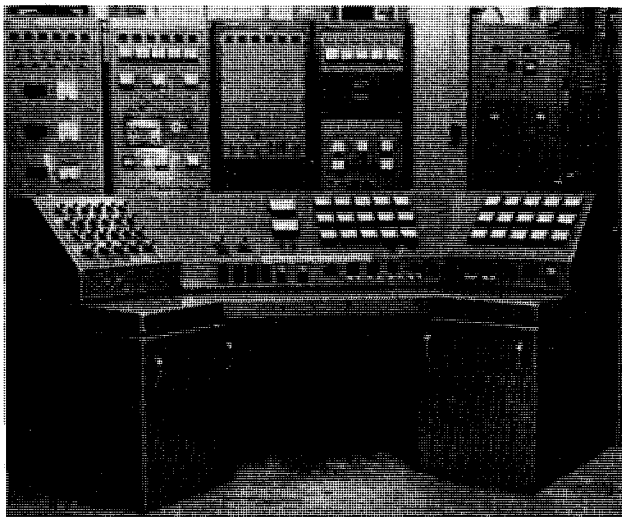
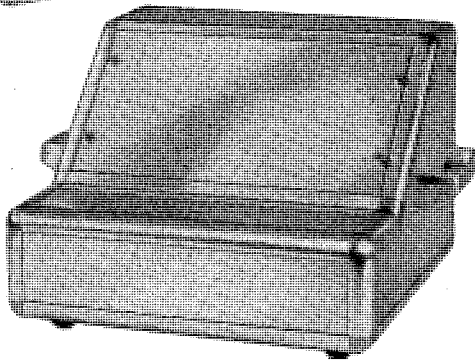
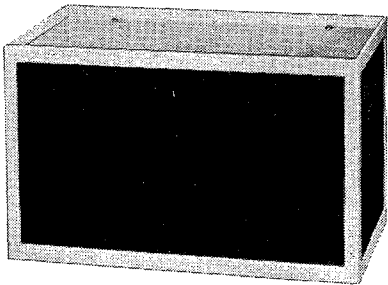
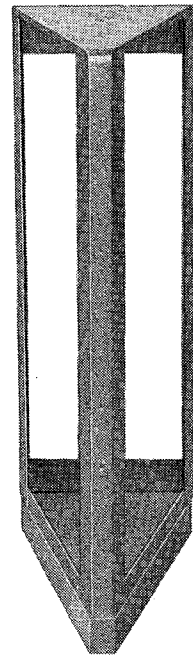
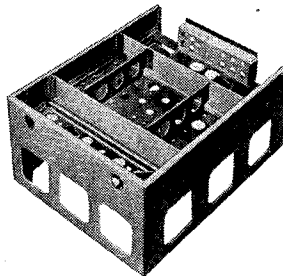
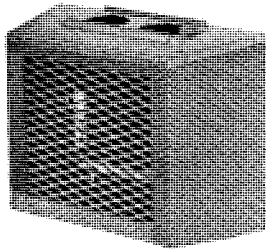
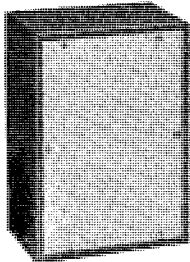



CALIFORNIA CHASSIS CO.

SLOPE-FRONT, ALL STEEL WELDED CABINET (AWCM)

The California Chassis AWCM-42 Slope-Front Cabinet offers the ultimate in clean, functional lines and versatility in construction. It is available as a finished "package" or with separate components to satisfy your specific requirements ■ The basic all-steel welded rack is open on all sides to simplify installation and permit adequate service access ■ Doors have chrome key locking handles and special spring-loaded hinge pins for rapid removal ■ Side panels are removable without use of tools ■ Panel slope is 34° and provides a full 14 x 19½ inch area for meters, dials and controls ■ Holes are provided in bottom for floor mounting ■ Panel mounting angles are drilled and tapped 10-32 with universal spacing to accept all standard panels ■ The AWCM-42 is attractively finished with our special low-maintenance, scratch resistant silver-grey hammertone formula. Other finishes optional. The AWCM-42 is shipped complete with two side panels and locking rear door.

	Width	Height	Depth
AWCM-42	23 in.	48 in.	23 in.
Slope panel opening	19½ in.	14 in.	—
Front panel opening	19½ in.	28 in.	—
Rear Door opening	19½ in.	42 in.	—
Front panel slope: 34°			

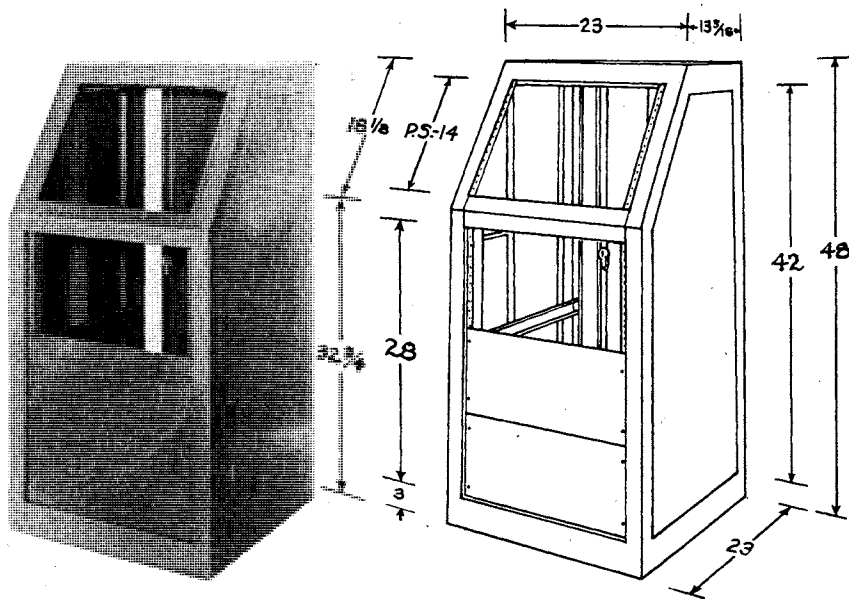

ALL STEEL WELDED CABINET

This flexible series is available as a complete package or as separate components to satisfy individual requirements — designated as follows: Solid top (AWC); or open top (AWCO) in styles as shown below. Doors and sides are interchangeable. Doors have chrome handles — spring-loaded hinge pins provide rapid removal and servicing without use of tools. Panel mounting angles are tapped 10-32 with universal spacing for all standard panels. Louvers available on sides and doors. Standard finish — gray hammertone; other finishes optional.

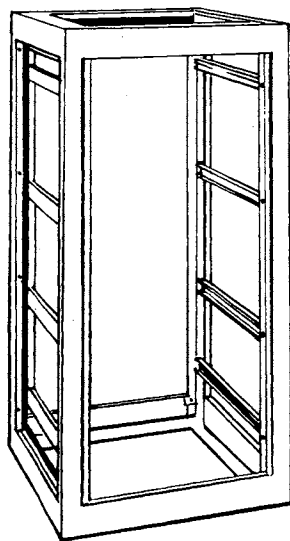
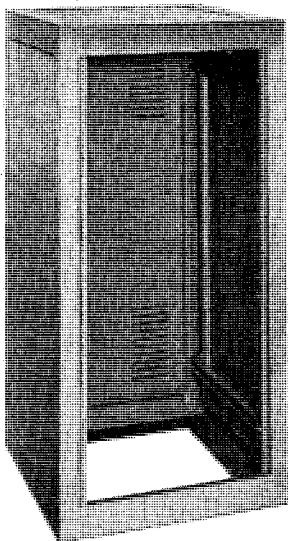

No.	Description	Price	No.	Description	Price
AWC-42	—Assembly consisting of 42 inch panel space frame, with solid top, two sides, one door, one pair panel mounting angles and all necessary hardware	\$127.95	AWCS-42	—Side panel—42" high.....each	\$15.10
AWCO-42	(REMOVABLE TOP)	134.77	AWCS-61	—Side panel—61¼" high.....each	18.17
AWC-61	—Same as above except 61¼ inch panel space frame	156.50	AWCS-70	—Side panel—70" high.....each	20.22
AWCO-61	(REMOVABLE TOP)	163.32	AWCS-77	—Side panel—77" high.....each	23.29
AWC-70	—Same as above except 70 inch panel space frame	169.92	AWCD-42	—Door—42" high.....	18.38
AWCO-70	(REMOVABLE TOP)	176.74	AWCD-61	—Door—61¼" high.....	21.45
AWC-77	—Same as above except 77 inch panel space frame	196.53	AWCD-70	—Door—70" high.....	24.52
AWCO-77	(REMOVABLE TOP)	203.35	AWCD-77	—Door—77" high.....	27.59
AWCF-42	—Basic frame only—42 inch panel space—solid top	61.83	AWCT-42	—Top.....	7.22
AWCOF-42	—Basic frame only—open top	64.33	AWCT-61	—Top.....	7.22
AWCF-61	—Basic frame only—61¼ inch panel space—solid top	77.18	AWCT-70	—Top.....	7.22
AWCOF-61	—Basic frame only—open top	79.68	AWCT-77	—Top.....	7.22
AWCF-70	—Basic frame only—70 inch panel space—solid top	82.29	AWCP-42	—Panel mounting angles—42 long.....pair	10.24
AWCOF-70	—Basic frame only—open top	84.79	AWCP-61	—Panel mounting angles—61¼ long.....pair	14.43
AWCF-77	—Basic frame only—77 inch panel space—solid top	97.66	AWCP-70	—Panel mounting angles—70 long.....pair	15.46
AWCOF-77	—Basic frame only—open top	100.16	AWCP-77	—Panel mounting angles—77 long.....pair	17.51
			AWCZ-42	—Vertical supports for chassis brackets.....set of four	14.64
			AWCZ-61	—Vertical supports for chassis brackets.....set of four	16.64
			AWCZ-70	—Vertical supports for chassis brackets.....set of four	17.71
			AWCZ-77	—Vertical supports for chassis brackets.....set of four	19.87

CALIFORNIA CHASSIS CO.

CABINET RACKS

These racks are made entirely of 16 gauge steel except for the heavy steel panel supports. They have universal spacing, the holes being tapped for 10/32" screws. Panels fit into a recess so that the edges do not show. Mounting plate on bottom of rack permits casters to be fastened directly to base for easy mobility. Casters are not included in price of rack but may be ordered separately. No. TC-10.

All standard 19" panels RETMA, Western Electric or Amateur will fit these racks. Double rows of louvres side and rear give ample ventilation.

Gray hammertone finish.

NO. CAT.	PANEL SPACE	HEIGHT	WIDTH		DEPTH INSIDE	SHIP. WT. LBS.	NET PRICE
			DEPTH	CLEAR.			
CR-36	36 3/4	42	22	17	15 1/2	90	53.23
CR-42	42	47 1/4	22	17	15 1/2	96	59.99
CR-61	61 1/4	66 1/2	22	17	15 1/2	120	75.74
CR-77	77	82 1/4	22	17	15 1/2	145	90.08
CRD-36	36 3/4	42	22	24	22 1/2	99	68.44
CRD-42	42	47 1/4	22	24	22 1/2	105	81.04
CRD-61	61 1/4	66 1/2	22	24	22 1/2	133	97.05
CRD-77	77	82 1/4	22	24	22 1/2	160	116.66

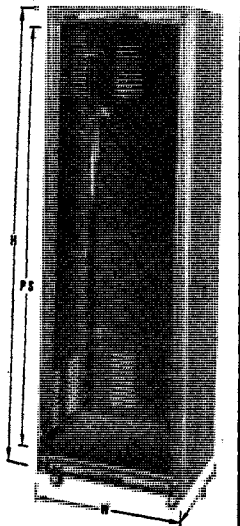
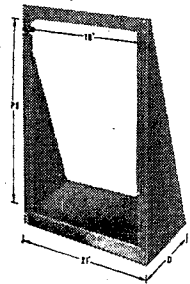

DOR SERIES

This open rack is made of 16 gauge steel. It is useful where the larger, heavier floor model is not necessary.

Mounting holes are on universal centers tapped 10/32" Gray hammertone finish.

Cat. No.	Panel Space	Overall Height	Overall Width	Depth	Ship. Wt.	Net Price
DOR-21	21 x 19	25	21	12	18	9.89
DOR-28	28 x 19	32	21	12	19	12.21

DESK CABINET RACKS

This solid welded, rounded front, deluxe desk cabinet has a professional look as well as being a sturdy utility unit. Embossed feet are on all sizes to reduce marring.

Cabinets have universal punching, accommodating W. E.; RETMA; or Amateur notched panels. Unit is made from 16 ga. steel, having a 2" opening on bottom rear for ventilation in addition to side louvers.

The five smaller models have solid welded backs. The five larger models have a removable hinged rear door.

All models clear 14 1/2" inside depth — Outside width is 21 1/2". Gray hammertone.

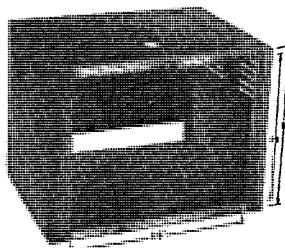

CATALOG NO.	PANEL SPACE	HEIGHT	SHPG. WT.	NET PRICE
DCR-7	7	8 1/8	25	18.43
DCR-8	8 3/4	10 1/8	27	18.81
DCR-10	10 1/2	12 1/8	29	21.50
DCR-12	12 1/4	14 1/8	31	22.59
DCR-14	14	15 1/8	33	24.62
DCR-17	17 1/2	19 1/8	37	29.46
DCR-21	21	22 1/8	39	31.53
DCR-26	26 1/4	28 1/8	47	33.78
DCR-31	31 1/2	33 1/8	51	35.88
DCR-35	35	36 1/8	58	37.87

OR SERIES

These open racks are constructed so the uppermost panel mounts at the top of the 1/8" steel upright. There is no loss of space at the top. Rack uprights are punched with universal spacing and tapped 10/32". Two brackets of 1/8" steel bind the uprights and a chassis like base into one solid unit. Gray hammertone.

CATALOG NO.	PANEL SPACE	OVERALL HEIGHT	SHPG. WT.	NET PRICE
OR-31	31 1/2	32 3/4	27	\$23.30
OR-36	36 3/4	38	28	23.52
OR-42	42	43 1/4	30	25.21
OR-61	61 1/4	62 1/2	37	26.05
OR-66	66 1/2	67 3/4	39	26.58
OR-71	71 3/4	73	41	27.52
OR-77	77	78 1/4	42	32.02

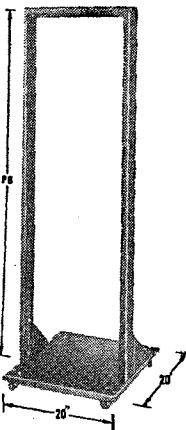

MULTI RACK SERIES

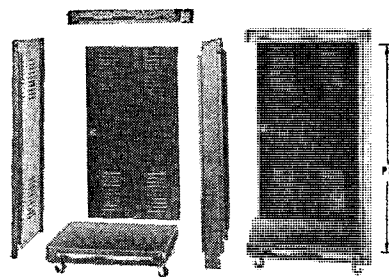

With this unit and a standard rack of the same size one can make a multiple rack or a series of connected racks. Each unit consists of a door, top, bottom, and a multi-rack connecting unit. This must have the same panel space as the unit it is to be used with. All hardware except casters is furnished. Colors to match mating units.

CATALOG NO.	PANEL SPACE	FITS RACK	SHPG. WT.	NFT PRICE
MR-36	36 3/4	CR-36	75	\$53.23
MR-42	42	CR-42	80	59.99
MR-61	61 1/4	CR-61	100	75.74
MR-77	77	CR-77	118	90.08
MRD-36	36 3/4	CRD-36	80	68.44
MRD-42	42	CRD-42	85	81.04
MRD-61	61 1/4	CRD-61	108	97.05
MRD-77	77	CRD-77	128	116.66

FRONT DOOR KIT

To convert CR, CRD, MR, MRD racks to Front Door type, formed of 16 gauge steel 1 3/4" deep to clear handles, knobs, etc. All corners seam welded and ground smooth. Supplied with locking handle with same keying as back door and all necessary hardware to mount on rack front. Finish grey hammertone.

Cat. No.	Price	Cat. No.	Price
FD-36	\$22.08	FD-61	\$32.66
FD-42	26.70	FD-77	39.54

MINIATURE CABINET RACKS

The MCR combines stylized function and compactness for desk-top use. Available in three sizes. Accepts standard relay rack panels and "PC" chassis units. Attractive grey hammertone with chrome trim.

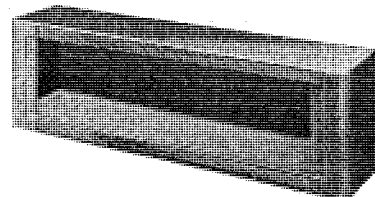

MCR-12 CABINET	— Panel space 19" x 5 1/4"	\$14.61
MCR-13 CABINET	— Panel space 19" x 7"	14.92
MCR-14 CABINET	— Panel space 19" x 8 3/4"	15.22

All above items available in gray hammertone finish. Other finishes available on special order. Contact factory for special finish prices.

All MCR units have embossed feet to protect desk tops.

TYPE	WIDTH	PANEL SPACE	DEPTH	HEIGHT	WT.
MCR-12	21 5/8	19 x 5 1/4	6 1/8	7 1/8	11 1/2 lb.
MCR-13	21 5/8	19 x 7	6 1/8	8"	12 1/2 lb.
MCR-14	21 5/8	19 x 8 3/4	6 1/8	10 5/8	13 1/2 lb.

LOW TEMPERATURE CABINETS

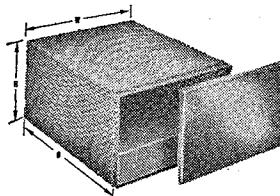

This cabinet made of perforated metal with 3/32 holes on 5/32 centers, solves most thermal problems. It is a real space saver, the chassis being almost the size of the cabinet.

Chassis is .063 aluminum and bolts to the rear panel which is welded to the perforated screen. Rear steel panel has rectangular hole in it to allow access to connectors in chassis. Front panel has no screws but is held on by control knobs mounted in chassis. Gray hammertone.

Chassis and front are one piece when unit is complete and can be easily removed yet cabinet chassis and front panel are solidly held together.

Catalog Number	Cabinet Size			Front Panel	Chassis Size	Hole in Rear Panel	Net Price
	H	W	D				
LTC-463	4 1/2	7 3/4	9 3/4	4 1/2 x 7 1/4	6 1/8 x 8 1/4 x 1 1/2	7/8 x 4	10.24
LTC-464	4 1/2	9 3/4	7 3/4	4 1/2 x 9 3/4	8 1/8 x 6 1/4 x 1 1/2	7/8 x 5	10.24
LTC-469	5 1/4	8 3/4	11 1/8	5 5/8 x 8 3/4	8 1/8 x 10 1/4 x 2	1 1/2 x 5	11.92
LTC-470	5 1/4	11 1/8	8 1/8	5 5/8 x 11 1/8	10 1/8 x 8 1/8 x 2	1 1/2 x 6	11.92
LTC-472	9 1/2	16 1/4	11 1/8	9 1/2 x 16 1/4	11 x 16 x 3	2 x 8	19.04
LTC-474	12	17 1/4	12 1/8	12 x 17 1/4	12 x 17 x 4	2 1/2 x 12	22.21

CALIFORNIA CHASSIS COMPANY

"ALL PRICES SUBJECT TO CHANGE W/O NOTICE"

CALIFORNIA CHASSIS CO.

STANDARD ALUMINUM CHASSIS—All chassis are stamped and formed from one piece of material. All four corners welded and sides flanged to accommodate bottom plates.

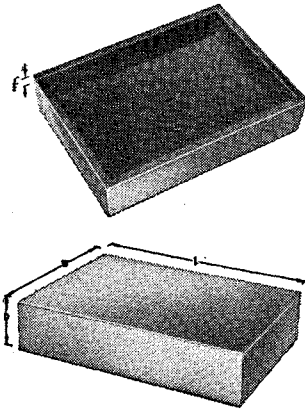

Aluminum	W	L	D	Gauge	App. Net		Aluminum	W	L	D	Gauge	App. Net		Aluminum	W	L	D	Gauge	App. Net	
					Wt.	Price						Wt.	Price						Wt.	Price
A-134	2 1/2	x 4	x 1	18	1/4	1.15	A-151	6	x 14	x 3	18	1	2.82	A-141	10	x 17	x 5	14	3/4	8.01
A-135	3 1/2	x 4	x 1	18	1/4	1.25	A-114	7	x 13	x 2	18	3/4	1.92	A-146	11	x 17	x 2	16	1 1/2	3.80
A-136	3 1/2	x 5	x 1	18	1/4	1.25	A-139	5	x 13	x 3	18	3/4	2.09	A-128	11	x 17	x 3	14	2 1/2	4.78
A-137	4	x 6	x 1 1/2	18	1/4	1.39	A-107	8	x 12	x 2 1/2	18	1	2.84	A-123	12	x 17	x 2	14	2 1/4	4.32
A-155	4	x 6	x 2	18	1/4	1.57	A-117	7	x 12	x 3	18	1	2.36	A-125	12	x 17	x 3	14	2 1/2	5.03
A-149	4	x 6	x 3	18	1/4	1.57	A-124	8	x 12	x 3	18	1	2.61	A-126	13	x 17	x 2	14	2 1/2	4.51
A-138	4	x 5	x 2	18	3/8	1.42	A-108	10	x 12	x 3	18	1 1/4	3.01	A-111	13	x 17	x 3	14	2 3/4	4.97
A-121	5 1/2	x 5 1/2	x 1	18	1/4	1.40	A-129	12	x 12	x 3	18	1 1/2	3.36	A-112	13	x 17	x 4	14	3 1/4	6.66
A-101	5	x 7	x 2	18	3/8	1.25	A-115	10	x 14	x 3	18	1 1/4	3.16	A-142	13	x 17	x 5	14	3 1/2	8.70
A-150	5	x 7	x 3	18	3/8	1.66	A-130	7	x 15	x 3	18	1 1/4	2.97	A-156	15	x 17	x 3	14	3 1/2	6.28
A-147	4	x 8	x 2	18	3/8	1.67	A-125	9	x 15	x 3	18	1 1/2	3.54	A-133	14	x 17	x 3	14	3 1/4	6.09
A-119	4 1/2	x 8	x 1 1/2	18	3/8	1.35	A-118	4	x 17	x 3	18	1	2.69	A-131	15	x 17	x 4	14	3 3/4	8.62
A-122	5	x 9	x 1 1/2	18	3/8	1.43	A-145	6	x 17	x 3	18	1 1/4	2.94	A-148	15	x 17	x 6	14	4	11.67
A-102	5	x 9	x 2 1/2	18	3/8	1.92	A-144	7	x 17	x 2	18	1	2.88	A-132	10	x 23	x 3	16	2 1/2	5.40
A-120	6	x 8	x 2	18	3/4	1.72	A-152	7	x 17	x 3	18	1 1/2	3.16	A-154	17	x 17	x 3	16	2 1/2	6.89
A-103	5	x 10	x 3	18	1/2	1.87	A-109	8	x 17	x 2	18	1 1/2	2.97	A-143	17	x 17	x 4	14	4 1/4	10.24
A-104	7	x 7	x 2	18	1/2	1.57	A-116	8	x 17	x 3	16	1 1/2	3.46	ENTIRE LINE OF CHASSIS DUPLICATED IN STEEL. USE PREFIX "C" INSTEAD OF "A" FOR ZINC STEEL CHASSIS						
A-105	7	x 9	x 2	18	3/4	1.67	A-140	10	x 17	x 2	16	2 1/4	3.46							
A-113	7	x 11	x 2	18	3/4	1.82	A-110	10	x 17	x 3	16	2 1/2	3.90							
A-106	8	x 10	x 2 1/2	18	1	2.43	A-153	10	x 17	x 4	16	3	5.14							

All aluminum chassis are etched finish. 1" and 1 1/2" chassis are flanged on long side only and contain no mounting holes.

CHASSIS BOTTOM PLATES

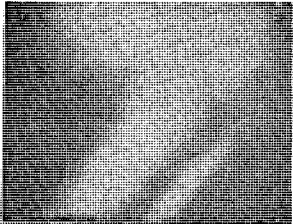

CATALOG NO.	SIZE	ALUM. WEIGHT	STEEL WEIGHT	Net Price	Steel Net Price
BP-105	7 x 9	1/4 lb.	3/4 lb.	1.03	1.03
BP-113	7 x 11	1/2 lb.	1 lb.	1.22	1.22
BP-106	8 x 10	1/4 lb.	3/4 lb.	1.20	1.20
BP-139	5 x 13	1/4 lb.	1/2 lb.	1.19	1.19
BP-114	7 x 13	1/2 lb.	1 lb.	1.38	1.38
BP-107	8 x 12	3/4 lb.	1 1/4 lb.	1.54	1.54
BP-117	7 x 12	1/2 lb.	1 lb.	1.25	1.25
BP-108	10 x 12	3/4 lb.	1 1/2 lb.	1.60	1.60
BP-129	12 x 12	3/4 lb.	2 lb.	1.74	1.74
BP-115	10 x 14	3/4 lb.	1 1/2 lb.	1.67	1.67
BP-130	7 x 15	1/2 lb.	1 lb.	1.47	1.47
BP-125	9 x 15	3/4 lb.	1 1/2 lb.	1.82	1.82
BP-118	4 x 17	1/2 lb.	1 lb.	1.19	1.19
BP-145	6 x 17	1/2 lb.	1 lb.	1.45	1.45
BP-144	7 x 17	1/2 lb.	1 lb.	1.40	1.40
BP-109	8 x 17	1/2 lb.	1 3/4 lb.	1.57	1.57
BP-110	10 x 17	3/4 lb.	2 1/2 lb.	1.64	1.64
BP-128	11 x 17	1 lb.	2 lb.	1.72	1.72
BP-123	12 x 17	1 1/4 lb.	3 lb.	2.09	2.09
BP-111	13 x 17	1 1/2 lb.	3 1/4 lb.	2.30	2.30
BP-133	14 x 17	1 1/2 lb.	3 1/2 lb.	2.49	2.49
BP-131	15 x 17	1 1/2 lb.	3 3/4 lb.	2.53	2.53
BP-143	17 x 17	2 lb.	5 lb.	3.07	3.07
BP-132	10 x 23	1 1/2 lb.	3 1/4 lb.	2.30	2.30

Steel bottom plates supplied in zinc plate aluminum is caustic etched. Actual size of BP is 1/8" under chassis size which is shown. This allows 1/8" of set back when attached to bottom of chassis.

RELAY RACK PANELS

Regular panels are made from 1/8 aluminum or steel material. Aluminum is 3003 H 14. Notching is Western Electric (WE). Finish gray hammertone, or unpainted. 24" wide panels are available on special order in both aluminum and steel.

CATALOG NO.	SIZE	ALUM. WEIGHT	STEEL WEIGHT	Net Price
BP-134	2 1/2 x 4 1/2	1 oz.	2 oz.	.60
BP-135	3 1/2 x 4 1/2	2 oz.	3/4 lb.	.65
BP-136	3 1/2 x 5 1/2	2 oz.	1/4 lb.	.70
BP-137	4 x 6	2 oz.	1/4 lb.	.73
BP-138	4 x 5	2 oz.	1/4 lb.	.68
BP-147	4 x 8	1/4 lb.	1/2 lb.	.87
BP-121	5 1/2 x 5 1/2	2 oz.	1/2 lb.	.79
BP-101	5 x 7	2 oz.	1/4 lb.	.79
BP-119	4 1/2 x 8	1/4 lb.	1/2 lb.	.91
BP-122	5 x 9	1/4 lb.	1/2 lb.	.95
BP-102	5 x 9 1/2	1/4 lb.	1/2 lb.	.93
BP-120	6 x 8	1/4 lb.	1/2 lb.	.95
BP-151	6 x 14	1/2 lb.	1 1/4 lb.	1.19
BP-103	5 x 10	1/4 lb.	1/2 lb.	.96
BP-104	7 x 7	1/4 lb.	1/2 lb.	1.02

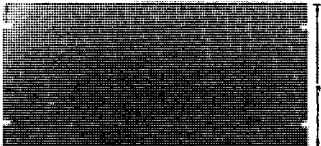

Notching

Western Electric	Height	Width	Wt. Alum.	Wt. Steel	Net Price
PW-10	1 3/4	19	1 1/2	1 1/4	1.22
PW-11	3 1/2	19	3/4	2 1/4	1.84
PW-12	5 1/4	19	1 1/4	4	2.32
PW-13	7	19	1 1/2	4 3/4	3.16
PW-14	8 3/4	19	2	5	4.01
PW-15	10 1/2	19	2 1/2	6 3/4	4.85
PW-16	12 1/4	19	3	8 3/4	5.12
PW-17	14	19	3 1/2	9 3/4	5.78
PW-18	15 3/4	19	4	10 3/4	6.61
PW-19	17 1/2	19	4 1/2	12	7.48
PW-20	19 1/4	19	5	13	8.35
PW-21	21	19	5 1/2	15 1/4	8.96
PW-22	24 1/2	19	6	18 1/2	10.55
PW-23	26 1/4	19	7	20 1/4	11.57

HARD ALUMINUM PANELS

Cat. No.	Height	Width	Wt.	Net Price	Cat. No.	Height	Width	Wt.	Net Price
PWHA-10	1 3/4	19	1/2	1.67	PWHA-16	12 1/4	19	3	5.92
PWHA-11	3 1/2	19	3/4	2.27	PWHA-17	14	19	3 1/2	6.78
PWHA-12	5 1/4	19	1 1/4	2.87	PWHA-18	15 3/4	19	4	7.39
PWHA-13	7	19	1 1/2	3.57	PWHA-19	17 1/2	19	4 1/2	8.01
PWHA-14	8 3/4	19	2 1/2	4.18	PWHA-20	19 1/4	19	5	8.62
PWHA-15	10 1/2	19	2 1/2	5.05	PWHA-21	21	19	5 1/2	9.83
					PWHA-22	24 1/2	19	6	11.96
					PWHA-23	26 1/4	19	7	12.18

PWHA series supplied in both 1/8 and 3/16 thickness in the 2024T3 alloy which is considered most suitable for drilling, machining or engraving. Panels are stocked in unpainted or gray hammertone. Other finishes available on request. All panels available in 24" width, on special order.

CALIFORNIA CHASSIS COMPANY

"ALL PRICES SUBJECT TO CHANGE W/O NOTICE"

CAT. NO.

STEEL	ALUM.	HEIGHT	WT. LBS.
PC-110	PCA-110	1 3/4	2
PC-111	PCA-111	3 1/2	2 3/4
PC-112	PCA-112	5 1/4	4
PC-113	PCA-113	7	4 1/2
PC-114	PCA-114	8 3/4	5 3/4
PC-115	PCA-115	10 1/2	6 3/4
PC-116	PCA-116	12 1/4	7 1/2
PC-117	PCA-117	14	8 1/2

Larger Sizes on Request

These are constructed so the sharp rib corner is cut to a 45° angle protecting the user's wrist. Side flange is 3/16" O.D. Height is 1/2" under size to permit proper mounting in rack.
PC Series is 16 GA—Zinc Plated Steel
PCA Series is 14 GA—Etched Aluminum

Cat. No.	Weight	Dimensions	Net Price
RT-1	5 1/4#	10x17x3	3.64
RT-2	7	13x17x3	4.53
RT-3	6 1/2	10x17x4	4.03
RT-4	9	13x17x4	5.02

Experimenters and the radio amateur when designing, will find it economical to use this type chassis, as the tops and bottoms may be easily replaced or discarded. Steel-Electro Zinc Only.

PANEL CHASSIS

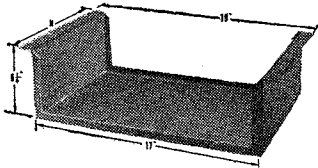

REMOVABLE TOP CHASSIS

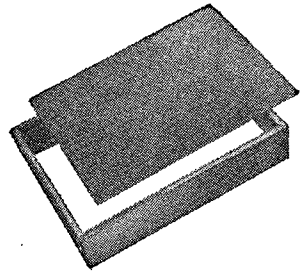

HINGED TOP SLOPING CABINET

This 20 gauge steel cabinet provides for a complete opening of top and front. Chassis may be attached to the face as there is no inside flange on the front. Bottom has embossed feet. Rear has opening for connectors. Gray hammertone finish.

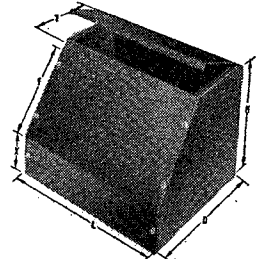

Catalog No.	H	L	D	X	F	T	Use Chassis Size	WT.	Net Price
HC-250	6 1/2	7 1/4	7 3/8	2 3/8	4 7/8	4 1/4	2 1/2	7x 6x2	3.78
HC-251	8	8 1/8	8	2 3/8	6 5/8	3 7/8	2 3/4	7x 7x2	4.56
HC-252	6 1/2	9 1/8	7 3/8	2 3/8	4 7/8	4 1/4	3	7x 8x2	4.30
HC-253	8	10 1/8	8	2 3/8	6 5/8	3 7/8	3	7x 9x2	5.07
HC-254	6 1/2	11 1/8	7 3/8	2 3/8	4 7/8	4 1/4	3 1/2	7x10x2	4.75
HC-255	8	14 1/8	8	2 3/8	6 5/8	3 7/8	4	7x13x2	5.49
HC-256	8	13 1/8	8 1/2	2 5/8	5 7/8	4 3/8	5 1/4	8x12x2 1/2	5.72
HC-257	9	18 1/8	8 1/8	3 5/8	6	4 1/4	7	7x17x3	7.86
HC-258	10	18 1/8	10 1/2	3 5/8	7 1/4	5 7/8	8 1/2	10x17x3	8.01

HEAVY DUTY ROLLER TRUCK

Formed of 12 gauge steel with seam welded corners. Supplied with heavy duty four inch swivel casters, mounting hardware, and drilled to fit the base of the "AWC" unit, offering ample stability to assemblies with a high center of gravity. Stocked in gray hammertone finish.

Cat. No. HDT

Price: \$51.34

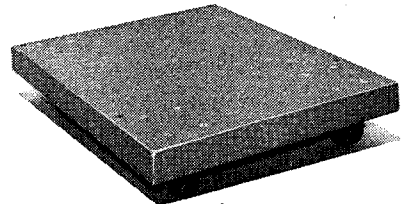



METAL WORKS INCORPORATED

STANDARD & CUSTOM DESIGNS

TURRETS FOR USE WITH "RB" SERIES — 19" PANELS

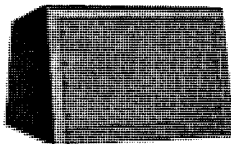

RBT-100 -100-1 -100-2

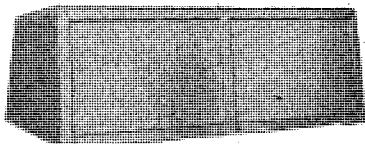

RBT-101 -101-1 -101-2

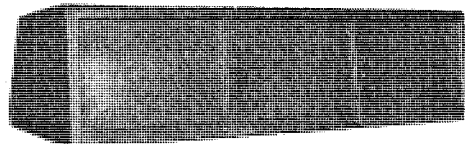

RBT-102 -102-1 -102-2

Turret console combinations are attractive instruments that accentuate any control room, office, etc., with their modern design.

Turrets featured in three different series and three sizes within each series offer a multiple of combinations that can be used in conjunction with our RB series of consoles. These combinations are readily adaptable to specialized applications in control equipment, testing facilities, sound systems, control units in language laboratories and many other applications in industry and entertainment services.

The standard turret which has 12 $\frac{1}{4}$ " panel space is especially designed for use on the consoles (RB-100, RB-101, RB-102) and on equipment tables (RB-80-1, RB-80-3, RB-90-1, RB-90-3), although it has a wide variety of other uses.

Panels included with turrets.

MATERIAL: 18 ga. CRS. **CONSTRUCTION:** 1. Spot weld throughout. 2. Corners brazed for added strength and finish appearance. 3. Removable rear panel for easy access to cabinet components. 4. Five $\frac{7}{8}$ " knockouts provided in rear of each panel space. These knockouts accommodate $\frac{1}{2}$ " conduit or pipe. 5. Two 6 $\frac{1}{8}$ " channel irons formed from 18 ga. CRS comprise the bottom of each turret. This type construction adds rigidity. 6. Front panel space has 10° slope. Rear of turrets has 10° slope. 7. Panel mounting holes are punched on standard Western Electric spacing. 8. 10-32 oval head screws, Tinnerman clips and finishing washers are furnished. 9. Panel spacing is recessed $\frac{1}{8}$ ". **FINISH:** Iron phosphate dipped and finished with Silver Gray Hammertone Bake On Enamel. Other colors available.

For front height add 2" to H dimension.

Model No.	W	H	WT	WB	PS	No. of Units	Shipping Weight
RBT-100	21 $\frac{3}{4}$	15 $\frac{3}{4}$	13 $\frac{1}{2}$	18	12 $\frac{1}{4}$	1	40 lbs.
RBT-101	42	15 $\frac{3}{4}$	13 $\frac{1}{2}$	18	12 $\frac{1}{4}$	2	65 lbs.
RBT-102	62 $\frac{1}{4}$	15 $\frac{3}{4}$	13 $\frac{1}{2}$	18	12 $\frac{1}{4}$	3	110 lbs.
RBT-100-1	21 $\frac{3}{4}$	17 $\frac{5}{8}$	12 $\frac{3}{4}$	18	14	1	50 lbs.
RBT-101-1	42	17 $\frac{5}{8}$	12 $\frac{3}{4}$	18	14	2	80 lbs.
RBT-102-1	62 $\frac{1}{4}$	17 $\frac{5}{8}$	12 $\frac{3}{4}$	18	14	3	130 lbs.
RBT-100-2	21 $\frac{3}{4}$	14	11 $\frac{5}{8}$	15 $\frac{7}{8}$	10 $\frac{1}{2}$	1	35 lbs.
RBT-101-2	42	14	11 $\frac{5}{8}$	15 $\frac{7}{8}$	10 $\frac{1}{2}$	2	60 lbs.
RBT-102-2	62 $\frac{1}{4}$	14	11 $\frac{5}{8}$	15 $\frac{7}{8}$	10 $\frac{1}{2}$	3	105 lbs.

INSTRUCTORS TURRETS FOR USE WITH "RB" SERIES — 19" PANELS

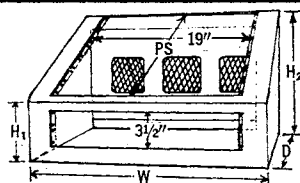
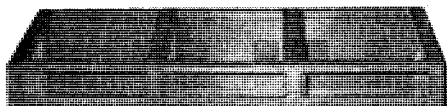

The T-103-1, 103-2, 103-3 series of turrets are especially designed for the language lab control unit ensemble. The low slope affords easy vision of the classroom as well as the equipment installed therein. These turrets are the result of considerable study in the field of audio education and are designed with the instructor, as well as maintenance personnel, in mind. Other applications of this turret are feasible where low slope aids vision of dials, meters and switch panel from a standing position. Takes panels:—ARP-123; RP-123; PM-163 or PA-163—lower space. Upper space:—ARP-1217; RP-1217; PM-1617 or PA-1617. Panels not furnished—order separately.

*** SPECIFICATIONS**
MATERIAL: 18 ga. CRS. **CONSTRUCTION:** 1. Spot weld throughout. 2. Corners brazed for added strength and finished appearance. 3. Removable rear panel for easy access to cabinet components. 4. Five $\frac{7}{8}$ " knockouts provided in rear of each panel space. These knockouts accommodate $\frac{1}{2}$ " conduit or pipe. 5. Two 6 $\frac{1}{8}$ " channel irons formed from 18 ga. CRS comprise the bottom of each turret. This construction adds rigidity. 6. Front panel, 3 $\frac{1}{2}$ " x 19", is made especially for our SP-1635 switch panel. 7. 17 $\frac{1}{2}$ " panel space in all bays provides ample space for most installations. 8. Panel mounting holes are punched on standard spacing. 9. 10-32 oval head screws, Tinnerman clips and finishing washers are furnished. 10. Panel spacing is recessed $\frac{1}{8}$ " to flush mount panel. **FINISH:** Iron phosphate dipped and finished with Silver Gray Hammertone Bake On Enamel. Other colors available.

Model No.	W	H1	H2	D	PS	Shipping Weight
T-103-1	22	6 $\frac{3}{8}$	10	20 $\frac{1}{2}$	17 $\frac{1}{2}$	40 lbs.
T-103-2	42 $\frac{3}{4}$	6 $\frac{3}{8}$	10	20 $\frac{1}{2}$	17 $\frac{1}{2}$	65 lbs.
T-103-3	63 $\frac{3}{8}$	6 $\frac{3}{8}$	10	20 $\frac{1}{2}$	17 $\frac{1}{2}$	95 lbs.

EQUIPMENT TABLES FOR SMALL OR LARGE DESK EQUIPMENT

Equipment tables are exclusively in the line. They are very handy when small equipment is being used. Models 80-1—80-3 have an overhanging top and plenty of knee room and are used for the smaller equipment. Models 90-1—90-3 are for larger table mounting equipment and have larger tops for more working area. Top is attractive linoleum with bright metal trim. Finish is modern silver gray hammertone.

Formica top can be supplied at additional cost.

Model No.	Width-in.	Height-in.	Depth-in.	Ship. Wt. Lbs.
RB-80-1	26	29	26	75
RB-80-2	36	29	26	95
RB-80-3	46 $\frac{1}{2}$	29	26	120
RB-90-1	53	29	30	120
RB-90-2	60	29	30	130
RB-90-3	70	29	30	150

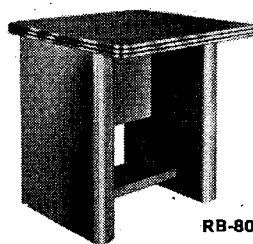

RB-80

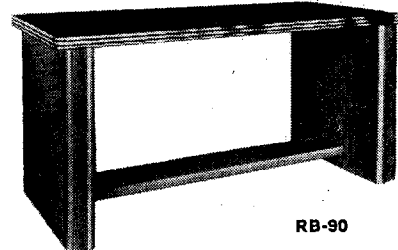

RB-90



METAL WORKS INCORPORATED

STANDARD & CUSTOM DESIGNS

CABINET CONSOLES

CR-1001 — SLOPE FRONT CONSOLE/RACK

Fixed Table Writing or Instrument Surface Available. Mounted to cabinet on support channels. Or a Sliding Writing Work Surface shelf is available. 17" television screen for testing equipment.

Lower panel area has sufficient space for control equipment.

Furnished without panels.

SPECIFICATIONS

MATERIAL: 16 ga. CRS except panel mounting angles and these are made of 11 ga. CRS. **CONSTRUCTION:** 1. Spot welded and brazed throughout. 2. Upper and lower panel mounting angles drilled and tapped to 10-32 thread and recessed $\frac{3}{16}$ ". 3. Ball corner brazed for added strength and finish appearance. 4. Rear panel removable, attached with Tinnerman clips and screws. 5. $1\frac{3}{4}$ " x 6" rectangle slot punched out of bottom and $1\frac{1}{2}$ " dia. hole in rear bottom for wiring inlet. 6. All reinforced channel iron on sides (3 ea. side) formed from 18 ga. CRS. 7. Channel support panel mounting angles and are fastened with $\frac{1}{4}$ x 20 binding head screws. 8. Upper panel space is on a 20° slope. 9. Two sets of four louvers each provided in top and bottom of rear panel. 10. Sides, front and back, and top, are formed with $\frac{5}{8}$ " radius. 11. Sides and top have a $\frac{1}{4}$ " flange turned in for added strength and smooth corners. 12. Four gussets — one on each corner, drilled for mounting $2\frac{1}{2}$ " rubber casters. 13. Casters are guaranteed to hold up 100 lbs. of weight each; total load capacity per console is 400 lbs. Heavy duty casters available at extra cost. 14. Cabinet weight — 105 lbs. 15. Shipping weight — 140 lbs. Shipped assembled. **FINISH:** Iron phosphate dipped and finished with Silver Gray Hammertone Bake On Enamel. Other colors available.

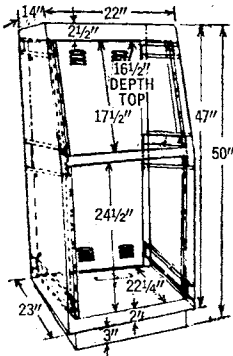

CR-1005 — LOW SLOPE FRONT CONSOLE/RACK

This console rack fits in well where height might be a problem yet offers a sufficient amount of panel space for most applications.

The base area contains a space for mounting a record player or an automatic turntable drawer. The control panel area has a 38° slope.

Rear of console rack has a removable louvered panel for easy servicing of the unit.

Furnished without drawer.

SPECIFICATIONS

MATERIAL: 16 ga. CRS. **CONSTRUCTION:** 1. Spot welded and brazed throughout. 2. Upper and lower panel mounting holes are punched to standard $1\frac{1}{4}$ " x $\frac{1}{2}$ " spacing and recessed $\frac{3}{16}$ ". 3. 10-32 Tinnerman clips, 10-32 oval head screws and finishing washers furnished. 4. Rear panel removable; attached with sheet metal screws. 5. Upper panel space has a 38° slope. 6. All corners are square — not rounded. 7. Cabinet strength is accomplished via formed parts eliminating channels for supporting members. 8. Louvers in fixed lower rear panel are reversed and faced up to help dissipate heat. 9. Shipping weight — 110 lbs. **FINISH:** Iron phosphate dipped and finished with Silver Gray Hammertone Bake On Enamel. Other colors available.

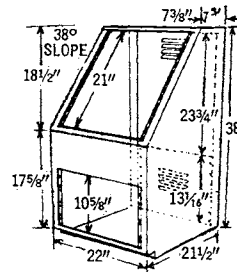
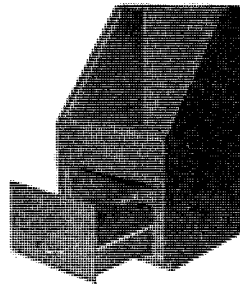

TRANSMITTER RACKS

Transmitter racks are made to accommodate 19", 24" and 30" rack panels. All models are furnished with front and rear doors.

Rear door opening provides easy access for equipment maintenance and installation. Front door furnishes full covering for dials, knobs, etc., mounted on panels. Front door is provided with a locking handle and rear door with a flush mounted lock and handle. This gives added protection where it is necessary to lock all components.

Slotted channels (3 per side) permit panel mounting angles to be recessed to full cabinet depth by simply tightening screws that hold each angle in place. Stainless steel panel mounting trim available. Order separately.

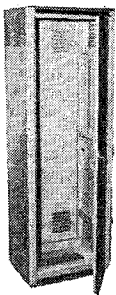

STR Standard

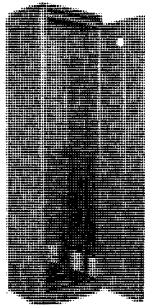

DTR Deluxe

SPECIFICATIONS

MATERIAL: 16 ga. CRS. Panel mounting angles 16 ga. CRS. Punch for Tinnerman Clips.

CONSTRUCTION:

- Louvers are provided in sides and rear door — four sets of six louvers each.
- Assembled with $\frac{1}{4}$ -20 bolts and nuts.
- Rear doors swing on rigid slip joint hinges. Front doors mounted on continuous hinges.
- All models furnished with stainless steel feature strip (colored) trim.
- Shipped knocked down unless otherwise requested.

FINISH: Iron phosphate dipped and finished with Silver Gray Hammertone Bake On Enamel. Other colors available.

STANDARD

Size	Model No.	Width-in.	Height-in.	Depth-in.	Panel Space-in.	Ship. Wt. Lbs.
For 19" Panels	STR-3675	23	42	18½	36¾	130
	STR-4200	23	47¼	18½	42	140
	STR-6125	23	66½	18½	61¼	150
	STR-7000	23	75¼	18½	70	155
	STR-7700	23	82¼	18½	77	160
For 24" Panels	STR-7024	27⅞	75¼	24	70	230
	STR-7724	27⅞	82¼	24	77	245
For 30" Panels	STR-7030	33⅞	75¼	24	70	250
	STR-7730	33⅞	82¼	24	77	265

DELUXE

Size	Model No.	Width-in.	Height-in.	Depth-in.	Panel Space-in.	Ship. Wt. Lbs.
For 19" Panels	DTR-3675	23	43⅞	18½	36¾	135
	DTR-4200	23	49⅞	18½	42	145
	DTR-6125	23	68¾	18½	61¼	155
	DTR-7000	23	77⅞	18½	70	160
	DTR-7700	23	84⅞	18½	77	160
For 24" Panels	DTR-7024	27⅞	77⅞	24	70	235
	DTR-7724	27⅞	84⅞	24	77	250
For 30" Panels	DTR-7030	33⅞	77⅞	24	70	255
	DTR-7730	33⅞	84⅞	24	77	270



METAL WORKS INCORPORATED

STANDARD & CUSTOM DESIGNS

AMPLIFIER CABINETS RACKS AND CONSOLES

For Recessed Application—TB Series

The recessed type amplifier enclosure has a grille cover. The door is equipped with a lock and piano hinge. The grille has an opening in the top part to permit hot air to escape. The back enclosure is designed to reflect the hot air toward the front of the cabinet so that it may escape. Adequate knockouts are placed in back for all wiring purposes. All TB's are furnished complete with TBG-1000 grille.

Surface Mounted—STB Series

Same size and panel space as TB listed above. Made for those applications where surface mounting is required. STB Panel Mtg. Angles furnished on request.

Heavy Duty—HTB Series

This cabinet offers adequate panel mounting space for most applications where the above listed TB's are too small. The rack portion of the cabinet is completely removable and mounted on 4 nylon ball bearing slides. The rack will support a maximum of 200 lbs. of weight. Maintenance convenience is offered in that the rack can be pulled forward to afford easy access to all components. Sturdy construction features of this cabinet are incorporated to give you quality in an economical unit. Doors are furnished with locking handles.

TB and STB

MATERIAL: 16 ga. CRS body
11 ga. CRS grille

CONSTRUCTION:

- All spot weld and braze construction.
- Panel mounting angles are supported in slotted bracket, adjustable 9½" front to rear, affording ample clearance for dials, tuning knobs, switches, etc., on TB only.
- 10½" of maximum panel space.
- Panel mounting angles are punched for use with Tinnerman clips.

FINISH: Iron phosphate dipped and finished with Silver Gray Hammertone Bake On Enamel. Other colors available.

HTB

MATERIAL: 16 ga. CRS cabinet
½" thick angle iron with 11 ga. bracing on rack.

CONSTRUCTION:

- Spot weld and electric arc construction on cabinet. Electric arc weld on removable rack.
- Panel mounting angles drilled and tapped for 10-32 thread.
- Nylon ball bearing slides used on rack.
- Complete panel mounting rack is removable.
- Front door made to provide adequate clearance space for dials, knobs, etc.

FINISH: Iron phosphate dipped and finished with Silver Gray Hammertone Bake On Enamel. Other colors available.

TB Series

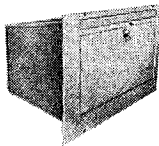

STB Series

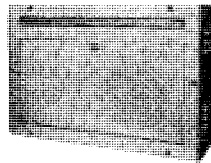

HTB Series

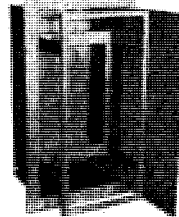

Model No.	Model	Height	Width	Depth	Ship. Wt.
TBG-1000	Grille	16"	23"		13 lbs.
TB -1200	Encl.	13"	20"	12"	35 lbs.
TB -1500	Encl.	13"	20"	15"	38 lbs.
TB -1800	Encl.	13"	20"	18"	41 lbs.

Model No.	Inside			Outside		
	H	W	D	H	W	D
STB-1200	14"	21"	11 1/8"	16"	23"	12"
STB-1500	14"	21"	14 1/8"	16"	23"	15"
STB-1800	14"	21"	17 1/8"	16"	23"	18"

Model No.	Height	Cabinet Only Width	Depth	Height	Removable Rack		P.S.	Ship. Wt.
					Width	Depth		
HTB-1575	19"	21 1/8"	18"	18 3/8"	20 3/8"	16"	15 3/8"	85
HTB-2800	31 1/4"	21 1/8"	18"	30 5/8"	20 3/8"	16"	28"	125
HTB-4200	45 1/4"	21 1/8"	18"	44 5/8"	20 3/8"	16"	42"	175
HTB-6125	64 1/2"	21 1/8"	18"	63 7/8"	20 3/8"	16"	61 1/4"	225

Door frame is 27¼" wide or 27½" wider each side than cabinet width. Add 6" to cabinet height for overall height of door frame.

RVTB Series

This series of cabinets is a compliment to Metal Works' TB—STB & HTB series. For serviceability of equipment the RVTB offers a swing out panel rack. The panel rack can also be recessed if necessary for knob, handle, etc., clearance.

A fully recessed cabinet which accepts standard 19" rack panels drilled and tapped 10-32 on WE spacing. The panel rack can be reversed to swing out from either side. A 4¾" wide full length ventilating partition is provided in the panel rack for maximum heat dissipation. Double cabinet doors are reinforced, double louvered (inside and outside). Doors lay flat against 2¼" door trim and are installed with full length piano hinges. Doors recess into trim or frame with no protruding handles or knobs and are locked in closed position with a two point (rods) flush lock.

Entire cabinet is made of steel and is finished in #4719 Gray Hammer-X. Other colors available on request.

MATERIAL: Back Can—16 ga. CRS
Panel Rack—1¼"x1¼" Structured steel angles
Ventilated Opening—16-18 ga. Flat expanded CRS
Door Frame—11 ga. HRPO

CONSTRUCTION:

- Entire cabinet made of steel as specified above.
- Constructed for full recess wall mounting installation.
- Rack panel frame drilled and tapped 10-24 on WE spacing, and made of structured steel angle.
- Rack panel frame provided so that it can swing from either right or left side.
- Five 7/8" KO provided in top and bottom for ½" conduit.
- Cabinet provided with reinforced double steel two point flush lock doors. Rack panel frame provided with camloc stud on side opposite hinged side so it can be locked in place.

FINISH: Iron phosphate dipped and finished in Silver Gray Hammer-X paint #4719.

Model No.	Cabinet			Rack			Vent Size	Ship Wt.
	H/C	W/C	D/C	H/R	W/R	PS		
RVTB 2100	25 3/8"	28"	18 1/2"	23 3/8"	26 3/8"	21"	4 3/4" x 21"	121
RVTB 2625	30 7/8"	28"	18 1/2"	28 3/8"	26 3/8"	26 3/4"	4 3/4" x 26 3/4"	148
RVTB 3675	41 3/8"	28"	18 1/2"	39 3/8"	26 3/8"	36 3/4"	4 3/4" x 36 3/4"	198
RVTB 5250	57 7/8"	28"	18 1/2"	55 3/8"	26 3/8"	52 1/2"	4 3/4" x 52 1/2"	275

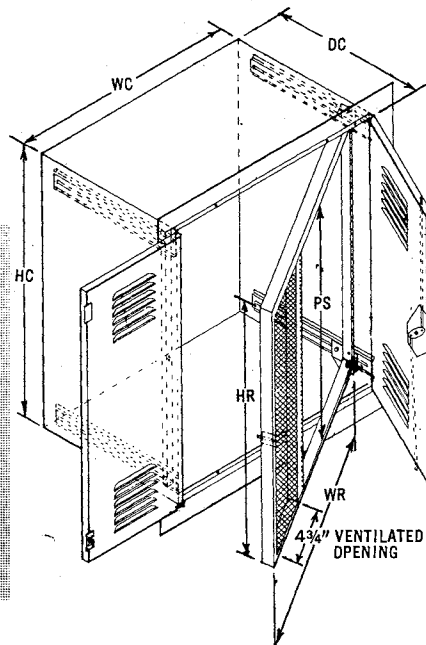
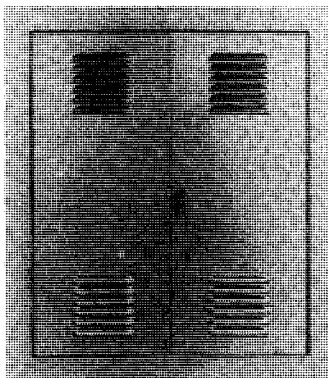
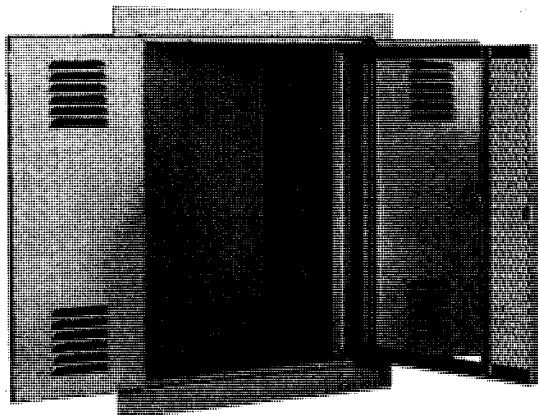



METAL WORKS INCORPORATED

STANDARD & CUSTOM DESIGNS

DUPLI-RACK MODEL DR

Dupli-rack features a maximum of cabinet space in a minimum of floor space at a savings in cost. To increase the size of an installation, simply remove the detachable side panels, bolt the units together through holes provided, forming a sturdy unit, and slip the detachable side panels on each side. This becomes an attractive installation where the addition of units will always remain the same in color tone and freshness of appearance. Each unit is of weld construction, forming a sturdy and rigid piece of equipment. Basic unit consists of frame and rear door.

SPECIFICATIONS MATERIAL: 16 ga. CRS. Panel mounting angles 11 ga. CRS. **CONSTRUCTION:** (1) Braze and spotweld assembly. (2) Detachable side panels are formed and supported and fastened by brackets. (3) Louvers provided in rear door. (4) Panel mounting angles drilled and tapped to 10-32 thread on standard 1¼" x ½" spacing. (5) Locking handle furnished on front door with flush mounted lock and separate handle on rear door.

Rack with Rear Door				Detachable Side Panels		Front Door	
Model No.	Overall Ht.	Panel Space	Ship. Wt. Lbs.	Model No.	Ship Wt. Lbs. (Per Pair)	Model No.	Ship. Wt. Lbs.
DR-3675	42⅞"	36¾"	100	DSP-36	20	FDR-36	10
DR-4200	48½"	42"	104	DSP-42	24	FDR-42	12
DR-6125	67⅜"	61¼"	120	DSP-61	32	FDR-61	18
DR-7000	76½"	70"	129	DSP-70	36	FDR-70	20
DR-7700	83½"	77"	133	DSP-77	40	FDR-77	22

HEAVY DUTY RACK MODEL DR-HD

Complimenting units to our Dupli Rack (DR) Series where component weight requires extra structural rigidity. No bolts or screws are visible from the outside.

The basic unit is of heli-arc weld construction and made from heavy 11 gauge (.119) steel to support weight of 1000# or more. Each unit can be bolted to an adjoining unit by removing the detachable side panels, bolting through holes provided, and then replacing the side panels on each end unit.

Supplied as part of the basic unit are a pair of 11 gauge drilled and tapped (10-32) panel angles (HD) plus two pair of support angles (SA-HD) drilled and tapped on same Western Elec.* spacing as panel angles and a 16 gauge CRS reinforced louvered rear door. Support angles are mounted to rear of panel angles to support

heavy equipment and/or shelves (CS-HD 1922) made specifically for these cabinets. Shelves are accessory equipment. Detachable side panels (DSP-HD) fit between front and rear corner posts and are mounted with machine screws.

Front doors are box type reinforced with an internal channel and without louvers. Doors swing open on hidden hinges within an attractive anodized aluminum extrusion around entire cabinet front to give a distinct shadow effect.

Finish is MWI Standard Baked On Enamel Colors. Other colors available on special order.

MATERIAL:

11 gauge steel top — bottom — corner posts — panel angles — rear support angles — panel support channels — and caster base.
16 gauge steel sides — doors.
Trim — .090 thick clear anodized aluminum extrusion.

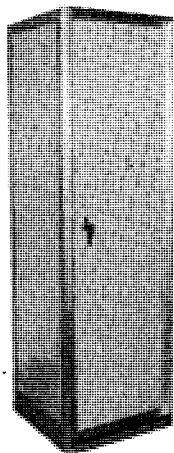

Model No.	Width	Height	Depth	Panel Space	Ship. Wt.	For Cabinet Number
DUPLI RACK — HEAVY DUTY						
DR-HD 3675	23⅝"	*44⅜"	24"	36¾"	210 #	
DR-HD 4200	23⅝"	*49⅝"	24"	42"	225 #	
DR-HD 6125	23⅝"	*68⅞"	24"	61¼"	275 #	
DR-HD 7000	23⅝"	*77⅞"	24"	70"	300 #	
DR-HD 7700	23⅝"	*84⅝"	24"	77"	320 #	
FDR-HD FRONT DOORS						
FDR-HD 36	19½"	37"	1¼"	—	17½ #	DR-HD 3675
FDR-HD 42	19½"	42¼"	1¼"	—	20¾ #	DR-HD 4200
FDR-HD 61	19½"	61½"	1¼"	—	28½ #	DR-HD 6125
FDR-HD 70	19½"	70¾"	1¼"	—	32¾ #	DR-HD 7000
FDR-HD 77	19½"	77¼"	1¼"	—	35¾ #	DR-HD 7700
DSP-HD DETACHABLE SIDE PANEL						
DSP-HD 36	19⅜"	36⅞"	⅛"	—	36 # pr.	DR-HD 3675
DSP-HD 42	19⅜"	42⅞"	⅛"	—	40 # pr.	DR-HD 4200
DSP-HD 61	19⅜"	61⅞"	⅛"	—	56 # pr.	DR-HD 6125
DSP-HD 70	19⅜"	70⅞"	⅛"	—	62¾ # pr.	DR-HD 7000
DSP-HD 77	19⅜"	77⅞"	⅛"	—	68¼ # pr.	DR-HD 7700

* Without casters. With casters add 3⅞".

NOTE: Width and depth may be specified other than noted above for customer's needs.



METAL WORKS INCORPORATED
STANDARD & CUSTOM DESIGNS

RECESSED WALL RECORD PLAYER CABINET

PDW-400 and PDW-800

These cabinets provided in two depths offer another way of wall mounting record players. Door frames are mounted to backcan by hidden weld studs. Therefore, no screws are visible.

Chassis to mount record player is furnished with a $\frac{1}{4}$ " thick motorboard and is welded to back side of door.

Hinged door in open position is held in horizontal position by a chain attached to each side of chassis and backcan. Cabinet is furnished with a flush lock and pull.

Finished in any of MWI standard colors. Other colors at extra charge.

Model — PDW-400 and PDW-800 • Material — 16 Ga. CRS

SPECIFICATIONS: Construction — 1. All spotweld assembled. 2. Formed front door frame and door. Formed flanges $\frac{3}{16}$ " deep over outside. 3. A $\frac{7}{8}$ " K.O. for $\frac{1}{2}$ " conduit is provided in backcan, located 3" from rear of backcan and centered in width dimension. 4. Backcan size $18\frac{1}{2}$ " H x $20\frac{1}{4}$ " W. 5. Motorboard 16" W x 14" D fastened to chassis with six (6) 10/32 Truss Hd MS and tinnerman clips.

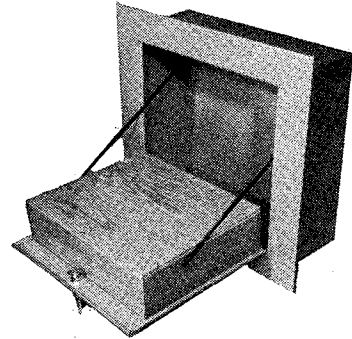

RACK MOUNT RECORD PLAYER CABINET

PDR-400 and PDR-1050

This model cabinet offers the same general features as our PDW series except that it is made to mount in 19" Panel Space cabinets.

The backcan is not closed in rear, therefore, the depth from motorboard in closed position is limited only by the depth of the cabinet in which it is mounted. Made in two backcan depth sizes — 4" and $10\frac{1}{2}$ ", with chassis heights of 2" and 3" respectively.

Hinged door in open positions is held in horizontal position by a chain attached to each side of chassis and each side of backcan. Cabinet is furnished with flush lock, pull and motorboard. Chassis is welded to inside of door.

Model — PDR-400 and PDR-1050 • Material — 16 Ga. CRS

SPECIFICATIONS: Construction: 1. All spotweld assembled. 2. Formed front door frame and door. Formed flanges $\frac{3}{16}$ " deep over outside. 3. A $\frac{7}{8}$ " K.O. for $\frac{1}{2}$ " conduit is provided in backcan, located 3" from rear of backcan and centered in width dimension. 4. Backcan size $15\frac{3}{4}$ " x $17\frac{1}{2}$ ". 5. Motorboard 16" W x 14" D fastened to chassis with six (6) 10/32 Truss Hd MS and tinnerman clips.

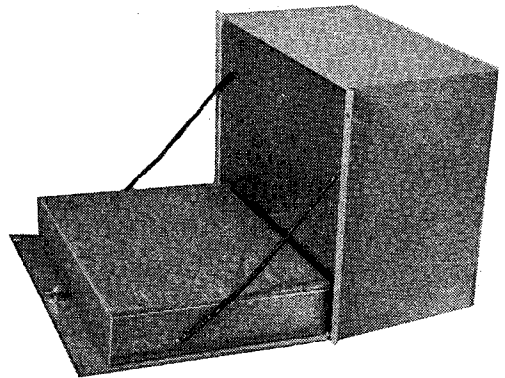

WALL MOUNTED TELESCOPING AMPLIFIER CABINET

TB-47 and TB-815

The wall mounted telescoping cabinet is made from 16 Ga. Cold Rolled Steel — with one pair of mounting angles. Cabinet comes finished in any one of MWI Standard colors. Two sizes are available.

TB-47 Adjustable in depth from 4" to 7"
TB-815 Adjustable in depth from 4" to 15"

Each for 19" panel mounting — Height of panel space is 14". Locking front door set in wall flushing panel 26" wide by 19" high.

Model — TB-47 and TB-815 • Material — 16 Ga. CRS

SPECIFICATIONS: Construction — 1. All spotwelded assembled. 2. Backcan is expandable from 4" to 7" in TB-47 and 8" to 15" in TB-815. 3. Panel angles 14" in height are moveable in backcan slots. 4. Panel angles are punched on WE spacing for use with 10/32 tinnerman clips. 5. Formed front door frame and door opening $10\frac{1}{4}$ " x 20". Maximum inside panel height 14". 6. Front door frame attached by 8/32 weld studs to backcan. No screws visible from front and tamper proof when locked. 7. Front door frame has a 1" x 20" vented opening above door for heat dissipation.

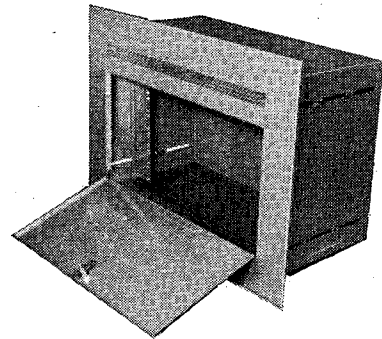



SERIES 500 STUDENT BOOTHS

METAL WORKS new design in Student Booths brings you "tomorrow's booth" today! Featured below is the 500 Series. These booths are designed to minimize noise entering the booth and prevent the students' response from adding to the general noise level. Designed to meet today's needs in an ever expanding educational program,

they can be added to as funds permit, or as the language program expands, by simply bolting on additional units, consisting of only 1 leg and deck. They are adaptable to flush mount any tape recorder. No part of the booths protrude into the aisle leaving all aisle space clear for passage.

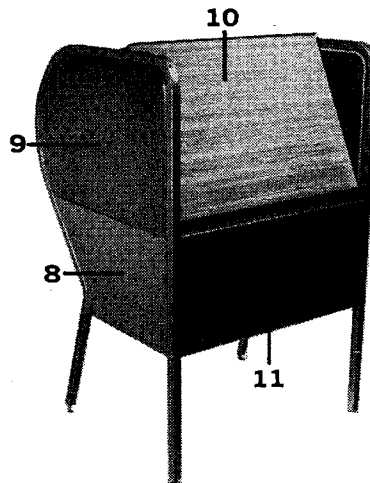
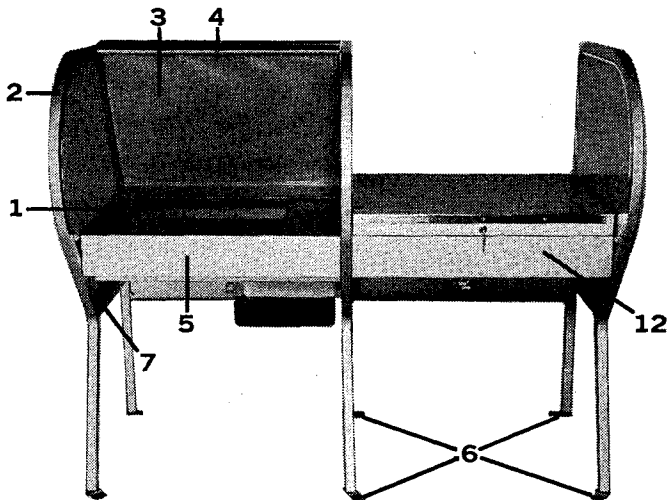

1. Tape recorder position hole cut to any size and positioned to customer requirements. Amplifier position hole furnished, if required, when tape recorders are not used.
2. Square steel tubing, modernistically designed, giving a better appearance, stronger, and a lifetime of use.
3. Acoustical treatment of slope top tilted forward (see back view) gives student maximum isolation.
4. Flush mounted lock in slope top offers protection for electronic equipment when not in use (see closed view).
5. & 11. Front and back view of deck. Rear view illustrates modesty panel conformation.

6. Leg levelers included with all legs or sides. Excellent feature for that uneven floor. Hold down tabs also furnished.
7. Cross brace welded to each leg assures maximum strength and rigidity.
8. Modesty panel (Part No. M-102) used on row ends only. This panel also serves to close the wire pan at the end of each row of booths.
9. Perforated metal covering for acoustical material. Perforated metal is used exclusively on these all new booths.
10. Formica covering on slope top (Part No. F-103). This is finished off with aluminum trim at front.
12. This view shows an add-on booth equipped with a formica covered slope top in the closed position. Note the slight slope (3°) to the front.

SPECIFICATIONS

MATERIAL:
Deck — 16 Ga. CRS.
Legs — 1 1/8" 18 Ga. Steel Tubing Frame with Perforated Metal supporting acoustical material.
Wiring Pan — 18 Ga. CRS.

CONSTRUCTION:

1. Wiring pan is fastened by sheet metal screws for more assembly convenience.
2. All booths are bolted together permitting addition of 1 leg or side, and tape deck, at any future date.
3. Corners of slope top brazed for strength and appearance.
4. Spot welded gussets and supports in deck and slope top.
5. Deck formed to serve as 14" modesty panel in rear.
6. Tape recorder or amplifier flush mounting holes in deck furnished at no additional charge.
7. Deck and wiring pan totally enclose all wiring within the booth row.
8. Legs on E-500 series of booths are of one piece formed construction with supporting brace.

FINISH:
Satin Beige Bake On Enamel is standard. Other colors can be supplied by submitting sample to match.

PARTS LIST

Model No.	Description
EB-500-11	End Booth, consisting of 2 legs, deck painted and channels for glass
AB-555-11	Add On Booth, 1 leg, deck painted and channels for glass
EB-500-22	End Booth, consisting of 2 legs, deck with formica, and channels for glass
AB-555-22	Add On Booth, 1 leg, deck with formica and channels for glass
EB-500-33	End Booth, consisting of 2 legs, deck painted, slope top painted, with lock
AB-555-33	Add On Booth, 1 leg, deck painted, slope top painted, with lock
EB-500-44	End Booth, consisting of 2 legs, deck painted, with turret for recorder
AB-555-44	Add On Booth, 1 leg, deck painted, with turret for recorder
OPTIONAL EQUIPMENT	
B-110	Book Storage Rack
F-103	Formica on slope top (in place of painted slope top)
FD-109	Formica on deck (in place of painted deck)
M-102	Modesty Panel (for desk side)
P-105	Acoustical Panel (in place of glass channels)

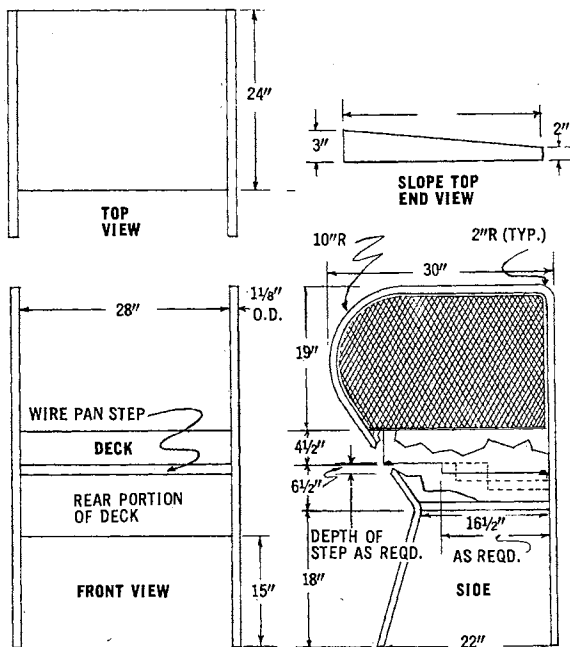

LMB® Box Chassis

The Engineered Precision Line with Interlocking and Flangelocking Construction

Here is the answer to box chassis needs, for the laboratory, manufacturer, experimenter, or builder. The following LMB® Boxes are available from stock in either interlocking (screw fastened) or snap latch. All screw fastenings are drilled and tapped. Self tapping screws are not used. Available colors include natural aluminum, gray or brown hammertone, and black crackle. When ordering specify style and color.

Aluminum used in all LMB® products is aircraft quality specifications type 3003-H 14.

Interlocking

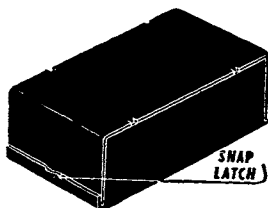
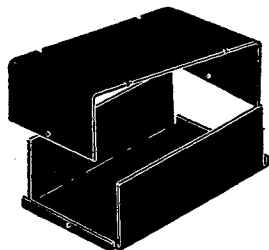

Flangelocking

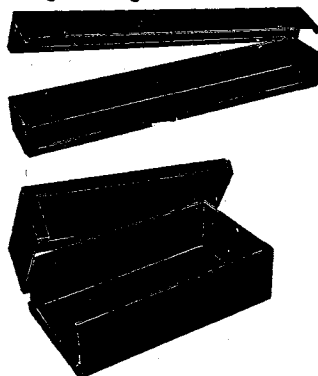

Endlock



SLIDE COVER



SHIELDED CHASSIS

PRINTED CIRCUIT CHASSIS

Printed circuit chassis are made with a shallow base with a cap cover on the bottom so that it can be removed to work on the assembly without removing the printed circuit from the chassis. All printed circuit chassis are of plain aluminum.

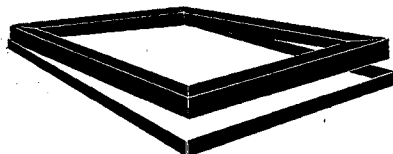

All prices quoted are dealer net. Manufacturers Special Discounts on Application.

WRITE FOR COMPLETE CATALOGUE

INTERLOCKING (SCREW-FASTENED OR SNAP LATCH)

Model	Size	Price	Model	Size	Price
M00	2 1/4" x 1 1/2" x 1 1/8"	.57	850	8 1/2" x 2 1/2" x 1 1/8"	1.35
00Z	2 3/8" x 2 1/4" x 1 1/4"	.64	138	6 1/4" x 3 1/2" x 2 1/2"	1.32
000	3 1/4" x 2 1/2" x 1 1/8"	.68	139	5 1/2" x 3" x 1 1/4"	1.01
00	4" x 2 1/2" x 1 1/8"	.71	140PL	3" x 4" x 5"	1.29
100	2 3/4" x 2 1/2" x 2 1/8"	.89	140	3" x 4" x 5"	1.61
101	4 1/4" x 2 1/4" x 1 1/4"	.87	141PL	6" x 4" x 3"	1.44
102	4" x 2" x 2 3/4"	1.02	141	6" x 4" x 3"	1.72
103	2 3/4" x 2 1/8" x 2 1/8"	.85	142PL	6" x 4" x 5"	1.68
107	4" x 2 1/4" x 2 1/4"	.96	142	6" x 4" x 5"	2.11
108	5" x 2 1/4" x 2 1/4"	1.03	143	4" x 4" x 2"	1.33
135	3 3/4" x 3" x 2 1/8"	.97	144	10" x 4" x 2 1/2"	2.19
136	5 1/4" x 3" x 2 1/8"	1.08	145	7" x 5" x 3"	2.11
650	6 1/2" x 2 1/8" x 1 1/8"	1.05	146	8" x 6" x 4 1/2"	2.99
137	8" x 3" x 2 3/4"	1.61	15	12" x 2" x 1 1/4"	1.61

SIDELOCK and ENDLOCK CONSTRUCTION

LMB® aluminum Box chassis with sidelock and endlock construction are dust proof, semi-water, and rain proof. Sturdy construction and 100% shielded. The following models are available in plain aluminum, or finished in black, gray, or brown. Endlock or sidelock construction:

Model	Size	Price	Model	Size	Price
221	2 3/4" x 3 1/8" x 1 1/8"	1.13	654	6" x 5" x 4"	2.51
321	3 1/4" x 2 1/2" x 1 1/8"	1.13	666	6" x 6" x 6"	3.39
421	4" x 2 1/2" x 1 1/8"	1.13	686	6" x 8" x 6"	4.27
422	4" x 2 1/4" x 2 1/4"	1.29	695	6" x 9" x 5"	3.84
424	4" x 2" x 4"	1.98	753	7" x 5" x 3"	2.60
435	4" x 3" x 5"	2.19	754	7" x 5" x 4"	2.76
444	4" x 4" x 4"	1.89	863	8" x 6" x 3 1/2"	2.86
531	5 1/4" x 3" x 1 1/2"	1.29	865	8" x 6" x 5"	3.57
532	5 1/4" x 3" x 2 1/8"	1.47	1063	10" x 6" x 3 1/2"	3.57
534	5 3/8" x 3" x 4"	2.06	1085	10" x 8" x 5"	4.42
543	5" x 4" x 3"	1.87	1221	12" x 2" x 1 3/4"	1.87
546	5" x 4" x 6"	2.74	1274	12" x 7" x 4"	4.65
645	6" x 4" x 5"	2.60	1754	17" x 5" x 4"	5.27

SLIDE COVER (or dust cover) BOXES

Designed by BROADCAST ENGINEERS

No.	L	W	H	Ea.	No.	L	W	H	Ea.
16—Natural Aluminum	13"	3 1/8"	2 3/8"	\$1.85	18—Natural Aluminum	13"	5 1/4"	2 3/8"	3.50
16—Gray, Black, Brown	13"	3 1/8"	2 3/8"	2.52	18—Gray, Black, Brown	13"	5 1/4"	2 3/8"	4.30
17—Natural Aluminum	13"	4 1/8"	2 3/8"	3.18	19—Natural Aluminum	17"	3 1/8"	2 3/8"	3.35
17—Gray, Black, Brown	13"	4 1/8"	2 3/8"	3.95	19—Gray, Black, Brown	17"	3 1/8"	2 3/8"	4.15

SHIELDED CHASSIS

No.	L	W	H	Ea.	No.	L	W	H	Ea.
No. 20 Plain	7 1/2"	7"	2"	\$1.67	No. 21 Anodized	13"	10"	3"	\$5.81
No. 20 Anodized	7 1/2"	7"	2"	2.06	No. 22 Plain	17"	10"	3"	5.13
No. 21 Plain	13"	10"	3"	4.34	No. 22 Anodized	17"	10"	3"	6.67

STANDARD SIZES

Model No.	L	W	D	Mounting Lip	Price
PC 325	3	2	1/2	3/16"	ea. .70
PC 635	6	3	1/2	3/16"	ea. .80
PC 645	6	4	1/2	1/8"	ea. .91
PC 855	8	5	1/2	1/8"	ea. 1.04
PC 10875	10	8	1/2	1/8"	ea. 1.52
PC 12975	12	9	1/2	1/8"	ea. 1.76

Model No.	Size	Mounting Lip	Model No.	Size	Mounting Lip
D 7131	7 x 13 x 1	1/2"	D 541	5 x 4 x 1	1/2"
for use in building with the Danco model			for use in building with the Danco model		
No. 14 printed amplifier circuit	ea. 1.17		No. 21, 31, 41 printed preamplifier circuit	ea. \$.63	

WRITE FOR COMPLETE CATALOG

PRICES SUBJECT TO CHANGE

LMB®

LMB® (Continued)

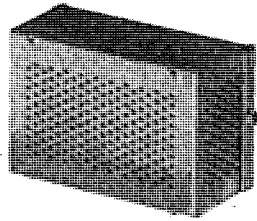
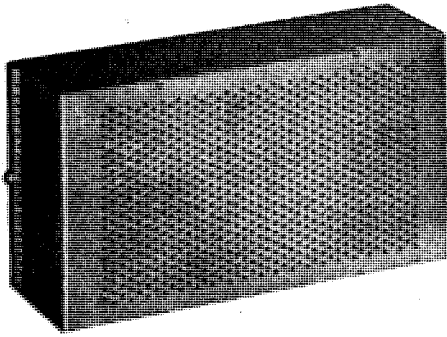

LMB® PERFORATED BOX CHASSIS

LMB® Perforated Boxes are adaptable wherever heat dissipation is required as they are spaced in perforations that are set by laboratory research to give utmost heat dissipation and also give utmost shielding. They are die perforated on three sides and top of the box.

NO.	FINISH	SIZE	NET EA.	NO.	FINISH	SIZE	NET EA.
00Z	Plain or Gray	2 3/4 x 2 1/8 x 1 3/4	\$.83	138	Plain or Gray	6 1/4 x 3 1/2 x 2 1/8	\$1.82
000	" "	3 1/4 x 2 1/8 x 1 5/8	.95	139	" "	5 1/2 x 3 x 1 1/4	1.36
00	" "	4 x 2 1/8 x 1 5/8	1.02	140	" "	3 x 4 x 5	1.75
100	" "	2 3/4 x 2 1/8 x 2 5/8	1.20	141	" "	6 x 4 x 3	1.88
101	" "	4 1/4 x 2 1/4 x 1 1/4	1.12	142	" "	6 x 4 x 5	2.18
102	" "	4 x 2 x 2 3/4	1.41	143	" "	4 x 4 x 2	1.40
107	" "	4 x 2 1/4 x 2 1/4	1.09	144	" "	10 x 4 x 2 1/2	2.19
108	" "	5 x 2 1/4 x 2 1/4	1.50	650	" "	6 1/2 x 2 1/8 x 1 5/8	1.41
135	" "	3 3/4 x 3 x 2 1/8	1.36	850	" "	8 1/2 x 2 1/8 x 1 5/8	1.59
136	" "	5 1/4 x 3 x 2 1/8	1.50	15	" "	12 x 2 x 1 3/4	1.79
137	" "	8 x 3 x 2 3/4	2.14				

THE CHASSIS WITH THE CAP COVERS AS ORIGINATED BY LMB®

Built with the new original LMB® popular cap cover construction. This construction enables the builder to use either the top or the bottom of the chassis for construction. The Chassis can also be mounted on its side and construction can be on both top and bottom at the same time. Sturdily built from Aircraft quality aluminum, Type 3003, H-14, the same material as is used in the construction of all LMB® precision box chassis. Special technique in welding the corners makes for a stronger chassis than the orthodox type. Cap construction allows for using all the space inside the chassis without being hindered by the mounting flange, which takes from 10% to 20% of the mounting space out of the average chassis.

The P Series are perforated on all four sides and are ideal where heat dissipation is a factor. LMB® chassis — the better chassis, with the year's ahead advanced construction for your better project application. An advanced quality product competitively priced.

LMB® PRESENTS SOMETHING NEW IN CHASSIS —

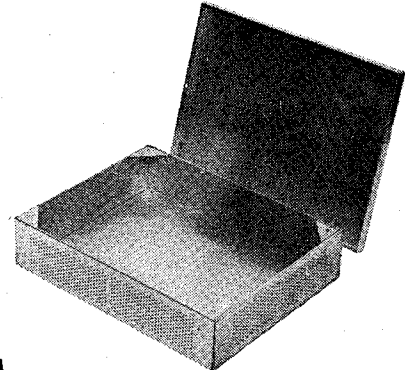
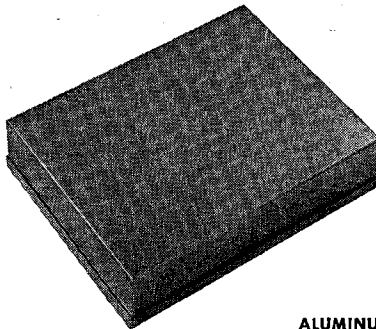
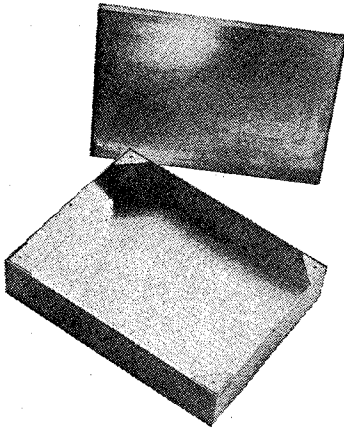

ALUMINUM

WITHOUT COVER				WITH CAP COVER			PERFORATED		
NO.	SIZE L W H	GAUGE	NET	NO.	L W H	NET	NO.	L W H	NET
553	5x 5x3	18	\$1.35	553C	5x 5x3	\$1.95	553P	5x 5x3	\$2.30
572	5x 7x2	18	1.17	572C	5x 7x2	1.75	572P	5x 7x2	2.05
573	5x 7x3	18	1.42	573C	5x 7x3	1.95	573P	5x 7x3	2.25
5952	5x9 1/2x2	18	1.25	5952C	5x9 1/2x2	1.85	5952P	5x9 1/2x2	2.15
5103	5x10x3	18	1.65	5103C	5x10x3	2.25	5103P	5x10x3	2.55
5133	5x13x3	18	1.85	5133C	5x13x3	2.50	5133P	5x13x3	2.80
642	6x 4x2	18	1.48	642C	6x 4x2	1.85	642P	6x 4x2	2.20
643	6x 4x3	18	1.55	643C	6x 4x3	2.45	643P	6x 4x3	2.45
6173	6x17x3	18	2.67	6173C	6x17x3	3.40	6173P	6x17x3	3.70
772	7x 7x2	18	1.35	772C	7x 7x2	1.90	772P	7x 7x2	2.20
792	7x 9x2	18	1.46	792C	7x 9x2	1.95	792P	7x 9x2	2.25
7103	7x10x3	18	1.53	7103C	7x10x3	2.50	7103P	7x10x3	2.80
7112	7x11x2	18	1.58	7112C	7x11x2	2.30	7112P	7x11x2	2.60
7123	7x12x3	18	2.03	7123C	7x12x3	2.75	7123P	7x12x3	3.05
7153	7x15x3	18	2.67	7153C	7x15x3	3.60	7153P	7x15x3	3.90
7173	7x17x3	18	2.75	7173C	7x17x3	3.70	7173P	7x17x3	4.00
8103	8x10x3	18	2.65	8103C	8x10x3	3.60	8103P	8x10x3	3.90
8123	8x12x3	18	2.42	8123C	8x12x3	3.23	8123P	8x12x3	3.53
8172	8x17x2	18	2.52	8172C	8x17x2	3.50	8172P	8x17x2	3.80
8173	8x17x3	16	2.95	8173C	8x17x3	4.50	8173P	8x17x3	4.80
10123	10x12x3	18	2.70	10123C	10x12x3	3.60	10123P	10x12x3	4.30
10143	10x14x3	18	2.95	10143C	10x14x3	4.30	10143P	10x14x3	4.70
10172	10x17x2	16	2.85	10172C	10x17x2	4.37	10172P	10x17x2	4.77
10*73	10x17x3	16	3.40	10173C	10x17x3	5.18	10173P	10x17x3	5.98
10174	10x17x4	16	4.85	10174C	10x17x4	6.37	10174P	10x17x4	7.17
11173	11x17x3	14	4.20	11173C	11x17x3	6.60	11173P	11x17x3	7.10
12172	12x17x2	14	4.50	12172C	11x17x2	6.60	12172P	12x17x2	7.20
12173	12x17x3	14	4.60	12173C	12x17x3	6.90	12173P	12x17x3	7.50
13172	13x17x2	14	4.50	13172C	13x17x2	6.60	13172P	13x17x2	7.30
13173	13x17x3	14	4.80	13173C	13x17x3	6.90	13173P	13x17x3	7.50
13174	13x17x4	14	5.95	13174C	13x17x4	7.95	13174P	13x17x4	8.55

WRITE FOR COMPLETE CATALOG

Par.Metal

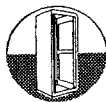

PRESENTS

PAR-EXCELLENT EQUIPMENT

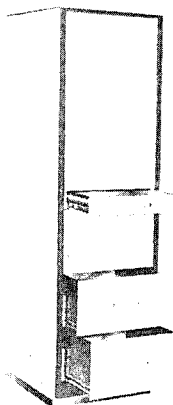

INCLUDING OUR
NEW CONTEMPO-RAMA
OF MODERN DESIGNED —
CONTEMPO-RACKS,
CONTEMPO-CONSOLES,
ACCESSORIES
and HARDWARE.

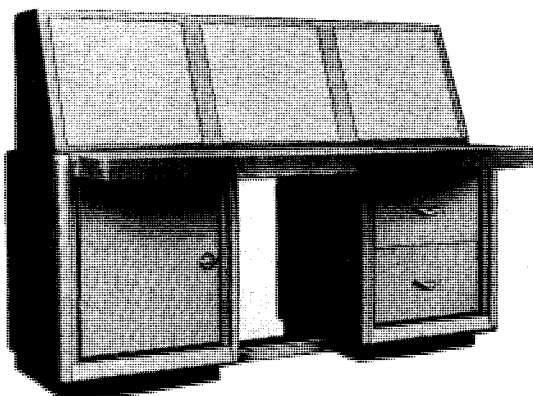

TABLE of CONTENTS by PAR-METAL PAGE NUMBERS

ORDERING INSTRUCTIONS & FINISHING COLOR CHARTS for:

MODULAR CABINET RACKS on Page 4.

CONSOLE ASSEMBLIES on Page 24.

CONTEMPO CABINET RACKS

ITEM	Code Letters	Par-Metal Pg.No.
Accessory Check List	PC/FC	12
Angular Frame Rack Wedges	CW	13
Catalog Number Identity Chart		5
Color and Ordering Guides		4
Construction Details		2
Door Modifications		23
General Description		3
Lift Bolt Top Assembly Access.	CIB	11
Rack Details Chart	PC/FC	11
Semi-Custom Racks		4
Top Panel Modifications		23

PROFESSIONAL CABINET RACKS

ITEM	Code Letters	Par-Metal Pg.No.
Accessory Check List	PL/FL, PR/FR	9/10
	PX/FX	
Angular Frame Wedges	AF	13
Ball Cornered Racks (Details)	PL/FL	6
Catalog Number Identity Chart		5
Color and Ordering Guides		4
Construction Details		2
Door Modifications		23
Flush Mounted Racks (Details)	PR/FR	7
General Description		3
Lift Bolt Top Assembly	IB	8
Semi-Custom Racks		4
Table Racks (Portable)	TR	20
Top Panel Modifications		23
Welded-on Side Wall Racks	PX/FX	8

RETMA PANELS

ITEM	Code Letters	Par-Metal Pg.No.
Blank Panels (Aluminum & Steel)		21
Desk Panels		21/22
Formed Panels (Blank)		21/22
Formed Panels (Louvered)		21/22
Grille Panels		21/22
Hinged Panels		21/22
Panel Doors	DR	29

HARDWARE

ITEM	Code Letters	Par-Metal Pg.No.
Blowers	DPB	37
Casters (Brake or Swivel)	CS	38
Fans	PE/PI	37
Floor Levelers	LF	38
Handles	H/V	38
Locks		38
Power Plug-in Strips		38
Screws		38
Slides	SB	38
Tilt Slides	SB	38

CONTEMPO-CONSOLES & ACCESSORIES

ITEM	Code Letters	Par-Metal Pg.No.
Basic Slide Assembly	BS	17
Brackets & Equipment		
Shelves	CB/SS	29
Casters	CS	16/38
Center Desk Section	CCD	29
Color and Ordering Guide		24
Component Group Check List	CPD/CPS	31/32
Desk/Shelf (Retractable)	SK	17
Desk Top Cabinets with Panels	CF/CX/HS/LS/PT/VF	33/34
Drawer, Storage (Retractable)	SD	17
Drawer/Shelf (Retractable)	SK	17
End Panels	EPD/EPS	29
End Pedestals	KPD/KPS	29
Exterior Desk Tables	DUD/DUS	29
General Description		24
Pedestal Doors	CCT	29
Pedestal Frames	DR	29
Table Tops (Formica)	CPD/CPS	25
Wedges for Pedestals	WT/WTX/LHT/HT	30
Wedges for Top Cabinets	PDW/PSW	32

PROFESSIONAL CONSOLES & ACCESSORIES

ITEM	Code Letters	Par-Metal Pg.No.
Basic Slide Assemblies	BS	17
Brackets & Equipment		
Shelves	CB/SS	29
Casters	CS	16/38
Center Desk Section	CD	29
Color & Ordering Guide		24
Component Group Check List	PD	27/28
Desk/Shelf	SK	17
Desk Top Cabinets	CX/HS/LS/VF	26
Drawer, Storage	DD	17
Drawer/Shelf (Retractable)	SD	17
End Panels	EP/KP	29
End Pedestals	DU	29
Exterior Desk Tables	CT	29
General Description		24
Pedestal Doors	DR	29
Pedestal Frames	PD	25
Table Tops (Formica)	HT/NT/WT	26

RELAY RACKS

ITEM	Code Letters	Par-Metal Pg.No.
Desk Panel Cabinets	DL	18
Knock-Down Cabinets	ER/FD	19/20
Open Channel Racks	RR/RX	18
Shelves for Relay Racks	ER/R	36
Table Racks (Portable)	TR	20

CONTEMPO-RACK ACCESSORIES

ITEM	Code Letters	Par-Metal Pg.No.
Basic Slide Assembly	BS	17
Brackets	BR	14/36
Check List for Racks	PC/FC	12
Desk/Shelf (Retractable)	SK	17
Drawer/Shelf (Retractable)	SD	17
Exterior Rack Table	CRX	13
Fans and Blowers	PE/PI/DPB	37
Lift Bolt Assembly	CIB	11
Panel Doors	DR	29
Panel Mounting Angles	CPA	14
Rack Base (Recessed)	CB	11
Roller Trucks	CR/CRB/CEB	15/16
Shelves for Racks	SS	14
Side Panels (Detachable)	CS	11
Sloping Panel Turrets	CSP	13
Drawers (Storage)	DD/SD	17
Vertical Side Supports	CVS	14

OTHER RACK ACCESSORIES

ITEM	Code Letters	Par-Metal Pg.No.
Accessory Check List for Racks	PL/FL, PR/FR, PX/FX	9/10
Basic Slide Assembly	BS	17
Brackets	BR	14/36
Desk/Shelf (Retractable)	SK	17
Drawer/Shelf (Retractable)	SD	17
Exterior Rack Table	RX	13
Fans and Blowers	PE/PI/DPB	37
Lift Bolt Assembly	IB	8
Panel Doors	DR	29
Panel Mounting Angles	PA	14
Rack Base (Recessed)	RB	6/7/8
Roller Trucks	RT/HD/EB	15/16
Shelves for Racks	SS	14
Side Panels (Detachable)		
Ball Cornered	RL	6
Flush Mounted	RS	7
Sloping Panel Turrets	SP	13
Storage Drawers	DD/SD	17

CASES and CHASSIS

ITEM	Code Letters	Par-Metal Pg.No.
Amplifier Foundation Chassis	DF/F	35
Bottom Plates	CP	36
Chassis	C	36
Chassis Mounting Brackets	SB	36
Desk Panel Cabinets	DL	18
Rack Mounted Chassis	AC/SC	36
Steel Utility Cases	MC	35
Table Top Cabinets	CA/SF	35

ASK YOUR DISTRIBUTOR FOR PAR-METAL PRODUCTS CATALOG

Par-Metal

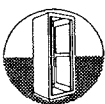

MODULAR CABINET RACKS

GENERAL DESCRIPTION

MODULAR CABINET RACKS are made in four (4) styles:

1. Racks built to accommodate removable Ball Cornered Side Panels (Series **PL** with Rear Door Only and Series **FL** with Front and Rear Doors). See Par-Metal Page 6.
2. Racks built for removable Square Cornered or Flush Mounted Side Panels (Series **PR** with Rear Door Only and Series **FR** with Front and Rear Doors). See Par-Metal Page 7.
3. Racks with Solid Side Walls (Series **PX** with Rear Door Only and Series **FX** with Front and Rear Doors). See Par-Metal Page 8.
4. **Contempo-Racks** in Modern design with "Pan-Shaped" Removable Side Panels. Series **PC** with "Dutch Formed" Rear Door only and with Flush-mounted Handle. Series **FC** with "Pan Shaped" Front Door added and with Flush mounted lock handles on both doors. Page 12.

Each of these four (4) Series of Modular Cabinet Racks are made in about 50 different standard sizes and a wide variety of finishes. Special work must be quoted.

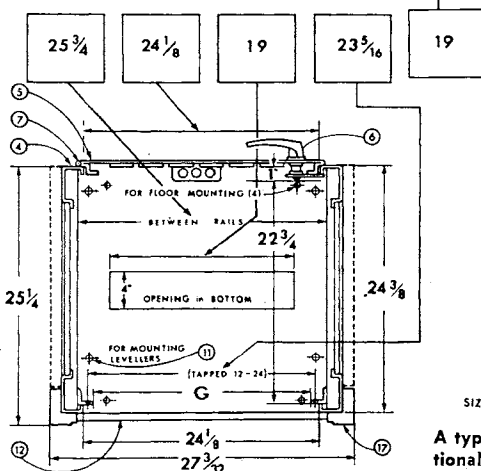
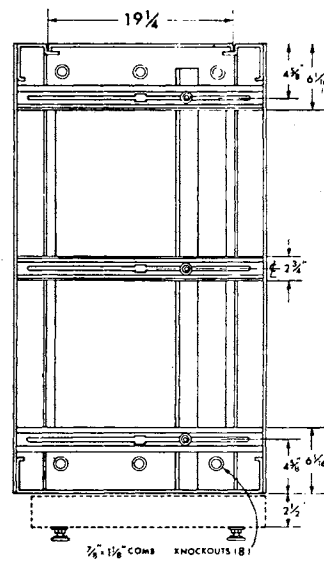
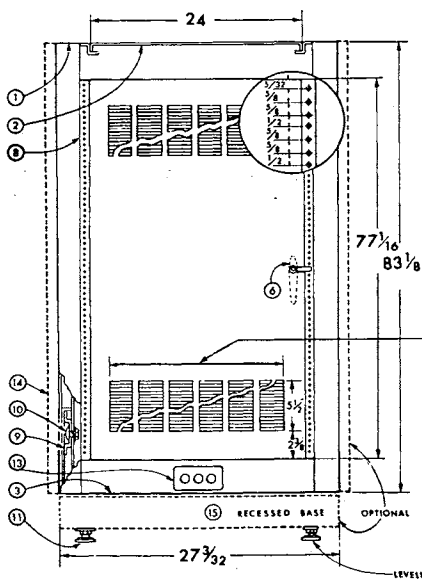

PART NO.	DESCRIPTION	MATERIAL	QUAN.
1	TOP-RACK FRAME	Steel-103"	1
2	TOP PANEL-FORMED STEEL	Steel-059"	1
3	BOTTOM-RACK FRAME	Steel-103"	1
4	CORNER UPRIGHTS	Steel-103"	4
5	DOOR(S)	Steel-059"	
6	DOOR HANDLE(S)	DIE CAST	
7	DOOR HINGES-Slip Joint	Steel-3"	3
8	PANEL MOUNTING ANGLES	Steel-187"	2
9	BOLT RETAINER RAILS	Steel-103"	6"
10	RAIL BOLT ASSEMBLIES	Steel-3/8"	6"
11	FLOOR LEVELERS	ADJUSTABLE	4
12	TOP & BOTTOM MOUNTINGS	Steel-059"	2
13	OUTLET BOX & RECEPTACLE	DUPLEX	1
14	SIDE PANELS (Optional)	Steel-059"	2
15	RECESSED BASE (Optional)	Steel-103"	1
16	PANEL MOUNTING SCREWS	Steel-1/2"	50
17	FRONT VERTICAL MOUNTINGS	Steel-048"	2

(4) On racks 42 1/2" & 48 1/2" inches high.

SIZES ARE GIVEN IN INCHES.

A typical Dimensional Drawing of Constructional Elements of a Par-Metal Modular Cabinet Rack Cat. No. PR-8427-B.

RACK FRAMES are #12 Gauge Steel (.104") and are fully welded, and have modern, functional design.

PANEL MOUNTING ANGLES of 3/16" structural steel are included. Hole spacing will match either **WE** or **EIA** specifications. Holes are tapped for 12/24 screws. 10/32 tapped holes are optional at no extra cost. Contempo-Panel Mounting Angles are tapped 10-32 only. Angles are secured to rails with 3/8" diameter steel bolts to provide maximum forward and back adjustment, for optional front to rear positioning.

DOORS: Except for Contempo Front Door (Series **FC**, see #4 above), all doors are "Dutch Formed" (one piece out of #16 gauge steel (.059")). On Racks with front doors, a solid door is standard. Louvered Rear Door is standard on all racks. However other door modifications are optional at no charge (see Part-Metal Page 23). To save aisle space, racks 30"

wide or more have double doors with three-point latches.

HINGES for ALL doors are of the slip-joint type for simple removal.

DOOR HANDLES are die cast, chrome plated and are non-locking. Lock handles are on both doors on Racks with "F" prefix.

REMOVABLE TOP PANELS are standard. For ventilating modifications see Par-Metal Page 23.

RECESSED RACK BASES are listed on Par-Metal Pages 6-8, 11. Do not use rack base with roller trucks.

HARDWARE is provided as needed at no charge. This includes bolts, washers, nuts, panel mounting screws and a grounding duplex electric outlet (below rear door).

PAR-METAL PRODUCTS • CONVENIENT FACTORY WAREHOUSE

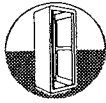
Par-Metal**RACK CATALOG NUMBER IDENTITY CHARTS****MODELS - PL/FL - PR/FR - PX/FX RACKS**

P—HERE MEANS Racks with Rear Door ONLY.

F—HERE MEANS Racks with Both Front and Rear Doors and Lock Handles

L—HERE MEANS Racks for OPTIONAL Detachable, Ball Cornered Side Panels

R—HERE MEANS Racks for OPTIONAL Detachable, Flush Mounted Side Panels

X—HERE MEANS Racks with Welded-on Solid Side Walls

37—HERE MEANS 42 $\frac{3}{8}$ " High Racks with 36 $\frac{3}{4}$ " Panel Height48—HERE MEANS 48 $\frac{3}{8}$ " High Racks with 42" Panel Height58—HERE MEANS 58 $\frac{3}{8}$ " High Racks with 52 $\frac{1}{2}$ " Panel Height67—HERE MEANS 67 $\frac{3}{8}$ " High Racks with 61 $\frac{1}{4}$ " Panel Height77—HERE MEANS 76 $\frac{3}{8}$ " High Racks with 70" Panel Height84—HERE MEANS 83 $\frac{3}{8}$ " High Racks with 77" Panel Height90—HERE MEANS 90 $\frac{3}{8}$ " High Racks with 84" Panel Height

18—HERE IDENTIFIES 18" Deep and 22" Wide Rack for 19" Panels

24—HERE IDENTIFIES 24" Deep and 22" Wide Rack for 19" Panels

27—HERE IDENTIFIES 24" Deep and 27" Wide Rack for 24" Panels

33—HERE IDENTIFIES 24" Deep and 33" Wide Rack for 30" Panels & Double Doors

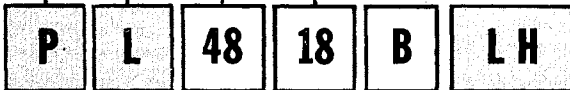

Typical Catalog Number

PLACE FINISHING CODE LETTERS HERE.....

See Par-Metal Page 4

CONTEMPO-RACKS: MODELS PC/FC

P—HERE MEANS Racks with Rear Door ONLY.

F—HERE MEANS Racks with Both Front and Rear Doors and Lock Handles

C—HERE MEANS CONTEMPO RACKS

42—HERE MEANS 46 $\frac{1}{8}$ " High Racks with 42" Panel Height52—HERE MEANS 56 $\frac{1}{8}$ " High Racks with 52 $\frac{1}{2}$ " Panel Height61—HERE MEANS 65 $\frac{1}{8}$ " High Racks with 61 $\frac{1}{4}$ " Panel Height70—HERE MEANS 74 $\frac{1}{8}$ " High Racks with 70" Panel Height77—HERE MEANS 81 $\frac{1}{8}$ " High Racks with 77" Panel Height84—HERE MEANS 88 $\frac{1}{8}$ " High Racks with 84" Panel Height

1—HERE IDENTIFIES 19" Panel Width

2—HERE IDENTIFIES 24" Panel Width

3—HERE IDENTIFIES 30" Panel Width

2—HERE SHOWS 26" Rack Depth

3—HERE SHOWS 31" Rack Depth

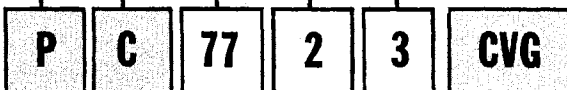

Typical Catalog Number

PLACE FINISHING CODE LETTERS HERE.....

See Par-Metal Page 4

PAR-METAL PRODUCTS • ENGINEERING ASSISTANCE AVAILABLE

Par.Metal

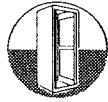

MODULAR CABINET RACKS

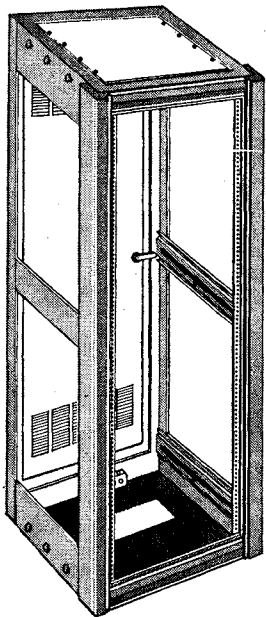

SERIES PR RACKS
With Rear Doors Only

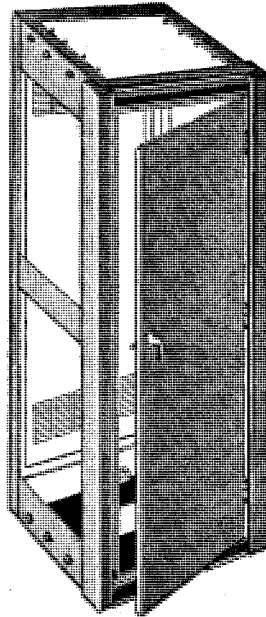

SERIES FR RACKS
With Front and Rear Doors

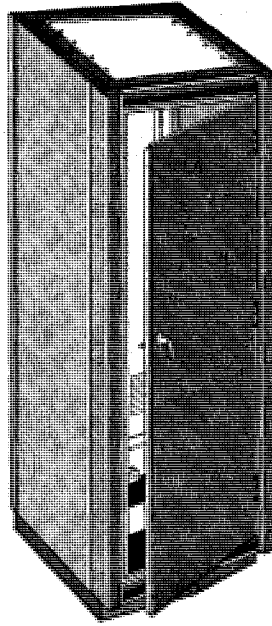

SERIES FR RACK
equipped with flush side panels
and recessed base.

MAJOR ACCESSORIES for Use with Series "PR" and "FR" Racks

FLUSH MOUNTED SIDE PANELS

Sturdily constructed from #16 gauge steel, formed edges, welded at all 4 corners. Vertical edges trimmed with recessed stainless steel mouldings. Coinciding brackets at bottom allow for easy alignment with rack sides. Readily removable, 3/4" thick panels, finishes to match racks.

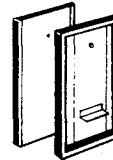

Cat. No.	To Fit PR, FR Racks	Net Price (Per Pair)
RS-418-B	4818	\$40.35
RS-518-B	5818	44.10
RS-618-B	6718	48.30
RS-718-B	7718	54.20
RS-818-B	8418	60.70
RS-424-B	4824, 4827, 4833	45.70
RS-524-B	5824, 5827, 5833	52.85
RS-624-B	6724, 6727, 6733	57.15
RS-724-B	7724, 7727, 7733	60.00
RS-824-B	8424, 8427, 8433	62.50
RS-924-B	9024, 9027, 9033	68.60

RECESSED RACK BASES: Heavy duty bases made from #12 gauge (7/64") steel, rigidly formed and welded. Tapped holes on top match holes in bottom of racks; 4 adjustable floor levelers mounted on bottom. Not required with roller trucks. Bases 2-1/2" high.

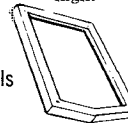

Cat. No.	To Fit All Racks	Net Price
RB-2217	22" wide, 18" deep	\$16.50
RB-2223	22" wide, 24" deep	17.00
RB-2723	27" wide, 24" deep	18.50
RB-3323	33" wide, 24" deep	20.00

(For full accessory check list, please turn to Par-Metal Pages 9 and 10).

RACKS FOR FLUSH MOUNTED SIDE PANELS (SERIES PR and FR)

PR SERIES REAR DOOR ONLY		FR SERIES FRONT & REAR DOORS		RACK DIMENSIONS							
Cat. No.	Net Price	Cat. No.	Net Price	OVERALL SIZE			PANEL SPACE	*CLEAR INSIDE DEPTH	**CLEAR INSIDE WIDTH (FRONT)	REMOVABLE TOP PANEL	
				Height	†Width	††Depth	Height x Width			Width	Depth
FOR 19" WIDE PANELS AND 18 3/8" DEEP RACKS											
PR-4818-B	\$ 96.90	FR-4818-B	\$114.70	48 3/8"			42" x 19"				
PR-5818-B	110.00	FR-5818-B	124.90	58 3/8"			52 1/2" x 19"				
PR-6718-B	114.30	FR-6718-B	134.45	67 3/8"	22 1/8"	18 3/8"	61 1/4" x 19"	16 3/4"	17 3/4"	19"	12 1/4"
PR-7718-B	126.60	FR-7718-B	152.50	76 3/8"			70" x 19"				
PR-8418-B	135.00	FR-8418-B	164.85	83 3/8"			77" x 19"				
FOR 19" WIDE PANELS AND 24 3/8" DEEP RACKS											
PR-4824-B	116.05	FR-4824-B	137.30	48 3/8"			42" x 19"				
PR-5824-B	123.90	FR-5824-B	147.50	58 3/8"			52 1/2" x 19"				
PR-6724-B	133.10	FR-6724-B	156.45	67 3/8"	22 1/8"	24 3/8"	61 1/4" x 19"	22 3/4"	17 3/4"	19"	19 1/4"
PR-7724-B	150.45	FR-7724-B	175.10	76 3/8"			70" x 19"				
PR-8424-B	160.45	FR-8424-B	190.30	83 3/8"			77" x 19"				
PR-9024-B	188.30	FR-9024-B	204.75	90 3/8"			84" x 19"				
FOR 24" WIDE PANELS AND 24 3/8" DEEP RACKS											
PR-4827-B	146.75	FR-4827-B	168.00	48 3/8"			42" x 24"				
PR-5827-B	156.50	FR-5827-B	180.60	58 3/8"			52 1/2" x 24"				
PR-6727-B	166.70	FR-6727-B	197.40	67 3/8"	27 1/8"	24 3/8"	61 1/4" x 24"	22 3/4"	22 3/4"	24"	19 1/4"
PR-7727-B	179.00	FR-7727-B	208.95	76 3/8"			70" x 24"				
PR-8427-B	197.15	FR-8427-B	234.15	83 3/8"			77" x 24"				
PR-9027-B	215.25	FR-9027-B	257.25	90 3/8"			84" x 24"				
†FOR 30" WIDE PANELS AND 24 3/8" DEEP RACKS											
†PR-4833-B	168.00	†FR-4833-B	194.25	48 3/8"			42" x 30"				
†PR-5833-B	183.80	†FR-5833-B	220.50	58 3/8"			52 1/2" x 30"				
†PR-6733-B	199.00	†FR-6733-B	243.10	67 3/8"	33 1/8"	24 3/8"	61 1/4" x 30"	22 3/4"	28 3/4"	30"	19 1/4"
†PR-7733-B	215.80	†FR-7733-B	265.40	76 3/8"			70" x 30"				
†PR-8433-B	235.50	†FR-8433-B	287.70	83 3/8"			77" x 30"				
†PR-9033-B	255.15	†FR-9033-B	307.65	90 3/8"			84" x 30"				

* ALLOW FOR LATCH HANDLE

† Racks for 30" wide Panels have TWO FRENCH DOORS—to save aisle space.

** FOR CLEAR INSIDE WIDTH AT REAR, ADD 1 3/8" †† For Racks with SIDE PANELS attached, add 2 1/2" to width and 7/8" to depth.

ASK YOUR DISTRIBUTOR FOR PAR-METAL PRODUCTS CATALOG

Par-Metal

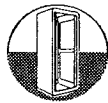

MODULAR CABINET RACK ACCESSORY CHECK LIST

For CONTEMPO-RACK Accessory Check List, please turn to Par-Metal Page 12.

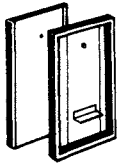

DETACHABLE SIDE PANELS (RS Type)

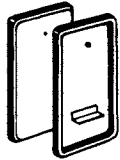

DETACHABLE SIDE PANELS (RL Type)

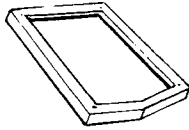

RECESSED RACK BASE

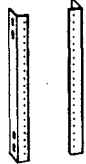

PANEL MOUNTING ANGLES



VERTICAL SIDE SUPPORTS

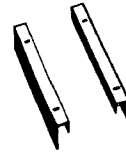

MOUNTING BRACKETS

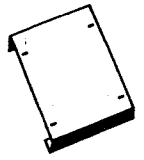

EQUIPMENT SHELF

RACK *Catalog Number	DETACHABLE SIDE PANELS Par-Metal Page Nos. 6 and 7	RECESSED RACK BASES Par-Metal Page Nos. 6-8	PANEL MOUNTING ANGLES Par-Metal Page 14	VERTICAL SIDE SUPPORTS Par-Metal Page 14	MOUNTING BRACKETS Par-Metal Page 14	EQUIPMENT SHELVES Par-Metal Page 14	EXTERIOR TABLE Par-Metal Page 13
FOR 19" WIDE PANELS AND 18³/₈" OR 18¹/₄" DEEP RACKS							
*-3718-B *-4818-B *-5818-B *-6718-B *-7718-B *-8418-B	**-418-B **-518-B **-618-B **-718-B **-818-B	RB-2217	PA-36 PA-42 PA-52 PA-61 PA-70 PA-77	VS-36 VS-42 VS-52 VS-61 VS-70 VS-77	BR-118	SS-1918	RX-119
FOR 19" WIDE PANELS AND 24³/₈" OR 24¹/₄" DEEP RACKS							
*-4824-B *-5824-B *-6724-B *-7724-B *-8424-B *-9024-B	**-424-B **-524-B **-624-B **-724-B **-824-B **-924-B	RB-2223	PA-42 PA-52 PA-61 PA-70 PA-77 PA-84	VS-42 VS-52 VS-61 VS-70 VS-77 VS-84	BR-124	SS-1924	RX-119
FOR 24" WIDE PANELS AND 24³/₈" OR 24¹/₄" DEEP RACKS							
*-4827-B *-5827-B *-6727-B *-7727-B *-8427-B *-9027-B	**-424-B **-524-B **-624-B **-724-B **-824-B **-924-B	RB-2723	PA-42 PA-52 PA-61 PA-70 PA-77 PA-84	VS-42 VS-52 VS-61 VS-70 VS-77 VS-84	BR-124	SS-2724	RX-124
FOR 30" WIDE PANELS AND 24³/₈" OR 24¹/₄" DEEP RACKS							
*-4833-B *-5833-B *-6733-B *-7733-B *-8433-B *-9033-B	**-424-B **-524-B **-624-B **-724-B **-824-B **-924-B	RB-3323	PA-42 PA-52 PA-61 PA-70 PA-77 PA-84	VS-42 VS-52 VS-61 VS-70 VS-77 VS-84	BR-124	SS-3324	RX-130

*For Prefix letters see chart on Par-Metal Page 5

**DETACHABLE SIDE PANELS used with Flush Mounted Side Panels use PREFIX LETTERS "RS".

**DETACHABLE SIDE PANELS used with Ball Cornered Side Panels use PREFIX LETTERS "RL".

KNOCKDOWN CABINET RELAY RACKS — FOR 19" WIDE PANELS AND 18" DEEP RACKS				Par-Metal Pages 19, 20
ER-213-A ER-215-A FD-215-A				ER-2212 ER-2212 R-2225
ER-217-A FD-217-A				ER-2212 R-2225
ER-223-A FD-223-A		PA-23	VS-23	ER-2212
ER-225-A FD-225-A		PA-25	VS-25	■BR-118 ■SS-1918 ER-2212
ER-227-A FD-227-A		PA-27	VS-27	■BR-118 ■SS-1918 ER-2212

■ For use with VS Supports. Without VS Supports, use Shelf R-2225 only.

The accessory charts shown on these 2 pages give you a complete listing of standard accessories which may be used with Par-Metal Modular Cabinet Racks listed on Par-Metal Pages 6, 7, 8. Relay Racks (see Par-Metal Pages 19-20) and Open Channel Type Racks (see Par-Metal Page 18).

PAR-METAL PRODUCTS • ENGINEERING ASSISTANCE AVAILABLE

Par.Metal

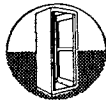

CONTEMPO-UNIT WELDED CABINET RACKS

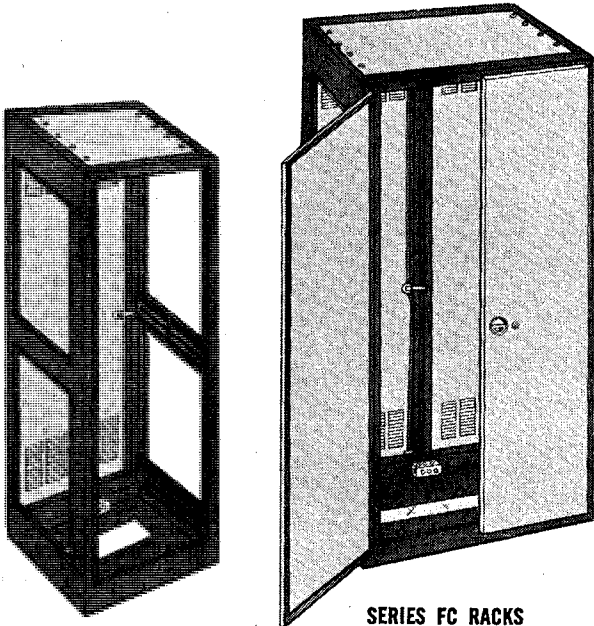

SERIES PC RACKS
With Rear Door Only
(Rack Frame)

SERIES FC RACKS
With Front and Rear Doors
(Racks for 30" Wide Panels Have
Two French Doors to Save Aisle Space)

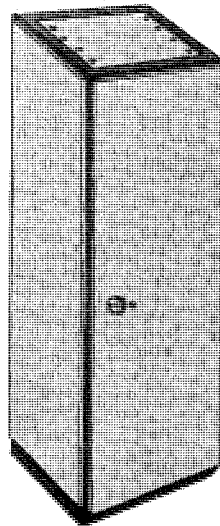

SERIES FC RACKS
With Pan Shaped Side Panels
and Recessed Base Added

MAJOR ACCESSORIES for Use With
CONTEMPO-RACKS Series "PC" and "FC"

(For full accessory check list, see facing page.)

PAN SHAPED SIDE PANELS: Side panels constructed from #16 gauge steel, formed edges, welded at all 4 corners. Supplied with coinciding brackets at bottom for easy alignment with rack sides. Top secured with cowl fastener, readily removable. 3/4" thick in finishes to match racks.

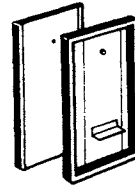

Cat. No.	To Fit Rack Nos.	Net Price (Per Pair)
CS-422	4212, 4222, 4232	\$49.55
CS-522	5212, 5222, 5232	53.55
CS-612	6112, 6122, 6132	58.60
CS-702	7012, 7022, 7032	62.40
CS-772	7712, 7722, 7732	65.75
CS-842	8412, 8422, 8432	69.40
CS-423	4213, 4223, 4233	56.99
CS-523	5213, 5223, 5233	61.59
CS-613	6113, 6123, 6133	67.39
CS-703	7013, 7023, 7033	71.77
CS-773	7713, 7723, 7733	75.61
CS-843	8413, 8423, 8433	79.81

RECESSED RACK BASES: Heavy duty bases made from #12 gauge (3/16") steel, rigidly formed and welded. Tapped holes on top match holes in bottom of racks; 4 adjustable floor levelers mounted on bottom. Not required with roller trucks. Bases 2 1/2" high.



Cat. No.	To Fit All Racks	Net Price
CB-1926	21" wide, 26" deep	\$17.85
CB-1931	21" wide, 31" deep	20.52
CB-2426	26" wide, 26" deep	19.43
CB-2431	26" wide, 31" deep	22.34
CB-3026	32" wide, 26" deep	21.00
CB-3031	32" wide, 31" deep	24.15

CONTEMPO-RACKS FOR PAN SHAPED SIDE PANELS (SERIES PC and FC)

PC SERIES REAR DOOR ONLY		FC SERIES FRONT & REAR DOORS		RACK DIMENSIONS							
Cat. No.	Net Price	Cat. No.	Net Price	OVERALL SIZE			PANEL SPACE Height x Width	*CLEAR INSIDE DEPTH	**CLEAR INSIDE WIDTH (FRONT)	REMOVABLE TOP PANEL	
				Height	Width	Depth				Width	Depth
FOR 19" WIDE PANELS AND 26" DEEP RACKS											
PC-4212	\$130.57	FC-4212	\$152.00	46 1/8"	21 1/8"	26 1/8"	42" x 19"	25"	17 3/4"	19"	21"
PC-5212	139.40	FC-5212	163.31	56 1/8"			52 1/2" x 19"				
PC-6112	149.74	FC-6112	174.39	65 1/8"			61 1/4" x 19"				
PC-7012	169.27	FC-7012	194.27	74 1/8"			70" x 19"				
PC-7712	180.51	FC-7712	210.51	81 1/8"			77" x 19"				
PC-8412	211.84	FC-8412	243.27	88 1/8"			84" x 19"				
FOR 19" WIDE PANELS AND 31" DEEP RACKS											
PC-4213	150.16	FC-4213	171.59	46 1/8"	21 1/8"	31 1/8"	42" x 19"	30"	17 3/4"	19"	24 1/2"
PC-5213	160.31	FC-5213	184.24	56 1/8"			52 1/2" x 19"				
PC-6113	172.20	FC-6113	196.84	65 1/8"			61 1/4" x 19"				
PC-7013	194.66	FC-7013	219.66	74 1/8"			70" x 19"				
PC-7713	207.59	FC-7713	237.59	81 1/8"			77" x 19"				
PC-8413	243.61	FC-8413	275.04	88 1/8"			84" x 19"				
FOR 24" WIDE PANELS AND 26" DEEP RACKS											
PC-4222	161.43	FC-4222	185.00	46 1/8"	26 1/8"	26 1/8"	42" x 24"	25"	22 3/4"	24"	21"
PC-5222	172.14	FC-5222	198.46	56 1/8"			52 1/2" x 24"				
PC-6122	183.37	FC-6122	210.47	65 1/8"			61 1/4" x 24"				
PC-7022	196.90	FC-7022	224.40	74 1/8"			70" x 24"				
PC-7722	216.86	FC-7722	249.86	81 1/8"			77" x 24"				
PC-8422	236.79	FC-8422	271.36	88 1/8"			84" x 24"				
FOR 24" WIDE PANELS AND 31" DEEP RACKS											
PC-4223	185.64	FC-4223	209.21	46 1/8"	26 1/8"	31 1/8"	42" x 24"	30"	22 3/4"	24"	24 1/2"
PC-5223	197.97	FC-5223	224.29	56 1/8"			52 1/2" x 24"				
PC-6123	210.87	FC-6123	237.97	65 1/8"			61 1/4" x 24"				
PC-7023	226.43	FC-7023	255.36	74 1/8"			70" x 24"				
PC-7723	248.07	FC-7723	281.07	81 1/8"			77" x 24"				
PC-8423	260.47	FC-8423	295.04	88 1/8"			84" x 24"				
FOR 30" WIDE PANELS AND 26" DEEP RACKS											
†PC-4232	181.44	†FC-4232	210.00	46 1/8"	32 1/8"	26 1/8"	42" x 30"	25"	28 3/4"	30"	21"
†PC-5232	198.51	†FC-5232	238.51	56 1/8"			52 1/2" x 30"				
†PC-6132	214.91	†FC-6132	260.63	65 1/8"			61 1/4" x 30"				
†PC-7032	233.06	†FC-7032	284.49	74 1/8"			70" x 30"				
†PC-7732	254.34	†FC-7732	310.05	81 1/8"			77" x 30"				
†PC-8432	275.56	†FC-8432	332.70	88 1/8"			84" x 30"				
FOR 30" WIDE PANELS AND 31" DEEP RACKS											
†PC-4233	208.66	†FC-4233	237.23	46 1/8"	32 1/8"	31 1/8"	42" x 30"	30"	28 3/4"	30"	24 1/2"
†PC-5233	228.29	†FC-5233	268.29	56 1/8"			52 1/2" x 30"				
†PC-6133	247.14	†FC-6133	292.86	65 1/8"			61 1/4" x 30"				
†PC-7033	268.01	†FC-7033	319.44	74 1/8"			70" x 30"				
†PC-7733	292.50	†FC-7733	348.21	81 1/8"			77" x 30"				
†PC-8433	316.88	†FC-8433	374.03	88 1/8"			84" x 30"				

* ALLOW FOR LATCH HANDLE. ** FOR CLEAR INSIDE WIDTH AT REAR, ADD 1 3/8". † Racks for 30" wide Panels have TWO FRENCH DOORS (with 3 point latching) to save aisle space. ■ ADD 3/4" for each side panel used. ■■ ADD 3/4" for front door. Handles are Flush Mounted.

Par-Metal

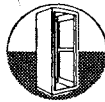

CABINET RACK ACCESSORIES

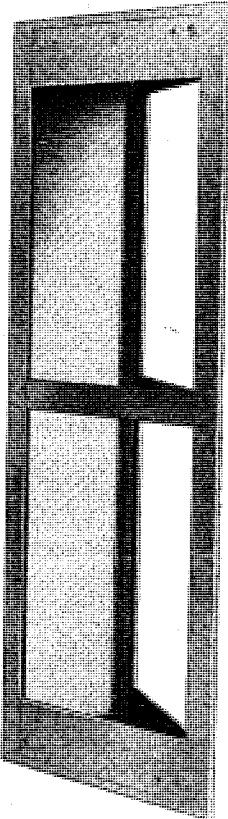

Cat. No. AF-6718-30
(with front vertical joining trim removed)

ANGULAR SECTION FRAMES (either 30° or 45°) are for use with Modular Cabinet Racks listed on Par-Metal Pages 6 through 11, and have the same sturdy welded frame. A removable formed steel panel is supplied at the rear. A similar panel is available for each side. Necessary joining trim is furnished.

To match Racks: Finish must be specified, (see Par-Metal Page 4). To supply the correct trims (at no charge with order), Rack prefix letters must be identified (see Par-Metal Page 5). Angular Wedges are bolted to racks and need no other base.

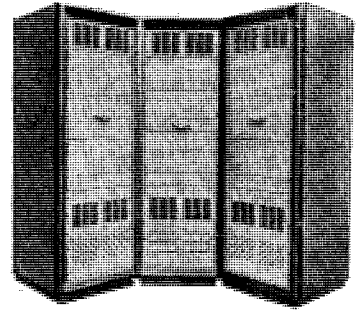

DIMENSIONS FOR ALL ANGULAR WEDGES

FOR 30° ANGLE FRAMES						FOR 45° ANGLE FRAMES				
Cat. No.	Rear Width	Rear Panel Width	Net Price	To Match Rack Height	Rack Depth	Panel Height	Cat. No.	Rear Width	Rear Panel Width	Net Price
WEDGES FOR PL/FL, PR/FR, PX/FX RACKS										
AF-4818-30	10"	7"	\$ 98.70	48 1/8"	18"	42"	AF-4818-45	15"	11 7/8"	\$103.55
AF-5818-30	10"	7"	105.00	58 5/8"	18"	52 1/2"	AF-5818-45	15"	11 7/8"	109.75
AF-6718-30	10"	7"	110.25	67 3/8"	18"	61 1/4"	AF-6718-45	15"	11 7/8"	115.80
AF-7718-30	10"	7"	122.60	76 1/4"	18"	70"	AF-7718-45	15"	11 7/8"	128.75
AF-8418-30	10"	7"	134.95	83 3/8"	18"	77"	AF-8418-45	15"	11 7/8"	141.65
AF-4824-30	13 1/4"	10 1/8"	120.20	48 1/8"	24"	42"	AF-4824-45	19 1/2"	16 1/2"	126.00
AF-5824-30	13 1/4"	10 1/8"	122.30	58 5/8"	24"	52 1/2"	AF-5824-45	19 1/2"	16 1/2"	132.30
AF-6724-30	13 1/4"	10 1/8"	132.30	67 3/8"	24"	61 1/4"	AF-6724-45	19 1/2"	16 1/2"	138.90
AF-7724-30	13 1/4"	10 1/8"	144.60	76 1/4"	24"	70"	AF-7724-45	19 1/2"	16 1/2"	151.85
AF-8424-30	13 1/4"	10 1/8"	157.00	83 3/8"	24"	77"	AF-8424-45	19 1/2"	16 1/2"	166.30
AF-9024-30	13 1/4"	10 1/8"	167.60	90 1/8"	24"	84"	AF-9024-45	19 1/2"	16 1/2"	180.60
WEDGES FOR CONTEMPO-RACKS										
CW-422-30	13 1/2"	10 3/8"	123.20	46 1/8"	26"	42"	CW-422-45	19 7/8"	16 3/4"	129.35
CW-522-30	13 1/2"	10 3/8"	125.35	56 1/8"	26"	52 1/2"	CW-522-45	19 7/8"	16 3/4"	131.60
CW-612-30	13 1/2"	10 3/8"	135.60	65 3/8"	26"	61 1/4"	CW-612-45	19 7/8"	16 3/4"	142.40
CW-702-30	13 1/2"	10 3/8"	148.20	74 3/8"	26"	70"	CW-702-45	19 7/8"	16 3/4"	155.63
CW-772-30	13 1/2"	10 3/8"	160.90	81 1/8"	26"	77"	CW-772-45	19 7/8"	16 3/4"	169.00
CW-842-30	13 1/2"	10 3/8"	171.80	88 1/8"	26"	84"	CW-842-45	19 7/8"	16 3/4"	180.35
CW-423-30	16"	12 7/8"	144.75	46 1/8"	31"	42"	CW-423-45	23 3/4"	20 5/8"	152.00
CW-523-30	16"	12 7/8"	147.30	56 1/8"	31"	52 1/2"	CW-523-45	23 3/4"	20 5/8"	154.65
CW-613-30	16"	12 7/8"	159.35	65 3/8"	31"	61 1/4"	CW-613-45	23 3/4"	20 5/8"	167.30
CW-703-30	16"	12 7/8"	174.15	74 3/8"	31"	70"	CW-703-45	23 3/4"	20 5/8"	182.85
CW-773-30	16"	12 7/8"	189.10	81 1/8"	31"	77"	CW-773-45	23 3/4"	20 5/8"	198.55
CW-843-30	16"	12 7/8"	201.85	88 1/8"	31"	84"	CW-843-45	23 3/4"	20 5/8"	211.90

EXTERIOR RACK TABLES

Table top is 3/4" plywood which is covered with formica across the full length of the top and on 3 sides. Sturdy battens underneath, plus 3/4" steel girders bolted to internal steel side supports, reinforce the assembly mounting. Tables are adjustable to any height and use 3 1/2" of panel height. They can be custom built to your specifications.

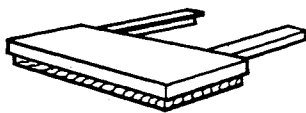

SIDE VIEW FOR CONTEMPO RACKS

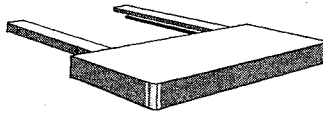

SIDE VIEW FOR OTHER RACKS

SINGLE UNIT			DOUBLE UNIT			TRIPLE UNIT		
Catalog Number	Table Width	Net Price	Catalog Number	Table Width	Net Price	Catalog Number	Table Width	Net Price
USE WITH RACKS FOR 19" WIDE PANELS								
•RX-119	21 1/4"	\$40.50	•RX-219	42 1/2"	\$83.50	•RX-319	64 1/4"	\$112.50
°CRX-19-1	21 1/4"	40.50	°CRX-19-2	42 1/4"	83.50	°CRX-19-3	63 3/4"	112.50
USE WITH RACKS FOR 24" WIDE PANELS								
•RX-124	26 1/4"	46.00	•RX-224	52 1/2"	91.00	•RX-324	79 1/4"	130.00
°CRX-24-1	26 1/4"	46.00	°CRX-24-2	52 1/4"	91.00	°CRX-24-3	78 3/4"	130.00
USE WITH RACKS FOR 30" WIDE PANELS								
•RX-130	32 1/4"	53.00	•RX-230	64 1/2"	98.50	•RX-330	96"	140.75
°CRX-30-1	32 1/4"	53.00	°CRX-30-2	64 1/4"	98.50	°CRX-30-3	96 1/4"	140.75
PRICES FOR QUAD UNIT TABLES ON REQUEST								
■ For Use with PL/FL, PR/FR and PX/FX Racks. ° For Use with Contempo-Racks.								

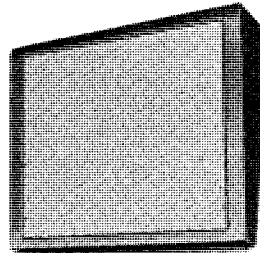

SLOPING PANEL TURRETS for 19" 24" and 30" wide panels. Turrets extend across full rack width and are fastened to panel mounting angles by means of adjustable brackets which are included. They may be used with the slope up or down. Complete with removable front panel. Matched to rack finishes. *Front width corresponds to rack dimensions. Overall height is 17 1/2".

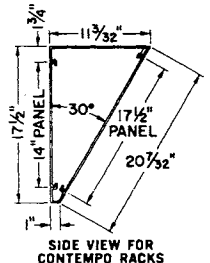

SIDE VIEW FOR CONTEMPO RACKS

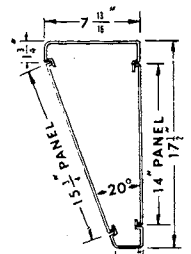

SIDE VIEW FOR OTHER RACKS

For Contempo-Racks		*Fits Racks with Panel Width	For PL/FL, PR/FR and PX/FR Racks	
Catalog Number	Net Price		Catalog Number	Net Price
CSP-19	\$46.00	19"	SP-1719	\$44.10
CSP-24	55.00	24"	SP-1724	52.50
CSP-30	71.00	30"	SP-1730	68.25

For information on Hinged Doors, Model DR, please turn to Par-Metal Page 29.

Par.Metal

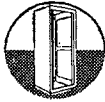

ROLLER TRUCKS

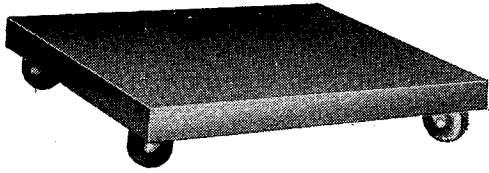

A Single Unit Contempo Roller Truck, Model No. CR-192-1.

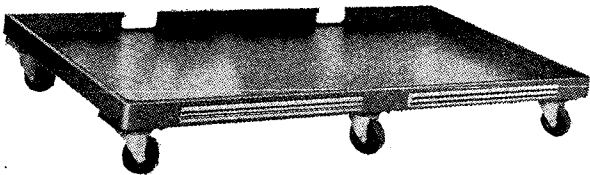

A Double Professional Roller Truck, Model No. HD-426-2.

2 PL-6718-B Racks with 1 RX-219 Exterior Table and a double EB-502 Extended Base Roller Truck with 2 EBL-501 Floor Locks.

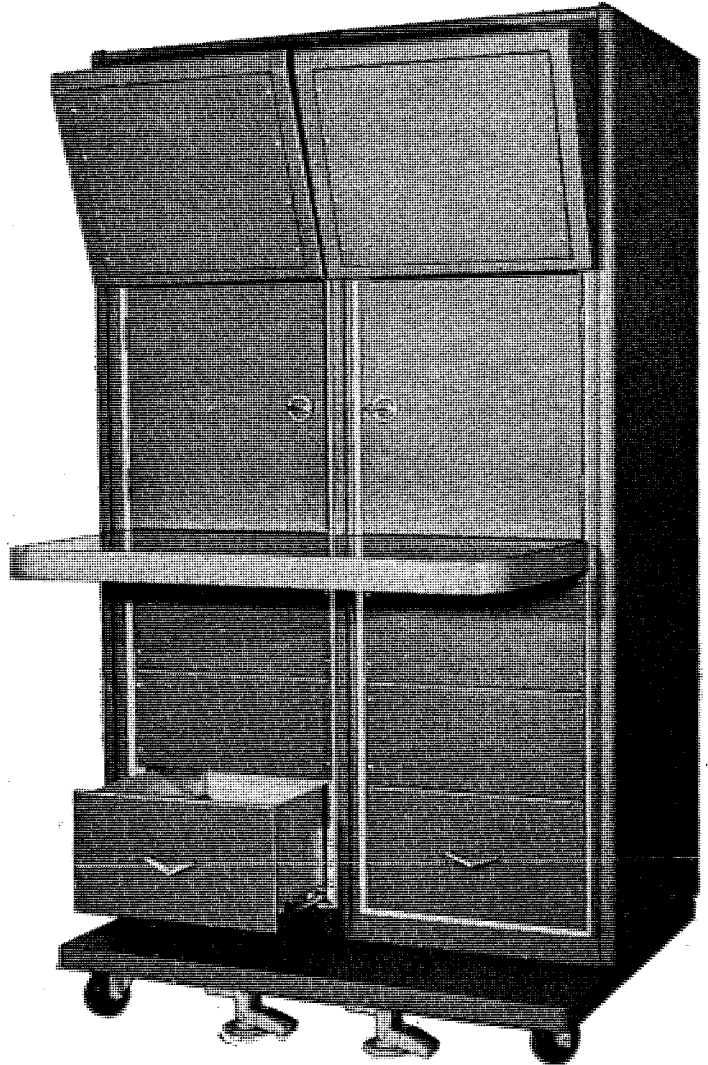

GENERAL DESCRIPTION

ROLLER TRUCKS are engineered to fit and complement all PAR-METAL cabinet racks. All Roller Trucks designated for PL/FL, PR/FR, PX/FX, ER/FD and DL racks are **Dish Shaped**. The inside dimensions are slightly larger than cabinet sizes, as a safety factor, and to provide better weight distribution. These models have rounded front corners and chrome plated moulding.

CONTEMPO-ROLLER TRUCKS (Models CR, CRB and CEB) are **Pan Shaped** — flat across the top with aprons which partially cover the casters. They are sized to match the rack they support. Mating holes allow rapid bolting to the rack. Roller Trucks are available for one, two, or three racks. Single rack trucks have four casters... double rack trucks, six casters... and triple rack trucks have eight casters.

Unless specified, **ALL** Roller Trucks except CONTEMPO, are finished in blue-gray wrinkle enamel. For PC/FC Racks, (Models CR, CRB and CEB) the **standard** finish is Dawn Gray Vinyl. When included in the order, Roller Trucks are matched to the Rack. For full finishing color guide, turn to PAR-METAL Page 4.

HEAVY DUTY TRUCKS: Construction: $\frac{1}{8}$ " welded steel plus $\frac{1}{4}$ " steel reinforcing braces. Casters: 3" diameter, swivel type, ball bearing, Rockite Composition. Non-marking wheels. Load Capacity 225 lbs. per wheel. Single Units have four casters, Double Units have six casters and Triple Units have eight.

BRAKE CASTERS: Toe-Touch Brake casters are optional; they replace the 2 Front corner casters of any Heavy Duty Roller Truck.

EXTENDED BASE ROLLER TRUCKS: Extended Base Roller Trucks offer extra depth in front and are strongly recommended when racks are equipped with slide, tables or drawers which may bear extra weight or pressure when extended. The added depth in front of the rack provides stability and safety. For easier movement of the racks 4" diameter wheel casters are supplied. Provision is made for adding Heavy Duty Floor Locks (optional). Construction: .104" welded steel — plus $\frac{1}{4}$ " steel reinforcing braces. Casters: 4" diameter, swivel type, ball bearing, hard Rockite non-marking wheel with grease fittings. Load Capacity 450 lbs. per wheel.

STANDARD TRUCKS Construction: $\frac{1}{8}$ " welded steel. Casters: 2" diameter, swivel-type, ball bearing, Rockite Composition wheels. Load capacity — 125 lbs. per wheel.

PAR-METAL PRODUCTS • CONVENIENT FACTORY WAREHOUSE

Par-Metal

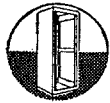

SLIDE ASSEMBLIES

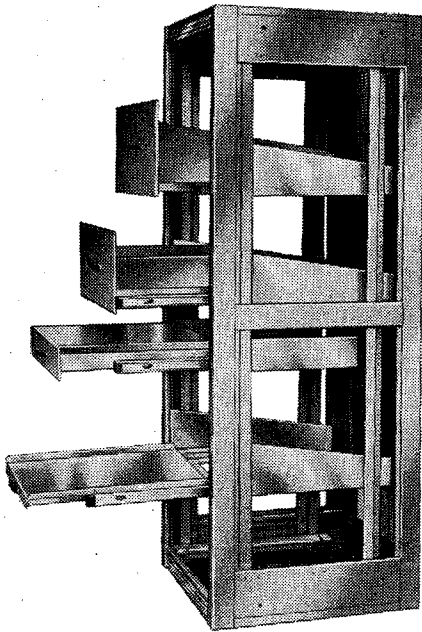

SIMPLICITY: Just a cradle and a shelf, table or drawer are all that is required. No time consuming assembly of slides and no alignment problem.

EASE OF INSTALLATION: Cradle is mounted to panel angles of the rack with screws and drawer, table or shelf drops into place. This manner of installing the sliding unit permits fast removal for service of equipment.

MOUNTING METHODS: Brackets are attached to Panel Angles and may be attached to Vertical Side Supports for additional stability. Either method will provide rigid support. Both may be used simultaneously.

FULL EXTENSION of the equipment from the rack is engineered in. Thus, accessibility to top, sides, and back of most adjustments may be made without removal.

RUGGED CONSTRUCTION: Parts welded or fastened with stainless steel rivets and machine screws... supporting parts made from 12 gauge (.104") Prime Steel.

MINIMAL DEFLECTION is produced when the listed load capacities are measured with the slides fully extended.

HANDLES: A "V" Shaped Chrome Plated Pull Handle Model V-24 with necessary hardware is standard equipment on all Slide Assemblies. On **CONTEMPO** line **ONLY**, to substitute modern handle H-505 (at same cost) Suffix "H" **MUST** be added to model number on your original order.

BASIC SLIDE ASSEMBLIES: Consist of a readily removable shelf, a pair of slides, and a mounting cradle. Each part is ready for installation. All movable parts are mounted on ball bearing wheels. Mounting or removal of slide is extremely simple and does not require tools.

Installation may be made to rack (or console) panel mounting angles or to standard vertical side supports through holes pre-drilled in the side brackets. Four Sizes are listed for using either 19" or 24" wide panels. ALL parts are zinc plated.

* All load capacities are conservatively rated to carry the full load with the sliding shelf completely extended. All parts are zinc plated.

Catalog No.	Usable Width	Space Depth	Panel Width	Rack Depth	*Load Capacity	Net Price	Shipping Weight
BS-1980	17 $\frac{1}{8}$ "	14"	19"	18" or 24"	50 lbs.	\$20.75	24 lbs.
BS-1940	17 $\frac{1}{8}$ "	20"	19"	24"	36 lbs.	26.45	32 lbs.
BS-2419	17 $\frac{1}{8}$ "	20"	19"	24"	60 lbs.	33.70	32 lbs.
BS-2424	22 $\frac{1}{8}$ "	20"	24"	24"	55 lbs.	36.30	35 lbs.

Special brackets are available for mounting rack panels, as listed on Par-Metal page 36.

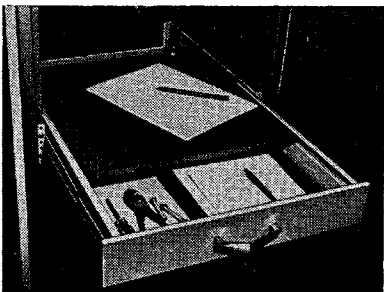
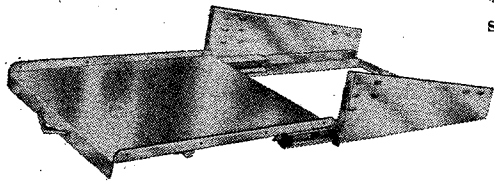

NEW SLIDE TOP STORAGE DRAWER DESK SHELF ASSEMBLIES

NEW PAR-METAL DESIGN (Patent Pending) presents the **FIRST** combination of a slide-back Formica retractable writing table on a 2 $\frac{1}{2}$ " deep storage drawer. All units are 17" deep with 3 $\frac{1}{2}$ " of panel height and have a 50 lb. load capacity in fully extended position. Keep your tools and notes in the **MOST** convenient place. Your fingers can't get caught between desk and front panel. Drawer has finger touch disconnect feature. **IMPORTANT:** When ordering, please specify finish on front panels.

Cat. No.	Drawer Width	Panel Width	Net Price	Shpg. Wt.
SD-1935	16 $\frac{1}{2}$ "	19"	\$48.90	32
SD-2435	21 $\frac{1}{2}$ "	24"	57.00	35

DESK SHELF ASSEMBLIES

Designed as a retractable writing desk or as a support for test equipment, etc. Front requires only 3 $\frac{1}{2}$ " of panel space, and is provided with a chrome plated drawer pull. **FINISH:** Writing surface is Gray Formica. Front panel matches Rack. **IMPORTANT:** When ordering, please specify finish on front panels.

Catalog No.	Shelf Width	Shelf Depth	Pulls Out	Panel Width	Rack Depth	*Load Capacity	Net Price	Shipping Weight
SK-1970	17"	17"	16 $\frac{3}{8}$ "	19"	18" or 24"	36 lbs.	\$37.85	32 lbs.
SK-2419	17"	17"	16 $\frac{3}{8}$ "	19"	18" or 24"	60 lbs.	43.70	32 lbs.
SK-2424	22"	17"	16 $\frac{3}{8}$ "	24"	24"	60 lbs.	50.90	35 lbs.

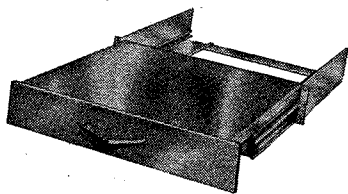

STORAGE DRAWER ASSEMBLIES

Drawers are mounted on racks or consoles and are available in 7" or 10 $\frac{1}{2}$ " panel heights; finished to match the equipment into which they are installed. Please mention **finish** in your order. Chrome plated door pull is furnished.

Catalog No.	Usable Width	Space Length	Depth	Panel Height	Panel Width	Rack Depth	*Load Capacity	Net Price	Shipping Weight
DD-1980	17"	14"	5"	7"	19"	18" or 24"	40 lbs.	\$27.85	33 lbs.
DD-1940	17"	20"	5"	7"	19"	24"	25 lbs.	36.75	42 lbs.
DD-2419	17"	20"	8"	10 $\frac{1}{2}$ "	19"	24"	45 lbs.	44.15	50 lbs.
DD-2424	22"	20"	8"	10 $\frac{1}{2}$ "	24"	24"	45 lbs.	49.00	50 lbs.

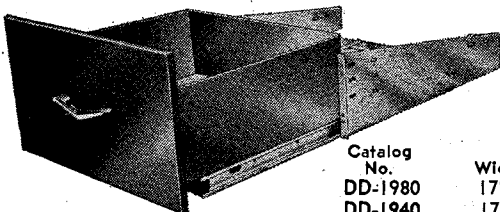

PAR-METAL PRODUCTS • ENGINEERING ASSISTANCE AVAILABLE

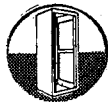
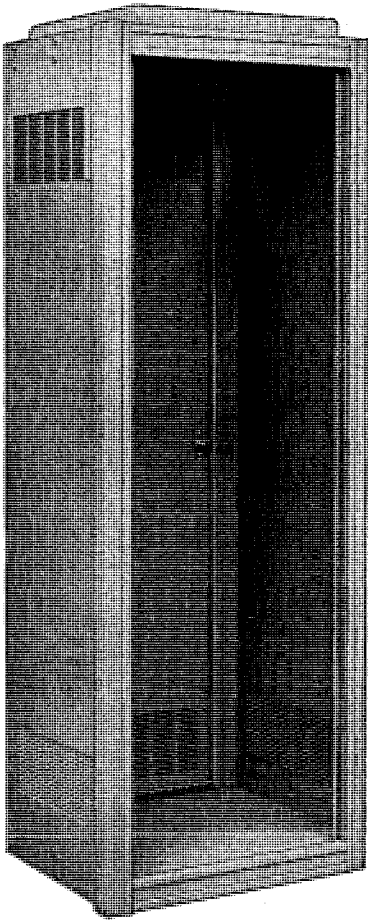
Par-Metal**KNOCKDOWN CABINET RELAY RACKS****DELUXE CABINETS — FOR 19" WIDE PANELS**

**"ER" SERIES
WITH REAR DOOR ONLY**

CABINET is 1/16" sheet steel. Sides are ventilated with "venetian" louvres. Vertical corner trims and formed mouldings are at top and bottom. Racks are shipped "knocked down" for easy assembly.

CORNER TRIMS: Front vertical corner and joining trims are engineered to permit rapid installation of sliding shelves, drawers, tables, etc.

PANEL MOUNTING: Angle irons are 7/64" thick steel, holes are drilled and tapped 10-32 on EIA hole spacing.

HARDWARE: Doors are the same as our modular racks. "Series ER" racks are equipped with automobile non-locking handles while "Series FD" racks have handles with key locks. Hinges are "slipjoint" type so doors may be easily removed.

FINISH: Blue grey wrinkle finish is standard. Black wrinkle enamel or grey hammertone enamel are available without extra charge.

ROLLER TRUCK: Use either No. RT-412 or HD-412 for all racks listed on this page.

PANELS: Panels 19" wide to fit these racks are listed on Par-Metal Pages 21 and 22.

SHELVES: For Series ER Racks use shelf No. ER-2212 listed on Par-Metal Page 36.

SERIES "FD" RACKS have bolt retainer rails to adjust the front to back position of their panel mounting angles. Optional Vertical Side Supports with Brackets and shelves (listed on Par-Metal Page 14) fit in these racks.

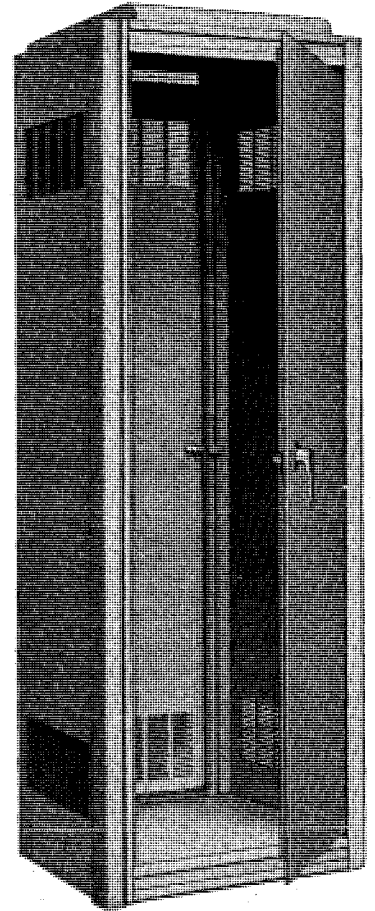

**"FD" SERIES
WITH FRONT AND
REAR DOOR**

SPECIFICATIONS

Catalog No.	Doors	Overall Dimensions	Panel Space	Clear Inside Width (Front)	Clear Inside Width (Rear)	Clear Inside Depth	Shipping Wt. Lbs.	Net Price
ER-223-A	Rear only	43¼x22x18"	36¾x19"	**17½"	19"	16¾"	90	\$ 57.40
ER-225-A	Rear only	67¾x22x18"	61¼x19"	**17½"	19"	16¾"	120	70.80
ER-227-A	Rear only	83½x22x18"	77 x19"	**17½"	19"	16¾"	140	85.50
FD-223-A	Front & Rear	43¼x22x18"	36¾x19"	19½"	19"	*16"	110	73.60
FD-225-A	Front & Rear	67¾x22x18"	61¼x19"	19½"	19"	*16"	150	91.40
FD-227-A	Front & Rear	83½x22x18"	77 x19"	19½"	19"	*16"	175	114.35

*clearance between front and rear doors.

**between panel mounting angles.

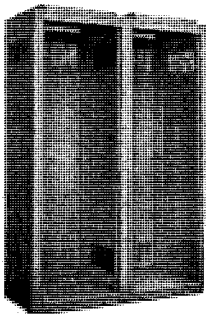

MULTI-RACK CABINET ASSEMBLIES

MULTI-RACK ASSEMBLIES: Both "ER" and "FD" racks may be set up in rows. The use of venetian louvers provides a flat surface on the sides; separate side plates with welded screw studs inserted at top and bottom simplify the assembly — no tools are needed. Vertical joining trims overlap the joint between racks (supplied at no cost if noted on original order).

PAR-METAL PRODUCTS • CONVENIENT FACTORY WAREHOUSE



PAR-METAL PANELS are divided into three types, flat blank panels, formed blank panels and panels for special uses.

ALL PAR-METAL PANELS are cut to fit any Electronic Housing Equipment that also meets EIA hole specifications.

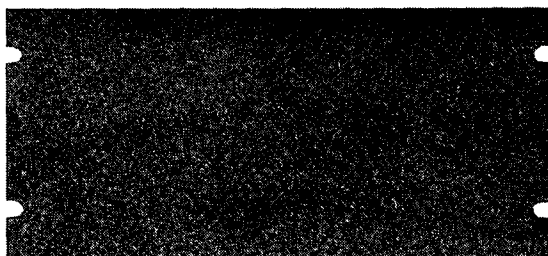

BLANK, FLAT PANELS 19" - 24" - 30" WIDE

For Simplicity, finishes have been omitted from these charts. To ORDER, COLOR PREFIXES MUST be added to the Catalog Numbers.

FINISH	USE PREFIX	USE NET PRICE COLUMN
Black Wrinkle Enamel	P	A
Blue-Gray Wrinkle Enamel	G	A
Oil Finish (No Paint)	NP	A
Light Gray Hammertone	LH	B
Dark Gray Hammertone	DH	B
Combination Light/Dark Gray Hammertone	LD	B
Dark Gray Metallic Enamel	GM	B
Beige Enamel	MT	B
Light Gray Equipment Enamel	LEGE	B
Primer Coat Only	PC	B
Dawn Gray Vinyl	DG	C

STANDARD FLAT STEEL BLANK PANELS - #11 Gauge - 1/8" (.119") STEEL

PANEL HEIGHT	FOR 19" WIDE PANELS				FOR 24" WIDE PANELS				FOR 30" WIDE PANELS			
	Cat. No.	NET PRICES			Cat. No.	NET PRICES			Cat. No.	NET PRICES		
		A	B	C		A	B	C		A	B	C
1 3/4"	-6600	\$.89	\$.98	\$ 1.02								
3 1/2"	-6601	1.12	1.23	1.29	-6201	\$ 1.45	\$ 1.59	\$ 1.67	-6301	\$ 2.10	\$ 2.31	\$ 2.42
5 1/4"	-6602	1.42	1.56	1.63	-6202	1.86	2.05	2.14	-6302	2.55	2.81	2.93
7"	-6603	1.72	1.89	1.98	-6203	2.27	2.50	2.61	-6303	3.00	3.30	3.45
8 3/4"	-6604	2.10	2.31	2.42	-6204	2.90	3.19	3.34	-6304	3.60	3.96	4.14
10 1/2"	-6605	2.31	2.54	2.66	-6205	3.30	3.63	3.80	-6305	3.99	4.39	4.59
12 1/4"	-6606	2.87	3.16	3.30	-6206	3.75	4.12	4.31	-6306	4.71	5.18	5.42
14"	-6607	3.18	3.50	3.66	-6207	4.35	4.78	5.00	-6307	5.37	5.91	6.18
15 3/4"	-6608	3.56	3.92	4.09	-6208	4.95	5.44	5.69	-6308	6.00	6.60	6.90
17 1/2"	-6609	3.96	4.36	4.55	-6209	5.40	5.94	6.21	-6309	6.72	7.39	7.73
19 1/4"	-6610	4.60	5.06	5.29	-6210	6.09	6.70	7.00	-6310	7.44	8.18	8.56
21"	-6611	4.86	5.35	5.59	-6211	6.60	7.26	7.59	-6311	8.16	8.98	9.38

STANDARD ALUMINUM BLANK PANELS - 1/8" No. 3003—H 14

PANEL HEIGHT	FOR 19" WIDE PANELS				FOR 24" WIDE PANELS				FOR 30" WIDE PANELS			
	Cat. No.	NET PRICES			Cat. No.	NET PRICES			Cat. No.	NET PRICES		
		A	B	C		A	B	C		A	B	C
1 3/4"	-6675	\$ 1.06	\$ 1.16	\$ 1.22	-6275	\$ 1.80	\$ 1.98	\$ 2.07				
3 1/2"	-6676	1.50	1.65	1.73	-6276	2.28	2.51	2.62	-6376	\$ 2.73	\$ 3.00	\$ 3.14
5 1/4"	-6677	2.05	2.25	2.36	-6277	3.00	3.30	3.45	-6377	3.96	4.36	4.55
7"	-6678	2.60	2.86	2.99	-6278	3.81	4.19	4.38	-6378	5.19	5.71	5.97
8 3/4"	-6679	3.15	3.46	3.62	-6279	4.74	5.21	5.45	-6379	6.42	7.06	7.38
10 1/2"	-6680	3.80	4.18	4.37	-6280	5.73	6.30	6.59	-6380	7.65	8.42	8.80
12 1/4"	-6681	4.25	4.67	4.89	-6281	6.66	7.33	7.66	-6381	8.88	9.77	10.21
14"	-6682	5.00	5.50	5.75	-6282	7.62	8.38	8.76	-6382	10.11	11.12	11.63
15 3/4"	-6683	5.65	6.22	6.50	-6283	8.58	9.44	9.87	-6383	11.34	12.47	13.04
17 1/2"	-6684	6.15	6.76	7.07	-6284	9.54	10.49	10.97	-6384	12.57	13.83	14.46
19 1/4"	-6685	6.70	7.37	7.71	-6285	10.47	11.52	12.04	-6385	13.80	15.18	15.87
21"	-6686	7.30	8.03	8.40	-6286	11.40	12.54	13.11	-6386	15.00	16.50	17.25

STANDARD ALUMINUM BLANK PANELS 19" WIDE - 3/16" No. 3003—H 14

PANEL HEIGHT	Cat. No.	NET PRICES			PANEL HEIGHT	Cat. No.	NET PRICES		
		A	B	C			A	B	C
1 3/4"	-6675-3	\$ 1.65	\$ 1.75	\$ 1.81	12 1/4"	-6681-3	\$ 7.20	\$ 7.62	\$ 7.84
3 1/2"	-6676-3	2.28	2.43	2.51	14"	-6682-3	8.22	8.72	8.97
5 1/4"	-6677-3	3.36	3.56	3.67	15 3/4"	-6683-3	9.30	9.86	10.15
7"	-6678-3	4.14	4.40	4.53	17 1/2"	-6684-3	10.35	10.96	11.27
8 3/4"	-6679-3	5.16	5.47	5.63	19 1/4"	-6685-3	11.40	12.07	12.41
10 1/2"	-6680-3	6.18	6.56	6.75	21"	-6686-3	12.60	13.33	13.70

COLOR FINISHES MUST BE SPECIFIED ON YOUR ORDER.

We will be pleased to estimate your requirements for any other sizes or finishes.

DOOR MODIFICATIONS

FRONT AND REAR DOORS FOR RACKS

Doors are mounted on slip-joint hinges for easy removal. On CONTEMPO-RACKS, front doors are PAN shaped, 3/4" thick and have flush mounted door handles. Rear doors are "Dutch Formed."

On other Racks all doors are "Dutch Formed." Right hand hinges are standard. Left Hand hinges are optional. Door modifications marked * are optional at NO additional cost. All others must be estimated. Doors are finished to match racks.

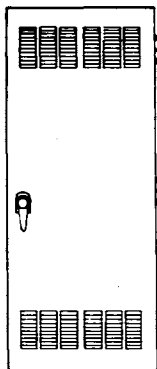

*MODIFICATION LS
VENETIAN LOUVERS at
TOP and BOTTOM ...
(Standard Rear Door)

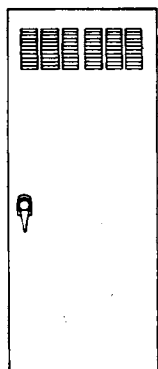

*MODIFICATION LT
VENETIAN LOUVERS at
TOP ONLY ...

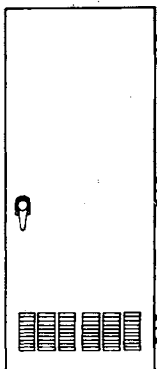

*MODIFICATION LB
VENETIAN LOUVERS at
BOTTOM ONLY ...

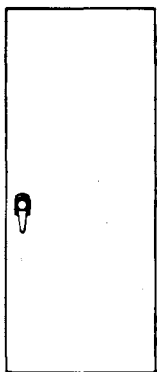

*MODIFICATION SS
NO LOUVERS SOLID
DOOR ...
(Standard Front Door.)

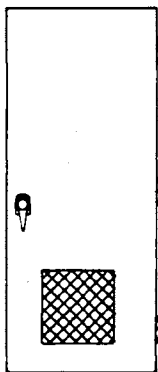

MODIFICATION FD
10" x 10" Opening for
filter (Filter included).

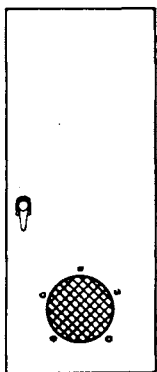

MODIFICATION FN
ROUND OPENING for FAN
with Mounting Holes.
See Hardware Section
Par-Metal Page 37.

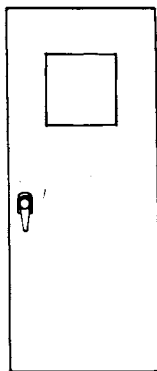

MODIFICATION SW
Square Opening for Win-
dow (Without Glass) Give
Full Specifications ...

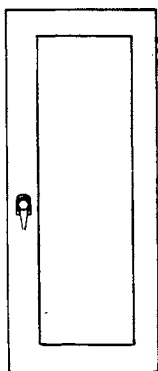

MODIFICATION RW
Rectangular Window
Opening (Without Glass)
Give Full Specifications...

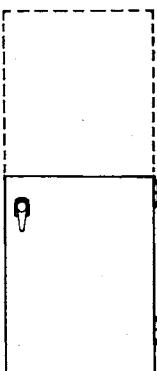

MODIFICATION HD
HALF OR SHORT DOOR
(On Estimate Only).
Give Full Specifications...

TOP PANEL MODIFICATIONS

FOR PANEL RACKS

Blank, #16 gauge Removable Formed steel panels are standard in the top of all racks. For the cost of Ventilating or Fan, etc. modifications, see chart below. Please use identity prefix letters.

EXPANDED METAL MESH Modification TA

Mesh is spot welded under the frame. .055" steel — Diamond shaped openings — 5/16" x 7/8".

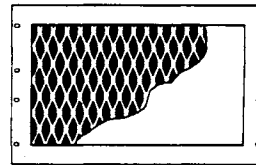

PRESSED LOUVERS Modification TB

Hooded Openings are 7" wide and formed into the steel with the louvers opening to the outside.

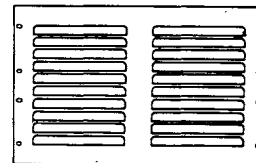

VENETIAN LOUVERS Modification TC

Vent openings are formed into the steel top with the louvers opening to the inside.

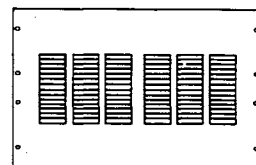

PERFORATED HOLES Modification TH

Mesh is spot welded under the frame. .055" steel. The holes are staggered — 3/16" diameter on 5/16" centers.

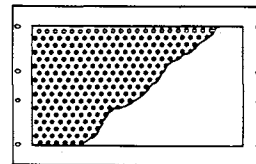

FAN OPENING Modification TF

Circular opening and mounting holes provided. When ordering, give complete dimensional specifications and mounting hole requirements, (see Par-Metal Page 37.)

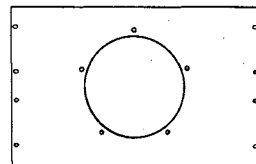

STANDARD TOP PANEL SUPPLIED UNLESS OTHERWISE SPECIFIED

TOP MODIFICATIONS ••• DIMENSIONS AND COSTS							
TO FIT RACK SIZE		Modification TA & TH		Modification TB Louvers		Modification TC Louvers	
Panel Width	Panel Depth	Mesh Size	Net Price	# of Rows	Net Price	Sets	Net Price
19"	18"	16 3/4" x 10 1/4"	\$3.50	2	\$2.50	Single	\$2.00
19"	24"	16 3/4" x 17 1/4"	4.00	2	3.00	Double	2.00
19"	26"	16 3/4" x 19 1/4"	4.25	2	3.25	Double	2.75
19"	31"	16 3/4" x 22 1/2"	4.75	3	3.75	Double	2.75
24"	24"	21 3/4" x 17 1/4"	4.50	2	3.00	Double	2.50
24"	26"	21 3/4" x 19 1/4"	4.75	2	3.25	Double	2.75
24"	31"	21 3/4" x 22 1/2"	5.25	2	4.25	Double	3.25
30"	24"	27 3/4" x 17 1/4"	5.25	3	4.00	Double	3.00
30"	26"	27 3/4" x 19 1/4"	5.50	3	4.25	Double	3.25
30"	31"	27 3/4" x 22 1/2"	6.00	3	5.00	Double	4.00

Par.Metal

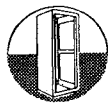

PROFESSIONAL PEDESTAL FRAMES

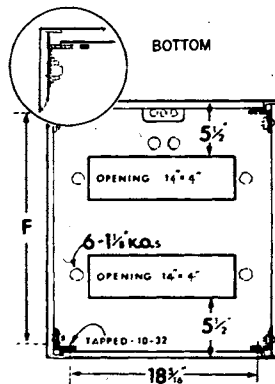
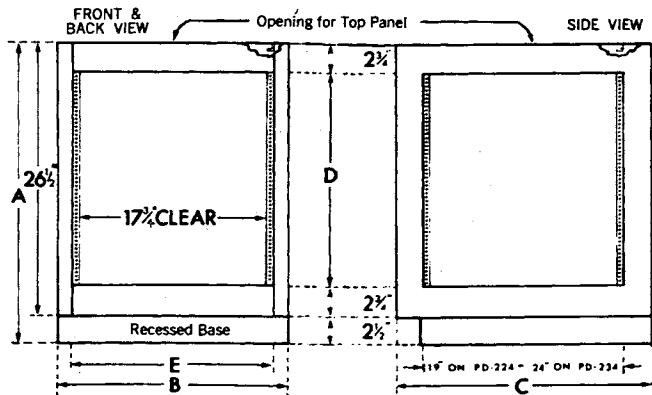

Catalog Number	Dimensions			Panel Space		Clear Inside Depth	Opening For Top Panel		Overall Dimensions with Side Panels and Front Mouldings			Shipping Wt. Lbs	Net Price
	Hgt.	Width	Depth	Front Hgt.	Back Hgt.		Width	Depth	Hgt.	Width	Depth		
PD-224	29"	22"	24 1/4"	21"	19"	23 1/8"	19"	19 1/4"	30"	24 1/2"	25 3/8"	80	\$ 84.50
PD-234	29"	22"	34 1/4"	21"	19"	33 1/8"	19"	28"	30"	24 1/2"	35 3/8"	90	101.50

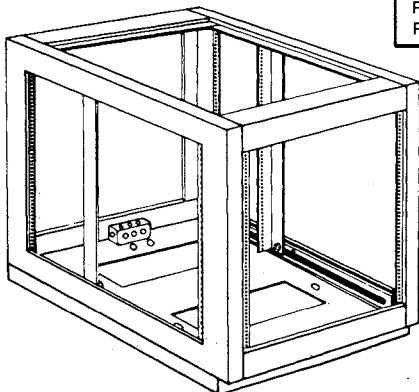

PROFESSIONAL PEDESTAL

PEDESTAL FRAMES: The Pedestal Frame forms the base of all equipment to be mounted below desk table level. It is solidly welded for rigorous use. It mounts 19" wide panel equipment. A reinforced base and two pairs of Panel Mounting Angles are included. Angles are readily adjustable to any forward or back position. Each Frame has a fitted #12 gauge (.104") steel removable bottom plate, some with knockouts and access areas (see diagrams above). PAR-METAL makes 2 basic design models, **PROFESSIONAL** and **CONTEMPO**. **PROFESSIONAL** Pedestals, illustrated above, (Prefix — PD) are trimmed to match and complement our "PL" Cabinet Racks. #PD-224 Frames have 19" x 19 1/4" Top and Bottom openings. On #PD-234, this opening is 19" x 28". See Component Group Check List on PAR-METAL Pages 27/28 and Top Cabinets on facing page.

CONTEMPO-PEDS, illustrated below, (Prefixes CPD & CPS) are designed to mate with CONTEMPO-RACKS. See Component Group List on PAR-METAL Pages 31/32. CONTEMPO-Top Cabinets are on PAR-METAL Page 33. 30° & 45° Angular Wedges for these are shown on PAR-METAL Page 32. A 3 1/2" x 19" panel, Model #6601-R with mounted Electric Dual Receptacle is available. Casters: 3" diameter Rockite composition non-marking ball bearing wheels — heavy duty. (Available at extra cost.)

FINISHES: Unless specified, "PD" Peds are finished in a combination of Light and Dark Gray Hammertone Enamel (LD) while CONTEMPO-PEDS are finished in Dawn and Charcoal Gray Textured Vinyl. For your choice of others, please turn to PAR-METAL Page 24. To fit these frames Panel Angles and Vertical Side Supports for Professional and Contempo are shown in chart below.

EXTRA PANEL ANGLES & VERTICAL SIDE SUPPORTS

TO FIT PEDESTAL	PANEL ANGLES		VERTICAL SIDE SUPPORTS	
	Catalog Number	Net Price Per Pair	Catalog Number	Net Price Per Set of 4
PD-224/234	PA-21	\$ 7.75	VS-21	\$12.95
CPD-24/34	CPA-26	8.65	CVS-26	13.85
CPS-24/34	CPA-36	10.00	CVS-36	15.75

CONTEMPO - PEDS

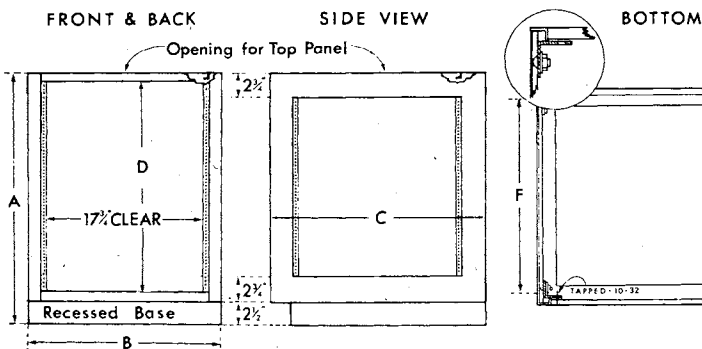
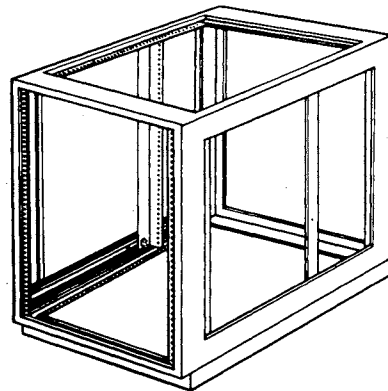

PEDESTAL DIMENSIONS

CATALOG NUMBER	OVERALL DIMENSIONS			#PANEL HEIGHT		SIDE OPENING		CLEAR INSIDE	NET PRICE
	Height	Width	Depth	Front/Back	Top	Height	Width	Depth	
	A	B	C	D	E			F	
CPD-24	29 1/8"	21 1/8"	24 1/4"	24 1/2"	19 3/4"	21"	19"	23 1/4"	\$ 79.00
CPD-34	29 1/8"	21 1/8"	34 3/4"	24 1/2"	29 3/4"	21"	30"	33 3/4"	96.00
CPS-24	39 1/8"	21 1/8"	24 1/4"	35"	19 1/4"	31 1/2"	19"	23 1/4"	94.80
CPS-34	39 1/8"	21 1/8"	34 3/4"	35"	29 3/4"	31 1/2"	30"	33 3/4"	113.25



COMPONENT GROUP CHECK LIST

PROFESSIONAL CONSOLES

There are four models of Desk Panel Cabinets, designed to complement and fit on top of the Consoles detailed here. For simplicity, they are omitted from these check lists. Complete information on Desk Panel Cabinets will be found on Par-Metal Page 26.

■ When Desk Panel Cabinet is to be added, follow this Key letter horizontally on facing page. Cabinet details are on Par-Metal Page 26.

‡ When Desk Panel Cabinets will not be used, follow this key letter horizontally on facing page.

SINGLE UNIT ASSEMBLIES

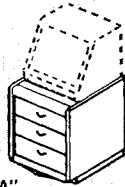

■ FIG. "A"
‡ FIG. "B"

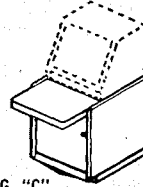

■ FIG. "C"
‡ FIG. "D"

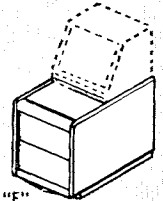

■ FIG. "E"
‡ FIG. "F"

DOUBLE UNIT ASSEMBLIES

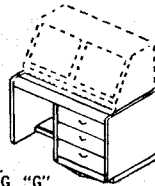

■ FIG. "G"
‡ FIG. "H"

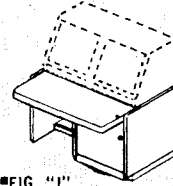

■ FIG. "J"
‡ FIG. "K"

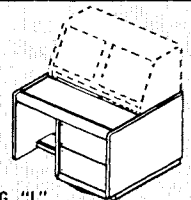

■ FIG. "L"
‡ FIG. "M"

TRIPLE UNIT ASSEMBLIES

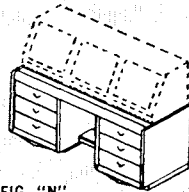

■ FIG. "N"
‡ FIG. "O"

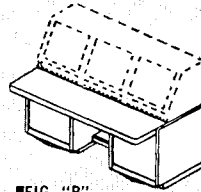

■ FIG. "P"
‡ FIG. "R"

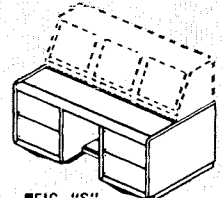

■ FIG. "S"
‡ FIG. "T"

TRIPLE UNIT ASSEMBLIES

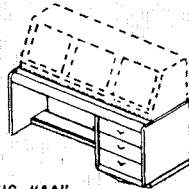

■ FIG. "AA"
‡ FIG. "BB"

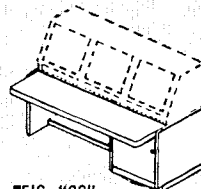

■ FIG. "CC"
‡ FIG. "DD"

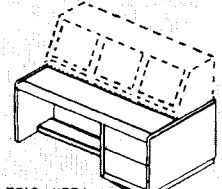

■ FIG. "EE"
‡ FIG. "FF"

QUAD UNIT ASSEMBLIES

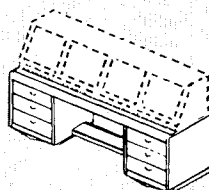

■ FIG. "GG"
‡ FIG. "HH"

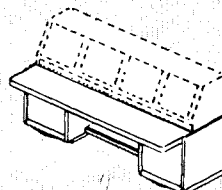

■ FIG. "JJ"
‡ FIG. "KK"

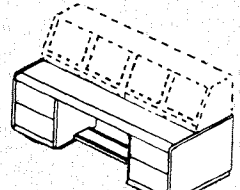

■ FIG. "LL"
‡ FIG. "MM"

QUAD UNIT ASSEMBLIES

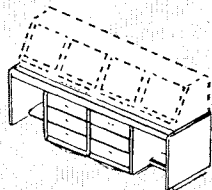

■ FIG. "PP"
‡ FIG. "RR"

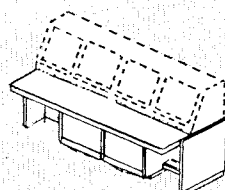

■ FIG. "SS"
‡ FIG. "TT"

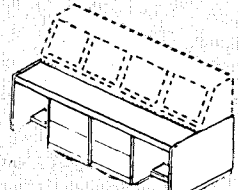

■ FIG. "XX"
‡ FIG. "ZZ"

PAR-METAL PRODUCTS • CONVENIENT FACTORY WAREHOUSE

Par-Metal CONSOLE ACCESSORIES

EXTERIOR DESK TABLES for CONSOLES listed on Par-Metal Pages 27/28 and 31/32 are made from 3/4" plywood with gray Formica on top and aprons. This provides a smooth writing surface across entire top. Tables have 3/4" steel horizontal channel supports, but no metal parts are exposed. Request estimate for custom work.

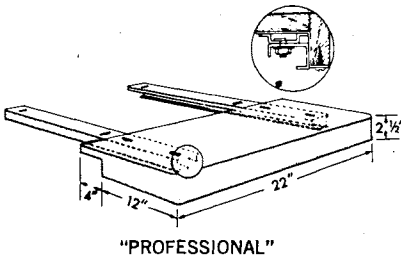

"PROFESSIONAL"

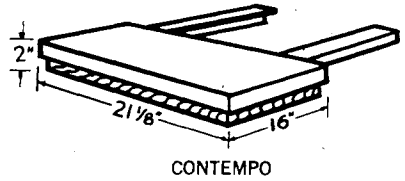

CONTEMPO

"Professional" Consoles			Contempo-Consoles		
Catalog No.	Net Price		Catalog No.	Net Price	
CT-119	\$27.30	SINGLE	CCT-116	\$ 29.35	
CT-219	46.20	DOUBLE	CCT-216	58.65	
CT-319	66.00	TRIPLE	CCT-316	84.00	
CT-419	80.90	QUAD	CCT-416	109.35	

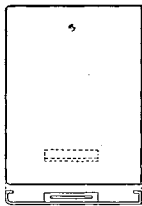

DETACHABLE SIDE PANELS for CONSOLES are shaped to match their pedestals. Made of #16 gauge steel with all formed edges; coinciding brackets with 1/4 turn cowl fasteners assure fast and accurate mounting. "Professional" Side Panels are 1 1/4" thick, while Contempo Side Panels are 3/4" thick. Finished same as Pedestals. EP models are for exterior use; KP models are for interior use. Model numbers indicate depth of console.

FOR 24" DEEP PEDESTALS			FOR 34" DEEP PEDESTALS		
Cat. No.	To Fit Pedestal	Net Price	Cat. No.	To Fit Pedestal	Net Price
EP-24	PD-224	\$20.00	EP-34	PD-234	\$25.00
EPD-24	CPD-24	17.50	EPD-34	CPD-34	22.50
EPS-24	CPS-24	21.00	EPS-34	CPS-34	26.55
KP-24	PD-224	17.50	KP-34	PD-234	20.00
KPD-24	CPD-24	17.50	KPD-34	CPD-34	20.00
KPS-24	CPS-24	21.00	KPS-34	CPS-34	23.60

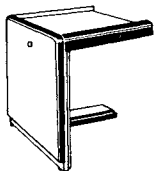

"PROFESSIONAL"

END PEDESTALS for CONSOLES or kneehole spaces for use at ends of Console Assemblies are equipped with a foot rest as well as a vertical member, end panel and top section. They are made in single and double widths. (Formica table top is extra). Left side installation is standard; right side installation optional. See Check lists on Par-Metal Pages 27/28 and 31/32 for correct model numbers.

FOR 24" DEEP PEDESTALS			FOR 34" DEEP PEDESTALS		
Cat. No.	To Fit Pedestal	Net Price	Cat. No.	To Fit Pedestal	Net Price
DU-24	PD-224	\$47.50	DU-34	PD-234	\$59.00
DU-34	PD-224	62.00	DU-342	PD-234	77.00
DUD-24	CPD-24	45.00	DUD-34	CPD-34	56.50
DUS-24	CPS-24	54.00	DUS-34	CPS-34	66.70
DUD-242	CPD-24	58.75	DUD-342	CPD-34	74.00
DUS-242	CPS-24	70.50	DUS-342	CPS-34	89.00

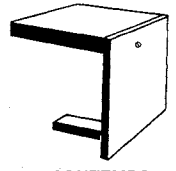

CONTEMPO

MOUNTING BRACKETS AND SHELVES

For "Professional" Pedestals Only
Brackets and Shelves for Contempo are on Par-Metal Page 14.
Brackets are mounted at desired height to side of pedestal, and slotted to match pedestal holes. Shelves are 17 1/2" Wide and 3/8" High and drilled for assembly with brackets.

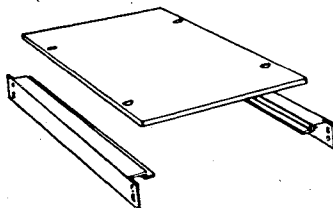

MOUNTING BRACKETS

Cat. No. (For Pair)	To Fit Pedestal	Overall Size	Shp. Wt. Lbs.	Net Price Per Pr.
CB-24	PD-224	2 1/2 x 3 x 18 3/4"	10	\$4.20
CB-34	PD-234	2 1/2 x 3 x 28 3/4"	15	5.80

SHELVES

Cat. No.	To Fit Brackets	For Pedestal Depth	Shp. Wt. Lbs.	Net Price Per Pr.
SS-24	CB-24	PD-234 22 3/4"	7	\$4.85
SS-34	CB-34	PD-234 32 3/4"	10	6.75

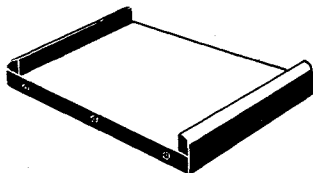

"PROFESSIONAL"

CENTER DESK SECTIONS for CONSOLES are kneehole spaces in single or double widths, for use in center of console assembly include a Foot Rest and a Bridge Section Top Support for Multiple Units. (Formica table top is extra). See Check Lists on Par-Metal Pages 27/28 and 31/32 for correct model numbers.

FOR 24" DEEP PEDESTALS			FOR 34" DEEP PEDESTALS		
Cat. No.	To Fit Pedestal	Net Price	Cat. No.	To Fit Pedestal	Net Price
CD-24	PD-224	\$17.65	CD-34	PD-234	\$20.80
CD-242	PD-224	35.30	CD-342	PD-234	41.60
CCD-24	CPD/CPS-24	17.65	CCD-34	CPD/CPS-34	20.80
CCD-242	CPD/CPS-24	35.30	CCD-342	CPD/CPS-34	41.60

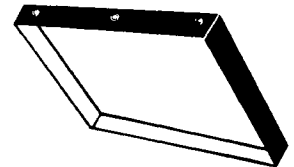

CONTEMPO

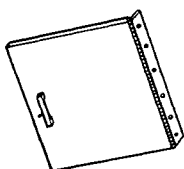

HINGED DOOR PANELS for CONSOLES are double wall construction. 3/8" thick, 19" wide, push button spring catch. FULL length Piano Hinge for strong left or right mounting. Finished on both sides to match console.

Cat. No.	Height	Net Price	Cat. No.	Height	Net Price
DR-7019	7"	\$11.75	DR-2119	21"	\$16.50
DR-1019	10 1/2"	13.50	DR-2419	24 1/2"	19.20
DR-1219	12 1/4"	14.00	DR-2619	26 1/4"	22.25
DR-1419	14"	14.53	DR-2819	28"	23.85
DR-1519	15 3/4"	15.20	DR-3119	31 1/2"	24.70
DR-1719	17 1/2"	15.75	DR-3519	35"	25.85
DR-1919	19 1/4"	16.20			



CONTEMPO-CONSOLES / PEDS

COMPONENT GROUP CHECK LIST

Select Desired Configuration from Drawings below
 — Follow up with Component Charts on Facing Page.

TOP CABINET, Model HS—19 is used to illustrate sketches. ANY TOP CABINET listed on Par-Metal Pages 33/34 may be substituted.

FRONT VIEW	(Either Desk or Standing Height)		USE KEY LETTERS	
SINGLE AND DOUBLE UNIT ASSEMBLIES				
	A		B	C
TRIPLE UNIT ASSEMBLIES				
	D	E	F	G
			H	
QUAD UNIT ASSEMBLIES Any number of pedestals may be assembled into a single unit console . . .				
	K		L	
M				

(SIDE VIEW) USE KEY NUMBERS	DESK HEIGHT		STANDING HEIGHT	
	24" DEEP	34" DEEP	24" DEEP	34" DEEP
When Pedestals are used with NO TOP CABINET.	#1 	#2 	#3 	#4
	When Pedestals are used with TOP CABINETS (see Par-Metal Pages 33/34)	#5 	#6 	#7

PAR-METAL PRODUCTS • CONVENIENT FACTORY WAREHOUSE

Par.Metal

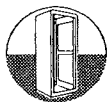

CONTEMPO-RAMA OF DESK PANEL CABINETS

For 19" Wide Panels

10 NEW CONTEMPO MODELS • NEW FEATURES • NEW USES

The SAME FULLY WELDED Sturdy Construction!

PAR-METAL's CONTEMPO Top Cabinets are made in single units with detachable End Panel, thus permitting the addition and/or removal of a unit at any time. Mating hardware is supplied. End Panels fit into brackets and lock in place with a 1/4 turn cowl fastener, and are set-in 3/8" off the edges.

To meet the exacting demands of modern electronics, our engineers have designed many new models. Your choice of layout configuration is further extended by PAR-METAL's new and exclusive line of **ANGULAR WEDGES** for both CONTEMPO-PEDS and DESK TOP CABINETS. (Details are on PAR-METAL Page 32). They satisfy a long overdue need in the industry.

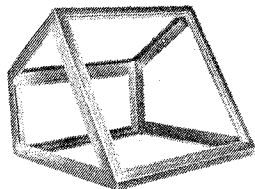

Desk Top Cabinet #PT-19 is shown without End Panels or Formed Panels. It is typical of ALL Models.

All models except LS-24 fit exactly and use no table tops on the 24 1/4" deep CONTEMPO-PEDS. For Model LS-24 and to use any model on a 34 3/4" deep pedestal, Formica Table Tops are listed on PAR-METAL Page 30. All CONTEMPO-PEDS may use exterior tables (see PAR-METAL Page 29). To decorate the CONTEMPO-LINE, we add a New Look! For the entire CONTEMPO-RAMA, standard finish is a combination of Dawn Gray and Charcoal Gray Textured Vinyl. Your choice of other available finishes are shown on PAR-METAL Page 24.

Construction: CONTEMPO Desk Top Cabinets are 21 1/8" wide. A full complement of 19" wide blank formed panels are supplied. They are listed with each cabinet's description. A flat 1/8" steel or aluminum panel may be substituted for these formed panels without extra charge, if so ordered. A formed **Rear Drop Door** with full length continuous hinge (Model DRD) may be substituted for the rear panel at an extra cost of 5% of the top cabinet. Ventilating formed **Rear Drop Door** (Model VRD) may be substituted at an extra cost of 7 1/2% of the top cabinet.

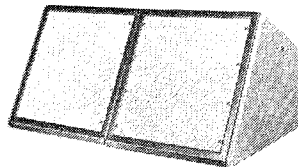

2 Peaked Desk Top Cabinets #PT-19 with one pair of PTP-19 End Panels and two 610 Front Panels.

LS-24

Uses End Panel LSP-24

LS-24 LOW SLOPE (Flat)			
CABINET CATALOG NUMBER	NET PRICE	Uses END PANEL CATALOG NUMBER	NET PRICE (pair)
LS-24	\$59.77	LSP-24	\$18.50
3 PANELS FURNISHED: 606, 610 AND 613.			

VF-19 VERTICAL FRONT

CABINET CATALOG NUMBER	NET PRICE	Uses END PANEL CATALOG NUMBER	NET PRICE (pair)
VF-19	\$72.80	VFP-19	\$21.40
4 PANELS FURNISHED: (2) 609 and (2) 610.			

Uses End Panel VFP-19

CX-19 DUAL FRONT

CABINET CATALOG NUMBER	NET PRICE	Uses END PANEL CATALOG NUMBER	NET PRICE (pair)
CX-19	\$78.10	CXP-19	\$23.00
4 PANELS FURNISHED: (2) 607, 609 and 610.			

Uses End Panel CXP-19

LS-14 LOW SLOPE (Upright)

CABINET CATALOG NUMBER	NET PRICE	Uses END PANEL CATALOG NUMBER	NET PRICE (pair)
LS-14	\$59.77	LSP-14	\$18.50
3 PANELS FURNISHED: 606, 610 and 613.			

Uses End Panel LSP-14

PAR-METAL PRODUCTS • ENGINEERING ASSISTANCE AVAILABLE

Par.Metal

DESK CABINETS - AMPLIFIER CHASSIS

DELUXE CABINETS

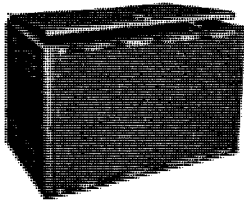

With formed door and modern handle, hinged at back for full access.

Chrome mouldings are mounted on front at top and bottom. Cabinet has ventilating louvres on each side, and full width opening at back for leads, etc.

Standard finish is blue grey wrinkle enamel. Prices do not include chassis which are listed on PAR METAL Page 36.

Catalog No.	Overall Dimensions	Panel Size	Uses Chassis	Shp. Wt. Lbs.	Net Price
CA-300	9x12½x8" 8"	7½ ³² "x10 ¹ / ₆ "	7x 9x2"	6	\$10.60
CA-301	9x16½x8" 8"	7½ ³² "x14 ¹ / ₆ "	7x13x2"	7	11.70
CA-302	10x17½x11" 11"	8½ ³² "x15 ¹ / ₆ "	10x14x3"	8	14.85
CA-303	10x20½x9" 9"	8½ ³² "x18 ¹ / ₆ "	8x17x3"	11	14.85
CA-304	13x20½x12" 12"	11½ ³² "x18 ¹ / ₆ "	10x17x3"	15	18.30

ROUNDED CORNER CABINETS

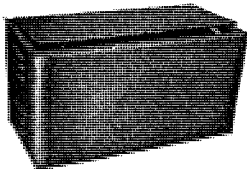

Similar in design to those listed above. Flat doors, hinged at back to permit full access. Vertical front corners are rounded; ventilating louvres are stamped in both

sides, and full width opening is provided at back for leads.

Standard finish is blue grey wrinkle enamel. Prices do not include chassis, which are listed on PAR METAL Page 36.

Catalog No.	Overall Dimensions	Panel Size	Uses Chassis	Shp. Wt. Lbs.	Net Price
CA-200	8½x10½x8" 8"	7½ ³² "x 8 ¹ / ₆ "	7x 7x2"	6	\$ 6.00
CA-201	8½x12½x8" 8"	7½ ³² "x10 ¹ / ₆ "	7x 9x2"	7	6.40
CA-202	8½x16½x8" 8"	7½ ³² "x14 ¹ / ₆ "	7x13x2"	8	7.95
CA-203	9½x17½x11" 11"	8½ ³² "x15 ¹ / ₆ "	10x14x3"	11	10.55
CA-204	12½x20½x12" 12"	11½ ³² "x18 ¹ / ₆ "	10x17x3"	15	12.40

SLOPING FRONT CABINETS

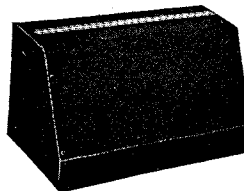

Also used as instrument cases or for use in studios, laboratories, etc.

- Top corner is rounded and trimmed with chrome moulding. Blue grey wrinkle finish.

- A chassis may be mounted to a front panel and removed as a unit.

- Rear of case is ventilated, with an opening for connections. Prices do not include chassis, which are listed on PAR METAL Page 36.

Catalog No.	Overall Dimensions	Uses Chassis	Shp. Wt. Lbs.	Net Price
SF-500	8x 8x 8"	7x 7x2"	6	\$ 6.50
SF-501	8x10x 8"	7x 9x2"	7	7.20
SF-502	8x14x 8"	7x13x2"	8	7.80
SF-503	9x18x 8"	7x17x3"	10	9.75
SF-504	12x18x12"	10x17x3"	14	12.30

AMPLIFIER FOUNDATION CHASSIS WITH SLOPING FRONT

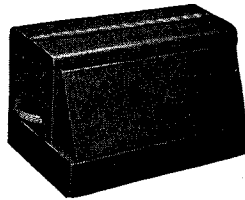

For mounting meters, switches, etc., panel is removable and protrudes 3" from face of the screen cover. All parts are finished in blue grey wrinkle.

Trimmed with a chrome moulding with handles at each end. Chassis are supplied WITH bottom plates.

Cat. No.	Chassis Size	Screen Cover	Shp. Wt. Lbs.	Net Price
F-10120	10x12x3"	6½" height	11	\$12.15
F-10170	10x17x3"		13	14.70
F-13170	13x17x3"		15	15.90

ROUNDED CORNER DESIGN

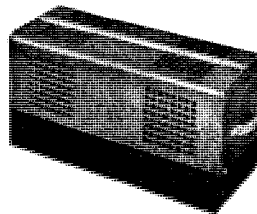

Streamlines the chassis screen covers. Ventilation is through rectangular openings. The moulding and handles are chrome plated with red striping.

Screen cover finish is blue grey wrinkle enamel to contrast with black chassis. Chassis are drilled for bottom plate. See PAR METAL Page 36.

Cat. No.	Chassis Size	Depth of Cover	Shp. Wt. Lbs.	Net Price
DF-510	5x10x3"	6"	7	\$ 6.75
DF-615	6x14x3"		8	7.50
DF-717	7x17x3"		9	8.70
DF-1012	10x12x3"		9	8.90
DF-1017	10x17x3"		10	9.80
DF-1317	13x17x3"		12	10.50

STEEL UTILITY CASES

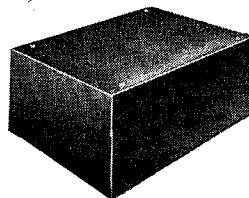

Removable flat tops and bottoms. 20 gauge sheet steel, with flanged edges and spot-welded corners. Finish is black wrinkle enamel.

Cat. No.	Overall Size	Shp. Wt. Lbs.	Net Price	Cat. No.	Overall Size	Shp. Wt. Lbs.	Net Price
MC-442	4x 4x 2"	1	\$1.37	MC-666	6x 6x 6"	3	\$2.57
MC-453	4x 5x 3"	2	1.65	MC-8101	8x10x10"	7	4.72
MC-596	5x 9x 6"	4	3.40	MC-8107	8x10x 7"	6	4.85
MC-654	6x 5x 4"	3	2.57	MC-1128	11x12x 8"	9	6.10

PAR-METAL PRODUCTS • CONVENIENT FACTORY WAREHOUSE

Par-Metal

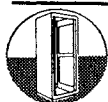

BLOWERS – FANS

PACKAGED TWIN BLOWERS FOR 19" WIDE PANEL SPACE

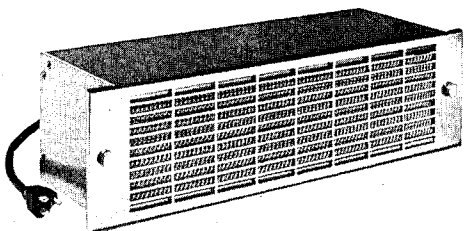

MODEL DPB-525
Front View

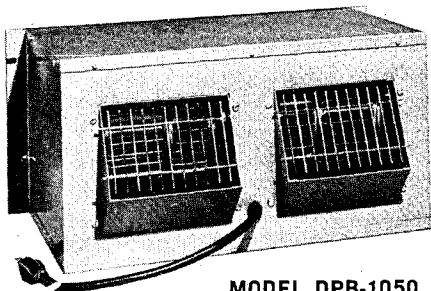

MODEL DPB-1050
Rear View

HIGH EFFICIENCY – SMALL SPACE
Packaged Electronic Cooling units have simple twin blowers powered by a permanently lubricated double-shielded ball-bearing motor, forced air cooled by a portion of the intake air.

Rotating components are suspended on six-way Neoprene shock mounts. AC hum is virtually impossible.

Grilles are engineered for low air resistance and are Chrome Plated cold-rolled steel. They are positioned by 2 captive screws. Wire exhaust guards are mounted on diagonal discharge ports. Each unit has a removable permanent washable aluminum mesh filter. Unit is panel mounted with EIA hole centering.

Adaptors available for mounting in 24" panel space.

CATALOG NUMBER	PANEL HEIGHT	cfm at "O" static pressure	DEPTH of ENCLOSURE	MOTOR 115V - 50/60 Cycles		NET PRICE
				RPM	AMPS	
DPB-525	5¼"	150	7"	3000	1.5	\$124.56
DPB-530	5¼"	300	7"	3200	1.0	131.76
DPB-700	7"	360	10"	1500	.8	148.92
DPB-730	7"	475	10"	3250	1.9	158.33
DPB-875	8¾"	525	11½"	1500	1.2	180.47
DPB-1050	10½"	820	13"	1500	2.2	220.33

"THIN" MODEL FANS

Engineered specially for electronic cabinet cooling, these highly compact fans ensure a quick and broad distribution of cooling air.

Fans are made in a whole range of sizes from 220 cfm to 750 cfm. Fans are accompanied by a full line of accessories including guards, grilles, mounting sleeves, filters and filter holders.

EXHAUST FANS blow air out of the cabinet and when mounted on the Top Panel for efficiency, filters are usually not used.

INTAKE FANS suck air into the cabinet. They are designed for greatest efficiency when door or base mounted.

PAR-METAL PERMANENT FILTERS are washable and are of the reusable impingement type and are ½" thick.

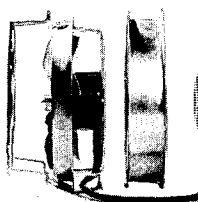

EXHAUST MODEL PE-300

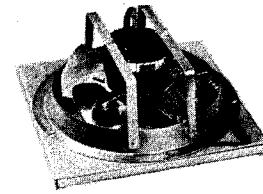
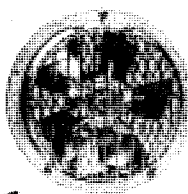

INTAKE MODEL PI-300

MOTORS are 50/60 cycle, 115 volt, single phase AC with 18" lead. They are permanently oiled, ball bearing, shaded pole type with low rise. Noise and vibration are minimized by shock mounting Fan and Motor Assemblies. To provide fan cut-out and mounting holes (at slight additional cost) please specify Modification "TF".

ACCESSORY CHECK LIST FOR THIN MODEL FAN

For Exhaust Fans	PE-220	PE-300	PE-400	PE-550	PE-750
Accessory	Cat. No. Net Price	Cat. No. Net Price	Cat. No. Net Price	Cat. No. Net Price	Cat. No. Net Price
Guards	GU-50 \$2.77	GU-650 \$2.77	GU-800 \$2.77	GU-900 \$3.33	GU-1000 \$3.87
Mounting Sleeve	MS-650 3.33	MS-650 3.33	MS-800 3.33	MS-900 3.87	MS-1000 4.43
Grille	GR-650 2.22	GR-650 2.22	GR-800 2.22	GR-900 2.77	GR-1000 3.33

For Intake Fans	PI-220	PI-300	PI-400	PI-550	PI-750
Accessory	Cat. No. Net Price	Cat. No. Net Price	Cat. No. Net Price	Cat. No. Net Price	Cat. No. Net Price
Filters	FF-650 \$2.77	FF-650 \$2.77	FF-800 \$2.77	FF-900 \$3.33	FF-1000 \$3.33
Filter Holders	FH-650 5.54	FH-650 5.54	FH-800 5.54	FH-900 6.09	FH-1000 7.20
Mounting Sleeve	MS-650 3.33	*	*	*	*

* not needed

Exhaust Fan Cat. No.	PE-220	PE-300	PE-400	PE-550	PE-750
Intake Fan Cat. No.	PI-220	PI-300	PI-400	PI-550	PI-750
Net Prices	\$42.18	\$44.83	\$52.04	\$55.91	\$59.79
CFM at "O" static pressure	220	300	400	550	750
Blade Diameter	6½"	6½"	8"	9"	10"
RPM	1550	3000	1460	1600	1560
Overall Diameter	8½"	8½"	10"	11½"	12½"
Overall Depth	3¼"	3½"	3¾"	4¾"	4¾"
Hole Size Required	7¾"	7¾"	9"	10¾"	11¾"



CABINET RACKS - RELAY RACKS CHASSIS - CASES - 19"/24" PANELS

Modular Electronic Cabinets

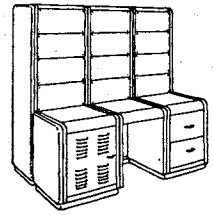
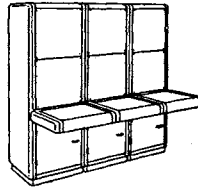

Modular Electronic Cabinets

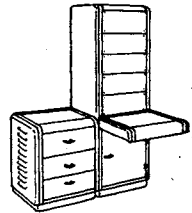
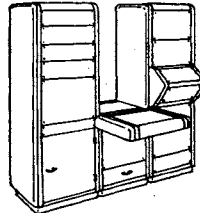
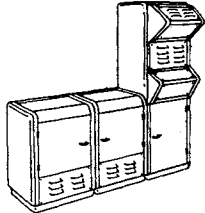

Chassis



Aluminum

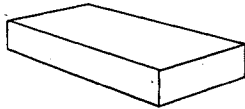

Steel

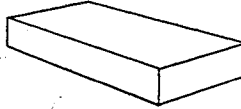

Aluminum

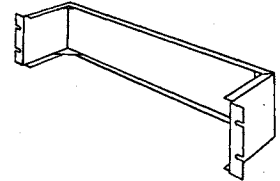

19" and 24" Wide Panels



Aluminum

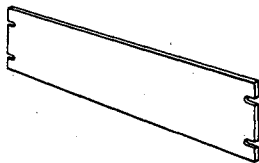

Steel

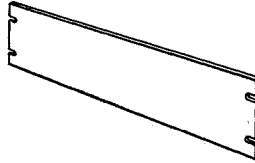

2024-T3 Aluminum

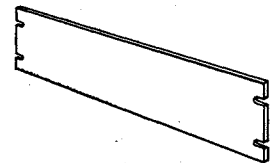

Accessories



Blowers

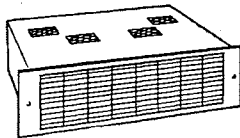

Fans

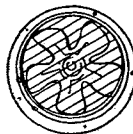

Slides

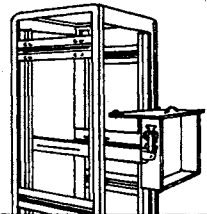

Contact

Your

Local Distributor for

a Free Complete Catalog

Wyco Metal Products

PREMIER MODULAR ROUNDED CORNER FRAMES



PREM-Ö-RAK® 22" and 25½" DEEP for 19" and 24" PANELS

• Frames accommodate Ball Cornered End Panels (CEP Series)

- Frame Made of No. 14 gauge steel.
- Supplied with two pair of No. 12 gauge steel Panel Mounting Angles. Both legs of the angle are tapped 10-32 on E.I.A. spacings (¾-¾-½) to accommodate Front Panels & Chassis Support Angles (CSA series) and Shelves (S series).
- Panel mounting angles are held in place at three points by ¾" carriage bolts and are adjustable to any desired position by means of channel slides.
- Three combination 1¾" and 1½" diameter knockouts furnished on both sides of top and bottom to provide access for cabling between racks.
- Frame completely welded throughout.
- Top of frame is solid. Round hole and 5 mounting holes on top of frame to accommodate Exhaust (EF Series) and Intake (IF Series) Fans, available at additional cost.
- Knockouts supplied on sides of uprights for use in ganging frames.
- A rectangular cutout is provided in bottom for leads, etc.
- Rectangular knockouts provided on front and rear of uprights of frame to accommodate hinge and handle brackets, so that door can be mounted either left or right hand. Doors can be mounted to front or rear of frame.
- Holes punched in bottom to accommodate CA-4 (2"), CA-5 (3"), CA-6 (double 2") and CA-7 (locking 3") casters.
- Finished in Gray Hammertone.

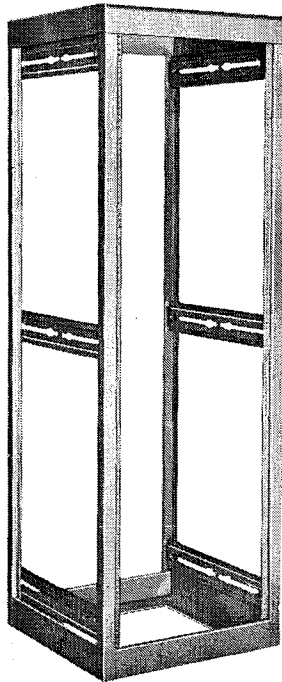

FA FRAME

- Designed for MULTIPLE INSTALLATIONS
- TOPS OF FRONT AND REAR ARE ROUNDED

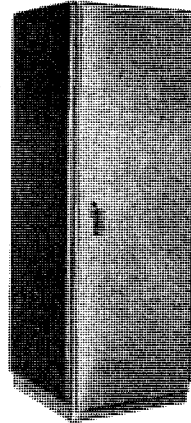

Above unit consists of Frame FA Series), 2 End Panels (CEP Series) and Door (DF Series).

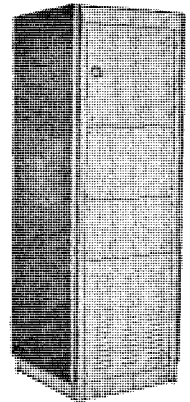

Above unit consists of Frame (FA Series), 2 End Panels (CEP Series), Flush Door (CD Series), Louvered Panel (FPL Series) and Formed Panels (FP Series)

FRAMES — 22" WIDE								
22" DEEP				25½" DEEP				
Cat. No.	Shpg. Wt. Lbs.	Net Price	Height	Panel Space	Cat. No.	Shpg. Wt. Lbs.	Net Price	
FA-42-22	50	\$86.85	48½"	42 x 19"	FA-42-255	58	\$91.25	
FA-52-22	65	94.20	59½"	52½ x 19"	FA-52-255	75	98.85	
FA-61-22	80	106.65	67½"	61¼ x 19"	FA-61-255	92	117.55	
FA-70-22	100	125.25	76½"	70 x 19"	FA-70-255	115	137.60	
FA-77-22	110	128.65	83½"	77 x 19"	FA-77-255	127	141.55	
22" DEEP			FRAMES — 27" WIDE			25½" DEEP		
FA-2761-22	90	116.85	67½"	61¼ x 24"	FA-2761-255	98	127.55	
FA-2770-22	110	137.60	76½"	70 x 24"	FA-2770-255	123	150.95	
FA-2777-22	120	140.25	83½"	77 x 24"	FA-2777-255	135	153.60	

ORDERING GUIDE

FRAME Cat. No.	Use END PANEL (Page 16) Cat. No.	Use DOOR (Page 18) Cat. No.	Use CHASSIS SUPPORT ANGLE (Page 22) Cat. No.	Use SHELF (Page 22) Cat. No.	Use CHASSIS SLIDES (Pages 27, 28) Length
FA-42-22	CEP-42-22	DF-42	CSA-22	S-22-22	20"
FA-52-22	CEP-52-22	DF-52	CSA-22	S-22-22	20"
FA-61-22	CEP-61-22	DF-61	CSA-22	S-22-22	20"
FA-70-22	CEP-70-22	DF-70	CSA-22	S-22-22	20"
FA-77-22	CEP-77-22	DF-77	CSA-22	S-22-22	20"
FA-42-255	CEP-42-255	DF-42	CSA-255	S-22-255	24"
FA-52-255	CEP-52-255	DF-52	CSA-255	S-22-255	24"
FA-61-255	CEP-61-255	DF-61	CSA-255	S-22-255	24"
FA-70-255	CEP-70-255	DF-70	CSA-255	S-27-255	24"
FA-77-255	CEP-77-255	DF-77	CSA-255	S-22-255	24"
FA-2761-22	CEP-61-22	DF-2761	CSA-22	S-27-22	20"
FA-2770-22	CEP-70-22	DF-2770	CSA-22	S-27-22	20"
FA-2777-22	CEP-77-22	DF-2777	CSA-22	S-27-22	20"
FA-2761-255	CEP-61-255	DF-2761	CSA-255	S-27-255	24"
FA-2770-255	CEP-70-255	DF-2770	CSA-255	S-27-255	24"
FA-2777-255	CEP-77-255	DF-2777	CSA-255	S-22-255	24"

FOR MODIFICATIONS
See Premier Page 2

FOR ACCESSORIES
Premier Pages 16 thru 22

FOR BLOWERS, FANS AND HARDWARE
Premier Pages 27 thru 32

PREMIER METAL PRODUCTS COMPANY

A Division of Sunshine Mining Company

PREMIER

PREM-O-RAK

MODULAR SLOPED FRONT FRAMES

10½" AND 17½" FOR 19" AND 24" PANELS

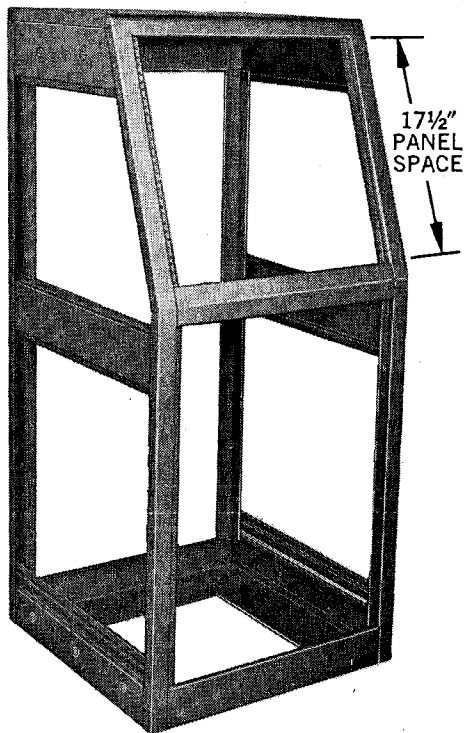

FS-1001

- TOPS OF FRONT AND REAR ARE ROUNDED
- Frames accommodate Ball Cornered End Panels (CEP Series)
- Designed for Multiple Installations
- Made of No. 14 Gauge (.0747) Steel
- Sloped Front Is 19° from Vertical
- Frame Completely Welded Throughout
- All Panel Mounting Angles are made of No. 12 Gauge Steel and Tapped on both legs 10/32 on E.I.A. Spacings (5/8-9/8-1/2). Front and Rear Vertical Angles Are Adjustable to Any Desired Position.
- Panels Fit into 1/2" Recess.
- Combination 1 3/8" and 1 1/8" Diameter Knockouts on Top and Bottom to Provide Access for Cabling Between Racks.
- Holes Punched in Bottom to Accommodate CA-4 (2"), CA-5 (3"), CA-6 (double 2") and CA-7 (locking 3") casters.
- A Rectangular Cutout Is Provided in Bottom for Leads, etc.
- Front Cross Piece Removable.
- Rectangular Knockouts On Rear Uprights to Accommodate Hinge and Handle Latch Brackets so that Door can be Mounted Either Left or Right.
- Finished in Gray Hammertone.

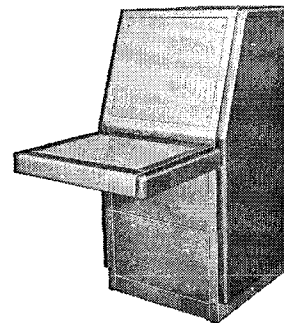

Above unit consists of Frame (FS Series), 2 End Panels (CEP-1201 Series), Writing Work Shelf (WW Series) and 2 End Panels (CEP Series) for shelf.

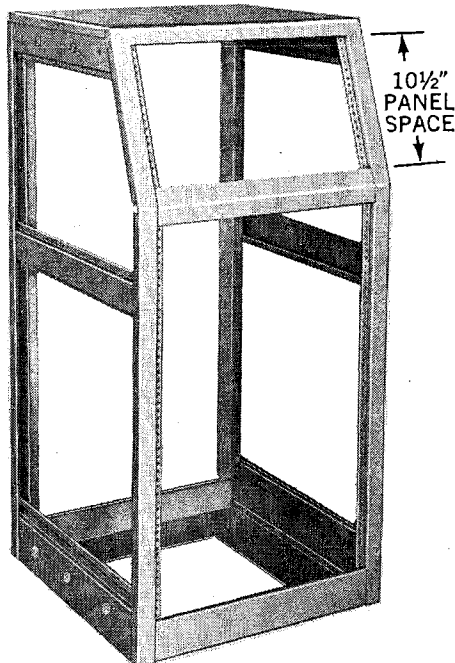

FS-1002

Cat. No.	Width	Hgt.	Depth	Sloped Front Panel Space	Front Vertical Space	Rear Vertical Space	Ship. Wt. Lbs.	Net Price
FS-1001	22"	50"	22"	17½ x 19"	26¼ x 19"	42 x 19"	66	\$89.50
FS-1002	22"	47"	22"	10½ x 19"	29¾ x 19"	42 x 19"	64	86.85
FS-1003	27"	50"	22"	17½ x 24"	26¼ x 24"	42 x 24"	76	98.20
FS-1004	27"	47"	22"	10½ x 24"	29¾ x 24"	42 x 24"	74	96.20
FS-1001-255	22"	50"	25½"	17½ x 19"	26¼ x 19"	42 x 19"	75	92.35
FS-1002-255	22"	47"	25½"	10½ x 19"	29¾ x 19"	42 x 19"	73	90.15
FS-1003-255	27"	50"	25½"	17½ x 24"	26¼ x 24"	42 x 24"	85	102.40
FS-1004-255	27"	47"	25½"	10½ x 24"	29¾ x 24"	42 x 24"	83	100.20

ORDERING GUIDE

FRAME Cat. No.	USE END PANEL (Page 16) Cat. No.	USE REAR DOOR (Page 18) Cat. No.	USE SHELF (Page 22) Cat. No.	USE CHASSIS SUPPORT ANGLE (Page 22) Cat. No.	USE CHASSIS SLIDES (Pgs. 27, 28) Length
FS-1001	CEP-1201 (LH and/or RH)	DF-42	S-22-22	CSA-22	20"
FS-1002	CEP-1202 (LH and/or RH)	DF-42-1002	S-22-22	CSA-22	20"
FS-1003	CEP-1201 (LH and/or RH)	DF-2742	S-27-22	CSA-22	20"
FS-1004	CEP-1202 (LH and/or RH)	DF-2742-1002	S-27-22	CSA-22	20"
FS-1001-255	CEP-1201-255 (LH and/or RH)	DF-42	S-22-255	CSA-255	24"
FS-1002-255	CEP-1202-255 (LH and/or RH)	DF-42-1002	S-22-255	CSA-255	24"
FS-1003-255	CEP-1201-255 (LH and/or RH)	DF-2742	S-27-255	CSA-255	24"
FS-1004-255	CEP-1202-255 (LH and/or RH)	DF-2742-1002	S-27-255	CSA-255	24"

FOR MODIFICATIONS SEE PREMIER PAGE 2 • FOR ACCESSORIES SEE PREMIER PAGES 16 THRU 22
FOR BLOWERS, FANS, HARDWARE SEE PREMIER PAGES 27 THRU 32

PREMIER METAL PRODUCTS COMPANY

A Division of Sunshine Mining Company

PREMIER MODULAR WEDGE FRAMES

PREM-O-RAK

30° and 45°

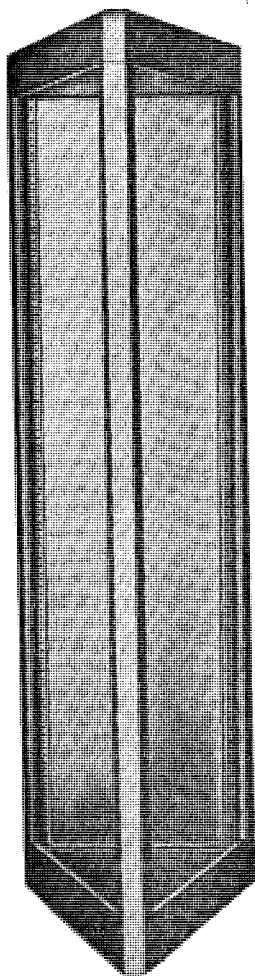

- Constructed of 16 gauge steel
- Completely welded throughout
- Supplied with formed panel on rear
- End panels (CEP Series) can be mounted to the side of wedge frames if desired
- Finished in Gray Hammertone
- Designed for use in Semi-Circular Arrangements when bolted to Pedestal Frames (CPF Series) or Transmitter Rack Frames (FA Series)

NOTE: One piece Formica Shelf available for semi-circular arrangements.

30 WEDGE RACK FRAMES

Cat. No.	Height	Width	For Use With	Net Price
WED-30-42-22	48 $\frac{5}{8}$ "	22"	FA-42-22	\$136.05
WED-30-52-22	59 $\frac{1}{8}$ "	22"	FA-52-22	146.95
WED-30-61-22	67 $\frac{7}{8}$ "	22"	FA-61-22	154.25
WED-30-70-22	76 $\frac{5}{8}$ "	22"	FA-70-22	165.30
WED-30-77-22	83 $\frac{3}{8}$ "	22"	FA-77-22	172.55
WED-30-42-255	48 $\frac{5}{8}$ "	25 $\frac{1}{2}$ "	FA-42-255	163.10
WED-30-52-255	59 $\frac{1}{8}$ "	25 $\frac{1}{2}$ "	FA-52-255	172.85
WED-30-61-255	67 $\frac{7}{8}$ "	25 $\frac{1}{2}$ "	FA-61-255	176.30
WED-30-70-255	76 $\frac{5}{8}$ "	25 $\frac{1}{2}$ "	FA-70-255	190.95
WED-30-77-255	83 $\frac{3}{8}$ "	25 $\frac{1}{2}$ "	FA-77-255	198.35

45° WEDGE RACK FRAMES

Cat. No.	Height	Width	For Use With	Net Price
WED-45-42-22	48 $\frac{5}{8}$ "	22"	FA-42-22	\$139.60
WED-45-52-22	59 $\frac{1}{8}$ "	22"	FA-52-22	150.60
WED-45-61-22	67 $\frac{7}{8}$ "	22"	FA-61-22	157.95
WED-45-70-22	76 $\frac{5}{8}$ "	22"	FA-70-22	168.95
WED-45-77-22	83 $\frac{3}{8}$ "	22"	FA-77-22	176.25
WED-45-42-255	48 $\frac{5}{8}$ "	25 $\frac{1}{2}$ "	FA-42-255	166.75
WED-45-52-255	59 $\frac{1}{8}$ "	25 $\frac{1}{2}$ "	FA-52-255	175.10
WED-45-61-255	67 $\frac{7}{8}$ "	25 $\frac{1}{2}$ "	FA-61-255	179.95
WED-45-70-255	76 $\frac{5}{8}$ "	25 $\frac{1}{2}$ "	FA-70-255	194.70
WED-45-77-255	83 $\frac{3}{8}$ "	25 $\frac{1}{2}$ "	FA-77-255	201.95

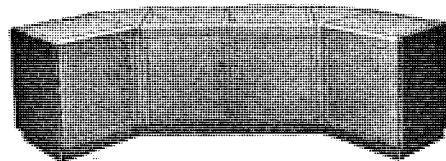

30° Wedge Pedestal Frames

Catalog No.	Height	Width	For Use With	Net Price
WED-30-101	29 $\frac{1}{2}$ "	22"	CPF-101 103	\$113.85
WED-30-101-18	29 $\frac{1}{2}$ "	18 $\frac{1}{2}$ "	CPF-101-18, 103-18	111.30
WED-30-101-255	29 $\frac{1}{2}$ "	25 $\frac{1}{2}$ "	CPF-101-255, 103-255	116.85

45° Wedge Pedestal Frames

Catalog No.	Height	Width	For Use With	Net Price
WED-45-101	29 $\frac{1}{2}$ "	22"	CPF-101 103	\$116.85
WED-45-101-18	29 $\frac{1}{2}$ "	18 $\frac{1}{2}$ "	CPF-101-18, 103-18	115.65
WED-45-101-255	29 $\frac{1}{2}$ "	25 $\frac{1}{2}$ "	CPF-101-255, 103-255	120.40

TYPICAL INSTALLATIONS OF THE PREM-O-RAK MODULAR CONSOLE SYSTEM

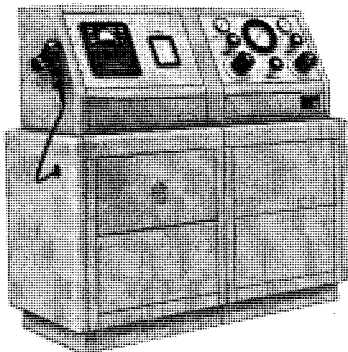

Photo Courtesy
Aerojet General
Corp.

Photo Courtesy
Commercial Radio-Sound
Corp.

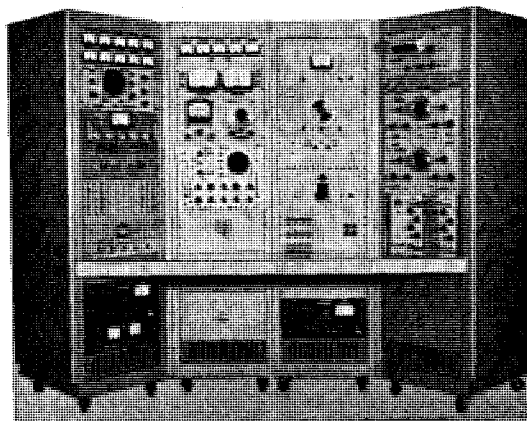
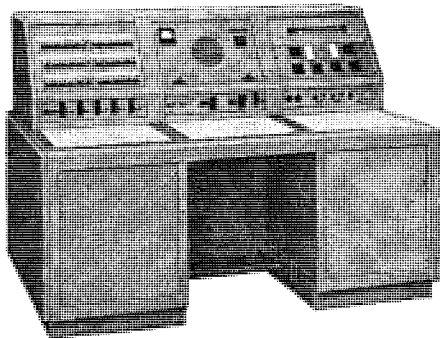

Photo Courtesy
Texas Instruments
Incorporated

PREMIER METAL PRODUCTS COMPANY

A Division of Sunshine Mining Company

PREMIER

HEAVY DUTY CUBICLES

FOR STANDARD 19, 24 and 30" WIDE PANELS

- Frame made of No. 12 gauge steel and supplied with 10-32 tapped holes on EIA spacings (5/8-3/4-1/2") on both legs of all vertical uprights.
- Top of frame supplied with knock-out in each corner to accommodate eye bolts for lifting.
- Top and side panels and doors made of No. 14 gauge steel and supplied with a return flange on all sides for easy gasketing.
- Doors and/or side panels can be mounted to any openings of frame.
- Finished in Gray Hammertone.

PREM-O-CUBE



FRAMES 23" WIDE for 19" PANELS

Overall Height	Panel Height	23" Deep Cat. No.	Net Price	28" Deep Cat. No.	Net Price	34" Deep Cat. No.	Net Price
40 3/4"	36 3/4"	POC-36-23-23	\$103.60	POC-36-23-28	\$107.30	POC-36-23-34	\$114.30
46"	42"	POC-42-23-23	107.30	POC-42-23-28	113.15	POC-42-23-34	120.15
65 1/4"	61 1/4"	POC-61-23-23	130.60	POC-61-23-28	136.50	POC-61-23-34	143.55
74"	70"	POC-70-23-23	139.95	POC-70-23-28	145.80	POC-70-23-34	152.75
81"	77"	POC-77-23-23	148.10	POC-77-23-28	153.90	POC-77-23-34	160.95
84 1/2"	80 1/2"	POC-80-23-23	152.75	POC-80-23-28	158.60	POC-80-23-34	165.40

FRAMES 28" WIDE for 24" PANELS

Overall Height	Panel Height	28" Deep Cat. No.	Net Price	34" Deep Cat. No.	Net Price
40 3/4"	36 3/4"	POC-36-28-28	\$113.15	POC-36-28-34	\$120.15
46"	42"	POC-42-28-28	118.95	POC-42-28-34	125.95
65 1/4"	61 1/4"	POC-61-28-28	142.25	POC-61-28-34	149.25
74"	70"	POC-70-28-28	151.60	POC-70-28-34	158.60
81"	77"	POC-77-28-28	159.70	POC-77-28-34	166.75
84 1/2"	80 1/2"	POC-80-28-28	164.40	POC-80-28-34	171.40

FRAMES 34" WIDE for 30" PANELS

Overall Height	Panel Height	34" Deep Cat. No.	Net Price
40 3/4"	36 3/4"	POC-36-34-34	\$127.10
46"	42"	POC-42-34-34	132.90
65 1/4"	61 1/4"	POC-61-34-34	156.25
74"	70"	POC-70-34-34	165.40
81"	77"	POC-77-34-34	173.75
84 1/2"	80 1/2"	POC-80-34-34	178.50

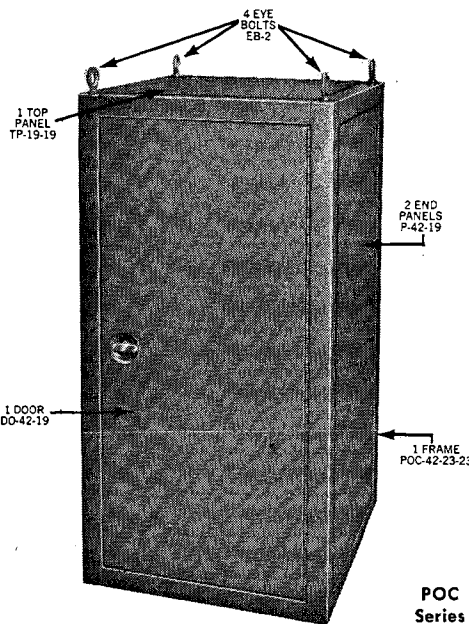

PANELS AND DOORS FOR PREM-O-CUBE HEAVY DUTY CUBICLES

END PANELS

Blank and Louvred — 3/4" DEEP. Made of No. 14 gauge steel with return bend for easy gasketing.

BLANK Cat. No.	Net Price	Height	LOUVRED Cat. No.	Net Price
P-36-19	\$26.15	36 3/4"	PL-36-19	\$35.45
P-42-19	28.50	42"	PL-42-19	37.75
P-61-19	37.80	61 1/4"	PL-61-19	47.10
P-70-19	41.55	70"	PL-70-19	50.85
P-77-19	47.80	77"	PL-77-19	54.10
P-80-19	46.65	80 1/2"	PL-80-19	55.95

FOR 24" WIDE

P	Net Price	Height	PL	Net Price
P-36-24	\$28.95	36 3/4"	PL-36-24	\$37.30
P-42-24	30.40	42"	PL-42-24	39.65
P-61-24	39.75	61 1/4"	PL-61-24	49.95
P-70-24	43.40	70"	PL-70-24	52.75
P-77-24	46.65	77"	PL-77-24	55.95
P-80-24	48.55	80 1/2"	PL-80-24	57.90

FOR 30" WIDE

P	Net Price	Height	PL	Net Price
P-36-30	\$31.30	36 3/4"	PL-36-30	\$40.65
P-42-30	33.60	42"	PL-42-30	42.90
P-61-30	42.95	61 1/4"	PL-61-30	52.30
P-70-30	46.65	70"	PL-70-30	55.95
P-77-30	49.90	77"	PL-77-30	59.25
P-80-30	51.80	80 1/2"	PL-80-30	61.15

DOORS

- Blank and Louvred**
- Made of No. 14 gauge steel
 - Continuous hinge flush fitting
 - Supplied with 3 point latching device and round flush handle

Blank	Net Price	Height	Width	Louvred	Net Price
DO-36-19	\$43.15	36 3/4"	19"	DOL-36-19	\$53.75
DO-36-24	47.60	36 3/4"	24"	DOL-36-24	56.90
DO-36-30	53.15	36 3/4"	30"	DOL-36-30	62.50
DO-42-19	48.40	42"	19"	DOL-42-19	57.75
DO-42-24	51.50	42"	24"	DOL-42-24	60.90
DO-42-30	56.20	42"	30"	DOL-42-30	65.25
DO-61-19	63.65	61 1/4"	19"	DOL-61-19	73.50
DO-61-24	67.40	61 1/4"	24"	DOL-61-24	77.70
DO-61-30	73.00	61 1/4"	30"	DOL-61-30	83.05
DO-70-19	70.56	70"	19"	DOL-70-19	80.65
DO-70-24	73.75	70"	24"	DOL-70-24	83.15
DO-70-30	79.30	70"	30"	DOL-70-30	88.65
DO-77-19	76.15	77"	19"	DOL-77-19	85.45
DO-77-24	79.30	77"	24"	DOL-77-24	88.65
DO-77-30	84.85	77"	30"	DOL-77-30	94.20
DO-80-19	79.30	80 1/2"	19"	DOL-80-19	88.65
DO-80-24	82.50	80 1/2"	24"	DOL-80-24	91.80
DO-80-30	88.00	80 1/2"	30"	DOL-80-30	97.35

ACCESSORIES FOR PREM-O-CUBE HEAVY DUTY CUBICLES

TOP & BOTTOM PANELS

Size	Blank Cat. No.	Net Price	Louvred Cat. No.	Net Price
19x19"	TP-19-19	\$17.75	TPL-19-19	\$23.55
19x24"	TP-19-24	20.10	TPL-19-24	25.95
19x30"	TP-19-30	22.85	TPL-19-30	28.55
24x24"	TP-24-24	22.40	TPL-24-24	27.95
24x30"	TP-24-30	25.20	TPL-24-30	31.05
30x30"	TP-30-30	28.05	TPL-30-30	33.85

PANEL MOUNTING ANGLES

12 gauge steel; topped 10-32 on E.I.A. spacings

Length	Cat. No.	Net Price (Pair)
36 3/4"	PMA 362-12	\$12.85
42"	PMA 422-12	14.70
61 1/4"	PMA 612-12	18.40
70"	PMA 702-12	20.65
77"	PMA 772-12	22.25
80 1/2"	PMA 802-12	23.40

HORIZONTAL CROSS PIECES

Fits Frame Depth	Cat. No.	Net Price
23"	HCP-23	\$2.95
28"	HCP-28	3.50
34"	HCP-34	4.10

ROLLER TRUCKS

with 4" Diameter Rockite Casters
Fits into recess in bottom of frame

Size	Cat. No.	Net Price
19x19"	CRT 19-19	\$58.30
19x24"	CRT 19-24	60.65
19x30"	CRT 19-30	63.45
24x24"	CRT 24-24	62.95
24x30"	CRT 24-30	65.75
30x30"	CRT 30-30	68.55

EYE BOLTS

2" Dia. — Cat. No. EB-2
Net Price — \$7.20 set of 4

PREMIER METAL PRODUCTS COMPANY

A Division of Sunshine Mining Company

PREMIER CABINET RELAY RACKS

FOR STANDARD 19" RACK PANELS (KNOCKED DOWN)



- Rigidly constructed of #16 gauge cold rolled sheet steel.
- The panel mounting angles are of #12 gauge steel and are tapped for 10-32 machine screws on E.I.A. spacings ($\frac{5}{8}$ - $\frac{5}{16}$).
- Panels fit into a $\frac{3}{16}$ " recess so that the edges are not exposed.
- Racks are shipped knocked down with all necessary bolts for easy assembly.
- Rear doors are hung on sturdy slip-jointed hinges, and closed by a chrome handle. Locking handle with two keys available at additional cost.
- Holes punched in bottom to accommodate CA-4 and CA-5 casters.

- **ROUNDED TYPE** has front vertical rounded corners.
- **DELUXE TYPE**—The removable vertical corner mouldings are rounded and cover the mounting screws.
- **DELUXE TYPE**—Top and bottom are trimmed with chrome finished moulding.
- **FRONT DOOR TYPE** has front vertical rounded corners and is supplied with locking chrome handle and two keys for front door.
- Finished in Gray Hammertone.

DELUXE TYPE

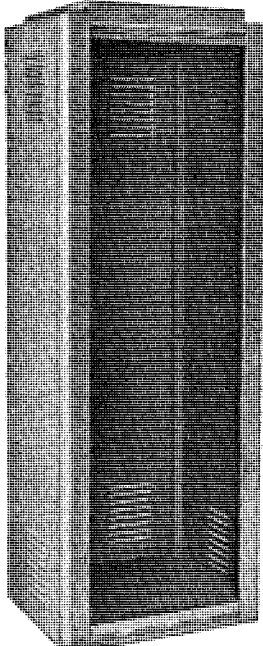

DR SERIES

FRONT DOOR TYPE

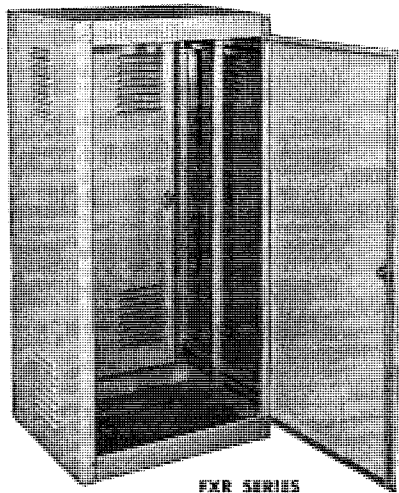

FXR SERIES

Supplied with adjustable Panel Mounting Angles

ROUNDED TYPE

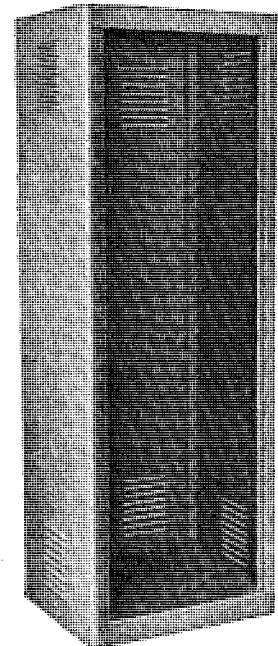

R SERIES

Racks are 22" wide x 18" deep

	Cat. No.	Overall Height	Panel Space	Use Slide Length*	Ship. Wt.—Lbs.	Net Price
DELUXE	DR-3619	43 $\frac{1}{8}$ "	36 $\frac{3}{4}$ "	16"	85	\$66.10
	DR-6119	67 $\frac{5}{8}$ "	61 $\frac{1}{4}$ "	16"	135	80.85
	DR-7719	83 $\frac{3}{8}$ "	77"	16"	160	97.85
FRONT DOOR	FXR-3619	41 $\frac{7}{8}$ "	36 $\frac{3}{4}$ "	16"	93	70.70
	FXR-4219	47 $\frac{1}{8}$ "	42"	16"	105	80.15
	FXR-6119	66 $\frac{3}{8}$ "	61 $\frac{1}{4}$ "	16"	140	110.40
	FXR-7719	82 $\frac{1}{8}$ "	77"	16"	164	121.30
ROUNDED	R-3619	41 $\frac{7}{8}$ "	36 $\frac{3}{4}$ "	16"	80	50.15
	R-4219	47 $\frac{1}{8}$ "	42"	16"	90	58.30
	R-6119	66 $\frac{3}{8}$ "	61 $\frac{1}{4}$ "	16"	120	74.65
	R-7719	82 $\frac{1}{8}$ "	77"	16"	140	88.65

	Cat. No.	Overall Height	Panel Space	Use Slide Length*	Used With	Net Price
MULTIPLE RACK SECTIONS	DMR-3619	43 $\frac{1}{8}$ "	36 $\frac{3}{4}$ "	16"	DR-3619	\$63.45
	DMR-6119	67 $\frac{5}{8}$ "	61 $\frac{1}{4}$ "	16"	DR-6119	75.70
	DMR-7719	83 $\frac{3}{8}$ "	77"	16"	DR-7719	90.35
	MR-3619	41 $\frac{7}{8}$ "	36 $\frac{3}{4}$ "	16"	R-3619	48.40
	MR-4219	47 $\frac{1}{8}$ "	42"	16"	R-4219	56.55
	MR-6119	66 $\frac{3}{8}$ "	61 $\frac{1}{4}$ "	16"	R-6119	72.95
	MR-7719	82 $\frac{1}{8}$ "	77"	16"	R-7719	86.85
	MXR-3619	41 $\frac{7}{8}$ "	36 $\frac{3}{4}$ "	16"	FXR-3619	67.90
	MXR-4219	47 $\frac{1}{8}$ "	42"	16"	FXR-4219	78.50
	MXR-6119	66 $\frac{3}{8}$ "	61 $\frac{1}{4}$ "	16"	FXR-6119	98.50
	MXR-7719	82 $\frac{1}{8}$ "	77"	16"	FXR-7719	119.70

* Use Slide Adapter Kit (Cat. No. SAK-35) for rear mounting. (See Premier Page 28).

FOR MODIFICATIONS SEE PREMIER PAGE 2
FOR ACCESSORIES SEE PREMIER PAGES 16 THRU 22
FOR BLOWERS, FANS and HARDWARE SEE PREMIER PAGES 27 THRU 32

PREMIER METAL PRODUCTS COMPANY
 A Division of Sunshine Mining Company

MULTIPLE RACK UNITS

These racks can be joined together to make multiple units by means of a solid center partition which is bolted to the top and bottom. Each multiple section comprises a top, bottom, rear door and center partition. On MXR Models, front door is also supplied. When ordering multiple units, specify number of units, such as double, triple, quad, etc.

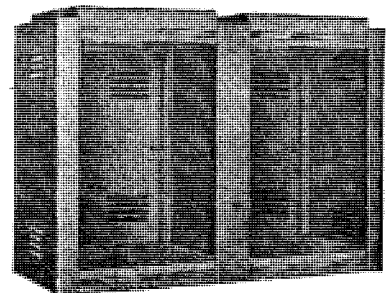

ABOVE UNIT IS ONE DOUBLE DR3619

Example: One Double DR-3619 consists of one DR-3619 and one DMR-3619.
 One Triple FXR-3619 consists of one FXR-3619 and two MXR-3619.
 One Quad R-3619 consists of one R-3619 and three MR-3619.

PREMIER

DESK CABINET RACKS

PREM-O-RAK

15 1/4" and 18" DEEP
FOR STANDARD
19" WIDE PANELS
(KNOCKED DOWN)

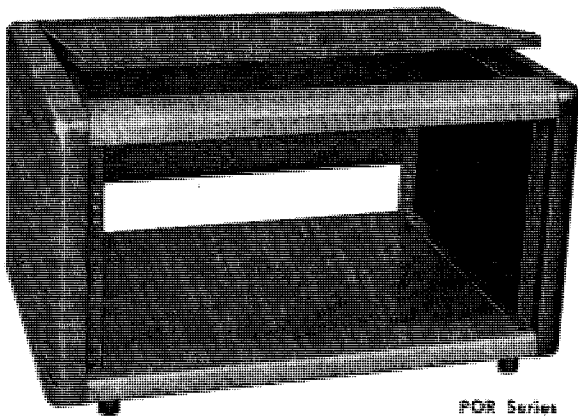

POR Series

- All screws for assembling PREM-O-RAK are not visible from the outside.
- Both front and rear verticals are tapped for 10/32 machine screws on E.I.A. spacings (5/8-5/8-1/2") so that panels may be mounted on both front and rear if desired.
- Interlocking removable top made of perforated metal and held in place by only one captive screw.
- Interlocking removable rear panel made of perforated metal and held in place by two captive screws.
- Rigidly constructed of #16 gauge steel.

BOTH FRONT AND REAR OF TOP HAVE ATTRACTIVE BALL CORNERS.

- Rear Panel has 3 1/2" opening on bottom for leads, etc., except on POR-3, 318, 5, 518.
- Panels fit into 1/2" recess.
- Base supplied with four rubber feet.
- Components may be mounted on base before assembly of rack into a complete unit.
- Shipped knocked down with all necessary hardware for easy assembly.
- **HANDSOMELY FINISHED IN TWO-TONE HAMMERTONE.**
 Top cross braces and base are Gray Hammertone. Top & rear panel & side panels are Brown Hammertone. Also available all Gray Hammertone. Specify color when ordering.

15 1/4" DEEP				ALL CABINETS ARE 21 3/4" WIDE		18" DEEP			
Catalog No.	Shp. Wt. Lbs.	Use Slide Length	Net Price	Overall Height	Panel Space	Catalog No.	Shp. Wt. Lbs.	Use Slide Length	Net Price
POR-3	18	14"	\$29.25	5 7/8"	3 1/2"	POR-318	20	16"	\$31.85
POR-5	20	14"	31.85	7 5/8"	5 1/4"	POR-518	22	16"	35.95
POR-7	22	14"	33.75	9 3/8"	7"	POR-718	24	16"	36.10
POR-8	24	14"	35.95	11 1/8"	8 3/4"	POR-818	26	16"	37.65
POR-10	26	14"	39.15	12 7/8"	10 1/2"	POR-1018	29	16"	42.85
POR-12	28	14"	42.05	14 5/8"	12 1/4"	POR-1218	31	16"	46.65
POR-14	32	14"	46.85	16 3/8"	14"	POR-1418	35	16"	51.85
POR-17	40	14"	55.85	19 7/8"	17 1/2"	POR-1718	44	16"	61.45
POR-21	44	14"	60.65	23 3/8"	21"	POR-2118	48	16"	58.75
POR-26	45	14"	65.25	28 3/8"	26 1/4"	POR-2618	49	16"	72.15
POR-31	50	14"	68.70	33 7/8"	31 1/2"	POR-3118	55	16"	76.55
POR-35	55	14"	72.75	37 3/8"	35"	POR-3518	60	16"	80.95

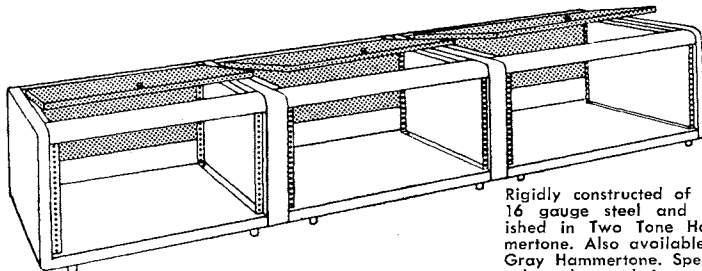

Rigidly constructed of No. 16 gauge steel and finished in Two Tone Hammertone. Also available in Gray Hammertone. Specify color when ordering.

Above unit is one Triple POR-8 which consists of one POR-8 two MOR-8

MULTIPLE SECTION FOR PREM-O-RAK DESK CABINETS

PREM-O-RAK DESK CABINETS can be joined together to make multiple units by means of a center frame section which is bolted to the top cross pieces and base. When ordering multiple units specify number of units, such as Double, Triple, etc.

EXAMPLE: One Double POR-1218 consists of one POR-1218 and one MOR-1218.
 One Triple POR-8 consists of one POR-8 and two MOR-8.

EACH MULTIPLE SECTION (MOR Series) comprises 6 pieces as shown.

15 1/4" DEEP					18" DEEP		
Cat. No.	Shp. Wt. Lbs.	Net Price	Overall Height	Panel Space	Cat. No.	Shp. Wt. Lbs.	Net Price
MOR-3	16	\$20.55	5 7/8"	3 1/2"	MOR-318	18	\$21.55
MOR-5	17	21.55	7 5/8"	5 1/4"	MOR-518	19	23.80
MOR-7	18	22.65	9 3/8"	7"	MOR-718	20	25.20
MOR-8	19	23.80	11 1/8"	8 3/4"	MOR-818	21	26.50
MOR-10	20	27.30	12 7/8"	10 1/2"	MOR-1018	23	30.20
MOR-12	21	29.50	14 5/8"	12 1/4"	MOR-1218	24	32.40
MOR-14	23	32.85	16 3/8"	14"	MOR-1418	26	36.25
MOR-17	31	39.15	19 7/8"	17 1/2"	MOR-1718	34	43.20
MOR-21	33	42.50	23 3/8"	21"	MOR-2118	37	47.10
MOR-26	34	45.95	28 3/8"	26 1/4"	MOR-2618	38	50.60
MOR-31	36	48.10	33 7/8"	31 1/2"	MOR-3118	40	53.65
MOR-35	40	50.95	37 3/8"	35"	MOR-3518	44	56.20

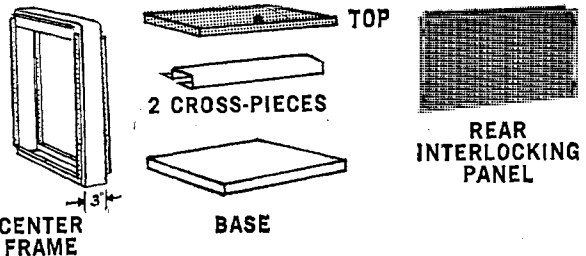

FOR MODIFICATIONS SEE PREMIER PAGE 2 • FOR ACCESSORIES SEE PREMIER PAGES 16 THRU 22
FOR BLOWERS, FANS, HARDWARE SEE PREMIER PAGES 27 THRU 32

PREMIER METAL PRODUCTS COMPANY

A Division of Sunshine Mining Company

PREMIER 12" DEEP MINIATURE DESK CABINET RACKS

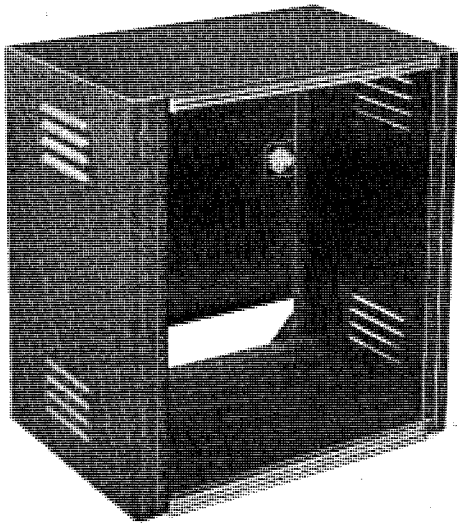

MDK SERIES
Shown with panels, horizontal (DH Series) and vertical (DV Series) dividers assembled.

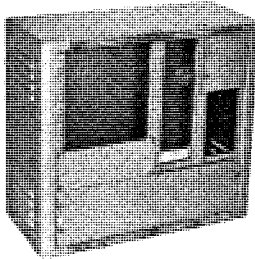

MODU-RAK®



FOR STANDARD 19" RACK PANELS

(KNOCKED DOWN)

- Front vertical corners are rounded and, the top and bottom are trimmed with red striped chrome moulding.
- Rigidly constructed of #16 gauge cold rolled sheet steel.
- Panels fit into a recess so that the edges are not exposed.
- Panel mounting holes are tapped for 10-32 machine screws on E.I.A. Spacings ($\frac{5}{8}$ - $\frac{1}{2}$ "').
- Rear doors have snap catches.
- Bolts are not visible from the outside and these units have the same appearance as the welded models.
- FINISHED IN GRAY HAMMERTONE.
- SHIPPED KNOCKED DOWN WITH ALL NECESSARY HARDWARE FOR EASY ASSEMBLY.

21 3/4" WIDE x 12" DEEP

	Catalog No.	Overall Height	Available Panel-Space	Shlp. Wt. Lbs.	Net Price
WITH REMOVABLE REAR PANEL	MDK-50	7"	5 1/4 x 19"	16	\$14.85
	MDK-70	8 3/4"	7 x 19"	20	15.30
	MDK-80	10 1/2"	8 3/4 x 19"	21	16.15
	MDK-100	12 1/4"	10 1/2 x 19"	23	18.30
	MDK-120	14"	12 1/4 x 19"	25	19.75
MDK-140	15 3/4"	14 x 19"	29	22.20	
WITH REAR DOOR	MDK-170	19 1/2"	17 1/2 x 19"	36	26.60
	MDK-210	22 3/4"	21 x 19"	39	28.85
	MDK-260	28"	26 1/4 x 19"	40	31.50
	MDK-280	29 3/4"	28 x 19"	41	33.80

ACCESSORIES FOR SUBDIVIDING ANY 19" WIDE PANEL SPACE INTO MODULAR UNITS

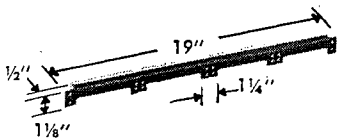

HORIZONTAL DIVIDERS

- Holes punched to accommodate vertical dividers (DV Series) which subdivides the panel space into 9 1/2" and 4 3/4" widths.
- Made of #16 gauge steel.
- Finished in Gray Hammertone.

Catalog No.	Dimensions	Net Price
DH-19	19" x 1 1/8"	\$4.35
DH-95	9 1/2" x 1 1/8"	3.55

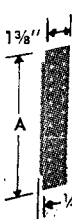

VERTICAL DIVIDERS

- Two rows of 10-32 tapped holes punched on E.I.A. Spacings.
- Made of No. 16 gauge steel.
- Finished in gray Hammertone.

Cat. No.	"A" Available Panel Mtg. Space	Net Price
DV-5	5 1/4"	\$1.20
DV-7	7"	1.65
DV-8	8 3/4"	2.05
DV-10	10 1/2"	2.50
DV-12	12 1/4"	2.65
DV-14	14"	2.90
DV-17	17 1/2"	3.80
DV-21	21"	4.60
DV-26	26 1/4"	5.75
DV-28	28"	5.95

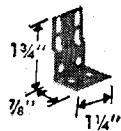

ANGLE BRACKETS

- Punched to accommodate vertical dividers.
- Made of No. 16 gauge steel.
- Finished in gray hammertone.

Cat. No.	Net Price	sold in pairs only
AB-2	\$1.30 pr.	

FOR MODIFICATIONS SEE PREMIER PAGE 2 • FOR ACCESSORIES SEE PREMIER PAGES 16 THRU 22

FOR BLOWERS, FANS and HARDWARE SEE PREMIER PAGES 27 THRU 32

PREMIER METAL PRODUCTS COMPANY

A Division of Sunshine Mining Company

PREMIER END PANELS For Square Cornered FRAMES



FLUSH END PANELS FOR PRXA FRAMES 1/2" DEEP

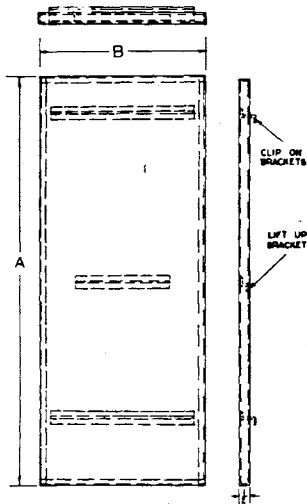

FL SERIES

- Fits into side recess of frame.
- Made of one piece of #16 gauge steel.
- Clips on to horizontal side section of frame. Finished in Gray Hammertone.

15" WIDE for 18" DEEP FRAMES				Height (A)	21" WIDE for 24" DEEP FRAMES			
Cat. No.	To Fit Frame No.	Shpg. Wt. Lbs.	Net Price Each		Cat. No.	To Fit Frame No.	Shpg. Wt. Lbs.	Net Price Each
FL-36	PRXA-36	18	\$16.45	42 3/4"	FL-36-24	PRXA-36-24	20	\$21.70
FL-42	PRXA-42	19	17.40	48"	FL-42-24	PRXA-42-24	21	22.75
FL-52	PRXA-52	21	19.70	58 1/2"	FL-52-24	PRXA-52-24	24	25.05
FL-61	PRXA-61, 2761, 3361	22	22.95	67 1/4"	FL-61-24	PRXA-61-24, 3361-24	27	27.70
FL-70	PRXA-70, 2770, 3370	25	24.75	76"	FL-70-24	PRXA-70-24, 2770-24, 3370-24	30	29.90
FL-77	PRXA-77, 2777, 3377	27	26.70	83"	FL-77-24	PRXA-77-24, 2777-24, 3377-24	33	32.25

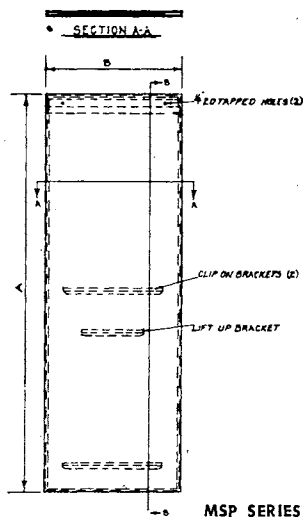

MSP SERIES

- Made of one piece of #16 gauge steel.
- End panels attach to frame by means of a bracket on bottom and held securely by two captive screws on top.
- Finished in Gray Hammertone.

SQUARE END PANELS FOR MSF FRAMES — 13/16" DEEP

22" WIDE for 22" DEEP FRAMES			Height (A)	25 1/2" WIDE for 25 1/2" DEEP FRAMES		
Cat. No.	To Fit Frame No.	Net Price		Cat. No.	To Fit Frame No.	Net Price
MSP-21-22	MSF-21-22	\$15.05	26"	MSP-21-255	MSF-21-255	\$17.25
MSP-28-22	MSF-28-22	17.25	33"	MSP-28-255	MSF-28-255	19.50

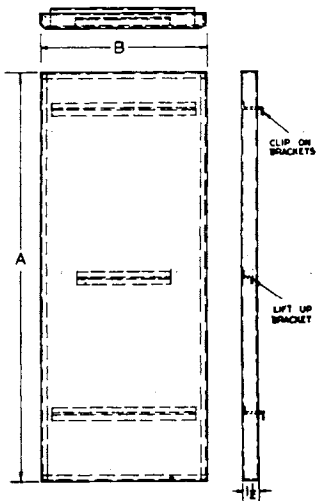

SP SERIES

- Fits into side recess of frame.
- Made of one piece of #16 gauge steel.
- Clips on to horizontal side section of frame.
- Finished in Gray Hammertone.

ROUNDED END PANELS FOR PRXA FRAMES

1 1/2" DEEP

15" WIDE for 18" DEEP FRAMES				
Cat. No.	To Fit Frame No.	Height (A)	Shpg. Wt. Lbs.	Net Price
SP-36	PRXA-36	42 3/4"	9	\$18.35
SP-42	PRXA-42	48"	20	19.35
SP-52	PRXA-52	58 1/2"	21	21.75
SP-61	PRXA-61	67 1/4"	23	25.20
SP-70	PRXA-70	76"	26	27.10
SP-77	PRXA-77	83"	28	29.10
21" WIDE for 24" DEEP FRAMES				
Cat. No.	To Fit Frame No.	Height (A)	Shpg. Wt. Lbs.	Net Price
SP-36-24	PRXA-36-24	42 3/4"	21	\$23.95
SP-42-24	PRXA-42-24	48"	22	24.95
SP-52-24	PRXA-52-24	58 1/2"	25	27.35
SP-61-24	PRXA-61-24	67 1/4"	28	30.25
SP-70-24	PRXA-70-24	76"	31	32.45
SP-77-24	PRXA-77-24	83"	34	35.10

PREMIER METAL PRODUCTS COMPANY

A Division of Sunshine Mining Company

PREMIER

ACCESSORIES

ONE PIECE FORMICA WORK WRITING SHELVES

For 22" Wide FA and FS FRAMES

- Gray linen weave Formica (2-C-1) bonded to 3/4" plywood
- Other Standard Formica Colors or Patterns Available
- 3" self edged Formica skirt on 3 sides
- Supplied with 3/2 x 19" formed panel, channels and brackets

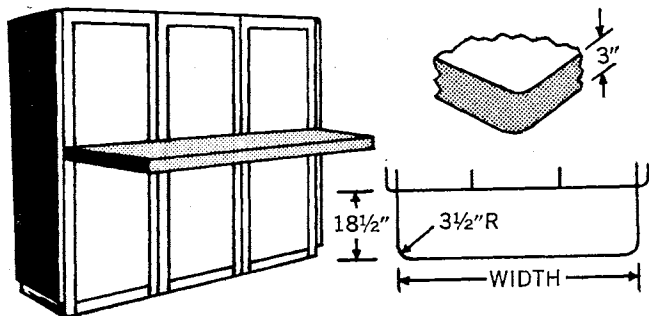

TO FIT 22" DEEP FRAMES				TO FIT 25 1/2" DEEP FRAMES			
Cat. No.	Net Price	Depth	Width	Cat. No.	Net Price	Depth	Width
For 1 Vertical Frame (FA MSF, or PRXA Series) or 1 Sloped Front Frame (FS Series)							
OFT-2218-22	\$87.50	18 1/2"	22"	OFT-2218-255	\$88.65	18 1/2"	25 1/2"
For 2 Vertical Frames (FA MSF, or PRXA Series) or 2 Sloped Front Frames (FS Series) Side By Side							
OFT-4418-22	110.75	18 1/2"	44"	OFT-4418-255	111.95	18 1/2"	44"
For 3 Vertical Frames (FA MSF, or PRXA Series) or 3 Sloped Front Frames (FS Series) Side By Side							
OFT-6618-22	134.05	18 1/2"	66"	OFT-6618-255	136.50	18 1/2"	66"
For 4 Vertical Frames (FA MSF, or PRXA Series) or 4 Sloped Front Frames (FS Series) Side By Side							
OFT-8818-22	163.25	18 1/2"	88"	OFT-8818-255	165.20	18 1/2"	88"

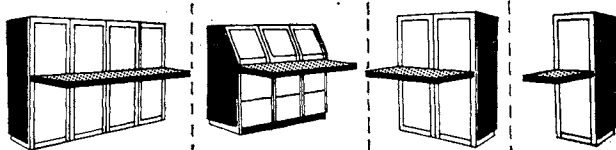

NOTE:
ONE PIECE Formica shelves available for use with semi-circular arrangements when used with Wedge Frames.

FORMICA WRITING PANELS

19" and 24" WIDE — 1/2" THICK

Gray Linen Weave Pattern Formica 2-C-1 bonded to plywood as top surface; Unfinished Formica bonded to bottom surface.

19" WIDE			
Cat. No.	Panel Space	Fits into	Net Price
FWP-1019	10 1/2" x 19"	WW-15-22 & WW-15-255	\$9.50
FWP-1419	14" x 19"	WW-18-22 & WW-18-255	10.90
FWP-1719	17 1/2" x 19"	WW-22-22 & WW-22-255, WTO-22-22 & Top Panel Space of CPF-101, CPF-102, MSF-21-22, MSF-28-22	13.00
FWP-2119	21" x 19"	WTO-22-255, WW-255-22, WW-255-255, MSF-21-255, MSF-28-255	16.10
FWP-2919	29 3/4" x 19"	CPF-101-34, WTO-22-34	28.80
24" WIDE			
Cat. No.	Panel Space	Fits into	Net Price
FWP-1024	10 1/2" x 24"	WW-2715-22, WW-2715-255	\$10.60
FWP-1424	14" x 24"	WW-2718-22, WW-2718-255	11.75
FWP-1724	17 1/2" x 24"	WW-2722-22, WW-2722-255, WTO-27-22 & Top Panel Space of CPF-103 & CPF-104	13.75
FWP-2124	21" x 24"	WTO-27-255, WW-27-255, WW-27-255-255	17.25



FORMED PANELS — 1/2" DEEP 19" and 24" WIDE

BLANK

LOUVRED

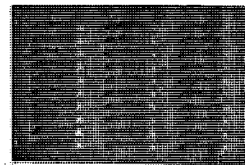
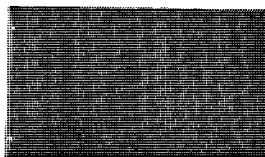

FP Series

FPL Series

- Made of one piece of No. 16 gauge steel, with edges formed for overall depth of 1/2".
- Each panel has only 2 mounting holes on each side.
- Finished in Gray Hammertone.

BLANK

19" WIDE				24" WIDE			
Cat. No.	Shpg. Wt. Lbs.	Net Price	Height	Cat. No.	Shpg. Wt. Lbs.	Net Price	Height
FP-119	1 1/2	\$1.35	1 3/4"	FP-124	2	\$1.55	1 3/4"
FP-319	2	1.40	3 1/2"	FP-324	3	1.70	3 1/2"
FP-519	2 1/2	1.60	5 1/4"	FP-524	3 1/2	1.95	5 1/4"
FP-719	3	1.80	7"	FP-724	4	2.25	7"
FP-819	4	2.30	8 3/4"	FP-824	5	2.75	8 3/4"
FP-1019	5	2.80	10 1/2"	FP-1024	6	3.35	10 1/2"
FP-1219	6	3.25	12 1/4"	FP-1224	7	3.85	12 1/4"
FP-1419	6 1/2	3.80	14"	FP-1424	7 1/2	4.35	14"
FP-1519	7	4.20	15 3/4"	FP-1524	8	4.90	15 3/4"
FP-1719	7 1/2	4.65	17 1/2"	FP-1724	8 1/2	5.50	17 1/2"
FP-1919	8	5.05	19 1/4"	FP-1924	9	5.95	19 1/4"
FP-2119	9	5.50	21"	FP-2124	10	6.50	21"
FP-2219	10	6.05	22 3/4"	FP-2224	11	7.35	22 3/4"
FP-2619	11	6.85	26 1/4"	FP-2624	12	8.35	26 1/4"
FP-2819	12	7.45	28"	FP-2824	13	8.85	28"
FP-4219	18	12.35	42"	FP-4224	20	14.85	42"

LOUVRED

19" WIDE				24" WIDE			
Cat. No.	Shpg. Wt. Lbs.	Net Price	Height	Cat. No.	Shpg. Wt. Lbs.	Net Price	Height
FPL-719	3	\$3.80	7"	FPL-724	4	\$4.65	7"
FPL-819	4	4.40	8 3/4"	FPL-824	5	5.30	8 3/4"
FPL-1019	5	4.95	10 1/2"	FPL-1024	6	5.80	10 1/2"
FPL-1219	6	5.45	12 1/4"	FPL-1224	7	6.55	12 1/4"
FPL-1419	6 1/2	5.85	14"	FPL-1424	7 1/2	7.05	14"
FPL-1719	7 1/2	6.90	17 1/2"	FPL-1724	8 1/2	8.30	17 1/2"
FPL-2119	9	8.55	21"	FPL-2124	10	10.25	21"
FPL-2219	10	9.25	22 3/4"	FPL-2224	11	10.50	22 3/4"
FPL-2619	11	9.60	26 1/4"	FPL-2624	12	11.55	26 1/4"
FPL-2819	12	10.20	28"	FPL-2824	13	12.20	28"
FPL-4219	18	17.30	42"	FPL-4224	20	21.05	42"

PERFORATED

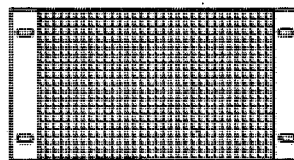

PPF Series

- Made of No. 20 gauge steel with 1/16" diameter holes on 3/16" staggered centers.
- Edges formed on 4 sides. • Overall depth 1/2".
- Each panel has 2 mounting holes on each side.
- Finished in Gray Hammertone.

19" WIDE				24" WIDE			
Cat. No.	Shpg. Wt. Lbs.	Net Price	Height	Cat. No.	Shpg. Wt. Lbs.	Net Price	Height
PPF-119	1 1/4	\$2.80	1 3/4"	PPF-124	2 1/4	\$3.65	1 3/4"
PPF-319	1 3/4	3.10	3 1/2"	PPF-324	2 3/4	3.95	3 1/2"
PPF-519	2 1/4	3.35	5 1/4"	PPF-524	3 1/4	4.40	5 1/4"
PPF-719	2 3/4	4.20	7"	PPF-724	3 3/4	5.65	7"
PPF-819	3 3/4	4.80	8 3/4"	PPF-824	4 3/4	6.50	8 3/4"
PPF-1019	4 3/4	5.60	10 1/2"	PPF-1024	5 3/4	7.05	10 1/2"
PPF-1219	5 3/4	6.30	12 1/4"	PPF-1224	6 3/4	8.30	12 1/4"
PPF-1419	6 1/4	6.95	14"	PPF-1424	7 1/4	9.00	14"
PPF-1519	6 3/4	7.50	15 3/4"	PPF-1524	7 3/4	9.95	15 3/4"
PPF-1719	7 1/4	8.05	17 1/2"	PPF-1724	8 1/4	10.70	17 1/2"
PPF-1919	7 3/4	8.90	19 1/4"	PPF-1924	8 3/4	11.80	19 1/4"
PPF-2119	8 3/4	9.55	21"	PPF-2124	9 3/4	12.65	21"
PPF-2619	10 3/4	12.25	26 1/4"	PPF-2624	11 3/4	14.60	26 1/4"
PPF-2819	11 3/4	13.00	28"	PPF-2824	12 3/4	16.05	28"

PREMIER METAL PRODUCTS COMPANY

A Division of Sunshine Mining Company

PREMIER

ACCESSORIES

SLIDING DRAWERS

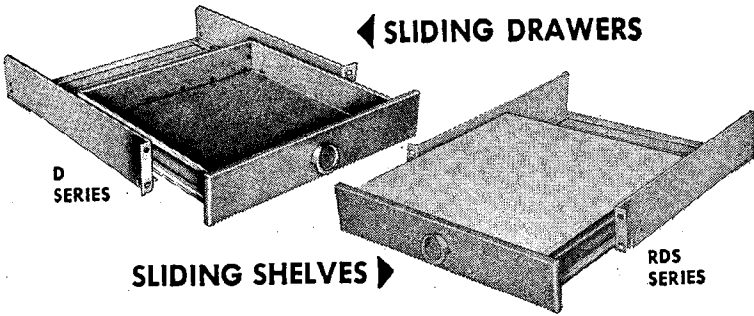

SLIDING DRAWERS

Cat. No.	Formed Panel Size	Drawer Size			Shpg. Wt. Lbs.	Net Price
		W	D	H		
FOR 19" WIDE PANEL SPACE						
D-1916	10 ³ / ₈ " x 18 ⁷ / ₈ " x 1 ¹ / ₂ "	16 ¹ / ₈ "	16	6"	23	\$21.05
D-2016	6 ⁷ / ₈ " x 18 ⁷ / ₈ " x 1 ¹ / ₂ "	16 ¹ / ₈ "	16	6"	22	20.20
D-2316	3 ³ / ₈ " x 18 ⁷ / ₈ " x 1 ¹ / ₂ "	16 ¹ / ₈ "	16	2 ¹ / ₁₆ "	16	25.25
FOR 24" WIDE PANEL SPACE						
D-2116	10 ³ / ₈ " x 23 ⁷ / ₈ " x 1 ¹ / ₂ "	21 ¹ / ₈ "	16	6"	25	24.20
D-2216	6 ⁷ / ₈ " x 23 ⁷ / ₈ " x 1 ¹ / ₂ "	21 ¹ / ₈ "	16	6"	24	19.05
D-2416	3 ³ / ₈ " x 23 ⁷ / ₈ " x 1 ¹ / ₂ "	21 ¹ / ₈ "	16	2 ¹ / ₁₆ "	17	21.05

SLIDING SHELVES

- Made of No. 16 gauge steel.
- Mounted on suspension slides, which sustain 46 lbs.
- Drawer extends 16" from front of cabinet.
- Supplied with brackets for mounting to tapped holes of panel mounting angles.
- Furnished with attractive, round chrome-plated handle.
- Shipped knocked down with all necessary hardware for easy assembly.
- Will fit CPF, FS, MSF, POR, PRXA, RMX, FDX SERIES.
- Finished in Gray Hammertone.
- Sliding shelves supplied with Gray linen weave Formica (2-C-1) on top surface.

SLIDING SHELVES

Cat. No.	Formed Panel Size	Shelf Size	Shpg. Wt. Lbs.	Net Price
RDS-319-22	3 ³ / ₈ " x 18 ⁷ / ₈ " x 1 ¹ / ₂ "	16 ¹ / ₈ " x 15 ³ / ₁₆ "	20	\$38.55
FOR 24" WIDE PANEL SPACE				
RDS-324-22	3 ³ / ₈ " x 23 ⁷ / ₈ " x 1 ¹ / ₂ "	21 ¹ / ₈ " x 15 ³ / ₁₆ "	22	49.10

SLIDING DRAWERS TO FIT STANDARD 19" RACKS 15 1/4" AND 18" DEEP

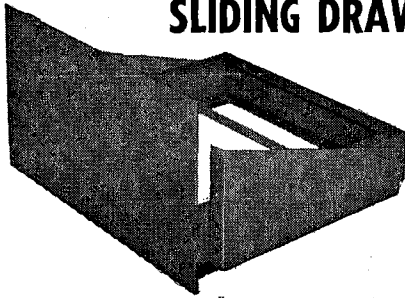

Panel made of #12 gauge steel; chassis of #16 steel and has a 1" flange on top and bottom to accommodate plywood for the record changer. The chassis is mounted on ball-bearing suspension slides which can sustain 40 lbs. Drawer extends 11" from front of cabinet. Entire unit mounts on angle brackets which can be bolted on to the cabinet. Supplied knocked down with all necessary bolts for easy assembly. Locks in place by means of 2 latches. Finished in Gray Hammertone.

Catalog No.	Will Fit Rack No.	Panel Size	Chassis Size			Shpg. Wt. Lbs.	Net Price
			W.	D.	H.		
RD-10	R, DCR-18, SDR-18, RMX & FDX Models	10 ³ / ₈ " x 18 ⁷ / ₈ "	17"	16"	3"	15	\$20.15
RD-12	Models	12 ¹ / ₈ " x 18 ⁷ / ₈ "	17"	16"	4"	18	22.30
RD-10-14	DCR, SDR, DRK, RMX & FDX, R, Models	10 ³ / ₈ " x 18 ⁷ / ₈ "	17"	14"	3"	14 1/2	19.95
RD-12-14	Models	12 ¹ / ₈ " x 18 ⁷ / ₈ "	17"	14"	4"	17	22.15

DESK PANELS TO FIT STANDARD 19" WIDE PANEL RACKS

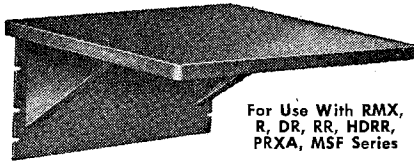

For Use With RMX, R, DR, RR, HDRR, PRXA, MSF Series

- Made of No. 16 gauge steel and bolted to a standard steel panel 10 1/2" x 19".
- Front corners are rounded.
- Finished in Gray Hammertone.
- SHIPPED KNOCKED DOWN WITH ALL NECESSARY HARDWARE FOR EASY ASSEMBLY.

Cat. No.	Width	Depth	Shpg. Wt. Lbs.	Net Price
DP-1016	22"	16"	20	\$20.90
DP-1020	22"	20"	22	21.35

SHELVES TO FIT 19" WIDE PANEL RACKS

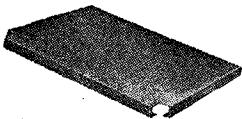

Made of one piece of #16 Ga. Cold Rolled Steel, 1" high. Holes are punched on sides for mounting to rack. Finished in Gray Hammertone.

Cat. No.	Will Fit Rack No.	Shelf Size	Shpg. Wt. Lbs.	Net Price
RS-1106	All 15 1/4" SDR, DCR & DRK Racks	12x21 3/8"	7	\$3.60
RS-1107	R & DR Racks	15x21 3/8"	7	4.50
RS-1108	FXR	13x21 3/8"	7	4.05
RS-1111	MDK Series - 21 3/4" wide	10x21 3/8"	6	3.50
RS-1113	18" deep DCR & SDR Racks	16x21 3/8"	7	4.65

ROLLER TRUCKS FOR RACKS

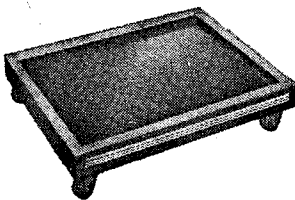

Made from 1 piece of No. 16 go. Cold Rolled Steel. Supplied with either 2" or 3" diameter casters and bolts for easy assembly. Finished in Gray Hammertone with a red striped chrome molding.

With 2" Dia Casters Cat. No.	Shpg. Wt. lbs.	Net Price	Will Fit Rack No.	Inside Dimensions	With 3" Dia. Casters Cat. No.	Shpg. Wt. lbs.	Net Price
RT-1100	22	\$12.20	All 15 1/4" Racks	15 3/4 x 22 1/4"	RT-1100-3	24	\$18.30
RT-1101	22	15.45	R, DR, FXR, 18" deep RMX, FDX, DCR and SDR Racks	18 3/4 x 22 3/4"	RT-1101-3	24	21.50
RT-1103	23	18.95	24" deep FDX & RMX Racks	22 1/2 x 24 1/2"	RT-1103-3	25	25.25
RT-1110	25	28.55	RMX-27 & FDX-27 Series	27 1/2 x 24 1/2"	RT-1110-3	27	34.95
RT-1111	30	36.75	RMX-7030	33 1/2 x 24 1/2"	RT-1111-3	32	42.85

PREMIER METAL PRODUCTS COMPANY

A Division of Sunshine Mining Company

PREMIER

CASES

SLOPING COMPACT CASES

Give your equipment a new look with the new **DESIGNER SERIES!**

In addition to the standard two-tone metallic gray enamelled finish, the **DESIGNER SERIES** is now available with a black outer shell and a choice of Blue, Olive or Gold inserts. Other color combinations are optional. Specify insert color when ordering.

- Two piece case made of No. 20 gauge cold rolled steel
- Top of unit extends beyond the front panel
- Supplied with necessary screws for assembly

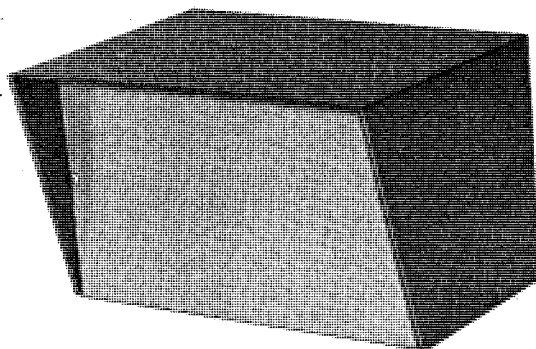
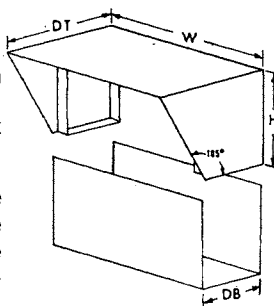

Standard Cat. No.		Net Price		Standard Cat. No.*		Net Price		OVERALL DIMENSIONS			
								Height (H)	Width (W)	Depth Top (DT)	Depth Bottom (DB)
SCC-3000	\$5.75	DSCC-3000	\$6.35	6"	10"	7"	5 1/8"				
SCC-3001	6.30	DSCC-3001	6.95	7"	12"	8"	5 3/4"				
SCC-3002	3.25	DSCC-3002	3.60	3"	8"	5"	3 7/8"				
SCC-3003	3.50	DSCC-3003	3.85	5"	5"	5"	3 3/8"				

DSCC — Designer Series

SCC — Standard Series

*For BLUE, OLIVE or GOLD INSERTS ADD B, O or G after Designer Series Number.

COMPACT CASES

with **ROUNDED CORNERS ON BOTH FRONT AND REAR OF TOP**

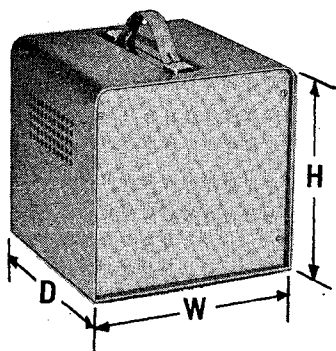

DCC — Designer Series

CC — Standard Series

- Body made of 20 gauge steel
- Front Panel made of .064 aluminum
- Recessed Handle supplied on top
- Perforated Sides for ventilation
- Base supplied with four rubber feet
- Panel fits into 1/2" recess
- Two-inch opening in rear for leads
- Jet Black outer shell with choice of Blue, Olive or Gold front panel inserts. Other color combinations are optional
- Supplied with necessary screws for assembly
- Welded construction

In addition to the standard two-tone metallic gray enamelled finish, the **DESIGNER SERIES** is now available with a black outer shell and a choice of Blue, Olive or Gold inserts. Other color combinations are optional. Specify insert color when ordering.

Standard Cat. No.		Net Price		Designer Cat. No.*		Net Price		OVERALL DIMENSIONS				
								Depth	Width	Height	Use Chassis	Wt. in Lbs.
CC-2000	\$ 9.80	DCC-2000	\$10.80	8"	6 1/8"	8"	ACH 426	5 x 7 x 2	4			
CC-2001	10.75	DCC-2001	11.85	8"	8 1/8"	8"	ACH 403	7 x 7 x 2	5			
CC-2002	11.50	DCC-2002	12.65	8"	10 1/8"	8"	ACH 404	7 x 9 x 2	6			
CC-2003	12.45	DCC-2003	13.70	12"	8 1/8"	9"	ACH 405	7 x 11 x 2	7			
CC-2004	14.75	DCC-2004	16.25	18"	11 1/8"	11"	ACH 415	10 x 17 x 3	10			
CC-2005	16.75	DCC-2005	18.45	18"	14 1/8"	12"	ACH 423	13 x 17 x 3	11			

* For BLUE, OLIVE or GOLD INSERTS ADD B, O or G after Designer Series Number

UTILITY CASES

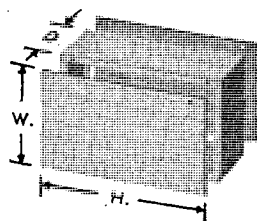

ALUMINUM

Constructed of #16 ga. (.051) aluminum with 1/2" flanged edges, spot welded corners and two removable flat covers. Natural Aluminum finish or Gray Hammertone.

Natural Aluminum Cat. No.	Net Price	Size H. W. D.	Ship. Wt. Lbs.	Gray Hammertone Cat. No.	Net Price
AC-442	\$1.60	4 4 2"	1/2	PAC-442	\$1.75
AC-453	1.70	4 5 3"	3/4	PAC-453	2.00
AC-564	2.00	5 6 4"	1	PAC-564	2.45
AC-596	3.35	5 9 6"	1 1/2	PAC-596	3.70
AC-666	2.60	6 6 6"	1 1/2	PAC-666	2.90
AC-1276	4.60	12 7 6"	2 1/4	PAC-1276	5.05
AC-1597	6.35	15 9 7"	3 1/2	PAC-1597	7.00
AC-695	3.25	6 9 5"	1 1/2	PAC-695	3.70

STEEL

Constructed of #20 ga. sheet steel with 1/2" flanged edges, spot welded corners, and two removable flat covers. Finished in Black Wrinkle.

Catalog No.	H.	W.	D.	Ship. Wt. Lbs.	Net Price
C-442	4"	4"	2"	7/8	\$1.55
C-453	4"	5"	3"	1 1/4	1.65
C-564	5"	6"	4"	1 3/4	1.95
C-596	5"	9"	6"	3	2.75
C-666	6"	6"	6"	2 1/4	2.45
C-695	6"	9"	5"	3	2.75
C-754	7"	5"	4"	2	2.30
C-8101	10"	10"	8"	6	4.65
C-1276	12"	7"	6"	4 1/2	3.75

PREMIER METAL PRODUCTS COMPANY

A Division of Sunshine Mining Company

PREMIER STEEL and ALUMINUM CHASSIS

STEEL and ALUMINUM BLANK

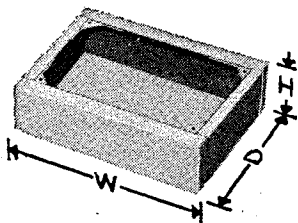

EXCLUSIVE PREMIER FEATURE!

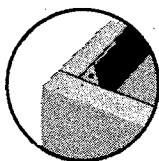

View of Chassis Showing Gusset Spot-Welded in Corner.

Chassis are of one piece construction with gussets spot-welded to the bottom flanges for additional strength. Corners have rounded effect and single inside thickness for mounting components. Bottom edges are flanged in on four sides and punched for bottom plates.

Steel chassis are zinc plated and made of No. 20 gauge cold rolled steel, except those marked * which are of No. 16 gauge.

Aluminum chassis are made of No. 18 gauge (.040) aluminum, except those marked * which are of No. 14 gauge (.064). Natural Aluminum Finish.

ALUMINUM			STEEL		
Cat. No.	Ship. Wt. Lbs.	Net Price	Cat. No.	Ship. Wt. Lbs.	Net Price
ACH-400	1/2	\$1.70	CH-400	1	\$1.90
ACH-401	3/4	1.85	CH-401	1 1/2	2.15
ACH-402	1	2.90	CH-402	2 1/2	2.35
ACH-403	1/2	1.65	CH-403	1 1/4	1.90
ACH-404	3/4	1.75	CH-404	1 1/2	1.90
ACH-405	3/4	1.90	CH-405	1 7/8	2.05
ACH-406	3/4	2.05	CH-406	2	2.25
ACH-407	1	3.25	CH-407	2 3/4	2.75
ACH-408	1	2.85	CH-408	2 1/4	2.55
ACH-409	1 1/2	3.40	CH-409	3 1/8	3.05
ACH-410	1 1/8	3.25	CH-410	2 3/4	2.85
ACH-411	1 1/2	3.55	CH-411	5/4	3.15
ACH-412	1 1/4	3.15	CH-412	2 3/4	2.70
ACH-413	1 1/4	3.80	CH-413	3 1/4	3.00
ACH-414	1 1/4	3.65	CH-414	3 1/4	2.95
ACH-415*	1 7/8	4.05	CH-415*	6	3.50
ACH-416*	2	5.15	CH-416*	7 1/2	4.30
ACH-417*	1 3/4	3.95	CH-417*	5 1/4	3.80
ACH-418*	2	4.80	CH-418*	6 1/4	4.20
ACH-419*	1 7/8	4.20	CH-419*	5	3.65
ACH-420*	2 1/8	5.05	CH-420*	7	4.40
ACH-421*	2 7/8	5.75	CH-421*	8 1/2	4.75
ACH-422*	1 7/8	4.40	CH-422*	6	4.35
ACH-423*	2 1/8	5.25	CH-423*	7	4.90
ACH-424*	2 1/2	6.35	CH-424*	10	5.75
ACH-425	7/8	2.30	CH-425	2 1/4	2.75
ACH-426	3/4	1.45	CH-426	1	1.75
ACH-427	1 1/4	3.50	CH-427	3	3.15
ACH-428	1 1/4	1.70	CH-428	1 1/4	2.10
ACH-429	3/4	2.10	CH-429	2	2.50
ACH-430	1	2.60	CH-430	2 1/2	2.70
ACH-431	1/4	1.40	CH-431	1	1.75
ACH-432	1/4	1.60	CH-432	1	2.20
ACH-433	7/8	2.40	CH-433	2 1/2	2.60
ACH-434	1	3.25	CH-434	4	2.85
ACH-435*	2 1/2	6.25	CH-435*	10	4.95
ACH-436	1/4	1.35	CH-436	3/4	1.60
ACH-437	3/8	1.50	CH-437	1	1.65
ACH-438*	3	11.50	CH-438*	13	8.25
—	—	—	CH-439*	8 1/2	6.25
—	—	—	CH-440*	11	7.05
—	—	—	CH-441	2 1/2	2.20
ACH-441	1	2.30			

*Made of No. 14 gauge (.064) aluminum.

For Chassis Mounting Brackets See Premier Page 24

*Made of No. 16 gauge steel.

For Steel and Aluminum Panels See Premier Page 26

ALUMINUM AND STEEL BOTTOM PLATES

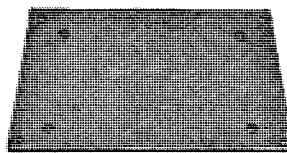

The bottom plates have holes to match the chassis and have 4 pressed dimples. Steel plates are zinc plated and made of No. 20 gauge steel. Aluminum plates made of No. 18 gauge (.040). Natural aluminum finish.

ALUMINUM			STEEL		
Cat. No.	Net Price	Size	Cat. No.	Ship. Wt. Lbs.	Net Price
ABP-400	\$0.95	5 1/2" x 9 1/2"	BP-400	1	\$0.80
ABP-401	.95	5" x 10"	BP-401	1	.85
ABP-402	1.45	6" x 14"	BP-402	1	1.00
ABP-403	.95	7" x 7"	BP-403	1	.80
ABP-404	1.00	7" x 9"	BP-404	1	.85
ABP-405	1.15	7" x 11"	BP-405	1	.95
ABP-406	1.40	7" x 13"	BP-406	2	1.00
ABP-407	1.45	7" x 15"	BP-407	2	1.05
ABP-408	1.45	4" x 17"	BP-408	2	1.15
ABP-409	1.55	7" x 17"	BP-409	2	1.45
ABP-410	1.70	8" x 17"	BP-410	2	1.55
ABP-412	1.65	10" x 12"	BP-412	2	1.45
ABP-413	1.75	10" x 14"	BP-413	2	1.45
ABP-414	1.85	10" x 17"	BP-414	2	1.65
ABP-418	2.50	11" x 17"	BP-418	3	1.75
ABP-419	2.60	12" x 17"	BP-419	3	1.85
ABP-422	2.65	13" x 17"	BP-422	3	1.95
ABP-423	.95	5" x 7"	BP-423	1	.75
ABP-424	1.10	5" x 13"	BP-424	1	1.00
ABP-425	1.45	8" x 12"	BP-425	2	1.35
ABP-426	.95	4" x 6"	BP-426	1	.65
ABP-427	1.30	7" x 12"	BP-427	2	1.25
ABP-428	1.50	6" x 17"	BP-428	2	1.35
ABP-429	2.85	10" x 23"	BP-429	2	2.30
ABP-430	1.05	4" x 8"	BP-430	1	.85
ABP-431	2.85	17" x 17"	BP-431	4	2.45
ABP-432	2.55	8 1/2" x 15"	BP-432	1 1/2	1.85
ABP-433	1.25	8" x 10"	BP-433	1	1.15

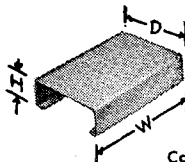

ALUMINUM OPEN END CHASSIS

Made of 18 ga. (.040) Aluminum.

Catalog No.	Depth	Width	Height	Ship. Wt. Lbs.	Net Price
ACH-1350	2 3/8"	2 3/4"	1 1/4"	1/4	\$0.50
ACH-1351	1 3/4"	3 3/8"	1"	1/4	.50
ACH-1352	3 1/2"	4 1/2"	2"	1/4	.55
ACH-1353	2 3/4"	4 1/8"	1 1/2"	1/4	.55
ACH-1354	3 3/4"	4 1/8"	1 1/2"	1/4	.55
ACH-1355	3 1/4"	6 1/8"	1 1/2"	1/4	.65
ACH-1356	5 3/8"	4 7/8"	1 1/2"	1/4	.70
ACH-1357	4 1/2"	3 3/8"	1"	1/2	.55
ACH-1358	4"	4 1/8"	1"	1/2	.60
ACH-1359	4"	5 5/8"	1"	1/2	.60
ACH-1360	4"	6 1/8"	1"	1/2	.70

ALUMINUM VERTICAL PANEL CHASSIS

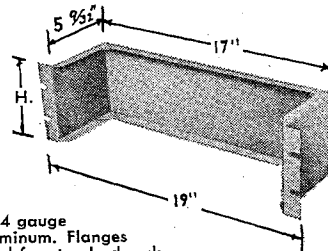

To FIT 19" STANDARD RACKS

Made of 14 gauge (.064) Aluminum. Flanges are notched for standard rack mounting. All chassis depths are 5 3/8". Gussets are spot welded in each corner for greater strength. Etched finish.

Catalog No.	Height	Ship. Wt. Lbs.	Net Price
ACH-1200	13 1/2"	3/4	\$3.00
ACH-1201	31 1/2"	1 3/4	3.25
ACH-1202	51 1/4"	1 1/2	3.60
ACH-1203	7"	2	4.05
ACH-1204	8 3/4"	2 1/4	4.75
ACH-1205	10 1/2"	2 3/4	5.35
ACH-1206	12 1/4"	3	5.90
ACH-1207	14"	3 1/4	6.75

FOR SIDE HINGED PANELS (SHP SERIES) SEE PREMIER PAGE 26

PREMIER METAL PRODUCTS COMPANY

A Division of Sunshine Mining Company

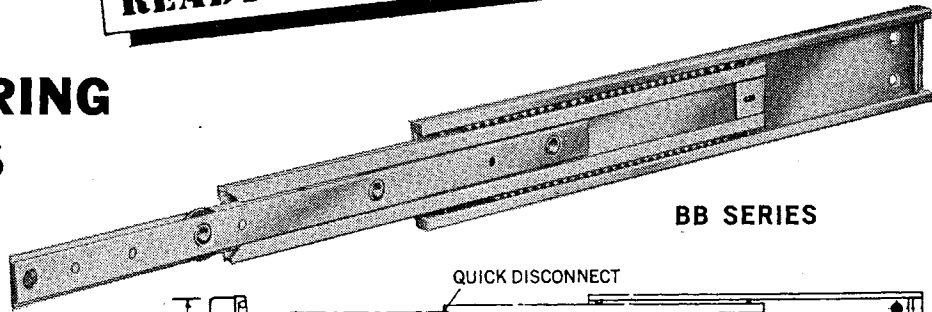
PREMIER**CHASSIS SLIDES****PREM-O-RAK[®]****READY-TO-MOUNT****100 lb.
BALL BEARING
SLIDES****BB SERIES**

- EXCLUSIVE "QUICK DISCONNECT" allows for immediate removal of chassis.

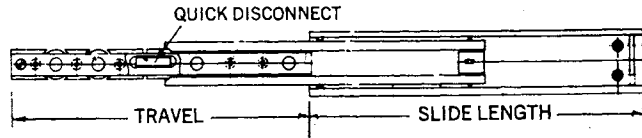
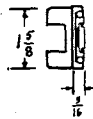

- Carries load of 100 lbs. when fully extended.
- Glides smoothly on stainless steel ball bearings.
- $\frac{5}{16}$ " horizontal side space adjustable $\pm \frac{1}{16}$.
- $1\frac{1}{8}$ " vertical side space.
- 3 telescoping anodized aluminum members.
- Allows full accessibility for instantaneous servicing.
- Slide mounts standard 17" wide chassis.
- Slide locks in open position.
- Supplied with all necessary hardware for immediate installation.

Catalog No.	Load Rating Lbs.	Slide Length	Travel Length	Will Fit Racks	Net Price per Pair
BB-100-14	100	14"	13"	15 $\frac{1}{4}$ " deep POR (DCR, SDR, DRK, FXR)* RMX, FDX	\$73.05
BB-100-16	100	16	15	18" deep PRXA, POR (R, DCR, SDR)*	73.05
BB-100-20	100	20	19	FS, 22" deep CPF & FA, MSF, RMX, FDX	79.10
BB-100-22	100	22	21	24" deep PRXA	80.55
BB-100-24	100	24	23	25 $\frac{1}{2}$ " deep FA & FS, MSF, CPF	82.60

*Slide Adapter Kit (Cat. No. SAK-35) required for rear mounting on all models in parenthesis (See page 28).

RAPID INSTALLATION

For BB, HBB, SB and SNR SERIES SLIDES

- ★ MOUNTS TO TAPPED HOLES OF FRONT AND REAR PANEL MOUNTING ANGLES
- ★ SIMPLE ADJUSTABILITY OF CHASSIS SLIDE ASSEMBLY FROM OUTSIDE OF FRAME

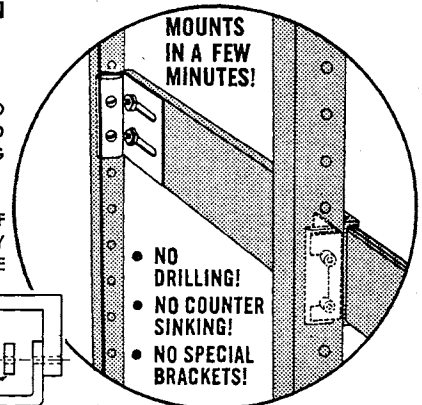
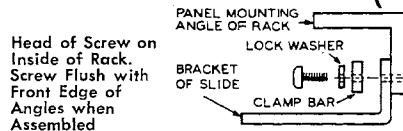
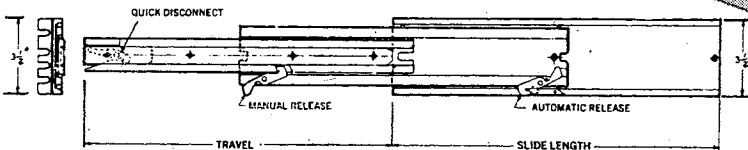
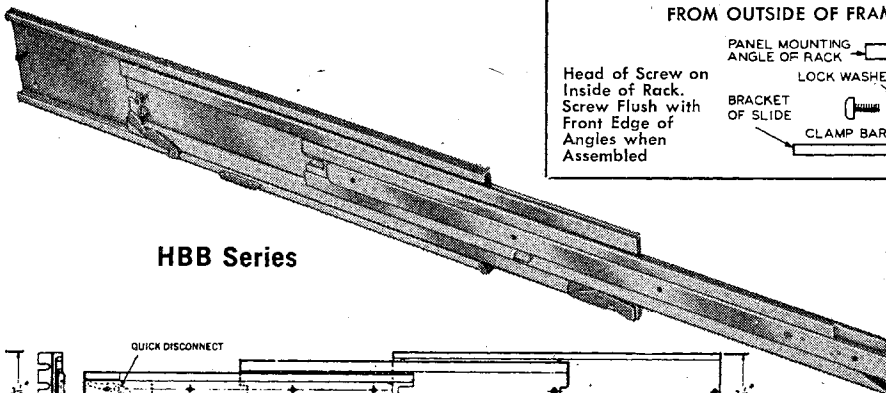
**HBB Series**

Catalog No.	Load Rating Lbs.	Slide Length	Travel Length	Will Fit Racks	Net Price per Pair
HBB-200-14	200	14"	13"	15 $\frac{1}{4}$ " deep POR, RMX, FDX (DCR, SDR, DRK, FXR)*	\$95.05
HBB-200-16	200	16	15	18" deep PRXA, POR, (R, DCR, SDR)*	95.05
HBB-200-20	200	20	19	FS, 22" deep CPF & FA, MSF RMX, FDX	103.60
HBB-200-22	200	22	21	24" deep PRXA	107.25
HBB-200-24	200	24	23	25 $\frac{1}{2}$ " deep FA & FS MSF, CPF	109.60

*Slide Adapter Kit (Cat. No. SAK-35) required for rear mounting on all models in parenthesis (See page 28).

**200 lb. HEAVY
BALL BEARING
SLIDES**

- EXCLUSIVE "QUICK DISCONNECT" allows for immediate removal of chassis.
- Chassis may be removed from side by depressing quick release lever.
- Slide locks in open position.
- $\frac{1}{2}$ " horizontal side space adjustable $\pm \frac{3}{32}$.
- Carries loads of 200 lbs. when fully extended.
- $3\frac{1}{2}$ " vertical side space.
- 4 telescoping anodized aluminum members.
- Allows full accessibility for instantaneous servicing.
- Glides smoothly on stainless steel ball bearings.
- Supplied with all necessary hardware for immediate installation.

SEE PREMIER PAGE 29 FOR PREMIER CABLE RETRACTORS

PREMIER METAL PRODUCTS COMPANY

A Division of Sunshine Mining Company

PREMIER

PREM-O-KOOL

FANS



ACCESSORIES FOR EXHAUST FANS

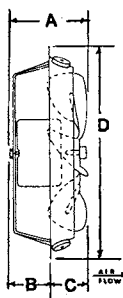
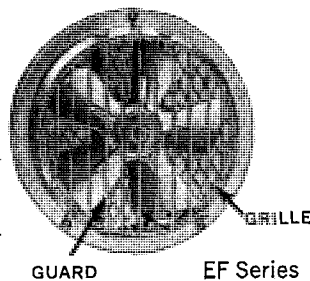

EXHAUST and INTAKE FANS

PREM-O-KOOL fans are available for exhausting air from cabinets (EF Series) and for drawing air into cabinets (IF Series).

- Motors are 115 volts 50/60 cycle single phase AC.
- Minimum space required. • Supplied with 18" lead.
- Fan and motor assembly shock mounted for minimum noise and vibration.
- Permanently lubricated ball bearing, shaded pole motors with low temperature rise.
- Easily interchangeable accessories for flexibility of mounting in cabinets.

• Cut-out and mounting holes for fans can be provided on any Premier rack or cabinet at slight additional cost.

Patent No. 3,019,965.
Other Patents Pending.

EXHAUST FANS

Cat. No.	CFM	Motor Watts	RPM	Fan Blade Dia.	A	B	C	D	Hole Dia. Required	Net Price
EF-165	165	20	1650	6 1/2"	2 7/8"	1 9/8"	1 1/4"	8 1/2"	7 3/8"	\$62.50
EF-220	220	25	1550	6 1/2"	3 1/4"	1 9/8"	1 5/8"	8 1/2"	7 3/8"	52.75
EF-300	300	65	3000	6 1/2"	4 1/8"	2 3/8"	1 1/2"	8 1/2"	7 3/8"	56.00
EF-400	400	46	1460	8"	3 5/8"	1 7/8"	1 3/4"	10 1/2"	9 1/4"	66.75
EF-550	550	90	1600	9"	4 3/8"	2 1/8"	2 1/4"	11 1/2"	10 5/8"	72.75
EF-750	750	105	1560	10"	4 3/8"	2 1/8"	2 1/4"	12 1/2"	11 3/8"	74.75

GUARDS

Cat. No.	Used with Fan	Dia.	Depth	Net Price
GU-6	EF165, 220, 300	6 3/4"	1 7/8"	\$2.90
GU-8	EF400	8 1/4"	2 3/16"	2.90
GU-9	EF550	9 1/4"	2 3/8"	3.55
GU-10	EF750	10 1/4"	2 3/8"	4.25

GRILLES

Cat. No.	Used with Fan	Dia.	Net Price
GR-6	EF165, 220, 300	8 1/2"	\$2.90
GR-8	EF400	10 1/2"	2.90
GR-9	EF550	11 1/2"	3.55
GR-10	EF750	12 1/2"	4.25

SLEEVES

Cat. No.	Used with Fan	Dia.	Depth	Net Price
SL-6	EF165, 220, 300	8 1/2"	1 3/4"	\$4.25
SL-8	EF400	10 1/2"	2"	4.25
SL-9	EF550	11 1/2"	2 3/8"	5.00
SL-10	EF750	12 1/2"	2 3/8"	5.65

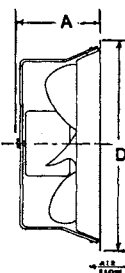
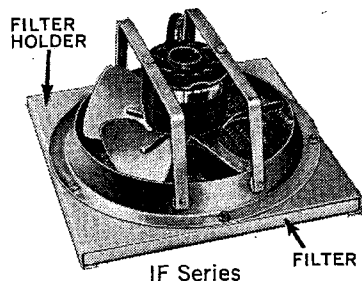

INTAKE FANS

Cat. No.	CFM	Motor Watts	RPM	Fan Blade Dia.	Dimensions A	D	Hole Diam. Required	Net Price
IF-160	160	20	1650	6 1/2"	2 7/8"	8 1/2"	7 3/8"	\$62.50
IF-180	180	25	1550	6 1/2"	3 1/4"	8 1/2"	7 3/8"	52.75
IF-300	300	65	3000	6 1/2"	4 1/8"	8 1/2"	7 3/8"	56.00
IF-360	400	46	1460	8"	3 3/4"	10 1/2"	9 1/4"	66.75
IF-540	540	90	1600	9"	4 3/8"	11 1/2"	10 5/8"	72.75
IF-740	740	105	1560	10"	4 3/8"	12 1/2"	11 3/8"	74.50

PREMIER CABINETS AND RACKS



FA, PRXA, FS, RMX, FDX, R, DR, DCR, DRK, SDR, POR and FXR models may be supplied with one round and 5 mounting holes to accommodate Exhaust and Intake Fans, at additional cost.

ACCESSORIES FOR INTAKE FANS

FILTERS				FILTER HOLDERS				
Cat. No.	Used with Fan	Size	Net Price	Cat. No.	Used with Fan	Size	Depth	Net Price
FL-6	IF 160, 180, 300	8 3/8" Sq.	\$2.85	FH-6	IF 160, 180, 300	8 3/8" Sq.	5/8"	\$5.68
FL-8	IF 360	10 3/8" Sq.	2.85	FH-8	IF 360	10 3/8" Sq.	5/8"	5.68
FL-9	IF 540	11 3/8" Sq.	3.65	FH-9	IF 540	11 3/8" Sq.	5/8"	7.25
FL-10	IF 740	12 3/8" Sq.	3.65	FH-10	IF 740	12 3/8" Sq.	5/8"	8.00

PREMIER BALL BEARING ACTION CABLE RETRACTOR

FOR CONTROL OF POWER SUPPLY CABLES

- Smooth gliding, stress-free motion
- Heavy duty construction
- Quick, simple installation
- Spring tension keeps cable "jam-proof"

The PREMIER CABLE RETRACTOR is designed for easy and fast installation in both new and existing equipment. It is attached to rear of cabinet and controls power supply cables most efficiently. As the chassis is extended, the retractor pivots and the inner ball bearing actuated member glides out as necessary.

CATALOG NO. PCR-3-16

Net Price \$18.55

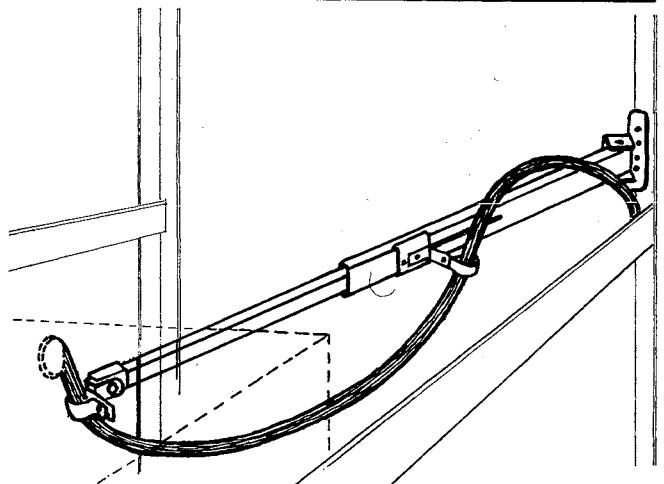

PREMIER METAL PRODUCTS COMPANY

A Division of Sunshine Mining Company

PREMIER HARDWARE

HW-1 NON-LOCKING HANDLE

Chrome plated
Net Price each
\$2.75



HW-3 LOCKING HANDLE

with 2 keys—
Chrome plated
Net Price each
\$5.75

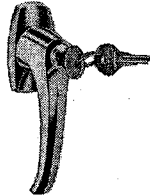

HW-5

DROP HANDLE
Finished in Gray
Hammer-tone. Also
available in Black
Wrinkle or Brown
Hammer-tone.
Net Price each
.85

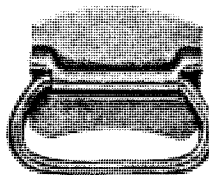

HW-6

CYLINDER LOCK
with 2 keys—
Nickel plated
Net Price each
\$4.65



HW-7

BLACK NYLON HANDLE
with 2 screws

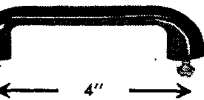

Net Price each
.72

HW-13

TRUSS HEAD MACHINE
SCREWS 10/32 x 3/4"
Nickel plated



Net Price
\$.50 per 40*
*Minimum Quantity

ECONOMY SLIDES

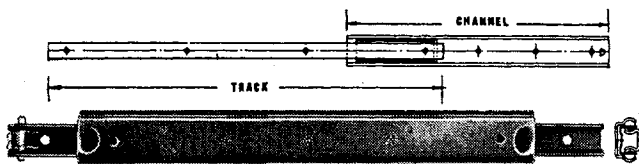

"A" SERIES

Patent No. 2,542,247

- May be mounted on side or underneath.
- Ball bearing spacer and patented silencer spring eliminates slide noise and vibration.
- All members made of 16 gauge cold rolled steel.
- Black oxidized finish.

Catalog No.	Slide Travel	Channel Length	Track Length	Load Cap.	Net Price Per Pair
A-50-13	9"	11"	13"	50	\$3.25
A-40-15	11	11	15	40	3.35
A-30-165	12 1/2	11	16 1/2	30	3.50
A-30-185	14 1/2	11	18 1/2	30	3.70



"330" SERIES

- Side mounted.
- Each slide rolls on 2 concealed and dust-free nylon wheels.
- No metal-to-metal contact—noiseless operation.
- Drawer is tilted up for quick removal.
- Made of 16 gauge cold rolled steel and zinc plated.

Catalog No.	Slide Travel	Track Length	Channel Length	Load Cap.	Net Price Per Pair
330-62-12	7 7/8"	12"	12"	62	\$3.75
330-58-14	9 7/8	14	14	58	3.95
330-54-16	11 7/8	16	16	54	4.05
330-50-18	13 7/8	18	18	50	4.30
330-46-20	15 7/8	20	20	46	4.40

2" - 3" - 4" DIA. CASTERS

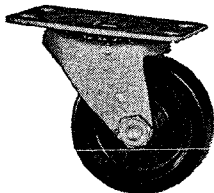

Cat. No.	Kind of Wheel	Wheel Size	Overall Height	Cap. per caster—lbs.	Net Price Set of 4
CA-4	Plaskite	2" dia. x 1 3/8"	2 1/8"	80	\$4.90
CA-5	Rockite	3" dia. x 1 1/2"	3 1/8"	225	11.55
CA-6	Soft	Double			
CA-7*	Rubber	2" dia. x 1 5/8"	2 1/8"	125	13.85
CA-8**	Rockite	3" dia. x 1 1/2"	3 1/8"	225	25.40
	Rockite	4" dia. x 1 5/8"	5 1/4"	450	53.85

*Foot operated friction brake for positive locking wheel.
**With roller bearing wheel.

Made of non-marking composition wheel with Ball Bearing Swivel Plate. Packed one set of 4 in box with screws for assembly.



SPRAY CAN LACQUER Available in 2 Colors

Cat. No.	To Match	Net Price Ea. 12 oz. Can
GHL-102	Premier Gray Hammer-tone	\$2.25
BHL-103	Premier Brown Hammer-tone	2.50



HW-2
ROUND
CHROME
PLATED
HANDLE
Net Price
each
.60



HW-8
QUICK
TURN
FASTENER
Nickel
Plated
Net Price
Each
\$1.35

HEAVY DUTY OUTLET BOXES FOR INTERNAL RACK MOUNTING

- Completely wired. Ready for use
- Supplied with 6' Neoprene cord set with molded plug
- Rated at 15 Amperes
- 130 Volts continuous duty
- "U" ground outlets—soldered connections
- Mounting centers 6"
- Circuit breaker
- 1 1/2" wide x 1 1/8" deep
- Mounts to crosspiece on PRXA, FA, FDX & RMX frames
- Steel case finished in Gray Hammer-tone

Model No.	Length	No. Of Outlets	Rack Panel Space	Net Price (Each)
OB-161	56 3/4"	9	6 1/4"†	\$26.85
OB-170	65 1/2"	10	7 0"†	32.20
OB-177	72 1/2"	11	7 7"†	33.80

PREMIER METAL PRODUCTS COMPANY

A Division of Sunshine Mining Company



CAPACITORS

ELECTROLYTICS

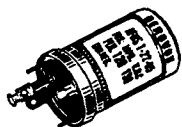
**TYPE AFH (85°C) TWIST PRONG
ELECTROLYTIC CAPACITOR**
SINGLES • DUALS • TRIPLES • QUADS

The outstanding line of twist-prong mounting electrolytic capacitors with all the latest refinements — 85°C operation — high purity aluminum foil construction through out — improved moisture resistant seal. Types AFHS-PWHS are specially constructed for high ripple current circuits. PWH and PWHS are constructed for printed wiring board applications.

These units operate over a wide temperature range with a minimum change in capacitance.

While designed for filter audio bypass applications in Radio-TV and Amplifier equipment as exact replacements, many values are rapidly gaining acceptance in industrial applications.

They are manufactured to meet all requirements of EIA specification number RS-154. Capacity tolerances of this specification are listed below.

ELECTROLYTIC CAPACITY TOLERANCES

0-50 Volts	—	—10	+250%
51-350 Volts	—	—10	+100%
351 Volts & Up	—	—10	+50%

Aerovox Corporation is currently working on a size reduction program. Many sizes shown in the following listing reflect latest design figures. However Aerovox reserves the right to furnish previous catalog sizes until present stocks are depleted.

The AFH capacitors listed here include only those ratings which might find usage in industrial applications. A complete line of ratings may be found in the latest Aerovox Industrial Catalog, IDC 567, or Servicemen's Catalog, SE-567, and may be requested from Aerovox Corporation, Distributor Sales, or through your nearest authorized Aerovox Industrial Distributor.

SINGLES

Catalog Number	Capacity	Voltage	Dia. x Length	Net
AFH 1-00-50	2000	6	1-3/8 x 2	\$1.83
AFH 1-02	1000	15	1 x 1 1/2	1.53
AFH 1-03	2000	15	1-3/8 x 2	2.07
AFH 1-04	3000	15	1-3/8 x 2	2.55
AFH 1-08	500	25	1 x 2	1.53
AFH 1-10	1000	25	1-3/8 x 2	2.13
AFH 1-13	500	50	1-3/8 x 2	1.59
AFH 1-13-05	500	50	1 x 1 1/2	1.59
AFH 1-14	1000	50	1-3/8 x 2	2.25
AFH 1-14-50	1500	50	1-3/8 x 2	2.64
AFH 1-18	50	150	1 x 1 1/2	.99
AFH 1-21	100	150	1 x 1 1/2	1.20
AFHS 1-22	120	150	1 x 1 1/2	1.23
AFHS 1-22-05	120	150	1-3/8 x 2	1.29
AFHS 1-23	140	150	1 x 1 3/4	1.26
AFH 1-24	150	150	1 x 2	1.29
AFH 1-24-01	150	150	1-3/8 x 2	1.29
AFHS 1-24-25	200	150	1-3/8 x 2	1.47
AFHS 1-24-75	300	150	1-3/8 x 2	1.68
PWH 1-25-75	160	200	1-3/8 x 2	1.74
AFH 1-29	40	250	1 x 1 1/2	1.08
AFH 1-31-25	100	250	1 x 2	1.62
AFH 1-31-75	150	250	1-3/8 x 2	1.86
AFHS 1-31-85	200	250	1-3/8 x 2	2.19
AFH 1-35	80	300	1 x 1 3/4	1.53
AFH 1-36	100	300	1 x 2 1/2	1.74
AFHS 1-37-25	150	300	1-3/8 x 2	2.10
AFH 1-37-35	250	300	1-3/8 x 2 1/2	3.33
AFH 1-41	50	350	1 x 2	1.26
AFH 1-42	80	350	1-3/8 x 2	1.71
AFHS 1-43	125	350	1-3/8 x 2	2.19
AFH 1-43-20	150	350	1-3/8 x 2	2.37
AFH 1-50	20	450	1 x 1 1/2	1.08
AFH 1-52	40	450	1 x 1 3/4	1.23
AFH 1-53	50	450	1 x 2 1/2	1.41

*Request O.E.M. Prices in the following quantities: 25-49, 50-99, 100-249

SINGLES (Continued)

Catalog Number	Capacity	Voltage	Dia. x Length	*Net
AFH 1-55	80	450	1-3/8 x 2	1.83
AFH 1-55-20	100	450	1-3/8 x 2 1/2	2.07
AFH 1-55-25	125	450	1-3/8 x 3	2.37
AFH 1-58	10	500	1 x 1 1/2	.96
AFH 1-59	20	500	1 x 1 1/2	1.11
AFH 1-61	40	500	1 x 2 1/2	1.50
AFH 1-62	80	500	1-3/8 x 2 1/2	2.16

DUALS

AFH 2-14	40-40	150	1 x 1 1/2	1.14
AFH 2-15	50-30	150	1 x 1 1/2	1.20
AFH 2-16	50-50	150	1 x 1 1/2	1.29
PWH 2-17-50	70-30	150	1 x 1 1/2	1.32
AFH 2-19-25	80-50	150	1 x 1 1/2	1.44
AFH 2-20	80-80	150	1-3/8 x 2	1.59
AFH 2-20-61	150-100	150	1-3/8 x 2	2.01
AFHS 2-21	200-5	150	1-3/8 x 2	1.62
AFH 2-23	200-200	150	1-3/8 x 2	2.40
AFH 2-24	60-60	200	1-3/8 x 2	1.53
AFHS 2-24-75	200-5	200	1-3/8 x 2	1.83
AFH 2-26	20-20	250	1 x 1 1/2	1.14
AFH 2-29	40-40	250	1 x 1 1/2	1.50
AFHS 2-30	150-150	250	1-3/8 x 2 1/2	3.09
AFHS 2-30-75	200-200	250	1-3/8 x 4	3.66
AFH 2-34	80-80	300	1-3/8 x 2	2.43
AFH 2-35	120-20	300	1-3/8 x 2	2.40
AFH 2-39	30-30	350	1 x 2	1.74
AFH 2-40-40	60-30	350	1-3/8 x 2	1.89
AFH 2-40-80	80-40	350	1-3/8 x 2	2.37
AFH 2-41-10	90-40	350	1-3/8 x 2 1/2	2.58
AFH 2-41-40	100-60	350	1-3/8 x 3	2.88



CAPACITORS

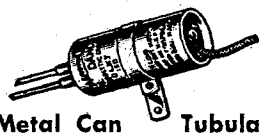

ELECTROLYTICS — (Continued)

TYPE PRS "DANDEE" (85°C)

SINGLES • DUALS • TRIPLES • MULTIPLES

Metal Can Tubular Electrolytic Capacitors TYPE PRS-AC (AC rated units) NP-PRS (non-polarized units)

Compact, electrolytic tubular capacitors furnished in aluminum cans with cardboard insulating sleeves. Designed for use in television and radio applications where space is at a premium. Included in this listing are the AC rated units (PRS-AC) and non-polarized units (NP PRS) for replacement use in cross-over networks and color TV receivers.

Single section capacitors are furnished with bare tinned copper leads 3 inches long. Negative grounded to case. Multiple units are furnished with insulated, stranded copper leads 5 inches long. Negative is common and grounded to case. Multiple units have common cathode.

Sizes listed are diameters over cardboard insulating sleeve. For actual can size deduct 1/8" from diameter and 1/4" from length. Multiple units are supplied with mounting strap. If mounting strap is required on single units, specify on order.

Tolerance and surge voltage are in accordance with EIA Specification RS-154.

The factory is currently in the process of reducing sizes of this type. AEROVOX reserves the right to ship sizes listed below until present stock is depleted and smaller sizes as they become available.

TYPE PRS — SINGLES

Prs No.	Cap. Mfd.	Size	Net Price*
1010	25	3V 7/16 x 1 1/4	.51
1015	50	7/16 x 1 1/4	.57
1020	100	7/16 x 1 1/4	.66
1025	200	7/16 x 1-7/8	.69
1030	300	9/16 x 1-3/8	.78
1040	500	9/16 x 1-7/8	.84
4V			
1050	2000	13/16 x 2	1.38
6V			
1075	5	7/16 x 1 1/4	.48
1080	25	7/16 x 1 1/4	.51
1090	50	7/16 x 1 1/4	.57
1100	100	7/16 x 1 1/4	.72
1110	250	9/16 x 1-3/8	.81
1120	500	11/16 x 1 1/2	.93
1130	1000	11/16 x 2-1/8	1.14
1140	1500	13/16 x 2	1.26
1145	2000	13/16 x 2-3/8	1.38
10V			
1147	2000	15/16 x 2	1.47
12V			
1149	50	7/16 x 1-3/8	.60
1150	100	7/16 x 1-3/8	.72
1155	200	9/16 x 1-7/8	.81
1160	250	9/16 x 1 1/4	.87
1170	500	11/16 x 1-7/8	1.02
1180	1000	13/16 x 2-1/8	1.35
15V			
1200	100	9/16 x 1-3/8	.75
1210	250	11/16 x 1-5/8	.93
1220	500	13/16 x 1 1/4	1.05
1230	1000	15/16 x 1-7/8	1.38
1240	2000	15/16 x 2 1/4	1.92
20V			
1243	2000	1 x 2-5/16	2.32
25V			
1245	5	7/16 x 1 1/4	.60
1255	16	7/16 x 1 1/4	.60
1257	20	7/16 x 1 1/4	.60
1260	25	7/16 x 1 1/4	.60
1265	50	7/16 x 1-3/8	.66
1270	100	9/16 x 1-5/8	.81
1280	250	13/16 x 1 1/4	1.02
1290	500	13/16 x 2 1/4	1.38
1295	1000	1-1/16 x 2-1/8	1.98
50V			
1297	1	7/16 x 1 1/4	.54
1300	2	7/16 x 1 1/4	.54
1310	5	7/16 x 1 1/4	.60
1320	10	7/16 x 1 1/4	.60
1325	15	7/16 x 1-3/8	.60
1330	20	7/16 x 1 1/4	.60
1340	25	7/16 x 1 1/4	.63
1350	50	11/16 x 1 1/2	.72
1360	100	11/16 x 1 1/4	.84
1370	150	13/16 x 1 1/4	.93
1380	250	15/16 x 1 1/4	1.05
1390	500	1-1/16 x 2 1/4	1.44
1395	1000	1 x 3	1.88
150V			
1400	4	7/16 x 1 1/4	.60
1401	5	7/16 x 1 1/4	.60
1405	8	9/16 x 1 1/4	.63
1410	10	9/16 x 1-3/8	.63
1420	12	9/16 x 1-3/8	.66
1425	15	9/16 x 1-3/8	.69
1430	16	9/16 x 1 1/2	.69
1440	20	9/16 x 1-5/8	.72
1450	24	9/16 x 1-7/8	.75
1451	25	9/16 x 1-7/8	.75
1460	30	11/16 x 1 1/2	.78
1470	40	11/16 x 1 1/4	.81
1480	50	13/16 x 1 1/4	.84

TYPE PRS-SINGLES (Cont)

Prs No.	Cap. Mfd.	Size	Net Price*
1490	60	13/16 x 1 1/4	.90
1500	80	13/16 x 2	.96
1510	100	13/16 x 2 1/4	1.05
1520	150	15/16 x 2-3/8	1.14
1530	200	15/16 x 2-7/8	1.32
1540	300	1-1/16 x 3	1.53
250V			
1550	4	7/16 x 1 1/4	.60
1555	8	9/16 x 1-3/8	.69
1560	12	9/16 x 1-5/8	.75
1565	16	11/16 x 1-3/8	.78
1570	20	11/16 x 1-5/8	.81
1575	30	11/16 x 2	.87
1580	40	13/16 x 1 1/4	.93
1585	50	13/16 x 2	1.02
1590	60	13/16 x 2-1/8	1.08
1595	100	15/16 x 2 1/2	1.47
350V			
1600	4	9/16 x 1 1/4	.63
1610	8	9/16 x 1-7/8	.72
1620	10	11/16 x 1 1/2	.75
1630	12	11/16 x 1 1/2	.78
1640	16	11/16 x 1 3/4	.84
1650	24	13/16 x 1-5/8	.93
1660	30	13/16 x 1 3/4	.99
1670	40	13/16 x 2-1/8	1.05
1680	50	15/16 x 2-1/8	1.11
1690	60	15/16 x 2-3/8	1.17
450V			
1700	1	7/16 x 1 1/4	.66
1705	2	9/16 x 1 1/4	.69
1710	4	9/16 x 1 1/2	.69
1715	8	11/16 x 1-5/8	.75
1720	10	11/16 x 1-7/8	.78
1725	12	13/16 x 1 1/2	.81
1730	16	13/16 x 1 3/4	.84
1735	20	13/16 x 2	.93
1740	30	15/16 x 2-1/8	1.02
1750	40	15/16 x 2 1/2	1.08
1760	50	15/16 x 3 1/4	1.26
1770	60	1-1/16 x 3	1.41
1780	80	1-1/16 x 3 3/4	1.68
1790	100	1-1/16 x 3 3/4	1.92
500V			
1795	1	1/2 x 1	.60
1800	4	9/16 x 1 1/4	.72
1805	8	13/16 x 1 1/2	.78
1810	10	13/16 x 1-5/8	.81
1815	12	13/16 x 1 3/4	.84
1820	16	13/16 x 2-1/8	.90
1830	20	15/16 x 2	.96
1840	30	15/16 x 2-5/8	1.05
600V			
1845	4	11/16 x 2 1/2	1.44
1850	8	13/16 x 2 1/4	1.71
1860	10	15/16 x 2 1/4	1.77
1870	12	15/16 x 2 3/4	1.89
1880	16	15/16 x 3 1/4	2.07
1890	20	1-1/16 x 3	2.13
700V			
1900	8	15/16 x 2 3/4	1.74
1905	10	15/16 x 3	1.83
1910	12	15/16 x 3 1/4	1.95
1915	16	1-1/16 x 3-3/8	2.10
TYPE PRS — DUALS			
2020	500-150	15/16 x 1 1/4	1.62
25V			
2050	10-10	11/16 x 1 1/4	.84
2075	20-20	11/16 x 1 1/4	.84
150V			
2150	8-8	11/16 x 1 1/4	.90

TYPE PRS-DUALS (Cont)

Prs No.	Cap. Mfd.	Size	Net Price*	
2155	16-8	13/16 x 1-3/8	.93	
2160	20-10	13/16 x 1 1/2	.93	
2165	20-20	13/16 x 1 3/4	.99	
2170	30-20	13/16 x 1 1/2	1.02	
2175	30-30	13/16 x 1-5/8	1.08	
2180	40-20	13/16 x 1-5/8	1.05	
2190	40-30	13/16 x 1 3/4	1.08	
2195	40-40	13/16 x 2	1.08	
2200	50-30	13/16 x 2	1.17	
2210	50-50	13/16 x 2 1/4	1.26	
2220	80-20	13/16 x 2 1/4	1.29	
2230	80-40	13/16 x 2	1.32	
2240	80-50	15/16 x 2-1/8	1.41	
2245	100-100	15/16 x 2 3/4	1.92	
200V				
2250	8-8	13/16 x 1 1/4	.90	
2260	16-8	13/16 x 1 1/2	.96	
2280	16-16	13/16 x 1 3/4	1.02	
2290	30-30	13/16 x 1-7/8	1.29	
250V				
2300	10-10	13/16 x 1-5/8	.99	
2320	16-16	13/16 x 2-1/8	1.02	
2330	20-20	13/16 x 1 3/4	1.11	
2340	30-30	13/16 x 2-1/8	1.35	
2345	50-10	1-1/16 x 2 1/4	1.50	
350V				
2348	30-5	15/16 x 2 1/4	1.29	
450V				
2350	8-8	13/16 x 1 3/4	1.02	
2360	10-10	13/16 x 2	1.11	
2370	16-8	13/16 x 2 1/4	1.20	
2380	16-16	15/16 x 2 1/4	1.35	
2390	20-20	15/16 x 2 1/2	1.50	
2400	30-30	1-1/16 x 2 3/4	1.80	
2410	40-20	1-1/16 x 3	1.77	
2420	40-40	1-1/16 x 3 3/4	2.01	
2430	50-30	1-1/16 x 3 3/4	2.04	
TYPE PRS — TRIPLES				
15V				
3200	500-100-100	15/16 x 1-13/16	1.80	
150V				
3500	20-20-20	15/16 x 1 1/4	1.51	
3550	30-20-10	15/16 x 1 1/4	1.51	
3555	30-25-20	15/16 x 1 1/4	1.51	
3560	30-30-20	15/16 x 1 1/4	1.58	
3570	30-30-30	15/16 x 1 1/4	1.58	
3600	40-20-20	15/16 x 1 1/4	1.58	
3625	40-30-20	15/16 x 1 1/4	1.58	
3650	40-40-20	15/16 x 1-7/8	1.63	
3675	40-40-40	15/16 x 2	1.67	
3700	50-30-10	15/16 x 1 1/4	1.58	
3750	50-30-20	15/16 x 1-7/8	1.63	
3800	80-40-20	15/16 x 2 1/4	1.74	
3825	80-50-20	15/16 x 2-3/8	1.74	
450V				
3900	10-10-10	15-16 x 2-1/8	1.67	
TYPE PRS — MULTIPLE VOLTAGES				
Prs No.	Cap Mfd.	VDCW	Size	Net Price*
4150	40-40/250	150/10	15/16 x 2 1/4	1.71
4200	20-20/20	150/25	15/16 x 1 1/4	1.48
4300	30-20/20	150/25	15/16 x 1 1/4	1.50
4350	30-20/100	150/25	15/16 x 1 1/4	1.58
4400	40-20/20	150/25	15/16 x 1 1/4	1.53
4425	40-30/20	150/25	15/16 x 1 1/4	1.55
4450	40-40/20	150/25	15/16 x 1 1/4	1.59
4475	40-40/100	150/25	15/16 x 2	1.67

TYPE PRS - MULTIPLE VOLTAGES (Cont)

Prs No.	Cap Mfd.	VDCW	Size	Net Price*
4500	50-30/20	150/25	15/16 x 1 1/4	1.59
4525	50-30/100	150/25	15/16 x 2	1.67
4550	50-30/250	150/25	15/16 x 2 1/2	1.81
4575	50-50/20	150/25	15/16 x 1-7/8	1.66
4600	80-20/100	150/25	15/16 x 2 1/4	1.69
4650	80-40/20	150/25	15/16 x 2-1/8	1.69
4700	20-20/20	450/25	1-1/16 x 2-3/8	1.86
*4800	20/100	475/50	15/16 x 2-7/8	1.56
4805	20/100	500/25	15/16 x 2-5/8	1.56
*No Tube				
TYPE PRS — AC Rated				
Prs No.	Cap. Mfd.	Size	Net Price*	
6200	8	11/16 x 1 1/2	\$.75	
6400	20	13/16 x 1 1/2	.75	
6500	30	15/16 x 1 3/4	.84	
6550	60	13/16 x 2 1/4	.93	
NP-PRS-NON-POLARIZED				
300V				
7050	1000	13/16 x 2	1.29	
6 VNP				
7100	500	11/16 x 1-1/2	1.17	
10 VNP				
7200	25	7/16 x 1 1/4	.69	
7220	50	7/16 x 1-3/8	.72	
7230	170	11/16 x 1-5/8	.96	
7240	450	1-1/16 x 2 1/4	1.20	
7245	500	15/16 x 1 3/4	1.20	
12 VNP				
**7247	200	11/16 x 1 1/4	1.08	
15 VNP				
7250	500	15/16 x 1-7/8	1.31	
7275	1000	1-1/16 x 2 1/4	1.74	
25 VNP				
7300	2	7/16 x 1 1/4	.69	
7315	10	7/16 x 1 1/4	.75	
7330	50	11/16 x 1 1/2	.84	
7340	100	11/16 x 1-5/8	1.02	
30 VNP				
7350	20	9/16 x 1 1/4	.75	
50 VNP				
7400	2	7/16 x 1-1/8	.69	
7405	4	7/16 x 1 1/4	.75	
150 VNP				
7450	40	1-1/16 x 2	1.0	



CAPACITORS

ELECTROLYTICS — (Continued)

TYPE PTT TUBULAR PLASTIC-CASED ELECTROLYTICS



Small in size big in performance, designed especially for wide applications in transistorized circuitry and cramped electronic assemblies, here is a truly MINIATURE electrolytic tubular that will handle full sized loads. AeroVox Type PTT units feature "Polycap" cases that are the next best thing to metal cans for maximum protection against humidity. Advanced construction techniques assure long capacitor life. Units are rated for operation at temperatures from -30°C to +65°C.

For full technical information request Bulletin NPJ-111 Rev.

TYPE B C D UPRIGHT MOUNTING BAKELITE CASED ELECTROLYTICS



"Polycap" cased, epoxy end filled electrolytic capacitors. Upright mounting for replacement in printed wiring, transistorized personal radios and car radios.

Small size and type of mounting make these units ideal for use in any printed wiring circuit.

Plastic case and epoxy end seal offer good moisture barrier which protects against drying out or leakage of electrolyte.

High purity foil insures long life and low leakage. Minimum 1" lead length assists in threading connections into printed wiring boards even in tightest spaces.

Positive lead is identified by a + (plus) mark on case. For full technical information request Bulletin NPJ-108.

Cap.	PTT #	3 VDCW Size	Net Price*
1	PTT 1	A	.42
2	PTT 2	A	.42
3	PTT 3	A	.42
5	PTT 4	A	.42
8	PTT 5	A	.42
10	PTT 6	A	.42
15	PTT 7	A	.42
20	PTT 8	B	.42
25	PTT 9	B	.42
30	PTT 10	B	.42
40	PTT 11	B	.42
50	PTT 12	C	.42
100	PTT 13	H	.45
150	PTT 100	J	.45
200	PTT 14	K	.45
250	PTT 15	K	.48
300	PTT 16	L	.54
500	PTT 17	O	.75
800	PTT 138	W	.75

Cap.	PTT #	6 VDCW Size	Net Price*
1	PTT 18	A	.42
2	PTT 19	A	.42
3	PTT 20	A	.42
5	PTT 21	A	.42
8	PTT 22	A	.42
10	PTT 23	A	.42
15	PTT 24	B	.42
20	PTT 25	B	.42
25	PTT 26	B	.42
30	PTT 27	C	.42
40	PTT 28	C	.45
50	PTT 29	C	.45
100	PTT 30	G	.45
150	PTT 101	J	.48
200	PTT 31	K	.48
250	PTT 32	M	.60
300	PTT 33	N	.75

Cap.	PTT #	10 VDCW Size	Net Price*
1	PTT 34	A	.42
2	PTT 35	A	.42
3	PTT 36	A	.42
5	PTT 37	A	.42
8	PTT 38	A	.42
10	PTT 39	A	.42
15	PTT 40	B	.42
20	PTT 41	B	.42
25	PTT 42	E	.45
30	PTT 43	E	.45
40	PTT 44	E	.45
50	PTT 45	F	.45
100	PTT 46	J	.45
150	PTT 102	K	.60
200	PTT 47	L	.75
250	PTT 103	N	.75
300	PTT 104	O	.75

Cap.	PTT #	12 VDCW Size	Net Price*
1	PTT 48	A	.42
2	PTT 49	A	.42
3	PTT 50	A	.42
5	PTT 51	A	.42
8	PTT 52	A	.42
10	PTT 53	B	.42
15	PTT 54	B	.42
20	PTT 55	E	.42
25	PTT 56	E	.45
30	PTT 57	E	.45
40	PTT 58	H	.45
50	PTT 59	H	.45
100	PTT 60	K	.45
150	PTT 105	L	.60
200	PTT 106	N	.75

Cap.	PTT #	15 VDCW (Continued) Size	Net Price*
5	PTT 64	A	.42
8	PTT 65	B	.42
10	PTT 66	B	.42
15	PTT 67	B	.42
20	PTT 68	E	.45
25	PTT 69	E	.45
30	PTT 70	E	.45
40	PTT 71	H	.45
50	PTT 72	H	.45
100	PTT 73	K	.60
150	PTT 107	L	.66
200	PTT 108	O	.75

Cap.	PTT #	20 VDCW Size	Net Price*
1	PTT 109	A	.42
2	PTT 110	A	.42
3	PTT 111	A	.42
5	PTT 112	A	.42
8	PTT 113	B	.42
10	PTT 114	B	.42
15	PTT 115	E	.45
20	PTT 116	E	.45
25	PTT 117	E	.45
30	PTT 118	H	.45
40	PTT 119	H	.45
50	PTT 120	J	.45
100	PTT 121	N	.60
150	PTT 122	S	.66
200	PTT 123	U	.75

Cap.	PTT #	25 VDCW Size	Net Price*
1	PTT 74	A	.42
2	PTT 75	A	.42
3	PTT 76	A	.42
5	PTT 77	B	.42
8	PTT 78	B	.42
10	PTT 79	E	.42
15	PTT 80	E	.45
20	PTT 81	H	.45
25	PTT 82	H	.45
30	PTT 83	H	.45
40	PTT 84	J	.45
50	PTT 85	K	.45
100	PTT 86	N	.66
150	PTT 124	V	.75

Cap.	PTT #	35 VDCW Size	Net Price*
1	PTT 125	A	.42
2	PTT 126	A	.42
3	PTT 127	A	.42
5	PTT 128	D	.42
8	PTT 129	E	.45
10	PTT 130	E	.45
15	PTT 131	H	.45
20	PTT 132	H	.45
25	PTT 133	J	.48
30	PTT 134	J	.60
40	PTT 135	P	.75
50	PTT 136	R	.75
100	PTT 137	T	.75

Cap.	PTT #	50 VDCW Size	Net Price*
1	PTT 87	A	.42
2	PTT 88	A	.42
3	PTT 89	B	.42
5	PTT 90	C	.42
8	PTT 91	E	.45
10	PTT 92	H	.45
15	PTT 93	H	.45
20	PTT 94	J	.45
25	PTT 95	K	.48
30	PTT 96	K	.60
40	PTT 97	M	.75
50	PTT 98	N	.75

SIZE CHART					
A	1/4 x 5/8	J	3/8 x 7/8	R	7/16 x 1
B	1/4 x 1/4	K	3/8 x 1	S	7/16 x 1 1/4
C	1/4 x 7/8	L	3/8 x 1-1/8	T	7/16 x 1 1/2
E	5/16 x 1/4	M	3/8 x 1 1/4	U	1/2 x 1 1/4
F	5/16 x 7/8	N	3/8 x 1-3/8	V	7/16 x 1-3/8
G	5/16 x 1	O	3/8 x 1 1/2	W	1/2 x 1-3/8
H	3/8 x 3/4	P	7/16 x 7/8		

Cap. Mfds.	BCD No.	3 VDCW Size	Net Price*
1	3001	A	.75
2	3002	A	.75
3	3003	A	.75
4	3004	A	.75
5	3005	A	.75
6	3006	A	.75
8	3008	A	.75
10	3010	A	.75
15	3015	A	.75
20	3020	A	.75
25	3025	A	.75
35	3035	B	.75
50	3050	B	.75
75	3075	B	.78
100	3100	C	.84
150	3150	D	.84
200	3200	D	.87
250	3250	F	.86
300	3300	F	.99
500-50	3X50050	N	1.14
1000-50	3X100050	Q	1.20

Cap. Mfds.	BCD No.	4 VDCW Size	Net Price*
100-100	4X100100	F	1.05

Cap. Mfds.	BCD No.	5 VNP Size	Net Price*
5	5005	A	.81

Cap. Mfds.	BCD No.	6 VDCW Size	Net Price*
1	6001	A	.75
2	6002	A	.75
3	6003	A	.75
4	6004	A	.75
5	6005	A	.75
6	6006	A	.75
8	6008	A	.75
10	6010	A	.75
15	6015	B	.75
20	6020	B	.75
25	6025	B	.75
35	6035	B	.75
50	6050	B	.75
75	6075	C	.81
100	6100	D	.90
150	6150	F	.93
200	6200	F	.96
100-30	6X10030	F	1.05

Cap. Mfds.	BCD No.	8 VDCW Size	Net Price*
800	8800	P	1.20

Cap. Mfds.	BCD No.	10 VNP Size	Net Price*
5	10005	A	.81

Cap. Mfds.	BCD No.	10 VDCW Size	Net Price*
10	10010	A	.75
25	10025	B	.75
50	10050	C	.75
80	10080	D	.84
100	10100	D	.90
190	10190	G	.99
50-30	10X5030	F	1.02
50-50	10X5050	F	1.02
80-50	10X8050	F	1.05
80-80	10X8080	F	1.05

Cap. Mfds.	BCD No.	12 VDCW Size	Net Price*
1	12001	A	.75
2	12002	A	.75
3	12003	A	.75
4	12004	A	.75
5	12005	A	.75
6	12006	A	.75
8	12008	A	.75
10	12010	A	.75
15	12015	B	.75
20	12020	B	.75
25	12025	B	.75
35	12035	B	.75
50	12050	C	.75
75	12075	D	.84
100	12100	F	.90
150	12150	G	.99
250	12250	H	1.08
500	12500	P	1.20

Cap. Mfds.	BCD No.	15 VDCW Size	Net Price*
1	15001	A	.75
2	15002	A	.75
3	15003	A	.75
4	15004	A	.75
5	15005	A	.75
6	15006	A	.75
8	15008	A	.75
10	15010	A	.75
15	15015	B	.75
20	15020	B	.75
25	15025	B	.75
35	15035	C	.75
50	15050	C	.75
75	15075	F	.87
100	15100	F	.90
100-100	*15X100100	J	1.05
300-100	15X300100	K	1.11
300	15300	N	1.20
500	15500	P	1.20

Cap. Mfds.	BCD No.	18 VDCW Size	Net Price*
100	18100	M	.96

Cap. Mfds.	BCD No.	20 VDCW Size	Net Price*
200	20200	N	1.05
100-100	*20X100100	R	1.11

Cap. Mfds.	BCD No.	25 VDCW Size	Net Price*
1	25001	A	.75
2	25002	A	.75
3	25003	A	.75
4	25004	A	.75
5	25005	A	.75
6	25006	A	.75
8	25008	A	.75
10	25010	A	.75
15	25015	B	.75
20	25020	C	.75
25	25025	C	.75
35	25035	D	.81
50	25050	F	.84
75	25075	E	.90

Cap. Mfds.	BCD No.	50 VDCW Size	Net Price*
1	50001	A	.75
2	50002	A	.75
3	50003	A	.75
4	50004	A	.75
5	50005	B	.75
6	50006	B	.75
8	50008	B	.75
10	50010	B	.75
15	50015	C	.75
20	50020	D	.75
25	50025	F	.81

* Common Positive

BCD SIZE CODE

A	5/16 x 5/8	H	1/2 x 1-1/8
B	3/8		



CAPACITORS

ADDITIONAL STYLES

For complete information on any Types shown on this page request Catalog or Brochure from Aerovox Corporation, Distributor Sales, or your nearest authorized Aerovox Industrial Distributor.



TYPE G Insulated Screw-Mounting Capacitors

Hermetically-sealed aluminum can unit, threaded cover size 7/8-16 with hex nut and washer for convenient mounting on chassis. Washer can be used to insulate can from chassis. Terminals molded in cover. Cathode connection thru terminal in cover. These units are the commercial equivalent of case style CE41 and 42 of specification MIL C62A.

7 Stock Values - 3 Voltages



TYPE FF Photo-Flash Capacitors

Selective choice of highest purity materials makes these units ideal for rugged photoflash application calling for lowest leakage requirements. Type FF-1 furnished in molded black plastic container; type FF-2 in aluminum can with black glazed tubing; both units furnished with screw lug terminals. Highly resistant to moisture and oil. Surge voltages and time duty cycles as listed in EIA specification No. RS-154.

2 Stock Values



TYPE E Hermetically-Sealed, Aluminum, Round Metal-Cased Capacitors

Can be mounted with terminals upright or inverted by use of a ring-type clamp provided with unit. Can is floating, thus having two terminals on single-section capacitors, three on duals, and four on triples.

These units are the commercial equivalent of case style CE31, 2 and 3 of MIL Specification C62A.

16 Stock Values - 10 Voltages

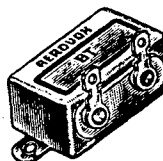

TYPE BT Drawn-Case "Bathtub" Electrolytic Capacitors

Hermetically-sealed units designed for rigid mounting in minimum space. Of sturdy construction, these high-quality units are commercial equivalent to the case style CE63 of MIL Specification C62A.

21 Stock Values - 6 Voltages



TYPE AEP Plug-in Electrolytic Capacitors

Hermetically sealed, dry electrolytic capacitor furnished in round, aluminum can and 4-pin, octal-base mounting. For quick changes, readily removed and replaced in a standard octal-base tube socket.

For use where continuous service is important. They are ideally suited for experimental testing, juke boxes and communication receiver uses. These units are the commercial equivalents of Type CE51's, 2's and 3's, as listed in MIL Specification C62A.

Operating temperature to +65°C. Quadruple element units furnished with ground lug for cathode connection.

28 Stock Values - 5 Voltages

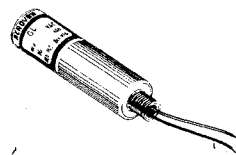

TYPE GL

These ever-popular inverted-mounting, aluminum can units, are furnished with the same high purity materials as the more expensive type E and G. Two separate color-coded leads 4" long for each section. Inverted chassis mounting can be made, using palmot and threaded neck. Threaded neck size 5/8-18.

24 Stock Values - 6 Voltages

Type VBC Vibrator Buffer Capacitors



These units are heavy-duty, Hyvol M impregnated, vibrator buffer capacitors in plastic tubes, specifically designed for severe-service auto-radio applications.

AUTOPASS® Vertical Mounting Plastic-Cased Paper Capacitors



Aerovox Autopass capacitors were specifically designed and developed for use in conjunction with printed-wiring assemblies where it is highly desirable to mount capacitors at right angles to the mounting surface thereby conserving valuable space.



CAPACITORS

FILM CAPACITORS

TYPES V146X AND V146XR "WRAP & FILL" AEROFILM® CAPACITORS



Miniature, mylar, tubular capacitor sections, extended foil construction, wrapped with a synthetic film and end-sealed with a plastic resin.

These units offer high insulation resistance, high operating temperature, low power factor and outstanding resistance to moisture.

Ideal for use in miniaturized circuits where size and weight are important factors.

Operating Temperature Range: Capable of operation in a temperature range of -65°C to +85°C at full voltage rating and to 125°C with voltage derating as follows:

DC Rated Voltage at 85°C	Maximum DC Working Voltage at 125°C
150	100
200	125
400	200
600	300

Leads: solder-coated "copper-weld" wire, 2" minimum length.

Tolerance: Standard ±10%. Available in closer tolerances on special order.

For Full technical information request bulletin NPJ-121 Rev.

STOCK LISTING V146XR

Capacity In Mfd.	150 VDC		Cat. No.	Net Price*	200 VDC		Cat. No.	Net Price*	400 VDC		Cat. No.	Net Price*	600 VDC		Cat. No.	Net Price*
	D	L			D	L			D	L			D	L		
.001	See Note 1				.156 x 1/2		V146XR-16	.31	.156 x 5/8		V146XR-37	.31	.156 x 3/4		V146XR-58	.31
.0015	See Note 1				.156 x 1/2		V146XR-17	.31	.156 x 5/8		V146XR-38	.31	.171 x 3/4		V146XR-59	.31
.0022	See Note 1				.156 x 1/2		V146XR-18	.31	.156 x 5/8		V146XR-39	.31	.187 x 3/4		V146XR-60	.31
.0033	See Note 1				.156 x 1/2		V146XR-19	.31	.156 x 5/8		V146XR-40	.31	.203 x 3/4		V146XR-61	.31
.0047	See Note 1				.156 x 1/2		V146XR-20	.31	.187 x 5/8		V146XR-41	.31	.234 x 3/4		V146XR-62	.31
.0068	See Note 1				.156 x 1/2		V146XR-21	.31	.218 x 5/8		V146XR-42	.31	.265 x 3/4		V146XR-63	.31
.01	.156 x 1/2		V146XR-1	.30	.171 x 1/2		V146XR-22	.31	.250 x 5/8		V146XR-43	.31	.312 x 3/4		V146XR-64	.31
.015	.187 x 1/2		V146XR-2	.30	.203 x 1/2		V146XR-23	.31	.296 x 5/8		V146XR-44	.31	.312 x 7/8		V146XR-65	.34
.022	.203 x 5/8		V146XR-3	.30	.250 x 5/8		V146XR-24	.31	.312 x 3/4		V146XR-45	.32	.375 x 7/8		V146XR-66	.38
.033	.218 x 5/8		V146XR-4	.30	.250 x 3/4		V146XR-25	.31	.312 x 7/8		V146XR-46	.33	.406 x 1		V146XR-67	.39
.047	.234 x 3/4		V146XR-5	.30	.296 x 3/4		V146XR-26	.31	.343 x 7/8		V146XR-47	.35	.453 x 1		V146XR-68	.43
.068	.265 x 3/4		V146XR-6	.32	.343 x 3/4		V146XR-27	.33	.375 x 1		V146XR-48	.39	.531 x 1		V146XR-69	.48
.1	.281 x 7/8		V146XR-7	.35	.375 x 7/8		V146XR-28	.35	.421 x 1		V146XR-49	.43	.562 x 1-3/8		V146XR-70	.52
.15	.328 x 7/8		V146XR-8	.38	.453 x 7/8		V146XR-29	.39	.468 x 1-1/4		V146XR-50	.47	.671 x 1-3/8		V146XR-71	.64
.22	.385 x 1		V146XR-9	.43	.438 x 1-1/8		V146XR-30	.44	.546 x 1-3/8		V146XR-51	.50	.718 x 1-5/8		V146XR-72	.86
.33	.375 x 1-1/8		V146XR-10	.45	.484 x 1-1/8		V146XR-31	.47	.593 x 1-5/8		V146XR-52	.61	.765 x 2		V146XR-73	1.09
.47	.468 x 1-1/4		V146XR-11	.54	.546 x 1-1/4		V146XR-32	.55	.671 x 1-5/8		V146XR-53	.78	.859 x 2		V146XR-74	1.25
.68	.562 x 1-1/4		V146XR-12	.59	.609 x 1-5/8		V146XR-33	.60	.796 x 1-3/4		V146XR-54	1.00	1.016 x 2		V146XR-75	1.61
1.0	.593 x 1-1/2		V146XR-13	.76	.671 x 1-3/4		V146XR-34	.85	.812 x 2		V146XR-55	1.12	1.125 x 2-1/2		V146XR-76	1.97
1.5	.718 x 1-3/4		V146XR-14	.97	.828 x 1-3/4		V146XR-35	1.31	.921 x 2-1/4		V146XR-56	1.48	1.234 x 3		V146XR-77	2.73
2.0	.812 x 1-3/4		V146XR-15	1.68	.875 x 1-7/8		V146XR-36	1.52	1.093 x 2-1/4		V146XR-57	1.92	1.421 x 3		V146XR-78	3.31

Note 1: These capacity values are only made at 200 VDC or higher.

The 200 VDC unit may be used for lower voltage requirements since sizes are as small as or smaller than competitive 100 VDC units.

® Registered Trademark

*Request O.E.M. prices in the following quantities: 25-49, 50-99, 100-499

AEROVOX MINIATURE TYPE WRAP & FILL FILM DIELECTRIC CAPACITORS Type V146X

Capacity	Thickness	Width	Length	Catalog No.	Capacity	Thickness	Width	Length	Catalog No.
150 VDC AT 85°C					400 VDC AT 85°C				
.033	3/16	11/32	15/16	V146X-15	.047	1/4	15/32	15/16	V146X-35
.047	3/16	3/8	15/16	V146X-16	.068	9/32	1/2	1-1/8	V146X-36
.068	7/32	3/8	15/16	V146X-17	.082	9/32	15/32	1-1/4	V146X-37
.082	7/32	13/32	15/16	V146X-18	.10	9/32	17/32	1-1/4	V146X-38
.1	1/4	15/32	15/16	V146X-19	.15	5/16	19/32	1-11/16	V146X-39
.15	1/4	7/16	1-1/16	V146X-20	.22	3/8	21/32	1-7/8	V146X-40
.22	1/4	17/32	1-1/4	V146X-21	.33	7/16	3/4	1-7/8	V146X-41
.33	5/16	19/32	1-1/4	V146X-22	.47	1/2	7/8	1-7/8	V146X-42
.47	7/16	23/32	1-7/16	V146X-23	.68	17/32	15/16	2-1/8	V146X-43
.68	13/32	23/32	1-11/16	V146X-24	.82	17/32	31/32	2-5/16	V146X-44
.82	15/32	3/4	1-11/16	V146X-25	1.0	9/16	1.0	2-5/16	V146X-45
1.0	13/32	3/4	1-7/8	V146X-26	600 VDC AT 85°C				
200 VDC AT 85°C					.001	3/16	5/16	13/16	V146X-46
.033	7/32	3/8	15/16	V146X-217	.0015	3/16	5/16	13/16	V146X-47
.047	7/32	13/32	15/16	V146X-218	.0022	3/16	5/16	13/16	V146X-48
.068	9/32	7/16	15/16	V146X-219	.0033	3/16	3/8	7/8	V146X-49
.1	5/16	15/32	1-1/8	V146X-220	.0047	3/16	13/32	7/8	V146X-50
.15	3/8	9/16	1-1/8	V146X-221	.0068	7/32	13/32	7/8	V146X-51
.22	13/32	9/16	1-1/4	V146X-222	.0082	1/4	13/32	7/8	V146X-52
.33	3/8	9/16	1-11/16	V146X-223	.01	1/4	7/16	7/8	V146X-53
.47	7/16	21/32	1-11/16	V146X-224	.015	5/16	1/2	7/8	V146X-54
.68	1/2	3/4	1-7/8	V146X-225	.022	5/16	1/2	1-1/16	V146X-55
1.0	9/16	13/16	2-1/8	V146X-226	.033	9/32	1/2	1-1/8	V146X-56
400 VDC AT 85°C					.047	5/16	17/32	1-1/8	V146X-57
.0033	3/16	5/16	13/16	V146X-27	.068	5/16	19/32	1-1/4	V146X-58
.0047	3/16	5/16	13/16	V146X-28	.082	3/8	5/8	1-9/16	V146X-59
.0068	3/16	5/16	13/16	V146X-29	.10	13/32	21/32	1-9/16	V146X-60
.0082	3/16	5/16	13/16	V146X-30	.15	3/8	23/32	1-7/8	V146X-61
.01	3/16	5/16	13/16	V146X-31	.22	1/2	27/32	1-7/8	V146X-62
.015	7/32	3/8	13/16	V146X-32	.33	1/2	29/32	2-1/8	V146X-63
.022	7/32	7/16	13/16	V146X-33	.47	5/8	1-1/16	2-1/8	V146X-64
.033	7/32	7/16	15/16	V146X-34	.68	11/16	1-3/32	2-7/16	V146X-65

Note: For capacities greater than listed use type V146XR.

Net Prices for V146X are same as like Vt. & Cap. in V146XR listing.



CAPACITORS

Type K323Z Metallized Polycarbonate Capacitors



If plastic sleeve is desired add suffix "P" to type number and specify when ordering. Add 1/16" to the diameter and length and add .02 to cost of unit.

Here is the first stock line of hermetically sealed metallized polycarbonate capacitors. Polycarbonate film offers many advantages over paper or other film dielectrics including high capacitance stability, low dissipation factor, low dielectric absorption and high insulation resistance. Metallized polycarbonate offers the additional feature of self-healing in the rare case of dielectric breakdown. Size and weight savings over paper capacitors are most obvious in lower voltage ratings but the added stability is an important plus at the higher voltages. Operating temperature is -65°C to +125°C at full rating. Standard tolerance is ±20%. Other tolerances available on special order. For full technical information request bulletin NPJ-136.

Capacity Mfd.	d x l	Net Price*	Capacity Mfd.	d x l	Net Price*	Capacity Mfd.	d x l	Net Price*	Capacity Mfd.	d x l	Net Price*
K323Z - 100 VDCW			K323Z - 200 VDCW			K323Z - 400 VDCW			K323Z - 600 VDCW		
.015	.175 x 5/8	2.10	.01	.175 x 5/8	1.86	.01	.235 x 11/16	2.16	.01	.312 x 13/16	2.49
.022	.175 x 5/8	2.10	.015	.195 x 5/8	1.86	.015	.235 x 13/16	2.16	.015	.400 x 13/16	2.49
.033	.195 x 11/16	2.18	.022	.195 x 11/16	1.86	.022	.312 x 11/16	2.19	.022	.400 x 13/16	2.55
.047	.235 x 5/8	2.16	.033	.235 x 11/16	1.89	.033	.312 x 13/16	2.19	.033	.400 x 15/16	2.58
.068	.235 x 11/16	2.19	.047	.235 x 13/16	1.92	.047	.400 x 13/16	2.19	.047	.400 x 1 1/8	2.61
.1	.235 x 13/16	2.22	.068	.235 x 13/16	1.95	.068	.400 x 15/16	2.22	.068	.400 x 1 1/8	2.61
.15	.312 x 13/16	2.22	.1	.312 x 13/16	1.98	.1	.400 x 1 1/8	2.25	.1	.562 x 1 1/8	2.82
.22	.312 x 13/16	2.25	.15	.312 x 15/16	2.04	.15	.400 x 1 5/16	2.34	.15	.562 x 1 5/16	2.94
.33	.400 x 13/16	2.46	.22	.400 x 13/16	2.10	.22	.562 x 1 1/8	2.55	.22	.562 x 1 13/16	3.48
.47	.400 x 15/16	2.46	.33	.400 x 1 1/8	2.25	.33	.562 x 1 9/16	2.76	.33	.670 x 1 13/16	3.54
.68	.400 x 1 1/8	2.76	.47	.400 x 1 5/16	2.31	.47	.670 x 1 13/16	3.06	.47	.750 x 1 13/16	4.02
1.0	.400 x 1 9/16	3.00	.68	.562 x 15/16	2.61	.68	.750 x 2 1/16	4.14	1.0	1.0 x 2 1/16	5.55
1.5	.562 x 1 1/8	3.42	1.0	.562 x 1 5/16	2.91	1.5	1.0 x 1 13/16	5.19			
2.0	.562 x 1 5/16	3.90	1.5	.562 x 1 9/16	3.21	2.0	1.0 x 2 1/16	6.24			
3.0	.562 x 1 13/16	4.92	2.0	.750 x 1 13/16	3.51						
4.0	.670 x 1 13/16	5.76	3.0	.750 x 2 1/16	4.05						
5.0	.670 x 2 1/16	6.54	4.0	.750 x 2 5/16	4.65						
			5.0	.750 x 2 5/16	5.25						

AEROVOX MINIATURE TYPE WRAP & FILL METALLIZED DIELECTRIC CAPACITORS

Aerovox Type K146Z and K146ZR offer excellent electrical characteristics to meet the miniature requirements of transistorized circuits for Military, Industrial and Consumer-Type applications. Aerovox capacitors utilize a metallized film dielectric proven by Aerovox Research and Engineering for capacitor use. Sizes chosen are consistent with high reliability and long service life at maximum rated conditions.

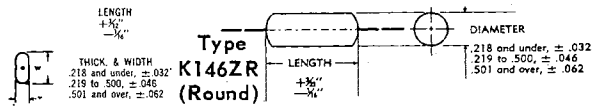
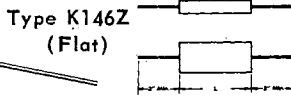
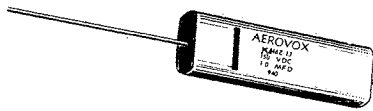

Capacity in Mfd.	100 VDC T x W x L	Cat. #	Net Price	200 VDC T x W x L	Cat. #	Net Price	Capacity in Mfd.	100 V D x L	Cat. #	Net Price	200 V D x L	Cat. #	Net Price
.027				.125 x .234 x 1/2	K146Z-20		.01	Use 200 V			.140 x 1/2	K146ZR-32	
.033				.125 x .234 x 1/2	K146Z-21		.012	Use 200 V			.140 x 1/2	K146ZR-33	
.039				.125 x .234 x 1/2	K146Z-22		.015	Use 200 V			.156 x 1/2	K146ZR-34	
.047				.109 x .218 x 11/16	K146Z-23		.018	Use 200 V			.156 x 1/2	K146ZR-35	
.056				.125 x .234 x 11/16	K146Z-24		.022	.140 x 1/2	K146ZR-6		.171 x 1/2	K146ZR-36	
.068				.140 x .250 x 11/16	K146Z-25		.027	.140 x 1/2	K146ZR-7		.187 x 1/2	K146ZR-37	
.082	.125 x .218 x 9/16	K146Z-1	Contact	.156 x .265 x 11/16	K146Z-26		.033	.156 x 1/2	K146ZR-8		.187 x 9/16	K146ZR-38	
.10	.140 x .250 x 9/16	K146Z-2	Your	.171 x .281 x 11/16	K146Z-27	Contact	.039	.171 x 1/2	K146ZR-9		.187 x 9/16	K146ZR-39	
.12	.156 x .265 x 9/16	K146Z-3	Local	.187 x .296 x 11/16	K146Z-28	Your	.047	.171 x 1/2	K146ZR-10		.171 x 11/16	K146ZR-40	
.15	.140 x .250 x 11/16	K146Z-4	Aerovox	.218 x .328 x 11/16	K146Z-29	Local	.056	.187 x 9/16	K146ZR-11		.187 x 11/16	K146ZR-41	Contact
.18	.156 x .265 x 11/16	K146Z-5	Industrial	.250 x .359 x 11/16	K146Z-30	Your	.068	.203 x 9/16	K146ZR-12	Your	.203 x 11/16	K146ZR-42	Your
.22	.171 x .281 x 11/16	K146Z-6	Distributor	.265 x .375 x 11/16	K146Z-31	Local	.082	.218 x 9/16	K146ZR-13	Local	.218 x 11/16	K146ZR-43	Local
.27	.203 x .312 x 11/16	K146Z-7	for	.234 x .390 x 1	K146Z-32	Prices	.1	.203 x 9/16	K146ZR-14	Aerovox	.234 x 11/16	K146ZR-44	Aerovox
.33	.218 x .328 x 11/16	K146Z-8		.250 x .390 x 1 3/16	K146Z-33		.12	.218 x 9/16	K146ZR-15	Industrial	.250 x 11/16	K146ZR-45	Industrial
.39	.250 x .359 x 11/16	K146Z-9		.281 x .406 x 1 3/16	K146Z-34		.15	.218 x 11/16	K146ZR-16	Distributor	.281 x 11/16	K146ZR-46	Distributor
.47	.234 x .343 x 13/16	K146Z-10		.328 x .484 x 1 3/16	K146Z-35		.18	.234 x 11/16	K146ZR-17	for	.328 x 13/16	K146ZR-47	for
.56	.234 x .390 x 1	K146Z-11		.359 x .515 x 1 3/16	K146Z-36		.22	.265 x 11/16	K146ZR-18	Prices	.312 x 1 1/16	K146ZR-48	Prices
.68	.250 x .406 x 1	K146Z-12		.359 x .556 x 1 7/16	K146Z-37		.27	.281 x 11/16	K146ZR-19		.312 x 1 1/16	K146ZR-49	
.82	.281 x .429 x 1	K146Z-13		.406 x .609 x 1 13/16	K146Z-38		.33	.312 x 11/16	K146ZR-20		.328 x 1	K146ZR-50	
1.0	.296 x .468 x 1	K146Z-14		.429 x .671 x 1 13/16	K146Z-39		.39	.296 x 13/16	K146ZR-21		.328 x 3/16	K146ZR-51	
1.5	.312 x .453 x 1 3/16	K146Z-15		.515 x .718 x 1 15/16	K146Z-40		.47	.328 x 1	K146ZR-22		.343 x 1 3/16	K146ZR-52	
2.0	.343 x .500 x 1 3/16	K146Z-16		.546 x .750 x 2 3/16	K146Z-41		.56	.343 x 1	K146ZR-23		.375 x 1 3/16	K146ZR-53	
3.0	.296 x .493 x 1 13/16	K146Z-17					.68	.375 x 1	K146ZR-24		.421 x 3/16	K146ZR-54	
4.0	.343 x .546 x 1 13/16	K146Z-18					.82	.406 x 1	K146ZR-25		.453 x 1 3/16	K146ZR-55	
5.0	.375 x .578 x 1 15/16	K146Z-19					1.0	.390 x 1 3/16	K146ZR-26		.484 x 7/16	K146ZR-56	
							1.5	.437 x 1 3/16	K146ZR-27		.484 x 1 1/16	K146ZR-57	
							2.0	.421 x 1 13/16	K146ZR-28		.593 x 1 13/16	K146ZR-58	
							3.0	.468 x 1 13/16	K146ZR-29		.643 x 1 15/16	K146ZR-59	
							4.0	.500 x 1 15/16	K146ZR-30				
							5.0		K146ZR-31				

Capacity in Mfd.	400 VDC T x W x L	Cat. #	Net Price	600 VDC T x W x L	Cat. #	Net Price	Capacity in Mfd.	400 V D x L	Cat. #	Net Price	600 V D x L	Cat. #	Net Price
.01	.140 x .250 x 9/16	K146Z-71		.125 x .281 x 11/16	K146Z-98		.01	.203 x 9/16	K146ZR-88		.218 x 11/16	K146ZR-115	
.012	.140 x .250 x 9/16	K146Z-72		.140 x .296 x 11/16	K146Z-99		.012	.203 x 9/16	K146ZR-89		.234 x 11/16	K146ZR-116	
.015	.171 x .281 x 9/16	K146Z-73		.156 x .312 x 11/16	K146Z-100		.015	.234 x 9/16	K146ZR-90		.250 x 11/16	K146ZR-117	
.018	.187 x .296 x 9/16	K146Z-74		.187 x .343 x 11/16	K146Z-101		.018	.250 x 9/16	K146ZR-91		.281 x 11/16	K146ZR-118	
.022	.203 x .312 x 9/16	K146Z-75		.203 x .359 x 11/16	K146Z-102		.022	.265 x 9/16	K146ZR-92		.296 x 11/16	K146ZR-119	
.027	.187 x .296 x 11/16	K146Z-76		.187 x .343 x 13/16	K146Z-103		.027	.250 x 11/16	K146ZR-93		.281 x 13/16	K146ZR-120	
.033	.203 x .312 x 11/16	K146Z-77		.218 x .375 x 13/16	K146Z-104		.033	.265 x 11/16	K146ZR-94		.312 x 13/16	K146ZR-121	
.039	.234 x .343 x 11/16	K146Z-78		.187 x .390 x 1	K146Z-105	Contact	.039	.296 x 11/16	K146ZR-95	Contact	.312 x 1	K146ZR-122	Contact
.047	.250 x .359 x 11/16	K146Z-79	Your	.203 x .406 x 1	K146Z-106	Your	.047	.312 x 11/16	K146ZR-96	Your	.328 x 1	K146ZR-123	Your
.056	.281 x .390 x 11/16	K146Z-80	Local	.218 x .421 x 1	K146Z-107	Local	.056	.343 x 11/16	K146ZR-97	Local	.343 x 1	K146ZR-124	Local
.068	.265 x .375 x 13/16	K146Z-81	Aerovox	.250 x .359 x 1	K146Z-108	Aerovox	.068	.328 x 13/16	K146ZR-98	Aerovox	.375 x 1	K146ZR-125	Aerovox
.082	.281 x .390 x 13/16	K146Z-82	Industrial	.281 x .484 x 1	K146Z-109	Industrial	.082	.343 x 13/16	K146ZR-99	Industrial	.406 x 1	K146ZR-126	Industrial
.10	.250 x .406 x 1	K146Z-83	Distributor	.312 x .515 x 1	K146Z-110	Distributor	.1	.343 x 1	K146ZR-100	for	.437 x 1	K146ZR-127	for
.12	.281 x .437 x 1	K146Z-84	Prices	.312 x .515 x 1 3/16	K146Z-111	Prices	.12	.375 x 1	K146ZR-101	Prices	.437 x 1 3/16	K146ZR-128	Prices
.15	.296 x .453 x 1	K146Z-85		.359 x .526 x 1 3/16	K146Z-112		.15	.390 x 1	K146ZR-102		.484 x 1 3/16	K146ZR-129	
.18	.343 x .500 x 1	K146Z-86		.390 x .593 x 1 7/16	K146Z-113		.18	.437 x 1	K146ZR-103		.515 x 7/16	K146ZR-130	
.22	.390 x .546 x 1	K146Z-87		.453 x .656 x 1 7/16	K146Z-114		.22	.484 x 1	K146ZR-104		.478 x 1 7/16	K146ZR-131	
.27	.375 x .531 x 1 3/16	K146Z-88		.500 x .703 x 1 7/16	K146Z-115		.27	.468 x 1 3/16	K146ZR-105		.625 x 1 7/16	K146ZR-132	
.33	.343 x .546 x 1 7/16	K146Z-89		.406 x .609 x 1 13/16	K146Z-116		.33	.468 x 1 7/16	K146ZR-106		.531 x 1 3/16	K146ZR-133	
.39	.375 x .578 x 1 7/16	K146Z-90		.453 x .656 x 1 13/16	K146Z-117		.39	.500 x 1 7/16	K146ZR-107		.573 x 1 3/16	K146ZR-134	
.47	.421 x .625 x 1 7/16	K146Z-91		.500 x .703 x 1 13/16	K146Z-118		.47	.546 x 1 7/16	K146ZR-108		.625 x 1 3/16	K146ZR-135	
.56	.453 x .656 x 1 7/16	K146Z-92		.562 x .765 x 1 13/16	K146Z-119		.56	.578 x 1 7/16	K146ZR-109		.687 x 1 3/16	K146ZR-136	
.68	.515 x .718 x 1 7/16	K146Z-93		.609 x .812 x 1 13/16	K146Z-120								



CAPACITORS

TYPES P323S AND P323SX

Tubular, metal-cased units with hermetically sealed construction and glass terminal end seals. Engineered to meet high-temperature, minimum space requirements, Types P323S and P323SX are designed for long life at elevated temperatures.

Impregnated with HYVOL "S", a special high temperature liquid impregnant. These units are capable of withstanding twice rated voltage between terminals or between terminal and case for a 1-minute period. Ambient temperature shall be +25°C, -10°C for this test. Power factor is less than 1% when measured or referred to a frequency of 1,000 cps at 25°C.

Type P323S and P323SX are rigidly processed to assure operation between -65°C and +100°C. Type P323S uses an inserted-tab construction to obtain minimum size, while type P323SX has extended-foil construction for applications at very-low AC voltages.

For equivalent types rated -65°C to +100°C in the same case size as shown, order as P123S, SX etc., and request prices.

Styles available from stock include units bearing suffixes S-SX which are as listed; G types, with one end grounded which are $\frac{1}{16}$ " shorter; GP types, grounded, with plastic insulating sleeve and $\frac{1}{16}$ " larger diameter and P types, with both ends insulated and a plastic sleeve, which are $\frac{1}{16}$ " larger in both length and diameter.

Grounded units to be discontinued when present stocks are depleted.

STYLE VARIATIONS

Suffix	Description	Can size change
S-SX	As listed	As listed
G	One end grounded	Deduct $\frac{1}{16}$ " from length
GP	Grounded with plastic insulating sleeve	Add $\frac{1}{16}$ " to diameter
P	Both ends insulated with plastic sleeve	Add $\frac{1}{16}$ " to diameter and length
GT	One end grounded with threaded neck mounting	Deduct $\frac{1}{16}$ " from length

Cap. uf	P323S	P323SX	Cap. uf	P323S	P323SX	Cap. uf	P323S	P323SX	Cap. uf	P323S	P323SX
100 VOLTS			200 VOLTS (Cont.)			400 VOLTS (Cont.)			600 VOLTS (Cont.)		
.001	.175 x $\frac{3}{4}$.175 x $\frac{3}{4}$.068	.312 x $\frac{7}{8}$.400 x $\frac{7}{8}$.01	.235 x $\frac{3}{4}$.312 x $\frac{7}{8}$.1	.562 x $1\frac{1}{8}$.562 x $1\frac{1}{8}$
.0015	.175 x $\frac{3}{4}$.175 x $\frac{3}{4}$.082	.400 x $\frac{7}{8}$.400 x $1\frac{1}{8}$.012	.312 x $\frac{7}{8}$.312 x $\frac{7}{8}$.12	.562 x $1\frac{1}{8}$.562 x $1\frac{1}{8}$
.0022	.175 x $\frac{3}{4}$.175 x $\frac{3}{4}$.1	.400 x $\frac{7}{8}$.400 x $1\frac{1}{8}$.015	.312 x $\frac{7}{8}$.312 x $\frac{7}{8}$.15	.562 x $1\frac{1}{8}$.562 x $1\frac{1}{8}$
.0033	.175 x $\frac{3}{4}$.175 x $\frac{3}{4}$.12	.400 x $1\frac{1}{8}$.400 x $1\frac{1}{8}$.018	.312 x $\frac{7}{8}$.400 x $\frac{7}{8}$.18	.562 x $1\frac{1}{8}$.670 x $1\frac{1}{8}$
.0047	.175 x $\frac{3}{4}$.175 x $\frac{3}{4}$.15	.400 x $1\frac{1}{8}$.400 x $1\frac{1}{8}$.022	.312 x $\frac{7}{8}$.400 x $\frac{7}{8}$.22	.562 x $1\frac{1}{8}$.670 x $1\frac{1}{8}$
.0068	.175 x $\frac{3}{4}$.195 x $\frac{3}{4}$.18	.400 x $1\frac{1}{8}$.562 x $1\frac{1}{8}$.027	.312 x $\frac{7}{8}$.400 x $\frac{7}{8}$.27	.670 x $1\frac{1}{8}$.750 x $2\frac{1}{8}$
.01	.175 x $\frac{3}{4}$.235 x $\frac{3}{4}$.22	.400 x $1\frac{1}{8}$.562 x $1\frac{1}{8}$.033	.312 x $\frac{7}{8}$.400 x $\frac{7}{8}$.33	.670 x $1\frac{1}{8}$.750 x $2\frac{1}{8}$
.015	.175 x $\frac{3}{4}$.235 x $\frac{3}{4}$.27	.562 x $1\frac{1}{8}$.562 x $1\frac{1}{8}$.039	.400 x $\frac{7}{8}$.400 x $1\frac{1}{8}$.39	.750 x $2\frac{1}{8}$.750 x $2\frac{1}{8}$
.022	.195 x $\frac{3}{4}$.312 x $\frac{7}{8}$.33	.562 x $1\frac{1}{8}$.562 x $1\frac{1}{8}$.047	.400 x $\frac{7}{8}$.400 x $1\frac{1}{8}$.47	.750 x $2\frac{1}{8}$.750 x $2\frac{1}{8}$
.027	.235 x $\frac{3}{4}$.312 x $\frac{7}{8}$.39	.562 x $1\frac{1}{8}$.562 x $1\frac{1}{8}$.056	.400 x $1\frac{1}{8}$.400 x $1\frac{1}{8}$.56	1.000 x $1\frac{1}{8}$	1.000 x $2\frac{1}{8}$
.033	.235 x $\frac{3}{4}$.312 x $\frac{7}{8}$.47	.562 x $1\frac{1}{8}$.562 x $1\frac{1}{8}$.068	.400 x $1\frac{1}{8}$.400 x $1\frac{1}{8}$.68	1.000 x $1\frac{1}{8}$	1.000 x $2\frac{1}{8}$
.047	.312 x $\frac{7}{8}$.312 x $\frac{7}{8}$.56	.562 x $1\frac{1}{8}$.670 x $1\frac{1}{8}$.082	.400 x $1\frac{1}{8}$.562 x $1\frac{1}{8}$.82	1.000 x $2\frac{1}{8}$	1.000 x $2\frac{1}{8}$
.068	.312 x $\frac{7}{8}$.400 x $\frac{7}{8}$.68	.562 x $1\frac{1}{8}$.670 x $1\frac{1}{8}$.1	.400 x $1\frac{1}{8}$.562 x $1\frac{1}{8}$	1.00	1.000 x $2\frac{1}{8}$	1.000 x $2\frac{1}{8}$
.082	.312 x $\frac{7}{8}$.400 x $\frac{7}{8}$.82	.670 x $1\frac{1}{8}$.750 x $2\frac{1}{8}$.12	.562 x $1\frac{1}{8}$.562 x $1\frac{1}{8}$	1000 VOLTS		
.1	.312 x $\frac{7}{8}$.400 x $\frac{7}{8}$	1.00	.670 x $1\frac{1}{8}$.750 x $2\frac{1}{8}$.15	.562 x $1\frac{1}{8}$.562 x $1\frac{3}{8}$.001	.400 x $\frac{7}{8}$.400 x $\frac{7}{8}$
.12	.400 x $\frac{7}{8}$.400 x $1\frac{1}{8}$	300 VOLTS			.18	.562 x $1\frac{1}{8}$.562 x $1\frac{3}{8}$.0012	.400 x $\frac{7}{8}$.400 x $\frac{7}{8}$
.15	.400 x $\frac{7}{8}$.400 x $1\frac{1}{8}$.001	.235 x $\frac{3}{4}$.235 x $\frac{3}{4}$.22	.562 x $1\frac{1}{8}$.562 x $1\frac{3}{8}$.0015	.400 x $\frac{7}{8}$.400 x $\frac{7}{8}$
.18	.400 x $1\frac{1}{8}$.400 x $1\frac{1}{8}$.0015	.235 x $\frac{3}{4}$.235 x $\frac{3}{4}$.27	.562 x $1\frac{1}{8}$.670 x $1\frac{1}{8}$.0018	.400 x $\frac{7}{8}$.400 x $\frac{7}{8}$
.22	.400 x $1\frac{1}{8}$.400 x $1\frac{1}{8}$.0022	.235 x $\frac{3}{4}$.235 x $\frac{3}{4}$.33	.562 x $1\frac{1}{8}$.670 x $1\frac{1}{8}$.0022	.400 x $\frac{7}{8}$.400 x $\frac{7}{8}$
.27	.400 x $1\frac{1}{8}$.562 x $1\frac{1}{8}$.0033	.235 x $\frac{3}{4}$.235 x $\frac{3}{4}$.39	.670 x $1\frac{1}{8}$.750 x $2\frac{1}{8}$.0027	.400 x $\frac{7}{8}$.400 x $\frac{7}{8}$
.33	.400 x $1\frac{1}{8}$.562 x $1\frac{1}{8}$.0047	.235 x $\frac{3}{4}$.235 x $\frac{3}{4}$.47	.670 x $1\frac{1}{8}$.750 x $2\frac{1}{8}$.0033	.400 x $\frac{7}{8}$.400 x $\frac{7}{8}$
.39	.562 x $1\frac{1}{8}$.562 x $1\frac{1}{8}$.0068	.235 x $\frac{3}{4}$.312 x $\frac{7}{8}$.56	.750 x $2\frac{1}{8}$.750 x $2\frac{1}{8}$.0039	.400 x $\frac{7}{8}$.400 x $\frac{7}{8}$
.47	.562 x $1\frac{1}{8}$.562 x $1\frac{1}{8}$.01	.235 x $\frac{3}{4}$.312 x $\frac{7}{8}$.68	.750 x $2\frac{1}{8}$.750 x $2\frac{1}{8}$.0047	.400 x $\frac{7}{8}$.400 x $\frac{7}{8}$
.56	.562 x $1\frac{1}{8}$.562 x $1\frac{1}{8}$.015	.235 x $\frac{3}{4}$.312 x $\frac{7}{8}$.82	1.000 x $1\frac{1}{8}$	1.000 x $2\frac{1}{8}$.0056	.400 x $\frac{7}{8}$.400 x $\frac{7}{8}$
.68	.562 x $1\frac{1}{8}$.562 x $1\frac{1}{8}$.022	.312 x $\frac{7}{8}$.312 x $\frac{7}{8}$	1.00	1.000 x $1\frac{1}{8}$	1.000 x $2\frac{1}{8}$.0068	.400 x $\frac{7}{8}$.400 x $\frac{7}{8}$
.82	.562 x $1\frac{1}{8}$.670 x $1\frac{1}{8}$.033	.312 x $\frac{7}{8}$.400 x $\frac{7}{8}$	600 VOLTS			.0082	.400 x $\frac{7}{8}$.400 x $\frac{7}{8}$
1.00	.562 x $1\frac{1}{8}$.670 x $1\frac{1}{8}$.047	.312 x $\frac{7}{8}$.400 x $\frac{7}{8}$.001	.235 x $\frac{3}{4}$.235 x $\frac{3}{4}$.01	.400 x $\frac{7}{8}$.400 x $\frac{7}{8}$
200 VOLTS			.068	.400 x $\frac{7}{8}$.400 x $1\frac{1}{8}$.0012	.235 x $\frac{3}{4}$.235 x $\frac{3}{4}$.012	.400 x $\frac{7}{8}$.400 x $1\frac{1}{8}$
.001	.235 x $\frac{3}{4}$.235 x $\frac{3}{4}$.1	.400 x $1\frac{1}{8}$.400 x $1\frac{1}{8}$.0015	.235 x $\frac{3}{4}$.235 x $\frac{3}{4}$.015	.400 x $\frac{7}{8}$.400 x $1\frac{1}{8}$
.0012	.235 x $\frac{3}{4}$.235 x $\frac{3}{4}$.15	.400 x $1\frac{1}{8}$.562 x $1\frac{1}{8}$.0018	.235 x $\frac{3}{4}$.235 x $\frac{3}{4}$.018	.400 x $1\frac{1}{8}$.400 x $1\frac{1}{8}$
.0015	.235 x $\frac{3}{4}$.235 x $\frac{3}{4}$.22	.562 x $1\frac{1}{8}$.562 x $1\frac{1}{8}$.0022	.235 x $\frac{3}{4}$.235 x $\frac{3}{4}$.022	.400 x $1\frac{1}{8}$.400 x $1\frac{1}{8}$
.0018	.235 x $\frac{3}{4}$.235 x $\frac{3}{4}$.33	.562 x $1\frac{1}{8}$.562 x $1\frac{1}{8}$.0027	.235 x $\frac{3}{4}$.312 x $\frac{7}{8}$.027	.400 x $1\frac{1}{8}$.562 x $1\frac{1}{8}$
.0022	.235 x $\frac{3}{4}$.235 x $\frac{3}{4}$.47	.562 x $1\frac{1}{8}$.670 x $1\frac{1}{8}$.0033	.235 x $\frac{3}{4}$.312 x $\frac{7}{8}$.033	.400 x $1\frac{1}{8}$.562 x $1\frac{1}{8}$
.0027	.235 x $\frac{3}{4}$.235 x $\frac{3}{4}$.68	.670 x $1\frac{1}{8}$.750 x $2\frac{1}{8}$.0039	.235 x $\frac{3}{4}$.312 x $\frac{7}{8}$.039	.562 x $1\frac{1}{8}$.562 x $1\frac{1}{8}$
.0033	.235 x $\frac{3}{4}$.235 x $\frac{3}{4}$	1.00	.750 x $2\frac{1}{8}$	1.000 x $2\frac{1}{8}$.0047	.235 x $\frac{3}{4}$.312 x $\frac{7}{8}$.047	.562 x $1\frac{1}{8}$.562 x $1\frac{1}{8}$
.0039	.235 x $\frac{3}{4}$.235 x $\frac{3}{4}$	400 VOLTS			.0056	.235 x $\frac{3}{4}$.312 x $\frac{7}{8}$.056	.562 x $1\frac{1}{8}$.562 x $1\frac{1}{8}$
.0047	.235 x $\frac{3}{4}$.235 x $\frac{3}{4}$.001	.235 x $\frac{3}{4}$.235 x $\frac{3}{4}$.0068	.235 x $\frac{3}{4}$.312 x $\frac{7}{8}$.068	.562 x $1\frac{1}{8}$.562 x $1\frac{1}{8}$
.0056	.235 x $\frac{3}{4}$.235 x $\frac{3}{4}$.0012	.235 x $\frac{3}{4}$.235 x $\frac{3}{4}$.0082	.235 x $\frac{3}{4}$.312 x $\frac{7}{8}$.082	.562 x $1\frac{1}{8}$.670 x $1\frac{1}{8}$
.0068	.235 x $\frac{3}{4}$.235 x $\frac{3}{4}$.0015	.235 x $\frac{3}{4}$.235 x $\frac{3}{4}$.01	.312 x $\frac{7}{8}$.312 x $\frac{7}{8}$.1	.562 x $1\frac{1}{8}$.670 x $1\frac{1}{8}$
.0082	.235 x $\frac{3}{4}$.312 x $\frac{7}{8}$.0018	.235 x $\frac{3}{4}$.235 x $\frac{3}{4}$.012	.312 x $\frac{7}{8}$.400 x $\frac{7}{8}$.12	.670 x $1\frac{1}{8}$.670 x $1\frac{1}{8}$
.01	.235 x $\frac{3}{4}$.312 x $\frac{7}{8}$.0022	.235 x $\frac{3}{4}$.235 x $\frac{3}{4}$.015	.312 x $\frac{7}{8}$.400 x $\frac{7}{8}$.15	.670 x $1\frac{1}{8}$.670 x $1\frac{1}{8}$
.012	.235 x $\frac{3}{4}$.312 x $\frac{7}{8}$.0027	.235 x $\frac{3}{4}$.235 x $\frac{3}{4}$.018	.312 x $\frac{7}{8}$.400 x $\frac{7}{8}$.18	.750 x $2\frac{1}{8}$.750 x $2\frac{1}{8}$
.015	.235 x $\frac{3}{4}$.312 x $\frac{7}{8}$.0033	.235 x $\frac{3}{4}$.235 x $\frac{3}{4}$.022	.312 x $\frac{7}{8}$.400 x $\frac{7}{8}$.22	.750 x $2\frac{1}{8}$.750 x $2\frac{1}{8}$
.018	.235 x $\frac{3}{4}$.312 x $\frac{7}{8}$.0039	.235 x $\frac{3}{4}$.312 x $\frac{7}{8}$.027	.400 x $\frac{7}{8}$.400 x $1\frac{1}{8}$.27	.750 x $2\frac{1}{8}$	1.000 x $2\frac{1}{8}$
.022	.235 x $\frac{3}{4}$.312 x $\frac{7}{8}$.0047	.235 x $\frac{3}{4}$.312 x $\frac{7}{8}$.033	.400 x $\frac{7}{8}$.400 x $1\frac{1}{8}$.33	.750 x $2\frac{1}{8}$	1.000 x $2\frac{1}{8}$
.027	.312 x $\frac{7}{8}$.312 x $\frac{7}{8}$.0056	.235 x $\frac{3}{4}$.312 x $\frac{7}{8}$.047	.400 x $1\frac{1}{8}$.400 x $1\frac{1}{8}$.47	1.000 x $2\frac{1}{8}$	1.000 x $2\frac{1}{8}$
.033	.312 x $\frac{7}{8}$.312 x $\frac{7}{8}$.0068	.235 x $\frac{3}{4}$.312 x $\frac{7}{8}$.056	.400 x $1\frac{1}{8}$.562 x $1\frac{1}{8}$	Request O.E.M. prices in the following quantities: 25-49, 50-99, 100-499		
.039	.312 x $\frac{7}{8}$.400 x $\frac{7}{8}$.0082	.235 x $\frac{3}{4}$.312 x $\frac{7}{8}$.068	.400 x $1\frac{1}{8}$.562 x $1\frac{1}{8}$			
.047	.312 x $\frac{7}{8}$.400 x $\frac{7}{8}$.082	.562 x $1\frac{1}{8}$.562 x $1\frac{1}{8}$			
.056	.312 x $\frac{7}{8}$.400 x $\frac{7}{8}$									

Contact your local Aerovox Industrial Distributor for Prices.



CAPACITORS

INDUSTRIAL SECTION—STANDARD TYPES (Continued) METALLIZED-PAPER

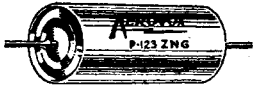

**TYPES P123ZN,
P123ZNG
and
TYPES P323ZN,
P323ZNG
Metal-Cased
Capacitors**

Metallized paper tubulars hermetically sealed in metal tubes with glass end seals soldered for positive moisture seal. P123ZN operating temperature range -55°C to +100°C. at full voltage rating and +125°C. with voltage derating to 75%.

Type P323ZN is in a similar construction but made to operate WITHOUT VOLTAGE DERATING over a temperature range of -55°C. to +125°C.

Standard tolerance - P123ZN -.01 mfd. and lower ±25% .012 mfd. and up ±20%. Type P323ZN - all values ±20%.

Sizes shown are for uninsulated styles, for insulated case add the suffix "P" to designation and 1/16" to diameter and length.

Capacity	P123ZN	P123ZNG	P323ZN	P323ZNG	Capacity	P123ZN	P123ZNG	P323ZN	P323ZNG
50 VOLTS					400 VOLTS (Continued)				
.047	.195 x 13/16	.195 x 3/4			.012	.235 x 13/16	.235 x 3/4	.235 x 13/16	.235 x 3/4
.068	.195 x 13/16	.195 x 3/4			.015	.235 x 13/16	.235 x 3/4	.235 x 13/16	.235 x 3/4
.1	.195 x 15/16	.195 x 7/8			.018	.235 x 13/16	.235 x 3/4	.312 x 13/16	.312 x 3/4
.15	.235 x 15/16	.235 x 7/8			.02	.235 x 13/16	.235 x 3/4	.235 x 3/4	.235 x 3/4
.22	.312 x 13/16	.312 x 3/4			.022	.235 x 13/16	.235 x 3/4	.312 x 13/16	.312 x 3/4
.33	.312 x 1-1/8	.312 x 1-1/16			.027	.312 x 13/16	.312 x 3/4	.312 x 13/16	.312 x 3/4
.47	.312 x 1-3/16	.312 x 1-1/8			.033	.312 x 13/16	.312 x 3/4	.312 x 13/16	.312 x 3/4
.68	.400 x 1-1/8	.400 x 1-1/16			.039	.312 x 1-1/8	.312 x 1-1/16	.312 x 1-1/8	.312 x 1-1/16
1.0	.400 x 1-5/16	.400 x 1-1/4			.04	.312 x 1-1/8	.312 x 1-1/16	.312 x 1-1/8	.312 x 1-1/16
1.5	.500 x 1-1/8	.500 x 1-1/16			.047	.312 x 1-1/8	.312 x 1-1/16	.312 x 1-1/8	.312 x 1-1/16
2.0	.562 x 1-5/16	.562 x 1-1/4			.05	.312 x 1-1/8	.312 x 1-1/16	.312 x 1-1/8	.312 x 1-1/16
3.0	.562 x 1-7/16	.562 x 1-3/8			.056	.312 x 1-1/8	.312 x 1-1/16	.312 x 1-1/8	.312 x 1-1/16
4.0	.670 x 1-7/16	.670 x 1-3/8			.068	.312 x 1-1/8	.312 x 1-1/16	.400 x 1-1/8	.400 x 1-1/16
200 VOLTS					600 VOLTS				
.0005	.175 x 1/2	.175 x 7/16			.12	.500 x 1-1/8	.500 x 1-1/16	.500 x 1-1/8	.500 x 1-1/16
.001	.175 x 1/2	.175 x 7/16			.15	.500 x 1-1/8	.500 x 1-1/16	.500 x 1-1/8	.500 x 1-1/16
.002	.175 x 1/2	.175 x 7/16			.18	.500 x 1-1/8	.500 x 1-1/16	.500 x 1-1/8	.500 x 1-1/16
.003	.175 x 1/2	.175 x 7/16			2	.500 x 1-1/8	.500 x 1-1/16	.500 x 1-1/8	.500 x 1-1/16
.005	.175 x 1/2	.175 x 7/16			22	.500 x 1-1/8	.500 x 1-1/16	.562 x 1-1/8	.562 x 1-1/16
.01	.175 x 1/2	.175 x 7/16	.175 x 1/2	.175 x 7/16	.25	.500 x 1-1/8	.500 x 1-1/16	.500 x 1-1/8	.500 x 1-1/16
.012	.195 x 5/8	.195 x 9/16	.195 x 5/8	.195 x 9/16	.27	.562 x 1-1/8	.562 x 1-1/16	.562 x 1-1/8	.562 x 1-1/16
.015	.195 x 5/8	.195 x 9/16	.195 x 5/8	.195 x 9/16	.33	.562 x 1-3/8	.562 x 1-5/16	.562 x 1-3/8	.562 x 1-5/16
.018	.195 x 5/8	.195 x 9/16	.235 x 5/8	.235 x 9/16	.39	.562 x 1-5/8	.562 x 1-9/16	.562 x 1-5/8	.562 x 1-9/16
.02	.195 x 5/8	.195 x 9/16	.235 x 5/8	.235 x 9/16	.47	.562 x 1-5/8	.562 x 1-9/16	.562 x 1-5/8	.562 x 1-9/16
.022	.195 x 5/8	.195 x 9/16	.235 x 5/8	.235 x 9/16	.5	.562 x 1-5/8	.562 x 1-9/16	.562 x 1-5/8	.562 x 1-9/16
.027	.235 x 5/8	.235 x 9/16	.235 x 5/8	.235 x 9/16	.56	.670 x 1-5/8	.670 x 1-9/16	.670 x 1-5/8	.670 x 1-9/16
.033	.235 x 5/8	.235 x 9/16	.235 x 3/4	.235 x 11/16	.68	.670 x 1-5/8	.670 x 1-9/16	.670 x 1-7/8	.670 x 1-13/16
.039	.235 x 11/16	.235 x 5/8	.235 x 13/16	.235 x 3/4	.82	.670 x 1-7/8	.670 x 1-13/16	.750 x 1-7/8	.750 x 1-13/16
.04	.235 x 11/16	.235 x 5/8			1.0	.670 x 2-1/8	.670 x 2-1/16	.750 x 1-7/8	.750 x 1-13/16
.047	.235 x 11/16	.235 x 5/8	.235 x 13/16	.235 x 3/4	1.5	.750 x 2-3/8	.750 x 2-5/16	1.000 x 1-7/8	1.000 x 1-13/16
.05	.235 x 11/16	.235 x 5/8			2.0	1.000 x 1-7/8	1.000 x 1-13/16	1.000 x 1-7/8	1.000 x 1-13/16
.056	.235 x 13/16	.235 x 3/4	.235 x 13/16	.235 x 3/4	400 VOLTS				
.068	.312 x 13/16	.312 x 3/4	.312 x 13/16	.312 x 3/4	.0005	.235 x 1/2	.235 x 7/16	.235 x 3/4	.235 x 11/16
.082	.312 x 13/16	.312 x 3/4	.312 x 13/16	.312 x 3/4	.001	.235 x 1/2	.235 x 7/16	.235 x 3/4	.235 x 11/16
.1	.312 x 13/16	.312 x 3/4	.312 x 13/16	.312 x 3/4	.002	.235 x 5/8	.235 x 9/16	.235 x 3/4	.235 x 11/16
.12	.312 x 1-1/8	.312 x 1-1/16	.312 x 1-1/8	.312 x 1-1/16	.003	.235 x 5/8	.235 x 9/16	.235 x 3/4	.235 x 11/16
.15	.312 x 1-1/8	.312 x 1-1/16	.312 x 1-1/8	.312 x 1-1/16	.0047			.235 x 3/4	.235 x 11/16
.18	.312 x 1-1/8	.312 x 1-1/16	.400 x 7/8	.400 x 13/16	.005	.235 x 5/8	.235 x 9/16	.235 x 3/4	.235 x 11/16
.2	.312 x 1-1/8	.312 x 1-1/16			.01	.235 x 5/8	.235 x 9/16	.312 x 13/16	.312 x 3/4
.22	.312 x 1-1/8	.312 x 1-1/16	.400 x 7/8	.400 x 13/16	.012	.312 x 13/16	.312 x 3/4	.312 x 13/16	.312 x 3/4
.25	.312 x 1-1/8	.312 x 1-1/16			.015	.312 x 13/16	.312 x 3/4	.312 x 13/16	.312 x 3/4
.27	.400 x 1-1/8	.400 x 1-1/16	.400 x 1-1/8	.400 x 1-1/16	.018	.312 x 13/16	.312 x 3/4	.312 x 13/16	.312 x 3/4
.33	.400 x 1-1/8	.400 x 1-1/16	.400 x 1-1/8	.400 x 1-1/16	.02	.312 x 13/16	.312 x 3/4	.312 x 13/16	.312 x 3/4
.39	.400 x 1-1/8	.400 x 1-1/16	.400 x 1-1/8	.400 x 1-1/16	.022	.312 x 13/16	.312 x 3/4	.312 x 13/16	.312 x 3/4
.47	.400 x 1-1/8	.400 x 1-1/16	.500 x 1-1/8	.500 x 1-1/16	.027	.400 x 13/16	.400 x 3/4	.400 x 1-1/8	.400 x 1-1/16
.5	.400 x 1-1/8	.400 x 1-1/16	.500 x 1-1/8	.500 x 1-1/16	.033	.400 x 13/16	.400 x 3/4	.400 x 1-1/8	.400 x 1-1/16
.56	.500 x 1-1/8	.500 x 1-1/16	.500 x 1-1/8	.500 x 1-1/16	.039	.400 x 13/16	.400 x 3/4	.400 x 1-1/8	.400 x 1-1/16
.68	.500 x 1-1/8	.500 x 1-1/16	.562 x 1-1/8	.562 x 1-1/16	.04	.400 x 13/16	.400 x 3/4	.400 x 1-1/8	.400 x 1-1/16
.82	.562 x 1-1/8	.562 x 1-1/16	.562 x 1-1/8	.562 x 1-1/16	.047	.400 x 13/16	.400 x 3/4	.400 x 1-1/8	.400 x 1-1/16
1.0	.562 x 1-1/8	.562 x 1-1/16	.562 x 1-1/8	.562 x 1-1/16	.05	.400 x 13/16	.400 x 3/4	.400 x 1-1/8	.400 x 1-1/16
1.5	.562 x 1-5/8	.562 x 1-5/16	.562 x 1-5/8	.562 x 1-5/16	.056	.400 x 1-1/8	.400 x 1-1/16	.400 x 1-1/8	.400 x 1-1/16
2.0	.562 x 1-7/8	.562 x 1-13/16	.670 x 1-5/8	.670 x 1-9/16	.068	.400 x 1-1/8	.400 x 1-1/16	.400 x 1-1/8	.400 x 1-1/16
3.0	.670 x 1-7/8	.670 x 1-13/16	.670 x 1-7/8	.670 x 1-13/16	.082	.400 x 1-1/8	.400 x 1-1/16	.400 x 1-1/8	.400 x 1-1/16
4.0	.750 x 1-7/8	.750 x 1-13/16	.750 x 1-7/8	.750 x 1-13/16	.1	.400 x 1-1/8	.400 x 1-1/16	.400 x 1-1/8	.400 x 1-1/16
5.0	1.000 x 1-7/8	1.000 x 1-13/16	1.000 x 1-7/8	1.000 x 1-13/16	.12	.500 x 1-1/8	.500 x 1-1/16	.500 x 1-1/8	.500 x 1-1/16
6.0	1.000 x 1-7/8	1.000 x 1-13/16	1.000 x 1-7/8	1.000 x 1-13/16	.15	.500 x 1-1/8	.500 x 1-1/16	.500 x 1-1/8	.500 x 1-1/16
8.0			1.000 x 1-7/8	1.000 x 1-13/16	.18	.562 x 1-1/8	.562 x 1-1/16	.562 x 1-1/8	.562 x 1-1/16
10.0			1.000 x 2-3/8	1.000 x 2-5/16	.2	.562 x 1-3/8	.562 x 1-5/16	.562 x 1-3/8	.562 x 1-5/16
12.0			1.000 x 2-5/8	1.000 x 2-9/16	.22	.562 x 1-3/8	.562 x 1-5/16	.562 x 1-3/8	.562 x 1-5/16
400 VOLTS					400 VOLTS				
.0005	.235 x 1/2	.235 x 7/16	.235 x 3/4	.235 x 11/16	.27	.670 x 1-5/8	.670 x 1-9/16	.670 x 1-5/8	.670 x 1-9/16
.001	.235 x 1/2	.235 x 7/16	.235 x 3/4	.235 x 11/16	.33	.670 x 1-5/8	.670 x 1-9/16	.670 x 1-5/8	.670 x 1-9/16
.002	.235 x 1/2	.235 x 7/16	.235 x 3/4	.235 x 11/16	.39	.670 x 1-5/8	.670 x 1-9/16	.670 x 1-5/8	.670 x 1-9/16
.0022			.235 x 3/4	.235 x 11/16	.47	.670 x 1-5/8	.670 x 1-9/16	.670 x 1-5/8	.670 x 1-9/16
.003	.235 x 5/8	.235 x 9/16	.235 x 3/4	.235 x 11/16	.5	.670 x 1-7/8	.670 x 1-13/16	.670 x 1-7/8	.670 x 1-13/16
.0047			.235 x 3/4	.235 x 11/16	.56	.670 x 1-7/8	.670 x 1-13/16	.670 x 1-7/8	.670 x 1-13/16
.005	.235 x 5/8	.235 x 9/16	.235 x 3/4	.235 x 11/16	.68	.670 x 1-7/8	.670 x 1-13/16	.670 x 1-7/8	.670 x 1-13/16
.01	.235 x 5/8	.235 x 9/16	.235 x 3/4	.235 x 11/16	.82	.750 x 2-3/8	.750 x 2-5/16	1.000 x 1-7/8	1.000 x 1-13/16
			.235 x 3/4	.235 x 11/16	1.0	.750 x 2-3/8	.750 x 2-5/16	1.000 x 1-7/8	1.000 x 1-13/16
			.235 x 3/4	.235 x 11/16	1.5	1.000 x 1-7/8	1.000 x 1-13/16	1.000 x 1-7/8	1.000 x 1-13/16
			.235 x 3/4	.235 x 11/16	2.0	1.000 x 2-3/8	1.000 x 2-5/16	1.000 x 2-3/8	1.000 x 2-5/16

Contact your local Aerovox Industrial Distributor for Prices.

*Request O.E.M. Prices in the following quantities: 25-99, 100-499



CAPACITORS

TYPE P09ZNR — MIL TYPE CH70

HIGH-TEMPERATURE METALLIZED PAPER CAPACITORS

Hermetically sealed rectangular case metallized paper capacitors, the Type P09ZNR is equivalent to the CH70 of MIL-C-18312C. These units may be operated at full voltage to 125°C and offer a great deal of weight and size saving over conventional oil paper units. The operating temperature of these units is -55°C to +125°C. The P09ZNR is furnished with silicone terminals such as the "B" terminal specified in MIL-C-25. Also available with porcelain terminals equivalent to the "E" terminal on special order.

NOTES: AT PRESENT WE ARE STOCKING ONLY MIL CAPACITIES AND VOLTAGES.

ALL CAPACITIES AND VOLTAGES NOT LISTED AS MIL WILL BE SUBJECT TO FACTORY DELIVERY CYCLES.

SPECIFY CHARACTERISTIC "M" OR "N" WHEN ORDERING AND ADD "K" (10%) OR "M" (20%) FOR TOLERANCE DESIRED.

AS PRESENT STOCKS ARE DEPLETED INVENTORY WILL BE CHANGED TO TYPE CH72 TO MEET MILITARY SPECIFICATION MIL-C-18312D.

Request O.E.M. Prices in the following quantities: 10-24, 25-49, 50-99

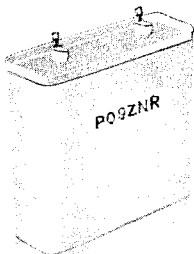
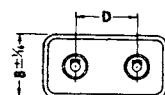
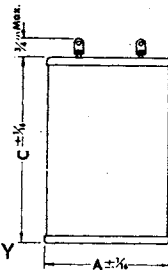

Capacity uf	MIL Number	S I Z E				Tolerance
		A	B	C	D	
150 VDCW						
4.0	_____	1 13/16	1 1/16	1 1/4	1 1/16	K,M
6.0	_____	1 13/16	1 1/16	1 1/2	1 1/16	K,M
8.0	_____	1 13/16	1 1/16	1 3/4	1 1/16	K,M
10.0	_____	1 13/16	1 1/16	1 1/8	1 1/16	K,M
12.0	_____	1 13/16	1 1/16	2 1/8	1 1/16	K,M
15.0	CH70B1-V156-	1 13/16	1 1/16	2 5/8	1 1/16	K,M
20.0	CH70B1-V206-	1 13/16	1 1/16	2 3/4	1 1/16	K,M
25.0	_____	1 13/16	1 1/16	3 3/8	1 1/16	K,M
30.0	CH70B1-V306-	1 13/16	1 1/16	4 1/4	1 1/16	K,M
40.0	_____	2 3/2	1 3/16	3 1/4	1 1/8	K,M
50.0	CH70B1-V506-	2 1/2	1 3/16	4	1 1/8	K,M
60.0	_____	3 3/4	1 1/4	3 3/8	2	K,M
75.0	_____	3 3/4	1 1/2	3 1/2	2	K,M
100.0	_____	3 3/4	1 3/4	3 3/4	2	K,M
200 VDCW						
4.0	_____	1 13/16	1 1/16	1 5/8	1 1/16	K,M
6.0	_____	1 13/16	1 1/16	2	1 1/16	K,M
8.0	_____	1 13/16	1 1/16	2 1/2	1 1/16	K,M
10.0	_____	1 13/16	1 1/16	3	1 1/16	K,M
12.0	_____	1 13/16	1 1/16	3 1/4	1 1/16	K,M
15.0	_____	1 13/16	1 1/16	3 3/8	1 1/16	K,M
20.0	_____	2 1/2	1 3/16	3 3/4	1 1/8	K,M
25.0	_____	2 1/2	1 3/16	4 1/8	1 1/8	K,M
30.0	_____	2 1/2	1 3/16	4 3/4	1 1/8	K,M
40.0	_____	3 3/4	1 1/4	4	2	K,M
50.0	_____	3 3/4	1 1/4	4 3/4	2	K,M
60.0	_____	3 3/4	1 3/4	4 3/8	2	K,M
75.0	_____	3 3/4	2 1/4	4 5/8	2	K,M
100.0	_____	3 3/4	2 1/4	5 5/8	2	K,M
400 VDCW						
4.0	_____	1 13/16	1 1/16	2 3/8	1 1/16	K,M
6.0	CH70B1-E605-	1 13/16	1 1/16	3 1/2	1 1/16	K,M
8.0	CH70B1-E805-	1 13/16	1 1/16	4	1 1/16	K,M
10.0	CH70B1-E106	1 13/16	1 1/16	4 1/4	1 1/16	K,M
12.0	_____	2 1/2	1 3/16	3 5/8	1 1/8	K,M
15.0	_____	2 1/2	1 3/16	4	1 1/8	K,M
20.0	CH70B1-E206-	2 1/2	1 1/4	4 3/4	2	K,M
25.0	_____	3 3/4	1 1/4	4 1/4	2	K,M
30.0	_____	3 3/4	1 1/4	4 3/4	2	K,M
600 VDCW						
4.0	_____	1 13/16	1 1/16	2 3/4	1 1/16	K,M
6.0	CH70B1-F605-	1 13/16	1 1/16	3 3/4	1 1/16	K,M
8.0	CH70B1-F805-	2 1/2	1 3/16	3 1/4	1 1/8	K,M
10.0	CH70B1-F106-	2 1/2	1 3/16	4	1 1/8	K,M
12.0	_____	2 1/2	1 3/16	4 3/8	1 1/8	K,M
15.0	CH70B1-F156-	3 3/4	1 1/4	3 5/8	2	K,M
22.0	CH72BINF226-	3 3/4	1 3/4	3 5/8	2	K,M
25.0	_____	3 3/4	2 1/4	3	2	K,M

Contact your local Aerovox Industrial Distributor for Prices.



CAPACITORS

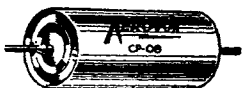

INDUSTRIAL SECTION — MIL TYPES MIL-C-25C



TYPES CPO8 and CPO9—Characteristics K Vibration Grades 1 and 3

Hermetically sealed tubular capacitors with glass terminal seal and axial wire leads. CP04 and CP05 are inserted tab construction; CP08 and CP09 are extended foil construction. Standard tolerance is $\pm 10\%$ (K). Specify Vibration Grade when ordering.

CP08, CHAR. K P323SX NO TUBE

CP09, CHAR. K P323XP PLASTIC TUBE

Capacity	Voltage	Case	Floating	Net Price*	Capacity	Voltage	Case	Floating	Net Price*	Capacity	Voltage	Case	Floating	Net Price*	Capacity	Voltage	Case	Floating	Net Price*
.0082	100V	CP08A1KB822K	-	.75	.0018	600V	CP08A1KF182K	-	.75	.0082	100V	CP09A1KB822K	-	.81	.0018	600V	CP09A1KF182K	-	.81
.01	100V	CP08A1KB103K	-	.75	.0022	600V	CP08A1KF222K	-	.78	.01	100V	CP09A1KB103K	-	.81	.0022	600V	CP09A1KF222K	-	.84
.012	100V	CP08A1KB123K	-	.75	.0027	600V	CP08A1KF272K	-	.78	.012	100V	CP09A1KB123K	-	.81	.0027	600V	CP09A1KF272K	-	.84
.015	100V	CP08A1KB153K	-	.75	.0033	600V	CP08A1KF32K	-	.78	.015	100V	CP09A1KB153K	-	.81	.0033	600V	CP09A1KF32K	-	.84
.039	100V	CP08A1KB393K	-	.84	.0039	600V	CP08A1KF392K	-	.81	.039	100V	CP09A1KB393K	-	.90	.0039	600V	CP09A1KF392K	-	.87
.047	100V	CP08A1KB473K	-	.90	.0047	600V	CP08A1KF472K	-	.81	.047	100V	CP09A1KB473K	-	.96	.0047	600V	CP09A1KF472K	-	.87
.082	100V	CP08A1KB823K	-	.99	.0056	600V	CP08A1KF562K	-	.87	.082	100V	CP09A1KB823K	-	1.05	.0056	600V	CP09A1KF562K	-	.93
.1	100V	CP08A1KB104K	-	1.05	.0068	600V	CP08A1KF682K	-	.87	.1	100V	CP09A1KB104K	-	1.11	.0068	600V	CP09A1KF682K	-	.93
.12	100V	CP08A1KB124K	-	1.08	.0082	600V	CP08A1KF822K	-	.87	.12	100V	CP09A1KB124K	-	1.14	.0082	600V	CP09A1KF822K	-	.93
.15	100V	CP08A1KB154K	-	1.11	.01	600V	CP08A1KF103K	-	.87	.15	100V	CP09A1KB154K	-	1.17	.01	600V	CP09A1KF103K	-	.93
.18	100V	CP08A1KB184K	-	1.20	.012	600V	CP08A1KF123K	-	.93	.18	100V	CP09A1KB184K	-	1.26	.012	600V	CP09A1KF123K	-	.99
.22	100V	CP08A1KB224K	-	1.26	.015	600V	CP08A1KF153K	-	.93	.22	100V	CP09A1KB224K	-	1.32	.015	600V	CP09A1KF153K	-	.99
.27	100V	CP08A1KB274K	-	1.32	.018	600V	CP08A1KF183K	-	.99	.27	100V	CP09A1KB274K	-	1.41	.018	600V	CP09A1KF183K	-	1.05
.33	100V	CP08A1KB334K	-	1.38	.022	600V	CP08A1KF223K	-	.99	.33	100V	CP09A1KB334K	-	1.47	.022	600V	CP09A1KF223K	-	1.05
.39	100V	CP08A1KB394K	-	1.44	.027	600V	CP08A1KF273K	-	1.02	.39	100V	CP09A1KB394K	-	1.53	.027	600V	CP09A1KF273K	-	1.08
.47	100V	CP08A1KB474K	-	1.47	.033	600V	CP08A1KF333K	-	1.08	.47	100V	CP09A1KB474K	-	1.56	.033	600V	CP09A1KF333K	-	1.14
.56	100V	CP08A1KB564K	-	1.56	.039	600V	CP08A1KF393K	-	1.14	.56	100V	CP09A1KB564K	-	1.65	.039	600V	CP09A1KF393K	-	1.20
.68	100V	CP08A1KB684K	-	1.62	.047	600V	CP08A1KF473K	-	1.14	.68	100V	CP09A1KB684K	-	1.71	.047	600V	CP09A1KF473K	-	1.20
.82	100V	CP08A1KB824K	-	1.71	.056	600V	CP08A1KF563K	-	1.20	.82	100V	CP09A1KB824K	-	1.80	.056	600V	CP09A1KF563K	-	1.29
1.0	100V	CP08A1KB105K	-	1.86	.068	600V	CP08A1KF683K	-	1.23	1.0	100V	CP09A1KB105K	-	1.95	.068	600V	CP09A1KF683K	-	1.32
.0039	200V	CP08A1KC392K	-	.72	.082	600V	CP08A1KF823K	-	1.26	.0039	200V	CP09A1KC392K	-	.78	.082	600V	CP09A1KF823K	-	1.35
.0047	200V	CP08A1KC472	-	.72	.1	600V	CP08A1KF104K	-	1.26	.0047	200V	CP09A1KC472K	-	.78	.1	600V	CP09A1KF104K	-	1.35
.0056	200V	CP08A1KC562K	-	.72	.12	600V	CP08A1KF124K	-	1.29	.0056	200V	CP09A1KC562K	-	.78	.12	600V	CP09A1KF124K	-	1.38
.0068	200V	CP08A1KC682K	-	.72	.15	600V	CP08A1KF154K	-	1.29	.0068	200V	CP09A1KC682K	-	.78	.15	600V	CP09A1KF154K	-	1.38
.018	200V	CP08A1KC183K	-	.84	.18	600V	CP08A1KF184K	-	1.47	.018	200V	CP09A1KC183K	-	.90	.18	600V	CP09A1KF184K	-	1.56
.022	200V	CP08A1KC223K	-	.84	.22	600V	CP08A1KF224K	-	1.59	.022	200V	CP09A1KC223K	-	.90	.22	600V	CP09A1KF224K	-	1.68
.027	200V	CP08A1KC273K	-	.87	.27	600V	CP08A1KF274K	-	1.77	.027	200V	CP09A1KC273K	-	.93	.27	600V	CP09A1KF274K	-	1.86
.033	200V	CP08A1KC333K	-	.87	.33	600V	CP08A1KF334K	-	1.89	.033	200V	CP09A1KC333K	-	.93	.33	600V	CP09A1KF334K	-	1.98
.039	200V	CP08A1KC393K	-	.96	.39	600V	CP08A1KF394K	-	1.89	.039	200V	CP09A1KC393K	-	1.02	.39	600V	CP09A1KF394K	-	1.98
.047	200V	CP08A1KC473K	-	.96	.47	600V	CP08A1KF474K	-	1.95	.047	200V	CP09A1KC473K	-	1.02	.47	600V	CP09A1KF474K	-	2.04
.056	200V	CP08A1KC563K	-	1.02	.001	1000V	CP08A1KG102K	-	.93	.056	200V	CP09A1KC563K	-	1.08	.001	1000V	CP09A1KG102K	-	.99
.068	200V	CP08A1KC683K	-	1.08	.0012	1000V	CP08A1KG122K	-	.93	.068	200V	CP09A1KC683K	-	1.14	.0012	1000V	CP09A1KG122K	-	.99
.082	200V	CP08A1KC823K	-	1.17	.0015	100V	CP08A1KG152K	-	.93	.082	200V	CP09A1KC823K	-	1.23	.0015	1000V	CP09A1KG152K	-	.99
.1	200V	CP08A1KC104K	-	1.17	.0018	1000V	CP08A1KG182K	-	.93	.1	200V	CP09A1KC104K	-	1.23	.0018	1000V	CP09A1KG182K	-	.99
.12	200V	CP08A1KC124K	-	1.23	.0022	1000V	CP08A1KG222K	-	.93	.12	200V	CP09A1KC124K	-	1.29	.0022	1000V	CP09A1KG222K	-	.99
.15	200V	CP08A1KC154K	-	1.23	.0027	1000V	CP08A1KG272K	-	.96	.15	200V	CP09A1KC154K	-	1.29	.0027	1000V	CP09A1KG272K	-	1.02
.18	200V	CP08A1KC184K	-	1.29	.0033	1000V	CP08A1KG332K	-	.96	.18	200V	CP09A1KC184K	-	1.38	.0033	1000V	CP09A1KG332K	-	1.02
.22	200V	CP08A1KC224K	-	1.29	.0039	1000V	CP08A1KG392K	-	1.02	.22	200V	CP09A1KC224K	-	1.38	.0039	1000V	CP09A1KG392K	-	1.08
.27	200V	CP08A1KC274K	-	1.35	.0047	1000V	CP08A1KG472K	-	1.02	.27	200V	CP09A1KC274K	-	1.44	.0047	1000V	CP09A1KG472K	-	1.08
.33	200V	CP08A1KC334K	-	1.35	.0056	1000V	CP08A1KG562K	-	1.05	.33	200V	CP09A1KC334K	-	1.44	.0056	1000V	CP09A1KG562K	-	1.11
.39	200V	CP08A1KC394K	-	1.41	.0068	1000V	CP08A1KG682K	-	1.05	.39	200V	CP09A1KC394K	-	1.50	.0068	1000V	CP09A1KG682K	-	1.11
.47	200V	CP08A1KC474K	-	1.41	.0082	1000V	CP08A1KG822K	-	1.05	.47	200V	CP09A1KC474K	-	1.50	.0082	1000V	CP09A1KG822K	-	1.11
.56	200V	CP08A1KC564K	-	1.56	.01	1000V	CP08A1KG103K	-	1.05	.56	200V	CP09A1KC564K	-	1.65	.01	1000V	CP09A1KG103K	-	1.11
.68	200V	CP08A1KC684K	-	1.68	.012	1000V	CP08A1KG123K	-	1.05	.68	200V	CP09A1KC684K	-	1.77	.012	1000V	CP09A1KG123K	-	1.11
.82	200V	CP08A1KC824K	-	1.86	.015	1000V	CP08A1KG153K	-	1.05	.82	200V	CP09A1KC824K	-	1.95	.015	1000V	CP09A1KG153K	-	1.11
1.0	200V	CP08A1KC105K	-	1.92	.018	1000V	CP08A1KG183K	-	1.05	1.0	200V	CP09A1KC105K	-	2.01	.018	1000V	CP09A1KG183K	-	1.11
.0027	400V	CP08A1KE272K	-	.75	.022	1000V	CP08A1KG223K	-	1.05	.0027	400V	CP09A1KE272K	-	.81	.022	1000V	CP09A1KG223K	-	1.11
.0033	400V	CP08A1KE332K	-	.75	.027	1000V	CP08A1KG273K	-	1.11	.0033	400V	CP09A1KE332K	-	.81	.027	1000V	CP09A1KG273K	-	1.20
.012	400V	CP08A1KE123K	-	.81	.033	1000V	CP08A1KG333K	-	1.17	.012	400V	CP09A1KE123K	-	.87	.033	1000V	CP09A1KG333K	-	1.26
.015	400V	CP08A1KE153K	-	.84	.039	1000V	CP08A1KG393K	-	1.23	.015	400V	CP09A1KE153K	-	.90	.039	1000V	CP09A1KG393K	-	1.32
.027	400V	CP08A1KE273K	-	.96	.047	1000V	CP08A1KG473K	-	1.29	.027	400V	CP09A1KE273K	-	1.02	.047	1000V	CP09A1KG473K	-	1.38
.033	400V	CP08A1KE333K	-	1.08	.056	1000V	CP08A1KG563K	-	1.35	.033	400V	CP09A1KE333K	-	1.14	.056	1000V	CP09A1KG563K	-	1.44
.039	400V	CP08A1KE393K	-	1.08	.068	1000V	CP08A1KG683K	-	1.38	.039	400V	CP09A1KE393K	-	1.14	.068	1000V	CP09A1KG683K	-	1.47
.047	400V	CP08A1KE473K	-	1.11	.082	1000V	CP08A1KG823K	-	1.44	.047	400V	CP09A1KE473K	-	1.17	.082	1000V	CP09A1KG823K	-	1.53
.056	400V	CP08A1KE563K	-	1.11	.1	1000V	CP08A1KG104K	-	1.47	.056	400V	CP09A1KE563K	-	1.17	.1	1000V	CP09A1KG104K	-	1.56
.068	400V	CP08A1KE683K	-	1.11	.12	1000V	CP08A1KG124K	-	1.56	.068	400V	CP09A1KE683K	-	1.17	.12				



CAPACITORS

INDUSTRIAL SECTION — MIL TYPES
TYPE CP70 MIL-C-25C
Characteristics E and F • Porcelain and Riveted Terminals

Hyvol M or J oil impregnated and filled, large, rectangular, metal-cased capacitor for heavy-duty, continuous-service applications such as power supplied for transmitters, amplifiers, etc. immersion proof and hermetically sealed. Available with either high-voltage screw-type porcelain-pillar terminals or the space-saving riveted terminal. Pillar terminals have soldering lugs.

Standard tolerance $\pm 10\%$ (K). MIL-C-25C mounting brackets are also available for all units.

Units meet Vibration Grade 1 of MIL-C-25C—Designated by addition of numeral 1 to part number.

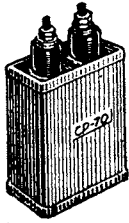

Capacity	Voltage	CHAR. E P09 Porc. Term	Case Size and Bkrt. Desig.	Net Price*	CHAR. F P09 Porc. Term	Case Size and Bkrt. Desig.	Net Price*	CHAR. E P09-R Rivet Term	Case Size and Bkrt. Desig.	Net Price*	CHAR. F P09-R Rivet Term	Case Size and Bkrt. Desig.	Net Price*
1.0	600V	CP70E1EF105K	A2	3.96				CP70B1EF105K	A2	3.60			
2.0	600V	CP70E1EF205K	A4	4.74	CP70E1FF205K	A3	4.89	CP70B1EF205K	A4	4.38	CP70B1FF205K	A3	4.71
4.0	600V	CP70E1EF405K	B4	6.30	CP70E1FF405K	B3	6.45	CP70B1EF405K	B4	5.94	CP70B1FF405K	B3	6.21
6.0	600V	CP70E1EF605K	C2	7.80	CP70E1FF605K	B6	7.05	CP70B1EF605K	C2	7.44	CP70B1FF605K	B6	6.81
8.0	600V	CP70E1EF805K	C3	9.30	CP70E1FF805K	C2	7.50	CP70B1EF805K	C3	8.94	CP70B1FF805K	C2	7.29
10.0	600V	CP70E1EF106K	D3	10.80	CP70E1FF106K	C4	9.00	CP70B1EF106K	D3	10.44	CP70B1FF106K	C4	7.89
.1	1000V	CP70E1EG104K	A1	4.14									
.25	1000V	CP70E1EG254K	A2	4.50									
.5	1000V	CP70E1EG504K	A2	4.68									
1.0	1000V	CP70E1EG105K	A3	5.19	CP70E1FG105K	A2	4.74	CP70B1EG105K	A3	4.83			
2.0	1000V	CP70E1EG205K	A6	6.06	CP70E1FG205K	A5	5.25	CP70B1EG205K	A6	5.70	CP70B1FG205K	A5	5.04
4.0	1000V	CP70E1EG405K	C2	8.10	CP70E1FG405K	B6	6.30	CP70B1EG405K	C2	7.74	CP70B1FG405K	B6	6.06
6.0	1000V	CP70E1EG605K	D3	9.90	CP70E1FG605K	C4	8.70	CP70B1EG605K	D3	9.54	CP70B1FG605K	C4	8.46
8.0	1000V	CP70E1EG805K	D5	11.34				CP70B1EG805K	D5	10.98	CP70B1FG805K	D2	9.96
10.0	1000V	CP70E1EG106K	E5	12.99	CP70E1FG106K	D5	11.40	CP70B1EG106K	E5	12.63	CP70B1FG106K	D5	11.16
12.0	1000V	CP70E1EG126K	E6	14.40				CP70B1EG126K	E6	14.04	CP70B1FG126K	E4	12.51
15.0	1000V	CP70E1EG156K	G2	16.65	CP70E1FG156K	F1	15.75	CP70B1EG156K	G2	16.29	CP70B1FG156K	F1	15.51
.5	1500V	CP70E1EH504K	A3	5.25				CP70B1EH504K	A3	4.89			
1.0	1500V	CP70E1EH105K	A6	6.00	CP70E1FH105K	A5	5.10	CP70B1EH105K	A6	4.70			
2.0	1500V	CP70E1EH205K	E6	7.26	CP70E1FH205K	B5	6.30	CP70B1EH205K	B6	6.90	CP70B1FH205K	B5	6.06
4.0	1500V	CP70E1EH405K	D4	10.20	CP70E1FH405K	C4	9.00	CP70B1EH405K	D4	9.84	CP70B1FH405K	C4	8.31
6.0	1500V	CP70E1EH605K	E5	12.90	CP70E1FH605K	D5	11.70	CP70B1EH605K	E5	12.54	CP70B1FH605K	D5	11.46
8.0	1500V	CP70E1EH805K	F2	15.60	CP70E1FH805K	F1	14.70	CP70B1EH805K	F2	15.24	CP70B1FH805K	F1	14.46
10.0	1500V	CP70E1EH106K	G4	18.00	CP70E1FH106K	G2	16.50	CP70B1EH106K	G4	17.64	CP70B1FH106K	G2	16.26
12.0	1500V	CP70E1EH126K	J3	21.30	CP70E1FH126K	G2	20.70	CP70B1EH126K	J3	20.94	CP70B1FH126K	G2	20.46
15.0	1500V	CP70E1EH156K	J6	25.50	CP70E1FH156K	J3	23.40	CP70B1EH156K	J6	25.14	CP70B1FH156K	J3	23.16
.25	2000V	CP70E1EJ254K	B1	5.22									
.5	2000V	CP70E1EJ504K	B2	5.55									
1.0	2000V	CP70E1EJ105K	B6	6.45	CP70E1FJ105K	B3	5.55						
2.0	2000V	CP70E1EJ205K	C4	7.95	CP70E1FJ205K	C3	6.90						
4.0	2000V	CP70E1EJ405K	E6	11.55	CP70E1FJ405K	E3	9.60						
6.0	2000V				CP70E1FJ605K	G1	12.90						
10.0	2000V				CP70E1FJ106K	J3	19.50						
12.0	2000V				CP70E1FJ126K	J5	22.50						
15.0	2000V				CP70E1FJ156K	J7	26.40						
.1	2500V	CP70E1EK104K	B1	5.10									
.5	2500V	CP70E1EK504K	B4	6.30	CP70E1FK504K	B3	6.00						
1.0	2500V	CP70E1EK105K	D2	7.95	CP70E1FK105K	D1	7.65						
2.0	2500V	CP70E1EK205K	E5	11.10	CP70E1FK205K	D5	10.20						
4.0	2500V	CP70E1EK405K	J2	17.70									
10.0	2500V	CP70E1EK106K	J10	33.00									
.1	3000V	CP70E1EL104K	B2	5.70									
.25	3000V	CP70E1EL254K	B3	6.30									
.5	3000V	CP70E1EL504K	B6	7.35									
1.0	3000V	CP70E1EL105K	E4	9.75	CP70E1FL105K	E3	5.61						
2.0	3000V	CP70E1EL205K	G2	13.95	CP70E1FL205K	G1	12.15						
4.0	3000V	CP70E1EL405K	J7	22.95	CP70E1FL405K	J3	18.00						
1.0	4000V	CP70E1EM104K	E1	13.89									
.25	4000V				CP70E1FM254K	E1	14.40						
.5	4000V				CP70E1FM504K	E3	17.10						
1.0	4000V				CP70E1FM105K	E6	19.74						
2.0	4000V				CP70E1FM205K	J4	25.14						
4.0	4000V	CP70E1EM405K	J11	36.00	CP70E1FM405K	J10	34.20						
.1	5000V	CP70E1EN104K	E1	15.15									
.25	5000V	CP70E1EN254K	E3	16.56									
.5	5000V	CP70E1EN504K	E6	19.29	CP70E1FN504K	E4	17.85						
1.0	5000V				CP70E1FN105K	J2	25.20						
2.0	5000V				CP70E1FN205K	J6	38.70						
.1	6000V	CP70D1EP104K	E3	16.35	CP70D1FP104K	E2	15.30						
.25	6000V	CP70D1EP254K	E5	19.14	CP70D1FP254K	E4	18.15						
.5	6000V	CP70D1EP504K	J3	22.20									
1.0	6000V	CP70D1EP105K	J11	41.16	CP70D1FP105K	J9	38.70						
.1	7500V				CP70D1FR104K	E3	18.15						
.25	7500V				CP70D1FR254K	J1	22.05						
.5	7500V				CP70D1FR504K	J4	29.10						

A1	1 1/4 x 1 1/4 x 1 1/2	E2	3/4 x 2 1/4 x 3 3/8
A2	1 1/4 x 1 1/4 x 2 1/4	E3	3/4 x 2 1/4 x 3 3/8
A3	1 1/4 x 1 1/4 x 2 7/8	E4	3/4 x 2 1/4 x 4 1/2
A4	1 1/4 x 1 1/4 x 3 1/4	E5	3/4 x 2 1/4 x 4 3/4
A5	1 1/4 x 1 1/4 x 3 7/8	E6	3/4 x 2 1/4 x 5 1/4
A6	1 1/4 x 1 1/4 x 4 3/4	F1	3/4 x 2 1/2 x 4 3/4
B1	2 1/2 x 1 1/4 x 2 1/2	F2	3/4 x 2 1/2 x 5 3/4
B2	2 1/2 x 1 1/4 x 2 7/8	G1	3/4 x 3 1/4 x 4 1/2
B3	2 1/2 x 1 1/4 x 3 1/8	G2	3/4 x 3 1/4 x 4 3/4
B4	2 1/2 x 1 1/4 x 3 3/8	G4	3/4 x 3 1/4 x 5 1/2
B5	2 1/2 x 1 1/4 x 4 1/4	J1	4 1/8 x 3 3/4 x 3 7/8
B6	2 1/2 x 1 1/4 x 4 3/4	J2	4 1/8 x 3 3/4 x 4 3/8
C2	3 3/4 x 1 1/4 x 3 7/8	J3	4 1/8 x 3 3/4 x 4 3/8
C3	3 3/4 x 1 1/4 x 4 1/4	J4	4 1/8 x 3 3/4 x 5 3/8
C4	3 3/4 x 1 1/4 x 4 3/4	J5	4 1/8 x 3 3/4 x 5 1/2
D1	3 3/4 x 1 3/4 x 3 3/4	J6	4 1/8 x 3 3/4 x 6
D2	3 3/4 x 1 3/4 x 3 7/8	J7	4 1/8 x 3 3/4 x 6 1/2
D3	3 3/4 x 1 3/4 x 4	J9	4 1/8 x 3 3/4 x 7 1/2
D4	3 3/4 x 1 3/4 x 4 1/4	J10	4 1/8 x 3 3/4 x 8 1/2
D5	3 3/4 x 1 3/4 x 4 3/4	J11	4 1/8 x 3 3/4 x 9 1/2
E1	3 3/4 x 2 1/4 x 2 3/4		

If MIL brackets are required with units, specify CP07S (spade) or CP07F (footed) and add the bracket designation listed beside the unit.

Example: CP70E1EF504K with CP07S2 brackets.

*Request O.E.M. Prices in the following quantities: 10-24, 25-49, 50-99



Cylindrical, hermetically sealed can with screwbase molded cover for vertical mounting. Operating temperature range -55 $+85^{\circ}\text{C}$. Solder lug, nonremovable terminals MIL designation B). Supplied with mounting nut and lockwasher. Standard tolerance $\pm 10\%$ (K).

Units meet Vibration Grade 1 of MIL-C-25C Designated by addition of numeral 1 to part number.

TYPE CP41 — Characteristics E and F

Capacity	Voltage	Char. E P10M	Net Price*	Char. F P10M	Net Price*
2.0	600V	CP41B1EF205K	5.51	CP41B1FF205K	5.51
4.0	600V	CP41B1EF405K	7.46	CP41B1FF405K	7.46
1.0	1000V	CP41B1EG105K	5.51	CP41B1FG105K	5.51
2.0	1000V	CP41B1EG205K	6.59	CP41B1FG205K	6.59
.5	1500V			CP41B1FH504K	6.26
1.0	1500V			CP41B1FH105K	7.07

*Request O.E.M. Prices in the following quantities: 25-49, 50-99



CAPACITORS

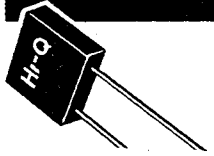

AEROVOX CK05 - CK06 EXTENDED RANGE CERAMIC CAPACITORS Per MIL-C-11015

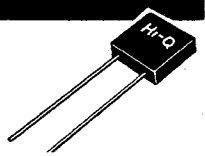

STYLE CK05 CHARACTERISTICS

STYLE CK06 CHARACTERISTICS

Capacitance pf	Type designation*	Rated voltage volts, dc	Aerovox Commercial Equivalent*	Capacitance tolerance	Capacitance pf	Type designation*	Rated voltage volts, dc	Aerovox Commercial Equivalent*	Capacitance tolerance
10	CK05BX100-	200		K, M					
12	CK05BX120K	200		K					
15	CK05BX150-	200		K, M	1,200	CK06BX122K	200		K
18	CK05BX180K	200		K	1,500	CK06BX152-	200		K, M
22	CK05BX220-	200		K, M	1,800	CK06BX182K	200		K
27	CK05BX270K	200		K	2,200	CK06BX222-	200		K, M
33	CK05BX330-	200		K, M	2,700	CK06BX272K	200		K
39	CK05BX390K	200		K	3,300	CK06BX332-	200		K, M
47	CK05BX470-	200		K, M	3,900	CK06BX392K	200		K
56	CK05BX560K	200		K	4,700	CK06BX472-	200		K, M
68	CK05BX680-	200		K, M	5,600	CK06BX562K	200		K
82	CK05BX820K	200		K	6,800	CK06BX682-	200		K, M
100	CK05BX101-	200		K, M	8,200	CK06BX822K	200		K
120	CK05BX121K	200		K	10,000	CK106BX103-	200		K, M
150	CK05BX151-	200		K, M	12,000	CK06BX123K	100		K
180	CK05BX181K	200		K	15,000	CK06BX153-	100	MC61C153R	K, M
220	CK05BX221-	200		K, M	18,000	CK06BX183K	100		K
270	CK05BX271K	200		K	22,000	CK06BX223-	100	MC61C223R	K, M
330	CK05BX331-	200		K, M	27,000	CK06BX273K	100		K
390	CK05BX391K	200		K	33,000	CK06BX333-	100	MC61C333R-	K, M
470	CK05BX471-	200		K, M	39,000	CK06BX393K	100		K
560	CK05BX561K	200		K	47,000	CK06BX473-	100	MC61C473R-	K, M
680	CK05BX681-	200		K, M	56,000	CK06BX563K	100		K
820	CK05BX821K	200		K	68,000	CK06BX683-	100	MC61C683R-	K, M
1,000	CK05BX102-	200		K, M	82,000	CK06BX823K	100		K
1,200	CK05BX122K	100		K	100,000	CK06BX104-	100	MC61C104R	K, M
1,500	CK05BX152-	100	MC51C152R-	K, M	120,000	CK06BX124K	50		K
1,800	CK05BX182K	100		K	150,000	CK06BX154-	50		K, M
2,200	CK05BX222-	100	MC51C222R-	K, M	180,000	CK06BX184K	50		K
2,700	CK05BX272K	100		K	220,000	CK06BX224-	50		K, M
3,300	CK05BX332-	100	MC51C332R-	K, M	270,000	CK06BX274K	50		K
3,900	CK05BX392K	100		K	330,000	CK06BX334-	50		K, M
4,700	CK05BX472-	100	MC51C472R	K, M	390,000	CK06BX394K	50		K
5,600	CK05BX562K	100		K	470,000	CK06BX474-	50		K, M
6,800	CK05BX682-	100	MC51C682R-	K, M	560,000	CK06BX564K	50		K
8,200	CK05BX822K	100		K	680,000	CK06BX684-	50		K, M
10,000	CK05BX103-	100	MC51C103R-	K, M	820,000	CK06BX824K	50		K
12,000	CK05BX123K	50		K	1,000,000	CK06BX105-	50		K, M
15,000	CK05BX153-	50		K, M					
18,000	CK05BX183K	50		K					
22,000	CK05BX223-	50		K, M					
27,000	CK05BX273K	50		K					
33,000	CK05BX333-	50	MC505C333R-	K, M					
39,000	CK05BX393K	50		K					
47,000	CK05BX473-	50		K, M					
56,000	CK05BX563K	50		K					
68,000	CK05BX683-	50		K, M					
82,000	CK05BX823K	50		K					
100,000	CK05BX104-	50		K, M					

* Where applicable, the complete type designation will include an additional symbol to indicate capacitance tolerance.

The following is a list of commercial units not contained in the MIL listing. As present stocks of these units are depleted they will be replaced by a MIL unit having the same capacity but a higher voltage.

COMMERCIAL STOCK LISTING MC505-605 - 50 VDCW

Cap. uf	Part No. ±10%	Part No. ±20%	Cap. uf	Part No. ±10%	Part No. ±20%
.00047	MC505A471RK	MC505A471RM	.0068	MC605B682RK	MC605B682RM
.00068	MC605A681RK	MC605A681RM	.01	MC605B103RK	MC605B103RM
.001	MC605A102RK	MC605A102RM	.015	MC605B153RK	MC605B153RM
.0015	MC605A152RK	MC605A152RM	.022	MC605B223RK	MC605B223RM
.0022	MC605A222RK	MC605A222RM	.047	MC605C473RK	MC605C473RM
.0033	MC505B332RK	MC505B332RM	.068	MC605C683RK	MC605C683RM
.0047	MC505B472RK	MC505B472RM	.1	MC605C104RK	MC605C104RM

COMMERCIAL STOCK LISTING MC502-602 - 25 VDCW

Cap. uf	Part No. ±10%	Cap. uf	Part No. ±10%	Cap. uf	Part No. ±20%
.001	MC502A102RK	.015	MC602A153RK	.15	MC502C154RM
.0015	MC502A152RK	.022	MC502B223RK	.22	MC502C224RM
.0022	MC502A222RK	.033	MC502B333RK	.33	MC502C334RM
.0033	MC502A332RK	.047	MC502B473RK	.47	MC602C474RM
.0047	MC502A472RK	.068	MC602B683RK	.68	MC602C684RM
.0068	MC502A682RK	.1	MC602B104RK	1.0	MC602C105RM
.01	MC602A103RK				

Contact your local Aerovox Industrial Distributor for Prices.



CAPACITORS

HIGH RELIABILITY CERAMICS (Cont.)

MIL TYPE CKR12 - 100 VOLTS

Cap. pf	± 10%		± 20%	
	MIL Type Designation	MIL Part Number	MIL Type Designation	MIL Part Number
330	CKR12BX331KR	MIL-C-39014/05-0321	CKR12BX331M	MIL-C-39014/05-0322
390	CKR12BX391KR	MIL-C-39014/05-0323		
470	CKR12BX471KR	MIL-C-39014/05-0324	CKR12BX471MR	MIL-C-39014/05-0325
560	CKR12BX561KR	MIL-C-39014/05-0326		
680	CKR12BX681KR	MIL-C-39014/05-0327	CKR12BX681MR	MIL-C-39014/05-0328
720	CKR12BX721KR	MIL-C-39014/05-0329		
820	CKR12BX821KR	MIL-C-39014/05-0330	CKR12BX821MR	MIL-C-39014/05-0331
1000	CKR12BX102KR	MIL-C-39014/05-0332	CKR12BX102MR	MIL-C-39014/05-0333
1200	CKR12BX122KR	MIL-C-39014/05-0334		
1500	CKR12BX152KR	MIL-C-39014/05-0335	CKR12BX152MR	MIL-C-39014/05-0336
1800	CKR12BX182KR	MIL-C-39014/05-0337		
2200	CKR12BX222KR	MIL-C-39014/05-0338	CKR12BX222MR	MIL-C-39014/05-0339
3300	CKR12BX332KR	MIL-C-39014/05-0340	VKR12BX332MR	MIL-C-39014/05-0341
4700	CKR12BX472KR	MIL-C-39014/05-0342	CKR12BX472MR	MIL-C-39014/05-0343
6800	CKR12BX682KR	MIL-C-39014/05-0344	CKR12BX682MR	MIL-C-39014/05-0345
10000	CKR12BX103KR	MIL-C-39014/05-0346	CKR12BX103MR	MIL-C-39014/05-0347

MIL TYPE CKR13 - 100 VOLTS

15000	CKR13BX153KR	MIL-C-39015/06-0003	CKR13BX153MR	MIL-C-39014/06-0007
22000	CKR13BX223KR	MIL-C-39014/06-0011	CKR13BX223MR	MIL-C-39014/06-0015
33000	CKR13BX333KR	MIL-C-39014/06-0019	CKR13BX333MR	MIL-C-39014/06-0023
47000	CKR13BX473KR	MIL-C-39014/06-0027	CKR13BX473MR	MIL-C-39014/06-0031
68000	CKR13BX683KR	MIL-C-39014/06-0035	CKR13BX683MR	MIL-C-39014/06-0039
82000	CKR13BX823KR	MIL-C-39014/06-0043	CKR13BX823MR	MIL-C-39014/06-0047
100000	CKR13BX104KR	MIL-C-39014/06-0051	CKR13BX104MR	MIL-C-39014/06-0055

Contact your local Aerovox Industrial Distributor for Prices.

MILITARY CERAMIC DISCS

CK60 TO CK67

PER MIL-C-11015

CONTACT FACTORY FOR PRICES



Cap. pf.	VDCW	Tol.	Mil. Number	Cap. pf.	VDCW	Tol.	Mil Number
2.2	1000	10%	CK60BX2R2K	2200	500	20%	CK61AW222M
3.3	1000	10%	CK60BX3R3K	22	1500	20%	CK62AY220M
4.7	1000	10%	CK60BX4R7K	47	1500	20%	CK62AY470M
6.8	1000	10%	CK60BX6R8K	100	1500	20%	CK62AY101M
10	1000	10%	CK60BX100K	220	1500	20%	CK62AY221M
15	1000	10%	CK60BX150K	470	1500	20%	CK62AY471M
22	1000	10%	CK60BX220K	820	500	10%	CK62BX821K
33	1000	10%	CK60BX330K	1000	500	10%	CK62BX102K
33	1000	20%	CK60BX330M	1000	500	20%	CK62BX102M
47	1000	10%	CK60BX470K	1500	500	10%	CK62BX152K
47	1000	20%	CK60BX470M	1500	500	20%	CK62BX152M
68	1000	10%	CK60BX680K	2200	500	10%	CK62AX222K
68	1000	20%	CK60BX680M	2200	500	20%	CK62AX222M
100	1000	10%	CK60BX101K	3300	500	20%	CK62AW332M
100	1000	20%	CK60BX101M	4700	500	20%	CK62AW472M
150	500	10%	CK60BX151K	6800	500	20%	CK62AW682M
150	500	20%	CK60BX151M	2200	500	10%	CK63BX222K
220	1000	10%	CK60AX221K	2200	500	20%	CK63BX222M
220	1000	20%	CK60AX221M	3300	500	20%	CK63BX332M
330	500	10%	CK60AX331K	4700	1000	20%	CK63AW472M
330	500	20%	CK60AX331M	10000	1000	20%	CK63AY103X
470	500	10%	CK60AX471K	10000	500	20%	CK63AW103M
470	500	20%	CK60AX471M	510	1600	20%	CK64AW511M
470	1000	20%	CK60AW471M	680	1600	20%	CK64AW681M
680	1000	20%	CK60AW681M	820	1600	20%	CK64AW821M
1000	1000	20%	CK60AW102M	1000	1600	20%	CK64AW102M
1500	500	20%	CK60AW152M	1500	1600	20%	CK64AE152M
220	500	10%	CK61BX221K	2200	1600	20%	CK64AW222M
220	500	20%	CK61BX221M	3300	500	10%	CK65BX332K
330	500	10%	CK61BX331K	3300	1600	20%	CK64AW332M
330	500	20%	CK61BX331M	3900	1600	20%	CK64AW392M
470	500	10%	CK61BX471K	4700	1600	20%	CK65AW472M
470	500	20%	CK61BX471M	5600	1600	20%	CK66AW562M
680	500	10%	CK61BX681K	6800	1600	20%	CK67AW682M
680	500	20%	CK61BX681M	7500	1600	20%	CK67AW752M

MILITARY GENERAL PURPOSE CERAMIC TUBULARS

CK21, CK22, CK26, CK27

MIL-C-11015

CK21 - 26

CK22 - 27

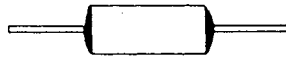

Cap. mmf.	±10%	** Price	±20%	* Price	±10%	* Price	±20%	* Price
12	CK21AX120K	.22			CK22AX120K	.17		
15	CK21AX150K	.22			CK22AX150K	.17		
18	CK21AX180K	.22			CK22AX180K	.17		
22	CK21AX220K	.22			CK22AX220K	.17		
27	CK21AX270K	.22			CK22AX270K	.17		
33	CK21AX330K	.22			CK22AX330K	.17		
39	CK21AX390K	.22			CK22AX390K	.17		
47	CK21AX470K	.22			CK22AX470K	.17		
56	CK21AX560K	.22			CK22AX560K	.17		
68	CK21AX680K	.22	CK21AX680M	.21	CK22AX680K	.17	CK22AX680M	.16
82	CK21AX820K	.22			CK22AX820K	.17		
100	CK21AX101K	.22	CK21AX101M	.21	CK22AX101K	.17	CK22AX101M	.16
120	CK21AX121K	.22			CK22AX121K	.17		
150	CK21AX151K	.28	CK21AX151M	.26	CK22AX151K	.23	CK22AX151M	.21
180	CK21AX181K	.28	CK21AX221M	.26	CK22AX181K	.23		
200	CK21AX221K	.28			CK22AX221K	.23	CK22AX221M	.21
270	CK21AX271K	.28			CK22AX271K	.23		
330	CK21AX331K	.28	CK21AX331M	.26	CK22AX331K	.23	CK22AX331M	.21
390					CK22AX391K	.23		
470	CK21AX471K	.28	CK21AX471M	.26	CK22AX471K	.23	CK22AX471M	.21
560					CK22AX561K	.23		
680	CK21AX681K	.28	CK21AX681M	.26	CK22AX681K	.23	CK22AX681M	.21
820	CK26AX821M	.30	CK26AX821M	.28	CK27AX821K	.25		
1000	CK26AX102K	.30	CK26AX102M	.28	CK27AX102K	.25	CK27AX102M	.23
1200					CK27AX122K	.25		
1500	CK26AX152K	.30	CK26AX152M	.28	CK27AX152K	.25	CK27AX152M	.23

Request O.E.M. Prices in the following quantities: 25-99, 100-249, 250-499, 500-999.



CAPACITORS

INDUSTRIAL CERAMIC CAPACITORS (cont.)

SUBMINIATURE THIN PLATE CAPACITORS TYPES TPNPO, TP25 & TP89



Subminiature rectangular ceramic capacitors with a difference. Slim design allows close assembly, small size-maximum circuit density. Ideal for transistorized circuit and micro-module applications.

- Close temperature coefficients
- Operation to 125°C
- Closer standard tolerances
- Radial or axial lead
- Gold plate Dumet leads

For complete technical data request bulletin NPJ-122.

TYPICAL PROPERTIES

	TYPE TPNPO	TYPE TP25	TYPE TP89
Voltage, VDCW (at 85°C, Derated 50% (at 125°C))	50	50	50
Power Factor, Maximum @ 1 KC.	.1%	.6%	2%
Temperature Coefficient with 0 Voltage, —55°C to +125°C.	0±30PPM/°C	+5%, —8%	+10%, —30%
Temperature Coefficient with rated Voltage applied, —55°C to +125°C.	0±30PPM/°C	+5%, —10%	+10%, —40%
Capacity Tolerance	±5%*	±10%	±20%

*To 6.8 mmf. ± .5 mmf.

TYPICAL CAPACITY RANGE—MMF

MAXIMUM SIZE (L x W x t)	TYPE TPNPO	TYPE TP25	TYPE TP89
.100 x .100 x .060"	5 - 20	25 - 140	360 - 1300
.150 x .150 x .060"	21 - 50	141 - 350	1301 - 3300
.200 x .200 x .060"	51 - 100	351 - 700	3301 - 6600
.250 x .250 x .060"	101 - 160	701 - 1200	6601 - 10500
.300 x .300 x .060"	161 - 220	1201 - 1500	10501 - 14500
.350 x .350 x .060"	221 - 305	1501 - 2100	14501 - 20000

Spacing between radial leads is .100" on the .100" and .150" case sizes; .200" on all other case sizes.

STOCK VALUES†

Capacitance In MMFD.	CAT. NO. TPNPO	*Net Price	CAT. NO. TP25	*Net Price	CAT. NO. TP89	*Net Price
4.7	TPNPO-4R7*D	.68				
6.8	TPNPO-6R8*D	.68				
10.0	TPNPO-100*J	.68				
15.0	TPNPO-150*J	.68				
22.0	TPNPO-220*J	.68				
33.0	TPNPO-330*J	.68	TP25-330*K	.60		
47.0	TPNPO-470*J	.68	TP25-470*K	.60		
68.0	TPNPO-680*J	.68	TP25-680*K	.60		
100	TPNPO-101*J	.68	TP25-101*K	.60		
150	TPNPO-151*J	.82	TP25-151*K	.60		
220	TPNPO-221*J	.82	TP25-221*K	.60		
330			TP25-331*K	.60		
470			TP25-471*K	.60	TP89-471*M	.48
680			TP25-681*K	.60	TP89-681*M	.48
1000			TP25-102*K	.72	TP89-102*M	.48
1500			TP25-152*K	.72	TP89-152*M	.48
2200			TP25-222*K	1.45	TP89-222*M	.48
3300					TP89-332*M	.48
4700					TP89-472*M	.48
6800					TP89-682*M	.58
10,000					TP89-103*M	.58
15,000					TP89-153*M	1.16
20,000					TP89-203*M	1.16

*Insert "A" for axial leads or "R" for radial leads

†Intermediate values and closer tolerances available on special order

*Request O.E.M. Prices in the following quantities: 50-99, 100-499

ML-10 MICROMINIATURE MOLDED TUBULAR CERAMAM® CAPACITORS

The ML-10 style is a microminiature monolithic ceramic capacitor molded into an environment resistant epoxy jacket. This unit, of proven reliable Hi-Q CeramAM® construction, will meet the environmental requirements of MIL-C-11015 and MIL-C-39014.

Ideal for automatic insertion in printed board circuitry.

Same size as previous listing .160 x .090, the axial lead designation (A in the part number) contained in the previous listing is no longer used and part number of 100vw units has been changed from ML110 to ML11. These units meet size of CK12BX per MIL-C-11015.

Cap. pf.	Part Number 100VW	Part Number 50 VW	Part Number 25 VW	Cap. pf.	Par Number 50 VW	Part Number 25 VW
10	ML11A100M			820		ML102A821M
15	ML11A150M			1000		ML102A102M
22	ML11A220M			1500	ML105B152M	
33	ML11A330M			2200	ML105B222M	
47	ML11A470M			3300	ML105B332M	
56	ML11A560M			4700		ML102B472M
68	ML11A680M			5600		ML102B562M
82	ML11A820M			6800		ML102B682M
100	ML11A101M			8200	ML105C822M	
150		ML105A151M		10000	ML105C103M	
220		ML105A221M		15000	ML105C153M	
330		ML105A331M		22000	ML105C223M	
470		ML105A471M		33000		ML102C333M
560			ML102A561M	47000		ML102C473M
680			ML102A681M			

Contact your local Aerovox Industrial Distributor for Prices.



CAPACITORS

INDUSTRIAL CERAMIC CAPACITORS

Type TTP Transistor Disks

These square miniature disks are ideally suited for all applications where size is a factor such as transistorized radios and industrial applications having critical space requirements.

Units are rated at 100 VDCW $\pm 20\%$ standard tolerance.



Capacity	Length & Width	Thickness	Net Price**
.005	.280	.125	.24
.01	.340	.125	.24
.02	.430	.125	.30
.025	.465	.125	.30
.03	.465	.125	.30
.05	.535	.125	.36
.1	.700	.125	.54

**Request O.E.M. Prices in the following quantities:
50-99, 100-249, 250-499, 500-999.

NEW GENERAL PURPOSE BYPASS AND COUPLING DISKS - TYPE GPD

NOW . . . a consolidated and comprehensive line of ceramic disk capacitors for all bypass, coupling and filtering applications. All units offer maximum protection against humidity, voltage breakdown and vibration.

Rated at 1000 VDCW unless otherwise specified.

All units marked for capacity and tolerance.

This new and consolidated line replaces Types ID1, BPD-GMV and DI line listed in previous catalogs.

New Cat. No.	Cap. uf	Tolerance	Volts	T. C.	Size Dia.	Old Cat. No.
GPD COJ2R2K	2.2	10%	1000	NPO	.310	D1-3.3mf
GPD COJ3R3K	3.3	10%	1000	NPO	.310	D1-3.3mf
GPD COH4R7K	4.7	10%	1000	NPO	.310	D1-5.0mf
GPD COH6R8K	6.8	10%	1000	NPO	.310	D1-6.8mf
GPD COH8R2K	8.2	10%	1000	NPO	.310	D1-8.2mf
GPD COH100K	10.0	10%	1000	NPO	.310	D1-10mf
GPD U2J102K	12.0	10%	1000	N750	.310	D1-12mf
GPD U2J150K	15.0	10%	1000	N750	.310	D1-15mf
GPD U2J180K	18.0	10%	1000	N750	.310	D1-18mf
GPD U2J200K	20.0	10%	1000	N750	.310	D1-20mf
GPD U2J220K	22.0	10%	1000	N750	.310	D1-22mf
GPD U2J250K	25.0	10%	1000	N750	.310	D1-25mf
GPD U2J270K	27.0	10%	1000	N750	.310	D1-27mf
GPD P3K300K	30	10%	1000	N1500	.310	D1-30mf
GPD P3K330K	33	10%	1000	N1500	.310	D1-33mf
GPD P3K390K	39	10%	1000	N1500	.310	D1-39mf
GPD X5F470K	47	10%	1000	X5F	.310	D1-47mf
GPD X5F500K	50	10%	1000	X5F	.310	D1-50mf
GPD X5F560K	56	10%	1000	X5F	.310	D1-56
GPD X5F680K	68	10%	1000	X5F	.310	D1-68
GPD X5F820K	82	10%	1000	X5F	.310	D1-82
GPD X5F910K	91	10%	1000	X5F	.310	-
GPD X5F101K	100	10%	1000	X5F	.310	D1-100
GPD X5F121K	120	10%	1000	X5F	.310	D1-120
GPD X5F151K	150	10%	1000	X5F	.310	D1-150
GPD X5F181K	180	10%	1000	X5F	.310	D1-180
GPD X5F201K	200	10%	1000	X5F	.310	D1-200
GPD X5F221K	220	10%	1000	X5F	.310	D1-220
GPD X5F251K	250	10%	1000	X5F	.310	D1-250

New Cat. No.	Cap pf	Tolerance	Volts	T. C.	Size Dia.	Old Cat. No.
GPD X5F271K	270	10%	1000	X5F	.310	D1-270
GPD X5F301K	300	10%	1000	X5F	.310	D1-300
GPD X5F331K	330	10%	1000	X5F	.310	D1-330
GPD X5F391K	390	10%	1000	X5F	.310	D1-390
GPD X5F471	470	10%	1000	X5F	.310	D1-470
GPD X5U471P5	470	$\pm 100 -0$	500V	X5U	.310	1D1-CK60Y471Z
GPD X5F501K	500	$\pm 10\%$	1000	X5F	.310	D1-500
GPD X5F561K	560	$\pm 10\%$	1000	X5F	.385	D1-560
GPD X5F681K	680	$\pm 10\%$	1000	X5F	.385	D1-680
GPD X5U681P5	680	$\pm 100 -0$	500	X5U	.310	1D1-CK60Y681Z
GPD X5F751K	750	± 10	1000	X5F	.385	D1-750
GPD X5F821K	820	± 10	1000	X5F	.385	D1-820
GPD X5U821P5	820	$\pm 100 -0$	500	X5U	.310	1D1-CK60Y821Z
GPD X5F911K	910	± 10	1000	X5F	.385	-
GPD X5F102K	1000	± 10	1000	X5F	.385	D1-1000
GPD Z5U102P	1000	$\pm 100 -0$	1000	Z5U	.310	BPD-001
GPD X5U102P5	1000	$\pm 100 -0$	500	X5U	.385	1D1-CK61Y102Z
GPD X5F122K	1200	± 10	1000	X5F	.437	D1-1200
GPD X5F152K	1500	+	1000	X5F	.437	D1-1500
GPD X5U152P5	1500	$\pm 100 -0$	500	X5U	.385	1D1-CK61Y152Z
GPD X5F182K	1800	± 10	1000	X5F	.590	D1-1800
GPD X5F202K	2000	± 10	1000	X5F	.590	D1-2000
GPD X5F222K	2200	± 10	1000	X5F	.590	D1-2200
GPD X5U222P5	2200	$\pm 100 -0$	500	X5U	.590	1D1-CK62Y222Z
GPD X5F252K	2500	± 10	1000	X5F	.590	D1-2500
GPD X5F272	2700	± 10	1000	X5F	.590	D1-2700
GPD X5R302	3000	± 10	1000	X5R	.590	D1-3000
GPD X5R332K	3300	± 10	1000	X5R	.690	D1-3300
GPD X5U332P5	3300	$\pm 100 -0$	500	X5U	.590	1D1-CK62Y332Z
GPD X5R392K	3900	± 10	1000	X5R	.690	-
GPD X5R402K	4000	± 10	1000	X5R	.690	D1-4000
GPD X5R472K	4700	± 10	1000	X5R	.690	D1-4700
GPD X5U472P5	4700	$\pm 100 -0$	500	X5U	.590	1D1-CK62Y472Z
GPD X5R502K	5000	± 10	1000	X5R	.690	D1-5000
GPD Z5U502P	5000	$\pm 100 -0$	1000	Z5U	.590	BPD-5000
GPD X5R562K	5600	± 10	1000	X5R	.760	D1-5600
GPD X5R682K	6800	± 10	1000	X5R	.760	D1-6800
GPD X5R752K	7500	± 10	1000	X5R	.760	D1-7500
GPD X5R822K	8200	± 10	1000	X5R	.906	D1-8200
GPD X5R912K	9100	± 10	1000	X5R	.906	-
GPD X5S103K	10000	± 10	1000	X5S	.906	D1-10000
GPD Z5U103P	10000	$\pm 100 -10$	1000	Z5U	.760	BPD-.01
GPD X5U103P5	10000	$\pm 100 -0$	500	X5U	.690	1D1-CK63Y103Z
GPD Z5U153P	15000	$\pm 100 -0$	1000	Z5U	.906	BPD-015
GPD Z5U203P	20000	$\pm 100 -0$	1000	Z5U	.906	BPD-.02
GPD Z5V303P	30000	$\pm 100 -0$	1000	Z5V	.760	BPD-.03
GPD Z5V503P	50000	$\pm 100 -0$	1000	Z5V	.906	BPD-.05
GPD Z5V2X102P	2X.001	$\pm 100 -0$	1000	Z5V	.437	BPD2X.001
GPD Z5V2X152P	2X.0051	$\pm 100 -0$	1000	Z5V	.590	BPD2X.0015
GPD Z5V2X202P	2X.002	$\pm 100 -0$	1000	Z5V	.590	BPD2X.002
GPD Z5V2X222P	2X.0022	$\pm 100 -0$	1000	Z5V	.590	BPD2X.0022
GPD Z5V2X302P	2X.003	$\pm 100 -0$	1000	Z5V	.690	BPD2X.003
GPD Z5V2X402P	2X.004	$\pm 100 -0$	1000	Z5V	.760	BPD2X.004
GPD Z5V2X472P	2X.0047	$\pm 100 -0$	1000	Z5V	.760	BPD2X.0047
GPD Z5V2X103P	2X.01	$\pm 100 -0$	1000	Z5V	.760	BPD2X.01
GPD Z5V2X203P	2X.02	$\pm 100 -0$	1000	Z5V	.906	BPD2X.02
GPD Z5V3X152P	3X.0015	$\pm 100 -0$	1000	Z5V	.760	BPD3X.0015
GPD Z5V3X202P	3X.002	$\pm 100 -0$	1000	Z5V	.760	BPD3X.002

Contact your local Aerovox Industrial Distributor for Prices.



CAPACITORS

INDUSTRIAL CERAMIC CAPACITORS (cont.)

Temperature Compensating Tubulars

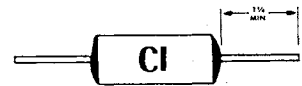
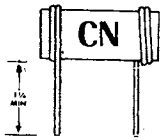

Popular values in accordance with the latest revisions of specification MIL-C-20 and EIA specification RS-198. Uninsulated units are furnished color coded, packaged in bulk. Insulated units—stamped with part number. Voltage rating 500 VDCW.

UNINSULATED TYPE CN			INSULATED TYPE CI			UNINSULATED TYPE CN			INSULATED TYPE CI		
Cap.	MIL No.	Net Price*	MIL No.	Net Price*	Cap.	MIL No.	Net Price*	MIL No.	Net Price*		
NPO						N750					
.3	CC20CK0R3C		CC21CK0R3C		.5	CC20UK0R5C					
.5	CC20CK0R5C		CC21CK0R5C		.75	CC20UKR75C		CC21UKR75C			
.68	CC20CKR68C		CC21CKR68C		1.0	CC20UK010C		CC21UK010C			
.75	CC20CKR75C		CC21CKR75C		1.5	CC20UK1R5C		CC21UK1R5C			
1.0	CC20CK010C		CC21CK010C		2.0	CC20UK020C		CC21UK020C			
1.2	CC20CK1R2C		CC21CK1R2C		5.0	CC20UJ050C		CC21UJ050C			
1.5	CC20CK1R5C		CC21CK1R5C		10.0	CC20UJ100C		CC21UJ100C			
2.0	CC20CK020C	Contact	CC21CK020C	Contact	12.0	CC20UJ120G	Contact	CC20UJ120G	Contact		
2.2	CC20CK2R2C		CC21CK2R2C		15.0	CC20UJ150G		CC21UJ150G			
3.0	CC20CJ030C	Your	CC21CJ030C	Your	18.0	CC20UJ180G	Your	CC21UJ180G	Your		
4.0	CC20CH040C		CC21CH040C	Your	20.0	CC20UJ200G	Your	CC21UJ200G	Your		
5.0	CC20CH050C		CC21CH050C		22.0	CC20UJ220G		CC21UJ220G			
6.0	CC20CH060C	Local	CC21CH060C	Local	24.0	CC20UJ240G	Local	CC21UJ240G	Local		
6.2	CC20CH6R2C		CC21CH6R2C		27.0	CC20UJ270G		CC21UJ270G			
7.0	CC20CH070C		CC21CH070C		30.0	CC20UJ300G		CC21UJ300G			
8.0	CC20CH080C	Aerovox	CC21CH080C	Aerovox	33.0	CC20UJ330G	Aerovox	CC21UJ330G	Aerovox		
9.0	CC20CH090C		CC21CH090C		36.0	CC20UJ360J		CC21UJ360J			
10.0	CC20CH100C		CC21CH100C		39.0	CC20UJ390J		CC21UJ390J			
12.0	CC20CH120G	Industrial	CC21CH120G	Industrial	43.0	CC20UJ430J	Industrial	CC21UJ430J	Industrial		
15.0	CC20CH150G		CC21CH150G		47.0	CC20UJ470J		CC21UJ470J			
18.0	CC20CH180G		CC21CH180G		51.0	CC20UJ510J		CC21UJ510J			
20.0	CC20CH200G	Distributor	CC21CH200G	Distributor	56.0	CC20UJ560J	Distributor	CC21UJ560J	Distributor		
22.0	CC20CH220G		CC21CH220G		62.0	CC20UJ620J		CC21UJ620J			
24	CC25CH240G	for	CC26CH240G	for	68.0	CC25UJ680J	for	CC26UJ680J	for		
27	CC25CH270G		CC26CH270G		75.0	CC25UJ750J		CC26UJ750J			
30	CC25CH300G		CC26CH300G		82.0	CC25UJ820J		CC26UJ820J			
33	CC25CH330G	Prices	CC26CH330G	Prices	91.0	CC25UJ910J	Prices	CC26UJ910J	Prices		
36	CC25CH360J		CC26CH360J		100.0	CC25UJ101G		CC26UJ101J			
39	CC25CH390J		CC26CH390J		110	CC25UJ111G		CC26UJ111J			
43	CC25CH430J		CC36CH430J		120	CC25UJ121G		CC26UJ121J			
47	CC25CH470J		CC36CH470J		130	CC25UJ131G		CC36UJ131J			
51	CC25CH510J		CC36CH510J		150	CC25UJ151G		CC36UJ151J			
56	CC32CG560J		CC36CG560J		160	CC32UJ161G		CC36UJ161J			
62	CC32CG620J		CC36CG620J		180	CC32UJ181G		CC36UJ181J			
68	CC32CG680J		CC36CG680J		200	CC32UJ201G		CC36UJ201J			
75	CC32CG750J		CC36CG750J		220	CC32UJ221G		CC36UJ221J			
82	CC32CG820J		CC36CG820J		240	CC32UJ241G		CC36UJ241J			
91	CC32CG910J		CC36CG910J		270	CC35UJ271F		CC36UJ271J			
100	CC32CG101G		CC36CG101J		300	CC35UJ301F		CC36UJ301J			
110	CC32CG111G		CC36CG111J		330	CC35UJ331F		CC36UJ331F			
120	CC35CG121G		CC36CG121J		360	CC35UJ361F		CC36UJ361J			
130	CC35CG131G		CC36CG131J								
150	CC35CG151G		CC36CG151J								

Type Designation	Max. Size	TOLERANCE	
		Letter Descrip.	Tolerance
CC20	.200 x .400	C	± .25 mmf.
CC21	.200 x .562		
CC25	.250 x .655		
CC26	.250 x .812	F	± 1%
CC32	.250 x .860		
CC35	.255 x 1.090	G	± 2%
CC36	.340 x 1.328		

*Request O.E.M. Prices in the following quantities: 1-49, 50-99, 100-249, 250-499, 500-999



CAPACITORS

RECEIVING MICA CAPACITORS — (Continued)

DIPPED SILVERED MICA CAPACITORS - TYPES ADM-10, ADM-15, ADM-19, ADM-20 AND ADM-30

Aerovox plastic-coated dipped-mica units exceed many of the advantages of molded mica units, and at the same time are smaller than conventional units. Meeting all the applicable MIL-C-5B Test Standards for molded mica capacitors, these unique dipped-mica units offer the following features:

- High operating temperatures —55° to +125°C • Excellent long-life characteristics • Improved temperature coefficient range • Radial leads for automatic insertion and plug-in assemblies • Ideal for printed-wiring assemblies • Unsurpassed performance and stability characteristics • Smaller physical size.

Humidity Resistance: these capacitors shall have an insulation resistance of not less than 2,000 megohms after being subjected to the Humidity Resistance Test as outlined in MIL-C-5B. Minimum Insulation Resistance: 25,000 megohms at 25°C; 1000 megohms at 125°C.

Capacitors will be marked with capacity and tolerance.

For full technical information request Bulletin NPJ-104.

Cap. pf	Type Designation	Type Designation
5		ADM-15-050
10	ADM-10-100	ADM-15-100
12	ADM-10-120	ADM-15-120
15	ADM-10-150	ADM-15-150
18	ADM-10-180	ADM-15-180
20	ADM-10-200	ADM-15-200
22	ADM-10-220	ADM-15-220
24	ADM-10-240	ADM-15-240
25	ADM-10-250	
27	ADM-10-270	ADM-15-270
30	ADM-10-300	ADM-15-300
33	ADM-10-330	ADM-15-330
36	ADM-10-360	ADM-15-360
39	ADM-10-390	ADM-15-390
43	ADM-10-430	ADM-15-430
47	ADM-10-470	ADM-15-470
50	ADM-10-500	ADM-15-500
51	ADM-10-510	ADM-15-510
56	ADM-10-560	ADM-15-560
62	ADM-10-620	ADM-15-620
68	ADM-10-680	ADM-15-680
75	ADM-10-750	ADM-15-750
82	ADM-10-820	ADM-15-820
91	ADM-10-910	ADM-15-910
100	ADM-10-101	ADM-15-101
110	ADM-10-111	ADM-15-111
120	ADM-10-121	ADM-15-121
130	ADM-10-131	ADM-15-131
150	ADM-10-151	ADM-15-151
160	ADM-10-161	ADM-15-161
180	ADM-10-181	ADM-15-181
200	ADM-10-201	ADM-15-201
220	ADM-10-221	ADM-15-221
240	ADM-10-241	ADM-15-241
250	ADM-10-251	ADM-15-251
270		ADM-15-271
300		ADM-15-301
330		ADM-15-331
360		ADM-15-361
390		ADM-15-391
430		ADM-15-431
470		ADM-15-471
500		ADM-15-501
510		ADM-15-511
560		ADM-15-561
620		ADM-15-621
680		ADM-15-681
750		ADM-15-751
820		ADM-15-821
910		ADM-15-911
1000		ADM-15-102
1100		ADM-15-112
1200		ADM-15-122
1300		ADM-15-132
1500		ADM-15-152
1600		ADM-15-162
1800		ADM-15-182
2000		ADM-15-202
2200		ADM-15-222
2400		ADM-15-242
2500		ADM-15-252
2700		ADM-15-272
3000		ADM-15-302
3300		
3600		
3900		
4300		
4700		
5000		
5100		
5600		
6200		
6800		
7500		
8200		
9100		
10000		
12000		
13000		
15000		

* To be discontinued when present stocks are depleted.

Contact your local Aerovox Industrial Distributor for Prices.

TRANSMITTING MICA CAPACITORS TYPES 1445, 1446 and 1447

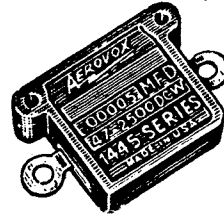

Designed with insulated mounting holes 1/8" apart independent of soldering lugs. Used to shunt meter windings. Size: 1 1/2" x 1 3/4" x 1/2". Standard Tolerance ±10% ±5% and ±2% tolerance are available on special order. Meter Mounting Bracket E available. Specify when ordering. These units are equivalent to case styles CM45 and CM50 of specification MIL-C5B.

TYPE 1445 600 VDCW 1000 VDCt		TYPE 1446 1200 VDCW 2500 VDCt		TYPE 1447 2500 VDCW 5000 VDCt	
Cap. Mfd.	Net* Price	Cap. Mfd.	Net* Price	Cap. Mfd.	Net* Price
.00005	.40	.00005	.48	.00005	.60
.0001	.40	.0001	.48	.000075	.60
.00015	.40	.00015	.48	.0001	.60
.0002	.40	.0002	.48	.00015	.60
.00025	.40	.00025	.48	.0002	.60
.0003	.40	.0003	.48	.00025	.60
.00035	.40	.00035	.48	.0003	.60
.0004	.40	.0004	.48	.00035	.60
.0005	.40	.0005	.48	.0004	.60
.001	.40	.001	.48	.0005	.66
.0015	.46	.0015	.58	.001	.90
.002	.48	.002	.66	.0015	1.14
.0025	.52	.0025	.72	.002*	1.42
.003	.54	.003	.82	.0025*	1.66
.004	.60	.004*	.96	.003*	1.90
.005	.66	.005*	1.14	.004*	2.40
.006	.76	.006*	1.30	.005*	2.88
.008	.84	.008*	1.62		
.01	1.00	.01*	2.40		
.015*	1.30	.015*	2.74		
.02*	1.62				
.025*	1.92				
.03*	2.26				
.04*	2.88				

*Request O.E.M. Prices in the following quantities: 100-499

*Thickness 7/16"

TYPES 1991 thru 1996 Porcelain-Cased Capacitors

Ideal for high-frequency application. Glazed porcelain case, high temperature wax sealed. Heavy duty power terminals. Minimum power loss due to dielectric absorption. No heating at full load.

Size: 4" overall by 3" high; 2 1/2" between mounting holes.

Standard Tolerance ±10%

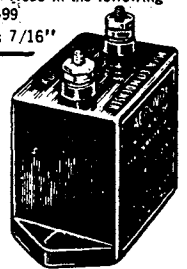

Cap. Mfd.	DC Voltage Rating	Type	Maximum Current Capacity — Amperes				Net Price
			15 mc	7.5 mc	3750 kc	1875 kc	
.00005	12,500	1996	3	2.5	1.5	1	8.75
.0001	12,500	1996	5	4	3	2	8.75
.00025	12,500	1996	7	8	6	4	8.75
.0005	12,500	1996	8	9	8	7	8.75
	7,000	1994	7	8	6	4	7.00
.001	12,500	1996	9	10	11	12	10.50
	7,000	1994	8	9	10	8	7.88
	3,500	1992	8	9	8	5	7.88
.0015	12,500	1996	9	10	11	12	12.25
	7,000	1994	9	9	10	8	8.75
	5,000	1993	8	9	9	7	7.88
	3,500	1992	8	9	8	5	7.88
.002	2,000	1991	7	8	8	5	7.00
	12,500	1996	9	12	13	15	14.00
	10,000	1995	9	10	11	12	12.25
	7,000	1994	9	9	10	10	9.63
	5,000	1993	8	9	9	8	8.75
	3,500	1992	8	8	9	7	7.88
.003	2,000	1991	7	8	8	6	7.00
	12,500	1996	9	12	13	15	17.50
	10,000	1995	9	11	12	13	15.75
	7,000	1994	9	10	10	10	10.50
	5,000	1993	8	9	9	9	9.63
	3,500	1992	8	9	9	8	8.75
.005	2,000	1991	7	8	8	7	7.88
	10,000	1995	10	13	14	15	17.50
	7,000	1994	9	11	12	11	15.75
	5,000	1993	9	11	12	10	10.50
	3,500	1992	9	10	11	9	9.63
.01	2,000	1991	8	9	10	8	8.75
	7,000	1994	10	13	15	15	21.00
	5,000	1993	10	13	15	15	15.75
	3,500	1992	10	13	14	14	14.00
	2,000	1991	10	13	14	14	10.50
.02	3,500	1992	10	14	16	17	15.75
	2,000	1991	10	13	15	15	12.25
.05	3,500	1992	10	14	17	18	17.50
	2,000	1991	10	14	16	17	14.00
.1	2,000	1991	10	14	17	18	17.50

ELMENCO

CAPACITORS

DIMENSIONAL DATA

Maximum Dimensions

The following is a tabulation of maximum dimensions of the various DM case sizes. They have been specified to anticipate variations in coat thickness and minor protrusions on the surface. As a result, average dimensions of a given lot may be appreciably smaller than those listed.

It is to be noted that the leads are not centered in the thickness dimension as can be seen on the end view dimensional drawing. Construction of Elmenco Dur-Mica capacitors provides for leads to project from one surface of the mica stack, causing them in turn to extend from one edge of the capacitor. Regardless of case size and overall thickness, leads will always be within $\frac{1}{16}$ to $\frac{1}{32}$ from one of the capacitor surfaces. (Exclude SCDM).

Not all dimensions of every capacitance value are listed below. It has been found that size varies almost linearly with capacitance value. As a result, dimensions of values between those specified below should be determined by interpolation.

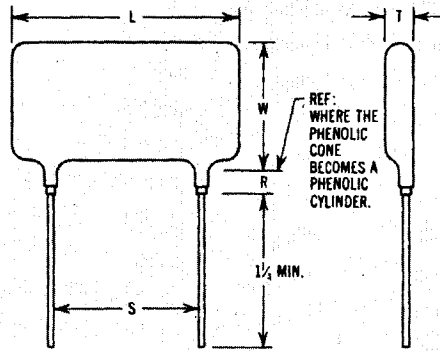

	DM-10	DM-15	DM-16	DM-19	DM-20	DM-30	DM-42	DM-43
R MAX.	$\frac{1}{8}$	$\frac{1}{8}$	$\frac{1}{8}$	$\frac{1}{4}$	$\frac{1}{4}$	$\frac{1}{4}$	$\frac{1}{4}$	$\frac{1}{4}$
S $\pm \frac{1}{32}$	$\frac{1}{4}$	$\frac{1}{4}$	$\frac{1}{2}$	$\frac{1}{2}$	$\frac{3}{8}$	$\frac{3}{8}$	$1\frac{1}{8}$	$1\frac{1}{8}$
LEAD WIRE GAGE	#26	#22	#22	#20	#20	#18	#18	#18

Dur-Mica leads may be either tinned brass or tinned copper-clad steel, 30% minimum conductivity, except the following which are copper-clad steel only:

DM-10, DM-42, and DM-43.

DM-19 and DM-20 — 3000 mmf. and above.

DM-30 — 10,000 mmf. and above.

Crimped Leads

In addition to the straight lead design, DM capacitors are also available with crimped leads for printed circuit application. The crimp provides a positive stop when capacitors are mounted. This prevents interference of resin coat on the leads with dip-solder operation, provides greater mounting uniformity, and elevates the components slightly above the surface of the board. The crimp lead design is not a regularly stocked item, but it is available to special order at a small fixed handling charge.

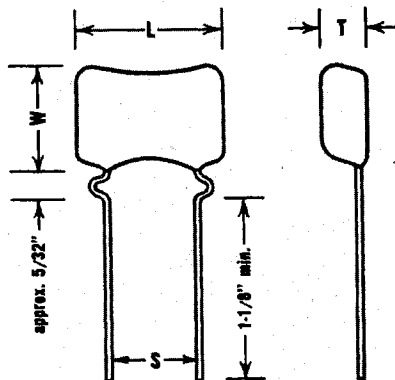

Lead wire gage for crimped lead units is the same as for straight lead capacitors with the exception of DM-15 and DM-16. Crimped lead gage of DM-15 and DM-16 is #20. The DM-10 case size is not available with crimped leads.

CASE SIZE	Cap. mmf.	Volt. VDCW	L max.	W max.	T max.
DM-10	10	500	.360	.330	.190
	50	500	.370	.340	.190
	100	500	.370	.350	.200
	150	500	.380	.360	.210
	250	500	.390	.380	.220
	300	300	.390	.380	.220
	390	100	.390	.380	.220
DM-15 (CM05)	10	500	.450	.360	.170
	100	500	.460	.360	.180
	200	500	.460	.380	.190
	300	500	.470	.390	.210
	500	500	.490	.420	.240
	560	300	.470	.390	.210
	680	300	.470	.390	.210
DM-16	820	300	.470	.400	.230
	1000	100	.490	.420	.240
	430	500	.730	.390	.210
	600	500	.740	.400	.220
DM-19 (CM06)	720	500	.740	.410	.230
	720	300	.730	.380	.200
	900	300	.740	.390	.220
DM-20	1300	300	.740	.390	.230
	100	500	.640	.500	.190
	500	500	.650	.510	.200
	1000	500	.650	.520	.220
	2000	500	.670	.530	.240
	3000	500	.680	.550	.280
	5000	500	.710	.590	.360
DM-30 (CM07)	6200	300	.690	.570	.330
	8200	100	.700	.580	.350
	680	500	.750	.510	.200
	1000	500	.750	.510	.200
	2000	500	.760	.520	.220
	3900	500	.780	.560	.300
	5600	500	.790	.570	.340
DM-42 (CM08)	6800	300	.790	.560	.320
	7500	100	.780	.560	.300
	10000	100	.790	.570	.340
	4300	500	.780	.860	.270
	6800	500	.780	.870	.300
	10000	500	.800	.890	.340
	15000	500	.810	.900	.390
DM-43	20000	500	.830	.920	.450
	20000	300	.810	.890	.370
	25000	300	.820	.910	.420
	30000	300	.830	.920	.460
	36000	100	.830	.920	.450
	20000	500	1.420	.870	.300
	30000	500	1.440	.890	.350
DM-43	50000	500	1.480	.920	.460
	62000	300	1.470	.920	.450
	82000	100	1.480	.920	.460
DM-43	50000	500	2.060	.900	.380
	68000	500	2.070	.910	.440
	75000	300	2.060	.900	.380
	100000	300	2.070	.910	.440
DM-43	130000	100	2.090	.930	.490

ELMENCO

CAPACITORS

DUR-MICA

TYPE DM-10 (CM04) 500VDCW

(SCDM10 values and prices the same)

CAP. MMF.	PART NUMBER	MIL-C-5 TYPE DESIGNATION (See Note on p. 13)	Net Price (1-24) Tolerance			
			±10% "K"	±5% "J"	±2% "G"	±1% "F"
1	DM-10-010	CM-04-CD-101D03	\$0.19			
2	DM-10-020		.19			
3	DM-10-030		.19			
5	DM-10-050	CM-04-CD-050D03	.19			
10	DM-10-100	CM-04-CD-100F03	.22	\$0.31		
12	DM-10-120	CM-04-CD-120F03	.22	.31		
15	DM-10-150	CM-04-CD-150F03	.22	.31		
18	DM-10-180	CM-04-CD-180F03	.22	.31		
20	DM-10-200	CM-04-ED-200F03	.22	.24		
22	DM-10-220	CM-04-ED-220F03	.22	.24		
24	DM-10-240	CM-04-ED-240F03	.22	.24		
27	DM-10-270	CM-04-ED-270F03	.22	.24	\$0.42	
30	DM-10-300	CM-04-ED-300F03	.22	.24	.42	
33	DM-10-330	CM-04-ED-330F03	.22	.24	.42	
36	DM-10-360	CM-04-ED-360F03	.22	.24	.44	
39	DM-10-390	CM-04-ED-390F03	.22	.24	.44	
43	DM-10-430	CM-04-ED-430F03	.22	.24	.44	
47	DM-10-470	CM-04-ED-470F03	.25	.27	.47	
50	DM-10-500		.25	.27	.45	\$0.69
51	DM-10-510	CM-04-ED-510F03	.25	.27	.45	.69
56	DM-10-560	CM-04-ED-560F03	.25	.27	.45	.69
62	DM-10-620	CM-04-ED-620F03	.25	.27	.45	.69
68	DM-10-680	CM-04-ED-680F03	.25	.27	.45	.72
75	DM-10-750	CM-04-ED-750F03	.25	.27	.45	.72
82	DM-10-820	CM-04-ED-820F03	.25	.27	.45	.72
91	DM-10-910	CM-04-FD-910F03	.25	.27	.46	.75
100	DM-10-101	CM-04-FD-101F03	.25	.27	.46	.63
110	DM-10-111	CM-04-FD-111F03	.25	.27	.46	.63
120	DM-10-121	CM-04-FD-121F03	.28	.31	.52	.63
130	DM-10-131	CM-04-FD-131F03	.28	.31	.52	.63
150	DM-10-151	CM-04-FD-151F03	.31	.34	.58	.69
160	DM-10-161	CM-04-FD-161F03	.34	.38	.64	.78
180	DM-10-181	CM-04-FD-181F03	.38	.42	.69	.84
200	DM-10-201	CM-04-FD-201F03	.38	.42	.69	.84
220	DM-10-221	CM-04-FD-221F03	.41	.46	.76	.90
240	DM-10-241	CM-04-FD-241F03	.44	.48	.80	.96
250	DM-10-251		.44	.48	.80	.96
270*	DM-10-271	CM-04-FC-271F03	.42	.46	.78	.92
300*	DM-10-301	CM-04-FC-301F03	.45	.50	.85	1.00
330**	DM-10-331	CM-04-FA-331F03	.45	.50	.85	1.00
360**	DM-10-361	CM-04-FA-361F03	.48	.53	.90	1.06
390**	DM-10-391	CM-04-FA-391F03	.51	.56	.95	1.12

TYPE DM-15 (CM05)

(SCDM15 values and prices the same)

CAP. MMF.	PART NUMBER	MIL-C-5 TYPE DESIGNATION (See Note on p. 13)	Net Price (1-24) Tolerance			
			±10% "K"	±5% "J"	±2% "G"	±1% "F"
1	DM-15-010†	CM-05-CD-010D03	\$0.21			
2	DM-15-020†		.21			
3	DM-15-030†		.21			
5	DM-15-050†	CM-05-CD-050D03	.21			
6	DM-15-060	CM-05-CD-060F03	.21			
7	DM-15-070	CM-05-CD-070F03	.21			
8	DM-15-080	CM-05-CD-080F03	.21			
10	DM-15-100	CM-05-CD-100F03	.16	\$0.21		
12	DM-15-120	CM-05-CD-120F03	.16	.21		
15	DM-15-150	CM-05-CD-150F03	.16	.21		
18	DM-15-180	CM-05-CD-180F03	.16	.21		
20	DM-15-200	CM-05-ED-200F03	.16	.18		
22	DM-15-220	CM-05-ED-220F03	.16	.18		
24	DM-15-240	CM-05-ED-240F03	.16	.18		
27	DM-15-270	CM-05-ED-270F03	.16	.18	\$0.25	
30	DM-15-300	CM-05-ED-300F03	.16	.18	.25	
33	DM-15-330	CM-05-ED-330F03	.16	.18	.25	
36	DM-15-360	CM-05-ED-360F03	.16	.18	.25	
39	DM-15-390	CM-05-ED-390F03	.16	.18	.25	
43	DM-15-430	CM-05-ED-430F03	.16	.18	.25	
47	DM-15-470	CM-05-ED-470F03	.16	.18	.25	
50	DM-15-500		.16	.18	.21	\$0.35
51	DM-15-510	CM-05-ED-510F03	.16	.18	.21	.35
56	DM-15-560	CM-05-ED-560F03	.16	.18	.21	.35
62	DM-15-620	CM-05-ED-620F03	.16	.18	.21	.35
68	DM-15-680	CM-05-ED-680F03	.16	.18	.21	.35
75	DM-15-750	CM-05-ED-750F03	.16	.18	.21	.35
82	DM-15-820	CM-05-ED-820F03	.16	.18	.21	.36
91	DM-15-910	CM-05-FD-910F03	.16	.18	.21	.36
100	DM-15-101	CM-05-FD-101F03	.16	.18	.21	.36

DM-15 (Continued)

CAP. MMF.	PART NUMBER	MIL-C-5 TYPE DESIGNATION (See Note on p. 13)	Net Price (1-24) Tolerance			
			±10% "K"	±5% "J"	±2% "G"	±1% "F"
110	DM-15-111	CM-05-FD-111F03	\$0.19	\$0.21	\$0.25	\$0.31
120	DM-15-121	CM-05-FD-121F03	.19	.21	.25	.31
130	DM-15-131	CM-05-FD-131F03	.19	.21	.25	.31
150	DM-15-151	CM-05-FD-151F03	.19	.21	.25	.31
160	DM-15-161	CM-05-FD-161F03	.22	.24	.29	.35
180	DM-15-181	CM-05-FD-181F03	.23	.25	.30	.36
200	DM-15-201	CM-05-FD-201F03	.23	.25	.30	.36
220	DM-15-221	CM-05-FD-221F03	.25	.27	.33	.40
240	DM-15-241	CM-05-FD-241F03	.26	.28	.34	.41
250	DM-15-251		.26	.28	.34	.41
270	DM-15-271	CM-05-FD-271F03	.28	.31	.37	.44
300	DM-15-301	CM-05-FD-301F03	.28	.31	.37	.44
330	DM-15-331	CM-05-FD-331F03	.31	.34	.41	.49
360	DM-15-361	CM-05-FD-361F03	.33	.36	.43	.52
390	DM-15-391	CM-05-FD-391F03	.34	.38	.46	.55
430	DM-15-431		.36	.40	.48	.57
470	DM-15-471		.38	.42	.50	.60
500	DM-15-501		.38	.42	.52	.63
510	DM-15-511		.40	.44	.54	.65
560*	DM-15-561		.40	.44	.54	.65
620*	DM-15-621		.44	.48	.58	.69
680*	DM-15-681		.47	.52	.62	.75
750*	DM-15-751		.50	.55	.66	.80
820*	DM-15-821		.54	.60	.72	.86
910**	DM-15-911		.57	.63	.75	.89
1000**	DM-15-102		.60	.66	.78	.96
1100**	DM-15-112		.69	.76	.90	1.10
1200**	DM-15-122		.78	.86	1.01	1.28

TYPE DM-19 (CM-06) 500VDCW

CAP. MMF.	PART NUMBER	MIL-C-5 TYPE DESIGNATION (See Note on p. 13)	Net Price (1-24) Tolerance			
			±10% "K"	±5% "J"	±2% "G"	±1% "F"
100	DM-19-101		\$0.18	\$0.20	\$0.22	\$0.26
110	DM-19-111		.18	.20	.22	.26
120	DM-19-121		.18	.20	.22	.26
130	DM-19-131		.20	.22	.24	.28
150	DM-19-151		.20	.22	.24	.28
160	DM-19-161		.20	.22	.24	.28
180	DM-19-181		.20	.22	.24	.28
200	DM-19-201		.20	.22	.24	.28
220	DM-19-221		.20	.22	.24	.28
240	DM-19-241		.22	.24	.26	.32
250	DM-19-251		.22	.24	.26	.32
270	DM-19-271		.25	.27	.30	.37
300	DM-19-301		.25	.27	.30	.37
330	DM-19-331		.25	.27	.30	.37
360	DM-19-361		.28	.31	.34	.43
390	DM-19-391		.28	.31	.34	.43
430	DM-19-431	CM-06-FD-431F03	.28	.31	.34	.43
470	DM-19-471	CM-06-FD-471F03	.31	.34	.37	.46
500	DM-19-501		.31	.34	.37	.46
510	DM-19-511	CM-06-FD-511F03	.31	.34	.37	.46
560	DM-19-561	CM-06-FD-561F03	.31	.34	.37	.46
620	DM-19-621	CM-06-FD-621F03	.34	.37	.41	.51
680	DM-19-681	CM-06-FD-681F03	.34	.37	.41	.51
750	DM-19-751	CM-06-FD-751F03	.37	.41	.44	.55
820	DM-19-821	CM-06-FD-821F03	.40	.44	.48	.60
910	DM-19-911	CM-06-FD-911F03	.40	.44	.48	.60
1000	DM-19-102	CM-06-FD-102F03	.43	.47	.52	.64
1100	DM-19-112	CM-06-FD-112F03	.45	.50	.54	.67
1200	DM-19-122	CM-06-FD-122F03	.48	.53	.58	.72
1300	DM-19-132	CM-06-FD-132F03	.51	.56	.61	.76
1500	DM-19-152	CM-06-FD-152F03	.54	.59	.65	.81
1600	DM-19-162	CM-06-FD-162F03	.57	.63	.69	.86
1800	DM-19-182	CM-06-FD-182F03	.63	.69	.76	.94
2000	DM-19-202	CM-06-FD-202F03	.69	.76	.83	1.03
2200	DM-19-222	CM-06-FD-222F03	.75	.82	.90	1.12
2400	DM-19-242	CM-06-FD-242F03	.81	.89	.97	1.21
2500	DM-19-252		.84	.92	1.10	1.26
2700	DM-19-272	CM-06-FD-272F03	.87	.96	1.04	1.30
3000	DM-19-302	CM-06-FD-302F03	.93	1.02	1.12	1.40
3300	DM-19-332	CM-06-FD-332F03	1.00	1.10	1.20	1.50
3600	DM-19-362	CM-06-FD-362F03	1.06	1.17	1.27	1.59
3900	DM-19-392	CM-06-FD-392F03	1.12	1.23	1.34	1.68
4300	DM-19-432	CM-06-FD-432F03	1.21	1.33	1.45	1.81
4700	DM-19-472	CM-06-FD-472F03	1.31	1.44	1.57	1.96
5000	DM-19-502		1.40	1.54	1.68	2.10
5100	DM-19-512		1.43	1.57	1.72	2.15
5600*	DM-19-562		1.40	1.54	1.68	2.10
6200*	DM-19-622		1.52	1.67	1.82	2.28
6800**	DM-19-682		1.40	1.54	1.68	2.10
7500**	DM-19-752		1.51	1.66	1.81	2.26
8200**	DM-19-822		1.62	1.78	1.94	2.43

NET (For quantities of 25 or more, please contact your local Arco-Elmenco distributor)
Sold Nationally to Electronic Parts Distributors by; Loral Distributor Products, a Division of Loral Corporation

ELMENCO
CAPACITORS**THIN-COAT DUR-MICA**

SPACE-SAVER

TYPE SCDM THIN COAT DIPPED MICA CAPACITORS

(ELMENCO TYPE 1CR)

In applications requiring the high performance characteristics of dipped mica capacitors where space is at a premium, the Type SCDM reduced coat ELMENCO capacitors may often be used to advantage. A single protective resin coat is applied instead of the full series of dips incorporated in the standard unit. The amount of coat material is thereby reduced to a minimum consistent with good design, and a significant reduction of all dimensions is achieved.

All electrical and environmental requirements of MIL-C-5 are retained with the exception of case insulation (3.5.3) and moisture resistance (3.14). A maximum voltage stress of 100VDC through the case insulation is recommended for SCDM units. Although some lots of this type capacitor will not meet stringent MIL moisture resistance specifications, all will meet the humidity requirements of Paragraph 2.3.6 of EIA Standard RS-153. Therefore, the SCDM capacitors will operate with satisfaction where they will not be exposed to extensive periods of high humidity. It is recommended that if these capacitors are destined for operation under extreme environmental conditions, they should be given additional moisture protection such as encapsulation or hermetic sealing of the assembly.

TYPES SCDM10, SCDM15, and SCDM19 capacitors are stocked in depth at ARCO regional facilities in all values. They may be obtained within 24 hours from your local ARCO distributor. See standard DM tabulations on preceding pages for values and pricing.

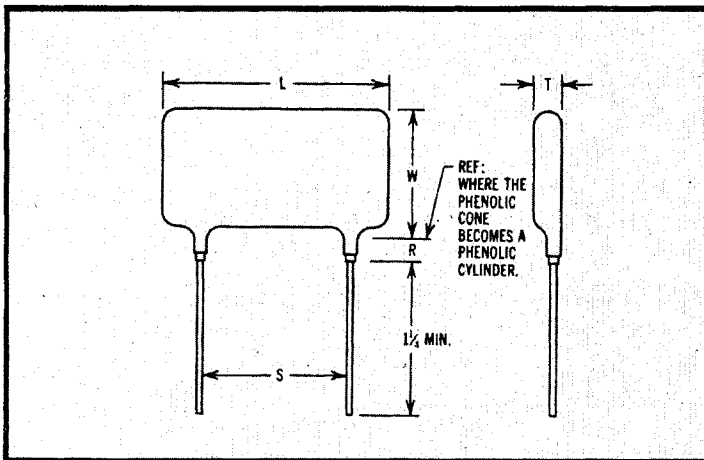

Representative dimensions of the SCDM style capacitors. The dimensions of intermediate values may be closely approximated by interpolation.

	SCDM10	SCDM15	SCDM19
R MAX.	1/8	1/8	9/64
S ± 1/32	9/64	15/64	11/32
LEAD WIRE GAGE	#26	#22	#20

Case Size	Cap. pf.	Volt. VDCW	L max.	W max.	T max.
SCDM10	10	500	.310	.230	.120
	100	500	.320	.230	.130
	180	500	.330	.240	.150
	250	500	.340	.250	.160
	300	300	.340	.250	.160
	390	100	.340	.250	.160
SCDM15	10	500	.430	.280	.140
	100	500	.430	.280	.150
	270	500	.440	.300	.160
	510	500	.450	.310	.190
	560	300	.450	.310	.160
	820	300	.450	.310	.170
SCDM19	1000	100	.450	.320	.170
	100	500	.610	.450	.130
	1000	500	.620	.460	.160
	3000	500	.630	.470	.230
	5100	500	.660	.500	.320
	5600	300	.640	.480	.250
6800	300	.640	.490	.270	
8200	100	.650	.490	.300	

SCDM capacitors in the larger sizes are available to special order.

ELMENCO

CAPACITORS

Molded Silvered Mica

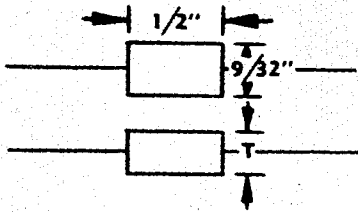

T—from 1-300 mmf. 3/16"
T—from 310-510 mmf. 7/32"

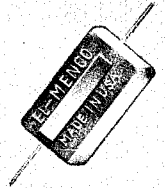
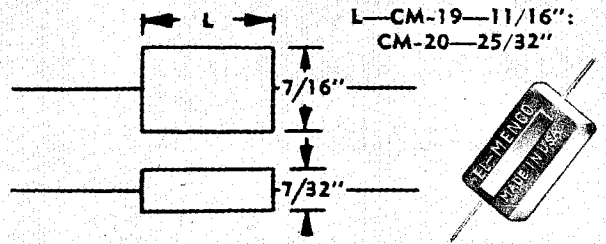
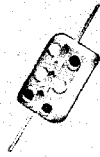

TYPE CM-15

500VDCW

CAP. MMF.	TYPE DESIGNATION	Net Price (1-24) Tolerance		
		"J" ±5%	"G" ±2%	"F" ±1%
1	CM-15-C-010†	\$0.21		
2	CM-15-C-020†	.21		
3	CM-15-C-030†	.21		
5	CM-15-C-050†	.21		
10	CM-15-C-100	.21		
12	CM-15-C-120	.21		
15	CM-15-C-150	.21		
18	CM-15-C-180	.21		
20	CM-15-C-200	.19		
22	CM-15-C-220	.19		
24	CM-15-E-240	.19		
27	CM-15-E-270	.19	\$0.26	
30	CM-15-E-300	.19	.26	
33	CM-15-E-330	.19	.26	
36	CM-15-E-360	.19	.26	
39	CM-15-E-390	.19	.26	
43	CM-15-E-430	.19	.26	
47	CM-15-E-470	.19	.26	
50	CM-15-E-500	.19	.26	\$0.35
51	CM-15-E-510	.19	.26	.35
56	CM-15-E-560	.19	.26	.35
62	CM-15-E-620	.19	.26	.35
68	CM-15-E-680	.19	.26	.35
75	CM-15-E-750	.19	.26	.35
82	CM-15-E-820	.19	.26	.36
91	CM-15-E-910	.19	.26	.36
100	CM-15-E-101	.19	.26	.31
110	CM-15-E-111	.22	.26	.31
120	CM-15-E-121	.22	.26	.31
130	CM-15-E-131	.22	.26	.31
150	CM-15-E-151	.22	.26	.31
160	CM-15-E-161	.25	.30	.35
180	CM-15-E-181	.25	.30	.36
200	CM-15-E-201	.25	.30	.36
220	CM-15-E-221	.28	.34	.41
240	CM-15-E-241	.28	.34	.41
250	CM-15-E-251	.28	.34	.41
270	CM-15-E-271	.32	.38	.45
300	CM-15-E-301	.32	.38	.45
330	CM-15-E-331	.35	.42	.50
360	CM-15-E-361	.38	.46	.55
390	CM-15-E-391	.41	.49	.59
430	CM-15-E-431	.41	.49	.59
470	CM-15-E-471	.44	.54	.65
500	CM-15-E-501	.44	.54	.65
510	CM-15-E-511	.44	.54	.65
560**	CM-15-E-561	.44	.54	.65
620**	CM-15-E-621	.48	.58	.69
680**	CM-15-E-681	.51	.61	.73
750**	CM-15-E-751	.54	.64	.77
820**	CM-15-E-821	.57	.68	.82

† Capacities marked with † denote that closest tolerance is ±0.5 mmf.

* Voltage rating 300 VDCW.

** Voltage rating 100 VDCW.

SPECIFICATIONS NOTES:

±1/2% tolerance available above 100 mmf., pricing upon request.

CM-15, available "F" characteristic above 30 mmf.

CM-19, 20 available "E" characteristic above 110 mmf.

CM-19, 20 available "F" characteristic above 200 mmf.

All CM-30, 35, and 42 values listed are available in "F" characteristic.

TYPE CM-19 & 20

500VDCW

CAP. MMF.	TYPE DESIGNATION	Net Price (1-24) Tolerance		
		"J" ±5%	"G" ±2%	"F" ±1%
100	CM-20-C-101	\$0.20	\$0.22	\$0.27
110	CM-20-C-111	.22	.24	.30
120	CM-20-C-121	.22	.24	.30
130	CM-20-C-131	.22	.24	.30
150	CM-20-C-151	.22	.24	.30
160	CM-20-C-161	.22	.24	.30
180	CM-20-C-181	.22	.24	.30
200	CM-20-D-201	.22	.24	.30
220	CM-20-D-221	.22	.24	.30
240	CM-20-D-241	.25	.28	.35
250	CM-20-D-251	.25	.28	.35
270	CM-20-D-271	.25	.28	.35
300	CM-20-D-301	.25	.28	.35
330	CM-20-D-331	.25	.28	.35
360	CM-20-D-361	.25	.28	.35
390	CM-20-D-391	.28	.31	.39
430	CM-20-D-431	.28	.31	.39
470	CM-20-D-471	.28	.31	.39
500	CM-20-D-501	.31	.34	.43
510	CM-20-D-511	.31	.34	.43
560	CM-20-D-561	.31	.34	.43
620	CM-20-D-621	.34	.38	.47
680	CM-20-D-681	.38	.41	.51
750	CM-20-D-751	.38	.41	.51
820	CM-20-D-821	.40	.44	.56
910	CM-20-D-911	.44	.48	.62
1000	CM-20-E-102	.44	.48	.62
1100	CM-20-E-112	.48	.53	.67
1200	CM-20-E-122	.50	.55	.70
1300	CM-20-E-132	.50	.55	.70
1500	CM-20-E-152	.53	.58	.75
1600	CM-20-E-162	.56	.62	.80
1800	CM-20-E-182	.62	.68	.86
2000	CM-20-E-202	.69	.76	.96
2200	CM-20-E-222	.76	.84	1.06
2400	CM-20-E-242	.78	.86	1.09
2500	CM-20-E-252	.81	.90	1.15
2700	CM-20-E-272	.87	.96	1.22
3000	CM-20-E-302	.94	1.04	1.31
3300	CM-20-E-332	1.01	1.11	1.41
3600*	CM-20-E-362	1.06	1.16	1.48
3900*	CM-20-E-392	1.15	1.26	1.62
4300*	CM-20-E-432	1.20	1.32	1.68
4700*	CM-20-E-472	1.25	1.38	1.74
5000*	CM-20-E-502	1.32	1.46	1.84
5100*	CM-20-E-512	1.32	1.46	1.84

Capacities from 100 to 2400 mmf. can be supplied in CM-19 cases. In values above 1000 mmf. the list prices for CM-19 are 10% higher than those listed above.

As can be seen in the line drawing above, the only difference between CM19 and CM20 is length dimension. For competitive reasons it has been necessary to retain both mold sizes. However both CM19 and CM20 fully conform to all specifications for MIL-C-5 case size CM20, and they are interchangeable for military requirements.

NET (For quantities of 25 or more, please contact your local Arco-Elmenco distributor)

Sold Nationally to Electronic Parts Distributors by; Loral Distributor Products, a Division of Loral Corporation

ELMENCO

CAPACITORS

Epoxy-dipped Flat Mylar

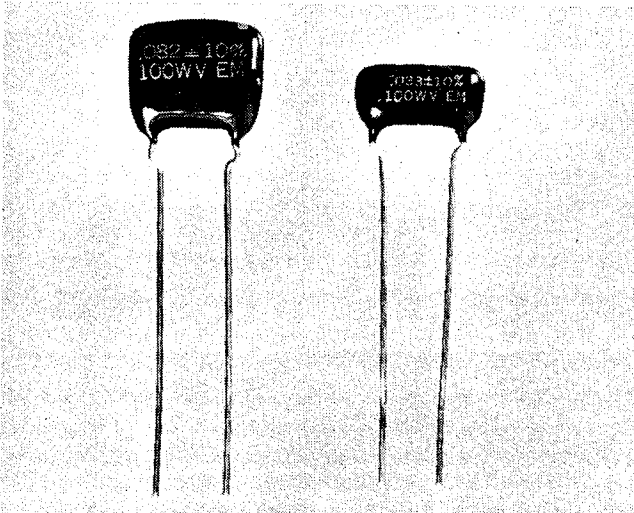

The new ELMENCO Type MDF capacitor is a mylar dielectric unit dipped in a newly formulated epoxy material and shaped in the flat configuration particularly suited to saving space on printed circuit boards. Before being brought to market, the design has been carefully evaluated for more than two years to be sure that the performance of the MDF will be of a level expected of ELMENCO capacitors. This release covers the 100VDCW rated series only. Dipped mylar capacitors with other voltage ratings will be announced shortly.

The specifications for the ELMENCO Type MDF are as follows:

Voltage Rating: 100VDCW, 250VDCT.

Insulation Resistance: 20,000 megohm-microfarads or 100,000 ohms, whichever is less, at 25°C.

At 85°C., the figures are 300 megohm-microfarads or 1500 megohms minimum; at 125°C., 20 and 100 respectively.

Maximum power factor at 1 kc.: 0.6%

Maximum cap. change from room temperature:

-7% at -55°C.

-3.5% at -30°C.

+4% at 85°C.

+17% at 125°C.

Capacitance drift: ±1% maximum.

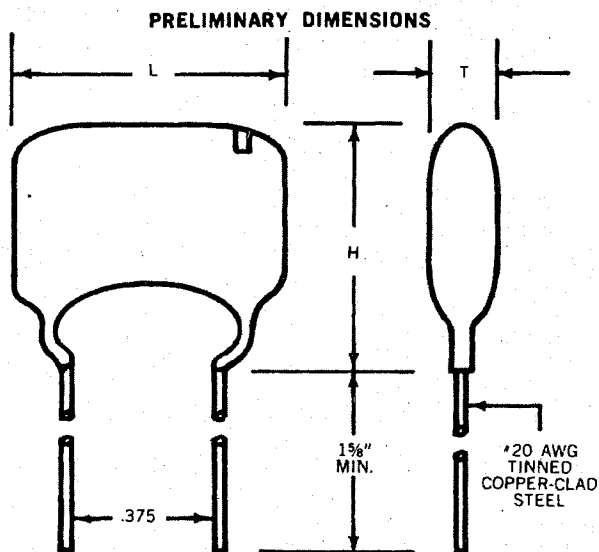

These preliminary dimensions are established maximums for the four basic configurations of Type MDF. When dimensional surveys are completed on production representative of all values, individual dimensional information for each capacitance value will be published as for other dipped ELMENCO capacitors. Dimensions, particularly thickness, will vary with capacitance value.

Cap. value (mfd.)	L max.	H max.	T max.
.001 - .033	.800	1 $\frac{1}{32}$	$\frac{7}{32}$
.034 - .068	.800	$\frac{5}{8}$	$\frac{1}{4}$
.069 - .15	.800	$\frac{7}{8}$	$\frac{5}{16}$
.16 - .47	.800	1 $\frac{1}{8}$	$\frac{9}{16}$

STANDARD TOLERANCE ±10%

Cap. mfd.	Part Number	List Price	Net Price (1-24)
.001	1MDF-1-102	\$0.25	\$0.15
.0012	1MDF-1-122	.25	.15
.0015	1MDF-1-152	.25	.15
.0018	1MDF-1-182	.25	.15
.002	1MDF-1-202	.25	.15
.0022	1MDF-1-222	.25	.15
.0027	1MDF-1-272	.25	.15
.003	1MDF-1-302	.25	.15
.0033	1MDF-1-332	.25	.15
.0039	1MDF-1-392	.25	.15
.0047	1MDF-1-472	.25	.15
.005	1MDF-1-502	.25	.15
.0051	1MDF-1-512	.25	.15
.0056	1MDF-1-562	.25	.15
.0062	1MDF-1-622	.25	.15
.0068	1MDF-1-682	.25	.15
.0075	1MDF-1-752	.25	.15
.0082	1MDF-1-822	.25	.15
.01	1MDF-1-103	.25	.15
.012	1MDF-1-123	.30	.18
.015	1MDF-1-153	.30	.18
.018	1MDF-1-183	.30	.18
.02	1MDF-1-203	.30	.18
.022	1MDF-1-223	.30	.18
.024	1MDF-1-243	.30	.18
.027	1MDF-1-273	.30	.18
.03	1MDF-1-303	.30	.18
.033	1MDF-1-333	.30	.18
.039	1MDF-2-393	.30	.18
.047	1MDF-2-473	.30	.18
.05	1MDF-2-503	.30	.18
.051	1MDF-2-513	.30	.18
.056	1MDF-2-563	.30	.18
.062	1MDF-2-623	.35	.21
.068	1MDF-2-683	.35	.21
.075	1MDF-3-753	.35	.21
.082	1MDF-3-823	.35	.21
.1	1MDF-3-104	.35	.21
.12	1MDF-3-124	.40	.24
.15	1MDF-3-154	.40	.24
.2	1MDF-4-204	.45	.27
.22	1MDF-4-224	.50	.30
.27	1MDF-4-274	.60	.36
.33	1MDF-4-334	.70	.42
.39	1MDF-4-394	.80	.48
.47	1MDF-4-474	.90	.54

Sold Nationally to Electronic Parts Distributors by: Loral Distributor Products, a Division of Loral Corporation

ARCOLYTIC CAPACITORS

TYPE DP GENERAL PURPOSE

Part Numbers:

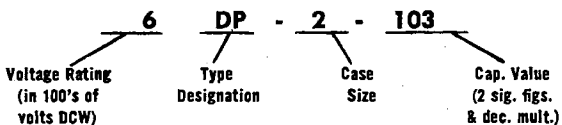

The above example calls for a .01 mfd. capacitor with a 600VDCW voltage rating.

600VDCW

CAP. MFD.	PART NUMBER	L	W	H	LIST PRICE	NET PRICE (1-24)
.001	6DP-1-102	2 ³ / ₃₂	2 ⁵ / ₆₄	5/8	\$0.25	\$0.15
.0012	6DP-1-122	2 ³ / ₃₂	2 ⁵ / ₆₄	5/8	.25	.15
.0015	6DP-1-152	2 ³ / ₃₂	2 ⁵ / ₆₄	5/8	.25	.15
.002	6DP-1-202	2 ³ / ₃₂	2 ⁵ / ₆₄	5/8	.25	.15
.0022	6DP-1-222	2 ³ / ₃₂	2 ⁵ / ₆₄	5/8	.25	.15
.0025	6DP-1-252	2 ³ / ₃₂	2 ⁵ / ₆₄	5/8	.25	.15
.0027	6DP-1-272	2 ³ / ₃₂	2 ⁵ / ₆₄	5/8	.25	.15
.003	6DP-1-302	2 ³ / ₃₂	2 ⁵ / ₆₄	5/8	.25	.15
.0033	6DP-1-332	2 ³ / ₃₂	2 ⁵ / ₆₄	5/8	.25	.15
.0039	6DP-1-392	2 ³ / ₃₂	2 ⁵ / ₆₄	5/8	.25	.15
.004	6DP-1-402	2 ³ / ₃₂	2 ⁷ / ₆₄	4 ¹ / ₆₄	.25	.15
.0047	6DP-1-472	2 ³ / ₃₂	2 ⁷ / ₆₄	4 ¹ / ₆₄	.25	.15
.005	6DP-1-502	2 ³ / ₃₂	2 ⁷ / ₆₄	4 ¹ / ₆₄	.25	.15
.0056	6DP-1-562	2 ³ / ₃₂	2 ⁷ / ₆₄	4 ¹ / ₆₄	.25	.15
.006	6DP-1-602	2 ³ / ₃₂	3/8	5/8	.25	.15
.0068	6DP-1-682	2 ³ / ₃₂	2 ³ / ₁₆	1 ¹ / ₁₆	.30	.18
.0075	6DP-1-752	2 ³ / ₃₂	2 ³ / ₁₆	4 ³ / ₆₄	.30	.18
.01	6DP-1-103	1 ¹ / ₁₆	2 ³ / ₁₆	4 ³ / ₆₄	.30	.18
.015	6DP-1-153	2 ³ / ₃₂	1 ¹ / ₃₂	1 ¹ / ₃₂	.30	.18
.02	6DP-1-203	2 ³ / ₃₂	1 ¹ / ₃₂	1 ¹ / ₃₂	.30	.18
.022	6DP-1-223	2 ³ / ₃₂	1 ¹ / ₃₂	1 ¹ / ₃₂	.30	.18
.025	6DP-1-253	2 ³ / ₃₂	1 ¹ / ₃₂	1 ¹ / ₃₂	.30	.18
.03	6DP-1-303	2 ³ / ₃₂	3/8	5/8	.30	.18
.033	6DP-1-333	2 ³ / ₃₂	3/8	5/8	.30	.18
.04	6DP-1-403	2 ³ / ₃₂	3/8	5/8	.30	.18
.047	6DP-2-473	7/8	1 ¹ / ₃₂	1 ¹ / ₁₆	.35	.21
.05	6DP-2-503	7/8	1 ¹ / ₃₂	1 ¹ / ₁₆	.35	.21
.056	6DP-2-563	7/8	3/8	5/8	.35	.21
.068	6DP-2-683	7/8	1 ¹ / ₃₂	5/8	.35	.21
.075	6DP-2-753	7/8	1 ¹ / ₃₂	5/8	.35	.21
.1	6DP-2-104	2 ³ / ₃₂	2 ³ / ₁₆	1 ¹ / ₁₆	.35	.21
.15	6DP-3-154	1 ¹ / ₃₂	2 ³ / ₁₆	1 ¹ / ₁₆	.40	.24
.2	6DP-3-204	1 ¹ / ₃₂	1/2	2 ³ / ₃₂	.45	.27
.22	6DP-3-224	1 ¹ / ₃₂	1/2	2 ³ / ₃₂	.45	.27
.25	6DP-3-254	1 ¹ / ₃₂	1 ¹ / ₃₂	3/4	.50	.30
.33	6DP-4-334	1 ³ / ₈	2 ³ / ₁₆	1 ¹ / ₁₆	.60	.36
.47	6DP-4-474	1 ³ / ₈	2 ³ / ₃₂	2 ³ / ₃₂	.75	.45
.5	6DP-4-504	1 ³ / ₈	2 ³ / ₃₂	2 ³ / ₃₂	.75	.45
.68	6DP-5-684	1 ¹ / ₂	1 ¹ / ₁₆	1 ¹ / ₁₆	.95	.57
1.0	6DP-5-105	1 ¹ / ₂	3/4	1	1.20	.72
.001	6DP-1-102	2 ³ / ₃₂	2 ⁵ / ₆₄	5/8	\$0.25	\$0.15
.0012	6DP-1-122	2 ³ / ₃₂	2 ⁵ / ₆₄	5/8	.25	.15
.0015	6DP-1-152	2 ³ / ₃₂	2 ⁵ / ₆₄	5/8	.25	.15
.002	6DP-1-202	2 ³ / ₃₂	2 ⁵ / ₆₄	5/8	.25	.15
.0022	6DP-1-222	2 ³ / ₃₂	2 ⁵ / ₆₄	5/8	.25	.15
.0025	6DP-1-252	2 ³ / ₃₂	2 ⁵ / ₆₄	5/8	.25	.15
.0027	6DP-1-272	2 ³ / ₃₂	2 ⁵ / ₆₄	5/8	.25	.15
.003	6DP-1-302	2 ³ / ₃₂	2 ⁵ / ₆₄	5/8	.25	.15
.0033	6DP-1-332	2 ³ / ₃₂	2 ⁵ / ₆₄	5/8	.25	.15
.0039	6DP-1-392	2 ³ / ₃₂	2 ⁵ / ₆₄	5/8	.25	.15
.004	6DP-1-402	2 ³ / ₃₂	2 ⁷ / ₆₄	4 ¹ / ₆₄	.25	.15
.0047	6DP-1-472	2 ³ / ₃₂	2 ⁷ / ₆₄	4 ¹ / ₆₄	.25	.15
.005	6DP-1-502	2 ³ / ₃₂	2 ⁷ / ₆₄	4 ¹ / ₆₄	.25	.15
.0056	6DP-1-562	2 ³ / ₃₂	2 ⁷ / ₆₄	4 ¹ / ₆₄	.25	.15
.006	6DP-1-602	2 ³ / ₃₂	3/8	5/8	.25	.15
.0068	6DP-1-682	2 ³ / ₃₂	2 ³ / ₁₆	1 ¹ / ₁₆	.30	.18
.0075	6DP-2-752	2 ³ / ₃₂	2 ³ / ₁₆	4 ³ / ₆₄	.30	.18
.008	6DP-2-802	2 ³ / ₃₂	2 ³ / ₁₆	4 ³ / ₆₄	.30	.18
.0082	6DP-2-822	2 ³ / ₃₂	2 ³ / ₁₆	4 ³ / ₆₄	.30	.18
.01	6DP-2-103	2 ³ / ₃₂	2 ³ / ₁₆	4 ³ / ₆₄	.30	.18
.012	6DP-2-123	2 ³ / ₃₂	2 ³ / ₁₆	4 ³ / ₆₄	.30	.18
.015	6DP-2-153	2 ³ / ₃₂	2 ³ / ₁₆	4 ³ / ₆₄	.30	.18
.018	6DP-2-183	2 ³ / ₃₂	2 ³ / ₁₆	4 ³ / ₆₄	.30	.18
.02	6DP-2-203	2 ³ / ₃₂	1/2	3/4	.30	.18
.022	6DP-2-223	2 ³ / ₃₂	1/2	3/4	.30	.18
.025	6DP-2-253	2 ³ / ₃₂	2 ³ / ₁₆	4 ³ / ₆₄	.35	.21
.027	6DP-3-273	1 ¹ / ₃₂	2 ³ / ₁₆	4 ³ / ₆₄	.35	.21
.03	6DP-3-303	1 ¹ / ₃₂	2 ³ / ₁₆	4 ³ / ₆₄	.35	.21
.033	6DP-3-333	1 ¹ / ₃₂	2 ³ / ₁₆	4 ³ / ₆₄	.35	.21
.036	6DP-3-363	1 ¹ / ₃₂	2 ³ / ₁₆	4 ³ / ₆₄	.35	.21
.039	6DP-3-393	1 ¹ / ₃₂	2 ³ / ₁₆	4 ³ / ₆₄	.35	.21
.04	6DP-3-403	1 ¹ / ₃₂	2 ³ / ₁₆	4 ³ / ₆₄	.35	.21
.047	6DP-3-473	1 ¹ / ₃₂	2 ³ / ₁₆	4 ³ / ₆₄	.40	.24
.05	6DP-3-503	1 ¹ / ₃₂	2 ³ / ₁₆	4 ³ / ₆₄	.40	.24
.056	6DP-3-563	1 ¹ / ₃₂	2 ³ / ₁₆	4 ³ / ₆₄	.40	.24
.06	6DP-3-603	1 ¹ / ₃₂	2 ³ / ₁₆	4 ³ / ₆₄	.45	.27
.068	6DP-4-683	1 ¹ / ₃₂	2 ³ / ₁₆	4 ³ / ₆₄	.45	.27
.075	6DP-4-753	1 ¹ / ₃₂	2 ³ / ₁₆	4 ³ / ₆₄	.45	.27
.082	6DP-4-823	1 ¹ / ₃₂	2 ³ / ₁₆	4 ³ / ₆₄	.45	.27
.1	6DP-4-104	1 ¹ / ₃₂	1 ¹ / ₁₆	2 ³ / ₃₂	.45	.27
.15	6DP-5-154	1 ¹ / ₂	1 ¹ / ₁₆	1 ¹ / ₁₆	.60	.36
.2	6DP-5-204	1 ¹ / ₂	2 ³ / ₁₆	1 ¹ / ₃₂	.70	.42
.22	6DP-5-224	1 ¹ / ₂	2 ³ / ₁₆	1 ¹ / ₃₂	.70	.42
.25	6DP-5-254	1 ¹ / ₂	2 ³ / ₁₆	1 ¹ / ₃₂	.75	.45
.33	6DP-6-334	1 ³ / ₈	2 ³ / ₁₆	1 ¹ / ₁₆	1.05	.63
.47	6DP-6-474	1 ³ / ₈	2 ³ / ₁₆	1 ¹ / ₁₆	1.50	.90
.5	6DP-6-504	1 ³ / ₈	2 ³ / ₁₆	1 ¹ / ₁₆	1.50	.90

100VDCW

CAP. MFD.	PART NUMBER	L	W	H	LIST PRICE	NET PRICE (1-24)
.005	1DP-1-502	1 ¹ / ₁₆	2 ³ / ₁₆	1 ¹ / ₃₂	\$0.30	\$0.18
.006	1DP-1-602	1 ¹ / ₁₆	2 ³ / ₁₆	1 ¹ / ₃₂	.30	.18
.0068	1DP-1-682	1 ¹ / ₁₆	2 ³ / ₁₆	1 ¹ / ₃₂	.30	.18
.0075	1DP-1-752	1 ¹ / ₁₆	2 ³ / ₁₆	1 ¹ / ₃₂	.30	.18
.01	1DP-1-103	1 ¹ / ₁₆	2 ³ / ₁₆	1 ¹ / ₃₂	.30	.18
.015	1DP-1-153	2 ³ / ₃₂	1 ¹ / ₃₂	1 ¹ / ₃₂	.30	.18
.02	1DP-1-203	2 ³ / ₃₂	1 ¹ / ₃₂	1 ¹ / ₃₂	.30	.18
.022	1DP-1-223	2 ³ / ₃₂	1 ¹ / ₃₂	1 ¹ / ₃₂	.30	.18
.025	1DP-1-253	2 ³ / ₃₂	1 ¹ / ₃₂	1 ¹ / ₃₂	.30	.18
.03	1DP-1-303	2 ³ / ₃₂	3/8	5/8	.30	.18
.033	1DP-1-333	2 ³ / ₃₂	3/8	5/8	.30	.18
.04	1DP-1-403	2 ³ / ₃₂	3/8	5/8	.30	.18
.047	1DP-2-473	7/8	1 ¹ / ₃₂	1 ¹ / ₁₆	.35	.21
.05	1DP-2-503	7/8	1 ¹ / ₃₂	1 ¹ / ₁₆	.35	.21
.056	1DP-2-563	7/8	3/8	5/8	.35	.21
.068	1DP-2-683	7/8	1 ¹ / ₃₂	5/8	.35	.21
.075	1DP-2-753	7/8	1 ¹ / ₃₂	5/8	.35	.21
.1	1DP-2-104	2 ³ / ₃₂	2 ³ / ₁₆	1 ¹ / ₁₆	.35	.21
.15	1DP-3-154	1 ¹ / ₃₂	2 ³ / ₁₆	1 ¹ / ₁₆	.40	.24
.2	1DP-3-204	1 ¹ / ₃₂	1/2	2 ³ / ₃₂	.45	.27
.22	1DP-3-224	1 ¹ / ₃₂	1/2	2 ³ / ₃₂	.45	.27
.25	1DP-3-254	1 ¹ / ₃₂	1 ¹ / ₃₂	3/4	.50	.30
.33	1DP-4-334	1 ³ / ₈	2 ³ / ₁₆	1 ¹ / ₁₆	.60	.36
.47	1DP-4-474	1 ³ / ₈	2 ³ / ₃₂	2 ³ / ₃₂	.75	.45
.5	1DP-4-504	1 ³ / ₈	2 ³ / ₃₂	2 ³ / ₃₂	.75	.45
.68	1DP-5-684	1 ¹ / ₂	1 ¹ / ₁₆	1 ¹ / ₁₆	.95	.57
1.0	1DP-5-105	1 ¹ / ₂	3/4	1	1.20	.72

200VDCW

CAP. MFD.	PART NUMBER	L	W	H	LIST PRICE	NET PRICE (1-24)
.1	2DP-3-104	1 ¹ / ₄	1/2	4 ¹ / ₄	\$0.35	\$0.21
.15	2DP-3-154	1 ¹ / ₄	3 ³ / ₆₄	2 ³ / ₃₂	.40	.24
.2	2DP-4-204	1 ¹ / ₄	2 ³ / ₆₄	2 ³ / ₃₂	.45	.27
.22	2DP-4-224	1 ¹ / ₄	2 ³ / ₆₄	2 ³ / ₃₂	.45	.27
.25	2DP-4-254	1 ¹ / ₄	5/8	7/8	.50	.30
.33	2DP-5-334	1 ³ / ₈	5/8	1 ³ / ₁₆	.60	.36
.47	2DP-5-474	1 ³ / ₈	4 ³ / ₆₄	6 ³ / ₆₄	.75	.45
.5	2DP-5-504	1 ³ / ₈	4 ³ / ₆₄	6 ³ / ₆₄	.75	.45

1600 VDCW

CAP. MFD.	PART NUMBER	L	W	H	LIST PRICE	NET PRICE (1-24)
.001	16DP-2-102	7/8	1 ¹ / ₃₂	2 ³ / ₁₆	\$0.40	\$0.24
.0015	16DP-2-152	7/8	1 ¹ / ₃₂	2 ³ / ₁₆	.40	.24
.0018	16DP-2-182	7/8	3/8	1 ¹ / ₃₂	.40	.24
.002	16DP-2-202	7/8	3/8	1 ¹ / ₃₂	.40	.24
.0022	16DP-2-222	7/8	3/8			

ELMENCO

CAPACITORS

Variable Compression Mica

SINGLE AND DUAL PADDERS

ELMENCO Padding Condensers have been acclaimed by engineers as the finest development in adjustable mica condensers.

The construction is such as to completely enclose and protect the delicate edges of the mica films, made of the finest quality clear India ruby mica.

The phosphor bronze adjusting plates assure permanent resilience and freedom from mechanical fatigue. All parts are heavily plated to resist corrosion.

TYPE 30 500 Volts DC Flash-Test — 250 WVDC

PART NUMBER	NUMBER OF PLATES	GUARANTEED RANGE		LIST PRICE	NET PRICE (1-24)
		At 1 3/4 Inch Pounds Cap. Will Be More Than MMF.	At 3 Turns Open Cap. Will Be Less Than MMF.		
302	2 Pl.	130	15	\$1.15	\$0.69
303	3 Pl.	340	65	1.25	.75
304	4 Pl.	550	100	1.35	.81
305	5 Pl.	760	190	1.45	.87
306	6 Pl.	970	275	1.55	.93
307	7 Pl.	1180	350	1.65	.99
308	8 Pl.	1390	450	1.75	1.05
309	9 Pl.	1600	550	1.90	1.14
310	10 Pl.	1890	650	2.00	1.20
311	11 Pl.	2110	780	2.15	1.29
312	12 Pl.	2330	880	2.25	1.35
313	13 Pl.	2605	1150	2.40	1.44
314	14 Pl.	2830	1300	2.55	1.53
315	15 Pl.	3055	1400	2.70	1.62

Screw is insulated from top plate by mica washer. Above maximum capacity values are based on using 1 1/2 to 1 3/4 Mil Mica films.

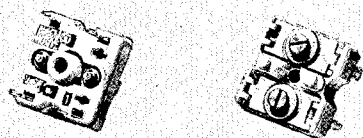

TYPE 50 DUAL PADDER — 175 VDCW

(will fit any size shield having dimensions exceeding 1 1/8" x 1 1/8")



TYPE 58 PADDER 1" x 1 1/32" — 175 VDCW

NET (For quantities of 25 or more, please contact your local Arco-Elmenco Distributor)
Sold Nationally to Electronic Parts Distributors by: Loral Distributor Products, a Division of Loral Corporation

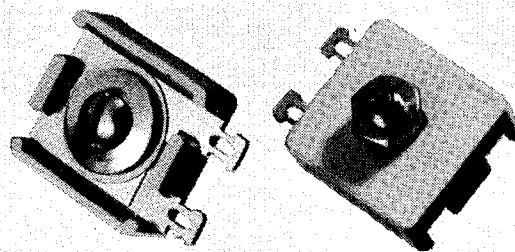

TYPE 30 AND TYPE 30-M PADDER 7/8" x 1 1/8"

TYPE 30-M 1000 Volts DC Flash-Test — 500 WVDC

PART NUMBER	NUMBER OF PLATES	GUARANTEED RANGE		LIST PRICE	NET PRICE (1-24)
		At 1 1/4 Inch Pounds Cap. Will Be More Than MMF.	At 3 Turns Open Cap. Will Be Less Than MMF.		
302-M	2 Pl.	120	15	\$1.20	\$0.72
303-M	3 Pl.	320	65	1.30	.78
304-M	4 Pl.	500	100	1.40	.84
305-M	5 Pl.	690	180	1.50	.90
306-M	6 Pl.	880	265	1.70	1.02
307-M	7 Pl.	1070	340	1.75	1.05
308-M	8 Pl.	1260	425	1.90	1.14
309-M	9 Pl.	1415	525	2.10	1.26
310-M	10 Pl.	1600	615	2.20	1.32
311-M	11 Pl.	1785	730	2.35	1.41
312-M	12 Pl.	1970	800	2.45	1.47
313-M	13 Pl.	2155	1000	2.60	1.56
314-M	14 Pl.	2340	1100	2.75	1.65
315-M	15 Pl.	2525	1200	3.00	1.80

Screw is insulated from top plate by mica washer. Above maximum capacity values are based on using 2 to 2 1/4 Mil Mica.

Type L-30 Same as Type 30-M but with special adjusting screw adapted for tuning knob — use designation above with prefix 'L'.

TYPE 50

PART NUMBER	NUMBER OF PLATES	GUARANTEED RANGE		LIST PRICE	NET PRICE (1-24)
		At Tight Cap. Will Be More Than MMF.	At 2 Turns Open Cap. Will Be Less Than MMF.		
502	2 Pl.	80	7.5	\$1.25	\$0.75
503	3 Pl.	160	19	1.45	.87
504	4 Pl.	240	50	1.60	.96

◀ TYPE 50 Dual Padders provide two variable trimmers mounted on a single base. This unit is designed as a tuning component for I.F. transformers; and as such, may be snap-in mounted along with the transformer coil in any size shield having dimensions exceeding 1 1/8" x 1 1/8".

TYPE 58

PART NUMBER	NUMBER OF PLATES	GUARANTEED RANGE		LIST PRICE	NET PRICE (1-24)
		At Tight Cap. Will Be More Than MMF.	At 2 Turns Open Cap. Will Be Less Than MMF.		
582	2 Pl.	80	7.5	\$0.80	\$0.48
583	3 Pl.	160	19	.90	.54
584	4 Pl.	240	50	1.00	.60

◀ TYPE 58 Padder is a single variable trimmer section provided with a two-pronged staple mounting for attachment to bracket or chassis. Base is made of lowest loss steatite and the mica is India Ruby.

LORCAPS**CERAMIC DISC****MINIATURE GENERAL PURPOSE****TYPE 3CCD**High Voltage $\pm 20\%$ TOLERANCE 3000 VDCW

(not recommended for deflection yoke application)

CAP. MMF.	PART NUMBER	LIST PRICE	NET PRICE (1-24)	CAP. MMF.	PART NUMBER	LIST PRICE	NET PRICE (1-24)
4.7	3CCD-4R7	\$0.40	\$0.24	180	3CCD-181	\$0.40	\$0.24
6.8	3CCD-6R8	.40	.24	220	3CCD-221	.40	.24
10	3CCD-100	.40	.24	270	3CCD-271	.40	.24
15	3CCD-150	.40	.24	330	3CCD-331	.40	.24
22	3CCD-220	.40	.24	390	3CCD-391	.40	.24
27	3CCD-270	.40	.24	470	3CCD-471	.40	.24
33	3CCD-330	.40	.24	560	3CCD-561	.40	.24
39	3CCD-390	.40	.24	680	3CCD-681	.40	.24
47	3CCD-470	.40	.24	820	3CCD-821	.40	.24
56	3CCD-560	.40	.24	1000	3CCD-102	.40	.24
68	3CCD-680	.40	.24	2000	3CCD-202	.40	.24
82	3CCD-820	.40	.24	3000	3CCD-302	.40	.24
100	3CCD-101	.40	.24	4000	3CCD-402	.40	.24
120	3CCD-121	.40	.24	5000	3CCD-502	.40	.24
150	3CCD-151	.40	.24				

TYPE 6CCDHigh Voltage $\pm 20\%$ TOLERANCE 6000 VDCW

(not recommended for deflection yoke application)

CAP. MMF.	PART NUMBER	LIST PRICE	NET PRICE (1-24)	CAP. MMF.	PART NUMBER	LIST PRICE	NET PRICE (1-24)
4.7	6CCD-4R7	\$0.60	\$0.36	100	6CCD-101	\$0.60	\$0.36
6.8	6CCD-6R8	.60	.36	120	6CCD-121	.60	.36
10	6CCD-100	.60	.36	150	6CCD-151	.60	.36
15	6CCD-150	.60	.36	220	6CCD-221	.60	.36
22	6CCD-220	.60	.36	330	6CCD-331	.60	.36
27	6CCD-270	.60	.36	470	6CCD-471	.60	.36
33	6CCD-330	.60	.36	560	6CCD-561	.70	.42
47	6CCD-470	.60	.36	680	6CCD-681	.70	.42
56	6CCD-560	.60	.36	820	6CCD-821	.70	.42
68	6CCD-680	.60	.36	1000	6CCD-102	.70	.42
82	6CCD-820	.60	.36	2000	6CCD-202	.70	.42

TEMPERATURE STABLE

This new ARCO ceramic capacitor maintains excellent capacitance stability with wide temperature variation. The graph illustrates typical percentage variation of capacity value with temperature. The operating temperature range has been extended to -55°C . to $+125^{\circ}\text{C}$, without derating of the 1000VDCW specification. Standard tolerance is $\pm 10\%$. The combined small size, low cost, and high stability represents another significant advance in the quality line of ARCO capacitors. All units are marked "TS" for identification.

TYPE CCS $\pm 10\%$ TOLERANCE 1000 VDCW

CAP. MMF.	PART NUMBER	LIST PRICE	NET PRICE (1-24)	CAP. MMF.	PART NUMBER	LIST PRICE	NET PRICE (1-24)
150	CCS-151	\$0.30	\$0.18	750	CCS-751	.30	.18
180	CCS-181	.30	.18	820	CCS-821	.35	.21
200	CCS-201	.30	.18	1000	CCS-102	.35	.21
220	CCS-221	.30	.18	1200	CCS-122	.35	.21
250	CCS-251	.30	.18	1500	CCS-152	.35	.21
				1800	CCS-182	.35	.21
270	CCS-271	.30	.18	2000	CCS-202	.35	.21
300	CCS-301	.30	.18	2200	CCS-222	.35	.21
330	CCS-331	.30	.18	2500	CCS-252	.40	.24
390	CCS-391	.30	.18	2700	CCS-272	.40	.24
470	CCS-471	.30	.18	3000	CCS-302	.40	.24
500	CCS-501	.30	.18	3300	CCS-332	.40	.24
560	CCS-561	.30	.18	3900	CCS-392	.40	.24
620	CCS-621	.30	.18	4700	CCS-472	.40	.24
680	CCS-681	.30	.18				

TEMPERATURE COMPENSATING**TYPE CCTO**

Arco Type CCTO ceramic disc capacitors are zero temperature coefficient units specifically suited for high stability, high Q application. In addition to extreme temperature stability, Type CCTO capacitors have very high insulation resistance and low aging rate. These special characteristics are added to the high 1000VDCW rating and close tolerance of the entire Arco ceramic line to provide a superior capacitor for the special purpose intended. Type CCTO capacitors are identified by "NPO" printed on each unit.

NPO-TYPE CCTO $\pm 10\%$ TOLERANCE 1000 VDCW

CAP. MMF.	PART NUMBER	LIST PRICE	NET PRICE (1-24)	CAP. MMF.	PART NUMBER	LIST PRICE	NET PRICE (1-24)
2.2*	CCTO-2R2	\$0.50	\$0.30	30	CCTO-300	.50	.30
3.3*	CCTO-3R3	.50	.30	33	CCTO-330	.50	.30
4.7*	CCTO-4R7	.50	.30				
5.0	CCTO-050	.50	.30	36	CCTO-360	.50	.30
6.8	CCTO-6R8	.50	.30	39	CCTO-390	.50	.30
				47	CCTO-470	.50	.30
10	CCTO-100	.50	.30	51	CCTO-510	.55	.33
12	CCTO-120	.50	.30	56	CCTO-560	.55	.33
15	CCTO-150	.50	.30				
18	CCTO-180	.50	.30	68	CCTO-680	.55	.33
20	CCTO-200	.50	.30	75	CCTO-750	.55	.33
				82	CCTO-820	.55	.33
22	CCTO-220	.50	.30	100	CCTO-101	.55	.33
24	CCTO-240	.50	.30	120	CCTO-121	.55	.33
27	CCTO-270	.50	.30	150	CCTO-151	.55	.33

* ± 0.5 mmf. tolerance**TYPE CCTN**

Another member of the Arco temperature compensating disc ceramic line is the Type CCTN unit which has a negative temperature coefficient of -750 ppm/ $^{\circ}\text{C}$. (N750). These units are used to counterbalance shifts in other circuit components with change in temperature. The result is a more stable circuit essential to many frequency control applications. Improved ceramic bodies in the temperature compensating line provide greater long term stability in addition to accurate temperature compensation. Type CCTN capacitors are identified by "N750" imprinted on each unit except the smallest size. On the small units the E.I.A. temperature coefficient designation "U2" is imprinted.

N750-TYPE CCTN $\pm 10\%$ TOLERANCE 1000 VDCW

CAP. MMF.	PART NUMBER	LIST PRICE	NET PRICE (1-24)	CAP. MMF.	PART NUMBER	LIST PRICE	NET PRICE (1-24)
5	CCTN-050	\$0.50	\$0.30	82	CCTN-820	.50	.30
10	CCTN-100	.50	.30	100	CCTN-101	.50	.30
15	CCTN-150	.50	.30	120	CCTN-121	.50	.30
22	CCTN-220	.50	.30				
27	CCTN-270	.50	.30	150	CCTN-151	.50	.30
				200	CCTN-201	.50	.30
33	CCTN-330	.50	.30	220	CCTN-221	.50	.30
39	CCTN-390	.50	.30	270	CCTN-271	.50	.30
47	CCTN-470	.50	.30	300	CCTN-301	.50	.30
56	CCTN-560	.50	.30				
62	CCTN-620	.50	.30	330	CCTN-331	.50	.30
				390	CCTN-391	.50	.30
68	CCTN-680	.50	.30	470	CCTN-471	.50	.30
75	CCTN-750	.50	.30				

NET (For quantities of 25 or more, please contact your local Arco-Elmenco Distributor)

Sold Nationally to Electronic Parts Distributors by; Loral Distributor Products, a Division of Loral Corporation

ARCO CAPACITORS

15VDCW (cont.)			
CAP. MFD.	PART NUMBER	LIST PRICE	NET PRICE (1-24)
6	ME-1-E-006	\$1.40	\$0.84
8	ME-1-E-008	1.40	.84
10	ME-1-E-010	1.40	.84
15	ME-2-E-015	1.45	.87
20	ME-2-E-020	1.45	.87
25	ME-2-E-025	1.45	.87
30	ME-3-E-030	1.50	.90
35	ME-3-E-035	1.55	.93
40	ME-3-E-040	1.60	.96
50	ME-3-E-050	1.60	.96
75	ME-4-E-075	1.60	.96
100	ME-4-E-100	1.65	.99
150	ME-6-E-150	1.75	1.05
200	ME-6-E-200	1.95	1.17
250	ME-8-E-250	2.05	1.23
25VDCW			
1	ME-1-G-001	1.25	.75
2	ME-1-G-002	1.30	.78
3	ME-1-G-003	1.30	.78
4	ME-1-G-004	1.30	.78
5	ME-1-G-005	1.40	.84
6	ME-2-G-006	1.40	.84
8	ME-2-G-008	1.45	.87
10	ME-2-G-010	1.45	.87
15	ME-3-G-015	1.45	.87
20	ME-3-G-020	1.50	.90
25	ME-3-G-025	1.55	.93
30	ME-3-G-030	1.60	.96
35	ME-4-G-035	1.65	.99
40	ME-4-G-040	1.65	.99
50	ME-4-G-050	1.65	.99
75	ME-7-G-075	1.70	1.02
100	ME-7-G-100	1.75	1.05
50VDCW			
1	ME-1-J-001	1.30	.78
2	ME-1-J-002	1.35	.81
3	ME-2-J-003	1.35	.81
4	ME-2-J-004	1.35	.81
5	ME-2-J-005	1.45	.87
6	ME-2-J-006	1.45	.87
8	ME-3-J-008	1.50	.90
10	ME-3-J-010	1.50	.90
15	ME-4-J-015	1.50	.90
20	ME-4-J-020	1.50	.90
25	ME-4-J-025	1.55	.93
30	ME-4-J-030	1.60	.96
35	ME-7-J-035	1.70	1.02
40	ME-7-J-040	1.75	1.05
50	ME-7-J-050	1.75	1.05
100VDCW			
1	ME-2-M-001	1.35	.81
2	ME-2-M-002	1.40	.84
3	ME-2-M-003	1.40	.84
4	ME-3-M-004	1.40	.84
5	ME-3-M-005	1.50	.90
6	ME-4-M-006	1.50	.90
8	ME-4-M-008	1.55	.93
10	ME-4-M-010	1.55	.93
15	ME-7-M-015	1.55	.93
20	ME-7-M-020	1.60	.96
25	ME-7-M-025	1.60	.96
150VDCW			
1	ME-3-N-001	1.40	.84
2	ME-3-N-002	1.45	.87
3	ME-3-N-003	1.45	.87
4	ME-3-N-004	1.45	.87
5	ME-3-N-005	1.55	.93
6	ME-3-N-006	1.55	.93
8	ME-4-N-008	1.60	.96
10	ME-4-N-010	1.60	.96
12	ME-4-N-012	1.60	.96
15	ME-7-N-015	1.60	.96
20	ME-8-N-020	1.60	.96
250VDCW			
1	ME-3-R-001	1.70	1.02
2	ME-3-R-002	1.70	1.02
5	ME-6-R-005	1.80	1.08
350VDCW			
1	ME-3-T-001	1.75	1.05
2	ME-5-T-002	1.75	1.05

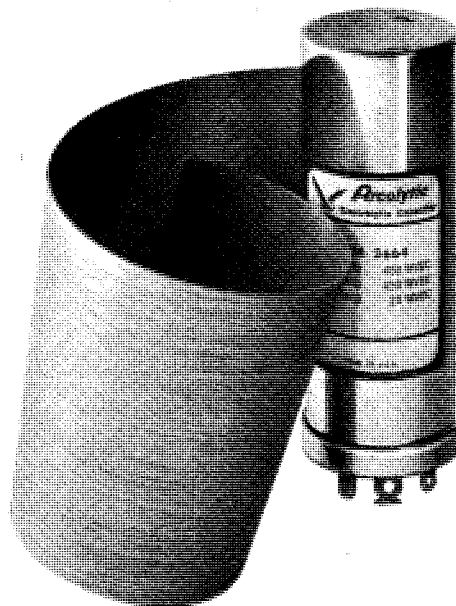

Why do we wind all our tv-replacement capacitors with computer-grade 99.99% pure aluminum foil?

To help cure that pain in your neck.

Impurities in aluminum foil can lead to deterioration, premature failures, lost customer confidence—and call-back time you can't charge for. Big pains in the neck.

So we wind every Arcolytic® electrolytic capacitor with the purest aluminum foil available: 99.99% pure. It meets computer manufacturer standards. And exceeds those of radio-tv manufacturers.

Result: Arcolytic capacitors last longer in your customer's set. In fact, they won't deteriorate even at high operating temperatures of 85° C.

And while we wind them with computer-grade foil, we price them for home-entertainment service. You pay no premium.

You'll find whatever discrete capacitance value you need at your LDP Distributor's. And in your choice of single- and multiple-section tubular, or twist-mount designs. (You'll also find a complete line of equivalent-quality miniature ceramic disc capacitors up to 6000 VDCW.)

Start using Arcolytic capacitors. And the next call from your customer will be because he likes your kind of reliability, and wants more of your service.

WRITE FOR YOUR COPY OF THE COMPLETE

ARCOLYTIC CAPACITOR CATALOG

NET (For quantities of 25 or more, please contact your local Arco-Elmenco distributor).

Sold Nationally to Electronic Parts Distributors by: Loral Distributor Products, a Division of Loral Corporation

Amperex Capacitors

ELECTROLYTIC CAPACITORS

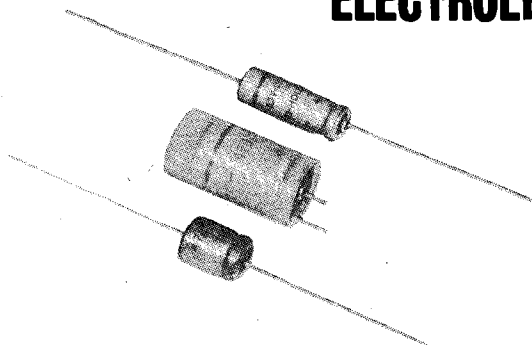

C426AR Series

CAN SIZE	DIMENSIONS*		CAPACITANCES — μ f							
	Length (in.)	Dia. (in.)	2.5 Voits	4.0 Voits	6.4 Voits	10 Voits	16 Voits	25 Voits	40 Voits	64 Voits
1	0.394	0.122	10	8	6.4	4	2.5	1.6	1	0.64
2	0.394	0.173	40	32	25	16	10	6.4	4	2.5
3	0.394	0.228	80	64	50	32	20	12.5	8	5
4	0.709	0.248	160	125	100	64	40	25	16	10
5	0.709	0.315	320	250	200	125	80	50	32	20
6	0.709	0.394	500	400	320	200	125	80	50	32

Amperex high quality, low cost electrolytic capacitors feature small size, high capacitance and long service life. Low leakage currents are achieved through the use of highly purified materials and carefully controlled manufacturing processes. They are the "dry" type with the liquid electrolyte absorbed into a layer of paper between cathode and anode foils. Winding is sealed in an aluminum can.

They are designed to operate at varied efficiencies over a temperature range of -40°C to $+85^{\circ}\text{C}$. The min. and max. temp. depends on the application; increase of impedance and losses are the limiting factors.

C437AR Series

CAN SIZE	DIMENSIONS*		CAPACITANCES — μ f							
	Length (in.)	Dia. (in.)	2.5 Voits	4.0 Voits	6.4 Voits	10 Voits	16 Voits	25 Voits	40 Voits	64 Voits
00	1.18	0.394	1000	800	640	400	250	160	100	64
01	1.18	0.492	1600	1250	1000	640	400	250	160	100
02	1.18	0.591	2500	2000	1600	1000	640	400	250	160
03	1.18	0.709	4000	3200	2500	1600	1000	640	400	250

*Includes Insulation

FILM CAPACITORS

Fixed Film Dielectric Capacitors

METALLIZED POLYCARBONATE

Metallized polycarbonate capacitors offer 125°C operation with no voltage de-rating, extreme capacitance stability with temperature, and low dissipation factor. High insulation resistance coupled with small physical size make these capacitors ideally suited for the most critical applications.

C280M Series



C281 Series

100VDC from .047 mfd to 6.8 mfd
400VDC from .01 mfd to 1.0 mfd
630VDC from .01 mfd to .47 mfd

METALLIZED POLYESTER

Available in 250VDC rating from .001 mfd to 2.2 mfd. Offer small size and cost advantages and are suitable for all general purpose applications.

C280AE Series



(Also available in C280M and C281 packaging configuration)

Variable Capacitors

CERAMIC DIELECTRIC

For high freq. temp.-compensating applications requiring low Zero capacitance. Feature high breakdown voltage, stability and accuracy of adjustment.

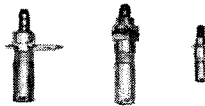
C004 Series
(typical configurations)

FILM DIELECTRIC

The CO10 is a general trimmer used when large Delta 'C' variations are required and space is limited. Adjustable top and bottom, available in following min.-max. ranges: 2pf-10pf, 5pf-20pf, 5pf-60pf.

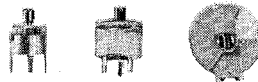

CO10/HT10 Series

HT10 TEFLON® SERIES

For applications requiring guaranteed Delta 'C' and where capacitance-variation is unaffected by temp. of 125° and higher. Same ranges as CO10 (above).

®DuPont Trademark

AMPEREX ELECTRONIC CORPORATION

Amperex®

TOMORROW'S THINKING IN TODAY'S PRODUCTS



CENTRALAB
Electronics Division
GLOBE-UNION INC.

Type DDM, DDM2 Low Voltage Discs

150 VDCW (300 VDC TEST)

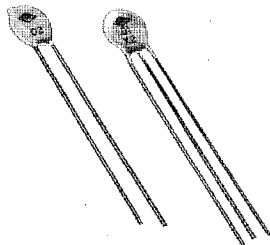

Designed for applications where voltages are higher and proper safety factors will not permit the use of lower voltage units. Durez⁺ coated and high temperature wax impregnated.

SPECIFICATIONS

OPERATING TEMPERATURE: -55°C to +85°C.

CAPACITY AND TOLERANCE: See Listing.

LEADS: #22 tinned wire 1½" minimum length.

TEMPERATURE VS. CAPACITANCE: EIA Z5V or better (+22 -82% maximum capacity change from 25°C reading over temperature range of +10°C to +85°C).

DISSIPATION FACTOR: 2% maximum @ 1KC.

LEAKAGE RESISTANCE: Initial 7500 megohms min.; after humidity over 1000 megohms.

MARKING: Stamped with capacity, voltage and CRL diamond.

PACKAGED: 5 pieces per plastic box or 100 pieces bulk per carton.—Warehouse Pak.

Cap. (μF)	Cat. No.	Max. Dia.	Max. Thickness	Lead Spacing	Tolerance
.005	DDM-502	.390"	.156"	.250"	+60 -40%
.01	DDM-103	.390"	.156"	.250"	+60 -40%
.02	DDM-203	.406"	.166"	.250"	+60 -40%
2 x .01	DDM2-103	.406"	.186"	.094"	+60 -40%

Type DD2

600 VDCW—1200 VDC TEST

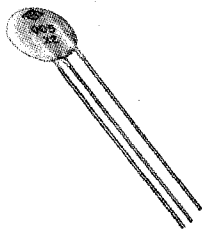

Type DD2—single disc dual capacity. Double "Durez" insulation. Stamped with capacity. Packaged 5 pieces per clear plastic box or 100 pieces bulk per carton.

Cap. Mfd. (μF)	Cat. No.	Max. Dia.	Max. Thick.	Lead Spacing	Tolerance
2 x .001	DD2-152	.408"	.156"	.125"	GMV
2 x .0015	DD2-152	.594"	.156"	.125"	GMV
2 x .005	DD2-502	.719"	.156"	.125"	+80 -20%

Type DM, DM2 Low Voltage

150 VOLTS DCW (300 VDC TEST)

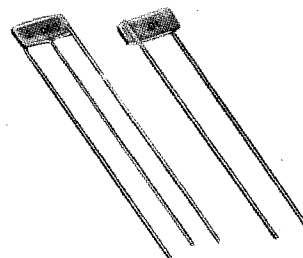

Miniature plate capacitors. Durez coated and high temperature wax impregnated.

SPECIFICATIONS

OPERATING TEMPERATURE: -55°C to +85°C.

CAPACITY AND TOLERANCE: See Listing.

LEADS: Tinned wire 1½" minimum lengths. DM-101, DM-201, DM-301, DM-501 and DM-102 have #24 wire leads. All others #26.

TEMPERATURE VS. CAPACITANCE: EIA Z5V or better (+22 -82% maximum capacity change from 25°C reading over temperature range of +10°C to +85°C).

MARKING: Stamped with capacity and CRL and PEC in individual diamonds.

PACKAGED: 5 pieces per plastic box of 100 pieces bulk per carton.

Cap. (pF)	Cat. No.	Tolerance	Length	SIZE Width	Thick-ness
100	DM-101	+50 -20%	1½"	½"	¼"
200	DM-201	+50 -20%	1½"	½"	¼"
300	DM-301	+50 -20%	1½"	½"	¼"
500	DM-501	+30 -20%	1½"	½"	¼"
Cap. (μF)	Cat. No.	Tolerance	Length	SIZE Width	Thick-ness
.001	DM-102	+50 -30%	1½"	½"	¼"
.002	DM-202	+80 -20%	1½"	½"	¼"
.003	DM-302	+80 -20%	1½"	½"	¼"
.005	DM-502	+80 -20%	1½"	½"	¼"
.01	DM-103	+80 -20%	1½"	½"	¼"
2 x .005	DM2-502	+20 -20%	1½"	½"	¼"

Type DD3

600 VDCW—1200 VDC TEST

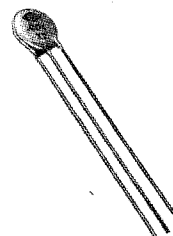

Type DD3—dual disc—two capacitors in the space required for one standard unit and shielded to minimize stray capacities between discs. Double "Durez" insulation. Stamped with capacity. Packaged 5 pieces per clear plastic box or 100 pieces bulk per carton.

PATENTED SHIELDED CONSTRUCTION

Cap. Mfd. (μF)	Cat. No.	Max. Dia.	Max. Thick.	Lead Spacing	Tolerance
2 x .001	DD3-102	.391"	.186"	.125"	GMV
2 x .0015	DD3-152	.391"	.186"	.125"	GMV
2 x .002	DD3-202	.593"	.225"	.125"	GMV
2 x .005	DD3-502	.593"	.225"	.125"	GMV
2 x .01	DD3-103	.719"	.225"	.125"	GMV

*Trademark

Type DD30 and DD60



Type DF Flat Plate

600 VDCW-1200 VDC TEST

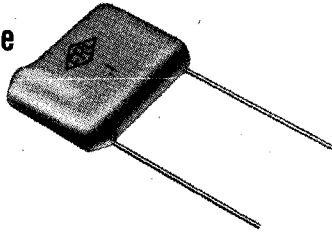

High capacity, low mass weight, unusual thin design plus inherent Centralab ceramic stability and permanence have made these units extremely popular as by-pass and filter capacitors and are excellent for audio coupling applications. No. 20 tinned wire leads. Packaged 2 pieces per clear plastic box or 50 pieces bulk per carton.

Cap. Mfd. (μF)	Cat. No.	Max. Dimensions	Lead Spacing	Tolerance
.05	DF-503	1 3/8" x 1 1/8" x 7/32"	7/8"	GMV
.1	DF-104	1 3/8" x 1 1/8" x 1/4"	7/8"	+80 -20%

Type DD16

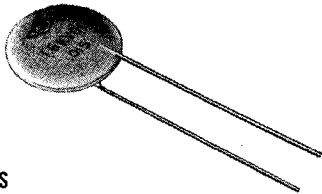

SPECIFICATIONS

VOLTAGE: 1600 VDCW, 3200 VDC test

SIZE: See listing

CAPACITY: .003 mfd. (μF thru) .015 mfd. (μF)

TOLERANCE: GMV, except DD16-153 which is +80 -20%

LEADS: #22 tinned copper wire

INSULATION: Double coating of "Durez" and high temperature wax impregnation

TEMPERATURE VS. CAPACITANCE: Will meet EIA 25U (+22% to -56% from +10°C to +85°C)

MARKING: Stamped with capacity and voltage. Tolerance also stamped on DD16-153.

PACKAGED: 5 pieces per plastic box or 100 pieces bulk per carton

TYPE DD16-HI-KAP BUFFERS

Cap. Mfd. (μF)	Cat. No.	Tolerance	Max. Dia.	Max. Thick-ness	Lead Spacing
.003	DD16-302	GMV	.605"	.172"	.375"
.004	DD16-402	GMV	.605"	.172"	.375"
.005	DD16-502	GMV	.605"	.172"	.375"
.006	DD16-602	GMV	.705"	.172"	.375"
.007	DD16-702	GMV	.705"	.172"	.375"
.0075	DD16-752	GMV	.835"	.172"	.375"
.008	DD16-802	GMV	.835"	.172"	.375"
.01	DD16-103	GMV	.835"	.172"	.375"
.015	DD16-153	+80 -20%	.935"	.172"	.375"

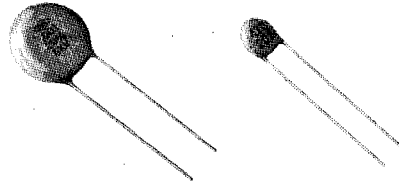

Centralab Hi-Vo Disc capacitors are designed to guarantee superior quality and extra performance. These Hi-Vo-Kaps® are tested at twice working voltage before shipment and exceed EIA-RS-165 life test. These ceramic capacitors are highly efficient for by-pass coupling in high frequency circuits under conditions of extreme humidity or temperature.

SPECIFICATIONS

OPERATING TEMPERATURE RANGE: -55°C to +85°C

VOLTAGE: DD30 series: 3000 VDCW, 6000 VDCT

DD60 series: 6000 VDCW-12,000 VDC Test

LIFE TEST: Per EIA-RS-165

SIZE: See Listing

CAPACITY: See listing

CAPACITY TEST: Test DD30-4R7 thru DD30-820 and DD60-4R7 thru DD60-151 at 1MC. Test all other DD30- and DD60-values at 1KC.

TOLERANCE: DD30 series and DD60 series all units ±20%

LEAKAGE RESISTANCE: Initial, over 10,000 megohms; after humidity, over 1000 megohms

LEADS: #22 tinned copper wire, 1 1/2" minimum length

DISSIPATION FACTOR: 2% maximum @ 1KC

INSULATION: Double coating of "Durez" and high temperature wax impregnation

TEMPERATURE VS. CAPACITANCE: EIA "25U" or better (+22% to -56% maximum capacity change from +25°C reading over temperature range of +10°C to +85°C).

MARKING: Stamped with capacity, tolerance and voltage

PACKAGED: 5 pieces per clear plastic box or 50 pieces bulk per carton.

TYPES DD30 AND DD60 HI-KAPS

CRL Size Code	60	61	62	63	67
Maximum Diameter					
DD30 Series	.330"	.430"	.630"	.730"	.800"
DD60 Series660"	.760"	.830"
Maximum Thickness					
DD30 Series	.203"	.203"	.203"	.203"	.203"
DD60 Series	.313"	.313"	.313"	.313"	.313"
Lead Spacing (±.060)	.250"	.250"	.375"	.375"	.375"

Cap. (pF)	Cat. No. 3000 V.D.C.W.	CRL Size	Cat. No. 6000 V.D.C.W.	CRL Size
4.7	DD30-4R7	60	DD60-4R7	62
10	DD30-100	60	DD60-100	62
15	DD30-150	60	DD60-150	62
22	DD30-220	60
25	DD30-250	60
30	DD30-300	60	DD60-300	62
33	DD30-330	60	DD60-330	62
39	DD30-390	60	DD60-390	62
47	DD30-470	60	DD60-470	62
50	DD30-500	60	DD60-500	62
56	DD30-560	60	DD60-560	62
68	DD30-680	60	DD60-680	62
75	DD30-750	60	DD60-750	62
82	DD30-820	60	DD60-820	62
100	DD30-101	60	DD60-101	62
120	DD30-121	60	DD60-121	62
150	DD30-151	60	DD60-151	62
180	DD30-181	60	DD60-181	62
200	DD30-201	60	DD60-201	62
220	DD30-221	60	DD60-221	62
250	DD30-251	60	DD60-251	62
270	DD30-271	60	DD60-271	62
300	DD30-301	60	DD60-301	62
330	DD30-331	60	DD60-331	62
390	DD30-391	60	DD60-391	62
400	DD30-401	60
470	DD30-471	60	DD60-471	62
500	DD30-501	60	DD60-501	62
560	DD30-561	60	DD60-561	62
680	DD30-681	60	DD60-681	62
750	DD30-751	60	DD60-751	62
820	DD30-821	61	DD60-821	62

Cap. (μF)				
.001	DD30-102	61	DD60-102	62
.0012	DD30-122	61	DD60-122	62
.0015	DD30-152	62	DD60-152	62
.002	DD30-202	62	DD60-202	63
.0022	DD30-222	62	DD60-222	63
.0025	DD30-252	62
.0027	DD30-272	62
.003	DD30-302	62
.0033	DD30-332	62
.0039	DD30-392	63
.0047	DD30-472	63
.005	DD30-502	67

Type TCZ, TCN, TCA, TCL Temperature Compensating Tubular



CENTRALAB
Electronics Division
GLOBE-UNION INC.

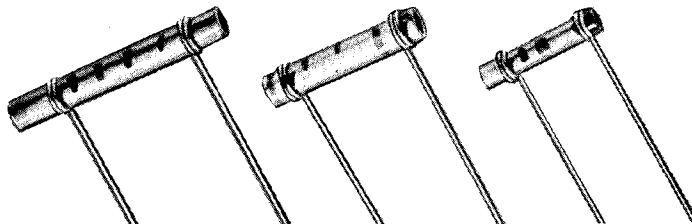

TYPE TCA—N330 T.C. TUBULAR

A new group of intermediate stock values allow additional T.C. values without combining NPO and N750 capacitors. This group changes negatively capacity-wise with temperature increases at the rate of 330 parts per million per degree C. Left end coded green, with leads away from you in the up position. See 5-Dot Color Code Chart.

Cap. Mmf.	Tolerance	Cat. No.	Size Type	Temp. Coeff.	T.C. Tol. PPM/°C
10	±.5 pF	TCA-10	CC20	N330	±60
15	±2%	TCA-15	CC20	N330	±60
22	±2%	TCA-22	CC20	N330	±60
33	±2%	TCA-33	CC20	N330	±60
47	±2%	TCA-47	CC30	N330	±60
68	±2%	TCA-68	CC25	N330	±60
100	±2%	TCA-100	CC25	N330	±60

TYPE TCL—N1500 T.C. TUBULAR

Show negative capacity change of minus 1500 parts per million per degree C. rise in temperature. Left end coded orange plus an orange stripe. (See 6-Dot Color Coding Chart.)

Cap. Mmf.	Tolerance	Cat. No.	Size Type	Temp. Coeff.	T.C. Tol. PPM/°C
10	±.5 pF	TCL-10	CC20	N1500	±250
15	±2%	TCL-15	CC20	N1500	±250
22	±2%	TCL-22	CC20	N1500	±250
33	±2%	TCL-33	CC20	N1500	±250
47	±2%	TCL-47	CC20	N1500	±250
68	±2%	TCL-68	CC20	N1500	±250
100	±2%	TCL-100	CC30	N1500	±250

See opposite page for other specifications and also T.C. discs.

TYPE TCZ—NPO OR ZERO T.C.

NOTE: Zero T.C. units (Type TCZ) are superior to micas for all applications and recommended as replacements for mica capacitors in any circuit.

Show zero capacitance changeover temperature range -20° to +85°C. Left end coded black, with leads away from you in the up position. (See 5-Dot Color Code Chart.)

Cap. (pF)	Tolerance	Cat. No.	Size Type	Temp. Coeff.	T.C. Tol. PPM/°C
.5	±.25 pF	TCZ-R5	CC20	NPO	±250
.68	±.25 pF	TCZ-R68	CC20	NPO	±250
1.0	±.25 pF	TCZ-1	CC20	NPO	±250
1.5	±.25 pF	TCZ-1R5	CC20	NPO	±250
2.2	±.25 pF	TCZ-2R2	CC20	NPO	±120
3.3	±.25 pF	TCZ-3R3	CC20	NPO	±120
4.7	±.5 pF	TCZ-4R7	CC20	NPO	±60
6.8	±.5 pF	TCZ-6R8	CC20	NPO	±60
10	±.5 pF	TCZ-10	CC20	NPO	±30
12	±2%	TCZ-12	CC20	NPO	±30
15	±2%	TCZ-15	CC20	NPO	±30
18	±2%	TCZ-18	CC20	NPO	±30
20	±2%	TCZ-20	CC20	NPO	±30
22	±2%	TCZ-22	CC20	NPO	±30
24	±2%	TCZ-24	CC20	NPO	±30
25	±2%	TCZ-25	CC30	NPO	±30
27	±2%	TCZ-27	CC30	NPO	±30
30	±2%	TCZ-30	CC30	NPO	±30
33	±2%	TCZ-33	CC30	NPO	±30
36	±2%	TCZ-36	CC30	NPO	±30
39	±2%	TCZ-39	CC25	NPO	±30
43	±2%	TCZ-43	CC25	NPO	±30
47	±2%	TCZ-47	CC25	NPO	±30
50	±2%	TCZ-50	CC25	NPO	±30
51	±2%	TCZ-51	CC25	NPO	±30
56	±2%	TCZ-56	CC25	NPO	±30
62	±2%	TCZ-62	CC32	NPO	±30
68	±2%	TCZ-68	CC32	NPO	±30
75	±2%	TCZ-75	CC32	NPO	±30
82	±2%	TCZ-82	CC32	NPO	±30
91	±2%	TCZ-91	CC32	NPO	±30
100	±2%	TCZ-100	CC32	NPO	±30
110	±5%	TCZ-110	CC35	NPO	±30
120	±5%	TCZ-120	CC35	NPO	±30
130	±5%	TCZ-130	CC35	NPO	±30
150	±5%	TCZ-150	CC35	NPO	±30
160	±5%	TCZ-160	CC35	NPO	±30
180	±5%	TCZ-180	CC35	NPO	±30
200	±5%	TCZ-200	CC35	NPO	±30
220	±5%	TCZ-220	CC45	NPO	±30
240	±5%	TCZ-240	CC45	NPO	±30
270	±5%	TCZ-270	CC45	NPO	±30
300	±5%	TCZ-300	CC45	NPO	±30

Centralab T.C. (temperature compensating) ceramic tubular and disc capacitors are available in zero and negative temperature coefficients to compensate for changes in other components due to temperature changes. Special lacquer coating only on the tubular series reduces to a minimum the time lag between temperature change and corrective capacity compensation.

SPECIFICATIONS

OPERATING TEMPERATURE RANGE: -55°C to +85°C

VOLTAGE: 600 VDCW, 1500 VDC Flash Test

LIFE TEST: 1000 VDC @ 1000 hours @ 85°C.

SIZE: See listings

CAPACITIES: Tubulars - NPO, 0.5 pF thru 300 pF; N750, 3.3 pF thru 750 pF; N330, 10 pF thru 100 pF; N1500, 10 pF thru 100 pF. Discs - NPO, 1.5 pF thru 270 pF; N750, 5 pF thru 330 pF.

TOLERANCES: See listings.

LEAKAGE RESISTANCE: Initial, 10,000 megohms minimum; after humidity, 1000 megohms minimum.

DISSIPATION FACTOR: Per EIA RS-198 Class 1.

TEMPERATURE VS. CAPACITANCE: T.C. tolerances per listings apply over a temperature range of +25°C to +85°C.

INSULATION: Tubulars, special lacquer coating; discs, durez coated and high temperature vacuum wax impregnated.

LEADS: #22 tinned copper, 1½" minimum length.

MARKING: Tubulars, color coded per 5 and 6 dot color code chart; (Per EIA RS-198 Class 1). Discs, stamped with capacity, tolerance and nominal T.C. value.

CAPACITY TESTS: Capacitance shall be within limits specified at +25°C with 0.5 to 5 volts RMS at a frequency of 1MC.

PACKAGED: 2 pieces per clear plastic box or 50 pieces bulk per carton.

TYPE TCN—N750 T.C.

Show negative capacity of minus 750 parts per million per degree C. rise in temperature. Left end coded violet, with leads away from you in the up position. See 5-Dot Color Code Chart.

Cap. (pF)	Tolerance	Cat. No.	Size Type	Temp. Coeff.	T.C. Tol. PPM/°C
3.3	±.5 pF	TCN-3R3	CC20	N750	±120
5	±.5 pF	TCN-5	CC20	N750	±120
10	±.5 pF	TCN-10	CC20	N750	±120
12	±2%	TCN-12	CC20	N750	±120
15	±2%	TCN-15	CC20	N750	±120
18	±2%	TCN-18	CC20	N750	±120
20	±2%	TCN-20	CC20	N750	±120
22	±2%	TCN-22	CC20	N750	±120
24	±2%	TCN-24	CC20	N750	±120
25	±2%	TCN-25	CC20	N750	±120
27	±2%	TCN-27	CC20	N750	±120
30	±2%	TCN-30	CC20	N750	±120
33	±2%	TCN-33	CC20	N750	±120
36	±2%	TCN-36	CC20	N750	±120
39	±2%	TCN-39	CC20	N750	±120
43	±2%	TCN-43	CC20	N750	±120
47	±2%	TCN-47	CC20	N750	±120
50	±2%	TCN-50	CC20	N750	±120
51	±2%	TCN-51	CC20	N750	±120
56	±2%	TCN-56	CC20	N750	±120
62	±2%	TCN-62	CC30	N750	±120
68	±2%	TCN-68	CC30	N750	±120
75	±2%	TCN-75	CC30	N750	±120
82	±2%	TCN-82	CC30	N750	±120
91	±2%	TCN-91	CC25	N750	±120
100	±2%	TCN-100	CC25	N750	±120
110	±5%	TCN-110	CC25	N750	±120
120	±5%	TCN-120	CC25	N750	±120
130	±5%	TCN-130	CC25	N750	±120
150	±5%	TCN-150	CC25	N750	±120
160	±5%	TCN-160	CC32	N750	±120
180	±5%	TCN-180	CC32	N750	±120
200	±5%	TCN-200	CC32	N750	±120
220	±5%	TCN-220	CC32	N750	±120
240	±5%	TCN-240	CC32	N750	±120
270	±5%	TCN-270	CC35	N750	±120
300	±5%	TCN-300	CC35	N750	±120
330	±5%	TCN-330	CC35	N750	±120
360	±5%	TCN-360	CC35	N750	±120
390	±5%	TCN-390	CC35	N750	±120
430	±5%	TCN-430	CC35	N750	±120
470	±5%	TCN-470	CC35	N750	±120
510	±5%	TCN-510	CC35	N750	±120
560	±5%	TCN-560	CC45	N750	±120
620	±5%	TCN-620	CC45	N750	±120
680	±5%	TCN-680	CC45	N750	±120
750	±5%	TCN-750	CC45	N750	±120

CERAMIC TRIMMER CAPACITORS



CENTRALAB
Electronics Division
GLOBE-UNION INC.

Centralab Ceramic Trimmers are small in size, light in weight and are easily mounted. Equal stability over 180° rotation is maintained even under adverse environmental conditions.

To eliminate any air film on the contact surfaces, mating surfaces of rotor and stator are ground optically flat and lubricated with silicone oil.

Type 820 Trimmer

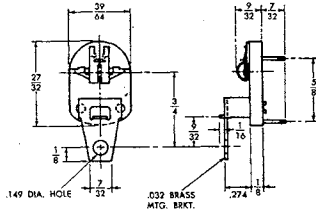
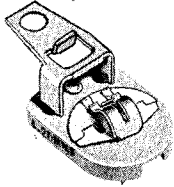

VOLTAGE RATING: 500 VDCW, 1500 VDCT
POWER FACTOR: Less than .2% @ 1 MC
TERMINALS: Brass, silver-plated, bent down 90° from plane of stator.
INSULATION RESISTANCE: 10,000 megohms min.
MOUNTING: Holes clear No. 4 machine screws (without bracket) spaced .375 centers. Bracket used for single hole mounting.
PACKAGED: Singly, or 5 pcs. bulk per carton.

Cap. pF	Cat. No.	Cap. pF	Cat. No.
1.0 to 3.5	820D	35.0 to 55.0	820E
2.5 to 6.0	820A	55.0 to 75.0	820F
5.0 to 20.0	820B	70.0 to 90.0	820G
7.0 to 35.0	820C		

All with bracket except 820E, 820F and 820G.

Type 822 Trimmer

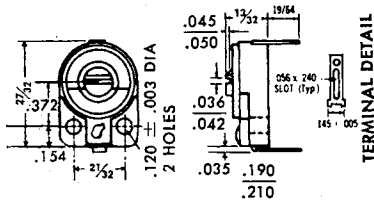
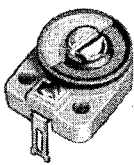

VOLTAGE RATING: 500 VDCW, 1500 VDCT
POWER FACTOR: Less than .2% @ 1 MC
SIZE: Same as 825.
TERMINALS: Brass, silver-plated, bent down 90° from plane of stator.
INSULATION RESISTANCE: 10,000 megohms min.
MOUNTING: Holes clear No. 4 machine screws
PACKAGED: Singly, or 5 pcs. bulk per carton.

NPO or Zero TC		N650 or Negative TC	
Cap. (pF)	Cat. No.	Cap. (pF)	Cat. No.
1.5 to 3	822-DZ	2.0 to 6.0	822-DN
1.5 to 7	822-EZ	4.0 to 30.0	822-EN
2.0 to 7.5	822-CZ	4.5 to 25.0	822-CN
2.5 to 13.0	822-BZ	7.0 to 45.0	822-BN
3.0 to 12.0	822-FZ	8.0 to 50.0	822-AN
4.5 to 25.0	822-AZ		

Type 823 Trimmer

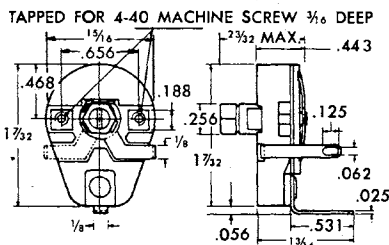
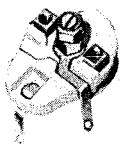

VOLTAGE RATING: 500 VDCW, 1500 VDCT
POWER FACTOR: Less than .2% @ 1 MC
TERMINALS: Brass, silver-plated, bent down 90° from plane of stator.
INSULATION RESISTANCE: 10,000 megohms min.
MOUNTING: Studs are set in base, tapped for 440 machine screws
PACKAGED: Singly, or 5 pcs. bulk per carton.

NPO or Zero TC		N650 or Negative TC	
Cap. pF	Cat. No.	Cap. pF	Cat. No.
5.0 to 12	823-EZ	5.0 to 15	823-FN
6 to 25	823-DZ	8 to 25	823-EN
10 to 50	823-BZ	8 to 50	823-DN
12 to 62	823-AZ	10 to 100	823-BN
		20 to 125	823-AN

Type 825 Trimmer

The new 825 series of ceramic trimmer capacitors are manufactured to meet the specifications of MIL-C-81A.

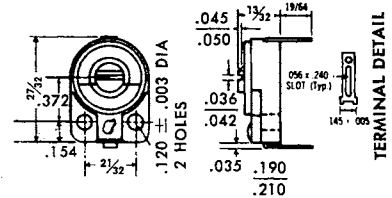
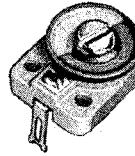

VOLTAGE RATING: 500 VDCW, 1500 VDCT
POWER FACTOR: Less than .2% @ 1 MC
CAPACITANCE DRIFT: ±.75% or ±.5 mmf, whichever is greater.
TERMINALS: Brass, silver-plated. Terminals bent at 90° angle from plane of stator, 1/8" long.
INSULATION RESISTANCE: 10,000 megohms min.
PACKAGED: Singly, or 5 pcs. bulk per carton.

NPO or Zero TC			N650 or Negative TC		
Cap. pF	CRL Cat. No.	MIL-C-81A Number	Cap. pF	CRL Cat. No.	MIL-C-81A Number
1.5 to 7	825-EZ	CV11A070	2.0 to 6	825-DN	CV11D060
3.0 to 12	825-FZ	CV11A120	4.0 to 30	825-EN	CV11D300
4.5 to 25	825-AZ	CV11A250	7.0 to 45	825-BN	CV11D450

Capacitance Range	CRL Cat. No.	Military Designation	Temperature Characteristic
3.0 to 13.0	825-AN	CV11B130	N300
5.0 to 20.0	825-FN	CV11B200	N300
4.0 to 30.0	825-CN	CV11C300	N500
7.0 to 45.0	825-GN	CV11C450	N500

Type 827 Trimmer

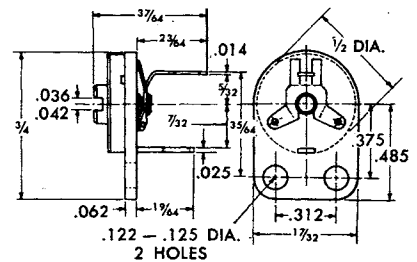
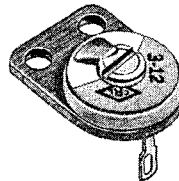

VOLTAGE RATING: 500 VDCW, 1000 VDCT
POWER FACTOR: Less than .2% @ 1 MC
SIZE: 1 1/2" wide, 3/4" long
TERMINALS: Brass, silver-plated, bent down 90° from plane of stator.
INSULATION RESISTANCE: Greater than 10,000 megohms.
MOUNTING: High grade phenolic mounting plate. Two .122"-.125" mounting holes spaced 3/8" apart. Can be mounted on chassis through 3/8" diameter hole.
PACKAGED: Singly, or 5 pcs. bulk per carton.

Cap. pF	Cat. No.	Cap. pF	Cat. No.
2.5 to 7	827A	6.0 to 30	827C
3.5 to 12	827B	7.0 to 35	827D

Type 829 Tubular Trimmer

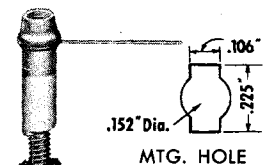

VOLTAGE RATING: 500 VDCW, 1000 VDCT
POWER FACTOR: Less than .25% @ 1 MC
SIZE: See listing
LEADS: AWG No. 22 tinned wire
INSULATION RESISTANCE: Greater than 10,000 megohms.
MOUNTING: Perpendicular to panel by means of special locknut.
PACKAGED: 2 pcs. per pkg., or 25 bulk per carton, including locknuts.

Cap. Range pF	Body Length	Cat. No.
0.5 to 3.0	1/2"	829-3
1.0 to 4.0	3/4"	829-4
1.0 to 6.0	5/8"	829-6
1.0 to 7.5	3/4"	829-7
1.5 to 10.0	3/4"	829-10

**whatever electronic products
you require...**



**...you'll find it
faster in
this catalog...**

**...the world's largest catalog
of electronic
products
sold through
distributors**



THE HAMMARLUND

MANUFACTURING COMPANY INCORPORATED

A Subsidiary of Electronic Assistance Corporation

88 STANDARD TYPES OF VARIABLE AIR CAPACITORS

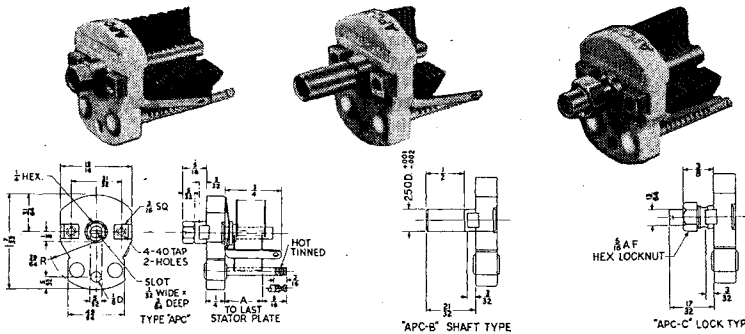

Capacitor Type	Net Price	Capacitor Type	Net Price
APC-25	\$ 1.20	APC-100-B	\$ 1.70
APC-50	1.35	APC-140-B	1.90
APC-75	1.45	APC-25-C	1.85
APC-100	1.60	APC-50-C	2.00
APC-140	1.80	APC-75-C	2.10
APC-25-B	1.30	APC-100-C	2.25
APC-50-B	1.40	APC-140-C	2.45
APC-75-B	1.50		

APC capacitors are available in three basic groups. The original APC group is furnished with a hex collar on a slotted shaft as indicated in the drawing. The APC-"B" group is furnished with 1/4" diameter shafts to permit adjustment of

the capacitance with a front panel knob. The APC-"C" group is supplied with slotted shafts for variation of the capacitance and a 3/8" hex locknut to prevent movement of the rotor in equipment subjected to high levels of vibration or shock.

TYPE	CAPACITANCE		PLATES	DIMENSION "A"
	Max.	Min.		
APC-25	25.	3.0	7	21/64
APC-50	50.	3.9	14	1/2
APC-75	75.	4.6	20	11/16
APC-100	100.	5.5	27	59/64
APC-140	140.	6.7	37	1-7/32

Note: When ordering the APC-"B" or "C" type, add the suffix -B or -C to the above listed type number.



FEATURES—The MAPC series is similar to the APC series of capacitors in that identical materials and assembly methods are employed. The silicone treated steatite bases and all brass nickel plated metal parts with exception of the phosphor bronze rotor wiper assure the same type of reliable performance that the APC series provides.

TYPE	CAPACITANCE		PLATES	DIMENSION "A"
	Max.	Min.		
MAPC-15	15	2.3	6	17/64
MAPC-25	25	2.6	10	3/8
MAPC-35	35	2.9	14	15/32
MAPC-50	50	3.2	19	37/64
MAPC-75	75	3.9	29	53/64
MAPC-100	100	4.5	38	1-5/64

Note: When ordering the MAPC-"B" or "C" type, add the suffix -B or -C to the type numbers listed above.

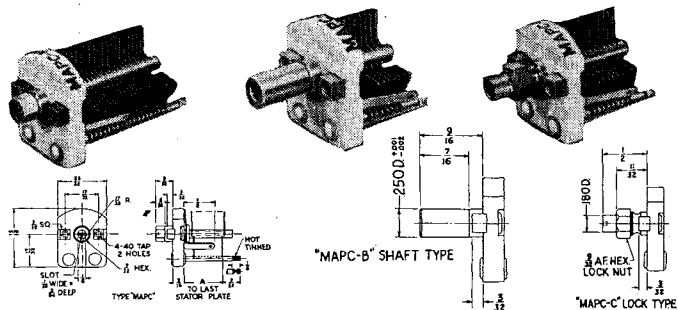

Capacitor Type	Net Price	Capacitor Type	Net Price	Capacitor Type	Net Price
MAPC-15	\$ 1.00	MAPC-15-B	\$ 1.00	MAPC-15-C	\$ 1.35
MAPC-25	1.05	MAPC-25-B	1.05	MAPC-25-C	1.40
MAPC-35	1.10	MAPC-35-B	1.10	MAPC-35-C	1.45
MAPC-50	1.15	MAPC-50-B	1.15	MAPC-50-C	1.50
MAPC-75	1.20	MAPC-75-B	1.20	MAPC-75-C	1.55
MAPC-100	1.30	MAPC-100-B	1.30	MAPC-100-C	1.70



The MAC capacitors provide the low minimum capacitance and inductance essential for trimming and tuning resonant circuits in the VHF and UHF range. The materials employed and the constructional methods are the same as those used in the manufacture of the APC and MAPC series of capacitors.

TYPE	CAPACITANCE		PLATES	DIMENSIONS	
	Max.	Min.		"A"	"B"
MAC-5	5.4	1.3	5	45/64	39/64
MAC-10	9.6	1.5	9	13/16	23/32
MAC-15	15.8	1.9	15	1	29/32
MAC-20	21.5	2.2	21	1-11/64	1-5/64
MAC-30	32.0	2.5	27	1-17/65	1-11/64

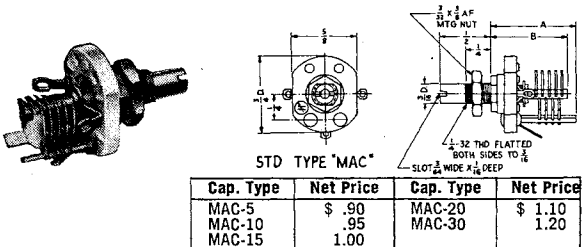

Cap. Type	Net Price	Cap. Type	Net Price
MAC-5	\$.90	MAC-20	\$ 1.10
MAC-10	.95	MAC-30	1.20
MAC-15	1.00		



The BFC capacitors are of the butterfly type permitting operation as a series capacitor without a rotor connection or as a split stator capacitor with provision for grounding the rotor independently from the capacitor mounting studs, which are insulated from the rotor in the silicone treated steatite base.

CODE	CAPACITY/SECTION		SERIES CAPACITY		PLATES		DIMENSION "A"
	Max.	Min.	Max.	Min.	Rotor	Ea. Stator	
BFC-12	14.5	3.4	7.6	2.2	4	3	29/32
BFC-25	27.3	4.8	14.1	2.9	7	6	1-13/64
BFC-38	40.1	6.2	20.6	3.6	10	9	1-1/2

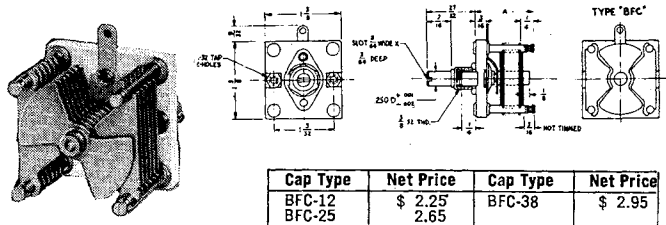

Cap Type	Net Price	Cap Type	Net Price
BFC-12	\$ 2.25	BFC-38	\$ 2.95
BFC-25	2.65		



The FC-46-S is an insulated flexible coupling to provide mechanical ganging of angularly misaligned shafts. The FNC-46-S is non-insulated.
FC-46-S — \$1.50; FNC-46-S — \$1.20.

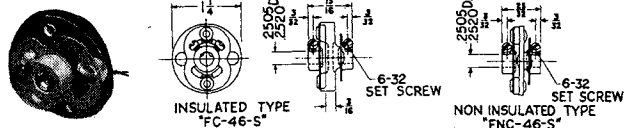

JFD

JFD ELECTRONICS CO./COMPONENTS DIVISION

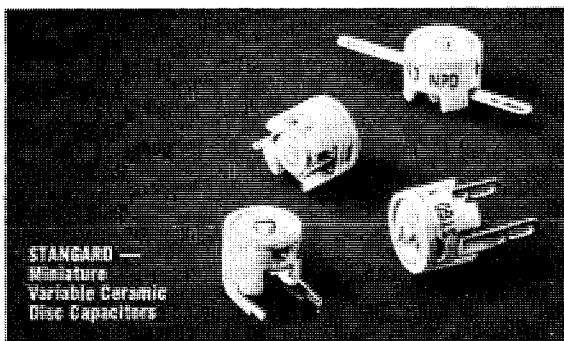

STANDARD —
Miniature
Variable Ceramic
Disc Capacitors

Low-cost for commercial and industrial applications. 9 Δ Cs are available from 2.0 to 60.0 pf in 4 versatile configurations. DV11 Series meets or exceeds applicable MIL-C-81A. Write for catalogs STD-DV/67-A and DVJ-300/66.

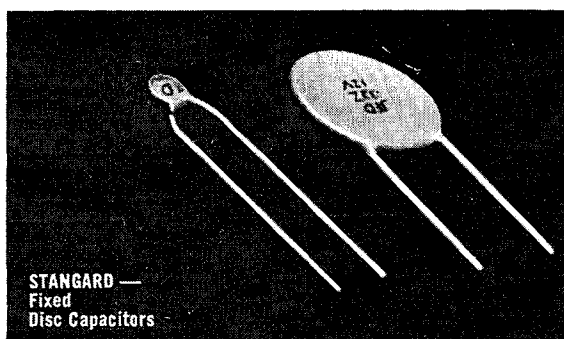

STANDARD —
Fixed
Disc Capacitors

Low-cost for transistor and general commercial circuitry. High K. Available in voltage ratings from 3 volts and higher. Write for catalog STD-FD/67-A.

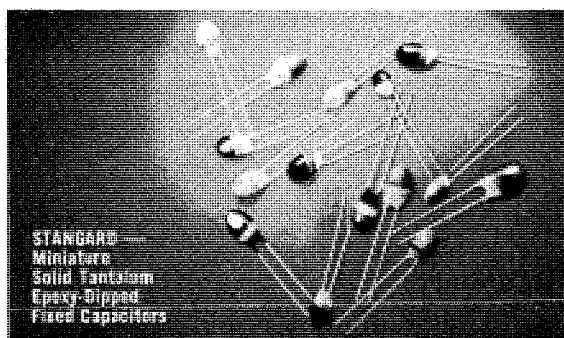

STANDARD —
Miniature
Solid Tantalum
Epoxy-Dipped
Fixed Capacitors

Low-cost for instrument, control, communication systems as well as general commercial circuitry. Capacitance range from 0.1 to 50.0 mfd. Write for catalog STD-TR/67.



DELAY LINES —
Electromagnetic,
Lumped Constant,
Distributed Constant,
Variable and Audio

Top quality, rugged, precision components of proven dependability. High delay to rise time ratios. Mounting methods for a wide variety of circuit applications. Write for catalog DL-68.

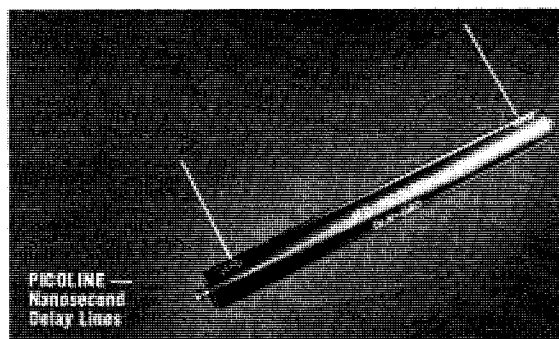

PICOLINE —
Nanosecond
Delay Lines

Ideal for nanosecond delay in high pulse circuitry. Rise time is less than one nanosecond. TC less than 20 PPM/°C. Operating temperature range —55°C to +125°C. Impedance 50 Ω . Write for catalog PL-67.

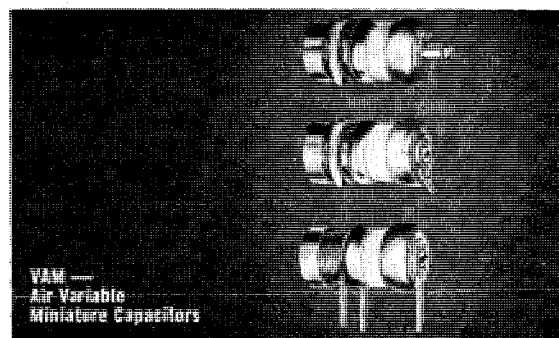

VAM —
Air Variable
Miniature Capacitors

Specially designed for high frequency applications that demand extreme stability, small size and high Q capacitance. Range measured at 1 MHz is 0.8 through 10.0 pf, Q measured at 10 pf and 100 MHz is greater than 2,000. Write for catalog VAM-67-B.

"TODAY'S COMPONENTS BUILT FOR TOMORROW'S CHALLENGES"



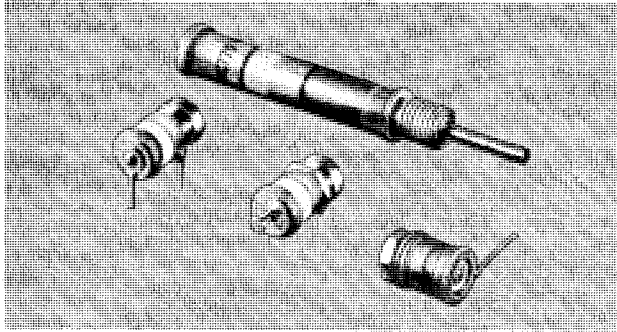

JFD ELECTRONICS CO./COMPONENTS DIVISION



JFD has available the largest selection of Precision Piston Trimmers in the industry—more than 2,500 standard and special designs that meet or exceed MIL-C-14409B.

JFD's unique capacitor-design-capability offers an unmatched number of exclusive features—Seven drive mechanisms incorporating advanced construction... Matched metalizing / homogeneous bond with dielectric... High level shock and vibration resistance... Clean room high reliability units available.

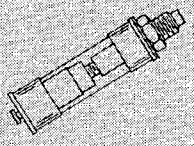
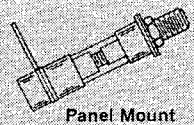
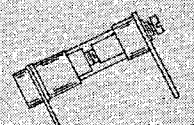
Write for complete catalog #C-67-A "Precision Piston Trimmer and Tuning Capacitors."

SERIES	PANEL MOUNT					PRINTED CIRCUIT					
	JFD No.	Mil. Spec.	Cap. (pf) Min. Max.	Body Length	JFD No.	Mil. Spec.	Cap. (pf) Min. Max.	Body Length			
Max-C High Range Miniature Telescopic Sealed Capacitor Series  (Dia. 5/16 in.)	GLASS ±1/32 in.					GLASS ±1/32 in.					
	NMC601	PC39J160	1.0 16.0	15/32	NMC621	PC43J160	1.0 16.0	.750			
	NMC603	PC39J360	1.0 36.0	45/64	NMC623	PC43J360	1.0 36.0	.990			
	NMC604	PC39J520	1.0 52.0	59/64	NMC624	PC43J520	1.0 52.0	1.205			
	NMC606	PC39J750	1.0 75.0	1 11/64	NMC626	PC43J750	1.0 75.0	1.450			
	NMC609	PC39J121	1.0 120.0	1 49/64	NMC629	PC43J121	1.0 120.0	2.050			
	MC601Y	PC39J140	1.0 14.0	15/32	MC621Y	PC43J140	1.0 14.0	.750			
	MC603Y	PC39J280	1.0 28.0	45/64	MC621	PC43J140	1.0 14.0	.700			
	MC604Y	PC39J420	1.0 42.0	59/64	MC623Y	PC43J280	1.0 28.0	.990			
	MC606Y	PC39J600	1.0 60.0	1 11/64	MC623	PC43J280	1.0 28.0	.940			
	MC609Y	PC39J900	1.0 90.0	1 49/64	MC624Y	PC43J420	1.0 42.0	1.205			
	MC601	PC39J140	1.0 14.0	15/32	MC624	PC43J420	1.0 42.0	1.155			
	MC603	PC39J280	1.0 28.0	45/64	MC626Y	PC43J600	1.0 60.0	1.450			
	MC604	PC39J420	1.0 42.0	59/64	MC626	PC43J600	1.0 60.0	1.400			
	MC606	PC39J600	1.0 60.0	1 11/64	MC629Y	PC43J900	1.0 90.0	2.050			
	MC609	PC39J900	1.0 90.0	1 49/64	MC629	PC43J900	1.0 90.0	2.000			
	Miniature Telescopic Capacitor Series*  Panel Mount  Printed Circuit  Wire Series  Lug & Lead Series (Dia. 1/4 in.)	GLASS +3/64-1/32					GLASS ±1/32 in.				
		NVC20G	PC50J110	0.8 11.0	35/64	NVC9GW	PC51J110	0.8 11.0	9/16		
		NVC21G	PC50J5R5	0.8 5.5	19/64	NVC10GW	PC51J5R5	0.8 5.5	5/16		
		NVC22G	PC50H160	0.8 16.0	3/4	NVC31GW	PC51H160	0.8 16.0	49/64		
NVC23G		PC50H230	0.8 23.0	63/64	NVC32GW	PC51H230	0.8 23.0	1			
NVC24G		PC50H380	1.0 38.0	1 19/32	NVC43GW	PC51H380	1.0 38.0	1 39/64			
VC20GY		PC40J8R5	0.8 8.5	35/64	VC9GWY	PC41J8R5	0.8 8.5	9/16			
VC21GY		PC40J4R5	0.8 4.5	19/64	VC10GWY	PC41J4R5	0.8 4.5	5/16			
VC22GY		PC40H120	0.8 12.0	3/4	VC31GWY	PC41H120	0.8 12.0	49/64			
VC23GY		PC40H180	0.8 18.0	63/64	VC32GWY	PC41H180	0.8 18.0	1			
VC24GY		PC40H300	1.0 30.0	1 19/32	VC43GWY	PC41H300	1.0 30.0	1 39/64			
VC20G		PC40J8R5	0.8 8.5	35/64	VC9GW	PC41J8R5	0.8 8.5	5/16			
VC21G		PC40J4R5	0.8 4.5	19/64	VC10GW	PC41J4R5	0.8 4.5	9/16			
VC22G		PC40H120	0.8 12.0	3/4	VC31GW	PC41H120	0.8 12.0	49/64			
VC23G		PC40H180	0.8 18.0	63/64	VC32GW	PC41H180	0.8 18.0	1			
VC24G		PC40H300	1.0 30.0	1 19/32	VC43GW	PC41H300	1.0 30.0	1 39/64			
QUARTZ +3/64-1/32					QUARTZ ±1/32 in.						
NMQ101		PC40Q1R8	0.6 1.8	19/64	NMQ121	PC41Q1R8	0.6 1.8	5/16			
NMQ103		PC40Q5R5	0.6 5.5	35/64	NMQ123	PC41Q5R5	0.6 5.5	9/16			
NMQ106		PC40Q9R5	0.6 9.5	63/64	NMQ126	PC41Q9R5	0.6 9.5	1			
NMQ109	PC40Q160	0.8 16.0	1 19/32	NMQ129	PC41Q160	0.8 16.0	1 19/32				
MQ101	PC40Q1R8	0.6 1.8	19/64	MQ121	PC41Q1R8	0.6 1.8	5/16				
MQ103	PC40Q5R5	0.6 5.5	35/64	MQ123	PC41Q5R5	0.6 5.5	9/16				
MQ106	PC40Q9R5	0.6 9.5	63/64	MQ126	PC41Q9R5	0.6 9.5	1				
MQ109	PC40Q160	0.8 16.0	1 19/32	MQ129	PC41Q160	0.8 16.0	1 39/64				

TYPICAL SPECIFICATIONS	GLASS	QUARTZ
JFD No./Prefix 'N'	Green Glass dielectric & Hi-Life mechanism	Hi-Life mechanism only
JFD No./Suffix 'Y'	Hi-Life mechanism only	
WVDC	750	750
Dielectric Strength VDC	1,500	1,500
"Q" Minimum at 20 MC	500 min.	1,500 min.
Temperature Coefficient PPM/°C	±50 (-55 to +125°C)	+25 ±25 (-55 to +150°C)
Insulation Resistance megohms	10 ⁶	10 ⁶
Turning Torque inch ounces	1-10	1-10

Body length indicated on Panel Mount only is exclusive of mounting bushing. 'N' and 'Y' Series mounting bushing dimension: 9/32 in. All other 1/4 in., 1/4 in.
 *Miniature Telescopic Capacitor Series available sealed.

Miniature Teflon[®] dielectric trimmer capacitors

E. F. JOHNSON CO.



These new trimming capacitors are ideally suited for VHF and UHF applications requiring low minimum capacity and delta C. They provide high resolution and electrical stability. Tuning is linear. Q is high (2000 at 1 MHz typically). Insulation resistance 10⁶ megohms. Temperature range -55° to +150°C. High resistance to shock and vibration.

Metal parts are gold plated on PC and solder lug types, silver plated on panel mount version. Insulation is Teflon[®].

©Teflon is a registered trade name of DuPont Co.

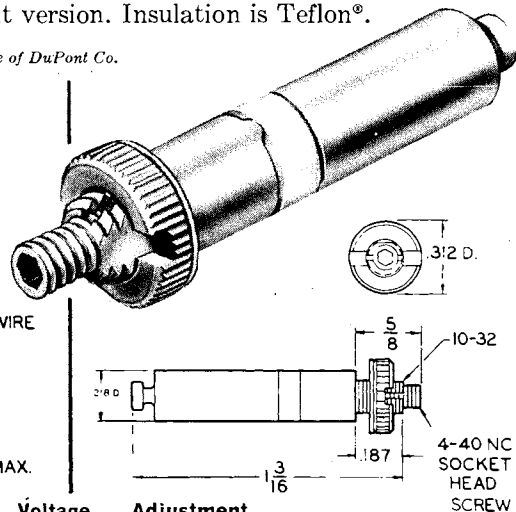
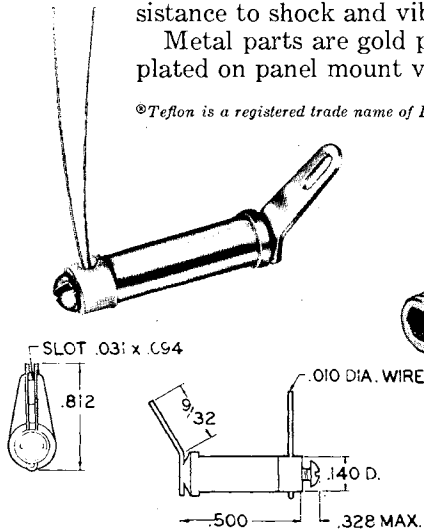
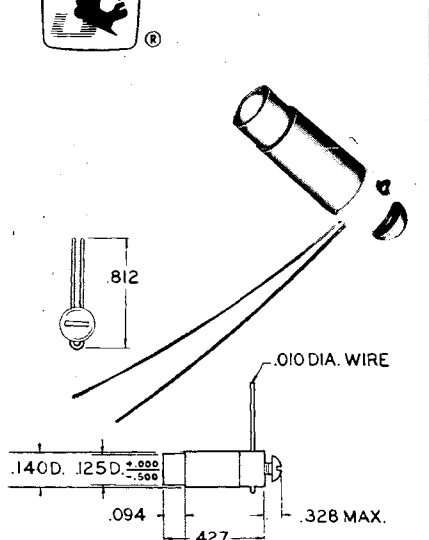

Cat. No.	Mounting	Nom. pf. Max.	Cap. Per Sec. Min.	Torque Oz. In.	Voltage Break-down	Adjustment Turns Per Inch	Net Price
273-1-1	PC	1.5	.25	.2-3.0	2,000	80	\$0.50
273-1-2	Solder Lug	1.5	.25	.2-3.0	2,000	80	.55
273-15-1	Panel	2.9	.30	.2-10.0	2,000	40	.80

Type "V" capacitors



These air variables provide high capacity in small space. Printed circuit and panel mount types mount in less than 0.3 sq. in. area. Rotors and stators precision machined from one piece of solid brass for high reliability and outstanding mechanical stability. High "Q" (greater than 1500 at 1 MC) . . . high torque (2½ to 10 ounce inches) . . . low temperature coefficient (plus 50 ± 20 PPM, °C) . . . exceptionally uniform delta C and voltage characteristics. Metal parts silver-plated. Ceramic is steatite Grade L-423 or better. Voltage breakdown rating 650 VDC. Freedom from moisture entrapment. Slotted rotor or shaft extension for convenient adjustment.

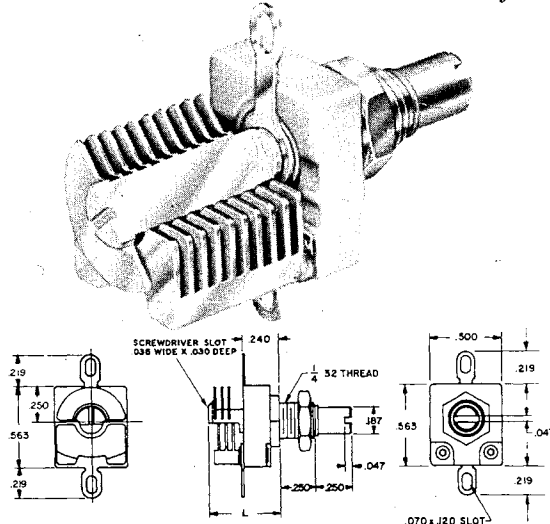
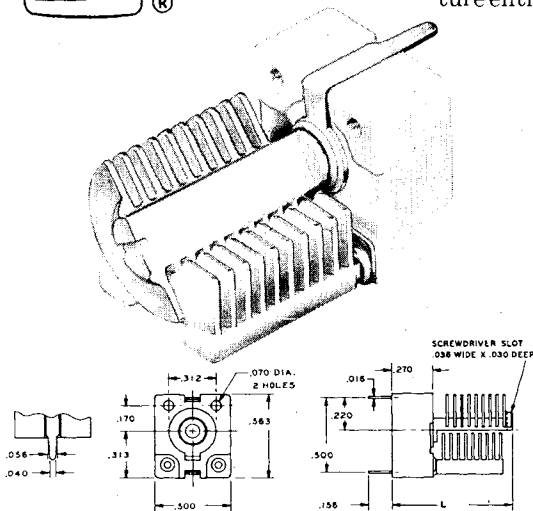

Cat. No.	Nom. Cap. pf. per Sec. Max.	Cap. pf. per Sec. Min.	Plates Per Section L ± 1/32"	Volts Peak Bkdwn.	Air Gap	Net Price
SINGLE SECTION—Printed Circuit Types						
193-4-5	13	1.4	8	37/64"	650 .010"	.76
193-6-5	20	1.7	12	1 1/16"	650 .010"	.78
193-8-5	27	2.0	16	2 5/32"	650 .010"	.80
193-10-5	34	2.2	20	5 7/64"	650 .010"	.82

Capacitors with .016" air gap available as specials.

Cat. No.	Nom. Cap. pf. per Sec. Max.	Cap. pf. per Sec. Min.	Plates Per Section L ± 1/32"	Volts Peak Bkdwn.	Air Gap	Net Price
SINGLE SECTION—Panel Mount Type						
193-4-1	13	1.4	8	35/64"	650 .010"	\$0.95
193-6-1	20	1.7	12	2 1/32"	650 .010"	1.00
193-8-1	27	2.0	16	3/4"	650 .010"	1.05
193-10-1	34	2.2	20	5 5/64"	650 .010"	1.10

Capacitors with .016" air gap available as specials.

MALLORY

Electrolytic Capacitors



Metal tubulars with insulating sleeve. Use etched cathode construction for maximum reliability. **TC, TCN** are single section with 3" tinned leads except (*) 2" leads; **TCD, TCT** have 7" insulated leads; **TCS** has solder lugs. Sizes .89" dia. and up have mtg. straps. **Temp. Range:** -20° C to +85° C except (*) rated at +65° C. **Tolerance:** -10%, +100% up to 350 WVDC; -10%, +50% 450 WVDC and up.

TC SINGLE SECTION

Mallory No.	Cap., μF	WV DC	Size, In. Dia. x Lg.	Net Each
TC304A*	200	3	.39 x .81	\$0.76
TC305A*	500	3	.39 x 1.44	.90
TC310A*	1000	3	.64 x 1.13	1.05
TC602	250	6	.39 x 1.06	.82
TC605A*	500	6	.42 x 1.56	.92
TC610A*	1000	6	.64 x 1.38	1.08
TC615	2000	6	.77 x 1.63	1.38
TC1205	500	12	.64 x 1.13	1.02
TC1210	1000	12	.64 x 1.88	1.35
TC1215	1500	12	.77 x 1.63	1.40
TC1220	2000	12	.77 x 2.13	1.62
TC1502A*	200	15	.39 x 1.44	.90
TC15025	250	15	.52 x 1.38	.97
TC1505A*	500	15	.64 x 1.38	1.05
TC1501A	1000	15	.77 x 1.63	1.38
TC1520A*	2000	15	.89 x 1.88	1.65
TC1530	3000	15	.89 x 2.13	2.40
TC1540	4000	15	.89 x 2.75	2.75
TC1550	5000	15	1.02 x 2.75	3.05
TC22A*	10	25	.28 x .69	.60
TC26A*	25	25	.32 x .81	.60
TC29A*	50	25	.39 x .94	.67
TC2501A*	100	25	.39 x 1.44	.80
TC25015A*	150	25	.42 x 1.69	.87
TC25025	250	25	.64 x 1.38	1.02
TC2505B	500	25	.77 x 1.63	1.35
TC2510	1000	25	.89 x 1.88	1.98
TC2515	1500	25	.89 x 2.13	2.35
TC2520	2000	25	1.02 x 2.75	2.75
TC31*	1	50	.28 x .69	.54
TC302*	2	50	.28 x .69	.54
TC30A*	5	50	.28 x .69	.60
TC32A*	10	50	.32 x .81	.60
TC36A*	25	50	.39 x .94	.64
TC39A*	50	50	.39 x 1.44	.72
TC3501A*	100	50	.64 x 1.63	.83
TC50015A*	150	50	.64 x 1.63	.90
TC50025A*	250	50	.77 x 1.63	1.00
TC50050A*	500	50	1.02 x 1.63	1.40
TC50100A*	1000	50	1.02 x 2.75	1.90
TC40A*	5	150	.32 x .81	.60
TC41A*	8	150	.39 x .94	.64
TC42A*	10	150	.39 x 1.06	.64
TC43A*	12	150	.39 x 1.06	.67
TC44A*	16	150	.39 x 1.19	.69
TC45A*	20	150	.39 x 1.44	.72
TC47A*	30	150	.64 x 1.13	.79
TC48A*	40	150	.77 x 1.13	.82
TC49A*	50	150	.64 x 1.63	.84
TC492A*	80	150	.77 x 1.63	.95
TC493A*	100	150	.77 x 1.88	1.05
TC495A*	150	150	1.02 x 1.38	1.13
TC496A*	200	150	1.02 x 1.63	1.32
TC499A*	300	150	1.02 x 2.13	1.63
TC50XA	5	250	.52 x 1.13	.69
TC51A	8	250	.64 x 1.13	.70
TC52A	10	250	.64 x 1.13	.72
TC53A	12	250	.64 x 1.13	.75
TC54A	16	250	.64 x 1.38	.79
TC55A	20	250	.64 x 1.38	.82
TC57	30	250	.77 x 1.38	.87
TC58A	40	250	.77 x 1.63	.94
TC59A	50	250	.77 x 1.63	1.02
TC1265A	100	250	.89 x 2.13	1.47
TC593A	150	300	1.02 x 2.75	1.84
TC595	2	350	.42 x 1.06	.60
TC60A	5	350	.64 x 1.13	.65
TC61A	8	350	.64 x 1.63	.72
TC62A	10	350	.64 x 1.63	.75
TC63A	12	350	.77 x 1.39	.79
TC64A	16	350	.77 x 1.63	.84
TC65A	20	350	.77 x 1.63	.87
TC67A	40	350	.77 x 2.13	1.05
TC68A	60	350	.89 x 2.75	1.17
TC69A	100	350	1.02 x 2.75	1.82
TC692A	150	350	1.02 x 3.88	2.22
TC695A	2	450	.52 x 1.38	.65
TC697A	4	450	.64 x 1.38	.69
TC70A	5	450	.64 x 1.38	.72
TC71A	8	450	.77 x 1.63	.75
TC72A	10	450	.77 x 1.63	.77
TC73A	12	450	.77 x 1.63	.82
TC74A	16	450	.89 x 1.63	.84
TC75A	20	450	.89 x 1.63	.93
TC77A	30	450	1.02 x 1.88	1.02
TC78A	40	450	1.02 x 2.13	1.08
TC79A	50	450	1.02 x 2.75	1.25
TC795A	60	450	1.02 x 2.75	1.40

METAL TUBULAR ELECTROLYTICS TC SINGLE SECTION (CONT'D)

Mallory No.	Cap., μF	WV DC	Size, In. Dia. x Lg.	Net Each
TC80A	80	450	1.02 x 3.38	\$1.63
TC805A	100	450	1.39 x 2.88	1.82
TC807	100	450	1.02 x 3.88	1.82
TC811*	2	500	.64 x 1.13	.81
TC81A*	10	500	.77 x 1.63	.82
TC82A	10	500	.69 x 3.00	.82
TC83A*	20	500	1.02 x 1.63	.97
TC84A*	30	500	1.02 x 2.13	1.16
TC90A	4	600	.69 x 2.50	1.17
TC92A	10	600	.81 x 2.50	1.77
TC96	20	600	1.06 x 2.94	2.35

NON-POLAR SINGLE SECTION

Mallory No.	Cap., μF	VNP	Size, In. Dia. x Lg.	Net Each
TCN105	5	10	.69 x 1.25	\$0.58
TCN106	6	10	.56 x 1.25	.68
TCN108	8	10	.69 x 1.50	.68
TCN1025	25	10	.39 x .81	.75
TCN412	500	10	.94 x 2.00	1.20
TCN1550	500	15	1.56 x 2.74	1.25
TCN415	1000	15	1.16 x 3.12	1.65
TCN2516	16	25	3/8 x 1 1/2	.94
TCN425	100	25	1 3/8 x 1 1/2	.97
TCN501	1	50	3/8 x 1 1/4	.68
TCN502	2	50	3/8 x 1 1/4	.68
TCN503	3	50	3/8 x 1 1/4	.68
TCN504	4	50	3/8 x 1 1/4	.68
TCN505	5	50	3/8 x 1 1/4	.70
TCN5010	10	50	3/8 x 1 1/4	.72
TCN5099	100	50	1 5/8 x 1 3/4	1.42
TCN510	4	150	3/8 x 1 1/4	.70
TCN1512	12	150	5/8 x 1 3/4	.97
TCN1540	40	150	1 5/8 x 1 3/4	1.07
TCN1551	50	150	1 5/8 x 2 1/4	1.19
TCN2550	4	200	1 1/8 x 1 3/4	1.12
TCN3520	20	350	1 1/8 x 2 7/8	1.19
TCN511	10	450	1 1/8 x 2 1/4	1.24

TCS DUAL SEPARATE SECTION

Mallory No.	Cap., μF	WV DC†	Size, In. Dia. x Lg.	Net Each
TCS44	15-15	150	1 3/8 x 2 3/8	\$1.37
TCS45	20-20	150	1 5/8 x 2 3/8	1.42
TCS47	30-30	150	1 1/8 x 2 3/8	1.55
TCS48	40-40	150	1 1/8 x 2 3/8	1.63
TCS49	120-120	150	1 1/8 x 3 3/8	2.07
TCS505	70-70	175	1 1/8 x 3 3/8	2.00
TCS52	10-10	250	1 1/8 x 2 3/8	1.55
TCS55	20-20	250	1 1/8 x 2 3/8	1.78
TCS61	8-8	350	1 1/8 x 2 3/8	1.55
TCS71	8-8	450	1 1/8 x 2 3/8	1.68
TCS74	15-15	450	1 1/8 x 2 3/8	1.87
TCS75	20-20	450	1 1/8 x 3 1/2	2.03

†Each section.

"SNAP-CAP" CARDBOARD TUBULAR ELECTROLYTICS



"Snap-Cap" capacitors are made to the same specifications as the "W" series and are supplied with an exclusive mounting ring which allows them to be snapped into a standard BP4 or MP4 mounting plate. Lugs hold securely and won't shake or vibrate loose, yet capacitors are easily removed if required. Furnished with color-coded insulated wire leads with stripped and tinned ends; wires 5" long. Used in equipment where temperature does not exceed 65° C. **Tolerance:** -10%, +100%.

Mallory No.	Cap., μF	WVDC*	Size, In.	Net Each
CVM2316	40-40	150	1x2	\$1.23
CVM2225	50-30	150	1x2	1.10
CVM2200	80-20	150	1x2 1/2	1.28
CVM3200	20-80-20	150	1x2 1/2	1.46
CVM3300	40-30-20	150	1x2	1.39
CVM3375	50-50-20	150	1x2 1/2	1.46
CVM3325	60-40-20	150	1x2 1/2	1.46
CVM3350	80-40-20	150	1x2 1/2	1.51
CVM3210	150-20-20	150	1x3	1.64
CVM3355	150-40-20	150	1x3	1.83

*WVDC each section.

TCD DUAL COMMON NEGATIVE

No. TCD-	Cap., μF	WVDC	Size, In. Dia. x Lg.	Net Each
204	250-1000	10-6	1 1/8 x 2 1/4	\$1.85
16	500-100	16-16	1 1/8 x 2 1/8	1.00
20	1000-1500	20-20	1 1/8 x 3	2.72
26	25-25	25-25	1 3/8 x 1 3/8	1.00
N201†	130-130	25-25	1 1/8 x 2 1/4	2.15
40	10-10	100-100	1 1/8 x 1 3/8	1.00
43	10-30	150-150	1 1/8 x 1 3/4	1.05
45	20-20	150-150	1 1/8 x 1 3/4	1.05
508	130-20	150-150	1 1/8 x 2 7/8	1.59
47	30-30	150-150	1 1/8 x 1 7/8	1.09
485	40-20	150-150	1 1/8 x 1 7/8	1.09
475	40-30	150-150	1 1/8 x 2 1/8	1.09
48	40-40	150-150	1 1/8 x 2 1/8	1.12
497	50-30	150-150	1 1/8 x 2 1/8	1.17
49	50-50	150-150	1 1/8 x 2 3/8	1.27
50	60-20	150-150	1 1/8 x 1 7/8	1.27
4975	80-40	150-150	1 1/8 x 2 3/8	1.34
498	80-50	150-150	1 1/8 x 2 3/8	1.42
2155	100-100	150-150	1 1/8 x 2 3/8	1.92
46	30-20	200-200	1 1/8 x 2 3/8	1.12
2165	30-30	200-200	1 1/8 x 2 3/8	1.24
2169	50-75	250-50	1 1/8 x 2 3/8	1.49
2174	100-150	250-50	1 1/8 x 4 1/8	2.15
2173	8-8	250-250	1 3/8 x 1 7/8	1.09
52	10-10	250-250	3/8 x 2	1.07
55	20-20	250-250	1 1/8 x 2	1.12
2274	40-40	300-300	1 1/8 x 3 1/8	1.84
58	80-40	300-300	1 1/8 x 4	1.94
62	10-10	350-350	1 1/8 x 2	1.12
65	20-20	350-350	1 1/8 x 2 3/8	1.44
68	30-5	350-350	1 1/8 x 2 3/8	1.40
2297	40-50	450-50	1 1/8 x 3 1/8	1.84
2302	30-60	450-300	1 1/8 x 4	2.09
71	8-8	450-450	1 1/8 x 2 1/8	1.17
72	10-10	450-450	1 1/8 x 2	1.24
74	15-15	450-450	1 1/8 x 3 1/8	1.35
745	20-8	450-450	1 1/8 x 2 1/4	1.50
75	20-20	450-450	1 1/8 x 3 1/4	1.34
77	30-30	450-450	1 1/8 x 4	1.95
78	40-40	450-450	1 1/8 x 4 1/8	2.24

†Non-polar.

TCT TRIPLE COMMON NEGATIVE

No. TCT-	Cap., μF	Volts	Size, In. Dia. x L.	Net Each
3053	20-30-20	150-150-25	1 5/8 x 2 3/8	\$1.74
3055	30-30-20	150-150-25	1 1/8 x 2 1/4	1.89
3094	50-30-200	150-150-25	1 1/8 x 2 3/8	2.02
3109	20-10-10	150-150-150	1 3/8 x 1 3/4	1.70
3112	20-20-20	150-150-150	1 1/8 x 1 7/8	1.77
3113	30-30-30	150-150-150	1 1/8 x 2 3/8	1.87
3114	40-20-20	150-150-150	1 1/8 x 2 1/4	1.80
3105	40-30-20	150-150-150	1 1/8 x 2 3/8	1.87
3116	40-40-20	150-150-150	1 1/8 x 2 3/8	1.87
3115	40-40-40	150-150-150	1 1/8 x 2 3/8	1.92
3107	50-30-20	150-150-15		

MALLORY

Computer Grade Capacitors

Two classes of Computer Grade Capacitors are available: CGS for 65° C operation and CG for 85° C operation. Operating life of both types should exceed 10 years when used within stated parameters. Derating voltage and/or lowering operating temperature will extend life by a large factor. **Temp. Range:** -20° C to +65° (CGS), +85° (CG). **Tolerance:** 0-150 WVDC, -10 +75% (U); 151 WVDC up, -10 +50% (T). For complete specifications, ask for Form 4-64 (CG), 4-80 (CGS). Both classes are supplied with polyester film insulating sleeves and have "High-post" terminals with #10-32 screws. Physical mounting of these capacitors is usually done with VR clamps shown below. The clamps, however, are not included with the capacitors. Order separately.

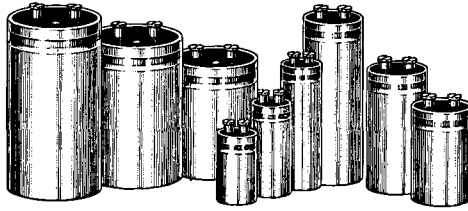

65° C COMPUTER GRADE (CONT.)

Mallory No.	Cap., μF	WV DC	Size	Net Each
CGS233U015DD1	23,000	15	DD	5.655
CGS343U015DF1	34,000	15	DF	6.99
CGS503U015D11	50,000	15	DI	8.90
CGS803U015FF1	80,000	15	FF	10.46
CGS104U015FH1	100,000	15	FH	11.25
CGS124U015FJ1	120,000	15	FJ	11.55
CGS302U025BB1	3,000	25	BB	2.29
CGS562U025BD1	5,600	25	BD	3.15
CGS822U025BF1	8,200	25	BF	3.82
CGS123U025DD1	12,000	25	DD	5.35
CGS183U025DF1	18,000	25	DF	6.43
CGS273U025D11	27,000	25	DI	7.56
CGS433U025FF1	43,000	25	FF	9.93
CGS573U025FH1	57,000	25	FH	10.81
CGS673U025FJ1	67,000	25	FJ	11.26
CGS222U040BB1	2,200	40	BB	2.14
CGS422U040BD1	4,200	40	BD	3.25
CGS622U040BF1	6,200	40	BF	4.00
CGS932U040DD1	9,300	40	DD	6.05
CGS133U040DF1	13,000	40	DF	6.88
CGS203U040D11	20,000	40	DI	7.41
CGS323U040FF1	32,000	40	FF	9.50
CGS433U040FH1	43,000	40	FH	10.60
CGS503U040FJ1	50,000	40	FJ	10.75
CGS162U050BB1	1,600	50	BB	2.10
CGS292U050BD1	2,900	50	BD	3.11
CGS432U050BF1	4,300	50	BF	3.42
CGS652U050DD1	6,500	50	DD	5.29
CGS962U050DF1	9,600	50	DF	6.48
CGS143U050D11	14,000	50	DI	8.35
CGS223U050FF1	22,000	50	FF	9.42
CGS303U050FH1	30,000	50	FH	9.97
CGS353U050FJ1	35,000	50	FJ	10.85
CGS821U075BB1	820	75	BB	2.18
CGS152U075BD1	1,500	75	BD	2.83
CGS232U075BF1	2,300	75	BF	3.46
CGS342U075DD1	3,400	75	DD	4.01
CGS502U075DF1	5,000	75	DF	6.32
CGS752U075D11	7,500	75	DI	7.14
CGS123U075FF1	12,000	75	FF	9.19
CGS163U075FH1	16,000	75	FH	10.56
CGS193U075FJ1	19,000	75	FJ	10.81
CGS651U100BB1	650	100	BB	2.29
CGS122U100BD1	1,200	100	BD	2.96
CGS182U100BF1	1,800	100	BF	3.21
CGS272U100DD1	2,700	100	DD	5.22
CGS402U100DF1	4,000	100	DF	6.17
CGS592U100D11	5,900	100	DI	7.45
CGS932U100FF1	9,300	100	FF	10.14
CGS123U100FH1	12,000	100	FH	10.39
CGS153U100FJ1	15,000	100	FJ	11.13
CGS401U150BB1	400	150	BB	2.21
CGS721U150BD1	720	150	BD	2.63
CGS112U150BF1	1,100	150	BF	3.05
CGS162U150DD1	1,600	150	DD	4.20
CGS252U150DF1	2,500	150	DF	5.92
CGS352U150D11	3,500	150	DI	6.93
CGS552U150FF1	5,500	150	FF	9.87
CGS742U150FH1	7,400	150	FH	10.69
CGS872U150FJ1	8,700	150	FJ	11.34
CGS201T250BB1	200	250	BB	2.56
CGS381T250BD1	380	250	BD	3.04
CGS551T250BF1	550	250	BF	3.52
CGS851T250DD1	850	250	DD	5.21
CGS122T250DF1	1,200	250	DF	6.20
CGS192T250D11	1,900	250	DI	7.60
CGS292T250FF1	2,900	250	FF	9.83
CGS392T250FH1	3,900	250	FH	10.52
CGS452T250FJ1	4,500	250	FJ	10.99
CGS131T350BB1	130	350	BB	2.54
CGS251T350BD1	250	350	BD	2.98
CGS371T350BF1	370	350	BF	3.44
CGS551T350DD1	550	350	DD	5.01
CGS801T350DF1	800	350	DF	5.98
CGS122T350D11	1,200	350	DI	7.91
CGS202T350FF1	2,000	350	FF	10.62
CGS262T350FH1	2,600	350	FH	10.92
CGS302T350FJ1	3,000	350	FJ	11.55
CGS750T450BB1	75	450	BB	1.72
CGS141T450BD1	140	450	BD	3.17
CGS211T450BF1	210	450	BF	3.51
CGS321T450DD1	320	450	DD	3.94
CGS481T450DF1	480	450	DF	4.70
CGS701T450D11	700	450	DI	6.30
CGS112T450FF1	1,100	450	FF	10.12
CGS152T450FH1	1,500	450	FH	10.71
CGS182T450FJ1	1,800	450	FJ	11.55

85° C COMPUTER GRADE

Mallory No.	Cap., μF	WV DC	Size	Net Each
CG552U3A1	5,500	3	A	2.02
CG1052U3B1	10,500	3	B	2.35
CG143U3C1	14,000	3	C	2.86
CG1752U3H1	17,500	3	H	3.09
CG233U3K1	23,000	3	K	3.57
CG243U3J1	24,000	3	J	3.68
CG363U3D1	36,000	3	D	4.41
CG54U3E1	50,000	3	E	5.65
CG753U3F1	75,000	3	F	7.06
CG1153U3G1	115,000	3	G	8.63
CG442U5A1	4,400	5	A	1.83
CG852U5B1	8,500	5	B	2.71
CG1252U5C1	12,500	5	C	3.28
CG143U5H1	14,000	5	H	3.72
CG1852U5K1	18,500	5	K	4.01
CG24U5J1	20,000	5	J	4.07
CG2752U5D1	27,500	5	D	4.60
CG453U5E1	45,000	5	E	6.05
CG653U5F1	65,000	5	F	7.14
CG15U5G1	100,000	5	G	9.39
CG322U10A1	3,200	10	A	1.75
CG63U10B1	6,000	10	B	2.37
CG822U10C1	8,200	10	C	2.84
CG14U10H1	10,000	10	H	3.15
CG1352U10K1	13,500	10	K	3.72
CG143U10J1	14,000	10	J	3.86
CG183U10D1	18,000	10	D	4.59
CG34U10E1	30,000	10	E	6.61
CG4352U10F1	43,500	10	F	8.25
CG683U10G1	68,000	10	G	9.66
CG252U15A1	2,500	15	A	1.97
CG452U15B1	4,500	15	B	2.60
CG642U15C1	6,400	15	C	2.69
CG85U15H1	8,000	15	H	3.07
CG1052U15K1	10,500	15	K	3.38
CG113U15J1	11,000	15	J	3.50
CG143U15D1	14,000	15	D	4.47
CG233U15E1	23,000	15	E	6.32
CG34U15F1	34,000	15	F	7.11
CG533U15G1	53,000	15	G	9.30
CG152U25A1	1,500	25	A	1.72
CG282U25B1	2,800	25	B	2.12
CG382U25C1	3,800	25	C	2.60
CG452U25H1	4,500	25	H	2.77
CG63U25K1	6,000	25	K	3.23
CG652U25J1	6,500	25	J	3.40
CG852U25D1	8,500	25	D	3.90
CG1352U25E1	13,500	25	E	5.99
CG24U25F1	20,000	25	F	6.55
CG3152U25G1	31,500	25	G	8.78
CG112U35A1	1,100	35	A	1.89
CG212U35B1	2,100	35	B	2.16
CG312U35C1	3,100	35	C	3.04
CG362U35H1	3,600	35	H	3.21
CG472U35K1	4,700	35	K	3.46
CG532U35J1	5,300	35	J	3.63
CG692U35D1	6,900	35	D	4.77
CG113U35E1	11,000	35	E	6.42
CG1652U35F1	16,500	35	F	7.16
CG243U35G1	24,000	35	G	7.75
CG82U50A1	800	50	A	1.74
CG152U50B1	1,500	50	B	2.05
CG23U50C1	2,000	50	C	2.29
CG252U50H1	2,500	50	H	2.52
CG352U50K1	3,500	50	K	3.25
CG352U50J1	3,500	50	J	3.29
CG452U50D1	4,500	50	D	3.47
CG732U50E1	7,300	50	E	5.33
CG14U50F1	10,000	50	F	6.70
CG1652U50G1	16,500	50	G	9.20
CG62U75A1	600	75	A	2.01
CG13U75B1	1,000	75	B	2.35
CG152U75C1	1,500	75	C	2.84
CG23U75H1	2,000	75	H	3.70
CG252U75K1	2,500	75	K	3.75
CG262U75J1	2,600	75	J	4.03
CG3451U75D1	3,450	75	D	6.40
CG552U75E1	5,500	75	E	6.40
CG822U75F1	8,200	75	F	7.25
CG1252U75G1	12,500	75	G	9.45
CG42U100A1	400	100	A	2.01
CG751U100B1	750	100	B	2.38
CG13U100C1	1,000	100	C	2.73
CG132U100H1	1,300	100	H	2.99
CG1651U100K1	1,650	100	K	3.17
CG172U100J1	1,700	100	J	3.31

85° C COMPUTER GRADE (CONT.)

Mallory No.	Cap., μF	WV DC	Size	Net Each
CG2251U100D1	2,250	100	D	5.4.12
CG362U100E1	3,600	100	E	6.03
CG532U100F1	5,300	100	F	6.74
CG832U100G1	8,300	100	G	9.68
CG2750U150A1	275	150	A	1.63
CG52U150B1	500	150	B	2.05
CG72U150C1	700	150	C	2.40
CG8750U150H1	875	150	H	2.71
CG112U150K1	1,100	150	K	3.13
CG115U150J1	1,150	150	J	3.17
CG155U150D1	1,550	150	D	4.01
CG25U150E1	2,500	150	E	5.92
CG362U150F1	3,600	150	F	7.08
CG562U150G1	5,600	150	G	9.87
CG181T200A1	180	200	A	2.02
CG341T200B1	340	200	B	2.42
CG451T200C1	450	200	C	2.58
CG551T200H1	550	200	H	2.86
CG751T200K1	750	200	K	3.30
CG82T200J1	800	200	J	3.44
CG13T200D1	1,000	200	D	4.51
CG165T200E1	1,650	200	E	5.36
CG245T200F1	2,450	200	F	6.83
CG382T200G1	3,800	200	G	12.26
CG141T250A1	140	250	A	2.41
CG275T250B1	275	250	B	2.75
CG375T250C1	375	250	C	2.99
CG451T250H1	450	250	H	3.24
CG62T250K1	600	250	K	3.65
CG6205T250J1	625	250	J	3.80
CG82T250D1	800	250	D	4.72
CG132T250E1	1,300	250	E	6.30
CG192T250F1	1,900	250	F	7.60
CG33T250G1	3,000	250	G	10.16
CG121T300A1	120	300	A	2.45
CG2250T300B1	225	300	B	2.66
CG3250T300C1	325	300	C	2.85
CG42T300H1	400	300	H	3.00
CG5250T300K1	525	300	K	3.27
CG551T300J1	550	300	J	3.32
CG72T300D1	700	300	D	4.74
CG1151T300E1	1,150	300	E	7.35
CG1651T300F1	1,650	300	F	8.46
CG262T300G1	2,600	300	G	10.63
CG12T350A1	100	350	A	2.43
CG181T350B1	180	350	B	2.73
CG251T350C1	250	350	C	2.96
CG32T350H1	300	350	H	3.15
CG42T350K1	400	350	K	3.57
CG4250T35				

MALLORY

Tantalum Capacitors

TYPE CSR13 SOLID ELECTROLYTE TANTALUM CAPACITORS TO MIL-C-39003/01, FRL (FAILURE RATE LEVEL) "M" (1%)

Established reliability design is hermetically sealed with plastic insulating sleeve. Meet MIL-C-39003A specifications. Life test, 10,000 hours. High reliability, low DC leakage and low impedance. Temperature range, -55° C to +125° C. Leads may be welded or soldered; are tinned nickel, type NI of MIL-STD-1276.

STOCK VALUES FRL (FAILURE RATE LEVEL) "M"—1% PER 1000 HOURS

Cap., µF	Tol.	WVDC at +85° C	MIL and Mallory No.	MIL Dash No.	Size †	Cap., µF	Tol.	WVDC at +85° C	MIL and Mallory No.	MIL Dash No.	Size †
5.6	±10%	6	CSR13B565KM	-2241	A	39	±10%	35	CSR13F396KM	-2311	D
6.8	±10%	6	CSR13B685KM	-2242	A	47	±10%	35	CSR13F476KM	-2312	D
6.8	±20%	6	CSR13B685MM	-2243	A	47	±20%	35	CSR13F476MM	-2313	D
47	±10%	6	CSR13B476KM	-2244	B	.0047	±10%	50	CSR13G472KM	-2314	A
47	±20%	6	CSR13B476MM	-2245	B	.0047	±20%	50	CSR13G472MM	-2315	A
56	±10%	6	CSR13B566KM	-2246	B	.0056	±10%	50	CSR13G562KM	-2316	A
150	±10%	6	CSR13B157KM	-2247	C	.0068	±10%	50	CSR13G682KM	-2317	A
150	±20%	6	CSR13B157MM	-2248	C	.0068	±20%	50	CSR13G682MM	-2318	A
180	±10%	6	CSR13B187KM	-2249	C	.0082	±10%	50	CSR13G822KM	-2319	A
270	±10%	6	CSR13B277KM	-2250	D	.01	±10%	50	CSR13G103KM	-2320	A
330	±10%	6	CSR13B337KM	-2251	D	.01	±20%	50	CSR13G103MM	-2321	A
330	±20%	6	CSR13B337MM	-2252	D	.012	±10%	50	CSR13G123KM	-2322	A
3.9	±10%	10	CSR13C395KM	-2253	A	.015	±10%	50	CSR13G153KM	-2323	A
4.7	±10%	10	CSR13C475KM	-2254	A	.015	±20%	50	CSR13G153MM	-2324	A
4.7	±20%	10	CSR13C475MM	-2255	A	.018	±10%	50	CSR13G183KM	-2325	A
27	±10%	10	CSR13C276KM	-2256	B	.022	±10%	50	CSR13G223KM	-2326	A
33	±10%	10	CSR13C336KM	-2257	B	.022	±20%	50	CSR13G223MM	-2327	A
33	±20%	10	CSR13C336MM	-2258	B	.027	±10%	50	CSR13G273KM	-2328	A
39	±10%	10	CSR13C396KM	-2259	B	.033	±10%	50	CSR13G333KM	-2329	A
82	±10%	10	CSR13C826KM	-2260	C	.033	±20%	50	CSR13G333MM	-2330	A
100	±10%	10	CSR13C107KM	-2261	C	.039	±10%	50	CSR13G393KM	-2331	A
100	±20%	10	CSR13C107MM	-2262	C	.047	±10%	50	CSR13G473KM	-2332	A
120	±10%	10	CSR13C127KM	-2263	C	.047	±20%	50	CSR13G473MM	-2333	A
150	±10%	10	CSR13C157KM	-2264	D	.056	±10%	50	CSR13G563KM	-2334	A
220	±10%	10	CSR13C227KM	-2265	D	.068	±10%	50	CSR13G683KM	-2335	A
220	±20%	10	CSR13C227MM	-2266	D	.068	±20%	50	CSR13G683MM	-2336	A
2.7	±10%	15	CSR13D275KM	-2267	A	.082	±10%	50	CSR13G823KM	-2337	A
3.3	±10%	15	CSR13D335KM	-2268	A	.1	±10%	50	CSR13G104KM	-2338	A
3.3	±20%	15	CSR13D335MM	-2269	A	.1	±20%	50	CSR13G104MM	-2339	A
18	±10%	15	CSR13D186KM	-2270	B	.12	±10%	50	CSR13G124KM	-2340	A
22	±10%	15	CSR13D226KM	-2271	B	.15	±10%	50	CSR13G154KM	-2341	A
22	±20%	15	CSR13D226MM	-2272	B	.15	±20%	50	CSR13G154MM	-2342	A
56	±10%	15	CSR13D566KM	-2273	C	.18	±10%	50	CSR13G184KM	-2343	A
68	±10%	15	CSR13D686KM	-2274	C	.22	±10%	50	CSR13G224KM	-2344	A
68	±20%	15	CSR13D686MM	-2275	C	.22	±20%	50	CSR13G224MM	-2345	A
120	±10%	15	CSR13D127KM	-2276	D	.27	±10%	50	CSR13G274KM	-2346	A
150	±10%	15	CSR13D157KM	-2277	D	.33	±10%	50	CSR13G334KM	-2347	A
150	±20%	15	CSR13D157MM	-2278	D	.33	±20%	50	CSR13G334MM	-2348	A
1.2	±10%	20	CSR13E125KM	-2279	A	.39	±10%	50	CSR13G394KM	-2349	A
1.5	±10%	20	CSR13E155KM	-2280	A	.47	±10%	50	CSR13G474KM	-2350	A
1.5	±20%	20	CSR13E155MM	-2281	A	.47	±20%	50	CSR13G474MM	-2351	A
1.8	±10%	20	CSR13E185KM	-2282	A	.56	±10%	50	CSR13G564KM	-2352	A
2.2	±10%	20	CSR13E225KM	-2283	A	.68	±10%	50	CSR13G684KM	-2353	A
2.2	±20%	20	CSR13E225MM	-2284	A	.68	±20%	50	CSR13G684MM	-2354	A
8.2	±10%	20	CSR13E825KM	-2285	B	.82	±10%	50	CSR13G824KM	-2355	A
10	±10%	20	CSR13E106KM	-2286	B	1.0	±10%	50	CSR13G105KM	-2356	A
10	±20%	20	CSR13E106MM	-2287	B	1.0	±20%	50	CSR13G105MM	-2357	A
12	±10%	20	CSR13E126KM	-2288	B	1.2	±10%	50	CSR13G125KM	-2358	B
15	±10%	20	CSR13E156KM	-2289	B	1.5	±10%	50	CSR13G155KM	-2359	B
15	±20%	20	CSR13E156MM	-2290	B	1.5	±20%	50	CSR13G155MM	-2360	B
27	±10%	20	CSR13E276KM	-2291	C	1.8	±10%	50	CSR13G185KM	-2361	B
33	±10%	20	CSR13E336KM	-2292	C	2.2	±10%	50	CSR13G225KM	-2362	B
33	±20%	20	CSR13E336MM	-2293	C	2.2	±20%	50	CSR13G225MM	-2363	B
39	±10%	20	CSR13E396KM	-2294	C	2.7	±10%	50	CSR13G275KM	-2364	B
47	±10%	20	CSR13E476KM	-2295	C	3.3	±10%	50	CSR13G335KM	-2365	B
47	±20%	20	CSR13E476MM	-2296	C	3.3	±20%	50	CSR13G335MM	-2366	B
56	±10%	20	CSR13E566KM	-2297	D	3.9	±10%	50	CSR13G395KM	-2367	B
56	±20%	20	CSR13E566MM	-2298	D	4.7	±10%	50	CSR13G475KM	-2368	B
68	±10%	20	CSR13E686KM	-2298	D	4.7	±20%	50	CSR13G475MM	-2369	B
68	±20%	20	CSR13E686MM	-2299	D	5.6	±10%	50	CSR13G565KM	-2370	C
82	±10%	20	CSR13E826KM	-2300	D	6.8	±10%	50	CSR13G685KM	-2371	C
100	±10%	20	CSR13E107KM	-2301	D	6.8	±20%	50	CSR13G685MM	-2372	C
100	±20%	20	CSR13E107MM	-2302	D	8.2	±10%	50	CSR13G825KM	-2373	C
5.6	±10%	35	CSR13F565KM	-2303	B	10	±10%	50	CSR13G106KM	-2374	C
6.8	±10%	35	CSR13F685KM	-2304	B	10	±20%	50	CSR13G106MM	-2375	C
6.8	±20%	35	CSR13F685MM	-2305	B	12	±10%	50	CSR13G126KM	-2376	C
22	±10%	35	CSR13F226KM	-2306	C	15	±10%	50	CSR13G156KM	-2377	C
22	±20%	35	CSR13F226MM	-2307	C	15	±20%	50	CSR13G156MM	-2378	C
27	±10%	35	CSR13F276KM	-2308	D	18	±10%	50	CSR13G186KM	-2379	C
33	±10%	35	CSR13F336KM	-2309	D	22	±10%	50	CSR13G226KM	-2380	D
33	±20%	35	CSR13F336MM	-2310	D	22	±20%	50	CSR13G226MM	-2381	D

†NET PRICES BY CASE SIZE, VOLTAGE AND TOLERANCE

Voltage	† Case	Size, Inches Dia. x Lgth.	±10% Tolerance Net Each, Lots of					±20% Tolerance Net Each, Lots of				
			1-24	25-49	50-99	100-499	500-999	1-24	25-49	50-99	100-499	500-999
6, 10, 15, 20 and 35 WVDC	A	.135 x .286	\$ 1.99	\$1.60	\$1.10	\$0.90	\$0.77	\$1.94	\$1.53	\$1.06	\$0.85	\$0.71
	B	.185 x .474	2.34	1.88	1.13	.93	.78	2.29	1.82	1.09	.89	.74
	C	.289 x .686	3.83	3.08	2.11	1.72	1.45	3.79	3.00	2.05	1.67	1.40
	D	.351 x .786	7.10	5.66	4.20	3.40	2.85	7.07	5.57	4.17	3.36	2.79
50 WVDC	A	.135 x .286	3.69	2.95	2.49	2.15	1.93	2.86	2.27	1.94	1.63	1.52
	B	.185 x .474	3.91	3.11	2.63	2.25	2.05	3.00	2.39	2.04	1.73	1.58
	C	.289 x .686	6.40	5.10	4.34	3.69	3.35	4.93	3.94	3.35	2.83	2.60
	D	.351 x .786	11.95	9.54	8.07	6.86	6.28	9.19	7.34	6.23	5.27	4.84

MALLORY Tantalum Capacitors

TAP-TNT MINIATURE PELLET EPOXY SEAL -55°C TO +85°C

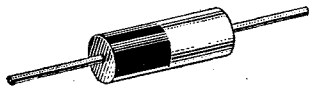

Mallory TNT-TAP capacitors employ sintered anode wet-slug construction and are furnished in metal cases with precision formed epoxy end seals and insulating sleeves. Standard tolerance: -15% +75%; other tolerances are available on special order. For detailed specifications, ask for bulletins: 4-38 (TNT) and 4-52 (TAP).

CASE SIZES

Case Code	Size, In. (Dia. x L.)	
	TNT	TAP
A	.162 x .418	.238 x .593
B	.162 x .568	.238 x .753
C		.238 x .968

TNT

Cap., μ F	WVDC +85°C	Mallory Number	Case Size
40	3	TNT406U003P1A	A
80	3	TNT806U003P1B	B
25	6	TNT256U006P1A	A
50	6	TNT506U006P1B	B
35	12	TNT356U012P1B	B
12	15	TNT126U015P1A	A
25	15	TNT256U015P1B	B
15	30	TNT156U030P1B	B
6	35	TNT605U035P1A	A
12	35	TNT126U035P1B	B
2	50	TNT205U050P1A	A
4	50	TNT405U050P1A	A
8	50	TNT805U050P1B	B

TAP

Cap., μ F	WVDC +85°C	Mallory Number	Case Size
30	6	TAP306U006P1A	A
140	6	TAP147U006P1B	B
330	6	TAP337U006P1C	C
20	10	TAP206U010P1A	A
100	10	TAP107U010P1B	B
250	10	TAP257U010P1C	C
15	15	TAP156U015P1A	A
70	15	TAP706U015P1B	B
170	15	TAP177U015P1C	C
12	20	TAP126U020P1A	A
10	25	TAP106U025P1A	A
8	30	TAP805U030P1A	A
40	30	TAP406U030P1B	B
100	30	TAP107U030P1C	C
7	35	TAP705U035P1A	A
6	40	TAP605U040P1A	A
30	40	TAP306U040P1B	B
5	50	TAP505U050P1A	A
25	50	TAP256U050P1B	B
60	50	TAP606U050P1C	C
4	60	TAP405U060P1A	A
20	60	TAP206U060P1B	B
50	60	TAP506U060P1C	C
3.5	75	TAP355U075P1A	A
15	75	TAP156U075P1B	B
40	75	TAP406U075P1C	C
2	90	TAP205U090P1A	A
11	90	TAP116U090P1B	B
30	90	TAP306U090P1C	C

TNT PRICES

Case Size	Net Each, Lots of				
	1-24	25-49	50-99	100-499	500-999
A	\$1.29	\$1.04	\$0.89	\$0.764	\$0.701
B	1.51	1.22	1.04	.89	.816

TAP PRICES

Case Size	Net Each, Lots of				
	1-24	25-49	50-99	100-499	500-999
A	\$1.51	\$1.22	\$1.04	\$0.89	\$0.816
B	2.51	2.02	1.71	1.465	1.34
C	4.33	3.47	2.94	2.51	2.30

HIGH TEMPERATURE—HERMETICALLY SEALED

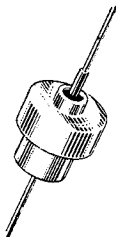

MTF

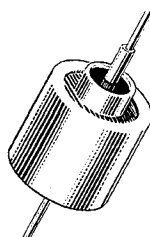

XTM-A

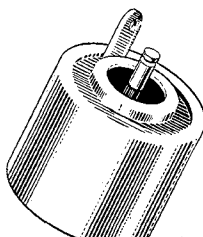

XTH-C, XTL-C, XTV-C

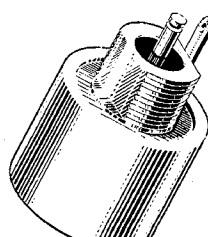

XTH-L, XTL-L

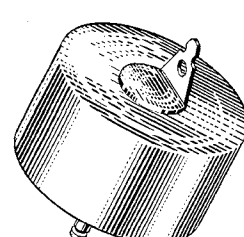

XTV-B

Mallory high temperature tantalum capacitors are furnished in hermetically sealed metal cases and are wet-slug polarized types. MTF and XTM-A have axial leads. Other XTM's and all XTL, H and V types have a wide variety of terminal arrangements available. The types shown here are the standard MIL-C-3965

values and all are available from stock. For detailed specifications, ask for bulletins: 4-41 (MTF); 4-49 (XTM); 4-60 (XTH-XTL-XTV). XTH, L and V also available in radiation proof construction; ask for bulletin 4-69 (XTG).

MTF -55°C TO +150°C

Axial leads, commercial equivalent to MIL-C-3965 Style CL44.

Cap., μ F	WVDC +85°C	Mallory Number	Cap., μ F	WVDC +85°C	Mallory Number
140	6	MTF147T006P0H	25	50	MTF256T050P0H
100	10	MTF107T010P0H	20	60	MTF206T060P0H
70	15	MTF706T015P0H	15	75	MTF156T075P0H
40	30	MTF406T030P0H	11	90	MTF116T090P0H
30	40	MTF306T040P0H			

Any Model listed above—Net Each, Lots of 1-24, \$6.76; 25-49, \$5.41; 50-99, \$4.56; 100-499, \$3.89.

XTM -55°C TO +175°C

Cap., μ F	WVDC +85°C	Mallory Number*	Net Each, Lots of		
			1-24	25-49	50-99
40	35	XTM406T035P0A	\$ 6.56	\$ 6.12	\$ 5.68
25	60	XTM256T060P0A	6.56	6.12	5.68
16	90	XTM166T090P0A	6.56	6.12	5.68
8	170	XTM805T170P0A	9.90	9.24	8.56
5	255	XTM505T255P0A	12.96	12.10	11.23
4	340	XTM405T340P0A	16.20	15.12	14.04

*Suffix A indicates MIL-C-3965/20A, Style CL10. Also available in Style CL13; change suffix A to D, add 5c to prices shown.

XTH -55°C TO +200°C

Cap., μ F	WVDC +85°C	Mallory Number*	Net Each, Lots of		
			1-24	25-49	50-99
240	18	XTH247U018P0L	\$ 9.65	\$ 9.04	\$ 8.42
150	30	XTH157U030P0C	9.30	8.69	8.07
150	30	XTH157U030P0L	9.65	9.04	8.42
120	35	XTH127U035P0C	9.30	8.69	8.07
80	60	XTH806U060P0C	9.30	8.69	8.07
80	60	XTH806U060P0L	9.65	9.04	8.42
50	90	XTH506U090P0C	9.30	8.69	8.07
25	180	XTH256U180P0C	14.80	13.81	12.83
25	180	XTH256U180P0L	15.15	14.16	13.18
16	270	XTH166U270P0C	20.48	19.12	17.76
16	270	XTH166U270P0L	20.83	19.47	18.11
12	360	XTH126U360P0C	26.06	24.33	22.59
12	360	XTH126U360P0L	26.41	24.68	22.94
7	630	XTH705U630P0C	42.62	39.78	36.94

*C, MIL-C-3965/1D, CL14; L, MIL-C-3965/1D, CL16.

XTL -55°C TO +200°C

Cap., μ F	WVDC +85°C	Mallory Number	Net Each, Lots of		
			1-24	25-49	50-99
120	18	XTL127U018P0C*	\$ 8.24	\$ 7.69	\$ 7.15
75	30	XTL756U030P0C*	8.24	7.69	7.15
75	30	XTL756U030P0L†	8.59	8.04	7.50
40	60	XTL406U060P0C*	8.24	7.69	7.15
40	60	XTL406U060P0L†	8.59	8.04	7.50
25	90	XTL256U090P0C*	8.24	7.69	7.15
12	180	XTL126U180P0C*	12.38	11.56	10.64
12	180	XTL126U180P0L†	12.73	11.91	11.09
8	270	XTL805U270P0C*	16.70	15.59	14.48
6	360	XTL605U360P0C*	21.16	19.75	18.34
5	450	XTL505U450P0C*	21.50	20.10	18.69
4	540	XTL405U540P0C*	25.70	23.99	22.28
3.5	630	XTL355U630P0C*	29.89	27.90	25.91
			34.30	32.01	29.73

*Stock Items (MIL-C-3965/1D, Style CL14). †Stock Items (MIL-C-3965/1D, Style CL16).

XTV -55°C TO +200°C

XTV listed by MIL-C-3965/19A Style CL17 ("C") and CL18 ("B") are stocked. Ten other case configurations available on special order.

Cap., μ F	WVDC +85°C	Mallory Number	Net Each, Lots of		
			1-24	25-49	50-99
370	30	XTV377T030P0C	\$19.55	\$18.25	\$16.95
650	30	XTV657T030P0C	30.05	28.05	26.05
1300	30	XTV1387030P0C*	43.55	40.65	37.75
190	40	XTV197T040P0B	13.55	12.65	11.75
290	40	XTV297T040P0*	19.55	18.25	16.95
500	40	XTV507T040P0*	30.05	28.05	26.05
1000	40	XTV1087040P0*	43.55	40.65	37.75
200	60	XTV207T060P0*	19.55	18.25	16.95
350	60	XTV357T060P0*	30.05	28.05	26.05
700	60	XTV707T060P0*	43.55	40.65	37.75
750	60	XTV757T060P0*	43.55	40.65	37.75
220	75	XTV227T075P0*	30.05	28.05	26.05
450	75	XTV457T075P0*	43.55	40.65	37.75
120	90	XTV127T090P0*	19.55	18.25	16.95
60	180	XTV606T180P0*	35.00	32.67	30.34
40	270	XTV406T270P0*	49.55	46.27	42.95
25	450	XTV256T450P0*	79.55	74.25	68.95

*Specify B for CL18 or C for CL17.



NYTRONICS, INC.
ESSEX ELECTRONICS DIVISION

Capacitors

The NYT-CAP

Ultra High Stability — Less than ± 25 ppm/°C
Miniature Molded Epoxy Case suitable for high component density applications
200 Volt D.C. rating

A new development from Nytronics' ceramic research laboratory now makes possible the manufacture of an extremely stable ceramic capacitor in a miniature package size. Now you can have the capacitor stability long desired for use in oscillators, filters, and other critical circuitry.

ELECTRICAL CHARACTERISTICS

Capacitance Range: 4.7 pf. to 4700 pf.
Capacitance Tolerance: $\pm 10\%$ standard.
Working Voltage: 200 Volts D.C.
Temperature Coefficient: Does not exceed ± 25 ppm/°C over temperature range of -55°C to $+125^\circ\text{C}$.
Dissipation Factor: Less than 0.001 at 25°C . (Measured at 1KC) Less than 0.002 at 125°C .
Insulation Resistance: 1,000,000 Megohms at 25°C . (Minimum) 10,000 Megohms at 125°C .

PHYSICAL AND ENVIRONMENTAL CHARACTERISTICS

Case Size: A: 0.1" dia. x 0.250" long.
B: 0.350" x 0.250" x 0.1".
Case Material: Epoxy.
Volume A: 0.002 cubic inches.
B: 0.0088 cubic inches.
Weight (Maximum): A: 0.352 grams.
B: 0.69 grams.

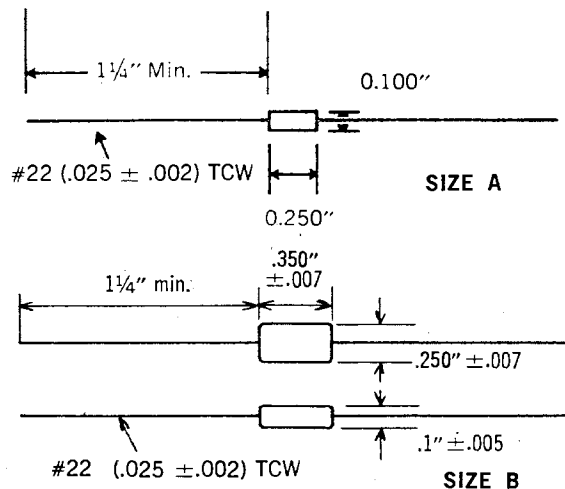

Nytronics Part No.	Capacity (pF)	Case Size	Nytronics Part No.	Capacity (pF)	Case Size	Nytronics Part No.	Capacity (pF)	Case Size	Nytronics Part No.	Capacity (pF)	Case Size
NC-047	4.7	A	NC-330	33	A	NC-221	220	A	NC-152	1500	B
NC-056	5.6	A	NC-390	39	A	NC-271	270	B	NC-182	1800	B
NC-068	6.8	A	NC-470	47	A	NC-331	330	B	NC-222	2200	B
NC-082	8.2	A	NC-560	56	A	NC-391	390	B	NC-272	2700	B
NC-100	10	A	NC-680	68	A	NC-471	470	B	NC-332	3300	B
NC-120	12	A	NC-820	82	A	NC-561	560	B	NC-392	3900	B
NC-150	15	A	NC-101	100	A	NC-681	680	B	NC-472	4700	B
NC-180	18	A	NC-121	120	A	NC-821	820	B			
NC-220	22	A	NC-151	150	A	NC-102	1000	B			
NC-270	27	A	NC-181	180	A	NC-122	1200	B			

The NYT-CHIP

Ultra High Stability — Less than ± 25 ppm/°C
200 Volt D.C. rating
Compatible with:
Integrated Circuitry; Thick and Thin Film Circuitry; Printed Circuitry

The NYT-CHIP provides in slug form all of the high stability and low loss features of the epoxy molded NYT-CAP. This configuration yields the greatest possible packaging density and has the highest degree of mounting flexibility for use with all presently used packaging techniques. NYT-CHIPS are supplied with "wrap-around" tinned terminals permitting connection to either face or to the ends of the chip.

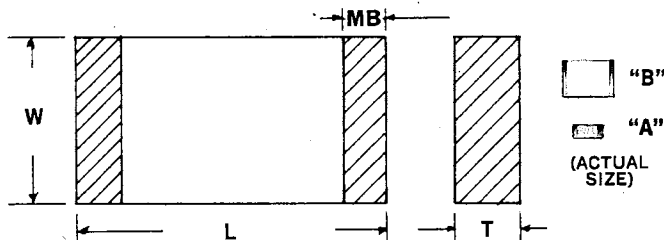

ELECTRICAL CHARACTERISTICS

Capacitance Range: 4.7 pf. to 4700 pf.
Capacitance Tolerance: $\pm 10\%$ standard.
Working Voltage: 200 Volts D.C.
Temperature Coefficient: Does not exceed ± 25 ppm/°C over temperature range of -55°C to $+125^\circ\text{C}$.
Dissipation Factor: Less than 0.001 at 25°C . (Measured at 1KC) Less than 0.002 at 125°C .
Insulation Resistance: 1,000,000 Megohms at 25°C . (Minimum) 10,000 Megohms at 125°C .

PHYSICAL CHARACTERISTICS

	L	W	T	MB
Size A:	.170 \pm .015	.065 \pm .015	.070 max.	.035 \pm .020 — .010
Size B:	.280 \pm .020	.195 \pm .020	.070 max.	.035 \pm .020 — .010

Note: Dimensions are for slugs with tinned terminals.

Nytronics Part No.	Capacity (pf)	Chip Size	Nytronics Part No.	Capacity (pf)	Chip Size
NCU-047	4.7	A	NCU-181	180	A
NCU-056	5.6	A	NCU-221	220	A
NCU-068	6.8	A	NCU-271	270	B
NCU-082	8.2	A	NCU-331	330	B
NCU-100	10	A	NCU-391	390	B
NCU-120	12	A	NCU-471	470	B
NCU-150	15	A	NCU-561	560	B
NCU-180	18	A	NCU-681	680	B
NCU-220	22	A	NCU-821	820	B
NCU-270	27	A	NCU-102	1000	B
NCU-330	33	A	NCU-122	1200	B
NCU-390	39	A	NCU-152	1500	B
NCU-470	47	A	NCU-182	1800	B
NCU-560	56	A	NCU-222	2200	B
NCU-680	68	A	NCU-272	2700	B
NCU-820	82	A	NCU-332	3300	B
NCU-101	100	A	NCU-392	3900	B
NCU-121	120	A	NCU-472	4700	B
NCU-151	150	A			





NYTRONICS, INC.® Capacitors

Film and Paper Dielectric Capacitors

Nytronics' broad experience in film and paper dielectrics is represented in a line of standard units for the aerospace, computer, instrumentation and consumer markets. The extensive Nytronics facilities are also available for production of custom components for use in these markets. A wide range of configurations and types is available to meet the most stringent requirements.



PSF SERIES — POLYSTYRENE AND FOIL Hermetically sealed in metal cases, these units are designed for applications requiring high insulation resistance, low dissipation factor, and minimal dielectric absorption. They are applicable for designs requiring high capacitor stability. Available in standard tolerance of $\pm 1\%$ to $\pm 20\%$. They can be provided to special close tolerance requirements of $\pm 0.1\%$, as well as matching sets for application in digital computers, precision timing circuits, and laboratory standards.



RPM SERIES — METALIZED POLYCARBONATE Available in tubular cases with glass-to-metal — seal terminals, the RPM Series provides high insulation resistance, exceptional stability and a minimal change in capacitance with temperature. Its self-healing properties, in the remote event of a dielectric breakdown, provide an extremely reliable unit. It also offers a low dissipation factor for AC applications.

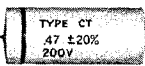

MAF SERIES — MYLAR AND FOIL Designed for applications requiring a flat capacitance change with temperature from $+15$ to $+65^\circ\text{C}$, the MAF series provides exceptional electrical properties in the temperature range of -55°C to $+125^\circ\text{C}$. The dissipation factor at room temperature is less than 0.6%. The extended foil design provides for positive electrical contact between leads and electrodes irrespective of the operating voltage.



MAM SERIES — METALIZED MYLAR The MAM series offers a reduction in size over the MAF series. Its self-healing property, in the remote event of a dielectric breakdown, makes this hermetic unit suitable for the most stringent applications. Special capacitance tolerance of $\pm 1\%$ can be provided on a special order basis.



AFS SERIES — KRAFT AND FOIL Hermetically sealed with compression type glass-to-metal solder-seal terminals the AFS series is approved to MIL-C-25. Designed for operation from -55°C to $+125^\circ\text{C}$ this series is intended for use in military and industrial electronics.

Various packaging configurations are available for the series shown above:

- wrap and fill
- plastic
- standard glassseals and other custom hermetic enclosures

Other dielectric series are available such as Teflon, Metalized Paper, Combination Films and/or Film Kraft.



NYTRONICS, INC.® / CAPACITOR DIVISION

OHMITE tan-o-mite® tantalum capacitors • wire • foil • slug

SERIES TS SLUG

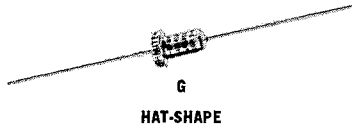

The "slug" type of tantalum capacitor utilizes a porous anode of sintered tantalum. Intended for polar applications, these capacitors offer the best characteristics of all the types described in this catalog. They exceed the vibration test of MIL-C-3965, Grade 3.

Available from stock in two physical types — the "hat-shaped" type, 3 sizes (U, F, G) and the "straight-cylindrical" type, 3 sizes (SU, SF, SG) which have the same range of capacitance and voltage as the equivalent hat-shape sizes. Hat-shape and straight-cylindrical types are offered in two operating temperature ranges, —55°C to +85°C and —55°C to +125°C. Tolerances: See footnotes under price and stock tables. Units insulated with plastic sleeve are available at slight extra cost. Stock listings below.

DIMENSIONS — UNINSULATED

HAT SHAPE				STRAIGHT-CYLINDRICAL				
Com'l.	MIL	Dia.	Lgth.	Com'l.	MIL	Dia.	Lgth.	Leads
U	T1	3/16	1 1/2	SU	T1	3/16	2 3/4	1 1/2
F	T2	15/32	1 1/4	SF	T2	3/32	4 3/4	2 1/4
G	T3	3/64	4 3/4	SG	T3	3/64	4 3/4	2 1/4

COMMERCIAL SLUG CAPACITOR 1-24 QTY. NET PRICES

HAT-SHAPE AND STRAIGHT-CYLINDRICAL — UNINSULATED*					
Case Size		85°C Tolerance†		125°C Tolerance†	
Hat	Straight	M	K	M	K
U	SU	\$1.98	\$2.22	\$2.06	\$3.30
F	SF	3.02	3.38	3.16	3.52
G	SG	4.72	5.32	4.96	5.56

*For plastic insulating sleeve add 10c for case sizes U, F, G. Add 5c for sizes SU, SF, SG.
†Standard Tolerances — M = ±20%; K = ±10%.

MIL-C-3965 SLUG CAPACITORS 1-24 QTY. NET PRICES

HAT-SHAPE (CL44) AND STRAIGHT-CYLINDRICAL (CL64) UNINSULATED*					
Case Size		85°C Tolerance†		125°C Tolerance†	
CL44*, 64*		M	K	M	K
T1		\$1.98	\$2.22	\$2.06	\$3.30
T2		3.02	3.38	3.16	3.52
T3		4.72	5.32	4.96	5.56

*For plastic insulating sleeve (MIL STYLES CL45, CL65) add 10c each.
†Standard Tolerances — M = ±20%; K = ±10%.

STOCK HAT-SHAPE & STRAIGHT-CYLINDRICAL SLUG CAPACITORS COMMERCIAL CASES U, F, G, SU, SF, SG — MIL STYLES CL44, CL45 (MIL-C-3965/4D) CL64, CL65, (MIL-C-3965/4D, 4E)

Mfd.	D.C. Volts		Commercial		MIL-C-3965	
	85°C	125°C	Case Size	Stock No. (Incomplete)†	Case Size	Type Designation (Incomplete)*
30	6		U	30_UB6	T1	CL_BB300_P3
30	6	4	U	30_UC4	T1	CL_CB300_P3
68±	6		U	68_UB6	T1	CL_BB680_P3
68±	6	4	U	68_UC4	T1	CL_CB680_P3
140	6		F	140_FB6	T2	CL_BB141_P3
140	6	4	F	140_FC4	T2	CL_CB141_P3
270±	6		F	270_FB6	T2	CL_BB271_P3
270±	6	4	F	270_FC4	T2	CL_CB271_P3
330	6		G	330_GB6	T3	CL_BB331_P3
330	6	4	G	330_GC4	T3	CL_CB331_P3
560±	6		G	560_GB6	T3	CL_BB561_P3
560±	6	4	G	560_GC4	T3	CL_CB561_P3
25	8		U	25_UB8	T1	CL_BC250_P3
25	8	5	U	25_UC5	T1	CL_CC250_P3
56±	8		U	56_UB8	T1	CL_BC560_P3
56±	8	5	U	56_UC5	T1	CL_CC560_P3
220±	8		F	220_FB8	T2	CL_BC221_P3
220±	8	5	F	220_FC5	T2	CL_CC221_P3
430±	8		G	430_GB8	T3	CL_BC431_P3
430±	8	5	G	430_GC5	T3	CL_CC431_P3
20	10		U	20_UB10	T1	CL_BD200_P3
20	10	7	U	20_UC7	T1	CL_CD200_P3
47±	10		U	47_UB10	T1	CL_BD470_P3
47±	10	7	U	47_UC7	T1	CL_CD470_P3
100	10		F	100_FB10	T2	CL_BD101_P3
100	10	7	F	100_FC7	T2	CL_CD101_P3
180±	10		F	180_FB10	T2	CL_BD181_P3
180±	10	7	F	180_FC7	T2	CL_CD181_P3
250	10		G	250_GB10	T3	CL_BD251_P3
250	10	7	G	250_GC7	T3	CL_CD251_P3
390±	10		G	390_GB10	T3	CL_BD391_P3
390±	10	7	G	390_GC7	T3	CL_CD391_P3
15	15		U	15_UB15	T1	CL_BE150_P3
15	15	10	U	15_UC10	T1	CL_CE150_P3
33±	15		U	33_UB15	T1	CL_BE330_P3
33±	15	10	U	33_UC10	T1	CL_CE330_P3
70	15		F	70_FB15	T2	CL_BE700_P3
70	15	10	F	70_FC10	T2	CL_CE700_P3
120±	15		F	120_FB15	T2	CL_BE121_P3
120±	15	10	F	120_FC10	T2	CL_CE121_P3
170	15		G	170_GB15	T3	CL_BE171_P3
170	15	10	G	170_GC10	T3	CL_CE171_P3
270±	15		G	270_GB15	T3	CL_BE271_P3
270±	15	10	G	270_GC10	T3	CL_CE271_P3
10	25		U	10_UB25	T1	CL_BG100_P3
22±	25	17	U	10_UC17	T1	CL_CG100_P3
22±	25	17	U	22_UB25	T1	CL_BG220_P3
22±	25	17	U	22_UC17	T1	CL_CG220_P3
100±	25		F	100_FB25	T2	CL_BG101_P3
100±	25	17	F	100_FC17	T2	CL_CG101_P3
180±	25		G	180_GB25	T3	CL_BG181_P3
180±	25	17	G	180_GC17	T3	CL_CG181_P3
8	30		U	8_UB30	T1	CL_BH080_P3
8	30	20	U	8_UC20	T1	CL_CH080_P3
15±	30		U	15_UB30	T1	CL_BH150_P3
15±	30	20	U	15_UC20	T1	CL_CH150_P3
40	30		F	40_FB30	T2	CL_BH400_P3
40	30	20	F	40_FC20	T2	CL_CH400_P3
68±	30		F	68_FB30	T2	CL_BH680_P3
68±	30	20	F	68_FC20	T2	CL_CH680_P3
100	30		G	100_GB30	T3	CL_BH101_P3
100	30	20	G	100_GC20	T3	CL_CH101_P3

Mfd.	D.C. Volts		Commercial		MIL-C-3965	
	85°C	125°C	Case Size	Stock No. (Incomplete)†	Case Size	Type Designation (Incomplete)*
150±	30		G	150_GB30	T3	CL_BH151_P3
150±	30	20	G	150_GC20	T3	CL_CH151_P3
5	50		U	5_UB50	T1	CL_BJ050_P3
5	50	33	U	5_UC33	T1	CL_CJ050_P3
10±	50		U	10_UB50	T1	CL_BJ100_P3
10±	50	33	U	10_UC33	T1	CL_CJ100_P3
25	50		F	25_FB50	T2	CL_BJ250_P3
25	50	33	F	25_FC33	T2	CL_CJ250_P3
47±	50		F	47_FB50	T2	CL_BJ470_P3
47±	50	33	F	47_FC33	T2	CL_CJ470_P3
60	50		G	60_GB50	T3	CL_BJ600_P3
60	50	33	G	60_GC33	T3	CL_CJ600_P3
82±	50		G	82_GB50	T3	CL_BJ820_P3
82±	50	33	G	82_GC33	T3	CL_CJ820_P3
4	60		U	4_UB60	T1	CL_BK040_P3
4	60	40	U	4_UC40	T1	CL_CK040_P3
8.2±	60		U	8R2_UB60	T1	CL_BK8R2_P3
8.2±	60	40	U	8R2_UC40	T1	CL_CK8R2_P3
20	60		F	20_FB60	T2	CL_BK200_P3
20	60	40	F	20_FC40	T2	CL_CK200_P3
39±	60		F	39_FB60	T2	CL_BK390_P3
39±	60	40	F	39_FC40	T2	CL_CK390_P3
50	60		G	50_GB60	T3	CL_BK500_P3
50	60	40	G	50_GC40	T3	CL_CK500_P3
68±	60		G	68_GB60	T3	CL_BK680_P3
68±	60	40	G	68_GC40	T3	CL_CK680_P3
3.5	75		U	3R5_UB75	T1	CL_BL3R5_P3
3.5	75	50	U	3R5_UC50	T1	CL_CL3R5_P3
6.8±	75		U	6R8_UB75	T1	CL_BL6R8_P3
6.8±	75	50	U	6R8_UC50	T1	CL_CL6R8_P3
15	75		F	15_FB75	T2	CL_BL150_P3
15	75	50	F	15_FC50	T2	CL_CL150_P3
33±	75		F	33_FB75	T2	CL_BL330_P3
33±	75	50	F	33_FC50	T2	CL_CL330_P3
40	75		G	40_GB75	T3	CL_BL400_P3
40	75	50	G	40_GC50	T3	CL_CL400_P3
56±	75		G	56_GB75	T3	CL_BL560_P3
56±	75	50	G	56_GC50	T3	CL_CL560_P3
2.5	100		U	2R5_UB100	T1	CL_BN2R5_P3
2.5	100	70	U	2R5_UC70	T1	CL_CN2R5_P3
4.7±	100		U	4R7_UB100	T1	CL_BN4R7_P3
4.7±	100	70	U	4R7_UC70	T1	CL_CN4R7_P3
11	100		F	11_FB100	T2	CL_BN110_P3
11	100	70	F	11_FC70	T2	CL_CN110_P3
22±	100		F	22_FB100	T2	CL_BN220_P3
22±	100	70	F	22_FC70	T2	CL_CN220_P3
30	100		G	30_GB100	T3	CL_BN300_P3
30	100	70	G	30_GC70	T3	CL_CN300_P3
43±	100		G	43_GB100	T3	CL_BN430_P3
43±	100	70	G	43_GC70	T3	CL_CN430_P3
1.7	125		U	1R7_UB125	T1	CL_BP1R7_P3
1.7	125	85	U	1R7_UC85	T1	CL_CP1R7_P3
3.6±	125		U	3R6_UB125	T1	CL_BP3R6_P3
3.6±	125	85	U	3R6_UC85	T1	CL_CP3R6_P3
9	125		F	9_FB125	T2	CL_BP090_P3
9	125	85	F	9_FC85	T2	CL_CP090_P3
14±	125		F	14_FB125	T2	CL_BP140_P3
14±	125	85	F	14_FC85	T2	CL_CP140_P3
25	125		G	25_GB125	T3	CL_BP250_P3
25	125	85	G	25_GC85	T3	CL_CP250_P3
39	125		G	39_GB125	T3	CL_BP390_P3
39±	125	85	G	39_GC85	T3	CL_CP390_P3

†Complete commercial stock no. as follows: If straight-cylindrical capacitor is desired, insert an "S" in the middle of the number where the underlined space is provided as in "30SUB6_". If a hat-shape capacitor is desired, write this number without the space as in "30UB6_". Add K, or M at end of number to indicate tolerance. Add "A" after tolerance letter if insulating sleeve is desired.

*Complete MIL type designation as follows: For hat-shape, un-insulated type insert

"44" after "CL_" for insulated type insert "45" instead. For straight-cylindrical shape, un-insulated, insert "64" after "CL_"; for insulated type insert "65" instead. Insert K, or M before "P" to indicate tolerance.

‡High capacitance units.

Tolerances: K = ±10%; M = ±20%.



HIGH VOLTAGE CAPACITORS TYPE OF



85°C GLASS CAP — PLASTIC FILM DC FILTER

TYPE OF Capacitors are housed in glass tubes with metal-to-glass soldered ferrules. Capacitor element is an improved plastic dielectric type, impregnated with a highly purified and inhibited mineral oil.

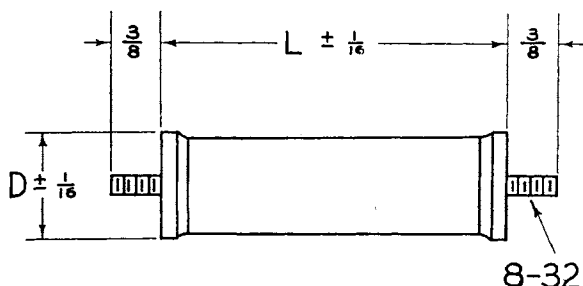

All glass containers with 'D' dimensions of 19/32 have 2-1/2 inch long 18 tinned copper pigtail leads.

PART NUMBER	CAP MFD	VOLTS DC	DIMENSIONS	
			L	D
OF20-102	.001	2000	1 3/16	19/32
OF20-202	.002	2000	1 3/16	19/32
OF20-502	.005	2000	1 3/16	19/32
OF20-103	.01	2000	1 3/16	19/32
OF20-203	.02	2000	1 9/16	19/32
OF20-503	.05	2000	1 3/4	3/4
OF20-104	0.1	2000	2 1/4	3/4
OF20-254	0.25	2000	2 3/4	29/32
OF20-504	0.5	2000	2	1 3/8
OF30-102	.001	3000	1 3/16	19/32
OF30-202	.002	3000	1 3/16	19/32
OF30-502	.005	3000	1 3/16	19/32
OF30-103	.01	3000	1 9/16	19/32
OF30-203	.02	3000	1 3/4	3/4
OF30-503	.05	3000	2 1/4	3/4
OF30-104	0.1	3000	1 3/4	1 1/8
OF30-254	0.25	3000	2	1 3/8
OF30-504	0.5	3000	2 3/4	1 5/8
OF40-102	.001	4000	1 3/16	19/32
OF40-202	.002	4000	1 3/16	19/32
OF40-502	.005	4000	1 3/16	19/32
OF40-103	.01	4000	1 3/16	3/4
OF40-203	.02	4000	1 3/4	3/4
OF40-503	.05	4000	2	13/16
OF40-104	0.1	4000	2	1 1/8
OF40-254	0.25	4000	2 1/4	1 5/8
OF40-504	0.5	4000	3 3/4	1 5/8

PART NUMBER	CAP MFD	VOLTS DC	DIMENSIONS	
			L	D
OF50-202	.002	5000	1 3/16	19/32
OF50-502	.005	5000	1 5/8	19/32
OF50-103	.01	5000	1 3/4	3/4
OF50-203	.02	5000	2 1/4	3/4
OF50-503	.05	5000	2 1/4	29/32
OF50-104	0.1	5000	2 1/4	1 3/8
OF50-254	0.25	5000	3	1 5/8
OF50-504	0.5	5000	6	1 5/8
OF60-103	.01	6000	1 3/4	3/4
OF60-203	.02	6000	2 1/4	3/4
OF60-503	.05	6000	3 1/4	29/32
OF60-104	0.1	6000	3	1 3/8
OF60-254	0.25	6000	4	1 5/8
OF60-504	0.5	6000	7	1 5/8
OF80-502	.005	8000	1 3/4	3/4
OF80-103	.01	8000	2 1/4	3/4
OF80-203	.02	8000	2 3/4	29/32
OF80-503	.05	8000	2 3/4	1 3/8
OF80-104	0.1	8000	3 5/8	1 5/8
OF80-204	0.2	8000	7	1 5/8
OF100-101	.0001	10 KV	1 5/8	19/32
OF100-201	.0002	10 KV	1 5/8	19/32
OF100-501	.0005	10 KV	1 5/8	19/32
OF100-102	.001	10 KV	1 5/8	19/32
OF100-202	.002	10 KV	1 5/8	3/4
OF100-502	.005	10 KV	1 3/4	13/16
OF100-103	.01	10 KV	2 1/4	29/32
OF100-203	.02	10 KV	2 3/4	1 1/8
OF100-503	.05	10 KV	2 3/4	1 5/8
OF100-603	.06	10 KV	3	1 5/8
OF100-104	0.1	10 KV	5	1 5/8
OF150-101	.0001	15 KV	2 1/4	19/32
OF150-201	.0002	15 KV	2 1/4	19/32
OF150-501	.0005	15 KV	2 1/4	19/32
OF150-102	.001	15 KV	2 1/4	3/4
OF150-202	.002	15 KV	2 1/4	3/4
OF150-502	.005	15 KV	2 3/4	1 1/8
OF150-103	.01	15 KV	3 3/4	1 1/8
OF150-203	.02	15 KV	4 1/4	1 3/8
OF150-503	.05	15 KV	7	1 5/8
OF150-603	.06	15 KV	8	1 5/8
OF200-101	.0001	20 KV	3 1/2	19/32
OF200-201	.0002	20 KV	3 1/2	19/32
OF200-501	.0005	20 KV	3 1/2	19/32
OF200-102	.001	20 KV	3 1/2	3/4
OF200-202	.002	20 KV	3 1/2	13/16
OF200-502	.005	20 KV	3 1/2	1 1/8
OF200-103	.01	20 KV	4 1/2	1 1/8
OF200-203	.02	20 KV	4 1/2	1 5/8
OF200-403	.04	20 KV	7 1/4	1 5/8
OF300-101	.0001	30 KV	4 9/16	19/32
OF300-201	.0002	30 KV	4 9/16	19/32
OF300-501	.0005	30 KV	4 9/16	19/32
OF300-102	.001	30 KV	5	3/4
OF300-202	.002	30 KV	5	29/32
OF300-502	.005	30 KV	5	1 3/8
OF300-103	.01	30 KV	6 1/2	1 5/8
OF300-203	.02	30 KV	9	1 5/8

The above is a partial listing. Additional capacitance and voltage values are available. Send for complete listing.

HIGH VOLTAGE POWER PACKS COMPACT "M" SERIES 2 TO 75 KVDC

SEE SECTION 4000, PAGE 1018

Plastic Capacitors, Inc.

SANGAMO ELECTRIC COMPANY

capacitors



ELECTRONIC COMPONENTS

Type DCM Computer Grade FILTER AND ENERGY STORAGE ELECTROLYTIC CAPACITOR

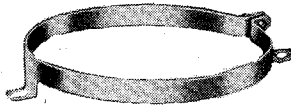

Type DCM Mounting Bracket	Capacitor Diameter (Inches)	Net Price
	1-7/16	\$0.24
	1-13/16	0.33
	2-1/16	0.36
	2-9/16	0.48
	3-1/16	0.60

Note: 1-7/16" bracket available with 2 feet only. Two or 3 feet are available in other sizes.

The SANGAMO Type DCM is a high quality, long life, electrolytic capacitor, specially designed for use as an energy storage or filter capacitor at 65°C. The Type DCM is enclosed in an aluminum can and is normally furnished with a clear plastic insulating sleeve. Aluminum terminals, which are permanently molded into the top, include #10-32 machine screws. A pressure-sensitive is provided as a safety mechanism in each top. A footed, wrap-around mounting bracket is available at extra cost. For more complete information write for Bulletin 2231.

Catalog Number	Cap. (Mfd)	Rated Volts d-c	Case Sizes *		Term. * Ctr. to Ctr.	Net Price 1-24†	Catalog Number	Cap. (Mfd)	Rated Volts d-c	Case Sizes *		Term. * Ctr. to Ctr.	Net Price 1-24†
			Diameter	Length						Diameter	Length		
539-2619-01	33,000	5	2-1/16	4-1/2	.875	\$ 7.62	539-2553-01	450	75	1-7/16	2-1/2	.500	2.85
539-2621-01	125,000	5	3-1/16	6	1.250	16.71	539-2554-01	900	75	1-7/16	3-1/2	.500	3.78
539-2530-01	3,750	10	1-7/16	2-1/2	.500	3.36	539-2653-01	1,000	75	1-7/16	4-1/2	.500	4.02
539-2531-01	7,000	10	1-7/16	3-1/2	.500	4.20	539-2555-01	1,350	75	1-7/16	4-1/2	.500	4.29
539-2622-01	10,000	10	1-7/16	4-1/2	.500	5.10	539-2654-01	3,000	75	2-1/16	4-1/2	.875	6.27
539-2736-01	15,000	10	1-13/16	4-1/2	.750	5.73	539-2656-01	5,000	75	2-9/16	4-1/2	1.125	10.23
539-2623-01	20,000	10	2-1/16	4-1/2	.875	8.07	539-2557-01	7,750	75	3-1/16	4-1/2	1.250	12.84
539-2624-01	35,000	10	2-1/16	6	.875	10.92	539-2657-01	10,000	75	3-1/16	6	1.250	16.20
539-2625-01	40,000	10	2-9/16	4-1/2	1.125	12.12							
539-2626-01	60,000	10	3-1/16	4-1/2	1.250	15.39	539-2558-01	350	100	1-7/16	2-1/2	.500	3.00
539-2627-01	90,000	10	3-1/16	6	1.250	19.77	539-2559-01	500	100	1-7/16	3-1/2	.500	3.18
539-2532-01	2,500	15	1-7/16	2-1/2	.500	2.94	539-2658-01	1,000	100	1-7/16	4-1/2	.500	4.41
539-2533-01	5,000	15	1-7/16	3-1/2	.500	4.17	539-2742-01	1,500	100	1-13/16	4-1/2	.750	4.86
539-2628-01	6,000	15	1-7/16	4-1/2	.500	4.23	539-2597-01	3,000	100	2-1/16	6	.875	9.42
539-2534-01	8,000	15	1-7/16	4-1/2	.500	4.98	539-2660-01	4,000	100	2-9/16	4-1/2	1.125	9.96
539-2737-01	10,000	15	1-13/16	4-1/2	.750	5.34	539-2661-01	5,000	100	3-1/16	4-1/2	1.250	10.71
539-2738-01	14,000	15	1-13/16	4-1/2	.750	6.94	539-2662-01	8,500	100	3-1/16	6	1.250	16.35
539-2629-01	18,000	15	2-1/16	4-1/2	.875	8.49							
539-2630-01	25,000	15	2-1/16	6	.875	10.95	539-2560-01	250	150	1-7/16	2-1/2	.500	2.64
539-2631-01	33,000	15	2-9/16	4-1/2	1.125	11.28	539-2663-01	500	150	1-7/16	3-1/2	.500	3.84
539-1246-02	35,000	15	3-1/16	4-1/2	1.250	11.34	539-2664-01	700	150	1-7/16	4-1/2	.500	4.32
539-2632-01	40,000	15	3-1/16	4-1/2	1.250	12.48	539-2561-01	750	150	1-7/16	4-1/2	.500	4.41
539-2598-01	45,000	15	3-1/16	4-1/2	1.250	13.77	539-2743-01	1,000	150	1-13/16	4-1/2	.750	4.83
539-2673-01	50,000	15	3-1/16	6	1.250	15.12	539-2744-01	1,250	150	1-13/16	4-1/2	.750	5.22
539-2633-01	60,000	15	3-1/16	6	1.250	17.67	539-2562-01	1,450	150	1-13/16	4-1/2	.750	6.12
539-2535-01	2,250	20	1-7/16	2-1/2	.500	2.97							
539-2536-01	4,500	20	1-7/16	3-1/2	.500	4.32	539-2861-01	1,850	150	2-1/16	4-1/2	.875	7.71
539-2537-01	6,500	20	1-7/16	4-1/2	.500	4.77	539-2665-01	2,000	150	2-1/16	6	.875	8.37
539-2538-01	10,000	20	1-13/16	4-1/2	.750	5.85	539-2666-01	2,500	150	2-9/16	4-1/2	1.125	9.57
539-2539-01	14,750	20	2-1/16	4-1/2	.875	8.04	539-2564-01	3,000	150	2-9/16	4-1/2	1.125	10.44
539-2540-01	22,000	20	2-1/16	6	.875	10.56	539-2667-01	4,000	150	3-1/16	4-1/2	1.250	12.63
539-2541-01	25,000	20	2-9/16	4-1/2	1.125	11.10	539-2565-01	4,500	150	3-1/16	4-1/2	1.250	13.29
539-2542-01	35,000	20	3-1/16	4-1/2	1.250	13.50	539-2668-01	6,000	150	3-1/16	6	1.250	15.18
539-2543-01	50,000	20	3-1/16	6	1.250	16.92							
539-2544-01	1,500	25	1-7/16	2-1/2	.500	2.79	539-2566-01	200	200	1-7/16	2-1/2	.500	3.12
539-2545-01	3,000	25	1-7/16	3-1/2	.500	3.69	539-2669-01	500	200	1-7/16	4-1/2	.500	4.17
539-2634-01	5,000	25	1-7/16	4-1/2	.500	4.74	539-2745-01	750	200	1-13/16	4-1/2	.750	5.37
539-2739-01	8,000	25	1-13/16	4-1/2	.750	6.12	539-2670-01	1,500	200	2-1/16	6	.875	7.65
539-2635-01	10,000	25	2-1/16	4-1/2	.875	7.26	539-2671-01	2,000	200	2-9/16	4-1/2	1.125	9.18
539-2636-01	15,000	25	2-1/16	6	.875	10.20	539-2672-01	2,500	200	3-1/16	4-1/2	1.250	10.80
539-2637-01	20,000	25	2-9/16	4-1/2	1.125	10.59	539-2570-01	4,500	200	3-1/16	6	1.250	14.13
539-2638-01	25,000	25	3-1/16	4-1/2	1.250	11.22							
539-2639-01	40,000	25	3-1/16	6	1.250	17.55	539-2746-01	500	250	1-13/16	4-1/2	.750	4.50
539-2640-01	1,500	35	1-7/16	3-1/2	.500	3.03	539-2575-01	1,000	250	2-1/16	4-1/2	.875	9.81
539-2547-01	2,500	35	1-7/16	3-1/2	.500	3.60	539-2874-01	1,500	250	2-9/16	4-1/2	1.125	10.83
539-2641-01	4,000	35	1-7/16	4-1/2	.500	4.50	539-2675-01	275	300	1-7/16	4-1/2	.500	4.50
539-2740-01	5,000	35	1-13/16	4-1/2	.750	5.31	539-2747-01	450	300	1-13/16	4-1/2	.750	5.10
539-2548-01	7,000	35	1-13/16	4-1/2	.750	6.69	539-2676-01	1,000	300	2-9/16	4-1/2	1.125	11.22
539-2642-01	8,000	35	2-1/16	4-1/2	.875	6.78	539-2677-01	1,500	300	3-1/16	4-1/2	1.250	17.73
539-2549-01	9,000	35	2-1/16	4-1/2	.875	7.71							
539-2643-01	10,000	35	2-1/16	6	.875	8.31	539-2584-01	150	350	1-7/16	3-1/2	.500	4.08
539-2550-01	13,500	35	2-1/16	6	.875	10.53	539-2748-01	350	350	1-13/16	4-1/2	.750	5.49
539-2644-01	15,000	35	2-9/16	4-1/2	1.125	11.07	539-2678-01	1,000	350	3-1/16	4-1/2	1.250	11.73
539-2645-01	20,000	35	3-1/16	4-1/2	1.250	12.12	539-2590-01	50	400	1-7/16	2-1/2	.500	3.00
539-2646-01	30,000	35	3-1/16	6	1.250	13.92	539-2595-01	50	450	1-7/16	2-1/2	.500	1.60
539-2551-01	750	50	1-7/16	2-1/2	.500	2.88	539-2682-01	100	450	1-7/16	3-1/2	.500	.50
539-1615-03	1,000	50	1-7/16	3-1/2	.500	3.24	539-2596-01	150	450	1-7/16	4-1/2	.500	5.04
539-2552-01	1,500	50	1-7/16	3-1/2	.500	3.69							
539-1463-03	2,000	50	1-7/16	4-1/2	.500	3.81	539-2749-01	250	450	1-13/16	4-1/2	.750	5.94
539-2647-01	2,500	50	1-7/16	4-1/2	.500	4.08	539-2683-01	300	450	2-1/16	4-1/2	.875	6.33
539-2741-01	4,000	50	1-13/16	4-1/2	.750	5.49	539-2684-01	500	450	2-1/16	6	.875	8.04
539-2648-01	5,000	50	2-1/16	4-1/2	.875	7.11	539-2685-01	600	450	2-9/16	4-1/2	1.125	9.90
539-2649-01	8,000	50	2-1/16	6	.875	8.79	539-2686-01	800	450	3-1/16	4-1/2	1.250	11.46
539-2650-01	10,000	50	2-9/16	4-1/2	1.125	11.46	539-2687-01	850	450	3-1/16	4-1/2	1.250	12.24
539-2651-01	15,000	50	3-1/16	4-1/2	1.250	13.65							
539-2652-01	20,000	50	3-1/16	6	1.250	16.71							

*All dimensions are in inches.

†Prices for larger quantities are available on request.

SANGAMO ELECTRIC COMPANY

capacitors



ELECTRONIC COMPONENTS

Type CE70 and CE71 MILITARY GRADE CAPACITORS

The Sangamo Types CE70 and CE71 are aluminum electrolytic capacitors designed and manufactured in accordance with Mil-C-62B. They are recommended for operation up to +85°C and are available in voltage ratings from 5 to 450 d-c volts. The Type CE70 is supplied with a plastic insulating sleeve. Commercial equivalents can be supplied which meet or exceed the applicable military requirements. **FOR MORE COMPLETE INFORMATION WRITE FOR BULLETIN 2236.**

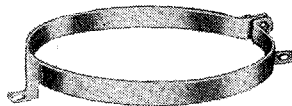

Type	Capacitor Diameter (Inches)	Net Price
CE70 & CE71	1-7/16	\$.24
Mounting Bracket	2-1/16	.36
	2-9/16	.48
	3-1/16	.60

Note: 1-7/16" bracket available with 2 feet only. Other sizes are available with 2 or 3 feet.

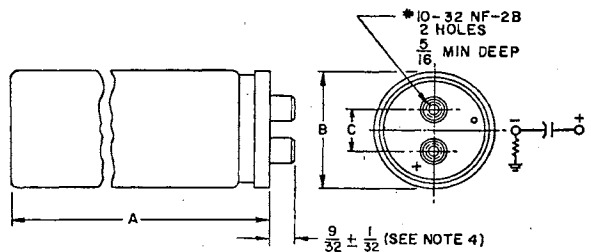

- All dimensions in inches.
- Capacitors are mounted by means of a wraparound, footed-type bracket.
- There is an indeterminate resistance between the metal case and the negative terminal.
- This dimension shall be measured from the base of the container.

Type Designation	Cap. (Mfd)	Rated Volts d-c	Case Sizes*		Term * Ctr. to Ctr.	Net Price 1-24†	Type Designation	Cap. (Mfd)	Rated Volts d-c	Case Sizes*		Term * Ctr. to Ctr.	Net Price 1-24†
			Diam.	Length						Diam.	Length		
CE71C103C	10,000	5	1-7/16	4-1/2	.500	\$ 4.98	CE71C202J	2,000	150	2-9/16	4-1/2	1.125	\$ 9.63
CE71C153C	15,000	5	2-1/16	4-1/2	.875	6.12	CE71C332J	3,300	150	3-1/16	4-1/2	1.250	12.63
CE71C253C	25,000	5	2-1/16	4-1/2	.875	7.62	CE71C351K	350	200	1-7/16	4-1/2	.500	4.23
CE71C333C	33,000	5	2-9/16	4-1/2	1.125	8.76	CE71C471K	470	200	1-7/16	4-1/2	.500	4.74
CE71C473C	47,000	5	2-9/16	4-1/2	1.125	10.77	CE71C681K	680	200	2-1/16	4-1/2	.875	5.85
CE71C683C	68,000	5	3-1/16	4-1/2	1.250	13.65	CE71C102K	1,000	200	2-1/16	4-1/2	.875	8.43
CE71C682D	6,800	10	1-7/16	4-1/2	.500	4.77	CE71C152K	1,500	200	2-9/16	4-1/2	1.125	8.79
CE71C103D	10,000	10	2-1/16	4-1/2	.875	5.88	CE71C222K	2,200	200	3-1/16	4-1/2	1.250	11.22
CE71C153D	15,000	10	2-1/16	4-1/2	.875	6.60	CE71C301M	300	250	1-7/16	4-1/2	.500	4.65
CE71C283D	28,000	10	2-9/16	4-1/2	1.125	11.76	CE71C471M	470	250	2-1/16	4-1/2	.875	5.10
CE71C403D	40,000	10	3-1/16	4-1/2	1.250	13.95	CE71C681M	680	250	2-1/16	4-1/2	.875	7.20
CE71C472E	4,700	15	1-7/16	4-1/2	.500	4.77	CE71C102M	1,000	250	2-9/16	4-1/2	1.125	11.28
CE71C562E	5,600	15	1-7/16	4-1/2	.500	4.83	CE71C122M	1,200	250	2-9/16	4-1/2	1.125	11.46
CE71C123E	12,000	15	2-1/16	4-1/2	.875	5.85	CE71C152M	1,500	250	2-9/16	4-1/2	1.125	12.33
CE71C223E	22,000	15	2-9/16	4-1/2	1.125	11.34	CE71C222M	2,200	250	3-1/16	4-1/2	1.250	15.72
CE71C333E	33,000	15	3-1/16	4-1/2	1.250	12.96	CE71C251N	250	300	1-7/16	4-1/2	.500	5.01
CE71C393E	39,000	15	3-1/16	4-1/2	1.250	14.04	CE71C331N	330	300	2-1/16	4-1/2	.875	5.46
CE71C332F	3,300	25	1-7/16	4-1/2	.500	4.26	CE71C471N	470	300	2-1/16	4-1/2	.875	5.94
CE71C472F	4,700	25	2-1/16	4-1/2	.875	5.25	CE71C551N	550	300	2-1/16	4-1/2	.875	6.18
CE71C682F	6,800	25	2-1/16	4-1/2	.875	6.72	CE71C681N	680	300	2-9/16	4-1/2	1.125	8.52
CE71C103F	10,000	25	2-1/16	4-1/2	.875	8.34	CE71C102N	1,000	300	2-9/16	4-1/2	1.125	12.90
CE71C153F	15,000	25	2-9/16	4-1/2	1.125	11.73	CE71C152N	1,500	300	3-1/16	4-1/2	1.250	19.38
CE71C223F	22,000	25	3-1/16	4-1/2	1.250	12.48	CE71C201P	200	350	1-7/16	4-1/2	.500	5.13
CE71C152G	1,500	50	1-7/16	4-1/2	.500	4.23	CE71C331P	330	350	2-1/16	4-1/2	.875	6.21
CE71C222G	2,200	50	2-1/16	4-1/2	.875	4.50	CE71C471P	470	350	2-1/16	4-1/2	.875	8.34
CE71C332G	3,300	50	2-1/16	4-1/2	.875	6.12	CE71C681P	680	350	2-9/16	4-1/2	1.125	10.23
CE71C472G	4,700	50	2-9/16	4-1/2	1.125	6.78	CE71C751P	750	350	2-9/16	4-1/2	1.125	10.62
CE71C562G	5,600	50	2-9/16	4-1/2	1.125	8.88	CE71C122P	1,200	350	3-1/16	4-1/2	1.250	15.30
CE71C682G	6,800	50	2-9/16	4-1/2	1.125	9.90	CE71C151Q	150	400	1-7/16	4-1/2	.500	5.34
CE71C103G	10,000	50	3-1/16	4-1/2	1.250	13.17	CE71C221Q	220	400	2-1/16	4-1/2	.875	6.06
CE71C681H	680	100	1-7/16	4-1/2	.500	4.08	CE71C331Q	330	400	2-1/16	4-1/2	.875	6.90
CE71C102H	1,000	100	1-7/16	4-1/2	.500	5.07	CE71C471Q	470	400	2-9/16	4-1/2	1.125	7.89
CE71C152H	1,500	100	2-1/16	4-1/2	.875	5.76	CE71C601Q	600	400	2-9/16	4-1/2	1.125	10.56
CE71C222H	2,200	100	2-9/16	4-1/2	1.125	7.59	CE71C681Q	680	400	2-9/16	4-1/2	1.125	10.77
CE71C332H	3,300	100	2-9/16	4-1/2	1.125	11.01	CE71C101R	100	450	1-7/16	4-1/2	.500	5.19
CE71C472H	4,700	100	3-1/16	4-1/2	1.250	12.00	CE71C151R	150	450	1-7/16	4-1/2	.500	5.79
CE71C471J	470	150	1-7/16	4-1/2	.500	4.38	CE71C221R	220	450	2-1/16	4-1/2	.875	6.39
CE71C681J	680	150	1-7/16	4-1/2	.500	4.89	CE71C331R	330	450	2-1/16	4-1/2	.875	7.41
CE71C122J	1,200	150	2-1/16	4-1/2	.875	5.94	CE71C471R	470	450	2-9/16	4-1/2	1.125	8.67

For Type CE70 (CE71 without sleeve), Deduct 3/8" From Length, 1/16" From Diameter and \$0.05 From Net Price

* All Dimensions are in Inches.

† Prices for Larger Quantities are Available on Request.

SANGAMO ELECTRIC COMPANY
capacitors



ELECTRONIC COMPONENTS

Type 557 Aluminum Electrolytic

—55°C TO +125°C
AXIAL LEAD CAPACITOR

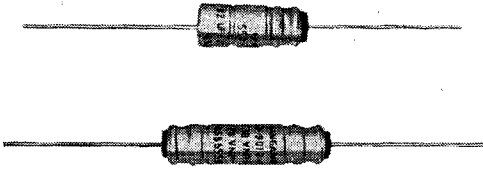

The axial lead type 557 has extremely stable characteristics at much wider temperature ranges. The type 557, designed for application in high reliability circuits, meets the MIL - C - 39018 military specifications at temperatures from -55°C to +125°C. Standard ratings are available for both polar and non-polar applications. Mylar sleeves are provided for improved electrical insulation and mechanical properties. **FOR MORE COMPLETE INFORMATION WRITE FOR BULLETIN 2240.**

Catalog Number	Cap. mfd.	d-c Volts				Case Sizes*		Price 1-9†	Catalog Number	Cap. mfd.	d-c Volts				Case Sizes*		Price 1-9†
		+85°C		+125°C		D	L				+85°C		+125°C		D	L	
		rated	surge	rated	surge						rated	surge	rated	surge			
557DC151U007B	150	7	10	5	7	3/8 x 13/16		\$2.92	557DJ101U050B	100	50	60	40	50	3/8 x 1-5/8		6.04
557DD221U007B	220	7	10	5	7	3/8 x 15/16		3.08	557DL151U050B	150	50	60	40	50	3/8 x 2-3/16		6.44
557DE281U007B	280	7	10	5	7	3/8 x 1-1/8		3.96	557DX181U050B	180	50	60	40	50	3/8 x 2-11/16		9.76
557DG421U007B	420	7	10	5	7	3/8 x 1-3/8		5.92									
557DJ561U007B	560	7	10	5	7	3/8 x 1-5/8		6.04	557DC200U060B	20	60	70	50	60	3/8 x 13/16		2.92
557DL851U007B	850	7	10	5	7	3/8 x 2-3/16		6.44	557DD250U060B	25	60	70	50	60	3/8 x 15/16		3.08
557DX102U007B	1000	7	10	5	7	3/8 x 2-11/16		9.76	557DE400U060B	40	60	70	50	60	3/8 x 1-1/8		3.96
									557DG600U060B	60	60	70	50	60	3/8 x 1-3/8		5.92
557DC101U015B	100	15	20	10	15	3/8 x 13/16		2.92	557DJ800U060B	80	60	70	50	60	3/8 x 1-5/8		6.04
557DD151U015B	150	15	20	10	15	3/8 x 15/16		3.08	557DL121U060B	120	60	70	50	60	3/8 x 2-3/16		6.44
557DE191U015B	190	15	20	10	15	3/8 x 1-1/8		3.96	557DX151U060B	150	60	70	50	60	3/8 x 2-11/16		9.76
557DG291U015B	290	15	20	10	15	3/8 x 1-3/8		5.92									
557DJ391U015B	390	15	20	10	15	3/8 x 1-5/8		6.04	557DC150U070B	15	70	80	60	70	3/8 x 13/16		2.92
557DL581U015B	580	15	20	10	15	3/8 x 2-3/16		6.44	557DD200U070B	20	70	80	60	70	3/8 x 15/16		3.08
557DX681U015B	680	15	20	10	15	3/8 x 2-11/16		9.76	557DE300U070B	30	70	80	60	70	3/8 x 1-1/8		3.96
									557DG500U070B	50	70	80	60	70	3/8 x 1-3/8		5.92
557DC800U020B	80	20	25	15	20	3/8 x 13/16		2.92	557DJ650U070B	65	70	80	60	70	3/8 x 1-5/8		6.04
557DD101U020B	100	20	25	15	20	3/8 x 15/16		3.08	557DL101U070B	100	70	80	60	70	3/8 x 2-3/16		6.44
557DE141U020B	140	20	25	15	20	3/8 x 1-1/8		3.96	557DX121U070B	120	70	80	60	70	3/8 x 2-11/16		9.76
557DG221U020B	220	20	25	15	20	3/8 x 1-3/8		5.92									
557DJ291U020B	290	20	25	15	20	3/8 x 1-5/8		6.04	557DC100T100B	10	100	125	75	100	3/8 x 13/16		2.92
557DL441U020B	440	20	25	15	20	3/8 x 2-3/16		6.44	557DD150T100B	15	100	125	75	100	3/8 x 15/16		3.08
557DX601U020B	600	20	25	15	20	3/8 x 2-11/16		9.76	557DE170T100B	17	100	125	75	100	3/8 x 1-1/8		3.96
									557DG250T100B	25	100	125	75	100	3/8 x 1-3/8		5.92
557DC700U025B	70	25	30	20	25	3/8 x 13/16		2.92	557DJ350T100B	35	100	125	75	100	3/8 x 1-5/8		6.04
557DD800U025B	80	25	30	20	25	3/8 x 15/16		3.08	557DL500T100B	50	100	125	75	100	3/8 x 2-3/16		6.44
557DE101U025B	100	25	30	20	25	3/8 x 1-1/8		3.96	557DX680T100B	68	100	125	75	100	3/8 x 2-11/16		9.76
557DG151U025B	150	25	30	20	25	3/8 x 1-3/8		5.92									
557DJ211U025B	210	25	30	20	25	3/8 x 1-5/8		6.04	557DC080T150B	8	150	175	100	125	3/8 x 13/16		2.92
557DL311U025B	310	25	30	20	25	3/8 x 2-3/16		6.44	557DD100T150B	10	150	175	100	125	3/8 x 15/16		3.08
557DX401U025B	400	25	30	20	25	3/8 x 2-11/16		9.76	557DE120T150B	12	150	175	100	125	3/8 x 1-1/8		3.96
									557DG180T150B	18	150	175	100	125	3/8 x 1-3/8		5.92
557DC400U040B	40	40	50	30	40	3/8 x 13/16		2.92	557DJ250T150B	25	150	175	100	125	3/8 x 1-5/8		6.04
557DD500U040B	50	40	50	30	40	3/8 x 15/16		3.08	557DL400T150B	40	150	175	100	125	3/8 x 2-3/16		6.44
557DE700U040B	70	40	50	30	40	3/8 x 1-1/8		3.96	557DX560T150B	56	150	175	100	125	3/8 x 2-11/16		9.76
557DG101U040B	100	40	50	30	40	3/8 x 1-3/8		5.92									
557DJ141U040B	140	40	50	30	40	3/8 x 1-5/8		6.04	557DC040T200B	4	200	225	150	175	3/8 x 13/16		2.92
557DL211U040B	210	40	50	30	40	3/8 x 2-3/16		6.44	557DD060T200B	6	200	225	150	175	3/8 x 15/16		3.08
557DX251U040B	250	40	50	30	40	3/8 x 2-11/16		9.76	557DE080T200B	8	200	225	150	175	3/8 x 1-1/8		3.96
									557DG130T200B	13	200	225	150	175	3/8 x 1-3/8		5.92
557DC250U050B	25	50	60	40	50	3/8 x 13/16		2.92	557DJ170T200B	17	200	225	150	175	3/8 x 1-5/8		6.04
557DD350U050B	35	50	60	40	50	3/8 x 15/16		3.08	557DL260T200B	26	200	225	150	175	3/8 x 2-3/16		6.44
557DE500U050B	50	50	60	40	50	3/8 x 1-1/8		3.96	557DX390T200B	39	200	225	150	175	3/8 x 2-11/16		9.76
557DG750U050B	75	50	60	40	50	3/8 x 1-3/8		5.92									

*All dimensions are in inches.

†Prices for larger quantities are available on request.

SANGAMO ELECTRIC COMPANY

capacitors





ELECTRONIC COMPONENTS

Type S Subminiature Hermetically Sealed Metal Tubular Capacitors

Sangamo Type S capacitors are designed to meet the demands for a high quality, hermetically sealed paper tubular capacitor. They are encapsulated in brass tubular cases finished with a high tin content alloy. Hermetic sealing is accomplished by using glass-to-metal solder seal terminals. The impregnant used in these units is Ethern, an oil of high thermal stability and superior electrical characteristics over the temperature range of -55°C to +125°C. Sangamo Type S capacitors meet the case sizes and performance requirements of military specification ML-C-25. The limited number of popular listings below are furnished with insulated sections. They are also available with grounded case if equipment requirements so dictate. The adjacent cross reference table will assist in the interpretation of Sangamo catalog nomenclatures with the various military types and case constructions.

For more complete information on other ratings, tolerances and voltages, write for Bulletin 2421.

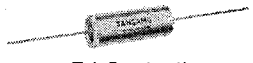
Sangamo Type	Military Type	Description
SBA	CP04	Tab construction (without sleeve)
SBB	CP05	Tab construction (with sleeve)
SDA	CP08	Extended foil (without sleeve)
SDB	CP09	Extended foil (with sleeve)
SBC	CP10	Tab construction (with bracket)
SBE	CP11	Tab construction (with threaded mtg)
SDC	CP12	Extended foil (with bracket)
SDE	CP13	Extended foil (with threaded mtg)

Capacitance Tolerance ±10% †		 Tab Construction		 Tab Construction		 Extended Foil		 Extended Foil	
Cap. (Mfd)	Rated Volts d-c	Catalog Number	Net Price 1-9*	Catalog Number	Net Price 1-9*	Catalog Number	Net Price 1-9*	Catalog Number	Net Price 1-9*
.027	100	SBA1K01273K	\$1.76	SBB1K01273K	\$1.84	SDA1K01273K	\$1.96	SDB1K01273K	\$2.04
.033	100	SBA1K01333K	1.80	SBB1K01333K	1.84	SDA1K01333K	1.96	SDB1K01333K	2.04
.082	100	SBA1K01823K	1.92	SBB1K01823K	1.96	SDA1K01823K	2.00	SDB1K01823K	2.08
.1	100	SBA1K01104K	1.92	SBB1K01104K	2.00	SDA1K01104K	2.04	SDB1K01104K	2.08
.15	100	SBA1K01154K	1.92	SBB1K01154K	2.04	SDA1K01154K	2.04	SDB1K01154K	2.12
.22	100	SBA1K01224K	2.00	SBB1K01224K	2.04	SDA1K01224K	2.16	SDB1K01224K	2.20
.27	100	SBA1K01274K	2.04	SBB1K01274K	2.08	SDA1K01274K	2.24	SDB1K01274K	2.28
.33	100	SBA1K01334K	2.08	SBB1K01334K	2.16	SDA1K01334K	2.32	SDB1K01334K	2.40
.39	100	SBA1K01394K	2.16	SBB1K01394K	2.24	SDA1K01394K	2.36	SDB1K01394K	2.44
.47	100	SBA1K01474K	2.24	SBB1K01474K	2.32	SDA1K01474K	2.44	SDB1K01474K	2.52
.68	100	SBA1K01684K	2.36	SBB1K01684K	2.48	SDA1K01684K	2.56	SDB1K01684K	2.64
.82	100	SBA1K01824K	2.44	SBB1K01824K	2.52	SDA1K01824K	2.68	SDB1K01824K	2.80
1.0	100	SBA1K01105K	2.52	SBB1K01105K	2.64	SDA1K01105K	2.88	SDB1K01105K	2.96
.015	200	SBA1K02153K	1.84	SBB1K02153K	1.92	SDA1K02153K	2.00	SDB1K02153K	2.08
.022	200	SBA1K02223K	1.84	SBB1K02223K	1.92	SDA1K02223K	2.00	SDB1K02223K	2.08
.039	200	SBA1K02393K	1.92	SBB1K02393K	2.00	SDA1K02393K	2.04	SDB1K02393K	2.12
.047	200	SBA1K02473K	1.96	SBB1K02473K	2.00	SDA1K02473K	2.08	SDB1K02473K	2.16
.068	200	SBA1K02683K	1.96	SBB1K02683K	2.04	SDA1K02683K	2.08	SDB1K02683K	2.16
.1	200	SBA1K02104K	2.00	SBB1K02104K	2.08	SDA1K02104K	2.08	SDB1K02104K	2.16
.15	200	SBA1K02154K	2.04	SBB1K02154K	2.08	SDA1K02154K	2.20	SDB1K02154K	2.28
.22	200	SBA1K02224K	2.16	SBB1K02224K	2.20	SDA1K02224K	2.32	SDB1K02224K	2.40
.33	200	SBA1K02334K	2.28	SBB1K02334K	2.36	SDA1K02334K	2.48	SDB1K02334K	2.56
.39	200	SBA1K02394K	2.36	SBB1K02394K	2.44	SDA1K02394K	2.52	SDB1K02394K	2.64
.47	200	SBA1K02474K	2.44	SBB1K02474K	2.52	SDA1K02474K	2.64	SDB1K02474K	2.72
.68	200	SBA1K02684K	2.56	SBB1K02684K	2.64	SDA1K02684K	2.88	SDB1K02684K	2.96
.82	200	SBA1K02824K	2.56	SBB1K02824K	2.76	SDA1K02824K	2.92	SDB1K02824K	3.00
1.0	200	SBA1K02105K	2.80	SBB1K02105K	2.88	SDA1K02105K	3.00	SDB1K02105K	3.08
.0082	400	SBA1K04822K	1.88	SBB1K04822K	1.96	SDA1K04822K	2.04	SDB1K04822K	2.12
.01	400	SBA1K04103K	1.92	SBB1K04103K	1.96	SDA1K04103K	2.04	SDB1K04103K	2.12
.033	400	SBA1K04333K	2.00	SBB1K04333K	2.04	SDA1K04333K	2.12	SDB1K04333K	2.20
.047	400	SBA1K04473K	2.04	SBB1K04473K	2.12	SDA1K04473K	2.16	SDB1K04473K	2.24
.068	400	SBA1K04683K	2.08	SBB1K04683K	2.16	SDA1K04683K	2.24	SDB1K04683K	2.32
.082	400	SBA1K04823K	2.12	SBB1K04823K	2.16	SDA1K04823K	2.28	SDB1K04823K	2.36
.1	400	SBA1K04104K	2.16	SBB1K04104K	2.24	SDA1K04104K	2.32	SDB1K04104K	2.40
.15	400	SBA1K04154K	2.28	SBB1K04154K	2.36	SDA1K04154K	2.48	SDB1K04154K	2.56
.22	400	SBA1K04224K	2.44	SBB1K04224K	2.52	SDA1K04224K	2.60	SDB1K04224K	2.68
.33	400	SBA1K04334K	2.56	SBB1K04334K	2.64	SDA1K04334K	2.88	SDB1K04334K	2.96
.47	400	SBA1K04474K	2.80	SBB1K04474K	2.88	SDA1K04474K	3.00	SDB1K04474K	3.12
.68	400	SBA1K04684K	3.00	SBB1K04684K	3.08	SDA1K04684K	3.12	SDB1K04684K	3.24
.82	400	SBA1K04824K	3.16	SBB1K04824K	3.24	-----	-----	-----	-----
1.0	400	SBA1K04105K	3.36	SBB1K04105K	3.48	-----	-----	-----	-----
.0015	600	SBA1K06152K	1.88	SBB1K06152K	1.92	SDA1K06152K	1.96	SDB1K06152K	2.00
.0022	600	SBA1K06222K	1.88	SBB1K06222K	1.92	SDA1K06222K	1.96	SDB1K06222K	2.04
.0047	600	SBA1K06472K	1.92	SBB1K06472K	1.96	SDA1K06472K	2.04	SDB1K06472K	2.12
.0068	600	SBA1K06682K	1.92	SBB1K06682K	2.00	SDA1K06682K	2.04	SDB1K06682K	2.12
.0082	600	SBA1K06822K	1.92	SBB1K06822K	2.04	SDA1K06822K	2.08	SDB1K06822K	2.12
.01	600	SBA1K06103K	1.96	SBB1K06103K	2.04	SDA1K06103K	2.08	SDB1K06103K	2.12
.015	600	SBA1K06153K	2.00	SBB1K06153K	2.08	SDA1K06153K	2.16	SDB1K06153K	2.20
.022	600	SBA1K06223K	2.00	SBB1K06223K	2.12	SDA1K06223K	2.16	SDB1K06223K	2.24
.033	600	SBA1K06333K	2.08	SBB1K06333K	2.16	SDA1K06333K	2.16	SDB1K06333K	2.24
.047	600	SBA1K06473K	2.12	SBB1K06473K	2.20	SDA1K06473K	2.28	SDB1K06473K	2.32
.068	600	SBA1K06683K	2.20	SBB1K06683K	2.32	SDA1K06683K	2.40	SDB1K06683K	2.48
.1	600	SBA1K06104K	2.32	SBB1K06104K	2.44	SDA1K06104K	2.48	SDB1K06104K	2.56
.15	600	SBA1K06154K	2.40	SBB1K06154K	2.52	SDA1K06154K	2.64	SDB1K06154K	2.72
.22	600	SBA1K06224K	2.60	SBB1K06224K	2.80	SDA1K06224K	2.92	SDB1K06224K	3.00
.39	600	SBA1K06394K	2.96	SBB1K06394K	3.12	SDA1K06394K	3.16	SDB1K06394K	3.24
.47	600	SBA1K06474K	3.04	SBB1K06474K	3.20	SDA1K06474K	3.24	SDB1K06474K	3.36
.68	600	SBA1K06684K	3.20	SBB1K06684K	3.52	SDA1K06684K	3.40	-----	-----
.82	600	SBA1K06824K	3.32	SBB1K06824K	3.52	-----	-----	-----	-----
1.0	600	SBA1K06105K	3.40	SBB1K06105K	3.72	-----	-----	-----	-----

*Prices for larger quantities are available on request.
 †For ±5% tolerance add 30% to above price.

PRICES

Prices in this MASTER should not be considered as final. INQUIRE ABOUT LATEST PRICES AND DELIVERY.

DISCOUNTS

Trade discounts apply in most cases where LIST PRICES are shown.

ORDERING

Since previous editions of the MASTER are frequently referred to, it is important, when ordering, to mention specifically the edition and page number, also the catalog number of each item. This will avoid possible confusion and delay.

INVENTORY

While most distributors maintain a large and varied stock, they do not represent that they stock all manufacturers' products shown in this MASTER catalog.

SPRAGUE CAPACITORS

TYPE 150D SOLID-ELECTROLYTE TANTALEX® CAPACITORS (Cont.)

50 WVDC, 65 VDC SURGE			75 WVDC, 97 VDC SURGE			125 WVDC, 140 VDC SURGE			100 WVDC, 115 VDC SURGE		
Size μF	Code	Catalog Number ±20% Tol. ±10% Tol.	Size μF	Code	Catalog Number ±20% Tol. ±10% Tol.	Size μF	Code	Catalog Number ±20% Tol. ±10% Tol.	Size μF	Code	Catalog Number ±20% Tol. ±10% Tol.
.0047	A	150D472X0050A2	1.0	B	150D105X0060B2	.0047	A	150D472X0125A2	.0047	A	150D472X0060A2
.0056	A	150D562X9050A2	1.2	B	150D125X9060B2	.0056	A	150D562X9075A2	.0056	A	150D562X9060A2
.0068	A	150D682X0050A2	1.5	B	150D155X0060B2	.0068	A	150D682X0075A2	.0068	A	150D682X0060A2
.0082	A	150D822X9050A2	1.8	B	150D185X9060B2	.0082	A	150D822X9075A2	.0082	A	150D822X9060A2
.01	A	150D103X0050A2	2.2	B	150D225X0060B2	.01	A	150D103X0075A2	.01	A	150D103X0060A2
.012	A	150D123X9050A2	2.7	B	150D275X9060B2	.012	A	150D123X9075A2	.012	A	150D123X9060A2
.015	A	150D153X9050A2	3.3	B	150D335X0060B2	.015	A	150D153X0075A2	.015	A	150D153X9060A2
.018	A	150D183X9050A2	3.9	B	150D395X9060B2	.018	A	150D183X9075A2	.018	A	150D183X9060A2
.022	A	150D223X0050A2	4.7	R	150D475X0060R2	.022	A	150D223X0075A2	.022	A	150D223X0060A2
.027	A	150D273X9050A2	5.6	R	150D565X9060R2	.027	A	150D273X9075A2	.027	A	150D273X9060A2
.033	A	150D333X0050A2	6.8	R	150D685X9060R2	.033	A	150D333X0075A2	.033	A	150D333X9060A2
.039	A	150D393X9050A2	8.2	R	150D825X9060R2	.039	A	150D393X0075A2	.039	A	150D393X9060A2
.047	A	150D473X0050A2	10	R	150D106X0060R2	.047	A	150D473X0075A2	.047	A	150D473X9060A2
.056	A	150D563X9050A2	12	S	150D126X9060S2	.056	A	150D563X9075A2	.056	A	150D563X9060A2
.068	A	150D683X0050A2	15	S	150D156X0060S2	.068	A	150D683X0075A2	.068	A	150D683X9060A2
.082	A	150D823X9050A2	18	S	150D186X9060S2	.082	A	150D823X0075A2	.082	A	150D823X9060A2
.1	A	150D104X0050A2	22	S	150D226X9060S2	.1	A	150D104X0075A2	.1	A	150D104X0060A2
.12	A	150D124X9050A2				.12	A	150D124X9075A2	.12	A	150D124X9060A2
.15	A	150D154X0050A2				.15	A	150D154X0075A2	.15	A	150D154X9060A2
.18	A	150D184X9050A2				.18	A	150D184X9075A2	.18	A	150D184X9060A2
.22	A	150D224X0050A2				.22	A	150D224X0075A2	.22	A	150D224X9060A2
.27	A	150D274X9050A2				.27	A	150D274X9075A2	.27	A	150D274X9060A2
.33	A	150D334X0050A2				.33	A	150D334X0075A2	.33	A	150D334X9060A2
.39	A	150D394X9050A2				.39	A	150D394X9075A2	.39	A	150D394X9060A2
.47	A	150D474X0050A2				.47	A	150D474X0075A2	.47	A	150D474X9060A2
.56	A	150D564X9050A2				.56	A	150D564X9075A2	.56	A	150D564X9060A2
.68	A	150D684X0050A2				.68	A	150D684X0075A2	.68	A	150D684X9060A2
.82	A	150D824X9050A2				.82	A	150D824X9075A2	.82	A	150D824X9060A2
1.0	A	150D105X0050A2				1.0	B	150D105X0075B2	1.0	B	150D105X0060B2
1.2	B	150D125X9050B2				1.2	B	150D125X9075B2	1.2	B	150D125X9060B2
1.5	B	150D155X0050B2				1.5	B	150D155X0075B2	1.5	B	150D155X9075B2
1.8	B	150D185X9050B2				1.8	B	150D185X9075B2	1.8	B	150D185X9075B2
2.2	B	150D225X0050B2				2.2	B	150D225X0075B2	2.2	B	150D225X9075B2
2.7	B	150D275X9050B2				2.7	B	150D275X9075B2	2.7	B	150D275X9075B2
3.3	B	150D335X0050B2				3.3	B	150D335X0075B2	3.3	B	150D335X9075B2
3.9	B	150D395X9050B2				3.9	B	150D395X0075B2	3.9	B	150D395X9075B2
4.7	R	150D475X0050R2				4.7	R	150D475X0075R2	4.7	R	150D475X9075R2
5.6	R	150D565X9050R2				5.6	R	150D565X9075R2	5.6	R	150D565X9075R2
6.8	R	150D685X9050R2				6.8	R	150D685X0075R2	6.8	R	150D685X9075R2
8.2	R	150D825X9050R2				8.2	R	150D825X9075R2	8.2	R	150D825X9075R2
10	R	150D106X0050R2				10.0	R	150D106X0075R2	10.0	R	150D106X9075R2
12	R	150D126X9050R2				12.0	S	150D126X9075S2	12.0	S	150D126X9075S2
15	R	150D156X9050R2				15.0	S	150D156X0075S2	15.0	S	150D156X9075S2
18	R	150D186X9050R2									
22	S	150D226X9050S2									

DIMENSIONS WITH SLEEVE

Code	D. x L.
A	.135" x .286"
B	.185" x .474"
R	.289" x .636"
S	.351" x .786"

Call your Sprague
Industrial Distributor
for Current Quantity
Prices

SPRAGUE CAPACITORS

TYPE 151D NON-POLARIZED SOLID-ELECTROLYTE TANTALEX® CAPACITORS (Cont.)

50 VOLTS NP, 65 NP SURGE				75 VOLTS NP, 97 NP SURGE				125 VOLTS NP, 140 NP SURGE				100 VOLTS NP, 115 NP SURGE			
μF	Size Code	Catalog Number ±20% Tol.	Catalog Number ±10% Tol.	μF	Size Code	Catalog Number ±20% Tol.	Catalog Number ±10% Tol.	μF	Size Code	Catalog Number ±20% Tol.	Catalog Number ±10% Tol.	μF	Size Code	Catalog Number ±20% Tol.	Catalog Number ±10% Tol.
.0023	W	151D232X0050W2	151D232X9050W2	.50	X	151D504X0060X2	151D504X9060X2	.016	W	151D163X0100W2	151D163X9100W2	.0023	W	151D232X0060W2	151D232X9060W2
.0028	W	151D282X9050W2	151D282X9050W2	.60	X	151D602X9050W2	151D602X9050W2	.019	W	151D193X9100W2	151D193X9100W2	.0028	W	151D282X9060W2	151D282X9060W2
.0034	W	151D342X0050W2	151D342X9050W2	.75	X	151D754X0060X2	151D754X9060X2	.023	W	151D233X0100W2	151D233X9100W2	.0034	W	151D342X0060W2	151D342X9060W2
.0041	W	151D412X9050W2	151D412X9050W2	.90	X	151D904X9060X2	151D904X9060X2	.028	W	151D283X9100W2	151D283X9100W2	.0041	W	151D412X9060W2	151D412X9060W2
.005	W	151D502X0050W2	151D502X9050W2	1.1	X	151D115X0060X2	151D115X9060X2	.034	W	151D343X0100W2	151D343X9100W2	.005	W	151D502X0060W2	151D502X9060W2
.006	W	151D602X9050W2	151D602X9050W2	1.3	X	151D135X9060X2	151D135X9060X2	.041	W	151D413X9100W2	151D413X9100W2	.006	W	151D602X9060W2	151D602X9060W2
.0075	W	151D752X0050W2	151D752X9050W2	1.6	X	151D165X0060X2	151D165X9060X2	.050	W	151D503X0100W2	151D503X9100W2	.0075	W	151D752X0060W2	151D752X9060W2
.009	W	151D902X9050W2	151D902X9050W2	1.9	X	151D195X9060X2	151D195X9060X2	.060	W	151D603X9100W2	151D603X9100W2	.009	W	151D902X9060W2	151D902X9060W2
.011	W	151D113X0050W2	151D113X9050W2	2.3	Y	151D235X0060Y2	151D235X9060Y2	.075	W	151D753X0100W2	151D753X9100W2	.011	W	151D113X0060W2	151D113X9060W2
.013	W	151D133X9050W2	151D133X9050W2	2.8	Y	151D285X9060Y2	151D285X9060Y2	.090	W	151D903X9100W2	151D903X9100W2	.013	W	151D133X9060W2	151D133X9060W2
.016	W	151D163X0050W2	151D163X9050W2	3.4	Y	151D345X0060Y2	151D345X9060Y2	.11	W	151D114X0100W2	151D114X9100W2	.016	W	151D163X9060W2	151D163X9060W2
.019	W	151D193X9050W2	151D193X9050W2	4.1	Y	151D415X9060Y2	151D415X9060Y2	.13	W	151D134X9100W2	151D134X9100W2	.019	W	151D193X9060W2	151D193X9060W2
.023	W	151D233X0050W2	151D233X9050W2	5.0	Y	151D505X0060Y2	151D505X9060Y2	.16	W	151D164X0100W2	151D164X9100W2	.023	W	151D233X0060W2	151D233X9060W2
.028	W	151D283X9050W2	151D283X9050W2	6.0	Z	151D605X9060Z2	151D605X9060Z2	.19	W	151D194X9100W2	151D194X9100W2	.028	W	151D283X9060W2	151D283X9060W2
.034	W	151D343X0050W2	151D343X9050W2	7.5	Z	151D755X0060Z2	151D755X9060Z2	.23	W	151D234X0100W2	151D234X9100W2	.034	W	151D343X0060W2	151D343X9060W2
.041	W	151D413X9050W2	151D413X9050W2	9.0	Z	151D905X9060Z2	151D905X9060Z2	.28	W	151D284X9100W2	151D284X9100W2	.041	W	151D413X9060W2	151D413X9060W2
.05	W	151D503X0050W2	151D503X9050W2	11.0	Z	151D116X0060Z2	151D116X9060Z2	.34	X	151D344X0100X2	151D344X9100X2	.05	W	151D503X0060W2	151D503X9060W2
.06	W	151D603X9050W2	151D603X9050W2	75 VOLTS NP, 97 NP SURGE				.41	X	151D414X9100X2	151D414X9100X2	.06	W	151D603X9060W2	151D603X9060W2
.075	W	151D753X0050W2	151D753X9050W2	.0023	W	151D232X0075W2	151D232X9075W2	.50	X	151D504X0100X2	151D504X9100X2	.075	W	151D753X0060W2	151D753X9060W2
.09	W	151D903X9050W2	151D903X9050W2	.0028	W	151D282X9075W2	151D282X9075W2	.60	X	151D604X9100W2	151D604X9100W2	.09	W	151D903X9060W2	151D903X9060W2
.11	W	151D114X0050W2	151D114X9050W2	.0034	W	151D342X0075W2	151D342X9075W2	.75	X	151D754X0100X2	151D754X9100W2	.11	W	151D114X0060W2	151D114X9060W2
.13	W	151D134X9050W2	151D134X9050W2	.0041	W	151D412X9075W2	151D412X9075W2	.90	X	151D904X9100X2	151D904X9100X2	.13	W	151D134X9060W2	151D134X9060W2
.16	W	151D164X0050W2	151D164X9050W2	.005	W	151D502X0075W2	151D502X9075W2	1.1	X	151D115X0100X2	151D115X9100X2	.16	W	151D164X0060W2	151D164X9060W2
.19	W	151D194X9050W2	151D194X9050W2	.006	W	151D602X9075W2	151D602X9075W2	1.3	X	151D135X9100X2	151D135X9100X2	.19	W	151D194X9060W2	151D194X9060W2
.23	W	151D234X0050W2	151D234X9050W2	.0075	W	151D752X0075W2	151D752X9075W2	1.6	Y	151D165X0100Y2	151D165X9100Y2	.23	W	151D234X0060W2	151D234X9060W2
.28	W	151D284X9050W2	151D284X9050W2	.009	W	151D902X9075W2	151D902X9075W2	1.9	Y	151D195X0100Y2	151D195X9100Y2	.28	W	151D284X9060W2	151D284X9060W2
.34	W	151D344X0050W2	151D344X9050W2	.011	W	151D113X0075W2	151D113X9075W2	2.3	Y	151D235X0100Y2	151D235X9100Y2	.34	W	151D344X0060W2	151D344X9060W2
.41	W	151D414X9050W2	151D414X9050W2	.013	W	151D133X9075W2	151D133X9075W2	2.8	Y	151D285X0100Y2	151D285X9100Y2	.41	X	151D414X9060W2	151D414X9060W2
.50	W	151D504X0050W2	151D504X9050W2	.016	W	151D163X0075W2	151D163X9075W2	3.4	Y	151D345X0100Y2	151D345X9100Y2	.50	W	151D504X0060W2	151D504X9060W2
.60	X	151D604X9050X2	151D604X9050X2	.019	W	151D193X9075W2	151D193X9075W2	4.1	Y	151D415X9100Y2	151D415X9100Y2	.60	X	151D604X9060X2	151D604X9060X2
.75	X	151D754X0050X2	151D754X9050X2	.023	W	151D233X0075W2	151D233X9075W2	5.0	Y	151D505X0050Y2	151D505X9050Y2	.75	X	151D754X0060X2	151D754X9060X2
.90	X	151D904X9050X2	151D904X9050X2	.028	W	151D283X0075W2	151D283X9075W2	6.0	Z	151D605X9050Z2	151D605X9050Z2	.90	X	151D904X9060X2	151D904X9060X2
1.1	X	151D115X0050X2	151D115X9050X2	.034	W	151D343X0075W2	151D343X9075W2	7.5	Z	151D755X9050Z2	151D755X9050Z2	1.1	X	151D115X0060X2	151D115X9060X2
1.3	X	151D135X9050X2	151D135X9050X2	.041	W	151D413X9075W2	151D413X9075W2	9.0	Z	151D905X9050Z2	151D905X9050Z2	1.3	X	151D135X9060X2	151D135X9060X2
1.6	X	151D165X0050X2	151D165X9050X2	.05	W	151D503X0075W2	151D503X9075W2	11.0	Z	151D116X0050Z2	151D116X9050Z2	1.6	X	151D165X0060X2	151D165X9060X2
1.9	X	151D195X0050X2	151D195X9050X2	.06	W	151D602X9075W2	151D602X9075W2	.23	W	151D234X0075W2	151D234X9075W2	1.9	X	151D195X0060X2	151D195X9060X2
2.3	X	151D235X0050X2	151D235X9050X2	.075	W	151D753X0075W2	151D753X9075W2	.28	W	151D284X9075W2	151D284X9075W2	2.3	Y	151D235X0060Y2	151D235X9060Y2
2.8	Y	151D285X9050Y2	151D285X9050Y2	.09	W	151D903X9075W2	151D903X9075W2	.34	W	151D344X0075W2	151D344X9075W2	3.4	Y	151D345X0050Y2	151D345X9050Y2
3.4	Y	151D345X0050Y2	151D345X9050Y2	.11	W	151D113X0075W2	151D113X9075W2	.41	X	151D414X9075X2	151D414X9075X2	4.1	Y	151D415X9050Y2	151D415X9050Y2
4.1	Y	151D415X9050Y2	151D415X9050Y2	.13	W	151D133X9075W2	151D133X9075W2	.50	W	151D504X0075X2	151D504X9075X2	5.0	Y	151D505X0050Y2	151D505X9050Y2
5.0	Y	151D505X0050Y2	151D505X9050Y2	.16	W	151D163X0075W2	151D163X9075W2	.60	X	151D604X9075X2	151D604X9075X2	6.0	Z	151D605X9050Z2	151D605X9050Z2
6.0	Z	151D605X9050Z2	151D605X9050Z2	.19	W	151D193X9075W2	151D193X9075W2	.75	X	151D754X0075X2	151D754X9075X2	7.5	Z	151D755X9050Z2	151D755X9050Z2
7.5	Z	151D755X9050Z2	151D755X9050Z2	.23	W	151D233X0075W2	151D233X9075W2	.90	X	151D904X9075X2	151D904X9075X2	9.0	Z	151D905X9050Z2	151D905X9050Z2
9.0	Z	151D905X9050Z2	151D905X9050Z2	.28	W	151D283X0075W2	151D283X9075W2	1.1	X	151D115X0075X2	151D115X9075X2	11.0	Z	151D116X0050Z2	151D116X9050Z2
11.0	Z	151D116X0050Z2	151D116X9050Z2	.34	W	151D343X0075W2	151D343X9075W2	1.3	X	151D135X9075X2	151D135X9075X2	.23	W	151D234X0075W2	151D234X9075W2
60 VOLTS NP, 78 NP SURGE				.41	X	151D413X9075W2	151D413X9075W2	1.6	Y	151D165X0100Y2	151D165X9100Y2	.28	W	151D284X9075W2	151D284X9075W2
.0023	W	151D232X0060W2	151D232X9060W2	.05	W	151D503X0075W2	151D503X9075W2	1.9	Y	151D195X0100Y2	151D195X9100Y2	.34	W	151D344X0075W2	151D344X9075W2
.0028	W	151D282X9060W2	151D282X9060W2	.06	W	151D602X9075W2	151D602X9075W2	2.3	Y	151D235X0075Y2	151D235X9075Y2	.41	X	151D414X9075X2	151D414X9075X2
.0034	W	151D342X0060W2	151D342X9060W2	.075	W	151D753X0075W2	151D753X9075W2	2.8	Y	151D285X0075Y2	151D285X9075Y2	.50	X	151D504X0075X2	151D504X9075X2
.0041	W	151D412X9060W2	151D412X9060W2	.09	W	151D903X9075W2	151D903X9075W2	3.4	Y	151D345X0075Y2	151D345X9075Y2	.60	X	151D604X9075X2	151D604X9075X2
.005	W	151D502X0060W2	151D502X9060W2	.11	W	151D113X0075W2	151D113X9075W2	.75	X	151D754X0075X2	151D754X9075X2	.75	X	151D754X0075X2	151D754X9075X2
.006	W	151D602X9060W2	151D602X9060W2	.13	W	151D133X9075W2	151D133X9075W2	.90	X	151D904X9075X2	151D904X9075X2	.90	X	151D904X9075X2	151D904X9075X2
.0075	W	151D752X0060W2	151D752X9060W2	.16	W	151D163X0075W2	151D163X9075W2	1.1	X	151D115X9075X2	151D115X9075X2	1.1	X	151D115X0125X2	151D115X9125X2
.009	W	151D902X9060W2	151D902X9060W2	.19	W	151D193X9075W2	151D193X9075W2	1.3	X	151D135X9075X2	151D135X9075X2	1.3	X	151D135X9125X2	151D135X9125X2
.011	W	151D113X0060W2	151D113X9060W2	.23	W	151D233X0075W2	151D233X9075W2	1.6	Y	151D165X9075Y2	151D165X9075Y2	1.6	Y	151D165X9125Y2	151D165X9125Y2
.013	W	151D133X9060W2	15												

SPRAGUE CAPACITORS

125C FOIL TANTALEX® CAPACITORS

- Small size, electrically stable, long life. For data, see latest Engineering Bulletin 3602.
- 120D, 122D available as MIL-C-3965 units.
- Tol., 120D, 121D, ±20%; 122D, 123D, -15, +75%.
- Listed units have plastic wrap. For bare metal case units, end Cat. No. in "0" instead of "1".

- Call Your Sprague Industrial Distributor for Quantity Prices.

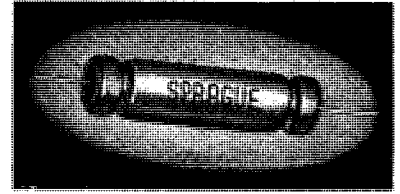

Size Code	D. x L.	Size Code	D. x L.
E	0.203 x 0.843	Q	0.390 x 2.968
H	0.296 x 1.125	S	0.483 x 2.968
K	0.390 x 1.656	Z	0.546 x 2.968
N	0.390 x 2.343		

Case Code	μF	Catalog Number	Case Code	μF	Catalog Number	Case Code	μF	Catalog Number	Case Code	μF	Catalog Number
TYPE 120D											
POLARIZED PLAIN-FOIL STANDARD RATINGS											
10 WORKING VOLTS D-C											
4.5	E	120D45X0010E1	18	H	120D186X0010H1	55	K	120D556X0010K1	110	N	120D117X0010N1
160	Q	120D167X0010Q1	260	S	120D267X0010S1	320	Z	120D327X0010Z1			
15 WORKING VOLTS D-C											
3	E	120D305X0015E1	12	H	120D126X0015H1	35	K	120D356X0015K1	70	N	120D706X0015N1
100	Q	120D107X0015Q1	180	S	120D187X0015S1	210	Z	120D217X0015Z1			
30 WORKING VOLTS D-C											
1.5	E	120D155X0030E1	6	H	120D605X0030H1	20	K	120D206X0030K1	40	N	120D406X0030N1
55	Q	120D556X0030Q1	100	S	120D107X0030S1	120	Z	120D127X0030Z1			
50 WORKING VOLTS D-C											
1	E	120D105X0050E1	4	H	120D405X0050H1	14	K	120D146X0050K1	28	N	120D286X0050N1
40	Q	120D406X0050Q1	70	S	120D706X0050S1	88	Z	120D886X0050Z1			
65 WORKING VOLTS D-C											
0.8	E	120D804X0065E1	3	H	120D305X0065H1	10	K	120D106X0065K1	20	N	120D206X0065N1
30	Q	120D306X0065Q1	57	S	120D576X0065S1	70	Z	120D706X0065Z1			
100 WORKING VOLTS D-C											
0.5	E	120D504X0100E1	2	H	120D205X0100H1	7	K	120D705X0100K1	14	N	120D146X0100N1
20	Q	120D206X0100Q1	40	S	120D406X0100S1	47	Z	120D476X0100Z1			
150 WORKING VOLTS D-C											
0.35	E	120D354X0150E1	1.5	H	120D155X0150H1	5	K	120D505X0150K1	10	N	120D106X0150N1
15	Q	120D107X0150Q1	25	S	120D256X0150S1	30	Z	120D306X0150Z1			
200 WORKING VOLTS D-C											
0.25	E	120D254X0200E1	1	H	120D105X0200H1	3	K	120D305X0200K1	7	N	120D705X0200N1
10	Q	120D107X0200Q1	18	S	120D186X0200S1						
250 WORKING VOLTS D-C											
0.2	E	120D204X0250E1	0.8	H	120D804X0250H1	2.5	K	120D255X0250K1	5	N	120D505X0250N1
8	Q	120D805X0250Q1	12	S	120D126X0250S1						
TYPE 121D											
NON-POLARIZED PLAIN-FOIL STANDARD RATINGS											
10 WORKING VOLTS N.P.											
0.15	E	120D154X0300E1	0.65	H	120D654X0300H1	2	K	120D205X0300K1	4	N	120D405X0300N1
6	Q	120D605X0300Q1									
15 WORKING VOLTS N.P.											
2.5	E	121D255X0010E1	10	H	121D106X0010H1	35	K	121D356X0010K1	70	N	121D706X0010N1
100	Q	121D107X0010Q1	160	S	121D167X0010S1	200	Z	121D207X0010Z1			
30 WORKING VOLTS N.P.											
1.5	E	121D155X0015E1	6	H	121D605X0015H1	20	K	121D206X0015K1	40	N	121D406X0015N1
100	S	121D107X0015S1	120	Z	121D127X0015Z1						
50 WORKING VOLTS N.P.											
0.8	E	121D804X0030E1	3	H	121D305X0030H1	10	K	121D106X0030K1	20	N	121D206X0030N1
30	Q	121D306X0030Q1	50	S	121D506X0030S1	65	Z	121D656X0030Z1			
65 WORKING VOLTS N.P.											
0.5	E	121D504X0050E1	2	H	121D205X0050H1	7	K	121D705X0050K1	14	N	121D146X0050N1
20	Q	121D206X0050Q1	40	S	121D406X0050S1	47	Z	121D476X0050Z1			
100 WORKING VOLTS N.P.											
0.4	E	121D404X0065E1	1.5	H	121D155X0065H1	5	K	121D505X0065K1	10	N	121D106X0065N1
15	Q	121D107X0065Q1	30	S	121D306X0065S1	37	Z	121D376X0065Z1			
150 WORKING VOLTS N.P.											
0.25	E	121D254X0100E1	1.0	H	121D105X0100H1	3.5	K	121D355X0100K1	7	N	121D705X0100N1
10	Q	121D107X0100Q1	20	S	121D206X0100S1	24	Z	121D246X0100Z1			
200 WORKING VOLTS N.P.											
0.15	E	121D154X0150E1	0.75	H	121D754X0150H1	2.5	K	121D255X0150K1	5.0	N	121D505X0150N1
7.5	Q	121D755X0150Q1	13	S	121D136X0150S1	16	Z	121D166X0150Z1			
250 WORKING VOLTS N.P.											
0.1	E	121D104X0200E1	0.5	H	121D504X0200H1	1.5	K	121D155X0200K1	3.5	N	121D355X0200N1
5.0	Q	121D505X0200Q1	9.5	S	121D955X0200S1						
TYPE 122D											
POLARIZED ETCHED-FOIL STANDARD RATINGS											
10 WORKING VOLTS D-C											
0.1	E	121D104X0250E1	0.4	H	121D404X0250H1	1.2	K	121D125X0250K1	2.5	N	121D255X0250N1
4.0	Q	121D405X0250Q1									
15 WORKING VOLTS D-C											
10	E	122D106X07015E1	40	H	122D406X07015H1	120	K	122D127X07015K1	250	N	122D257X07015N1
350	Q	122D357X07015Q1									
30 WORKING VOLTS D-C											
4.5	E	122D455X0300E1	18	H	122D186X0300H1	60	K	122D606X0300K1	100	N	122D107X0300N1
150	Q	122D157X0300Q1									
50 WORKING VOLTS D-C											
3	E	122D305X0500E1	12	H	122D126X0500H1	30	K	122D306X0500K1	70	N	122D706X0500N1
100	Q	122D107X0500Q1									
65 WORKING VOLTS D-C											
2	E	122D205X03065E1	8	H	122D805X03065H1	25	K	122D256X03065K1	50	N	122D506X03065N1
70	Q	122D706X03065Q1									
100 WORKING VOLTS D-C											
1	E	122D105X03100E1	4	H	122D405X03100H1	13	K	122D136X03100K1	25	N	122D256X03100N1
36	Q	122D366X03100Q1									
150 WORKING VOLTS D-C											
36	E	122D366X07010E1	130	H	122D137X07010H1	370	K	122D377X07010K1	780	N	122D787X07010N1
1100	Q	122D118X07010Q1	2000	S	122D208X07010S1	2500	Z	122D258X07010Z1			
200 WORKING VOLTS D-C											
23	E	122D236X0715E1	80	H	122D806X0715H1	240	K	122D247X0715K1	510	N	122D517X0715N1
720	Q	122D727X0715Q1	1300	S	122D138X0715S1	1600	Z	122D168X0715Z1			
250 WORKING VOLTS D-C											
19	E	122D196X07020E1	67	H	122D676X07020H1	200	K	122D207X07020K1	420	N	122D427X07020N1
590	Q	122D597X07020Q1	1100	S	122D118X07020S1	1400	Z	122D148X07020Z1			
30 WORKING VOLTS N.P.											
2.5	E	123D255X0300E1	10	H	123D106X0300H1	30	K	123D306X0300K1	60	N	123D606X0300N1
22	Q	123D226X0300Q1	43	S	123D436X0300S1	60	Z	123D606X0300Z1			
65 WORKING VOLTS N.P.											
1.4	E	123D145X03065E1	5	H	123D505X03065H1	14	K	123D146X03065K1	29	N	123D296X03065N1
41	Q	123D416X03065Q1	78	S	123D786X03065S1	110	Z	123D117X03065Z1			
100 WORKING VOLTS N.P.											
0.75	E	123D754X03100E1	2.7	H	123D275X03100H1	7.5	K	123D755X03100K1	15	N	123D156X03100N1
23	Q	123D236X03100Q1	43	S	123D436X03100S1	60	Z	123D606X03100Z1			
150 WORKING VOLTS N.P.											
1.3	H	122D135X0250H1	4	K	122D405X0250K1	8	N	122D805X0250N1	12	Q	122D126X0250Q1
TYPE 123D											
NON-POLARIZED ETCHED-FOIL STANDARD RATINGS											
10 WORKING VOLTS N.P.											
10	E	123D106X0710E1	40	H	123D406X0710H1	120	K	123D127X0710K1	250	N	123D257X0710N1
350	Q	123D357X0710Q1									
15 WORKING VOLTS N.P.											
5	E	123D505X0715E1	20	H	123D206X0715H1	70	K	123D706X0715K1	140	N	123D147X0715N1
200	Q	123D207X0715Q1									
30 WORKING VOLTS N.P.											
2.5	E	123D255X0300E1	10	H	123D106X0300H1	30	K	123D306X0300K1	60	N	123D606X0300N1
22	Q	123D226X0300Q1	43	S	123D436X0300S1	60	Z	123D606X0300Z1			

SPRAGUE CAPACITORS

TYPE 130D 125C SINTERED-ANODE TANTALEX[®] CAPACITORS

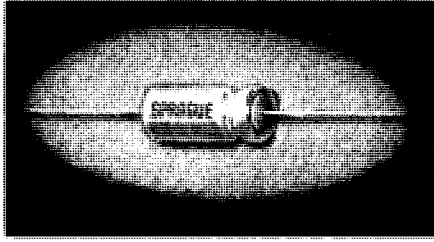

DIMENSIONS

Code D x L Code D x L Code D x L Code D x L
 C .203 x .515 F .296 x .703 T .390 x .828 W .390 x 1.312

- Reliable, Superior Quality Capacitors With no Voltage Derating for 125C Operation
- Especially Suited for Military Electronics
- Meets 2000 Cycle MIL Missile Vibration Requirements
- Clean, Shoulder-Less Design Simplifies Mounting on Printed Wiring Boards
- Voltage Ratings From 4 WVDC Through 100 WVDC
- Capacitances from 1.7 μ F to 1200 μ F
- For Complete Technical Data, Refer to the Latest Issue of Sprague Engineering Bulletin No. 3701
- Listed Units Have Plastic-Film Insulation For Bare Metal Cases, Change Last Digit of Cat. No. to "0"
- Call Your Sprague Industrial Distributor for Current Quantity Prices

GROUP 1: $\pm 10\%$, ± 20 , -15% , and $+75, -15\%$ Capacitance Tolerance with outer plastic-film insulation

Catalog Number					Catalog Number						
μ F	WVDC	Size Code	$\pm 10\%$	$\pm 20 - 15\%$	$+75 - 15\%$	μ F	WVDC	Size Code	$\pm 10\%$	$\pm 20 - 15\%$	$+75 - 15\%$
27	4	C	130D276X9004C2	130D276C2004C2	130D276C7004C2	35	20	F	130D356X9020F2	130D356C2020F2	130D356C7020F2
30	4	C	130D306X9004C2	130D306C2004C2	130D306C7004C2	40	20	F	130D406X9020F2	130D406C2020F2	130D406C7020F2
120	4	F	130D127X9004F2	130D127C2004F2	130D127C7004F2	80	20	T	130D806X9020T2	130D806C2020T2	130D806C7020T2
140	4	F	130D147X9004F2	130D147C2004F2	130D147C7004F2	100	20	T	130D107X9020T2	130D107C2020T2	130D107C7020T2
290	4	T	130D297X9004T2	130D297C2004T2	130D297C7004T2	4.5	30	C	130D455X9030C2	130D455C2030C2	130D455C7030C2
330	4	T	130D337X9005T2	130D337C2005T2	130D337C7005T2	5	30	C	130D505X9030C2	130D505C2030C2	130D505C7030C2
22	5	C	130D226X9005C2	130D226C2005C2	130D226C7005C2	22	30	F	130D226X9030F2	130D226C2030F2	130D226C7030F2
25	5	C	130D256X9005C2	130D256C2005C2	130D256C7005C2	25	30	F	130D256X9030F2	130D256C2030F2	130D256C7030F2
100	5	F	130D107X9005F2	130D107C2005F2	130D107C7005F2	55	30	T	130D556X9030T2	130D556C2030T2	130D556C7030T2
120	5	F	130D127X9005F2	130D127C2005F2	130D127C7005F2	60	30	T	130D606X9030T2	130D606C2030T2	130D606C7030T2
260	5	T	130D267X9005T2	130D267C2005T2	130D267C7005T2	3.6	40	C	130D365X9040C2	130D365C2040C2	130D365C7040C2
290	5	T	130D297X9005T2	130D297C2005T2	130D297C7005T2	4	40	C	130D405X9040C2	130D405C2040C2	130D405C7040C2
18	7	C	130D186X9007C2	130D186C2007C2	130D186C7007C2	18	40	F	130D186X9040F2	130D186C2040F2	130D186C7040F2
20	7	C	130D206X9007C2	130D206C2007C2	130D206C7007C2	25	40	F	130D206X9040F2	130D206C2040F2	130D206C7040F2
85	7	F	130D856X9007F2	130D856C2007F2	130D856C7007F2	40	40	T	130D405X9040T2	130D405C2040T2	130D405C7040T2
100	7	F	130D107X9007F2	130D107C2007F2	130D107C7007F2	50	40	T	130D506X9040T2	130D506C2040T2	130D506C7040T2
220	7	T	130D227X9007T2	130D227C2007T2	130D227C7007T2	3	50	C	130D305X9050C2	130D305C2050C2	130D305C7050C2
250	7	T	130D257X9007T2	130D257C2007T2	130D257C7007T2	3.5	50	C	130D355X9050C2	130D355C2050C2	130D355C7050C2
13	10	C	130D136X9010C2	130D136C2010C2	130D136C7010C2	13	50	F	130D136X9050F2	130D136C2050F2	130D136C7050F2
15	10	C	130D156X9010C2	130D156C2010C2	130D156C7010C2	15	50	F	130D156X9050F2	130D156C2050F2	130D156C7050F2
55	10	F	130D556X9010F2	130D556C2010F2	130D556C7010F2	35	50	T	130D356X9050T2	130D356C2050T2	130D356C7050T2
70	10	F	130D706X9010F2	130D706C2010F2	130D706C7010F2	40	50	T	130D406X9050T2	130D406C2050T2	130D406C7050T2
150	10	T	130D157X9010T2	130D157C2010T2	130D157C7010T2	2.5	70	C	130D255X9070C2	130D255C2070C2	130D255C7070C2
170	10	T	130D177X9010T2	130D177C2010T2	130D177C7010T2	10	70	F	130D106X9070F2	130D106C2070F2	130D106C7070F2
9	15	C	130D905X9015C2	130D905C2015C2	130D905C7015C2	11	70	F	130D116X9070F2	130D116C2070F2	130D116C7070F2
10	15	C	130D106X9015C2	130D106C2015C2	130D106C7015C2	27	70	T	130D276X9070T2	130D276C2070T2	130D276C7070T2
45	15	F	130D456X9015F2	130D456C2015F2	130D456C7015F2	30	70	T	130D306X9070T2	130D306C2070T2	130D306C7070T2
50	15	F	130D506X9015F2	130D506C2015F2	130D506C7015F2	1.7	85	C	130D175X9085C2	130D175C2085C2	130D175C7085C2
100	15	T	130D107X9015T2	130D107C2015T2	130D107C7015T2	9	85	F	130D905X9085F2	130D905C2085F2	130D905C7085F2
110	15	T	130D117X9015T2	130D117C2015T2	130D117C7015T2	18	85	T	130D186X9085T2	130D186C2085T2	130D186C7085T2
7	20	C	130D705X9020C2	130D705C2020C2	130D705C7020C2	1.7	100	C	130D175X9100C2	130D175C2100C2	130D175C7100C2
8	20	C	130D805X9020C2	130D805C2020C2	130D805C7020C2	6.8	100	F	130D685X9100F2	130D685C2100F2	130D685C7100F2
						14	100	T	130D146X9100T2	130D146C2100T2	130D146C7100T2

GROUP 2: $\pm 20\%$ and $\pm 10\%$ Capacitance Tolerance with outer plastic-film insulation

These capacitors have approximately twice the capacitance of Group 1 Capacitors of the same physical size at a given voltage rating.

Case Code				Case Code				Case Code						
μ F	WVDC	Code	$\pm 20\%$ Tol.	$\pm 10\%$ Tol.	μ F	WVDC	Code	$\pm 20\%$ Tol.	$\pm 10\%$ Tol.	μ F	WVDC	Code	$\pm 20\%$ Tol.	$\pm 10\%$ Tol.
68	4	C	130D686X0004C2	130D686X9004C2	22	15	C	130D226X0015C2	130D226X9015C2	6.8	50	C	130D685X0050C2	130D685X9050C2
270	4	F	130D277X0004F2	130D277X9004F2	100	15	F	130D107X0015F2	130D107X9015F2	33	50	F	130D336X0050F2	130D336X9050F2
560	4	T	130D567X0004T2	130D567X9004T2	180	15	T	130D187X0015T2	130D187X9015T2	56	50	T	130D566X0050T2	130D566X9050T2
1200	4	W	130D128X0004W2	130D128X9004W2	350	15	W	130D357X0015W2	130D357X9015W2	110	50	W	130D117X0050W2	130D117X9050W2
56	5	C	130D566X0005C2	130D566X9005C2	15	20	C	130D156X0020C2	130D156X9020C2	4.7	70	C	130D475X0070C2	130D475X9070C2
220	5	F	130D227X0005F2	130D227X9005F2	68	20	F	130D686X0020F2	130D686X9020F2	22	70	F	130D226X0070F2	130D226X9070F2
430	5	T	130D437X0005T2	130D437X9005T2	150	20	T	130D157X0020T2	130D157X9020T2	43	70	T	130D436X0070T2	130D436X9070T2
850	5	W	130D857X0005W2	130D857X9005W2	300	20	W	130D307X0020W2	130D307X9020W2	86	70	W	130D866X0070W2	130D866X9070W2
47	7	C	130D476X0007C2	130D476X9007C2	10	30	C	130D106X0030C2	130D106X9030C2	3.6	85	C	130D365X0085C2	130D365X9085C2
180	7	F	130D187X0007F2	130D187X9007F2	47	30	F	130D476X0030F2	130D476X9030F2	14	85	F	130D146X0085F2	130D146X9085F2
390	7	T	130D397X0007T2	130D397X9007T2	82	30	T	130D826X0030T2	130D826X9030T2	25	85	T	130D256X0085T2	130D256X9085T2
750	7	W	130D757X0007W2	130D757X9007W2	160	30	W	130D167X0030W2	130D167X9030W2	56	85	W	130D566X0085W2	130D566X9085W2
33	10	C	130D336X0010C2	130D336X9010C2	8.2	40	C	130D825X0040C2	130D825X9040C2	3	100	C	130D305X0100C2	130D305X9100C2
120	10	F	130D127X0010F2	130D127X9010F2	39	40	F	130D396X0040F2	130D396X9040F2	11	100	F	130D116X0100F2	130D116X9100F2
270	10	T	130D277X0010T2	130D277X9010T2	68	40	T	130D686X0040T2	130D686X9040T2	22	100	T	130D226X0100T2	130D226X9100T2
540	10	W	130D547X0010W2	130D547X9010W2	140	40	W	130D147X0040W2	130D147X9040W2					

SPRAGUE CAPACITORS

"CUP STYLE" TANTALEX® CAPACITORS

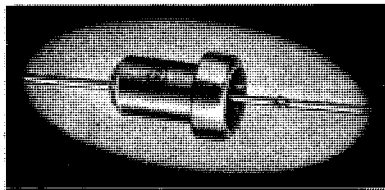

Size Code	Dimensions		CALL YOUR SPRAGUE INDUSTRIAL DISTRIBUTOR FOR CURRENT QUANTITY PRICES
	Dia. x Length		
U	7/32 x 15/32		
V	9/32 x 11/16		
T	3/8 x 49/64		

- -55C to +85C Operation at Full Rating. 100C Operation With 15% Derating.
- Stable in Performance Characteristics Over Entire Temperature Range.
- Large Capacitance in Small Size.
- Extremely Low Leakage Currents.
- 132D Designed to Withstand Severe Military Vibration Tests.
- For Plastic Tube on units, change "0" to "4" at End of Catalog Number.
- For Complete Technical Data See Latest Issue of Engineering Bulletin 3710 and 3711.

VIBRATION-PROOF TYPE 132D

μF	Size Code	Catalog Number		μF	Size Code	Catalog Number		μF	Size Code	Catalog Number	
		+10% Tol.	-15, +20% Tol.			+10% Tol.	-15, +20% Tol.			+10% Tol.	-15, +20% Tol.
6 WVDC — 7 VDC SURGE											
30	U	132D306X9006U0	132D306C2006U0	10	U	132D106X9025U0	132D106C2025U0	3.5	U	132D355X9075U0	132D355C2075U0
140	V	132D147X9006V0	132D147C2006V0	30 WVDC — 36 VDC SURGE				15	V	132D156X9075V0	132D156C2075V0
320	T	132D327X9006T0	132D327C2006T0	8	U	132D805X9030U0	132D805C2030U0	40	T	132D406X9075T0	132D406C2075T0
8 WVDC — 10 VDC SURGE											
25	U	132D256X9008U0	132D256C2008U0	40	V	132D406X9030V0	132D406C2030V0	100 WVDC — 115 VDC SURGE			
10 WVDC — 12 VDC SURGE											
20	U	132D206X9010U0	132D206C2010U0	100	T	132D107X9030T0	132D107C2030T0	2	U	132D205X9100U0	132D205C2100U0
100	V	132D107X9010V0	132D107C2010V0	50 WVDC — 60 VDC SURGE				11	V	132D116X9100V0	132D116C2100V0
250	T	132D257X9010T0	132D257C2010T0	5	U	132D505X9050U0	132D505C2050U0	30	T	132D306X9100T0	132D306C2100T0
15 WVDC — 18 VDC SURGE											
15	U	132D156X9015U0	132D156C2015U0	25	V	132D256X9050V0	132D256C2050V0	125 WVDC — 140 VDC SURGE			
70	V	132D706X9015V0	132D706C2015V0	60	T	132D606X9050T0	132D606C2050T0	1.7	U	132D175X9125U0	132D175C2125U0
170	T	132D177X9015T0	132D177C2015T0	60 WVDC — 72 VDC SURGE				9	V	132D905X9125V0	132D905C2125V0
				4	U	132D405X9060U0	132D405C2060U0	25	T	132D256X9125T0	132D256C2125T0
				20	V	132D206X9060V0	132D206C2060V0				
				50	T	132D506X9060T0	132D506C2060T0				

VIBRATION-PROOF TYPE 133D

- -55C to +125C Operation at Full Rating. May Be Up-Rated 50% for Operation at 85C.
- Meet Stringent Requirements in Military and Missile Applications.
- Sintered Anode for Unusual Capacitance Stability, Large Values of Capacitance in Small Physical Size.
- Non-Tarnish Finish to Prevent Discoloration During Storage or Use.
- For Units With Outer Plastic Insulating Tube, Substitute "4" for "0" at End of Catalog Number.
- Housed in Miniature Silver Thimble.

μF	Size Code	Catalog Number		μF	Size Code	Catalog Number		μF	Size Code	Catalog Number	
		-15, +20% Tol.	±10% Tol.			-15, +20% Tol.	±10% Tol.			-15, +20% Tol.	±10% Tol.
4 WORKING VOLTS D-C											
30	U	133D306C2004U0	133D306X9004U0	10	U	133D106C2015U0	133D106X9015U0	50 WORKING VOLTS D-C			
140	V	133D147C2004V0	133D147X9004V0	20 WORKING VOLTS D-C				3.5	U	133D355C2050U0	133D355X9050U0
320	T	133D327C2004T0	133D327X9004T0	8	U	133D805C2020U0	133D805X9020U0	15	V	133D156C2050V0	133D156X9050V0
5 WORKING VOLTS D-C											
25	U	133D256C2005U0	133D256X9005U0	40	V	133D406C2020V0	133D406X9020V0	40	T	133D406C2050T0	133D406X9050T0
7 WORKING VOLTS D-C											
20	U	133D206C2007U0	133D206X9007U0	100	T	133D107C2020T0	133D107X9020T0	70 WORKING VOLTS D-C			
100	V	133D107C2007V0	133D107X9007V0	5	U	133D505C2030U0	133D505X9030U0	2	U	133D205C2070U0	133D205X9070U0
250	T	133D257C2007T0	133D257X9007T0	25	V	133D256C2030V0	133D256X9030V0	11	V	133D116C2070V0	133D116X9070V0
10 WORKING VOLTS D-C											
15	U	133D156C2010U0	133D156X9010U0	60	T	133D606C2030T0	133D606X9030T0	30	T	133D306C2070T0	133D306X9070T0
70	V	133D706C2010V0	133D706X9010V0	40 WORKING VOLTS D-C				85 WORKING VOLTS D-C			
170	T	133D177C2010T0	133D177X9010T0	4	U	133D405C2040U0	133D405X9040U0	1.7	U	133D175C2085U0	133D175X9085U0
				20	V	133D206C2040V0	133D206X9040V0	9	V	133D905C2085V0	133D905X9085V0
				50	T	133D506C2040T0	133D506X9040T0	25	T	133D256C2085T0	133D256X9085T0

SPRAGUE CAPACITORS

MIL-C-26655 Solid TANTALUM CAPACITORS

- Military Version of Type 150D.
- CS12, Bare Tube; CS13, Insulating Sleeve
- Solid Electrolyte Will Not Seep Even if Hermetic Seal is Accidentally Broken
- Temperature Range of -55C to +85C. Also -55C to +125C With Voltage Derating

- See Latest Issue of Engineering Bulletin 3502.1
- Call Your Sprague Distributor For Quantity Prices
- For Insulated Style CS13, Add 0.010" to Diameter and 0.036" to Length

SIZE CODE

A = .125" D. x .250" L. C = .279" D. x .650" L.
 B = .175" D. x .438" L. D = .341" D. x .750" L.

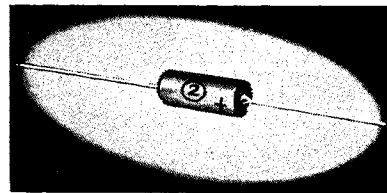

μF	Size Code	Tot.	CS12		CS13	
			Type Designation	Type Designation	Type Designation	Type Designation
6 WVDC						
5.6	A	10%	CS12BB565K	CS13BB565K		
6.8	A	10%	CS12BB685K	CS13BB685K		
6.8	A	20%	CS12BB685M	CS13BB685M		
47	B	10%	CS12BB476K	CS13BB476K		
47	B	20%	CS12BB476M	CS13BB476M		
56	B	10%	CS12BB566K	CS13BB566K		
150	C	10%	CS12BB157K	CS13BB157K		
150	C	20%	CS12BB157M	CS13BB157M		
180	C	10%	CS12BB187K	CS13BB187K		
270	D	10%	CS12BB277K	CS13BB277K		
330	D	10%	CS12BB337K	CS13BB337K		
330	D	20%	CS12BB337M	CS13BB337M		

μF	Size Code	Tot.	CS12		CS13	
			Type Designation	Type Designation	Type Designation	Type Designation
10 WVDC						
3.9	A	10%	CS12BC395K	CS13BC395K		
4.7	A	10%	CS12BC475K	CS13BC475K		
4.7	A	20%	CS12BC475M	CS13BC475M		
27	B	10%	CS12BC276K	CS13BC276K		
33	B	10%	CS12BC336K	CA13BC336K		
33	B	20%	CS12BC336M	CA13BC336M		
39	B	10%	CS12BC396K	CS13BC396K		
82	C	10%	CS12BC826K	CS13BC826K		
100	C	10%	CS12BC107K	CS13BC107K		
100	C	20%	CS12BC107M	CS13BC107M		
120	C	10%	CS12BC127K	CS13BC127K		
180	D	10%	CS12BC187K	CS13BC187K		
220	D	10%	CS12BC227K	CS13BC227K		
220	D	20%	CS12BC227M	CS13BC227M		

μF	Size Code	Tot.	CS12		CS13	
			Type Designation	Type Designation	Type Designation	Type Designation
15 WVDC						
2.7	A	10%	CS12BD275K	CS13BD275K		
3.3	A	10%	CS12BD335K	CS13BD335K		
3.3	A	20%	CS12BD335M	CS13BD335M		
18	B	10%	CS12BD186K	CS13BD186K		
22	B	10%	CS12BD226K	CS13BD226K		
22	B	20%	CS12BD226M	CS13BD226M		
56	C	10%	CS12BD566K	CS13BD566K		
68	C	10%	CS12BD686K	CS13BD686K		
68	C	20%	CS12BD686M	CS13BD686M		
120	D	10%	CS12BD127K	CS13BD127K		
150	D	10%	CS12BD157K	CS13BD157K		
150	D	20%	CS12BD157M	CS13BD157M		

μF	Size Code	Tot.	CS12		CS13	
			Type Designation	Type Designation	Type Designation	Type Designation
20 WVDC						
1.2	A	10%	CS12BE125K	CS13BE125K		
1.5	A	10%	CS12BE155K	CS13BE155K		
1.5	A	20%	CS12BE155M	CS13BE155M		
1.8	A	10%	CS12BE185K	CS13BE185K		
2.2	A	10%	CS12BE225K	CS13BE225K		
2.2	A	20%	CS12BE225M	CS13BE225M		
8.2	B	10%	CS12BE825K	CS13BE825K		
10	B	10%	CS12BE106K	CS13BE106K		
10	B	20%	CS12BE106M	CS13BE106M		
12	B	10%	CS12BE126K	CS13BE126K		
15	B	10%	CS12BE156K	CS13BE156K		
15	B	20%	CS12BE156M	CS13BE156M		
27	C	10%	CS12BE276K	CS13BE276K		
33	C	10%	CS12BE336K	CS13BE336K		
33	C	20%	CS12BE336M	CS13BE336M		
39	C	10%	CS12BE396K	CS13BE396K		
47	C	10%	CS12BE476K	CS13BE476K		
47	C	20%	CS12BE476M	CS13BE476M		
56	D	10%	CS12BE566K	CS13BE566K		
68	D	10%	CS12BE686K	CS13BE686K		
68	D	20%	CS12BE686M	CS13BE686M		
82	D	10%	CS12BE826K	CS13BE826K		
100	D	10%	CS12BE107K	CS13BE107K		
100	D	20%	CS12BE107M	CS13BE107M		

μF	Size Code	Tot.	CS12		CS13	
			Type Designation	Type Designation	Type Designation	Type Designation
35 WVDC						
.33	A	10%	CS12BF334K	CS13BF334K		
.33	A	20%	CS12BF334M	CS13BF334M		
.39	A	10%	CS12BF394K	CS13BF394K		
.47	A	10%	CS12BF474K	CS13BF474K		
.47	A	20%	CS12BF474M	CS13BF474M		
.56	A	10%	CS12BF564K	CS13BF564K		
.68	A	10%	CS12BF684K	CS13BF684K		
.68	A	20%	CS12BF684M	CS13BF684M		

μF	Size Code	Tot.	CS12		CS13	
			Type Designation	Type Designation	Type Designation	Type Designation
50 WVDC						
.82	A	10%	CS12BF824K	CS13BF824K		
1.0	A	10%	CS12BF105K	CS13BF105K		
1.0	A	20%	CS12BF105M	CS13BF105M		
1.2	B	10%	CS12BF125K	CS13BF125K		
1.5	B	10%	CS12BF155K	CS13BF155K		
1.5	B	20%	CS12BF155M	CS13BF155M		
1.8	B	10%	CS12BF185K	CS13BF185K		
2.2	B	10%	CS12BF225K	CS13BF225K		
2.2	B	20%	CS12BF225M	CS13BF225M		
2.7	B	10%	CS12BF275K	CS13BF275K		
3.3	B	10%	CS12BF335K	CS13BF335K		
3.3	B	20%	CS12BF335M	CS13BF335M		
3.9	B	10%	CS12BF395K	CS13BF395K		
4.7	B	10%	CS12BF475K	CS13BF475K		
4.7	B	20%	CS12BF475M	CS13BF475M		
5.6	B	10%	CS12BF565K	CS13BF565K		
6.8	B	10%	CS12BF685K	CS13BF685K		
6.8	B	20%	CS12BF685M	CS13BF685M		
8.2	C	10%	CS12BF825K	CS13BF825K		
10	C	10%	CS12BF106K	CS13BF106K		
10	C	20%	CS12BF106M	CS13BF106M		
12	C	10%	CS12BF126K	CS13BF126K		
15	C	10%	CS12BF156K	CS13BF156K		
15	C	20%	CS12BF156M	CS13BF156M		
18	C	10%	CS12BF186K	CS13BF186K		
22	C	10%	CS12BF226K	CS13BF226K		
22	C	20%	CS12BF226M	CS13BF226M		
27	D	10%	CS12BF276K	CS13BF276K		
33	D	10%	CS12BF336K	CS13BF336K		
33	D	20%	CS12BF336M	CS13BF336M		
39	D	10%	CS12BF396K	CS13BF396K		
47	D	10%	CS12BF476K	CS13BF476K		
47	D	20%	CS12BF476M	CS13BF476M		

μF	Size Code	Tot.	CS12		CS13	
			Type Designation	Type Designation	Type Designation	Type Designation
75 WVDC						
1.0	A	10%	CS12BG105K	CS13BG105K		
1.0	A	20%	CS12BG105M	CS13BG105M		
1.2	B	10%	CS12BG125K	CS13BG125K		
1.5	B	10%	CS12BG155K	CS13BG155K		
1.5	B	20%	CS12BG155M	CS13BG155M		
1.8	B	10%	CS12BG185K	CS13BG185K		
2.2	B	10%	CS12BG225K	CS13BG225K		
2.2	B	20%	CS12BG225M	CS13BG225M		
2.7	B	10%	CS12BG275K	CS13BG275K		
3.3	B	10%	CS12BG335K	CS13BG335K		
3.3	B	20%	CS12BG335M	CS13BG335M		
3.9	B	10%	CS12BG395K	CS13BG395K		
4.7	B	10%	CS12BG475K	CS13BG475K		
4.7	B	20%	CS12BG475M	CS13BG475M		
5.6	C	10%	CS12BG565K	CS13BG565K		
6.8	C	10%	CS12BG685K	CS13BG685K		
6.8	C	20%	CS12BG685M	CS13BG685M		
8.2	C	10%	CS12BG825K	CS13BG825K		
10	C	10%	CS12BG106K	CS13BG106K		
10	C	20%	CS12BG106M	CS13BG106M		
12	C	10%	CS12BG126K	CS13BG126K		
15	C	10%	CS12BG156K	CS13BG156K		
15	C	20%	CS12BG156M	CS13BG156M		
18	C	10%	CS12BG186K	CS13BG186K		
22	D	10%	CS12BG226K	CS13BG226K		
22	D	20%	CS12BG226M	CS13BG226M		

μF	Size Code	Tot.	CS12		CS13	
			Type Designation	Type Designation	Type Designation	Type Designation
100 WVDC						
.0047	A	10%	CS12BH472K	CS13BH472K		
.0047	A	20%	CS12BH472M	CS13BH472M		
.0056	A	10%	CS12BH562K	CS13BH562K		
.0068	A	10%	CS12BH682K	CS13BH682K		
.0068	A	20%	CS12BH682M	CS13BH682M		
.0082	A	10%	CS12BH822K	CS13BH822K		
.01	A	10%	CS12BH103K	CS13BH103K		
.01	A	20%	CS12BH103M	CS13BH103M		
.012	A	10%	CS12BH123K	CS13BH123K		
.015	A	10%	CS12BH153K	CS13BH153K		
.015	A	20%	CS12BH153M	CS13BH153M		
.018	A	10%	CS12BH183K	CS13BH183K		
.022	A	10%	CS12BH223K	CS13BH223K		
.022	A	20%	CS12BH223M	CS13BH223M		
.027	A	10%	CS12BH273K	CS13BH273K		
.033	A	10%	CS12BH333K	CS13BH333K		
.033	A	20%	CS12BH333M	CS13BH333M		
.039	A	10%	CS12BH393K	CS13BH393K		
.047	A	10%	CS12BH473K	CS13BH473K		
.047	A	20%	CS12BH473M	CS13BH473M		
.056	A	10%	CS12BH563K	CS13BH563K		
.068	A	10%	CS12BH683K	CS13BH683K		
.068	A	20%	CS12BH683M	CS13BH683M		
.082	A	10%				

SPRAGUE CAPACITORS

TYPE CSR13 SOLID-ELECTROLYTE TANTALUM CAPACITORS (Cont.)

MIL Type Designation				MIL Type Designation					
μ F	Case Code	L 2% Failure Rate	M 1% Failure Rate	P .1% Failure Rate	μ F	Case Code	L 2% Failure Rate	M 1% Failure Rate	P .1% Failure Rate
50 WVDC (Cont.)				75 WVDC (Cont.)					
.56	A	CSR13G564KL	CSR13G564KM	CSR13G564KP	.18	A	CSR13H184KL	CSR13H184KM	_____
.68	A	CSR13G684KL	CSR13G684KM	CSR13G684KP	.22	A	CSR13H224KL	CSR13H224KM	_____
.68	A	CSR13G684ML	CSR13G684MM	CSR13G684MP	.22	A	CSR13H224ML	CSR13H224MM	_____
.82	A	CSR13G824KL	CSR13G824KM	CSR13G824KP	.27	A	CSR13H274KL	CSR13H274KM	_____
1	A	CSR13G105KL	CSR13G105KM	CSR13G105KP	.33	A	CSR13H334KL	CSR13H334KM	_____
1	A	CSR13G105ML	CSR13G105MM	CSR13G105MP	.33	A	CSR13H334ML	CSR13H334MM	_____
1.2	B	CSR13G125KL	CSR13G125KM	CSR13G125KP	.39	A	CSR13H394KL	CSR13H394KM	_____
1.5	B	CSR13G155KL	CSR13G155KM	CSR13G155KP	.47	A	CSR13H474KL	CSR13H474KM	_____
1.5	B	CSR13G155ML	CSR13G155MM	CSR13G155MP	.47	A	CSR13H474ML	CSR13H474MM	_____
1.8	B	CSR13G185KL	CSR13G185KM	CSR13G185KP	.56	A	CSR13H564KL	CSR13H564KM	_____
2.2	B	CSR13G225KL	CSR13G225KM	CSR13G225KP	.68	A	CSR13H684KL	CSR13H684KM	_____
2.2	B	CSR13G225ML	CSR13G225MM	CSR13G225MP	.68	A	CSR13H684ML	CSR13H684MM	_____
2.7	B	CSR13G275KL	CSR13G275KM	CSR13G275KP	.82	B	CSR13H824KL	CSR13H824KM	_____
3.3	B	CSR13G335KL	CSR13G335KM	CSR13G335KP	1	B	CSR13H105KL	CSR13H105KM	_____
3.3	B	CSR13G335ML	CSR13G335MM	CSR13G335MP	1	B	CSR13H105ML	CSR13H105MM	_____
3.9	B	CSR13G395KL	CSR13G395KM	CSR13G395KP	1.2	B	CSR13H125KL	CSR13H125KM	_____
4.7	B	CSR13G475KL	CSR13G475KM	CSR13G475KP	1.5	B	CSR13H155KL	CSR13H155KM	_____
4.7	B	CSR13G475ML	CSR13G475MM	CSR13G475MP	1.5	B	CSR13H155ML	CSR13H155MM	_____
5.6	C	CSR13G565KL	CSR13G565KM	CSR13G565KP	1.8	B	CSR13H185KL	CSR13H185KM	_____
6.8	C	CSR13G685KL	CSR13G685KM	CSR13G685KP	2.2	B	CSR13H225KL	CSR13H225KM	_____
6.8	C	CSR13G685ML	CSR13G685MM	CSR13G685MP	2.2	B	CSR13H225ML	CSR13H225MM	_____
8.2	C	CSR13G825KL	CSR13G825KM	CSR13G825KP	2.7	B	CSR13H275KL	CSR13H275KM	_____
10	C	CSR13G106KL	CSR13G106KM	CSR13G106KP	3.3	B	CSR13H335KL	CSR13H335KM	_____
10	C	CSR13G106ML	CSR13G106MM	CSR13G106MP	3.3	B	CSR13H335ML	CSR13H335MM	_____
12	C	CSR13G126KL	CSR13G126KM	CSR13G126KP	3.9	B	CSR13H395KL	CSR13H395KM	_____
15	C	CSR13G156KL	CSR13G156KM	CSR13G156KP	4.7	C	CSR13H475KL	CSR13H475KM	_____
15	C	CSR13G156ML	CSR13G156MM	CSR13G156MP	4.7	C	CSR13H475ML	CSR13H475MM	_____
18	C	CSR13G186KL	CSR13G186KM	CSR13G186KP	5.6	C	CSR13H565KL	CSR13H565KM	_____
22	D	CSR13G226KL	CSR13G226KM	CSR13G226KP	6.8	C	CSR13H685KL	CSR13H685KM	_____
22	D	CSR13G226ML	CSR13G226MM	CSR13G226MP	6.8	C	CSR13H685ML	CSR13H685MM	_____
75 WVDC				75 WVDC					
.1	A	CSR13H104KL	CSR13H104KM	_____	10	C	CSR13H106KL	CSR13H106KM	_____
.1	A	CSR13H104ML	CSR13H104MM	_____	10	C	CSR13H106ML	CSR13H106MM	_____
.12	A	CSR13H124KL	CSR13H124KM	_____	12	D	CSR13H126KL	CSR13H126KM	_____
.15	A	CSR13H154KL	CSR13H154KM	_____	15	D	CSR13H156KL	CSR13H156KM	_____
.15	A	CSR13H154ML	CSR13H154MM	_____	15	D	CSR13H156ML	CSR13H156MM	_____

TYPE 196D EPOXY-DIPPED SOLID-ELECTROLYTE TANTALEX[®] CAPACITORS

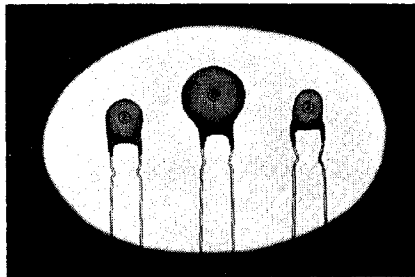

- Epoxy-Dipped Coating Economically Provides Good Electrical and Mechanical Protection
- High Stability, Very Little Capacitance Change, Even at Outer Limits of Operation Temperature Range (-55C to +85C)
- Low Dissipation Factor Permits Higher Ripple Currents
- Radial Leads For Plug-in Mounting on Printed Wiring Boards
- Small Size Lets You Minimize Equipment Size and Weight
- Call Your Sprague Distributor For Quantity Prices

μ F	Catalog Number	Height x Width x Thickness
4 WVDC		
33	196D336X0004EB	.350 x .400 x .225
150	196D157X0004FB	.450 x .450 x .250
6 WVDC		
22	196D226X0006EB	.350 x .400 x .225
100	196D107X0006FB	.450 x .450 x .250
330	196D337X0006GB	.670 x .600 x .275
10 WVDC		
15	196D156X0010EB	.350 x .400 x .225
68	196D686X0010FB	.450 x .450 x .250
220	196D227X0010GB	.670 x .600 x .275
15 WVDC		
10	196D106X0015EB	.350 x .400 x .225
33	196D336X0015FB	.450 x .450 x .250
47	196D476X0015FB	.450 x .450 x .250
150	196D157X0015GB	.670 x .600 x .275
20 WVDC		
2.2	196D225X0020EB	.350 x .400 x .225
4.7	196D475X0020EB	.350 x .400 x .225

μ F	Catalog Number	Height x Width x Thickness
20 WVDC (Cont.)		
6.8	196D685X0020EB	.350 x .400 x .225
10	196D106X0020FB	.450 x .450 x .250
22	196D226X0020FB	.450 x .450 x .250
100	196D107X0020GB	.670 x .600 x .275
35 WVDC		
.1	196D104X0035DB	.400 x .250 x .200
.22	196D224X0035DB	.400 x .250 x .200
.33	196D334X0035DB	.400 x .250 x .200
.47	196D474X0035DB	.400 x .250 x .200
.68	196D684X0035DB	.400 x .250 x .200
1.0	196D105X0035DB	.400 x .250 x .200
1.0	196D105X0035EB	.350 x .400 x .225
1.5	196D155X0035EB	.350 x .400 x .225
2.2	196D225X0035FB	.450 x .450 x .250
3.3	196D335X0035FB	.450 x .450 x .250
4.7	196D475X0035FB	.450 x .450 x .250
6.8	196D685X0035FB	.450 x .450 x .250
27	196D276X0035GB	.670 x .600 x .275

SPRAGUE CAPACITORS

MIL-C-3965 TUBULAR FOIL TANTALUM ELECTROLYTICS TYPES CL20, CL21, CL22, CL23, CL30, CL31, CL32, and CL33

- Meet Requirements of Military Specification MIL-C-3965
- Small Electrically Stable Foil Tantalums, Long, Reliable Life
- Available in Industrial Equivalents as Types 120D, 121D, 122D, 123D
- Temperature Rating 125C
- Types Marked (*) Have Insulating Sleeves All Others are Bare Case

- Capacitance Tolerance

$$\begin{array}{ll} M = +20, -20\% & S = +30, -15\% \\ T = +50, -15\% & U = +75, -15\% \end{array}$$

- Call Your Sprague Industrial Distributor for Current Quantity Prices

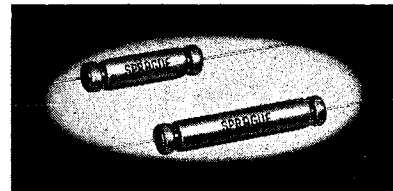

SIZE CODE (Diam x Length)

E $1\frac{3}{4} \times 3\frac{1}{2}$	N $2\frac{3}{4} \times 2\frac{1}{2}$
H $1\frac{3}{4} \times 1\frac{1}{2}$	Q $2\frac{3}{4} \times 2\frac{1}{8}$
K $2\frac{3}{4} \times 1\frac{1}{8}$	

μ F	Size Code	MIL Type	μ F	Size Code	MIL Type	μ F	Size Code	MIL Type	μ F	Size Code	MIL Type	μ F	Size Code	MIL Type
TYPE CL20			TYPE CL22			50 WORKING VOLTS D-C			110 WORKING VOLTS D-C			60 WORKING VOLTS D-C		
POLARIZED ETCHED FOIL			NON-POLARIZED ETCHED FOIL			10 WORKING VOLTS D-C			15 WORKING VOLTS D-C			100 WORKING VOLTS D-C		
10 WORKING VOLTS D-C			10 WORKING VOLTS D-C			10 WORKING VOLTS D-C			30 WORKING VOLTS D-C			150 WORKING VOLTS D-C		
15	E	CL20CD1500P3	10	E	CL22CD1000N3	1	E	CL23CK010TN3	1.5	E	CL31CH1R5MP3	0.4	E	CL32CK0R4MN3
60	H	CL20CD6000P3	40	H	CL22CD4000N3	4	H	CL23CK040TN3	4	H	CL31CH060MP3	1.5	H	CL32CK1R5MN3
200	K	CL20CD201UP3	120	K	CL22CD121UN3	15	K	CL23CK150TN3	12	H	CL31CE120MP3	5	K	CL32CK050MN3
400	N	CL20CD401UP3	250	N	CL22CD251UN3	35	N	CL23CK350TN3	35	K	CL31CE350MP3	10	N	CL32CK100MN3
580	Q	CL20CD581UP3	350	Q	CL22CD351UN3	50	Q	CL23CK500TN3	70	N	CL31CE700MP3	15	Q	CL32CK150MN3
15 WORKING VOLTS D-C			15 WORKING VOLTS D-C			60 WORKING VOLTS D-C			50 WORKING VOLTS D-C			100 WORKING VOLTS D-C		
10	E	CL20CE1000P3	10	E	CL22CE050UN3	1	E	CL23CN010TN3	1.5	E	CL31CH1R5MP3	0.25	E	CL32CN2R5MN3
40	H	CL20CE4000P3	20	H	CL22CE200UN3	4	H	CL23CN040TN3	6	H	CL31CH060MP3	1	H	CL32CN010MN3
120	K	CL20CE121UP3	70	K	CL22CE700UN3	12	K	CL23CN120TN3	20	K	CL31CH200MP3	3.5	K	CL32CN3R5MN3
250	N	CL20CE251UP3	140	N	CL22CE141UN3	25	N	CL23CN250TN3	40	N	CL31CH400MP3	7	N	CL32CN070MN3
350	Q	CL20CE351UP3	200	Q	CL22CE201UN3	35	Q	CL23CN350TN3	55	Q	CL31CH550MP3	10	Q	CL32CN100MN3
30 WORKING VOLTS D-C			30 WORKING VOLTS D-C			100 WORKING VOLTS D-C			50 WORKING VOLTS D-C			150 WORKING VOLTS D-C		
4.5	E	CL20CH4R5TP3	5	E	CL22CE050UN3	0.5	E	CL23CN0R5SN3	1	E	CL31CJ010MP3	0.15	E	CL32CQR15MN3
18	H	CL20CH180TP3	20	H	CL22CE200UN3	2	H	CL23CN020SN3	4	H	CL31CJ040MP3	0.75	H	CL32CQR75MN3
60	K	CL20CH600TP3	70	K	CL22CE700UN3	6	K	CL23CN060SN3	14	K	CL31CJ140MP3	2.5	K	CL32CQ2R5MN3
100	N	CL20CH101TP3	140	N	CL22CE141UN3	12	N	CL23CN120SN3	28	N	CL31CJ280MP3	5	N	CL32CQ050MN3
150	Q	CL20CH151TP3	200	Q	CL22CE201UN3	18	Q	CL23CN180SN3	40	Q	CL31CJ400MP3	7.5	Q	CL32CQ7R5MN3
50 WORKING VOLTS D-C			50 WORKING VOLTS D-C			TYPE CL30			60 WORKING VOLTS D-C			TYPE CL33*		
POLARIZED ETCHED FOIL			POLARIZED PLAIN FOIL			10 WORKING VOLTS D-C			60 WORKING VOLTS D-C			NON-POLARIZED PLAIN FOIL		
10 WORKING VOLTS D-C			10 WORKING VOLTS D-C			10 WORKING VOLTS D-C			60 WORKING VOLTS D-C			10 WORKING VOLTS D-C		
3	E	CL20CJ030TP3	2.5	E	CL22CH2R5TN3	4.5	E	CL30CD4R5MP3	0.8	E	CL31CK0R8MP3	2.5	E	CL33CD2R5MN3
12	H	CL20CJ120TP3	10	H	CL22CH100TN3	18	H	CL30CD180MP3	3	H	CL31CK030MP3	10	H	CL33CD100MN3
30	K	CL20CJ300TP3	30	K	CL22CH300TN3	55	K	CL30CD550MP3	10	K	CL31CK100MP3	35	K	CL33CD350MN3
70	N	CL20CJ700TP3	60	N	CL22CH600TN3	110	N	CL30CD111MP3	20	N	CL31CK200MP3	70	N	CL33CD700MN3
100	Q	CL20CJ101TP3	80	Q	CL22CH800TN3	160	Q	CL30CD161MP3	30	Q	CL31CK300MP3	100	Q	CL33CD101MN3
60 WORKING VOLTS D-C			50 WORKING VOLTS D-C			15 WORKING VOLTS D-C			100 WORKING VOLTS D-C			15 WORKING VOLTS D-C		
2	E	CL20CK020TP3	1.5	E	CL22CJ1R5TN3	3	E	CL30CE030MP3	0.5	E	CL31CN0R5MP3	1.5	E	CL33CE1R5MN3
8	H	CL20CK080TP3	6	H	CL22CJ060TN3	12	H	CL30CE120MP3	2	H	CL31CN020MP3	6	H	CL33CE060MN3
25	K	CL20CK250TP3	15	K	CL22CJ150TN3	35	K	CL30CE350MP3	7	K	CL31CN070MP3	20	K	CL33CE200MN3
50	N	CL20CK500TP3	35	N	CL22CJ350TN3	70	N	CL30CE700MP3	14	N	CL31CN140MP3	40	N	CL33CE400MN3
70	Q	CL20CK700TP3	50	Q	CL22CJ500TN3	100	Q	CL30CE101MP3	20	Q	CL31CN200MP3	60	Q	CL33CE600MN3
100 WORKING VOLTS D-C			60 WORKING VOLTS D-C			30 WORKING VOLTS D-C			150 WORKING VOLTS D-C			30 WORKING VOLTS D-C		
1	E	CL20CN010SP3	1	E	CL22CK010TN3	1.5	E	CL30CH1R5MP3	0.35	E	CL31CQR35MP3	0.8	E	CL33CH0R8MN3
4	H	CL20CN040SP3	4	H	CL22CK040TN3	6	H	CL30CH060MP3	1.5	H	CL31CQ1R5MP3	3	H	CL33CH030MN3
13	K	CL20CN130SP3	12	K	CL22CK120TN3	20	K	CL30CH200MP3	5	K	CL31CQ050MP3	10	K	CL33CH100MN3
25	N	CL20CN250SP3	25	N	CL22CK250TN3	40	N	CL30CH400MP3	10	N	CL31CQ100MP3	20	N	CL33CH200MN3
36	Q	CL20CN360SP3	35	Q	CL22CK350TN3	55	Q	CL30CH550MP3	15	Q	CL31CQ150MP3	30	Q	CL33CH300MN3
TYPE CL21*			TYPE CL23*			50 WORKING VOLTS D-C			50 WORKING VOLTS D-C			50 WORKING VOLTS D-C		
POLARIZED ETCHED FOIL			NON-POLARIZED ETCHED FOIL			10 WORKING VOLTS D-C			10 WORKING VOLTS D-C			10 WORKING VOLTS D-C		
10 WORKING VOLTS D-C			10 WORKING VOLTS D-C			100 WORKING VOLTS D-C			60 WORKING VOLTS D-C			60 WORKING VOLTS D-C		
15	E	CL21CD1500P3	10	E	CL23CD1000N3	0.5	E	CL22CN0R5SN3	1	E	CL30CJ010MP3	0.5	E	CL33CJ0R5MN3
60	H	CL21CD6000P3	40	H	CL23CD4000N3	2	H	CL22CN020SN3	4	H	CL30CJ040MP3	2	H	CL33CJ020MN3
200	K	CL21CD201UP3	120	K	CL23CD121UN3	6	K	CL22CN060SN3	14	K	CL30CJ140MP3	7	K	CL33CJ070MN3
400	N	CL21CD401UP3	250	N	CL23CD251UN3	12	N	CL22CN120SN3	28	N	CL30CJ280MP3	14	N	CL33CJ140MN3
580	Q	CL21CD581UP3	350	Q	CL23CD351UN3	18	Q	CL22CN180SN3	40	Q	CL30CJ400MP3	20	Q	CL33CJ200MN3
15 WORKING VOLTS D-C			15 WORKING VOLTS D-C			50 WORKING VOLTS D-C			50 WORKING VOLTS D-C			50 WORKING VOLTS D-C		
10	E	CL21CE1000P3	10	E	CL23CE050UN3	0.5	E	CL30CN0R5MP3	1.5	E	CL32CE1R5MN3	0.5	E	CL33CE1R5MN3
40	H	CL21CE4000P3	20	H	CL23CE200UN3	2	H	CL30CN020MP3	6	H	CL32CE060MN3	2	H	CL33CE060MN3
120	K	CL21CE121UP3	70	K	CL23CE700UN3	6	K	CL30CN060MP3	10	K	CL32CE100MN3	7	K	CL33CE100MN3
250	N	CL21CE251UP3	140	N	CL23CE141UN3	12	N	CL30CN120MP3	20	N	CL32CE200MN3	10	N	CL33CE200MN3
350	Q	CL21CE351UP3	200	Q	CL23CE201UN3	18	Q	CL30CN180MP3	100	Q	CL32CE101MN3	20	Q	CL33CE200MN3
30 WORKING VOLTS D-C			30 WORKING VOLTS D-C			100 WORKING VOLTS D-C			150 WORKING VOLTS D-C			60 WORKING VOLTS D-C		
4.5	E	CL21CH4R5TP3	5	E	CL23CE050UN3	0.5	E	CL30CN0R5MP3	1.5	E	CL32CD2R5MN3	0.4	E	CL33CK0R4MN3
18	H	CL21CH180TP3	20	H	CL23CE200UN3	2	H	CL30CN020MP3	6	H	CL32CD060MN3	1.5	H	CL33CK1R5MN3
60	K	CL21CH600TP3	70	K	CL23CE700UN3	6	K	CL30CN060MP3	10	H	CL32CD100MN3	5	K	CL33CK050MN3
100	N	CL21CH101TP3	140	N	CL23CE141UN3	12	N	CL30CN120MP3	20	K	CL32CD200MN3	10	N	CL33CK100MN3
150	Q	CL21CH151TP3	200	Q	CL23CE201UN3	18	Q	CL30CN180MP3	100	Q	CL32CD101MN3	15	Q	CL33CK150MN3
50 WORKING VOLTS D-C			15 WORKING VOLTS D-C			150 WORKING VOLTS D-C			150 WORKING VOLTS D-C			100 WORKING VOLTS D-C		
3	E	CL21CJ030TP3	5	E	CL23CE050UN3	0.35	E	CL30CQR35MP3	0.8	E	CL32CH0R8MN3	0.25	E	CL33CJR25MN3
12	H	CL21CJ120TP3	20	H	CL23CE200UN3	1.5	H	CL30CQ1R5MP3	1.5	H	CL32CH030MN3	1	H	CL33CJ020MN3
30	K	CL21CJ300TP3	70	K	CL23CE700UN3	5	K	CL30CQ050MP3	10	K	CL32CH100MN3	3.5	K	CL33CJ3R5MN3
70	N	CL21CJ700TP3	140	N	CL23CE141UN3	10	N	CL30CQ100MP3	20	N	CL32CH200MN3	7	N	CL33CJ070MN3
100	Q	CL21CJ101TP3	200	Q	CL23CE201UN3	15	Q	CL30CQ150MP3	100	Q	CL32CH101MN3	10	Q	CL33CJ100MN3
60 WORKING VOLTS D-C			30 WORKING VOLTS D-C			TYPE CL31*			50 WORKING VOLTS D-C			150 WORKING VOLTS D-C		
2	E	CL21CK020TP3	2.5	E	CL23CH2R5TN3	POLARIZED PLAIN FOIL			50 WORKING VOLTS D-C			150 WORKING VOLTS D-C		
8	H	CL21CK080TP3	10	H	CL23CH100TN3	10 WORKING VOLTS D-C			50 WORKING VOLTS D-C			150 WORKING VOLTS D-C		
25	K	CL21CK250TP3	30	K	CL23CH300TN3	10 WORKING VOLTS D-C			50 WORKING VOLTS D-C			150 WORKING VOLTS D-C		
50	N	CL21CK500TP3	60	N	CL23CH600TN3	10 WORKING VOLTS D-C			50 WORKING VOLTS D-C			150 WORKING VOLTS D-C		
70	Q	CL21CK700TP3	80	Q	CL23CH800TN3	10 WORKING VOLTS D-C			50 WORKING VOLTS D-C			150 WORKING VOLTS D-C		
100 WORKING VOLTS D-C			30 WORKING VOLTS D-C			TYPE CL32			50 WORKING VOLTS D-C			150 WORKING VOLTS D-C		
1	E	CL21CN010SP3	2.5	E	CL23CH2R5TN3	NON-POLARIZED PLAIN FOIL			50 WORKING VOLTS D-C			150 WORKING VOLTS D-C		
4	H	CL21CN040SP3	10	H	CL23CH100TN3	10 WORKING VOLTS D-C			50 WORKING VOLTS D-C			150 WORKING VOLTS D-C		
13	K	CL21CN130SP3	30	K	CL23CH300TN3	10 WORKING VOLTS D-C			50 WORKING VOLTS D-C			150 WORKING VOLTS D-C		

SPRAGUE CAPACITORS

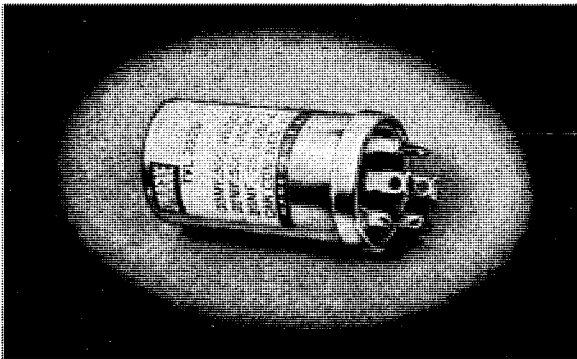
TVL TWIST-LOK® ELECTROLYTICS



- Hermetically Sealed in Aluminum Cans for Long Life and Dependable Performance in TV, Radio and Hi-Fi
- Designed for 85C (185F) Operation
- Stand Up Under Extremely High Temperatures Often Encountered in TV, Hi-Fi, and Auto Radio Cabinets
- Withstand High Surge Voltages
- Ideal for High Ripple Selenium Rectifier Circuits
- Can Be Safely Mounted "Above Ground" Using Phenolic Mounting Plate and Insulating Tube
- Easy to Mount — Unit Locks Firmly in Place with a Twist of the Tabs
- Furnished Complete with Both Phenolic and Metal Mounting Plates

The Twist-lok Capacitors listed here include only popular ratings for industrial applications. For the complete line of more than 2300 Twist-lok Capacitors, please refer to Distributor's Guide to Replacement Electrolytic Capacitors, C-1004.

μF	WVDC	Dia. x Length	Cat. No.		μF	WVDC	Dia. x Length	Cat. No.		
SINGLE UNITS				CALL YOUR SPRAGUE INDUSTRIAL DISTRIBUTOR FOR CURRENT QUANTITY PRICES	DUAL UNITS					
2000	6	1 3/8 x 2	TVL-1115		160	250	1 x 4	TVL-1541.1	CALL YOUR SPRAGUE INDUSTRIAL DISTRIBUTOR FOR CURRENT QUANTITY PRICES	
3000	10	1 3/8 x 2 1/2	TVL-1140		200	250	1 3/8 x 2 1/2	TVL-1547		
225	15	3/4 x 2	TVL-1160		60	300	1 x 3	TVL-1570		
1000	15	1 x 1 1/2	TVL-1165		80	300	1 x 2 1/2	TVL-1573		
1500	15	1 x 2	TVL-1167		100	300	1 x 2 1/2	TVL-1578		
2000	15	1 3/8 x 2	TVL-1168		125	300	1 3/8 x 2 1/2	TVL-1580		
3000	15	1 3/8 x 2	TVL-1170		150	300	1 3/8 x 3 1/2	TVL-1584		
4000	15	1 3/8 x 3 1/2	TVL-1173		250	300	1 3/8 x 4	TVL-1590		
100	25	3/4 x 2	TVL-1215		30	350	1 x 2	TVL-1617		
500	25	1 x 1 1/2	TVL-1220		40	350	1 x 2	TVL-1621		
1000	25	1 3/8 x 2	TVL-1230		50	350	1 x 2	TVL-1622		
25	50	3/4 x 2	TVL-1308		60	350	1 x 2 1/2	TVL-1624		
100	50	3/4 x 2	TVL-1317		80	350	1 3/8 x 2	TVL-1630		
150	50	3/4 x 2 1/2	TVL-1320		125	350	1 3/8 x 2 1/2	TVL-1638		
250	50	1 x 2	TVL-1324		150	350	1 3/8 x 2 1/2	TVL-1642		
500	50	1 3/8 x 2	TVL-1330		250	350	1 3/8 x 4 1/2	TVL-1644.2		
1000	50	1 3/8 x 2 1/2	TVL-1338		320	350	1 3/8 x 4	TVL-1645		
1500	50	1 3/8 x 3	TVL-1341		4	450	1 x 2	TVL-1702		
30	150	1 x 2	TVL-1408		10	450	1 x 1 1/2	TVL-1705		
50	150	1 x 1 1/2	TVL-1415		15	450	1 x 1 1/2	TVL-1709		
80	150	1 x 2 1/2	TVL-1420		20	450	1 x 2	TVL-1714		
100	150	1 x 1 1/2	TVL-1423		25	450	1 x 2	TVL-1716		
120	150	1 x 2	TVL-1425		30	450	1 x 2 1/2	TVL-1720		
120	150	1 3/8 x 2 1/2	TVL-1426		40	450	1 x 2 1/2	TVL-1725		
140	150	1 x 2 1/2	TVL-1428		50	450	1 x 2 1/2	TVL-1728		
150	150	1 x 2	TVL-1429		60	450	1 3/8 x 2 1/2	TVL-1730		
150	150	1 3/8 x 2	TVL-1430		80	450	1 3/8 x 2 1/2	TVL-1735		
200	150	1 3/8 x 2	TVL-1431		100	450	1 3/8 x 2 1/2	TVL-1750		
200	150	1 x 3	TVL-1431.1		125	450	1 3/8 x 3 1/2	TVL-1760		
300	150	1 3/8 x 2	TVL-1434		150	450	1 3/8 x 4	TVL-1770		
500	150	1 3/8 x 4	TVL-1439.5		40	475	1 3/8 x 2	TVL-1820		
125	200	1 x 2 1/2	TVL-1470		10	500	1 x 1 1/2	TVL-1940		
150	200	1 x 2 7/8	TVL-1471		20	500	1 x 2 1/2	TVL-1943		
160	200	1 3/8 x 2	TVL-1473		30	500	1 x 2 1/2	TVL-1947		
200	200	1 3/8 x 2	TVL-1475		40	500	1 x 2 1/2	TVL-1950		
500	200	1 3/8 x 4	TVL-1490		80	500	1 3/8 x 2 1/2	TVL-1958		
20	250	1 x 2	TVL-1509		90	500	1 3/8 x 3	TVL-1960		
40	250	1 x 2	TVL-1519		15	525	1 3/8 x 3	TVL-1980		
100	250	1 x 3	TVL-1535							
150	250	1 x 3	TVL-1539							
150	250	1 3/8 x 2 1/2	TVL-1540							
160	250	1 3/8 x 2 1/2	†TVL-1541							

† Furnished with a plastic outer insulating sleeve.

SPRAGUE CAPACITORS

ATOM[®] ELECTROLYTICS

- The Smallest Dependable Standard Tubular—Designed for 85C (185F) Operation in Voltages to 475 WVDC
- Whether For AC-DC Sets, Auto Radios, Home Radio-phono Combinations, Or TV Sets, The SPRAGUE Line Will Handle All Your Replacement Requirements—No Dual Inventory Problems
- Have Low Leakage And Long Shelf Life
- Will Withstand High Temperatures, High Ripple Currents, High Surge Voltages
- Metal Case Construction with Outer Kraftboard Insulating Case Except as Noted by † Sign

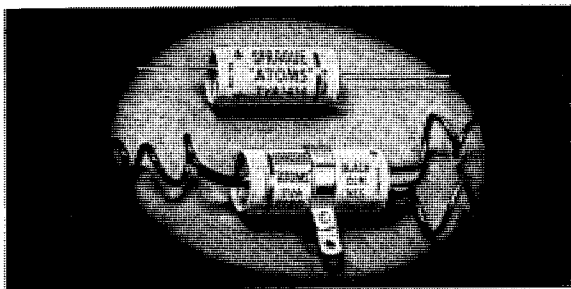

μF	WVDC	D. x L.	Cat. No.		μF	WVDC	D. x L.	Cat. No.		μF	WVDC	D. x L.	Cat. No.
SINGLE UNITS				CALL YOUR SPRAGUE INDUSTRIAL DISTRIBUTOR FOR CURRENT QUANTITY PRICES	3	50	7/16 x 1 1/16	TVA-1302	CALL YOUR SPRAGUE INDUSTRIAL DISTRIBUTOR FOR CURRENT QUANTITY PRICES	8	250	7/16 x 1 1/16	TVA-1503
750	3	7/16 x 2 1/16	TVA-1097		3	50NP	7/16 x 1 1/16	TVA-1302.1		10	250	7/8 x 1 1/16	TVA-1504
					4	50NP	1 1/16 x 7/16	★ TVA-1302.5		12	250	7/8 x 1 1/16	TVA-1505
50	6	7/16 x 1 1/4]*	TVA-1100		5	50	7/16 x 1 3/8]*	TVA-1303		16	250	1 1/16 x 1 1/16	TVA-1507
100	6	7/16 x 1 1/16	TVA-1101				7/16 x 1 3/8]*			20	250	1 1/16 x 1 1/16	TVA-1508
250	6	7/16 x 1 1/16	TVA-1102		5	50NP	1 1/16 x 2 1/16	TVAN-1303.1		30	250	1 1/16 x 1 1/16	TVA-1510
500	6	5/8 x 1 1/16	TVA-1103				1 1/16 x 2 1/16			40	250	1 1/16 x 2 1/16	TVA-1511
1000	6	3/4 x 1 1/16	TVA-1104		10	50	7/16 x 1 1/4]*	TVA-1304		50	250	1 1/16 x 1 1/16	TVA-1512
1500	6	1 1/16 x 2 1/16	TVA-1105		10	50NP	3/8 x 1 1/16	TVAN-1304.1		60	250	1 x 1 1/16	TVA-1513
2000	6	7/16 x 2 1/16	TVA-1106				3/8 x 1 1/16			70	250	1 1/16 x 2 1/16	TVA-1515
8	10NP	7/16 x 1 1/16	TVAN-1112		10	50NP	1 1/16 x 2 1/16	TVAN-1304.1		100	250	1 1/16 x 2 1/16	TVA-1522
50	10NP	7/16 x 1 1/16	TVAN-1117		15	50	7/16 x 1 1/4]*	TVA-1305		200	250	1 3/8 x 3 1/8	TVA-1528†
160	10NP	1 1/16 x 1 1/16	TVAN-1120				3/8 x 1 1/16			100	300	1 1/8 x 3 1/8	TVA-1573
100	12	7/16 x 1 1/16	TVA-1130		20	50	7/16 x 1 1/4]*	TVA-1305.5		140	300	1 1/8 x 3 3/8	★ TVA-1575†
250	12	5/8 x 1 1/16	TVA-1131				3/8 x 1 1/16			150	300	1 3/8 x 3 3/8	★ TVA-1576†
500	12	1 1/16 x 1 1/16	TVA-1132		25	50	7/16 x 1 1/4]*	TVA-1306		4	350	1 1/8 x 1 1/16	TVA-1601
1000	12	1 1/16 x 1 1/16	TVA-1133				3/8 x 1 1/16			5	350NP	1 1/8 x 1 1/16	TVAN-1602
100	15	7/16 x 1 1/16	TVA-1160		50	50	5/8 x 1 1/16	TVA-1308		8	350	1 1/16 x 1 1/16	TVA-1603
250	15	5/8 x 1 1/16	TVA-1161		100	50NP	1 1/16 x 2 1/16	TVAN-1303.1		10	350	3/4 x 1 1/16	TVA-1604
500	15	1 1/16 x 1 1/16	TVA-1162		150	50	5/8 x 1 1/16	TVA-1310		10	350NP	1 1/16 x 2 1/16	TVAN-1604.1
1000	15	1 1/16 x 1 1/16	TVA-1163		250	50	3/4 x 1 1/16	TVA-1311		12	350	1 1/16 x 1 1/16	TVA-1605
2000	15	1 1/16 x 2 1/16	★ TVA-1170		500	50	1 1/16 x 1 1/16	TVA-1312		16	350	1 1/16 x 1 1/16	TVA-1607
3000	15	1 1/16 x 4 1/16	TVA-1175				1 x 1 1/16	TVA-1315		20	350	1 1/16 x 1 1/16	TVA-1608
2	25	7/16 x 1 3/8]*	TVA-1201		10	90	7/16 x 1 1/8	TVA-1320		30	350	1 1/16 x 2 1/16	TVA-1610
2	25NP	7/16 x 1 1/16	TVAN-1202		10	100NP	1 1/16 x 1 1/16	TVAN-1333		40	350	1 1/16 x 2 1/16	TVA-1611
4	25NP	1 1/16 x 1 1/16	★ TVA-1202.2				1 1/16 x 1 1/16			60	350	1 1/16 x 2 1/16	TVA-1613
5	25	7/16 x 1 3/8]*	TVA-1203		1	150	7/16 x 1 3/8]*	TVA-1400		100	350	1 1/16 x 2 1/16	TVA-1620
5	25NP	7/16 x 1 1/16	TVAN-1203.1		4	150	7/16 x 1 1/2]*	TVA-1402		150	350	1 1/8 x 3 3/8	TVA-1622†
8	25NP	1 1/16 x 1 1/16	★ TVA-1203.8		4	150NP	7/16 x 1 1/16	TVAN-1402.1		200	350	1 3/8 x 4 1/8	TVA-1624†
10	25	7/16 x 1 3/8]*	TVA-1204		5	150	7/16 x 1 1/4]*	TVA-1403		10	400NP	1 1/16 x 2 1/16	★ TVA-1650
10	25NP	7/16 x 1 1/16	TVAN-1204.1				3/8 x 1 1/16			20	400NP	1 1/16 x 2 1/16	TVAN-1652
20	25	7/16 x 1 1/4]*	TVA-1204.5		8	150	7/16 x 1 1/8	TVA-1405		1	450	7/16 x 1 1/16	TVA-1700
25	25	3/8 x 1 1/16	TVA-1205		10	150	7/16 x 1 1/8	TVA-1406		2	450	7/16 x 1 1/16	TVA-1701
50	25	7/16 x 1 1/16	TVA-1206	10	150	9/16 x 1 1/16	TVA-1406	4	450	1 1/16 x 1 1/16	TVA-1702		
100	25NP	1 1/16 x 1 1/16	TVAN-1206.1	10	150NP	1 1/16 x 1 1/16	TVAN-1406.1	5	450	1 1/16 x 1 1/16	TVA-1703		
100	25	7/16 x 1 1/16	TVA-1207	12	150	9/16 x 1 1/16	TVA-1407	8	450	3/4 x 1 1/16	TVA-1704		
100	25NP	1 1/16 x 1 1/16	TVAN-1207.1	16	150	9/16 x 1 1/16	TVA-1409	10	450	1 1/16 x 1 1/16	TVA-1705		
150	25	1 1/16 x 1 1/16	TVA-1207.5	20	150	5/8 x 1 1/16	TVA-1410	12	450	1 1/16 x 1 1/16	TVA-1706		
250	25	1 1/16 x 1 1/16	TVA-1208	25	150	3/4 x 1 1/16	TVA-1411	16	450	1 1/16 x 1 1/16	TVA-1708		
500	25	3/4 x 1 1/16	TVA-1209	30	150	1 1/16 x 1 1/16	TVA-1412	20	450	1 1/16 x 1 1/16	TVA-1709		
1000	25	1 1/16 x 2 1/16	TVA-1211	40	150	1 1/16 x 1 1/16	TVA-1413	30	450	1 1/16 x 2 1/16	TVA-1711		
3	30NP	1 1/16 x 1 1/16	TVAN-1215	50	150	1 1/16 x 1 1/16	TVA-1414	40	450	1 1/16 x 2 1/16	TVA-1712		
20	30NP	1 1/16 x 1 1/16	TVAN-1220	60	150	1 1/16 x 1 1/16	TVA-1415	50	450	1 1/16 x 2 1/16	TVA-1713		
10	40NP	7/16 x 1 1/16	TVAN-1230	80	150	1 1/16 x 1 1/16	TVA-1418	60	450	1 1/16 x 2 1/16	TVA-1714		
1	50	7/16 x 1 1/8]*	TVA-1300	100	150	1 1/16 x 2 1/16	TVA-1420	80	450	1 1/16 x 3 1/16	TVA-1716		
2	50	7/16 x 1 3/8]*	TVA-1301	150	150	1 1/16 x 2 1/16	TVA-1422	100	450	1 1/16 x 4 1/16	TVA-1718		
2	50NP	1 1/16 x 1 1/16	TVAN-1301.1	200	150	1 1/16 x 2 1/16	TVA-1423	150	450	1 3/8 x 3 3/8	TVA-1719†		
				250	150	1 1/4 x 4 3/8	★ TVA-1424†	200	450	1 1/2 x 4 3/8	TVA-1720†		
				300	150	1 1/16 x 3 3/8	TVA-1425	10	475	1 1/16 x 2 1/16	TVA-1802		
				80	175	1 1/8 x 2 1/16	TVA-1430	20	475	1 1/16 x 2 1/16	TVA-1804		
				2	200NP	9/16 x 1 1/16	TVAN-1435.1	8	500	1 1/16 x 1 1/16	TVA-1902		
				60	200NP	1 1/16 x 2 1/16	TVAN-1440	10	500	1 1/16 x 1 1/16	TVA-1903		
				100	200	1 1/16 x 2 3/16	TVA-1445	12	500	1 1/16 x 2 1/16	TVA-1904		
				150	200	1 3/8 x 3 3/8	★ TVA-1447†	16	500	1 x 2 3/16	TVA-1905		
				200	200	1 3/8 x 3 3/8	★ TVA-1480†	20	500	1 1/16 x 2 3/16	TVA-1906		
				1	250	9/16 x 1 1/16	TVA-1500	40	500	1 1/16 x 3 1/16	TVA-1908		
				4	250	9/16 x 1 1/16	TVA-1501	8	600	1 1/16 x 3 3/16	TVA-1962		
								10	600	1 1/16 x 3 3/16	TVA-1963		
								16	600	1 1/16 x 4 3/16	TVA-1965		
								20	600	1 1/16 x 4 3/16	TVA-1966		

★ Mounting straps attached †Kraftboard construction. *Either of the two listed sizes may be supplied at Sprague's option.

SPRAGUE CAPACITORS

TYPE 500D MINIATURE METAL-CASE ALUMINUM ELECTROLYTICS

- Excellent Low Temperature Operation
- Reliability at Low Cost
- Withstand High Surge Voltages
- Long Shelf Life, Extremely Low Leakage Current
- High Capacitance in Ultra-Small Physical Size
- Available in Voltage Ratings From 3WVDC Through 150 WVDC

- Furnished with Plastic Outer Insulating Sleeves
- Packaged 5 to A Handy Rigid Klee-Pak Plastic Box
- For Complete Technical Data, See Latest Issue of Sprague Engineering Bulletin 3149
- Call Your Sprague Industrial Distributor For Current Quantity Prices

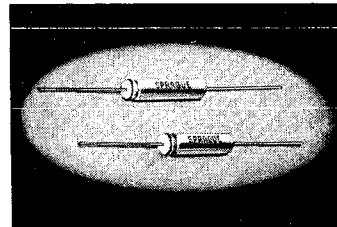

μ F	WVDC	D. x L.	Cat. No.	μ F	WVDC	D. x L.	Cat. No.	μ F	WVDC	D. x L.	Cat. No.
1	3	.260 x .536	500D105G003BA2	2	12	.260 x .536	500D205G012BA2	4	25	.260 x .536	500D405G025BA2
2	3	.260 x .536	500D205G003BA2	3	12	.260 x .536	500D305G012BA2	5	25	.260 x .536	500D505G025BA2
3	3	.260 x .536	500D305G003BA2	4	12	.260 x .536	500D405G012BA2	6	25	.260 x .536	500D605G025BA2
4	3	.260 x .536	500D405G003BA2	5	12	.260 x .536	500D505G012BA2	8	25	.260 x .536	500D805G025BA2
5	3	.260 x .536	500D505G003BA2	6	12	.260 x .536	500D605G012BA2	10	25	.260 x .723	500D106G025BB2
6	3	.260 x .536	500D605G003BA2	8	12	.260 x .536	500D805G012BA2	15	25	.260 x .723	500D156G025BB2
8	3	.260 x .536	500D805G003BA2	10	12	.260 x .536	500D106G012BA2	25	25	.322 x .723	500D256G025CB2
10	3	.260 x .536	500D106G003BA2	15	12	.260 x .536	500D156G012BA2	30	25	.322 x .723	500D306G025CB2
15	3	.260 x .536	500D156G003BA2	20	12	.260 x .723	500D206G012BB2	35	25	.322 x .723	500D356G025CB2
20	3	.260 x .536	500D206G003BA2	25	12	.260 x .723	500D256G012BB2	50	25	.322 x .848	500D506G025CC2
25	3	.260 x .536	500D256G003BA2	30	12	.260 x .723	500D306G012BB2	75	25	.385 x .848	500D756G025DC2
30	3	.260 x .536	500D306G003BA2	50	12	.322 x .723	500D506G012CB2	100	25	.385 x .973	500D107G025DD2
50	3	.260 x .723	500D506G003BB2	60	12	.322 x .723	500D606G012CB2	150	25	.385 x 1.286	500D157G025DF2
65	3	.260 x .723	500D656G003BB2	75	12	.322 x .848	500D756G012CC2	200	25	.385 x 1.536	500D207G025DH2
75	3	.322 x .723	500D756G003CB2	90	12	.385 x .723	500D906G012DB2	1	50	.260 x .536	500D105G050BA2
100	3	.322 x .723	500D107G003CB2	100	12	.322 x .848	500D107G012CC2	2	50	.260 x .536	500D205G050BA2
130	3	.322 x .723	500D137G003CB2	140	12	.385 x .848	500D147G012DC2	3	50	.260 x .536	500D305G050BA2
150	3	.322 x .848	500D157G003CC2	150	12	.385 x .973	500D157G012DD2	4	50	.260 x .536	500D405G050BA2
200	3	.322 x .848	500D207G003CC2	190	12	.385 x .973	500D197G012DD2	5	50	.260 x .723	500D505G050BB2
250	3	.385 x .848	500D257G003DC2	200	12	.385 x 1.286	500D207G012DF2	6	50	.260 x .723	500D605G050BB2
300	3	.385 x .848	500D307G003DC2	250	12	.385 x 1.286	500D257G012DF2	8	50	.260 x .723	500D805G050BB2
400	3	.385 x .973	500D407G003DD2	290	12	.385 x 1.286	500D297G012DF2	10	50	.322 x .723	500D106G050CB2
500	3	.385 x 1.286	500D507G003DF2	390	12	.385 x 1.536	500D397G012DH2	15	50	.322 x .723	500D156G050CB2
600	3	.385 x 1.286	500D607G003DF2	1	15	.260 x .536	500D105G015BA2	20	50	.322 x .848	500D206G050CC2
800	3	.385 x 1.536	500D807G003DH2	2	15	.260 x .536	500D205G015BA2	25	50	.322 x .848	500D256G050CC2
1	6	.260 x .536	500D105G006BA2	3	15	.260 x .536	500D305G015BA2	35	50	.385 x .848	500D356G050DC2
2	6	.260 x .536	500D205G006BA2	4	15	.260 x .536	500D405G015BA2	50	50	.385 x .973	500D506G050DD2
3	6	.260 x .536	500D305G006BA2	5	15	.260 x .536	500D505G015BA2	75	50	.385 x 1.286	500D756G050DF2
4	6	.260 x .536	500D405G006BA2	6	15	.260 x .536	500D605G015BA2	100	50	.385 x 1.536	500D107G050DH2
5	6	.260 x .536	500D505G006BA2	8	15	.260 x .536	500D805G015BA2	1	100	.260 x .536	500D105F100BA2
6	6	.260 x .536	500D605G006BA2	10	15	.260 x .536	500D106G015BA2	2	100	.260 x .723	500D205F100BB2
8	6	.260 x .536	500D805G006BA2	15	15	.260 x .723	500D156G015BB2	3	100	.322 x .723	500D305F100CB2
10	6	.260 x .536	500D106G006BA2	20	15	.260 x .723	500D206G015BB2	4	100	.322 x .723	500D405F100CB2
15	6	.260 x .536	500D156G006BA2	25	15	.260 x .723	500D256G015BB2	5	100	.322 x .848	500D505F100CC2
20	6	.260 x .536	500D206G006BA2	30	15	.322 x .723	500D306G015CB2	6	100	.322 x .848	500D605F100CC2
25	6	.260 x .723	500D256G006BB2	35	15	.322 x .723	500D356G015CB2	8	100	.385 x .848	500D805F100DC2
35	6	.260 x .723	500D356G006BB2	50	15	.322 x .723	500D506G015CB2	10	100	.385 x .848	500D106F100DC2
50	6	.260 x .723	500D506G006BB2	75	15	.322 x .848	500D756G015CC2	15	100	.385 x .848	500D156F100DD2
75	6	.322 x .723	500D756G006CB2	85	15	.385 x .723	500D856G015DB2	20	100	.385 x 1.286	500D206F100DF2
90	6	.322 x .723	500D906G006CB2	90	15	.322 x .848	500D906G015CC2	25	100	.385 x 1.536	500D256F100DH2
100	6	.322 x .848	500D107G006CC2	100	15	.385 x .848	500D107G015DC2	30	100	.385 x 1.536	500D306F100DH2
140	6	.322 x .848	500D147G006CC2	130	15	.385 x .848	500D137G015DC2	1	150	.260 x .536	500D105F150BA2
150	6	.385 x .848	500D157G006DC2	150	15	.385 x .973	500D157G015DD2	2	150	.260 x .723	500D205F150BB2
200	6	.385 x .848	500D207G006DC2	180	15	.385 x .973	500D187G015DD2	3	150	.322 x .723	500D305F150CB2
250	6	.385 x .973	500D257G006DD2	200	15	.385 x 1.286	500D207G015DF2	4	150	.322 x .848	500D405F150CC2
300	6	.385 x .973	500D307G006DD2	250	15	.385 x 1.286	500D257G015DF2	5	150	.322 x .848	500D505F150CC2
400	6	.385 x 1.286	500D407G006DF2	300	15	.385 x 1.536	500D307G015DH2	6	150	.385 x .848	500D605F150DC2
500	6	.385 x 1.536	500D507G006DH2	350	15	.385 x 1.536	500D357G015DH2	7	150	.385 x .848	500D705F150DC2
600	6	.385 x 1.536	500D607G006DH2	1	25	.260 x .536	500D105G025BA2	8	150	.385 x .848	500D805F150DC2
1	12	.260 x .536	500D105G012BA2	2	25	.260 x .536	500D205G025BA2	10	150	.385 x .973	500D106F150DD2
				3	25	.260 x .536	500D305G025BA2	15	150	.385 x 1.286	500D156F150DF2
								20	150	.385 x 1.536	500D206F150DH2

SPRAGUE CAPACITORS

TL TRANSI-LYTIC® ELECTROLYTICS

- Miniature Low-Cost Capacitors For Use in Transistorized Pocket and "Personal Portable" Radios
- Special Low-Leakage Current Construction to Meet The Requirements of Transistor Circuitry
- Sturdy Plastic Case With Thermo-setting Resin End Seals
- Excellent Resistance to High Humidity Conditions
- Polarity Stamped on Each Unit

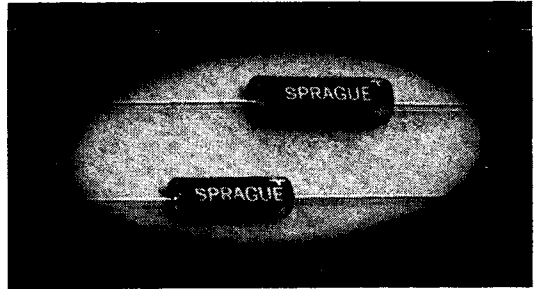

μF	D. x L.	Sprague Products Cat. No.	Sprague O.E.M. Part No.	μF	D. x L.	Sprague Products Cat. No.	Sprague O.E.M. Part No.	μF	D. x L.	Sprague Products Cat. No.	Sprague O.E.M. Part No.
3 WVDC											
1	.180 x .570	TL-1050	31D1	5	.180 x .570	TL-1127	31D40	50	.312 x .820	TL-1182	31D78
2	.180 x .570	TL-1051	31D2	6	.180 x .570	TL-1127.1	31D41	75	.375 x 1.070	TL-1183	31D79
3	.180 x .570	TL-1052	31D3	8	.210 x .700	TL-1127.3	31D42	100	.375 x 1.070	TL-1184	31D135
4	.180 x .570	TL-1052.1	31D4	10	.210 x .700	TL-1128	31D43	150	.437 x 1.070	TL-1185	31D136
5	.180 x .570	TL-1052.2	31D5	15	.210 x .700	TL-1129	31D44	200	.500 x 1.440	TL-1186	31D137
6	.180 x .570	TL-1052.3	31D6	20	.250 x .820	TL-1130	31D45	250	.500 x 1.440	TL-1187	31D138
8	.180 x .570	TL-1052.5	31D7	25	.250 x .820	TL-1131	31D46	300	.500 x 1.440	TL-1188	31D139
10	.180 x .570	TL-1053	31D8	35	.250 x .820	TL-1132	31D47	400	.625 x 1.700	TL-1189	31D140
15	.180 x .570	TL-1053.5	31D9	50	.312 x .820	TL-1133	31D48	500	.625 x 1.700	TL-1190	31D141
20	.210 x .700	TL-1054	31D10	75	.375 x 1.070	TL-1134	31D49	1000	.750 x 1.700	TL-1191	31D142
25	.210 x .700	TL-1055	31D11	100	.375 x 1.070	TL-1135	31D50	1500	.750 x 2.100	TL-1192	31D143
35	.250 x .820	TL-1056	31D12	150	.375 x 1.070	TL-1136	31D113	2000	.875 x 2.320	TL-1193	31D144
50	.250 x .820	TL-1058	31D13	200	.437 x 1.070	TL-1137	31D114	2500	1.000 x 2.320	TL-1194	31D145
75	.250 x .820	TL-1059	31D14	250	.500 x 1.440	TL-1138	31D115	3000	1.000 x 2.320	TL-1195	31D146
100	.312 x .820	TL-1059.5	31D15	300	.500 x 1.440	TL-1139	31D116	25 WVDC			
150	.375 x 1.070	TL-1061	31D16	400	.500 x 1.440	TL-1140	31D181	1	.180 x .570	TL-1200	31D80
200	.375 x 1.070	TL-1064	31D17	500	.625 x 1.700	TL-1141	31D117	2	.180 x .570	TL-1201	31D81
250	.375 x 1.070	TL-1065	31D18	1000	.625 x 1.700	TL-1142	31D118	3	.180 x .570	TL-1201.1	31D82
300	.375 x 1.070	TL-1066	31D93	1500	.750 x 1.440	TL-1143	31D119	4	.180 x .570	TL-1201.2	31D83
400	.437 x 1.070	TL-1067	31D94	2000	.750 x 2.100	TL-1144	31D120	5	.210 x .700	TL-1202	31D84
500	.437 x 1.070	TL-1068	31D95	2500	.875 x 2.320	TL-1145	31D121	6	.210 x .700	TL-1203	31D85
1000	.625 x 1.700	TL-1069	31D96	3000	.875 x 2.320	TL-1146	31D122	8	.210 x .700	TL-1203.5	31D86
1500	.625 x 1.700	TL-1070	31D97	4000	1.000 x 2.320	TL-1147	31D123	10	.250 x .820	TL-1204	31D87
2000	.625 x 1.700	TL-1071	31D98	16 WVDC				15	.250 x .820	TL-1205	31D88
2500	.750 x 2.100	TL-1072	31D99	1	.180 x .570	TL-1148	31D51	20	.250 x .820	TL-1206	31D89
3000	.750 x 2.100	TL-1073	31D100	2	.180 x .570	TL-1149	31D52	25	.312 x .820	TL-1207	31D90
4000	.750 x 2.100	TL-1074	31D101	3	.180 x .570	TL-1150	31D53	35	.375 x 1.070	TL-1208	31D91
6 WVDC				4	.180 x .570	TL-1151	31D54	50	.375 x 1.070	TL-1209	31D92
1	.180 x .570	TL-1080	31D19	5	.180 x .570	TL-1152	31D55	75	.375 x 1.070	TL-1210	31D93
2	.180 x .570	TL-1081	31D20	6	.180 x .570	TL-1153	31D56	100	.437 x 1.070	TL-1211	31D94
3	.180 x .570	TL-1082	31D21	8	.210 x .700	TL-1154	31D57	150	.500 x 1.440	TL-1212	31D95
4	.180 x .570	TL-1083	31D22	10	.210 x .700	TL-1155	31D58	200	.500 x 1.440	TL-1213	31D150
5	.180 x .570	TL-1084	31D23	15	.250 x .820	TL-1156	31D59	250	.625 x 1.700	TL-1214	31D151
6	.180 x .570	TL-1085	31D24	20	.250 x .820	TL-1157	31D60	300	.625 x 1.700	TL-1215	31D152
8	.180 x .570	TL-1086	31D25	25	.250 x .820	TL-1157.1	31D61	400	.625 x 1.700	TL-1216	31D153
10	.180 x .570	TL-1087	31D26	35	.312 x .820	TL-1159	31D62	500	.625 x 1.700	TL-1217	31D154
15	.210 x .700	TL-1089	31D27	50	.312 x .820	TL-1160	31D63	1000	.750 x 2.100	TL-1218	31D155
20	.210 x .700	TL-1090	31D28	75	.375 x 1.070	TL-1161	31D64	1500	.875 x 2.320	TL-1219	31D156
25	.250 x .820	TL-1091	31D29	100	.375 x 1.070	TL-1162	31D65	2000	1.000 x 2.320	TL-1220	31D157
35	.250 x .820	TL-1093	31D30	150	.375 x 1.070	TL-1163	31D124	50 WVDC			
50	.250 x .820	TL-1100	31D31	200	.437 x 1.070	TL-1164	31D125	1	.180 x .570	TL-1300	31D158
75	.312 x .820	TL-1101.5	31D32	250	.500 x 1.440	TL-1164.5	31D126	2	.180 x .570	TL-1301	31D159
100	.375 x 1.070	TL-1102	31D33	300	.500 x 1.440	TL-1165	31D127	3	.210 x .700	TL-1302	31D160
150	.375 x 1.070	TL-1103	31D34	400	.625 x 1.700	TL-1165.5	31D128	4	.210 x .700	TL-1302.1	31D161
175	.375 x 1.070	TL-1103.5	31D35	500	.625 x 1.700	TL-1166	31D129	5	.250 x .820	TL-1303	31D162
200	.375 x 1.070	TL-1104	31D102	1000	.750 x 1.700	TL-1166.5	31D130	6	.250 x .820	TL-1303.1	31D163
250	.437 x 1.070	TL-1105	31D103	1500	.750 x 1.700	TL-1167	31D131	8	.250 x .820	TL-1303.3	31D164
300	.437 x 1.070	TL-1106	31D104	2000	.875 x 2.320	TL-1167.5	31D132	10	.250 x .820	TL-1304	31D165
400	.500 x 1.440	TL-1107	31D105	2500	.875 x 2.320	TL-1168	31D133	15	.312 x .820	TL-1304.2	31D166
500	.500 x 1.440	TL-1108	31D106	3000	1.000 x 2.320	TL-1168.5	31D134	20	.375 x 1.070	TL-1305	31D167
1000	.625 x 1.700	TL-1111	31D107	20 WVDC				25	.375 x 1.070	TL-1305.1	31D168
1500	.625 x 1.700	TL-1112	31D108	1	.180 x .570	TL-1170	31D66	35	.375 x 1.070	TL-1306	31D169
2000	.750 x 2.100	TL-1113	31D109	2	.180 x .570	TL-1171	31D67	50	.437 x 1.070	TL-1307	31D170
2500	.750 x 2.100	TL-1114	31D110	3	.180 x .570	TL-1172	31D68	75	.500 x 1.440	TL-1308	31D171
3000	.875 x 2.320	TL-1115	31D111	4	.180 x .570	TL-1173	31D69	100	.500 x 1.440	TL-1309	31D172
4000	.875 x 2.320	TL-1116	31D112	5	.180 x .570	TL-1174	31D70	150	.625 x 1.700	TL-1310	31D173
12 WVDC				6	.210 x .700	TL-1175	31D71	175	.625 x 1.700	TL-1311	31D174
1	.180 x .570	TL-1120	31D36	8	.210 x .700	TL-1176	31D72	200	.625 x 1.700	TL-1312	31D175
2	.180 x .570	TL-1121	31D37	10	.210 x .700	TL-1177	31D73	250	.625 x 1.700	TL-1313	31D176
3	.180 x .570	TL-1122	31D38	15	.250 x .820	TL-1178	31D74	300	.750 x 1.195	TL-1314	31D177
4	.180 x .570	TL-1123	31D39	20	.250 x .820	TL-1179	31D75	400	.750 x 2.100	TL-1315	31D178
				25	.250 x .820	TL-1180	31D76	500	.750 x 2.100	TL-1316	31D179
				35	.312 x .820	TL-1181	31D77	1000	1.000 x 2.320	TL-1317	31D180

CALL YOUR SPRAGUE INDUSTRIAL DISTRIBUTOR FOR CURRENT QUANTITY PRICES

CALL YOUR SPRAGUE INDUSTRIAL DISTRIBUTOR FOR CURRENT QUANTITY PRICES

CALL YOUR SPRAGUE INDUSTRIAL DISTRIBUTOR FOR CURRENT QUANTITY PRICES

SPRAGUE CAPACITORS

TYPE 39D POWERLYTIC® CAPACITORS

- Designed for Such Applications as Transistorized Apparatus, Which Require the Greatest Possible Capacitance in Small Case Size.
- Type 39D Capacitors Supplement the Original Type 36D Powerlytic by Offering Lower Capacitance Values in Small Case Size.
- Welds at all Critical Anode and Cathode Terminals Eliminates Riveted or Pressure Connections to Assure Freedom from Open Circuits Even During Operation in the Microvolt or Millivolt Signal Range.
- End-seals of an Improved Molded Phenolic
- Furnished with an Outer Insulation of Flexible Plastic.
- Operating Temperature Up to 85C
- These Capacitors are Provided with a Pressure-sensitive Safety Vent.
- For Additional Technical Data, Consult the Latest Issue of Sprague Electric Company Engineering Bulletin 3415.

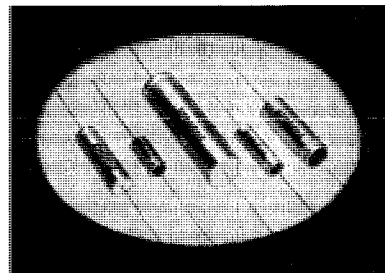

μF	D. x L.	Catalog Number	μF	D. x L.	Catalog Number	μF	D. x L.	Catalog Number	μF	D. x L.	Catalog Number
3 WVDC, 4 VDC SURGE			15 WVDC, 18 VDC SURGE			50 WVDC, 65 VDC SURGE			350 WVDC, 400 VDC SURGE		
1,300	1/2 x 2 1/8	39D138G003E14	600	1/2 x 2 1/8	39D607G015E14	50	1/2 x 1 1/8	39D506G050E4	20	3/8 x 2 1/8	39D206F350FL4
2,100	7/8 x 1 1/8	39D218G003HE4	1,200	3/8 x 2 1/8	39D128G015FL4	100	1/2 x 1 1/8	39D107G050E14	30	3/8 x 2 3/8	39D306F350FP4
3,000	1 x 1 1/8	39D308G003JE4	2,500	3/4 x 2 3/8	39D258G015GP4	150	7/8 x 2 1/8	39D157G050E14	40	3/4 x 2 1/8	39D406F350GL4
5,700	3/4 x 2 3/8	39D578G003GP4	4,000	1 x 2 1/8	39D408G015JL4	250	7/8 x 1 1/8	39D257G050HE4	50	3/4 x 2 3/8	39D506F350GP4
10,000	7/8 x 3 1/8	39D109G003HS4	8,000	1 x 3 1/8	39D808G015JT4	500	3/4 x 2 1/8	39D507G050GL4	100	7/8 x 3 1/8	39D107F350HS4
18,000	1 x 3 3/8	39D189G003JT4				1,100	7/8 x 2 3/8	39D118G050HP4	160	1 x 3 3/8	39D167F350JT4
						2,300	1 x 3 3/8	39D238G050JT4			
6 WVDC, 8 VDC SURGE			25 WVDC, 30 VDC SURGE			150 WVDC, 175 VDC SURGE			450 WVDC, 525 VDC SURGE		
600	1/2 x 1 1/8	39D607G006E14	200	1/2 x 1 3/8	39D207G025E14	25	1/2 x 1 3/8	39D256F150E14	5	1/2 x 2 1/8	39D505F450E14
1,000	3/4 x 1 1/8	39D108G006GE4	500	7/8 x 1 1/8	39D507G025HE4	50	3/8 x 1 1/8	39D506F150F14	10	3/8 x 2 1/8	39D106F450FL4
2,000	3/4 x 1 3/8	39D208G006GJ4	1,000	3/4 x 2 1/8	39D108G025GL4	100	3/8 x 2 1/8	39D107F150FP4	20	3/4 x 2 1/8	39D206F450GL4
4,000	3/4 x 2 1/8	39D408G006GP4	2,200	7/8 x 2 3/8	39D228G025HP4	250	7/8 x 2 3/8	39D257F150HP4	50	1 x 2 1/8	39D506F450JP4
6,000	3/4 x 2 3/8	39D608G006HP4	4,000	1 x 3 1/8	39D408G025JT4	530	1 x 3 3/8	39D537F150JT4	75	1 x 3 3/8	39D756F450JT4
10,000	1 x 3 1/8	39D109G006J54									
10 WVDC, 12 VDC SURGE			30 WVDC, 40 VDC SURGE			250 WVDC, 300 VDC SURGE			<p align="center">CALL YOUR SPRAGUE INDUSTRIAL DISTRIBUTOR FOR CURRENT QUANTITY PRICES</p>		
500	1/2 x 1 1/8	39D507G010E14	75	1/2 x 1 1/8	39D756G030EE4	20	1/2 x 2 1/8	39D206F250E14			
1,000	3/8 x 1 3/8	39D108G010F14	150	1/2 x 1 3/8	39D157G030E14	50	1 x 1 1/8	39D506F250E14			
1,600	3/8 x 2 1/8	39D168G010FL4	250	1/2 x 2 1/8	39D257G030E14	100	7/8 x 2 1/8	39D107F250HL4			
2,500	3/4 x 2 1/8	39D258G010GL4	500	3/8 x 2 1/8	39D507G030FL4	200	1 x 2 1/8	39D207F250JP4			
5,000	7/8 x 2 3/8	39D508G010HP4	1,100	3/4 x 2 3/8	39D118G030GP4	300	1 x 3 3/8	39D307F250JT4			
10,000	1 x 3 3/8	39D109G010JT4	2,100	7/8 x 3 1/8	39D218G030HS4						
			3,000	1 x 3 3/8	39D308G030J54						

TYPE 601D EXTRALYTIC® ALUMINUM ELECTROLYTIC CAPACITORS

- Supplement Type 600D Extralytic Capacitors With Larger Case Sizes and Higher Capacitance Values
- Unique New Electrolyte, High-gain Etched Foil, Improved Oxide System Provide Long Life With Superior Electrical Characteristics
- Pressure-sensitive Safety Vent
- Designed to Operate at a Temperature Range of -55C to +85C
- For Complete Technical Data, See Latest Issue of Sprague Engineering Bulletin 3456

Call Your Sprague Industrial Distributor For Current Quantity Prices

μF	Diam. (±0.031)	Length (±0.062)	Catalog Number*	μF	Diam. (±0.031)	Length (±0.062)	Catalog Number*	μF	Diam. (±0.031)	Length (±0.062)	Catalog Number*
5 VOLTS D-C WORKING, 7 VDC SURGE				15 VOLTS D-C WORKING, 20 VDC SURGE				50 VOLTS D-C WORKING, 75 VDC SURGE			
1500	.687	1.250	601D158G005F14	650	.812	1.250	601D657G015GE4	110	.687	1.250	601D117G050FE4
2300	.687	2.250	601D238G005FL4	1200	.687	2.250	601D128G015FL4	170	.812	1.250	601D177G050GE4
3500	.687	3.250	601D358G005FS4	2500	1.062	1.750	601D258G015J14	250	.937	1.250	601D257G050HE4
5500	.812	3.250	601D558G005GS4	4200	.937	3.250	601D428G015HS4	500	.687	3.250	601D507G050FS4
10000	1.062	3.250	601D109G005J54	6900	1.062	3.750	601D698G015JT4	1100	.937	3.250	601D118G050HS4
13000	1.062	3.750	601D139G005JT4					1800	1.062	3.750	601D188G050JT4
7.5 VOLTS D-C WORKING, 10 VDC SURGE				25 VOLTS D-C WORKING, 40 VDC SURGE				150 VOLTS D-C WORKING, 200 VDC SURGE			
650	.687	1.250	601D657G7R5FE4	220	.687	1.250	601D227G025FE4	18	.687	1.250	601D186F150FE4
1000	.812	1.250	601D108G7R5GE4	500	.937	1.250	601D507G025HE4	55	.687	2.250	601D556F150FL4
2000	.812	1.750	601D208G7R5GJ4	1000	.812	2.250	601D108G025GL4	100	.687	3.750	601D107F150FT4
4000	1.062	1.750	601D408G7R5J14	2200	.937	3.250	601D228G025HS4	260	.937	3.750	601D267F150HT4
6000	1.062	2.250	601D608G7R5JL4	3700	1.062	3.750	601D378G025JT4	360	1.062	3.750	601D367F150JT4
11000	1.062	3.750	601D119G7R5JT4								
10 VOLTS D-C WORKING, 15 VDC SURGE				30 VOLTS D-C WORKING, 45 VDC SURGE				200 VOLTS D-C WORKING, 250 VDC SURGE			
540	.687	1.250	601D547G010FE4	190	.687	1.250	601D197G030FE4	16	.687	1.250	601D166F200FE4
1000	.687	1.750	601D108G010F14	310	.812	1.250	601D317G030GE4	50	.812	1.750	601D506F200GJ4
1600	.687	2.250	601D168G010FL4	580	.687	2.250	601D587G030FL4	100	.812	3.250	601D107F200GS4
2500	.812	2.250	601D258G010GL4	1000	.687	3.750	601D108G030FT4	160	1.062	2.250	601D167F200JL4
5000	1.062	2.250	601D508G010JL4	2000	.937	3.250	601D208G030HS4	210	.937	3.750	601D217F200HT4
9100	1.062	3.750	601D918G010JT4	3300	1.062	3.750	601D338G030JT4	290	1.062	3.750	601D297F200JT4

*Catalog numbers listed are for capacitors with Outer Insulation. For units with bare can substitute "0" for "4" at the end of the catalog number, and subtract 1/64" from diameter.

SPRAGUE CAPACITORS

PE OCTAL-BASE ELECTROLYTICS

- For Applications where Rapid Changing of Capacitors is Desired
- Will Fit Standard Octal-Base Tube Sockets
- Hermetically Sealed in Metal Cans for Long Life
- Will Stand Up Under High Temperatures, High Ripple Currents, High Surge Voltages

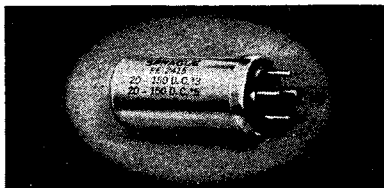

Terminal Code

Sections	—	+
Single	1	5
Dual	1	3,5
Triple	1	3,5,7
Quadruple	Gnd Lug	1,3,5,7

μF	WVDC	Diam. x Lgth.	Cat. No.	Call Your Sprague Distributor for Prices	μF	WVDC	Diam. x Lgth.	Cat. No.	Call Your Sprague Distributor for Prices
100	350	1 3/8 x 3	PE-1636		10-10	450-450	1 3/8 x 2 1/2	PE-2750	
10	450	1 3/8 x 2 1/2	PE-1705	20-20	450-450	1 3/8 x 2 1/2	PE-2755		
20	450	1 3/8 x 2 1/2	PE-1714	40-40	450-450	1 3/8 x 3 1/2	PE-2764		
40	450	1 3/8 x 2 1/2	PE-1725	10-10-10	450-450-450	1 3/8 x 2 1/2	PE-3776		
80	450	1 3/8 x 3 1/2	PE-1730	20-20-20	450-450-450	1 3/8 x 3	PE-3780		
20-20	150-150	1 3/8 x 2 1/2	PE-2415	30-30-10-20	450-450-450-50	1 3/8 x 3 1/2	PE-4741		
40-40	150-150	1 3/8 x 2 1/2	PE-2428						

MIL-C-25 CAPACITORS—TYPE CP53

- Impregnated with specially processed mineral oil to exceed performance requirements of MIL-C-25A
- Hermetically sealed, with silicone rubber compression terminals
- Rated for—55°C to +85°C operation
- Drawn metal cases have mounting flanges as integral part of containers
- Single and dual capacitance units have insulated sections — triple capacitance units have grounded cases
- Call Your Sprague Distributor for Current Prices

NOTE: Capacitors listed below have capacitance tolerances of +20%, -10% (V) or ±10% (K). For ±20% units, change last letter in catalog number from K to M or V to M.

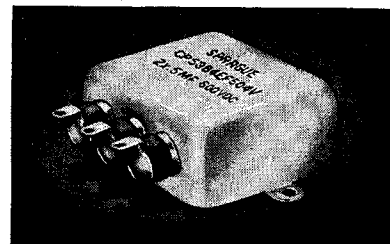

μF	Volts	L. x W. x H.	Cat. No.	Call Your Sprague Distributor for Prices	μF	Volts	L. x W. x H.	Cat. No.	Call Your Sprague Distributor for Prices
Single Capacitance					Dual Capacitance				
.05	600	1 13/16 x 1 x 3/4	*CP53B1EF503KI	.05 + .05	600	1 13/16 x 1 x 3/4	CP53B4EF503VI		
.05	1000	1 13/16 x 1 x 3/4	CP53B1EG503KI	.05 + .05	1000	1 13/16 x 1 x 3/4	CP53B4EG503VI		
.1	600	1 13/16 x 1 x 3/4	*CP53B1EF104KI	.1 + .1	600	1 13/16 x 1 x 3/4	CP53B4EF104VI		
.1	1000	1 13/16 x 1 x 3/4	CP53B1EG104KI	.1 + .1	1000	1 13/16 x 1 x 3/4	CP53B4EG104VI		
.25	600	1 13/16 x 1 x 3/4	CP53B1EF254KI	.25 + .25	600	1 13/16 x 1 x 1	CP53B4EF254VI		
.25	1000	1 13/16 x 1 x 3/4	CP53B1EG254KI	.25 + .25	1000	2 x 1 3/4 x 3/8	CP53B4EF504VI		
.5	400	1 13/16 x 1 x 7/8	*CP53B1EE504KI	.5 + .5	600	2 x 1 3/4 x 1	CP53B4EG254VI		
.5	600	1 13/16 x 1 x 1	CP53B1EF504KI	.5 + .5	1000	2 x 2 x 1 1/8	CP53B4EG504VI		
.5	1000	2 x 1 3/4 x 7/8	CP53B1EG504KI	1.0 + 1.0	600	2 x 2 x 1 1/8	CP53B4EF105VI		
1.0	600	2 x 1 3/4 x 1	CP53B1EF105KI	Triple Capacitance					
1.0	1000	2 x 2 x 1 1/8	CP53B1EG105KI	.05 + .05 + .05	600	1 13/16 x 1 x 3/4	*CP53B5EF503VI		
2.0	100	2 x 1 3/4 x 7/8	CP53B1EB205KI	.1 + .1 + .1	600	1 13/16 x 1 x 3/8	CP53B5EF104VI		
2.0	200	2 x 2 x 1	CP53B1EC205KI	.5 + .5 + .5	600	2 x 2 x 1 1/8	CP53B5EF504VI		
2.0	600	2 x 2 x 1 1/8	CP53B1EF205KI						
4.0	100	2 x 2 x 1 1/8	CP53B1EB405KI						

*Available until present stocks are exhausted

SPRAGUE CAPACITORS

TYPE 91P, continued

μF	WVDC	Size D. x L.	Capacitance Tolerance ±20%				Capacitance Tolerance ±10%			
			Style 2 (bare metal case)		Style 4 (w/plastic sleeve)*		Style 2 (bare metal case)		Style 4 (w/plastic sleeve)*	
			Cat. No.		Cat. No.		Cat. No.		Cat. No.	
.01	100	.175 x 3/4	91P10301S2	CALL YOUR SPRAGUE INDUSTRIAL DISTRIBUTOR FOR CURRENT QUANTITY PRICES	91P10301S4	CALL YOUR SPRAGUE INDUSTRIAL DISTRIBUTOR FOR CURRENT QUANTITY PRICES	91P10391S2	CALL YOUR SPRAGUE INDUSTRIAL DISTRIBUTOR FOR CURRENT QUANTITY PRICES	91P10391S4	
	200	.235 x 3/4	91P10302S2		91P10302S4		91P10392S2		91P10392S4	
	300	.235 x 3/4	91P10303S2		91P10303S4		91P10393S2		91P10393S4	
	400	.235 x 3/4	91P10304S2		91P10304S4		91P10394S2		91P10394S4	
	600	.312 x 7/8	91P10306S2		91P10306S4		91P10396S2		91P10396S4	
.015	100	.175 x 3/4	91P15301S2	CALL YOUR SPRAGUE INDUSTRIAL DISTRIBUTOR FOR CURRENT QUANTITY PRICES	91P15301S4	CALL YOUR SPRAGUE INDUSTRIAL DISTRIBUTOR FOR CURRENT QUANTITY PRICES	91P15391S2	CALL YOUR SPRAGUE INDUSTRIAL DISTRIBUTOR FOR CURRENT QUANTITY PRICES	91P15391S4	
	200	.235 x 3/4	91P15302S2		91P15302S4		91P15392S2		91P15392S4	
	300	.235 x 3/4	91P15303S2		91P15303S4		91P15393S2		91P15393S4	
	400	.312 x 7/8	91P15304S2		91P15304S4		91P15394S2		91P15394S4	
	600	.312 x 7/8	91P15306S2		91P15306S4		91P15396S2		91P15396S4	
.022	100	.195 x 3/4	91P22301S2	CALL YOUR SPRAGUE INDUSTRIAL DISTRIBUTOR FOR CURRENT QUANTITY PRICES	91P22301S4	CALL YOUR SPRAGUE INDUSTRIAL DISTRIBUTOR FOR CURRENT QUANTITY PRICES	91P22391S2	CALL YOUR SPRAGUE INDUSTRIAL DISTRIBUTOR FOR CURRENT QUANTITY PRICES	91P22391S4	
	200	.235 x 3/4	91P22302S2		91P22302S4		91P22392S2		91P22392S4	
	300	.312 x 7/8	91P22303S2		91P22303S4		91P22393S2		91P22393S4	
	400	.312 x 7/8	91P22304S2		91P22304S4		91P22394S2		91P22394S4	
	600	.312 x 7/8	91P22306S2		91P22306S4		91P22396S2		91P22396S4	
.033	100	.235 x 3/4	91P33301S2	CALL YOUR SPRAGUE INDUSTRIAL DISTRIBUTOR FOR CURRENT QUANTITY PRICES	91P33301S4	CALL YOUR SPRAGUE INDUSTRIAL DISTRIBUTOR FOR CURRENT QUANTITY PRICES	91P33391S2	CALL YOUR SPRAGUE INDUSTRIAL DISTRIBUTOR FOR CURRENT QUANTITY PRICES	91P33391S4	
	200	.312 x 7/8	91P33302S2		91P33302S4		91P33392S2		91P33392S4	
	300	.312 x 7/8	91P33303S2		91P33303S4		91P33393S2		91P33393S4	
	400	.312 x 7/8	91P33304S2		91P33304S4		91P33394S2		91P33394S4	
	600	.400 x 7/8	91P33306S2		91P33306S4		91P33396S2		91P33396S4	
.047	100	.312 x 7/8	91P47301S2	CALL YOUR SPRAGUE INDUSTRIAL DISTRIBUTOR FOR CURRENT QUANTITY PRICES	91P47301S4	CALL YOUR SPRAGUE INDUSTRIAL DISTRIBUTOR FOR CURRENT QUANTITY PRICES	91P47391S2	CALL YOUR SPRAGUE INDUSTRIAL DISTRIBUTOR FOR CURRENT QUANTITY PRICES	91P47391S4	
	200	.312 x 7/8	91P47302S2		91P47302S4		91P47392S2		91P47392S4	
	300	.312 x 7/8	91P47303S2		91P47303S4		91P47393S2		91P47393S4	
	400	.400 x 7/8	91P47304S2		91P47304S4		91P47394S2		91P47394S4	
	600	.400 x 1 1/8	91P47306S2		91P47306S4		91P47396S2		91P47396S4	
.068	100	.312 x 7/8	91P68301S2	CALL YOUR SPRAGUE INDUSTRIAL DISTRIBUTOR FOR CURRENT QUANTITY PRICES	91P68301S4	CALL YOUR SPRAGUE INDUSTRIAL DISTRIBUTOR FOR CURRENT QUANTITY PRICES	91P68391S2	CALL YOUR SPRAGUE INDUSTRIAL DISTRIBUTOR FOR CURRENT QUANTITY PRICES	91P68391S4	
	200	.312 x 7/8	91P68302S2		91P68302S4		91P68392S2		91P68392S4	
	300	.400 x 7/8	91P68303S2		91P68303S4		91P68393S2		91P68393S4	
	400	.400 x 1 1/8	91P68304S2		91P68304S4		91P68394S2		91P68394S4	
	600	.400 x 1 1/8	91P68306S2		91P68306S4		91P68396S2		91P68396S4	
.1	100	.312 x 7/8	91P10401S2	CALL YOUR SPRAGUE INDUSTRIAL DISTRIBUTOR FOR CURRENT QUANTITY PRICES	91P10401S4	CALL YOUR SPRAGUE INDUSTRIAL DISTRIBUTOR FOR CURRENT QUANTITY PRICES	91P10491S2	CALL YOUR SPRAGUE INDUSTRIAL DISTRIBUTOR FOR CURRENT QUANTITY PRICES	91P10491S4	
	200	.400 x 7/8	91P10402S2		91P10402S4		91P10492S2		91P10492S4	
	300	.400 x 1 1/8	91P10403S2		91P10403S4		91P10493S2		91P10493S4	
	400	.400 x 1 3/8	91P10404S2		91P10404S4		91P10494S2		91P10494S4	
	600	.562 x 1 1/8	91P10406S2		91P10406S4		91P10496S2		91P10496S4	
.15	100	.400 x 7/8	91P15401S2	CALL YOUR SPRAGUE INDUSTRIAL DISTRIBUTOR FOR CURRENT QUANTITY PRICES	91P15401S4	CALL YOUR SPRAGUE INDUSTRIAL DISTRIBUTOR FOR CURRENT QUANTITY PRICES	91P15491S2	CALL YOUR SPRAGUE INDUSTRIAL DISTRIBUTOR FOR CURRENT QUANTITY PRICES	91P15491S4	
	200	.400 x 1 1/8	91P15402S2		91P15402S4		91P15492S2		91P15492S4	
	300	.400 x 1 3/8	91P15403S2		91P15403S4		91P15493S2		91P15493S4	
	400	.562 x 1 1/8	91P15404S2		91P15404S4		91P15494S2		91P15494S4	
	600	.562 x 1 3/8	91P15406S2		91P15406S4		91P15496S2		91P15496S4	
.22	100	.400 x 1 1/8	91P22401S2	CALL YOUR SPRAGUE INDUSTRIAL DISTRIBUTOR FOR CURRENT QUANTITY PRICES	91P22401S4	CALL YOUR SPRAGUE INDUSTRIAL DISTRIBUTOR FOR CURRENT QUANTITY PRICES	91P22491S2	CALL YOUR SPRAGUE INDUSTRIAL DISTRIBUTOR FOR CURRENT QUANTITY PRICES	91P22491S4	
	200	.400 x 1 3/8	91P22402S2		91P22402S4		91P22492S2		91P22492S4	
	300	.562 x 1 1/8	91P22403S2		91P22403S4		91P22493S2		91P22493S4	
	400	.562 x 1 3/8	91P22404S2		91P22404S4		91P22494S2		91P22494S4	
	600	.562 x 1 3/8	91P22406S2		91P22406S4		91P22496S2		91P22496S4	
.33	100	.400 x 1 3/8	91P33401S2	CALL YOUR SPRAGUE INDUSTRIAL DISTRIBUTOR FOR CURRENT QUANTITY PRICES	91P33401S4	CALL YOUR SPRAGUE INDUSTRIAL DISTRIBUTOR FOR CURRENT QUANTITY PRICES	91P33491S2	CALL YOUR SPRAGUE INDUSTRIAL DISTRIBUTOR FOR CURRENT QUANTITY PRICES	91P33491S4	
	200	.562 x 1 1/8	91P33402S2		91P33402S4		91P33492S2		91P33492S4	
	300	.562 x 1 3/8	91P33403S2		91P33403S4		91P33493S2		91P33493S4	
	400	.562 x 1 3/8	91P33404S2		91P33404S4		91P33494S2		91P33494S4	
	600	.670 x 1 1/8	91P33406S2		91P33406S4		91P33496S2		91P33496S4	
.47	100	.400 x 1 1/8	91P47401S2	CALL YOUR SPRAGUE INDUSTRIAL DISTRIBUTOR FOR CURRENT QUANTITY PRICES	91P47401S4	CALL YOUR SPRAGUE INDUSTRIAL DISTRIBUTOR FOR CURRENT QUANTITY PRICES	91P47491S2	CALL YOUR SPRAGUE INDUSTRIAL DISTRIBUTOR FOR CURRENT QUANTITY PRICES	91P47491S4	
	200	.562 x 1 1/8	91P47402S2		91P47402S4		91P47492S2		91P47492S4	
	300	.562 x 1 3/8	91P47403S2		91P47403S4		91P47493S2		91P47493S4	
	400	.670 x 1 1/8	91P47404S2		91P47404S4		91P47494S2		91P47494S4	
	600	.750 x 2 1/8	91P47406S2		91P47406S4		91P47496S2		91P47496S4	
.68	100	.562 x 1 1/8	91P68401S2	CALL YOUR SPRAGUE INDUSTRIAL DISTRIBUTOR FOR CURRENT QUANTITY PRICES	91P68401S4	CALL YOUR SPRAGUE INDUSTRIAL DISTRIBUTOR FOR CURRENT QUANTITY PRICES	91P68491S2	CALL YOUR SPRAGUE INDUSTRIAL DISTRIBUTOR FOR CURRENT QUANTITY PRICES	91P68491S4	
	200	.562 x 1 3/8	91P68402S2		91P68402S4		91P68492S2		91P68492S4	
	300	.670 x 1 1/8	91P68403S2		91P68403S4		91P68493S2		91P68493S4	
	400	.750 x 2 1/8	91P68404S2		91P68404S4		91P68494S2		91P68494S4	
	600	1.000 x 1 3/8	91P68406S2		91P68406S4		91P68496S2		91P68496S4	
1.0	100	.562 x 1 3/8	91P10501S2	CALL YOUR SPRAGUE INDUSTRIAL DISTRIBUTOR FOR CURRENT QUANTITY PRICES	91P10501S4	CALL YOUR SPRAGUE INDUSTRIAL DISTRIBUTOR FOR CURRENT QUANTITY PRICES	91P10591S2	CALL YOUR SPRAGUE INDUSTRIAL DISTRIBUTOR FOR CURRENT QUANTITY PRICES	91P10591S4	
	200	.670 x 1 3/8	91P10502S2		91P10502S4		91P10592S2		91P10592S4	
	300	.750 x 2 1/8	91P10503S2		91P10503S4		91P10593S2		91P10593S4	
	400	1.000 x 1 3/8	91P10504S2		91P10504S4		91P10594S2		91P10594S4	

*For Style 4 units add .0625" to diameter and 1/16" to length.

SPRAGUE CAPACITORS

TYPE 96P, continued

μF	WVDC	Size D. x L.	Capacitance Tolerance = ±20%				Capacitance Tolerance = ±10%			
			Style 2 (bare metal case)		Style 4 (w/ plastic sleeve)*		Style 2 (bare metal case)		Style 4 (w/ plastic sleeve)*	
			Cat. No.		Cat. No.		Cat. No.		Cat. No.	
.068	100	.312 x 7/8	96P68301S2		96P68301S4		96P68391S2		96P68391S4	
	200	.312 x 7/8	96P68302S2		96P68302S4		96P68392S2		96P68392S4	
	300	.400 x 7/8	96P68303S2		96P68303S4		96P68393S2		96P68393S4	
	400	.400 x 7/8	96P68304S2		96P68304S4		96P68394S2		96P68394S4	
	600	.400 x 1 1/8	96P68306S2		96P68306S4		96P68396S2		96P68396S4	
.082	1000	.400 x 1 3/8					96P683910S2		96P683910S4	
	100	.562 x 1 3/8					96P82391S2		96P82391S4	
	200	.312 x 7/8					96P82392S2		96P82392S4	
	400	.400 x 7/8					96P82394S2		96P82394S4	
	600	.400 x 1 1/8					96P82396S2		96P82396S4	
.1	1000	.562 x 1 3/8					96P823910S2		96P823910S4	
	100	.562 x 1 5/8	96P10401S2		96P10401S4		96P10491S2		96P10491S4	
	200	.312 x 7/8	96P10402S2		96P10402S4		96P10492S2		96P10492S4	
	300	.400 x 7/8	96P10403S2		96P10403S4		96P10493S2		96P10493S4	
	400	.400 x 1 1/8	96P10404S2		96P10404S4		96P10494S2		96P10494S4	
.12	600	.400 x 1 3/8	96P10406S2		96P10406S4		96P10496S2		96P10496S4	
	1000	.562 x 1 3/8					96P104910S2		96P104910S4	
	100	.562 x 1 5/8					96P12491S2		96P12491S4	
	200	.400 x 7/8					96P12492S2		96P12492S4	
	400	.400 x 1 1/8					96P12494S2		96P12494S4	
.15	600	.562 x 1 1/8					96P12496S2		96P12496S4	
	1000	.562 x 1 3/8					96P124910S2		96P124910S4	
	100	.670 x 1 1/8	96P15491S2		96P15401S4		96P15491S2		96P15491S4	
	200	.400 x 7/8	96P15492S2		96P15402S4		96P15492S2		96P15492S4	
	300	.400 x 1 1/8	96P15493S2		96P15403S4		96P15493S2		96P15493S4	
.18	400	.400 x 1 3/8	96P15494S2		96P15404S4		96P15494S2		96P15494S4	
	600	.562 x 1 1/8	96P15496S2		96P15406S4		96P15496S2		96P15496S4	
	1000	.562 x 1 3/8					96P154910S2		96P154910S4	
	100	.670 x 1 3/8					96P18491S2		96P18491S4	
	200	.400 x 1 1/8					96P18492S2		96P18492S4	
.22	400	.400 x 1 3/8					96P18494S2		96P18494S4	
	600	.562 x 1 1/8					96P18496S2		96P18496S4	
	1000	.562 x 1 3/8					96P184910S2		96P184910S4	
	100	.750 x 2 1/8	96P22401S2		96P22401S4		96P22491S2		96P22491S4	
	200	.400 x 1 1/8	96P22402S2		96P22402S4		96P22492S2		96P22492S4	
.27	300	.400 x 1 3/8	96P22403S2		96P22403S4		96P22493S2		96P22493S4	
	400	.562 x 1 1/8	96P22404S2		96P22404S4		96P22494S2		96P22494S4	
	600	.562 x 1 3/8	96P22406S2		96P22406S4		96P22496S2		96P22496S4	
	1000	.562 x 1 5/8					96P224910S2		96P224910S4	
	100	.750 x 2 1/8					96P27491S2		96P27491S4	
.33	200	.400 x 1 3/8					96P27492S2		96P27492S4	
	400	.562 x 1 1/8					96P27494S2		96P27494S4	
	600	.670 x 1 1/8					96P27496S2		96P27496S4	
	1000	.750 x 2 1/8					96P274910S2		96P274910S4	
	100	.400 x 1 3/8	96P33401S2		96P33401S4		96P33491S2		96P33491S4	
.39	200	.562 x 1 1/8	96P33402S2		96P33402S4		96P33492S2		96P33492S4	
	300	.562 x 1 3/8	96P33403S2		96P33403S4		96P33493S2		96P33493S4	
	400	.562 x 1 5/8	96P33404S2		96P33404S4		96P33494S2		96P33494S4	
	600	.670 x 1 3/8	96P33406S2		96P33406S4		96P33496S2		96P33496S4	
	1000	.750 x 2 3/8					96P334910S2		96P334910S4	
.47	100	.562 x 1 1/8					96P39491S2		96P39491S4	
	200	.562 x 1 3/8					96P39492S2		96P39492S4	
	300	.562 x 1 5/8					96P39494S2		96P39494S4	
	400	.670 x 1 1/8					96P39496S2		96P39496S4	
	600	.750 x 2 1/8					96P394910S2		96P394910S4	
.56	1000	1.000 x 2 1/8					96P47491S2		96P47491S4	
	100	.562 x 1 3/8	96P47401S2		96P47401S4		96P47492S2		96P47492S4	
	200	.562 x 1 5/8	96P47402S2		96P47402S4		96P47493S2		96P47493S4	
	300	.562 x 1 7/8	96P47403S2		96P47403S4		96P47494S2		96P47494S4	
	400	.670 x 1 1/8	96P47404S2		96P47404S4		96P47496S2		96P47496S4	
.68	600	.750 x 2 1/8	96P47406S2		96P47406S4		96P474910S2		96P474910S4	
	1000	1.000 x 2 3/8					96P56491S2		96P56491S4	
	100	.562 x 1 5/8					96P56492S2		96P56492S4	
	200	.562 x 1 7/8					96P56494S2		96P56494S4	
	300	.750 x 2 1/8					96P56496S2		96P56496S4	
.82	400	1.000 x 1 1/8					96P68491S2		96P68491S4	
	100	.562 x 1 3/8	96P68401S2		96P68401S4		96P68492S2		96P68492S4	
	200	.562 x 1 5/8	96P68402S2		96P68402S4		96P68493S2		96P68493S4	
	300	.670 x 1 1/8	96P68403S2		96P68403S4		96P68494S2		96P68494S4	
	400	.750 x 2 1/8	96P68404S2		96P68404S4		96P68496S2		96P68496S4	
1.0	600	1.000 x 1 3/8	96P68406S2		96P68406S4		96P82491S2		96P82491S4	
	1000	1.000 x 1 5/8					96P82492S2		96P82492S4	
	100	.562 x 1 7/8					96P82494S2		96P82494S4	
	200	.670 x 1 5/8					96P10591S2		96P10591S4	
	300	1.000 x 1 7/8	96P10501S2		96P10501S4		96P10592S2		96P10592S4	
1.0	400	1.000 x 1 9/8	96P10502S2		96P10502S4		96P10593S2		96P10593S4	
			96P10503S2		96P10503S4		96P10594S2		96P10594S4	
			96P10504S2		96P10504S4					

*For Style 4 units add .0625" to diameter and 1/16" to length.

SPRAGUE CAPACITORS

TYPE 191P, continued

μF	WVDC	Size D. x L.	Capacitance Tolerance ±20%				Capacitance Tolerance ±10%			
			Style 2 (bare metal case)		Style 4 (w/plastic sleeve*)		Style 2 (bare metal case)		Style 4 (w/plastic sleeve*)	
			Cat. No.	CALL YOUR SPRAGUE INDUSTRIAL DISTRIBUTOR FOR CURRENT QUANTITY PRICES	Cat. No.	CALL YOUR SPRAGUE INDUSTRIAL DISTRIBUTOR FOR CURRENT QUANTITY PRICES	Cat. No.	CALL YOUR SPRAGUE INDUSTRIAL DISTRIBUTOR FOR CURRENT QUANTITY PRICES	Cat. No.	CALL YOUR SPRAGUE INDUSTRIAL DISTRIBUTOR FOR CURRENT QUANTITY PRICES
.033	100	.312 x 7/8	191P33301S2				191P33301S4			
	200	.312 x 7/8	191P33302S2		191P33302S4		191P33392S2		191P33392S4	
	300	.400 x 7/8	191P33303S2		191P33303S4		191P33393S2		191P33393S4	
	400	.400 x 7/8	191P33304S2		191P33304S4		191P33394S2		191P33394S4	
	600	.400 x 1 1/8	191P33306S2		191P33306S4		191P33396S2		191P33396S4	
.047	100	.312 x 7/8	191P47301S2		191P47301S4		191P47391S2		191P47391S4	
	200	.400 x 7/8	191P47302S2		191P47302S4		191P47392S2		191P47392S4	
	300	.400 x 7/8	191P47303S2		191P47303S4		191P47393S2		191P47393S4	
	400	.400 x 1 1/8	191P47304S2		191P47304S4		191P47394S2		191P47394S4	
	600	.400 x 1 3/8	191P47306S2		191P47306S4		191P47396S2		191P47396S4	
.068	100	.400 x 7/8	191P68301S2		191P68301S4		191P68391S2		191P68391S4	
	200	.400 x 7/8	191P68302S2		191P68302S4		191P68392S2		191P68392S4	
	300	.400 x 1 1/8	191P68303S2		191P68303S4		191P68393S2		191P68393S4	
	400	.400 x 1 3/8	191P68304S2		191P68304S4		191P68394S2		191P68394S4	
	600	.562 x 1 1/8	191P68306S2		191P68306S4		191P68396S2		191P68396S4	
.1	100	.400 x 7/8	191P10401S2		191P10401S4		191P10491S2		191P10491S4	
	200	.400 x 1 1/8	191P10402S2		191P10402S4		191P10492S2		191P10492S4	
	300	.400 x 1 3/8	191P10403S2		191P10403S4		191P10493S2		191P10493S4	
	400	.562 x 1 1/8	191P10404S2		191P10404S4		191P10494S2		191P10494S4	
	600	.562 x 1 3/8	191P10406S2		191P10406S4		191P10496S2		191P10496S4	
.15	100	.400 x 1 1/8	191P15401S2		191P15401S4		191P15491S2		191P15491S4	
	200	.400 x 1 3/8	191P15402S2		191P15402S4		191P15492S2		191P15492S4	
	300	.562 x 1 1/8	191P15403S2		191P15403S4		191P15493S2		191P15493S4	
	400	.562 x 1 3/8	191P15404S2		191P15404S4		191P15494S2		191P15494S4	
	600	.562 x 1 5/8	191P15406S2		191P15406S4		191P15496S2		191P15496S4	
.22	100	.400 x 1 3/8	191P22401S2		191P22401S4		191P22491S2		191P22491S4	
	200	.562 x 1 1/8	191P22402S2		191P22402S4		191P22492S2		191P22492S4	
	300	.562 x 1 3/8	191P22403S2		191P22403S4		191P22493S2		191P22493S4	
	400	.562 x 1 5/8	191P22404S2		191P22404S4		191P22494S2		191P22494S4	
	600	.670 x 1 1/8	191P22406S2		191P22406S4		191P22496S2		191P22496S4	
.33	100	.562 x 1 1/8	191P33401S2		191P33401S4		191P33491S2		191P33491S4	
	200	.562 x 1 3/8	191P33402S2		191P33402S4		191P33492S2		191P33492S4	
	300	.562 x 1 5/8	191P33403S2		191P33403S4		191P33493S2		191P33493S4	
	400	.670 x 1 1/8	191P33404S2		191P33404S4		191P33494S2		191P33494S4	
	600	.750 x 2 1/8	191P33406S2		191P33406S4		191P33496S2		191P33496S4	
.47	100	.562 x 1 3/8	191P47401S2		191P47401S4		191P47491S2		191P47491S4	
	200	.562 x 1 5/8	191P47402S2		191P47402S4		191P47492S2		191P47492S4	
	300	.670 x 1 1/8	191P47403S2		191P47403S4		191P47493S2		191P47493S4	
	400	.750 x 2 1/8	191P47404S2		191P47404S4		191P47494S2		191P47494S4	
	600	.750 x 2 3/8	191P47406S2		191P47406S4		191P47496S2		191P47496S4	
.68	100	.562 x 1 5/8	191P68401S2		191P68401S4		191P68491S2		191P68491S4	
	200	.670 x 1 1/8	191P68402S2		191P68402S4		191P68492S2		191P68492S4	
	300	.750 x 2 1/8	191P68403S2		191P68403S4		191P68493S2		191P68493S4	
1.0	100	.670 x 1 5/8	191P10501S2		191P10501S4		191P10591S2		191P10591S4	
	200	.750 x 2 1/8	191P10502S2		191P10502S4		191P10592S2		191P10592S4	

*For Style 4 units add .0625" to diameter and 1/16" to length

SPRAGUE CAPACITORS

TYPE 196P, continued

μF	WVDC	Size D. x L.	Capacitance Tolerance ±20%				Capacitance Tolerance ±10%			
			Style 2 (bare metal case)		Style 4 (w/plastic sleeve*)		Style 2 (bare metal case)		Style 4 (w/plastic sleeve*)	
			Cat. No.		Cat. No.		Cat. No.		Cat. No.	
.039	100	.312 x 7/8	---	---	---	---	196P39391S2	---	196P39391S4	
	200	.400 x 7/8	---	---	---	196P39392S2	---	196P39392S4		
	400	.400 x 1 1/8	---	---	---	196P39394S2	---	196P39394S4		
	600	.400 x 1 3/8	---	---	---	196P39396S2	---	196P39396S4		
	1000	.562 x 1 3/8	---	---	---	196P393910S2	---	196P393910S4		
.047	100	.312 x 7/8	196P47301S2	---	196P47301S4	---	196P47391S2	---	196P47391S4	
	200	.400 x 7/8	196P47302S2	---	196P47302S4	---	196P47392S2	---	196P47392S4	
	300	.400 x 7/8	196P47303S2	---	196P47303S4	---	196P47393S2	---	196P47393S4	
	400	.400 x 1 1/8	196P47304S2	---	196P47304S4	---	196P47394S2	---	196P47394S4	
	600	.400 x 1 3/8	196P47306S2	---	196P47306S4	---	196P47396S2	---	196P47396S4	
.056	1000	.562 x 1 3/8	---	---	---	196P473910S2	---	196P473910S4		
	200	.400 x 7/8	---	---	---	196P56392S2	---	196P56392S4		
	400	.400 x 1 1/8	---	---	---	196P56394S2	---	196P56394S4		
	600	.562 x 1 1/8	---	---	---	196P56396S2	---	196P56396S4		
	1000	.562 x 1 3/8	---	---	---	196P563910S2	---	196P563910S4		
.068	100	.400 x 7/8	196P68301S2	---	196P68301S4	---	196P68391S2	---	196P68391S4	
	200	.400 x 7/8	196P68302S2	---	196P68302S4	---	196P68392S2	---	196P68392S4	
	300	.400 x 1 1/8	196P68303S2	---	196P68303S4	---	196P68393S2	---	196P68393S4	
	400	.400 x 1 3/8	196P68304S2	---	196P68304S4	---	196P68394S2	---	196P68394S4	
	600	.562 x 1 1/8	196P68306S2	---	196P68306S4	---	196P68396S2	---	196P68396S4	
.082	1000	.562 x 1 3/8	---	---	---	196P683910S2	---	196P683910S4		
	100	.400 x 7/8	---	---	---	196P82391S2	---	196P82391S4		
	200	.400 x 1 1/8	---	---	---	196P82392S2	---	196P82392S4		
	400	.562 x 1 1/8	---	---	---	196P82394S2	---	196P82394S4		
	600	.562 x 1 3/8	---	---	---	196P82396S2	---	196P82396S4		
.1	1000	.670 x 1 3/8	---	---	---	196P823910S2	---	196P823910S4		
	100	.400 x 7/8	196P10401S2	---	196P10401S4	---	196P10491S2	---	196P10491S4	
	200	.400 x 1 1/8	196P10402S2	---	196P10402S4	---	196P10492S2	---	196P10492S4	
	300	.400 x 1 3/8	196P10403S2	---	196P10403S4	---	196P10493S2	---	196P10493S4	
	400	.562 x 1 1/8	196P10404S2	---	196P10404S4	---	196P10494S2	---	196P10494S4	
.12	600	.562 x 1 3/8	196P10406S2	---	196P10406S4	---	196P10496S2	---	196P10496S4	
	1000	.670 x 1 3/8	---	---	---	196P104910S2	---	196P104910S4		
	100	.400 x 1 1/8	---	---	---	196P12491S2	---	196P12491S4		
	200	.400 x 1 3/8	---	---	---	196P12492S2	---	196P12492S4		
	400	.562 x 1 3/8	---	---	---	196P12494S2	---	196P12494S4		
.15	600	.562 x 1 5/8	---	---	---	196P12496S2	---	196P12496S4		
	1000	.670 x 1 7/8	---	---	---	196P124910S2	---	196P124910S4		
	100	.400 x 1 1/8	196P15401S2	---	196P15401S4	---	196P15491S2	---	196P15491S4	
	200	.400 x 1 3/8	196P15402S2	---	196P15402S4	---	196P15492S2	---	196P15492S4	
	300	.562 x 1 1/8	196P15403S2	---	196P15403S4	---	196P15493S2	---	196P15493S4	
.18	400	.562 x 1 3/8	196P15404S2	---	196P15404S4	---	196P15494S2	---	196P15494S4	
	600	.670 x 1 3/8	196P15406S2	---	196P15406S4	---	196P15496S2	---	196P15496S4	
	1000	.670 x 1 7/8	---	---	---	196P154910S2	---	196P154910S4		
	100	.400 x 1 3/8	---	---	---	196P18491S2	---	196P18491S4		
	200	.562 x 1 1/8	---	---	---	196P18492S2	---	196P18492S4		
.22	400	.562 x 1 3/8	---	---	---	196P18494S2	---	196P18494S4		
	600	.670 x 1 3/8	---	---	---	196P18496S2	---	196P18496S4		
	1000	.750 x 2 1/8	---	---	---	196P184910S2	---	196P184910S4		
	100	.400 x 1 3/8	196P22401S2	---	196P22401S4	---	196P22491S2	---	196P22491S4	
	200	.562 x 1 1/8	196P22402S2	---	196P22402S4	---	196P22492S2	---	196P22492S4	
.27	300	.562 x 1 3/8	196P22403S2	---	196P22403S4	---	196P22493S2	---	196P22493S4	
	400	.562 x 1 5/8	196P22404S2	---	196P22404S4	---	196P22494S2	---	196P22494S4	
	600	.670 x 1 5/8	196P22406S2	---	196P22406S4	---	196P22496S2	---	196P22496S4	
	1000	.750 x 2 1/8	---	---	---	196P224910S2	---	196P224910S4		
	100	.562 x 1 1/8	---	---	---	196P27491S2	---	196P27491S4		
.33	200	.562 x 1 3/8	---	---	---	196P27492S2	---	196P27492S4		
	300	.562 x 1 5/8	---	---	---	196P27494S2	---	196P27494S4		
	400	.670 x 1 5/8	---	---	---	196P27496S2	---	196P27496S4		
	600	.750 x 2 1/8	---	---	---	196P274910S2	---	196P274910S4		
	1000	1.000 x 2 1/8	---	---	---	---	---	---		
.39	100	.562 x 1 1/8	196P33401S2	---	196P33401S4	---	196P33491S2	---	196P33491S4	
	200	.562 x 1 3/8	196P33402S2	---	196P33402S4	---	196P33492S2	---	196P33492S4	
	300	.562 x 1 5/8	196P33403S2	---	196P33403S4	---	196P33493S2	---	196P33493S4	
	400	.670 x 1 3/8	196P33404S2	---	196P33404S4	---	196P33494S2	---	196P33494S4	
	600	.750 x 2 1/8	196P33406S2	---	196P33406S4	---	196P33496S2	---	196P33496S4	
.47	1000	1.000 x 2 1/8	---	---	---	196P334910S2	---	196P334910S4		
	100	.562 x 1 3/8	---	---	---	196P39491S2	---	196P39491S4		
	200	.562 x 1 5/8	---	---	---	196P39492S2	---	196P39492S4		
	300	.670 x 1 5/8	---	---	---	196P39494S2	---	196P39494S4		
	400	.750 x 2 1/8	---	---	---	196P39496S2	---	196P39496S4		
.56	600	.750 x 2 3/8	---	---	---	196P394910S2	---	196P394910S4		
	1000	1.000 x 2 3/8	---	---	---	---	---	---		
	100	.562 x 1 3/8	196P47401S2	---	196P47401S4	---	196P47491S2	---	196P47491S4	
	200	.562 x 1 5/8	196P47402S2	---	196P47402S4	---	196P47492S2	---	196P47492S4	
	300	.670 x 1 5/8	196P47403S2	---	196P47403S4	---	196P47493S2	---	196P47493S4	
.68	400	.750 x 2 1/8	196P47404S2	---	196P47404S4	---	196P47494S2	---	196P47494S4	
	600	.750 x 2 3/8	196P47406S2	---	196P47406S4	---	196P47496S2	---	196P47496S4	
	1000	1.000 x 2 3/8	---	---	---	196P474910S2	---	196P474910S4		
	100	.562 x 1 3/8	---	---	---	196P56491S2	---	196P56491S4		
	200	.670 x 1 3/8	---	---	---	196P56492S2	---	196P56492S4		
.82	100	.562 x 1 5/8	196P68401S2	---	196P68401S4	---	196P68491S2	---	196P68491S4	
	200	.670 x 1 5/8	196P68402S2	---	196P68402S4	---	196P68492S2	---	196P68492S4	
	300	.750 x 2 1/8	196P68403S2	---	196P68403S4	---	196P68493S2	---	196P68493S4	
1.0	100	.670 x 1 5/8	---	---	---	196P82491S2	---	196P82491S4		
	200	.750 x 2 1/8	---	---	---	196P82492S2	---	196P82492S4		
	200	.750 x 2 1/8	---	---	---	196P10591S2	---	196P10591S4		
	100	.670 x 1 5/8	196P10501S2	---	196P10501S4	---	196P10592S2	---	196P10592S4	
	200	.750 x 2 1/8	196P10502S2	---	196P10502S4	---	---	---	---	

CALL YOUR SPRAGUE INDUSTRIAL DISTRIBUTOR FOR CURRENT QUANTITY PRICES

CALL YOUR SPRAGUE INDUSTRIAL DISTRIBUTOR FOR CURRENT QUANTITY PRICES

CALL YOUR SPRAGUE INDUSTRIAL DISTRIBUTOR FOR CURRENT QUANTITY PRICES

CALL YOUR SPRAGUE INDUSTRIAL DISTRIBUTOR FOR CURRENT QUANTITY PRICES

*For Style 4 units add .0625" to diameter and 1/16" to length.

SPRAGUE CAPACITORS

TYPE CP05 CAPACITORS TO MIL-C-25C

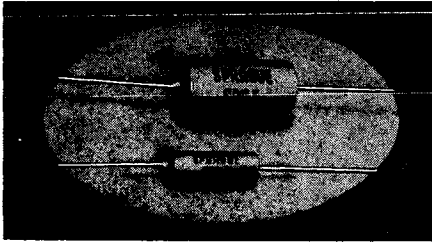

- Vitamin Q impregnation assures performance above and beyond MIL-C-25C requirements.
- Inserted tab construction for applications where minimum size is necessary.
- Positive hermetic closure of the metal cases assured by glass-to-metal solder-seal terminals.
- Type CP05 has insulating sleeve.
- Capacitance Tolerance $\pm 10\%$. Characteristic K Temperature Range (-55°C to $+125^{\circ}\text{C}$).
- Only popular insulated section (ungrounded case) capacitors are listed. For information on grounded case units, consult you Sprague Industrial Distributor.
- Call your Sprague Industrial Distributor for Quantity Prices.

μF	WVDC	D. x L.	Cat. No.*	μF	WVDC	D. x L.	Cat. No.*	μF	WVDC	D. x L.	Cat. No.*
.001	600	.298 x $1\frac{3}{16}$	CP05A1KF102K3	600	600	.463 x $1\frac{3}{16}$	CP05A1KF393K3	100	400	.463 x $1\frac{3}{16}$	CP05A1KB224K3
.0012	600	.298 x $1\frac{3}{16}$	CP05A1KF122K3	1000	1000	.625 x $1\frac{3}{16}$	CP05A1KG393K3	200	200	.463 x $1\frac{3}{16}$	CP05A1KC224K3
.0015	600	.298 x $1\frac{3}{16}$	CP05A1KF152K3	200	200	.375 x $1\frac{5}{16}$	CP05A1KC473K3	400	400	.625 x $1\frac{7}{16}$	CP05A1KE224K3
.0018	600	.298 x $1\frac{3}{16}$	CP05A1KF182K3	400	.047	.463 x $1\frac{5}{16}$	CP05A1KE473K3	600	600	.625 x $1\frac{5}{16}$	CP05A1KF224K3
.0022	600	.298 x $1\frac{3}{16}$	CP05A1KF222K3	600	600	.463 x $1\frac{3}{16}$	CP05A1KF473K3	1000	1000	.813 x $2\frac{3}{16}$	CP05A1KG224K3
.0027	600	.298 x $1\frac{3}{16}$	CP05A1KF272K3	1000	1000	.625 x $1\frac{3}{16}$	CP05A1KG473K3	100	100	.463 x $1\frac{7}{16}$	CP05A1KB274K3
.0033	600	.298 x $1\frac{3}{16}$	CP05A1KF332K3	200	200	.375 x $1\frac{5}{16}$	CP05A1KC563K3	200	200	.625 x $1\frac{3}{16}$	CP05A1KC274K3
.0039	600	.298 x $1\frac{3}{16}$	CP05A1KF392K3	400	.056	.463 x $1\frac{3}{16}$	CP05A1KE563K3	400	400	.625 x $1\frac{11}{16}$	CP05A1KE274K3
.0047	600	.298 x $1\frac{3}{16}$	CP05A1KF472K3	600	600	.463 x $1\frac{7}{16}$	CP05A1KF563K3	600	600	.733 x $1\frac{5}{16}$	CP05A1KF274K3
.0056	600	.298 x $1\frac{3}{16}$	CP05A1KF562K3	1000	1000	.625 x $1\frac{7}{16}$	CP05A1KG563K3	1000	1000	.813 x $2\frac{1}{16}$	CP05A1KG274K3
.0068	600	.298 x $1\frac{3}{16}$	CP05A1KF682K3	200	200	.375 x $1\frac{5}{16}$	CP05A1KC683K3	100	100	.463 x $1\frac{7}{16}$	CP05A1KB334K3
.0082	400	.298 x $1\frac{3}{16}$	CP05A1KE822K3	400	.068	.463 x $1\frac{3}{16}$	CP05A1KE683K3	200	200	.625 x $1\frac{3}{16}$	CP05A1KC334K3
	600	.375 x $1\frac{5}{16}$	CP05A1KF822K3	600	600	.463 x $1\frac{7}{16}$	CP05A1KF685K3	400	400	.625 x $1\frac{11}{16}$	CP05A1KE334K3
				1000	1000	.625 x $1\frac{7}{16}$	CP05A1KG683K3	600	600	.733 x $1\frac{5}{16}$	CP05A1KF334K3
.01	400	.298 x $1\frac{3}{16}$	CP05A1KE103K3	100	100	.375 x $1\frac{5}{16}$	CP05A1KB823K3	1000	1000	.813 x $2\frac{1}{16}$	CP05A1KG334K3
	600	.375 x $1\frac{5}{16}$	CP05A1KF103K3	200	200	.463 x $1\frac{5}{16}$	CP05A1KC823K3	100	100	.625 x $1\frac{3}{16}$	CP05A1KB394K3
.012	200	.298 x $1\frac{3}{16}$	CP05A1KC123K3	400	.082	.463 x $1\frac{7}{16}$	CP05A1KE823K3	200	200	.625 x $1\frac{7}{16}$	CP05A1KC394K3
	600	.375 x $1\frac{5}{16}$	CP05A1KF123K3	600	600	.625 x $1\frac{3}{16}$	CP05A1KF823K3	400	400	.733 x $1\frac{11}{16}$	CP05A1KE394K3
				1000	1000	.625 x $1\frac{11}{16}$	CP05A1KG823K3	600	600	.813 x $2\frac{3}{16}$	CP05A1KF394K3
200	.298 x $1\frac{3}{16}$	CP05A1KC153K3	100	100	100	.463 x $1\frac{5}{16}$	CP05A1KB104K3	1000	1000	1.063 x $2\frac{3}{16}$	CP05A1KG394K3
600	.375 x $1\frac{5}{16}$	CP05A1KF153K3	200	200	200	.463 x $1\frac{5}{16}$	CP05A1KC104K3	100	100	.625 x $1\frac{3}{16}$	CP05A1KB474K3
1000	.463 x $1\frac{5}{16}$	CP05A1KG153K3	400	400	400	.463 x $1\frac{7}{16}$	CP05A1KE104K3	200	200	.625 x $1\frac{7}{16}$	CP05A1KC474K3
200	.298 x $1\frac{3}{16}$	CP05A1KC183K3	600	600	600	.625 x $1\frac{3}{16}$	CP05A1KF104K3	400	400	.733 x $1\frac{5}{16}$	CP05A1KE474K3
600	.375 x $1\frac{5}{16}$	CP05A1KF183K3	1000	1000	1000	.625 x $1\frac{11}{16}$	CP05A1KG104K3	600	600	.813 x $2\frac{3}{16}$	CP05A1KF474K3
1000	.463 x $1\frac{3}{16}$	CP05A1KG183K3	100	100	100	.463 x $1\frac{5}{16}$	CP05A1KB124K3	1000	1000	1.063 x $2\frac{3}{16}$	CP05A1KG474K3
200	.298 x $1\frac{3}{16}$	CP05A1KC223K3	200	200	200	.463 x $1\frac{3}{16}$	CP05A1KC124K3	100	100	.625 x $1\frac{7}{16}$	CP05A1KB564K3
600	.375 x $1\frac{5}{16}$	CP05A1KF223K3	400	400	400	.625 x $1\frac{3}{16}$	CP05A1KE124K3	200	200	.625 x $1\frac{11}{16}$	CP05A1KC564K3
1000	.463 x $1\frac{3}{16}$	CP05A1KG223K3	600	600	600	.625 x $1\frac{7}{16}$	CP05A1KF124K3	400	400	.813 x $2\frac{3}{16}$	CP05A1KE564K3
100	.298 x $1\frac{3}{16}$	CP05A1KB273K3	1000	1000	1000	.733 x $1\frac{11}{16}$	CP05A1KG124K3	600	600	1.063 x $1\frac{11}{16}$	CP05A1KF564K3
400	.375 x $1\frac{5}{16}$	CP05A1KE273K3	100	100	100	.463 x $1\frac{5}{16}$	CP05A1KB154K3	100	100	.625 x $1\frac{7}{16}$	CP05A1KB684K3
600	.463 x $1\frac{5}{16}$	CP05A1KF273K3	200	200	200	.463 x $1\frac{7}{16}$	CP05A1KC154K3	200	200	.625 x $1\frac{11}{16}$	CP05A1KC684K3
1000	1.463 x $1\frac{7}{16}$	CP05A1KG273K3	400	400	400	.625 x $1\frac{3}{16}$	CP05A1KE154K3	400	400	.813 x $2\frac{3}{16}$	CP05A1KE684K3
100	.298 x $1\frac{3}{16}$	CP05A1KB333K3	600	600	600	.625 x $1\frac{7}{16}$	CP05A1KF154K3	600	600	1.063 x $1\frac{11}{16}$	CP05A1KF684K3
400	.375 x $1\frac{5}{16}$	CP05A1KE333K3	1000	1000	1000	.733 x $1\frac{11}{16}$	CP05A1KG154K3	100	100	.625 x $1\frac{3}{16}$	CP05A1KB824K3
600	.463 x $1\frac{5}{16}$	CP05A1KF333K3	100	100	100	.463 x $1\frac{3}{16}$	CP05A1KB184K3	200	200	.733 x $1\frac{11}{16}$	CP05A1KC824K3
1000	1.463 x $1\frac{7}{16}$	CP05A1KG333K3	200	200	200	.463 x $1\frac{7}{16}$	CP05A1KC184K3	400	400	1.063 x $1\frac{11}{16}$	CP05A1KE824K3
200	.375 x $1\frac{5}{16}$	CP05A1KC393K3	400	400	400	.625 x $1\frac{7}{16}$	CP05A1KE184K3	100	100	.625 x $1\frac{11}{16}$	CP05A1KB105K3
.039	400	.463 x $1\frac{3}{16}$	CP05A1KE393K3	600	600	.625 x $1\frac{11}{16}$	CP05A1KF184K3	200	200	.733 x $1\frac{11}{16}$	CP05A1KC105K3
				1000	1000	.813 x $2\frac{3}{16}$	CP05A1KG184K3	400	400	1.063 x $1\frac{11}{16}$	CP05A1KE105K3

*For Vibration Grade 1, change last digit of Catalog Number to "1."

CALL YOUR SPRAGUE INDUSTRIAL DISTRIBUTOR FOR CURRENT QUANTITY PRICES

SPRAGUE CAPACITORS

TYPE CP09 CAPACITORS TO MIL-C-25C

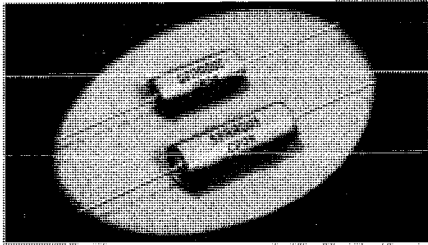

- Vitamin Q impregnation assures performance above and beyond MIL-C-25C requirements.
- Positive hermetic closure of the metal cases with glass-to-metal solder-seal terminals.
- Available in Characteristic K (-55C to +125C). Capacitance Tolerance $\pm 10\%$.
- Type CP09 has insulating sleeve.
- Extended foil, non-inductive section construction.
- Listed below are popular insulated section (ungrounded case) capacitors. Consult your Sprague Industrial Distributor for information on grounded case units.
- Call your Sprague Industrial Distributor for Quantity Prices.

μ F	WVDC	D. x L.	Cat. No.
.001	600	.298 x $1\frac{1}{16}$	CP09A1KF102K3
	1000	.463 x $1\frac{1}{16}$	CP09A1KG102K3
.0012	600	.298 x $1\frac{1}{16}$	CP09A1KF122K3
	1000	.463 x $1\frac{1}{16}$	CP09A1KG122K3
.0015	600	.298 x $1\frac{1}{16}$	CP09A1KF152K3
	1000	.463 x $1\frac{1}{16}$	CP09A1KG152K3
.0018	600	.298 x $1\frac{1}{16}$	CP09A1KF182K3
	1000	.463 x $1\frac{1}{16}$	CP09A1KG182K3
.0022	600	.298 x $1\frac{1}{16}$	CP09A1KF222K3
	1000	.463 x $1\frac{1}{16}$	CP09A1KG222K3
.0027	400	.298 x $1\frac{1}{16}$	CP09A1KE272K3
	600	.375 x $1\frac{1}{16}$	CP09A1KF272K3
	1000	.463 x $1\frac{1}{16}$	CP09A1KG272K3
.0033	400	.298 x $1\frac{1}{16}$	CP09A1KE332K3
	600	.375 x $1\frac{1}{16}$	CP09A1KF332K3
	1000	.463 x $1\frac{1}{16}$	CP09A1KG332K3
.0039	200	.298 x $1\frac{1}{16}$	CP09A1KC392K3
	600	.375 x $1\frac{1}{16}$	CP09A1KF393K3
	1000	.463 x $1\frac{1}{16}$	CP09A1KG393K3
.0047	200	.298 x $1\frac{1}{16}$	CP09A1KC472K3
	600	.375 x $1\frac{1}{16}$	CP09A1KF472K3
	1000	.463 x $1\frac{1}{16}$	CP09A1KG472K3
.0056	200	.298 x $1\frac{1}{16}$	CP09A1KC562K3
	600	.375 x $1\frac{1}{16}$	CP09A1KF562K3
	1000	.463 x $1\frac{1}{16}$	CP09A1KG562K3
.0068	200	.298 x $1\frac{1}{16}$	CP09A1KC682K3
	600	.375 x $1\frac{1}{16}$	CP09A1KF682K3
	1000	.463 x $1\frac{1}{16}$	CP09A1KG682K3
.0082	100	.298 x $1\frac{1}{16}$	CP09A1KB822K3
	600	.375 x $1\frac{1}{16}$	CP09A1KF822K3
	1000	.463 x $1\frac{1}{16}$	CP09A1KG822K3
.01	100	.298 x $1\frac{1}{16}$	CP09A1KB103K3
	600	.375 x $1\frac{1}{16}$	CP09A1KF103K3
	1000	.463 x $1\frac{1}{16}$	CP09A1KG103K3
.012	100	.298 x $1\frac{1}{16}$	CP09A1KB123K3
	400	.375 x $1\frac{1}{16}$	CP09A1KE123K3
	600	.463 x $1\frac{1}{16}$	CP09A1KF123K3
	1000	.463 x $1\frac{1}{16}$	CP09A1KG123K3
.015	100	.298 x $1\frac{1}{16}$	CP09A1KB153K3
	400	.375 x $1\frac{1}{16}$	CP09A1KE153K3
	600	.463 x $1\frac{1}{16}$	CP09A1KF153K3
	1000	.463 x $1\frac{1}{16}$	CP09A1KG153K3
.018	200	.375 x $1\frac{1}{16}$	CP09A1KC183K3
	600	.463 x $1\frac{1}{16}$	CP09A1KF183K3
	1000	.463 x $1\frac{1}{16}$	CP09A1KG183K3
.022	200	.375 x $1\frac{1}{16}$	CP09A1KC223K3
	600	.463 x $1\frac{1}{16}$	CP09A1KF223K3
	1000		CP09A1KG223K3

CALL YOUR SPRAGUE INDUSTRIAL DISTRIBUTOR FOR CURRENT QUANTITY PRICES

μ F	WVDC	D. x L.	Cat. No.
.027	200	.375 x $1\frac{1}{16}$	CP09A1KC273K3
	400	.463 x $1\frac{1}{16}$	CP09A1KE273K3
	600	.463 x $1\frac{1}{16}$	CP09A1KF273K3
	1000	.625 x $1\frac{1}{16}$	CP09A1KG273K3
.033	200	.375 x $1\frac{1}{16}$	CP09A1KC333K3
	400	.463 x $1\frac{1}{16}$	CP09A1KE333K3
	600	.463 x $1\frac{1}{16}$	CP09A1KF333K3
	1000	.625 x $1\frac{1}{16}$	CP09A1KG333K3
.039	100	.375 x $1\frac{1}{16}$	CP09A1KB393K3
	200	.463 x $1\frac{1}{16}$	CP09A1KC393K3
	400	.463 x $1\frac{1}{16}$	CP09A1KE393K3
	600	.463 x $1\frac{1}{16}$	CP09A1KF393K3
.047	100	.375 x $1\frac{1}{16}$	CP09A1KB473K3
	200	.463 x $1\frac{1}{16}$	CP09A1KC473K3
	400	.463 x $1\frac{1}{16}$	CP09A1KE473K3
	600	.463 x $1\frac{1}{16}$	CP09A1KF473K3
.056	100	.375 x $1\frac{1}{16}$	CP09A1KB563K3
	200	.463 x $1\frac{1}{16}$	CP09A1KC563K3
	400	.463 x $1\frac{1}{16}$	CP09A1KE563K3
	600	.463 x $1\frac{1}{16}$	CP09A1KF563K3
.068	100	.375 x $1\frac{1}{16}$	CP09A1KB683K3
	200	.463 x $1\frac{1}{16}$	CP09A1KC683K3
	400	.463 x $1\frac{1}{16}$	CP09A1KE683K3
	600	.463 x $1\frac{1}{16}$	CP09A1KF683K3
.082	100	.463 x $1\frac{1}{16}$	CP09A1KB823K3
	200	.463 x $1\frac{1}{16}$	CP09A1KC823K3
	400	.625 x $1\frac{1}{16}$	CP09A1KE823K3
	600	.625 x $1\frac{1}{16}$	CP09A1KF823K3
.1	100	.463 x $1\frac{1}{16}$	CP09A1KB104K3
	200	.463 x $1\frac{1}{16}$	CP09A1KC104K3
	400	.625 x $1\frac{1}{16}$	CP09A1KE104K3
	600	.625 x $1\frac{1}{16}$	CP09A1KF104K3
.12	100	.463 x $1\frac{1}{16}$	CP09A1KB124K3
	200	.463 x $1\frac{1}{16}$	CP09A1KC124K3
	400	.625 x $1\frac{1}{16}$	CP09A1KE124K3
	600	.625 x $1\frac{1}{16}$	CP09A1KF124K3
.15	100	.463 x $1\frac{1}{16}$	CP09A1KB154K3
	200	.463 x $1\frac{1}{16}$	CP09A1KC154K3
	400	.625 x $1\frac{1}{16}$	CP09A1KE154K3
	600	.625 x $1\frac{1}{16}$	CP09A1KF154K3
.18	100	.463 x $1\frac{1}{16}$	CP09A1KB184K3
	200	.625 x $1\frac{1}{16}$	CP09A1KC184K3
	400	.625 x $1\frac{1}{16}$	CP09A1KE184K3
	600	.733 x $1\frac{1}{16}$	CP09A1KF184K3
.22	100	.463 x $1\frac{1}{16}$	CP09A1KB224K3
	200	.625 x $1\frac{1}{16}$	CP09A1KC224K3
	400	.625 x $1\frac{1}{16}$	CP09A1KE224K3
	600	.733 x $1\frac{1}{16}$	CP09A1KF224K3

CALL YOUR SPRAGUE INDUSTRIAL DISTRIBUTOR FOR CURRENT QUANTITY PRICES

SPRAGUE CAPACITORS

118P DIFILM® METALLIZED CAPACITORS

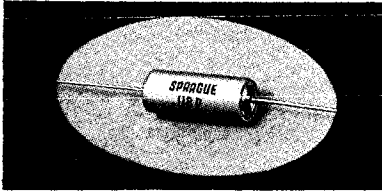

- The Best of Their Type Possible to Produce at the Present State of the Art
- Rated for Operation at 125°C WITHOUT VOLTAGE DERATING
- Unique Dual Dielectric — a Combination of Metallized Paper and of Polyester Film, Impregnated With Special High-Temperature Mineral Wax
- Subjected to Stringent Quality Control During Manufacture
- Higher Insulation Resistance Than Any Other Metallized Paper Capacitors—at 125°C, Minimum Product of Insulation Resistance and Capacitance is 10 Megohm-microfarads for 200 V Units or 40 Megohm-microfarads for 400 and 600 V Units
- Capacitor Sections are Effectively of Non-inductive Construction, Resulting in Capacitors Unmatched in Performance Quality by any Other Metallized Capacitors
- Hermetically Sealed, with Glass-to-metal Solder-seal Terminals
- Have Unusual Self-healing Characteristics, in the Rare Event of Capacitor Dielectric Breakdown
- May be Used at Extremely Low Voltages Where Metallized Paper Construction has Previously Been Unsatisfactory
- For Complete Performance Characteristics, see Latest Issue of Engineering Bulletin 2211
- For Units With Outer Plastic Insulating Sleeves, Change Last Digit of Cat. No. From "2" to "4"
- Capacitors Listed Below Are Ungrounded Case (Insulating Section) Units Without Outer Insulating Sleeves. For Information on Other Styles Consult Your Sprague Industrial Distributor
- Call your Sprague Industrial Distributor for Quantity Prices.

Metallized Paper and of Polyester Film, Impregnated With Special High-Temperature Mineral Wax

μF	D. x L.	±20% Tol.		±10% Tol.	
		Catalog Number		Catalog Number	
200 WVDC					
.01	.175 x .749	118P10302S2		118P10392S2	
.012	.195 x .749			118P12392S2	
.015	.195 x .749	118P15302S2		118P15392S2	
.018	.235 x .749			118P18392S2	
.022	.235 x .749	118P22302S2		118P22392S2	
.027	.235 x .749			118P27392S2	
.033	.235 x .749	118P33302S2		118P33392S2	
.039	.312 x .874			118P39392S2	
.047	.312 x .874	118P47302S2		118P47392S2	
.056	.312 x .874			118P56392S2	
.068	.312 x .874	118P68302S2		118P68392S2	
.082	.312 x .874			118P82392S2	
.1	.312 x .874	118P10402S2		118P10492S2	
.12	.312 x 1.124			118P12492S2	
.15	.312 x 1.124	118P15402S2		118P15492S2	
.18	.400 x .874			118P18492S2	
.22	.400 x .874	118P22402S2		118P22492S2	
.27	.400 x 1.124			118P27492S2	
.33	.400 x 1.124	118P33402S2		118P33492S2	
.39	.500 x 1.124			118P39492S2	
.47	.500 x 1.124	118P47402S2		118P47492S2	
.56	.500 x 1.124			118P56492S2	
.68	.500 x 1.124	118P68402S2		118P68492S2	
.82	.562 x 1.124			118P82492S2	
1.0	.562 x 1.124	118P10502S2		118P10592S2	
1.5	.562 x 1.624	118P15502S2		118P15592S2	
2.0	.670 x 1.624	118P20502S2		118P20592S2	
3.0	.670 x 1.874	118P30502S2		118P30592S2	
4.0	.750 x 1.874	118P40502S2		118P40592S2	
5.0	1.000 x 1.874	118P50502S2		118P50592S2	
6.0	1.000 x 1.874	118P60502S2		118P60592S2	
8.0	1.000 x 1.874	118P80502S2		118P80592S2	
10.0	1.000 x 2.374	118P10602S2		118P10692S2	
12.0	1.000 x 2.624	118P12602S2		118P12692S2	

μF	D. x L.	±20% Tol.		±10% Tol.	
		Catalog Number		Catalog Number	
400 WVDC					
.01	.312 x .874	118P10304S2		118P10394S2	
.015	.312 x .874	118P15304S2		118P15394S2	
.022	.312 x .874	118P22304S2		118P22394S2	
.033	.312 x 1.124	118P33304S2		118P33394S2	
.047	.400 x 1.124	118P47304S2		118P47394S2	
.068	.400 x 1.124	118P68304S2		118P68394S2	
.1	.500 x 1.124	118P10404S2		118P10494S2	
.15	.500 x 1.124	118P15404S2		118P15494S2	
.22	.562 x 1.374	118P22404S2		118P22494S2	
.33	.562 x 1.624	118P33404S2		118P33494S2	
.47	.670 x 1.624	118P47404S2		118P47494S2	
.68	.670 x 1.874	118P68404S2		118P68494S2	
1.0	.750 x 1.874	118P10504S2		118P10594S2	
1.5	1.000 x 1.874	118P15504S2		118P15594S2	
2.0	1.000 x 1.874	118P20504S2		118P20594S2	
3.0	1.000 x 2.624	118P30504S2		118P30594S2	

μF	D. x L.	±20% Tol.		±10% Tol.	
		Catalog Number		Catalog Number	
600 WVDC					
.01	.312 x .874	118P10306S2		118P10396S2	
.015	.312 x .874	118P15306S2		118P15396S2	
.022	.312 x 1.124	118P22306S2		118P22396S2	
.033	.312 x 1.124	118P33306S2		118P33396S2	
.047	.400 x 1.124	118P47306S2		118P47396S2	
.068	.400 x 1.124	118P68306S2		118P68396S2	
.1	.500 x 1.124	118P10406S2		118P10496S2	
.15	.562 x 1.124	118P15406S2		118P15496S2	
.22	.562 x 1.374	118P22406S2		118P22496S2	
.33	.562 x 1.624	118P33406S2		118P33496S2	
.47	.670 x 1.624	118P47406S2		118P47496S2	
.68	.670 x 1.874	118P68406S2		118P68496S2	
1.0	1.000 x 1.874	118P10506S2		118P10596S2	
1.5	1.000 x 1.874	118P15506S2		118P15596S2	
2.0	1.000 x 2.124	118P20506S2		118P20596S2	
2.5	1.000 x 2.624	118P25506S2		118P25596S2	

SPRAGUE CAPACITORS

TYPE 431P METFILM® 'E' CAPACITORS

- Unique Construction Gives Definite Space Advantages Over Metal-Encased, Molded, or Wax-Coated Cardboard-Case Tubulars of Comparable Ratings.
- Axial-Lead Polyester-Film Capacitor Section Protected Against Moisture By An Outer Wrap of Polyester-Film Tape.
- An Improved End Seal of a Plastic Resin Which Bonds With the Film Wrap and the Tinned Leads Provides Superior Humidity Resistance.
- Because of Their Small Size, These Capacitors Are Particularly Well-Suited For Potting or Encapsulating in Electronic Sub-Assemblies.
- For Complete Technical Data, Refer to The Latest Issue of Sprague Engineering Bulletin 2445.
- Call Your Sprague Industrial Distributor For Current Quantity Prices.

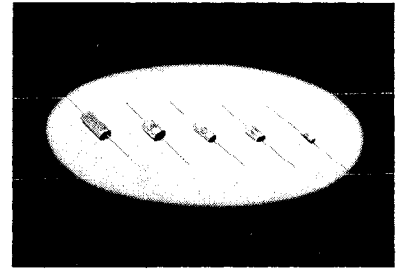

μF	T. x W. x L.	WVDC	Catalog Number	μF	T. x W. x L.	WVDC	Catalog Number
.047	$\frac{3}{32} \times \frac{3}{16} \times \frac{5}{8}$	50	431P4739R5	.0033	$\frac{3}{32} \times \frac{3}{16} \times \frac{5}{8}$	400	431P33294
.068	$\frac{1}{8} \times \frac{7}{32} \times \frac{5}{8}$	50	431P6839R5	.0047	$\frac{1}{8} \times \frac{3}{16} \times \frac{5}{8}$	400	431P47294
.10	$\frac{5}{32} \times \frac{7}{32} \times \frac{5}{8}$	50	431P1049R5	.0068	$\frac{5}{32} \times \frac{7}{32} \times \frac{5}{8}$	400	431P68294
.15	$\frac{3}{16} \times \frac{1}{4} \times \frac{5}{8}$	50	431P1549R5	.01	$\frac{3}{16} \times \frac{1}{4} \times \frac{5}{8}$	400	431P10394
.22	$\frac{5}{32} \times \frac{9}{32} \times \frac{3}{4}$	50	431P2249R5	.015	$\frac{5}{32} \times \frac{9}{32} \times \frac{3}{4}$	400	431P15394
.33	$\frac{3}{16} \times \frac{5}{16} \times \frac{3}{4}$	50	431P3349R5	.022	$\frac{3}{16} \times \frac{5}{16} \times \frac{3}{4}$	400	431P22394
.47	$\frac{3}{16} \times \frac{5}{16} \times 1$	50	431P4749R5	.033	$\frac{7}{32} \times \frac{11}{32} \times \frac{3}{4}$	400	431P33394
.68	$\frac{3}{16} \times \frac{3}{8} \times 1$	50	431P6849R5	.047	$\frac{1}{4} \times \frac{13}{32} \times \frac{3}{4}$	400	431P47394
1.0	$\frac{1}{4} \times \frac{13}{32} \times 1$	50	431P1059R5	.068	$\frac{7}{32} \times \frac{3}{8} \times 1$	400	431P68394
1.5	$\frac{9}{32} \times \frac{1}{2} \times 1$	50	431P1559R5	.1	$\frac{9}{32} \times \frac{7}{16} \times 1$	400	431P10494
2.0	$\frac{3}{8} \times \frac{9}{16} \times 1$	50	431P2059R5	.15	$\frac{5}{16} \times \frac{17}{32} \times 1$	400	431P15494
2.5	$\frac{11}{32} \times \frac{17}{32} \times 1 \frac{1}{4}$	50	431P2559R5	.22	$\frac{13}{32} \times \frac{19}{32} \times 1$	400	431P22494
3.0	$\frac{3}{8} \times \frac{19}{32} \times 1 \frac{1}{4}$	50	431P3059R5	.33	$\frac{11}{32} \times \frac{9}{16} \times 1 \frac{1}{2}$	400	431P33494
4.0	$\frac{3}{8} \times \frac{19}{32} \times 1 \frac{1}{2}$	50	431P4059R5	.47	$\frac{3}{8} \times \frac{9}{16} \times 1 \frac{3}{4}$	400	431P47494
5.0	$\frac{13}{32} \times \frac{19}{32} \times 1 \frac{3}{4}$	50	431P5059R5	.68	$\frac{15}{32} \times \frac{21}{32} \times 1 \frac{3}{4}$	400	431P68494
6.0	$\frac{15}{32} \times \frac{11}{16} \times 1 \frac{1}{2}$	50	431P6059R5	1.0	$\frac{1}{2} \times \frac{23}{32} \times 2$	400	431P10594
7.0	$\frac{15}{32} \times \frac{11}{16} \times 1 \frac{3}{4}$	50	431P7059R5	1.5	$\frac{1}{2} \times \frac{25}{32} \times 2 \frac{1}{2}$	400	431P15594
10.0	$\frac{9}{16} \times \frac{25}{32} \times 1 \frac{3}{4}$	50	431P1069R5	.0015	$\frac{3}{32} \times \frac{3}{16} \times \frac{5}{8}$	600	431P15296
12.0	$\frac{1}{2} \times \frac{13}{16} \times 2 \frac{1}{4}$	50	431P1269R5	.0022	$\frac{1}{8} \times \frac{3}{16} \times \frac{5}{8}$	600	431P22296
.015	$\frac{3}{32} \times \frac{3}{16} \times \frac{5}{8}$	200	431P15392	.0033	$\frac{5}{32} \times \frac{7}{32} \times \frac{5}{8}$	600	431P33296
.022	$\frac{1}{8} \times \frac{3}{16} \times \frac{5}{8}$	200	431P22392	.0047	$\frac{1}{8} \times \frac{1}{4} \times \frac{3}{4}$	600	431P47296
.033	$\frac{1}{8} \times \frac{7}{32} \times \frac{5}{8}$	200	431P33392	.0068	$\frac{5}{32} \times \frac{9}{32} \times \frac{3}{4}$	600	431P68296
.047	$\frac{5}{32} \times \frac{1}{4} \times \frac{5}{8}$	200	431P47392	.01	$\frac{3}{16} \times \frac{5}{16} \times \frac{3}{4}$	600	431P10396
.068	$\frac{5}{32} \times \frac{9}{32} \times \frac{3}{4}$	200	431P68392	.015	$\frac{3}{16} \times \frac{3}{8} \times \frac{3}{4}$	600	431P15396
.1	$\frac{3}{16} \times \frac{5}{16} \times \frac{3}{4}$	200	431P10492	.022	$\frac{1}{4} \times \frac{13}{32} \times \frac{3}{4}$	600	431P22396
.15	$\frac{7}{32} \times \frac{11}{32} \times \frac{3}{4}$	200	431P15492	.033	$\frac{7}{32} \times \frac{3}{8} \times 1$	600	431P33396
.22	$\frac{1}{4} \times \frac{13}{32} \times \frac{3}{4}$	200	431P22492	.047	$\frac{7}{32} \times \frac{3}{8} \times 1 \frac{1}{4}$	600	431P47396
.33	$\frac{7}{32} \times \frac{13}{32} \times 1$	200	431P33492	.068	$\frac{5}{16} \times \frac{1}{2} \times 1$	600	431P68396
.47	$\frac{7}{32} \times \frac{13}{32} \times 1 \frac{1}{4}$	200	431P47492	.1	$\frac{3}{8} \times \frac{19}{32} \times 1$	600	431P10496
.68	$\frac{3}{16} \times \frac{17}{32} \times 1$	200	431P68492	.15	$\frac{3}{8} \times \frac{19}{32} \times 1 \frac{1}{4}$	600	431P15496
1.0	$\frac{5}{16} \times \frac{17}{32} \times 1 \frac{1}{4}$	200	431P10592	.22	$\frac{11}{32} \times \frac{9}{16} \times 1 \frac{3}{4}$	600	431P22496
1.5	$\frac{11}{32} \times \frac{9}{16} \times 1 \frac{1}{2}$	200	431P15592	.33	$\frac{7}{16} \times \frac{21}{32} \times 1 \frac{3}{4}$	600	431P33496
2.0	$\frac{3}{8} \times \frac{9}{16} \times 1 \frac{3}{4}$	200	431P20592	.47	$\frac{9}{16} \times \frac{3}{4} \times 1 \frac{3}{4}$	600	431P47496
2.5	$\frac{15}{32} \times \frac{21}{32} \times 1 \frac{1}{2}$	200	431P25592	.68	$\frac{15}{32} \times \frac{25}{32} \times 2 \frac{1}{2}$	600	431P68496
3.0	$\frac{15}{32} \times \frac{21}{32} \times 1 \frac{3}{4}$	200	431P30592	1.0	$\frac{3}{4} \times \frac{23}{32} \times 2$	600	431P10596
4.0	$\frac{17}{32} \times \frac{3}{4} \times 1 \frac{3}{4}$	200	431P40592	1.5	$\frac{3}{4} \times 1 \frac{1}{16} \times 2 \frac{1}{2}$	600	431P15596
5.0	$\frac{15}{32} \times \frac{3}{4} \times 2 \frac{1}{4}$	200	431P50592				
6.0	$\frac{15}{32} \times \frac{25}{32} \times 2 \frac{1}{2}$	200	431P60592				
7.0	$\frac{3}{4} \times \frac{15}{16} \times 1 \frac{3}{4}$	200	431P70592				
10.0	$\frac{23}{32} \times 1 \times 2 \frac{1}{4}$	200	431P10692				
12.0	$\frac{23}{32} \times 1 \times 2 \frac{1}{2}$	200	431P12692				

CALL YOUR SPRAGUE INDUSTRIAL DISTRIBUTOR FOR CURRENT QUANTITY PRICES

CALL YOUR SPRAGUE INDUSTRIAL DISTRIBUTOR FOR CURRENT QUANTITY PRICES

SPRAGUE CAPACITORS

DIFILM[®] BLACK BEAUTY[®] MOLDED TUBULARS

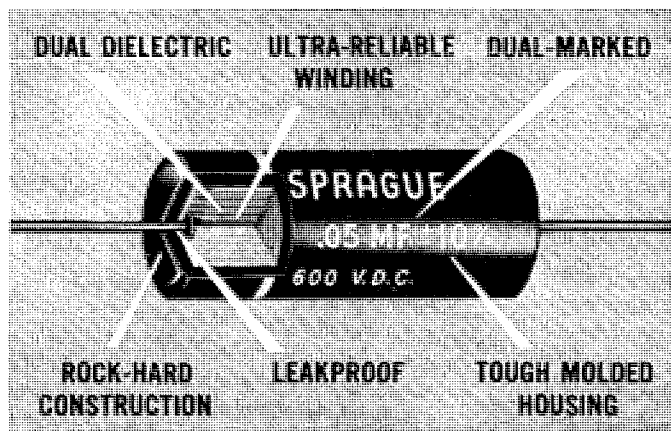

- Developed Especially for Long Life Under High Humidity and Temperature Operating Conditions
- Dual Dielectric (film and paper) Combines Best Features of Both Polyester Film and Paper Capacitors
- Exclusive HCX[®] Solid Impregnant Construction Results in Rock-hard Capacitor Section
- Won't Leak or Drip

LOOK FOR THE RED MARKINGS
ON THE BLACK CASE

- Mica-filled, Non-flammable Molded Case. Won't Crack when Dropped; Soldering won't Harm it
- Every Capacitor Marked Twice. No Twisting the Case to Read Ratings
- Also Available in Handy Sprague Kleer-Pak[®]
- **Capacitance Tolerance:** $\pm 10\%$ from .001 μF up
Except 2TM-M1 $\pm 20\%$

For Complete Technical Data, See Latest Sprague Engineering Bulletin 2025

The World's Best Molded Tubular at No Extra Cost!

μF	D. x L.	Sprague Products Cat. No.	Sprague O.E.M. Part. No.	μF	D. x L.	Sprague Products Cat. No.	Sprague O.E.M. Part. No.
200 WVDC				400 WVDC (Cont.)			
.01	$\frac{5}{16} \times 1$	2TM-S10	160P10392	.02	$\frac{3}{8} \times 1 \frac{1}{4}$	4TM-S20
.02	$\frac{3}{8} \times 1 \frac{1}{4}$	2TM-S20022	$\frac{3}{8} \times 1 \frac{1}{4}$	4TM-S22	160P22394
.022	$\frac{3}{8} \times 1 \frac{1}{4}$	2TM-S22	160P22392	.025	$\frac{3}{8} \times 1 \frac{1}{4}$	4TM-S25
.047	$\frac{3}{8} \times 1 \frac{1}{4}$	2TM-S47	160P47392	.03	$\frac{3}{8} \times 1 \frac{1}{4}$	4TM-S30
.05	$\frac{3}{8} \times 1 \frac{1}{4}$	2TM-S5004	$\frac{7}{16} \times 1 \frac{1}{4}$	4TM-S40
.1	$\frac{7}{16} \times 1 \frac{1}{4}$	2TM-P10	160P10492	.047	$\frac{7}{16} \times 1 \frac{1}{4}$	4TM-S47	160P47394
.15	$\frac{1}{2} \times 1 \frac{1}{2}$	2TM-P15	160P15492	.05	$\frac{7}{16} \times 1 \frac{1}{4}$	4TM-S50
.22	$\frac{5}{8} \times 1 \frac{7}{8}$	2TM-P22	160P22492	.068	$\frac{1}{2} \times 1 \frac{1}{2}$	4TM-S68	160P68394
.25	$\frac{5}{8} \times 1 \frac{7}{8}$	2TM-P251	$\frac{1}{2} \times 1 \frac{1}{2}$	4TM-P10	160P10494
.47	$\frac{5}{8} \times 1 \frac{7}{8}$	2TM-P47	160P47492	.15	$\frac{5}{8} \times 1 \frac{7}{8}$	4TM-P15	160P15494
.5	$\frac{5}{8} \times 1 \frac{7}{8}$	2TM-P502	$\frac{5}{8} \times 1 \frac{7}{8}$	4TM-P20
1.0	$\frac{3}{4} \times 2 \frac{1}{4}$	2TM-M1	161P10502	.22	$\frac{5}{8} \times 1 \frac{7}{8}$	4TM-P22	160P22494
400 WVDC				.25	$\frac{5}{8} \times 1 \frac{7}{8}$	4TM-P25
.001	$\frac{5}{16} \times 1$	4TM-D10	160P10294	.47	$\frac{3}{4} \times 2 \frac{1}{4}$	4TM-P47	160P47494
.005	$\frac{5}{16} \times 1$	4TM-D505	$\frac{3}{4} \times 2 \frac{1}{4}$	4TM-P50
.01	$\frac{5}{16} \times 1$	4TM-S10	160P10394	1.0	$1 \times 2 \frac{1}{2}$	4TM-M1	161P10594
.015	$\frac{3}{8} \times 1 \frac{1}{4}$	4TM-S15	160P15394				

SPRAGUE CAPACITORS

DIFILM® ORANGE DROP® DIPPED TUBULARS

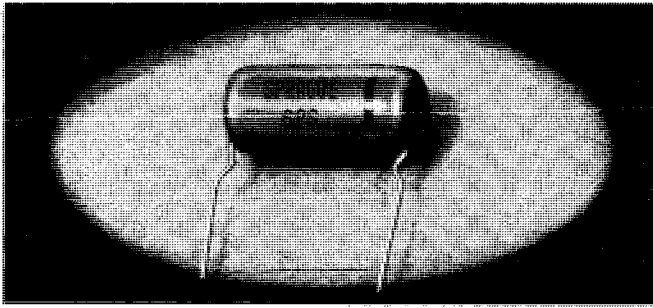

- Especially Made for Exact, Original Replacement
- Outperforms Any Other Dipped Tubular Capacitor

- Dual Dielectric (Film-paper) Solidly Impregnated With Exclusive HCX®—Produces Rock-Hard Capacitor Section
- Crimped Wire Leads for Correct Spacing When Mounted On Printed Wiring Boards.
- Voltage Ratings From 200 VDC to 2000 VDC
- Outside Foil on All Units Identified by Black Striping
- Double Dipped in Bright Orange Epoxy Resin—Beats Heat and Humidity
- Won't Leak or Drip
- Also Available in Handy Sprague Kleer-Pak® Boxes
- For Complete Technical Data, See Latest Issue of Engineering Bulletin 2004

μF	D. x L.	Sprague Products Cat. No.	Sprague O.E.M. Part No.
200 VOLTS D-C			
.02	3/8 x 7/8	2PS-S20
.022	23/64 x 7/8	2PS-S22	220P22392
.047	23/64 x 7/8	2PS-S47	220P47392
.05	13/32 x 7/8	2PS-S50
.1	31/64 x 13/16	2PS-P10	220P10492
.15	7/16 x 13/16	2PS-P15	220P15492
.2	13/32 x 13/16	2PS-P20
.22	33/64 x 13/16	2PS-P22	220P22492
.25	3/8 x 13/16	2PS-P25
.33	5/8 x 1 5/8	2PS-P33	220P33492
.47	43/64 x 1 5/8	2PS-P47	220P47492
.5	23/32 x 1 5/8	2PS-P50

μF	D. x L.	Sprague Products Cat. No.	Sprague O.E.M. Part No.
400 VOLTS D-C			
.01	13/32 x 11/16	4PS-S10	220P10394
.015	23/64 x 11/16	4PS-S15	220P15394
.02	13/32 x 7/8	4PS-S20
.022	23/64 x 7/8	4PS-S22	220P22394
.025	7/16 x 7/8	4PS-S25
.03	23/64 x 7/8	4PS-S30
.033	13/32 x 7/8	4PS-S33	220P33394
.04	23/64 x 13/16	4PS-S40
.047	23/64 x 13/16	4PS-S47	220P47394
.05	23/64 x 13/16	4PS-S50
.056	33/64 x 13/16	4PS-S56	220P56394
.068	33/64 x 13/16	4PS-S68	220P68394
.075	33/64 x 13/16	4PS-S75
.1	33/64 x 13/16	4PS-P10	220P10494
.15	33/64 x 13/16	4PS-P15	220P15494
.2	13/32 x 1 5/8	4PS-P20
.22	33/64 x 1 5/8	4PS-P22	220P22494
.25	43/64 x 1 5/8	4PS-P25

μF	D. x L.	Sprague Products Cat. No.	Sprague O.E.M. Part No.
600 VOLTS D-C			
.001	23/64 x 11/16	6PS-D10	220P10296
.0012	23/64 x 11/16	6PS-D12	220P12296
.0015	23/64 x 11/16	6PS-D15	220P15296
.0018	31/64 x 11/16	6PS-D18	220P18296
.002	23/64 x 11/16	6PS-D20
.0022	23/64 x 11/16	6PS-D22	220P22296
.0025	31/64 x 11/16	6PS-D25
.0027	13/32 x 11/16	6PS-D27	220P27296
.003	13/32 x 11/16	6PS-D30
.0033	23/64 x 11/16	6PS-D33	220P33296
.0039	3/8 x 13/16	6PS-D39	220P39296
.004	3/8 x 13/16	6PS-D40
.0047	23/64 x 11/16	6PS-D47	220P47296
.005	23/64 x 11/16	6PS-D50
.0056	23/64 x 11/16	6PS-D56	220P56296
.006	13/32 x 11/16	6PS-D60
.0068	13/32 x 11/16	6PS-D68	220P68296
.0075	23/64 x 7/8	6PS-D75
.008	23/64 x 7/8	6PS-D80
.0082	3/8 x 7/8	6PS-D82	220P82296
.01	23/64 x 7/8	6PS-S10	220P10396
.012	23/64 x 7/8	6PS-S12	220P12396
.015	23/64 x 7/8	6PS-S15	220P15396
.02	31/64 x 7/8	6PS-S20

μF	D. x L.	Sprague Products Cat. No.	Sprague O.E.M. Part No.
600 VOLTS D-C (cont.)			
.022	23/64 x 7/8	6PS-S22	220P22396
.025	13/32 x 7/8	6PS-S25
.027	7/16 x 13/16	6PS-S27	220P27396
.03	7/16 x 13/16	6PS-S30
.033	13/32 x 13/16	6PS-S33	220P33396
.035	13/32 x 13/16	6PS-S35
.039	33/64 x 13/16	6PS-S39	220P39396
.04	1/2 x 13/16	6PS-S40
.047	13/32 x 13/16	6PS-S47	220P47396
.05	13/32 x 13/16	6PS-S50
.056	33/64 x 13/16	6PS-S56	220P56396
.06	7/16 x 13/16	6PS-S60
.068	23/64 x 13/16	6PS-S68	220P68396
.075	9/16 x 13/16	6PS-S75
.082	23/64 x 13/16	6PS-S82	220P82396
.1	5/8 x 13/16	6PS-P10	220P10496
.15	43/64 x 1 5/8	6PS-P15	220P15496
.2	3/4 x 1 5/8	6PS-P20
.22	23/32 x 1 5/8	6PS-P22	220P22496
.25	13/16 x 1 5/8	6PS-P25
.33	53/64 x 1 5/8	6PS-P33
.47	63/64 x 1 5/8	6PS-P47

μF	D. x L.	Sprague Products Cat. No.	Sprague O.E.M. Part No.
1000 VOLTS D-C			
.001	23/64 x 11/16	10PS-D10	220P102910
.0015	13/32 x 11/16	10PS-D15	220P152910
.002	3/8 x 11/16	10PS-D20
.0022	3/8 x 11/16	10PS-D22	220P222910
.003	11/32 x 7/8	10PS-D30
.004	3/8 x 7/8	10PS-D40
.0047	13/32 x 7/8	10PS-D47	220P472910
.005	13/32 x 7/8	10PS-D50

μF	D. x L.	Sprague Products Cat. No.	Sprague O.E.M. Part No.
1600 VOLTS D-C			
.0005	3/8 x 1 1/4	16PS-T50
.001	3/8 x 1 1/4	16PS-D10	220P102916
.0015	3/8 x 1 1/4	16PS-D15	220P152916
.002	3/8 x 1 1/4	16PS-D20
.0022	3/8 x 1 1/4	16PS-D22	220P222916
.003	7/16 x 1 1/4	16PS-D30
.0033	7/16 x 1 1/4	16PS-D33	220P332916
.004	1/2 x 1 1/2	16PS-D40
.0047	1/2 x 1 1/2	16PS-D47	220P472916
.005	1/2 x 1 1/2	16PS-D50
.006	1/2 x 1 1/2	16PS-D60
.0068	1/2 x 1 1/2	16PS-D68	220P682916
.007	1/2 x 1 1/2	16PS-D70
.0075	1/2 x 1 1/2	16PS-D75
.008	5/8 x 1 7/8	16PS-D80
.01	5/8 x 1 7/8	16PS-S10	220P103916
.015	5/8 x 1 7/8	16PS-S15	220P153916
.02	5/8 x 1 7/8	16PS-S20
.022	5/8 x 1 7/8	16PS-S22	220P223916
.03	3/4 x 2 1/4	16PS-S30
.04	3/4 x 2 1/4	16PS-S40
.05	3/4 x 2 1/4	16PS-S50

μF	D. x L.	Sprague Products Cat. No.	Sprague O.E.M. Part No.
2000 VOLTS D-C			
.001	3/8 x 1 1/4	20PS-D10

CALL YOUR SPRAGUE INDUSTRIAL DISTRIBUTOR FOR CURRENT QUANTITY PRICES

CALL YOUR SPRAGUE INDUSTRIAL DISTRIBUTOR FOR CURRENT QUANTITY PRICES

SPRAGUE CAPACITORS

BF ISOFARAD® PLASTIC FILM CAPACITORS

For Applications Where the Best in Tubulars is None Too Good

- Isofarad Quality is a Must in Color TV Synchroguide Circuits, Horizontal and Vertical Oscillators, Bridge and Parallel T Circuits and Other Tuned Circuit Applications Requiring Close Tolerance and Zero Temperature Coefficient of Capacitance
- Superior to Silvered Mica Capacitors, Yet Far Less Expensive
- Constant Capacitance—Will Not Change More Than $\pm 0.2\%$ from Room Temperature to $+80\text{C}$ at Maximum Rated Voltage Will Withstand Operating Temperatures to 85C (185F)
- **Capacitance Tolerance:** $\pm 5\%$
- Also Available in Handy Sprague Kleer-Pak® Boxes
- For Complete Technical Data, See Latest Issue of Sprague Engineering Bulletin 2075



μF	D. x L.	Sprague Products Cat. No.	Sprague O.E.M. Part No.		μF	D. x L.	Sprague Products Cat. No.	Sprague O.E.M. Part No.	
500 WVDC				CALL YOUR SPRAGUE INDUSTRIAL DISTRIBUTOR FOR CURRENT PRICES	500 WVDC (cont.)				
.001	$\frac{5}{16} \times 1$	5BF-D10	183P10255		.022	$\frac{1}{2} \times 1\frac{1}{2}$	5BF-S22	183P22355	
.0012	$\frac{5}{16} \times 1$	5BF-D12	183P12255		.027	$\frac{1}{2} \times 1\frac{1}{2}$	5BF-S27	183P27355	
.0015	$\frac{5}{16} \times 1$	5BF-D15	183P15255		.033	$\frac{1}{2} \times 1\frac{1}{2}$	5BF-S33	183P33355	
.0018	$\frac{5}{16} \times 1$	5BF-D18	183P18255		.039	$\frac{5}{8} \times 1\frac{1}{8}$	5BF-S39	183P39355	
.0022	$\frac{5}{16} \times 1$	5BF-D22	183P22255		.047	$\frac{5}{8} \times 1\frac{1}{8}$	5BF-S47	183P47355	
.0027	$\frac{5}{16} \times 1$	5BF-D27	183P27255		.056	$\frac{5}{8} \times 1\frac{1}{8}$	5BF-S56	183P56355	
.0033	$\frac{5}{16} \times 1$	5BF-D33	183P33255		.068	$\frac{5}{8} \times 1\frac{1}{8}$	5BF-S68	183P68355	
.0039	$\frac{3}{8} \times 1\frac{1}{4}$	5BF-D39	183P39255		.082	$\frac{3}{4} \times 2\frac{1}{4}$	5BF-S82	145P82355	
.0047	$\frac{3}{8} \times 1\frac{1}{4}$	5BF-D47	183P47255		.1	$\frac{3}{4} \times 2\frac{1}{4}$	5BF-P10	145P10455	
.0056	$\frac{3}{8} \times 1\frac{1}{4}$	5BF-D56	183P56255		.12	$\frac{7}{8} \times 2\frac{1}{2}$	5BF-P12	145P12455	
.0068	$\frac{3}{8} \times 1\frac{1}{4}$	5BF-D68	183P68255		.15	$\frac{7}{8} \times 2\frac{1}{2}$	5BF-P15	145P15455	
.0082	$\frac{3}{8} \times 1\frac{1}{4}$	5BF-D82	183P82255		.18	$\frac{7}{8} \times 2\frac{1}{2}$	5BF-P18	145P18455	
.01	$\frac{3}{8} \times 1\frac{1}{4}$	5BF-S10	183P10355		.22	$\frac{7}{8} \times 2\frac{1}{2}$	5BF-P22	145P22455	
.012	$\frac{7}{16} \times 1\frac{1}{4}$	5BF-S12	183P12355		.27	$1 \times 2\frac{1}{2}$	5BF-P27	145P27455	
.015	$\frac{7}{16} \times 1\frac{1}{4}$	5BF-S15	183P15355	.33	$1 \times 2\frac{1}{2}$	5BF-P33	145P33455		
.018	$\frac{1}{2} \times 1\frac{1}{2}$	5BF-S18	183P18355						

*WF YELLOW-JACKET® FILMITE® 'E' CAPACITORS

- Excellent for Use in Transistorized Circuits and Low-Voltage Electron Tube Circuits
- Extended Foil Type Sections, Wound from Selected, Ultra-Thin Polyester Film and Thin Gage Foil
- Outer Plastic Film Wrap and Resin End Seals Protect Against Moisture and Humidity
- "Smaller Than Small" — These Capacitors Will Fit Anywhere
- Rated to **200 WVDC** — Capacitance Tolerance: $\pm 10\%$
- Designed for Operation to 85C (185F)
- Available in Kleer-Pak® Boxes
- For Technical Data, See Latest Issue of Sprague Bulletin 2063

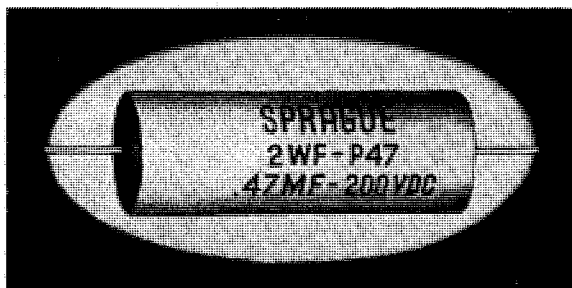

μF	D. x L.	Sprague Products Cat. No.	Sprague O.E.M. Part No.		μF	D. x L.	Sprague Products Cat. No.	Sprague O.E.M. Part No.	
200 WVDC				CALL YOUR SPRAGUE INDUSTRIAL DISTRIBUTOR FOR CURRENT PRICES	200 WVDC (cont.)				
.01	$\frac{1}{8} \times \frac{1}{16}$	2WF-S10	148P10392		.1	$\frac{1}{8} \times \frac{1}{16}$	2WF-P10	148P10492	
.012	$\frac{1}{8} \times \frac{1}{16}$	2WF-S12	148P12392		.12	$\frac{1}{32} \times \frac{1}{16}$	2WF-P12	148P12492	
.015	$\frac{1}{8} \times \frac{1}{16}$	2WF-S15	148P15392		.15	$\frac{1}{32} \times \frac{1}{16}$	2WF-P15	148P15492	
.018	$\frac{1}{8} \times \frac{1}{16}$	2WF-S18	148P18392		.18	$\frac{1}{32} \times \frac{1}{16}$	2WF-P18	148P18492	
.022	$\frac{1}{8} \times \frac{1}{16}$	2WF-S22	148P22392		.22	$\frac{1}{32} \times \frac{1}{16}$	2WF-P22	148P22492	
.027	$\frac{1}{8} \times \frac{1}{16}$	2WF-S27	148P27392		.27	$\frac{1}{32} \times \frac{1}{16}$	2WF-P27	148P27492	
.033	$\frac{1}{8} \times \frac{1}{16}$	2WF-S33	148P33392		.33	$\frac{1}{32} \times \frac{1}{16}$	2WF-P33	148P33492	
.039	$\frac{1}{8} \times \frac{1}{16}$	2WF-S39	148P39392		.39	$\frac{3}{64} \times \frac{1}{16}$	2WF-P39	148P39492	
.047	$\frac{1}{8} \times \frac{1}{16}$	2WF-S47	148P47392		.47	$\frac{3}{64} \times \frac{1}{16}$	2WF-P47	148P47492	
.056	$\frac{1}{4} \times \frac{1}{16}$	2WF-S56	148P56392		.56	$\frac{3}{64} \times \frac{1}{16}$	2WF-P56	148P56492	
.068	$\frac{1}{4} \times \frac{1}{16}$	2WF-S68	148P68392		.68	$\frac{3}{64} \times \frac{1}{16}$	2WF-P68	148P68492	
.082	$\frac{1}{8} \times \frac{1}{16}$	2WF-S82	148P82392		.82	$\frac{1}{32} \times \frac{1}{16}$	2WF-P82	148P82492	
					1.0	$\frac{1}{32} \times \frac{1}{16}$	2WF-M1	148P10592	

* Available until present stocks are exhausted.

SPRAGUE FILTERS

HYPASS® CAPACITORS

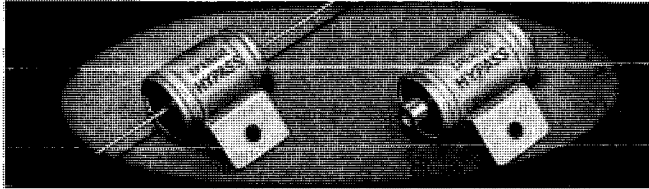

- Exclusive Sprague 3-terminal Network Feed-thru Capacitors
- Bypass V-H-F Currents Where Ordinary Capacitors are Ineffective
- Suppress TVI from Short-wave Transmitters, Diathermy Machines, Electronic Heating Apparatus, etc.
- Eliminate Interference caused by Line-conducted Radiation Between Neighboring TV Sets
- Install Leads in Series with Circuit Being Filtered and Ground the Case

μF	Amps.	WVDC	Dia. x Length	Cat. No.
.5	40	50	1 x 1 13/16	*48P18
.5	60	50	1 x 1 13/16	48P100
.25	20	200	3/4 x 1 13/16	*48P10
.5	20	200	1 x 1 13/16	*48P14
.1	20	250(VAC)	1 1/16 x 1 13/16	*48P9
.1	20	400	1 1/16 x 1 13/16	*48P6
.1	20	400	1 1/16 x 1 13/16	†80P1
.002	15	600	1/4 x 1 3/8	46P12
.005	15	600	1/4 x 1 3/8	46P8
.01	20	600	7/16 x 1 1/4	47P6
.02	20	600	7/16 x 1 1/2	47P8
.1	20	600	1 1/16 x 1 13/16	*48P8
.1	20	600	1 1/16 x 1 13/16	*†80P3
.25	20	600	1 x 1 13/16	*48P12
.5	20	600	1 x 2 1/4	*48P16
.005	20	1000	7/16 x 1 1/4	47P12
.01	20	1000	7/16 x 1 1/2	47P13
.005	20	2500	1 x 1 3/16	47P14
.01	20	2500	1 x 1 3/16	47P15
.002	20	5000	1 x 1 3/16	47P16

CALL YOUR SPRAGUE INDUSTRIAL DISTRIBUTOR FOR CURRENT PRICES

*Has female screw terminals

†Bulkhead mounting

TYPE F-400 MIRACLE FILTEROL®

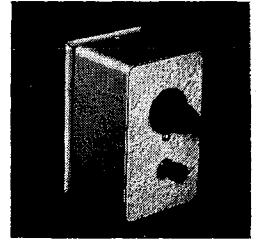
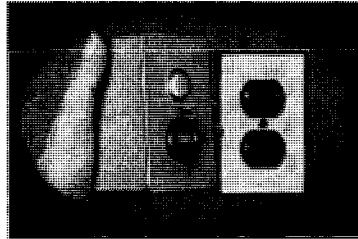

A LINE FILTER THAT REALLY WORKS

- Effectively Suppresses Radio Interference by Filtering Power Lines of Receivers and Appliances
- Maximum Noise Eliminating Efficiency because of Practically Zero Length of Ground Lead
- Plugs into Standard Duplex Wall Outlet — Captive Screw Fastens Filterol F-400 to Outlet for Safe, Secure Mounting
- Direct Wall-Mounting Provides Neat Installation — No Unsightly Cord — Receiver or Appliance Plugs into Standard Outlet on Face of F-400
- Will Also Operate at Slightly Reduced Efficiency in Older Homes where Wiring is of Knob and Tube or 2-Conductor Non-Metallic Sheathed Cable Type by Using the External Grounding Post Provided for this Purpose
- Handsomely Finished in Tan Hammerloid Baked Enamel
- Rated at 5 Amperes, 125 Volts AC or DC

CALL YOUR SPRAGUE INDUSTRIAL DISTRIBUTOR FOR CURRENT PRICES

TYPE IF FILTERS

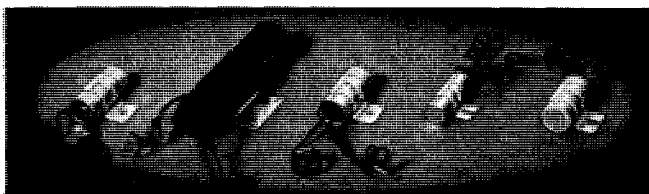

IF-15 IF-11 IF-21 IF-S1 IF-37

IF-15 — TRIPLE-SECTION FILTER for small motor-operated devices such as fans, drills, etc. designed to prevent shocks from discharge of filter capacitors.

IF-11 — DUAL HIGH-CAPACITY FILTER designed for use on motors over 1 hp up to 220 volts ac-dc. Also used on high-current arcing devices.

IF-21 — COMPACT DUAL FILTER for use on fractional horsepower motors with case grounded to motor frame. Also used across line terminals of motors.

IF-S1 — SINGLE SECTION 2-LEAD FILTER for use across make-and-break contacts, such as thermostats, circuit breakers, etc.

IF-37 — 3-SECTION DELTA-CONNECTED FILTER especially designed for fluorescent fixtures. Also used on governor-type motors.

Underwriters' Laboratories, Inc. listed.

Cat. No.	Volts AC or DC	Dia. x Length
IF-15	220	1 x 2 3/8
IF-11	220	1 3/8 x 5 1/4
IF-21	220	1 x 2 3/8
IF-S1	220	3/4 x 2 1/8
IF-37	220	1 x 2"

CALL YOUR SPRAGUE INDUSTRIAL DISTRIBUTOR FOR CURRENT PRICES

FILTEROL® FILTERS

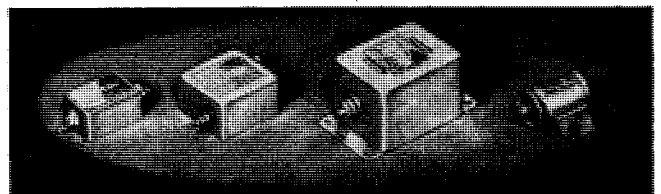

FILTEROL 1 FILTEROL 2 FILTEROL 3 FILTEROL 4

Filterol Types 1, 2, and 3 — Designed for connection in series with power supply lines to interference-producing devices . . . A 3-terminal network with the case as one terminal . . . The selected filter should have a rating higher than the continuous operating current of the offending device . . . A single Filterol connected to the high side of the line is usually sufficient . . . In severe cases a Filterol in each leg of the power line may be necessary . . . For three or four-wire systems, a Filterol in each wire is necessary.

Filterol Type 4 — A new, exclusive Sprague development incorporating a Sprague HYPASS® Capacitor . . . Provides exceptionally high attenuation at frequencies above 5 megacycles . . . Intended for small devices with continuous current ratings up to 20 amperes.

Cat. No.	Amps.	Volts AC or DC	Size
Filterol 1	1	115	3/4 x 1 1/4 x 1 3/4
Filterol 2	10	115	1 1/8 x 2 x 2
Filterol 3	35	115	1 7/8 x 2 7/8 x 3 1/8
Filterol 4	20	115	1" dia. x 1 13/16" long

SPRAGUE CAPACITORS

MONOLYTHIC® LAYER-BUILT CERAMIC CAPACITORS

Types 3C and 4C—Formulation N030

- Temperature Compensating Units, N030 Dielectric Offers Greater Capacitance Per Unit Volume and Greater Stability Than Previously Available.
- Highly Reliable, Small in Size, Axial or Radial Leads.
- Temperature Coefficient Guaranteed Less Than $\pm .6\%$ Between -55C and $+125\text{C}$.

Types 2C, 3C, 4C, 5C—Formulation 023

- High-K General Application—High Capacitances in Small Physical Size, Axial or Radial Leads.
- Well Suited for By-pass and Filtering Applications
- For Complete Technical Data, See Latest Sprague Engineering Bulletin 6212 (N030) or 6201 (023)

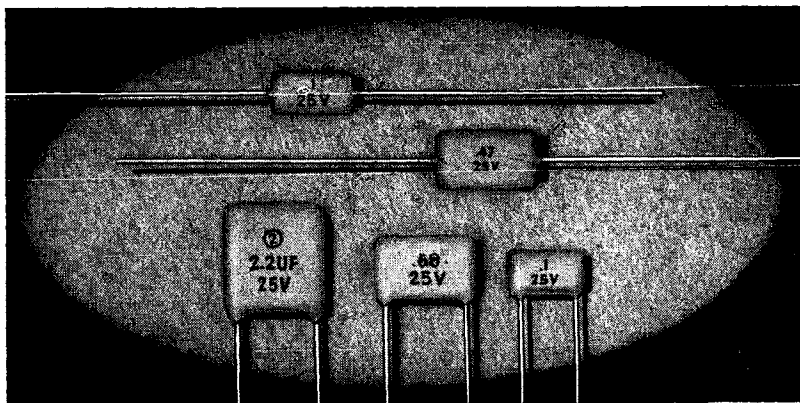

Type 3C, 4C Monolythic Ceramic Capacitors—Formulation N030—Temperature Compensating—200 V

μF	Tol.	Cat. No.		μF	Tol.	Cat. No.		μF	Tol.	Cat. No.		μF	Tol.	Cat. No.			
TYPE 3C AXIAL LEADS			CALL YOUR SPRAGUE INDUSTRIAL DISTRIBUTOR FOR CURRENT QUANTITY PRICES	TYPE 4C AXIAL LEADS			CALL YOUR SPRAGUE INDUSTRIAL DISTRIBUTOR FOR CURRENT QUANTITY PRICES	TYPE 3C RADIAL LEADS			CALL YOUR SPRAGUE INDUSTRIAL DISTRIBUTOR FOR CURRENT QUANTITY PRICES	TYPE 4C RADIAL LEADS					
51	5%	3C5105BH1		240	2%	3C2412BH1		1200	5%	4C1225BH1		150	2%	3C1512BH3	300	5%	3C3015BH3
51	2%	3C5102BH1		270	10%	3C2719BH1		1200	2%	4C1222BH1		160	5%	3C1615BH3	300	2%	3C3012BH3
56	10%	3C5609BH1		270	5%	3C2715BH1		1300	5%	4C1325BH1		160	2%	3C1612BH3	330	10%	3C3319BH3
56	5%	3C5605BH1		270	2%	3C2712BH1		1300	2%	4C1322BH1		180	10%	3C1819BH3	330	5%	3C3315BH3
56	2%	3C5602BH1		300	5%	3C3015BH1		1500	10%	4C1529BH1		180	5%	3C1815BH3	330	2%	3C3312BH3
62	5%	3C6205BH1		300	2%	3C3012BH1		1500	5%	4C1525BH1		180	2%	3C1812BH3	360	5%	3C3615BH3
62	2%	3C6202BH1		330	10%	3C3319BH1		1500	2%	4C1522BH1		200	5%	3C2015BH3	360	2%	3C3612BH3
68	10%	3C6809BH1		330	5%	3C3315BH1		1600	5%	4C1625BH1		200	2%	3C2012BH3	390	10%	3C3919BH3
68	5%	3C6805BH1		330	2%	3C3312BH1		1600	2%	4C1622BH1		220	10%	3C2219BH3	390	5%	3C3915BH3
68	2%	3C6802BH1		360	5%	3C3615BH1		1800	10%	4C1829BH1		220	5%	3C2215BH3	390	2%	3C3912BH3
75	5%	3C7505BH1		360	2%	3C3612BH1		1800	5%	4C1825BH1		220	2%	3C2212BH3	430	5%	3C4315BH3
75	2%	3C7502BH1		390	10%	3C3919BH1		1800	2%	4C1822BH1		240	5%	3C2415BH3	430	2%	3C4312BH3
82	10%	3C8209BH1		390	5%	3C3915BH1		1800	5%	4C1825BH1		240	2%	3C2412BH3	470	10%	3C4719BH3
82	5%	3C8205BH1		390	2%	3C3912BH1		1800	2%	4C1822BH1		270	10%	3C2719BH3	470	5%	3C4715BH3
82	2%	3C8202BH1		430	5%	3C4315BH1		TYPE 3C RADIAL LEADS				270	5%	3C2715BH3	470	2%	3C4712BH3
91	5%	3C9105BH1		430	2%	3C4312BH1		51	5%	3C5105BH3		270	2%	3C2712BH3	510	5%	3C5115BH3
91	2%	3C9102BH1		470	10%	3C4719BH1		51	2%	3C5102BH3		300	5%	3C3015BH3	510	2%	3C5112BH3
100	10%	3C1019BH1		470	5%	3C4715BH1		56	10%	3C5609BH3		300	2%	3C3012BH3	560	10%	3C5619BH3
100	5%	3C1015BH1		470	2%	3C4712BH1		56	5%	3C5605BH3		330	10%	3C3319BH3	560	5%	3C5615BH3
100	2%	3C1012BH1		510	5%	3C5115BH1		56	2%	3C5602BH3		330	5%	3C3315BH3	560	2%	3C5612BH3
110	5%	3C1115BH1		510	2%	3C5112BH1		62	5%	3C6205BH3		360	5%	3C3615BH3	620	5%	3C6215BH3
110	2%	3C1112BH1		510	5%	3C5115BH1		62	2%	3C6202BH3		360	2%	3C3612BH3	620	2%	3C6212BH3
120	10%	3C1219BH1		560	10%	3C5619BH1		68	10%	3C6809BH3		390	10%	3C3919BH3	680	10%	3C6819BH3
120	5%	3C1215BH1		560	5%	3C5615BH1		68	5%	3C6805BH3		390	5%	3C3915BH3	680	5%	3C6815BH3
120	2%	3C1212BH1		560	2%	3C5612BH1		68	2%	3C6802BH3		390	2%	3C3912BH3	680	2%	3C6812BH3
130	5%	3C1315BH1		620	5%	3C6215BH1		75	5%	3C7505BH3		430	5%	3C4315BH3	750	5%	3C7515BH3
130	2%	3C1312BH1		620	2%	3C6212BH1		75	2%	3C7502BH3		430	2%	3C4312BH3	750	2%	3C7512BH3
150	10%	3C1519BH1		680	10%	3C6819BH1		82	10%	3C8209BH3		470	10%	3C4719BH3	820	10%	3C8219BH3
150	5%	3C1515BH1		680	5%	3C6815BH1		82	5%	3C8205BH3		470	5%	3C4715BH3	820	5%	3C8215BH3
150	2%	3C1512BH1		680	2%	3C6812BH1		82	2%	3C8202BH3		470	2%	3C4712BH3	820	2%	3C8212BH3
160	5%	3C1615BH1		750	5%	3C7515BH1		91	5%	3C9105BH3		510	5%	3C5115BH3	820	5%	3C8215BH3
160	2%	3C1612BH1		750	2%	3C7512BH1		91	2%	3C9102BH3		510	2%	3C5112BH3	820	2%	3C8212BH3
180	10%	3C1819BH1		820	10%	3C8219BH1		100	10%	3C1019BH3		560	10%	3C5619BH3	820	10%	3C8219BH3
180	5%	3C1815BH1		820	5%	3C8215BH1		100	5%	3C1015BH3		560	5%	3C5615BH3	820	5%	3C8215BH3
180	2%	3C1812BH1		820	2%	3C8212BH1		100	2%	3C1012BH3		560	2%	3C5612BH3	820	2%	3C8212BH3
200	5%	3C2015BH1		910	5%	3C9115BH1		110	5%	3C1115BH3		620	5%	3C6215BH3	820	5%	3C8215BH3
200	2%	3C2012BH1		910	2%	3C9112BH1		110	2%	3C1112BH3		620	2%	3C6212BH3	820	2%	3C8212BH3
220	10%	3C2219BH1		1000	10%	3C1029BH1		120	10%	3C1219BH3		680	10%	3C6819BH3	820	10%	3C8219BH3
220	5%	3C2215BH1		1000	5%	3C1025BH1		120	5%	3C1215BH3		680	5%	3C6815BH3	820	5%	3C8215BH3
220	2%	3C2212BH1		1000	2%	3C1022BH1		120	2%	3C1212BH3		680	2%	3C6812BH3	820	2%	3C8212BH3
240	5%	3C2415BH1		1100	5%	3C1125BH1		130	5%	3C1315BH3		750	5%	3C7515BH3	820	5%	3C8215BH3
				1100	2%	3C1122BH1		130	2%	3C1312BH3		750	2%	3C7512BH3			
				1200	10%	3C1229BH1		150	10%	3C1519BH3		820	10%	3C8219BH3			
								150	5%	3C1515BH3							

SPRAGUE CAPACITORS

CERA-MITE[®] CERAMIC CAPACITORS

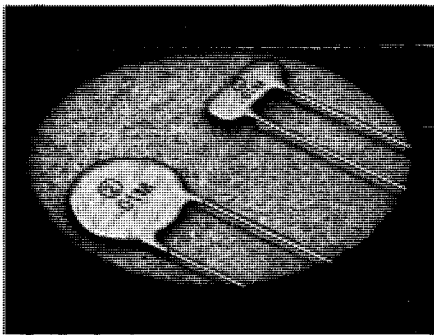

- Tiny, Tough, Dependable In Every Application
- Low Self-Inductance Of Silvered Flat-plate Design Means Very High By-pass Efficiency In All TV Circuits
- Flat-plate Construction Permits Higher Self-resonant Frequency Than Tubular Ceramic Or Molded Mica Capacitors
- Tough Moisture-proof Coating Protects Against Short-circuiting And Assures Good Performance Under Severe Conditions Of Humidity And Vibration
- Cera-mite Capacitors Easily Fit Into Tight Spaces, Even Across Subminiature Tube Sockets
- Designed For 85C (185F) Continuous Operation

Call your Sprague Industrial Distributor for Current Quantity Prices

GENERAL APPLICATION TYPES

- Excellent Where Temperature Coefficient Is Not Important, Such As By-pass and Coupling Applications in IF and RF Circuits
- EIA Designation: 5GA=Z5U, TG=Z5U
- Low Cost, Smallest Size 1 kV General Application Type Available
- Same Characteristic Available In High Voltage At Low Cost

pF	Sprague Products Cat. No.	Sprague O.E.M. Part No.	Size D. x T.	pF	Sprague Products Cat. No.	Sprague O.E.M. Part No.	Size D. x T.	pF	Sprague Products Cat. No.	Sprague O.E.M. Part No.	Size D. x T.
1000 WVDC (discs) ± 20% Tol.				1000 WVDC (discs) (cont.)				3000 WVDC (discs) ± 20% Tol.			
5.0	5GA-V50	C023B102E5R0M	5/16 x 5/32	500	5GA-T50	C023B102E501M	5/16 x 5/32	1.5	30GA-V15	19C306	3/8 x 1/4
6.8	5GA-V68	C023B102E6R8M	5/16 x 5/32	560	5GA-T56	C023B102E561M	5/16 x 5/32	3.3	30GA-V33	19C307	3/8 x 1/4
7.5	5GA-V75	C023B102E7R5M	5/16 x 5/32	680	5GA-T68	C023B102E681M	5/16 x 5/32	4.7	30GA-V47	19C308	3/8 x 1/4
8.2	5GA-V82	C023B102E8R2M	5/16 x 5/32	750	5GA-T75	C023B102E751M	5/16 x 5/32	5.0	30GA-V50	19C309	3/8 x 1/4
10	5GA-Q10	C023B102E100M	5/16 x 5/32	800	5GA-T80	C023B102E801M	5/16 x 5/32	6.0	30GA-V60	19C310	3/8 x 1/4
12	5GA-Q12	C023B102E120M	5/16 x 5/32	820	5GA-T82	C023B102E821M	5/16 x 5/32	6.8	30GA-V68	19C311	3/8 x 1/4
15	5GA-Q15	C023B102E150M	5/16 x 5/32	.001 μ F	5GA-D10	C023B102E102M	5/16 x 5/32	7.5	30GA-V75	19C291	3/8 x 1/4
18	5GA-Q18	C023B102E180M	5/16 x 5/32	.0012	5GA-D12	C023B102E122M	5/16 x 5/32	8.2	30GA-V82	19C290	3/8 x 1/4
20	5GA-Q20	C023B102E200M	5/16 x 5/32	.0015	5GA-D15	C023B102E152M	5/16 x 5/32	10	30GA-Q10	19C312	3/8 x 1/4
22	5GA-Q22	C023B102E220M	5/16 x 5/32	.0018	5GA-D18	C023B102F182M	3/8 x 5/32	12	30GA-Q12	19C313	3/8 x 1/4
25	5GA-Q25	C023B102E250M	5/16 x 5/32	.002	5GA-D20	C023B102F202M	3/8 x 5/32	15	30GA-Q15	19C314	3/8 x 1/4
27	5GA-Q27	C023B102E270M	5/16 x 5/32	.0022	5GA-D22	C023B102F222M	3/8 x 5/32	18	30GA-Q18	19C292	3/8 x 1/4
30	5GA-Q30	C023B102E300M	5/16 x 5/32	.0025	5GA-D25	C023B102F252M	3/8 x 5/32	20	30GA-Q20	19C315	3/8 x 1/4
33	5GA-Q33	C023B102E330M	5/16 x 5/32	.0027	5GA-D27	C023B102F272M	3/8 x 5/32	22	30GA-Q22	19C316	3/8 x 1/4
39	5GA-Q39	C023B102E390M	5/16 x 5/32	.003	5GA-D30	C023B102F302M	3/8 x 5/32	25	30GA-Q25	19C317	3/8 x 1/4
47	5GA-Q47	C023B102E470M	5/16 x 5/32	.0033	5GA-D33	C023B102G332M	7/16 x 5/32	27	30GA-Q27	19C318	3/8 x 1/4
50	5GA-Q50	C023B102E500M	5/16 x 5/32	.0039	5GA-D39	C023B102G392M	7/16 x 5/32	30	30GA-Q30	19C319	3/8 x 1/4
56	5GA-Q56	C023B102E560M	5/16 x 5/32	.004	5GA-D40	C023B102G402M	7/16 x 5/32	33	30GA-Q33	19C320	3/8 x 1/4
68	5GA-Q68	C023B102E680M	5/16 x 5/32	.0047	5GA-D47	C023B102H472M	1/2 x 5/32	39	30GA-Q39	19C321	3/8 x 1/4
75	5GA-Q75	C023B102E750M	5/16 x 5/32	.005	5GA-D50	C023B102H502M	1/2 x 5/32	47	30GA-Q47	19C322	3/8 x 1/4
82	5GA-Q82	C023B102E820M	5/16 x 5/32	.0068	5GA-D68	C023B102J682M	5/8 x 5/32	50	30GA-Q50	19C323	3/8 x 1/4
100	5GA-T10	C023B102E101M	5/16 x 5/32	.0082	5GA-D82	C023B102K822M	5/8 x 5/32	56	30GA-Q56	19C324	3/8 x 1/4
120	5GA-T12	C023B102E121M	5/16 x 5/32	.01	5GA-S10	C023A102J103M	5/8 x 5/32	60	30GA-Q60	19C325	3/8 x 1/4
150	5GA-T15	C023B102E151M	5/16 x 5/32	.015	5GA-S15	C023A102M153M	3/4 x 5/32	62	30GA-Q62	19C326	3/8 x 1/4
180	5GA-T18	C023B102E181M	5/16 x 5/32	.02	5GA-S20	C023A102P203M	7/8 x 5/32	68	30GA-Q68	19C327	3/8 x 1/4
200	5GA-T20	C023B102E201M	5/16 x 5/32	500 WVDC (discs) ± 20% Tol.				75	30GA-Q75	19C328	3/8 x 1/4
220	5GA-T22	C023B102E221M	5/16 x 5/32	.01 μ F	5GAS-S10	C023A501G103M	7/16 x 5/32	82	30GA-Q82	20C184	7/16 x 1/4
250	5GA-T25	C023B102E251M	5/16 x 5/32	.02	5GAS-S20	C023A501J203M	5/8 x 5/32	100	30GA-T10	20C43	7/16 x 1/4
270	5GA-T27	C023B102E271M	5/16 x 5/32	.025	5GA-S25	C023A501L253M	11/16 x 5/32	120	30GA-T12	20C44	7/16 x 1/4
300	5GA-T30	C023B102E301M	5/16 x 5/32	.04	5GA-S40	C023A501P403M	7/8 x 5/32	150	30GA-T15	20C45	7/16 x 1/4
330	5GA-T33	C023B102E331M	5/16 x 5/32	.05	5GA-S50	33C17A	11/16 x 3/16	180	30GA-T18	20C46	7/16 x 1/4
360	5GA-T36	C023B102E361M	5/16 x 5/32	.1	5GA-P10	41C92A10	7/8 x 3/16	200	30GA-T20	20C47	7/16 x 1/4

SPRAGUE CAPACITORS

CERA-MITE® CERAMIC CAPACITORS, continued

SEMI-STABLE TYPES

- Better Stability Than the General Application Types. • Tighter Tolerance of $\pm 10\%$ is Better Than General Application Types
- Ideal for Replacing Other Types of Capacitors Such as Molded Micacs, Paper Tubulars, and Mylar Film Tubulars
- Available in IKV and a Smaller Size 250 Volt Rating • Small Size, Low Cost • EIA Designation: 10SS=Z5P, 2SS=Z5P

SEMI-STABLE 250 WVDC STANDARD TOLERANCE $\pm 10\%$

μF	Sprague Products Cat. No.	Sprague O.E.M. Part No.	Size D. x T.	μF	Sprague Products Cat. No.	Sprague O.E.M. Part No.	Size D. x T.	μF	Sprague Products Cat. No.	Sprague O.E.M. Part No.	Size D. x T.
750pF	2SS-T75	C067B251E751K	$\frac{5}{16} \times \frac{5}{32}$.0022	2SS-D22	C067B251E222K	$\frac{5}{16} \times \frac{5}{32}$.0068	2SS-D68	C067A251J682K	$\frac{7}{16} \times \frac{5}{32}$
820pF	2SS-T82	C067B251E821K	$\frac{5}{16} \times \frac{5}{32}$.0027	2SS-D27	C067B251G272K	$\frac{7}{16} \times \frac{5}{32}$.0082	2SS-D82	C067A251K822K	$\frac{5}{8} \times \frac{5}{32}$
.001	2SS-D10	C067B251E102K	$\frac{5}{16} \times \frac{5}{32}$.0033	2SS-D33	C067B251G332K	$\frac{7}{16} \times \frac{5}{32}$.01	2SS-S10	C067A251L103K	$1\frac{1}{16} \times \frac{5}{32}$
.0012	2SS-D12	C067B251E122K	$\frac{5}{16} \times \frac{5}{32}$.0039	2SS-D39	C067B251G392K	$\frac{7}{16} \times \frac{5}{32}$.012	2SS-S12	29C527	$\frac{7}{16} \times \frac{7}{32}$
.0015	2SS-D15	C067B251E152K	$\frac{5}{16} \times \frac{5}{32}$.0047	2SS-D47	C067B251H472K	$\frac{1}{2} \times \frac{5}{32}$.015	2SS-S15	44C136	$1\frac{1}{16} \times \frac{5}{32}$
.0018	2SS-D18	C067B251E182K	$\frac{5}{16} \times \frac{5}{32}$.005	2SS-D50	C067B251H502K	$\frac{1}{2} \times \frac{5}{32}$.018	2SS-S18	33C291	$\frac{3}{4} \times \frac{7}{32}$
.002	2SS-D20	C067B251E202K	$\frac{5}{16} \times \frac{5}{32}$.0056	2SS-D56	C067A251J562K	$\frac{7}{16} \times \frac{5}{32}$.02	2SS-S20	33C292	$\frac{3}{4} \times \frac{7}{32}$

SEMI-STABLE 1000 WVDC STANDARD TOLERANCE $\pm 10\%$

pF	Sprague Products Cat. No.	Sprague O.E.M. Part No.	Size D. x T.	μF	Sprague Products Cat. No.	Sprague O.E.M. Part No.	Size D. x T.	μF	Sprague Products Cat. No.	Sprague O.E.M. Part No.	Size D. x T.
470	10SS-T47	C067B102E471K	$\frac{5}{16} \times \frac{5}{32}$.0018	10SS-D18	C067B102G182K	$\frac{7}{16} \times \frac{5}{32}$.0068	10SS-D68	C067A102M682K	$\frac{3}{4} \times \frac{5}{32}$
500	10SS-T50	C067B102E501K	$\frac{5}{16} \times \frac{5}{32}$.002	10SS-D20	C067B102G202K	$\frac{7}{16} \times \frac{5}{32}$.0082	10SS-D82	C067A102P822K	$\frac{7}{8} \times \frac{5}{32}$
560	10SS-T56	C067B102E561K	$\frac{5}{16} \times \frac{5}{32}$.0022	10SS-D22	C067B102H222K	$\frac{1}{2} \times \frac{5}{32}$.010	10SS-S10	C067A102P103K	$\frac{7}{8} \times \frac{5}{32}$
680	10SS-T68	C067B102E681K	$\frac{5}{16} \times \frac{5}{32}$.0027	10SS-D27	C067B102H272K	$\frac{1}{2} \times \frac{5}{32}$.012	10SS-S12	33C249A	$\frac{3}{4} \times \frac{7}{32}$
750	10SS-T75	C067B102F751K	$\frac{5}{8} \times \frac{5}{32}$.0033	10SS-D33	C067A102J332K	$\frac{7}{16} \times \frac{5}{32}$.015	10SS-S15	41C299A	$1\frac{1}{16} \times \frac{7}{32}$
820	10SS-T82	C067B102F821K	$\frac{3}{8} \times \frac{5}{32}$.0039	10SS-D39	C067A102J392K	$\frac{7}{16} \times \frac{5}{32}$.018	10SS-S18	41C300A1	$1\frac{5}{16} \times \frac{7}{32}$
.001 μF	10SS-D10	C067B102F102K	$\frac{3}{8} \times \frac{5}{32}$.0047	10SS-D47	C067A102K472K	$\frac{5}{8} \times \frac{5}{32}$.02	10SS-S20	41C301A1	$1\frac{5}{16} \times \frac{7}{32}$
.0012	10SS-D12	C067B102F122K	$\frac{3}{8} \times \frac{5}{32}$.005	10SS-D50	C067A102K502K	$\frac{5}{8} \times \frac{5}{32}$.022	10SS-S22	41C310A1	$1\frac{5}{16} \times \frac{7}{32}$
.0015	10SS-D15	C067B102G152K	$\frac{7}{16} \times \frac{5}{32}$.0056	10SS-D56	C067A102L562K	$1\frac{1}{16} \times \frac{5}{32}$				

TEMPERATURE-STABLE TYPES

- Used Where Minimum Capacitance Change With Temperature Is An Important Consideration • Rated at **1000 WVDC**
- Standard Capacitance Tolerance: $\pm 10\%$ except 10TS-S15, 10TS-S20, 10TS-S30 $\pm 15\%$. • EIA Designation: 10TS=X5E

pF	Sprague Products Cat. No.	Sprague O.E.M. Part No.	Size D. x T.	pF	Sprague Products Cat. No.	Sprague O.E.M. Part No.	Size D. x T.	μF	Sprague Products Cat. No.	Sprague O.E.M. Part No.	Size D. x T.
3.3	10TS-V33	C028B102E3R3K	$\frac{5}{16} \times \frac{5}{32}$	75	10TS-Q75	C028B102E750K	$\frac{5}{16} \times \frac{5}{32}$.001	10TS-D10	C106B102G102K	$\frac{7}{16} \times \frac{5}{32}$
5.0	10TS-V50	C028B102E5R0K	$\frac{5}{16} \times \frac{5}{32}$	82	10TS-Q82	C028B102E820K	$\frac{5}{16} \times \frac{5}{32}$.0012	10TS-D12	C016B102G122K	$\frac{7}{16} \times \frac{5}{32}$
6.8	10TS-V68	C028B102E6R8K	$\frac{5}{16} \times \frac{5}{32}$	91	10TS-Q91	C028B102E910K	$\frac{5}{16} \times \frac{5}{32}$.0015	10TS-D15	C016A102J152K	$\frac{5}{16} \times \frac{5}{32}$
7.5	10TS-V75	C028B102E7R5K	$\frac{5}{16} \times \frac{5}{32}$	100	10TS-T10	C028B102E101K	$\frac{5}{16} \times \frac{5}{32}$.0018	10TS-D18	C016A102J182K	$\frac{5}{16} \times \frac{5}{32}$
8.2	10TS-V82	C028B102E8R2K	$\frac{5}{16} \times \frac{5}{32}$	120	10TS-T12	C028B102E121K	$\frac{5}{16} \times \frac{5}{32}$.0020	10TS-D20	C016A102J202K	$\frac{5}{16} \times \frac{5}{32}$
10	10TS-Q10	C028B102E100K	$\frac{5}{16} \times \frac{5}{32}$	150	10TS-T15	C028B102E151K	$\frac{5}{16} \times \frac{5}{32}$.0022	10TS-D22	C016A102J222K	$\frac{5}{16} \times \frac{5}{32}$
12	10TS-Q12	C028B102E120K	$\frac{5}{16} \times \frac{5}{32}$	180	10TS-T18	C028B102E181K	$\frac{5}{16} \times \frac{5}{32}$.0025	10TS-D25	C016A102K252K	$\frac{5}{8} \times \frac{5}{32}$
15	10TS-Q15	C028B102E150K	$\frac{5}{16} \times \frac{5}{32}$	200	10TS-T20	C028B102E201K	$\frac{5}{16} \times \frac{5}{32}$.0027	10TS-D27	C016A102L272K	$1\frac{1}{16} \times \frac{5}{32}$
18	10TS-Q18	C028B102E180K	$\frac{5}{16} \times \frac{5}{32}$	220	10TS-T22	C028B102E221K	$\frac{5}{16} \times \frac{5}{32}$.0030	10TS-D30	C016A102L302K	$1\frac{1}{16} \times \frac{5}{32}$
20	10TS-Q20	C028B102E200K	$\frac{5}{16} \times \frac{5}{32}$	250	10TS-T25	C028B102E251K	$\frac{5}{16} \times \frac{5}{32}$.0033	10TS-D33	C016A102L332K	$1\frac{1}{16} \times \frac{5}{32}$
22	10TS-Q22	C028B102E220K	$\frac{5}{16} \times \frac{5}{32}$	270	10TS-T27	C016B102E271K	$\frac{5}{16} \times \frac{5}{32}$.0039	10TS-D39	C016A102M392K	$\frac{3}{4} \times \frac{5}{32}$
25	10TS-Q25	C028B102E250K	$\frac{5}{16} \times \frac{5}{32}$	300	10TS-T30	C016B102E301K	$\frac{5}{16} \times \frac{5}{32}$.0040	10TS-D40	C016A102M402K	$\frac{3}{4} \times \frac{5}{32}$
27	10TS-Q27	C028B102E270K	$\frac{5}{16} \times \frac{5}{32}$	330	10TS-T33	C016B102E331K	$\frac{5}{16} \times \frac{5}{32}$.0047	10TS-D47	C016A102P472K	$\frac{7}{8} \times \frac{5}{32}$
30	10TS-Q30	C028B102E300K	$\frac{5}{16} \times \frac{5}{32}$	390	10TS-T39	C016B102E391K	$\frac{5}{16} \times \frac{5}{32}$.0050	10TS-D50	C016A102P502K	$\frac{7}{8} \times \frac{5}{32}$
33	10TS-Q33	C028B102E330K	$\frac{5}{16} \times \frac{5}{32}$	470	10TS-T47	C016B102F471K	$\frac{3}{8} \times \frac{5}{32}$.0056	10TS-D56	C016A102P562K	$\frac{7}{8} \times \frac{5}{32}$
39	10TS-Q39	C028B102E390K	$\frac{5}{16} \times \frac{5}{32}$	500	10TS-T50	C016B102F501K	$\frac{3}{8} \times \frac{5}{32}$.0068	10TS-D68	36C108A	$1\frac{3}{16} \times \frac{7}{32}$
47	10TS-Q47	C028B102E470K	$\frac{5}{16} \times \frac{5}{32}$	560	10TS-T56	C016B102F561K	$\frac{3}{8} \times \frac{5}{32}$.0075	10TS-D75	36C395	$1\frac{3}{16} \times \frac{7}{32}$
50	10TS-Q50	C028B102E500K	$\frac{5}{16} \times \frac{5}{32}$	680	10TS-T68	C016B102F681K	$\frac{3}{8} \times \frac{5}{32}$.0082	10TS-D82	41C306A	$1\frac{5}{16} \times \frac{7}{32}$
56	10TS-Q56	C028B102E560K	$\frac{5}{16} \times \frac{5}{32}$	750	10TS-T75	C016B102F751K	$\frac{3}{8} \times \frac{5}{32}$.01	10TS-S10	41C121A1	$1\frac{5}{16} \times \frac{7}{32}$
68	10TS-Q68	C028B102E680K	$\frac{5}{16} \times \frac{5}{32}$	820	10TS-T82	C016B102G821K	$\frac{7}{16} \times \frac{5}{32}$				

DISC CERAMICS FOR AC APPLICATIONS

- Rated at 125 VAC or 1400 VDC • Standard Tolerance $\pm 20\%$
- For AC Line Bypass Application • Heavy Duty for Long Life
- May Be Connected Across the Line or Chassis to Line

μF	Sprague Products Catalog No.	Sprague O.E.M. Part No.	D. x T.
.001	125L-D10	19C251	$\frac{3}{8} \times \frac{7}{32}$
.0015	125L-D15	19C252	$\frac{3}{8} \times \frac{7}{32}$
.002	125L-D20	19C253	$\frac{3}{8} \times \frac{7}{32}$
.0047	125L-D47	29C145	$\frac{5}{16} \times \frac{7}{32}$
.005	125L-D50	29C145A	$\frac{5}{16} \times \frac{7}{32}$
.01	125L-S10	36C218	$\frac{3}{4} \times \frac{7}{32}$
.02	125L-S20	36C220	$\frac{3}{4} \times \frac{1}{4}$
2 x .005	125L-2D50	29C147	$\frac{5}{16} \times \frac{1}{4}$
2 x .01	125L-2S10	36C219	$\frac{3}{4} \times \frac{1}{4}$

DISC CERAMICS FOR BUFFER APPLICATIONS

- Rated at 2000 WVDC • Standard Tolerance $\pm 20\%$

μF	Sprague Products Catalog No.	Sprague O.E.M. Part No.	D. x T.
.001	BL-D10	29C162	$\frac{5}{16} \times \frac{7}{32}$
.002	BL-D20	29C163	$\frac{5}{16} \times \frac{7}{32}$
.003	BL-D30	29C164	$\frac{5}{16} \times \frac{7}{32}$
.004	BL-D40	29C165	$\frac{5}{16} \times \frac{7}{32}$
.005	BL-D50	29C251	$\frac{5}{16} \times \frac{7}{32}$
.006	BL-D60	44C126	$1\frac{1}{16} \times \frac{7}{32}$
.007	BL-D70	33C82	$1\frac{1}{16} \times \frac{7}{32}$
.0075	BL-D75	33C81	$1\frac{1}{16} \times \frac{7}{32}$
.008	BL-D80	33C84	$1\frac{1}{16} \times \frac{7}{32}$
.01	BL-S10	36C151	$\frac{3}{4} \times \frac{7}{32}$

SPRAGUE CAPACITORS

CERA-MITE[®] CERAMIC CAPACITORS, continued

Sprague Products Cat. No.			Sprague O.E.M. Part No.			Size D. x T.			Sprague Products Cat. No.			Sprague O.E.M. Part No.			Size D. x T.											
N220 (cont.)									N470 (cont.)									N1500								
5.0	10TCR-V50	C033B102S5R0D	3/8	x	1/4	4.7	10TCT-V47	C035B102S4R7D	3/8	x	1/4	10	10TCW-Q10	C048B102S100J	3/8	x	1/4									
5.6	10TCR-V56	C033B102S5R6D	3/8	x	1/4	5.0	10TCT-V50	C035B102S5R0D	3/8	x	1/4	12	10TCW-Q12	C048B102S120J	3/8	x	1/4									
6.8	10TCR-V68	C033B102E6R8D	5/16	x	5/32	5.6	10TCT-V56	C035B102S5R6D	3/8	x	1/4	15	10TCW-Q15	C048B102S150J	3/8	x	1/4									
8.2	10TCR-V82	C033B102E8R2D	5/16	x	5/32	6.8	10TCT-V68	C035B102S6R8D	3/8	x	1/4	18	10TCW-Q18	C048B102E180J	5/16	x	5/32									
10	10TCR-Q10	C033B102E100J	5/16	x	5/32	8.2	10TCT-V82	C035B102S8R2D	3/8	x	1/4	20	10TCW-Q20	C048B102F500J	5/16	x	5/32									
12	10TCR-Q12	C033B102E120J	5/16	x	5/32	10	10TCT-Q10	C035B102E100J	5/16	x	5/32	22	10TCW-Q22	C048B102E220J	5/16	x	5/32									
15	10TCR-Q15	C033B102E150J	5/16	x	5/32	12	10TCT-Q12	C035B102E120J	5/16	x	5/32	25	10TCW-Q25	C048B102E250J	5/16	x	5/32									
18	10TCR-Q18	C033B102E180J	5/16	x	5/32	15	10TCT-Q15	C035B102F150J	5/16	x	5/32	27	10TCW-Q27	C048B102E270J	5/16	x	5/32									
20	10TCR-Q20	C033B102E200J	5/16	x	5/32	18	10TCT-Q18	C035B102E180J	5/16	x	5/32	30	10TCW-Q30	C048B102E300J	5/16	x	5/32									
22	10TCR-Q22	C033B102F220J	3/8	x	5/32	20	10TCT-Q20	C035B102E200J	5/16	x	5/32	33	10TCW-Q33	C048B102E330J	5/16	x	5/32									
25	10TCR-Q25	C033B102F250J	3/8	x	5/32	22	10TCT-Q22	C035B102E220J	5/16	x	5/32	39	10TCW-Q39	C048B102E390J	5/16	x	5/32									
27	10TCR-Q27	C033B102F270J	3/8	x	5/32	25	10TCT-Q25	C035B102E250J	5/16	x	5/32	47	10TCW-Q47	C048B102F470J	3/8	x	5/32									
30	10TCR-Q30	C033B102F300J	3/8	x	5/32	27	10TCT-Q27	C035B102F270J	3/8	x	5/32	50	10TCW-Q50	C048B102F500J	3/8	x	5/32									
33	10TCR-Q33	C033B102F330J	3/8	x	5/32	30	10TCT-Q30	C035B102F300J	3/8	x	5/32	56	10TCW-Q56	C048B102F560J	3/8	x	5/32									
39	10TCR-Q39	C033B102G390J	7/16	x	5/32	33	10TCT-Q33	C035B102F330J	3/8	x	5/32	68	10TCW-Q68	C048B102F680J	3/8	x	5/32									
47	10TCR-Q47	C033B102G470J	7/16	x	5/32	39	10TCT-Q39	C035B102F390J	3/8	x	5/32	75	10TCW-Q75	C048B102G750J	7/16	x	5/32									
50	10TCR-Q50	C033B102G500J	7/16	x	5/32	47	10TCT-Q47	C035B102F470J	3/8	x	5/32	82	10TCW-Q82	C048B102G820J	7/16	x	5/32									
56	10TCR-Q56	C033B102G560J	7/16	x	5/32	50	10TCT-Q50	C035B102G500J	7/16	x	5/32	100	10TCW-T10	C048B102G101J	7/16	x	5/32									
68	10TCR-Q68	C033B102H680J	1/2	x	5/32	56	10TCT-Q56	C035B102G560J	7/16	x	5/32	120	10TCW-T120	C048B102G121J	7/16	x	5/32									
75	10TCR-Q75	C033B102H750J	1/2	x	5/32	68	10TCT-Q68	C035B102G680J	7/16	x	5/32	150	10TCW-T150	C048B102H151J	1/2	x	5/32									
82	10TCR-Q82	C033A102J820J	9/16	x	5/32	75	10TCT-Q75	C035B102G750J	7/16	x	5/32	180	10TCW-T180	C048A102J181J	9/16	x	5/32									
100	10TCR-T100	C033A102J101J	9/16	x	5/32	82	10TCT-Q82	C035B102H820J	1/2	x	5/32	200	10TCW-T200	C048A102J201J	9/16	x	5/32									
120	10TCR-T120	C033A102K121J	5/8	x	5/32	100	10TCT-T100	C035B102H101J	1/2	x	5/32	220	10TCW-T220	C048A102K221J	5/8	x	5/32									
150	10TCR-T150	C033A102L151J	11/16	x	5/32	120	10TCT-T120	C035A102J121J	9/16	x	5/32	270	10TCW-T270	C048A102K271J	3/4	x	5/32									
180	10TCR-T180	C033A102M181J	3/4	x	5/32	150	10TCT-T150	C035A102K151J	5/8	x	5/32	300	10TCW-T300	C048A102L301J	11/16	x	5/32									
200	10TCR-T200	C033A102M201J	3/4	x	5/32	180	10TCT-T180	C035A102K181J	5/8	x	5/32	330	10TCW-T330	C048A102L331J	11/16	x	5/32									
220	10TCR-T220	C033A102P221J	7/8	x	5/32	200	10TCT-T200	C035A102L201J	11/16	x	5/32	390	10TCW-T390	C048A102M391J	3/4	x	5/32									
270	10TCR-T270	C033A102P271J	7/8	x	5/32	220	10TCT-T220	C035A102L221J	11/16	x	5/32	470	10TCW-T470	C048A102P471J	7/8	x	5/32									
300	10TCR-T300	C033A102P301J	7/8	x	5/32	270	10TCT-T270	C035A102M271J	3/4	x	5/32	560	10TCW-T560	C048A102P561J	7/8	x	5/32									
330	10TCR-T330	33C199	3/4	x	7/32	300	10TCT-T300	C035A102P301J	7/8	x	5/32	680	10TCW-T680	33C263	3/4	x	7/32									
390	10TCR-T390	36C321	13/16	x	7/32	330	10TCT-T330	C035A102P331J	7/8	x	5/32	750	10TCW-T750	36C363	13/16	x	7/32									
470	10TCR-T470	41C235	15/16	x	7/32	390	10TCT-T390	C035A102P391J	7/8	x	5/32	820	10TCW-T820	36C364	13/16	x	7/32									
560	10TCR-T560	41C277	15/16	x	7/32	470	10TCT-T470	36C344	13/16	x	7/32	1000	10TCW-D10	41C331	15/16	x	7/32									
N330									560	10TCT-T560	41C248	15/16	x	7/32	1200	10TCW-D120	41C332	15/16	x	7/32						
3.0	10TCS-V30	C034B102S3R0D	3/8	x	1/4	680	10TCT-T680	41C291	15/16	x	7/32	N2200														
3.3	10TCS-V33	C034B102S3R3D	3/8	x	1/4	750	10TCT-T750	41C292	15/16	x	7/32	10	10TCY-Q10	C041B102S100J	3/8	x	1/4									
3.9	10TCS-V39	C034B102S3R9D	3/8	x	1/4	N750									12	10TCY-Q12	C041B102S120J	3/8	x	1/4						
4.7	10TCS-V47	C034B102S4R7D	3/8	x	1/4	4.7	10TCU-V47	C036B102S4R7D	3/8	x	1/4	15	10TCY-Q15	C041B102S150J	3/8	x	1/4									
5.0	10TCS-V50	C034B102S5R0D	3/8	x	1/4	5.0	10TCU-V50	C036B102S5R0D	3/8	x	1/4	18	10TCY-Q18	C041B102S180J	3/8	x	1/4									
5.6	10TCS-V56	C034B102S5R6D	3/8	x	1/4	5.6	10TCU-V56	C036B102S5R6D	3/8	x	1/4	20	10TCY-Q20	C041B102S200J	3/8	x	1/4									
6.8	10TCS-V68	C034B102S6R8D	3/8	x	1/4	6.8	10TCU-V68	C036B102S6R8D	3/8	x	1/4	22	10TCY-Q22	C041B102E220J	5/16	x	5/32									
8.2	10TCS-V82	C034B102E8R2D	5/16	x	5/32	8.2	10TCU-V82	C036B102S8R2D	3/8	x	1/4	25	10TCY-Q25	C041B102E250J	5/16	x	5/32									
10	10TCS-Q10	C034B102E100J	5/16	x	5/32	10	10TCU-Q10	C036B102S100J	3/8	x	1/4	27	10TCY-Q27	C041B102E270J	5/16	x	5/32									
12	10TCS-Q12	C034B102E120J	5/16	x	5/32	12	10TCU-Q12	C036B102E120J	5/16	x	5/32	30	10TCY-Q30	C041B102E300J	5/16	x	5/32									
15	10TCS-Q15	C034B102E150J	5/16	x	5/32	15	10TCU-Q15	C036B102E150J	5/16	x	5/32	33	10TCY-Q33	C041B102E330J	5/16	x	5/32									
18	10TCS-Q18	C034B102E180J	5/16	x	5/32	18	10TCU-Q18	C036B102E180J	5/16	x	5/32	39	10TCY-Q39	C041B102E390J	5/16	x	5/32									
20	10TCS-Q20	C034B102E200J	5/16	x	5/32	20	10TCU-Q20	C036B102E200J	5/16	x	5/32	47	10TCY-Q47	C041B102E470J	5/16	x	5/32									
22	10TCS-Q22	C034B102E220J	5/16	x	5/32	22	10TCU-Q22	C036B102E220J	5/16	x	5/32	50	10TCY-Q50	C041B102E500J	5/16	x	5/32									
25	10TCS-Q25	C034B102F250J	3/8	x	5/32	25	10TCU-Q25	C036B102E250J	5/16	x	5/32	56	10TCY-Q56	C041B102E560J	5/16	x	5/32									
27	10TCS-Q27	C034B102F270J	3/8	x	5/32	27	10TCU-Q27	C036B102E270J	5/16	x	5/32	68	10TCY-Q68	C041B102E680J	5/16	x	5/32									
30	10TCS-Q30	C034B102F300J	3/8	x	5/32	30	10TCU-Q30	C036B102E300J	5/16	x	5/32	75	10TCY-Q75	C041B102E750J	5/16	x	5/32									
33	10TCS-Q33	C034B102F330J	3/8	x	5/32	33	10TCU-Q33	C036B102E330J	5/16	x	5/32	82	10TCY-Q82	C041B102F820J	3/8	x	5/32									
39	10TCS-Q39	C034B102G390J	7/16	x	5/32	39	10TCU-Q39	C036B102F390J	3/8	x	5/32	100	10TCY-T100	C041B102F101J	3/8	x	5/32									
47	10TCS-Q47	C034B102G470J	7/16	x	5/32	47	10TCU-Q47	C036B102F470J	3/8	x	5/32	120	10TCY-T120	C041B102F121J	3/8	x	5/32									
50	10TCS-Q50	C034B102G500J	7/16	x	5/32	50	10TCU-Q50	C036B102F500J	3/8	x	5/32	150	10TCY-T150	C104B102G151J	7/16	x	5/32									
56	10TCS-Q56	C034B102G560J	7/16	x	5/32	56	10TCU-Q56	C036B102F560J	3/8	x	5/32	180	10TCY-T180	C041B102G181J	7/16	x	5/32									
68	10TCS-Q68	C034B102H680J	1/2	x	5/32	68	10TCU-Q68	C036B102G680J	7/16	x	5/32	200	10TCY-T200	C041B102G201J	7/16	x	5/32									
75	10TCS-Q75	C034B102H750J	1/2	x	5/32	75	10TCU-Q75	C036B102G750J	7/16	x	5/32	220	10TCY-T220	C041B102H221J	1/2	x	5/32									
82	10TCS-Q82	C034A102J820J	9/16	x	5/32	82	10TCU-Q82	C036B102G820J	7/16	x	5/32	270	10TCY-T270	C041B102H271J	1/2	x	5/32									
100	10TCS-T100	C034A102J101J	9/16	x	5/32	100	10TCU-T100	C036B102H101J	1/2	x	5/32	300	10TCY-T300	C041A102J301J	9/16	x	5/32									
120	10TCS-T120	C034A102K121J	5/8	x	5/32	120	10TCU-T120	C036B102H121J	1/2	x	5/32	330	10TCY-T330	C041A102J331J	9/16	x	5/32									
150	10TCS-T150	C034A102L151J	11/16	x	5/32	150	10TCU-T150	C036A102J151J	5/8	x	5/32	390	10TCY-T390	C041A102J391J	9/16	x	5/32									
180	10TCS-T180	C034A102M181J	3/4	x	5/32	180	10TCU-T180	C036A102K181J	5/8	x	5/32	470	10TCY-T470	C041A102K471J	5/8	x	5/32									
200	10TCS-T200	C034A102M201J	3/4	x	5/32	200	10TCU-T200	C036A102K201J	5/8	x	5/32	560	10TCY-T560	C041A102L561J	11/16	x	5/32									
220	10TCS-T220	C034A102P221J	7/8	x	5/32	220	10TCU-T220	C036A102K221J	5/8	x	5/32	680	10TCY-T680	C041A102M681J	3/4	x	5/32									
270	1																									

SPRAGUE CAPACITORS

MICA CAPACITORS TYPE MS and 1FM MICAS

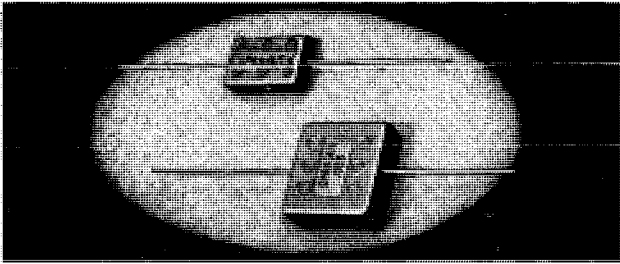

- Each Mica Capacitor Section Receives a Radio Frequency Test Before Molding
- Careful Selection and Electrical Grading of Raw Mica Assures Maximum Quality
- Section Foils on Foil Micacs are Connected to Terminals through Special Low-resistance R-F Bonds
- R-F Current Tested for Peak Ratings After Impregnation and Molding

TYPE MS — SILVERED MICA (Standard Capacitance Tolerance ±5%)

µF	Cat. No.	µF	Cat. No.	µF	Cat. No.	µF	Cat. No.
500 WVDC, 1000 V Test							
.000005	MS-55	.000068	MS-468	.000470	MS-347	.002500	MS-225
.000010	MS-41	.000070	MS-47	.000500	MS-35	.002700	MS-227
.000012	MS-412	.000075	MS-475	.000510	MS-351	.003000	MS-23
.000015	MS-415	.000082	MS-482	.000560	MS-356	.003300	MS-233
.000018	MS-418	.000091	MS-491	.000600	MS-36	.003600	MS-236
.000020	MS-42	.000100	MS-31	.000620	MS-362	.003900	MS-239
.000022	MS-422	.000110	MS-311	.000680	MS-368	.004000	MS-24
.000024	MS-424	.000120	MS-312	.000700	MS-37	.004300	MS-243
.000025	MS-425	.000130	MS-313	.000750	MS-375	.004700	MS-247
.000027	MS-427	.000150	MS-315	.000800	MS-38	.005000	MS-25
.000030	MS-43	.000160	MS-316	.000820	MS-382	.005100	MS-251
.000033	MS-433	.000180	MS-318	.000900	MS-39	.005600	MS-256
.000036	MS-436	.000200	MS-32	.000910	MS-391	.006000	MS-26
.000039	MS-439	.000220	MS-322	.001000	MS-21	.006200	MS-262
.000040	MS-44	.000240	MS-324	.001100	MS-211	300 WVDC, 600 V Test	
.000043	MS-443	.000250	MS-325	.001200	MS-212	.006800	MS-268
.000047	MS-447	.000270	MS-327	.001300	MS-213	.007000	MS-27
.000050	MS-45	.000300	MS-33	.001500	MS-215	.007500	MS-275
.000051	MS-451	.000330	MS-333	.001600	MS-216	.008000	MS-28
.000056	MS-456	.000360	MS-336	.001800	MS-218	.008200	MS-282
.000060	MS-46	.000390	MS-339	.002000	MS-22	.009000	MS-29
.000062	MS-462	.000400	MS-34	.002200	MS-222	.009100	MS-291
		.000430	MS-343	.002400	MS-224	.010000	MS-11

TYPE 1FM (Standard Capacitance Tolerance ±20%)

µF	Cat. No.	µF	Cat. No.	µF	Cat. No.	µF	Cat. No.
500 WVDC, 1000 V Test							
.000010	1FM-41	.000082	1FM-482	.000470	1FM-347	.003000	1FM-23
.000012	1FM-412	.000091	1FM-491	.000500	1FM-35	.003300	1FM-233
.000015	1FM-415	.000100	1FM-31	.000510	1FM-351	.003600	1FM-236
.000018	1FM-418	.000110	1FM-311	.000560	1FM-356	.003900	1FM-239
.000020	1FM-42	.000120	1FM-312	.000620	1FM-362	.004000	1FM-24
.000022	1FM-422	.000130	1FM-313	.000680	1FM-368	.004300	1FM-243
.000024	1FM-424	.000150	1FM-315	.000700	1FM-37	.004700	1FM-247
.000027	1FM-427	.000160	1FM-316	.000750	1FM-375	.005000	1FM-25
.000030	1FM-43	.000180	1FM-318	.000800	1FM-382	.005100	1FM-251
.000033	1FM-433	.000200	1FM-32	.000900	1FM-391	.005600	1FM-256
.000036	1FM-436	.000220	1FM-322	.001000	1FM-21	.006000	1FM-26
.000039	1FM-439	.000240	1FM-324	.001100	1FM-211	.006200	1FM-262
.000040	1FM-44	.000250	1FM-325	.001200	1FM-212	300 WVDC, 600 V Test	
.000043	1FM-443	.000270	1FM-327	.001300	1FM-213	.006800	1FM-268
.000047	1FM-447	.000300	1FM-33	.001500	1FM-215	.007000	1FM-27
.000050	1FM-45	.000330	1FM-333	.001600	1FM-216	.007500	1FM-275
.000051	1FM-451	.000360	1FM-336	.001800	1FM-218	.008000	1FM-28
.000056	1FM-456	.000390	1FM-339	.002000	1FM-22	.008200	1FM-282
.000062	1FM-462	.000400	1FM-34	.002200	1FM-222	.009000	1FM-29
.000068	1FM-468	.000430	1FM-343	.002400	1FM-224	.009100	1FM-291
				.002500	1FM-225	.010000	1FM-11
				.002700	1FM-227		

MS and 1FM Dimensions

Catalog Numbers	L x W x T	Catalog Numbers	L x W x T	Catalog Numbers	L x W x T
MS-55 thru MS-35	5/16 x 1 1/32 x 7/32	MS-233	5/16 x 5/16 x 7/32	1FM-482 thru 1FM-356	5/16 x 1 1/32 x 7/32
MS-351 thru MS-222	5/16 x 5/16 x 7/32	MS-236 thru MS-282	5/16 x 5/16 x 1 1/32	1FM-362 thru 1FM-233	5/16 x 5/16 x 7/32
MS-224	5/16 x 5/16 x 1 1/32	MS-29 thru MS-11	1 x 5/8 x 5/16	1FM-236 thru 1FM-282	5/16 x 5/16 x 1 1/32
MS-225 thru MS-227	5/16 x 5/16 x 7/32	1FM-41 thru 1FM-462	5/16 x 1 1/32 x 7/32	1FM-29 thru 1FM-11	1 x 5/8 x 5/16
MS-23	5/16 x 5/16 x 1 1/32	1FM-468 thru 1FM-475	5/16 x 5/16 x 7/32		

Tansitor ELECTRONICS, INC.

MIL-C-3965C

TANSITOR TANTALUM FOIL CAPACITORS

TYPES: CL24, CL25, CL26, CL27, CL34, CL35, CL36, CL37
 -55°C to +85°C

Tansitor Military Type 85°C capacitors are tantalum foil capacitors which will operate reliably over the temperature range -55°C to +85°C. These units are equivalent to Tansitor Type TEF capacitors.

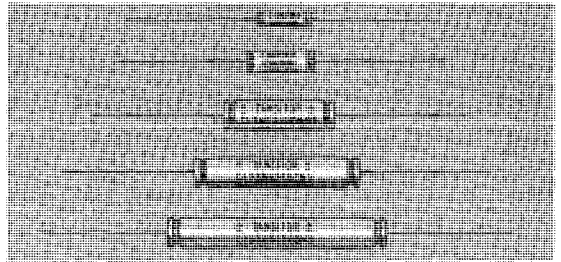

MILITARY DESIGNATION CODE

CL26 B Q 180 S N 3
 Style Temp. Characteristic Voltage Capacitance Capacitance Tolerance Polarity Vibration Grade

CASE DIMENSIONS

CL24, CL26, CL34, CL36 — Uninsulated*

CASE SIZE	Dimensions (Nominal) Length x Diameter, Inches
C1	0.688 x 0.188
C2	0.875 x 0.281
C3	1.438 x 0.375
C4	2.125 x 0.375
C5	2.750 x 0.375

*For dimensions of insulated units add approximately 0.125" to length, 0.015" to diameter.

MIL-C-3965/2 — ETCHED FOIL, POLAR

TYPE: CL24 (Uninsulated) CL25 (Insulated)

All Part Numbers are listed as CL24 Type. If insulating sleeve is required, change CL24 to CL25.

Designation Military	D.C. Volts	Mfds. Cap.	Case Size	Net Price (1-24)†	Military Designation	Volts D.C.	Cap. Mfds.	Case Size	Net Price (1-24)†
CL24BE150UP3	15	15	C1	\$ 4.20	CL24BJ101TP3	50	100	C4	20.55
CL24BE600UP3	15	60	C2	7.55	CL24BJ151TP3	50	150	C5	27.35
CL24BE201UP3	15	200	C3	12.40	CL24BL030TP3	75	3	C1	4.20
CL24BE401UP3	15	400	C4	20.55	CL24BL120TP3	75	12	C2	7.55
CL24BE581UP3	15	580	C5	27.35	CL24BL300TP3	75	30	C3	12.40
CL24BG100UP3	25	10	C1	4.20	CL24BL700TP3	75	70	C4	20.55
CL24BG400UP3	25	40	C2	7.55	CL24BL101TP3	75	100	C5	27.35
CL24BG121UP3	25	120	C3	12.40	CL24BN020SP3	100	2	C1	4.20
CL24BG251UP3	25	250	C4	20.55	CL24BN080SP3	100	8	C2	7.55
CL24BG351UP3	25	350	C5	27.35	CL24BN250SP3	100	25	C3	12.40
CL24BH080UP3	30	8	C1	4.20	CL24BN500SP3	100	50	C4	20.55
CL24BH320UP3	30	32	C2	7.55	CL24BN700SP3	100	70	C5	27.35
CL24BH111UP3	30	110	C3	12.40	CL24BQ010SP3	150	1	C1	4.20
CL24BH221UP3	30	220	C4	20.55	CL24BQ40SP3	150	4	C2	7.55
CL24BH301UP3	30	300	C5	27.35	CL24BQ130SP3	150	13	C3	12.40
CL24BJ4R5TP3	50	4.5	C1	4.20	CL24BQ250SP3	150	25	C4	20.55
CL24BJ180TP3	50	18	C2	7.55	CL24BQ360SP3	150	36	C5	27.35
CL24BJ600TP3	50	60	C3	12.40					

MIL-C-3965/12 — ETCHED FOIL, NON-POLAR

TYPE: CL26 (Uninsulated) CL27 (Insulated)

All Part Numbers are listed as CL 26 Type. If insulating sleeve is required, change CL 26 to CL27.

Military Designation	Volts D.C.	Cap. Mfds.	Case Size	Net Price (1-24)†	Military Designation	Volts D.C.	Cap. Mfds.	Case Size	Net Price (1-24)†
CL26B100UN3	15	10	C1	\$ 4.20	CL26BJ600TN3	50	60	C4	20.55
CL26B400UN3	15	40	C2	7.55	CL26BJ800TN3	50	80	C5	27.35
CL26B121UN3	15	120	C3	12.40	CL26BL1R5TN3	75	1.5	C1	4.20
CL26B251UN3	15	250	C4	20.55	CL26BL060TN3	75	6	C2	7.55
CL26B351UN3	15	350	C5	27.35	CL26BL150TN3	75	15	C3	12.40
CL26B6050UN3	25	5	C1	4.20	CL26BL350TN3	75	35	C4	20.55
CL26B6200UN3	25	20	C2	7.55	CL26BL500TN3	75	50	C5	27.35
CL26B6700UN3	25	70	C3	12.40	CL26BN101SN3	100	1	C1	4.20
CL26B6141UN3	25	140	C4	20.55	CL26BN040SN3	100	4	C2	7.55
CL26B6201UN3	25	200	C5	27.35	CL26BN120SN3	100	12	C3	12.40
CL26BH4R5UN3	30	4.5	C1	4.20	CL26BN250SN3	100	25	C4	20.55
CL26BH180UN3	30	18	C2	7.55	CL26BN350SN3	100	35	C5	27.35
CL26BH600UN3	30	60	C3	12.40	CL26BQ0R5SN3	150	0.5	C1	4.20
CL26BH121UN3	30	120	C4	20.55	CL26BQ20SN3	150	2	C2	7.55
CL26BH171UN3	30	170	C5	27.35	CL26BQ60SN3	150	6	C3	12.40
CL26BJ2R5TN3	50	2.5	C1	4.20	CL26BQ120SN3	150	12	C4	20.55
CL26BJ100TN3	50	10	C2	7.55	CL26BQ180SN3	150	18	C5	27.35
CL26BJ300TN3	50	30	C3	12.40					

MIL-C-3965/3 — PLAIN FOIL, POLAR

TYPE: CL34 (Uninsulated) CL35 (Insulated)

All Part Numbers are listed as CL34 Type. If insulating sleeve is required, change CL34 to CL35.

Military Designation	Volts D.C.	Cap. Mfds.	Case Size	Net Price (1-24)†	Military Designation	Volts D.C.	Cap. Mfds.	Case Size	Net Price (1-24)†
CL34BA100MP3	3	10	C1	\$ 4.20	CL34BJ1R5MP3	50	1.5	C1	4.20
CL34BA500MP3	3	50	C2	6.60	CL34BJ060MP3	50	6	C2	6.60
CL34BB080MP3	6	8	C1	4.20	CL34BJ200MP3	50	20	C3	10.45
CL34BB300MP3	6	30	C2	6.60	CL34BJ400MP3	50	40	C4	14.60
CL34BB101MP3	6	100	C3	10.45	CL34BJ550MP3	50	55	C5	19.60
CL34BB201MP3	6	200	C4	14.60	CL34BL010MP3	75	1	C1	4.20
CL34BB301MP3	6	300	C5	19.60	CL34BL040MP3	75	4	C2	6.60
CL34BD060MP3	10	6	C1	4.20	CL34BL140MP3	75	14	C3	10.45
CL34BD250MP3	10	25	C2	6.60	CL34BL280MP3	75	28	C4	14.60
CL34BD800MP3	10	80	C3	10.45	CL34BL400MP3	75	40	C5	19.60
CL34BD161MP3	10	160	C4	14.60	CL34BN0R8MP3	100	0.8	C1	4.20
CL34BD221MP3	10	220	C5	19.60	CL34BN030MP3	100	3	C2	6.60
CL34BE4R5MP3	15	4.5	C1	4.20	CL34BN100MP3	100	10	C3	10.45
CL34BE100MP3	15	10	C2	6.60	CL34BN200MP3	100	20	C4	14.60
CL34BE180MP3	15	18	C2	6.60	CL34BN300MP3	100	30	C5	19.60
CL34BE550MP3	15	55	C3	10.45	CL34BQ0R5MP3	150	0.5	C1	4.20
CL34BE111MP3	15	110	C4	14.60	CL34BQ020MP3	150	2	C2	6.60
CL34BE161MP3	15	160	C5	19.60	CL34BQ40MP3	150	4	C3	10.45
CL34BH2R5MP3	30	2.5	C1	4.20	CL34BQ70MP3	150	7	C3	10.45
CL34BH300MP3	30	30	C3	10.45	CL34BQ80MP3	150	8	C4	14.60
CL34BH600MP3	30	60	C4	14.60	CL34BQ120MP3	150	12	C4	14.60
CL34BH850MP3	30	85	C5	19.60	CL34BQ140MP3	150	14	C4	14.60
					CL34BQ200MP3	150	20	C5	19.60

MIL-C-3965/14 — PLAIN FOIL, NON-POLAR

TYPE: CL36 (Uninsulated) CL37 (Insulated)

All Part Numbers are listed as CL36 Type. If insulating sleeve is required, change CL36 to CL37.

Military Designation	Volts D.C.	Cap. Mfds.	Case Size	Net Price (1-24)†	Military Designation	Volts D.C.	Cap. Mfds.	Case Size	Net Price (1-24)†
CL36BA100MN3	3	10	C1	\$ 4.20	CL36BH1R4MN3	30	1.4	C1	\$ 4.20
CL36BA150MN3	3	45	C2	6.60	CL36BH5R5MN3	30	5.5	C2	6.60
CL36BA141MN3	3	140	C3	10.45	CL36BH180MN3	30	18	C3	10.45
CL36BA281MN3	3	280	C4	14.60	CL36BH360MN3	30	36	C4	14.60
CL36BA401MN3	3	400	C5	19.60	CL36BH450MN3	30	45	C5	19.60
CL36B070MN3	6	7	C1	4.20	CL36BJ0R8MN3	50	0.8	C1	4.20
CL36B250MN3	6	25	C2	6.60	CL36BJ030MN3	50	3	C2	6.60
CL36B850MN3	6	85	C3	10.45	CL36BJ100MN3	50	10	C3	10.45
CL36B171MN3	6	170	C4	14.60	CL36BJ200MN3	50	20	C4	14.60
CL36B251MN3	6	250	C5	19.60	CL36BJ300MN3	50	30	C5	19.60
CL36BD040MN3	10	4	C1	4.20	CL36BL0R5MN3	75	0.5	C1	4.20
CL36BD160MN3	10	16	C2	6.60	CL36BL020MN3	75	2	C2	6.60
CL36BD550MN3	10	55	C3	10.45	CL36BL070MN3	75	7	C3	10.45
CL36BD111MN3	10	110	C4	14.60	CL36BL140MN3	75	14	C4	14.60
CL36BD151MN3	10	150	C5	19.60	CL36BL200MN3	75	20	C5	19.60
CL36BE2R5MN3	15	2.5	C1	4.20	CL36BN0R4MN3	100	0.4	C1	4.20
CL36BE100MN3	15	10	C2	6.60	CL36BN1R5MN3	100	1.5	C2	6.60
CL36BE350MN3	15	35	C3	10.45	CL36BN050MN3	100	5	C3	10.45
CL36BE700MN3	15	70	C4	14.60	CL36BN100MN3	100	10	C4	14.60
CL36BE101MN3	15	100	C5	19.60	CL36BN150MN3	100	15	C5	19.60
CL36BG1R5MN3	25	1.5	C1	4.20	CL36BQ0R5MN3	150	0.25	C1	4.20
CL36BG060MN3	25	6	C2	6.60	CL36BQ010MN3	150	1	C2	6.60
CL36BG200MN3	25	20	C3	10.45	CL36BQ3R5MN3	150	3.5	C3	10.45
CL36BG400MN3	25	40	C4	14.60	CL36BQ070MN3	150	7	C4	14.60
CL36BG600MN3	25	60	C5	19.60	CL36BQ100MN3	150	10	C5	19.60

†See your Tansitor Distributor for prices for 25 or more pieces.

Tansitor ELECTRONICS, INC.

TANSITOR TANTALUM CAPACITORS

TYPE: TES -55°C to +85°C

Tansitor Type TES tantalum capacitors are unique small foil tantalum capacitors ideally suited for use in printed circuits. They are similar in performance to CL34 and CL24 type capacitors, but offer significant savings in space because both leads emerge from one end of the capacitors. They operate reliably over the temperature range of -55°C to +85°C.

CASE DIMENSIONS (Uninsulated)*

CASE SIZE	Dimensions (Nominal) Length x Diameter, Inches
C1	0.650 x 0.312
C2	1.000 x 0.375

*For dimensions of insulated units add approximately 0.125" to length, 0.030" to diameter.

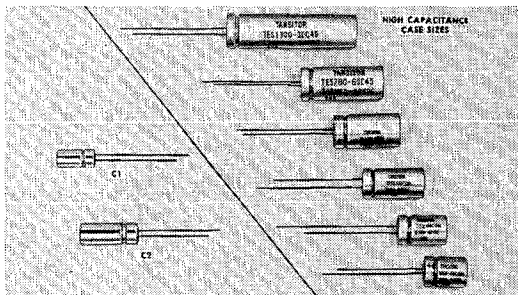

**HIGH CAPACITANCE TYPE
CASE DIMENSIONS (Uninsulated)***

CASE SIZE	Dimensions (Nominal) Length x Diameter, Inches	CASE SIZE	Dimensions (Nominal) Length x Diameter, Inches
C30	0.813 x 0.563	C40	0.813 x 0.625
C32	0.938 x 0.563	C42	0.938 x 0.625
C33	1.188 x 0.563	C43	1.188 x 0.625
C34	1.250 x 0.563	C44	1.250 x 0.625
C35	1.563 x 0.563	C45	1.563 x 0.625
C36	1.688 x 0.563	C46	1.688 x 0.625
C37	1.938 x 0.563	C47	1.938 x 0.625
C38	2.188 x 0.563	C48	2.188 x 0.625
C39	2.438 x 0.563	C49	2.438 x 0.625

*For dimensions of insulated units add approximately 0.065" to length, 0.015" to diameter.

ETCHED FOIL, POLAR*

VOLTS D.C.	CASE SIZE	CAP. MFDS.	TANSITOR ¹ CATALOG NO.	NET PRICE (1-24)†
6	C1	220	TES220-6C1	3.74
	C2	600	TES600-6C2	6.10
10	C1	140	TES140-10C1	3.74
	C2	375	TES375-10C2	6.10
15	C1	90	TES90-15C1	3.74
	C2	250	TES250-15C2	6.10
20	C1	70	TES70-20C1	3.74
	C2	180	TES180-20C2	6.10
35	C1	35	TES35-35C1	3.74
	C2	100	TES100-35C2	6.10
50	C1	25	TES25-50C1	3.74
	C2	60	TES60-50C2	6.10
60	C1	19	TES19-60C1	3.74
	C2	50	TES50-60C2	6.10
75	C1	14	TES14-75C1	3.74
	C2	35	TES35-75C2	6.10
100	C1	8.5	TES8.5-100C1	3.74
	C2	20	TES20-100C2	6.10
125	C1	5	TES5-125C1	3.74
	C2	14	TES14-125C2	6.10
150	C1	3.5	TES3.5-150C1	3.74
	C2	10	TES10-150C2	6.10

ETCHED FOIL, NON-POLAR*

VOLTS D.C.	CASE SIZE	CAP. MFDS.	TANSITOR ¹ CATALOG NO.	NET PRICE (1-24)†
6	C1	150	TES150-6C1N	3.74
	C2	350	TES350-6C2N	6.10
10	C1	80	TES80-10C1N	3.74
	C2	200	TES200-10C2N	6.10
15	C1	50	TES50-15C1N	3.74
	C2	140	TES140-15C2N	6.10
20	C1	35	TES35-20C1N	3.74
	C2	100	TES100-20C2N	6.10
35	C1	18	TES18-35C1N	3.74
	C2	50	TES50-35C2N	6.10
50	C1	13	TES13-50C1N	3.74
	C2	30	TES30-50C2N	6.10
60	C1	9.5	TES9.5-60C1N	3.74
	C2	25	TES25-60C2N	6.10
75	C1	7	TES7-75C1N	3.74
	C2	18	TES18-75C2N	6.10
100	C1	4.2	TES4.2-100C1N	3.74
	C2	10	TES10-100C2N	6.10
125	C1	2.5	TES2.5-125C1N	3.74
	C2	7	TES7-125C2N	6.10
150	C1	1.8	TES1.8-150C1N	3.74
	C2	5	TES5-150C2N	6.10

*Ratings in plain foil also available.

HIGH CAPACITANCE FOIL, POLAR

VOLTS D.C.	CASE SIZE	CAP. MFDS.	TANSITOR ¹ CATALOG NO.	NET PRICE (1-24)†
3	C40	2000	TES2000-3C40	8.84
	C42	3000	TES3000-3C42	13.20
	C43	4000	TES4000-3C43	17.42
	C44	5000	TES5000-3C44	22.04
	C45	7000	TES7000-3C45	30.80
	C46	8000	TES8000-3C46	35.16
	C47	10000	TES10K-3C47	44.00
	C48	12000	TES12K-3C48	52.76
	C49	14000	TES14K-3C49	61.54
	25	C30	170	TES170-25C30
C32		260	TES260-25C32	9.60
C33		350	TES350-25C33	12.80
C34		430	TES430-25C34	16.00
C35		600	TES600-25C35	22.38
C36		690	TES690-25C36	25.36
C37		870	TES870-25C37	31.96
C38		1000	TES1000-25C38	38.36
C39		1200	TES1200-25C39	44.74
50		C40	100	TES100-50C40
	C42	150	TES150-50C42	13.20
	C43	210	TES210-50C43	17.42
	C44	260	TES260-50C44	22.04
	C45	360	TES360-50C45	30.80
	C46	410	TES410-50C46	35.16
	C47	520	TES520-50C47	44.00
	C48	620	TES620-50C48	52.76
	C49	720	TES720-50C49	61.54
	100	C30	27	TES27-100C30
C32		41	TES41-100C32	9.60
C33		55	TES55-100C33	12.80
C34		68	TES68-100C34	16.00
C35		95	TES95-100C35	22.38
C36		110	TES110-100C36	25.36
C37		140	TES140-100C37	31.96
C38		160	TES160-100C38	38.36
C39		190	TES190-100C39	44.74
150		C40	23	TES23-150C40
	C42	34	TES34-150C42	13.20
	C43	46	TES46-150C43	17.42
	C44	57	TES57-150C44	22.04
	C45	80	TES80-150C45	30.80
	C46	92	TES92-150C46	35.16
	C47	115	TES115-150C47	44.00
	C48	140	TES140-150C48	52.76
	C49	160	TES160-150C49	61.54

HIGH CAPACITANCE FOIL, NON-POLAR

VOLTS D.C.	CASE SIZE	CAP. MFDS.	TANSITOR ¹ CATALOG NO.	NET PRICE (1-24)†
25	C40	140	TES140-25C40N	8.84
	C42	210	TES210-25C42N	13.20
	C43	280	TES280-25C43N	17.42
	C44	350	TES350-25C44N	22.04
	C45	490	TES490-25C45N	30.80
	C46	550	TES550-25C46N	35.16
	C47	690	TES690-25C47N	44.00
	C48	830	TES830-25C48N	52.76
	C49	970	TES970-25C49N	61.54
	50	C30	37	TES37-50C30N
C32		55	TES55-50C32N	9.60
C33		75	TES75-50C33N	12.80
C34		90	TES90-50C34N	16.00
C35		130	TES130-50C35N	22.38
C36		150	TES150-50C36N	25.36
C37		180	TES180-50C37N	31.96
C38		220	TES220-50C38N	38.36
C39		260	TES260-50C39N	44.74
150		C30	8	TES8-150C30N
	C32	12	TES12-150C32N	9.60
	C33	16	TES16-150C33N	12.80
	C34	20	TES20-150C34N	16.00
	C35	28	TES28-150C35N	22.38
	C36	33	TES33-150C36N	25.36
	C37	41	TES41-150C37N	31.96
	C38	50	TES50-150C38N	38.36
	C39	57	TES57-150C39N	44.74

¹When insulating tube is desired, add letter "I" as a suffix to catalog number.

†See your Tansitor Distributor for prices for 25 or more pieces.

Tansitor ELECTRONICS, INC.

MIL-C-3965C TANSITOR TANTALUM CAPACITORS TYPES: CL64 & CL65 — CHARACTERISTICS "B" & "C" —55°C to +85°C and —55°C to +125°C

Tansitor wet sintered anode capacitors listed herein are manufactured to meet all the requirements of MIL-C-3965C for MIL types CL64 and CL65. Encased in a fine silver can, the sintered porous tantalum anode provides exceptionally high capacitance per unit volume. These units exhibit extremely low leakage currents, low power factor, and little change in capacitance with frequency.

As opposed to "Shoulder Type" construction of other wet types, the CL64 and CL65 offer a straight cylindrical shape, readily lending them to flat circuit applications. CL 64 and CL65 styles are equivalent to Tansitor Type W. Tansitor Type WF equivalent with neutral electrolyte is also available.

CASE DIMENSIONS — CL64, CL65 (Uninsulated)*

CASE SIZE	Dimensions (Nominal) Length x Diameter, Inches
T1	0.453 x 0.188
T2	0.641 x 0.281
T3	0.766 x 0.375

*For dimensions of insulated units add approximately 0.065" to length, 0.015" to diameter. Basic case dimensions for insulated style are same as uninsulated.

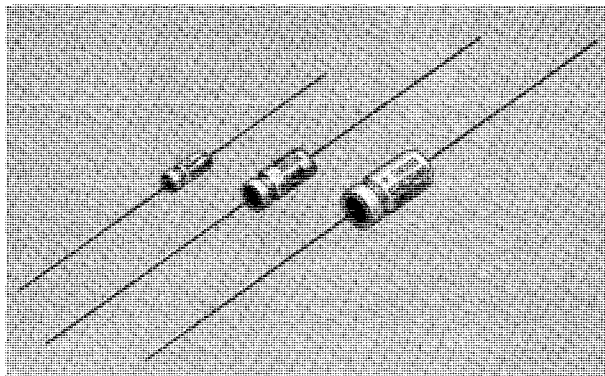

MILITARY DESIGNATION CODE

CL65	C	J	050	M	P	3
Style	Temp. Characteristic	Voltage	Capacitance	Capacitance Tolerance	Polarity	Vibration Grade

STANDARD MILITARY 125°C RATINGS† TYPE: CL64 & CL65 — CHARACTERISTIC "C"

MIL-C-3965** DESIGNATION	VOLTS D.C. AT 125°C	CAPACITY MFDS.	CASE SIZE	NET PRICE (1-24)†
CL64(65)CB300MP3	4	30	T1	\$2.30
CL64(65)CB680MP3	4	68	T1	2.30
CL64(65)CB141MP3	4	140	T2	3.52
CL64(65)CB271MP3	4	270	T2	3.52
CL64(65)CB331MP3	4	330	T3	5.56
CL64(65)CB561MP3	4	560	T3	5.56
CL64(65)CC250MP3	5	25	T1	2.30
CL64(65)CC560MP3	5	56	T1	2.30
CL64(65)CC221MP3	5	220	T2	3.52
CL64(65)CC431MP3	5	430	T3	5.56
CL64(65)CD200MP3	7	20	T1	2.30
CL64(65)CD470MP3	7	47	T1	2.30
CL64(65)CD101MP3	7	100	T2	3.52
CL64(65)CD181MP3	7	180	T2	3.52
CL64(65)CD251MP3	7	250	T3	5.56
CL64(65)CD391MP3	7	390	T3	5.56
CL64(65)CE150MP3	10	15	T1	2.30
CL64(65)CE330MP3	10	33	T1	2.30
CL64(65)CE700MP3	10	70	T2	3.52
CL64(65)CE121MP3	10	120	T2	3.52
CL64(65)CE171MP3	10	170	T3	5.56
CL64(65)CE271MP3	10	270	T3	5.56
CL64(65)CG100MP3	15	10	T1	2.30
CL64(65)CG220MP3	15	22	T1	2.30
CL64(65)CG101MP3	15	100	T2	3.52
CL64(65)CG181MP3	15	180	T3	5.56
CL64(65)CH080MP3	20	8	T1	2.30
CL64(65)CH150MP3	20	15	T1	2.30
CL64(65)CH400MP3	20	40	T2	3.52
CL64(65)CH680MP3	20	68	T2	3.52
CL64(65)CH101MP3	20	100	T3	5.56
CL64(65)CH151MP3	20	150	T3	5.56

MIL-C-3965** DESIGNATION	VOLTS D.C. AT 125°C	CAPACITY MFDS.	CASE SIZE	NET PRICE (1-24)†
CL64(65)CJ050MP3	30	5	T1	\$2.30
CL64(65)CJ100MP3	30	10	T1	2.30
CL64(65)CJ250MP3	30	25	T2	3.52
CL64(65)CJ470MP3	30	47	T2	3.52
CL64(65)CJ600MP3	30	60	T3	5.56
CL64(65)CJ820MP3	30	82	T3	5.56
CL64(65)CK040MP3	40	4	T1	2.30
CL64(65)CK8R2MP3	40	8.2	T1	2.30
CL64(65)CK200MP3	40	20	T2	3.52
CL64(65)CK390MP3	40	39	T2	3.52
CL64(65)CK500MP3	40	50	T3	5.56
CL64(65)CK680MP3	40	68	T3	5.56
CL64(65)CL3R5MP3	50	3.5	T1	2.30
CL64(65)CL6R8MP3	50	6.8	T1	2.30
CL64(65)CL150MP3	50	15	T2	3.52
CL64(65)CL330MP3	50	33	T2	3.52
CL64(65)CL400MP3	50	40	T3	5.56
CL64(65)CL560MP3	50	56	T3	5.56
CL64(65)CN2R5MP3	70	2.5	T1	2.30
CL64(65)CN4R7MP3	70	4.7	T1	2.30
CL64(65)CN110MP3	70	11	T2	3.52
CL64(65)CN220MP3	70	22	T2	3.52
CL64(65)CN300MP3	70	30	T3	5.56
CL64(65)CN430MP3	70	43	T3	5.56
CL64(65)CP1R7MP3	85	1.7	T1	2.30
CL64(65)CP3R6MP3	85	3.6	T1	2.30
CL64(65)CP090MP3	85	9	T2	3.52
CL64(65)CP140MP3	85	14	T2	3.52
CL64(65)CP250MP3	85	25	T3	5.56

†See your Tansitor Distributor for prices for 25 or more pieces.

**CL64 indicates uninsulated capacitors. If outer insulating sleeve is required, change CL64 to CL65.

†Standard Military 85°C Ratings (formerly "B" characteristic) are also available.

TANSITOR MICRO-MODULE — TANTALUM CAPACITORS DISC TYPE — -80°C to +125°C

Tansitor Disc Type are a new concept in tantalum capacitors. This capacitor has the best volumetric efficiency of any tantalum capacitor yet designed and produced for volume use. Specifically aimed at the micro-module market it supplements other Tansitor tantalum capacitors. Its characteristics include extremely low electrical leakage current, high capacitance per unit volume, exceptional stability over its temperature range -80°C to +125°C.

Unit	B, ±1/4"	DIMENSIONS FOR D TYPE				NET PRICE (1-24)†
		C, Max.	D, ±0.015"	E, ±0.001"	F, ±0.001"	
C1	1 1/2"	0.060"	0.100"	0.010"	0.010"	\$4.00
C2	1 1/2"	0.100"	0.100"	0.010"	0.010"	4.50
C3	1 1/2"	0.060"	0.250"	0.010"	0.010"	5.00
C4	1 1/2"	0.100"	0.250"	0.010"	0.010"	5.50
C5	1 1/2"	0.060"	0.500"	0.010"	0.010"	6.00
C6	1 1/2"	0.100"	0.500"	0.010"	0.010"	6.50

DISC CAPACITORS

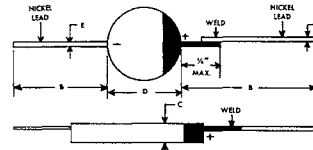

These capacitors are not intended to be mounted by their leads.

RATINGS AT 85 °C

RATED VOLTAGE AT 85°C	DIMENSIONS OF UNITS											
	C1 0.100" Dia. x 0.060"		C2 0.100" Dia. x 0.100"		C3 0.250" Dia. x 0.060"		C4 0.250" Dia. x 0.100"		C5 0.500" Dia. x 0.060"		C6 0.500" Dia. x 0.100"	
	CAP.	PART NO.	CAP.	PART NO.	CAP.	PART NO.	CAP.	PART NO.	CAP.	PART NO.	CAP.	PART NO.
3VDC	2.5	D2.5-3C1	5	D5-3C2	20	D20-3C3	40	D40-3C4	80	D80-3C5	160	D160-3C6
5	1.5	D1.5-5C1	3	D3-5C2	12	D12-5C3	24	D24-5C4	48	D48-5C5	96	D96-5C6
6	1.2	D1.2-6C1	2.4	D2.4-6C2	10	D10-6C3	20	D20-6C4	40	D40-6C5	80	D80-6C6
10	0.8	D0.8-10C1	1.6	D1.6-10C2	6	D6-10C3	12	D12-10C4	24	D24-10C5	48	D48-10C6
15	0.5	D0.5-15C1	1	D1-15C2	4	D4-15C3	8	D8-15C4	16	D16-15C5	32	D32-15C6
20	0.4	D0.4-20C1	0.8	D0.8-20C2	3	D3-20C3	6	D6-20C4	12	D12-20C5	24	D24-20C6
25	0.3	D0.3-25C1	0.6	D0.6-25C2	2.4	D2.4-25C3	4.8	D4.8-25C4	9.5	D9.5-25C5	19	D19-25C6
30	0.25	D0.25-30C1	0.5	D0.5-30C2	2	D2-30C3	4	D4-30C4	8	D8-30C5	16	D16-30C6
35	0.2	D0.2-35C1	0.4	D0.4-35C2	1.5	D1.5-35C3	3	D3-35C4	7	D7-35C5	14	D14-35C6
35	0.15	D0.15-35C1	0.3	D0.3-35C2	1.2	D1.2-35C3	2.4	D2.4-35C4	5	D5-35C5	10	D10-35C6
35	0.12	D0.12-35C1	0.24	D0.24-35C2	1	D1-35C3	2	D2-35C4	4	D4-35C5	8	D8-35C6

Tansitor ELECTRONICS, INC.

TANSITOR TYPE S POLAR AND NON-POLAR SOLID TANTALUM CAPACITORS

Tansitor Type S Polar and Non-polar Solid Tantalum Capacitors are designed for continuous, dependable use over their full operating range of -80°C to +125°C. The units are similar to MIL Styles CS12 and CS13.

These advantages for the design engineer are further enhanced by the excellent showing made by S type units under conditions of high frequency application and when subjected to extensive vibration and shock, including all the stringent environmental requirements of MIL-C-26655, Styles CS12 and CS13.

TYPE S POLARIZED CAPACITORS

Net Price (1-24)†

Case Size	Price (±20% tol.)	Case Size	Price (±20% tol.)
C1	\$1.29	C3	\$2.18
C2	1.52	C4	4.70

NOTE: Add 2¢ to unit price if sleeving is required.

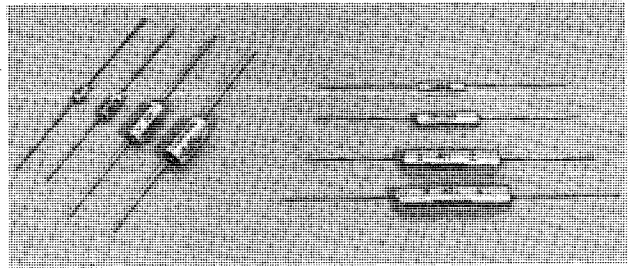

STANDARD RATINGS OF TYPE S POLARIZED SOLID ELECTROLYTE TANTALUM CAPACITORS*

Cap. Mfds.	6VDC	10VDC	15VDC	20VDC	35VDC
0.0047	S0.0047-6C1	S0.0047-10C1	S0.0047-15C1	S0.0047-20C1	S0.0047-35C1
0.0056	S0.0056-6C1	S0.0056-10C1	S0.0056-15C1	S0.0056-20C1	S0.0056-35C1
0.0068	S0.0068-6C1	S0.0068-10C1	S0.0068-15C1	S0.0068-20C1	S0.0068-35C1
0.0082	S0.0082-6C1	S0.0082-10C1	S0.0082-15C1	S0.0082-20C1	S0.0082-35C1
0.01	S0.01-6C1	S0.01-10C1	S0.01-15C1	S0.01-20C1	S0.01-35C1
0.012	S0.012-6C1	S0.012-10C1	S0.012-15C1	S0.012-20C1	S0.12-35C1
0.015	S0.015-6C1	S0.015-10C1	S0.015-15C1	S0.015-20C1	S0.015-35C1
0.018	S0.018-6C1	S0.018-10C1	S0.018-15C1	S0.018-20C1	S0.018-35C1
0.022	S0.022-6C1	S0.022-10C1	S0.022-15C1	S0.022-20C1	S0.022-35C1
0.027	S0.027-6C1	S0.027-10C1	S0.027-15C1	S0.027-20C1	S0.027-35C1
0.033	S0.033-6C1	S0.033-10C1	S0.033-15C1	S0.033-20C1	S0.033-35C1
0.039	S0.039-6C1	S0.039-10C1	S0.039-15C1	S0.039-20C1	S0.039-35C1
0.047	S0.047-6C1	S0.047-10C1	S0.047-15C1	S0.047-20C1	S0.047-35C1
0.056	S0.056-6C1	S0.056-10C1	S0.056-15C1	S0.056-20C1	S0.056-35C1
0.068	S0.068-6C1	S0.068-10C1	S0.068-15C1	S0.068-20C1	S0.068-35C1
0.082	S0.082-6C1	S0.082-10C1	S0.082-15C1	S0.082-20C1	S0.082-35C1
0.1	S0.1-6C1	S0.1-10C1	S0.1-15C1	S0.1-20C1	S0.1-35C1
0.12	S0.12-6C1	S0.12-10C1	S0.12-15C1	S0.12-20C1	S0.12-35C1
0.15	S0.15-6C1	S0.15-10C1	S0.15-15C1	S0.15-20C1	S0.15-35C1
0.18	S0.18-6C1	S0.18-10C1	S0.18-15C1	S0.18-20C1	S0.18-35C1
0.22	S0.22-6C1	S0.22-10C1	S0.22-15C1	S0.22-20C1	S0.22-35C1
0.27	S0.27-6C1	S0.27-10C1	S0.27-15C1	S0.27-20C1	S0.27-35C1
0.33	S0.33-6C1	S0.33-10C1	S0.33-15C1	S0.33-20C1	S0.33-35C1
0.39	S0.39-6C1	S0.39-10C1	S0.39-15C1	S0.39-20C1	S0.39-35C1
0.47	S0.47-6C1	S0.47-10C1	S0.47-15C1	S0.47-20C1	S0.47-35C1
0.56	S0.56-6C1	S0.56-10C1	S0.56-15C1	S0.56-20C1	S0.56-35C1
0.68	S0.68-6C1	S0.68-10C1	S0.68-15C1	S0.68-20C1	S0.68-35C1
0.82	S0.82-6C1	S0.82-10C1	S0.82-15C1	S0.82-20C1	S0.82-35C1
1.0	S1.0-6C1	S1.0-10C1	S1.0-15C1	S1.0-20C1	S1.0-35C1
1.2	S1.2-6C1	S1.2-10C1	S1.2-15C1	S1.2-20C1	S1.2-35C2

Cap. Mfds.	6VDC	10VDC	15VDC	20VDC	35VDC
1.5	S1.5-6C1	S1.5-10C1	S1.5-15C1	S1.5-20C1	S1.5-35C2
1.8	S1.8-6C1	S1.8-10C1	S1.8-15C1	S1.8-20C1	S1.8-35C2
2.2	S2.2-6C1	S2.2-10C1	S2.2-15C1	S2.2-20C1	S2.2-35C2
2.7	S2.7-6C1	S2.7-10C1	S2.7-15C1	S2.7-20C2	S2.7-35C2
3.3	S3.3-6C1	S3.3-10C1	S3.3-15C1	S3.3-20C2	S3.3-35C2
3.9	S3.9-6C1	S3.9-10C1	S3.9-15C2	S3.9-20C2	S3.9-35C2
4.7	S4.7-6C1	S4.7-10C1	S4.7-15C1	S4.7-20C2	S4.7-35C2
5.6	S5.6-6C1	S5.6-10C2	S5.6-15C2	S5.6-20C2	S5.6-35C2
6.8	S6.8-6C1	S6.8-10C2	S6.8-15C2	S6.8-20C2	S6.8-35C2
8.2	S8.2-6C2	S8.2-10C1	S8.2-10C2	S8.2-20C2	S8.2-35C3
10.0	S10-6C2	S10-10C2	S10-15C2	S10-20C2	S10-35C3
12.0	S12-6C2	S12-10C2	S12-15C2	S12-20C2	S12-35C3
15.0	S15-6C2	S15-10C2	S15-15C2	S15-20C2	S15-35C3
18.0	S18-6C2	S18-10C2	S18-15C2	S18-20C3	S18-35C3
22.0	S22-6C2	S22-10C2	S22-15C2	S22-20C3	S22-35C3
27.0	S27-6C2	S27-10C2	S27-15C3	S27-20C3	S27-35C4
33.0	S33-6C2	S33-10C2	S33-15C3	S33-20C3	S33-35C4
39.0	S39-6C2	S39-10C2	S39-15C3	S39-20C3	S39-35C4
47.0	S47-6C2	S47-10C3	S47-15C3	S47-20C3	S47-35C4
56.0	S56-6C2	S56-10C3	S56-15C3	S56-20C4	xxxxxxxx
68.0	S68-6C3	S68-10C3	S68-15C3	S68-20C4	xxxxxxxx
82.0	S82-6C3	S82-10C3	S82-15C4	S82-20C4	xxxxxxxx
100.0	S100-6C3	S100-10C3	S100-15C4	S100-20C4	xxxxxxxx
120.0	S120-6C3	S120-10C3	S120-15C4	xxxxxxxx	xxxxxxxx
150.0	S150-6C3	S150-10C4	S150-15C4	xxxxxxxx	xxxxxxxx
180.0	S180-6C3	S180-10C4	xxxxxxxx	xxxxxxxx	xxxxxxxx
220.0	S220-6C4	S220-10C4	xxxxxxxx	xxxxxxxx	xxxxxxxx
270.0	S270-6C4	xxxxxxxx	xxxxxxxx	xxxxxxxx	xxxxxxxx
330.0	S330-6C4	xxxxxxxx	xxxxxxxx	xxxxxxxx	xxxxxxxx

*TO COMPLETE PART NUMBERS, ADD APPLICABLE TOLERANCE LETTER, AND IF FLEXIBLE OUTER INSULATING SLEEVE IS REQUIRED, ADD FINAL SUFFIX LETTER "I"

POLAR CASE DIMENSIONS (Uninsulated)*			
CASE SIZE	Dimensions (Nominal) Length x Diameter, Inches	CASE SIZE	Dimensions (Nominal) Length x Diameter, Inches
C1	0.125 x 0.250	C3	0.279 x 0.650
C2	0.175 x 0.438	C4	0.341 x 0.750

NON-POLAR CASE DIMENSIONS (Uninsulated)*			
CASE SIZE	Dimensions (Nominal) Length x Diameter, Inches	CASE SIZE	Dimensions (Nominal) Length x Diameter, Inches
N1	0.145 x 0.540	N3	0.304 x 1.320
N2	0.197 x 0.915	N4	0.366 x 1.520

*For dimensions of insulated units add approximately 0.063" to length, 0.015" to diameter.

STANDARD RATINGS OF TYPE S NON-POLAR SOLID ELECTROLYTE TANTALUM CAPACITORS*

Cap. Mfds.	6 Volts	10 Volts	15 Volts	20 Volts	35 Volts
0.16	S0.16-6N1	S0.16-10N1	S0.16-15N1	S0.16-20N1	S0.16-35N1
0.24	S0.24-6N1	S0.24-10N1	S0.24-15N1	S0.24-20N1	S0.24-35N1
0.34	S0.34-6N1	S0.34-10N1	S0.34-15N1	S0.34-20N1	S0.34-35N1
0.50	S0.50-6N1	S0.50-10N1	S0.50-15N1	S0.50-20N1	S0.50-35N1
0.75	S0.75-6N1	S0.75-10N1	S0.75-15N1	S0.75-20N1	S0.75-35N2
1.1	S1.1-6N1	S1.1-10N1	S1.1-15N1	S1.1-20N1	S1.1-35N2
1.6	S1.6-6N1	S1.6-10N1	S1.6-15N1	S1.6-20N2	S1.6-35N2
2.4	S2.4-6N1	S2.4-10N1	S2.4-15N2	S2.4-20N2	S2.4-35N2
3.4	S3.4-6N1	S3.4-10N2	S3.4-15N2	S3.4-20N2	S3.4-35N2
5.0	S5-6N2	S5-10N2	S5-15N2	S5-20N2	S5-35N3
7.5	S7.5-6N2	S7.5-10N2	S7.5-15N2	S7.5-20N2	S7.5-35N3
11.0	S11-6N2	S11-10N2	S11-15N2	S11-20N3	S11-35N3
16.0	S16-6N2	S16-10N2	S16-15N3	S16-20N3	S16-35N4
24.0	S24-6N2	S24-10N3	S24-15N3	S24-20N3	S24-35N4
34.0	S34-6N3	S34-10N3	S34-15N3	S34-20N4	xxxxxxxx
50.0	S50-6N3	S50-10N3	S50-15N4	S50-20N4	xxxxxxxx
75.0	S75-6N3	S75-10N4	S75-15N4	xxxxxxxx	xxxxxxxx
110.0	S110-6N4	S110-10N4	xxxxxxxx	xxxxxxxx	xxxxxxxx
160.0	S160-6N4	xxxxxxxx	xxxxxxxx	xxxxxxxx	xxxxxxxx

Type S, Non-Polar Capacitors

Net Price (1-24)†	
Case Size	Price (±20% tol.)
C1	\$2.78
C2	3.24
C3	5.34
C4	9.70

NOTE: Add 2¢ to unit price if sleeving is required.

*To complete part numbers, add applicable tolerance letter, and if flexible outer insulating sleeve is required, add final suffix letter "I"

†See your Tansitor distributor for prices for 25 or more pieces.

CHEMTRONICS

CHEMTRONICS



COLOR LUBE Non-Drift Color TV Tuner Cleaner

A tuner cleaner specially formulated with TC-5 to safely clean and lubricate all color TV tuners.

- Will not detune tuners • Safe for all plastics • Non-flammable

Cat. No.	Unit Size	Dealer Net
CL 8	8 oz.	2.39

SUPER FROST AID Cools Faster • Leaves No Liquid Residue

SUPER FROST AID is a faster circuit freezer designed to locate thermal intermittent components...without leaving a liquid residue.

Cat. No.	Unit Size	Dealer Net
1550	15-oz.	2.79



new New TUN-O-LUBE Tuner Cleaner Specially Formulated for Nuvistor & Transistor Tuners

- Leaves NO oily residual deposits
- Fast drying
- Will not detune the most critical tuners
- Safe for all plastics
- Non-flammable

Cat. No.	Unit Size	Dealer Net
800	8 oz.	1.98

FROST AID Saves Hours in Locating Defective Components

FROST AID is a circuit freezer used to instantly cool and pin-point suspected intermittent resistors, capacitors, coils and other components.

Cat. No.	Description	Unit Size	Dealer Net
850	8 oz. ECONOMY SIZE	8-oz.	1.39
1650	16 oz. GIANT SIZE	16-oz.	2.19



TUN-O-LUBE Triple Action Tuner Cleaner

Cleans • Lubricates • Protects

CHEMTRONICS "Non-Drift" TUN-O-LUBE is designed to clean and lubricate tuners in one simple operation.

- Will not harm plastic parts
- Non-flammable

AVAILABLE IN THREE SIZES

Cat. No.	Description	Unit Size	Dealer Net
301	Special "Caddy Size"	3 oz.	.98
810	8 oz. Economy Size	8 oz.	1.98
1610	16 oz. Giant Size	16 oz.	2.79



TAPE HEAD CLEANER With Special Felt Applicator

CHEMTRONICS' TAPE HEAD CLEANER is scientifically designed to clean heads, tape guides, capstan rollers and all other critical parts of TAPE RECORDERS.

- Increases the life of tape and heads
- Improves fidelity and eliminates tape squeal
- Guaranteed not to affect plastic parts of tape recorder.

Cat. No.	Unit Size	Dealer Net
504-3	2-oz.	.89

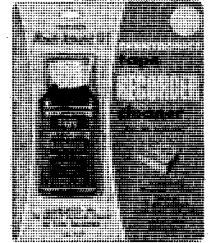

TROL AID Activated Control-Contact Cleaner

Cleans and lubricates controls, contacts, switches, relays and all other sliding contact devices...in one fast operation.

- Safe for all plastics
- Longer lasting protection against oxidation
- Non-flammable

Cat. No.	Description	Unit Size	Dealer Net
302	Special "Caddy Size"	3-oz.	.98
820	8 oz. Economy Size	8-oz.	1.98
506-5	Bottle	2-oz.	.79



NON-SLIP For Record Changers and Tape Recorders

Prevents slippage of rubber drives, belts and cords.

- Fast-drying
- Will not harm rubber
- Prevents slippage to insure uniform speed

Cat. No.	Unit Size	Dealer Net
507-7	2-oz.	.98

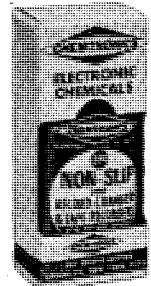

Will restore the gripping of old and hardened phono drives and belts.

RECORD CLEANER With FREE "Lint-Free" Record Cleaning Cloth

CHEMTRONICS Anti-Static RECORD CLEANER is a specially formulated cleaner that is highly effective for cleaning phonograph records and keeping them static-free!

- Provides long lasting protection for all records
- Safe to use for all records

Cat. No.	Unit Size	Dealer Net
RC 33	6-oz.	.98



MASK-N-GLAS Anti-Static Glass & Plastic Cleaner & Polisher

CLEANS and POLISHES Plastic TV Masks—Safety Glass—Face of Picture Tube.

MASK-N-GLAS is a non-abrasive dirt and grime remover...highly suitable for the cleaning of television masks, safety glass and the front of picture tubes.

FREE—Lint-Free Cleaning Cloth Attached!

Cat. No.	Unit Size	Dealer Net
840	6-oz.	1.79





CHEMICALS AND KITS

GC Chemicals (Cements, Thinners, Paints, Varnishes, etc.), are available in handy 2 oz. bottles with brush-in-cap. Also supplied in larger sizes.



G-C No. 41 Q-DOPE THINNER—Excellent solvent for Polystyrene, Q-Dope and any other Polystyrene Coil Dopes and Cements. Will soften and dissolve polystyrene rods, sheets, etc. Clear water-white solvent will not change characteristics of original materials.
Cat. No. 41-2 GC 2-oz. Net \$.52
56-02 Walsco

G-C RUBBER-TO-METAL & PHONO DRIVE CEMENT—Specially prepared for cementing rubber phono and dial drives to shafts and pulleys.
Cat. No. 35-2 GC 2-oz. Net \$.60
56-02 Walsco

2-C PLIOROND CEMENT—Bonds anything to anything—iron, steel, plastic, glass, aluminum, cotton, vinyl sheets, stainless steel, etc. A truly universal cement.
Cat. No. 43-2 GC 2-oz. Net \$.60
67-02 Walsco

G-C ACRYLIC-PLEXIGLASS CEMENT—Specially prepared for cementing Lucite, Plexiglass and other acrylic materials.
Cat. No. 43-2 GC 2-oz. Net \$.60
65-02 Walsco

G-C NE-O-PRENE CEMENT—For cementing neoprene rubber to neoprene or neoprene to other products, such as metal, wood, paper, etc.
Cat. No. 52-2 2-oz. Net \$.87

G-C LABEL CEMENT—Here's a label cement that will make labels stick to anything—metal, glass, wood, tin, etc.
Cat. No. 46-2 2-oz. Net \$.55

G-C TV HIGH VOLTAGE CORONA DOPE—Prevents corona shorts on high voltage circuits in Television sets.
Cat. No. 47-2 GC 2-oz. Net \$.78
195-02 Walsco

G-C RED-X TV CORONA DOPE—Prevents corona shorts in high voltage circuits in TV sets. Coat surfaces and sharp corners to stop corona effect.
Cat. No. 49-2 GC 2-oz. Net \$.78
198-02 Walsco

G-C TV TUBE KOAT—For recoating the outside of TV picture tubes that have become scratched or the surface is peeling.
Cat. No. 49-2 GC 2-oz. Net \$.72
199-02 Walsco

NON-SLIP COMPOUND FOR RADIO DIALS—Powder Compound for treating friction type dial drives such as cords, cables and belts.
Cat. No. 1210 Non-Slip, 2-oz. Net \$.55

LIQUID NON-SLIP—Penetrating and fast-drying liquid dressing. Shrinks fibres, prolongs life of cables and belts and prevents slipping.
Cat. No. 1211 1/2-oz. Net \$.38

G-C No. 67 PAINT THINNER—Excellent for Ruf-Koat, Krome-Koat, B-K Cement, Insulating Varnish and Rubber Cements.
Cat. No. 67-2 GC 2-oz. Net \$.52
204-02 Walsco

G-C RADIO-TELEVISION SERVICE CEMENT—This high grade cement is specially prepared for Radio, Television and Speaker Work. Unexcelled for cementing and replacing cones on dynamic speakers, repairing rattling or torn cones, cementing voice coils, spiders, etc.
Cat. No. 30-2 GC 2-oz. Net \$.55
50-2 Walsco

G-C PLASTIC CEMENT—Excellent for cementing broken plastic cabinets, cementing grille cloth in place, cementing dial and glass crystal assemblies, cementing knots in dial, cords, etc.
Cat. No. 32-2A GC 2-oz. Net \$.55
40-02 Walsco

G-C "BAKELITE" CEMENT—This cement is especially made for cementing "BAKELITE" to "BAKELITE" and to other materials.
Cat. No. 32-2 GC 2-oz. Net \$.87
65-02 Walsco

G-C "VINYLITE" CEMENT—This new G-C Cement based upon "VINYLITE" vinyl resins, has great adhesion, high tackiness and extreme flexibility.
Cat. No. 58-2 GC 2-oz. Net \$.55
55-02 Walsco

G-C FABRIC AND GRILLE CLOTH CEMENT—For cementing grille cloth and fabrics to either metal, plastic or wood cabinets.
Cat. No. 22-2 GC 2-oz. Net \$.60
53-02 Walsco

G-C WOOD CABINET GLUE—This is the ordinary well-known wood glue that is used in repair of furniture, chairs, radio cabinets, etc.
Cat. No. 39-2 GC 2-oz. Net \$.55
78-02 Walsco

G-C No. 28 CEMENT THINNER—This thinner is made of same solvents as G-C Service Cement and makes the best thinner for G-C Service Cement.
Cat. No. 28-2 GC 2-oz. Net \$.52

G-C RADIO SERVICE SOLVENT—The best solvent for loosening cement on speaker cones, frames, etc., made to dissolve all types of cements. Can also be used as a thinner for G-C Cement and other cements.
Cat. No. 31-2 GC 2-oz. Net \$.52
201-02 Walsco

G-C No. 29 LACQUER THINNER—Solvent for thinning all lacquers, lacquer enamels, telephone black and gray, touch-up lacquers.
Cat. No. 29-2 2-oz. Net \$.52

G-C DE-OX-ID—Cleans and prevents oxidation on sensitive circuit contacts. Use in Television, Radio, Telephone, Relays, Instruments, etc.
Cat. No. 19-1 GC 1-oz. 100-01 Walsco Net \$.70
19-2 GC 2-oz. 100-02 Walsco Net \$ 1.03

G-C PHONO NON-SLIP COMPOUND—Prevents slippage of phono drives on changers, tape recorders, and all types of recorder drives.
Cat. No. 86-2 GC 2-oz. Net \$.96
144-02 Walsco

G-C RED GLYPHOL INSULATING VARNISH—Most common of all protective insulating coatings, used on all solder connections, high voltage points, anti-corona.
Cat. No. 90-2 GC 2-oz. Net \$.63
134-02 Walsco

G-C CARBON TETRA-CHLORIDE—100% pure Carbon Tetra-Chloride, non-explosive and non-inflammable. For cleaning electrical controls and contacts.
Cat. No. 211-2 2-oz. Net \$.52

G-C CONTACT DOPE—Ideal contact cleaner for electronic switches, controls and contacts. Specially prepared to resist corrosion and oxidation on contacts.
Cat. No. 1214 2-oz. Net \$.48

G-C NON-CORROSIVE LIQUID SOLDERING FLUX—Best quality non-corrosive flux for all types of radio and electrical soldering, for copper, brass, steel, nickel, etc.
Cat. No. 42-2 2-oz. Net \$.55

G-C Q-DOPE (COIL DOPE)—Specially prepared for coating, doping, sealing, cementing, and impregnating coils and paints in "Very High" and "Ultra High" frequency ranges.
Cat. No. 37-2 GC 2-oz. Net \$.55
57-02 Walsco

G-C LIQUIDOPE—Gives coils a tough protective film that insures firmness and prevents characteristic changes due to weather.
Cat. No. 36-2 2-oz. Net \$.60

G-C RADIO AND TELEVISION CEMENT—High grade speaker cement in a handy tube for those who prefer to use a tube. Cement can be applied directly from tube on the parts to be cemented without the use of a brush. Also used for television work, sealing nuts, bolts, etc., on antennas, rotators, etc.
Cat. No. 34-2 2-oz. tube Net \$.55

G-C INSULATING & DIPPING VARNISH—Produces a smooth, tough film that is water-proof, oil-proof and non-corrosive. Recommended for treating field coils, noisy or buzzing transformers and choke coils.
Cat. No. 56-2 GC 2-oz. Net \$.60
190-02 Walsco

G-C FUNGUS VARNISH—Used on all types of Radio, Electronics and Communication equipment to prevent moisture absorption and fungus growth, where equipment is used in hot and humid climates.
Cat. No. 57-2 GC 2-oz. Net \$.66
135-02 Walsco

G-C STRIP-X—Removes insulating enamel from wires for easy soldering. Use on magnet wire, etc.
Cat. No. 26-2 GC 2-oz. Net \$.78
251-02 Walsco

G-C MAG-NETIK RECORDING HEAD CLEANER—Cleans without injury to the recording head that gradually lose their sensitivity if oxide accumulates.
Cat. No. 53-1 1-oz. Net \$.67
53-2 2-oz. Net \$ 1.03

G-C MAGNETIC CEMENT—Permanently bonds iron cores, broken loopsticks, slugs, flyback and yoke cores. Repairs part to original function.
Cat. No. 38-2 2-oz. Net \$.80

G-C No. 14-2 PRINT-KOTE SILICONE RESIN—After repairing or replacing parts in printed circuits, protect the panel joints and parts. Fast air drying.
Cat. No. 14-2 2-oz. Net \$ 1.40

G-C No. 13-2 PRINT-KOTE SOLVENT FOR SILICONE RESIN—The only solvent for G-C 14-2 Silicone Resin. Will dissolve and remove silicone resin from printed circuits.
Cat. No. 13-2 2-oz. Net \$.42

G-C PRINT-KOTE SOLDERING FLUX—Non-corrosive liquid flux for easy soldering and repairing of printed circuits.
Cat. No. 12-2 2-oz. Net \$.60

G-C CEMENT KIT—A kit containing a complete selection for every application. Kit includes 2-oz. samples of Service, Pli-O-Bond, Acrylic, Plastic, Bakelite, Vinylite, Grille Cloth, Model Wood, Rubber-to-Metal, Electrical and Resistor, Neoprene, Label and Vinyl Cements. Ideal for research and development.
Cat. No. 345 Net \$ 5.97

GC SPRAY CANS

GLASS TREATMENT COMPOUND "For All Glass and Plastics"
• DEGREASES
• REMOVES STATIC
• WATERPROOFS

"GC 60" treatment compound makes all glass and plastics cleaner and brighter, degreases, removes static, waterproofs and keeps surfaces cleaner longer. Comes with handy spray applicator for easier application. Easy to use, just spray on and wipe clean.

GC No.	Size	Std. Pkg.	Net
175-5	16 oz. bottle	12	1.15
175-16	15 oz. bottle	3	2.02
175-G	1 gallon	1	12.99

SUPER FREEZE MIST PLASTIC SPRAY EXTENSION
"COOL CIRCUITS THREE TIMES FASTER"

Instant cooling action at its best. Super Freeze Mist is a "Dry" cooler because it leaves no liquid residue. Here is a cooling agent which is non-toxic and nonflammable, has a pleasant odor, and does the job three times faster than other coolers. Super Freeze Mist enables the Serviceman to pinpoint bad capacitors, transistors, oxidized joints, by cooling components.

GC No.	Walsco	Net
8668	216-06 6 oz. aerosol	1.25

Standard Package 24

"Most Powerful All-Purpose TV-Radio Cleaner"

The most outstanding "All purpose" electronic contact cleaner. This is not a solvent-type cleaner but consists of active ingredients in light oil base. Use it on volume controls, tone controls, audio mixers, relays, etc. A small drop lasts for months of years.

GC No.	DE-OX-ID		NO-OX		
	Std. Pkg.	Net	Std. Pkg.	Net	
19-1	1 oz. bottle	6 .70	100-01	1 oz. bottle	6 .70
19-2	2 oz. bottle	12 1.03	100-02	2 oz. bottle	12 1.03
19-2-S	2 oz. bottle carded	12 1.03	100-02-S	2 oz. bottle carded	12 1.03
19-6	6 oz. aerosol can	6 2.45	100-06	6 oz. aerosol can	6 2.45
19-16	16 oz. bottle	3 8.50	100-16	16 oz. bottle	3 8.50
			100-33	1 gallon	1 40.65

SPRA-KLEEN—eliminates noise due to dust, dirt and corrosion on contacts. Just spray, and work controls.
Cat. No. 8666...6 oz....Net \$.89
Cat. No. 8666-16.....Net \$ 1.95
16 oz. (sprays upside-down)

RELAY-KLEEN—contact cleaner; excellent for cleaning relays and contacts in switchboards, automatic pinball or bowling machines, rocket or satellite circuitry.
Cat. No. 8682...6 oz....Net \$ 1.89
Cat. No. 8682-16...16 oz.....Net \$ 3.49

ZERO-MIST SPRA KOAT—instantly locates defective (intermittent) circuit components due to temperature change. Circuits cooled instantly. Components isolated.
Cat. No. 8667...16 oz....Net \$ 2.42

RUF-KOAT WRINKLE VARNISH
Cat. No. 60-12.....Net \$ 2.25
12 oz. Black
Cat. No. 60-13.....Net \$ 2.25
12 oz. Gray

GC ELECTRONIC DRY CLEANER
"Leaves Absolutely No Deposits"

Plastic Spray Extension Included FREE!
Clean contacts, relays, and other electronic devices with this "Dry" cleaner where no residual, oily deposits are desired. This product is also an excellent degreaser and general solvent for inks, gummy deposits, etc., on all electrical or mechanical devices such as typewriters, presses, etc.

No.	Std. Pkg.	Net
8669	16 oz. aerosol	12 2.10

K-27 PRINT-KOTE—TV silicone resin for printed circuits. Insulates, protects, prevents shorts. As used by the original manufacturer.
Cat. No. 14-6 GC 6-oz. Net \$ 2.42
120-06 Walsco

GC SILVER PRINT—for printed circuit repairs. Same Pure Silver as used by original printed circuit manufacturers.
Cat. No. 21-1 GC 1/2 tray oz. Net 3.30
36 Walsco
Cat. No. 21-2 GC 1 tray oz. Net 5.75
36-1 Walsco

GC COPPERPRINT 2 oz. bottle
Cat. No. 20-2.....Net \$ 1.95

JIF—contact and control cleaner will not harm plastics. Contains no harsh solvents. Cleans, lubricates, long-lasting protection.
Cat. No. 8670-6...6 oz....Net \$ 1.79

MP-5 outdoor meal protectant; provides chemisorption type bond to metal surfaces. Superior to other organic compounds. Contains UCARSIL® silicones. *Trademark of Union Carbide Corp.
Cat. No. 8681...6 oz.....Net \$ 1.79

GC DE-OX-ID—electrical contact cleaner for silver, detent and radar contacts. For TV, radio, telephone, relays, contacts, etc.
Cat. No. 19-6...6 oz....Net \$ 2.45

GC STANDARD PRINTED CIRCUIT KIT—contains foil, solder washers, solder wire, solder probe tool and brush, silicone resin lacquer and solvent, tweezers and instructions.
Cat. No. 682.....Net \$ 5.35

CREME-O-WAX POLISH
New Improved
"For Radio and TV Cabinets"

The best white non-staining polish that money can buy for furniture, radio-TV cabinets, pianos, etc. Dries to hard glossy finish. Polish cabinets after service calls, results bring added sales.

GC No.	Walsco	Std. Pkg.	Net
92-2		2 oz. bottle	6 .49
92-8	230-08	8 oz. bottle	6 .70
95-16		16 oz. bottle	3 1.05
95-G		1 gallon	1 4.95

Spra-Koat
RED - X TV CORONA DOPE
Prevents Corona Shorts in High Voltage TV Circuits
New red color coats surface and corners to stop corona effect. Fast drying, silicone base. Has excellent dielectric strength.
Net \$ 2.18
Standard Package 12

WRITE FOR CATALOG #FR-69 FOR COMPLETE LISTINGS

**IMPERIAL****SPECIALIZED LUBRICANTS-CLEANERS-GREASES****FOR COMMERCIAL, INDUSTRIAL AND AUTOMOTIVE USES****X-27 DRI-SPA-Water Displacement Spray**

Seals out moisture, cleans, lubricates, prevents rust and corrosion which causes 80% of electrical equipment failures. Use wherever moisture could be a problem . . . contacts, switches, motors . . . leaves a dry surface on locks, hinges, tools, type-writers, business machines, and drawer slides. Does not harm paint, rubber, plastic, metal or wood. Will not freeze, melt, drip or wash off. It moisture proofs engines, ignition systems, assures fast starts, prevents electrical current leakage of batteries, wires and points.

Part No. 79-702 16 oz. can
12 per case Net Ea. 2.85

LOOSE-ALL MECHANICAL THREAD FREE-ER

Free tight, rusted and seized parts, fast! Displaces moisture, leaves a rust and corrosion resistant film. Ideal for use on tools, dies, tight or rusted nuts, bolts, pin, hinges, linkage fasteners and valves. Effective as a lubricant and rust protector on threaded steel stock and machine shafting. Useful on automotive muffler-tailpipe connections and couplings, latches, hinges, and wiper assembly.

Part No. 79-109 16 oz. Can - 12 per case Net Ea. 1.70

CUTTING AND TAPPING OIL

All purpose aerosol for all metal cutting and tapping operations. Clings to curved surfaces, even overhead. Spray tube equipped can sends oil to all those hard to lubricate places. Reduces tap breakage, increases tap life, produces cleaner threads, cuts tapping costs.

Part No. 79-105 16 oz. can - 12 per case Net Ea. 1.90

PENETRATING AND LUBRICATING OIL

A high quality penetrating oil that loosens corrosion, frees rusty nuts and bolts. With high pressure spray, oil penetrates in record time. Ideal for carrying in coverall pocket or tool kit. The aerosol method of applying a cleaner and lubricant actually saves time and money. Ideal for marine, automotive, and plant maintenance personnel.

Part No. 79-101 16 oz. can - 12 per case Net Ea. 1.65

HEAVY DUTY OPEN GEAR AND WIRE ROPE LUBRICANT

A heavy-duty lubricant with exceptionally strong adherence to teeth and gears, penetrating metal pores, forcing grease to the core of wire rope. Clings well, resists heat and pressure, will not wash off or wear away. Moisture resisting, offers excellent rust protection. Ideal for fifth wheels on tractor, trucks & drive chains, screw threads, flexible coupling and die set leader pins, wire rope, cables, industrial and commercial wires. Excellent lubrication on all open gears . . . saves teeth . . . eliminates stripping.

Part No. 79-103 16 oz. can - 12 per case Net Ea. 1.67

OPEN CHAIN LUBRICANT WITH MOLY

A light oil lubricant with Moly-Additive which resists higher pressures or temperatures. Will force water and moisture out of metal pores. Use on chain drives, hoist chains, chain saws, link and roller assemblies, linkages, hinges, sprockets, clippers, cutter bars and conveyors.

Part No. 79-106 16 oz can - 12 per case Net Ea. 1.66

ALL PURPOSE DEGREASER & ENGINE DEGREASER

1, 1, 1-Trichloroethane - A Safe, Easy-to-use Cleaner. Safe, non-flammable solvent that attacks oil, grease, inks, adhesives, fresh paint coatings with a slow evaporation rate. Will not cause dermatitis. Excellent for cleaning of silicone from molds, wax build-ups, removing resin and pitch from equipment, cleaning up polyester and epoxy equipment. Also used as an adhesive agent for styrofoam.

Part No. 79-604 16 oz. can - 12 per case Net Ea. 1.55

MOLY OIL LUBRICANT

A molybdenum disulfide, highly effective lubricant under conditions of higher pressures of temperatures. Excellent for use on conveyors, hoist chains, chain saws, chain drives, link and roller assemblies, cutter bars, hinges, clippers, linkages and sprockets.

Part No. 79-107 16 oz. can - 12 per case Net Ea. 1.50

ZINC CHROMATE PRIMER-AEROSOL

A high quality metal primer excellent for painting galvanized metal. Keeps paints from chipping, bubbling, peeling or cracking, protects against rust and corrosion. Ideal for touch up of equipment and machinery, provides tough bonding and adhesive qualities.

Part No. 79-5958 Yellow - 20 oz. can Net Ea. 2.10

Part No. 79-5959 Yellow - Bulk Contact Factory

Part No. 79-5956 Green - 20 oz. can Net Ea. 2.10

Part No. 79-5957 Green - Bulk Contact Factory

Meets performance requirements of government specifications MIL-P-8585A (superseding MIL-P-6889A) modified for aerosol packaging.

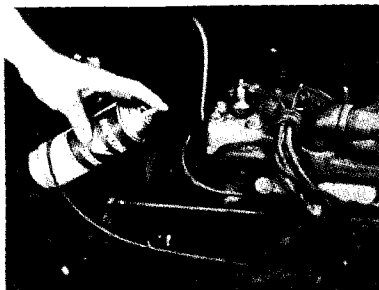
**PROFESSIONAL TOOL AND DIE LAYOUT INK**

Quick drying, provides smooth, even surface that takes scribing beautifully, no brushes or rags, will not flake or peel, scribed lines last until job is finished. Pigmented ink has firm gripping action . . . no acid in formula. Non-corrosive . . . does not clog in can, resists heat.

Both aerosol and bulk Imperial Tool and Die Makers Inks are readily removable by using Imperial Tool and Die Layout Ink Remover and General Solvent.

Part No. 79-457 Blue Layout Ink - 6 oz. 12 per case Net Ea. .98

Part No. 79-458 Blue Layout Ink - 16 oz. 12 per case Net Ea. 1.75

Part No. 79-460 Red Layout Ink - 16 oz. 12 per case Net Ea. 1.75

1%, 3% or 5% SILICONE MOLD RELEASES

Lets you use just the right amount of silicone for the job at hand. Ends molding problems . . . no sticking, no ripples. Will not discolor molded pieces. Hundreds of applications from one can. No more over use. Fixed percentages of Silicone spray enables you to use just the right amount of silicone content for the job, which when sprayed into the mold every few shots, insures complete penetration and coverage.

Part No. 79-304 16 oz. spray can - 12 per case

1% Silicone Net Ea. 1.00

Part No. 79-303 16 oz. spray can - 12 per case

3% Silicone Net Ea. 1.15

Part No. 79-305 16 oz. spray can - 12 per case

5% Silicone Net Ea. 1.30

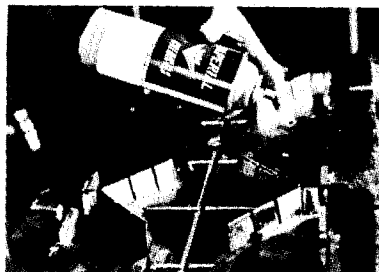
**PAINTABLE MOLD RELEASE AGENT**

A tested paintable mold release agent for ABS resins, acrylics, cellulotics, melamines, polyesters, polystyrenes, and rubber compounds. Will not discolor molded parts . . . produces flawless moldings and smooth release. Surfaces may be painted with any solvent-base paint after normal preparation procedures are followed. With handy spray can, you apply only what you need . . . surplus build-up may easily be removed from molded piece with a cloth dampened with solvents or other detergents.

Part No. 79-306 16 oz. spray can - 12 per case Net Ea. 1.57

FLUOROCARBON RELEASE AGENT AND LUBRICANT

Acts as excellent release agent up to a temperature of 500 degree F. A 20% dispersion of white, waxy tetrafluoroethylene telomer (chemically related to *Teflon TFE fluorocarbon resins) in *Freon solvent. Non-staining and transparent. May be used on plastics, rubber, metals, and wood, or used as a lubricant for metal cutting, rolling and drawing. As a dry lubricant, it repels water, oil, grime, etc., will not interfere with post-finishing operations. Used in dairy, baking, paper making, on machinery, in farming, painting, tooling, packaging, conveyor, electrical, electronic, automotive, musical instrument and vending machine industries.

Part No. 79-307 16 oz. aerosol
12 per case Net Ea. 1.95

**MP-5 METAL PROTECTANT**

Contains Ucarasil, Silicones

MP-5 metal protectant prevents corrosion on most metals. Easily applied, air dries in 5 to 10 minutes. Cures in 15 minutes at 250 degrees F., 10 to 14 days at normal temperature. MP-5 provides a chemisorption type of bond superior to any other organic material. The effective outdoor life of treated articles is 6 to 12 months.

Part No. 79-206 16 oz. spray can - 12 per case Net Ea. 3.45

BENCH FIRE EXTINGUISHER

Works on all Types of fire.

A fast, low-cost method of fighting small fires before serious trouble develops. Good for any kind of fire, including electrical, oil, and grease fires. These chemicals remove oxygen from the fire area, smother the flame. Ideal for garage, basement, service shop, any place where highly inflammable solvents and thinners are used.

Part No. 79-10-914 16 oz. spray can - 12 per case Net Ea. 1.65

ANTI-STATIC SPRAY NON-STAINING . . . NON-TOXIC

Designed to neutralize static electricity generated by friction or atmospheric conditions. Also effective in limiting airborne dust accumulation. Tested and proven in production applications involving rollers, drive belts, conveyors, slitters, gluers, etc., in the plastics, paper, printing and packaging industries. Anti-Static treated surfaces are paintable after normal cleaning procedures are followed to remove dust and oil.

Part No. 79-503 16 oz. spray can - 12 per case Net Ea. 1.70

CARTON SAVER - "SPRA-KOAT" TAN

Restore unused imprinted cartons to like-new condition. Matches carton color. Fast drying with maximum coverage. Will not rub off, makes carton overruns a thing of the past. Waterproofs at the same time it hides. For use on all porous and non-porous surfaces.

Part No. 79-10-912 16 oz. spray can - 12 per case Net Ea. 1.65

GLASS AND PLASTIC CLEANER

Contains grease cutting ammonia and special cleaning agent which will not streak or smear. Does not contain silicone, leaves no film. Convenient, economical to use, just spray on and wipe with clean cloth or paper towel. Excellent for windshields, windows, mirrors, porcelain and ceramic surfaces, and for cleaning and brightening aluminum reflectors in lighting fixtures.

Part No. 79-9082 16 oz. can - 12 per case Net Ea. .79

SPRA-KLEEN-SWITCH AND CONTACT CONTROL CLEANER/LUBE

Eliminates noise due to dust, dirt and corrosion. Cleans and lubricates all electrical switches and contacts. Cleans and lubricates contacts, controls, relays, circuit breakers, switches, servo-mechanisms, motor starters and other sliding contact devices in one operation. Will not inhibit electrical contacts. Will not harm materials around parts to be sprayed. Equipped with plastic extended spray tube to pinpoint use in confined areas. Ideal for use in plant, office, and mobile units.

Part No. 79-8666 6 oz. can - 24 per case Net Ea. .99

WRITE FOR CATALOG #FR-075-1 FOR COMPLETE LISTINGS

Heeger, Inc., as national sales administrators, present the following chemicals that have found favor with engineers, laboratory technicians and production in industry, to assist them in procuring the best proven material to enable them to arrive at the best results.

From the laboratories of
H. M. H. INDUSTRIES

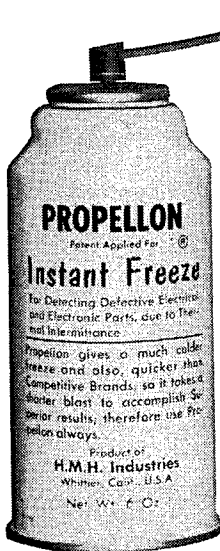

PROPELLON INSTANT FREEZE

Used by electronic engineers and technicians for detecting defective electronic and electrical parts, due to thermal intermittance. Valuable in the laboratory, field testing, service bench or field work, maintenance of equipment and in the electronic and electrical analysis of trouble. Propellon "Instant Freeze" delivers the lowest temperature practical for above uses. Odorless, non-toxic and non-flammable.

The 12" extender facilitates in directing the spray directly onto the area tested. Also aids in getting into inaccessible places.

12 TO A CASE

PACKED IN 7 OZ. CANS AND 15 OZ. CANS — 12" EXTENDER FREE WITH EACH CAN

7 OZ. CAN, with 12" extender.....ea. \$1.45
15 OZ. CAN, with 12" extender.....ea. \$2.25

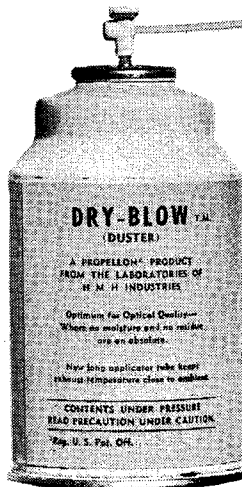

"DRY-BLOW"™ T.M. (Duster)

A Propellon product for the service technician for cleaning before and after integrated circuitry repairs or replacements. For blowing dust and dirt out of chassis and between parts and tubes where it is impossible to reach with brush or cloth.

Used by electronic engineers and technicians, electronic and optical laboratories and any place where fine dust particles are a problem to eliminate.

12 TO A CASE

PACKED IN 15 OZ. CANS — 18" EXTENDER FREE WITH EACH CAN
15 OZ. CAN, with 18" extender.....ea. \$2.25

From the laboratories of
HASCOL ENTERPRISES

LOC-JAW



**A SCIENTIFICALLY COMPOUNDED
ADHERENT FORMULA**

"Loc-Jaw" is an "Epoxy" base compound for bonding metal to metal, glass to glass, glass to wood, wood to wood, metal to wood, etc. Properly proportioned, it hermetically seals small parts and connections. After setting, it actively resists salt water and salt air, gasoline, chemicals and solvents of all types and withstands temperatures up to 300° F. Applicable to many industrial uses. Packed in its own plastic container and applicator. Indispensable where an adherent or sealer is needed.

INDIVIDUAL PLASTIC CONTAINERea. \$.98
BAG OF 10per bag \$7.50

From HASCOL LABORATORIES

SAL-MET

NON-CORROSIVE FLUX

- SOLDERS COPPER TO ALUMINUM
- ALUMINUM TO ALUMINUM
- SOLDERS ALL METALS

A scientific laboratory non-corrosive flux for soldering all metals. By using "SAL-MET," copper can be soldered to aluminum, aluminum to aluminum, copper to steel, copper to copper; in fact, any metal to metal is possible. No special preparation on material to be soldered. Use conventional solder, applied with quick heat, regular soldering iron, torch or pot.

1 oz. Tubes.....ea. \$.95
1 lb. Can.....ea. \$7.88

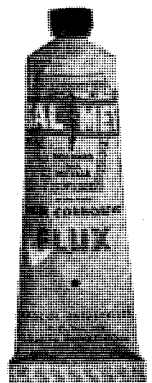

WRITE FOR COMPLETE CATALOG

PRICES SUBJECT TO CHANGE

L M B®

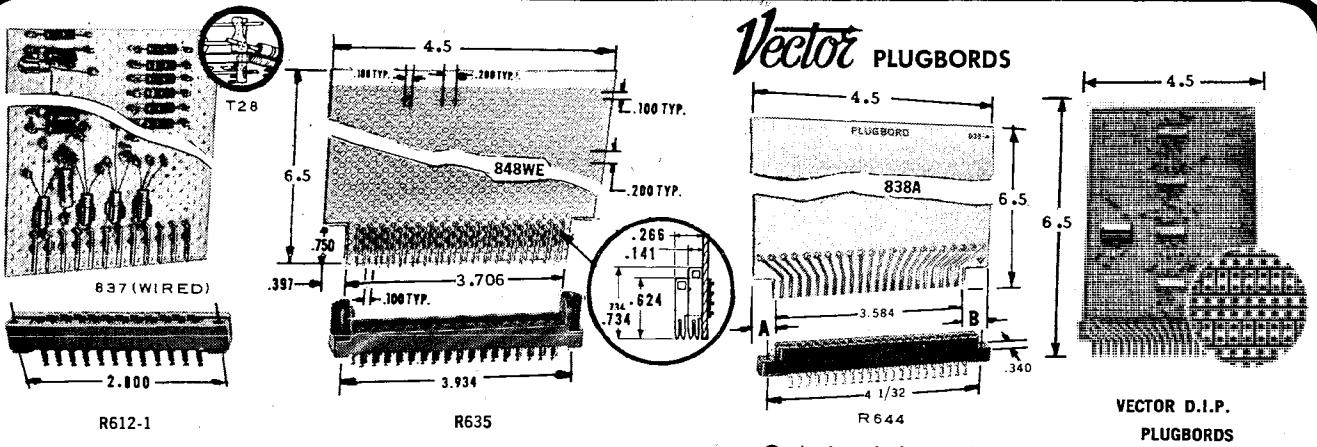

Ordering Information

VECTOR PLUGBORDS speed plug-in circuit construction because the pre-punched holes accept push-in terminals, eyelets or turned terminals and the contacts are already on the board. Epoxy paper boards meet requirements of MIL-P-22323, Type PEE; Epoxy glass is G-10 grade per MIL-P-18177; copper clad Epoxy paper meets MIL-P-13949 Type PX, and copper clad Epoxy glass meets MIL-P-13949.

838 SERIES same as above, except with 2 oz. copper etched contacts on .156" centers. 838PWE has TO-5 transistor base pad network one side. "GN" types have nickel plated gold flashed contacts.

812, 837, 848 SERIES furnished with attached Elco Varicon contacts have .062" holes on alternate 0.1" centers.

VECTOR D.I.P. PLUGBORDS permit quick hookup of integrated circuits. Boards are punched with .041" holes on 0.1" centers and have mounting pad areas for twelve D.I.P.s. Etched lines .070" wide spaced on .1" centers run horizontally on front side and vertically on rear side of board to reduce hand wiring. Listed boards have: (A) 44 etched contacts (total front and back) spaced on 0.156" centers; (B) 35 Elco Varicon contacts on 0.1" centers; (C) 39 Vector Edge-pin contacts on 0.1" centers; (D) 78 etched contacts (total front and back) on 0.1" centers. Patchcords are available.

Receptacles listed are glass filled diallyl phthalate.

Cat. No.	Description	A	B	Net Price 1-19
812	4 1/2" x 6 1/2" Epoxy Paper, 16 Varicon Contacts			\$2.87
812WE	4 1/2" x 6 1/2" Epoxy Glass, 16 Varicon Contacts			3.39
R616-1	Molded Receptacle for 812, 812WE			2.24
837	3" x 4 1/2" Epoxy Paper, 12 Varicon Contacts			2.24
837WE	3" x 4 1/2" Epoxy Glass, 12 Varicon Contacts			2.48
R612-1	Molded Receptacle for 837, 837WE			1.80
838	4 1/2" x 6 1/2" Epoxy Paper, 43 Etched Contacts, 2 Sides	.408"	.508"	3.74
838-1	4 1/2" x 6 1/2" Epoxy Paper, 43 Etched Contacts, 2 Sides	.453"	.453"	3.74
838A	4 1/2" x 6 1/2" Epoxy Paper, 22 Etched Contacts, 1 Side	.408"	.508"	2.70
838A-1	4 1/2" x 6 1/2" Epoxy Paper, 22 Etched Contacts, 1 Side	.453"	.453"	2.70
838AWE	4 1/2" x 6 1/2" Epoxy Glass, 22 Etched Contacts, 1 Side	.408"	.508"	3.05
838AWE-1GN	4 1/2" x 6 1/2" Epoxy Glass, 22 Etched Contacts, 1 Side	.453"	.453"	4.52
838PWE	4 1/2" x 6 1/2" Epoxy Glass, Etched Pads, 1 side	.408"	.508"	3.51
838WE	4 1/2" x 6 1/2" Epoxy Glass, 43 Etched Contacts, 2 Sides	.408"	.508"	3.71
838WE-1GN	4 1/2" x 6 1/2" Epoxy Glass, 43 Etched Contacts, 2 Sides	.453"	.453"	5.59
R644	Receptacle for above (fits all above etched boards)			2.62
R648	4 1/2" x 6 1/2" Epoxy Glass, 35 Varicon Contacts			5.86
R635	Receptacle for 848WE			4.91
D.I.P. PLUGBORDS and Accessories—All boards 4 1/2" W. by 6 1/2" L.				
3474	44 Etched Contacts (Mate w/R644 Listed Above)			10.50
3475	39 Vector Edge-pins (Mate w/RW241-S w/B-60 Guides)			10.57
B60	Card Guide Brackets for RW241-S Receptacle Pkg. of 5 pr.		Any Quantity	1.50
RW241-S	Receptacle for D.I.P. Plugboard 3475			2.80
3476	35 Elco Contacts (Mate w/R635 Listed Above)			11.40
3477-7	72 Etched Contacts (Mate w/R635 Receptacle)			9.94
K24C	Terminal Pin for D.I.P. Plugboard, Tin Plated			.83/50 \$10.78/M
P139	Hand Line Cutter Tool—Breaks D.I.P. Plugboard Copper Lines			Any Quantity 1.50

VECTORCONN CONNECTORS WITH EDGE-PIN PLUGBORDS

VERSATILE NEW VECTORCONN CONNECTORS

(For .040" diameter round pins)

Contact Reliability • Large Variety of Sizes • Top, Bottom, or Side Mounting Styles • Solder Tab or Printed Circuit Tab • Optional Card Guide Ends

VECTORCONN employ wrap around contacts with outstanding time proven reliability in the tube socket industry. Receptacles accept available Vector Edge-pins and Inboard pins or any .040" diameter round pins. Receptacle can also be used as: Multiple test points on printed circuit boards. Front panel test points, in-out jacks, patch points.

EDGE-PIN PLUGBORDS are ready-to-wire and plug into VECTORCONN receptacles. Plugboards are provided with an overall pattern of .062" holes on alternate 0.1" centers, Vector Pattern "G".

Castings, end pieces and card guides are Diallyl Phthalate, glass filled per MIL-M-14 type SDG. Contacts are beryllium copper or phosphor bronze, nickel and gold plated.

Vectorconn Ordering Information

Cat. No.	Description	A	Net Price 1-49
.296" Wide Casting			
R112-S	12 Contact Single Row Solder Tab	2.742	\$1.50
R225-S	25 Contact Double Row Solder Tab	2.742	1.86
.450 Wide Casting			
RW120-S	20 Contact Single Row Solder Tab	4.350	1.81
RW241-S	41 Contact Double Row Solder Tab	4.350	2.80
K-23A	Lower Row Edge Pin—Bags of 50 any Quantity		1.93
K-28	Upper Row Edge Pin—Bags of 50 any Quantity		1.93
Accessories			
P-93A	Staking Pliers for K-23A, K-28		26.00
B-61	End Brackets, Small for side mounting— and cut down VECTORCONN—Pkg. 10 any Quantity		1.30
B-60	Card Guide Brackets, Pkg. of 5 Pr. any Quantity		1.50

• Additional VECTORCONN Connectors listed in Vector's General Catalog.

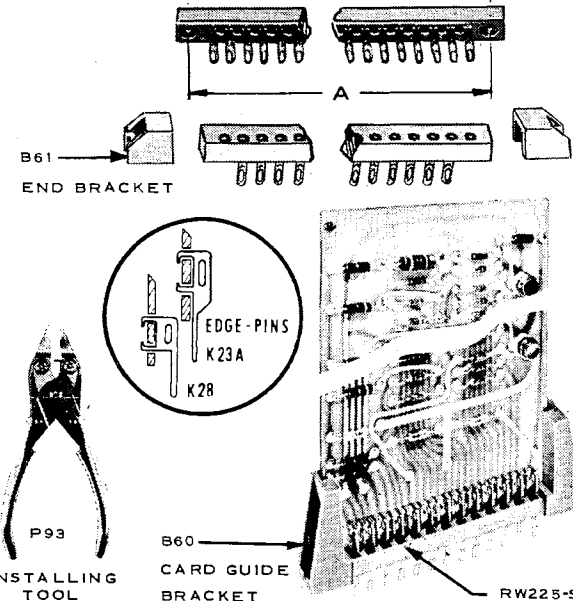

Plugboard Ordering Information

PLUGBOARD CAT. NO.	DESCRIPTION MATERIAL	WIDTH	LENGTH (With Pins)	CONTACTS		NET PRICE 1-19	USE WITH
				Lower	Upper		
842-120	Epoxy-Paper	4.5"	6.5"	20	—	\$2.90	RW-120-S
842-120WE	Epoxy-Glass	4.5"	6.5"	20	—	3.20	RW-120-S
842-241WE	Epoxy-Glass	4.5"	6.5"	20	21	4.75	RW-241-S
856-112	Epoxy-Paper	3"	4.5"	12	—	1.80	R-112-S
856-112WE	Epoxy-Glass	3"	4.5"	12	—	2.00	R-112-S
856-225WE	Epoxy-Glass	3"	4.5"	12	13	3.00	R-225-S

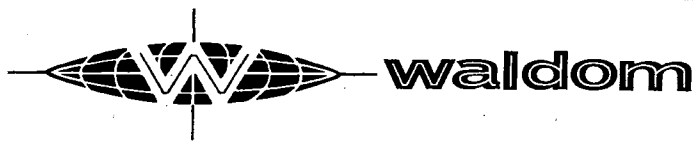

CIRCUIT DEVELOPMENT BOARDS

"Wizardbord" Phenolic, Epoxy Paper, Glass Epoxy

Punched board as shown below consists of the more popular patterns and are precut to the more asked for sizes. We will be happy to quote prices on sizes to meet your specifications.

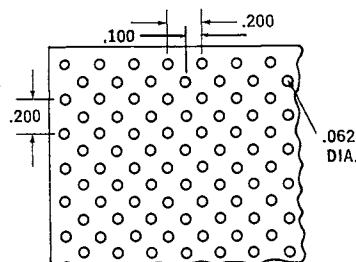
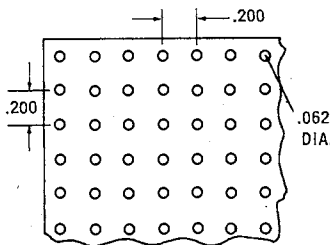
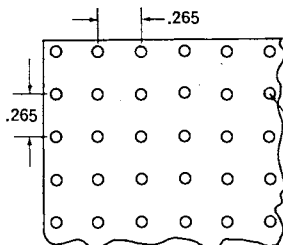

"A" PATTERN PUNCHED BOARD with .093 diameter holes on .265 grid centers.

"F" PATTERN PUNCHED BOARD with .062 diameter holes on .200 grid centers.

"G" PATTERN PUNCHED BOARD with .062 diameter holes on .100 alternate grid centers.

"A," "F," & "G" PATTERN PUNCHED BOARDS

PATTERN	SIZE Width x Length	THICK- NESS Inches	SEE NOTE	NO. OF HOLES Width x Length	PART NO. MAT'L XXXX PHENOLIC	PRICE EACH			PART NO. MAT'L EPOXY PAPER	PRICE EACH			PART NO. MAT'L GLASS EPOXY	PRICE EACH		
						1-19	20-99	100-199		1-19	20-99	100-199		1-19	20-99	100-199
A	4.77 x 4.77	1/16		18 x 18	18P18	.43	.39	.36	18E18P	.72	.65	.60	18E18G	1.44	1.30	1.19
	1.06 x 8.48	1/16		3 x 32	3P32	.30	.27	.25	3E32P	.40	.36	.34	3E32G	.44	.40	.36
	1.88 x 8.48	1/16		7 x 32	7P32	.39	.35	.33	7E32P	.66	.61	.55	7E32G	.72	.65	.63
	2.41 x 8.48	1/16		9 x 32	9P32	.45	.41	.38	9E32P	.78	.71	.67	9E32G	.98	.89	.81
	3.25 x 8.48	1/16		13 x 32	13P32	.60	.56	.52	13E32P	.95	.88	.74	13E32G	1.48	1.39	1.32
	4.77 x 8.48	1/16	1	18 x 32	18P32	.72	.65	.59	18E32P	1.25	1.13	1.06	18E32G	1.89	1.70	1.59
	4.77 x 16.96	1/16	2	18 x 64	18P64	1.25	1.15	1.10	18E64P	2.06	1.85	1.74	18E64G	3.72	3.37	3.12
	8.48 x 16.96	1/16	4	32 x 64	32P64	2.13	1.91	1.79	32E64P	3.17	2.86	2.67	32E64G	5.86	5.32	5.00
	8.48 x 11.92	1/16	3	32 x 45	32P45	1.60	1.44	1.34	32E45P	2.12	1.90	1.70	32E45G	3.91	3.55	3.40
	4.77 x 4.77	3/32		18 xx 18	18PP18	.43	.39	.36	18EE18P	.80	.72	.65				
	1.06 x 8.48	3/32		3 xx 32	3PP32	.46	.42	.39	3EE32P	.40	.36	.34				
	1.38 x 8.48	3/32		5 xx 32	5PP32	.48	.43	.40	5EE32P	.74	.67	.59				
1.88 x 8.48	3/32		7 xx 32	7PP32	.60	.55	.51	7EE32P	.95	.88	.83					
3.25 x 8.48	3/32		13 xx 32	13PP32	.74	.69	.63	13EE32P	1.15	1.06	1.00					
4.77 x 8.48	3/32	1	18 xx 32	18PP32	.84	.76	.71	18EE32P	1.40	1.26	1.18					
4.77 x 16.96	3/32	2	18 xx 64	18PP64	1.60	1.44	1.34	18EE64P	2.73	2.46	2.29					
8.48 x 16.96	3/32	4	32 xx 64	32PP64	2.45	2.20	2.05	32EE64P	4.35	3.95	3.65					
8.48 x 11.92	3/32	3	32 xx 45	32PP45	1.99	1.80	1.62	32EE45P	2.83	2.55	2.30					
F	1.25 x 8.50	1/16		8 x 42	F8P42	.33	.30	.27	F8E42P	.44	.40	.36	F8E42G	.48	.44	.40
	2.25 x 8.50	1/16		11 x 42	F11P42	.55	.50	.45	F11E42P	.80	.72	.65	F11E42G	1.16	1.03	.94
	3.63 x 8.50	1/16		18 x 42	F18P42	.62	.56	.50	F18E42P	.95	.85	.80	F18E42G	1.75	1.57	1.48
	4.88 x 8.50	1/16	1	24 x 42	F24P42	.72	.65	.58	F24E42P	1.42	1.27	1.12	F24E42G	1.89	1.71	1.57
	4.88 x 17.00	1/16	2	24 x 85	F24P85	1.20	1.10	1.05	F24E85P	2.06	1.85	1.73	F24E85G	3.60	3.24	3.06
	8.50 x 12.00	1/16	3	42 x 59	F42P59	1.45	1.30	1.17	F42E59P	2.10	1.90	1.70	F42E59G	3.75	3.40	3.10
	8.50 x 17.00	1/16	4	42 x 85	F42P85	1.90	1.68	1.58	F42E85P	3.17	2.85	2.66	F42E85G	5.44	4.90	4.59
G	1.25 x 8.50	1/16		(8 x 42) 2	G16P84	.33	.30	.27	G16E84P	.44	.40	.36	G16E84G	.48	.44	.40
	2.25 x 8.50	1/16		(11 x 42) 2	G22P84	.55	.51	.46	G22E84P	.80	.75	.70	G22E84G	1.16	1.03	.94
	3.63 x 8.50	1/16		(18 x 42) 2	G36P84	.62	.56	.50	G36E84P	.95	.85	.76	G36E84G	1.75	1.57	1.48
	4.88 x 8.50	1/16	1	(24 x 42) 2	G48P84	.72	.65	.59	G48E84P	1.42	1.30	1.22	G48E84G	1.89	1.71	1.57
	4.88 x 17.00	1/16	2	(24 x 85) 2	G48P170	1.20	1.10	1.05	G48E170P	2.06	1.85	1.73	G48E170G	3.60	3.24	3.06
	8.50 x 12.00	1/16	3	(42 x 59) 2	G84P158	1.45	1.30	1.17	G84E158P	2.10	1.90	1.70	G84E158G	3.75	3.40	3.10
	8.50 x 17.00	1/16	4	(42 x 85) 2	G84P170	1.90	1.65	1.58	G84E170P	3.17	2.85	2.66	G84E170G	5.40	4.85	4.40

- Notes:
1. This size punched board can be used with our 20001 and 20010 metal bases.
 2. This size punched board can be used with our 20002 and 20011 metal bases.
 3. This size punched board can be used with our 20003 metal base.
 4. This size punched board can be used with our 20004 metal base.
 5. XXXP Phenolic Type PBE is per Mil-P-3115C and withstands temperatures to 250°F.
 6. Epoxy Paper Type PEE is per Mil-P-22324 and withstands temperatures to 250°F.
 7. Glass Epoxy G-10 Type GEE is per Mil-P-18177 and withstands temperatures to 300°F.



waldom

BREADBOARDING KITS

"ECONOMY LINE" MODELS

The economy line breadboarding kits listed below have the same high quality and workmanship in the components supplied as found in the most expensive professional kits. They

are designed for use in setting up basic types of circuits and therefore, differ only in that they contain lesser quantities of the various parts.

MODEL NO. 10001 (8½" Long x 4¼" Wide x 2⅝" High) \$6.25 ea. net

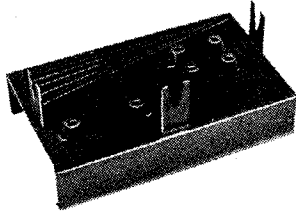

Description	Qty.	Part No.	Description	Qty.	Part No.
Two Piece Metal Base	1	20010	Component Mounting Brackets	6	20041
"A" Pattern (.093" Holes on .265" Grid Ctrs.) XXXP Phenolic Board — 4.77" x 8.48" x .062"	1	18X32	Control Mounting Brackets	2	20051
Terminal Board, "A" Pattern — 1.88" x 4.24"	1	30001	#3-48 x ¾" Round Hd. Machine Screws	20	F-464
Solder-Type, Self Locking, Feed-Thru Terminals	50	20021	#3-48 x ¾" x ¼" Hex Nuts	20	F-555
Right Angle Brackets	2	20061	No. 4 x ½" Washer	2	MW-401
			Wire Leads (Bus) (No. 18 A.W.G., Solid, Tinned, 8" Long)	4	20080
			Grid Paper (4¼" x 8½")	6	20090
			Plastic Small Parts Container	1	PB-90

Phenolic Deckboards with other grid spacings are available for this size base. See punched boards listed on page 2.

MODEL NO. 10002 (17" Long x 4¼" Wide x 2⅝" High) \$9.95 ea. net

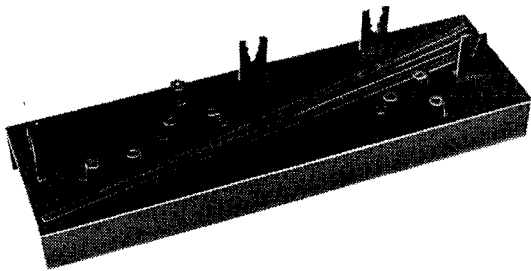

Description	Qty.	Part No.	Description	Qty.	Part No.
Two Piece Metal Base	1	20011	Right Angle Brackets	4	20061
"A" Pattern (.093 Holes on .265 Grid Ctrs.) XXXP Phenolic Board — 4.77" x 17" x .062"	1	18X64	Component Mounting Bracket	8	20041
Terminal Board, "A" Pattern — 1.88" x 4.24"	1	30001	Control Mounting Bracket	3	20051
Large Terminal Board "A" Pattern 1.35" x 8.48"	1	30004	#3-48 x ¾" Round Head Machine Screws	32	F-464
Solder Type, Self Locking, Feed-Thru Terminals	75	20021	#3-48 x ¾" x ¼" Hex Nuts	32	F-555
			#4 x ½" Washer	3	MW-401
			Wire Leads (Bus) No. 18 A.W.G., Solid, Tinned, 16" Long	4	20082
			Grid Paper (4¼" x 17")	6	20092
			Plastic Small Parts Container	1	PB-90

Phenolic Deckboards with other grid spacings are available for this size base. See punched boards listed on page 2.

RF MODEL

Specifically designed for use in the development of critical RF circuits involving problems of shielding and/or isolation. This model gives the choice of either aluminum or two-sided copper clad deck (both furnished). Contains special teflon

insulated brass feed-through terminals, and aluminum shielding separators for isolation purposes. Above or below deck separators can easily be cut. This RF kit is the only one of its type on the market.

MODEL NO. 10003 (17" Long x 6" Wide x 2⅝" High) \$29.95 ea. net

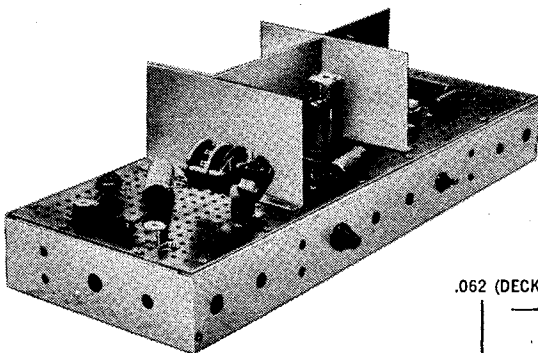

Description	Qty.	Part No.	Description	Qty.	Part No.
Four Piece Metal Base	1	20012	Brass Feed-Thru Terminals	25	20025
Aluminum Deck—½" holes, ¼" thick	1	20013	Teflon Insulating Bushings for above	25	20026
Two-Sided Copper Clad, XXXP Phenolic Deck ¼" holes, ¼" thick	1	40001	Component Mounting Brackets	10	20041
Aluminum Separator with Mounting Flange 5¼" long x 27⁄8" high (For Top Deck Mounting)	5	20086	Control Mounting Brackets	5	20051
Aluminum Separator with Mounting Flange 5¼" long x 17⁄8" high (For Underside Mounting)	5	20085	#3-48 x ¾" Round Head Machine Screws	52	F-464
			#3-48 x ¾" x ¼" Hex Nuts	52	F-555
			Plastic Small Parts Container	1	PB-90

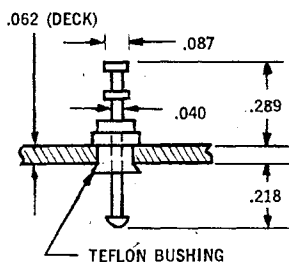



BREADBOARDING COMPONENTS

FOUR-SIDED METAL BREADBOARDING BASES, SLANTED FRONT

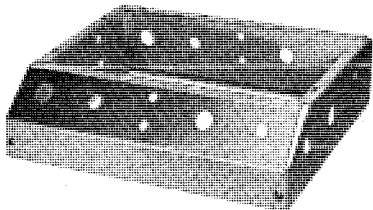

These metal bases are made from .032" aluminum per mil. Spec. QQA-250-C, 1/4", 3/8", and 1/2" control mounting holes available on each side. Slotted holes on top flanges accept punched board of any size hole pattern. See listings of punched boards for specific reference to the four sizes of bases listed here. A generous amount of screws and nuts are included.

Part No.	Size Length x Width x Height	Price Each		
		1-99	100-249	250 or More
20001	6 1/8" x 8 1/2" x 2 1/8"	\$3.25	\$3.10	\$2.90
20002	6 1/8" x 17" x 2 1/8"	3.75	3.50	3.30
20003	10" x 12" x 2 1/8"	4.40	4.00	3.70
20004	10" x 17" x 2 1/8"	4.70	4.40	4.15

SOLDER TYPE TERMINAL

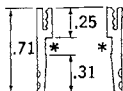
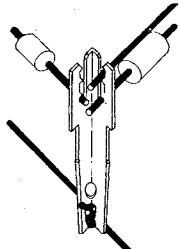

A feed-through terminal for "A" pattern punched board made of half-hard brass, tin plated. Two serrated slots of .032" will accommodate three or more wires per slot, while two .062" holes at bottom allow additional connections. Insertion or extraction is accomplished with part 20022 tool or long-nose pliers. Locking notch (*) insures terminal from falling out of punched board. Its great feature is that wires are held securely before soldering. Request quotation for gold or silver plating.

Part No.	Qty. Per Pkg.	Price Per Pkg.
20021/25	25	\$.65
20021/C	100	2.25
20021/M	1000*	18.25
Insertion/Extraction Tool 20022	1	.50

*Includes one 20022 insertion/extraction tool.

"WIZARD SPRING" SOLDERLESS CONNECTOR

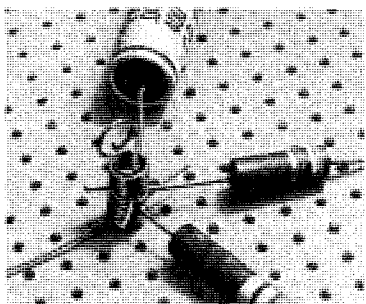

"Wizard Spring" is a plated solderless connector designed to hold many wires from any direction, and may be mounted either top-side or under-side. It may be secured to "A" pattern boards quickly by the use of a 20021 terminal as the holding device. Before insertion both parts are held with tool No. 20022. Otherwise, they are easily secured with the use of sheet metal screws. Finger loop (illustrated) is a unique feature for quick, easy usage. The "Wizard Spring" costs less than any similar device.

Part No.	Qty. Per Pkg.	Price Per Pkg.
20031/25	25*	\$1.50
20031/C	100*	4.95
20031/M	1000*	39.75
20032/25	25**	1.50
20032/C	100**	4.95
20032/M	1000**	39.75

*Pkg. includes, at no additional cost, same quantity of No. 4 x 1/2" (Part No. F-596) Sheet Metal Screws for mounting in "A" Pattern (.093 hole) punched boards.

**Pkg. includes, at no additional cost, same quantity of No. 2 x 3/8" (Part No. F-701) Sheet Metal Screws for Mounting in "F" or "G" Pattern (.062" Hole) punched boards.

COMPONENT MOUNTING BRACKET

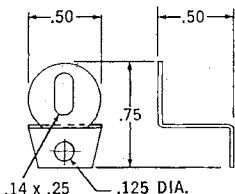

This mounting bracket is universally used to mount components such as: transformers, sockets, relays, and terminal boards on the breadboarding deck. Slotted hole enables easy mounting of a component requiring two or more brackets. Material is plated steel.

Part No.	Qty.* Per Pkg.	Price Per Pkg.
20041/10	10	\$.70
20041/C	100	5.75
20041/M	1000	54.00

*Pkg. includes, at no additional cost, same quantity of No. 3-48 x 3/4" Round Head Machine Screws (Part No. F-464) and No. 3-48 Hex Nuts (Part No. F-555).

CONTROL MOUNTING BRACKET

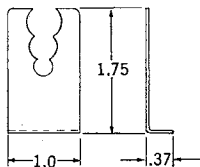

An all purpose bracket with 1/4", 3/8", and 1/2" holes for deck mounting of switches, potentiometers, and similar components. Positive retention eliminates possibility of shafts falling out. Material is plated steel.

Part No.	Qty.* Per Pkg.	Price Per Pkg.
20051/10	10	\$1.00
20051/C	100	8.50
20051/M	1000	79.50

*Pkg. includes, at no additional cost, same quantity of No. 3-48 x 3/4" Round Head Machine Screws (Part No. F-464) and No. 3-48 Hex Nuts (Part No. F-555).

RIGHT ANGLE BRACKET

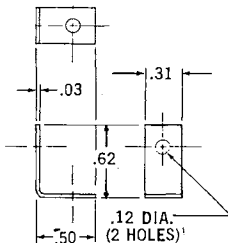

This right-angle bracket has many useful applications. It may be used above or below breadboarding deck to mount terminal boards, connectors, tube sockets, switches and all types of smaller components. Material is plated steel.

Part No.	Qty.* Per Pkg.	Price Per Pkg.
20061/10	10	\$.95
20061/C	100	8.50
20061/M	1000	75.00

*Pkg. includes, at no additional cost, double quantity (bracket has two mtg. holes) of No. 3-48 x 3/4" Round Head Machine Screws (Part No. F-464) and No. 3-48 Hex Nuts (Part No. F-555).

JEFFERS MOLDED INDUCTORS

JEFFERS inductors are for use at radio frequencies and in pulse circuitry. The listed standard inductors, in values from 0.1 μ h through 10,000 μ h, are designed to meet the requirements of MIL-C-15305 Revision C.

Important features of JEFFERS standard inductors.

- High Reliability, proven by over 253,470,000 unit test hours.
- High Q and SRF.
- Maximum protection with minimum dimension as a result of full encapsulation in a thermo-setting mineral filled plastic jacket.
- Assured uniformity of product, a result of stringent Quality Control and Inspection procedures at every production stage.

Suffix letter on part number denotes standard tolerance. J = 5%, K = 10%, M = 20%.

These inductors, in standard tolerances, are available for immediate delivery from your local Airco Speer Distributor.

TYPE 15 — Dia. .156 ± .010 - Length .375 ± .010

Jeffers P/N	L μ h	Max. Oper. Temp. °C	Test Freq. (MC)	Q Min	SRF Min (MC)	DCR Max Ohms	Direct Current (MA)
4415-1M	0.15	125°	25.0	50	525	0.03	2450
4415-2M	0.22	125°	25.0	50	450	0.055	1900
4425-1M	0.33	125°	25.0	45	360	0.09	1400
4425-2M	0.47	125°	25.0	45	310	0.12	1225
4425-3K	0.56	125°	25.0	50	280	0.135	1220
4425-4K	0.68	105°	25.0	50	250	0.15	1100
4425-5K	0.82	125°	25.0	50	220	0.22	900
4425-6K	1.00	125°	25.0	50	200	0.29	830
4425-7K	1.20	125°	7.9	33	180	0.42	650
4425-8K	1.50	125°	7.9	33	160	0.50	600
4425-9K	1.80	125°	7.9	33	150	0.65	525
4425-10K	2.20	125°	7.9	33	135	0.95	435
4425-11K	2.70	125°	7.9	33	120	1.20	385
4425-12K	3.30	125°	7.9	33	110	2.00	300
4425-13K	3.90	125°	7.9	33	100	2.30	280
4425-14K	4.70	125°	7.9	33	90	2.60	260
4435-1K	5.60	125°	7.9	45	80	0.32	750
4435-2K	6.80	125°	7.9	50	55	0.50	600
4445-1K	8.20	125°	7.9	50	50	0.60	545
4445-2K	10.0	125°	7.9	55	45	0.90	445
4445-3K	12.0	125°	2.5	65	42	1.10	404
4445-4K	15.0	125°	2.5	65	40	1.40	370
4445-5J	18.0	125°	2.5	75	34	2.25	280
4445-6J	20.0	125°	2.5	80	34	2.30	275
4445-7J	22.0	125°	2.5	75	30	2.50	265
4455-1J	24.0	125°	2.5	65	27	2.20	265
4455-2J	27.0	125°	2.5	60	25	2.60	260
4465-1J	30.0	125°	2.5	70	20	2.80	255
4465-2J	33.0	125°	2.5	65	19	3.00	250
1315-1J	36.0	105°	2.5	60	15.5	2.50	180
1315-2J	39.0	105°	2.5	60	14.5	2.60	176
1315-3J	43.0	105°	2.5	60	13.7	2.70	172
1315-4J	47.0	105°	2.5	55	13.0	2.75	170
1315-5J	51.0	105°	2.5	55	12.7	2.85	167
1315-6J	56.0	105°	2.5	55	12.0	3.00	164
1315-7J	62.0	105°	2.5	55	11.5	3.15	160
1315-8J	68.0	105°	2.5	55	11.0	3.30	156
1315-9J	75.0	105°	2.5	55	10.5	3.70	147
1315-10J	82.0	105°	2.5	50	10.3	3.90	143
1315-11J	91.0	105°	2.5	50	10.0	4.30	136
1315-12J	100.0	105°	2.5	50	9.5	4.50	133
1315-13J	110.0	105°	.790	60	8.9	4.90	128
1315-14J	120.0	105°	.790	65	8.7	5.20	124
1315-15J	130.0	105°	.790	65	8.5	5.45	121
1315-16J	150.0	105°	.790	65	8.0	6.05	114
1315-17J	160.0	105°	.790	65	7.5	6.40	111
1315-18J	180.0	105°	.790	65	7.0	6.75	108
1315-19J	200.0	105°	.790	65	6.5	7.10	106
1315-20J	220.0	105°	.790	65	6.2	7.45	103
1315-21J	240.0	105°	.790	65	5.9	7.80	101

TYPE 09 — Dia. .095 ± .005 - Length .250 ± .010

Jeffers P/N	L μ h	Max. Oper. Temp. °C	Test Freq. (MC)	Q Min	SRF Min (MC)	DCR Max Ohms	Direct Current (MA)
4416-1K	0.10	125°	25.0	34	680	0.08	1315
4416-2K	0.12	125°	25.0	34	640	0.09	1240
4416-3K	0.15	125°	25.0	34	600	0.10	1170
4416-4K	0.18	125°	25.0	34	550	0.12	1070
4416-5K	0.22	125°	25.0	32	510	0.14	990
4416-6K	0.27	125°	25.0	30	460	0.16	925
4416-7K	0.33	125°	25.0	28	410	0.22	790
4426-1K	0.39	125°	25.0	35	355	0.30	675
4426-2K	0.47	125°	25.0	35	325	0.34	635
4426-3K	0.56	125°	25.0	34	310	0.40	585
4426-4K	0.68	125°	25.0	33	280	0.54	500
4426-5K	0.82	125°	25.0	32	260	0.63	465
4426-6K	1.00	125°	25.0	32	240	0.74	430
4436-1K	1.20	105°	7.9	32	150	0.18	875
4436-2K	1.50	105°	7.9	32	140	0.22	790
4436-3K	1.80	105°	7.9	32	125	0.28	700
4436-4K	2.20	105°	7.9	32	115	0.38	600
4436-5K	2.70	105°	7.9	40	100	0.55	500
4436-6K	3.30	105°	7.9	45	90	0.80	415
4436-7K	3.90	105°	7.9	45	82	1.00	370
4436-8K	4.70	105°	7.9	45	75	1.20	340
4446-1K	5.60	105°	7.9	50	67	1.50	300
4446-2K	6.80	105°	7.9	50	60	1.80	275
4446-3K	8.20	105°	7.9	60	55	2.40	240
4446-4K	10.0	105°	7.9	60	50	3.10	210
1316-1K	12.0	105°	2.5	40	40	2.40	240
1316-2K	15.0	105°	2.5	40	36	2.75	225
1316-3K	18.0	105°	2.5	50	32	3.00	215
1316-4K	22.0	105°	2.5	50	28	3.30	205
1316-5K	27.0	105°	2.5	50	24	3.60	195
1326-1K	33.0	105°	2.5	45	29	2.80	225
1326-2K	39.0	105°	2.5	45	26	3.10	210
1326-3K	47.0	105°	2.5	45	24	4.30	180
1326-4K	56.0	105°	2.5	45	22	5.30	160
1326-5K	68.0	105°	2.5	50	19	6.00	152
1326-6K	82.0	105°	2.5	50	17	6.70	144
1326-7K	100.0	105°	2.5	50	14	7.50	135

TYPE 19 — Dia. .190 ± .010 - Length .440 ± .010

Jeffers P/N	L μ h	Max. Oper. Temp. °C	Test Freq. (MC)	Q Min	SRF Min (MC)	DCR Max Ohms	Direct Current (MA)
4411-1M	0.15	125°	25.0	55	510	0.030	3000
4411-2M	0.22	125°	25.0	50	415	0.035	2800
4411-3M	0.33	125°	25.0	50	350	0.065	2000
4411-4M	0.47	125°	25.0	50	300	0.085	1700
4411-5K	0.56	125°	25.0	50	270	0.125	1450
4411-6K	0.68	125°	25.0	45	250	0.150	1300
4411-7K	0.82	125°	25.0	40	210	0.205	1100
4411-8K	1.00	125°	25.0	40	200	0.290	930
4411-9K	1.20	125°	7.9	30	180	0.400	785
4411-10K	1.50	125°	7.9	30	170	0.485	700
4411-11K	1.80	125°	7.9	30	150	0.740	580
4411-12K	2.20	125°	7.9	30	140	0.970	505
4411-13K	2.70	125°	7.9	30	120	1.200	460
4421-1K	3.30	125°	7.9	30	70	0.140	1350
4421-2K	3.90	125°	7.9	30	65	0.155	1250
4421-3K	4.70	125°	7.9	30	60	0.210	1100
4421-4K	5.60	125°	7.9	30	50	0.280	935
4421-5K	6.80	125°	7.9	30	50	0.375	810
4421-6K	8.20	125°	7.9	30	48	0.440	750
4421-7K	10.0	125°	7.9	30	42	0.605	640
4421-8K	12.0	125°	2.5	50	36	1.050	490
4421-9K	15.0	125°	2.5	55	30	1.200	460
4421-10K	18.0	125°	2.5	60	30	1.950	360
4421-11K	22.0	125°	2.5	60	24	2.200	335
4421-12K	27.0	125°	2.5	65	22	2.750	300
1331-21J	270.0	125°	.790	65	5.6	8.2	110
1331-22J	300.0	125°	.790	65	5.3	8.7	107
1331-23J	330.0	125°	.790	65	5.0	9.1	105
1331-24J	360.0	125°	.790	65	4.7	9.6	102
1331-25J	390.0	125°	.790	65	4.5	10.0	100
1331-26J	430.0	125°	.790	65	4.3	10.6	97
1331-27J	470.0	125°	.790	65	4.0	11.1	95
1331-28J	510.0	125°	.790	65	3.8	11.6	93
1331-29J	560.0	125°	.790	65	3.6	12.3	91
1331-30J	620.0	125°	.790	60	3.5	13.0	88
1331-31J	680.0	125°	.790	60	3.4	13.7	85
1331-32J	750.0	125°	.790	60	3.3	14.4	83
1331-33J	820.0	125°	.790	60	3.1	15.1	81
1331-34J	910.0	125°	.790	60	2.9	15.8	79
1331-35J	1000.0	125°	.790	60	2.8	16.5	78

SECTION 1800

PRICE LIST

CATALOG NUMBER	NET PRICE	CATALOG NUMBER	NET PRICE	CATALOG NUMBER	NET PRICE	CATALOG NUMBER	NET PRICE	CATALOG NUMBER	NET PRICE	CATALOG NUMBER	NET PRICE
20A000-0	.78	22A155RBI	1.38	25A014-0	.72	46A825CPC	1.80	60A022-2	1.50	70F226AI	.60
20A000-1	.96	22A222RBI	1.71	25A014-1	.90	46A826CPC	1.77	60A022-3	1.50	70F227AP	.60
20A000-2	.96	22A223RBI	1.50	25A014-2	.90	46A827CPC	1.71	60A022-4	1.50	70F252AF	1.08
20A000-3	.96	22A224RBI	1.47	25A014-3	.90	47A024-0	1.56	60A022-5	1.71	70F253AI	.84
20A000-4	.96	22A225RBI	1.47	25A014-4	.90	47A024-1	1.62	60A022-6	1.50	70F254AI	.69
20A000-5	1.17	22A332RBI	1.74	25A014-5	1.20	47A024-2	1.62	60A022-7	1.50	70F255AI	.69
20A000-6	.96	22A333RBI	1.56	25A014-6	.90	47A024-3	1.62	60A024-0	1.29	70F272AF	1.08
20A000-7	.96	22A334RBI	1.50	25A014-7	.90	47A024-4	1.62	60A024-1	1.50	70F273AI	.84
20A103RBI	1.29	22A335RBI	1.50	26A024-0	1.05	47A024-5	1.86	60A024-2	1.50	70F274AI	.69
20A104RBI	1.26	22A472RBI	1.77	26A024-1	1.17	47A024-6	1.62	60A024-3	1.50	70F275AI	.69
20A105RBI	1.26	22A473RBI	1.56	26A024-2	1.17	47A024-7	1.62	60A024-4	1.50	70F276AI	.60
20A106RBI	1.14	22A474RBI	1.50	26A024-3	1.17	47A103CPC	2.76	60A024-5	1.71	70F304AI	.69
20A107RBI	1.08	22A475RBI	1.50	26A024-4	1.17	47A104CPC	2.67	60A024-6	1.50	70F332AF	1.11
20A154RBI	1.29	22A682RBI	1.80	26A024-5	1.50	47A105CPC	2.58	60A024-7	1.50	70F333AI	.84
20A155RBI	1.26	22A683RBI	1.56	26A024-6	1.17	47A106CPC	2.52	62A022-0	1.44	70F334AI	.69
20A156RBI	1.14	22A684RBI	1.50	26A024-7	1.17	47A107CPC	2.49	62A022-1	1.62	70F335AI	.69
20A157RBI	1.08	22A685RBI	1.50	27A013-0	.72	47A124CPC	2.67	62A022-2	1.62	70F336AI	.60
20A224RBI	1.29	22A822RBI	1.89	27A013-1	.90	47A125CPC	2.58	62A022-3	1.62	70F337AP	.60
20A225RBI	1.14	22A823RBI	1.59	27A013-2	.90	47A126CPC	2.52	62A022-4	1.62	70F354AI	.69
20A226RBI	1.14	22A824RBI	1.50	27A013-3	.90	47A127CPC	2.49	62A022-5	1.86	70F392AF	1.14
20A227RBI	1.08	22A825RBI	1.50	27A013-4	.90	47A154CPC	2.67	62A022-6	1.62	70F393AI	.84
20A334RBI	1.29	23A013-0	.75	27A013-5	1.20	47A155CPC	2.58	62A022-7	1.62	70F394AI	.75
20A335RBI	1.26	23A013-1	.90	27A013-6	.90	47A156CPC	2.55	62A024-0	1.44	70F395AI	.69
20A336RBI	1.14	23A013-2	.90	27A013-7	.90	47A157CPC	2.49	62A024-1	1.62	70F396AI	.60
20A337RBI	1.14	23A013-3	.90	27A014-0	.72	47A184CPC	2.67	62A024-2	1.62	70F472AF	1.17
20A474RBI	1.29	23A013-4	.90	27A014-1	.90	47A185CPC	2.58	62A024-3	1.62	70F473AI	.84
20A475RBI	1.26	23A013-5	1.17	27A014-2	.90	47A186CPC	2.55	62A024-4	1.62	70F474AI	.75
20A476RBI	1.14	23A013-6	.90	27A014-3	.90	47A187CPC	2.49	62A024-5	1.86	70F475AI	.69
20A477RBI	1.14	23A013-7	.90	27A014-4	.90	47A224CPC	2.67	62A024-6	1.62	70F476AI	.60
20A684RBI	1.29	23A013-8	.90	27A014-5	1.20	47A225CPC	2.58	62A024-7	1.62	70F477AP	.60
20A685RBI	1.26	23A014-0	.75	27A014-6	.90	47A226CPC	2.55	64A022-0	1.74	70F502AF	1.20
20A686RBI	1.14	23A014-1	.96	27A014-7	.90	47A227CPC	2.52	64A022-1	1.89	70F504AI	.75
20A687RBI	1.14	23A014-2	.96	46A013-0	.75	47A274CPC	2.67	64A022-2	1.89	70F562AF	1.26
20A824RBI	1.29	23A014-3	.96	46A013-1	.90	47A275CPC	2.61	64A022-3	1.89	70F563AI	.84
20A825RBI	1.26	23A014-4	.96	46A013-2	.90	47A276CPC	2.55	64A022-4	1.89	70F564AI	.75
20A826RBI	1.14	23A014-5	1.17	36A013-3	.90	47A277CPC	2.52	64A022-5	2.04	70F565AI	.69
20A827RBI	1.14	23A014-6	.96	46A013-4	.90	47A334CPC	2.76	64A022-6	1.89	70F566AI	.60
21A000-0	.78	23A014-7	.96	46A013-5	1.17	47A335CPC	2.61	64A022-7	1.89	70F682AF	1.35
21A000-1	.96	23A014-8	.96	46A013-6	.90	47A336CPC	2.55	64A024-0	1.74	70F683AI	.84
21A000-2	.96	23A101RPC	1.38	46A013-7	.90	47A337CPC	2.52	64A024-1	1.89	70F684AI	.75
21A000-3	.96	23A102RPC	1.32	46A014-0	.84	47A338CPC	2.52	64A024-2	1.89	70F685AI	.69
21A000-4	.96	23A103RPC	1.32	46A014-1	1.05	47A394CPC	2.76	64A024-3	1.89	70F686AI	.60
21A000-5	1.17	23A104RPC	1.23	46A014-2	1.05	47A395CPC	2.61	64A024-4	1.89	70F687AP	.60
21A000-6	.96	23A105RPC	1.14	46A014-3	1.05	47A396CPC	2.55	64A024-5	2.04	70F752AF	1.44
21A000-7	.96	23A106RPC	1.05	46A014-4	1.05	47A397CPC	2.52	64A024-6	1.89	70F753AI	.84
21A102RBI	1.59	23A107RPC	1.05	46A014-5	1.23	47A474CPC	2.76	64A024-7	1.89	70F754AI	.75
21A103RBI	1.44	46A014-6	1.05	46A103CPC	1.89	47A475CPC	2.61	66A022-1	1.89	70F755AI	.69
21A104RBI	1.35	46A103CPC	1.83	46A104CPC	1.83	47A476CPC	2.58	66A022-2	2.10	70F822AF	1.44
21A105RBI	1.29	46A104CPC	1.77	46A105CPC	1.77	47A477CPC	2.52	66A022-3	2.10	70F912AF	1.47
21A106RBI	1.17	46A105CPC	1.71	46A106CPC	1.68	47A478CPC	2.76	66A022-4	2.10	70F913AI	.69
21A106RBI	1.17	46A107CPC	1.68	46A107CPC	1.68	47A479CPC	2.61	66A022-5	2.10	70F914AI	.75
21A153RBI	1.44	46A124CPC	1.83	46A125CPC	1.77	47A566CPC	2.58	66A022-6	2.10	70F915AI	.69
21A154RBI	1.44	46A125CPC	1.77	46A126CPC	1.71	47A567CPC	2.52	66A022-7	2.10	70F916AI	.60
21A155RBI	1.35	46A126CPC	1.71	46A127CPC	1.68	47A568CPC	2.58	66A024-0	2.28	70E825AI	.69
21A156RBI	1.17	46A127CPC	1.68	46A128CPC	1.68	47A569CPC	2.61	66A024-1	2.10	70E826AI	.69
21A223RBI	1.44	46A128CPC	1.63	46A129CPC	1.63	47A570CPC	2.58	66A024-2	2.10	70E827AF	.60
21A223RBI	1.44	46A129CPC	1.77	46A130CPC	1.77	47A571CPC	2.52	66A024-3	2.28	70E828AF	.60
21A224RBI	1.35	46A130CPC	1.74	46A131CPC	1.68	47A572CPC	2.76	66A024-4	2.10	70F912AF	1.47
21A225RBI	1.29	46A131CPC	1.63	46A132CPC	1.63	47A573CPC	2.58	66A024-5	2.10	70F913AI	.69
21A226RBI	1.17	46A132CPC	1.63	46A133CPC	1.83	47A574CPC	2.61	66A024-6	2.10	70F914AI	.75
21A227RBI	1.44	46A133CPC	1.77	46A134CPC	1.77	47A575CPC	2.58	66A024-7	2.10	70F915AI	.69
21A228RBI	1.44	46A134CPC	1.74	46A135CPC	1.74	47A576CPC	2.52	66A024-8	2.28	70F916AI	.60
21A229RBI	1.35	46A135CPC	1.74	46A136CPC	1.74	47A577CPC	2.52	66A024-9	2.28	70F917AI	.60
21A230RBI	1.35	46A136CPC	1.74	46A137CPC	1.74	47A578CPC	2.52	66A024-10	2.28	70F918AI	.60
21A231RBI	1.35	46A137CPC	1.74	46A138CPC	1.74	47A579CPC	2.52	66A024-11	2.28	70F919AI	.60
21A232RBI	1.35	46A138CPC	1.74	46A139CPC	1.74	47A580CPC	2.52	66A024-12	2.28	70F920AI	.60
21A233RBI	1.35	46A139CPC	1.74	46A140CPC	1.74	47A581CPC	2.52	66A024-13	2.28	70F921AI	.60
21A234RBI	1.35	46A140CPC	1.74	46A141CPC	1.74	47A582CPC	2.52	66A024-14	2.28	70F922AI	.60
21A235RBI	1.35	46A141CPC	1.74	46A142CPC	1.74	47A583CPC	2.52	66A024-15	2.28	70F923AI	.60
21A236RBI	1.35	46A142CPC	1.74	46A143CPC	1.74	47A584CPC	2.52	66A024-16	2.28	70F924AI	.60
21A237RBI	1.35	46A143CPC	1.74	46A144CPC	1.74	47A585CPC	2.52	66A024-17	2.28	70F925AI	.60
21A238RBI	1.35	46A144CPC	1.74	46A145CPC	1.74	47A586CPC	2.52	66A024-18	2.28	70F926AI	.60
21A239RBI	1.35	46A145CPC	1.74	46A146CPC	1.74	47A587CPC	2.52	66A024-19	2.28	70F927AI	.60
21A240RBI	1.35	46A146CPC	1.74	46A147CPC	1.74	47A588CPC	2.52	66A024-20	2.28	70F928AI	.60
21A241RBI	1.35	46A147CPC	1.74	46A148CPC	1.74	47A589CPC	2.52	66A024-21	2.28	70F929AI	.60
21A242RBI	1.35	46A148CPC	1.74	46A149CPC	1.74	47A590CPC	2.52	66A024-22	2.28	70F930AI	.60
21A243RBI	1.35	46A149CPC	1.74	46A150CPC	1.74	47A591CPC	2.52	66A024-23	2.28	70F931AI	.60
21A244RBI	1.35	46A150CPC	1.74	46A151CPC	1.74	47A592CPC	2.52	66A024-24	2.28	70F932AI	.60
21A245RBI	1.35	46A151CPC	1.74	46A152CPC	1.74	47A593CPC	2.52	66A024-25	2.28	70F933AI	.60
21A246RBI	1.35	46A152CPC	1.74	46A153CPC	1.74	47A594CPC	2.52	66A024-26	2.28	70F934AI	.60
21A247RBI	1.35	46A153CPC	1.74	46A154CPC	1.74	47A595CPC	2.52	66A024-27	2.28	70F935AI	.60
21A248RBI	1.35	46A154CPC	1.74	46A155CPC	1.74	47A596CPC	2.52	66A024-28	2.28	70F936AI	.60
21A249RBI	1.35	46A155CPC	1.74	46A156CPC	1.74	47A597CPC	2.52	66A024-29	2.28	70F937AI	.60
21A250RBI	1.35	46A156CPC	1.74	46A157CPC	1.74	47A598CPC	2.52	66A024-30	2.28	70F938AI	.60
21A251RBI	1.35	46A157CPC	1.74	46A158CPC	1.74	47A599CPC	2.52	66A024-31	2.28	70F939AI	.60
21A252RBI	1.35	46A158CPC	1.74	46A159CPC	1.74	47A600CPC	2.52	66A024-32	2.28	70F940AI	.60
21A253RBI	1.35	46A159CPC	1.74	46A160CPC	1.74	47A601CPC	2.52	66A024-33	2.28	70F941AI	.60
21A254RBI	1.35	46A160CPC	1.74	46A161CPC	1.74	47A602CPC	2.52	66A024-34	2.28	70F942AI	.60
21A255RBI	1.35	46A161CPC	1.74	46A162CPC	1.74	47A603CPC	2.52	66A024-35	2.28	70F943AI	.60
21A256RBI	1.35	46A162CPC	1.74	46							

MICRO MITE MOLDED R.F. CHOKES J. W. MILLER COMPANY

Nicknamed the "Micro-Mite", these rugged coils exhibit high Q and very low distributed capacity, all concentrated into an amazingly small package. They are ideal for use where weight, space and high Q considerations are involved. Size reduction ranges up to 80% of equivalent standard molded chokes. The construction of these coils permits miniaturization without the use of ferrite materials, thus maintaining temperature stability. This series of molded coils conforms to MIL-C-15305.

Miller Part Number	M S Type	Measured on Model 260A Q-Meter			Self Resonant Frequency Minimum (MHz)	D. C. Resistance Maximum	Milliamp Rating Maximum*	Core Material
		Inductance Microhenries	Q Minimum	Testing Frequency				
9210-54	90538-01	36 ± 5%	60	2.5 MHz	15.5	2.50	180	IRON
9210-56	90538-02	39 ± 5%	60	2.5 MHz	14.5	2.60	176	IRON
9210-58	90538-03	43 ± 5%	60	2.5 MHz	13.7	2.70	172	IRON
9210-60	90538-04	47 ± 5%	55	2.5 MHz	13.0	2.75	170	IRON
9210-62	90538-05	51 ± 5%	55	2.5 MHz	12.7	2.85	167	IRON
9210-64	90538-06	56 ± 5%	55	2.5 MHz	12.0	3.00	164	IRON
9210-66	90538-07	62 ± 5%	55	2.5 MHz	11.5	3.15	160	IRON
9210-68	90538-08	68 ± 5%	55	2.5 MHz	11.0	3.30	156	IRON
9210-70	90538-09	75 ± 5%	55	2.5 MHz	10.5	3.70	147	IRON
9210-72	90538-10	82 ± 5%	50	2.5 MHz	10.3	3.90	143	IRON
9210-74	90538-11	91 ± 5%	50	2.5 MHz	10.0	4.30	136	IRON
9210-76	90538-12	100 ± 5%	50	2.5 MHz	9.5	4.50	133	IRON
9210-78	90538-13	110 ± 5%	60	.790 MHz	8.9	4.90	128	IRON
9210-80	90538-14	120 ± 5%	65	.790 MHz	8.7	5.20	124	IRON
9210-82	90538-15	130 ± 5%	65	.790 MHz	8.5	5.45	121	IRON
9210-84	90538-16	150 ± 5%	65	.790 MHz	8.0	6.05	114	IRON
9210-86	90538-17	160 ± 5%	65	.790 MHz	7.5	6.40	111	IRON
9210-88	90538-18	180 ± 5%	65	.790 MHz	7.0	6.75	108	IRON
9210-90	90538-19	200 ± 5%	65	.790 MHz	6.5	7.10	106	IRON
9210-92	90538-20	220 ± 5%	65	.790 MHz	6.2	7.45	103	IRON
9210-94	90538-21	240 ± 5%	65	.790 MHz	5.9	7.80	101	IRON

Mold Size: .155 ± .010 diameter; .375 ± .010 length. Leads: AWG #22 TCW; 1.44 ± .125 length. Power Rating: .22 Watt Max. at 90° C.
 *Current based on (1) Temperature rise not to exceed 15°C at 90° ambient. (2) Overload not to exceed 1/2 times rated current.

Miller Part Number	M S Type	Measured on Model 260A Q-Meter			Self Resonant Frequency Minimum (MHz)	D. C. Resistance Maximum	Milliamp Rating Maximum*	Mold Size	Core Material
		Inductance Microhenries	Q Minimum	Testing Frequency					
9220-00	90539-01	270 ± 5%	65	.790 MHz	5.6	8.2	110	A	IRON
9220-02	90539-02	300 ± 5%	65	.790 MHz	5.3	8.7	107	A	IRON
9220-04	90539-03	330 ± 5%	65	.790 MHz	5.0	9.1	105	A	IRON
9220-06	90539-04	360 ± 5%	65	.790 MHz	4.7	9.6	102	A	IRON
9220-08	90539-05	390 ± 5%	65	.790 MHz	4.5	10.0	100	A	IRON
9220-10	90539-06	430 ± 5%	65	.790 MHz	4.3	10.6	97	A	IRON
9220-12	90539-07	470 ± 5%	65	.790 MHz	4.0	11.1	95	A	IRON
9220-14	90539-08	500 ± 5%	65	.790 MHz	3.8	11.6	93	A	IRON
9220-15	90539-08	510 ± 5%	65	.790 MHz	3.8	11.6	92	A	IRON
9220-16	90539-09	560 ± 5%	65	.790 MHz	3.6	12.3	91	A	IRON
9220-18	90539-10	620 ± 5%	60	.790 MHz	3.5	13.0	88	A	IRON
9220-20	90539-11	680 ± 5%	60	.790 MHz	3.4	13.7	85	A	IRON
9220-22	90539-12	750 ± 5%	60	.790 MHz	3.3	14.4	83	A	IRON
9220-24	90539-13	820 ± 5%	60	.790 MHz	3.1	15.1	81	A	IRON
9220-26	90539-14	910 ± 5%	60	.790 MHz	2.9	15.8	79	A	IRON
9220-28	90539-15	1000 ± 5%	60	.790 MHz	2.8	16.5	78	A	IRON
9220-30	90540-01	1100 ± 5%	60	.250 MHz	2.8	21.0	78	B	IRON
9220-32	90540-02	1200 ± 5%	60	.250 MHz	2.7	22.0	76	B	IRON
9220-34	90540-03	1300 ± 5%	60	.250 MHz	2.6	23.0	75	B	IRON
9220-36	90540-04	1500 ± 5%	65	.250 MHz	2.4	25.0	72	B	IRON
9220-38	90540-05	1600 ± 5%	65	.250 MHz	2.3	26.0	70	B	IRON
9220-40	90540-06	1800 ± 5%	65	.250 MHz	2.2	28.0	68	B	IRON
9220-42	90540-07	2000 ± 5%	65	.250 MHz	2.1	29.0	67	B	IRON
9220-44	90540-08	2200 ± 5%	70	.250 MHz	2.0	30.0	66	B	IRON
9220-46	90540-09	2400 ± 5%	70	.250 MHz	1.9	31.0	64	B	IRON
9220-48	90540-10	2700 ± 5%	70	.250 MHz	1.8	33.0	62	B	IRON
9220-50	90540-11	3000 ± 5%	70	.250 MHz	1.7	35.0	61	B	IRON
9220-52	90540-12	3300 ± 5%	70	.250 MHz	1.6	38.0	58	B	IRON
9220-54	90540-13	3600 ± 5%	70	.250 MHz	1.5	40.0	57	B	IRON
9220-56	90541-01	3900 ± 5%	80	.250 MHz	1.45	44.0	61	C	IRON
9220-58	90541-02	4300 ± 5%	80	.250 MHz	1.40	46.0	59	C	IRON
9220-60	90541-03	4700 ± 5%	80	.250 MHz	1.35	48.0	58	C	IRON
9220-62	90541-04	5000 ± 5%	80	.250 MHz	1.30	50.0	57	C	IRON
9220-64	90541-05	5600 ± 5%	80	.250 MHz	1.25	53.0	56	C	IRON
9220-66	90541-06	6200 ± 5%	80	.250 MHz	1.20	56.0	54	C	IRON
9220-68	90541-07	6800 ± 5%	80	.250 MHz	1.15	59.0	52	C	IRON
9220-70	90541-08	7500 ± 5%	80	.250 MHz	1.10	62.0	51	C	IRON
9220-72	90541-09	8200 ± 5%	80	.250 MHz	1.05	65.0	50	C	IRON
9220-74	90541-10	9100 ± 5%	80	.250 MHz	1.00	68.0	49	C	IRON
9220-76	90541-11	10000 ± 5%	80	.250 MHz	.95	72.0	47	C	IRON

*Current based on (1) Temperature rise not to exceed 15°C at 90° ambient. (2) Overload not to exceed 1/2 times rated current.

Mold Size	Mold Diameter	Mold Length	Lead Size	Lead Length	Max. Watt at 90° C.
A	.190 ± .010	.440 ± .010	AWG #22	1.44 ± .125	.25
B	.215 ± .010	.560 ± .010	AWG #21	1.44 ± .125	.40
C	.240 ± .010	.740 ± .010	AWG #20	1.44 ± .125	.45

Refer to Pages 1-2 for Prices.

Miller Part Number	M S Type	Measured on Model 260A Q-Meter			Self Resonant Frequency Minimum (MHz)	D. C. Resistance Maximum	Milliamp Rating Maximum*	Core Material
		Inductance Microhenries	Q Minimum	Testing Frequency				
9340-00	91189-14	1.2 ± 10%	60	7.9 MHz	170	.075	2400	PHENOLIC
9340-02	91189-15	1.5 ± 10%	60	7.9 MHz	160	.090	2150	PHENOLIC
9340-03	91189-16	1.8 ± 10%	60	7.9 MHz	140	.135	1750	PHENOLIC
9340-04	91189-17	2.2 ± 10%	60	7.9 MHz	125	.160	1600	PHENOLIC
9340-06	91189-18	2.7 ± 10%	60	7.9 MHz	115	.220	1350	PHENOLIC
9340-08	91189-19	3.3 ± 10%	60	7.9 MHz	100	.305	1150	PHENOLIC
9340-10	91189-20	3.9 ± 10%	60	7.9 MHz	95	.45	955	PHENOLIC
9340-12	91189-21	4.7 ± 10%	60	7.9 MHz	90	.560	860	PHENOLIC
9340-14	91189-22	5.6 ± 10%	60	7.9 MHz	80	.745	745	PHENOLIC
9340-16	91189-23	6.8 ± 10%	60	7.9 MHz	75	1.05	635	PHENOLIC
9340-18	91189-24	8.2 ± 10%	60	7.9 MHz	68	1.4	550	PHENOLIC
9340-20	91189-25	10.0 ± 10%	60	7.9 MHz	60	1.9	460	PHENOLIC
9340-22	91189-26	12.0 ± 10%	40	2.5 MHz	53	2.65	395	PHENOLIC
9340-24	91189-27	15.0 ± 10%	40	2.5 MHz	50	3.25	355	PHENOLIC
9340-26	91189-28	18.0 ± 10%	40	2.5 MHz	45	4.15	315	PHENOLIC
9340-28	91189-29	22.0 ± 10%	50	2.5 MHz	25	.295	1150	IRON
9340-30	91189-30	27.0 ± 10%	45	2.5 MHz	22	.350	1050	IRON
9340-32	91189-31	33.0 ± 10%	60	2.5 MHz	20	.550	865	IRON
9340-34	91189-32	39.0 ± 10%	55	2.5 MHz	18	.65	810	IRON
9340-36	91189-33	47.0 ± 10%	65	2.5 MHz	16	1.0	640	IRON
9340-38	91189-34	56.0 ± 10%	65	2.5 MHz	14	1.15	620	IRON
9340-39	91189-35	68.0 ± 10%	75	2.5 MHz	13	1.85	470	IRON
9340-40	91189-36	82.0 ± 10%	75	2.5 MHz	13	2.10	440	IRON
9340-42	91189-37	100.0 ± 10%	75	2.5 MHz	12	2.50	405	IRON
9340-44	91189-38	120.0 ± 10%	95	.79 MHz	10	4.00	315	IRON

Mold Size: 0.280 ± .010 diameter; 0.900 ± .010 length. Leads: AWG #21 TCW; 1.437 ± .125 length. Power Rating: 9/8 Watt Max. at 90° C.
 *Current based on (1) Temperature rise not to exceed 35°C at 90° ambient. (2) Overload not to exceed 1 1/2 times rated current.

Miller Part Number	M S Type	Measured on Model 260A Q-Meter			Self Resonant Frequency Minimum (MHz)	D. C. Resistance Maximum	Milliamp Rating Maximum*	Mold Size	Core Material
		Inductance Microhenries	Q Minimum	Testing Frequency					
9350-00	75052-1	47 ± 10%	18	2.5 MHz	13.5	5.9	195	A	PHENOLIC
9350-02	75052-2	56 ± 10%	18	2.5 MHz	13	6.4	185	A	PHENOLIC
9350-04	75052-3	68 ± 10%	70	2.5 MHz	13	3.3	255	A	IRON
9350-06	75052-4	82 ± 10%	65	2.5 MHz	11.7	3.5	245	A	IRON
9350-08	75052-5	100 ± 10%	65	2.5 MHz	10.7	3.8	235	A	IRON
9350-10	75052-6	120 ± 10%	75	.79 MHz	9.3	4.7	215	A	IRON
9350-12	75052-7	150 ± 10%	75	.79 MHz	8.3	5.3	200	A	IRON
9350-14	75053-1	180 ± 10%	80	.79 MHz	6.0	5.5	225	B	IRON
9350-16	75053-2	220 ± 10%	80	.79 MHz	5.5	5.9	220	B	IRON
9350-18	75053-3	270 ± 10%	80	.79 MHz	5.1	6.6	210	B	IRON
9350-20	75053-4	330 ± 10%	75	.79 MHz	4.2	7.8	185	B	IRON
9350-22	75053-5	390 ± 10%	75	.79 MHz	3.9	8.7	180	B	IRON
9350-24	75054-1	470 ± 10%	80	.79 MHz	3.7	9.0	190	C	IRON
9350-26	75054-2	560 ± 10%	80	.79 MHz	3.5	10.0	180	C	IRON
9350-28	75054-3	680 ± 10%	75	.79 MHz	3.2	11.2	170	C	IRON
9350-30	75054-4	820 ± 10%	75	.79 MHz	3.0	13.0	155	C	IRON
9350-32	75054-5	1000 ± 10%	70	.79 MHz	2.7	14.5	145	C	IRON
9350-34	75055-1	1500 ± 10%	85	.25 MHz	2.2	22.0	127	D	IRON
9350-36	75055-2	2000 ± 10%	85	.25 MHz	1.9	26.0	125	D	IRON
9350-37	75055-2	2200 ± 10%	85	.25 MHz	1.8	27.0	115	D	IRON
9350-38	75055-3	2500 ± 10%	85	.25 MHz	1.7	30.0	115	D	IRON
9350-39	75055-3	2700 ± 10%	85	.25 MHz	1.6	32.0	105	D	IRON
9350-40	75055-4	5000 ± 10%	70	.25 MHz	1.2	65.0	78	D	IRON
9350-41	75055-4	5100 ± 10%	70	.25 MHz	1.0	66.0	73	D	IRON
9350-44	75055-5	10000 ± 10%	70	.25 MHz	0.8	70.0	71	D	FERRITE

*Current based on (1) Temperature rise not to exceed 35°C at 90° ambient. (2) Overload not to exceed 1 1/2 times rated current.

COIL DIMENSIONS	A	B	C	D	LEAD DIMENSIONS
DIAMETER ± .010	.250	.310	.375	.468	AWG 20, 21, 22 TCW
LENGTH ± .010	.560	.560	.625	.687	1.437 ± .125
MAX. WATT. AT 90° C.	.30	.40	.45	.55	

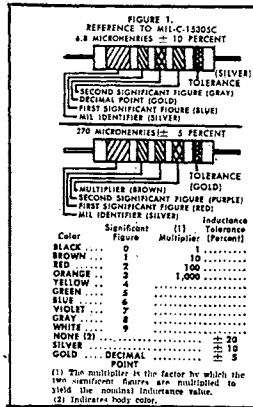

Molded Choke Coils Color Coding

For cylindrical choke coils. Cylindrical choke coils shall be marked with five colored bands. A silver band MIL identifier of double the width of the other four bands, located near one end of the coil, identifies military radiofrequency coils; four other bands of equal width, three indicating the inductance in microhenries and the fourth band indicating the tolerance in percent. Color coding shall be in accordance with the color code of table II. When either the first or second band of the three bands is gold, this band shall represent the decimal point for inductance values less than 10, and the other two bands shall represent significant figures. For inductance values of 10 or more, the first two bands shall represent significant figures, and the third band shall represent the multiplier. For small units, dots may be used instead of bands, when specified. The diameter of the MIL-identifier dot shall be larger than the other dots. The colors used shall be in accordance with MIL-STD-174. Typical color coding for units with inductance values less than 10 and for 10 or greater is shown on figure 1.

Refer to Pages 1-2 for Prices

MOLDED SHIELDED MINIATURE R.F. CHOKES

This is the first major development in R.F. Choke design for many years.
The electromagnetic shielding is fully effective at the ends of the coil as well as along the body.
Molded construction assures top performance under severe conditions.

Size: 0.157" Diameter, 0.375" Length
Shielding: Less than 2% coupling
Inductance: 0.1 uh thru 10,000 uh (61 values)
Environment: Grade 1, Class B, MIL-C-15305

Power Rating: .20 watts @ 90° ambient and rated current flow
*Current based on (1) Temperature rise not to exceed 35°C at 90°C ambient
(2) Overload not to exceed 1½ times rated current
**Current required to decrease inductance 5%



Miller P.C.1 Number	Measured on Model 260A Q-Meter			Self Resonant Frequency Minimum (MHz)	D. C. Resistance Maximum	*Milliamp Rating Maximum	**Incremental Current Milliamperes Approx.
	Inductance ± 10%	Q Minimum	Testing Frequency				
9240-770	.10uh.	50	25 MHz	250	.015	3100	3100
9240-771	.12uh.	50	25 MHz	250	.020	2650	2650
9240-701	.15uh.	50	25 MHz	250	.025	2400	2400
9240-772	.18uh.	50	25 MHz	250	.030	2190	2190
9240-702	.22uh.	50	25 MHz	250	.035	2030	2030
9240-773	.27uh.	50	25 MHz	250	.045	1790	1790
9240-703	.33uh.	45	25 MHz	250	.075	1380	1380
9240-774	.39uh.	45	25 MHz	250	.085	1300	1300
9240-704	.47uh.	45	25 MHz	235	.100	1200	1200
9240-705	.56uh.	45	25 MHz	210	.180	890	890
9240-706	.68uh.	45	25 MHz	190	.200	850	850
9240-707	.82uh.	45	25 MHz	180	.280	710	710
9240-708	1.0 uh.	45	25 MHz	150	.070	1430	1430
9240-709	1.2 uh.	45	7.9 MHz	145	.080	1340	1340
9240-710	1.5 uh.	45	7.9 MHz	130	.100	1200	1200
9240-711	1.8 uh.	50	7.9 MHz	120	.120	1090	1090
9240-712	2.2 uh.	50	7.9 MHz	110	.150	980	980
9240-713	2.7 uh.	50	7.9 MHz	105	.220	800	800
9240-714	3.3 uh.	50	7.9 MHz	90	.270	730	730
9240-715	3.9 uh.	50	7.9 MHz	85	.290	700	700
9240-716	4.7 uh.	55	7.9 MHz	82	.320	670	670
9240-717	5.6 uh.	55	7.9 MHz	80	.560	500	500
9240-718	6.8 uh.	55	7.9 MHz	75	.700	450	450
9240-719	8.2 uh.	55	7.9 MHz	70	.820	410	410
9240-720	10.0 uh.	50	7.9 MHz	60	.900	400	400
9240-721	12 uh.	55	2.5 MHz	50	.950	380	380
9240-722	15 uh.	45	2.5 MHz	45	.750	430	225
9240-723	18 uh.	45	2.5 MHz	42	.850	410	190
9240-724	22 uh.	50	2.5 MHz	40	.950	380	170
9240-725	27 uh.	50	2.5 MHz	35	1.10	360	150
9240-726	33 uh.	45	2.5 MHz	33	1.30	330	130
9240-727	39 uh.	50	2.5 MHz	29	1.80	280	115
9240-728	47 uh.	50	2.5 MHz	27	2.00	260	110
9240-729	56 uh.	50	2.5 MHz	25	2.20	250	100
9240-730	68 uh.	50	2.5 MHz	20	2.50	240	87
9240-731	82 uh.	50	2.5 MHz	15	3.50	215	85
9240-732	100 uh.	50	2.5 MHz	11	2.20	200	80
9240-733	120 uh.	60	.79 MHz	10	2.50	265	74
9240-734	150 uh.	60	.79 MHz	9	2.80	240	68
9240-735	180 uh.	60	.79 MHz	9	3.20	215	50
9240-736	220 uh.	60	.79 MHz	8	3.70	205	46
9240-737	270 uh.	60	.79 MHz	7	4.60	200	40
9240-738	330 uh.	60	.79 MHz	7	5.00	195	37
9240-739	390 uh.	60	.79 MHz	6	5.50	190	34
9240-740	470 uh.	60	.79 MHz	5.8	6.00	180	32
9240-741	560 uh.	60	.79 MHz	5.5	7.50	160	32
9240-742	680 uh.	60	.79 MHz	5	8.50	145	30
9240-743	820 uh.	60	.79 MHz	4.3	12.00	135	26
9240-744	1000 uh.	65	.79 MHz	4.2	13.00	105	24
9240-745	1.2 mh.	50	.25 MHz	4	16.50	100	22
9240-746	1.5 mh.	50	.25 MHz	3.8	20	90	20
9240-747	1.8 mh.	50	.25 MHz	3.2	25	80	18
9240-748	2.2 mh.	50	.25 MHz	2.6	27	75	15
9240-749	2.7 mh.	50	.25 MHz	2.1	35	65	13
9240-750	3.3 mh.	45	.25 MHz	2	40	60	13
9240-751	3.9 mh.	45	.25 MHz	1.8	44	55	12
9240-752	4.7 mh.	45	.25 MHz	1.4	58	50	11
9240-753	5.6 mh.	45	.25 MHz	2.1	72	45	10
9240-754	6.8 mh.	45	.25 MHz	1.5	80	42	8.0
9240-755	8.2 mh.	40	.25 MHz	1.4	107	40	7.0
9240-756	10.0 mh.	40	.25 MHz	1.3	137	38	6.5

Refer to Pages 1-2 for Prices

Sub-Miniature R.F. Chokes

An extremely versatile series of iron core R.F. chokes designed to meet the industries' demand for high reliability, ultra-miniature components. The coils are ideally suited to network and filter design, delay lines, and computer applications. Rated at 50 milliamperes maximum D.C. current they are more than satisfactory for most applications. The coils are impregnated with a moisture resistant lacquer and on special order they can be fungus-proofed per JAN-T-152 using varnish per MIL-V-173A. They can also be encapsulated in epoxy resin to conform to Grade 1, Class B of MIL-C-15305.

Miller Part Number	Measured on Model 260A Q-Meter			Resonant Frequency Minimum MHz	D.C. Resistance Maximum	Milliamp Rating Maximum	Maximum Winding Diameter	Form Length $\pm \frac{1}{32}$
	Inductance Nominal*	Q Minimum	Test Frequency					
70F107AP★★	.10 uh★	49	25 MHz	600	.013	3200	.156	$\frac{3}{16}$
70F157AP★★	.15 uh★	52	25 MHz	490	.025	1600	.141	$\frac{3}{16}$
70F227AP★★	.22 uh★	48	25 MHz	400	.038	1280	.141	$\frac{3}{16}$
70F337AP★★	.33 uh★	47	25 MHz	330	.070	800	.125	$\frac{3}{16}$
70F477AP★★	.47 uh★	46	25 MHz	280	.125	510	.125	$\frac{3}{16}$
70F687AP★★	.68 uh★	48	25 MHz	240	.200	400	.125	$\frac{3}{16}$
70F757AP★★	.75 uh★	48	25 MHz	224	.264	320	.125	$\frac{3}{16}$
70F827AP★★	.82 uh★	48	25 MHz	216	.290	300	.125	$\frac{3}{16}$
70F106A1	1.0 uh	41	25 MHz	118	.048	636	.165	$\frac{1}{4}$
70F126A1	1.2 uh	45	7.9 MHz	118	.072	400	.160	$\frac{1}{4}$
70F156A1	1.5 uh	42	7.9 MHz	102	.096	316	.160	$\frac{1}{4}$
70F186A1	1.8 uh	31	7.9 MHz	89	.096	400	.160	$\frac{1}{4}$
70F226A1	2.2 uh	43	7.9 MHz	87	.156	202	.160	$\frac{1}{4}$
70F276A1	2.7 uh	34	7.9 MHz	74	.168	256	.160	$\frac{1}{4}$
70F336A1	3.3 uh	40	7.9 MHz	66	.240	159	.150	$\frac{1}{4}$
70F396A1	3.9 uh	35	7.9 MHz	61	.264	159	.150	$\frac{1}{4}$
70F476A1	4.7 uh	43	7.9 MHz	53	.457	100	.150	$\frac{1}{4}$
70F566A1	5.6 uh	41	7.9 MHz	49	.492	100	.150	$\frac{1}{4}$
70F686A1	6.8 uh	40	7.9 MHz	49	.624	100	.150	$\frac{1}{4}$
70F756A1	7.5 uh	32	7.9 MHz	44	.624	100	.150	$\frac{1}{4}$
70F826A1	8.2 uh	37	7.9 MHz	41	.744	100	.150	$\frac{1}{4}$
70F916A1	9.1 uh	41	7.9 MHz	21	1.44	75	.160	$\frac{1}{4}$
70F105A1	10 uh	36	7.9 MHz	19	1.56	75	.160	$\frac{1}{4}$
70F125A1	12 uh	52	2.5 MHz	19	1.68	75	.160	$\frac{1}{4}$
70F155A1	15 uh	52	2.5 MHz	16	1.92	75	.165	$\frac{1}{4}$
70F185A1	18 uh	52	2.5 MHz	15	2.28	75	.165	$\frac{1}{4}$
70F225A1	22 uh	51	2.5 MHz	13	2.28	75	.165	$\frac{1}{4}$
70F255A1	25 uh	48	2.5 MHz	13	2.64	75	.170	$\frac{1}{4}$
70F275A1	27 uh	49	2.5 MHz	12	2.64	75	.170	$\frac{1}{4}$
70F335A1	33 uh	50	2.5 MHz	10	2.76	75	.170	$\frac{1}{4}$
70F395A1	39 uh	48	2.5 MHz	9.3	3.36	75	.175	$\frac{1}{4}$
70F475A1	47 uh	44	2.5 MHz	9.1	3.36	75	.175	$\frac{1}{4}$
70F565A1	56 uh	45	2.5 MHz	8.6	3.84	75	.180	$\frac{1}{4}$
70F685A1	68 uh	42	2.5 MHz	8.1	4.20	75	.180	$\frac{1}{4}$
70F755A1	75 uh	38	2.5 MHz	7.2	4.56	75	.185	$\frac{1}{4}$
70F825A1	82 uh	41	2.5 MHz	6.7	4.80	75	.185	$\frac{1}{4}$
70F915A1	91 uh	41	2.5 MHz	6.7	4.92	75	.185	$\frac{1}{4}$
70F104A1	100 uh	25	2.5 MHz	3.6	7.68	75	.165	$\frac{1}{4}$
70F124A1	120 uh	40	790 kHz	3.2	8.16	75	.165	$\frac{1}{4}$
70F154A1	150 uh	47	790 kHz	3.0	8.16	75	.165	$\frac{1}{4}$
70F184A1	180 uh	48	790 kHz	2.8	8.16	75	.170	$\frac{1}{4}$
70F204A1	200 uh	47	790 kHz	2.7	10.3	75	.170	$\frac{1}{4}$
70F224A1	220 uh	46	790 kHz	2.5	11.5	75	.170	$\frac{1}{4}$
70F254A1	250 uh	49	790 kHz	2.5	12.1	75	.170	$\frac{1}{4}$
70F274A1	270 uh	46	790 kHz	2.5	13.2	75	.175	$\frac{1}{4}$
70F304A1	300 uh	46	790 kHz	2.2	13.2	75	.175	$\frac{1}{4}$
70F334A1	330 uh	41	790 kHz	2.0	13.9	75	.175	$\frac{1}{4}$
70F354A1	350 uh	46	790 kHz	2.0	14.4	75	.180	$\frac{1}{4}$
70F394A1	390 uh	45	790 kHz	2.0	15.8	75	.180	$\frac{1}{4}$
70F474A1	470 uh	35	790 kHz	1.8	16.3	75	.185	$\frac{1}{4}$
70F504A1	500 uh	49	790 kHz	1.8	18.0	75	.195	$\frac{1}{4}$
70F564A1	560 uh	41	790 kHz	1.7	19.2	75	.195	$\frac{1}{4}$
70F684A1	680 uh	37	790 kHz	1.6	19.8	75	.200	$\frac{1}{4}$
70F754A1	750 uh	40	790 kHz	1.6	22.9	75	.210	$\frac{1}{4}$
70F824A1	820 uh	33	790 kHz	1.6	22.9	75	.210	$\frac{1}{4}$
70F914A1	910 uh	32	790 kHz	1.4	24.0	75	.220	$\frac{1}{4}$

*Tolerance 0.1 to 1.0 UH $\pm 20\%$, 1.1 to 15 UH $\pm 10\%$, over 15 UH $\pm 5\%$

★Measured with leads $\frac{1}{4}$ " long from Q Meter binding posts.

Continued on following page

Refer to Page 1-2 for Prices

★★ Stars Indicate New Items

Encapsulated Radio Frequency Chokes

The following series of R.F. chokes range in value from 0.1 uh to 50 mh. These coils are encapsulated in epoxy resin and conform to MIL-C-15305. Min. lead length 1".

Miller Part Number	Measured on Model Z60A Q-Meter			Self Resonant Frequency Minimum MHz	D. C. Resistance Maximum	*Milliamp Rating Maximum	Diameter and Length	Total Turns
	Inductance Nominal ²	Q Minimum	Test Frequency					
4580-E	.10 uh	68	25 MHz	400	.017	3000	.312 x 1.000	3
4582-E	.15 uh	73	25 MHz	328	.018	2900	.312 x 1.000	4
4584-E	.22 uh	77	25 MHz	272	.020	2800	.312 x 1.000	7
4586-E	.33 uh	80	25 MHz	230	.024	2600	.312 x 1.000	10
4588-E	.47 uh	90	25 MHz	194	.034	2500	.312 x 1.000	13
4590-E	.68 uh	83	25 MHz	166	.036	2400	.312 x 1.000	18
4592-E	.75 uh	81	25 MHz	163	.040	2200	.312 x 1.000	21
4594-E	.82 uh	88	25 MHz	160	.043	2100	.312 x 1.000	22
4602-E	1.0 uh	60	7.9 MHz	152	.050	2000	.312 x 1.000	28
4604-E	1.5 uh	58	7.9 MHz	119	.093	1800	.312 x 1.000	34
4606-E	2.4 uh	56	7.9 MHz	96	.190	1500	.312 x 1.000	44
4608-E	3.9 uh	60	7.9 MHz	74	.450	1000	.312 x 1.000	50
4609-E	5.5 uh	57	7.9 MHz	64	.670	850	.312 x 1.000	64
4610-E	6.2 uh	57	7.9 MHz	61	.830	700	.312 x 1.000	66
4611-E	8.2 uh	57	7.9 MHz	52	1.20	600	.312 x 1.000	77
4612-E	10 uh	36	2.5 MHz	49	1.50	500	.312 x 1.000	96
4622-E	10 uh	69	2.5 MHz	32	.110	1500	.375 x 1.125	32
4624-E	15 uh	62	2.5 MHz	26	.170	1000	.375 x 1.125	36
4626-E	24 uh	65	2.5 MHz	20	.340	800	.375 x 1.125	50
4628-E	39 uh	70	2.5 MHz	16	.650	600	.375 x 1.125	83
4629-E	55 uh	72	2.5 MHz	13	1.00	500	.375 x 1.125	83
4630-E	62 uh	83	2.5 MHz	12	1.20	475	.375 x 1.125	77
4631-E	82 uh	85	2.5 MHz	10	1.90	450	.375 x 1.125	92
4632-E	100 uh	107	.79 MHz	9.6	3.00	400	.375 x 1.125	96
4642-E	.10 mh	49	.79 MHz	8.8	5.40	160	.500 x 1.000	219
4644-E	.15 mh	53	.79 MHz	7.0	6.50	160	.500 x 1.000	258
4646-E	.24 mh	56	.79 MHz	5.7	8.50	160	.500 x 1.000	321
4648-E	.39 mh	57	.79 MHz	4.5	11.0	160	.500 x 1.000	396
4649-E	.55 mh	58	.79 MHz	3.8	13.0	160	.625 x 1.000	420
4650-E	.62 mh	59	.79 MHz	3.6	15.0	160	.625 x 1.000	477
4651-E	.75 mh	56	.79 MHz	3.2	16.0	160	.625 x 1.000	495
4652-E	1.0 mh	59	.25 MHz	2.9	19.0	160	.625 x 1.000	574
4662-E	1.0 mh	83	.25 MHz	2.1	8.6	160	.625 x 1.125	300
4664-E	1.5 mh	82	.25 MHz	1.7	11.0	160	.625 x 1.125	366
4666-E	2.4 mh	80	.25 MHz	1.3	15.0	160	.625 x 1.125	471
4668-E	3.9 mh	73	.25 MHz	1.1	20.0	160	.625 x 1.125	585
4669-E	5.5 mh	69	.25 MHz	.88	25.0	160	.625 x 1.125	600
4670-E	6.2 mh	89	.25 MHz	.80	37.0	100	.625 x 1.125	750
4671-E	8.2 mh	83	.25 MHz	.75	46.0	100	.625 x 1.125	900
4672-E	10 mh	68	79 kHz	.65	50.0	100	.625 x 1.125	948
6302-E	2.5 mh	106	250 kHz	1.00	9.0	160	.625 x 1.125	300
6304-E	5.0 mh	91	250 kHz	.80	14.0	160	.625 x 1.125	432
6306-E	10 mh	108	79 kHz	.57	31.0	100	.625 x 1.125	615
6308-E	25 mh	102	79 kHz	.37	82.0	65	.625 x 1.125	969
6310-E	50 mh	113	79 kHz	.26	127	65	.625 x 1.125	1392

*TOLERANCE 0.1 TO 1.0 UH \pm 20%, 1.1 TO 15 UH \pm 10%, OVER 15 UH \pm 5%

Air Core Printed Circuit R.F. Chokes

The following R.F. Chokes have been designed to offer a wide range of inductance values for use in printed circuit applications. Our standard stock of these coils is impregnated with a high grade coil varnish to prevent

moisture absorption. On special orders we can supply these items treated with fungus resistant material, or encapsulated in epoxy resin to meet MIL-C-15305.

Coil length: $\frac{7}{8}$ " on all items. Diameter as tabulated.

Miller Part Number	Measured on General Radio Inductance Bridge Type 1632-A		Self Resonant Frequency Minimum MHz	D. C. Resistance Maximum	Milliamp Rating Maximum	Diameter over Winding	Total Turns
	Inductance @ 1000 Hertz	Q Minimum					
970	1.0 mh. \pm 5%	45 @ 250 kHz	1.57	20.6	125	.700	251
971	1.2 mh. \pm 5%	47 @ 250 kHz	1.46	23.8	125	.720	278
972	1.5 mh. \pm 5%	49 @ 250 kHz	1.38	26.4	125	.740	305
973	1.8 mh. \pm 5%	50 @ 250 kHz	1.24	29.6	125	.750	335
974	2.2 mh. \pm 5%	51 @ 250 kHz	1.04	32.9	125	.770	373
975	2.7 mh. \pm 5%	52 @ 250 kHz	1.06	37.4	125	.800	410
976	3.3 mh. \pm 5%	52 @ 250 kHz	.985	41.8	125	.820	450
977	3.9 mh. \pm 5%	52 @ 250 kHz	.900	46.7	125	.850	490
978	4.7 mh. \pm 5%	52 @ 250 kHz	.848	51.8	125	.875	533
979	5.6 mh. \pm 5%	51 @ 250 kHz	.760	57.6	125	.910	580
980	6.8 mh. \pm 5%	51 @ 250 kHz	.716	64.4	125	.950	635
981	8.2 mh. \pm 5%	38 @ 250 kHz	.520	73.0	100	.850	785
982	10.0 mh. \pm 5%	43 @ 79 kHz	.480	81.6	100	.880	850
983	12.0 mh. \pm 5%	46 @ 79 kHz	.424	92.4	100	.910	940
984	15.0 mh. \pm 5%	48 @ 79 kHz	.398	105	100	.950	1050
985	18.0 mh. \pm 5%	51 @ 79 kHz	.370	117	100	.985	1130
986	22.0 mh. \pm 5%	51 @ 79 kHz	.320	130	75	.985	1347
987	27.0 mh. \pm 5%	51 @ 79 kHz	.294	145	75	1.045	1367
988	33.0 mh. \pm 5%	44 @ 79 kHz	.288	251	75	1.000	1527
989	39.0 mh. \pm 5%	44 @ 79 kHz	.264	277	75	1.050	1647
990	47.0 mh. \pm 5%	40 @ 79 kHz	.190	316	50	.910	1995
991	56.0 mh. \pm 5%	39 @ 79 kHz	.177	351	50	.950	2160
992	68.0 mh. \pm 5%	33 @ 79 kHz	.160	391	50	1.000	2390
993	82.0 mh. \pm 5%	31 @ 79 kHz	.145	442	50	1.025	2590
994	100.0 mh. \pm 5%	29 @ 79 kHz	.138	473	50	1.075	2720

Refer to Pages 1-2 for Prices

Transmitter R.F. Chokes

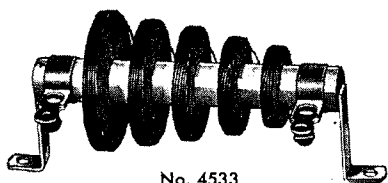

No. 4533

Dimensions: (form) 1/2" diameter by 3 1/2" long.

Part No.	mh.	Ohms Max.	ma	Schematic	Net Price
4534	1.0	3.00	1000	1	\$2.07
4535	1.5	4.32	1000	1	2.37
4533	2.5	5.40	750	1	2.61
4536	4.0	6.60	750	1	3.03
2881	7.0	8.60	750	1	4.14

Dimensions: (form) 1/2" diameter by 2 1/2" long.

Part No.	mh.	Ohms Max.	ma	Schematic	Net Price
4550	2.0	7.80	400	1	\$2.04
4551	4.0	12.0	400	1	2.58

High Inductance Chokes

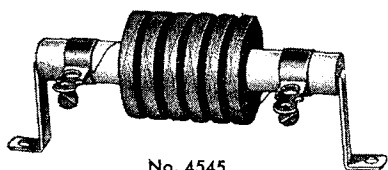

No. 4545

Dimensions: (form) 1/2" diameter by 2 1/2" long.

Part No.	mh.	Ohms Max.	Fo. Min.	ma.	Q Min.	Net Price
4542	50	266	344 kc.	100	65 @ 79 kc.	\$2.37
4543	75	348	312 kc.	100	66 @ 79 kc.	2.58
4544	100	420	256 kc.	100	60 @ 79 kc.	2.82

Dimensions: (form) 1/2" diameter by 3 1/2" long.

4545	150	576	196 kc.	75	75 @ 50 kc.	4.02
4546	200	636	168 kc.	75	75 @ 50 kc.	4.41
4547	250	828	160 kc.	75	80 @ 50 kc.	4.74

Capacity Relay Coil

This coil may be used for almost all types of capacity operated electronic devices such as alarm systems, show windows, counter displays, novelties, etc. The coil is a center-tapped oscillator winding with an adjustable grid coupling condenser and an r.f. choke, all assembled on a bakelite form. A typical wiring diagram is supplied.

Dimensions: 7/8" diameter (form) x 2 1/4" high.

Cat. No.	Use	Schematic	Net Price
695	Capacity Relay Coil	78	\$2.49

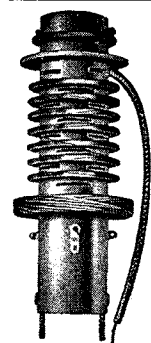

R.F. Transformer for HV Power Supply

These R.F. power supply transformers for use with television receivers and cathode ray oscilloscopes make it possible to construct an inexpensive source of high voltage DC. Two types are available, the #4525 for voltage to 5000 DC and the #4526 for voltages to 10,000 DC (or 30,000 DC in a voltage rectifier tripler circuit). Type 1B3-GT tubes are used as rectifiers and the R.F. oscillator circuit uses one or more type 6V6 or 6Y6 tubes connected in parallel. The high frequency AC source permits use of simple and inexpensive resistive capacitive filters with low ripple content in the output.

Cat. No.	Item	Schematic	Net Price
4525	H.V. R.F. Trans. (to 5 KV)	52	\$6.30
Dimensions: 1 1/4" diameter x 3 3/4" high. (Not Illustrated)			
4526	H.V. R.F. Trans. (to 30 KV)	52	\$9.45
Dimensions: 2 1/4" diameter x 6" high. (Illustrated)			

Heavy Duty Hash Chokes



Through the use of a molded powdered iron form we are able to offer a series of relatively high inductance, high current hash filter chokes.

Dimensions: 3/8" diameter x 1 1/4" long.

Part No.	Uh. ± 20%	Ohms Max.	Amperes	Schematic	Net Price
5218	3.35	.010	13	3	\$1.41
5219	4.9	.016	8	3	1.41
5220	8.8	.021	5	3	1.41
5230	4.0	.012	2	3	1.05
5240	40.0	.082	2	3	1.11
5248	68.0	.054	2	3	1.29
5250	100.0	.216	2	3	1.29

Filament Choke



Designed to prevent ignition and generator interference noise pick-up from battery wiring systems and from vibrator and motor-generator plate supply systems.

Dimensions: 3/4" diameter by 2" long.

Part No.	Uh. ± 20%	Ohms Max.	Amperes	Schematic	Net Price
5221	4	.024	6	1	\$1.05

Plate Supply Choke



A companion choke to the #5221 filament choke for use in the power supply of battery and generator or vibrator "B" supply packs for portable or mobile radio and electronic equipment. Will prevent interference and r.f. "hash" present in the power source from interfering with normal operation of the equipment. Unit is a duo-lateral wound coil enclosed in a sealed Kraft container and provided with convenient axial wire leads. Insulated enclosure permits mounting in out-of-the-way corners of the chassis.

Dimensions: 3/4" diameter by 1 1/8" long.

Part No.	Mh. ± 10%	Ohms Max.	MA	Schematic	Net Price
5222	2.5	33.6	200	1	\$1.23

Rectifier Hash Filter Chokes

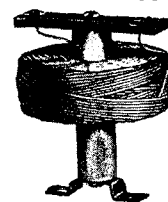

Duo-lateral wound chokes for use in series with the plate leads of mercury vapor rectifiers to prevent r.f. hash feed-back. The chokes are wound on Alsimag forms and have solder type lugs for connection. Two hole mounting brackets prevent the choke from turning. The terminal lugs are eyeleted to a canvas base bakelite strip and provide a spacing of 1 1/2" between connections. The insulation to ground will withstand in excess of 10,000 volts.

Dimensions: 2" diameter x 2 3/8" high.

Part No.	Mh. ± 10%	Ohms Max.	MA	Schematic	Net Price
7867	4.50	5.40	500	1	\$2.37
7868	2.75	2.76	1000	1	2.64

Twin Rectifier Filter Chokes

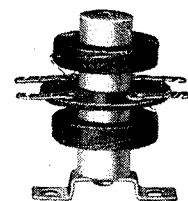

These chokes are similar to those listed above except that two duo-lateral wound coils are assembled on a single ceramic form with a bakelite terminal plate. They are for use with full wave mercury vapor rectifier tubes or with separate tubes having a maximum plate current of less than 300 MA. A two-hole mounting clip is provided. Insulation is adequate for peak voltages up to 2500. The entire assembly is thoroughly impregnated in tropicalized Q-Max lacquer.

Dimensions: 1 1/4" diameter x 1 3/4" high. Mounting centers: 1".

Part No.	Mh.	Ohms	MA	Net Price
7865	3.25 (per coil)	15.	300	\$2.04
9501	1 mh. (per coil)	1.72	1,000	1.89



Stud Mounted Low-Capacity R.F. Chokes

Single stud mounted resistor-type r.f. chokes for use in transmitters and receivers. Pi-wound for very low distributed capacity. Constructed on moulded bakelite forms and equipped with Miller "Sta-On" terminal clips which will not work loose. Co-axial #6-32 thread mounting stud.

Dimensions: 5/8" o.d. by 1 1/4" high (plus 3/8" stud)

Part No.	mh*	Ohms	ma	Schematic	Net Price
4527	1.0	16.8	200	1	\$1.08
4530	2.5	27.6	200	1	1.26

Prices Subject to Change or Withdrawal Without Notice

TV AND RADIO INTERFERENCE FILTERS

TV High-Pass Filters



This TV High-Pass Filter will eliminate or greatly reduce annoying interference which may be picked up by the intermediate-frequency amplifier section of your television receiver. Improves picture clarity by rejecting interference from short wave stations, amateur transmitters, X-Ray and diathermy equipment, industrial r.f. heating units, electric appliances, etc. Clear, steady pictures insured with a minimum of noise streaks, sound bars or herringbone. Filter is designed to attenuate all signals from zero frequency to 40 megacycles. All television channels passed with minimum loss. No tuning required. Installed easily in antenna lead-in receiver. In aluminum shield with convenient "L"-type bracket for mounting.

Dimensions: 1 7/8" by 1 7/8" by 3 1/2" high.

Cat. No.	Use	Schematic	Net Price
6167	TV High-Pass Filter—72-ohm line	46	\$3.90
6168	TV High-Pass Filter—300-ohm line	47	3.90

Cash Register Filter

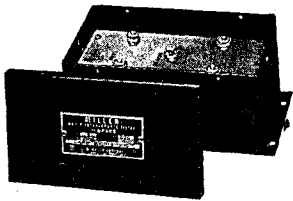

The radio interference produced by most cash registers and business machines, such as comptometers and billing machines, is, in many cases, quite severe and the general purpose type of filter does not always give adequate protection. The Miller Cash Register Filter has been expressly designed to meet the requirements of this type of equipment and will

provide positive elimination of radio interference feed-back into the power supply line. The filter is of the two-section type and consists of four duo-lateral wound chokes and four .5 mfd. condensers.

Dimensions: 3 1/4" x 4" x 7" long.

Part No.	Volts	Amperes	Schematic	Net Price
7814	230	5	17	\$29.70

TV and Appliance Filter



Similar in construction to the Cat. No. 7818, the Cat. No. 7815 is designed for use with larger household appliances and commutator-type motors as well as communications-type receivers and recording equipment. Useful for elimination of

TV interference in radio receivers when inserted in television receiver-line cord. The #7815 filter uses larger capacitors and heavier capacity inductors to handle load requirements up to 550 watts. It is assembled in a gray Hammertone finished case.

Dimensions: 2 1/4" square x 4 1/2" long.

Cat. No.	Volts	Watts	Schematic	Net Price
7815	115	550	11	\$11.10

Electric Shaver Filter



This filter contains an inductive-capacitive circuit consisting of two duo-lateral wound chokes and a non-inductive condenser, giving complete freedom from radio interference. No ground connection is needed for the filter and

the danger of accidental shock is avoided through the use of shock-proof, unbreakable moulded rubber construction.

Dimensions: 1 1/8" diameter x 3" long.

Cat. No.	Volts	Watts	Finish	Schematic	Net Price
7817	115	50	Black	14	\$4.50

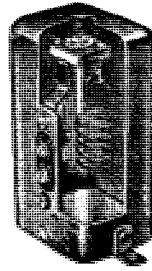

TV and FM Wave Traps

These new high-Q series-resonant wave traps may completely eliminate interference and undesirable images in television and FM receivers. When tuned to the frequency of interfering signal, they are very effective in reducing sound bars and herringbone patterns, or streaks and tearing in the television picture. Superimposed pictures from two different stations also may be prevented. For FM receiver use, cross-talk from interfering station is greatly diminished. Use of one of these traps generally will

reduce interference caused by a near-by transmitter to a degree which will permit satisfactory reception from a weaker station.

Dimensions: 1 3/8" by 1 7/8" by 3 1/2" high.

Cat. No.	Frequency Range	Schematic	Net Price
6163	150-250 MC	45	\$3.30
6164	75-150 MC	45	3.30
6165	40- 80 MC	45	3.30
6166	20- 40 MC	79	3.30

All-Wave Interference Filter

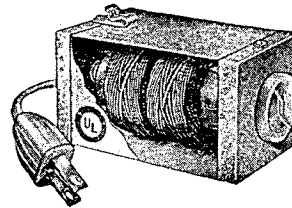

Designed to eliminate radio noises caused by small household appliances such as food mixers, sewing machines, vacuum cleaners, etc. When connected between the radio receiver and the power outlet, the filter will prevent pick-up of interference and unwanted signals through the house wiring system. When used with household appliances the filter prevents the interference energy from getting into the house wiring circuit and disturbing receivers throughout the neighborhood.

Dimensions: 2 1/4" square x 4 1/2" long.

Cat. No.	Volts	Watts	Schematic	Net Price
7818	115	220	13	\$10.80

Capacity Type Line Filter

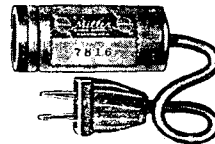

The Miller Capacity Line filter is an all purpose filter for the elimination of radio interference caused by the operation of household appliances such as electric razors, heating pads, hair dryers, food mixers, vacuum cleaners and practically all common household devices and fractional horsepower motors. This filter will provide adequate filtering in less severe cases of interference and in instances where the cost of Miller Inductive-Capacitive type filters is not warranted. A bakelite receptacle at one end and one foot long cord with plug at the other end makes installation simple.

Dimensions: 1 1/8" diameter x 2 5/8" long.

Cat. No.	Volts	Watts	Schematic	Net Price
7816	115	660	15	\$2.61

Un-Cased Interference Filters

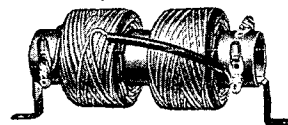

These filters utilize two duo-lateral wound chokes and a dual .2 mfd. non-inductive wound, oil impregnated condenser. The filters are assembled on 1" diameter bakelite tubes and are provided with solder-type terminals and brass mounting brackets. While designed primarily for use with traffic signals, its usefulness is by no means limited to this application. These filters may be used for built-in application with any type of radio interference producing electronic device whose voltage and current requirements are within the rating limits of the filters.

Dimensions: #7880—2 1/4" diameter x 5" long; 90 uh; .125 ohms; dual .2 mfd. condenser.
#7881—3 1/4" diameter x 5" long; 125 uh; .065 ohms; dual .2 mfd. condenser.

Cat. No.	Volts	Amperes	Schematic	Net Price
7880	220	5.	10	\$6.60
7881	220	10.	10	8.70

Prices Subject to Change or Withdrawal Without Notice

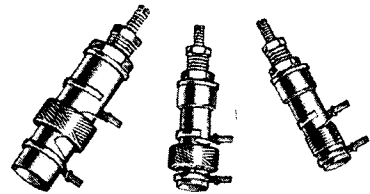

Resinite Adjustable R.F. Coils

Resinite is a phenolic impregnated tubing which combines the mechanical and dielectric advantages of phenolics with the high dielectric strength, moisture resistance, and non-corrosive properties of cellulose acetate. Resinite can be certified to MIL-P-79B Type PBG. This series features an extremely wide choice of inductance ranges and utilizes only the highest quality commercial materials throughout. They find application where the severe moisture resistant characteristics of the encapsulated units and the mechanical properties of the ceramics are not required.

COILS WOUND ON FORM NO. 20A000

Dimensions (form): 1/4" Diameter x 1 3/16" long. Mounting hole 1/4".

Miniature Adjustable R.F. Coils

Miller Part Number	Minimum Core Position			Maximum Core Position			R Ohms Maximum	Maximum Current Milliampere	Diameter over Winding	Turns
	Inductance Maximum	Q Min.	Test Frequency	Inductance Minimum	Q Min.	Test Frequency				
20A107RBI	.088 uh	56	25. MHz	.120 uh	51	25. MHz	.041	1600	.343	3
20A157RBI	.108 uh	77	25. MHz	.180 uh	72	25. MHz	.044	1600	.343	4
20A227RBI	.162 uh	77	25. MHz	.264 uh	68	25. MHz	.051	1600	.343	5
20A337RBI	.238 uh	64	25. MHz	.396 uh	68	25. MHz	.054	1000	.343	6
20A477RBI	.356 uh	66	25. MHz	.564 uh	60	25. MHz	.078	1000	.343	7
20A687RBI	.508 uh	72	25. MHz	.816 uh	50	25. MHz	.082	635	.343	8
20A827RBI	.735 uh	57	25. MHz	.984 uh	41	25. MHz	.090	635	.343	9
20A106RBI	.885 uh	53	25. MHz	1.20 uh	42	7.9 MHz	.135	400	.343	10
20A156RBI	1.08 uh	44	7.9 MHz	1.80 uh	44	7.9 MHz	.205	400	.343	12
20A226RBI	1.62 uh	39	7.9 MHz	2.64 uh	44	7.9 MHz	.522	100	.343	13
20A336RBI	2.38 uh	40	7.9 MHz	3.96 uh	42	7.9 MHz	.640	100	.343	17
20A476RBI	3.56 uh	44	7.9 MHz	5.64 uh	42	7.9 MHz	.770	100	.343	20
20A686RBI	5.08 uh	43	7.9 MHz	8.16 uh	40	7.9 MHz	.950	100	.343	24
20A826RBI	7.35 uh	45	7.9 MHz	9.84 uh	38	7.9 MHz	1.00	100	.343	28
20A105RBI	8.85 uh	37	7.9 MHz	12.0 uh	45	2.5 MHz	1.45	100	.343	31
20A155RBI	10.8 uh	32	2.5 MHz	18.0 uh	52	2.5 MHz	1.70	100	.343	37
20A225RBI	16.2 uh	39	2.5 MHz	26.4 uh	42	2.5 MHz	2.10	100	.343	48
20A335RBI	23.8 uh	40	2.5 MHz	39.6 uh	40	2.5 MHz	2.59	100	.343	57
20A475RBI	35.6 uh	42	2.5 MHz	56.4 uh	37	2.5 MHz	3.10	100	.343	68
20A685RBI	50.8 uh	36	2.5 MHz	81.6 uh	32	2.5 MHz	3.84	100	.343	80
20A825RBI	73.5 uh	38	2.5 MHz	98.4 uh	36	2.5 MHz	4.71	100	.375	94
20A104RBI	88.5 uh	32	2.5 MHz	120. uh	37	.79 MHz	5.00	100	.406	105
20A154RBI	108. uh	28	.79 MHz	180. uh	40	.79 MHz	5.95	100	.406	125
20A224RBI	162. uh	40	.79 MHz	264. uh	38	.79 MHz	7.50	100	.406	154
20A334RBI	238. uh	43	.79 MHz	396. uh	44	.79 MHz	9.50	100	.437	187
20A474RBI	356. uh	43	.79 MHz	564. uh	38	.79 MHz	12.0	100	.500	224
20A684RBI	508. uh	40	.79 MHz	816. uh	32	.79 MHz	14.5	100	.500	266
20A824RBI	735. uh	39	.79 MHz	984. uh	32	.79 MHz	17.0	100	.562	308
20A103RBI	885. uh	40	.79 MHz	1.20 mh	24	.25 MHz	21.0	100	.594	341

COILS WOUND ON FORM NO. 21A000

Dimensions (form): 3/8" Diameter x 1 1/8" long. Mounting hole 1/4".

Standard Adjustable R.F. Coils

Miller Part Number	Minimum Core Position			Maximum Core Position			R Ohms Maximum	Maximum Current Milliampere	Diameter over Winding	Turns
	Inductance Maximum	Q Min.	Test Frequency	Inductance Minimum	Q Min.	Test Frequency				
21A106RBI	.885 uh	64	25. MHz	1.20 uh	52	7.9 MHz	.121	635	.437	7
21A156RBI	1.08 uh	55	7.9 MHz	1.80 uh	52	7.9 MHz	.135	635	.437	9
21A226RBI	1.62 uh	56	7.9 MHz	2.64 uh	44	7.9 MHz	.160	635	.437	11
21A336RBI	2.38 uh	65	7.9 MHz	3.96 uh	35	7.9 MHz	.184	635	.437	15
21A476RBI	3.56 uh	60	7.9 MHz	5.64 uh	44	7.9 MHz	.210	635	.437	17
21A686RBI	5.08 uh	57	7.9 MHz	8.16 uh	41	7.9 MHz	.468	255	.437	18
21A826RBI	7.35 uh	53	7.9 MHz	9.84 uh	44	7.9 MHz	.780	255	.437	20
21A105RBI	8.85 uh	47	7.9 MHz	12.0 uh	51	2.5 MHz	1.46	100	.437	21
21A155RBI	10.8 uh	40	2.5 MHz	18.0 uh	49	2.5 MHz	1.76	100	.437	26
21A225RBI	16.2 uh	36	2.5 MHz	26.4 uh	41	2.5 MHz	2.08	100	.437	31
21A335RBI	23.8 uh	36	2.5 MHz	39.6 uh	32	2.5 MHz	2.56	100	.468	38
21A475RBI	35.6 uh	36	2.5 MHz	56.4 uh	38	2.5 MHz	3.50	100	.468	47
21A685RBI	50.8 uh	32	2.5 MHz	81.6 uh	32	2.5 MHz	3.50	100	.468	54
21A825RBI	73.5 uh	27	2.5 MHz	98.4 uh	36	2.5 MHz	3.94	100	.500	59
21A104RBI	88.5 uh	27	2.5 MHz	120. uh	40	.79 MHz	4.43	100	.500	65
21A154RBI	108. uh	20	.79 MHz	180. uh	40	.79 MHz	5.88	100	.531	86
21A224RBI	162. uh	33	.79 MHz	264. uh	39	.79 MHz	7.20	100	.531	103
21A334RBI	238. uh	34	.79 MHz	396. uh	38	.79 MHz	9.20	100	.562	128
21A474RBI	356. uh	33	.79 MHz	564. uh	35	.79 MHz	10.7	100	.562	155
21A684RBI	508. uh	32	.79 MHz	816. uh	32	.79 MHz	12.8	100	.625	180
21A824RBI	735. uh	26	.79 MHz	984. uh	26	.79 MHz	15.0	100	.625	200
21A103RBI	885. uh	26	.79 MHz	1.20 mh	28	.25 MHz	17.6	100	.687	235
21A153RBI	1.08 mh	32	.25 MHz	1.80 mh	32	.25 MHz	22.8	100	.687	291
21A223RBI	1.62 mh	36	.25 MHz	2.64 mh	35	.25 MHz	28.6	100	.781	350
21A333RBI	2.38 mh	32	.25 MHz	3.96 mh	31	.25 MHz	49.8	65	.687	422
21A473RBI	3.56 mh	37	.25 MHz	5.64 mh	32	.25 MHz	64.7	65	.750	507
21A683RBI	5.08 mh	36	.25 MHz	8.16 mh	32	.25 MHz	76.1	65	.812	591
21A823RBI	7.35 mh	36	.25 MHz	9.84 mh	20	.25 MHz	91.0	65	.843	694
21A102RBI	8.85 mh	36	.25 MHz	12.0 mh	18	79. kHz	104.	65	.950	774

Refer to Pages 1-2 for Prices

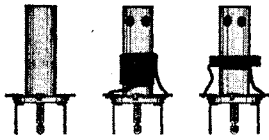

Vertical Mounted Printed Circuit
Ceramic Adjustable R.F. Coils

COILS WOUND ON FORM NO. 46A013

*Self resonant frequency measured at maximum inductance.

For use where mechanical and electrical stability is of paramount importance. This series features a silicone impregnated ceramic form and a silicone-fiberglass terminal collar. A Kel-F locking insert is provided with each coil to prevent accidental core movement under conditions of shock and vibration.

Miller Part Number	Minimum Core Position			Maximum Core Position			R Ohms Max.	Max. Current Ma.	Min* Fo. MHz.	Dia. over Winding	Color Code	
	Inductance Maximum	Q Min.	Test Frequency	Inductance Minimum	Q Min.	Test Frequency					1	2
46A107CPC	.095 uh	70	25.0 MHz	.105 uh	74	25.0 MHz	.02	2500	370.	.343	Brown	—
46A127CPC	.114 uh	55	25.0 MHz	.126 uh	75	25.0 MHz	.04	2000	340.	.343	Red	—
46A157CPC	.142 uh	70	25.0 MHz	.158 uh	90	25.0 MHz	.03	2500	300.	.343	Orange	—
46A187CPC	.171 uh	80	25.0 MHz	.189 uh	90	25.0 MHz	.03	2000	280.	.343	Yellow	—
46A227CPC	.209 uh	70	25.0 MHz	.231 uh	90	25.0 MHz	.04	1300	245.	.343	Green	—
46A277CPC	.256 uh	85	25.0 MHz	.284 uh	90	25.0 MHz	.06	635	220.	.343	Blue	—
46A337CPC	.314 uh	85	25.0 MHz	.347 uh	90	25.0 MHz	.07	810	200.	.343	Violet	—
46A397CPC	.370 uh	85	25.0 MHz	.410 uh	90	25.0 MHz	.08	635	185.	.343	Grey	—
46A477CPC	.446 uh	85	25.0 MHz	.495 uh	85	25.0 MHz	.08	400	175.	.343	White	—
46A567CPC	.532 uh	85	25.0 MHz	.590 uh	85	25.0 MHz	.09	400	160.	.343	Brown	Black
46A687CPC	.645 uh	85	25.0 MHz	.715 uh	85	25.0 MHz	.10	400	142.	.343	Brown	Brown
46A827CPC	.770 uh	85	25.0 MHz	.850 uh	85	25.0 MHz	.11	400	130.	.343	Brown	Red
46A106CPC	.950 uh	85	25.0 MHz	1.05 uh	85	25.0 MHz	.13	400	119.	.343	Brown	Orange
46A126CPC	1.14 uh	67	7.9 MHz	1.26 uh	67	7.9 MHz	.14	635	108.	.343	Brown	Yellow
46A156CPC	1.42 uh	71	7.9 MHz	1.58 uh	70	7.9 MHz	.16	635	97.	.343	Brown	Green
46A186CPC	1.62 uh	71	7.9 MHz	1.98 uh	68	7.9 MHz	.16	400	86.	.343	Brown	Blue
46A226CPC	1.99 uh	76	7.9 MHz	2.42 uh	73	7.9 MHz	.17	400	78.	.343	Brown	Violet
46A276CPC	2.42 uh	76	7.9 MHz	2.96 uh	75	7.9 MHz	.19	400	70.	.343	Brown	Grey
46A336CPC	2.96 uh	76	7.9 MHz	3.64 uh	75	7.9 MHz	.21	400	64.	.343	Brown	White
46A396CPC	3.50 uh	61	7.9 MHz	4.27 uh	52	7.9 MHz	.24	400	59.	.343	Red	Black
46A476CPC	4.24 uh	65	7.9 MHz	5.20 uh	51	7.9 MHz	.38	400	53.	.343	Red	Brown
46A566CPC	5.00 uh	65	7.9 MHz	6.30 uh	51	7.9 MHz	1.0	100	23.	.343	Red	Red
46A686CPC	6.10 uh	52	7.9 MHz	7.50 uh	52	7.9 MHz	1.1	100	21.	.343	Red	Orange
46A826CPC	7.30 uh	48	7.9 MHz	8.90 uh	56	7.9 MHz	1.2	100	20.	.343	Red	Yellow
46A105CPC	8.50 uh	48	7.9 MHz	11.5 uh	52	7.9 MHz	1.3	100	18.	.343	Red	Green
46A125CPC	10.8 uh	48	2.5 MHz	13.2 uh	56	2.5 MHz	1.4	100	16.	.343	Red	Blue
46A155CPC	13.2 uh	60	2.5 MHz	16.5 uh	56	2.5 MHz	1.6	100	14.	.343	Red	Violet
46A185CPC	16.2 uh	59	2.5 MHz	19.5 uh	56	2.5 MHz	1.8	100	12.	.343	Red	Grey
46A225CPC	19.5 uh	63	2.5 MHz	24.3 uh	56	2.5 MHz	2.0	100	11.	.375	Red	White
46A275CPC	24.2 uh	61	2.5 MHz	29.5 uh	68	2.5 MHz	2.2	100	10.	.375	Orange	Black
46A335CPC	29.5 uh	59	2.5 MHz	36.5 uh	67	2.5 MHz	2.7	100	9.2	.375	Orange	Brown
46A395CPC	35.0 uh	58	2.5 MHz	43.0 uh	64	2.5 MHz	2.9	100	8.0	.375	Orange	Red
46A475CPC	42.0 uh	56	2.5 MHz	51.5 uh	56	2.5 MHz	2.9	100	6.8	.406	Orange	Orange
46A565CPC	50.0 uh	56	2.5 MHz	62.0 uh	60	2.5 MHz	3.2	100	5.8	.406	Orange	Yellow
46A685CPC	61.0 uh	52	2.5 MHz	75.0 uh	59	2.5 MHz	3.5	100	5.3	.406	Orange	Green
46A825CPC	74.0 uh	56	2.5 MHz	90.0 uh	55	2.5 MHz	3.9	100	4.8	.406	Orange	Blue
46A104CPC	90.0 uh	48	2.5 MHz	110.0 uh	52	2.5 MHz	4.1	100	4.4	.406	Orange	Violet
46A124CPC	108.0 uh	65	.79 MHz	132.0 uh	62	.79 MHz	4.5	100	4.1	.406	Orange	Grey
46A154CPC	132.0 uh	64	.79 MHz	165.0 uh	72	.79 MHz	5.0	100	3.7	.406	Orange	White
46A184CPC	162.0 uh	59	.79 MHz	198.0 uh	62	.79 MHz	5.5	100	3.5	.406	Yellow	Black
46A224CPC	197.0 uh	64	.79 MHz	243.0 uh	63	.79 MHz	6.0	100	3.2	.437	Yellow	Brown
46A274CPC	242.0 uh	68	.79 MHz	295.0 uh	68	.79 MHz	6.6	100	3.0	.437	Yellow	Red
46A334CPC	295.0 uh	67	.79 MHz	365.0 uh	60	.79 MHz	7.3	100	2.8	.437	Yellow	Orange
46A394CPC	350.0 uh	64	.79 MHz	430.0 uh	64	.79 MHz	8.0	100	2.5	.468	Yellow	Yellow
46A474CPC	420.0 uh	67	.79 MHz	515.0 uh	64	.79 MHz	10.	100	2.3	.468	Yellow	Green
46A564CPC	500.0 uh	65	.79 MHz	620.0 uh	62	.79 MHz	12.	100	2.2	.500	Yellow	Blue
46A684CPC	610.0 uh	64	.79 MHz	750.0 uh	60	.79 MHz	13.	100	2.1	.500	Yellow	Violet
46A824CPC	740.0 uh	60	.79 MHz	900.0 uh	58	.79 MHz	15.	100	2.0	.531	Yellow	Grey
46A103CPC	900.0 uh	61	.79 MHz	1100.0 uh	58	.79 MHz	18.	100	1.9	.531	Yellow	White

Adjustable Wide Range Inductors

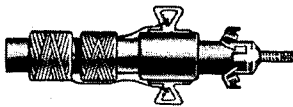

Dimensions: Max. dia. 7/8" x 2 1/4" long. Mtg. hole 5/16"

*Inductance calculated at frequency shown.

**Minimum self resonant frequency measured at maximum inductance.

Due to the wide range of these coils they will find immediate application in many prototype designs where the exact value of the required inductance is not known.

Miller Part Number	Minimum Core Position			Maximum Core Position			R Ohms Max.	Max. Current Ma.	Min.** Fo. MHz.	Dia. over Winding	Total Turns
	Inductance Maximum	Q Min.	Test Frequency	Inductance Minimum	Q Min.	Test Frequency					
9001	40. uh	85	2.5 MHz	.240 mh	220	790. kHz	2.04	250	6.0	.40	102
9002	.180 mh	80	790. kHz	.800 mh	170	790. kHz	4.08	250	4.0	.45	204
9003	.570 mh	73	790. kHz	2.80 mh	110	250. kHz	8.52	250	.90	.58	376
9004	2.10 mh	72	250. kHz	8.00 mh	88	250. kHz	15.4	250	.62	.68	608
9005	6.00 mh	69	250. kHz	16.0 mh	105	79. kHz	33.6	200	.40	.80	1000
9006	12.0 mh	43	79. kHz	40.0 mh	72	79. kHz	91.2	125	.26	.75	1480
9007	30.0 mh	43	79. kHz	105. mh	76	50 kHz*	148.	75	.14	.68	2480
9008	78.0 mh	36	79. kHz	240. mh	61	20 kHz*	264.	75	.10	.75	3860
9009	180. mh	20	20. kHz*	750. mh	41	20 kHz*	620.	50	.03	.75	6100

Refer to Pages 1-2 for Prices

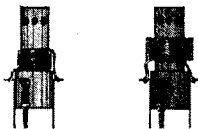

Vertical Mounted Printed Circuit Velvetork Adjustable R.F. Coils

COILS WOUND ON FORM NO. 23A013

Dimensions (form only) Over Collar 3/8" Dia. x 3/4" long.

*Minimum self resonant frequency measured at maximum inductance

The coil form is Polyester impregnated Alpha-Cellulose tubing with internally bonded resilient ribs which provide both thread and torque control. Coils may be adjusted from either end of form.

Miller Part Number	Minimum Core Position			Maximum Core Position			R Ohms Max.	Max. Current Ma.	Min.* Fo. MHz.	Dia. over Winding	Color Code		
	Inductance Maximum	Q Min.	Test Frequency	Inductance Minimum	Q Min.	Test Frequency					1	2	3
23A107RPC	.095 uh	77	25.0 MHz	.125 uh	94	25.0 MHz	.02	4100	350.	.40	Brown	Black	Silver
23A157RPC	.130 uh	68	25.0 MHz	.170 uh	92	25.0 MHz	.02	1600	300.	.37	Brown	Green	Silver
23A227RPC	.185 uh	88	25.0 MHz	.265 uh	100	25.0 MHz	.02	1600	230.	.37	Red	Red	Silver
23A337RPC	.285 uh	88	25.0 MHz	.410 uh	93	25.0 MHz	.03	1000	198.	.37	Orange	Orange	Silver
23A477RPC	.420 uh	100	25.0 MHz	.580 uh	80	25.0 MHz	.03	2500	150.	.37	Yellow	Violet	Silver
23A687RPC	.540 uh	101	25.0 MHz	.850 uh	89	25.0 MHz	.03	1600	136.	.37	Blue	Grey	Silver
23A827RPC	.640 uh	101	25.0 MHz	1.00 uh	78	25.0 MHz	.03	1600	118.	.37	Grey	Red	Silver
23A106RPC	.760 uh	98	25.0 MHz	1.25 uh	70	7.9 MHz	.04	1600	114.	.37	Brown	Black	Gold
23A156RPC	1.20 uh	65	7.9 MHz	1.87 uh	70	7.9 MHz	.06	1000	89.	.37	Brown	Green	Gold
23A226RPC	1.65 uh	61	7.9 MHz	2.75 uh	65	7.9 MHz	.14	400	77.	.37	Red	Red	Gold
23A336RPC	2.40 uh	64	7.9 MHz	4.10 uh	60	7.9 MHz	.17	400	62.	.37	Orange	Orange	Gold
23A476RPC	3.40 uh	68	7.9 MHz	5.80 uh	60	7.9 MHz	.24	400	53.	.37	Yellow	Violet	Gold
23A686RPC	4.60 uh	64	7.9 MHz	8.50 uh	56	7.9 MHz	.39	250	45.	.37	Blue	Grey	Gold
23A826RPC	5.60 uh	64	7.9 MHz	10.0 uh	57	2.5 MHz	.64	160	40.	.37	Grey	Red	Gold
23A105RPC	7.10 uh	68	7.9 MHz	12.5 uh	55	2.5 MHz	.77	160	38.	.37	Brown	Black	Black
23A155RPC	10.0 uh	58	2.5 MHz	18.7 uh	95	2.5 MHz	1.68	100	11.7	.37	Brown	Green	Black
23A225RPC	14.8 uh	61	2.5 MHz	27.5 uh	90	2.5 MHz	1.91	100	8.4	.37	Red	Red	Black
23A335RPC	22.0 uh	60	2.5 MHz	41.0 uh	75	2.5 MHz	2.34	100	6.7	.37	Orange	Orange	Black
23A475RPC	31.0 uh	58	2.5 MHz	58.0 uh	68	2.5 MHz	2.72	100	5.6	.40	Yellow	Violet	Black
23A685RPC	43.5 uh	56	2.5 MHz	85.0 uh	55	2.5 MHz	3.30	100	4.6	.40	Blue	Grey	Black
23A825RPC	61.0 uh	48	2.5 MHz	100.0 uh	88	790. kHz	3.89	100	4.3	.40	Grey	Red	Black
23A104RPC	76.0 uh	52	2.5 MHz	125.0 uh	90	790. kHz	4.39	100	3.8	.40	Brown	Black	Brown
23A154RPC	105.0 uh	57	790. kHz	187.0 uh	92	790. kHz	5.46	100	3.3	.40	Brown	Green	Brown
23A224RPC	160.0 uh	63	790. kHz	275.0 uh	90	790. kHz	6.70	100	2.9	.44	Red	Red	Brown
23A334RPC	240.0 uh	66	790. kHz	410.0 uh	90	790. kHz	8.30	100	2.5	.44	Orange	Orange	Brown
23A474RPC	360.0 uh	68	790. kHz	580.0 uh	81	790. kHz	10.50	100	2.1	.48	Yellow	Violet	Brown
23A684RPC	530.0 uh	66	790. kHz	850.0 uh	75	790. kHz	12.90	100	1.75	.48	Blue	Grey	Brown
23A824RPC	700.0 uh	64	790. kHz	1.00 mh	80	250. kHz	14.90	100	1.70	.53	Grey	Red	Brown
23A103RPC	910.0 uh	66	790. kHz	1.25 mh	85	250. kHz	17.10	100	1.61	.58	Brown	Black	Red
23A153RPC	990.0 uh	35	250. kHz	1.87 mh	60	250. kHz	28.20	65	.73	.45	Brown	Green	Red
23A223RPC	1.60 mh	39	250. kHz	2.75 mh	62	250. kHz	34.80	65	.62	.45	Red	Red	Red
23A333RPC	2.40 mh	41	250. kHz	4.10 mh	60	250. kHz	42.90	65	.60	.48	Orange	Orange	Red
23A473RPC	3.40 mh	42	250. kHz	5.80 mh	57	250. kHz	51.60	65	.53	.48	Yellow	Violet	Red
23A683RPC	5.15 mh	42	250. kHz	8.50 mh	50	250. kHz	63.60	65	.50	.55	Blue	Grey	Red
23A823RPC	7.40 mh	42	250. kHz	10.00 mh	50	79. kHz	75.60	65	.40	.55	Grey	Red	Red
23A102RPC	9.80 mh	40	250. kHz	12.50 mh	52	79. kHz	87.30	65	.38	.55	Brown	Black	Orange
23A152RPC	12.00 mh	39	79. kHz	18.70 mh	55	79. kHz	111.0	65	.32	.60	Brown	Green	Orange
23A222RPC	12.10 mh	20	79. kHz	27.50 mh	51	79. kHz	197.0	33	.26	.60	Red	Red	Orange
23A332RPC	18.20 mh	24	79. kHz	41.00 mh	54	79. kHz	244.0	33	.21	.60	Orange	Orange	Orange
23A472RPC	27.50 mh	28	79. kHz	58.00 mh	56	79. kHz	302.0	33	.20	.60	Yellow	Violet	Orange
23A682RPC	40.00 mh	32	79. kHz	85.00 mh	56	79. kHz	378.0	33	.16	.58	Blue	Grey	Orange
23A822RPC	50.00 mh	34	79. kHz	100.00 mh	58	79. kHz	423.0	33	.15	.58	Grey	Red	Orange
23A101RPC	62.00 mh	35	79. kHz	125.00 mh	56	79. kHz	468.0	33	.14	.60	Brown	Black	Yellow

Shielded Subminiature Adjustable R.F. Coils



These compact adjustable coils offer a minimum two-to-one inductance range with relatively small changes in Q. The tuning adjustment is accessible from either the top or bottom of the coil assembly. Magnetic shielding is achieved through the use of cup cores while the metal shield offers effective electrostatic shielding. Printed circuit terminals on base and shield.

Dimension: 1/2" sq. x 5/8" high. *Minimum self resonant frequency measured at maximum inductance.

Miller Part Number	Minimum Core Position			Maximum Core Position			R Ohms Max.	Max. Current Ma.	Min.* Fo. MHz
	Inductance Maximum	Q Min.	Test Frequency	Inductance Minimum	Q Min.	Test Frequency			
9050	1.5 uh	40	7.9 MHz	3.0 uh	41	7.9 MHz	.66	80	39.
9051	3.0 uh	46	7.9 MHz	7.0 uh	45	7.9 MHz	.85	125	23.
9052	7.0 uh	40	7.9 MHz	14.0 uh	62	2.5 MHz	1.38	80	12.
9053	14.0 uh	48	2.5 MHz	28.0 uh	66	2.5 MHz	2.10	80	7.2
9054	28.0 uh	48	2.5 MHz	60.0 uh	45	2.5 MHz	3.00	100	4.9
9055	60.0 uh	40	2.5 MHz	120. uh	69	790. kHz	4.00	100	3.6
9056	120. uh	52	790. kHz	280. uh	68	790. kHz	5.75	80	2.5
9057	280. uh	52	790. kHz	650. uh	62	790. kHz	12.0	80	1.7
9058	650. uh	36	790. kHz	1.3 mh	68	250. kHz	15.0	100	1.2
9059	1.3 mh	43	250. kHz	3.0 mh	53	250. kHz	23.0	100	.57
9060	3.0 mh	32	250. kHz	10.0 mh	32	79. kHz	76.0	30	.48
9061	8.0 mh	35	250. kHz	20.0 mh	38	79. kHz	110.	30	.33
9062	15.0 mh	25	79. kHz	40.0 mh	40	79. kHz	150.	30	.24
9063	20.0 mh	36	79. kHz	60.0 mh	60	79. kHz	175.	25	.09

Refer to Pages 1-2 for Prices

**Ceramic, Phenolic, Nylon and Alpha Cellulose Coil Forms
Printed Circuit and Bushing Mount**

This short form listing of our adjustable coils forms tabulates the major parameters and available cores. All metal parts are plated for protection against corrosion and the powdered iron core materials are moisture proofed. For detailed information, request our Coil Form Catalog.

ILLUSTRATIONS FOR STYLE ONLY
For detailed information request our
Coil Form Catalog or General Catalog

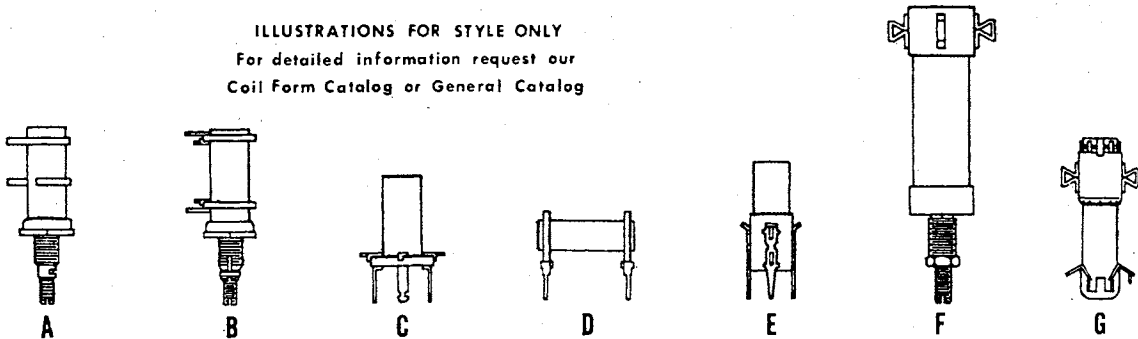

Miller Part Number	Style	Form Material	Form Dimensions	Mounting	Terminals
4300 60A022	A B	Ceramic Ceramic	.205 x .593 .205 x .593	Bushing Bushing	2 Wire rings 2 Collars with 1 Terminal on each
60A024	B	Ceramic	.205 x .593	Bushing	2 Collars with 2 Terminals on each
4500	A	Ceramic	.260 x .858	Bushing	2 Wire rings
62A022	B	Ceramic	.260 x .858	Bushing	2 Collars with 1 Terminal on each
62A024	B	Ceramic	.260 x .858	Bushing	2 Collars with 2 Terminals on each
4400 64A022	A B	Ceramic Ceramic	.375 x 1.060 .375 x 1.060	Bushing Bushing	2 Wire rings 2 Collars with 1 Terminal on each
64A024	B	Ceramic	.375 x 1.060	Bushing	2 Collars with 2 Terminals on each
66A022	B	Ceramic	.500 x 1.249	Bushing	2 Collars with 2 Collars with 1 Terminal on each
66A024	B	Ceramic	.500 x 1.249	Bushing	2 Collars with 2 Terminals on each
20A000	A	Phenolic (PBG)	.250 x .860	Bushing	2 Wire rings
21A000	A	Phenolic (PBG)	.375 x 1.125	Bushing	2 Wire rings
22A000	F	Phenolic (PBG)	.500 x 1.937	Bushing	4 Terminals
27A013 (1)	C	Alpha Cellulose	.162 x .400	Printed Circuit	3 Terminals
27A014 (1)	C	Alpha Cellulose	.162 x .400	Printed Circuit	4 Terminals
26A024 (1)	D	Alpha Cellulose	.162 x .520	Printed Circuit	2 Collars with 2 Terminals on each
25A014 (1)	C	Alpha Cellulose	.211 x .625	Printed Circuit	4 Terminals
24A024 (1)	D	Alpha Cellulose	.211 x .680	Printed Circuit	2 Collars with 2 Terminals on each
46A013	C	Ceramic	.260 x .625	Printed Circuit	3 Terminals
*46A014	C	Ceramic	.260 x .625	Printed Circuit	4 Terminals
47A024	D	Ceramic	.260 x .625	Printed Circuit	2 Collars with 2 Terminals on each
23A013*	E	Alpha Cellulose	.281 x .750	Printed Circuit	3 Terminals
23A014*	E	Alpha Cellulose	.281 x .750	Printed Circuit	4 Terminals
4200*	G	Nylon	.285 x 1.250	Clip	2 Terminals

The following cores are available for all listed coil forms. Add the Core Dash No. after the Miller Part No., i.e. 4500-4.

Core Dash No.	Recommended Frequency Range	Material	Color Code
-0	Form only		
-1	0.2 — 1.5 MHz	Powdered Iron	Yellow
-2	1.0 — 20 MHz	Powdered Iron	Red
-3	20 — 50 MHz	Powdered Iron	Green
-4	50 — 200 MHz	Powdered Iron	White
-5	100 and up MHz	Brass	None
-6	2.0 — 25 MHz	Powdered Iron	Purple
-7	25 and up MHz	Powdered Iron	Blue
-8*	Under 25 MHz	Ferrite	None

(1) -6 and -7 cores are ferrite for these coil forms * Available for 23A013, 23A014 and 4200 forms only
Mounting hardware supplied where required

★ Star Indicates New Items

Refer to Pages 1-2 for Prices

FM Variable Capacitors

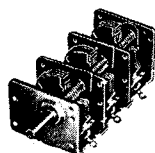

These two- and three-gang variable capacitors feature wide plate spacing (.042 Air Gap) along with a rigid construction to assure the highest stability. The plate contour results in an almost linear frequency versus rotation characteristic. Trimmers are supplied on each section. However, it is recommended that the oscillator trimmer be replaced with an NPO adjustable ceramic. Capacity range 6.6-22.7 pf per section. Trimmer capacity 2-20 pf. Shaft .250 diameter, one inch long.

Dimensions: 1461-B5 $3\frac{3}{16}'' \times 1\frac{1}{16}'' \times 1\frac{5}{16}''$
1461-2 $2\frac{3}{16}'' \times 1\frac{1}{16}'' \times 1\frac{5}{16}''$

Cat. No.	Item	Net Price
1461-B5	3-Gang FM Tuning Capacitor	\$4.44
1461-2	2-Gang FM Tuning Capacitor	2.91

Midget Variable Condensers



These midget variable condensers have the same precision construction as our standard series and will find ready application in the construction of portable and compact receivers of all types. Split outer plates on the rotors permit accurate alignment. High frequency trimmers are provided on the short side of the condenser. Mounting is provided by tapped holes in the frame of the condenser. Maximum rotor swing is 1". Counterclock rotation for capacity increase. Shaft is $\frac{1}{4}''$

Capacity range—10 to 365 mmf.

Cat. No.	Sections	Dimensions	Net Price
2111	1	$1\frac{3}{16}'' \times 1\frac{3}{8}'' \times 1\frac{5}{16}''$	\$2.31
2112	2	$2\frac{3}{16}'' \times 1\frac{1}{16}'' \times 1\frac{5}{16}''$	2.79
2113	3	$3\frac{3}{16}'' \times 1\frac{1}{16}'' \times 1\frac{5}{16}''$	3.90

Variable Condensers

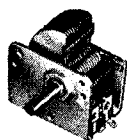

A miniature 2-gang variable condenser. The antenna section has a range of 10-130 mmf. The oscillator section has a range of 10-78 mmf. Trimmer capacitors are self-contained and have a range of approximately 12 mmf. Tapped mounting holes provided on front of condenser. Counterclockwise rotation. Shaft is $\frac{1}{4}''$ dia. x $\frac{3}{4}''$ long.

Cat. No.	Sections	Dimensions	Net Price
2110	2	$1\frac{5}{16}'' \times 1\frac{3}{8}'' \times 1\frac{5}{16}''$	\$2.31

Front Panel Dials

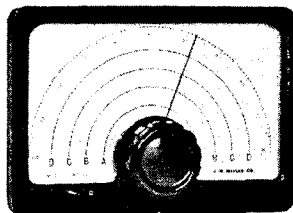

High quality panel dials with black crackle finish on the exterior metal work while the calibration plate is finished in a light grey color with the calibration scale 0-100 printed in red. The self calibration scales are in black and a supply of numerals for use on these scales are included to give a professional finish.

Dial MD-4 is $4\frac{1}{8}''$ wide $3\frac{3}{4}''$ high $\frac{1}{8}''$ deep

Dials MD-5 and MD-7 are $6\frac{1}{4}''$ wide $4\frac{1}{8}''$ high $\frac{1}{2}''$ deep

Dials MD-6 and MD-8 are $7\frac{1}{2}''$ wide $4\frac{7}{8}''$ high $\frac{1}{2}''$ deep

Cat. No.	Scales	Turns Ratio	Net Price
MD-4	3	6:1 and 36:1	\$ 7.50
MD-5	4	9:1	8.25
MD-6	6	9:1	9.00
MD-7	6	6:1 and 36:1	15.00
MD-8	6	6:1 and 36:1	15.00

Slide Rule Dial

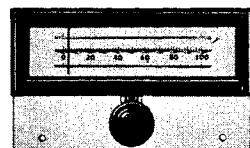

A top quality slide rule dial for use on projects where this feature would add to the appearance of the completed assembly. The dial face opening is $6\frac{1}{4}''$ wide by $1\frac{3}{8}''$ high and requires a slightly larger opening in the metal panel.

This dial has a 10:1 turns ratio.

Cat. No.	Description	Net Price
SL-16	Slide Rule Dial	\$6.00

FM Three Gang Variable with Planetary Drive

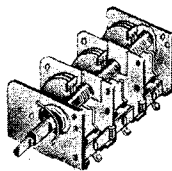

A commercial quality FM variable having a delta C of 10 picofarads and intended for use in circuits having a minimum amount of stray capacitance. Capacitor is an ideal unit for use as a bandspread variable in short wave receivers.

This capacitor features a planetary drive that has a 6:1 turning ratio, and can be used with knobs #565-24 and 565-26.

Capacitance range 7.0 to 17.7pf per section

Trimmers on all three sections 2-15pf

Cat. No.	Dimensions	Net Price
777-VC	$3\frac{3}{16}'' \times 1\frac{1}{16}'' \times 1\frac{5}{16}''$	\$4.86

Two Section Variable Capacitor with Planetary Drive

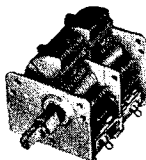

A two section variable capacitor having equal values of capacitance for use in tuned radio frequency circuits or in superhet circuits where a series paddler is used in the oscillator circuit. This capacitor features a planetary drive that has a 6:1 turning ratio and can be used with knobs #565-24 and 565-26.

Capacitance range 10 to 365pf. per section

Trimmers on both sections 2-15pf.

Cat. No.	Dimensions	Net Price
565-8	$2\frac{3}{16}'' \times 1\frac{1}{16}'' \times 1\frac{5}{16}''$	\$3.30

Cut Section Two Gang with Planetary Drive

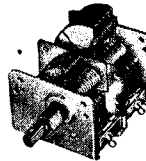

A two section variable capacitor for use in broadcast band (535 to 1650 kc) receivers. The special design of the oscillator plate makes the use of a padding capacitor unnecessary. This capacitor features a planetary drive that has a 6:1 turning ratio and can be used with knobs #555-20 and 555-21.

Capacitance range RF section 10 to 365pf

Osc section 8.6 to 170.6pf

Trimmers on both sections 2-15pf

Cat. No.	Dimensions	Net Price
555-27	$2\frac{3}{16}'' \times 1\frac{1}{16}'' \times 1\frac{5}{16}''$	\$3.27

Planetary Drive Knobs



A two piece knob that has been specifically designed for use with the planetary drives used on the above variable capacitors. The larger knob #555-20 has a gold stamped calibration covering 550 to 1600 kc while #565-24 has a gold marker for use with a self calibrated scale on the front panel of a piece of equipment.

The two drive knobs have a metallic inlaid insert.

Diameter of larger knob $2\frac{1}{2}$ inches

Diameter of drive knob $\frac{1}{4}$ inches

Cat. No.	Description	Net Price
555-20	Calibrated knob	\$1.26
555-21	Drive knob	.57
565-24	Marker knob.	1.08
565-26	Drive knob	.54

Sub-Miniature Three Gang Variable Cap.

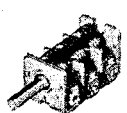

An extremely small but stable air dielectric variable capacitor. Each section is composed of 4 stator and 5 rotor plates. Trimmer capacitors are mounted on the antenna and R.F. sections only. Capacitor range: 5.7-20.7 mmfd.; Trimmer range: 2.0-12 mmfd. Shaft .250" diameter and $1\frac{1}{16}''$ long. Send for detailed literature.

Dimensions: $1\frac{1}{16}''$ wide x $1\frac{1}{16}''$ high x 2" deep.

Cat. No.	Item	Net Price
1460	3-Gang Variable Capacitor	\$4.32
1460-1	3-Gang Variable Capacitor	4.32

Prices Subject to Change or Withdrawal Without Notice



NORTH HILLS ELECTRONICS, INC.

COILS

HIGH PERFORMANCE SERIES, ADJUSTABLE AND FIXED
To Cover All Frequency Ranges from Audio to 200 MHz

COILS ON CERAMIC FORMS PER MIL-I-10

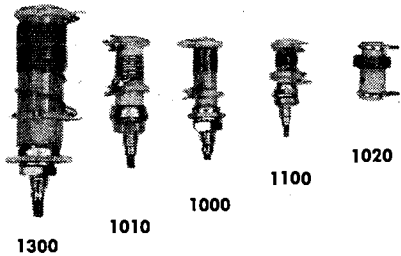

Series No.	Dimensions (Inches) Dia. Length	Mfg. Hole Dia. (Inches)
1000	.50 .88	.196
1020	.50 .63	.050, .500 Apart
1100	.33 .63	.166
1300	.70 1.80	.252
1010	.43 .88	.196

Miniature 1000 Series

Part No.	Range Microhenries	Average Q
1000-A	1.0- 1.6	70 @ 7.9 MHz
1000-B	1.6- 2.7	80 @ 7.9 MHz
1000-C	2.7- 4.5	85 @ 7.9 MHz
1000-D	4.5- 8.5	85 @ 7.9 MHz
1000-E	8.5-14.5	75 @ 2.5 MHz
1000-F	14.5-22	65 @ 2.5 MHz
1000-G	22-29	65 @ 2.5 MHz
1000-H	29-55	85 @ 2.5 MHz
1000-I	55-110	80 @ 2.5 MHz
1000-J	110-185	85 @ .79 MHz
1000-K	185-305	85 @ .79 MHz
1000-L	305-515	85 @ .79 MHz
1000-M	515-820	85 @ .79 MHz
1000-N	820-1100	75 @ .79 MHz

RF Printed Circuit Coils

1020-A	0.41- 0.53	75 @ 25 MHz
1020-B	0.85- 1.15	65 @ 7.9 MHz
1020-C	1.87- 2.50	65 @ 7.9 MHz
1020-D	4.0 - 5.4	70 @ 7.9 MHz
1020-E	0.75- 1.25	70 @ 2.5 MHz
1020-F	20 -29	80 @ 2.5 MHz
1020-G	33 -61	80 @ 2.5 MHz
1020-H	80 -120	60 @ 0.79 MHz
1020-I	170 -260	70 @ 0.79 MHz

Subminiature 1100 Series

1100-A	0.9- 1.4	60 @ 7.9 MHz
1100-B	1.4- 1.9	70 @ 7.9 MHz
1100-C	1.9- 2.6	70 @ 7.9 MHz
1100-D	2.6- 3.7	65 @ 7.9 MHz
1100-E	3.7- 5.5	65 @ 7.9 MHz
1100-F	5.5- 7.4	60 @ 7.9 MHz
1100-G	7.4-12.5	70 @ 7.9 MHz
1100-H	12.5-18.0	65 @ 2.5 MHz
1100-I	18.0-28.0	70 @ 2.5 MHz
1100-J	28.0-38.0	70 @ 2.5 MHz
1100-K	38.0-55.0	70 @ 2.5 MHz

Transmitter 1300 Series

1300-A		For use from 90-200 MHz
1300-B		For use from 40-90 MHz
1300-C		For use from 20-40 MHz
1300-D	0.7- 1.1	170 @ 25 MHz
1300-E	1.1- 1.7	130 @ 7.9 MHz
1300-F	1.7- 2.7	140 @ 7.9 MHz
1300-G	2.7- 4.5	140 @ 7.9 MHz
1300-H	4.5- 6.8	140 @ 7.9 MHz
1300-I	6.8-10.8	140 @ 7.9 MHz
1300-J	10.8-17.0	110 @ 2.5 MHz
1300-K	17.0-29.0	95 @ 2.5 MHz
1300-L	29.0-45.0	100 @ 2.5 MHz
1300-M	45.0-75.0	100 @ 2.5 MHz

HF Coils, Variable Approx. ±15%

1010-A	0.118	115 @ 50 MHz
1010-B	0.225	125 @ 25 MHz
1010-C	0.315	130 @ 25 MHz

WIDE ADJUSTMENT RANGE 120 SERIES

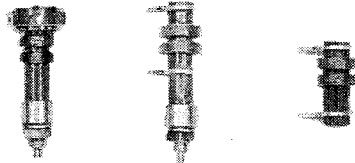

120 Series Mica-filled form
PCS-120 Series Phenolic form
PC-120 Series Phenolic form

75" O.D. x 1.3" H.
.196" dia. mfg. hole

5" O.D. x 1.25" L.
.05" Pins,
.70" Apart

Part No.	Range Microhenries	Average Q
120-A	2-3	70 @ 7.9 MHz
120-B	3-5	80 @ 7.9 MHz
120-C	5-9	85 @ 7.9 MHz
120-D	9-18	65 @ 2.5 MHz
120-E	18-36	70 @ 2.5 MHz
120-F	36-64	65 @ 2.5 MHz
120-G	64-105	85 @ 2.5 MHz
120-H	105-200	80 @ .79 MHz
120-I	200-500	75 @ .79 MHz
120-J	500-1000	85 @ .79 MHz
120-K	1000-2000	50 @ .25 MHz



Subminiature 600 Series

- Variable ±10%
- Shielded
- 0.3" O.D. x 0.4" H
- .020" Leads .30" Apart

Part No.	Nominal Microhenries	Average Q
600U1X0	1.0	120 @ 7.9 MHz
600U1X5	1.5	120 @ 7.9 MHz
600U2X2	2.2	120 @ 7.9 MHz
600U3X3	3.3	130 @ 7.9 MHz
600U4X7	4.7	125 @ 7.9 MHz
600U6X8	6.8	140 @ 7.9 MHz
600U10X	10	135 @ 7.9 MHz
600U15X	15	130 @ 2.5 MHz
600U22X	22	135 @ 2.5 MHz
600U33X	33	130 @ 2.5 MHz
600U47X	47	130 @ 2.5 MHz
600U68X	68	120 @ 2.5 MHz
600MX10	100	100 @ 2.5 MHz
600MX15	150	125 @ .79 MHz
600MX22	220	130 @ .79 MHz
600MX33	330	125 @ .79 MHz
600MX47	470	120 @ .79 MHz
600MX68	680	100 @ .79 MHz
600M1X0	1000	100 @ .79 MHz

High Q RF Coils, Fixed

- .75" O.D. x .63" H
- Hermetically sealed
- Complete shielding
- For printed circuitry
- For standard circuitry



Part No.	Nominal Microhenries	Average Q
1219-A	0.47 ± 5%	170 @ 20 MHz
1219-B	1.0 ± 5%	170 @ 10 MHz
1219-C	2.2 ± 5%	170 @ 8 MHz
1219-D	4.7 ± 5%	170 @ 5 MHz
1219-E	10 ± 5%	170 @ 3 MHz
1219-F	22 ± 2%	170 @ 1.5 MHz
1219-G	47 ± 2%	170 @ 1 MHz
1219-H	100 ± 2%	170 @ 0.8 MHz
1219-I	220 ± 2%	170 @ 0.7 MHz
1219-J	470 ± 2%	170 @ 0.6 MHz
1219-K	1000 ± 2%	170 @ 0.5 MHz
1219-L	2200 ± 2%	150 @ 0.25 MHz

Hi Q 801, 802 Series, Adjustable ±10%

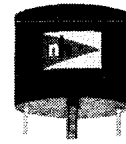

Industrial
801, 802 Series
1.13" O.D. x .88" H

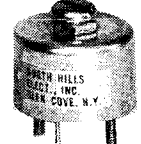

Hermetically Sealed
MS801, MS802 Series
1.25" O.D. x 1.25" H

Part No.	Nominal Millihenries	Peak Q
801M1X0	1.0	100 @ 10 kHz
801M1X5	1.5	100 @ 10 kHz
801M2X2	2.2	100 @ 10 kHz
801M3X3	3.3	100 @ 10 kHz
801M4X7	4.7	100 @ 10 kHz
801M6X8	6.8	100 @ 10 kHz
801M10X	10	200 @ 20 kHz
801M15X	15	200 @ 20 kHz
801M22X	22	200 @ 20 kHz
801M33X	33	200 @ 20 kHz
801M47X	47	200 @ 20 kHz
801M68X	68	200 @ 20 kHz
801HX10	100	300 @ 30 kHz
801HX15	150	300 @ 30 kHz
801HX22	220	300 @ 30 kHz
801HX33	330	250 @ 20 kHz
801HX47	470	250 @ 20 kHz
801HX68	680	250 @ 20 kHz
801HX10	1000	150 @ 15 kHz

802M1X0	1.0	400 @ 100 kHz
802M1X5	1.5	400 @ 100 kHz
802M2X2	2.2	400 @ 100 kHz
802M3X3	3.3	400 @ 100 kHz
802M4X7	4.7	400 @ 100 kHz
802M6X8	6.8	400 @ 100 kHz
802M10X	10	400 @ 70 kHz
802M15X	15	400 @ 70 kHz
802M22X	22	400 @ 70 kHz
802M33X	33	400 @ 70 kHz
802M47X	47	400 @ 40 kHz

SHIELDED COILS



- Shielded
 - Encapsulated
- .44" Diameter **900 Series**

Part No.	Range Microhenries	Average Q
900-A	0.5- 0.8	80 @ 25 MHz
900-B	0.8- 1.3	70 @ 18 MHz
900-C	1.3- 2.0	60 @ 15 MHz
900-D	2.0- 4.0	70 @ 8 MHz
900-E	4.0- 7.0	70 @ 5 MHz
900-F	7.0-12.0	70 @ 4 MHz
900-G	12.0-20.0	70 @ 3 MHz
900-H	20.0-35.0	70 @ 2.5 MHz
900-I	35.0-60.0	70 @ 2.0 MHz
900-J	60.0-100.0	70 @ 1.0 MHz

• .63" Diameter **1500 Series**

Part No.	Range Millihenries	Average Q
1500-A	.100-.175	80 @ 790 kHz
1500-B	.175-.300	80 @ 790 kHz
1500-C	.300-.500	80 @ 790 kHz
1500-D	.500-.800	75 @ 790 kHz
1500-E	.800-1.15	55 @ 500 kHz
1500-F	1.15-1.50	55 @ 250 kHz
1500-G	1.50-2.30	55 @ 250 kHz
1500-H	2.30-3.50	50 @ 250 kHz
1500-I	3.50-7.50	40 @ 250 kHz

SEE SECTION 5600 FOR WIDEBAND TRANSFORMERS

NYTRONICS, INC.
 ESSEX ELECTRONICS DIVISION

Inductors
SUPER WEE WEE-DUCTOR STANDARD VALUES

NYTRONICS PART NO.	L	Q min.		min. Fo	approx. Cd	min. Rp		min. Rp		Max. DCR at 25°C	Max. I	Incr.* I
		μH	MC	MC	Pf	K Ω	MC	K Ω	MC			
SW-W- 0.10	0.10	42	25	480	.70	5	125	10	230	.087	1650	>1650
SW-W- 0.12	0.12	42	25	460	.63	5	125	10	230	.090	1630	>1630
SW-W- 0.15	0.15	42	25	400	.66	6	100	10	230	.098	1550	>1550
SW-W- 0.18	0.18	42	25	360	.62	6	100	10	230	.117	1420	>1420
SW-W- 0.22	0.22	42	25	340	.63	8	100	12	230	.141	1330	>1330
SW-W- 0.27	0.27	42	25	320	.59	10	100	12	230	.157	1230	>1230
SW-W- 0.33	0.33	42	25	295	.55	10	100	12	230	.178	1140	>1140
SW-W- 0.39	0.39	42	25	275	.55	12	100	12	230	.208	1060	>1060
SW-W- 0.47	0.47	41	25	250	.56	12	75	15	230	.257	960	> 960
SW-W- 0.56	0.56	39	25	238	.52	15	75	15	230	.283	915	> 915
SW-W- 0.68	0.68	36	25	224	.50	15	75	20	230	.337	840	> 840
SW-W- 0.82	0.82	35	25	205	.50	15	75	20	230	.470	720	> 720
SW-W- 1.0	1.0	38	25	135	.87	10	75	10	170	.170	1180	>1180
SW-W- 1.2	1.2	38	7.9	124	.87	10	50	10	150	.177	1150	>1150
SW-W- 1.5	1.5	38	7.9	114	.87	12	50	12	140	.212	1050	>1050
SW-W- 1.8	1.8	38	7.9	105	.89	12	50	12	130	.242	990	> 990
SW-W- 2.2	2.2	38	7.9	95	.88	15	40	15	118	.263	950	> 950
SW-W- 2.7	2.7	38	7.9	85	.83	20	40	20	105	.300	880	> 880
SW-W- 3.3	3.3	38	7.9	78	.81	20	30	20	100	.345	820	> 820
SW-W- 3.9	3.9	42	7.9	74	.76	20	30	20	90	.411	755	> 755
SW-W- 4.7	4.7	42	7.9	68	.75	25	25	20	80	.562	650	> 650
SW-W- 5.6	5.6	42	7.9	62	.77	25	25	25	75	.742	565	> 565
SW-W- 6.8	6.8	45	7.9	55	.80	25	20	37	65	1.00	485	> 485
SW-W- 8.2	8.2	47	7.9	51	.78	29	20	38	60	1.20	440	> 440
SW-W- 10	10	51	7.9	45	.78	38	20	39	55	1.84	355	> 355
SW-W- 12	12	51	2.5	41	.85	9	15	9	50	2.60	300	> 300
SW-W- 15	15	45	2.5	48	.55	9	15	9	50	.635	610	200
SW-W- 18	18	45	2.5	44	.55	10	15	10	50	.728	570	175
SW-W- 22	22	45	2.5	37	.60	16	10	11	45	.825	530	160
SW-W- 27	27	45	2.5	32	.65	17	10	13	40	.950	500	155
SW-W- 33	33	46	2.5	30	.65	22	10	13	37	1.26	430	150
SW-W- 39	39	46	2.5	27	.66	27	5	18	33	1.42	405	145
SW-W- 47	47	46	2.5	23	.66	34	5	21	29	1.72	370	140
SW-W- 56	56	48	2.5	21	.75	37	5	24	27	2.03	340	130
SW-W- 68	68	48	2.5	18.5	.75	57	5	31	23	2.29	320	120
SW-W- 82	82	46	2.5	17.0	.75	62	4	33	21	2.55	305	115
SW-W- 100	100	46	2.5	15.5	.78	68	4	47	19	2.92	280	100
SW-W- 120	120	53	0.79	14.5	.72	100	4	60	16	3.30	235	80
SW-W- 150	130	53	0.79	13.0	.70	100	3	75	15	3.90	215	68
SW-W- 180	180	53	0.79	11.5	.70	125	3	90	14	5.40	200	64
SW-W- 220	220	55	0.79	10.0	.84	150	3	150	12	6.65	150	60
SW-W- 270	270	57	0.79	9.50	.74	175	3	175	11	7.60	140	58
SW-W- 330	330	57	0.79	8.50	.75	200	3	200	10	8.50	130	56
SW-W- 390	390	57	0.79	8.00	.74	220	2.5	270	10	10.0	120	54
SW-W- 470	470	57	0.79	7.20	.70	340	2.0	320	8.9	13.5	100	52
SW-W- 560	560	61	0.79	6.40	.70	340	2.0	320	7.5	14.5	95	50
SW-W- 680	680	61	0.79	5.80	.78	320	1.5	320	7.0	16.0	90	48
SW-W- 820	820	58	0.79	5.30	.78	320	1.5	320	6.5	19.0	85	47
SW-W- 1000	1000	58	0.79	4.80	.78	320	1.5	320	6.0	21.5	80	45
SW-W- 1200	1200	55	0.25	2.90	1.9	500	3.4	400	1.0	23	100	40
SW-W- 1500	1500	55	0.25	2.80	1.6	600	3.3	500	1.0	30	90	35
SW-W- 1800	1800	55	0.25	2.60	1.5	700	3.1	600	1.0	33	86	32
SW-W- 2200	2200	55	0.25	2.55	1.3	800	3.0	700	0.8	40	78	30
SW-W- 2700	2700	55	0.25	2.40	1.2	900	2.8	800	0.8	43	74	28
SW-W- 3300	3300	55	0.25	2.00	1.1	1000	2.7	900	0.8	58	65	26
SW-W- 3900	3900	55	0.25	1.95	1.1	1200	2.25	800	0.6	76	56	23
SW-W- 4700	4700	55	0.25	1.85	1.1	1600	2.2	1000	0.6	85	53	20
SW-W- 5600	5600	55	0.25	1.75	1.0	2000	2.1	1100	0.6	100	48	18
SW-W- 6800	6800	50	0.25	1.58	1.0	2100	1.85	1200	0.5	127	43	15
SW-W- 8200	8200	50	0.25	1.55	1.0	2200	1.80	1400	0.5	150	40	12
SW-W- 10,000	10,000	50	0.25	1.45	1.0	2000	1.60	1400	0.5	190	37	10

*Incremental Current: The D.C. current required to cause a maximum reduction of 5 percent from nominal inductance value.



NYTRONICS, INC.
ESSEX ELECTRONICS DIVISION

Inductors

WEE-DUCTOR

Subminiature Shielded Inductor with high inductance-to-size ratio.
0.10uH to 180,000uH in 76 values
Designed to meet MIL-C-15305C.

The WEE-DUCTOR was the first miniature shielded inductor that Nytronics standardized for stock delivery. This encapsulated non-flammable shielded unit in a 0.164" diameter by 0.450" long envelope offers the design engineer extremely high inductance for density packaging. The WEE-DUCTOR is designed to meet the environmental requirements of MIL-C-15305C, Grade 1, Class B.

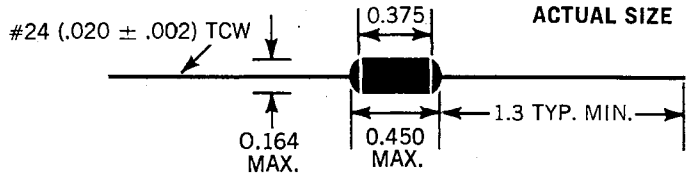

ELECTRICAL CHARACTERISTICS

Inductance Tolerance: 0.1 to 22uH ±10% (Q-Meter); 27uH to 1,000 ±5% (1KC Bridge); 1,200uH to 56,000uH ±10% (1KC Bridge) 68,000uH to 180,000uH ±20% (1KC Bridge) measured at point on leads 1/2 inch from body.

Dielectric Strength: 700 volts RMS at sea level.

Self-Resonant Frequency: Minimum f_0 to be not less than 80% of published data, and measured with full length leads on Q-Meter.

Q and Rp Values: Measured on Q-Meter. Minimum Rp values on published data sheet are conservative.

Maximum Current: Based on temperature rise not to exceed 40°C at 85°C ambient.

DENSITY CHARACTERISTICS

Volume: 0.0087 cubic inches **Weight:** 0.75 grams maximum
Shielding: Less than 3% coupling with two units measured side by side at 1000 cycles.

PHYSICAL AND ENVIRONMENTAL CHARACTERISTICS

Operating Temperature: -55°C to +125°C.

Terminal Strength: Meets five pound pull test; five 360° rotations in alternate directions per MIL-C-15305C.

Moisture, Vibration, and Shock Resistance: Meets requirements of MIL-C-15305C, Grade 1, Class B. Low frequency 10 to 55 cps @ .06" maximum total excursion at rate of 1 linear sweep per minute for 2 hours repeated for each of three mutually perpendicular planes. Shock: 50G, 11 MS.

Marking: Printed with pertinent data.

NYTRONICS PART NO.	L		Q min	approx. Fo		approx. Cd		min. Rp	min. Rp	Max. DCR at 125°C	Max. I	Incr* I
	μH	MC		MC	μH	KΩ	MC					
WEE-0.10	0.10	63	25	>500	0.67	6	100	11	230	0.020	4000	>4000
WEE-0.12	0.12	61	25	>500	0.67	7	100	13	230	0.029	3350	>3350
WEE-0.15	0.15	59	25	>500	0.67	8	100	16	230	0.032	3000	>3000
WEE-0.18	0.18	57	25	458	0.67	10	100	20	230	0.040	2850	>2850
WEE-0.22	0.22	56	25	414	0.67	13	100	28	230	0.045	2700	>2700
WEE-0.27	0.27	50	25	373	0.67	15	100	32	230	0.08	2000	>2000
WEE-0.33	0.33	48	25	337	0.67	18	100	37	230	0.09	1900	>1900
WEE-0.39	0.39	48	25	310	0.67	21	100	41	230	0.16	1420	>1420
WEE-0.47	0.47	48	25	283	0.67	27	100	51	230	0.17	1400	>1400
WEE-0.56	0.56	45	25	258	0.67	32	100	56	230	0.36	960	>960
WEE-0.68	0.68	45	25	235	0.67	40	100	65	230	0.37	940	>940
WEE-0.82	0.82	41	25	214	0.67	47	100	72	230	0.46	870	>870
WEE-1.0	1.0	42	7.9	164	0.92	12	75.0	13	164	0.062	2300	>2300
WEE-1.2	1.2	43	7.9	150	0.92	13	75.0	14	150	0.067	2200	>2200
WEE-1.5	1.5	41	7.9	135	0.92	16	50.0	17	135	0.16	1420	>1420
WEE-1.8	1.8	42	7.9	124	0.92	18	50.0	20	124	0.17	1370	>1370
WEE-2.2	2.2	42	7.9	112	0.92	21	40.0	23	112	0.19	1300	>1300
WEE-2.7	2.7	41	7.9	107	0.92	24	40.0	26	107	0.20	1270	>1270
WEE-3.3	3.3	40	7.9	91.5	0.92	23	30.0	31	91.5	0.31	1030	>1030
WEE-3.9	3.9	40	7.9	84.5	0.92	26	30.0	34	84.5	0.33	1000	>1000
WEE-4.7	4.7	40	7.9	76.5	0.92	28	25.0	41	76.5	0.58	750	>750
WEE-5.6	5.6	40	7.9	69.5	0.92	32	25.0	45	69.5	0.64	710	>710
WEE-6.8	6.8	40	7.9	63.5	0.92	29	20.0	51	63.5	0.68	680	>680
WEE-8.2	8.2	45	7.9	57.5	0.92	33	20.0	57	57.5	1.3	500	>500
WEE-10	10	46	2.5	52.5	0.92	33	15.0	59	52.5	1.4	480	>480
WEE-12	12	47	2.5	47.5	0.92	37	15.0	61	47.5	1.5	460	>460
WEE-15	15	47	2.5	42.5	0.92	43	15.0	64	42.5	1.7	440	>440
WEE-18	18	45	2.5	53.5	0.49	12	20.0	14	53.5	0.88	610	235
WEE-22	22	47	2.5	47.0	0.50	13	15.0	17	47.0	0.95	590	220
WEE-27	27	42	2.5	44.0	0.48	17	15.0	20	44.0	1.15	530	200
WEE-33	33	43	2.5	40.0	0.48	23	12.0	23	40.0	1.2	520	193
WEE-39	39	45	2.5	36.5	0.48	27	12.0	27	36.5	1.6	450	183
WEE-47	47	46	2.5	33.0	0.49	31	12.0	31	33.0	1.8	420	177
WEE-56	56	40	2.5	30.0	0.49	33	10.0	33	30.0	2.2	390	170
WEE-68	68	40	2.5	27.0	0.50	35	10.0	35	27.0	2.3	375	165
WEE-82	82	42	2.5	17.5	1.0	44	8.0	44	17.5	2.4	360	160
WEE-100	100	63	.79	15.0	1.0	62	5.0	62	15.0	2.6	345	157
WEE-120	120	62	.79	14.0	1.0	75	5.0	75	14.0	2.9	330	145

NYTRONICS PART NO.	L		Q min	approx. Fo		approx. Cd		min. Rp	min. Rp	Max. DCR at 125°C	Max. I	Incr* I
	μH	MC		MC	μH	KΩ	MC					
WEE-150	150	63	.79	12.5	1.0	84	4.0	84	12.5	3.3	315	126
WEE-180	180	60	.79	11.5	1.0	95	4.0	95	11.5	3.6	300	110
WEE-220	220	57	.79	11.0	0.94	98	4.0	106	11.0	4.1	280	105
WEE-270	270	52	.79	10.0	0.92	115	3.0	117	10.0	4.8	260	91
WEE-330	330	50	.79	9.0	0.92	125	3.0	130	9.0	5.6	240	87
WEE-390	390	43	.79	8.5	0.87	130	3.0	132	8.5	6.2	230	72
WEE-470	470	66	.79	8.0	0.83	220	1.5	230	8.0	10.0	180	67
WEE-560	560	64	.79	7.5	0.82	269	1.5	275	7.5	11.5	170	65
WEE-680	680	71	.79	6.5	0.87	320	1.5	340	6.5	12.0	160	60
WEE-820	820	67	.79	6.0	0.87	355	1.5	420	6.0	13.8	150	55
WEE-1000	1000	62	.79	5.6	0.87	430	1.5	450	5.6	16.0	140	52
WEE-1200	1200	52	.250	1.490	9.0	225	.500	290	1.490	18.2	135	50
WEE-1500	1500	51	.250	1.460	8.0	280	.500	425	1.460	23.7	118	48
WEE-1800	1800	51	.250	1.420	6.5	340	.500	540	1.420	30.2	105	42
WEE-2200	2200	50	.250	1.300	6.8	380	.500	560	1.300	33.7	99	37
WEE-2700	2700	51	.250	1.180	6.8	510	.500	700	1.180	43.1	87	33
WEE-3300	3300	52	.250	1.050	7.0	640	.500	830	1.050	48.7	82	30
WEE-3900	3900	48	.250	.960	7.0	600	.500	850	.960	62.7	72	29
WEE-4700	4700	48	.250	.840	7.4	560	.400	860	.840	70.5	68	28
WEE-5600	5600	48	.250	.810	6.8	610	.350	940	.810	104	56	24
WEE-6800	6800	45	.250	.740	6.8	690	.350	960	.740	118	53	20
WEE-8200	8200	38	.250	.580	9.2	710	.300	1000	.580	146	47	18
WEE-10,000	10,000	36	.079	.470	11.5	520	.200	670	.470	76.6	66	15
WEE-12,000	12,000	36	.079	.370	15.0	580	.200	710	.370	109	55	14
WEE-15,000	15,000	38	.079	.330	15.0	610	.150	780	.330	119	52	13
WEE-18,000	18,000	38	.079	.305	15.0	630	.150	850	.305	138	49	13
WEE-22,000	22,000	32	.079	.295	13.0	720	.150	970	.295	219	39	12
WEE-27,000	27,000	32	.079	.270	13.0	810	.150	1000	.270	259	35	12
WEE-33,000	33,000	32	.079	.250	12.5	1070	.150	1040	.250	296	33	11
WEE-39,000	39,000	30	.079	.215	14.0	690	.100	1050	.215	395	29	10
WEE-47,000	47,000	25	.079	.210	12.5	850	.100	1310	.209	452	27	9
WEE-56,000	56,000	25	.079	.195	12.0	1050	.100	1450	.195	499	26	8
WEE-68,000	68,000	20	.079	.130	18.4	860	.079	1300	.130	395	29	1.1
WEE-82,000	82,000	20	.079	.125	16.5	900	.079	1340	.125	452	27	1.1
WEE-100,000	100,000	20	.079	.115	16.2	940	.060	1450	.115	499	26	1.1
WEE-120,000	120,000	20	.070	.105	16.8	1000	.055	1560	.105	540	23	1.1
WEE-150,000	150,000	20	.060	.098	13.4	1175	.055	1600	.098	750	20	1.0
WEE-180,000	180,000	20	.050	.094	13.4	1100	.050	1650	.094	880	18	0.8

*Incremental Current: The D.C. current required to cause a maximum reduction of 5 percent from nominal inductance value.



NYTRONICS, INC.
ESSEX ELECTRONICS DIVISION

Inductors

**MOLDED NON-SHIELDED
S, M, and L INDUCTORS**

Proven reliability molded inductors designed to meet MIL-C-15305A. Inductance 0.10 to 10,000 uH in three envelopes.

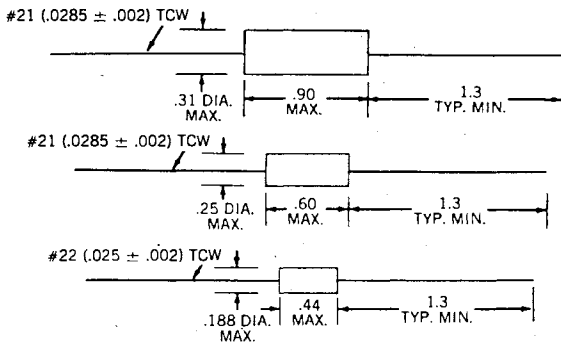

These units offer the design engineer a rugged, molded inductor that has been recognized for years throughout the industry for exceptional reliability in critical circuitry applications.

ELECTRICAL CHARACTERISTICS

- Inductance Tolerance:** 0.1 to 22uH ±10% on Q-Meter
27uH to 10,000 ±5% 1,000 cps bridge
- Dielectric Strength:** 700 volts RMS at sea level.
- Self-Resonant Frequency:** Minimum f₀ to be not less than 80% of published data and measured with full length leads on Grid-Dip Meter.
- Q and Rp Values:** Measured on Q-Meter.
- Rating:** 1/3 watt dissipation for series S and M and 1/2 watt dissipation for L series.

DENSITY CHARACTERISTICS

- Volume:** S Type — 0.012 cu. in.
M Type — 0.029 cu. in.
L Type — 0.068 cu. in.
- Weight:** S Type — 0.90 grams
M Type — 2.00 grams
L Type — 4.10 grams

PHYSICAL AND ENVIRONMENTAL CHARACTERISTICS

- Operating Temperature:** -55°C to +125°C.
- Terminal Strength:** Meets five pound pull test per MIL-C-15305C.
- Moisture, Vibration, and Shock Resistance:** Meets requirements of MIL-C-15305C, Grade 1, Class B. High frequency 10 cps to 2000 cps @ 15G ±10% maximum for 12 logarithmic swings, each of 20 minute duration repeated for each of three mutually perpendicular planes. (body mounted)

NYTRONICS PART NO.	L		Q min		approx. Fo	approx. Cd	min. Rp		min. Rp		max DCR at 125°C	max. I
	uH		MC	MC	uF	K Ω	MC	K Ω	MC	Ω	mA	
RFC-S- 0.10	0.10	85	50	>500	0.4	2.7	50	15	200	.02	4000	
RFC-S- 0.12	0.12	85	50	500	0.4	3.2	50	20	200	.025	3500	
RFC-S- 0.15	0.15	85	50	>500	0.4	4.1	50	25	200	.03	3000	
RFC-S- 0.18	0.18	75	50	500	0.4	4.2	50	27	200	.03	3000	
RFC-S- 0.22	0.22	75	50	500	0.4	5.2	50	30	200	.03	3000	
RFC-S- 0.27	0.27	70	45	470	0.4	5.3	45	40	200	.04	2700	
RFC-S- 0.33	0.33	70	40	440	0.4	6.0	40	50	200	.05	2500	
RFC-S- 0.39	0.39	65	40	400	0.4	6.3	40	55	200	.08	2000	
RFC-S- 0.47	0.47	60	25	360	0.4	4.5	25	60	200	.08	2000	
RFC-S- 0.56	0.56	55	25	330	0.4	4.8	25	80	200	.10	1700	
RFC-S- 0.68	0.68	55	25	300	0.4	6.0	25	120	200	.12	1500	
RFC-S- 0.82	0.82	50	25	275	0.4	6.2	25	120	200	.18	1300	
RFC-S- 1.0	1.0	50	20	250	0.4	6.5	20	120	200	.24	1100	
RFC-S- 1.2	1.2	45	20	220	0.4	6.5	20	120	200	.35	1000	
RFC-S- 1.5	1.5	45	15	200	0.4	6.5	15	120	200	.43	850	
RFC-S- 1.8	1.8	45	15	180	0.4	7.6	15	120	180	.65	720	
RFC-S- 2.2	2.2	45	15	165	0.4	9.5	15	120	165	.80	610	
RFC-S- 2.7	2.7	55	10	110	0.7	9	10	20	110	.12	1600	
RFC-S- 3.3	3.3	55	10	100	0.7	11	10	25	100	.15	1400	
RFC-S- 3.9	3.9	60	10	95	0.7	14	10	27	95	.23	1200	
RFC-S- 4.7	4.7	70	7.9	90	0.7	17	8	30	90	.30	1000	
RFC-S- 5.6	5.6	65	7.9	80	0.7	18	8	35	80	.45	900	
RFC-S- 6.8	6.8	65	7.9	70	0.7	22	8	45	70	.55	800	
RFC-S- 8.2	8.2	60	7.9	65	0.7	24	8	47	65	.65	720	
RFC-S- 10	10	60	5	60	0.7	19	5	50	60	.73	650	
RFC-S- 12	12	65	5	53	0.7	24	5	60	53	1.1	590	
RFC-S- 15	15	80	2.5	47	0.7	19	2.5	70	47	1.4	500	
RFC-S- 18	18	75	2.5	43	0.7	18	2.5	72	43	1.6	460	
RFC-S- 22	22	75	2.5	40	0.7	26	2.5	75	40	1.8	430	
RFC-S- 27	27	75	2.5	36	0.7	30	2.5	75	36	2.7	360	
RFC-S- 33	33	85	2.5	32	0.7	44	2.5	80	32	3.5	300	
RFC-S- 39	39	80	2.5	26	0.9	48	2.5	80	26	3.8	290	
RFC-S- 47	47	80	2.5	22	1.1	60	2.5	80	22	4.0	275	
RFC-S- 56	56	75	2.5	19	1.3	66	2.5	80	19	4.4	265	
RFC-S- 68	68	75	2.5	16	1.5	83	2.5	80	14	4.7	250	
RFC-S- 82	82	75	2.5	13	2.0	96	2.5	80	13	5.3	235	
RFC-S- 100	100	75	1.5	10	2.5	72	1.5	80	9.5	6.0	220	
RFC-M- 120	120	95	1.5	14	1.1	100	1.5	150	14	7.5	200	
RFC-M- 150	150	90	1.0	11	1.3	85	1.0	150	11	8	190	
RFC-M- 180	180	85	1.0	9	1.8	96	1.0	150	9	9	185	
RFC-M- 220	220	85	1.0	7	2.2	112	1.0	150	7	10	180	
RFC-M- 270	270	80	1.0	5.5	*3.0	135	1.0	135	5.5	11	172	
RFC-M- 330	330	80	.8	4.5	3.8	136	.8	120	4.5	12	165	
RFC-M- 390	390	75	.8	4.0	4.1	147	.8	120	4.0	13	157	
RFC-M- 470	470	75	.8	3.5	4.4	180	.8	120	3.5	14	150	
RFC-M- 560	560	65	.8	3.1	4.7	183	.8	135	3.1	16	145	
RFC-M- 680	680	65	.8	2.7	5.0	225	.8	150	2.7	17	140	
RFC-M- 820	820	65	.8	2.5	5.0	225	.8	150	2.5	19	132	
RFC-M-1000	1000	70	.5	2.3	5.0	225	.5	150	2.3	21	125	
RFC-L- 1200	1200	75	.5	2.1	4.4	250	.5	160	2.1	27	137	
RFC-L- 1500	1500	75	.4	1.9	4.5	290	.4	200	1.9	29	130	
RFC-L- 1800	1800	65	.4	1.7	4.6	290	.4	200	1.7	32	125	
RFC-L 2200	2200	65	.25	1.5	4.7	230	.25	200	1.5	35	120	
RFC-L 2700	2700	65	.25	1.3	5.0	277	.25	200	1.3	40	112	
RFC-L 3300	3300	65	.25	1.2	5.3	330	.25	200	1.2	45	105	
RFC-L 3900	3900	65	.25	1.05	5.6	395	.25	200	1.05	49	100	
RFC-L 4700	4700	65	.25	.95	6.2	470	.25	300	.95	53	95	
RFC-L 5600	5600	65	.25	.85	6.3	570	.25	300	.95	60	90	
RFC-L 6800	6800	65	.25	.75	6.3	700	.25	300	.75	67	85	
RFC-L 8200	8200	65	.25	.65	7.2	835	.25	400	.65	75	82	
RFC-L-10000	10000	65	.15	.58	7.8	1040	.15	400	.58	80	80	



NYTRONICS, INC.
ESSEX ELECTRONICS DIVISION

Inductors

WEE V-L

Subminiature Shielded Adjustable Inductor
High Q Values
Vertical or Horizontal* Mounting
Unitized Epoxy-Molded Construction
0.400" by 0.300"
0.10 to 100,000uH

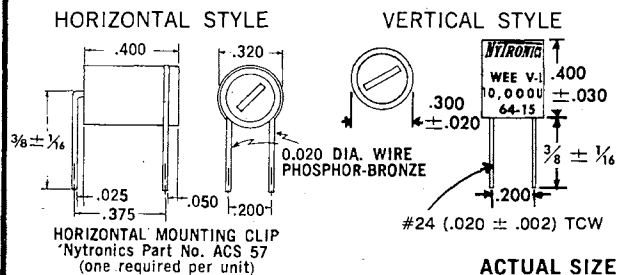

The WE V-L is designed to accommodate close inductance adjustments in high-density circuits that demand exceptional stability and high "Q" in the smallest size available. The WE V-L is designed to meet MIL-C-15305C, Grade 1, Class B. Printed board mounting is facilitated by 0.200 grid spacing and unit has shield construction to allow maximum density packaging. Standardized in 73 stock values.

ELECTRICAL CHARACTERISTICS

Adjustable Inductance Range:	±10%** over entire range as measured per MIL-C-15305C
Q and f_o Values:	Minimum not less than 80% of specified value at L nominal.
Dielectric Strength:	840 Volts R.M.S. at sea level.
Working Voltage:	300 Volts D.C.
Maximum Current:	Based on temperature rise not to exceed 35°C at 90°C ambient.
Incremental Current:	Defined as the DC current required to cause a five percent reduction in the nominal inductance value.

DENSITY CHARACTERISTICS

Weight:	1.5 grams maximum
Volume:	.0346 cubic inches
Shielding:	3% coupling maximum when two units are tested side by side.

PHYSICAL AND ENVIRONMENTAL CHARACTERISTICS

Use Nytronics Tuning Tool No. B-469 or equal.

Torque:	0.75 to 6.0 inch-oz.
Operating Temperature:	-55°C to +125°C.
Moisture, Vibration, and Shock Resistance:	Meet requirements of MIL-C-15305C, Grade 1, Class B. Low frequency 10 to 55 cps @ .06" maximum total excursion at rate of 1 linear sweep per minute for 2 hours repeated for each of three mutually perpendicular planes. Shock: 50G, 11 MS. (body mounted)
Marking:	Manufacturer data printed.
Terminal Pull:	Three pounds.

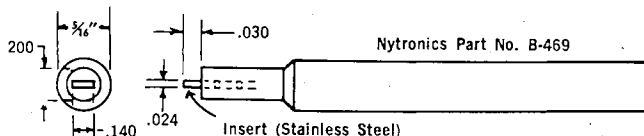

NYTRONICS CATALOG NO.	L nom.	f	Q nom.	Fo nom.	D.C.R.	Max. I	Incr. I	
	uH	MC		MC	ohms	m.a.	m.a.	
**WEE V-L	0.10	.10	25	70	>250	0.030	2500	2500
**WEE V-L	0.12	.12	25	70	>250	0.030	2500	2500
WEE V-L	0.15	.15	25	70	>250	0.030	2500	2500
WEE V-L	0.18	.18	25	70	>250	0.035	2400	2400
WEE V-L	0.22	.22	25	70	>250	0.038	2300	2300
WEE V-L	0.27	.27	25	80	>250	0.040	2200	2200
WEE V-L	0.33	.33	25	80	>250	0.040	2200	2200
WEE V-L	0.39	.39	25	80	250	0.045	2100	2100
WEE V-L	0.47	.47	25	80	230	0.045	2100	2100
WEE V-L	0.56	.56	25	80	220	0.050	2000	2000
WEE V-L	0.68	.68	25	80	190	0.055	1900	1900
WEE V-L	0.82	.82	25	85	180	0.060	1800	1800
WEE V-L	1.00	1.00	25	85	160	0.070	1700	1700
WEE V-L	1.2	1.2	7.9	90	170	0.085	1670	1670
WEE V-L	1.5	1.5	7.9	100	155	0.100	1540	1540
WEE V-L	1.8	1.8	7.9	115	135	0.110	1470	1470
WEE V-L	2.2	2.2	7.9	110	120	0.120	1410	1410
WEE V-L	2.7	2.7	7.9	110	104	0.125	1380	1380
WEE V-L	3.3	3.3	7.9	90	93.0	0.165	1200	1200
WEE V-L	3.9	3.9	7.9	90	87.0	0.180	1135	1135
WEE V-L	4.7	4.7	7.9	95	79.0	0.245	985	985
WEE V-L	5.6	5.6	7.9	95	72.0	0.265	950	950
WEE V-L	6.8	6.8	7.9	85	63.0	0.330	853	853
WEE V-L	8.2	8.2	7.9	95	60.0	0.460	720	720
WEE V-L	10	10	7.9	90	54.0	0.640	620	620
WEE V-L	12	12	2.5	120	37.0	0.800	545	545
WEE V-L	15	15	2.5	120	28.8	0.865	520	520
WEE V-L	18	18	2.5	115	23.8	0.940	504	504
WEE V-L	22	22	2.5	125	21.3	1.03	460	460
WEE V-L	27	27	2.5	115	20.6	1.18	418	418
WEE V-L	33	33	2.5	120	18.6	1.30	398	398
WEE V-L	39	39	2.5	120	17.7	1.41	385	385
WEE V-L	47	47	2.5	110	14.9	1.61	350	350
WEE V-L	56	56	2.5	115	13.9	2.08	330	330
WEE V-L	68	68	2.5	105	12.9	2.20	320	320
WEE V-L	82	82	2.5	105	11.7	2.42	300	300
WEE V-L	100	100	2.5	95	10.5	2.15	333	333
WEE V-L	120	120	0.790	95	5.60	2.38	316	190
WEE V-L	150	150	0.790	90	5.20	2.52	306	175
WEE V-L	180	180	0.790	95	4.90	2.88	288	150
WEE V-L	220	220	0.790	95	4.60	3.18	273	125
WEE V-L	270	270	0.790	100	4.20	3.50	260	120
WEE V-L	330	330	0.790	100	3.55	4.80	222	110
WEE V-L	390	390	0.790	100	3.45	5.44	209	105
WEE V-L	470	470	0.790	100	3.20	5.90	201	100
WEE V-L	560	560	0.790	95	2.90	6.30	194	90
WEE V-L	680	680	0.790	100	2.70	7.20	181	80
WEE V-L	820	820	0.790	90	2.50	8.00	172	70
WEE V-L	1,000	1,000	0.790	100	2.35	12.0	141	65
WEE V-L	1,200	1,200	0.250	95	2.20	13.5	132	60
WEE V-L	1,500	1,500	0.250	90	1.90	16.5	119	55
WEE V-L	1,800	1,800	0.250	100	1.80	18.0	114	47
WEE V-L	2,200	2,200	0.250	100	1.70	20.5	107	43
WEE V-L	2,700	2,700	0.250	95	1.50	22.5	102	39
WEE V-L	3,300	3,300	0.250	90	1.40	42.0	76	36
WEE V-L	3,900	3,900	0.250	85	1.27	47.5	71	35
WEE V-L	4,700	4,700	0.250	85	1.24	53.0	67	34
WEE V-L	5,600	5,600	0.250	85	0.93	62.5	65	31
WEE V-L	6,800	6,800	0.250	75	0.79	69.5	58	27
WEE V-L	8,200	8,200	0.250	80	0.75	75.0	56	26
WEE V-L	10,000	10,000	0.250	70	0.70	100.0	49	24
WEE V-L	12,000	12,000	0.079	70	.50	64	60	40
WEE V-L	15,000	15,000	0.079	70	.38	84	52	34
WEE V-L	18,000	18,000	0.079	70	.36	93	50	30
WEE V-L	22,000	22,000	0.079	70	.32	104	45	28
WEE V-L	27,000	27,000	0.079	70	.30	173	35	26
WEE V-L	33,000	33,000	0.079	70	.27	187	32	24
WEE V-L	39,000	39,000	0.079	70	.26	220	30	22
WEE V-L	47,000	47,000	0.079	70	.25	253	28	20
WEE V-L	56,000	56,000	0.079	70	.24	285	26	19
WEE V-L	68,000	68,000	0.079	60	.20	311	24	18
WEE V-L	82,000	82,000	0.079	60	.19	385	22	16
WEE V-L	100,000	100,000	0.079	60	.17	420	20	15

*For Horizontal mounting use Nytronics mounting clip No. ACS-57 or order with prefix H (i.e. H WEE V-L 0.10).

**Tunable range ±5.0% on 0.10uH & 0.12uH

*You can depend on your local
ELECTRONIC DISTRIBUTOR for ...*

- *Instant off-the-shelf delivery*
- *In-depth inventories*
- *Wide varieties*
- *Prompt service*
- *Technical assistance*
- *Availability of the latest products*
- *Speedy purchasing — one order does the job*

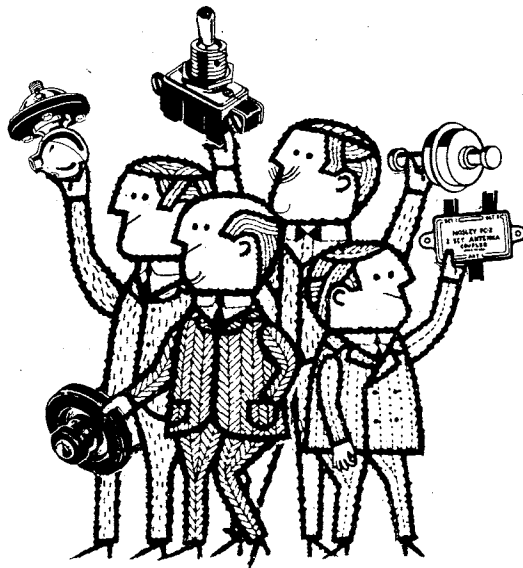

*Contact your local **ELECTRONIC DISTRIBUTOR**
for all your requirements!*



JAN HARDWARE

MANUFACTURING COMPANY, INC.



U.S. PATENT NO. 2,681,378

HI-VOLTAGE INSULATED COUPLINGS

MEETS MIL SPECS: TEMPERATURE - HUMIDITY - SHOCK - VIBRATION - FUNGUS

HI-VOLTAGE INSULATED COUPLINGS

15 KV Breakdown 10 inch pounds torque
Series No. AK-5079 & No. AK-5164

Engineered with stainless steel shaft and precision, screw-driver tip molded integrally with Diallyl Pthalate Material in accordance with Military Specifications. Completely shock, vibration and fungus proof, they operate with ease over an ambient temperature range of -75 to +175° C. Supplied complete with nickel plated mounting hardware.

Stainless steel screw driver tip fits all standard slotted shafts (potentiometer, etc.) without need for further machining. Ideally suited to adjust high voltage controls thus protecting operating personnel against danger. They are also used to reduce ground capacitance on other types of sensitive instrument controls.

For Commercial Instrument Applications... These couplings are available in general Purpose Black Bakelite.

Cat. No. 6164-(X or B)-() For Standard Type
Cat. No. 6079-(X or B)-() with Locking Type Bushing.
Dimensions are identical with 5000 series, in chart above.

CAT No.	"A"	"B" *	SHAFT	"C"
AK-5164-X-1	3/8"	3/8"	Slotted	3/8"
AK-5164-B-1	3/8"	3/8"	Slotted	3/8"
AK-5164-X-2	3/8"	3/8"	Slotted	15/32"
AK-5164-B-2	3/8"	3/8"	Slotted	15/32"
AK-5164-X-3	3/8"	3/8"	No Slot	15/32"
AK-5164-B-3	3/8"	3/8"	No Slot	15/32"
AK-5164-X-4	3/8"	3/8"	No Slot	17/16"
AK-5164-B-4	3/8"	3/8"	No Slot	17/16"
AK-5164-X-5	3/8"	3/8"	Slotted	Minus 1/16"
AK-5164-B-5	3/8"	3/8"	Slotted	Minus 1/16"
AK-5079-X-1	3/8"	3/8"	Slotted	1/8"
AK-5079-B-1	3/8"	3/8"	Slotted	1/8"
AK-5079-X-2	3/8"	3/8"	Slotted	3/32"
AK-5079-B-2	3/8"	3/8"	Slotted	3/32"

STANDARD TYPE

WITH LOCKING TYPE BUSHING

* (3/16") to be used with 1/8" long shaft.
(1/8") to be used with 1/4" long shaft.

Hi-Voltage Insulated Couplings for 1/8" shafts. White Cycalac material. Voltage rating: 6000VDC. Hubs—Brass, Nickel Pltd.; Shafts—St. Steel. *Insert letter "S" or "N" followed by 1st two numbers of decimal equivalent, for fractional length of shaft beyond bushing. "S" = with slot. "N" = no slot.

Typical part number: AK2164-N31 = 3/8" long shaft beyond bushing (standard), no slot. If length is 1" use "X". Typical part numbers: AK2164-SX = 1" long shaft beyond bushing, slotted. If length exceeds 1", use "X" and decimal equivalent for balance of no. Typical part numbers: AK2164-NX31 = 1 3/8" long shaft beyond bushing, no slot.

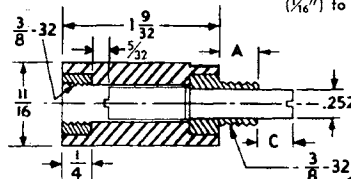
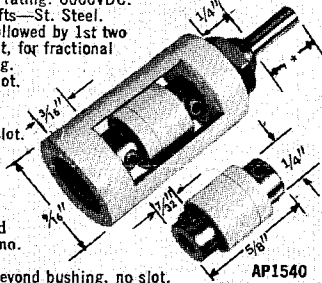

AK-5164- ()
AK-5079- ()

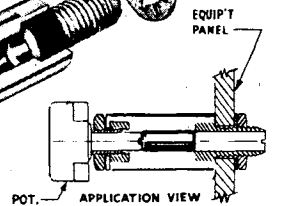

COMMERCIAL INSULATED COUPLINGS—30 KV Breakdown 10 inch pounds torque Series No. AK-4160 For TV and Industrial Applications. These handy couplings, capable of withstanding 30 KV, are made of high grade Bakelite throughout except for the stainless steel screwdriver tip molded within the drive shaft. Mounting hardware supplied.

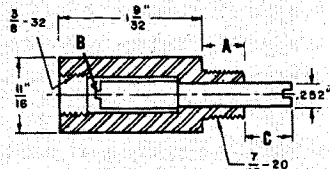

CAT No.	"A"	"B"	SHAFT	"C"
AK-4160-X-1	3/4"	3/4"	Slotted	1/2"
AK-4160-B-1	3/4"	3/4"	Slotted	1/2"
AK-4160-X-2	3/4"	3/4"	No Slot	1/2"
AK-4160-B-2	3/4"	3/4"	No Slot	1/2"

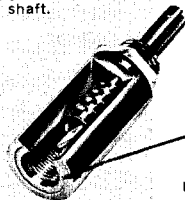

REDUCER INSERT BUSHING
Cat. No. AK771

Used as an adapter with high voltage insulated couplings to accommodate miniature (3/16" shaft) potentiometers. External thread 3/8x32. Internal thread 1/4x32.

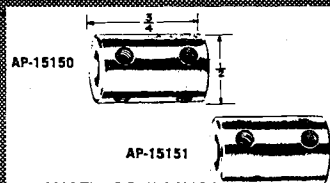

SHAFT COUPLING
Cat. No. AP-15150

A rugged, nickel plated brass coupling for joining two 1/4" shafts. Supplied with 4 set screws for firm attachment to shafts.

CAT. NO. AP-15151
Same as above, 2 set screws.

AUTOLINEAR (INSULATED) SHAFT COUPLINGS

2.5 - 5KV BREAKDOWN
Universal, miniature, self-aligning
Cat. No. AP-1530 & AP-1538

A unique series of shaft couplers that accommodate either similar or dissimilar 3/8", 1/2" or 5/8" shafts. Permits offset misalignment to 1/16" and 5° angle. Operates free of backlash. Self-extinguishing low water absorption characteristic plastic insulator between precision cast aluminum hubs. Each hub has 2 set screws for firm attachment. Alodine finish.

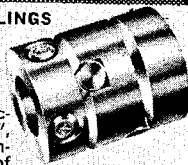

PART NO.	DIA.	HOLE "A"	"B"	"C"
AP-1530	-2	1/8"	1/2"	1 3/4" ± 1/32"
	-3	3/16"	1/2"	1 3/4" ± 1/32"
	-4	1/4"	1/2"	1 3/4" ± 1/32"
AP-1538	-2	1/8"	1/2"	1 3/4" ± 1/32"
	-3	3/16"	1/2"	1 3/4" ± 1/32"
	-4	1/4"	1/2"	1 3/4" ± 1/32"

TYPICAL PART NUMBERS: AP-1530-34
AP-1538-22
VOLTAGE RATING: AP-1530 — 2500 VOLTS
AP-1538 — 5000 VOLTS

OFFSET-SHAFT (INSULATED) COUPLINGS

10 KV Breakdown—±30° Offset
Cat. No. AP-15299

Highly versatile, durable insulated couplings made with single-unit, molded Nylon-to-metal insert construction. Application requires two couplings—permits smooth control for two parallel shafts offset from each other up to 30 degrees at separations greater than 3 inches. Secured to component and control shafts by 2 set screws.

Note: Coupling is accomplished with a 1/4" shaft of any length (not furnished). Coupling shaft keyed to coupler by steel drive pins supplied.

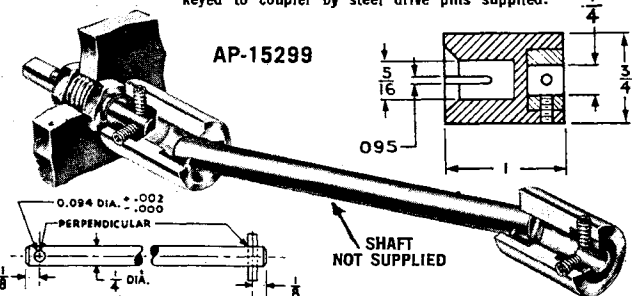



JAN HARDWARE

MANUFACTURING COMPANY, INC.



New Items

THUMB SCREW
TOL. ±.005

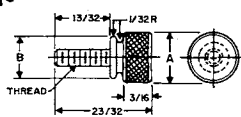

THREAD	A DIA.	B DIA.	PT. NO.
6-32	3/8	5/16	TS 6056
	7/16	3/8	TS 7066
8-32	1/2	7/16	TS 8076
	3/8	5/16	TS 6058
10-32	7/16	3/8	TS 7068
	1/2	7/16	TS 8078
	3/8	5/16	TS 6050
	7/16	3/8	TS 7060
	1/2	7/16	TS 8070

EXAMPLE (TO ORDER)
PT. NO. TS6058 • 8 • 8-32 X 1 1/2 LG. THREAD,
THUMB SCREW - BRASS

THUMB NUT KNURLED
TOL. ±.005

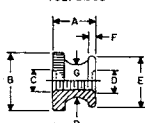

THREAD SIZE	A	B DIA.	C DIA.	D DIA.	E DIA.	F	G	R RAD.	PART NO.
4-36	1/4	3/8	1/8	.147	5/16	3/64	7/32	3/64	KN436
4-40	1/4	3/8	1/8	.147	5/16	3/64	7/32	3/64	KN440
6-32	1/4	3/8	9/64	.169	5/16	3/64	7/32	3/64	KN632
6-32	9/32	13/32	9/64	15/64	11/32	3/64	7/32	1/16	KN632
8-32	5/16	7/16	11/64	15/64	3/8	1/16	1/4	1/16	KN832
10-24	21/64	1/2	13/64	17/64	7/16	1/16	9/32	.070	KN124
10-32	21/64	1/2	13/64	17/64	7/16	1/16	9/32	.070	KN132
12-24	11/32	9/16	7/32	19/64	1/2	1/16	21/64	.070	KN224
14-20	3/8	5/8	17/64	21/64	9/16	1/16	23/64	5/64	KN420

THREADED ROD
1/4-20 THREAD
2" EACH END



LENGTH	LENGTH	LENGTH	LENGTH	LENGTH	LENGTH	LENGTH
4-1/2 TR 1445	7 TR 1470	9-1/2 TR 1495	12 TR 1420	14-1/2 TR 1445	17-1/2 TR 1470	20 TR 1495
5 TR 1450	7-1/2 TR 1475	10 TR 14100	12-1/2 TR 14125	15 TR 14150	18 TR 14180	21 TR 14210
5-1/2 TR 1455	8 TR 1480	10-1/2 TR 14105	13 TR 14130	15-1/2 TR 14155	18-1/2 TR 14185	21-1/2 TR 14215
6 TR 1460	8-1/2 TR 1485	11 TR 14110	13-1/2 TR 14135	16 TR 14160	19 TR 14190	22 TR 14220
6-1/2 TR 1465	9 TR 1490	11-1/2 TR 14115	14 TR 14140	16-1/2 TR 14165	19-1/2 TR 14195	22-1/2 TR 14225
				17 TR 14170	20 TR 14200	

MATERIALS B = BRASS, A = ALUMINUM, SS = STAINLESS STEEL.

CAPTIVE SCREW & NUT ASSEMBLIES

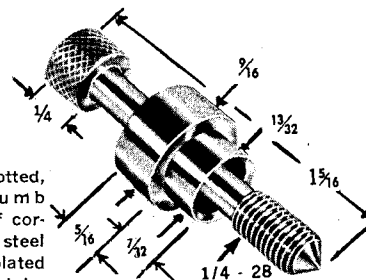

Cat. No. Ap-711
Consists of slotted, knurled thumb screws made of corrosion resistant steel bar, and nickel-plated (on brass) panel inserts.

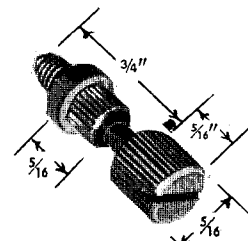

Cat. No. AP1039
Insert, Captive

Cat. No. AP1040
Screw, Captive

"NO-MAR" CLAMPS

Set screw does not touch shaft. Ideal for knob and gear applications. Variety of sizes available.

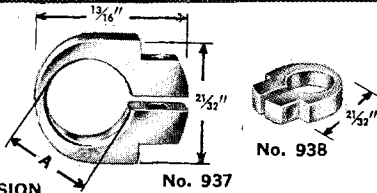

A DIMENSION

Cat. No.	-2	-3	-4	-5	-6	-7	-8
937	1/8"	3/16"	1/4"	5/16"	3/8"	13/32"	7/8"
938	1/8"	3/16"	1/4"	5/16"	3/8"	13/32"	7/8"

RETAINER NUT
Cat. No. R-1030

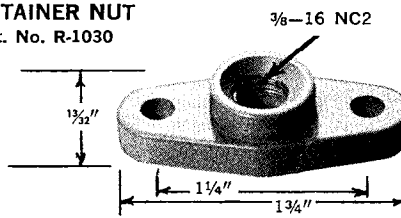

Used in conjunction with captive screw and nut assemblies. Die casting. Can be painted. Other thread sizes available upon special order.

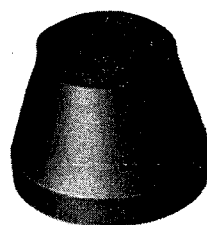

Cat. No. H 465
VIEWING HOOD and/or ADAPTER

Can be used as viewing hood, on 2 3/4" dia. bezels. (#1427; 1428; 1429). Also serves as adapter to permit use of face-fitting neoprene rubber viewing hoods. (see above). All aluminum. Dull black enamel finish.



VIEWING HOOD

No. H-689-1 (5 5/8" I.D.)

Black neoprene rubber, contour-molded, fits shape of face. Keeps out ambient light when viewing scope.

Used with following Jan Bezels: 19636; 19495; 13584; 1465

No. H-689-2 (4 7/8" I.D.)
Used with Jan Bezel #545

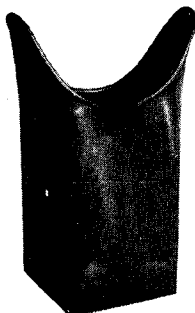

VIEWING HOOD

to fit rectangular bezels

Cat. No. H-1008

Black, contour molded neoprene rubber. Keeps ambient light out, when viewing scope. Fits shape of face. Can be adapted for smaller I.D.'S.

Used with Jan Bezel #1328. Can be adapted for #1533-P

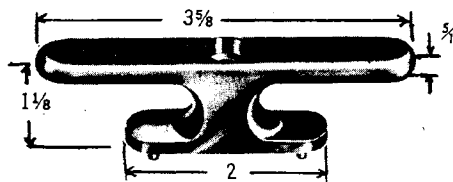

HANDLE, CORD Cat. No. H-692-1

This durable, die-cast aluminum handle is designed for use on small instrument panels. Single integral hole accepts No. 10 screw.

Colors:
(-1) Grey.
Special colors on request.

The service of JAN's design engineers is available to assist you with your Component requirements.

JAN will design and manufacture special Components to customers' specifications.

Complete facilities for prototype work.



JAN HARDWARE

MANUFACTURING COMPANY, INC.



New Items

STANDOFF-THREADED

HEX & ROUND

TOL ±.005

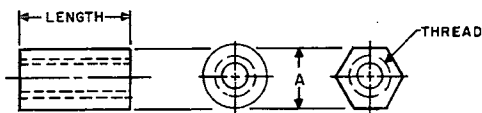

LENGTH	A=1/8 DIA. 0-80 THREAD		A=3/16 DIA. 2-56 THREAD		A=3/16 DIA. 4-40 THREAD	
	ROUND	HEX	ROUND	HEX	ROUND	HEX
1/16	SR201	SH201	SR3012	SH3012	SR3014	SH3014
1/8	SR202	SH202	SR3022	SH3022	SR3024	SH3024
3/16	SR203	SH203	SR3032	SH3032	SR3034	SH3034
1/4	SR204	SH204	SR3042	SH3042	SR3044	SH3044
5/16	SR205	SH205	SR3052	SH3052	SR3054	SH3054
3/8	SR206	SH206	SR3062	SH3062	SR3064	SH3064
7/16	SR207	SH207	SR3072	SH3072	SR3074	SH3074
1/2	SR208	SH208	SR3082	SH3082	SR3084	SH3084
9/16	SR209	SH209	SR3092	SH3092	SR3094	SH3094
5/8	SR210	SH210	SR3102	SH3102	SR3104	SH3104
3/4	SR212	SH212	SR3122	SH3122	SR3124	SH3124
1			SR3162	SH3162	SR3164	SH3164

EXAMPLE (TO ORDER)

PT. NO. SR3032-A = 3/16 DIA. X 3/16 LG. ROUND STANDOFF - ALUMINUM W/2-56 THREADED HOLE

LENGTH	A=1/4 DIA.							
	4-40 THREAD		6-32 THREAD		8-32 THREAD		10-32 THREAD	
	ROUND	HEX	ROUND	HEX	ROUND	HEX	ROUND	HEX
1/8	SR4024	SH4024	SR4026	SH4026	SR4028	SH4028	SR40210	SH40210
3/16	SR4034	SH4034	SR4036	SH4036	SR4038	SH4038	SR40310	SH40310
1/4	SR4044	SH4044	SR4046	SH4046	SR4048	SH4048	SR40410	SH40410
5/16	SR4054	SH4054	SR4056	SH4056	SR4058	SH4058	SR40510	SH40510
3/8	SR4064	SH4064	SR4066	SH4066	SR4068	SH4068	SR40610	SH40610
7/16	SR4074	SH4074	SR4076	SH4076	SR4078	SH4078	SR40710	SH40710
1/2	SR4084	SH4084	SR4086	SH4086	SR4088	SH4088	SR40810	SH40810
9/16	SR4094	SH4094	SR4096	SH4096	SR4098	SH4098	SR40910	SH40910
5/8	SR4104	SH4104	SR4106	SH4106	SR4108	SH4108	SR41010	SH41010
3/4	SR4124	SH4124	SR4126	SH4126	SR4128	SH4128	SR41210	SH41210
7/8	SR4144	SH4144	SR4146	SH4146	SR4148	SH4148	SR41410	SH41410
1	SR4164	SH4164	SR4166	SH4166	SR4168	SH4168	SR41610	SH41610

EXAMPLE (TO ORDER)

PT. NO. SH4086-B = 1/4 DIA. X 1/2 LG. HEX STANDOFF-BRASS W/6-32 THREADED HOLE.

LENGTH	A=5/16 DIA.							
	4-40 THREAD		6-32 THREAD		8-32 THREAD		10-32 THREAD	
	ROUND	HEX	ROUND	HEX	ROUND	HEX	ROUND	HEX
1/8	SR5024	SH5024	SR5026	SH5026	SR5028	SH5028	SR50210	SH50210
3/16	SR5034	SH5034	SR5036	SH5036	SR5038	SH5038	SR50310	SH50310
1/4	SR5044	SH5044	SR5046	SH5046	SR5048	SH5048	SR50410	SH50410
5/16	SR5054	SH5054	SR5056	SH5056	SR5058	SH5058	SR50510	SH50510
3/8	SR5064	SH5064	SR5066	SH5066	SR5068	SH5068	SR50610	SH50610
7/16	SR5074	SH5074	SR5076	SH5076	SR5078	SH5078	SR50710	SH50710
1/2	SR5084	SH5084	SR5086	SH5086	SR5088	SH5088	SR50810	SH50810
9/16	SR5094	SH5094	SR5096	SH5096	SR5098	SH5098	SR50910	SH50910
5/8	SR5104	SH5104	SR5106	SH5106	SR5108	SH5108	SR51010	SH51010
3/4	SR5124	SH5124	SR5126	SH5126	SR5128	SH5128	SR51210	SH51210
7/8	SR5144	SH5144	SR5146	SH5146	SR5148	SH5148	SR51410	SH51410
1	SR5164	SH5164	SR5166	SH5166	SR5168	SH5168	SR51610	SH51610

EXAMPLE (TO ORDER)

PT. NO. SR5146-PH = 5/16 DIA. X 7/8 LG. ROUND STANDOFF - PHENOLIC W/6-32 THREADED HOLE.

LENGTH	3/8 DIA.					
	6-32 THREAD		8-32 THREAD		10-32 THREAD	
	ROUND	HEX	ROUND	HEX	ROUND	HEX
1/8	SR6026	SH6026	SR6028	SH6028	SR60210	SH60210
3/16	SR6036	SH6036	SR6038	SH6038	SR60310	SH60310
1/4	SR6046	SH6046	SR6048	SH6048	SR60410	SH60410
5/16	SR6056	SH6056	SR6058	SH6058	SR60510	SH60510
3/8	SR6066	SH6066	SR6068	SH6068	SR60610	SH60610
7/16	SR6076	SH6076	SR6078	SH6078	SR60710	SH60710
1/2	SR6086	SH6086	SR6088	SH6088	SR60810	SH60810
9/16	SR6096	SH6096	SR6098	SH6098	SR60910	SH60910
5/8	SR6106	SH6106	SR6108	SH6108	SR61010	SH61010
3/4	SR6126	SH6126	SR6128	SH6128	SR61210	SH61210
7/8	SR6146	SH6146	SR6148	SH6148	SR61410	SH61410
1	SR6166	SH6166	SR6168	SH6168	SR61610	SH61610

EXAMPLE (TO ORDER)

PT. NO. SH6068-B = 3/8 DIA. X 3/8 LG. HEX STANDOFF-BRASS W/8-32 THREADED HOLE.

LENGTH	A=1/2 DIA.							
	8-32 THREAD		10-32 THREAD		12-24 THREAD		1/4-20 THREAD	
	ROUND	HEX	ROUND	HEX	ROUND	HEX	ROUND	HEX
1/8	SR8028	SH8028	SR80210	SH80210	SR80212	SH80212	SR80214	SH80214
3/16	SR8038	SH8038	SR80310	SH80310	SR80312	SH80312	SR80314	SH80314
1/4	SR8048	SH8048	SR80410	SH80410	SR80412	SH80412	SR80414	SH80414
5/16	SR8058	SH8058	SR80510	SH80510	SR80512	SH80512	SR80514	SH80514
3/8	SR8068	SH8068	SR80610	SH80610	SR80612	SH80612	SR80614	SH80614
7/16	SR8078	SH8078	SR80710	SH80710	SR80712	SH80712	SR80714	SH80714
1/2	SR8088	SH8088	SR80810	SH80810	SR80812	SH80812	SR80814	SH80814
9/16	SR8098	SH8098	SR80910	SH80910	SR80912	SH80912	SR80914	SH80914
5/8	SR8108	SH8108	SR81010	SH81010	SR81012	SH81012	SR81014	SH81014
3/4	SR8128	SH8128	SR81210	SH81210	SR81212	SH81212	SR81214	SH81214
7/8	SR8148	SH8148	SR81410	SH81410	SR81412	SH81412	SR81414	SH81414
1	SR8168	SH8168	SR81610	SH81610	SR81612	SH81612	SR81614	SH81614

EXAMPLE (TO ORDER)

PT. NO. SR80910-A = 1/2 DIA. X 9/16 LG. ROUND STANDOFF-ALUMINUM W/10-32 THREADED HOLE.

SPECIAL SIZES AND MATERIALS MANUFACTURED TO ORDER

MATERIALS

- B = BRASS
- A = ALUMINUM
- SS = STAINLESS STEEL
- PH = PHENOLIC



JAN HARDWARE

MANUFACTURING COMPANY, INC.



Catalog No.	CRT Face	Material	Type	Panel Opening	A Overall Width	B Overall Height	C Visible Area (Bezel) Width	D Visible Area (Bezel) Height	E Mounting Holes Width	F Mounting Holes Height	G-Thickness (Face Only)	H-Thickness (Incl. Flange)	Visible Area (Cushion) Height	Visible Area (Cushion) Width
-------------	----------	----------	------	---------------	-----------------	------------------	------------------------------	-------------------------------	------------------------	-------------------------	-------------------------	----------------------------	-------------------------------	------------------------------

BEZELS FOR 7" C.R.T.

CP-7330 -1 CP-7331 -2**	Curved Flat	Aluminum	Standard E.L.B.A.**	7 ¹ / ₃₂ "	7 ¹ / ₁₆ "	7 ¹ / ₁₆ "	6 ⁵ / ₁₆ " Dia.		6 ³ / ₁₆ "	6 ³ / ₁₆ "	3/4"	3/4"	6 ³ / ₈ " Dia.	
CP-7375 -1** -2**	Curved Flat	Aluminum	E.L.B.A.**	7 ¹ / ₃₂ "	8"	8"	4 ¹ / ₂ "	4 ¹ / ₂ "	6 ³ / ₁₆ "	6 ³ / ₁₆ "	1 ¹ / ₃₂ "	2 ²⁹ / ₃₂ "	4 ¹ / ₂ "	4 ¹ / ₂ "
CP-7420 -1** -2**	Curved Flat	Aluminum	Camera Mount	7 ¹ / ₃₂ "	7 ¹ / ₁₆ "	7 ¹ / ₁₆ "	6 ⁵ / ₁₆ " Dia.		6 ³ / ₁₆ "	6 ³ / ₁₆ "	3/4"	1 ¹ / ₂ "	6 ³ / ₈ " Dia.	
CP-7550	Curved or Flat	Aluminum	Camera Mount	4 ²⁹ / ₃₂ "	7 ³ / ₈ "	6 ¹ / ₂ "	4 ³ / ₄ "	4 ³ / ₄ "	6 ¹ / ₄ "	5 ¹ / ₈ "	1 ³ / ₁₆ "	1 ³ / ₁₆ "	No Cushion	

BEZEL FOR 10" C.R.T.

** Edge Lit Bezel Assemblies

CP-10860	Curved or Flat	Aluminum	Standard	11 ¹ / ₃₂ "	12 ¹ / ₄ " Dia.		8 ³ / ₁₆ "	6 ¹ / ₄ "	11 ¹ / ₂ " B.C		1 ¹ / ₁₆ "	1 ¹ / ₁₆ "	No Cushion	
----------	----------------	----------	----------	-----------------------------------	---------------------------------------	--	----------------------------------	---------------------------------	--------------------------------------	--	----------------------------------	----------------------------------	------------	--

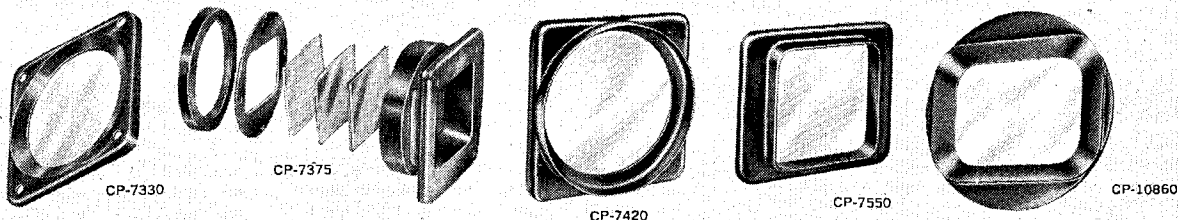

DISTINCTIVE FEATURES

- Engineered for 2", 3", 4", 5", 7", 8" and 10" CRT
- Maximum display area
- Precision engraved, scale-calibrated graticules; standard or to customer's specifications
- Materials and finish to "Mil Spec"
- Heavy buna-S shock cushion
- Models for edge-lighting
- Phosphor-matched light filters
- Non-reflecting matte surfaces
- Rugged camera mounts
- Models for curved and flat-faced CRT

ESCUTCHEON PLATES For Elegant Framing of Panel Openings

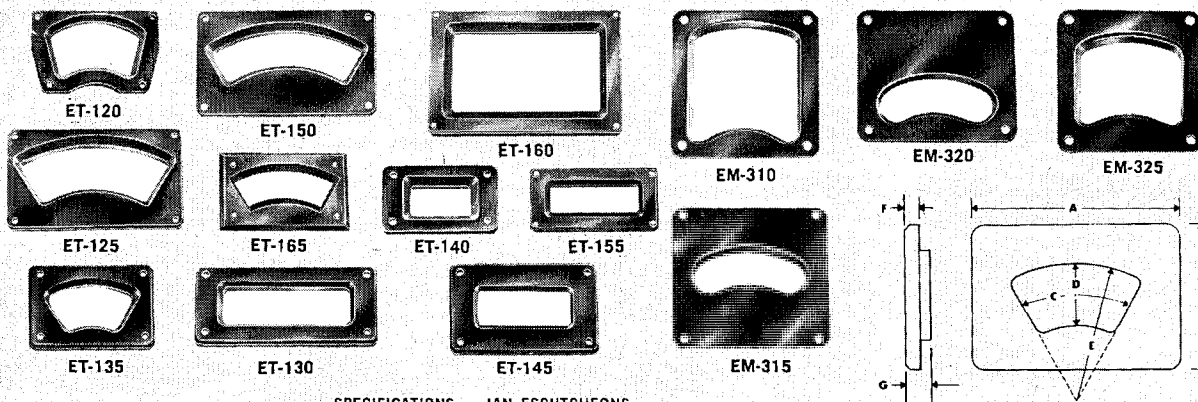

SPECIFICATIONS — JAN ESCUTCHEONS

Escutcheon Cat. No.	A Overall Width	B Overall Height	C Window Width	D Window Height	E Effective Outer Dial Radius	Thickness F=Face G=Incl. Only Flange		Panel Opening Width Height		Mounting Holes Width Height		Type of Dial	Material
ET-120	2 ⁷ / ₃₂ "	1 ³ / ₈ "	1 ¹ / ₄ "	1"	1 ¹ / ₃₂ "	3/16"	3/16"	2 ¹ / ₃₂ "	1 ¹ / ₈ "	2 ³ / ₁₆ " top 2 ³ / ₁₆ " bottom	1 ¹ / ₁₆ "	Circular	Injection Molded Tenite II, Black Matte Finish
ET-125	3 ³ / ₈ "	2 ³ / ₁₆ "	2 ¹ / ₂ "	1"	3/4"	3/16"	3/16"	3 ¹ / ₂ "	1 ¹ / ₂ "	3 ¹ / ₂ "	1 ¹ / ₁₆ "	Circular	Injection Molded Tenite II, Black Matte Finish
ET-135	2 ³ / ₄ "	1 ¹ / ₄ "	1 ¹ / ₂ "	3/8"	1 ¹ / ₄ "	3/16"	3/16"	1 ¹ / ₂ "	1 ¹ / ₂ "	1 ¹ / ₂ "	1 ¹ / ₁₆ "	Circular	Injection Molded Tenite II, Black Matte Finish
ET-150	3 ³ / ₈ "	2 ³ / ₁₆ "	2 ¹ / ₂ "	3/8"	3/4"	3/16"	3/16"	3 ¹ / ₂ "	1 ¹ / ₂ "	3 ¹ / ₂ "	1 ¹ / ₁₆ "	Circular	Injection Molded Tenite II, Black Matte Finish
ET-165	2 ³ / ₄ "	1 ¹ / ₄ "	1 ¹ / ₂ "	3/8"	2 ²⁹ / ₃₂ "	3/16"	3/16"	1 ¹ / ₂ "	1 ¹ / ₂ "	1 ¹ / ₂ "	1 ¹ / ₁₆ "	Circular	Injection Molded Tenite II, Black Matte Finish
ET-130	4"	1 ³ / ₈ "	2 ¹ / ₄ "	1 ¹ / ₈ "	—	3/16"	1/4"	2 ¹ / ₃₂ "	1 ¹ / ₃₂ "	3 ¹ / ₂ "	1 ¹ / ₁₆ "	Flexible Tape.	Injection Molded Tenite II, Black Matte Finish
ET-140	2 ¹ / ₂ "	1 ¹ / ₂ "	1 ¹ / ₄ "	3/8"	—	3/16"	3/16"	1 ¹ / ₂ "	1 ¹ / ₂ "	2"	1"	Digital Counter, Cylinder or Drum	Injection Molded Tenite II, Black Matte Finish
ET-145	3 ³ / ₄ "	2 ³ / ₈ "	1 ¹ / ₈ "	3/4"	—	3/16"	3/16"	2 ¹ / ₃₂ "	1 ¹ / ₂ "	2 ¹ / ₂ "	1 ¹ / ₁₆ "	Cylinder or Drum	Injection Molded Tenite II, Black Matte Finish
ET-155	2 ¹ / ₂ "	1 ¹ / ₄ "	1 ¹ / ₈ "	1/2"	—	3/16"	3/16"	2 ¹ / ₃₂ "	2 ¹ / ₂ "	2 ¹ / ₂ "	1 ¹ / ₁₆ "	Cylinder or Drum	Injection Molded Tenite II, Black Matte Finish
ET-160	3 ³ / ₄ "	2 ¹ / ₂ "	2 ¹ / ₂ "	1 ¹ / ₈ "	—	3/16"	1/8"	3"	2 ¹ / ₂ "	3 ¹ / ₂ "	2 ¹ / ₂ "	Helical	Soft Aluminum with Black Matte Enamel Finish
EM-310	3"	3"	2 ¹ / ₁₆ "	1 ¹ / ₁₆ "	2 ³ / ₁₆ "	1/2"	1/4"	3 ¹ / ₂ "	2 ¹ / ₂ "	2 ¹ / ₂ "	2 ¹ / ₂ "	Helical	Soft Aluminum with Black Matte Enamel Finish
EM-315	3 ¹ / ₄ "	3"	2 ¹ / ₄ "	3/8"	2 ³ / ₁₆ "	1/2"	1/8"	2 ¹ / ₃₂ "	1 ¹ / ₄ "	2 ¹ / ₂ "	2 ¹ / ₂ "	Circular	Soft Aluminum with Black Matte Enamel Finish
EM-320	3 ¹ / ₄ "	2 ³ / ₄ "	2 ¹ / ₄ "	3/8"	2 ³ / ₁₆ "	1/2"	1/8"	2 ¹ / ₃₂ "	1 ¹ / ₄ "	2 ¹ / ₂ "	2 ¹ / ₂ "	Circular	Soft Aluminum with Black Matte Enamel Finish
EM-325	3"	3"	2 ¹ / ₄ "	1 ¹ / ₂ "	2 ³ / ₁₆ "	1/2"	1/4"	2 ¹ / ₃₂ "	1 ¹ / ₄ "	2 ¹ / ₂ "	2 ¹ / ₂ "	Helical	Soft Aluminum with Black Matte Enamel Finish

* To Order specify: (1) frame only; (2) frame with clear window; (3) frame with clear window scribed with a center line.

JAN'S molded, black, shock-resistant plastic escutcheons are available in an exceptionally wide variety of different types and sizes. They provide a pleasing window to frame dial plates mounted behind the panel. Plastic escutcheons are available in the following ways: frame only; frame with clear windows; frame with clear window scribed with a center line. For especially large working areas, stamped aluminum escutcheons, finished in dull black are available to meet the needs for space economy. Withstands temperature shock -65° to +85° C. **NON INFLAMMABLE**



JAN HARDWARE

MANUFACTURING COMPANY, INC.



JAN'S MAGNETIC SHIELDS are made of MU-Metal or equal and are hydrogen annealed by a special process to assure optimum orientation of the molecular structure of the alloy for best magnetic shielding. JAN'S MAGNETIC SHIELDS prevent distortion and intensity modulation of the electron beam due to stray magnetic fields.

In addition, the use of these shields protect personnel against the dangers of accidental tube breakage. Mounting holes are tapped for No. 6-32 screws as shown. These shields are designed to fit JAN'S standard bezels as listed below. See preceding pages for specifications on JAN'S BEZEL ASSEMBLIES.

SHIELD CAT. NO.	FOR USE WITH C.R.T. NO.	MATCHING JAN BEZEL	
S2001 S2001-1	902 2AP 2BP	CP1110P2 CP1120P2	
S3001 adaptable for edge-lighting graticule using S3010 with Bezel CP1428*	3RP 3RPA	CP1328-P-1 CP1427-1 CP1429-1 CP1328-P-2 CP1427-2 CP1429-2 CP3430-1 CP3430-2	
S3003 S3003-1	3KP 908A 3AP	CP1328-P1 CP1427-1 CP1429-1	Same type as S-3001, except A=10 5/8 B=2
S3004 —12 (less anode hole) —22 (with anode hole) adaptable for edge-lighting graticule using S3012 with Bezel CP1428*	3BP 3JP 3ACP	Same as S3003 Same as S3005	Same type as S-3001, except A=8 5/8 B=2 3/8
S3005 adaptable for edge-lighting graticule using S3008 with Bezel CP1428*	3WP	CP1328-P2 CP1427-2 CP1429-2	Same type as S-3001, except A=10 5/8 B=1 1/4
S3016	3ASP		
S3019	3XP	CP-725	
S3031	3BFP		

ALL SHIELDS ARE FABRICATED WITH OVERLAPPED AND SPOT WELDED CONSTRUCTION
*See mounting hole arrangement illustrated with S3001 edge-lit dimension drawing.





JAN HARDWARE

MANUFACTURING COMPANY, INC.



SHIELD CAT. NO.	FOR USE WITH C.R.T. NO.	MATCHING JAN BEZEL	
S5008 adaptable for edge-lighting	5AMP	CP1465-2 CP13549-2 CP13584-2 CP13595-2 CP19495-2	
S5017 adaptable for edge-lighting	5ABP 5ADP	CP1465-2 CP19636-2	
S5027	5BTP	CP19495-2	
S5032	5CEP	CP19495-2	
S5500	5BXP		
S6600	6E17P		

ALL SHIELDS ARE FABRICATED WITH OVERLAPPED AND SPOT WELDED CONSTRUCTION

The service of JAN's design engineers is available to assist you with your Shield & Bezel requirements. We will design and manufacture special Shields & Bezels to customers specifications. Complete facilities for prototype work.



DESIGN ENGINEER'S SHIELD SELECTOR GUIDE

For Magnetic Shielding Cathode Ray Tubes



TYPE -- A
(Cylinder)



TYPE -- AR
(Rectangle or Square)



TYPE -- E
(Cylinder & Cylinder)



TYPE -- ER
(Rectangle)



TYPE -- J
(Cylinder-Cone-Cylinder-Cylinder)



TYPE -- JR
(Rectangle or Square)



TYPE -- B
(Cone)



TYPE -- BR
(Rectangle or Square)



TYPE -- F
(Cone-Cylinder)



TYPE -- FG
(Rectangle or Square)

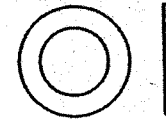

TYPE -- K
(Discs)



TYPE -- C
(Cylinder & Cone)



TYPE -- CR
(Rectangle or Square)



TYPE -- G
(Rectangle & Cylinder)



TYPE -- GR
(Square)



TYPE -- L
(Radial Cones)



TYPE -- LR
(Rectangle or Square)



TYPE -- D
(Cylinder-Cone-Cylinder)



TYPE -- DR
(Rectangle or Square)



TYPE -- H
(Rectangle-Rectangle-Cylinder)



TYPE -- HR
(Rectangle or Square)



TYPE -- T
(Cylinder Drawn Cans)



TYPE -- TR
(Rectangle or Square)

HOW TO DESIGNATE SHIELD SIZE AND SHAPE

This "Shield Selector Guide" has been created as an aid to shield designers. Properly used, it will eliminate (or minimize) your design time, and facilitate the ordering of the correct size and shape shield. There is no longer a need to draw your own prints. We probably have made shields the same, or similar to your needs.

Shown are representative configurations of shields that we feel cover most applications. However, other combinations of these shapes can easily be created, to meet your specifications. Just let us know dimensions.

Typical P/N and ordering information is shown to the right.

TYP P/N

3.6 B 2.3 L.3

FRONT I.D. OF SHIELD CONTOUR OF SHIELD REAR I.D. OF SHIELD

SHIELD LENGTH IN INCREMENTS OF 1/4" Using alphabet starting with 'A' = 1"; 'B' = 2"; 'C' = 3"; etc. Do not use letters 'I' or 'O' (In Typ P/N above, L.3=11.3")

JAN's Design Engineers are available to assist you with your shield requirements. • We will design and manufacture shields to your specifications. COMPLETE FACILITIES FOR PROTOTYPE WORK.

JAN HARDWARE MANUFACTURING COMPANY, INC.



JAN HARDWARE

MANUFACTURING COMPANY, INC.



KNOBS TO MILITARY SPECIFICATIONS

One of the largest assortment of Military Knobs in the country.

NEW CAST KNOBS

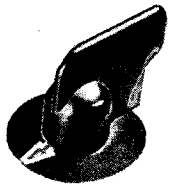

No. 1005
Available with or without skirt

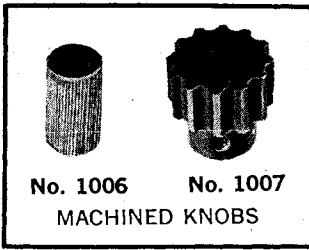

No. 1006 No. 1007
MACHINED KNOBS



No. 1020



No. 1021

CAST ALUMINUM KNOBS

Available in black. Other colors on request. Specify shaft hole size required.

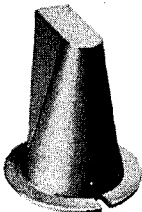

No. 1022
Full Round Skirt



No. 1023
Flat Back Round Skirt



No. 1024
With Cam Shape Cut-out.

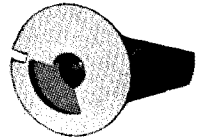

ZINC ALLOY

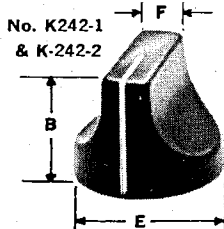

Cat. No.	B	E	F	Marking
242-1	3/4"	1 3/8"	3/8"	White
242-2	7/8"	1 1/8"	3/8"	White
242-3	3/4"	1 3/8"	3/8"	None

SIGNAL CORPS DIE CAST KNOBS

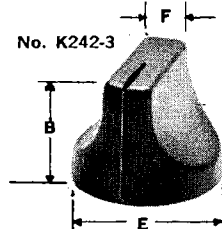

ALUMINUM



Cat. No. 984
Dimensions as per 242-3
No markings. Aluminum.

Manufactured in accordance with applicable military specifications.

MS SIGNAL CORPS DIE-CAST ALUMINUM & ZINC ALLOY CONTROL KNOBS

Manufactured in accordance with applicable Military Specifications

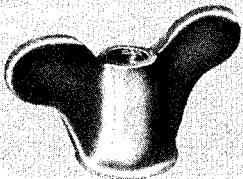

SMC 414401

MS 91524



K 680

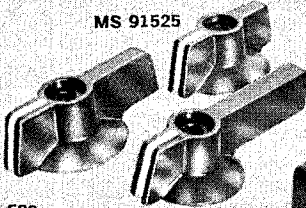

MS 91525

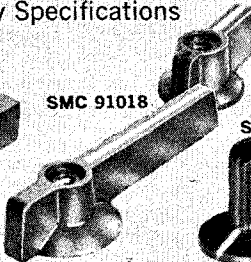

SMC 91018

SMC 414393



SMC 414399

SMB 134171

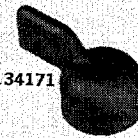

SMB 134094

SMB 134884



SMC 414680-1 Thru 10

(Many sizes available. Lengths from 1 3/8" to 2 3/8").

PARTIAL LIST
OF GOV'T KNOBS
MFG'D BY JAN

SMC 100446
SCB 104717
SMC 108874
SMC 108875
SMC 108876
SMC 108951
SMB 134093
SMB 134094
SMB 134171
SMB 134884

SMB 134957
SMB 143975
SMB 144318
SMB 144319
SMB 144358
SMB 144517
SMB 16505
SMB 16552
SMB 180288A2
SMB 180465A1

MS 25165
SMC 328371
SMC 344847
SMC 345389
SCB 35862
SCB 35863
SCB 40771
SCB 40859
SCB 40860
SCB 41848

SMC 414393
SMC 414399
SMC 414401
SMC 414680-1
thru -10
SMD 415160
SMD 415161
SMD 415223
BU ORD 416956 PT2
SMC 447052

SMC 447226
SMB 456374
SMC 500407
SMC 502491
NAS 539 1B
NAS 539 1C
USAF 61D40474
SCB 16532
SCB 65884
SCB 72585

SCB-72687
NAV ORD 814528
SCB 82716
SMB 902574-1
SMC 91018
MS 91524
MS 91525-1
thru -4
MS 91528
MS 91522



DELUXE INSTRUMENT KNOBS

MEETS PERFORMANCE OF MIL-STD-242D (SHIPS) AND MS 91528C



JAN's Standard Instrument Control Knobs for use with electronic equipment. Molded of polycarbonate, these knobs will withstand the extreme environmental conditions of

MIL-E-16400. Either knob-cap or entire knob is available in a variety of colors, in MATTE (M) or GLOSSY (G) finish. Complete range of sizes... send for catalog.

TACTILE SHAPE CONTROL KNOBS

Expressly made for both visual and tactile function identification. Each Tactile knob is produced in the standard recognizable color identified with its configuration. Available in other colors on special order. See column—below, for applicable tactile shape.

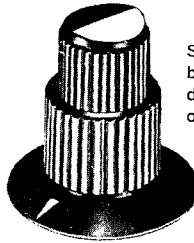
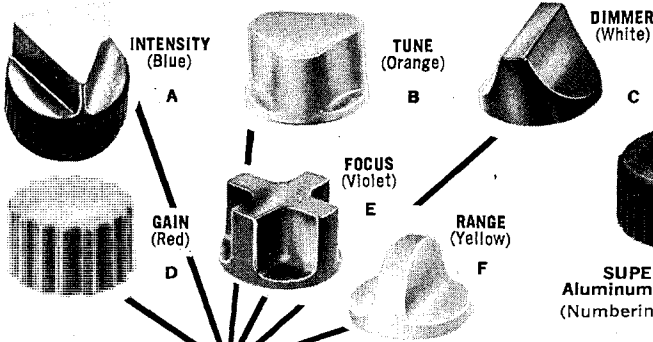

See diagrams below for dimensions of each knob.

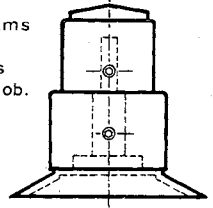

DUAL KNOBS FOR CONCENTRIC CONTROLS APPROVED FOR USE MIL STD 242D and MS 91528C

Molded of polycarbonate plastic, these "piggy-back" knobs are used with dual concentric potentiometers and in other similar applications. Meet performance of military specs above.

SUPER DELUXE
Aluminum Anodized Top.
(Numbering as below)

DIMENSIONS

PART NO.		A	D	F	G	H	K	M	N	P	R	S	T	Y
5	1 A	.505	.302				.509	.158	.026	.408				
7	1 A	.708	.486				.626	.158	.026	.406				.915
9	1 A	.911	.645				.798	.255	.114	.521				1.171
12	1 A	1.255	.974				.703	.260	.115	.458				1.220
17	1 A	1.755	1.465				.854	.255	.114	.521				
22	1 A	2.255	1.870				.885	.255	.114	.521				
5	1 B	.505	.302	.450		.660	.509				.181	.563	.324	
7	1 B	.708	.486	.670		.805	.626				.188	.568	.340	1.100
9	1 B	.911	.654	.826		1.027	.798				.323	.730	.484	1.399
12	1 B	1.255	.974	1.155		.870	.703				.262	.605	.427	1.399
17	1 B	1.755	1.465	1.666		1.088	.854				.333	.740	.489	
22	1 B	2.255	1.870	2.153		1.114	.885				.333	.740	.489	
5	1 C	.505	.302			.885	.660	.509			.181	.563	.324	
7	1 C	.708	.486			1.135	.805	.626			.188	.568	.340	1.100
9	1 C	.911	.645			1.510	1.027	.798			.323	.730	.484	1.399
12	1 C	1.255	.974			1.822	.870	.703			.262	.605	.427	1.399
17	1 C	1.755	1.465			2.453	1.088	.854			.333	.740	.489	
22	1 C	2.255	1.870			3.005	1.114	.885			.333	.740	.489	

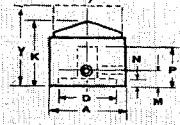

NO SKIRT

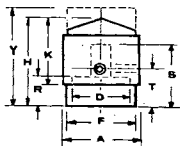
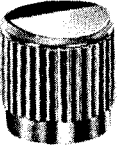

PLAIN SKIRT

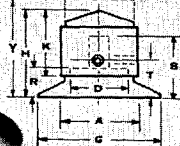
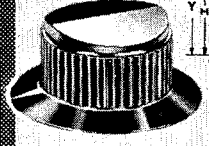

DIAL SKIRT

SPECIFY AS REQUIRED

- 1 TOP (Color or Tactile)
 - 2 BODY DIA.
 - 3 BODY STYLE
 - 4 SKIRT
 - 5 SHAFT HOLE DIA.
 - 6 FINISH
 - 7 COLOR
- 0 = NO TOP—
 Shaft Hole Drilled Thru. 5 = .51 1 = ROUND 2 = .128 M = MATTE A = BLACK
 *T = STANDARD 7 = .72 2 = POINTER B = PLAIN 3 = .190 G = GLOSSY B = RED
 A = (INTENSITY—Blue) 9 = .90 C = DIAL W/ 4 = .253 C = GREY
 B = (TUNE—Orange) 12 = 1.25 POINTER 5 = .312 D = GREEN
 C = (DIMMER—White) 17 = 1.75 D = DIAL W/O 6 = .375 E = YELLOW
 D = (GAIN—Red) 22 = 2.25 POINTER 7 = .268 F = PURPLE
 E = (FOCUS—Violet) G = BLUE
 F = (RANGE—Yellow) H = WHITE
 J = ORANGE
- M = ALUMINUM ANODIZED TOP
- "D" FLAT SHAFT HOLES
 B = .107 (3/8")
 D = .222 (1/4")

TYPICAL PART NUMBERS

- 91C4GA = 90 Dia./Round/Dial/1/4"/Glossy/Black
- A71B4MA = Triangle Top Blue/.72/Round/Plain/1/4"/Matte/Black
- BA71B4MA = Triangle Top Red/.72/Round/Plain/1/4"/Matte/Black
- BT71B4MA = Standard Top Red/.72/Round/Plain/1/4"/Matte/Black
- ** 071B4MA = No Top, Shaft hole drilled thru/.72/Round/Plain/1/4"/Matte/Black

**—Specify if .127, .190, .250 hole is required for dual mounting
 NOTE: *T—Preceded by color code (BT—would mean Standard RED top)

IF WHITE DOTS ARE REQUIRED—ADD SUFFIX WD TO CATALOG NO.
 FOR SPECIAL KNOBS—GIVE FULL DESCRIPTION OR SKETCH WITH ORDER.



JAN HARDWARE

MANUFACTURING COMPANY, INC.



JOLTA SHOCK TEST MACHINES

For reproducible impact-shock test pulses

Four models engineered to reproduce the entire spectrum of all significant impact shock waves.

Designed for laboratory and production testing of light to medium weight components as well as complete instrumentation. Produced to meet practically all requirements of common Mil. Spec. qualification tests. Each JOLTA is electronically calibrated to certify compliance with test specifications.

JOLTA — Bench Model No. 1001 — Produced to meet JAN-S-44 & Mil-Std. 202 (202A). Standard model range 30-120G. Accessory plate springs available for test pulses to 500 G.

JOLTA — Bench Model No. M-500 — Produced to meet Mil-T-12679A (Sig. C) and Mil. T-19500A. Standard model range —200 to 1000 G at 1.0 milliseecs. Alternate anvil and pad kits available to order.

JOLTA—Floor Model Nos. F-3003-C1, C2, C-3—Designed for high impact shock testing for small and moderate-sized components. Precision-machined magnesium casting utilized for higher shock amplitudes. Typical tests with these units 50 to 5000 G at .2 to 11.0 milliseecs. For high impact testing, accessory springs and twin anvil combinations yield impulses of 0.2 milliseecs to 5000 G.

Note: New design allows for quick changeovers of accessories.

FEATURES

- Economical
- Simple to operate
- Rugged
- Uniformly accurate

JOLTA UNIVERSAL SHOCK TESTERS No. S-200-V

A functionally engineered test machine for large components and complete instrumentation. Accepts specimens up to 200 lbs. and volume of 2 cubic feet. Standard model provides pulses of from 20 to 250 G at 3.0 to over 30.0 milliseecs.

For Production Testing,
JAN's Jolta Shock Test Machines
can be automated for continuous operation.

SPECIFICATIONS — JOLTA SHOCK TESTERS

Model No.	Carriage Volume	Test Weight	"G" Ranges
1001	4" x 4" x 5"	0-12 lbs.	25-500
M-500	3" cube	0-2.0 lbs.	100-1000
F-3003-C-1	5" cube	0-12 lbs.	50-1500
F-3003-C-2	5" cube	0-4.0 lbs.	350-5000
S-200-V	2 Foot cube	0-200 lbs.	20-250

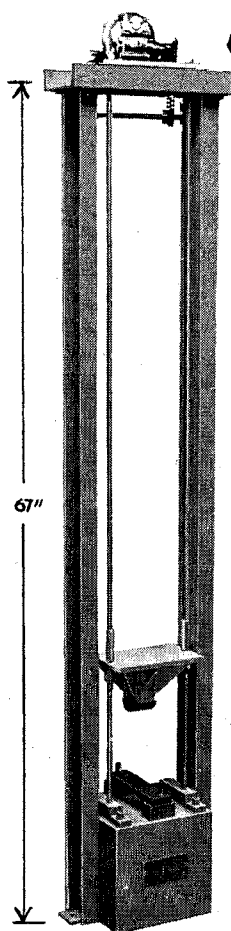

F-3003-C

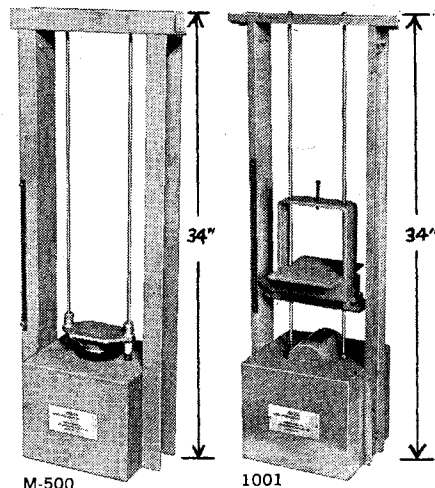

M-500

1001

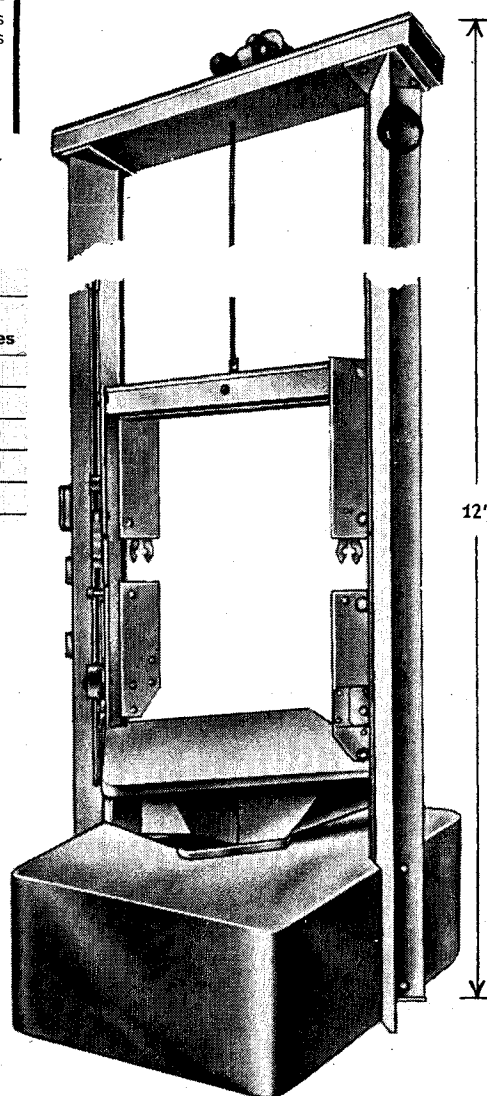

S-200-V

NEW! Plastic impact pad for clean 1/2 MS-2000 G impact shock.

Free engineering services available to customers where adaptation or conversion of standard machines are needed to meet Mil. Spec. changes or other special needs.

READOUT INDICATORS • PILOT LIGHTS

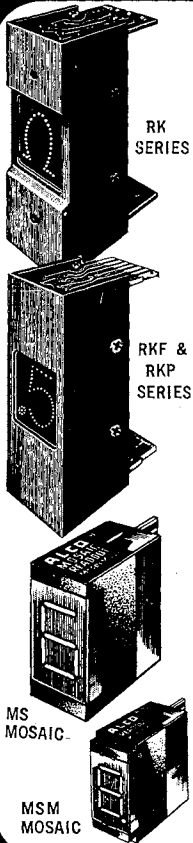

READOUT INDICATORS

RK Series—precision machined from 1-piece aluminum which also serves as a heat sink for the bulbs. Front and rear tapped holes for mounting on a panel or on RKA-2-8 brackets. The RK-FLV violet filter is available to reduce reflected lighting effects resulting in a better contrast.

Unique in-line design provides clear displays without focusing problems thereby allowing equally clear viewing from any angle. Compact size assures a neat fit in a limited space. Long life bulbs—20,000 to 50,000 hrs. Engraved acrylic plates are of a non-yellowing quality are mounted in a tightly-packed stack and edge-lit.

RKP Series—plug-in readout indicators are designed for ease of use.

RKF Series—has a larger 1-piece aluminum body with 1" high numerals, along with 2 long-life bulbs per numeral for increased brightness, and acts as safety alarm should a bulb be inoperative.

SPECIFICATIONS

Numerals: 0 to 9 and a period
 Numeral Size: .55" high (RK, RKP)
 1.0" high (RKF)
 Standard Voltages: 6, 14, 24 volts
 Bulbs Used (T-1 $\frac{3}{4}$): #2181 (6.3V), 2182 (14V), A-24 (24V)
 Current Drain: 6.3V @ 200 ma., 14V @ 80 ma., 24V @ 50 ma. (RK, RKP)
 6.3V @ 400 ma., 14V @ 160 ma., 24V @ 100 ma. (RKF)
 Body Size: 2.56 x .78 x .83" (RK, RKP)
 3.30 x 1.18 x 1.18" (RKF)
 Bracket: Holds 2 to 8 readouts. (RK, RKP)
MS Series Mosaic—0-9 and some alphabet is displayed through diode-matrix (not supplied). Decimal points used as colon. High illumination. Figures 25/32" high. 20,000 hr. bulb life. Body size: .827" w. x 1.73" h. x 1.69" d. Available 6 or 14V.
MSM Series Mosaic (Miniature)—as above, except smaller. Figures .472" high, 100,000 hr. bulb life. Body size: .433" w. x 1.15" h. x 1.18" d. Available as 5V.

Model	Volt	Description	One-9	10-24	25-49	50-99
RK-6	6.3	Numeric	9.95	7.95	6.95	6.35
RK-14	14.	Numeric	9.95	7.95	6.95	6.35
RK-24	24.	Numeric	10.45	8.34	7.29	6.66
RK-6S	6.3	Symbol	9.95	7.95	6.95	6.35
RK-14S	14.	Symbol	9.95	7.95	6.95	6.35
RK-24S	24.	Symbol	10.45	8.34	7.29	6.66
RKP-6	6.3	Numeric	10.45	8.34	7.29	6.66
RKP-14	14.	Numeric	10.45	8.34	7.29	6.66
RKP-24	24.	Numeric	10.95	8.74	7.64	6.98
RKP-6S	6.3	Symbol	10.45	8.34	7.29	6.66
RKP-14S	14.	Symbol	10.45	8.34	7.29	6.66
RKP-24S	24.	Symbol	10.95	8.74	7.64	6.98
RKF-6	6.3	Numeric	18.95	15.16	13.26	12.13
RKF-14	14.	Numeric	18.95	15.16	13.26	12.13
RKF-24	24.	Numeric	19.95	15.96	13.97	12.77
RKF-6S	6.3	Symbol	18.95	15.16	13.26	12.13
RKF-14S	14.	Symbol	18.95	15.16	13.26	12.13
RKF-24S	24.	Symbol	19.95	15.96	13.97	12.77
RKA-2-8		Bracket (RK, RKP)	1.95	1.56	1.36	1.24
RK-FLV		Filter (RK, RKP)	.40	.32	.28	.25
RKF-FLV		Filter (RKF)	.50	.40	.35	.31
RK-SKT		Pr. Sockets (RKP, RKF)	1.95	1.56	1.36	1.24
RK-SKT-C		Pr. Sockets w/cover (RKP, RKF)	2.95	2.36	2.06	1.92
MS-6A	6.3	Numeric	9.95	7.95	6.95	6.35
MS-14A	14.	Numeric	9.95	7.95	6.95	6.35
MS-6S*	6.3	Symbol	9.95	7.95	6.95	6.35
MS-14S*	14.	Symbol	9.95	7.95	6.95	6.35
MSM-5A	5.	Miniature Numeric	10.95	8.74	7.64	6.98
MSM-5S*	5.	Miniature Numeric	10.95	8.74	7.64	6.98
MS-SKT		Socket (MS)	1.15	1.06	1.01	.92
MS-FLV		Filter, violet	.40	.32	.28	.25
MS-FLR		Filter, red	.40	.32	.28	.25
MS-FLG		Filter, green	.40	.32	.28	.25
MS-MTX		Matrix	14.95	11.96	10.46	9.42
MS-SK-R		Right Angle Socket (MS)	1.55	1.43	1.36	1.24
MSM-SK		Socket (MSM)	.85	.78	.75	.68
MS-MTX-S		Matrix and socket	16.50	13.20	11.55	10.40

Symbol indicators (+ - V Ω %) can be used with numeric readouts.
 * Symbol indicators (+ -)

PILOT LIGHT ASSEMBLIES

BNE Series—featuring a 1-piece body construction, this miniature neon pilot is ideally suited to indicate toggle switch positions, or for other display configurations with space limitations. A particular characteristic of this model is the compact lens system protruding slightly above the panel. Operating voltage, 75 VAC without resistor; for 115 VAC operations use external resistors (150K for standard intensity, 33K for high intensity) not supplied. Single $\frac{3}{16}$ -.32 mounting.

BNF Series—similar to the BNE Series except that the lens system extends a greater distance beyond the panel for a bright illumination. This model has a permanent built-in neon and operates on 75 VAC. An external resistor required for 115 VAC. Turret type lugs are used for simplified hookup. Single $\frac{3}{16}$ -.32 mounting.

BND Series—combines an entirely new look in a space-saving pilot assembly. The neon protrudes beyond the panel to provide maximum light intensity. This model is available with or without built-in series resistor for 75V or 115V operation, and is also available as standard or high intensity. Single $\frac{3}{16}$ -.32 mounting.

BRITE-GLO[™] NEON LAMPS

Extremely small size lamp (equivalent to T-1 $\frac{3}{4}$). Smallest neon in the industry. Bullseye appearance gives the largest glow where needed on top. Rounded top places the illuminated area closer to the viewing point. Metal base (Model MNE-4SL) increases light output and protects lamp from damage.

[™]Trademark

Model	Description	One-24	25-99	100-499	500-999
MNE-4	With Short Bare Leads	.49	.33	.29	.24
MNE-4L	With 10" Insulated Leads	.53	.35	.31	.27
MNE-4SL	With 10" Insulated Leads and Metal Base	.59	.39	.35	.29

Model	Color	Description	One-24	25-99	100-499	500-999
BNE-2	Red	Standard, less resistor	.49	.33	.29	.24
BNE-2	Amber	Standard, less resistor	.49	.33	.29	.24
BNE-2	Clear	Standard, less resistor	.49	.33	.29	.24
BNE-2	White	Standard, less resistor	.49	.33	.29	.24
BNE-3	Red	Hi-Intensity, less res.	.59	.39	.35	.29
BNE-3	Amber	Hi-Intensity, less res.	.59	.39	.35	.29
BNE-3	Clear	Hi-Intensity, less res.	.59	.39	.35	.29
BNE-3	White	Hi-Intensity, less res.	.59	.39	.35	.29
BNF-2	Red	Standard, less resistor	.49	.33	.29	.24
BNF-2	Amber	Standard, less resistor	.49	.33	.29	.24
BNF-2	Clear	Standard, less resistor	.49	.33	.29	.24
BNF-2	White	Standard, less resistor	.49	.33	.29	.24
BNF-3	Red	Hi-Intensity, less res.	.59	.39	.35	.29
BNF-3	Amber	Hi-Intensity, less res.	.59	.39	.35	.29
BNF-3	Clear	Hi-Intensity, less res.	.59	.39	.35	.29
BNF-3	White	Hi-Intensity, less res.	.59	.39	.35	.29
BND-2	Red	Standard, less resistor	.49	.33	.29	.24
BND-2	Amber	Standard, less resistor	.49	.33	.29	.24
BND-2	Clear	Standard, less resistor	.49	.33	.29	.24
BND-2	White	Standard, less resistor	.49	.33	.29	.24
BND-2R	Red	Std., with 150K res.	.59	.39	.35	.29
BND-2R	Amber	Std., with 150K res.	.59	.39	.35	.29
BND-2R	Clear	Std., with 150K res.	.59	.39	.35	.29
BND-2R	White	Std., with 150K res.	.59	.39	.35	.29
BND-3	Red	Hi-Intensity, less res.	.59	.39	.35	.29
BND-3	Amber	Hi-Intensity, less res.	.59	.39	.35	.29
BND-3	Clear	Hi-Intensity, less res.	.59	.39	.35	.29
BND-3	White	Hi-Intensity, less res.	.59	.39	.35	.29
BND-3R	Red	Hi-Int., with 33K res.	.69	.46	.41	.35
BND-3R	Amber	Hi-Int., with 33K res.	.69	.46	.41	.35
BND-3R	Clear	Hi-Int., with 33K res.	.69	.46	.41	.35
BND-3R	White	Hi-Int., with 33K res.	.69	.46	.41	.35

BNG SERIES LAMP HOLDERS

Alco offers a simplified, low-cost, snap-type lamp holder for miniature lamps. Various types are available, each adaptable to particular panel thickness, and can be ordered in red, amber, clear. Detailed information supplied on request. Less lamp.

Model	100-over	500-over	1000-over
BNG	.09 ea.	.08 ea.	.07 ea.

ADC bantam patch cords

Bantam Patch Cords are plastic jacketed, shielded cords complete with molded-on plugs. The plugs are made with molded insulation between conductors. Bantam Patch Cords are avail-

able with single and double two and three conductor plugs. A cord strain relief feature is included in the plug construction.

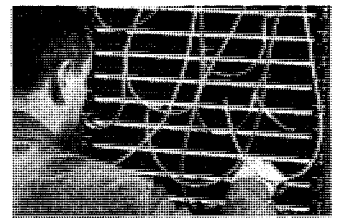

2 CONDUCTOR SINGLE PLUG

Length (see Note 1)	Single (2) Conductor Plug
6 inch	PJ-701
12 inch	PJ-702
18 inch	PJ-703
24 inch	PJ-704
30 inch	PJ-705
36 inch	PJ-706
48 inch	PJ-708
60 inch	PJ-710

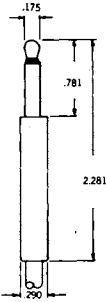

3 CONDUCTOR SINGLE PLUG

Length (see Note 1)	Single (3) Conductor Plug
6 inch	PJ-711
12 inch	PJ-712
18 inch	PJ-713
24 inch	PJ-714
30 inch	PJ-715
36 inch	PJ-716
48 inch	PJ-718
60 inch	PJ-720

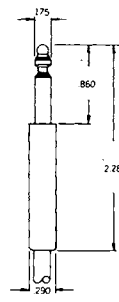

specifications

Cord: Plastic jacketed, stranded copper conductors, braided shield. Jacket color — gray.

Plugs: Conductor parts are brass, finished to 32 microinch finish maximum.

Plug Insulation: Molded polystyrene.

Internal Connections: Soldered.

Plug Shell: Plastic, black, rigid thermoplastic.

NOTE 1: Length is measured from the rear of the plug shell to rear of plug shell on opposite end.

2 CONDUCTOR (DOUBLE)

Length	Double (2) Conductor Plug
6 inch	PJ-751
12 inch	PJ-752
18 inch	PJ-753
24 inch	PJ-754
30 inch	PJ-755
36 inch	PJ-756
48 inch	PJ-758
60 inch	PJ-760

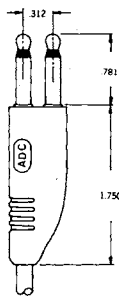

3 CONDUCTOR (DOUBLE)

Length	Double (3) Conductor Plug
6 inch	PJ-761
12 inch	PJ-762
18 inch	PJ-763
24 inch	PJ-764
30 inch	PJ-765
36 inch	PJ-766
48 inch	PJ-768
60 inch	PJ-770

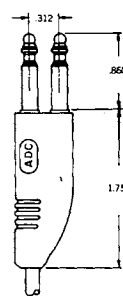

specifications

Cord: Plastic jacketed, stranded copper conductors, braided shield. Jacket color — gray.

Plugs: Conductor parts are brass, finished to 32 microinch finish maximum.

Plug Insulation: Molded polystyrene.

Internal Connections: Soldered.

Plug Shell: Plastic, gray, flexible thermoplastic.

ADC jack panels

ADC offers the most complete assortment of jack panels available today. ADC panels are used in television and broadcasting stations, recording studios, industrial paging systems, and communication equipment of all kinds where there is a need to efficiently switch and distribute audio signals. Molded of solid phenolic, reinforced with steel to provide maximum rigidity and

strength. Jacks are spaced to permit use of any standard double plug with $\frac{5}{8}$ " spacing. Mounting brackets and designation strips furnished with each panel. All panels designed to fit standard 19" relay rack. Consult ADC for your standard and special jack panel requirements.

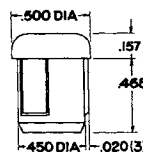
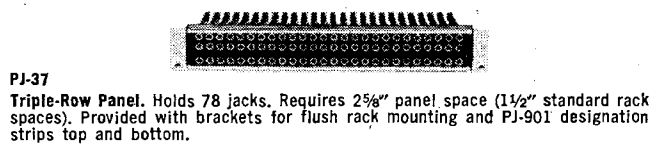
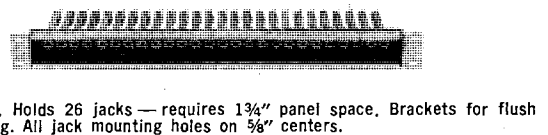
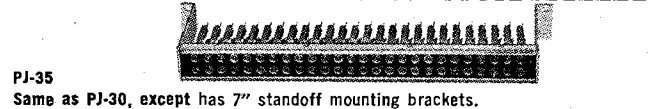
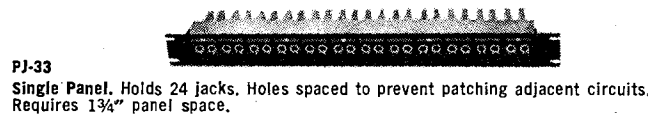
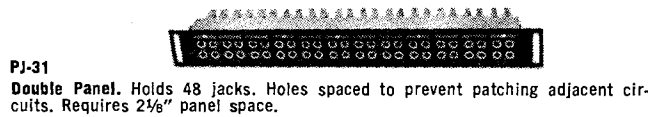
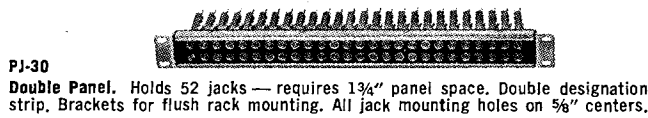

HOLE PLUG

Molded of black polyethylene plastic. Fits all ADC standard jack panels. Made to plug unused jack mounting holes in jack panels. **PJ-29**

Panel Less Jacks		Panel With PJ-318		Panel With PJ-339	
PJ-30	PJ-31	PJ-340	PJ-341	PJ-390	PJ-391
PJ-31	PJ-33	PJ-343	PJ-343	PJ-391	PJ-393
PJ-33				PJ-35	PJ-36
				PJ-37	PJ-370
					PJ-395
					PJ-396
					PJ-397

ADC plugs

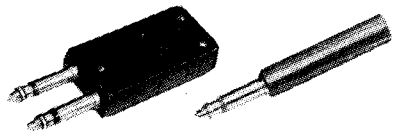

TWO CONDUCTOR

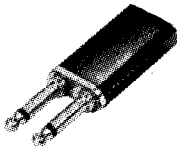

PJ-1 — Equivalent WE-241. Heavy duty die cast frame. Black phenolic shell. Has self-aligning plug sleeves on $\frac{5}{8}$ " centers for use with all standard jack panels. Two tip conductors, plus sleeve connection common to both sleeves.



PJ-047R — Equivalent WE-347. Designed for use with tip and sleeve jacks. Molded insulation, red plastic handle, design and construction in accordance with MIL-P-642B specifications.

PJ-047B — Same as above except black plastic handle.



PJ-055B — Formerly ADC PJ-5, fits $\frac{1}{4}$ " phone jacks. Black plastic shell. Screw terminals, designed and manufactured in accordance with MIL-P-642B.

PJ-055M — Same as above except has metal handle, brass, nickel plated.

PJ-055R — Same as above except has red plastic handle.

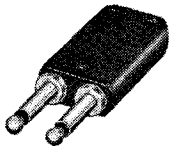

THREE CONDUCTOR



PJ-327 — Equivalent WE-327. Twin plug provides two electrically independent 2 conductor plugs in a black phenolic shell which is notched to indicate polarity. Self-aligning plug sleeves are on $\frac{5}{8}$ " centers. Designed and constructed in accordance with specification MIL-P-642B.

PJ-2 — Equivalent WE-291A. Designed for use with $\frac{1}{4}$ " diameter tip, ring and sleeve jacks. Especially designed cone-shaped tip to prevent momentary shorting of tip and ring conductors when used with ADC PJ-339, WE-239A or similar three circuit jacks.

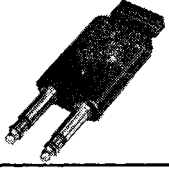

PJ-4 — Looping plug, dual three conductor type. Same conductor configuration as PJ-051 except has conductors wired internally, tip to tip, ring to ring and sleeve to sleeve. Black plastic shell.

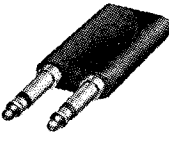

PJ-6 — Equivalent WE-213. Designed for applications requiring two separate 3 conductor circuits. Popularly used with operator's intercom / monitor headsets. Black shell notched for polarity identification. Self-aligning plug on $\frac{1}{4}$ " centers. (Note: Not intended for use with standard jack panels where jacks are mounted on $\frac{5}{8}$ " centers.)

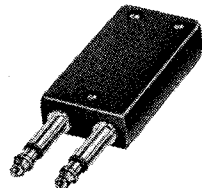

PJ-7 — Equivalent WE-425. Twin type plug with tip, ring and sleeve conductors on $\frac{5}{8}$ " centers for use with all standard jack panels. Designed to mate with three conductor jacks having $\frac{1}{4}$ " diameter sleeves. Molded insulation. Black phenolic shell is notched to indicate polarity.

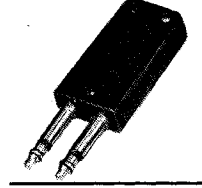

PJ-8 — Dual three conductor type with same conductor configuration as PJ-2, designed for non-shortening of tip and ring circuits when used with PJ-339, WE-239A or similar jacks. Black plastic handle notched to indicate polarity.

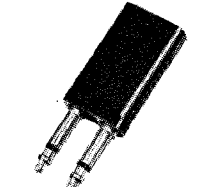

PJ-9 — Equivalent WE-338. Designed for applications requiring two separate 3 conductor circuits. Will mate with three-conductor jacks having $\frac{1}{4}$ " diameter sleeves. Molded insulation, black plastic handle notched to indicate polarity. Self-aligning plug sleeves on $\frac{5}{8}$ " centers. Has two separate cord entry holes and requires "Y" type cord or two separate cords.



PJ-051R — Equivalent WE-310. Formerly ADC PJ-3. Designed for use with $\frac{1}{4}$ " tip, ring and sleeve jacks. Molded insulation, red plastic shell, three conductor. Is in accordance with MIL-P-642B.

PJ-051B — Same as above except black plastic handle.

ADC patch cords

ADC Patch Cords have become standards in the communications industry. The heavy Nylon braided jacket excels in abrasion resistance. All cords have been designed to give the ultimate combination of durability, flexibility and reliability. ADC has numerous combinations of special cord assemblies using virtually every plug combination required. You are invited to submit your requests or requirements for quotations.

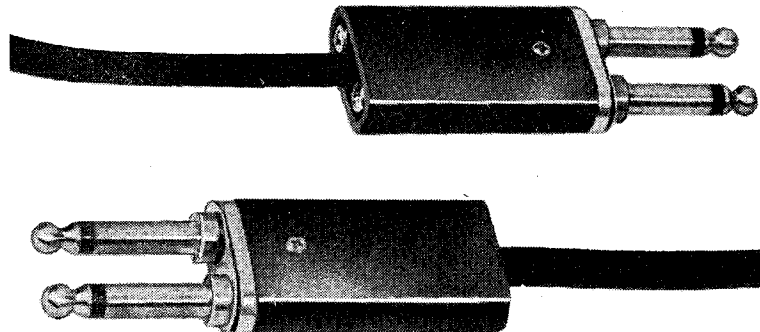

2 CONDUCTOR SHIELDED, CORD ASSEMBLIES

Length	Cord w/ PJ-1 Plugs	Cord w/ PJ-055B Plugs	Replacement Cords Only
6 inch	PJ-10 $\frac{1}{2}$	PJ-50 $\frac{1}{2}$	PJ-20 $\frac{1}{2}$
1 foot	PJ-11	PJ-51	PJ-21
2 feet	PJ-12	PJ-52	PJ-22
3 feet	PJ-13	PJ-53	PJ-23
4 feet	PJ-14	PJ-54	PJ-24
5 feet	PJ-15	PJ-55	PJ-25
6 feet	PJ-16	PJ-56	PJ-26
10 feet	PJ-10	PJ-50	PJ-20

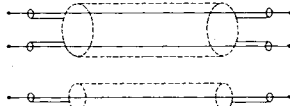

These cords provide two tinsel wire conductors plus a braided shield. The overall jacket is braided nylon. Black nylon is standard, also available in slate, green and red on special order.

3 CONDUCTOR SHIELDED, CORD ASSEMBLIES

Length	Cord w/ PJ-2 Plugs	Cord w/ PJ-051R Plugs	Replacement Cords Only
1 foot	PJ-71	PJ-81	PJ-61
2 feet	PJ-72	PJ-82	PJ-62
3 feet	PJ-73	PJ-83	PJ-63
4 feet	PJ-74	PJ-84	PJ-64
5 feet	PJ-75	PJ-85	PJ-65
6 feet	PJ-76	PJ-86	PJ-66

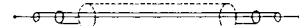

These cords provide two tinsel wire conductors plus a braided shield. Overall jacket is braided nylon. Black nylon is standard with slate colored jacket also stocked. Green and red are available on special order.

2 CONDUCTOR UNSHIELDED, CORD ASSEMBLIES

Patch Cords Length	Cord w/ PJ-327 Plugs	Cord w/ PJ-047R Plugs
1 foot	PJ-181	PJ-471
2 feet	PJ-182	PJ-472
3 feet	PJ-183	PJ-473
4 feet	PJ-184	PJ-474
5 feet	PJ-185	PJ-475
6 feet	PJ-186	PJ-476

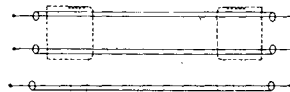

The PJ-180 and PJ-470 series cords offer tinsel wire conductors, thermo plastic insulated. Standard color for PJ-180 series patch cords is slate. The standard color for the PJ-470 series cords is red. Other colors are available on special order.

3 CONDUCTOR SHIELDED, CORD ASSEMBLIES

Length	Cord w/ PJ-7 Plugs	Cord w/ PJ-8 Plugs
1 foot	PJ-171	PJ-91
2 feet	PJ-172	PJ-92
3 feet	PJ-173	PJ-93
4 feet	PJ-174	PJ-94
5 feet	PJ-175	PJ-95
6 feet	PJ-176	PJ-96

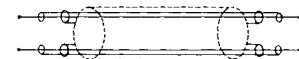

The PJ-90 and PJ-170 series cords provide four tinsel wire conductors, plus a shield common to both sleeves on the plugs. Standard color for these cords is black. They are also available in slate, green or red on special order.

Electronics & Machine Corp.



No. AC-52  No. AC-52 — "C" type cable connector for RG/59/U cable. Net \$36 ea.	No. AF-56  No. AF-56 — "F" male cable connector for RG6/U foam cable. Net \$45 ea.	No. AF-59  No. AF-59 — "F" male RG-59/U cable connector. Net \$.30 ea.	No. AF-59A  No. AF-59A — "F" male RG-59/U cable connector, ferrule built on. Net \$.30 ea.	No. APG-59  No. APG-59 — "F" male pushon connector with pin for RG-59/U cable. Net \$1.25 ea.	No. AG-59  No. AG-59 — "F" male pushon connector for RG-59/U cable. Net \$.50 ea.
No. AF-59-TS  No. AF-59-TS — "F" terminating male connector. Net .75 ea.	No. AC-52-TS  No. AC-52-TS — "C" terminating male connector. Net \$.75 ea.	No. AF-61A  No. AF-61A — "F" female spring contact chassis connector. Net \$.50 ea.	No. AF-61-ABM  No. AF-61-ABM — "F" female back mount chassis connector spring contact. Net \$.50 ea.	No. AF61-APO  No. AF61-APO — "F" female spring contact push-on chassis connector. Net \$.75 ea.	No. AF61-AP  No. AF61-AP — "F" female pressurized spring contact chassis connector. Net \$.90 ea.
No. AF-81  No. AF-81 — "F" female adaptor, mates with F-59 and F-59A male connector. Net \$.50 ea.	No. AF81-A  No. AF81-A — "F" female adaptor, with spring contact, fits all "F" male connectors. Net \$.95 ea.	No. AF81-AB  No. AF81-AB — "F" bulk head spring contact connector 1 3/4" long. Net \$1.25 ea.	No. P091-APM  No. P091-APM — "F" pushon panel mount connector, spring contacts front and rear. Net \$2.95 ea.	No. AF-71  No. AF-71 — "F" male adaptor. Net \$1.25 ea.	Crimping Ring for RG-59 cable, ACR-59-10 (10 per bag), Net \$.30 bag; ACR-59-100 (100 per bag) Net \$2.50 bag.  Crimping Ring for RG-6 foam cable, ACR-6-10 (10 per bag), Net \$.50 bag; ACR-6-100 (100 per bag), Net \$3.50 bag. 
No. PL-259  No. PL-259 — Male UHF cable connector. Net \$.50 ea.	No. M-359  No. M-359 — Right angle UHF adaptor. Net \$1.25 ea.	No. M-358  No. M-358 — "T" UHF adaptor. Net \$1.95 ea.	No. PL-258  No. PL-258 — Female UHF adaptor. Net \$1.15 ea.	No. S0-239  No. S0-239 — Female chassis UHF connector. Net \$.45 ea.	No. UG-175/U — Adaptor for RG-58/U cable. Net \$.15 ea.  No. UG-176/U — Adaptor for RG-59/U cable. Net \$.15 ea. 
No. 5804  No. 5804 — Female UHF chassis connector, 1/2" demounting. Net \$1.15 ea.	No. A56-5804  No. A56-5804 — UHF male to "F" female adaptor. Net \$3.50 ea.	No. B-259-PO  No. B-259-PO — UHF pushon male connector for RG-59/U cable. Net \$1.95 ea.	WALL PLATES all types TV - CATV - MATV 	No. M-20-59 No. M-20-56  No. M-20-59 for RG-59/U, No. M-20-56 for RG-6/U — RF and shielded connectors. Net \$.20 ea.	No. AF-61-APSO  No. AF-61-APSO — "F" female pushon chassis connector, staked or soldered body to chassis. Net \$.75 ea.
CABLE ASSEMBLIES all types  "F" to "F" "C" to Motorola" "C" to transformers.	No. CT-5911  No. CT-5911 — Crimping tool — crimps ferrules on RG-6, RG-59 and RG-11/U cables. Net \$2.95 ea.	No. NC-75  No. NC-75 — Cable clip — for installing RG-59/U and other cables, up to .0250 OD, to wood or brick. Net \$2.00 C	No. GB-568 — Single cable ground block "F" female spring contact on each end of connector SS hardware. Net \$2.50 ea. 	No. GB-668-2 — Dual cable ground block, "F" female spring contacts on each end of connector, SS hardware. Net \$3.95 ea. 	No. FK-36 — Kits — assorted "F" connectors — Contents: 6 ea. — AC-52, AF-56, AF-59, AF-59A, AF-61A, AF-81. Net \$12.95 per kit 



FOR ALL YOUR CONNECTOR NEEDS

CONNECTORS



AMPHENOL

Tube Sockets "S" Type (continued) Saddle Type Octal

High quality economical sockets with 4 lugs for below-chassis mounting. Choice of wrap around or tuning fork contacts. Socket mounts in 1" diameter round hole. Dielectric is black phenolic. Mica-filled phenolic sockets are available when specified.

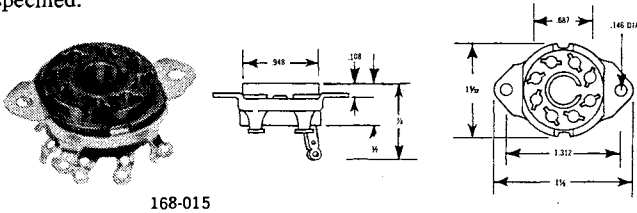

168-015

Part No.	Contacts		Pin Circle Diameter	Voltage Rating (RMS at Sea Level)	Current Rating (Amps)
	No.	Material			
168-001	8	Brass	.687	1250	3
168-015	8	Lubaloy	.687	1250	3

Steatite Replacement Type

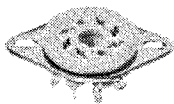

49-RSS8

Black Phenolic Part No.	Steatite Part No.	Contacts No.	Pin Circle Dia.	Voltage Rating (RMS Sea Level)	Current Rating (Amps)
78-RS4	49-RSS4	4	.640	2000	5
78-RS5	49-RSS5	5	.750	1250	5
78-RS6	49-RSS6	6	.750	1250	5
78-RS7L	49-RSS7L	7 Large	.855	1250	5
78-RS7S	49-RSS7S	7 Std.	.750	1250	5
78-RS8	49-RSS8	8	.687	1250	3

7 & 9 Contact Miniature

147 and 59 Series sockets, suitable for any miniature application, may be ordered with or without tube shield base or center shield, for top or below-chassis mounting.

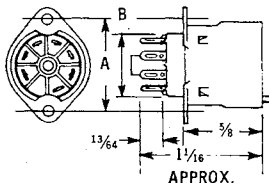

APPROX.

Part	A	B
147 Series	.175	.615
59 Series	1.125	3/4

2 HOLES A DIA. APPROX.

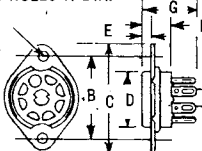

Part	A	B	C	D	E	F	G
147 Series	.125	.875	1/8	.610	.113	.306	3/4
59 Series	.095	1.125	—	3/4	.062	.295	1 1/2

7 Pin
147-905
(Shown)
9 Pin
59-407

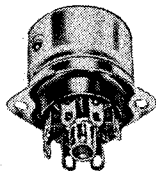

7 Pin
147-500
(Shown)
9 Pin
59-409



147 Series — 7 Contacts

Insulator Material	Part Number		Mtg. Hole Dia. Saddle	Center Shield
	Phosphor Bronze, Cadmium Plated Contacts	Beryllium Copper, Silver Plated Contacts		
Black	147-905	*	.095	Large
Mica	147-913	*	.095	Small
Mica	—	147-916	.125	Small

SADDLE TYPE — Bottom Mounting (Top mounting available when specified).

Insulator Material	Part No.	Contacts No.	Pin Circle Diameter	Current Rating (Amps)	Mating Plugs	
					Unshielded	Shielded
Mica	147-170-20	—	—	—	—	—
Black	147-500	—	—	—	—	—
Black	147-504	—	—	—	—	—
Mica	147-505	—	—	—	—	—
Mica	—	—	147-840	.125	—	—

* Must be specified.
For tube shields, see page 518, for mating plugs see page 517.

59 Series — 9 Contacts

Insulator Material	Part Number		Mtg. Hole Dia. Saddle	Center Shield
	Phosphor Bronze, Cadmium Plated Contacts	Beryllium Copper, Silver Plated Contacts		
SHIELDED BASE TYPE				
Mica	*	59-403	.125	Large
Mica	59-405	*	.095	No
Black	59-406	*	.095	Large
Mica	59-407	*	.095	Large
Black	59-461	*	.125	Large
SADDLE TYPE — Bottom Mounting				
Black	59-409	*	.095	Large
Mica	59-410	*	.095	Large
Mica	59-411	*	.095	No
Mica	*	59-412	.125	Large
Mica	59-424	*	.125	Large
Black	59-446	*	.125	No

* Must be specified.
For tube shields, see page 6; for mating plugs see page 5.

Tube and Chassis Sockets Miniature WITH RETAINER RING MOUNTING

Sockets are easily mounted without screws or rivets in 5/8" round or "D" shaped hole. sockets is easily assembled which assures a Correct size retainer ring supplied with all tight and secure mounting. Body is black phenolic but is also available in mica-filled phenolic when specified.

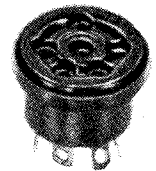

78-S6S
78-7P

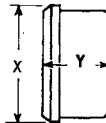

Part	X	Y
78-7P	—	—
78-S3S	3/4	1/2
78-S4S	3/4	1/2

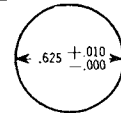
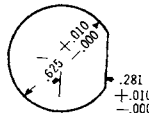

Size and mounting hole for No. 78-7P. Size and mounting hole for No. 78-S5S, 78-S3S and 78-S4S.

Part No.	Contacts No.	Pin Circle Diameter	Voltage Rating (RMS)	Current Rating (Amps)	Mating Plugs (Pages 4 & 5)	
					Unshielded	Shielded
78-S3S	3	.344	500	3	71-3S	91-MPM31
78-S4S	4	.406	500	3	71-4S	91-MPM4L
78-S5S	5	.406	500	3	71-5S	91-MPM5L
78-S6S	6	.406	500	3	71-6S	91-MPM6L
78-7P	7	.375	500	3	86-896	86-895

Shielded Chassis Type

Mount on surface or behind chassis or panel in 7/8" diameter hole on 1 1/4" centers.

For a fully shielded connection, mate with 91 Series Long Shell Shielded Plugs.

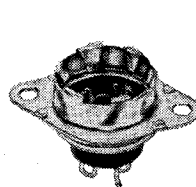

78-PCG3

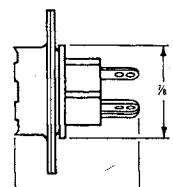
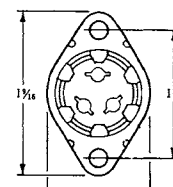

Part No.	Contacts No.	Pin Circle Diameter	Current Rating (Amps)	Mating Plugs	
				Unshielded	Shielded
78-PCG3	3	.344	3	71-3S	91-MPM3L
78-PCG4	4	.406	3	71-4S	91-MPM4L
78-PCG5	5	.406	3	71-5S	91-MPM5L
78-PCG6	6	.406	3	71-6S	91-MPM6L

CONNECTORS



AMPHENOL

Hardware and Accessories

Tube Shields

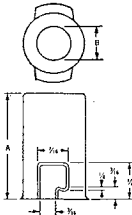

5-401

Made of cold rolled steel, cadmium plated. Spiral spring assembly holds tube firmly to prevent movement.

Part No.	A	B	Application
5-401	1 3/8"	1/2"	7-Contact Miniature Sockets
5-402	1 3/4"	1/2"	7-Contact Miniature Sockets
5-405	1 1/2"	1/2"	9-Contact Miniature Sockets
5-408	1 1/2"	1/2"	9-Contact Miniature Sockets
5-409	2 3/8"	1/2"	9-Contact Miniature Sockets

Plug Caps

Sturdy drawn steel plug caps. Provide protected, attractive cable terminations when assembled with retainer ring type plugs and sockets.



3-13



3-17



3-24



79-CC4

Part No.	Cable Outlet	Finish	Instr.	Lgth.
3-10	None	Blk. Japan	No	1"
3-10-1000	None	Cadmium	No	1"
3-12	End Metal Grommet 3/4" I.D.	Blk. Japan	Yes	1"
3-13	End Metal Grommet 7/8" I.D.	Blk. Japan	Yes	1"
3-17	Side Rubber Grommet 7/8" I.D.	Blk. Japan	Yes	1"
3-24	Cable Clamp for Cables to 3/8"	Blk. Japan	Yes	1 1/16"
3-856	Cable Clamp for Cables to 3/8"	Cadmium	Yes	1 1/16"
3-857	End Rubber Grommet 7/8" I.D.	Cadmium	Yes	1"
79-CC4	Cable Clamp only as used on 3-24	Cadmium	—	—

All the above caps can be easily assembled to the following standard grooved connector series: 49SS, 60, 61, 78S, 86CP, and 160.

Receptacle Shells

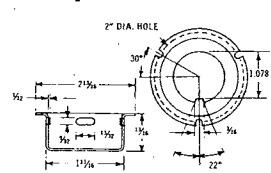

Aluminum shells extend "S" sockets, "CP" plugs, and outlet type connectors 1 3/16" above or below surface. Knockouts on 4 sides of shell provide wire entrances from any angle. Mount in 1 3/4" hole; have 3 notched holes for No. 6 screws.

Part Number to Order: 23-1S — For standard "S" sockets (Page 6) or "CP" Plugs (Page 5).

Recessed Mounting Shells

Cadmium plated steel shells lower S sockets, CP plugs, and outlet type connectors 1 3/16" below surface. Mount in 1 1/16" hole; have two 5/32" dia. screw holes on 1 3/4" centers.

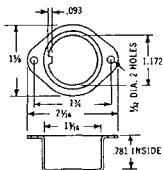

Tip Jacks—Commercial or Military (MS16108)

Complete selection of tip jacks in different terminal styles, variety of contact and mounting shell platings, wide range of colors, and other options.

Specifications

INSULATORS—Nylon (Zytel 101) per MIL-P-17091; or teflon.
 MOUNTING SHELLS—Brass per Q-4-B-746 Comp. A. Nickel or cadmium plated.
 HEX NUTS—Standard thickness .062" brass per QQ-B-626, Comp. 22. Nickel or cadmium plated.
 LOCKWASHERS—Phosphor bronze per QQ-B-746 Comp. A. Nickel or cadmium plated.
 CONTACTS—Beryllium copper per QQ-C-530, Cond. H. Silver, gold or nickel plated or electro-tinned.
 FEED THRU TERMINAL—Brass per QQ-B-611 Comp. B.
 RATED CURRENT—5 amps.
 MILLIVOLT DROP—20 Mv. maximum at rated current.
 MAXIMUM OPERATING VOLTAGE—1000 volts rms.
 INSULATION RESISTANCE—5000 megohms min.
 MAXIMUM OPERATING TEMPERATURE—256°F.
 All jacks mount through a 1/4" hole.

Dimensions

Part No.	A	B
350-		
14400	5/8"	3/4"
16175	5/8"	3/4"
19175	5/8"	3/4"
29175	5/8"	3/4"
39175	5/8"	3/4"
60000	5/8"	3/4"
61000	5/8"	3/4"
19100	1/2"	3/2"
19200	1 1/2"	3/4"
29200	1 1/2"	3/4"
50200	1 1/2"	3/4"

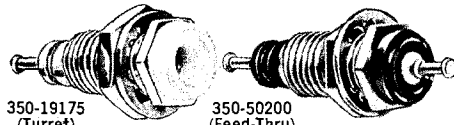

350-19175 (Turret)

350-50200 (Feed-Thru)

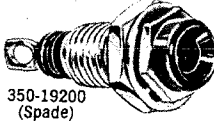

350-19200 (Spade)

Colors Available

(Add suffix for desired color at end of part number.)

- 1 Red
- 2 Black
- 3 Brown
- 4 Green
- 5 Orange
- 6 White
- 7 Blue
- 8 Gray
- 9 Pink
- 10 Lt. Blue
- 11 Lt. Green
- 12 Buff
- 13 Yellow
- 14 Natural
- 15 Violet

Test Jacks



78-1S

Mount in .375" - .000 + .010 hole with retainer ring (furnished). Contacts recessed 1/8" below top of insulator to prevent accidental shorts from contact tip to chassis. Contact-to-panel breakdown voltage (with plug inserted) is over 10,000 VAC.

Part Number	Application	
	Black Phenolic	Red Phenolic
78-1S	78-1S-1000	For 3/32" Plug
78-1L	78-1L-1000	For 1/8" Plug
78-1M	78-1M-1000	For 1/4" Plug
78-1P	78-1P-1000	For .080" Phone Tip

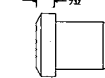

78-1S

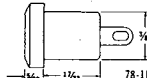

78-1P



78-1L & 78-1M

Single Prong Plugs

Black or red phenolic. For use with Test Jacks.

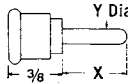

71-1S

Part Number	Application		Dimensions	
	Black Phenolic	Red Phenolic	X	Y
71-1M	71-1S-1000	For 3/32" Socket	7/16"	3/32"
71-1S	71-1M-1000	For 1/8" Socket	3/16"	1/8"
71-1L	71-1L-1000	For 3/32" Socket	3/16"	3/32"

Industrial Tube and Relay Sockets Industrial Relay Type

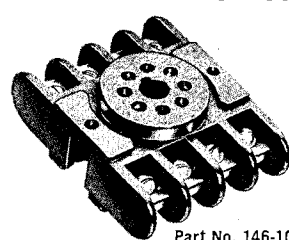

Part No. 146-103 (8 Contact)

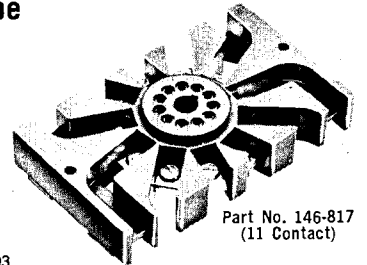

Part No. 146-817 (11 Contact)

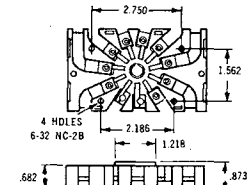
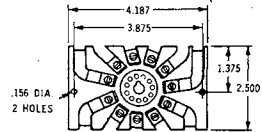
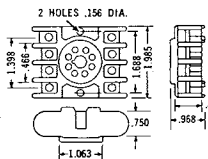

11 Contact/Type

Rated 10 amps., 600 volts. May be gang mounted, either above or below chassis. High, thick insulating barriers provide long creepage paths between contacts.

Socket-type contacts assure firm, smooth mating action and excellent relay retention even after repeated matings.

RETMA-numbered solderless, reversible screw terminals. 4 molded-in threaded-brass insert tie points. Replaceable contacts.

(continued)

CONNECTORS



AMPHENOL

80 Series Single and Double Contact

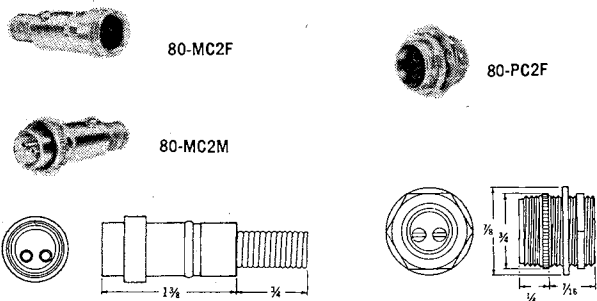

Single and double-contact connectors.

Element is black phenolic; shell is machined from solid brass and finished in polished chrome.

All mounts in $\frac{3}{8}$ " holes. Maximum chassis thickness for lock-nut type receptacles is $1\frac{1}{32}$ ".

Electrical and Mechanical Characteristics

	Single Contact		Double Contact	
	Male	Female	Male	Female
Voltage Rating (RMS Sea Level)	1250 V	100 V	600 V	600 V
Current Rating	5 Amps	3 Amps	3 Amps	3 Amps
Voltage Breakdown Between Terminals and Ground (RMS)	3000 V	4000 V	2000 V	2000 V

Plugs		Jacks		Receptacles	
Part No.	Contacts	Part No.	Contacts	Part No.	Contacts
80-M	1 Male	80-F	1 Female	80-C	1 Female
80-F1	1 Female	80-M1	1 Male	80-C1	1 Male
80-MC2M	2 Male	80-MC2F	2 Female	80-PC2F	2 Female
80-MC2F1	2 Female	80-MC2M1	2 Male	80-PC2M	2 Male

Protective Cap & Chain

For sealing power plugs and radio connectors against dirt and tampering.

Part Number to Order: 91-CCC3.

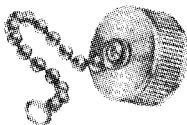

Plugs and Receptacles

125 Volt Home and Industrial Type

Heavy duty outlet plugs and receptacles that meet Underwriters' Laboratories requirements for grounding home appliances and tools. All have UL approval except the 160-10 and 160-11 which requires grounding after mounting. Rated at 15 amp 125 volt or 10 amp 250 volt.

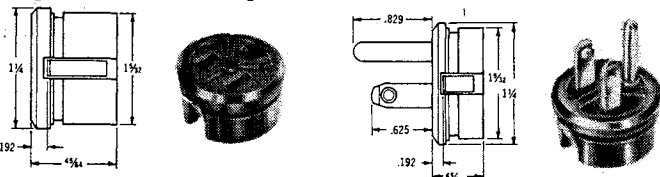

Inserts

General purpose phenolic bodies meet MIL-M-14-F requirements.

Part Number to Order: 160-10 2-Pole Receptacle Insert
160-11 2-Pole Plug Insert

With Mounting Plate

Nickel plated steel mounting plate assembled to general purpose phenolic body.

Part Number to Order:
160-2 2-Pole Receptacle
160-3 2-Pole Plug

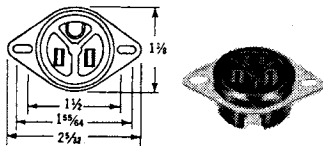

125 Volt Home and Industrial Type (Cont.)

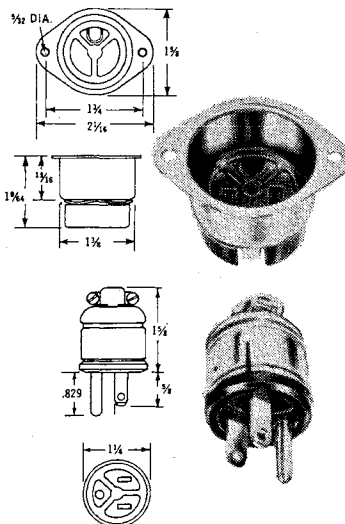

Flush Motor Type

Consist of 160-10 and 160-11 inserts assembled in cadmium plated steel shells for below-surface mounting.

Part Number to Order:

- 160-4 2-Pole Flush Motor Receptacle
- 160-5 2-Pole Flush Motor Plug

Shielded

Consists of inserts 160-10 and 160-11 assembled in sturdy steel plug caps finished in cadmium plate. Also available in black japan on special request.

Part Number to Order:

- 160-6 2-Pole Shielded Receptacle with Rubber Grommet
- 160-7 2-Pole Shielded Plug with Rubber Grommet
- 160-8 2-Pole Shielded Receptacle with cable clamp
- 160-9 2-Pole Shielded Plug with Cable Clamp

110 Volt Home and Industrial Type

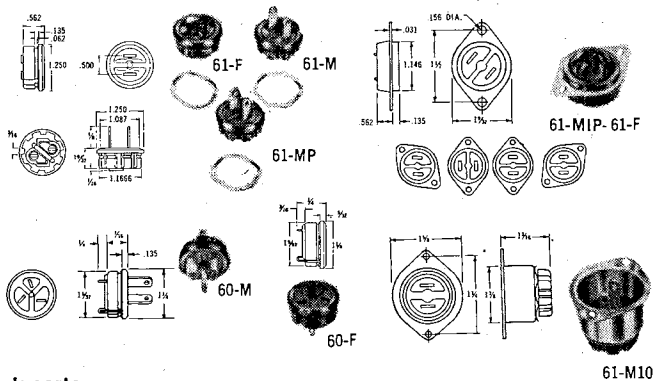

Inserts

Compact black phenolic units built to Underwriters' Laboratories standards. Rated at 15 amp, 110 volt or 10 amp, 250 volt. Available in either retainer ring or mounting plate style.

Assemble retainer ring style with plug caps listed on page 16 for required type. Mounts in $1\frac{1}{64}$ " keyed hole on chassis up to $.125$ " thick. Mounting plate style requires $1\frac{5}{32}$ " dia. hole. Mounts on $1\frac{1}{2}$ " to $1\frac{5}{64}$ " centers.

61-M plug has standard $\frac{1}{4}$ " blades spread $\frac{1}{2}$ ". 61-MP has one $\frac{5}{16}$ " blade spread $\frac{1}{2}$ ". 60-M has three $\frac{1}{4}$ " blades staggered spaced. Binding screws for connecting cables are used on both plugs and receptacles.

Part Number		Description
Retainer Ring Type	Mounting Plate Type	
PLUGS		
61-M	61-M1	2-pole, Standard
61-MP	61-MP1	2-pole, Polarized
60-M	60-M1	3-pole, Polarized
RECEPTACLES		
61-F	61-F1	2-pole, Universal
60-F	60-F1	3-pole, Polarized

Molded-In-Plate Receptacle

High quality 110-volt receptacle identical to 61-F except for steel mounting plate molded into phenolic body. Mounts in $1\frac{1}{16}$ " dia. hole on $1\frac{1}{2}$ " centers. Mounting hole, $\frac{5}{32}$ " dia.

Flush Motor Plug & Receptacle

Compact plug or receptacle assembled in No. 61-61 steel shell for below-surface mounting. Mounts in $1\frac{7}{16}$ " hole; two $\frac{5}{32}$ " screw holes on $1\frac{3}{4}$ " centers.

Part No.	Description
60-F10	3-pole Polarized Receptacle
60-M10	3-pole Polarized Plug
61-F10	2-pole Universal Receptacle
61-M10	2-pole Standard Plug
61-MP10	2-pole Polarized Plug

AMPHENOL RF COAXIAL CONNECTORS



AMPHENOL

STANDARD TYPE BNC (Cont'd.) ANGLE

UG-/U No.	No.	Ins.	Notes	Lgth.
535	5675	T		1 1/32
1098	31-222	T		2 3/32
1098A	31-2222	T	I	2 3/32
—	5075	T		1 1/8

BULKHEAD

UG-/U No.	No.	Ins.	Notes	Lgth.
254A	31-016	R	P, RM	1 1/32
625	5575	R	FM	1 1/32
625B	31-236	T	I, FM	1 1/8
657	31-102	R	P, FM	1 1/4
657A	31-239	T	P, FM	1 1/4
911A	31-237	GT	I, H, RM	1 1/4
912	31-238	GT	I, H, FM	1 1/4
912A	31-2238	GT	I, H, FM	1 1/4
1094	31-221	T	I, FM	1 1/4
1094A	31-2221	T	I, FM	1 1/4
—	11300	T	FM	1 1/32
—	11325	T	PM, FM	1 1/32
—	78725	GT	I, H, FM	1 1/32
—	86250	GT	H, FM	1 1/32
—	87225	GT	H, FM	1 1/32

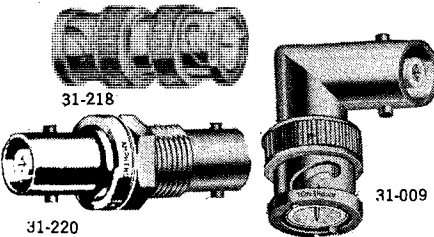

ADAPTERS

50 ohm impedance • weatherproof

STRAIGHT

UG-/U No.	No.	Ins.	Notes	Adapter Ends	Lgth.
491	8425	T		PP	1 1/4
491A	31-218	T		PP	1 1/4
491B	31-2218	T	BOC	PP	1 1/4
914	31-219	T		JJ	1 1/32
—	21925	T		PJ	1 1/32
—	75000	T		JJ	1 1/32

ANGLE

UG-/U No.	No.	Ins.	Notes	Adapter Ends	Lgth.
306	31-009	T		JP	1
306A	31-209	T	BOC	JP	1 1/16
306B	31-2209	T	BOC	JP	1 1/16

TEE

UG-/U No.	No.	Ins.	Notes	Adapter Ends	Lgth.
274	31-008	R		JPJ	1 1/32
274A	31-208	T	BOC	JPJ	1 1/32
274B	31-2208	T	BOC	JPJ	1 1/32
—	4725	T		PPP	1 1/8
—	17450	R		JJJ	1 1/32
—	21900	T		PJJ	1 1/32
—	27750	T		PJP	1 1/16
—	33725	T	RG-58/U	CPC	1 1/4

BULKHEAD

UG-/U No.	No.	Ins.	Notes	Adapter Ends	Lgth.
414	4700	T		JJ	1 1/32
414A	47025	T		JJ	1 1/32
492A	31-220	GT		JJ	1 1/32
492B	31-2220	GT		JJ	1 1/32
492D	31-3220	GT		JJ	1 1/32
—	4525	GT		JJ	1 1/32
—	75500	T	H	PP	1 1/4

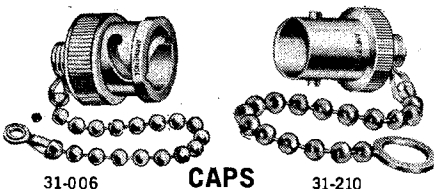

CAPS

weatherproof

MALE

CW No.	No.	Ins.	Notes	Lgth.
123	31-006			1 1/16
123A	31-026		I	4 5/16
155	31-007			3 7/16
155A	31-027		I	3 7/16
159	31-017	T	SMC	1 1/16
—	900			2 3/32
—	5275	T	SMC	1 1/32
—	87300		SL	2 3/32

FEMALE

CW No.	No.	Ins.	Notes	Lgth.
282	31-210		I	1 1/16
—	1550	T	SFC	5/8
—	1750			2 3/32
—	2025			2 3/32
—	15300	T	SFC	2 3/32

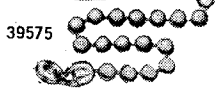
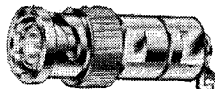

RESISTOR TERMINATED CAPS

male contacts • weatherproof

MX No.	No.	Ins.	Notes	Lgth.
554	4700	R	100 ohm	1 1/4
554A	39575	T	100 ohm	1 1/4
—	35650	T	*	1 1/4
—	4750	R	*	1 1/4
—	35725	T	*	1 1/2
—	46650	T	*	1 1/2

*Add resistor value (ohms) to part no. when ordering: 47, 51, 68, 75, 82, 91, 100, 120, 130, 150, 180, 240, 270, 300, 470, 510, 560, 680, 750, 820, 1000, 1500, 3900, 4700, 10000, 100000, 150000.



HOODS

87175 non-weatherproof 31-759

For RG-/U Cable	MX No.	No.	Notes	Lgth.
58	195	10900		7/8
58, 59, 62	195A	87175	PI	1 1/16
58	367	10925		7/8

NUT STRAP

No.	MX No.	Notes	Lgth.
1600	MT-412	4 Holes with No. 4-40 NC-2B Thds.	3/4 sq.

MIL-CRIMP TNC



PLUGS

weatherproof • captivated center contact
add -1000 suffix to part number for safety wiring holes
50 ohm impedance • male contacts

STRAIGHT

For RG-/U Cable	No.	MIL. No. M23329/	Ins.	Notes	Lgth.
55, 142, 223	31-2373	4-02-04	T	GC	1 1/2
58, 141	31-2367	4-01-03	T	GC	1 1/2
59, 62, 140, 210	31-2368	4-05	T	GC	1 1/2
71	31-2369	—	T	GC	1 1/2
122	31-2371	—	T	GC	1 1/2
174, 188	31-2315	—	T	GC	1 1/2
179, 187	31-2242	—	T	GC	1 1/2
180, 195	31-2370	4-06	T	GC	1 1/2
A 21-597	31-2372	—	T	GC	1 1/2

ANGLE

For RG-/U Cable	No.	MIL. No. M23329/	Ins.	Notes	Lgth.
55, 142, 223	31-2381	—	T	GC	1 1/2
58, 141	31-2382	—	T	GC	1 1/2
59, 62, 140, 210	31-2383	—	T	GC	1 1/2
71	31-2384	—	T	GC	1 1/2
122	31-2386	—	T	GC	1 1/2
179, 187	31-2243	—	T	GC	1 1/2
174, 183	31-2316	—	T	GC	1 1/2
180, 195	31-2385	—	T	GC	1 1/2
A 21-597	31-2387	—		GC	1 1/2

JACKS

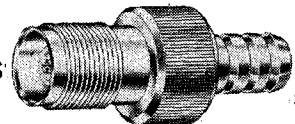

31-2375

non-weatherproof • captivated center contact
50 ohm impedance • female contacts

STRAIGHT

For RG-/U Cable	No.	MIL. No. M23329/	Ins.	Notes	Lgth.
55, 142, 223	31-2380	4-08	T	GC	1 1/2
58, 141	31-2374	4-07	T	GC	1 1/2
59, 62, 140, 210	31-2375	4-11	T	GC	1 1/2
71	31-2376	—	T	GC	1 1/2
122	31-2378	—	T	GC	1 1/2
179, 187	31-2244	—	T	GC	1 1/2
174, 188	31-2317	—	T	GC	1 1/2
180, 195	31-2377	4-12	T	GC	1 1/2
A 21-597	31-2379	—	T	GC	1 1/2

BULKHEAD

For RG-/U Cable	No.	MIL. No. M23329/	Ins.	Notes	Lgth.
55, 142, 223	31-2388	4-14	T	GC	1 1/2
58, 141	31-2389	4-13	T	GC	1 1/2
59, 62, 140, 210	31-2390	4-17	T	GC	1 1/2
71	31-2391	—	T	GC	1 1/2
122	31-2393	—	T	GC	1 1/2
179, 187	31-2245	—	T	GC	1 1/2
174, 188	31-2318	—	T	GC	1 1/2
180, 195	31-2392	4-18	T	GC	1 1/2
A 21-597	31-2394	—	T	GC	1 1/2

STANDARD TYPE TNC



79525

PLUGS

50 ohm impedance • male contacts • weatherproof

STRAIGHT

For RG-/U Cable	No.*	Ins.	Notes	Lgth.
55, 58, 141, 142, 223	77175	T	BOC	1 1/8
	79050	T	PF, BOC	1 1/8
	79875	T		1 1/8
	76175	T	GC, SW, BOC	1 1/8
59, 62, 71, 140, 210	79475	T	PF, BOC	1 1/8
	79525	T		1 1/8
122, 180, 195, 21-597	79725	T	BOC	1 1/8
180	78625	T		1 1/8
	79375	T	BOC	1 1/8
174, 179, 187, 188	73475	T		1 1/8

ANGLE

For RG-/U Cable	No.	Ins.	Notes	Lgth.
55, 58, 141, 142, 223	79075	T	BOC	1 1/8
	79550	T	BOC	1 1/8
59, 62, 71, 140, 210	79400	T	BOC	1 1/8

*Add -1000 to part number to order connectors with safety wiring holes.

AMPHENOL RF COAXIAL CONNECTORS



AMPHENOL

SUBMINAX® SERIES 27 (Cont'd.)

SCREW-ON

No.	Imp. Ohms	Adapter Ends	Lgth.
27-11	50	JJ	2 1/32
27-23	75	JJ	2 1/32

27-70



TEE ADAPTER

SCREW-ON

No.	Imp. Ohms	Adapter Ends	Lgth.
27-70	75	JJJ	1.050

SERIES C

CHARACTERISTICS (Typical)

ELECTRICAL
impedance 50 ohm constant
frequency range 0-10 GHz, 1,500 volt type
0-2 GHz, 4,000 volt type
voltage rating 1,500 volts peak — standard;
4,000 volts peak as noted
dielectric with- 3,000 volts RMS, 1,500 volt type;
standing voltage 6,000 volts RMS, 4,000 volt type;
SWR 1.25

ENVIRONMENTAL
thermal limits -67° to 390°F (-55° to 199°C)
weatherproof except as noted, all C Series
connectors are weatherproof
hermetic seals pass Helium leak test of
2 x 10⁻⁸ cc/sec
compression seal

pressurized
MECHANICAL
mating 2-stud bayonet lock
cable affixment Improved: screw-thread nut and
braid clamp

MATERIAL
contacts male: brass; female and outer:
beryllium copper
brass
other metal parts .0002" silver min
plating Teflon, glass-Teflon (herm. sealed)
insulators silicone rubber
weatherproof gaskets

MILITARY SPECIFICATIONS
Meet applicable sections of MIL-C-3989.

PLUGS

82-530



50 ohm impedance * male contacts
STRAIGHT weatherproof

For RG-/U Cable	UG-/U No.	No.	Ins.	Notes	Lgth.
5, 21, 143, 212, 222	626A	80025	T		1 3/4
8, 9, 87, 213, 214, 225	573A	82-530	T	AK	1 3/4
	573B	28650	T	AK	1 3/4
	628A	82-532	T	4000, AK	1 3/4
		79150	T	4000, PF	1 3/4
10, 12, 116, 215, 227	943A	82-538	T	AC, AK	2 1/8
14, 217	707A	82-533	T		1 1/16
17, 218	708A	80075	T		2 3/32
55, 58, 141, 142, 223	709A	82-534	T		1 3/8
59, 62, 71, 140, 210		81650	T	4000	1 1/16
		80375	T	4000	1 1/16
	627A	82-548	T		1 1/32
63, 114		80300	T		1 3/4
117, 118	711A	80200	T		2 3/32

ANGLE

For RG-/U Cable	UG-/U No.	No.	Ins.	Notes	Lgth.
8, 9, 87, 213, 214, 225	710A	82-531	T		1 3/8
55, 58, 141, 142, 223		80775	T		1 3/8

JACKS

50 ohm impedance
female contacts
weatherproof

82-503



STRAIGHT

For RG-/U Cable	UG-/U No.	No.	Ins.	Notes	Lgth.
8, 9, 87, 213, 214, 225	572	82-503	T		1 1/32
55, 58, 141, 142, 223		81575	T		1 1/4
59, 62, 71, 140, 210		81550	T		1 1/4

82-501

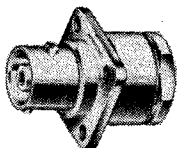

PANEL

For RG-/U Cable	UG-/U No.	No.	Ins.	Notes	Lgth.
8, 9, 87, 213, 214, 225	571	82-501	T	AK	1 1/32
10, 12, 116, 215, 227	938	82-523	T	AC, AK	2
14, 217		81275	T		2
55, 58, 141, 142		74675	T	FM	1 1/4
		81150	T		1 1/4
59, 62, 71, 140, 210		81100	T	FM	1 1/4

BULKHEAD

For RG-/U Cable	UG-/U No.	No.	Ins.	Notes	Lgth.
8, 9, 87, 213, 214, 225	570	82-502	T	AK	1 1/32
	570A	82-614	T		1 1/32
	632	82-521	T	4000, AK	1 1/16
10, 12, 116, 215, 227	937	82-522	T		2
55, 58, 141, 142	704	81175	T		1 1/4
	704A	74475	T	FM	1 1/4
		81425	gT	H	1 3/8
		81400	T		1 1/4
59, 62, 71, 140, 210		81600	T	FM, 4000	1 1/32

RECEPTACLES

female contacts

PANEL 50 ohm impedance • weatherproof

UG-/U No.	No.	Ins.	Notes	Lgth.
568	82-504	T		1 3/32
	82275	T		1 3/16

BULKHEAD

UG-/U No.	No.	Ins.	Notes	Lgth.
569	82-505	T		1 3/32
634	82-515	T	4000	1 3/16
705	82-511	GT	H	1 1/16
706	82125	T	FM	1 3/32

82-514



ADAPTERS

50 ohm impedance - weatherproof

STRAIGHT

UG-/U No.	No.	Ins.	Adapter Ends	Notes	Lgth.
642A	83150	T	PP		1 3/64
643	82-514	T	JJ	NW	1 1/32

ANGLE

UG-/U No.	No.	Ins.	Notes	Lgth.	
567A	82-535	T	JP	NW	1 1/4

TEE

UG-/U No.	No.	Ins.	Notes	Lgth.	
566A	82-536	T	JPJ	1 3/64	
	83525	T	CJC	RG-13/U	2 3/4

BULKHEAD

UG-/U No.	No.	Ins.	Notes	Lgth.	
701	83050	GT	JJ	H	1 1/16
	82250	GT	JJ	H, 4000	2 3/32

RESISTOR TERMINATED CAP

male contact
weatherproof

83925

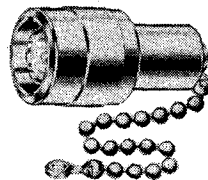

No.	Notes	Lgth.
83925	*	1 1/16

*Add resistor value (ohms) to part no. when ordering:
47, 51, 75, 82, 91, 100, 120, 130, 150, 180, 240,
270, 300, 470, 510, 560, 680, 750, 820, 1000, 1500,
3900, 4700, 10000, 150000.

82-512

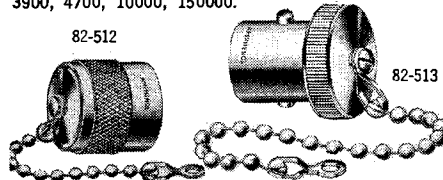

MALE CAPS weatherproof

MALE

MX No.	No.	Notes	Lgth.
1142	82-512		5/16
	83675	SMC	7/8

FEMALE

MX No.	No.	Notes	Lgth.
1143	82-513		27/32
	83700	SFC	1 1/16

82-510

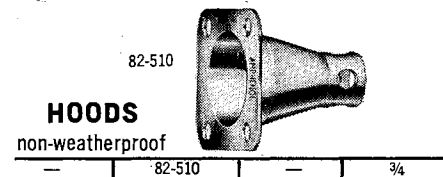

HOODS

non-weatherproof

MX No.	No.	Notes	Lgth.
	82-510		3/4

82-517



ARMOR CLAMPS

weatherproof • improved N type

For RG-/U Cable	MX No.	No.	Lgth.
10, 12, 79, 116, 215, 227	1286	82-517	1 1/8
18, 219	1441	92100	1 3/8
74, 224	1462	16850	1 3/16

SERIES N

CHARACTERISTICS (Typical)

ELECTRICAL
impedance as noted, 50 or 70 ohms
frequency range 0-10 GHz
voltage rating 1,500 volts peak (1,000 v m)
3,500 volts rms (2,500 and
dielectric with- 1500 vrms at 50 MHz)
standing voltage MIL-Crimp/MIL-Clamp: 1-15
(solder) 1.35 per spec; others: 1.25
contact resistance 1.0 mv, RF
leakage -90 db, insertion loss
SWR :15 db, insulation resistance
5,000 megohms

other

ENVIRONMENTAL
thermal limits Teflon: -67°F to 390°F (-55°
to 199°C)
Rexolite: -67°F to 185°F
(-55° to 85°C)

weatherproof all Series N with gaskets are
weatherproof
hermetic seals pass Helium leak test of 2 x 10⁻⁸
cc/sec
compression seal
pressurized MIL-Std. 202 method 202
shock MIL-Std. 202 method 204
vibration (test cond. B)

moisture resistance MIL-Std. 202 method 106
corrosion MIL-Std. 202 method 101
(test cond. B)

temperature MIL-Std. 202 method 102
(test cond. C)

altitude MIL-Std. 202 method 105
(test cond. C)

AMPHENOL RF COAXIAL CONNECTORS



AMPHENOL

STANDARD TYPE N (Cont'd.) PANEL

For RG-/U Cable	UG-/U No.	No.	Imp. Ohms	Ins.	Notes	Lgth.
10, 12, 116, 215, 227	935A	82-211	50	T		2 1/4
	935B	82-321A	50	T	I	2 1/4
11, 13, 149, 216	96A	82-90	70	T		1 3/16
55, 58, 141, 142	1052	36000	50	R		1 3/16
55, 58, 141, 142, 223	1095A	36250	50	T	I	1 1/2
59, 62, 71, 140, 210	593	35500	50	R		1 3/16
	—	35550	70	T		1 3/16
	—	91250	70	T	I	1 1/2

BULKHEAD

5, 21, 143, 212, 222	159B	15550	50	T	I	1 1/4
8, 9, 87, 213, 214, 225	160A	82-67	50	T		1 3/16
	160B	82-93	50	T		1 3/16
	160D	91025	50	T	I	1 3/4
8, 9, 213, 214	—	23025	50	gT	H	2 5/8
55, 58, 141, 142	556	35250	50	T		1 3/16
55, 58, 141, 142, 223	556B	35275	50	T	I	1 3/4
59, 62, 71, 140, 210	—	18250	50	R		1 3/8

RECEPTACLES

male • male contact • weatherproof

UG-/U No.	No.	Imp. Ohms	Ins.	Notes	Lgth.
—	49000	50	R	FM	1 3/8

female • female contacts • weatherproof

58	82-24	50	T		1 3/4
58A	82-97	50	T		1 3/4
58B	82-368	50	T	M39012/04-0002	1 3/4
231	2750	50	R	RG-58/U	1 3/4
—	82-112	70	T		1 3/4
—	9575	50	T		1 3/4

BULKHEAD male • male contact

—	19550	50	GT	H, FM	1 3/4
---	-------	----	----	-------	-------

female • female contacts

680	82-811	50	GT	H, FM	1 3/4
680B	82-369	50	G	M39012/04-0001	1 3/4
—	13275	50	gT	H, FM	1 3/8
—	31150	50	T	W, FM	1 3/8

ANGLE female • female contacts

997A	8975	50	T		1 3/8
—	23775	50	T		1 3/8

ADAPTERS

weatherproof

STRAIGHT

UG-/U No.	No.	Imp. Ohms	Ins.	Notes	Adapter Ends	Lgth.
29	15000	50	R		JJ	1 3/4
29A	82-65	50	T		JJ	1 3/4
29B	82-101	50	T		JJ	1 3/4
57A	45250	50	T		PP	1 1/2
57B	82-100	50	T		PP	1 1/2
—	17075	70	T		PP	1 3/8
—	21650	70	T		JJ	1 3/4

ANGLE

27A	82-64	50	T		JP	1 3/4
27B	82-98	50	T		JP	1 3/8
27C	82-213	50	T		JP	1 3/4

BULKHEAD

30	82-66	50	R	P	JJ	1 5/8
30C	82-201	50	G	H	JJ	1 3/4
30D	91100	50	G	H	JJ	1 3/8
—	82-849	50	T	P	JJ	1 5/8
—	90950	50	G	H	JJ	1 3/4

TEE

UG-/U No.	No.	Imp. Ohms	Ins.	Notes	Adapter Ends	Lgth.
28A	82-99	50	T		JJJ	1 3/4
107	4800	50	R		JPJ	3
107A	82-35	50	T		JPJ	2
107B	82-102	50	T		JPJ	1 3/4
—	4850	50	R		PPP	3 1/2

CROSS

—	17125	50	T		JJJJ	2 1/4
---	-------	----	---	--	------	-------



MALE

MX No.	No.	Notes	Length
913	82-106		3/4
—	9225		3/4
—	13700	SMC	2 3/8
—	18575		2 1/4

FEMALE

—	6950		3/8
—	13675	SFC	1

ARMOR CLAMPS non-weatherproof

For RG-/U Cable	MX No.	No.	Notes	Lgth.
10, 12, 79	564	82-48	N or HN	7/8
116, 215, 227	564A	82-109	N or HN	1 1/4
	1286	82-517	I	1 1/8
18, 219	1441	92100	I	1 3/8
74, 224	1462	16850	I, W	1 3/4

SERIES UHF

CHARACTERISTICS (Typical)

ELECTRICAL impedance non-constant
frequency range 0-300 MHz
voltage rating 500 v. peak

ENVIRONMENTAL thermal limits
Teflon: -67°F to 390°F
Rexolite: -67°F to 185°F
polystyrene: -67°F to 185°F
mica-filled Bakelite: -67°F to 300°F
no, except as noted

weatherproof MECHANICAL mating
1/2-24 thrd. coupling (small body)
1-20 thrd. coupling (large body)
braid solder, Quick Crimp or Solderless

MATERIAL contacts
male: brass
female: beryllium copper
die-cast zinc or brass
0.002" silver min.
bodies plating Teflon, Rexolite, polystyrene or mica-filled Bakelite
insulators small and large body types do not intermate

OTHER DATA



PLUGS

non-constant impedance • male contacts
non-weatherproof

STRAIGHT small body, except as noted

For RG-/U Cable	MIL No.	No.	Ins.	Notes	Lgth.
8, 9, 11, 13, 63, 87, 149, 213, 214, 216, 225	PL-259	83-822	T		1 1/2
	PL-259	83-ISP	FB		1 1/2
	PL-259A	83-756	T		1 3/4
	PL-259A	83-ISP	FB		1 3/4
	—	83-ISP-1002	FB		1 1/2
	—	83-851	FB	SBC	1 3/4
8, 11, 149, 213	—	83-87	B	QC	1 3/8
11, 149	—	83-850	FB	SC, SBC	1 3/4
17, 218	—	83-86	T		2 1/8
—	—	10450	R		2 1/8
34	UG-358/U	83-2ISP	FB	LB, W	1 3/8
55, 142, 223	—	83-90	B	QC	1 3/8
58, 141	UG-203/U	83-776	FB		1 3/4
—	—	83-89	B	QC	1 3/8
59, 62, 71, 140, 210	UG-111/U	83-750	FB		1 3/4
—	—	83-88	B	QC	1 3/8

ANGLE small body

For RG-/U Cable	MIL No.	No.	Ins.	Notes	Lgth.
8, 9, 11, 13, 63, 87, 149, 213, 214, 216, 225	—	83-67	T		1 3/8
—	—	83-59	PST		1 3/8

RECEPTACLES non-constant impedance female contacts • non-weatherproof

MIL No.	No.	Ins.	Notes	Lgth.
SO-239	83-1R	FB		1 1/4
SO-239A	83-798	T		1 3/16
UG-357/U	83-21R	FB	LB	1 3/4
—	83-716	C	P	1 3/16
—	83-876	B	—	1 3/4

BULKHEAD small body

UG-266/U	4575	R	P	1 1/2
—	83-875	R, T	FM	1 3/8
—	74525	GT	H, RM	1 3/8
—	83-875-1002	RT	FM	1 3/8

ADAPTERS

83-1J non-constant impedance non-weatherproof

STRAIGHT small body, except as noted adapter ends are Jack-Jack.

UG-/U No.	No.	Ins.	Notes	Lgth.
224	29500	R		1 3/8
PL-258	83-1J	PST		1 1/8
360	83-21J	PST	LB	1 1/8
363	83-1F	PST		2
—	11850	T		1 1/8
—	13725	T		1 3/8

ANGLE small body

MIL No.	No.	Ins.	Adapter Ends	Lgth.
M-359A	83-58	PST	JP	1 3/8
UG-646/U	83-1AP	PST	PJ	1 3/8

TEE small body

M-358	83-1T	PST	JPJ	1 1/8
-------	-------	-----	-----	-------

REDUCING small body

For RG-/U Cable	UG-/U No.	No.	Length
55, 58, 141, 142	175	83-185	1
59, 62, 71, 140, 210	176	83-188	1

HOODS non-weatherproof • small body

For RG-/U Cable	MIL No.	No.	Lgth.
8, 9, 10, 11, 12, 63, 79, 87, 115, 149, 213, 215	MX-543	5475	1
	UG-106/U	83-1H	3/4
	UG-372/U	83-1HP	7/8
58, 141	UG-177/U	83-765	3/4
55, 59, 140, 142, 223	MX-539	5375	1

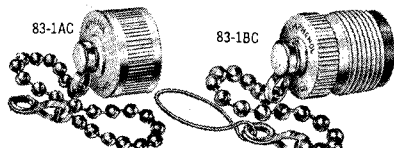

CAPS

weatherproof • small body

MALE

No.	Length
83-IAC	1 3/8

FEMALE

83-IBC	1 3/8
--------	-------

BINDING POST

non-weatherproof male contact

UG-/U No.	No.	Ins.	Length
332	58000	R	1 7/8



BEAUPUG 3300 SERIES PLUGS & SOCKETS

The 3300 Series BEAUCHAINE ELECTRICAL CONNECTOR line has been developed to fulfill the industry need for a reasonably priced, reliable and versatile connector for chassis, cable and modular use where space is not a prime consideration. The 3300 Series is made in 2, 3, 4, 6, 8, 10, 12, 15, 18, 21, 24, 27, 30 & 33 contact configurations. Male contacts are brass, cadmium plated. Female contacts are phosphor bronze, also cadmium plated and are covered

by U. S. Patents # 3,271,728 & 3,311,867 For greater dielectric strength, protection and economy, we have developed the molded POLYPROPYLENE and the new POLYCARBONATE backshells (or caps) which are described on the following page.

BEAUPUGS meet or exceed UL Std. #498, oil contacts carrying "rated" current simultaneously.

Current (2-12 Contacts) -- 7.5 amperes & 1875 watts
Current (15-33 Contacts) -- 4.5 amperes & 1125 watts

CHASSIS MOUNTED CONNECTORS

Part Number	Price Each Net			
	1-49	50-99	100-249	250-499
Plug, Angle Bracket Mounted, (-AB) End Bracket (-EB), Snap C Clip (-SCC)				
P-3302-AB, -SCC	.21	.175	.14	.133
03	.246	.205	.164	.156
04	.252	.21	.168	.16
06	.306	.255	.204	.194
06-8	.366	.305	.244	.232
08	.366	.305	.244	.232
10	.414	.345	.276	.262
12	.462	.385	.308	.293
P-3315-AB (or -EB)	.63	.525	.42	.399
18	.78	.65	.52	.494
21	.99	.825	.66	.627
24	1.20	1.00	.80	.76
27	1.41	1.175	.94	.893
30	1.62	1.35	1.08	1.026
33	1.83	1.525	1.22	1.159
Socket, Angle Bracket Mounted (-AB) End Bracket (-EB), Snap C Clip (-SCC)				
S-3302-AB, -SCC	.228	.19	.152	.144
03	.258	.215	.172	.163
04	.264	.22	.176	.167
06	.33	.275	.22	.209
06-8	.414	.345	.276	.262
08	.414	.345	.276	.262
10	.492	.41	.328	.312
12	.57	.475	.38	.361
S-3315-AB (or -EB)	.72	.60	.48	.456
18	.87	.725	.58	.551
21	1.08	.90	.72	.684
24	1.29	1.075	.86	.817
27	1.50	1.25	1.00	.95
30	1.74	1.45	1.16	1.102
33	1.92	1.60	1.28	1.216

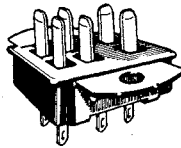

P-3306-8-AB (for positive orientation)

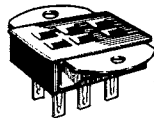

S-3306-AB

3300 SERIES SNAP "C" CLIP BEAUPUGS (SCC) FOR PANEL MOUNTING

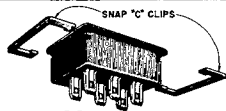

S-3306-SCC

IMPORTANT - - -

Customer must advise the Factory as to the chassis thickness "X" from which we will determine the location of the milled slot.

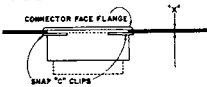

Plug, Angle Bracket Mounted w/ Tapped Holes (-ABT) End Bracket w/ Tapped Holes (-EBT)				
P-3303-ABT	.288	.24	.192	.182
04	.312	.26	.208	.198
06	.366	.305	.244	.232
06-8	.426	.355	.284	.27
08	.426	.355	.284	.27
10	.474	.395	.316	.30
12	.522	.435	.348	.331
P-3315-ABT (or -EBT)	.69	.575	.46	.437
18	.90	.75	.60	.57
21	1.11	.925	.74	.703
24	1.32	1.10	.88	.836
27	1.53	1.275	1.02	.969
30	1.746	1.455	1.164	1.106
33	1.95	1.625	1.30	1.235
Socket, Angle Bracket Mounted w/ Tapped Holes (-ABT) End Bracket w/ Tapped Holes (-EBT)				
S-3303-ABT	.30	.25	.20	.19
04	.324	.27	.216	.205
06	.39	.325	.26	.247
06-8	.474	.395	.316	.30
08	.474	.395	.316	.30
10	.552	.46	.368	.35
12	.63	.525	.42	.399
S-3315-ABT (or -EBT)	.78	.65	.52	.494
18	.99	.825	.66	.627
21	1.20	1.00	.80	.76
24	1.41	1.175	.94	.893
27	1.62	1.35	1.08	1.026
30	1.86	1.55	1.24	1.178
33	2.04	1.70	1.36	1.292

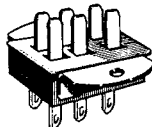

P-3306-ABT

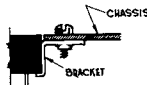

-ABT & -EBT detail

Part Number	Each, Net			
	1-49	50-99	100-249	250-499
Plug, Flat Plate Mounted (-FP)				
P-3302-FP	.366	.305	.244	.232
03	.378	.315	.252	.239
04	.384	.32	.256	.243
06	.426	.355	.284	.27
06-8	.486	.405	.324	.308
08	.486	.405	.324	.308
10	.54	.45	.36	.342
12	.582	.485	.388	.369
S-3302-FP	.372	.31	.248	.236
03	.39	.325	.26	.247
04	.396	.33	.264	.251
06	.45	.375	.30	.285
06-8	.534	.445	.356	.338
08	.534	.445	.356	.338
10	.618	.515	.412	.391
12	.69	.575	.46	.437

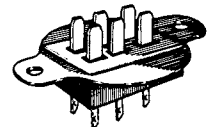

P-3306-FP

Plug, Shallow Bracket Mounted (-SB)				
P-3315-SB	.828	.69	.552	.524
18	1.02	.85	.68	.646
21	1.242	1.035	.828	.787
24	1.50	1.25	1.00	.95
27	1.68	1.40	1.12	1.064
30	1.92	1.60	1.28	1.216
33	2.13	1.775	1.42	1.349
Socket, Shallow Bracket Mounted (-SB)				
S-3315-SB	.948	.79	.632	.60
18	1.14	.95	.76	.722
21	1.35	1.125	.90	.855
24	1.602	1.335	1.068	1.015
27	1.80	1.50	1.20	1.14
30	2.04	1.70	1.36	1.292
33	2.25	1.875	1.50	1.425

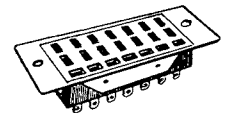

S-3321-SB

Plug, Deep Bracket Mounted (-DB)				
P-3302-DB	.522	.435	.348	.331
03	.528	.44	.352	.334
04	.534	.445	.356	.338
06	.60	.50	.40	.38
06-8	.648	.54	.432	.41
08	.648	.54	.432	.41
10	---	---	---	---
12	.78	.65	.52	.494
15	.93	.775	.62	.589
18	1.146	.955	.764	.726
21	1.35	1.125	.90	.855
24	1.602	1.335	1.068	1.015
27	1.80	1.50	1.20	1.14
30	2.07	1.725	1.38	1.311
33	2.274	1.895	1.516	1.44
Socket, Deep Bracket Mounted (-DB)				
S-3302-DB	.546	.455	.364	.346
03	.558	.465	.372	.353
04	.564	.47	.376	.357
06	.636	.53	.424	.403
06-8	.714	.595	.476	.452
08	.714	.595	.476	.452
10	---	---	---	---
12	.90	.75	.60	.57
15	1.044	.87	.696	.661
18	1.242	1.035	.828	.787
21	1.452	1.21	.968	.92
24	1.716	1.43	1.144	1.087
27	1.914	1.595	1.276	1.212
30	2.178	1.815	1.452	1.379
33	2.382	1.985	1.588	1.509

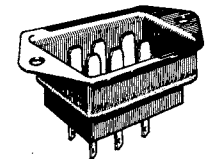

P-3306-DB

SERIES CROSS REFERENCE			
BEAUCHAINE	3300 Series	-----	C-J 300 Series
BEAUCHAINE	4400 Series	-----	C-J 400 Series
BEAUCHAINE	5400 Series	-----	C-J 2400 Series



BEAUPUG 5400 SERIES PLUGS & SOCKETS

5400 Series Plugs and Sockets mate with our 4400 Series, as well as C-J 400 and 2400 Series. Electrical Ratings: 15 Amps @ 250 Volts, UL Listing No. E 34742 and CSA No. 22156, both of which include the 3300 Series.

Male contacts are of 1/4" x 1/16" brass and are cadmium plated: gold, silver and rhodium are available on special order. The double-wiping action female contacts are made of phosphor bronze and are also cadmium plated.

Number 1-49 50-99 100-249 250-499

Plug, Less Angle Bracket (-LAB)				
P-5404-LAB	.48	.40	.32	.304
06	.57	.475	.38	.361
08	.66	.55	.44	.418
10	.846	.705	.564	.536
12	.966	.805	.644	.612
Socket, Less Angle Bracket (-LAB)				
S-5404-LAB	.552	.46	.368	.85
06	.666	.555	.444	.422
08	.804	.67	.536	.509
10	.93	.775	.62	.589
12	1.068	.89	.712	.676

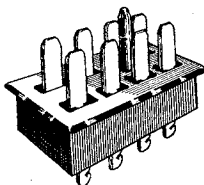

P-5404-LAB

Number 1-49 50-99 100-249 250-499

Plug, Shallow Bracket Mounted (-SB)				
P-5404-SB	.756	.63	.504	.479
06	.882	.735	.588	.559
08	.96	.80	.64	.608
10	1.158	.965	.772	.733
12	1.266	1.055	.844	.802
Socket, Shallow Bracket Mounted (-SB)				
S-5404-SB	.828	.69	.552	.524
06	.966	.805	.644	.612
08	1.122	.935	.748	.711
10	1.248	1.04	.832	.79
12	1.38	1.15	.92	.874

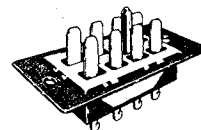

P-5404-SB

Plug, Angle Bracket Mounted (-AB)				
P-5404-AB	.672	.56	.448	.426
06	.762	.635	.508	.483
08	.87	.725	.58	.551
10	1.056	.88	.704	.669
12	1.188	.99	.792	.752
Socket, Angle Bracket Mounted (-AB)				
S-5404-AB	.762	.635	.508	.483
06	.876	.73	.584	.555
08	1.02	.85	.68	.646
10	1.14	.95	.76	.722
12	1.272	1.06	.848	.806

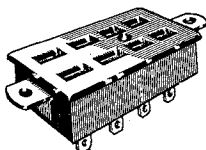

S-5404-AB

Plug, Deep Bracket Mounted (-DB)				
P-5404-DB	.81	.675	.54	.513
06	.93	.775	.62	.589
08	1.056	.88	.704	.669
10	1.20	1.00	.80	.76
12	1.332	1.11	.888	.844
Socket, Deep Bracket Mounted (-DB)				
S-5404-DB	.888	.74	.592	.562
06	.996	.83	.664	.631
08	1.158	.965	.772	.733
10	1.302	1.085	.868	.825
12	1.434	1.195	.956	.908

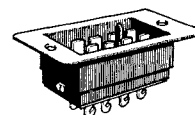

P-5404-DB

Plug, Cable Clamp Top (-CCT) Cable Clamp End (-CCE)				
P-5404-CCT or CCE	1.02	.85	.68	.646
06	1.158	.965	.772	.733
08	1.224	1.02	.816	.775
10	1.41	1.175	.94	.893
12	1.554	1.295	1.036	.984
Socket, Cable Clamp Top (-CCT) Cable Clamp End (-CCE)				
S-5404-CCT or CCE	1.122	.935	.748	.711
06	1.212	1.01	.808	.768
08	1.368	1.14	.912	.866
10	1.506	1.255	1.004	.954
12	1.65	1.375	1.10	1.045

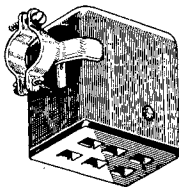

S-5406-CCE

Plug, Cable Clamp Top, Latch (-CCT-L) Cable Clamp Top, Keeper (-CCT-K)				
P-5404-CCT-L or -K	1.422	1.185	.948	.901
06	1.56	1.30	1.04	.988
08	1.626	1.355	1.084	1.03
10	1.812	1.51	1.208	1.148
12	1.956	1.63	1.304	1.239
Socket, Cable Clamp Top, Latch (-CCT-L) Cable Clamp Top, Keeper (-CCT-K)				
S-5404-CCT-L or -K	1.524	1.27	1.016	.965
06	1.614	1.345	1.076	1.022
08	1.77	1.475	1.18	1.121
10	1.908	1.59	1.272	1.208
12	2.052	1.71	1.368	1.30

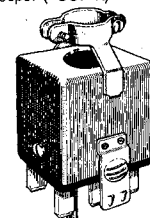

P-5406-CCT-L

All connectors in the 3300 & 5400 Series are available in the -FHT (Flared Hole, Top) and -FHE (Flared Hole, End) configurations. We have not listed them here because of space considerations.

4400 & 5400 Series CONTACT TAILS AVAILABLE at no extra charge (Except for Screw Type Terminals, on application)

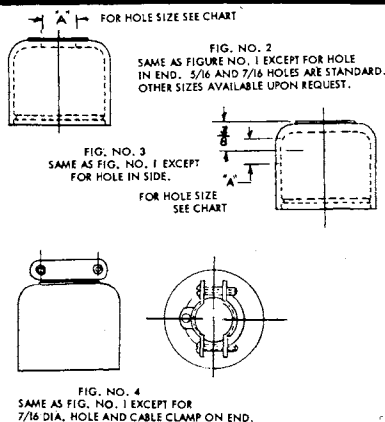
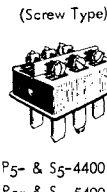
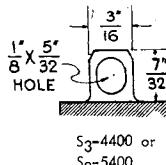
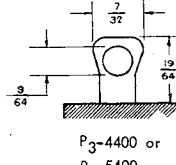
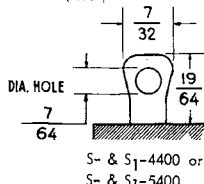
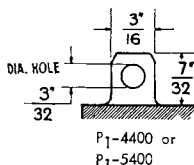
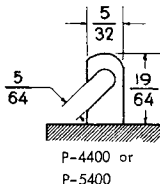

2001 SERIES BEAUCAPS

Molded of rugged Linear Polyethylene, the single piece 2001 Series "BEAUCAP" replaces the metal cap with rubber grommet and fishpaper insulation.



PRICE LIST				
Number	1-49	50-99	100-249	250-499
2001-1	.09	.075	.06	.057
2001-2	.102	.085	.068	.065
2001-3	.102	.085	.068	.065
2001-4	.162	.135	.108	.103

HOW TO ORDER:

PART NO.	FIG. NO.	COLOR	HOLE SIZE
2001 - 1	1		
2001 - 2	2	Add Suffix B-Black, R-Red, G-Green, BL-Blue	Add Suffix -5 5/16 Dia. Hole -7 7/16 Dia. Hole
2001 - 3	3		
2001 - 4	4		

EXAMPLE:

A cap with opening in end 5/16 dia., green color would be ordered as shown below.
(2001 - 2) (G) (-5)
Part No. and Style Color 5/16 Dia. Hole Opening



BINDING POSTS

BINDING POST

"Standard" Type

DESCRIPTION: Banana Plug Receptacle, .161 I.D.; Head non-removable from Stud; Molded in Brass Bushing in Head; Molded in Brass Bushing in Washers; For Panels $\frac{1}{8}$ " to $\frac{1}{4}$ " thick; Drill $\frac{1}{8}$ " hole for mounting washers; Wire Hole is at right angle to Flat on Insulated Washers; Production Punch for keyed Slot for mounting Washers.

Cat. No. 274 Standard Brass Red or Black



BINDING POST

30 Amp. 2000 VDC

Molded Nylon Body Banana Plug Receptacle, .161 I.D.; Head non-removable from Stud; Molded in Brass Bushing in Head; Molded in Brass Bushing in Washers; For Panels $\frac{1}{8}$ " to $\frac{1}{4}$ " thick; Drill $\frac{1}{8}$ " hole for mounting washers; Wire Hole is at right angle to Flat on Insulated Washers; Production Punch for keyed Slot for mounting Washers.

WRAP AROUND TYPE COLORS

Cat. No. 275 Brass, Nickel Plated, Red, Black, Yellow, Green, White, Blue, Brown, Grey.

Cat. No. 275A Brass Plated, Red, Black, Yellow, Green, White, Blue, Brown, Grey.

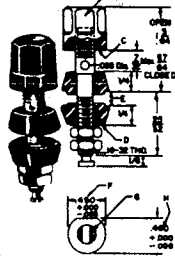

TIP JACK TYPE

Similar to 275A, Plated, Brass, except with Tip Jack receptacle.

Cat. No. 277 Red, Black

BINDING POST FLUTED HEAD

New fluted nut design is attractive and functional molded nylon body per MIL-P-20693A completely insulates panel from binding post. Makes ideal connection for electrical and electronic equipment. Brass nickel plated "Wrap Around Type" solder connection to stud rated 30 amp. 2000 VAC test capacitance 5.0 mmfd. Similar construction as our No. 275.

Cat. No. 273 Nickel plated Red, Black



BINDING POST

NEW! BIRNBACH "Multi-Use" Binding Posts Safe-Positive-Heavy Duty

Rugged, versatile "Multi-Use" binding post made of molded nylon with molded-in brass inserts in head and washer for complete insulation from panel. For use on panels $\frac{1}{8}$ " to $\frac{1}{4}$ " thick. Mounting hole $\frac{1}{8}$ ". Current Capacity: 30 Amps. Voltage: 2000 VAC. RMS Test. No. 276 can be soldered directly to stud. Will permit six different methods of connection above panel and three below panel.

Cat. No. 276 Nickel Plated; Red, Black, Yellow, Green, White, Blue, Brown, Grey.



BINDING POST

Wrap Around Type

Designed to accept phone tip plug, spade lug, banana plug, alligator clip and wire strand. Direct solder connection. Molded nylon head (non-removable from stud) and washer completely insulates post from panel. Mounts in $\frac{1}{2}$ " or keyed hole for panels $\frac{1}{8}$ "- $\frac{1}{4}$ " thick. Nickel-plated brass metal parts. Molded-in brass bushings in head and washers. Rated 2,000 volts AC RMS test. 30 amp safe current-carrying capacity.

Cat. No. 271 Red, Black

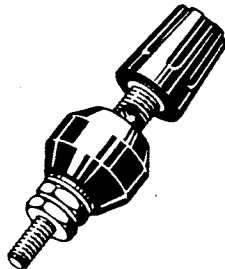

STANDARD DUTY 5-WAY BINDING POST

Molded-in brass bushings for complete insulation. Useful for standard duty work. Available in Red or Black. Specify color. Body is brass nickel plated.

6 AMPS

Cat. No. 278 Red, Black
Cat. No. 279* Red, Black

* Same as above, but normally grounded. (Without bottom insulating section.)

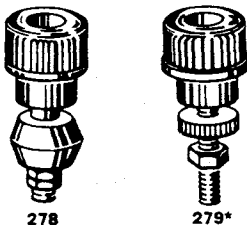

NYLON BINDING POST

Head: MOLDED NYLON, with brass plated insert. Body: Brass Plated. Washers: MOLDED NYLON, brass plated inserts. Accepts: Phone tip plug, spade lug, banana plug, alligator clip or wire strand. Rating: 15 Amps AC for 10°C Temp. rise, continuous duty. 1 KV Volts 60 cycle AC continuous working voltage. CAPACITANCE 3.0 mmfd., Molded washers completely insulate post from panel. Miniature washers and narrow fluted head require minimum panel space. Mounts in $\frac{3}{8}$ " round or "D" hole in panel as indicated. Wrap-around solder terminal on stud for direct connection.

Cat. No. 280 Red, Black, Yellow, Green.

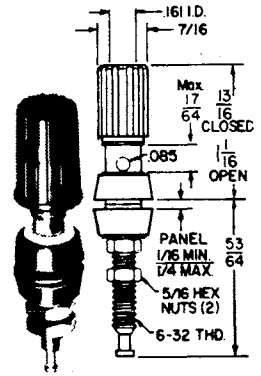

METAL BINDING POST

Head: Fluted Brass, Plated. Body: Brass, Plated. Washer: MOLDED BLACK NYLON, with brass plated insert. Accepts: Phone tip plug, spade lug, banana plug, alligator clip, or wire strand. Rating: 15 Amps AC for 10°C temp. rise, continuous duty, Fluted-head metal post to match our No. 280. For use where direct ground connection is made to panel or chassis. Supplied with brass, gold-plated flat metal washer for grounding.

Cat. No. 281

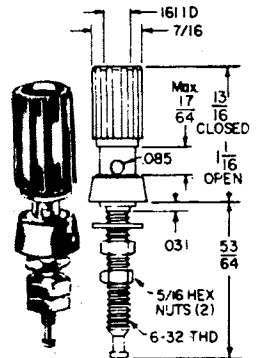

METAL BINDING POST

Insulated

Head: Fluted Brass, plated. Body: Brass plated. Washer: MOLDED BLACK NYLON, with brass plated insert. Accepts: Phone tip plug, spade lug, banana plug, alligator clip, or wire strand. Rating: 15 Amps AC for 10°C temp. rise, continuous duty. 1 K Volts, 60 cycle AC continuous working voltage. CAPACITANCE 3.0 mmfd. Fluted-head metal post to match our No. 280. Molded washers insulate post from panel for use where internal ground circuit is isolated from chassis or panel.

Cat. No. 282

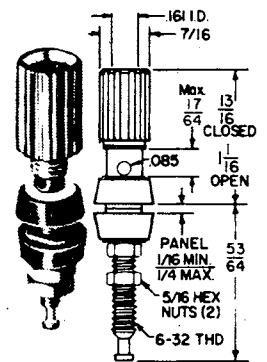

INSULATED BINDING POST

Molded bakelite head with brass insert molded-in. Supplied complete with 8/32 x $\frac{1}{2}$ " screw, lock washer. Has brass insert molded-in. Supplied with washer. Available in black. Cat. No. 184

Binding Post Molded bakelite-head with brass insert molded-in. Supplied complete with 8/32 x $\frac{1}{2}$ " screw, lock washer. Has brass nickel-plated retaining washer. Red, Black. Cat. No. 185

Binding Post Brass, heavily nickel-plated overall. Complete with screw and lock washer. Designed for high amperage, low resistance connections.

Cat. No. 186 Metal Binding Post

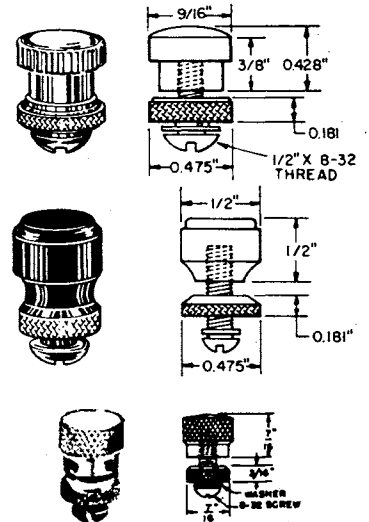

BIRNBACH

FOR MORE INFORMATION ON COMPLETE LINES, WRITE FOR NEW CATALOG.

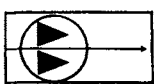
**NON-INSULATED BANANA PLUGS**

Variations of Standard Plugs Available to Order. Plated to Gov't. Specs.

BANANA PLUG No. 400

Hexed brass nickel plated. Fits all standard banana plugs. Complete with hex brass n.pl. nut and tinned copper lug. Spring is four-leaved nickel plated. Rated at 5 amps.

Cat. No.	Spring	Dim. "A"
400	Phos. Bronze	1/2"
400A	Phos. Bronze	3/8"
400B	Beryl. Copper	1/2"

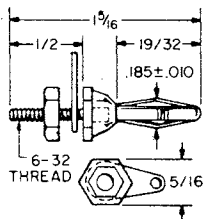
**BANANA PLUG No. 401**

Hexed brass nickel plated. One-piece four-leaved spring. Complete with brass n.pl. screw and tinned copper lug. Rated at 5 amps. Fits all standard banana jacks.

Cat. No.	Spring
401	Phos. Bronze
401B	Beryl. Copper

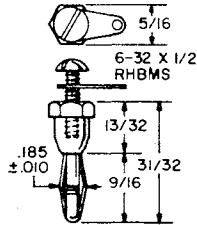
**BANANA PLUG No. 404A**

Hexed brass and four-leaved phosphor bronze spring all nickel plated. Rated at 5 amps. Fits all standard banana jacks.

Cat. No.	Spring
404A	Banana Plug

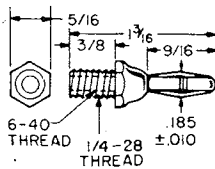
**BANANA PLUG No. 404S**

Hexed brass nickel pl. Complete with hex brass n.pl. nut. Has solderless Scrulok connection. Fits all standard banana plugs. Spring is four-leaved phosphor bronze nickel plated. Rated at 5 amps.

Cat. No.	Spring
404S	Phos. Bronze
404SB	Beryl. Copper

Scrulok Banana Plug

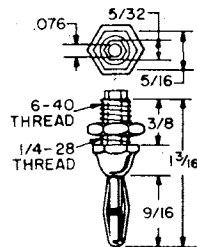
**BANANA PLUG No. 414**

Hexed brass, nickel plated. One-piece construction. Four-leaved phosphor bronze spring. Complete with brass hexed nut n.pl. Rated at 5 amps. Fits all standard banana jacks.

Cat. No.	Spring
414	Phos. Bronze

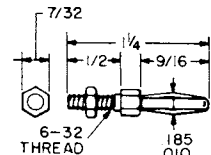
**BANANA PLUG No. 416**

Hexed brass nickel plated. Cross slotted for positive contact. One-piece construction. Fits all standard banana jacks. Complete with hexed brass n.pl. nut.

Cat. No.	Spring
416	Banana Plug

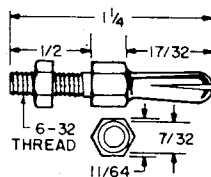
**MIDGET BANANA PLUG Rivet Type — No. 426**

Brass silver plated body. One-piece four-leaved phosphor bronze spring silver plated. Also made to Rigid Jan specs.

Cat. No.	"A"
426	7/32"
426A	5/32"

Midget Banana Plug Rivet Type

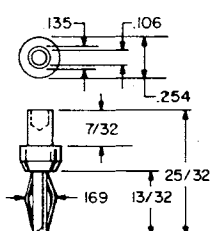
**GIANT PLUG No. 392A**

Body is hexed brass nickel plated. Rated at 25 amps. Has large soldering well in threaded shank. Fits all Giant Banana Jacks.

Cat. No.	Spring
392A	Phos. Bronze

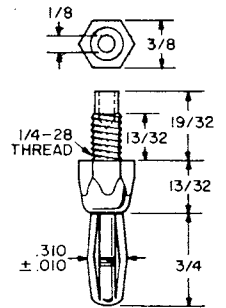
**GIANT PLUG No. 396**

Body is hexed brass, nickel plated. Fits all giant banana jacks. Complete with nickel plated screw and soldering lug. Rated at 25 amps.

Cat. No.	Spring
396	Phos. Bronze
396B	Beryl. Copper

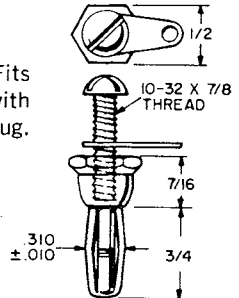
**GIANT PLUG No. 397**

Body is hexed brass, nickel plated. Fits all giant banana jacks. Complete with nickel plated screw and soldering lug. Heavy duty, 25 amp. rating.

Cat. No.	Spring
397	Phos. Bronze
397B	Beryl. Copper

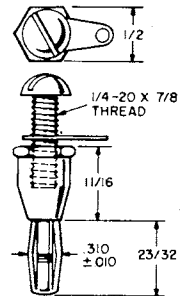
**GIANT PLUG No. 398**

Body is hexed brass, n.pl. nut and tinned copper lug. Has large soldering well in threaded shank. Used in high amperage circuits rated at 25 amps. Fits all giant banana jacks.

Cat. No.	Spring
398	Phos. Bronze
398B	Beryl. Copper

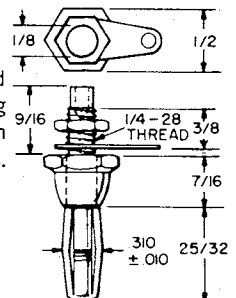
**SUB MINIATURE BANANA PLUGS**

One piece beryllium copper springs insure positive and lasting contact. Silver plated overall.

Cat. No.	Description
590	Rivet Type Plug
591	Screw Type Plug

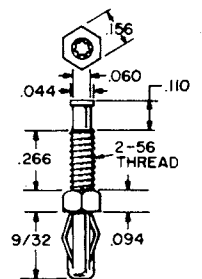
**BIRNBACH**

COMPANY INC. FOR MORE INFORMATION ON COMPLETE LINES, WRITE FOR NEW CATALOG.

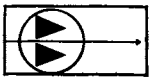

INSULATED PHONE TIPS, TEST PRODS

SOLDERLESS PHONE TIPS

Brass, nickel plated. Wire fits thru body of tip, tightened around screw with nickel plated knurled nut. Fits all standard phone tip jacks.

- Cat. No.
 23 Junior Solderless Phone Tip
 24 Senior Solderless Phone Tip

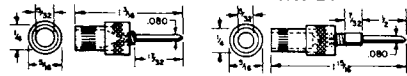

BRASS NICKEL PLATED TIPS

Fits all standard phone tip jacks

- Cat. No.
 402 Standard Phone Tip
 402A Phone Tip Larger Diam
 402B Heavy Duty Phone Tip

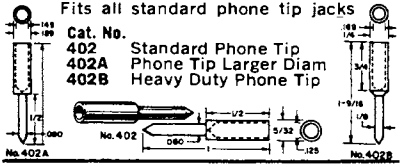

SCRULOK PHONE TIP

Fits standard phone tip jacks. Plug is brass, nickel plated. Has Scrulok solderless connection. Molded handle.

Colors: Red, Black, Yellow, Blue, Green, White.

Cat. No. 419

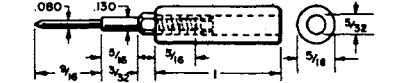

PHONE TIP

Plugs into standard phone tip jacks. Brass nickel plated plug. Accommodates standard banana plug in molded plastic handle.

Colors: Red, Black, Yellow, Blue, Green, White.

Cat. No. 331

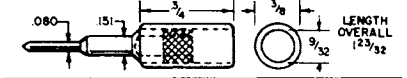

PHONE TIP PLUG No. 331A

Plugs into all standard phone tip jacks. Barrel of plug accommodates all standard banana jacks. Brass, nickel plated.

Cat. No. 331A Phone Tip Plug

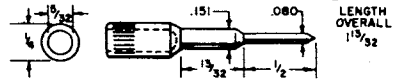

NEEDLE POINT PLUG

Brass nickel plated body. Needle point tip. Accommodates standard banana plug in molded plastic handle.

Colors: Red, Black.

Cat. No. 330

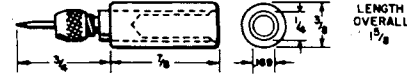

BAKELITE PENCIL TEST PROD

Body is brass nickel plated with steel n.pl. needle. Has Scrulok solderless connection. Bakelite handle.

Colors: Red, Black.

Cat. No. 411 Bakelite Pencil Test Prod

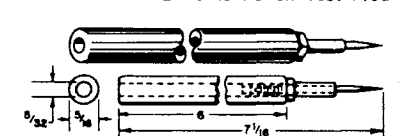

SOLDERLESS TEST PRODS

Body is brass nickel plated with solderless knurled nut connection. Heavy duty needle-point, nickel plated.

Colors: Red, Black.

Cat. No. (A) Overall (B) Handle Length

- 410 5 1/2" 4"
 343 6 1/4" 5"

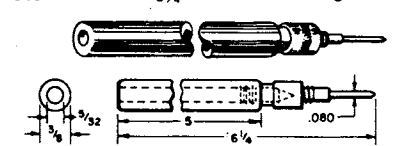

SCRULOK PHONE TIP

Brass nickel plated. Fits standard phone tip jacks. Scrulok solderless connection. Molded handle.

Colors: Red, Black, Yellow, Blue, Green, White.

Cat. No. 412



INSULATED SOLDERLESS PHONE TIPS No. 409

Insulated handles, fitted to solderless phone tips. Made of Brass, Nickel Plated. Wire easily attached by threading through hole in handle and tightening knurled nut.

Colors: Red, Black, Yellow, Blue, Green, White

Cat. No. 409 Senior Solderless Phone Tip

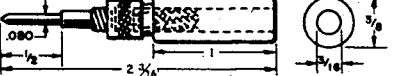

JUNIOR SOLDERLESS PHONE TIP

Same as above except 2" overall length. Specify colors.

Cat. No. 415Jr.



HEAVY DUTY TIP PLUG

Threaded

BODY: Brass, nickel plated.

DESCR.: Extra large well for soldering. Rear of plug accepts standard banana plugs. Fits standard phone tip jacks. Threaded for easy assembly in plastic handle.

No. 349A

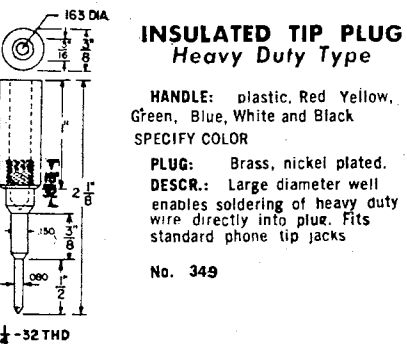

INSULATED TIP PLUG Heavy Duty Type

HANDLE: plastic. Red, Yellow, Green, Blue, White and Black
 SPECIFY COLOR

PLUG: Brass, nickel plated.

DESCR.: Large diameter well enables soldering of heavy duty wire directly into plug. Fits standard phone tip jacks

No. 349

TEST PRODS

NEEDLEPOINT TEST PRODS

Brass nickel plated body with steel nickel plated needle. Chuck threaded in end of handle is removable for replacing needles. Polished cast phenolic handle.

Cat. No. (A) Overall (B) Handle Length

- 344 4 1/4" 4"
 345 5 1/4" 5"

Colors: Red, Black.

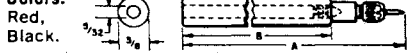

SCRULOK NEEDLEPOINT TEST PRODS

Phenolic insulated prod, has Scrulok solderless connection. Body is brass nickel plated with steel n.pl. needle.

Colors: Red, Black.

Cat. No. (A) Overall (B) Handle Length

- 417 5 3/32" 4"
 418 6 3/32" 5"

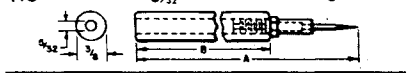

HEAVY DUTY HIGH VOLTAGE TEST PROD HANDLES No. 558

These bakelite prods are the same as used on the meter end of high voltage test leads Cat. No. 562. Tips are heavy brass with nickel plating.

Colors: Red, Black.

Cat. No. 558

1 1/2" H.V. Test Prod Handles

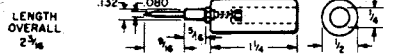

SOLDERLESS PHONE TIP No. 343A

Brass, nickel plated. Wire easily attached by threading thru hole provided, and tightening knurled nut. Threaded to take plastic handle.

Cat. No. 343A Solderless Phone Tip

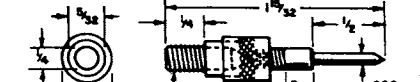

PUSH BUTTON PHONE TIP PLUGS

Wire is fastened easily, speedily, and securely without soldering. Simply by pressing the push buttons the bare wire can be inserted into the opening of the plug.

Colors: Red, Black.

Cat. No. 121 Push Button Phone Tip Plug

No. 121 Phone Tip Plug will fit all Standard Phone Tip Jacks.

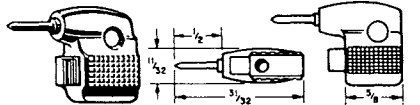

HIGH VOLTAGE TEST PROD TIP No. 559A

Heavy brass, nickel plated. Large solder well accommodates heavy wires. As used on Birnbach High Voltage Test prod Handle. No. 559 and 562 Test Leads.

Cat. No. 559A H.V. Test Prod Tip

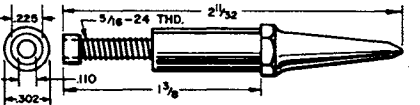

NEEDLE POINT PROD TIP No. 439

Extra heavy needle point for piercing insulations or plating. Solderless Scrulok wire connection. Brass, nickel plated body; needle point, steel, nickel plated. Replacement tip for No. 408 Leads.

Replacement Needle Point Prod Tip

Cat. No. 439

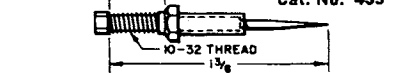

NEEDLE POINT PLUG No. 345A

Has a brass, nickel plated body, steel nickel plated needle. Sharp point will pierce insulation or plating. Has removable chuck for replacing needle. Threaded to take handle.

Cat. No. 345A Needlepoint Plug



HEAVY DUTY HI-VOLTAGE TEST PROD HANDLE

Tip is heavy brass nickel plated. Bakelite finger guard. Accommodates 1N-34 diode and condenser for use as RF Probe.

Colors: Red, Black.

Cat. No. 559

6" H.V. Test Prod Handles

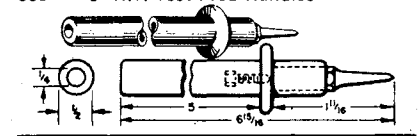

TEST PROD No. 424A

Shouldered insulated handle made of bakelite. Tip made of nickel-plated brass has set screw in side for securing conductor and thus making a solderless connection. Tip screw into handle. Available in Red and Black. Indicate color.

TEST PROD No. 424B with Banana Plug Adapter

Same as No. 424A except with a banana plug adapter in back of handle.

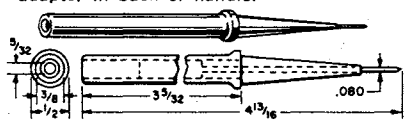

THE ORIGINAL AC POWER CONTROL UNITS

"Much more than an outlet box"

FEATURES

- PROTECTION BY FUSE OR CIRCUIT BREAKER
- U L APPROVED COMPONENTS
- PORTABLE OR STATIONARY
- SELF CONTAINED POWER SWITCHES
- RUGGED CONSTRUCTION
- REQUIRES LITTLE SPACE & EASY TO STORE
- LIFETIME NEON INDICATOR
- 2 PRONG & "U" GROUND OUTLETS
- EASY TO KEEP CLEAN
- FINISH OF BROWN HAMMERTONE OR CHROME
- RATED FOR 15 AMPS 130 VOLTS
- HEAVY DUTY LINE CORD

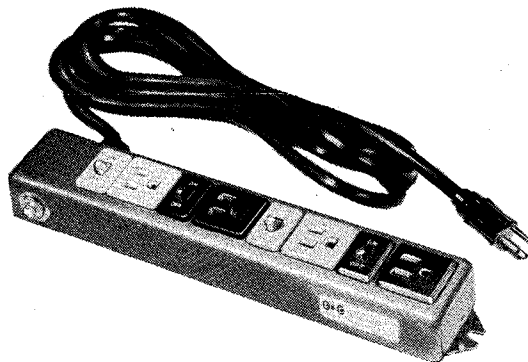

SS-GD Series — All models contain four colored sets of power switches and heavy duty "U" type outlets, paired for easy identification. Choice of fuse or circuit breaker protection. Dimension 13½" x 2¼" x 1½".

Model SS-GD (Fuse type, 10 Ft. cord)	\$ 8.95
Model SS-GD-15 (Fuse type, 15 Ft. cord)	9.95
Model SS-GD-CB (Circuit breaker, 10 Ft. cord)	10.75
Model SS-GD-CB-15 (Circuit breaker, 15 Ft. cord)	11.75

Add suffix CR to model number for chrome plating plus an additional \$1.50 to the net price.

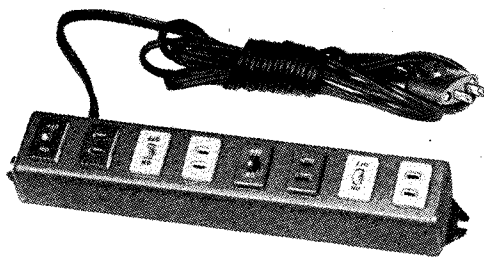

SS Series — Provides four independently controlled 2 prong outlets, each set in a contrasting color for easy recognition. Choice of fuse or circuit breaker protection. Dimensions 13½" x 2¼" x 1½".

Model SS (Fused plug 10 Ft. cord)	\$ 6.75
Model SS-F (Same as SS but with one fuse)	6.25
Model SS-CB (Circuit breaker 10 Ft. cord)	8.75

Add suffix CR to the model number for chrome plating plus an additional \$1.50 to the net price.

Model SS-2 — Provides two independently controlled 2 prong outlets, each set in a contrasting color for easy recognition. Dimensions 5" x 2" x 1¼".

(Fused plug 6 Ft. cord)	\$ 4.15
-------------------------	---------

Add suffix CR to the model number for chrome plating plus an additional \$1.00 to the net price.

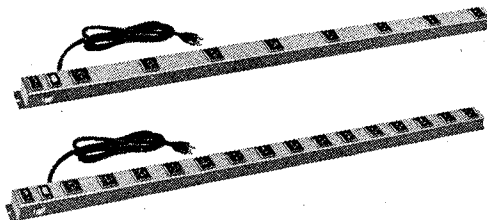

LL-GD Series — 4' HEAVY DUTY LONG LINE — Each unit has a switch and pilot light. With "U" type grounded outlets. Choice of fuse or circuit breaker protection. Dimensions 49" x 2" x 1½".

8 OUTLETS	
LL-GD-8-10 (Fuse type, 10 Ft. cord)	\$14.95
LL-GD-8-15 (Fuse type, 15 Ft. cord)	15.95
LL-GD-CB-8-10 (Circuit breaker, 10 Ft. cord)	15.95
LL-GD-CB-8-15 (Circuit breaker, 15 Ft. cord)	16.95
15 OUTLETS	
LL-GD-15-10 (Fuse type, 10 Ft. cord)	18.95
LL-GD-15-15 (Fuse type, 15 Ft. cord)	19.95
LL-GD-CB-15-10 (Circuit breaker 10 Ft. cord)	19.95
LL-GD-CB-15-15 (Circuit breaker 15 Ft. cord)	20.95

All prices are net and subject to change without notice.

NEW! NOISE LIMITER —

Line Filter available in any CBC power control. Shielded filter network prevents R.F. feedback into line. Add prefix "NL" to Power Control model number \$2.25 additional

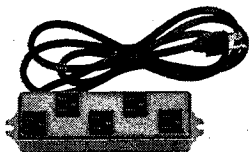

**NEW!
COMPACT
POWER CENTER**

Model C-MO-GD-15 — A convenient outlet box with 5 "U" type grounded outlets. Includes 15 ft., heavy-duty line cord. Dimensions 8⁵/₈" x 2¹/₄" x 1¹/₂" \$5.00

NEW!

19" RACK-MOUNT CONTROL PANELS

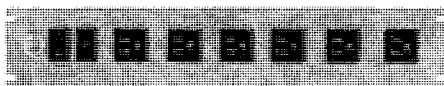

TR-MO-GD Series—One master switch controls power to six "U" type grounded outlets. Pilot light shows when power is on. Choice of fuse or circuit breaker protection. Dimensions 3¹/₂" x 19".

- Model TR-MO-GD-10 (Fuse type, 10 Ft. cord)..... \$10.95
- Model TR-MO-GD-15 (Fuse type, 15 Ft. cord)..... 11.95
- Model TR-MO-GD-CB-10 (Circuit breaker, 10 Ft. cord)..... 11.95
- Model TR-MO-GD-CB-15 (Circuit breaker, 15 Ft. cord)..... 12.95

TR-MO-GD-R Series—Same as above except that two outlets are on front of panel; four in rear.

- Model TR-MO-GD-R-10 (Fuse type, 10 Ft. cord)..... \$12.95
- Model TR-MO-GD-R-15 (Fuse type, 15 Ft. cord)..... 13.95
- Model TR-MO-GD-R-CB-10 (Circuit breaker, 10 Ft. cord)..... 13.95
- Model TR-MO-GD-R-CB-15 (Circuit breaker, 15 Ft. cord)..... 14.95

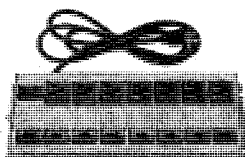

ML-SS-GD Series

One master switch controls power to seven color-coded "U" type ground outlets with color-matched sub-switches. Pilot light shows when master power switch is on. Choice of fuse or circuit breaker protection. Dimensions 13¹/₈" x 4³/₄" x 1⁵/₈".

7 OUTLETS

- Model ML-SS-GD-10 (Fuse type, 10 Ft. cord)..... \$15.50
- Model ML-SS-GD-15 (Fuse type, 15 Ft. cord)..... 16.50
- Model ML-SS-GD-CB-10 (Circuit breaker, 10 Ft. cord)..... 16.50
- Model ML-SS-GD-CB-15 (Circuit breaker, 15 Ft. cord)..... 17.50

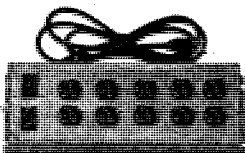

ML-MO-GD Series

Same as above except with 10 "U" type grounded outlets and without individual switches for each outlet.

- 10 OUTLETS
- Model ML-MO-GD-10 (Fuse type, 10 Ft. cord)..... \$13.50
- Model ML-MO-GD-15 (Fuse type, 15 Ft. cord)..... 14.50
- Model ML-MO-GD-CB-10 (Circuit breaker, 10 Ft. cord)..... 14.50
- Model ML-MO-GD-CB-15 (Circuit breaker, 15 Ft. cord)..... 15.50

CBC INDUSTRIES INC.

NEW!

Economy Long-Line Power Control



Model E-LL-GD-CB

One master switch controls 14 "U" type grounded outlets. Pilot light indicates when power is on. Circuit breaker protection. 10 Ft. line cord. Dimensions 49" x 2" x 1¹/₂".... \$16.75

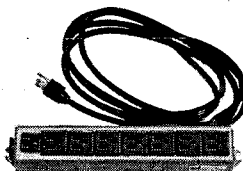

**POPULAR
EXTENSION
OUTLETS**

MO-GD-S Series—Lets you series string from the end of one unit to the cord at the beginning of the next. Seven "U" type grounded outlets with an 8th and 9th "U" type grounded outlet for series stringing. Dimensions 13¹/₈" x 2¹/₄" x 1¹/₂".

- Model MO-GD-S-10 (10 Ft. cord).....\$6.75
- Model MO-GD-S-15 (15 Ft. cord)..... 7.75



Model LL-SS-GD-CB



Model LL-SS-PL-GD-CB

LL-SS-GD-CB Series — 4 Ft., Heavy-Duty, Long-Line. Eight pairs of individually color-matched switches and "U" type grounded outlets. Individually colored pilot lights available on LL-SS-PL-GD Series. Circuit breaker protection on all models. Dimensions 49" x 2" x 1¹/₂".

- Model LL-SS-GD-CB-8-10 (10 Ft. cord)..... \$19.95
- Model LL-SS-GD-CB-8-15 (15 Ft. cord)..... 20.95
- Model LL-SS-PL-GD-CB-8-10 (with Pilot Lights, 10 Ft. cord).. 20.95
- Model LL-SS-PL-GD-CB-8-15 (with Pilot Lights, 15 Ft. cord).. 21.95

SPEEDTROL —

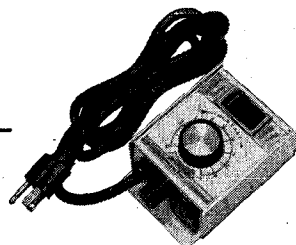

Solid-State Motor Speed Control

MODEL SC-2000—For use with any standard AC-DC universal motor. Handles up to 800 watts. Constant motor torque at all speed control settings. Precise speed adjustment from 3% to 50%. Speed can also be increased to 100%. Fused for circuit protection. Grounding type line cord and receptacle for maximum safety. Industrial quality for use with power tools and other heavy-duty applications... \$11.95

CBC INDUSTRIES INC.



"Jones" Type Plugs, Sockets

300 SERIES CONNECTORS are from the famous line of "Jones" plugs and sockets which have been a standard of the electrical and electronic industry for over a generation. For medium duty applications, they are small in size with good separation between contacts.

Molded bakelite insulator has 2 to 33 cadmium-plated phosphor-bronze contacts, for cap or panel mounting. All plugs and sockets are polarized so that plugs of one size cannot fit into sockets of another size. "Knife-switch" type socket contacts engage both sides of flat plug contacts, providing double contact area. Rated Voltage... 730 Volts rms. Contact Resistance... 0.16 Ohms max. Rated Current... 10A max.

In accordance with UL Standard #498, (all contacts carrying "rated" current simultaneously) as follows: Current (2-12 contacts).....7.5 amperes Wattage (2-12 contacts).....1875 watts
 (15-33 contacts).....4.5 amperes (15-33 contacts).....1125 watts

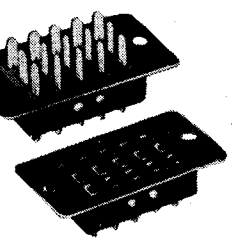
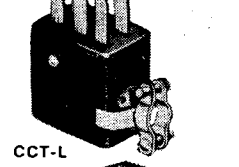
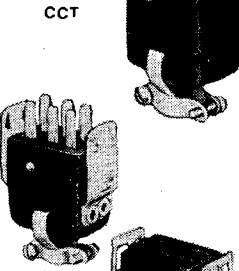
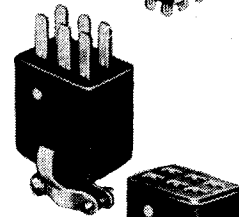
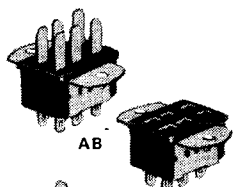

PLUGS WITH ANGLE BRACKETS

C-J No.	Contacts	Net Each, Lots of				
		1-24	25-49	50-99	100-249	250-499
P-302-AB	2	0.29	0.23	0.20	0.16	0.15
P-303-AB	3	.33	.26	.22	.18	.17
P-304-AB	4	.37	.29	.25	.20	.19
P-306-AB	6	.46	.37	.31	.24	.23
P-308-AB	8	.53	.42	.35	.28	.27
P-310-AB	10	.59	.47	.40	.32	.30
P-312-AB	12	.66	.53	.44	.35	.33
P-315-AB	15	.89	.71	.59	.47	.45
P-318-AB	18	1.07	.85	.71	.57	.54
P-321-AB	21	1.34	1.07	.89	.71	.68
P-324-AB	24	1.62	1.30	1.08	.86	.82
P-327-AB	27	1.90	1.52	1.27	1.01	.96
P-330-AB	30	2.18	1.74	1.45	1.16	1.10
P-333-AB	33	2.45	1.96	1.63	1.30	1.24

PLUGS WITH CABLE CLAMPS/TOP

C-J No.	Contacts	Net Each, Lots of				
		1-24	25-49	50-99	100-249	250-499
P-302-CCT	2	0.60	0.48	0.40	0.32	0.30
P-303-CCT	3	.66	.53	.44	.35	.33
P-304-CCT	4	.70	.56	.47	.37	.35
P-306-CCT	6	.80	.64	.53	.42	.40
P-308-CCT	8	.86	.69	.58	.46	.44
P-310-CCT	10	.95	.76	.64	.51	.46
P-312-CCT	12	1.03	.82	.69	.55	.52
P-315-CCT	15	1.37	1.10	.92	.73	.70
P-318-CCT	18	1.60	1.28	1.07	.85	.81
P-321-CCT	21	1.91	1.53	1.28	1.02	.97
P-324-CCT	24	2.24	1.79	1.50	1.20	1.14
P-327-CCT	27	2.57	2.05	1.71	1.37	1.30
P-330-CCT	30	2.89	2.31	1.93	1.54	1.46
P-333-CCT	33	3.20	2.56	2.14	1.71	1.62

PLUGS WITH CABLE CLAMPS/TOP & LOCKS

C-J No.	Contacts	Net Each, Lots of				
		1-24	25-49	50-99	100-249	250-499
P-302-CCT-L	2	0.75	0.60	0.50	0.40	0.38
P-303-CCT-L	3	.81	.65	.54	.43	.41
P-304-CCT-L	4	.85	.68	.57	.45	.43
P-306-CCT-L	6	.95	.76	.63	.50	.48
P-308-CCT-L	8	1.01	.81	.68	.54	.51
P-310-CCT-L	10	1.10	.88	.74	.59	.56
P-312-CCT-L	12	1.18	.94	.79	.63	.60
P-315-CCT-L	15	1.52	1.22	1.02	.81	.77
P-318-CCT-L	18	1.75	1.40	1.17	.93	.89
P-321-CCT-L	21	2.06	1.65	1.38	1.10	1.05
P-324-CCT-L	24	2.35	1.91	1.60	1.28	1.21
P-327-CCT-L	27	2.72	2.17	1.81	1.45	1.38
P-330-CCT-L	30	3.04	2.43	2.03	1.62	1.54
P-333-CCT-L	33	3.35	2.68	2.24	1.79	1.70

PLUGS WITH CABLE CLAMPS/END

C-J No.	Contacts	Net Each, Lots of				
		1-24	25-49	50-99	100-249	250-499
P-306-CCE	6	0.83	0.67	0.56	0.44	0.42
P-308-CCE	8	.90	.72	.60	.48	.46
P-310-CCE	10	.99	.79	.66	.53	.50
P-312-CCE	12	1.07	.85	.71	.57	.54
P-315-CCE	15	1.41	1.13	.94	.75	.71
P-318-CCE	18	1.64	1.31	1.09	.87	.83
P-321-CCE	21	1.95	1.56	1.30	1.04	.99
P-324-CCE	24	2.28	1.82	1.52	1.22	1.16
P-327-CCE	27	2.60	2.08	1.74	1.39	1.32
P-330-CCE	30	2.93	2.34	1.95	1.56	1.48
P-333-CCE	33	3.24	2.59	2.16	1.73	1.64

PLUGS WITH DEEP BRACKETS

C-J No.	Contacts	Net Each, Lots of				
		1-24	25-49	50-99	100-249	250-499
P-302-DB	2	0.72	0.58	0.48	0.38	0.37
P-303-DB	3	.73	.58	.49	.39	.37
P-304-DB	4	.77	.61	.51	.41	.39
P-306-DB	6	.86	.68	.57	.46	.43
P-308-DB	8	.92	.74	.62	.49	.47
P-312-DB	12	1.06	.85	.71	.56	.54
P-315-DB	15	1.30	1.04	.87	.69	.66
P-318-DB	18	1.55	1.24	1.04	.83	.79
P-321-DB	21	1.86	1.49	1.24	.99	.94
P-324-DB	24	2.18	1.75	1.46	1.16	1.11
P-327-DB	27	2.50	2.00	1.67	1.33	1.27
P-330-DB	30	2.81	2.25	1.88	1.50	1.43
P-333-DB	33	3.12	2.50	2.08	1.66	1.58

PLUGS WITH SHALLOW BRACKETS

C-J No.	Contacts	Net Each, Lots of				
		1-24	25-49	50-99	100-249	250-499
P-315-SB	15	1.30	1.04	0.87	0.69	0.66
P-318-SB	18	1.55	1.24	1.04	.83	.79
P-321-SB	21	1.86	1.49	1.24	.99	.94
P-324-SB	24	2.18	1.75	1.46	1.16	1.11
P-327-SB	27	2.50	2.00	1.67	1.33	1.27
P-330-SB	30	2.81	2.25	1.88	1.50	1.43
P-333-SB	33	3.12	2.50	2.08	1.66	1.58

SOCKETS WITH ANGLE BRACKETS

C-J No.	Contacts	Net Each, Lots of				
		1-24	25-49	50-99	100-249	250-499
S-302-AB	2	0.31	0.25	0.21	0.16	0.16
S-303-AB	3	.35	.28	.23	.18	.18
S-304-AB	4	.39	.31	.26	.21	.20
S-306-AB	6	.49	.39	.33	.26	.25
S-308-AB	8	.59	.47	.40	.32	.30
S-310-AB	10	.69	.55	.46	.37	.35
S-312-AB	12	.82	.65	.55	.44	.41
S-315-AB	15	1.04	.84	.69	.55	.52
S-318-AB	18	1.19	.95	.78	.64	.60
S-321-AB	21	1.47	1.18	.98	.78	.75
S-324-AB	24	1.75	1.40	1.17	.93	.89
S-327-AB	27	2.03	1.62	1.35	1.08	1.03
S-330-AB	30	2.33	1.86	1.55	1.24	1.18
S-333-AB	33	2.60	2.08	1.73	1.38	1.32

SOCKETS WITH CABLE CLAMPS/TOP

C-J No.	Contacts	Net Each, Lots of				
		1-24	25-49	50-99	100-249	250-499
S-302-CCT	2	0.62	0.50	0.42	0.33	0.32
S-303-CCT	3	.68	.54	.45	.36	.34
S-304-CCT	4	.72	.58	.48	.38	.37
S-306-CCT	6	.83	.66	.55	.44	.42
S-308-CCT	8	.93	.74	.62	.50	.47
S-310-CCT	10	1.05	.84	.70	.56	.53
S-312-CCT	12	1.19	.95	.79	.63	.60
S-315-CCT	15	1.52	1.22	1.02	.81	.77
S-318-CCT	18	1.73	1.38	1.15	.92	.87
S-321-CCT	21	2.05	1.64	1.37	1.09	1.04
S-324-CCT	24	2.37	1.90	1.58	1.26	1.14
S-327-CCT	27	2.69	2.15	1.80	1.44	1.36
S-330-CCT	30	3.04	2.43	2.03	1.62	1.54
S-333-CCT	33	3.35	2.68	2.24	1.79	1.70

SOCKETS WITH CABLE CLAMPS/TOP & KEEPERS

C-J No.	Contacts	Net Each, Lots of				
		1-24	25-49	50-99	100-249	250-499
S-302-CCT-K	2	0.77	0.62	0.52	0.41	0.39
S-303-CCT-K	3	.83	.66	.55	.44	.42
S-304-CCT-K	4	.87	.70	.58	.46	.44
S-306-CCT-K	6	.98	.78	.65	.52	.49
S-308-CCT-K	8	1.08	.86	.72	.58	.55
S-310-CCT-K	10	1.20	.96	.80	.64	.61
S-312-CCT-K	12	1.34	1.07	.89	.71	.68
S-315-CCT-K	15	1.67	1.34	1.12	.89	.85
S-318-CCT-K	18	1.88	1.50	1.25	1.00	.95
S-321-CCT-K	21	2.20	1.76	1.47	1.17	1.11
S-324-CCT-K	24	2.52	2.02	1.68	1.34	1.28
S-327-CCT-K	27	2.84	2.27	1.90	1.52	1.44
S-330-CCT-K	30	3.19	2.55	2.13	1.70	1.62
S-333-CCT-K	33	3.50	2.80	2.34	1.87	1.78

SOCKETS WITH CABLE CLAMPS/END

C-J No.	Contacts	Net Each, Lots of				
		1-24	25-49	50-99	100-249	250-499
S-306-CCE	6	0.86	0.69	0.58	0.46	0.44
S-308-CCE	8	.97	.77	.65	.52	.49
S-310-CCE	10	1.09	.87	.73	.58	.55
S-312-CCE	12	1.22	.98	.82	.65	.62
S-315-CCE	15	1.56	1.25	1.04	.83	.79
S-318-CCE	18	1.76	1.41	1.18	.94	.89
S-321-CCE	21	2.09	1.67	1.39	1.11	1.06
S-324-CCE	24	2.41	1.93	1.61	1.28	1.22
S-327-CCE	27	2.73	2.18	1.82	1.46	1.38
S-330-CCE	30	3.07	2.45	2.05	1.64	1.55
S-333-CCE	33	3.39	2.71	2.26	1.81	1.72

SOCKETS WITH DEEP BRACKETS

C-J No.	Contacts	Net Each, Lots of				
		1-24	25-49	50-99	100-249	250-499
S-302-DB	2	0.74	0.59	0.50	0.40	0.38
S-303-DB	3	.74	.59	.50	.40	.38
S-304-DB	4	.79	.63	.53	.42	.40
S-306-DB	6	.89	.71	.59	.47	.45
S-308-DB	8	.99	.79	.66	.53	.50
S-312-DB	12	1.22	.97	.81	.65	.62
S-315-DB	15	1.45	1.16	.97	.77	.73
S-318-DB	18	1.68	1.34	1.12	.90	.85
S-321-DB	21	2.00	1.60	1.33	1.06	1.01
S-324-DB	24	2.32	1.85	1.55	1.24	1.17
S-327-DB	27	2.63	2.10	1.75	1.40	1.33
S-330-DB	30	2.96	2.37	1.98	1.58	1.50
S-333-DB	33	3.27	2.62	2.18	1.74	1.66

SOCKETS WITH SHALLOW BRACKETS

C-J No.	Contacts	Net Each, Lots of				
		1-24	25-49	50-99	100-249	250-499
S-315-SB	15	1.45	1.16	0.97	0.77	0.73
S-318-SB	18	1.68	1.34	1.12	.90	

Barrier Terminal Blocks

Interposed barriers between terminal positions in Jones Barrier Terminal Blocks produce higher voltage ratings and protection from frayed wire faults. Bakelite base has eyelets and binder screws of nickel plated brass.



TERMINALS
Barrier type terminal blocks are also available where indicated with "Y", "W", or "3/4 W" terminals. Made of hot-solder-dipped brass. For blocks with "W" terminals, change suffix "Y" to "W", for blocks with "3/4 W" terminals, change suffix "Y" to "3/4 W" (2-172-W, 2-172-3/4 W, etc.); same price.

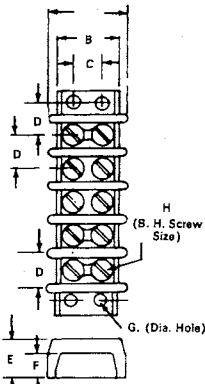

SERIES DIMENSIONS

	140	141	142	164
A	3/8"	1 1/8"	1 1/4"	3/4"
B	1 1/16"	3/4"	1 1/8"	1 1/16"
C	3/16"	2 3/4"	1/2"	5/16"
D	3/8"	3/8"	3/8"	3/8"
E	1 13/32"	1/2"	5/8"	1 13/32"
F	1/4"	3/8"	3/8"	1/4"
G	.160"	.175"	.209"	.171" / .175"
H	5/40 x 3/16"	6/32 x 1/4"	8/32 x 3/16"	6/32 x 1/4"

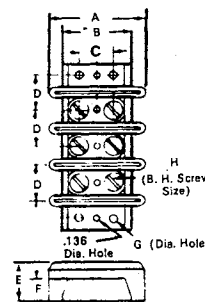

SERIES DIMENSIONS

	150	151	152
A	1 13/16"	2"	2 1/2"
B	1 1/16"	1 1/2"	1 13/16"
C	3/8"	3/4"	3/8"
D	1 1/16"	3/8"	1 1/4"
E	3/4"	1 1/8"	1 1/8"
F	7/16"	1/2"	3/8"
G	.160"	.180"	.209"
H	10/32 x 3/16"	12/32 x 3/8"	1/4 x 2/8"

140 SERIES

C-J No.	Contacts	Net Each, Lots of				
		1-24	25-49	50-99	100-249	250-499
1-140	1	0.19	0.15	0.13	0.11	0.10
2-140	2	.23	.19	.16	.13	.12
3-140	3	.27	.22	.18	.15	.14
4-140	4	.33	.26	.22	.18	.17
5-140	5	.41	.32	.27	.22	.21
6-140	6	.47	.37	.31	.25	.24
7-140	7	.53	.43	.36	.28	.27
8-140	8	.61	.49	.41	.32	.31
9-140	9	.68	.54	.45	.36	.34
10-140	10	.75	.60	.50	.40	.38
11-140	11	.81	.65	.54	.43	.41
12-140	12	.89	.71	.59	.47	.45
13-140	13	.95	.76	.64	.51	.48
14-140	14	1.03	.82	.69	.55	.52
15-140	15	1.10	.88	.73	.58	.56
16-140	16	1.16	.93	.78	.62	.59
17-140	17	1.23	.98	.82	.66	.62
18-140	18	1.30	1.04	.87	.69	.66
19-140	19	1.37	1.09	.91	.73	.69
20-140	20	1.43	1.15	.96	.76	.73
21-140	21	1.51	1.21	1.01	.80	.76

141 SERIES

C-J No.	Contacts	Net Each, Lots of				
		1-24	25-49	50-99	100-249	250-499
1-141	1	0.23	0.19	0.16	0.13	0.12
2-141	2	.26	.20	.17	.14	.13
3-141	3	.34	.27	.23	.18	.17
4-141	4	.43	.34	.29	.23	.22
5-141	5	.52	.41	.35	.28	.26
6-141	6	.59	.47	.40	.32	.30
7-141	7	.70	.56	.47	.37	.35
8-141	8	.78	.62	.52	.42	.40
9-141	9	.86	.69	.58	.46	.44
10-141	10	.96	.77	.64	.51	.49
11-141	11	1.04	.83	.70	.56	.53
12-141	12	1.13	.90	.75	.60	.57
13-141	13	1.22	.97	.81	.65	.62
14-141	14	1.31	1.04	.87	.70	.66
15-141	15	1.39	1.11	.93	.74	.70
16-141	16	1.48	1.18	.99	.79	.75
17-141	17	1.57	1.25	1.05	.84	.79
18-141	18	1.66	1.33	1.11	.88	.84
19-141	19	1.75	1.40	1.17	.93	.89
20-141	20	1.84	1.47	1.23	.98	.93

142 SERIES

C-J No.	Contacts	Net Each, Lots of				
		1-24	25-49	50-99	100-249	250-499
1-142	1	0.26	0.20	0.17	0.14	0.13
2-142	2	.30	.24	.20	.16	.15
3-142	3	.41	.32	.27	.22	.21
4-142	4	.51	.41	.34	.27	.26
5-142	5	.62	.49	.41	.33	.31
6-142	6	.73	.58	.49	.39	.37
7-142	7	.84	.67	.56	.45	.43
8-142	8	.95	.76	.63	.50	.48
9-142	9	1.05	.84	.70	.56	.53
10-142	10	1.17	.94	.78	.62	.59
11-142	11	1.28	1.02	.85	.68	.65
12-142	12	1.39	1.11	.93	.74	.70
13-142	13	1.50	1.20	1.00	.80	.76
14-142	14	1.61	1.29	1.08	.86	.82
15-142	15	1.73	1.38	1.15	.92	.87
16-142	16	1.84	1.47	1.23	.98	.93
17-142	17	1.95	1.56	1.30	1.04	.99

150 SERIES

C-J No.	Contacts	Net Each, Lots of				
		1-24	25-49	50-99	100-249	250-499
1-150	1	0.56	0.45	0.38	0.30	0.29
2-150	2	.75	.60	.50	.40	.38
3-150	3	1.05	.84	.70	.56	.53
4-150	4	1.36	1.09	.91	.72	.69
5-150	5	1.67	1.33	1.11	.89	.84
6-150	6	1.97	1.58	1.32	1.05	1.00
7-150	7	2.28	1.82	1.52	1.21	1.16
8-150	8	2.59	2.07	1.73	1.38	1.31
9-150	9	2.90	2.32	1.93	1.54	1.47
10-150	10	3.20	2.56	2.14	1.71	1.62

151 SERIES

C-J No.	Contacts	Net Each, Lots of				
		1-24	25-49	50-99	100-249	250-499
1-151	1	0.83	0.66	0.55	0.44	0.42
2-151	2	1.35	1.08	.90	.72	.68
3-151	3	1.95	1.56	1.30	1.04	.99
4-151	4	2.55	2.04	1.70	1.36	1.29
5-151	5	3.15	2.52	2.10	1.68	1.59
6-151	6	3.75	3.00	2.50	2.00	1.90
7-151	7	4.35	3.48	2.90	2.32	2.20
8-151	8	4.95	3.96	3.30	2.64	2.51

152 SERIES

C-J No.	Contacts	Net Each, Lots of				
		1-24	25-49	50-99	100-249	250-499
1-152	1	1.58	1.26	1.05	0.84	0.80
2-152	2	2.25	1.80	1.50	1.20	1.14
3-152	3	3.08	2.46	2.05	1.64	1.56
4-152	4	3.90	3.12	2.60	2.08	1.98
5-152	5	4.73	3.78	3.15	2.52	2.39
6-152	6	5.55	4.44	3.70	2.96	2.81

140-Y, W SERIES

C-J No.	Contacts	Net Each, Lots of				
		1-24	25-49	50-99	100-249	250-499
1-140-Y	1	0.23	0.19	0.16	0.13	0.12
2-140-Y	2	.29	.23	.20	.16	.15
3-140-Y	3	.36	.29	.24	.19	.18
4-140-Y	4	.46	.37	.31	.24	.23
5-140-Y	5	.56	.45	.38	.30	.29
6-140-Y	6	.66	.53	.44	.35	.33
7-140-Y	7	.76	.61	.51	.40	.38
8-140-Y	8	.86	.69	.58	.46	.44
9-140-Y	9	.97	.77	.65	.52	.49
10-140-Y	10	1.07	.86	.72	.57	.54
11-140-Y	11	1.16	.93	.78	.62	.59
12-140-Y	12	1.27	1.01	.85	.68	.64
13-140-Y	13	1.37	1.10	.92	.73	.70
14-140-Y	14	1.48	1.18	.99	.79	.75
15-140-Y	15	1.58	1.26	1.05	.84	.80
16-140-Y	16	1.67	1.34	1.12	.89	.85
17-140-Y	17	1.78	1.42	1.19	.95	.90
18-140-Y	18	1.88	1.50	1.25	1.00	.95
19-140-Y	19	1.97	1.58	1.32	1.05	1.00
20-140-Y	20	2.07	1.66	1.38	1.10	1.05
21-140-Y	21	2.18	1.75	1.46	1.16	1.11

*For 3/4W or W Series, substitute for Y such as 1-140-3/4W. Mounting Centers and Overall Lengths same as 140 Series. See Distributor for exact prices which are slightly higher than for Y Series.

141-Y, W SERIES

C-J No.	Contacts	Net Each, Lots of				
		1-24	25-49	50-99	100-249	250-499
1-141-Y	1	0.28	0.22	0.19	0.15	0.14
2-141-Y	2	.35	.28	.23	.18	.18
3-141-Y	3	.47	.38	.32	.25	.24
4-141-Y	4	.61	.49	.41	.32	.31
5-141-Y	5	.74	.59	.49	.39	.37
6-141-Y	6	.85	.68	.57	.45	.43
7-141-Y	7	1.00	.80	.67	.53	.51
8-141-Y	8	1.12	.89	.75	.60	.57
9-141-Y	9	1.24	.99	.83	.66	.63
10-141-Y	10	1.38	1.10	.92	.74	.70
11-141-Y	11	1.51	1.21	1.01	.80	.76
12-141-Y	12	1.64	1.31	1.09	.87	.83
13-141-Y	13	1.78	1.42	1.19	.95	.90
14-141-Y	14	1.91	1.53	1.28	1.02	.97
15-141-Y	15	2.04	1.63	1.36	1.09	1.03
16-141-Y	16	2.18	1.75	1.46	1.16	1.11
17-141-Y	17	2.32	1.85	1.55	1.24	1.17
18-141-Y	18	2.45	1.96	1.64	1.31	1.24
19-141-Y	19	2.60	2.08	1.73	1.38	1.32
20-141-Y	20	2.73	2.18	1.82	1.46	1.38

*For 3/4W or W Series, substitute for Y, such as 1-141-3/4W. Mounting Centers and Overall Lengths same as 141 Series. See Distributor for exact prices which are slightly higher than for Y Series.

142-Y, W SERIES

C-J No.	Contacts	Net Each, Lots of				
		1-24	25-49	50-99	100-249	250-499
1-142-Y	1	0.31	0.25	0.21	0.16	0.16
2-142-Y	2	.42	.34	.28	.22	.21
3-142-Y	3	.57	.46	.38	.30	.29
4-142-Y	4	.74	.59	.49	.39	.37
5-142-Y	5	.89	.71	.60	.48	.45
6-142-Y	6	1.07	.85	.71	.57	.54
7-142-Y	7	1.23	.98	.82	.66	.62
8-142-Y	8	1.35	1.11	.93	.74	.70
9-142-Y	9	1.55	1.24	1.03	.82	.78
10-142-Y	10	1.73	1.38	1.15	.92	.87
11-142-Y	11	1.88	1.51	1.26	1.00	.95
12-142-Y	12	2.05	1.64	1.37	1.09	1.04
13-142-Y	13	2.22	1.78	1.48	1.18	1.13
14-142-Y	14	2.38	1.90	1.59	1.27	1.21
15-142-Y	15	2.55	2.04	1.70	1.36	1.29
16-142-Y	16	2.72	2.18	1.82	1.45	1.38
17-142-Y	17	2.88	2.30	1.92	1.54	1.46

*For 3/4W or W Series, substitute for Y

Barrier Block Fanning Strips

Fanning strips serve as a convenient means for rapidly making and removing connections from barrier terminal blocks. They facilitate cable or harness wiring and minimize the possibility of subsequent wiring errors. Both straight and angle type fanning strips are available. Terminals are made of .032" brass, cadmium-plated. The 3/32" thick, 1/2" wide XP black phenolic mounts are furnished with a hole, in either the right or left side, for securing the cable with lacing twine. For larger sizes, use of a cable clamp is recommended.

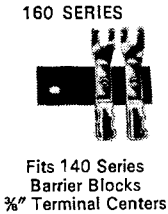

STRAIGHT TYPE—160 SERIES

No. of Term.	C-J Number		Net Each, Lots of				
	C. C. Hole on Left	C. C. Hole on Right	1-24	25-49	50-99	100-249	250-499
2	2-160-L	2-160-R	\$0.22	\$0.17	\$0.15	\$0.13	\$0.12
3	3-160-L	3-160-R	.26	.22	.18	.15	.14
4	4-160-L	4-160-R	.33	.26	.23	.18	.17
5	5-160-L	5-160-R	.39	.31	.26	.21	.20
6	6-160-L	6-160-R	.44	.35	.29	.23	.22
7	7-160-L	7-160-R	.51	.40	.33	.26	.25
8	8-160-L	8-160-R	.55	.44	.37	.30	.28
9	9-160-L	9-160-R	.63	.51	.43	.33	.32
10	10-160-L	10-160-R	.70	.56	.47	.37	.36
11	11-160-L	11-160-R	.77	.61	.52	.41	.39
12	12-160-L	12-160-R	.86	.69	.58	.46	.44
13	13-160-L	13-160-R	.94	.75	.63	.51	.47
14	14-160-L	14-160-R	.99	.78	.66	.53	.49
15	15-160-L	15-160-R	1.04	.83	.69	.55	.53
16	16-160-L	16-160-R	1.12	.89	.75	.60	.56
17	17-160-L	17-160-R	1.15	.92	.77	.61	.59
18	18-160-L	18-160-R	1.20	.95	.81	.64	.61
19	19-160-L	19-160-R	1.27	1.01	.85	.68	.64
20	20-160-L	20-160-R	1.32	1.06	.89	.70	.67
21	21-160-L	21-160-R	1.39	1.12	.93	.74	.70

160A SERIES



Fits 140 Series Barrier Blocks % Terminal Centers

ANGLE TYPE—160A SERIES

No. of Term.	C-J Number		Net Each, Lots of				
	C. C. Hole on Left	C. C. Hole on Right	1-24	25-49	50-99	100-249	250-499
2	2-160A-L	2-160A-R	\$0.26	\$0.22	\$0.18	\$0.15	\$0.14
3	3-160A-L	3-160A-R	.33	.26	.23	.18	.17
4	4-160A-L	4-160A-R	.44	.35	.29	.23	.22
5	5-160A-L	5-160A-R	.53	.43	.36	.28	.26
6	6-160A-L	6-160A-R	.63	.51	.43	.33	.32
7	7-160A-L	7-160A-R	.70	.56	.47	.37	.36
8	8-160A-L	8-160A-R	.86	.69	.58	.46	.44
9	9-160A-L	9-160A-R	.95	.77	.64	.51	.48
10	10-160A-L	10-160A-R	1.04	.83	.69	.55	.53
11	11-160A-L	11-160A-R	1.15	.92	.77	.61	.59
12	12-160A-L	12-160A-R	1.20	.95	.81	.64	.61
13	13-160A-L	13-160A-R	1.32	1.06	.89	.70	.67
14	14-160A-L	14-160A-R	1.44	1.15	.97	.77	.74
15	15-160A-L	15-160A-R	1.54	1.23	1.02	.82	.78
16	16-160A-L	16-160A-R	1.63	1.30	1.09	.87	.83
17	17-160A-L	17-160A-R	1.73	1.38	1.15	.92	.87
18	18-160A-L	18-160A-R	1.85	1.47	1.23	.99	.93
19	19-160A-L	19-160A-R	1.97	1.58	1.31	1.05	1.00
20	20-160A-L	20-160A-R	2.04	1.63	1.36	1.08	1.04
21	21-160A-L	21-160A-R	2.13	1.70	1.43	1.14	1.08

STRAIGHT TYPE—160B SERIES

No. of Term.	C-J Number		Net Each, Lots of				
	C. C. Hole on Left	C. C. Hole on Right	1-24	25-49	50-99	100-249	250-499
2	2-160B-L	2-160B-R	\$0.26	\$0.22	\$0.18	\$0.15	\$0.14
3	3-160B-L	3-160B-R	.33	.26	.23	.18	.17
4	4-160B-L	4-160B-R	.44	.35	.29	.23	.22
5	5-160B-L	5-160B-R	.53	.43	.36	.28	.26
6	6-160B-L	6-160B-R	.63	.51	.43	.33	.32
7	7-160B-L	7-160B-R	.70	.56	.47	.37	.36
8	8-160B-L	8-160B-R	.86	.69	.58	.46	.44
9	9-160B-L	9-160B-R	.95	.77	.64	.51	.48
10	10-160B-L	10-160B-R	1.04	.83	.69	.55	.53
11	11-160B-L	11-160B-R	1.15	.92	.77	.61	.59
12	12-160B-L	12-160B-R	1.20	.95	.81	.64	.61
13	13-160B-L	13-160B-R	1.32	1.06	.89	.70	.67
14	14-160B-L	14-160B-R	1.44	1.15	.97	.77	.74
15	15-160B-L	15-160B-R	1.54	1.23	1.02	.82	.78
16	16-160B-L	16-160B-R	1.63	1.30	1.09	.87	.83
17	17-160B-L	17-160B-R	1.73	1.38	1.15	.92	.87
18	18-160B-L	18-160B-R	1.85	1.47	1.23	.99	.93
19	19-160B-L	19-160B-R	1.97	1.58	1.31	1.05	1.00
20	20-160B-L	20-160B-R	2.04	1.63	1.36	1.08	1.04
21	21-160B-L	21-160B-R	2.13	1.70	1.43	1.14	1.08

160BA SERIES



Fits 140 Series Barrier Blocks % Terminal Centers

ANGLE TYPE—160BA SERIES

No. of Term.	C-J Number		Net Each, Lots of				
	C. C. Hole on Left	C. C. Hole on Right	1-24	25-49	50-99	100-249	250-499
2	2-160BA-L	2-160BA-R	\$0.26	\$0.22	\$0.18	\$0.15	\$0.14
3	3-160BA-L	3-160BA-R	.33	.26	.23	.18	.17
4	4-160BA-L	4-160BA-R	.44	.35	.29	.23	.22
5	5-160BA-L	5-160BA-R	.53	.43	.36	.28	.26
6	6-160BA-L	6-160BA-R	.63	.51	.43	.33	.32
7	7-160BA-L	7-160BA-R	.70	.56	.47	.37	.36
8	8-160BA-L	8-160BA-R	.86	.69	.58	.46	.44
9	9-160BA-L	9-160BA-R	.95	.77	.64	.51	.48
10	10-160BA-L	10-160BA-R	1.04	.83	.69	.55	.53
11	11-160BA-L	11-160BA-R	1.15	.92	.77	.61	.59
12	12-160BA-L	12-160BA-R	1.20	.95	.81	.64	.61
13	13-160BA-L	13-160BA-R	1.32	1.06	.89	.70	.67
14	14-160BA-L	14-160BA-R	1.44	1.15	.97	.77	.74
15	15-160BA-L	15-160BA-R	1.54	1.23	1.02	.82	.78
16	16-160BA-L	16-160BA-R	1.63	1.30	1.09	.87	.83
17	17-160BA-L	17-160BA-R	1.73	1.38	1.15	.92	.87
18	18-160BA-L	18-160BA-R	1.85	1.47	1.23	.99	.93
19	19-160BA-L	19-160BA-R	1.97	1.58	1.31	1.05	1.00
20	20-160BA-L	20-160BA-R	2.04	1.63	1.36	1.08	1.04
21	21-160BA-L	21-160BA-R	2.13	1.70	1.43	1.14	1.08

STRAIGHT TYPE—161 SERIES

No. of Term.	C-J Number		Net Each, Lots of				
	C. C. Hole on Left	C. C. Hole on Right	1-24	25-49	50-99	100-249	250-499
2	2-161-L	2-161-R	\$0.24	\$0.20	\$0.16	\$0.14	\$0.13
3	3-161-L	3-161-R	.30	.23	.20	.16	.15
4	4-161-L	4-161-R	.33	.26	.23	.18	.17
5	5-161-L	5-161-R	.40	.32	.28	.22	.21
6	6-161-L	6-161-R	.46	.37	.31	.24	.23
7	7-161-L	7-161-R	.53	.43	.36	.28	.26
8	8-161-L	8-161-R	.58	.46	.39	.31	.30
9	9-161-L	9-161-R	.63	.51	.43	.33	.32
10	10-161-L	10-161-R	.72	.58	.48	.39	.37
11	11-161-L	11-161-R	.82	.66	.55	.44	.41
12	12-161-L	12-161-R	.89	.71	.60	.47	.45
13	13-161-L	13-161-R	.95	.77	.64	.51	.48
14	14-161-L	14-161-R	1.01	.81	.68	.54	.52
15	15-161-L	15-161-R	1.06	.84	.70	.56	.53
16	16-161-L	16-161-R	1.13	.91	.76	.60	.58
17	17-161-L	17-161-R	1.17	.94	.78	.62	.60
18	18-161-L	18-161-R	1.27	1.01	.84	.67	.63
19	19-161-L	19-161-R	1.30	1.04	.86	.69	.65
20	20-161-L	20-161-R	1.37	1.09	.91	.72	.69

ANGLE TYPE—161A SERIES

No. of Term.	C-J Number		Net Each, Lots of				
	C. C. Hole on Left	C. C. Hole on Right	1-24	25-49	50-99	100-249	250-499
2	2-161A-L	2-161A-R	\$0.26	\$0.22	\$0.18	\$0.15	\$0.14
3	3-161A-L	3-161A-R	.33	.26	.23	.18	.17
4	4-161A-L	4-161A-R	.44	.35	.29	.23	.22
5	5-161A-L	5-161A-R	.53	.43	.36	.28	.26
6	6-161A-L	6-161A-R	.63	.51	.43	.33	.32
7	7-161A-L	7-161A-R	.70	.56	.47	.37	.36
8	8-161A-L	8-161A-R	.86	.69	.58	.46	.44
9	9-161A-L	9-161A-R	.95	.77	.64	.51	.48
10	10-161A-L	10-161A-R	1.04	.83	.69	.55	.53
11	11-161A-L	11-161A-R	1.15	.92	.77	.61	.59
12	12-161A-L	12-161A-R	1.20	.95	.81	.64	.61
13	13-161A-L	13-161A-R	1.32	1.06	.89	.70	.67
14	14-161A-L	14-161A-R	1.44	1.15	.97	.77	.74
15	15-161A-L	15-161A-R	1.54	1.23	1.02	.82	.78
16	16-161A-L	16-161A-R	1.63	1.30	1.09	.87	.83
17	17-161A-L	17-161A-R	1.73	1.38	1.15	.92	.87
18	18-161A-L	18-161A-R	1.85	1.47	1.23	.99	.93
19	19-161A-L	19-161A-R	1.97	1.58	1.31	1.05	1.00
20	20-161A-L	20-161A-R	2.04	1.63	1.36	1.08	1.04

STRAIGHT TYPE—162 SERIES

No. of Term.	C-J Number		Net Each, Lots of				
	C. C. Hole on Left	C. C. Hole on Right	1-24	25-49	50-99	100-249	250-499
2	2-162-L	2-162-R	\$0.26	\$0.22	\$0.18	\$0.15	\$0.14
3	3-162-L	3-162-R	.31	.25	.21	.17	.16
4	4-162-L	4-162-R	.39	.31	.26	.21	.20
5	5-162-L	5-162-R	.44	.35	.29	.23	.22
6	6-162-L	6-162-R	.51	.44	.37	.30	.28
7	7-162-L	7-162-R	.55	.44	.37	.30	.28
8	8-162-L	8-162-R	.63	.51	.43	.33	.32
9	9-162-L	9-162-R	.68	.54	.45	.36	.35
10	10-162-L	10-162-R	.75	.60	.51	.40	.38
11	11-162-L	11-162-R	.84	.67	.56	.45	.43
12	12-162-L	12-162-R	.94	.75	.63	.51	.47
13	13-162-L	13-162-R	.99	.78	.66	.53	.49
14	14-162-L	14-162-R	1.04	.83	.69	.55	.53
15	15-162-L	15-162-R	1.10	.89	.74	.59	.56
16	16-162-L	16-162-R	1.15	.92	.77	.61	.59
17	17-162-L	17-162-R	1.20	.95	.81	.64	.61

ANGLE TYPE—162A SERIES

No. of Term.	C-J Number		Net Each, Lots of				
	C. C. Hole on Left	C. C. Hole on Right	1-24	25-49			



Printed Circuit Edge Connectors

BIFURCATED CONTACT EDGE CONNECTORS



Designed for minimum printed circuit card wear, low insertion force and positive contact with printed circuit board. Insulation is glass-filled diallyl phthalate, type SDG-F per MIL-M-14. Contacts are of phosphor bronze with .00003" minimum gold plated. Types 250, 251 and 252 utilize bifurcated contacts, permitting two flexing surfaces instead of one for positive contact.

Bifurcated contacts are especially recommended for added contact reliability where vibration or printed circuit board irregularities would otherwise cause trouble. Connectors meet requirements of MIL-C-21097A (Ships) where applicable. One plastic polarizing key furnished unassembled. Rating: 830 v. AC rms.

C-J No.		Cont. Pos.	No. of Cont.	Net Each, Lots of				
				1-24	25-49	50-99	100-249	250-499
50-6A-20	6	6	12	1.23	0.98	0.82	0.66	0.62
50-10A-20	10	10	10	1.65	1.32	1.10	.88	.84
50-12A-20	12	12	12	1.86	1.49	1.24	.99	.94
50-15A-20	15	15	15	2.18	1.74	1.45	1.16	1.10
50-18A-20	18	18	18	2.49	1.99	1.66	1.33	1.26
50-22A-20	22	22	22	2.91	2.33	1.94	1.55	1.47
50-25A-20	25	25	25	3.47	2.77	2.31	1.85	1.76

C-J No.		Cont. Pos.	No. of Cont.	Net Each, Lots of				
				1-24	25-49	50-99	100-249	250-499
50-12A-30	6	12	12	1.23	0.98	0.82	0.66	0.62
50-20A-30	10	20	10	1.65	1.32	1.10	.88	.84
50-24A-30	12	24	12	1.86	1.49	1.24	.99	.94
50-30A-30	15	30	15	2.18	1.74	1.45	1.16	1.10
50-36A-30	18	36	18	2.49	1.99	1.66	1.33	1.27
50-44A-30	22	44	22	2.91	2.33	1.94	1.55	1.47
50-50A-30	25	50	25	3.47	2.77	2.31	1.85	1.76

C-J No.		Cont. Pos.	No. of Cont.	Net Each, Lots of				
				1-24	25-49	50-99	100-249	250-499
50-12B-10	6	12	12	1.23	0.98	0.82	0.66	0.62
50-20B-10	10	20	10	1.65	1.32	1.10	.88	.84
50-24B-10	12	24	12	1.86	1.49	1.24	.99	.94
50-30B-10	15	30	15	2.18	1.74	1.45	1.16	1.10
50-36B-10	18	36	18	2.49	1.99	1.66	1.33	1.26
50-44B-10	22	44	22	2.91	2.33	1.94	1.55	1.47

C-J No.		Cont. Pos.	No. of Cont.	Net Each, Lots of				
				1-24	25-49	50-99	100-249	250-499
50-12B-20	6	12	12	3.00	2.40	2.00		
50-20B-20	10	20	10	3.75	3.00	2.50		
50-24B-20	12	24	12	4.50	3.60	2.75		
50-30B-20	15	30	15	4.69	3.75	3.13		
50-36B-20	18	36	18	5.25	4.20	3.50		

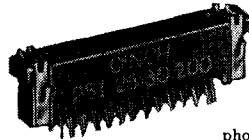

High density edge connectors with .050" centers for use with double-sided .062" printed circuit boards. Conventional wiring tails. Insulator is diallyl phthalate, type SDG-F per MIL-M-14. Contacts are phosphor bronze with .00003" gold plate. Carbon steel mounting for use in semi-flush printed circuit mounting, and cellulose acetate polarizing key available as separate items.

TYKON EDGE CONNECTORS

C-J No.		Cont. Pos.	No. of Cont.	Net Each, Lots of				
				1-24	25-49	50-99	100-249	250-499
50-12A-40	6	12	12	3.35	2.68	2.23	1.78	1.70
50-20A-40	10	20	10	4.13	3.30	2.75	2.20	2.09
50-30A-40	15	30	15	5.10	4.09	3.41	2.72	2.59
50-40A-40	20	40	20	6.08	4.86	4.05	3.24	3.08
50-50A-40	25	50	25	7.05	5.64	4.70	3.76	3.57
50-MC			(Mounting Clip)	.15	.12	.10	.09	.08
50-PK			(Polarizing Key)	.15	.12	.10	.09	.08

Rack and Panel Connectors

BLUE Ribbon CONNECTORS

Ideal and used universally in a wide variety of applications. Proven reliability combines with smooth, easy insertion action. Self-wiping and self-cleaning contacts available in linear arrays up to 32 per unit. Barrier-type polarization and interlocking mating of dielectric bodies gives easy alignment without visual aid. Ribbon contacts can't bend. Rectangular body for easy layout. Corrosion resistant, passivated stainless steel mounting plates are molded in. **Current:** 5 amps. **Voltage:** 800 VDC at sea level; 300 VDC at 70,000 ft. **Insulator:** Diallyl phthalate per MIL-M-14F. **Type MDG. Plug Contacts:** Gold per MIL-G-14204 over silver per QQ-S-365 on copper per ASTM-B-152. **Type RTP. Receptacle Contacts:** Gold per MIL-G-14202 over silver per QQ-S-365 on phosphor bronze per ASTM-B-103-51. **MIL-B-892. Grade A. Size:** (Other than shown in table below): Body 3/8" w. x 1/2" d. below mtg. plate, socket; 3/8" d., plug Mtg. plate 1/2" wide. Plug mtg. holes .125" dia.; socket, in bushing .116" dia. **Code:** Suffix indicates number of contacts (-8, -16, etc.); S, socket; P, plug.

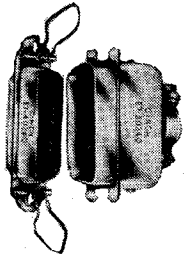
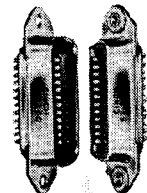
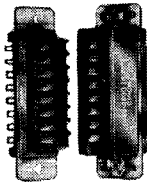

C-J No.	Dimensions, Inches			Net Each, Lots of			
	Plate Lgth.	Mtg. Ctrs.	Body Lgth.	1-9	10-49	50-99	100-249
26-4100-8P	1 1/4	1.375	1 1/4	\$1.06	\$0.89	\$0.72	\$0.65
26-4200-8S	1 1/4	1.375	1 1/4	1.73	1.46	1.19	1.07
26-4100-16P	2 1/4	2.125	2 1/4	1.98	1.67	1.35	1.22
26-4200-16S	2 1/4	2.125	2 1/4	2.52	2.12	1.72	1.55
26-4100-24P	3 1/4	2.875	3 1/4	2.38	2.01	1.63	1.46
26-4200-24S	3 1/4	2.875	3 1/4	2.98	2.51	2.04	1.83
26-4100-32P	4 1/4	3.625	4 1/4	2.77	2.33	1.89	1.70
26-4200-32S	4 1/4	3.625	4 1/4	3.56	2.99	2.43	2.18

Micro RIBBON RACK and PANEL PLUGS and RECEPTACLES

Extremely small, ribbon-contact connectors suited for airborne and computer applications with high reliability. Shell type polarization; easily inserted or withdrawn without visual aid; self-wiping, self-cleaning contacts in units up to 50 per connector. Float-mounted receptacle prevents mis-alignment. **Current:** 5 amps. **Voltage:** 700 VDC at sea level; 200 VDC at 70,000 ft. **Insulator:** Diallyl phthalate per MIL-M-14F. **Type MDG. Contacts:** Gold plate per MIL-G-14204 over silver plate per QQ-S-365 on cadmium bronze, ASTM-B-105. **Shells:** Cadmium-plated brass (ASTM-B-36, Alloy 6) with clear chromate finish. **Size:** Dimensions on request. Cable plugs come with hoods; chassis-mounted sockets come with spring latches.

C-J No.	Type	No. of Contacts	Net Each, Lots of			
			1-9	10-49	50-99	100-249
57-10140	R & P Plug	14	\$1.85	\$1.55	\$1.26	\$1.14
57-10240	R & P Plug	24	2.47	2.08	1.79	1.51
57-10360	R & P Plug	36	2.83	2.38	1.93	1.74
57-10500	R & P Plug	50	3.73	3.15	2.55	2.28
57-20140	R & P Sckt.	14	1.90	1.60	1.29	1.17
57-20240	R & P Sckt.	24	2.52	2.12	1.73	1.55
57-20360	R & P Sckt.	36	2.90	2.44	1.98	1.78
57-20500	R & P Sckt.	50	3.77	3.19	2.58	2.32
57-30140	Cable Plug	14	3.55	2.98	2.42	2.19
57-30240	Cable Plug	24	3.90	3.28	2.65	2.40
57-30360	Cable Plug	36	4.77	4.02	3.25	2.94
57-30500	Cable Plug	50	5.23	4.40	3.58	3.22
57-40140	Chassis Skt.	14	2.33	1.97	1.60	1.44
57-40240	Chassis Skt.	24	2.78	2.33	1.90	1.71
57-40360	Chassis Skt.	36	3.00	2.52	2.04	1.83
57-40500	Chassis Skt.	50	3.92	3.30	2.67	2.40



Tube Sockets

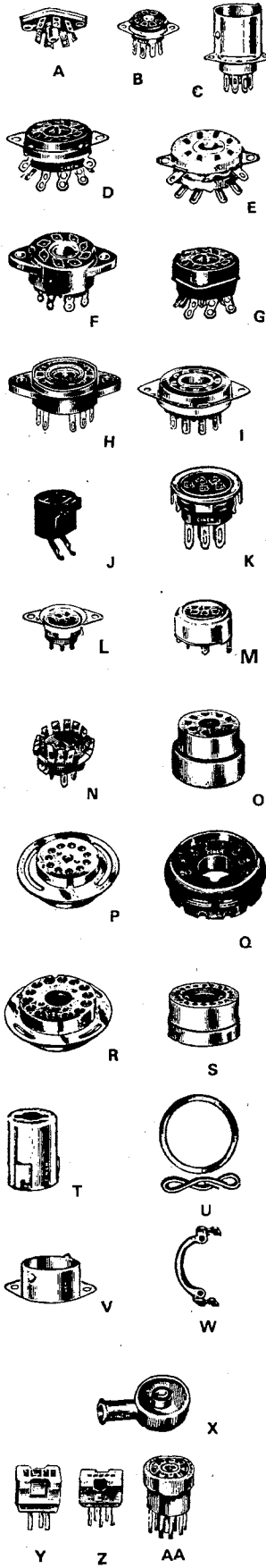

C-J No.	Fig.	No. of Contacts and Tube Group	Description	Construction Materials		Top or Bottom Mount	Mtg. Ctrs.	MIL-S-12883A No.	Net Each, Lots of				
				Insulator*	Contacts†				1-24	25-49	50-99	100-249	250-499
7W2A	A	7 miniature	Wafer	A	A	Bottom	1 3/8"		\$0.12	\$0.10	\$0.09	\$0.08	\$0.07
7WL2	A	7 miniature	Wafer	A	A	Bottom	1 3/8"		.10	.09	.08	.07	.06
7WL4	A	7 miniature	Wafer	A	A	Both	1 3/8"		.17	.13	.11	.10	.09
7EB	A	7 miniature	Saddle	B	A	Bottom	1 3/8"		.12	.10	.09	.08	.07
7EC	B	7 miniature	Saddle	D	A	Bottom	1 3/8"		.46	.37	.33	.24	.23
7EM	B	7 miniature	Saddle	A	A	Bottom	1 3/8"		.14	.11	.10	.09	.08
7AB1	B	7 miniature	Saddle	C	B	Top	1 3/8"		.14	.11	.10	.09	.08
7AM1	B	7 miniature	Saddle	C	C	Top	1 3/8"		.17	.13	.11	.10	.09
7JM-3	B	7 miniature	Saddle	A	B	Bottom	1 3/8"	TS102P03	.23	.19	.15	.13	.12
7JC-3	B	7 miniature	Saddle	D	B	Bottom	1 3/8"	TS102C03	.37	.30	.25	.20	.19
7JMN-1	B	7 miniature	Saddle	C	B	Top	1 3/8"	TS102P02	.23	.19	.15	.13	.12
7JMN-2	B	7 miniature	Saddle	C	C	Top	1 3/8"	TS102P02	.23	.19	.15	.13	.12
7JCN-1	B	7 miniature	Saddle	D	B	Top	1 3/8"	TS102C02	.37	.30	.25	.20	.19
7JCN-2	B	7 miniature	Saddle	D	C	Top	1 3/8"	TS102C02	.37	.30	.25	.20	.19
7JM-2	C	7 miniature	Shield base	B	A	Top	1 3/8"	TS102P01	.29	.22	.19	.15	.14
7XB1	C	7 miniature	Shield base	B	C	Top	1 3/8"		.17	.13	.11	.10	.09
7XM1	C	7 miniature	Shield base	D	A	Top	1 3/8"		.21	.17	.14	.12	.11
7XC	C	7 miniature	Shield base	D	A	Top	1 3/8"		.44	.35	.30	.23	.22
7JC-2	C	7 miniature	Shield base	D	B	Top	1 3/8"	TS102C01	.39	.31	.26	.21	.20
8AB	D	8 octal	Saddle	A	A	Bottom	1 3/8"		.14	.11	.10	.09	.08
8AM	D	8 octal	Saddle	C	C	Bottom	1 3/8"		.17	.13	.11	.10	.09
8AB	E	8 octal	Saddle	E	A	Bottom	1 3/8"		.14	.11	.10	.09	.08
8EB	E	8 octal	Saddle	E	B	Bottom	1 3/8"		.17	.13	.11	.10	.09
8EM	F	8 octal	All-molded	C	A	Both	1 3/8"		.14	.11	.10	.09	.08
8XM	F	8 octal	All-molded	C	B	Both	1 3/8"		.12	.10	.09	.08	.07
8XB	F	8 octal	All-molded	C	B	Both	1 3/8"		.21	.17	.14	.12	.11
8R1	G	8 octal	Ring mount*	E	A	Top	1 3/8"		.35	.28	.23	.19	.18
8R2	G	8 octal	Ring mount*	E	A	Top	1 3/8"		.25	.21	.18	.14	.13
8R3	G	8 octal	Ring mount*	E	B	Top	1 3/8"		.48	.39	.32	.25	.24
8R4	G	8 octal	Ring mount*	E	C	Top	1 3/8"		.48	.39	.32	.25	.24
8R5	G	8 octal	Ring mount*	E	A	Top	1 3/8"		.48	.39	.32	.25	.24
8R6	G	8 octal	Ring mount*	E	B	Top	1 3/8"		.48	.39	.32	.25	.24
8CS-B	H	8 compactron	All-molded	E	A	Both	1 3/8"		.46	.37	.30	.24	.23
8CS-M	H	8 compactron	All-molded	E	C	Both	1 3/8"		.44	.40	.34	.27	.25
9NB-B	I	9 novar	Saddle	E	A	Bottom	1 3/8"		.16	.12	.11	.10	.09
9NS-B1	I	9 novar	Saddle	E	C	Bottom	1 3/8"		.24	.20	.17	.14	.13
9NS-M	I	9 novar	Saddle	E	A	Bottom	1 3/8"		.18	.14	.12	.11	.10
9NS-M1	I	9 novar	Saddle	E	C	Bottom	1 3/8"		.27	.21	.18	.15	.14
9W1	A	9 novar	Wafer	A	A	Bottom	1 3/8"		.14	.11	.10	.09	.08
9W2	A	9 novar	Wafer	A	A	Both	1 3/8"		.14	.11	.10	.09	.08
9AB	B	9 novar	Saddle	B	C	Top	1 3/8"		.14	.11	.10	.09	.08
9AM	B	9 novar	Saddle	B	C	Top	1 3/8"		.14	.11	.10	.09	.08
9EB	B	9 novar	Saddle	B	C	Bottom	1 3/8"		.14	.11	.10	.09	.08
9EM	B	9 novar	Saddle	B	C	Bottom	1 3/8"		.17	.13	.11	.10	.09
9JM-3	B	9 novar	Saddle	C	C	Bottom	1 3/8"	TS103P03	.29	.22	.19	.15	.14
9JM-4	B	9 novar	Saddle	C	D	Bottom	1 3/8"	TS103P03	.29	.22	.19	.15	.14
9JC-3	B	9 novar	Saddle	D	B	Bottom	1 3/8"	TS103C03	.44	.35	.30	.23	.22
9JCN-1	B	9 novar	Saddle	D	B	Top	1 3/8"	TS103C02	.44	.35	.30	.23	.22
9JMN-1	B	9 novar	Saddle	D	C	Top	1 3/8"	TS103P02	.29	.22	.19	.15	.14
9JMN-2	B	9 novar	Saddle	D	C	Top	1 3/8"	TS103P02	.29	.22	.19	.15	.14
9XB	C	9 novar	Shield base	B	A	Top	1 3/8"		.21	.17	.14	.12	.11
9XM	C	9 novar	Shield base	D	A	Top	1 3/8"		.23	.19	.15	.13	.12
9AB	C	9 novar	Shield base	D	A	Top	1 3/8"		.35	.28	.23	.19	.18
9JM-2	C	9 novar	Shield base	D	B	Top	1 3/8"	TS103P01	.30	.24	.20	.17	.15
9JC-2	C	9 novar	Shield base	D	B	Top	1 3/8"	TS103C01	.42	.33	.28	.22	.21
12CS-B	H	12 compactron	All-molded	E	C	Both	1 3/8"		.16	.13	.11	.10	.09
12CS-M	H	12 compactron	All-molded	E	C	Both	1 3/8"		.62	.49	.41	.33	.32

*Insulator material: A indicates chocolate phenolic; B, black phenolic; C, MPE plastic; D, ceramic; E, high-dielectric black phenolic (CFG); F, MAI-60 Alkyd Glass Fiber (JETEC No. 20-120). †Contact material: A indicates cadmium-plated brass; B, silver-plated phosphor bronze; C, silver-plated beryllium copper. *Max. chassis thickness. *Crimped retainer ring furnished.

SPECIAL PURPOSE TUBE SOCKETS

C-J No.	Fig.	No. of Contacts and Tube Group	Description	Construction Materials		Top or Bottom Mount	Mtg. Ctrs.	MIL-S-12883A No.	Net Each, Lots of				
				Insulator*	Contacts†				1-24	25-49	50-99	100-249	250-499
2B2	J	2 cetron	For CE701, CE702	B	A				\$0.75	\$0.60	\$0.50	\$0.40	\$0.38
2M2	J	2 cetron	For CE701, CE702	C	A				1.10	.88	.74	.59	.56
5NS	K	5 nuvistor	Crimp tab mount	C	A				.17	.13	.11	.10	.09
5NS-1	L	5 nuvistor	Saddle	C	A				.26	.20	.17	.14	.13
5NS-2	M	5 nuvistor	PC standoff	C	A				.42	.34	.28	.22	.21
5NS-3	N	5 nuvistor	Heat dissipating	C	A				.23	.19	.16	.13	.12
7-VT	O	7 vidicon	For RCA vidicon	A	B				2.38	1.90	1.59	1.27	1.21
8-VT	O	8 vidicon	For RCA vidicon	A	B				2.38	1.90	1.59	1.27	1.21
3M11	P	11 magal	For 5BP1, etc.	C	C				4.50	3.60	3.00	2.40	2.28
3B12	Q	12 duodecal	For 10BP4, etc.	B	C				.61	.49	.41	.32	.31
3M12	Q	12 duodecal	Same as 3B12	A	C				1.82	1.45	1.21	.97	.92
3B14	R	14 diheptal	CR7	C	C				1.58	1.27	1.06	.84	.80
3M14	R	14 diheptal	CR7	C	C				1.67	1.33	1.11	.89	.84
20-PM	S	20 photomult	For RCA 6810, etc.	F	A				5.00	4.00	3.34	2.67	2.54

*Insulator material: A indicates chocolate phenolic; B, black phenolic; C, MPE plastic; D, ceramic; E, high-dielectric black phenolic (CFG); F, MAI-60 Alkyd Glass Fiber (JETEC No. 20-120). †Contact material: A indicates cadmium-plated brass; B, silver-plated phosphor bronze; C, silver-plated beryllium copper. *JETEC No. ES-11. *Crimped retainer ring furnished; mounting centers dimensions column lists chassis thickness accommodated.

J-SLOT TUBE SHIELDS (FIG. T)

C-J No.	Description	Length, Inches	Net Each, Lots of				
			1-24	25-49	50-99	100-249	250-499
7S2	Steel	1 3/8"	\$0.17	\$0.13	\$0.11	\$0.10	\$0.09
7S3	Steel	1 3/8"	.19	.14	.12	.11	.10
7S4	Steel	1 3/8"	.25	.21	.18	.14	.13
7S12-1	MIL* brass	1 3/8"	.25	.21	.18	.14	.13
7S13-1	MIL* brass	1 3/8"	.29	.22	.19	.15	.14
7S14-1	MIL* brass	2 3/4"	.32	.25	.22	.18	.17
9S1	Steel	1 3/8"	.35	.28	.23	.19	.18
9S2	Steel	1 3/8"	.23	.19	.15	.12	.11
9S3	Steel	2 3/4"	.44	.35	.30	.23	.22
9S11-1	MIL* brass	1 3/8"	.30	.24	.20	.17	.15
9S12-1	MIL* brass	1 3/8"	.35	.28	.23	.19	.18
9S13-1	MIL* brass	2 3/4"	.37	.30	.25	.20	.19

*JAN-S-28A.

SUBMINIATURE TUBE SOCKETS

Use extensively for hearing aids, radios and other electronic apparatus. Molds from mica-filled low loss Bakelite with silver-plated beryllium copper contacts. No. 2B5 can be used for four prong tube or as a transistor socket. No. 5PC for printed circuits. No. 5WC for wired circuits.

C-J No.	Pin	Fig.	Net Each, Lots of				
			1-24	25-49	50-99	100-249	250-499
2H3	3	Y	\$0.23	\$0.19	\$0.16	\$0.13	\$0.12
2H5	5	Z	.19	.15	.13	.11	.10
2H6	6	Z	.30	.27	.23	.18	.17
2H7	7	Z	.34	.27	.23	.18	.17
8SM	8	AA	.50	.40	.34	.27	.26
8SM-P*	8	AA	.63	.50	.42	.34	.32

*Has mounting plate; all others include mounting ring.

MODEL 8R0 RETAINER RING (FIG. U)

A crimped retaining ring formed of .020" spring steel. Will securely anchor sockets. Standard finish is cadmium.

C-J No.	8R0	Net Each, Lots 1-24	9c	25-49	8c	Lots 50-99	7c	100-249	6c	250-499	5c
---------	-----	---------------------	----	-------	----	------------	----	---------	----	---------	----

SHIELD BASES (FIG. V)

Material: 7SB2, brass; others, steel.

C-J No.	Dimensions, in.			Net Each, Lots of				
	H.	Mtg. Hole	Ctr.	1-24	25-49	50-99	100-249	250-499
7SB1	3/8"	.125 dia.	3/8"	\$0.12	\$0.10	\$0.09	\$0.08	\$0.07
7SB2	3/8"	.125 dia.	3/8"	.17	.13	.11	.10	.09
9SB1	1/2"	1/2 dia.	1/2"	.14	.11	.10	.09	.08

STRAP NUTS (FIG. W)

C-J No. 7SN—Cadmium-plated brass strap nuts for use in mounting sockets with saddles or shield bases. One strap nut takes the place of two conventional type nuts. Mounting centers, 3/8". For 7-contact sockets. Ground lugs are hot-solder-dipped. Net Each, Lots of 1-24..... 29c; 25-49..... 22c; 50-99..... 19c; 100-249..... 15c; 250-499..... 14c
 C-J No. 9SN—Same as Model 7SN except mounting centers are 1 1/8" and are for 9-contact sockets. Net Each, Lots of 1-24..... 30c; 25-49..... 24c; 50-99..... 20c; 100-249..... 17c; 250-499..... 15c

MODEL 3A1 SECOND ANODE CONNECTOR (FIG. X)

Snap over .096" dia. prong on side of diheptal tubes. Cadmium-plated brass contact surrounded by rubber insulator. Size, 3/4" x 1 1/4".
 C-J No. 3A1—Net Each, Lots 1-24..... \$1.09; 25-49..... 87c; 50-99..... 74c; 100-249..... 59c; 250-499..... 56c

MOUNTING RINGS

C-J No. 3R11—Steel mounting ring for No. 3M11. Net Each, Lots 1-24..... 61c; 25-49..... 48c; 50-99..... 40c; 100-249..... 32c; 250-499..... 31c
 C-J No. 3R14—Steel mounting ring for Nos. 3B14 and 3M14. Net Each, Lots 1-24..... 68c; 25-49..... 47c; 50-99..... 45c; 100-249..... 36c; 250-499..... 33c



Terminal Strips

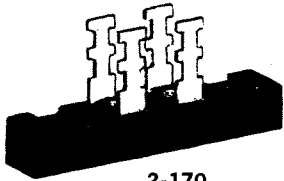

2-170

NO. 170 TERMINAL STRIPS

A heavy-duty solder-type terminal of .032" brass, hot solder coated. Insulation: Black molded Bakelite, $\frac{1}{8}$ " wide, $\frac{1}{4}$ " thick. Terminals mounted on $\frac{3}{8}$ " centers. Mounting holes are $\frac{3}{8}$ " from center of end terminals. Mounting hole size is .128.

C-J No.	Contacts	Net Each, Lots of				
		1-24	25-49	50-99	100-249	250-499
1-170	1	\$0.23	\$0.18	\$0.16	\$0.13	\$0.12
2-170	2	.23	.23	.19	.16	.15
3-170	3	.40	.32	.24	.21	.19
4-170	4	.45	.36	.30	.24	.23
5-170	5	.50	.40	.34	.27	.25
6-170	6	.55	.45	.38	.30	.28
7-170	7	.60	.49	.42	.34	.32
8-170	8	.65	.53	.46	.38	.36
9-170	9	.70	.57	.50	.42	.40
10-170	10	.75	.62	.55	.47	.45



17-3

SCREW-TYPE TERMINAL STRIPS

These strips are ideal for chassis or breadboard layouts. Strips with 1 to 6 lugs are of $\frac{1}{8}$ " bakelite; those with 7 to 10 terminals are of $\frac{3}{16}$ " bakelite. Ends of screws are captivated to prevent removal.

Terminals: Cadmium-plated brass. Spaced on $\frac{1}{2}$ " centers.

Mounting Holes: 0.136" diameter.

Screws: Cadmium-plated steel.

C-J No.	Mtg. Ctrs.	Net Each, Lots of				
		1-24	25-49	50-99	100-249	250-499
17-1	$\frac{1}{2}$ "	\$0.09	\$0.08	\$0.07	\$0.06	\$0.05
17-2	$1\frac{1}{4}$ "	.10	.09	.08	.07	.06
17-3	$1\frac{3}{4}$ "	.12	.10	.09	.08	.07
17-4	$2\frac{1}{4}$ "	.16	.13	.11	.10	.09
17-5	$2\frac{3}{4}$ "	.18	.14	.12	.11	.10
17-6	$3\frac{1}{4}$ "	.22	.18	.15	.13	.12
17-7	$3\frac{1}{2}$ "	.27	.21	.18	.15	.14
17-8	$3\frac{3}{4}$ "	.28	.23	.19	.16	.15
17-9	$3\frac{3}{8}$ "	.34	.26	.22	.18	.17
17-10	$4\frac{1}{8}$ "	.36	.28	.24	.19	.18

NO. 2000 TERMINAL STRIPS

These compact and sturdy junction terminal strips are useful in assembling radio chassis, wiring, etc.

Terminals: .019" brass, pre tin plate spaced on $\frac{1}{8}$ " centers.

Insulation: Bakelite.

Brackets: Cadmium-plated steel.

Mounting holes: .140 diameter.

Center of mounting hole to end of bracket: $\frac{3}{8}$ ".

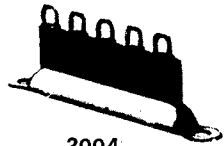

2004

C-J No.	No. of Terminal Positions	Mtg. Hole Centers	Net Each, Lots of				
			1-24	25-49	50-99	100-249	250-499
2002	2	1"	.10	.09	.08	.07	.06
2003	3	$1\frac{1}{4}$ "	.11	.10	.08	.07	.06
2004	4	$1\frac{1}{2}$ "	.12	.10	.09	.08	.07
2005	5	$1\frac{3}{4}$ "	.13	.11	.09	.08	.07
2006	6	$2\frac{1}{4}$ "	.14	.11	.10	.09	.08
2007	7	$2\frac{3}{4}$ "	.15	.12	.10	.09	.08
2008	8	$2\frac{3}{4}$ "	.17	.13	.11	.10	.09
2009	9	$3\frac{1}{4}$ "	.18	.14	.12	.11	.10
2010	10	$3\frac{1}{2}$ "	.19	.15	.13	.11	.10
2011	11	$3\frac{3}{4}$ "	.20	.16	.14	.12	.11
2012	12	$4\frac{1}{2}$ "	.21	.17	.14	.12	.11
2013	13	$4\frac{3}{4}$ "	.23	.19	.16	.13	.12

LUG-TYPE TERMINAL STRIPS

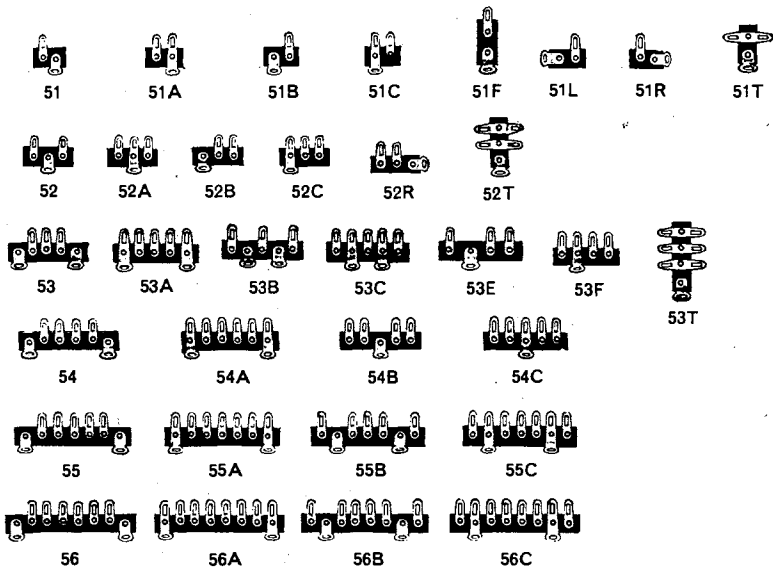

These terminal strips are handy for neatly supporting resistors, capacitors, etc. in circuit wiring. Cadmium-plated steel lugs are spaced on $\frac{1}{8}$ " centers with 0.140" dia. mounting holes. Chocolate-colored phenolic is used. Strips are $\frac{1}{2}$ " thick and $\frac{3}{8}$ " wide.

C-J No.	Description	Mtg. Centers	Net Each, Lots of				
			1-24	25-49	50-99	100-249	250-499
51	1L		.06	.05	.04	.03	.02
51A	2L; 1G		.06	.05	.04	.03	.02
51B	1L		.06	.05	.04	.03	.02
51C	2L; 1G		.06	.05	.04	.03	.02
51F	1L		.06	.05	.04	.03	.02
51T	D L		.07	.06	.05	.04	.03
52	2L		.06	.05	.04	.03	.02
52A	3L; 1G		.06	.05	.04	.03	.02
52B	2L		.06	.05	.04	.03	.02
52C	3L; 1G		.06	.05	.04	.03	.02
52T	2D L		.08	.07	.06	.05	.04
53	3L	$1\frac{1}{2}$ "	.07	.06	.05	.04	.03
53E	3L		.07	.06	.05	.04	.03
53F	4L; 1G		.07	.06	.05	.04	.03
53T	3 D L		.09	.08	.07	.06	.05
54	4L	$1\frac{1}{2}$ "	.07	.06	.05	.04	.03
54A	6L; 2G	$1\frac{1}{2}$ "	.07	.06	.05	.04	.03
54B	4L		.07	.06	.05	.04	.03
54C	5L; 1G		.07	.06	.05	.04	.03
55	5L	$2\frac{1}{2}$ "	.08	.07	.06	.05	.04
55A	7L; 2G	$2\frac{1}{2}$ "	.08	.07	.06	.05	.04
55C	7L; 2G	$1\frac{1}{2}$ "	.08	.07	.06	.05	.04
56	6L	$2\frac{1}{2}$ "	.08	.07	.06	.05	.04
56A	8L; 2G	$2\frac{1}{2}$ "	.08	.07	.06	.05	.04
56C	8L; 2G	$1\frac{1}{2}$ "	.08	.07	.06	.05	.04

AVAILABLE FROM STOCK

OUR COMPLETE LINE OF

STANDARD SOLDER-TYPE & TEFLON INSULATED TERMINALS & HARDWARE

WE MAINTAIN THE MOST PRECISE, UP-TO-DATE HIGH SPEED SWISS AUTOMATIC SCREW MACHINERY AVAILABLE

MIL. Spec. Platings Available: Silver: MIL-F-14072, QQ-S-365 • Electro-Tin: MIL-T-10727, Type 1 • Electro-Tin-Lead (Electro-Solder): MIL-F-14072 • Hot-Solder-Dip: MIL-F-14072, Type 221 • Hot-Tin-Dip: MIL-T-10727 • Gold: MIL-G-45204, Type II • Nickel: QQ-N-290, Type VI • Cadmium: QQ-P-416A, Type II, Class B, Clear Chromate • Bright Alloy: MIL Spec. • Copper: MIL Spec.

ALL STANDARD PANEL AND CHASSIS HARDWARE AVAILABLE

THESE ARE ONLY 36 OF THE HUNDREDS OF STYLES OF TERMINALS WE PRODUCE

SINGLE TURRET TERMINALS, SERIES 10-100

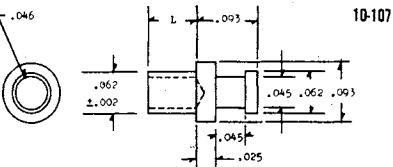
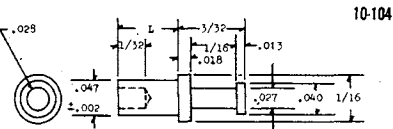
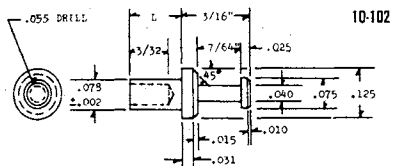

DOUBLE TURRET TERMINALS, SERIES 10-200

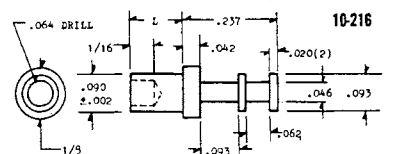
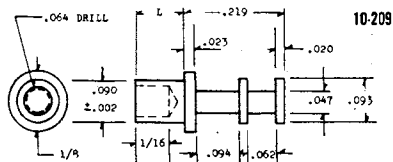
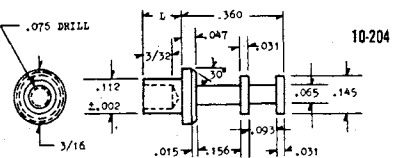
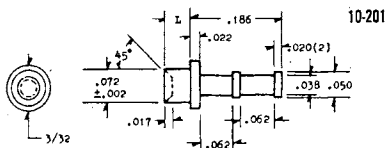

TUBULAR TERMINALS, SERIES 10-300

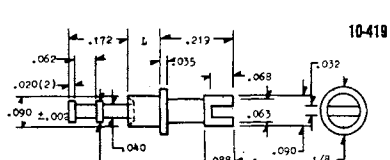
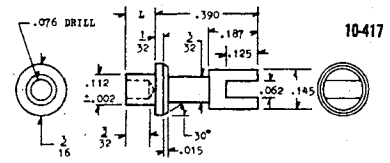
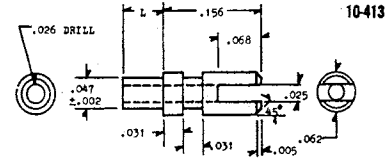
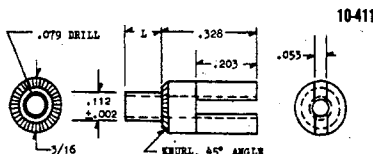
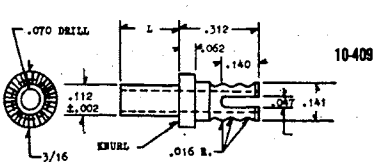
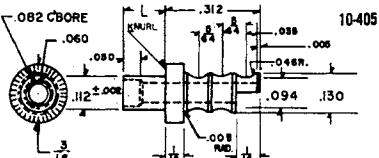
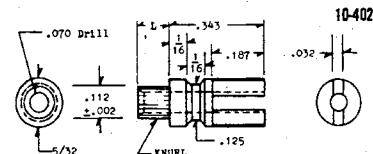
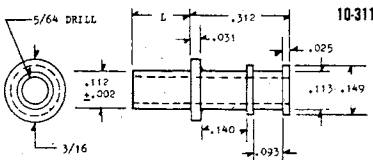
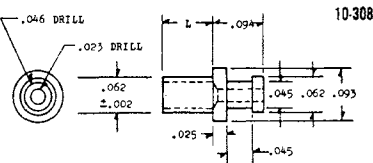
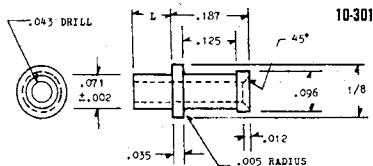

DOUBLE END TERMINALS, SERIES 10-500

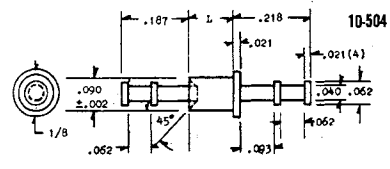
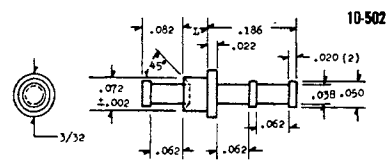
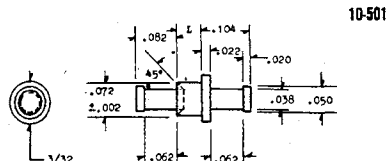

CALL OR WRITE FOR FREE CATALOG • BE SURE TO SPECIFY SHANK LENGTH & BOARD THICKNESS

CONCORD ELECTRONICS CORPORATION

DABURN

DABURN ELECTRONICS & CABLE CORP.
 WIRE • CABLE • TUBING • MIL/COMM • SWITCHES • ELECTRONIC HARDWARE

DABURN SOLDERLESS TERMINALS

Material is pure electrolytic copper with heavy cadmium plating, chromate finish resists corrosion and assures long shelf life — one piece design for maximum conductivity and strength. Beveled edges to facilitate wire insertion, barrels are full 1/4" length, "V" grooves for wire protection.

NON INSULATED • QUICK DISCONNECT TERMINALS

COLOR CODE: For matching to wire sizes.

RED: For 22-16 wire, .160" I.D. **BLUE:** For 16-14 wire, .185" I.D.

YELLOW: For 12-10 wire, .260" I.D.

Female disconnect terminals are .020" brass, cadmium plated. Male disconnect terminals are .032" copper, cadmium plated. Beveled mouth and "V" grooves plus full 1/4" length barrels for all.

INSULATED TERMINALS • QUICK DISCONNECT TERMINALS

The insulated terminals have strong, permanently attached rigid vinyl insulating sleeves for increased vibration resistance.

**QUICK DISCONNECT TERMINALS
NON-INSULATED**

Wire Size Range	Male Catalog No.	Female Catalog No.	Standard Package
22-16	21-12	21-22	100
16-14	21-13	21-23	100
12-10	21-14	21-24	100

INSULATED

Wire Size Range	Male Catalog No.	Female Catalog No.	Standard Package
22-16	21-17	21-27	100
16-14	21-18	21-28	100
12-10	21-19	21-29	100

**SOLDERLESS TERMINALS
NON-INSULATED — HOOK TONGUE**

Wire Size Range	Stud Size	Catalog No.	Standard Package
22-16	6	21-31	100
	8	21-32	100
16-14	6	21-34	100
	8	21-35	100
	10"	21-36	100

INSULATED

Wire Size Range	Stud Size	Catalog No.	Standard Package
22-16	6	21-38	100
	8	21-39	100
16-14	6	21-41	100
	8	21-42	100
	10	21-43	100

**BUTT CONNECTORS
NON-INSULATED**

Wire Size Range	Catalog No.	I.D.	Stub Clearance	Standard Package
22-16	21-47	.140"	37/64	100
16-14	21-48	.170"	37/64	100

INSULATED

22-16	21-51	.140"	37/64	100
16-14	21-52	.170"	37/64	100

**RING TONGUE
NON-INSULATED**

Wire Size Range	Specify Stud Sizes	Catalog No.	Standard Package
22-16	4, 6, 8, 10	21-60	100
16-14	4, 6	21-61	100
16-14	6, 8, 10	21-62	100
12-10	6, 8, 10	21-63	100
12-10	1/4	21-64	100

INSULATED

22-16	4, 6, 8, 10	21-70	100
16-14	4, 6	21-71	100
16-14	6, 8, 10	21-72	100
12-10	6, 8, 10	21-73	100
12-10	1/4	21-74	100

**SPADE TONGUE
NON-INSULATED**

Wire Size Range	"H" Stud Sizes Specify	Catalog No.	Standard Package
22-16	4, 6, 8, 10	21-79	100
16-14	4, 6, 8, 10	21-80	100
12-10	6, 8, 10	21-81	100

INSULATED

22-16	4, 6, 8, 10	21-84	100
16-14	4, 6, 8, 10	21-85	100
12-10	6, 8, 10	21-86	100

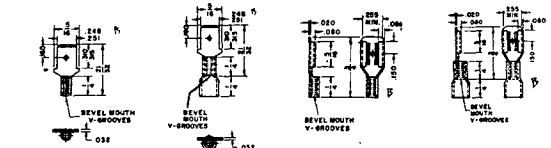

CAT. NOS. 21-12, 21-13, 21-14 CAT. NOS. 21-17, 21-18, 21-19 CAT. NOS. 21-22, 21-23, 21-24 CAT. NOS. 21-27, 21-28, 21-29

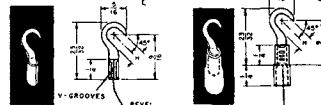

CAT. NOS. 21-31 THRU — 36 CAT. NOS. 21-38 THRU — 43

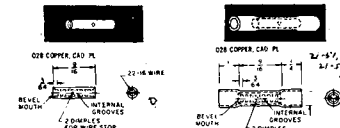

CAT. NOS. 21-47, 21-48 CAT. NOS. 21-51, 21-52

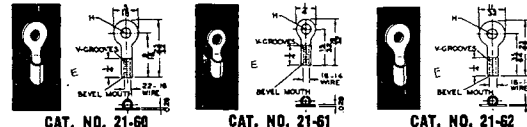

CAT. NO. 21-60 CAT. NO. 21-61 CAT. NO. 21-62

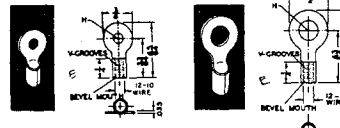

CAT. NO. 21-63 CAT. NO. 21-64

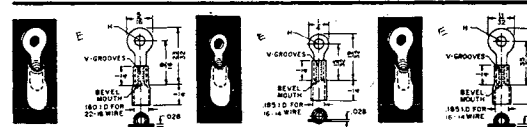

CAT. NO. 21-70 CAT. NO. 21-71 CAT. NO. 21-72

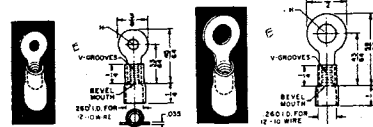

CAT. NO. 21-73 CAT. NO. 21-74

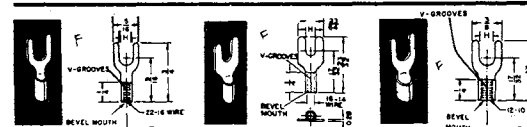

CAT. NO. 21-79 CAT. NO. 21-80 CAT. NO. 21-81

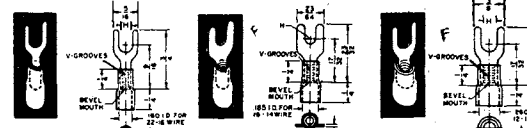

CAT. NO. 21-84 CAT. NO. 21-85 CAT. NO. 21-86

DABURN

DABURN ELECTRONICS & CABLE CORP.
WIRE • CABLE • TUBING • MIL/COMM • SWITCHES • ELECTRONIC HARDWARE

BANANA, PHONE PLUGS & TIPS

INSULATED BANANA PLUG SOLDERLESS

Fits standard banana jacks. Plug is brass nickel plated. Spring is four leaf phosphor bronze, nickel plated. Side set screw holds wire without soldering. Molded plastic handle.

COLORS
Red, Black, Yellow, Green, Blue (Specify)

DABURN No.	SPRING	Std. Pkg.
19-46	Phosphor Bronze N.P.	50
19-46A	Beryllium Copper N.P.	50

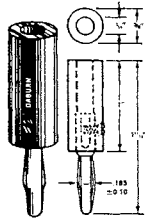

INSULATED BANANA PLUG SOLDERLESS

This split plug, brass N. PL., has internal brass N. PL., stud for solderless connection. Fits standard banana jacks. Molded plastic handle.

COLORS
Red, Black, Yellow, Green, Blue. (Specify)

DABURN No.	Std. Pkg.
19-47	50

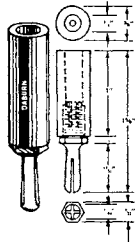

ADAPTER

TIP PLUG TO BANANA PLUG

Fits standard banana jacks, accepts standard phone tips. Plug is brass nickel plated. Spring is four leaf phosphor bronze, nickel plated. Phone tip jack is phosphor bronze molded plastic handle and cap.

COLORS
Red, Black (Specify)

DABURN No.	Std. Pkg.
19-67	50

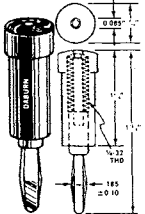

INSULATED MIDGET BANANA PLUG SOLDERLESS

Spring is four leaf phosphor bronze, or beryllium copper, nickel plated. Wire can be soldered directly into plug. Molded plastic handle. Fits standard banana jacks.

COLORS
Red, Black. (Specify)

DABURN No.	SPRING	Std. Pkg.
19-55	Phosphor Bronze N.P.	50
19-55B	Beryllium Copper S.P.	50

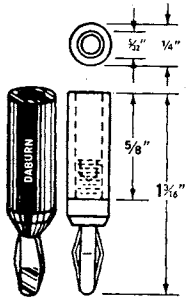

INSULATED BANANA PLUG SOLDERLESS

Fits standard banana jacks. Plug is hex brass, Nickel plated. Spring is four leaf phosphor bronze nickel plated. Molded plastic handle.

For solderless connection: wire can be passed thru hex brass N.P. stud and spread, which locks wire to plug. Wire can also be soldered directly to plug.

COLORS
Red, Black, Yellow, Green, Blue. (Specify)

DABURN No.	SPRING	Std. Pkg.
19-04	Phosphor Bronze N.P.	50
19-04B	Beryllium Copper S.P.	50

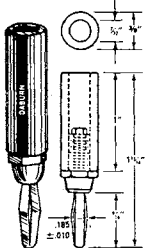

INSULATED BANANA PLUG SOLDERLESS

Split plug, brass N. PL., with side screw fits standard banana jacks. Plug is slotted, set screw holds wire without soldering. Molded plastic handles.

COLORS
Red, Black, Yellow, Green, Blue. (Specify)

DABURN No.	Std. Pkg.
19-44	50

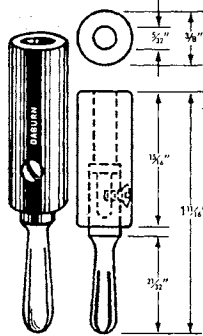

INSULATED BANANA PLUG SOLDERLESS

Fits standard banana jacks. Plug is brass nickel plated. Spring is four leaf phosphor bronze nickel plated. Molded plastic handle.

COLORS
Red, Black, Yellow, Green, Blue. (Specify)

For solderless connection same as our No. 19-04.

DABURN No.	SPRING	Std. Pkg.
19-65	Phos. Bronze N.P.	50
19-65B	Beryllium Copper S.P.	50

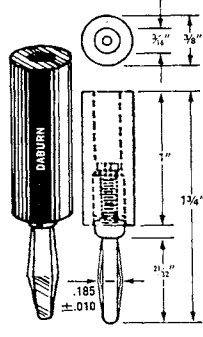

INSULATED PHONE TIP SOLDERLESS — SENIOR

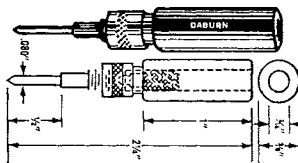

Fits standard phone tip jacks. Brass nickel plated. Solderless connection for wire which fits thru body of tip and fastens under knurled nut. Molded plastic handle.

COLORS: Red, Black, Yellow, Green, Blue. (Specify)

Daburn No.	Std. Pkg.
19-09	Senior 50

INSULATED PHONE TIP SOLDERLESS — JUNIOR

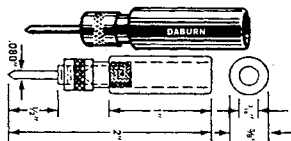

Fits standard phone tip jacks. Brass nickel plated. Solderless connection for wire which fits thru body of tip and fastens under knurled nut. Molded plastic handle.

COLORS: Red, Black, Yellow, Green, Blue. (Specify)

Daburn No.	Std. Pkg.
19-15	Junior 50

BANANA PLUG — No. 17-40

Fits all standard banana jacks. Hex brass, nickel plated. Comes thru with hex N. PL. nut and tinned copper lug. Spring is four leaf phosphor bronze, nickel plated.

RATED: 15 Amps. AC.

DABURN No.	Spring	Dim. A	Std. Pkg.
17-40	Phosphor Bronze	1/2"	100
17-40A	Phosphor Bronze	3/8"	100
17-40B	Beryllium Copper	1/2"	100

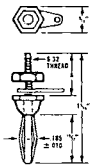

BANANA PLUG — No. 17-14

Nickel plated hex brass; spring is four leaf phosphor bronze, nickel plated. Comes thru with hex nut, nickel plated. Fits all standard banana jacks.

RATED: 15 Amps. AC.

DABURN No.	Spring	Std. Pkg.
17-14	Phosphor Bronze	100

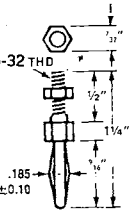

BANANA PLUG — No. 17-41

Body is hex brass, nickel plated, comes thru complete with N. PL. screw and tinned copper lug; spring is four leaf phosphor bronze or beryllium copper, nickel plated. Fits all standard banana jacks.

RATED: 15 Amps. AC.

DABURN No.	Spring	Std. Pkg.
17-41	Phosphor Bronze	100
17-41B	Beryllium Copper	100

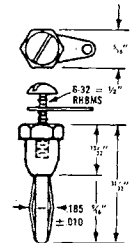

MIDGET BANANA PLUG RIVET TYPE

Brass silver plated body. Spring is four leaf phosphor bronze, silver plated.

RATED: 10 Amps. AC.

DABURN No.	Std. Pkg.
17-26	100 Rivet Type Midget Plug

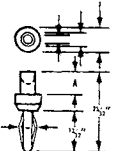

Additional Midget Plugs & Jacks Available. Also Sub-Miniature Plugs & Jacks.

SOLDERLESS PHONE TIP PLUG

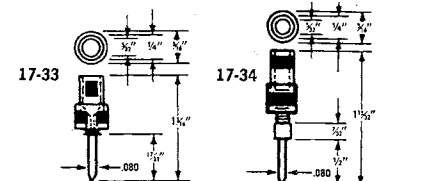

Brass nickel plated. Both fit all standard phone tip jacks. Slipping the wire thru body of tip, then wrapping same around screw, is tightened by knurled collar.

DABURN No.	Description Type	Std. Pkg.
17-33	Junior	100
17-34	Senior	100

DABURN

DABURN ELECTRONICS & CABLE CORP.
WIRE • CABLE • TUBING • MIL/COMM • SWITCHES • ELECTRONIC HARDWARE

POSTS • PRODS • CAPTIVE HARDWARE

COMBINATION POST — BANANA PLUG

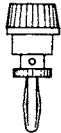

Molded fluted nylon captive head rated at 15 amps AC. Body is brass nickel plated; spring — N.P.L. phosphor bronze. Converts a standard banana jack into a five way binding post.

Cat. No. 18-40 Combination plug 100
Std. Pkg. 100
COLORS: Red, Black.

COMBINATION POST — BANANA PLUG



Molded hex head nylon captive head. Rated at 15 amps AC. Body is brass nickel plated; spring — N.P.L. Phosphor bronze. Converts a standard banana jack into a five way binding post.

Cat. No. 18-42 Combination plug 100
Std. Pkg. 100
COLORS: Red, Black.

COMBINATION TERMINAL METAL BINDING POST



Brass nickel plated turret terminal screw head. Knurled shank. Knurled end. For 3/8" thick panel. 10-32 x 1/4" long BHM screw.

Cat. No. 18-30 Combination terminal 100
Std. Pkg. 100

COMBINATION TERMINAL METAL BINDING POST

Brass nickel plated turret terminal screw head. Knurled shank. Knurled end. 8-32 x 1/4" long BHM screw. For 1/8" thick panel.

Cat. No. 18-32 Combination terminal 100
Std. Pkg. 100

METAL BINDING POST — 5 WAY

Hex brass, nickel plated. Wrap around terminal. Captive head.

Cat. No. 18-34 Binding post 100
Std. Pkg. 100

BINDING POST — 5 WAY

Hex head molded nylon with spade lug. Brass nickel plated.

Cat. No. 18-77 Binding post 100
Std. Pkg. 100

STANDARD DUTY BINDING POST

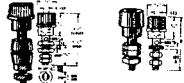

Colors: Red, black.

Molded-in brass bushings similar as above. Rated at 15 Amps AC, capacitance 3.0 MMFD. Body is brass nickel plated. Mounts in 3/8" hole for locking. Has milled slot complete with two hex nuts.

DABURN No.	Description	Std. Pkg.
18-78	All Insulated Type	100
18-79	Grounding Type	100

BINDING POSTS — MULTI-PURPOSE Wrap Around Type

Molded nylon body. Accepts tip plug, spade lug, banana plug, wire alligator clip and direct solder connection. Has molded-in brass insets in head and washer. Rated at 30 amps AC, capacitance 5.0 MMFD. Banana plug receptacle .151" I.D. head non-removable from stud and washer completely insulates post from panel. For panels 1/4" to 1/2" thick; drill 1/2" hole for mounting washers. Wire hole is at right angle to flat on insulated washer.

COLORS: Red Black, (Specify)

DABURN No.	Description	Std. Pkg.
18-72	Nylon Fluted Head Post	100
18-75	Nylon Binding Post	100

DUAL BINDING POSTS NYLON — 5 WAYS

Hex nylon captive head. Brass nickel plated. Turret terminals wrap around 15 amp rating AC. Mounts in 3/4" centers. Available in red or black combinations. Specify.

Cat. No. 18-50 Dual Binding Post 100
Std. Pkg. 100

DUAL BINDING POSTS NYLON — 5 WAYS

Fluted nylon captive head. Brass nickel plated. Turret terminals — wrap around. 15 amp rating AC. Mounts in 3/4" centers. Available in red or black combinations. Specify

Cat. No. 18-52 Dual Binding Post 100
Std. Pkg. 100

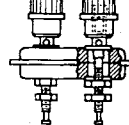

INSULATED SPADE LUG

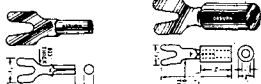

Molded plastic handle lug is steel hot tinned. Rated at 25 amps AC. Rear barrel accommodates all standard banana plugs.

DABURN No.	Description	Std. Pkg.
19-32	Insulated Spade Lug	50
19-32A	Spade Lug Only	50

ALLIGATOR CLIPS

Steel, cadmium plated. 5 amp continuous duty. 1/2" jaw opening. Jaws match accurately, grips securely. Accepts standard banana plugs.

DABURN Cat. No.	Description	Std. Pkg.
20-3	Clip (no screw)	50
20-3S	Clip (with screw)	50

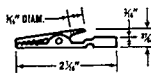

ALLIGATOR CLIP ALL INSULATED

Fully insulated. Cadmium plated sharp steel jaws. Accepts banana plug in rear.

Cat. No. 20-25 Insulated Clip 100
Std. Pkg. 100



NYLON HANDLE PRODS AND TIPS

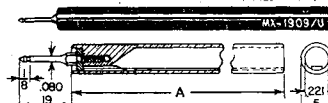

Handle is molded nylon per MIL-P-20693A with brass, silver plated tip. Solderless prods made to meet Signal Corps Drawing SC-C-82761. Rated at 10 amps AC for 10° temperature rise, continuous duty.

DABURN Cat. No.	Sig. Corps. Drawing & Part No.	Size "A"	Color	Std. Pkg.
19-57	MX-1906/U	1"	Red	25
19-58	MX-1907/U	1"	Black	25
19-59	MX-1909/U	4"	Red	25
19-60	MX-1910/U	4"	Black	25

NEEDLEPOINT TEST PROD

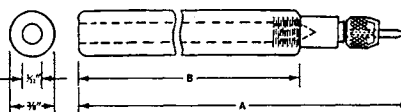

Brass ricket plated plug, chuck is removable for replacement of broken needles. Sharp needle pierces insulation or corrosion for testing purposes. Molded plastic handle.

DABURN No.	Handle (B)	Overall L'gth (A)	Std. Pkg.
19-20	4"	4 7/8"	50
19-21	5"	6 3/8"	50

SOLDERLESS TEST PROD

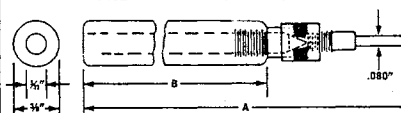

Body is brass nickel plated with molded plastic handle. Solderless connection, for wire fits thru handle and plug body and wraps under knurled nut.

DABURN No.	Handle (B)	Overall L'gth (A)	Std. Pkg.
19-10	4"	5 3/4"	50
19-43	5"	6 1/2"	50

CAPTIVE SCREW

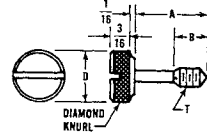

Cat. No.	A	B	D	T	Material
14-555	3/4	3/8	3/16	6-32	Brass
14-555SS	3/4	3/8	3/16	6-32	St. St.
14-556	3/4	3/8	3/16	8-32	Brass
14-556SS	3/4	3/8	3/16	8-32	St. St.
14-557	7/8	3/8	5/8	10-32	Brass
14-557SS	7/8	3/8	5/8	10-32	St. St.
14-558	7/8	3/8	5/8	1/4-20	Brass
14-558SS	7/8	3/8	1/2	1/4-20	St. St.

MATERIAL: Brass per QQB-626A, Comp. 22, 1/2 Hard. FINISH: Nickel Plate and Polish per MIL-QQN-290, Type VI. Stainless Steel per QQS-763, Class 7, Type A available

CAPTIVE BUSHING

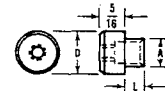

Cat. No.	D	A	L	T	Panel Thickness
14-560	3/8	3/16	3/32	6-32	1/8
14-561	3/8	3/16	3/32	8-32	1/8
14-562	3/8	3/16	3/32	10-32	1/8
14-563	3/8	3/16	3/32	1/4-20	1/8
14-564	3/8	3/16	3/32	6-32	3/16
14-565	3/8	3/16	3/32	8-32	3/16
14-566	3/8	3/16	3/32	10-32	3/16
14-567	3/8	3/16	3/32	1/4-20	3/16
14-568	3/8	3/16	3/32	6-32	1/4
14-569	3/8	3/16	3/32	8-32	1/4
14-570	3/8	3/16	3/32	10-32	1/4
14-571	3/8	3/16	3/32	1/4-20	1/4

MATERIAL: Brass per QQB-626A, Comp. 22, 1/2 Hard. FINISH: Nickel Plate per MIL-QQN-290, Type VI. Available in Stainless Steel, add suffix -S to part number. Special Sizes Also Available. Standard Package 100

THUMB SCREW

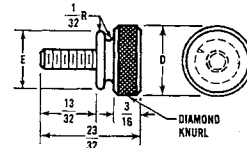

Cat. No.	O	E	Thread
14-501	3/8	3/16	6-32
14-502	3/8	3/16	8-32
14-503	3/8	3/16	10-32
14-504	3/8	3/16	6-32
14-505	3/8	3/16	8-32
14-506	3/8	3/16	10-32
14-507	3/8	3/16	6-32
14-508	3/8	3/16	8-32
14-509	3/8	3/16	10-32

MATERIAL: Brass per QQB-626A, Comp. 22, 1/2 Hard. FINISH: Nickel Plate per MIL-QQN-290, Type VI. Standard Package 100

BAKELITE PENCILTYPE TEST PROD

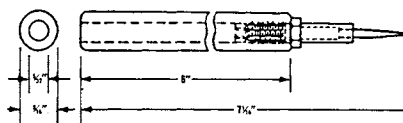

Body is brass nickel plated with heavy steel phono needle in tip. Handle is XX bakelite per MIL-P-79 Spec. Wire threaded thru stud and tightened allows for solderless connection.

DABURN No.	Description	Std. Pkg.
19-11	Bakelite Pencil Type Prod	25



BINDING POSTS

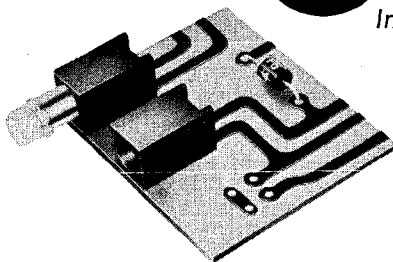

LAMP SOCKETS



TEST JACKS



TERMINALS

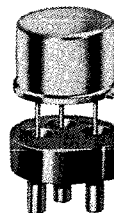

TRANSISTOR AND IC SOCKETS

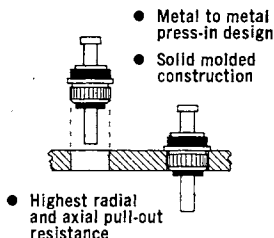

NURL-LOC DESIGN – TERMINALS AND TEST JACKS

Electronic Molding offers the largest variety of molded insulated terminals and test jacks available anywhere. The metal inserts are molded into high-temperature Diallyl Phthalate, (500°F) forming a strong integral unit that will not crack while soldering. The metal to metal Nurl-Loc press-in feature (shown left) assures highest radial and axial pullout resistance of any terminal of this type. Ten colors are available, in a wide range of types for various applications, many designed to meet military specifications, plus mounting tools.

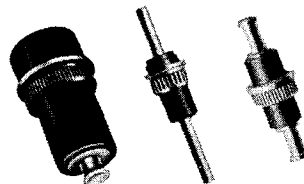

WRITE FOR COMPLETE CATALOG

TERMINALS	FEED-THRU END HOLE 8 50 6 4				STANDOFF TERMINALS 11 1 12			FEED-THRU THRU HOLE 10 2 49				
	FEED-THRU 47 13 7 5 9 3 36 28						THREADED NURL-LOC FEED-THRU 37	THREADED FEED-THRU 33	INSULATED SPACER 84			
MIL-T-55155 TERMINALS 89M 90M 91M			STANDOFF TERMINALS DOUBLE TURRET 92 94 91				SINGLE TURRET 89 95		STRAIGHT PIN 97 98		BIFURCATED 100 101	
TEST JACKS	MS-16108 & MIL-C-39024 TEST JACKS 85 86		MIL-C-39024 NURL-LOC TEST JACKS 78 42		PUSH-ON TEST JACKS 65		MIL-C-39024 PRINTED CIRCUIT TEST JACKS 122 88 77 104			NURL-LOC PROBE 60		

ELECTRONIC MOLDING CORPORATION



ELECTROCRAFT ELECTRONIC COMPONENTS

BANANA PLUGS

ILLUSTRATIONS	DESCRIPTION								
	<p>BANANA PLUG</p> <p>DESC: Right angle "Gun" Tip (meter plug), lead wire solders to body.</p> <p>RATING: 10 amps AC for 10 degree C Temp. rise, continuous duty.</p> <p>HANDLE: Molded plastic, per MIL-P-14 CFG.</p> <p>TIP: Four leaved, phosphor bronze, nickel plated springs.</p> <p style="text-align: right;">Net per C 36.00</p> <table border="1"> <tr> <td>No.</td> <td>Color</td> <td>No.</td> <td>Color</td> </tr> <tr> <td>33-046-BU</td> <td>Red</td> <td>33-048-BU</td> <td>Blk</td> </tr> </table>	No.	Color	No.	Color	33-046-BU	Red	33-048-BU	Blk
No.	Color	No.	Color						
33-046-BU	Red	33-048-BU	Blk						

ILLUSTRATIONS	DESCRIPTION								
	<p>BANANA PLUG</p> <p>DESC: All metal, threaded shank type, with terminal lug and hex nut.</p> <p>BODY: Brass, nickel plated.</p> <p>TIP: Four leaved, nickel plated phosphor bronze spring.</p> <p style="text-align: right;">Net per C 18.00</p> <table border="1"> <tr> <td>No.</td> <td>Color</td> <td>No.</td> <td>Color</td> </tr> <tr> <td>33-058-BU</td> <td></td> <td></td> <td></td> </tr> </table>	No.	Color	No.	Color	33-058-BU			
No.	Color	No.	Color						
33-058-BU									

ILLUSTRATIONS	DESCRIPTION								
	<p>BANANA PLUG</p> <p>DESC: Threaded shank type, supplied with terminal lug and hex nut.</p> <p>BODY: Brass, nickel plated.</p> <p>TIP: Cross slotted, brass, nickel plated.</p> <p style="text-align: right;">Net per C 14.00</p> <table border="1"> <tr> <td>No.</td> <td>Color</td> <td>No.</td> <td>Color</td> </tr> <tr> <td>33-060-BU</td> <td></td> <td></td> <td></td> </tr> </table>	No.	Color	No.	Color	33-060-BU			
No.	Color	No.	Color						
33-060-BU									

ILLUSTRATIONS	DESCRIPTION								
	<p>BANANA PLUG</p> <p>DESC: Panel mounting type, number 6-32 tapped body; with screw and terminal lug.</p> <p>BODY: Brass, nickel plated.</p> <p>TIP: Four leaved, phosphor bronze, nickel plated spring.</p> <p style="text-align: right;">Net per C 18.00</p> <table border="1"> <tr> <td>No.</td> <td>Color</td> <td>No.</td> <td>Color</td> </tr> <tr> <td>33-052-BU</td> <td></td> <td></td> <td></td> </tr> </table>	No.	Color	No.	Color	33-052-BU			
No.	Color	No.	Color						
33-052-BU									

ILLUSTRATIONS	DESCRIPTION								
	<p>BANANA PLUG</p> <p>DESC: Threaded shank type, with terminal lug and hex nut.</p> <p>BODY: Brass, nickel plated.</p> <p>TIP: Four leaved, phosphor bronze, nickel plated spring.</p> <p style="text-align: right;">Net per C 20.00</p> <table border="1"> <tr> <td>No.</td> <td>Color</td> <td>No.</td> <td>Color</td> </tr> <tr> <td>33-064-BU</td> <td></td> <td></td> <td></td> </tr> </table>	No.	Color	No.	Color	33-064-BU			
No.	Color	No.	Color						
33-064-BU									

ILLUSTRATIONS	DESCRIPTION								
	<p>BANANA PLUG</p> <p>DESC: Panel mounting type, tapped number 6-32, with screw and terminal lug.</p> <p>BODY: Brass, nickel plated.</p> <p>TIP: Cross slotted, brass, nickel plated.</p> <p style="text-align: right;">Net per C 15.00</p> <table border="1"> <tr> <td>No.</td> <td>Color</td> <td>No.</td> <td>Color</td> </tr> <tr> <td>33-066-BU</td> <td></td> <td></td> <td></td> </tr> </table>	No.	Color	No.	Color	33-066-BU			
No.	Color	No.	Color						
33-066-BU									

ILLUSTRATIONS	DESCRIPTION								
	<p>BANANA PLUG</p> <p>DESC: Printed circuit, sub-miniature rivet type, solder connection, fits jacks with .104 I.D.</p> <p>TIP: Four leaved, beryllium copper, silver plated spring.</p> <p style="text-align: right;">Net per C 15.00</p> <table border="1"> <tr> <td>No.</td> <td>Color</td> <td>No.</td> <td>Color</td> </tr> <tr> <td>33-068-BU</td> <td></td> <td></td> <td></td> </tr> </table>	No.	Color	No.	Color	33-068-BU			
No.	Color	No.	Color						
33-068-BU									

ILLUSTRATIONS

DESCRIPTION

ILLUSTRATIONS	DESCRIPTION								
	<p>MIDGET BANANA PLUG</p> <p>DESC: Rivet type, fits all standard Banana Jacks.</p> <p>TIP: Four leaved phosphor bronze silver plated spring.</p> <p style="text-align: right;">Net per C 16.20</p> <table border="1"> <tr> <td>No.</td> <td>Color</td> <td>No.</td> <td>Color</td> </tr> <tr> <td>33-069-BU</td> <td></td> <td></td> <td></td> </tr> </table>	No.	Color	No.	Color	33-069-BU			
No.	Color	No.	Color						
33-069-BU									

ILLUSTRATIONS	DESCRIPTION								
	<p>BANANA PLUG ADAPTOR</p> <p>DESC: Adopts tip plug to banana plug, ends are standard tip jack and banana plug.</p> <p>RATING: 15 amps AC for 10 degree C Temp. rise, continuous duty.</p> <p>HANDLE: Molded Butyrate, per MIL-LP-349-A and ASEA letter QUD4-59-4820 type 3.</p> <p>TIP: Standard tip jack one end; other end four leaved banana plug.</p> <p style="text-align: right;">Net per C 30.00</p> <table border="1"> <tr> <td>No.</td> <td>Color</td> <td>No.</td> <td>Color</td> </tr> <tr> <td>33-072-BU</td> <td>Red</td> <td>33-074-BU</td> <td>Blk</td> </tr> </table>	No.	Color	No.	Color	33-072-BU	Red	33-074-BU	Blk
No.	Color	No.	Color						
33-072-BU	Red	33-074-BU	Blk						

ILLUSTRATIONS	DESCRIPTION								
	<p>STACK BANANA PLUG</p> <p>DESC: Stack type, fits standard banana plugs in top and side.</p> <p>RATING: 15 amps AC for 10 degree C Temp. rise, continuous duty.</p> <p>HANDLE: Molded Butyrate, per MIL-LP-349-A and ASEA letter QUD4-59-4820 type 3.</p> <p>TIP: Four leaved phosphor bronze, nickel plated spring.</p> <p style="text-align: right;">Net per C 33.00</p> <table border="1"> <tr> <td>No.</td> <td>Color</td> <td>No.</td> <td>Color</td> </tr> <tr> <td>33-084-1BU</td> <td>Red</td> <td>33-084-2BU</td> <td>Blk</td> </tr> </table>	No.	Color	No.	Color	33-084-1BU	Red	33-084-2BU	Blk
No.	Color	No.	Color						
33-084-1BU	Red	33-084-2BU	Blk						

ILLUSTRATIONS	DESCRIPTION								
	<p>STACK BANANA PLUG</p> <p>DESC: Stack type, fits standard banana plugs in top and side.</p> <p>RATING: 15 amps AC for 10 degree C Temp. rise, continuous duty.</p> <p>HANDLE: Molded Butyrate, per MIL-LP-349-A and ASEA letter QUD4-59-4820 type 3.</p> <p>TIP: Four leaved beryllium copper, nickel plated spring.</p> <p style="text-align: right;">Net per C 36.00</p> <table border="1"> <tr> <td>No.</td> <td>Color</td> <td>No.</td> <td>Color</td> </tr> <tr> <td>33-086-1BU</td> <td>Red</td> <td>33-086-2BU</td> <td>Blk</td> </tr> </table>	No.	Color	No.	Color	33-086-1BU	Red	33-086-2BU	Blk
No.	Color	No.	Color						
33-086-1BU	Red	33-086-2BU	Blk						

TIP PLUGS

ILLUSTRATIONS	DESCRIPTION								
	<p>PHONO NEEDLE TIP PLUG</p> <p>DESC: Nickel plated brass body, chuck design to hold .058 replaceable phono needle. Wire solders to body.</p> <p>RATING: 12 amps AC for 10 degree C Temp. rise, continuous duty.</p> <p>HANDLE: Molded Butyrate, per MIL-LP-349-A and ASEA letter QUD4-59-4820 type 3.</p> <p>TIP: Phono needle, brass alloy.</p> <p style="text-align: right;">Net per C 20.00</p> <table border="1"> <tr> <td>No.</td> <td>Color</td> <td>No.</td> <td>Color</td> </tr> <tr> <td>33-100-BU</td> <td>Red</td> <td>33-102-BU</td> <td>Blk</td> </tr> </table>	No.	Color	No.	Color	33-100-BU	Red	33-102-BU	Blk
No.	Color	No.	Color						
33-100-BU	Red	33-102-BU	Blk						

ILLUSTRATIONS	DESCRIPTION								
	<p>INSULATED TIP PLUG*</p> <p>DESC: Solderless type, wire tightens under knurled collar; machined brass body, nickel plated.</p> <p>RATING: 12 amps AC for 10 degree C Temp. rise, continuous duty.</p> <p>HANDLE: Molded Butyrate per MIL-LP-349-A and ASEA letter QUD4-59-4820 type 3.</p> <p>TIP: Phono needle, brass alloy.</p> <p style="text-align: right;">Net per C 15.00</p> <table border="1"> <tr> <td>No.</td> <td>Color</td> <td>No.</td> <td>Color</td> </tr> <tr> <td>33-106-BU</td> <td>Red</td> <td>33-108-BU</td> <td>Blk</td> </tr> </table>	No.	Color	No.	Color	33-106-BU	Red	33-108-BU	Blk
No.	Color	No.	Color						
33-106-BU	Red	33-108-BU	Blk						

ILLUSTRATIONS	DESCRIPTION								
	<p>HEAVY DUTY PHONO TIP PLUG*</p> <p>DESC: Standard tip, large diameter body for accepting heavy duty wire solder type.</p> <p>RATING: 12 amps AC for 10 degree C Temp. rise, continuous duty.</p> <p>HANDLE: Molded Butyrate, per MIL-LP-349-A and ASEA letter QUD4-59-4820 type 3.</p> <p>TIP: Brass, nickel plated phono needle.</p> <p style="text-align: right;">Net per C 15.00</p> <table border="1"> <tr> <td>No.</td> <td>Color</td> <td>No.</td> <td>Color</td> </tr> <tr> <td>33-110-1BU</td> <td>Red</td> <td>33-110-2BU</td> <td>Blk</td> </tr> </table>	No.	Color	No.	Color	33-110-1BU	Red	33-110-2BU	Blk
No.	Color	No.	Color						
33-110-1BU	Red	33-110-2BU	Blk						

* Also available in Bulk quantities in yellow, green, or blue. To order: add to part number, "-3BU" for yellow, "+4BU" for green, "-5BU" for blue. Example: No. 33-000-3BU (for yellow).

WRITE FOR CATALOG #FR-69 FOR COMPLETE LISTINGS



ELECTROCRAFT ELECTRONIC COMPONENTS

TIP PLUGS

ILLUSTRATIONS	DESCRIPTION				
	<p>HEAVY DUTY PHONE TIP PLUG</p> <p>DESC: Solder type. Solid metal tip for heavy duty applications. BODY: Brass, nickel plated. TIP: Solid, brass, nickel plated.</p> <p style="text-align: right;">Net per C 2.70</p> <table border="1"> <tr> <td>No.</td> <td></td> </tr> <tr> <td>33-158-BU</td> <td></td> </tr> </table>	No.		33-158-BU	
No.					
33-158-BU					

ILLUSTRATIONS	DESCRIPTION								
	<p>COMBINATION POST-PLUG</p> <p>DESC: Captive head, type; for converting panel-mounted banana jack to 5-way binding post termination. Accepts solid or standard wire, spade lug, phone tip, banana plug or alligator clip. Brass, nickel plated body. RATING: 15 amps AC for 10 degree C Temp. rise, continuous duty. HANDLE: Nylon - Dupont Zytel No. 101, per MIL-M-20693A. TIP: Four leaved, phosphor bronze, nickel plated spring.</p> <p style="text-align: right;">Net per C 30.00</p> <table border="1"> <tr> <td>No.</td> <td>Color</td> <td>No.</td> <td>Color</td> </tr> <tr> <td>33-165-1BU</td> <td>Red</td> <td>33-165-2BU</td> <td>Blk</td> </tr> </table>	No.	Color	No.	Color	33-165-1BU	Red	33-165-2BU	Blk
No.	Color	No.	Color						
33-165-1BU	Red	33-165-2BU	Blk						

ILLUSTRATIONS	DESCRIPTION								
	<p>COMBINATION POST-PLUG*</p> <p>DESC: Captive head, type; for converting panel-mounted banana jack to a spring-loaded push post. Accepts solid or stranded wire, standard phone tip which locks in place upon release of pressure on cap. Brass, nickel plated body. RATING: 15 amps AC for 10 degree C Temp. rise, continuous duty. HEAD: Molded nylon, per MIL-M-20693A. TIP: Four leaved, phosphor bronze, nickel plated spring.</p> <p style="text-align: right;">Net per C 30.00</p> <table border="1"> <tr> <td>No.</td> <td>Color</td> <td>No.</td> <td>Color</td> </tr> <tr> <td>33-166-1BU</td> <td>Red</td> <td>33-166-2BU</td> <td>Blk</td> </tr> </table>	No.	Color	No.	Color	33-166-1BU	Red	33-166-2BU	Blk
No.	Color	No.	Color						
33-166-1BU	Red	33-166-2BU	Blk						

ILLUSTRATIONS	DESCRIPTION				
	<p>COMBINATION POST-PLUG</p> <p>DESC: Captive head type. For converting panel-mounted banana jack to a spring-loaded push post. Accepts solid or stranded wire, standard phone tip which locks in place upon release of pressure on cap. Brass, nickel plated body. HEAD: Molded styrene cap per MIL-L-416, type 1. TIP: Four leaved phosphor bronze, nickel plated spring.</p> <p style="text-align: right;">Net per C 42.00</p> <table border="1"> <tr> <td>No.</td> <td></td> </tr> <tr> <td>33-167-BU</td> <td></td> </tr> </table>	No.		33-167-BU	
No.					
33-167-BU					

ILLUSTRATIONS	DESCRIPTION				
	<p>HEAVY DUTY PHONE TIP PLUG</p> <p>DESC: All metal, nickel plated brass body is large enough to accept standard banana plug. Body is threaded to fit into plastic handle.</p> <p style="text-align: right;">Net per C 12.00</p> <table border="1"> <tr> <td>No.</td> <td></td> </tr> <tr> <td>33-170-BU</td> <td></td> </tr> </table>	No.		33-170-BU	
No.					
33-170-BU					

ILLUSTRATIONS	DESCRIPTION				
	<p>"JR" SOLDERLESS PHONE TIP "THREADED"</p> <p>DESC: Threaded shank type. Wire fastens under knurled collar. BODY: Brass, nickel plated. RATING: 12 amps AC for 10 degree C Temp. rise, continuous duty. TIP: Brass, nickel plated phone tip.</p> <p style="text-align: right;">Net per C 12.00</p> <table border="1"> <tr> <td>No.</td> <td></td> </tr> <tr> <td>33-172-BU</td> <td></td> </tr> </table>	No.		33-172-BU	
No.					
33-172-BU					

ILLUSTRATIONS	DESCRIPTION				
	<p>DUAL STANDARD TIP PLUG</p> <p>DESC: Solderless type; brass, nickel plated body. Designed mates with No. 33-206. BODY: Molded Cyclocac plastic, per MIL-M-22544, type 4. TIPS: 2 brass, nickel plated tips on 3/4" centers.</p> <p style="text-align: right;">Net per C 74.00</p> <table border="1"> <tr> <td>No.</td> <td></td> </tr> <tr> <td>33-174-BU</td> <td></td> </tr> </table>	No.		33-174-BU	
No.					
33-174-BU					

ILLUSTRATIONS	DESCRIPTION				
	<p>DUAL SHORT TIP PLUG SOLDERLESS TYPE</p> <p>DESC: Brass, nickel plated body. Mates with No. 33-206. BODY: Molded Cyclocac plastic, per MIL-M-22544, type 4. TIPS: 2 brass, nickel plated tips on 3/4" centers.</p> <p style="text-align: right;">Net per C 72.00</p> <table border="1"> <tr> <td>No.</td> <td></td> </tr> <tr> <td>33-176-BU</td> <td></td> </tr> </table>	No.		33-176-BU	
No.					
33-176-BU					

ILLUSTRATIONS	DESCRIPTION				
	<p>DUAL BANANA JACK</p> <p>DESC: Mounts in 2 - 3/8" holes on 3/4" centers in panel up 1/4" thick. Accepts standard and dual banana plugs. Solder connection. RATING: 15 amps AC for 10 degree C Temp. rise, continuous duty. 2 K Volts 60 cycle AC continuous working voltage. Capacitance 2.0 mmfd. between conductors, 4.0 mmfd. to panel. HEAD: Insulated, molded black styrene, per MIL-L-P416, type 1. BODY: Brass, nickel plated.</p> <p style="text-align: right;">Net per C 50.00</p> <table border="1"> <tr> <td>No.</td> <td></td> </tr> <tr> <td>33-179-BU</td> <td></td> </tr> </table>	No.		33-179-BU	
No.					
33-179-BU					

BANANA & TIP PLUG JACKS

ILLUSTRATIONS	DESCRIPTION								
	<p>BANANA JACK *</p> <p>DESC: Mounts in 5/16" hole. Fits panel up to 3/8" thick. Accepts Standard Banana Plug. RATING: 15 amps AC for 10 degree C Temp. rise, continuous duty. HEAD: Melamine MIL-14F, type CMC. BODY: Brass, nickel plated; with tinned solder lug.</p> <p style="text-align: right;">Net per C 14.00</p> <table border="1"> <tr> <td>No.</td> <td>Color</td> <td>No.</td> <td>Color</td> </tr> <tr> <td>33-180-BU</td> <td>Red</td> <td>33-182-BU</td> <td>Blk</td> </tr> </table>	No.	Color	No.	Color	33-180-BU	Red	33-182-BU	Blk
No.	Color	No.	Color						
33-180-BU	Red	33-182-BU	Blk						

ILLUSTRATIONS	DESCRIPTION				
	<p>BANANA JACK</p> <p>DESC: Mounts in 1/4" hole and fits panel up to 3/8" thick. Accepts standard banana plugs. BODY: Brass, nickel plated; with tinned solder lug.</p> <p style="text-align: right;">Net per C 12.00</p> <table border="1"> <tr> <td>No.</td> <td></td> </tr> <tr> <td>33-184-BU</td> <td></td> </tr> </table>	No.		33-184-BU	
No.					
33-184-BU					

*Also available in Bulk quantities in yellow, green, or blue. To order: add to part number, "-3BU" for yellow, "-4BU" for green, "-5BU" for blue. Example: No. 33-000-3BU (for yellow).

WRITE FOR CATALOG #FR-69 FOR COMPLETE LISTINGS



ELECTROCRAFT ELECTRONIC COMPONENTS

BANANA & TIP PLUG JACKS

ILLUSTRATIONS

DESCRIPTION

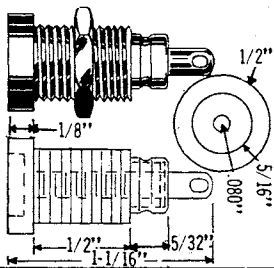

TIP JACK, ALL-INSULATED*
 DESC: Mounts in 3/8" hole; fits panel up to 5/16" thick; with mounting nut.
 RATING: 10 amps AC for 10 degree C Temp. rise, continuous duty. 5K Volts 60 cycle AC continuous working voltage. Capacitance 3.0 mmfd.
 BODY: Molded of nylon per MIL-M-20693A.
 CONTACT: Phosphor bronze.

Net per C 18.00			
No.	Color	No.	Color
33-216-BU	Red	33-218-BU	Blk

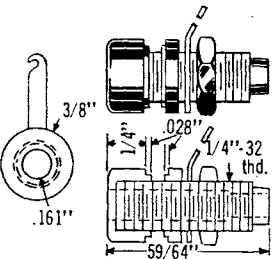

MINIATURE BANANA JACK*
 DESC: Insulating washer provides isolation from panel. Fits 5/16" mounting hole; for panels up to 1/4" thick.
 HEAD AND WASHER: Molded nylon per MIL-M-20693A.
 BODY: Brass, nickel plated body; tinned solder lug.

Net per C 24.00			
No.	Color	No.	Color
33-220-1BU	Red	33-220-2BU	Blk

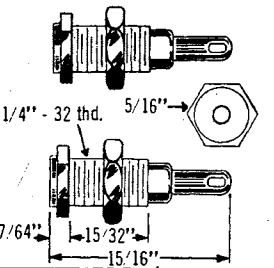

TIP JACK, ALL-METAL
 DESC: Brass nickel plated body; mounts in 1/4" hole; fits panels up to 3/8" thick.
 RATING: 15 amps AC for 10 degree C Temp. rise, continuous duty.
 TIP: Phosphor bronze contact.

Net per C 12.00			
No.	Color	No.	Color
33-226-BU			

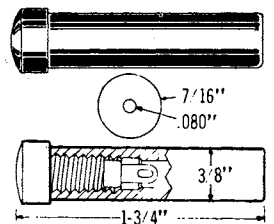

TIP JACK, IN-LINE STYLE
 DESC: Brass nickel plated body; mounts on end of cords. For test lead extensions, etc.
 RATING: 15 amps AC for 10 degree C Temp. rise, continuous duty.
 HANDLE: Molded Butyrate, per MIL-LP-349-A and ASESAL letter, QUD4-59-4820 type 3.
 CONTACT: Phosphor bronze.

Net per C 21.00			
No.	Color	No.	Color
33-228-BU	Red	33-230-BU	Blk

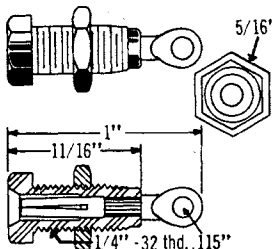

NYLON TIP JACK WITH SPADE TERMINAL*
 DESC: Fits phone tip plugs. Mounts in 1/4" hole in panel up to 1/4" thick with hex nut.
 BODY: Insulated molded nylon per MIL-M-20693A.
 CONTACT: Spade terminal.

Net per C 30.00			
No.	Color	No.	Color
33-245-1BU	Red	33-245-2BU	Blk

ILLUSTRATIONS

DESCRIPTION

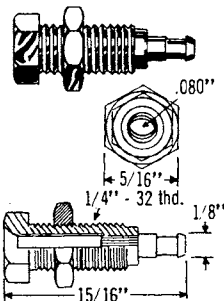

NYLON TIP JACK (WRAP AROUND TYPE)*
 DESC: Hex head for sure grip tightening. Mounts in 1/4" hole in panels up to 1/4" thickness.
 SALT SPRAY TEST: 100 hours.
 INSULATION RESISTANCE: 5000 Meg. Resistance Ohms.
 RATED VOLTAGE & CURRENT: 1000 volts peak at 5 amp max.
 OPERATING TEMPERATURE: -55 degree to +150C
 NOMINAL CAPACITY: -2.0 mmf
 TEST VOLTAGE: 9000 volts DC peak.
 BODY: Nylon per MIL-M-20693A.

Net per C 21.00			
No.	Color	No.	Color
33-240-BU	Red	33-242-BU	Blk

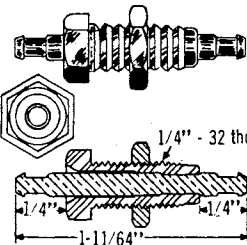

NYLON FEED-THRU JACK*
 DESC: Feed-thru type. Fits all standard phone tip plugs. Mounts in 1/4" hole in panel up to 1/4" thick with hex nut.
 BODY: Insulated nylon per MIL-M-20693A.
 CONTACT: Brass, silver plated.

Net per C 28.20			
No.	Color	No.	Color
33-247-1BU	Red	33-247-2BU	Blk

BINDING POSTS

BINDING POST

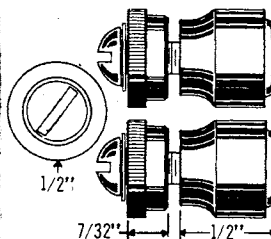

DESC: Brass nickel plated body, supplied with 8-32 mounting screw and lock washer.
 RATING: 15 amps AC for 10 degree C Temp. rise, continuous duty.
 HEAD: Molded plastic.

Net per C 18.00			
No.	Color	No.	Color
33-250-BU	Red	33-252-BU	Blk

BINDING POST

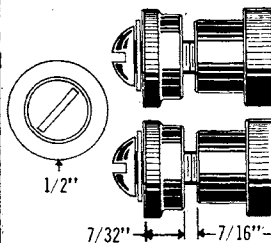

DESC: Brass, nickel plated body, comes complete with 8-32 threaded screw - 1/2" long, nickel plated, brass lockwasher. Head diameter 1/2"
 RATING: 15 amps AC for 10 degree C Temp. rise, continuous duty.
 HEAD: Molded bakelite.

Net per C 18.00			
No.	Color	No.	Color
33-254-BU	Red	33-255-BU	Blk

BINDING POST COMBINATION TYPE

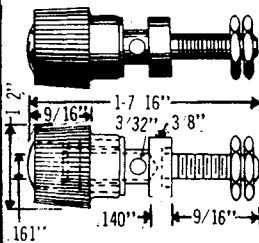

DESC: Brass nickel plated body. Accepts banana plug, tip plug, bare wire, or spade lug. Threaded No. 8-32 mounting stud 1/2" long; supplied with 2 hex nuts.
 RATING: 15 amps AC for 10 degree C Temp. rise, continuous duty.
 HEAD: Molded nylon per MIL-M-20693A.

Net per C 22.00			
No.	Color	No.	Color
33-256-BU	Red	33-258-BU	Blk

*Also available in Bulk quantities in yellow, green, or blue. To order: add to part number, "-3BU" for yellow, "-4BU" for green, "-5BU" for blue. Example: No. 33-000-3BU (for yellow).

WRITE FOR CATALOG #FR-69 FOR COMPLETE LISTINGS



ELECTROCRAFT ELECTRONIC COMPONENTS

BINDING POSTS

ILLUSTRATIONS

DESCRIPTION

BINDING POST, ALL METAL

DESC: Knurled cap; designed for connection of bare wires or spade lugs; No. 8-32 x 1/2" mounting screw and lock washer supplied.

BODY: Heavy brass, nickel plated.

No.	Color	No.	Color
33-284-BU			

Net per C 24.00

ILLUSTRATIONS

DESCRIPTION

METAL BINDING POST

DESC: Gold plated, fluted brass, captive head. Molded black nylon washer with gold plated brass insert. Use where direct ground connection is made to panel or chassis. Complete with gold plated brass flat washer for grounding. Accepts phone tip plug, spade lug, banana plug, alligator clip or stranded wire.

No.	Color	No.	Color
33-285-BU			

Net per C 45.00

ILLUSTRATIONS

DESCRIPTION

BINDING POST

DESC: 5-way metal binding post. Can accept banana plug. Mounts in .171" hole in 1/16" to 3/8" panels. Has wrap-around solder stud 8-32 thread.

No.	Color	No.	Color
33-286-BU			

Net per C 33.00

ILLUSTRATIONS

DESCRIPTION

METAL BINDING POST

DESC: Gold plated, fluted brass, captive head, molded black nylon washer with gold plated brass insert. Use where internal ground circuit is isolated from chassis or panel. Accepts phone tip plug, spade lug, banana plug, alligator clip or wire strand.

No.	Color	No.	Color
33-287-BU			

Net per C 50.00

ILLUSTRATIONS

DESCRIPTION

DUAL BINDING POST INSULATED

DESC: 5-way binding post with fluted heads. Accepts Dual Banana Plug. Mounts in two 3/8" holes, on 3/4" centers in panels from 1/16" to 1/4". Has soldered studs. With four hex nuts, black styrene washers.

RATING: 15 amps AC for 10 degree C Temp. rise, continuous duty.

HEAD: Molded nylon per MIL-M-20693A.

No.	Color	No.	Color
33-288-BU			

Net per C 54.00

ILLUSTRATIONS

DESCRIPTION

DUAL BINDING POST

DESC: Accepts standard phone tips, forward or sideways. Brass, nickel plated body. Mounts in two 3/8" holes on 3/4" centers in panels up to 1/4" thick. Accommodates single or dual banana plugs.

RATING: 15 amps AC for 10 degree C Temp. rise, continuous duty.

HEAD: Molded nylon per MIL-M-20693A.

No.	Color	No.	Color
33-290-BU	Blk	33-299-BU	Red

Net per C 70.00

ILLUSTRATIONS

DESCRIPTION

DUAL BINDING POST

DESC: Brass, nickel plated body. Molded styrene washer; cross slot accommodates phone tip forward, back or sideways. With hex nuts and washers. Mounts in two 3/8" holes on 3/4" centers on panels up to 1/4" thick.

RATING: 15 amps AC for 10 degree C Temp. rise, continuous duty.

HEAD: Nylon heads per MIL-M-20693A.

No.	Color	No.	Color
33-291-BU	Blk	33-293-BU	Red

Net per C 65.00

ILLUSTRATIONS

DESCRIPTION

NYLON BINDING POST

DESC: Grounding type, with molded nylon, non-removable head takes direct solder connection to stud.

RATING: 15 amps AC for 10 degree C Temp. rise, continuous duty.

HEAD AND WASHER: Molded nylon per MIL-M-20693A.

No.	Color	No.	Color
33-294-1BU	Red	33-294-2BU	Blk

Net per C 35.00

ILLUSTRATIONS

DESCRIPTION

NYLON BINDING POST

DESC: Brass, nickel plated body. Takes direct solder connection to stud.

RATING: 15 amps AC for 10 degree C Temp. rise, continuous duty.

HEAD AND WASHER: Molded nylon per MIL-M-20693A.

No.	Color	No.	Color
33-296-1BU	Red	33-296-2BU	Blk

Net per C 35.00

ILLUSTRATIONS

DESCRIPTION

NYLON BINDING POST*

DESC: Gold plated body. Miniature washers and narrow head require minimum mounting space. Requires 5/16" round or "D" hole in panel. Wrap around solder terminal. Accepts phone tip plug banana plug, spade lug, alligator clip or stranded wire.

RATING: 15 amps AC for 10 degree C Temp. rise, continuous duty.

HEAD: Molded nylon per MIL-M-20693A.

No.	Color	No.	Color
33-297-1BU	Red	33-297-2BU	Blk

Net per C 40.00

ILLUSTRATIONS

DESCRIPTION

DUAL SPRING LOADED BINDING POST

DESC: Cross-slotted to accept standard phone tips or wire either forward or sideways. Molded black styrene cap; nickel plated brass body. Requires 2-3/8" holes on 3/4" centers for mounting on panels up to 1/4" thick. Accommodates phone tips or wires in side holes and secures them when pressure on cap is released. With hex nuts and flat washers.

RATING: 15 amps AC for 10 degree C Temp. rise, continuous duty. 5 KV 60 cycle AC continuous working voltage.

No.	Color	No.	Color
33-298-BU			

Net per C 120.00

SPADE LUGS, ALLIGATOR & BATTERY CLIPS

ILLUSTRATIONS

DESCRIPTION

SPADE LUG, INSULATED

DESC: Tapered "fork" fits binding posts and terminal screws up to No. 10 size. Accepts soldered wire or banana plug.

RATING: 25 amps AC for 10 degree C Temp. rise, continuous duty.

HANDLE: Molded Butyrate, per MIL-LP-349A and ASES letter QUD4-59-4820 type 3.

LUG: Brass, nickel plated.

No.	Color	No.	Color
33-300-BU	Red	33-302-BU	Blk

Net per C 10.80

* Also available in Bulk quantities in yellow, green, or blue. To order, add to part number, "-3BU" for yellow, "-4BU" for green, "-5BU" for blue. Example: No. 33-000-3BU (for yellow).

WRITE FOR CATALOG #FR-69 FOR COMPLETE LISTINGS



ELECTROCRAFT ELECTRONIC COMPONENTS

SPADE LUGS, ALLIGATOR & BATTERY CLIPS

ILLUSTRATIONS	DESCRIPTION
	<p>BATTERY CONNECTING & TESTING CLIP</p> <p>DESC: Steel cadmium plated jaws with 1/2" spread. RATING: 5 amps</p> <p>No. _____ Net per C 6.50 33-370-BU _____</p>

	<p>BATTERY CONNECTING & TESTING CLIP</p> <p>DESC: Steel cadmium plated jaws with 9/16" spread. RATING: 10 amps</p> <p>No. _____ Net per C 6.50 33-372-BU _____</p>
--	---

TEST PRODS, LEADS & ADAPTORS

	<p>HEAVY DUTY TEST LEAD SETS</p> <p>DESC: 2 New heavy duty Test Lead sets. Both sets have 5" long solderless Phone Tip Test Prods - other ends have right angle or straight Banana Plugs.</p> <p>No. 33-440-S Straight Banana Plugs Net per pair 1.50 33-442-S Right Angle Banana Plugs Net per pair 1.50</p>
--	---

	<p>DELUXE TEST PROD</p> <p>DESC: Solderless design; wire fits through handle and is fastened to tip with knurled collar. 6-3/8" long.</p> <p>RATING: 12 amps AC for 10 degree C Temp. rise, continuous duty. HANDLE: Butyrate, per MIL-LP-349A and ASEA letter QUD4-59-4820 type 3. TIP: Brass, nickel plated.</p> <p>No. _____ Color _____ Net per C 25.50 33-380-BU Red 33-382-BU Blk</p>
--	---

	<p>NEEDLE POINT TEST PROD</p> <p>DESC: Extra safe, long handle; wire solders to nickel plated brass chuck.</p> <p>RATING: 12 amps AC for 10 degree C Temp. rise, continuous duty. HANDLE: Butyrate, per MIL-LP-349A and ASEA letter QUD4-59-4820 type 2. TIP: Replaceable Phono Needle.</p> <p>No. _____ Color _____ Net per C 31.50 33-384-BU Red 33-386-BU Blk</p>
--	--

	<p>THIN HANDLE TEST PROD</p> <p>DESC: Solderless wire connection; slim type for hard-to-reach places. Ideal for portable testers.</p> <p>RATING: 12 amps AC for 10 degree C Temp. rise, continuous duty. HANDLE: Butyrate, per MIL-LP-349A and ASEA letter QUD4-59-4820 type 3. TIP: Brass, nickel plated.</p> <p>No. _____ Color _____ Net per C 21.00 33-392-BU Red 33-394-BU Blk</p>
--	---

	<p>UNIVERSAL TEST LEADS</p> <p>DESC: Interchangeable tips; one end solderless tip plug; other end banana plug; includes alligator clips, spade lugs and phono tip plugs, which fit on banana plug end.</p> <p>HANDLE: Butyrate, per MIL-LP-349-A and ASEA letter QUD4-59-4820 type 3. CABLE: 50" flexible</p> <p>No. _____ Net per pair 1.88 33-450-S One pair, red and black</p>
--	--

ILLUSTRATIONS

DESCRIPTION

UNIVERSAL "NEEDLEPOINT" TEST LEADS

DESC: Interchangeable tips, one end interchangeable Phono needle type test prod, other end banana plug; includes spade lugs, alligator clips and phono tip plugs, which fit on banana plug end.

HANDLE: Butyrate, per MIL-LP-349A and ASEA letter QUD4-59-4820 type 3.
 CABLE: 50" flexible

No. _____ Net per pair 1.88
 33-452-S One pair, red and black

"THRIFTY" TEST LEADS

DESC: One end 4" test prods, other end terminated in standard phono tip.

HANDLE: Butyrate, per MIL-LP-349-A and ASEA letter QUD4-59-4820 type 3.
 CABLE: 50" flexible

No. _____ Net per pair .75
 33-454-S One pair, red and black

SPECIAL CONNECTORS & ADAPTORS

"Y" ADAPTOR

DESC: Input - 2 phono jacks (in parallel); output phono plug.

No. _____ Net per C 98.50
 33-880-BU _____

"Y" ADAPTOR

DESC: Input - 2 phono jacks (in parallel); output - single phono jack.

No. _____ Net per C 94.50
 33-882-BU _____

"Y" ADAPTOR

DESC: Input - 2 phono jacks (in parallel); output standard phono pin plug.

No. _____ Net per C 94.50
 33-884-BU _____

"Y" ADAPTOR

DESC: Input - 2 male microphone connectors (in parallel); output standard phono plug.

No. _____ Net per C 102.60
 33-886-BU _____

"Y" ADAPTOR

DESC: Input - 2 male microphone connectors (in parallel); output - female microphone connector.

No. _____ Net per C 89.63
 33-888-BU _____

WRITE FOR CATALOG #FR-69 FOR COMPLETE LISTINGS



ELECTROCRAFT ELECTRONIC COMPONENTS

PHONE PLUGS

ILLUSTRATIONS

DESCRIPTION

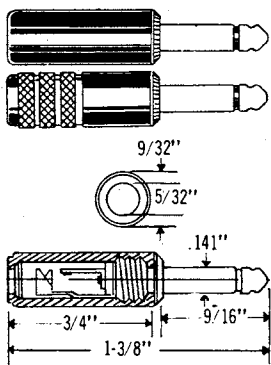

MIN. PHONE PLUGS COMB. CLAMP & SOLDER TER.

DESC: These small plugs are designed for use with hearing aids, pocket radios, portable recorders, etc. Two-conductor style; tested for 500 V breakdown.

RATING: 5 amps AC for 10 degree C Temp. rise, continuous duty.

HANDLE: Butyrate, per MIL-LP-349-A and ASEA letter QUD4-59-4820 type 3.

No.	Net per C 51.66
33-660-BU with metal (shielded) handle	Net per C 40.02
33-662-BU with black plastic handle	Net per C 40.02
33-664-BU with red plastic handle	

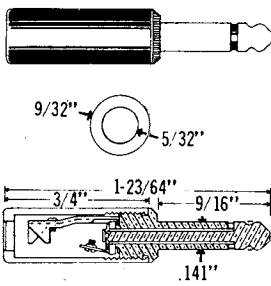

MIN. PHONE PLUGS COMB. CLAMP & SOLDER TER.

DESC: Same plug as 33-660 except for different style terminals.

HANDLE: Butyrate, per MIL-LP-349-A and ASEA letter QUD4-59-4820 type 3.

No.	Net per C 59.85
33-666-BU with metal (shielded) handle.	Net per C 42.51
33-668-BU with black plastic handle.	Net per C 42.51
33-670-BU with red plastic handle.	

PHONE JACKS

PANEL MOUNTING TWO-CONDUCTOR PHONE JACKS

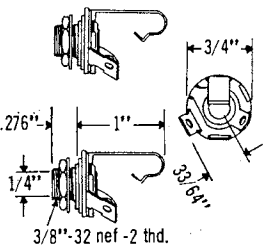

DESC: Open circuit, 2-conductor.

RATING: 10 amps AC for 10 degree C Temp. rise, continuous duty. 1.2 K Volts 60 cycle AC continuous working voltage.

WASHER: Phenolic, per MIL-LL-31 and ASTM-D-709 type 1.

No.	Net per C 27.00
33-690-BU	

PANEL MOUNTING TWO-CONDUCTOR PHONE JACKS

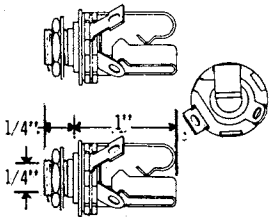

DESC: Panel mounting - two conductor Phone Jack. Use with Revere/Wollensach type. Will accommodate 33-620 phone plug.

No.	Net per C 29.83
33-691-BU	

MINIATURE CORD MOUNTED JACKS

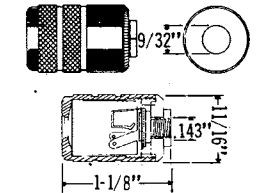

DESC: Miniature type, mates with plugs No. 33-660 through 33-670, with solder lugs and metal (shielded) handle.

No.	Net per C 70.00
33-746-BU	

PHONO PIN PLUGS & JACKS

PHONO PLUGS

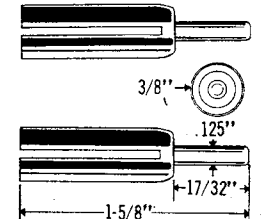

DESC: Motorola type, tube pin nickel plated-1/8" Pin extends from split brass, cadmium plated shell. Provides positive ground connection when inserted into connector.

No.	Net per C 10.35
33-765-BU	

ILLUSTRATIONS

DESCRIPTION

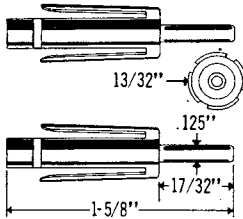

PHONO PLUG

DESC: Motorola type, tube pin nickel plated-1/8" Pin extends from split brass shell, designed for use with small diameter cable. Shell is cadmium plated.

No.	Net per C 10.35
33-766-BU	

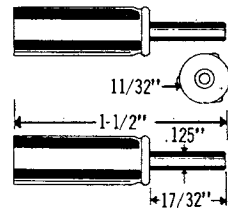

PHONO PLUG

DESC: Motorola type 1/8" tube pin extends from solid brass, cadmium plated shell, small ribbed.

No.	Net per C 10.35
33-767-BU	

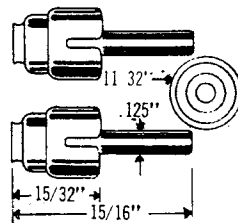

PHONO PLUG

DESC: Solder type.

No.	Net per C 5.80
33-768-BU	15/16" overall
	Net per C 4.80
No.	
33-770-BU	13/16" overall

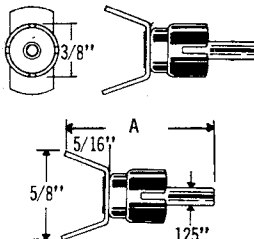

PHONO PLUG

DESC: New RCA type, 1/8" tube pin, nickel plated, brass, cadmium plated shell. Eliminates damaging shielded cable when connecting. Short Pin (13/16" overall) Long Pin (1" overall)

No.	Net per C 7.50
33-769-BU	short 1-1/16"

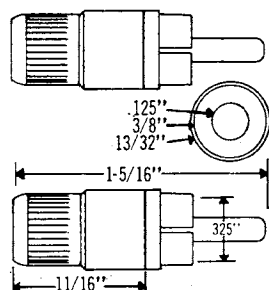

PHONO PLUG

DESC: Combination clamp, solder type, with removable metal (shielded) handle. Much easier to attach than the standard phono plug, and provides "finished" appearance. Mates with 33-774.

No.	Net per C 28.50
33-772-BU	

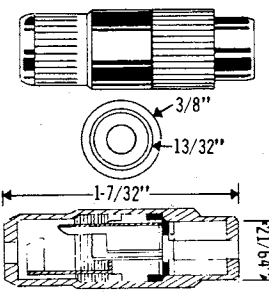

PHONO JACK, CORD MOUNTED

DESC: Also known as "extension" or "inline" jacks. Combination clamp and solder terminal; removable metal (shielded) handle. Mates with 33-772.

No.	Net per C 34.17
33-774-BU	

WRITE FOR CATALOG #FR-69 FOR COMPLETE LISTINGS



ELECTROCRAFT ELECTRONIC COMPONENTS

SPECIAL CONNECTORS & ADAPTORS

ILLUSTRATIONS	DESCRIPTION
	<p>ADAPTOR</p> <p>DESC: Phono jack input, standard phone plug output.</p> <p>HANDLE: Butyrate, per MIL-LP-349-A and ASES letter QUD4-59-4820 type 3.</p> <p>No. 33-850-BU</p> <p>Net per C 67.50</p>

	<p>ADAPTOR</p> <p>DESC: Phono jack input, standard phone plug output, heavy duty metal shielded type.</p> <p>No. 33-852-BU</p> <p>Net per C 78.30</p>
--	--

	<p>MALE ADAPTOR</p> <p>DESC: Phone jack input, microphone connector output.</p> <p>No. 33-854-BU</p> <p>Net per C 59.40</p>
--	--

	<p>FEMALE ADAPTOR</p> <p>DESC: Phono jack input, microphone connector output.</p> <p>No. 33-856-BU</p> <p>Net per C 67.50</p>
--	--

	<p>MALE ADAPTOR</p> <p>DESC: Microphone connector input, standard phone plug output.</p> <p>No. 33-858-BU</p> <p>Net per C 30.00</p>
--	---

	<p>ADAPTOR</p> <p>DESC: Miniature phone jack input, standard phone plug output.</p> <p>No. 33-860-BU</p> <p>Net per C 78.30</p>
--	--

	<p>MALE CONNECTOR</p> <p>DESC: Connects 2 female microphone connectors.</p> <p>No. 33-862-BU</p> <p>Net per C 40.00</p>
--	--

ILLUSTRATIONS	DESCRIPTION
	<p>FEMALE CONNECTOR</p> <p>DESC: Connects 2 male microphone connectors.</p> <p>No. 33-864-BU</p> <p>Net per C 44.17</p>

	<p>ADAPTOR</p> <p>DESC: Miniature phone jack input, standard phone plug output.</p> <p>No. 33-865-BU</p> <p>Net per C 78.30</p>
--	--

	<p>ADAPTOR</p> <p>DESC: Standard phone jack input, phono plug output.</p> <p>No. 33-866-BU</p> <p>Net per C 105.84</p>
--	---

PHONO PIN PLUGS & JACKS	
	<p>PHONO JACKS</p> <p>DESC: Fastens to chassis with 2 rivets or 2 screws.</p> <p>No. 33-792-BU</p> <p>W/oval, space saving metal mounting plate.</p> <p>No. 33-796-BU</p> <p>W/regular, round mounting plate.</p> <p>Net per C 7.33</p> <p>Net per C 7.50</p>

PHONO PIN JACKS																
	<table border="1"> <thead> <tr> <th>No.</th> <th>Description</th> <th>Net per C</th> </tr> </thead> <tbody> <tr> <td>33-798-BU</td> <td>single phono pin jack</td> <td>7.50</td> </tr> <tr> <td>33-800-BU</td> <td>double phono pin jack</td> <td>12.00</td> </tr> <tr> <td>33-802-BU</td> <td>triple phono pin jack</td> <td>15.00</td> </tr> <tr> <td>33-803-BU</td> <td>quadruple phono pin jack</td> <td>24.00</td> </tr> </tbody> </table>	No.	Description	Net per C	33-798-BU	single phono pin jack	7.50	33-800-BU	double phono pin jack	12.00	33-802-BU	triple phono pin jack	15.00	33-803-BU	quadruple phono pin jack	24.00
No.	Description	Net per C														
33-798-BU	single phono pin jack	7.50														
33-800-BU	double phono pin jack	12.00														
33-802-BU	triple phono pin jack	15.00														
33-803-BU	quadruple phono pin jack	24.00														

	<p>SINGLE HOLE PANEL PHONO JACK</p> <p>DESC: Mounts in 9/32 inch hole, requires only one hole drilled. Comes equipped with nut, washer and solder lug for ground.</p> <p>No. 33-804-BU</p> <p>Net per C 16.20</p>
--	--

STANDARD MICROPHONE CONNECTORS	
	<p>CORD MOUNTED MALE MICROPHONE CONNECTOR</p> <p>DESC: With flexible spring to protect cable; center conductor solders to contact; braid is clamped securely by set screw.</p> <p>No. 33-810-BU</p> <p>Net per C 24.00</p>

WRITE FOR CATALOG #FR-69 FOR COMPLETE LISTINGS

E. F. JOHNSON COMPANY



Tip jacks

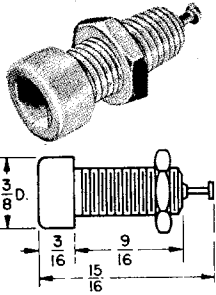

DELUXE TIP JACK
(U.S. Patent No. 2,704,357)

Molded body with recessed closed entry design contact. Silver-plated beryllium copper contact spring. Brass solder terminal is hot tin dipped. Current rating: 10 amps. Voltage breakdown: 11,000 VDC. Capacity to 1/8" panel: 2.0 pf. 1/4-32 nut furnished.

Cat. No. 105-600 Net Price \$0.15
(See color chart below)

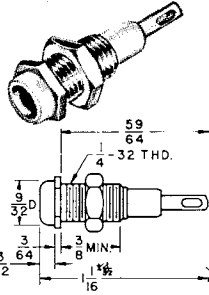

METAL-CLAD TIP JACKS—STANDARD

Molded body, nickel-plated machined brass jacket. Formed, silver-plated phosphor bronze contact. Current rating: 10 amps. Voltage breakdown: 7,000 volts DC. Capacity to 1/8" panel: 3.8 pf. 1/4"-32 nut furnished.

Cat. No. 105-250 Net Price \$0.18.
(See color chart below)

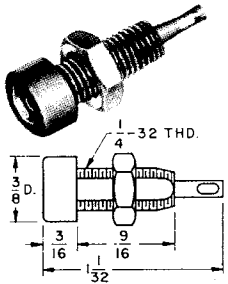

STANDARD TIP JACK

Molded body with recessed, cadmium-plated formed phosphor bronze contact. Current rating: 10 amps. Voltage breakdown: 9,000 volts DC. Capacity to 1/8" panels: 2.0 mmf. 1/4"-32 nut furnished.

Cat. No. 105-800 Net Price \$0.13
(See color chart below)

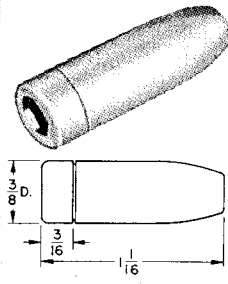

JACK AND SLEEVE ASSEMBLY
(U.S. Pat. No. 2,704,357)

Includes Deluxe Tip Jack (105-601 to 105-613), less mounting nut, with inside threaded molded sleeve. Ideal for patch cords, or insulated rear connection of panel mounted tip jack.

Cat. No. 105-700 Net Price \$0.20
(See color chart below)

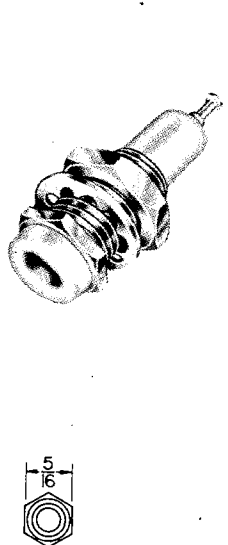

METAL-CLAD TIP JACKS—MILITARY

High reliability tip jack for military use or demanding industrial applications. Highest quality materials — withstand severe environmental temperature, vibration and salt spray conditions. Complies with MS-16108, Rev. F of MIL-STD-242A. Closed entry contact design prohibits entry of tip plug .085" or larger—prevents accidental contact damage by careless probe insertion. Heavy nickel-plated brass jacket. Gold-plated beryllium copper contact spring greatly exceeds minimum insertion/withdrawal cycle requirements of MS-16108. Current rating: 5 amps. Voltage breakdown: 8,000 volts DC. Capacity to 1/8" panel: 3.8 pf. 1/4"-32 nut and lock washer furnished. Terminal Style: "A". (Terminal Style "C" per MS-16108 available on special order in production quantities.) Brass solder terminal is gold-plated.

Cat. No. 105-200-200 Net Price \$0.30

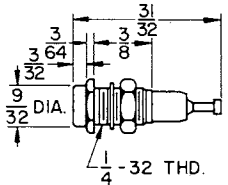

Mil. Std. Number	Color	E. F. Johnson Number
MS16108-1A	White	105-201-200
MS16108-2A	Red	105-202-200
MS16108-3A	Black	105-203-200
MS16108-4A	Brown	105-208-200
MS16108-5A	Green*	105-204-200
MS16108-6A	Orange	105-206-200
MS16108-7A	Blue	105-210-200
MS16108-8A	Yellow	105-207-200
MS16108-9A	Gray	105-213-200
MS16108-10A	Violet	105-212-200

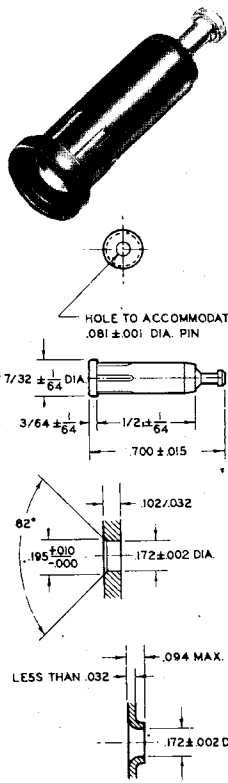

RIB-LOC PRESS-IN TIP JACKS

Johnson Rib-Loc design permits substantial production line savings—no mounting hardware to handle and assemble. Rib-Loc tip jacks install by pressing into proper size chassis hole. Accept .080" tip plug in recessed, closed-entry type contact that rejects plugs .085" or larger to prevent accidental contact damage. Silver-plated beryllium copper contact spring. Brass solder terminal silver-plated and Ir-dited for good solderability. Insulating body molded of low-loss polyamide. Current rating: 10 amps. Voltage breakdown: 5,000 VDC. Capacity to 1/8" panel: 1.4 pf nominal.

Cat. No. 105-1040 Net Price \$0.12
(See color chart below)

Note: Connectors, unless otherwise specified, are available in 6 molded colors to Federal Standard 595. Other colors listed are available as specials. Catalog number for color desired is determined by adding color numbers on chart below to 5th and 6th digits of catalog number listed for series. Example: 105-800 in Violet, add color number for Violet (12) to 5th and 6th digits of series number, and order 105-812. To order 105-1040 in Violet, add 12 to 5th and 6th digits of series number and order 105-1052.

Color	No.	Color	No.	Color	No.
White*	01	Orange	06	Violet	12
Red*	02	Yellow*	07	Grey	13
Black*	03	Brown	08		
Green*	04	Blue*	10		

*Indicates colors available from stock. Other colors listed are, for some items, available as specials.

Banana jacks and plugs

E. F. JOHNSON CO.

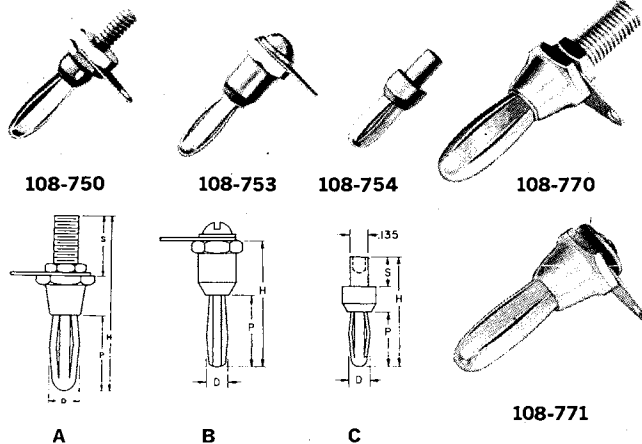

STANDARD BANANA PLUGS

This group of standard banana plugs has accurately machined brass studs which extend the full length of the plugs, providing extra strength. Springs are nickel-silver—highly resistant to corrosion. Bodies and hardware .0001 nickel-plated. All banana plugs listed below are available with beryllium copper springs and nickel, cadmium, or silver plating, when desired. A wide selection of miniature solder-type plugs is also available on special order—however, quantities in special platings or plugs should be sufficiently large for economical production runs. Solder terminal and nut or screw furnished.

Cat. No.	Dwg.	S	P	D	H	Thread	Net Price
108-750	A	3/8"	17/32"	.175"	1 1/8"	6-32	\$0.15
108-750-2	A	3/4"	17/32"	.175"	1 1/2"	6-32	.16
108-753	B	—	17/32"	.175"	1 5/16"	6-32	.16

This banana plug is similar to the standard types listed above, except that it is designed for riveting. Springs are beryllium copper, cadmium-plated.

108-754	C	7/32"	13/32"	.155"	1 3/16"	—	\$0.13
---------	---	-------	--------	-------	---------	---	--------

Jumbo type banana plugs with accurately machined brass studs extending full length of the pins. Nickel-silver springs. Bodies and hardware .0001 nickel-plated. With solder lug and nut or screw.

108-770	A	5/8"	3/4"	.300"	1 29/32"	1/4"-28	\$0.35
108-771	B	—	3/4"	.300"	1 1/8"	10-32	.50

STANDARD BANANA JACKS

High quality, machined brass banana jack. Nickel-plated. Furnished complete with solder terminal and nut.

Cat. No.	F	D	S	H	Hole Dia.	Thread	Net Price
108-740	3/8"	1/4"	17/32"	5/8"	.166"	1/4"-28	\$0.13

High quality machined brass banana jacks with plastic head molded to body. Nickel-plated. Furnished complete with solder terminal and nut. The 108-745-1 is equipped with red plastic head—the 108-745-2 is equipped with black plastic head.

108-745-1	7/16"	1/4"	32/64"	21/32"	.166"	1/4"-28	\$0.28
108-745-2	7/16"	1/4"	32/64"	21/32"	.166"	1/4"-28	.28

This jumbo banana jack will accommodate plugs such as the 108-770 and the 108-771 listed above. Machined brass, nickel-plated. Furnished complete with solder terminal and nut.

108-760	9/16"	3/8"	21/32"	1"	.277"	3/8"-32	\$0.45
---------	-------	------	--------	----	-------	---------	--------

BANANA JACK

Completely insulated molded body with cadmium-plated insert. Accommodates banana plugs of nominal .175" diameter. Voltage breakdown: 10,000 volts DC. Capacity to 1/16" panel; 2.4 mmf. nominal. Mounts in 2 3/4" diameter circular, "D", or double flat hole (1/4" across flats). Single nut furnished for mounting—no other mounting hardware needed.

Cat. No. 108-900	Net Price	\$0.10
------------------	-----------	--------

(See Color Chart under tip jacks)

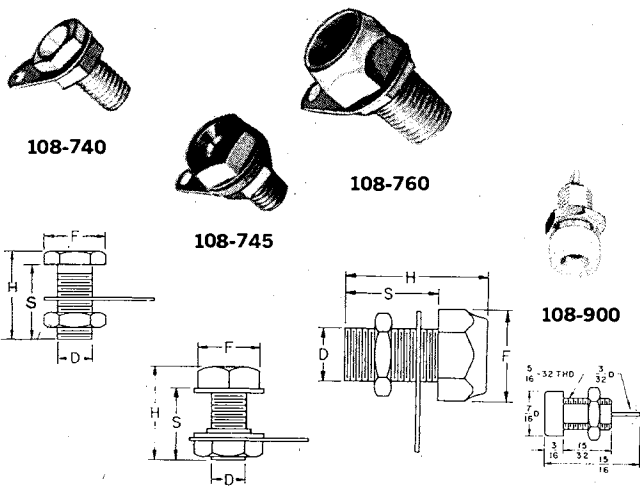

STANDARD INSULATED BANANA PLUGS

These standard insulated banana plugs are equipped with plastic handles, brass nickel-plated bodies, and nickel-silver springs. The 108-752-1 has a black plastic handle—the 108-752-2 has a red plastic handle.

Cat. No.	S	P	D	H	G	O	Net Price
108-752-1	1 3/8"	17/32"	.175"	2 1/8"	7/32"	7/16"	\$0.30
108-752-2	1 3/8"	17/32"	.175"	2 1/8"	7/32"	7/16"	.30

JUMBO INSULATED BANANA PLUGS

These jumbo size insulated banana plugs are similar in design to the standard types listed above, but are somewhat larger in size. With brass nickel-plated bodies, and nickel-silver springs. The 108-772-1 has a black plastic handle—the 108-772-2 has a red plastic handle.

Cat. No.	S	P	D	H	G	O	Net Price
108-772-1	1 3/4"	3/4"	.300"	2 25/32"	3/8"	5/8"	\$0.60
108-772-2	1 3/4"	3/4"	.300"	2 25/32"	3/8"	5/8"	.60

SOLDERLESS BANANA PLUGS

Compact, high voltage insulated plug for a wide variety of applications. Designed for fast, solderless connection of up to 16 gauge stranded wire. Body and pin are constructed of one-piece, nickel-plated brass with high grade nickel-silver springs. Sleeve is molded. Current rating: 15 amps.

Cat. No. 108-300	Net Price	\$0.19
------------------	-----------	--------

(See Color Chart under tip jacks)

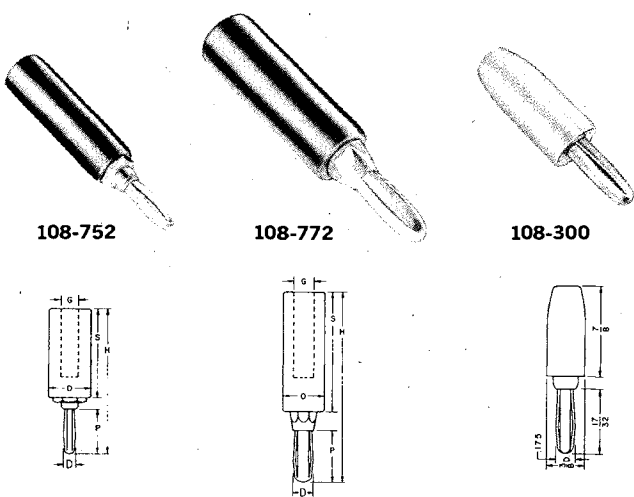

DUAL BANANA PLUGS

Extremely versatile dual banana plug available for either solderless or set screw connection. Molded body incorporates polarity indication and strain relief hole for wire leads. Springs are high quality nickel-silver—bodies are nickel plated. Accurately machined brass studs extend full length of pins for extra strength. Voltage breakdown: 10,000 VDC. Capacity plug to plug: 1.3 pf. Current rating: 15 amps.

Cat. No. 108-200 (solderless)	Net Price	\$0.70
-------------------------------	-----------	--------

Cat. No. 108-250 (with set screws)	Net Price	.72
------------------------------------	-----------	-----

(See Color Chart under tip jacks)

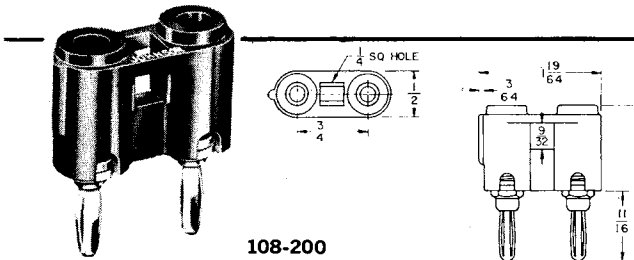

KEYSTONE ALL STEEL BATTERY HOLDERS

STANDARDIZED ALL STEEL BATTERY HOLDERS

An important advance in design that has gained wide acceptance for military and commercial usage. Battery when installed is held under spring tension at a constant pressure assuring low resistance contact will hold up to 4 cells in series in sturdy insulating tube. Retainer clips available to lock battery securely. This prevents shifting or loosening of battery in holder. Recommended for use where shock or severe vibration is encountered.

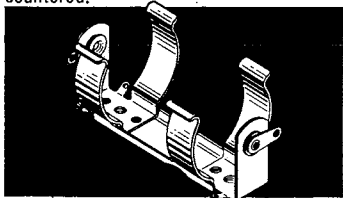

SPECIFICATIONS

Made of SAE 1065 Carbon Steel to MIL Spec. 17919, heat treated to spring temper and nickel plated .0002 thick. Contact assembly consists of a stainless steel eyelet, moisture proof vulcoloid washers and a coated copper solder lug. Ribbed carbon steel base for added support is nickel plated and has 2 mounting holes for ease in mounting.

- CORROSION RESISTANT NICKEL PLATED
- STAINLESS STEEL CONTACTS
- MOISTURE PROOF INSULATING WASHERS
- IDEAL FOR NI-CAD AND ALKALINE CELLS

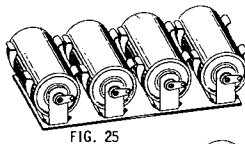

FIG. 25

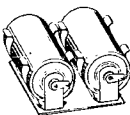

FIG. 23

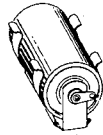

FIG. 19

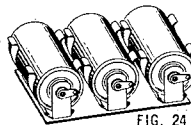

FIG. 24

FIG. 20

FIG. 21

FIG. 22

MODIFICATIONS AVAILABLE

Variety of stock parts permits fast delivery on special requirements. Use our engineering service for your special custom-built holders.

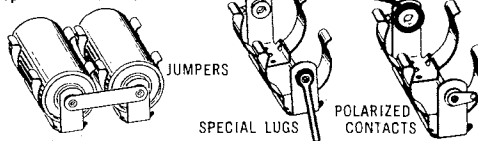

SPACE SAVER BATTERY CLIPS



DIMPLE AND INSULATED CONTACTS

Std. Pkg. 10 Pieces



These holders are available insulated contact or with a dimple contact. Provides positive contact in either case. They are compact and economical. The "AA", "C", "D", Mercury and Ni-Cad batteries are accommodated. Made of SAE 1065 steel heat treated to spring temper and nickel plated. Insulated type has steel nickel plated eyelet and resin impregnated vulcanized fibre insulation. Snap-on washer for polarization will be supplied upon request.

Cat. No.	Battery Types	Min. to max. Diameter	Net Each	
			5-19	20-99
92*	AA	.531-.660	.05	.04
99*	AA	.531-.660	.05	.04
100†	AA	.531-.660	.08	.07
86*	C	.875-1.125	.08	.08
87†	C	.875-1.125	.12	.11
88†	D	1.187-1.375	.13	.12
89*	D	1.187-1.375	.10	.09

*Non-Insulated

†Insulated

INSULATED POLARIZING WASHERS

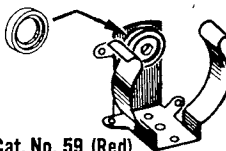

Cat. No. 59 (Red)
Cat. No. 60 (Black)

Molded Insulated Polarizing Washers. The washers hold securely when snapped over the eyelets used on our standardized battery holders.

POLARITY LABELS

Cat. No. 58

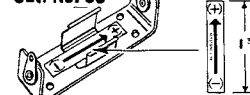

- PRESSURE SENSITIVE
- WILL ADHERE TO ANY SURFACE
- NO GLUE OR DAMPING REQUIRED
- ECONOMICAL

Wherever circuit polarity is to be shown labels colored Blue and Red.



1100 SERIES
DIMPLE CONTACT



2100 SERIES
INSULATED CONTACTS

One Insulated Contact	Net Each		All Contacts Insulated	Net Each		Fig. No.	Holds No. of Cells	All Batteries in the Group are of Similar Size and Fit Holders Listed		
	5-19	20-99		5-19	20-99			Burgess	Eveready	RCA
PENCCELL HOLDERS										
Cat. No.	Net Each		Cat. No.	Net Each		Fig. No.	Holds No. of Cells	All Batteries in the Group are of Similar Size and Fit Holders Listed		
	5-19	20-99		5-19	20-99			Burgess <td>Eveready <td>RCA</td> </td>	Eveready <td>RCA</td>	RCA
1139	.25	.23	2139	.30	.26	19	1	Z, HG9	E9, E12	VS034A
	—	—	2140*	.45	.43	23	2	CD6, 9R	E91, E133	VS144
	—	—	2171*	.70	.68	24	3	HG12R	E502, N46	VS149
	—	—	2182*	.80	.75	25	4	H133	515, 915	VS313A
1189	.40	.38	2189	.40	.38	20	2	HG502R	1015	VS334
1191	.45	.41	2191	.45	.40	21	3	920		
1194	.50	.48	2194	.55	.51	22	4	930		
"C" CELL HOLDERS										
1173	.35	.30	2173	.35	.33	19	1	1		VS035A
	—	—	2174*	.60	.59	23	2	P6	E233	VS300
	—	—	2187*	.80	.75	24	3	120	635	VS335
	—	—	2188*	1.05	.95	25	4	130	935	VS400
1185	.50	.45	2185	.50	.49	20	2	H233		
1195	.50	.48	2195	.55	.51	21	3	302599		
1198	.55	.51	2198	.60	.57	22	4			
"D" CELL HOLDERS										
1175	.35	.30	2175	.35	.33	19	1	2	E42	VS036
	—	—	2176*	.60	.59	23	2	2R	N56	VS036A
	—	—	2190*	.85	.80	24	3	CD7	E95	VS336
	—	—	2192*	1.05	.95	25	4	210	D99	
1186	.48	.44	2186	.50	.49	20	2	230	A100	
1199	.55	.51	2199	.60	.56	21	3		950	
1162	.60	.54	2162	.65	.62	22	4		1050	
1179	.35	.30	2179	.35	.34	19	1		E94	

*Clips mounted on phenolic 1/16" thick Mil Spec 3115B.

BATTERY AND COMPONENT HOLDERS

Cat. No.	Battery Types	Min. to Max. Diameters		NET EACH		Cat. No.	Battery Types	Min. to Max. Diameters		NET EACH	
		5-19	20-99	5-19	20-99			5-19	20-99		
69	2U6 or (2) AA	3/8 x 1 1/8		.07	.06	95	(1) K 20	3/8 x 1 3/8		.08	.07
70	(2) RM 12	3/8 x 1 3/8		.09	.08	97	(2) "C"	(2) 1 3/8 Dia.		.09	.08
90	#7	3/8 to 2 3/4		.06	.04	98	(2) D	(2) 1 3/8 Dia.		.11	.10
91	(1) AA	1/2 to 2 3/2		.07	.05	217	1 3/8 Dia.	1 3/8 Dia.		.18	.14
93	(1) C	7/8 to 1 1/2		.07	.06	218	1 1/2 Dia.	1 1/2 Dia.		.20	.15
94	(1) D	1 1/8 to 1 3/8		.08	.07	219	2" Dia.	2" Dia.		.22	.16
95	(1) U-15	3/8 x 1 1/2		.07	.06						

Clips are made of Aluminum except Nos. 69, 217, 218, 219 are made of Steel.

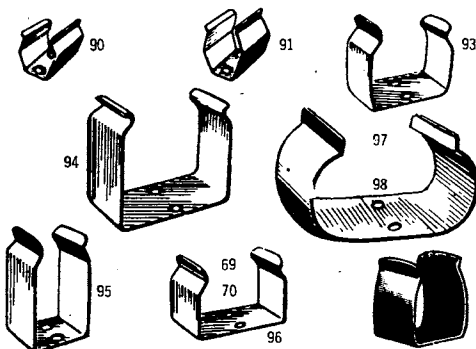

PRE-PUNCHED TERMINAL BOARDS



KEYBOARDS

- COMPLETE RANGE OF SIZES AND SUITABLE HARDWARE
- "DO IT YOURSELF" STAKING TOOLS
- STANDARD AND CUSTOM-MADE
- COPPER CLAD FOR PRINTED CIRCUITS
- UNCLAD TYPE FOR WIRED CIRCUITS

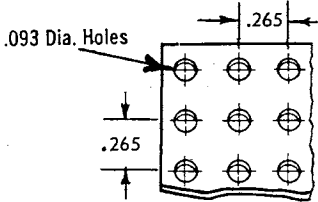

"A" PATTERN .093 DIA. HOLES

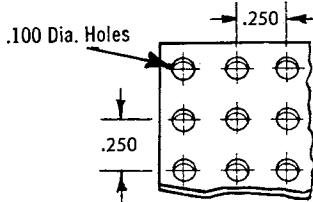

"E" PATTERN .100 DIA. HOLES

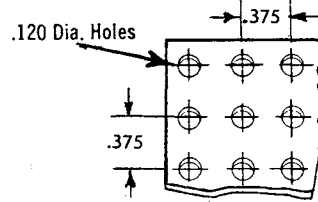

"H" PATTERN .120 DIA. HOLES

"A" PATTERN .093 DIA. HOLES .265 x .265 C to C

Size Width & Length	No. of Holes W & L	1/16" THICK		
		XXXX Natural	Glass Epoxy	Paper Base Epoxy
		Cat. No.	Cat. No.	Cat. No.
.82 x 8.50	3 x 32	1731	1790	1796EP
1.88 x 8.50	7 x 32	1737	1791	1797EP
2.44 x 8.50	9 x 32	1738	1788	1798EP
3.25 x 8.50	13 x 32	1785	1789	1801EP
3.25 x 17.00	13 x 64	1786	1787	1802EP
4.88 x 4.88	18 x 18	1806	1807	1803EP
4.88 x 8.50	18 x 32	1784	1792	1804EP
4.88 x 17.00	18 x 64	1739	1793	1805EP
8.50 x 8.50	32 x 32	1732	1794	1808EP
8.50 x 17.00	32 x 64	1733	1795	1809EP
3/32" THICK				
1.38 x 1.88	5 x 7	1758	—	1758EP
1.38 x 4.00	5 x 15	1760	—	1760EP
1.38 x 8.50	5 x 32	1749	—	1749EP
1.88 x 2.94	7 x 11	1759	—	1759EP
1.88 x 8.50	7 x 32	1740	—	1740EP
2.44 x 8.50	9 x 32	1741	—	1741EP
3.25 x 8.50	13 x 32	1814	—	1814EP
3.25 x 17.00	13 x 64	1816	—	1816EP
4.88 x 8.50	18 x 32	1756	—	1756EP
4.88 x 17.00	18 x 64	1742	—	1742EP
8.50 x 8.50	32 x 32	1817	—	1817EP
8.50 x 17.00	32 x 64	1757	—	1757EP

"E" PATTERN .100 DIA. HOLES .250 x .250 C to C

Size Width & Length	No. of Holes W & L	XXXX Natural	
		1/16" THICK	3/32" THICK
		Cat. No.	Cat. No.
2.13 x 4.00	8 x 16	1750	—
2.13 x 8.50	8 x 34	1765	—
3.63 x 8.50	14 x 34	1766	—
8.50 x 8.50	34 x 34	1767	—
8.50 x 17.00	34 x 68	1768	—
3/32" THICK			
2.13 x 8.50	8 x 34	—	1770
8.50 x 8.50	34 x 34	—	1771
8.50 x 17.00	34 x 68	—	1772

"H" PATTERN .120 DIA. HOLES .375 x .375 C to C

Size Width & Length	No. of Holes W & L	XXXX Natural		Paper Base Epoxy
		1/16" THICK	3/32" THICK	
		Cat. No.	Cat. No.	
1.88 x 8.25	5 x 22	1743	—	—
2.25 x 8.25	6 x 22	1744	—	—
4.13 x 8.25	11 x 22	1782	—	—
4.13 x 16.50	11 x 44	1745	—	—
3/32" THICK				
1.88 x 8.25	5 x 22	1746	—	1746EP
2.25 x 8.25	6 x 22	1747	—	1747EP
4.13 x 8.25	11 x 22	1783	—	1783EP
4.13 x 16.50	11 x 44	1748	—	1748EP
6.00 x 8.25	16 x 22	1941	—	1941EP
6.00 x 16.50	16 x 44	1942	—	1942EP
8.25 x 8.25	22 x 22	1943	—	1943EP
8.25 x 16.50	22 x 44	1939	—	1939EP

TERMINALS AND EYELETS For Boards with .093-.100 dia. Holes

TERMINALS

Brass (Mil Spec QQ626) and Silver Plated.

NOTE: When ordering Turret Terminals BE SURE TO SPECIFY Cat. No. of Terminal and add -2 for 1/16" thick Board and -3 for 3/32" thick Board

I.E. 1598-2 for 1/16" thick Board and 1598-3 for 3/32" thick Board

ALL TERMINAL DRAWINGS ARE ACTUAL SIZE.

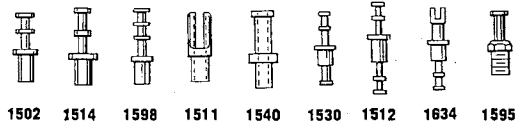

PUSH-IN TERMINAL

SOLDERLESS

Made of Beryllium Copper.

Cat. No. 1498-CP (cadmium plate)

Cat. No. 1498-SP (silver plate)

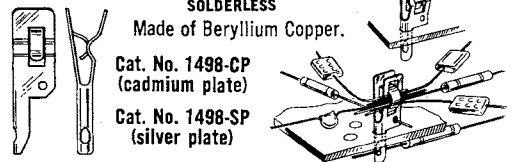

PRECISION MADE EYELETS

Made of Brass and Hot Tinned for easy solderability

Specify Cat. No. 33 for 1/16" thick Board
Cat. No. 34 for 3/32" thick Board

TERMINALS AND EYELETS For Boards with .120 dia. Holes

TERMINALS

ALL TERMINAL DRAWINGS ARE ACTUAL SIZE.

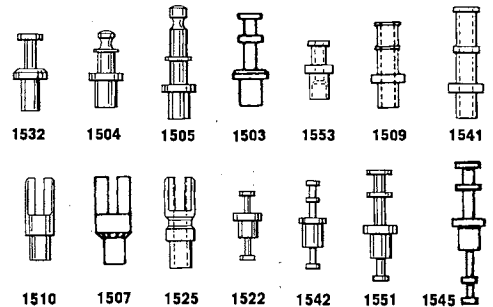

PRECISION MADE EYELETS

Specify Cat. No. 43 eyelet for 1/16" thick Board
Cat. No. 44 eyelet for 3/32" thick Board

STANDARDIZED TERMINAL BOARDS

STANDARDIZED TURRET TERMINAL BOARDS

Cut your production cost by eliminating the tooling and setup charge usually applied to nonstandardized boards. Terminals are securely riveted and hot tinned for easy soldering.

TERMINALS: Your choice of most popular types.

Made of Brass: QQ-626, comp. 22, 1/2 hard.
Hot Dip Solder finish: Mil-F-14072 Type 221.

Material: Your choice of either PBE or GEE Phenolic.

PBE: Paper base electrical, Mil-P-3115C, Temp. 250° F max. Type XXXP.

GEE: Glass Epoxy, Mil-P-18177, Temp. 300° F max. Type G-10.

Five sections SCORED for easy separation M'tg. holes in each section.

These boards CAN BE MODIFIED with terminals staked in all holes, scoring eliminated. Marking can be added.

SCORED TURRET TERMINAL BOARDS

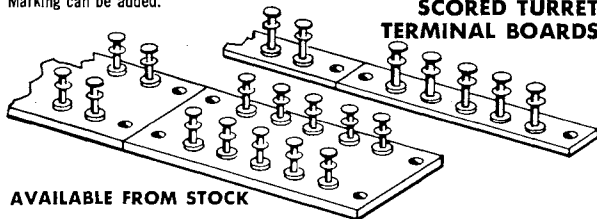

AVAILABLE FROM STOCK

3/8" SPACING AND SCORED

3/32" THICK PHENOLIC — Choice of 4 Types of Terminals
Overall Length of Board 13 3/8", FIVE 2 5/8" Sections.

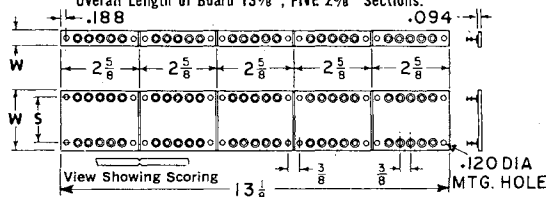

Five sections SCORED for easy operation.
M'tg. holes in each section.

CHOICE OF TERMINALS

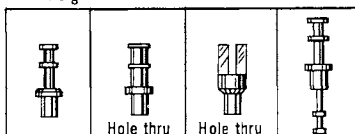

W	S	No. of Terms.	Material	With 1503 Term. Cat. No.	With 1509 Term. Cat. No.	With 1507 Term. Cat. No.	With 1545 Term. Cat. No.
1/2	Single Row	25	PBE	15031	15091	15071	15041
			GEE	15231	15291	15271	15241
1 1/2	1	50	PBE	15032	15092	15072	15042
			GEE	15232	15292	15272	15242
1 1/2	1 3/4	50	PBE	15036	15096	15076	15046
			GEE	15236	15296	15276	15246
2	1 1/2	50	PBE	15033	15093	15073	15043
			GEE	15233	15293	15273	15243
2 1/2	2	50	PBE	15034	15094	15074	15044
			GEE	15234	15294	15274	15244
3	2 1/2	50	PBE	15035	15095	15075	15045
			GEE	15235	15295	15275	15245

MINIATURE TURRET TERMINAL BOARDS

1/4" SPACING AND SCORED — 1/16" THICK PHENOLIC
Overall Length of Board Is 9 1/16", Five 1 5/8" Sections
Choice of 6 Types of Terminals

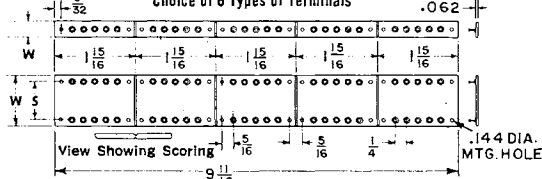

Five sections SCORED for easy operation.
M'tg. holes in each section.

CHOICE OF TERMINALS

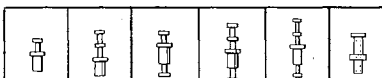

W	S	No. of Terms.	Material	With 1572 Term. Cat. No.	With 1573 Term. Cat. No.	With 1574 Term. Cat. No.	With 1575 Term. Cat. No.	With 1583 Term. Cat. No.	With 1559 Term. Cat. No.
5/16	Single Row	25	PBE	15047	15057	15067	15077	15087	15097
			GEE	15247	15257	15267	15277	15287	15297
7/8	9/16	50	PBE	15048	15058	15068	15078	15088	15098
			GEE	15248	15258	15268	15278	15288	15298
1 1/8	13/16	50	PBE	15049	15059	15069	15079	15089	15099
			GEE	15249	15259	15269	15279	15289	15299

MINIATURE TURRET TERMINAL BOARDS

7/32" SPACING AND SCORED — 1/16" THICK PHENOLIC
Overall Length of Board 7 1/8". Five 1 1/8" Sections
Choice of 5 Types of Terminals

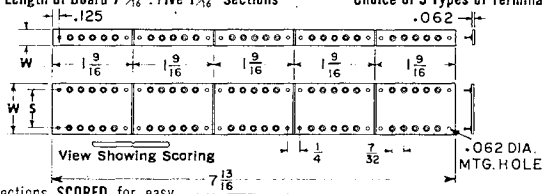

Five sections SCORED for easy operation.
M'tg. holes in each section

CHOICE OF TERMINALS

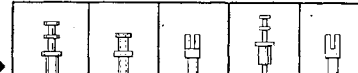

W	S	No. of Terms.	Material	With 1502 Term. Cat. No.	With 1502 Term. Cat. No.	With 1526 Term. Cat. No.	With 1512 Term. Cat. No.	With 1533 Term. Cat. No.
5/16	Single Row	25	PBE	15021	15023	15025	15063	15053
			GEE	15221	15223	15225	15263	15253
3/4	1/2	50	PBE	15028	15029	15026	15064	15054
			GEE	15228	15229	15226	15264	15254
1	3/4	50	PBE	15022	15024	15030	15065	15056
			GEE	15222	15224	15230	15265	15256

UNIVERSAL TERMINAL BOARDS

Designed for production or experimental use, these standardized boards are well suited for any electronic application requiring a sturdy mounting surface for resistors, condensers and components.

TERMINAL: 1503-3 HOT TIN DIP finish for easier soldering and infinite shelf life.

MATERIALS: PBE (Paper Base Elect. Mil-P-3115C type XXXP) or GEE (Glass Epoxy Mil-P-18177 type G-10)

NOTE: 5 Sections Scored for easy separation. 3 Rows of Terminals.

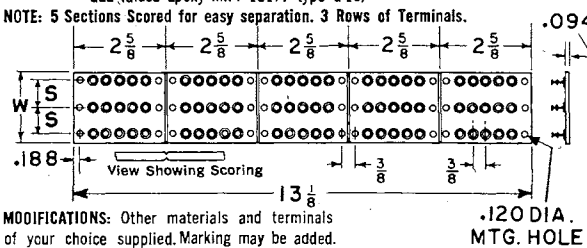

MODIFICATIONS: Other materials and terminals of your choice supplied. Marking may be added.



W	S	Total No. of Terms.	Material	Cat. No.
2 1/2	1	75	PBE	15332
			GEE	15342
3 1/2	1 1/2	75	PBE	15333
			GEE	15343

READI-MADE TERMINAL BOARDS

- ECONOMICAL • SAVE TOOLING COST
- DELIVERY FROM STOCK • RANGE OF SIZES • APPROVED MATERIALS

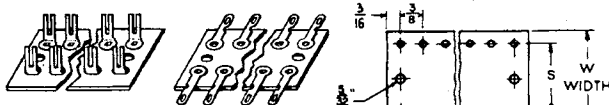

Read-made Terminal Boards are ideal for General Use. Excellent for mounting resistors, condensers, etc. Choice of Terminals.

MATERIAL: 1/16" thick Bakelite (Mil Spec 3115C-Pbe-P grade).

TERMINALS: 1204 and 1268 are stamped from .023 thick brass, 1539 is turned from 3/16" dia. brass rod.

PLATING: 1204 is Cadmium plated. 1268 and 1539 are Hot Tinned for easy soldering.

CHOICE OF TERMINALS

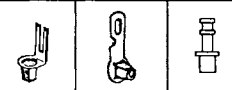

W	L	S	A	Terminals Each Side	With 1268 Term. Cat. No.	With 1204 Term. Cat. No.	With 1539 Term. Cat. No.
1	1 1/2	1/4	1 1/2	5	1268-10	1204-10	1239-10
1	2 1/4	1/4	1 1/4	6	1268-12	1204-12	1239-12
1	5 1/4	1/4	4 1/4	14	1268-28	1204-28	1239-28
1 1/4	3 1/4	1/4	3 1/4	10	1268-20	1204-20	1239-20
1 1/2	4 1/4	1/4	3 3/4	11	1268-22	1204-22	1239-22
1 3/4	7 1/4	1/4	6 3/4	19	1268-38	1204-38	1239-38
1/2	7 1/4	Single Row	6 3/4	19	1268-19	1204-19	1239-19



KEYSTONE TERMINAL BOARDS

BINDING POST STRIPS

Terminal supplied on these boards is No. 1209

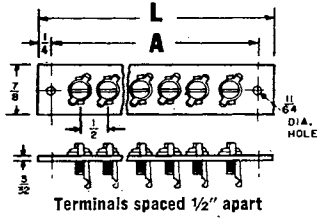
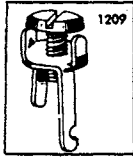

HEAVY DUTY 3/32" THICK MATERIAL 7/8" WIDE

Glass Epoxy Cat. No.	Fiber-glass Cat. No.	L Length	A Mtg. C'trs	No. Term.
4147	4157	1 1/2	1	1
4148	4158	2	1 1/2	2
4149	4159	2 1/2	2	3
4150	4160	3	2 1/2	4
4151	4161	3 1/2	3	5
4152	4162	4	3 1/2	6
4153	4163	4 1/2	4	7
4154	4164	5	4 1/2	8
4155	4165	5 1/2	5	9
4156	4166	6	5 1/2	10

- Available from Stock
- Eliminate Costly Setup Charges

MATERIAL SPECIFICATIONS:
LOW COST TAN COLORED FIBERGLASS
 — Nema Grade GPO-1 a glass polyester rated for 300°F.

OR
GEE:
GLASS EPOXY: MIL-P-18177 temp., 300°F. MAX. Type G-10.

YOUR CHOICE OF GLASS EPOXY OR FIBERGLASS MATERIALS

Terminal supplied on these boards is No. 1248

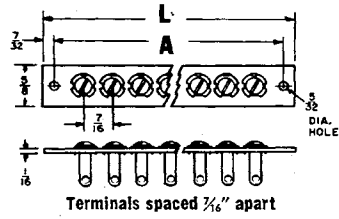

STANDARD 1/16" THICK MATERIAL 5/8" WIDE

Glass Epoxy Cat. No.	Fiber-glass Cat. No.	L Length	A Mtg. C'trs	No. Term.
4177	4167	1 1/4	1	1
4178	4168	1 1/2	1 1/2	2
4179	4169	2 1/4	2 1/2	3
4180	4170	2 1/2	2 1/2	4
4181	4171	3	3	5
4182	4172	3 1/4	3 1/2	6
4183	4173	3 3/8	3 1/2	7
4184	4174	4 1/4	4 1/2	8
4185	4175	4 3/4	4 1/2	9
4186	4176	5 3/8	4 1/2	10

FEED-THRU TERMINAL BOARDS

- Low Cost Feed-Thru Terminations
- For Light or Heavy Duty Applications

Copper pins are forced into hole of the phenolic, then flattened and pierced. Terminals are hot tin dipped for good solderability.

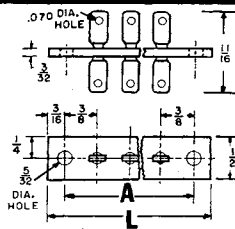

Cat. No.	No. Lugs	A Mtg. Ctr.	L Length
1220-1	1	3/4	1 1/8
1220-2	2	1 1/8	1 1/2
1220-3	3	1 1/2	1 7/8
1220-4	4	1 3/4	2 1/4
1220-5	5	2 1/4	2 3/4
1220-6	6	2 3/4	3
1220-7	7	3	3 3/4
1220-8	8	3 3/8	3 3/4
1220-9	9	3 3/4	4 1/4
1220-10	10	4 1/8	4 1/2

CONICAL GRIP BOARDS

- Spring Action Fingers Hold Leads
- Eliminates Time-consuming Wrapping of Wires
- More Reliable
- Less Costly
- Time Saving
- Easily Serviced

W	S	L	No. of Term. Each Side	Cat. No.
1/2	Single Row	2 5/8	5	4500
		5 1/4	12	4501
		7 7/8	19	4502
		10 1/2	26	4503
1 1/2	1	13 1/8	33	4504
		2 5/8	5	4505
		5 1/4	12	4506
		7 7/8	19	4507
2	1 1/2	10 1/2	33	4509
		13 1/8	33	4509
		2 5/8	5	4510
		5 1/4	12	4511
		7 7/8	19	4512
		10 1/2	26	4513
		13 1/8	33	4514

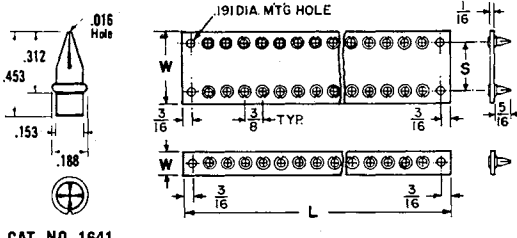

CAT. NO. 1641

MATERIAL:
 Brass, tinned Conical Terminals are firmly staked to 1/16" thick fiberglass insulator that will withstand temperatures to 300 degrees F. Wire leads are retained until ready to multiple dip solder.

STANDARD LAMINATED PHENOLIC MATERIAL

- RANGE OF SIZES
- CERTIFIED MATERIAL

• CHOICE OF —

- XXXP
- GLASS EPOXY
- COPPER CLAD
- FIBERGLASS

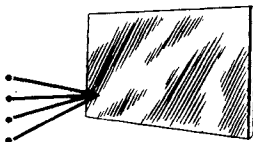

The finest grade laminated phenolic sheets we use in our production fabrication are available to you in a range of standard sizes or special sizes cut to order; and in a variety of types.

NEMA GRADE XXXP-MIL-P-3115C, paper base electrical-color natural. Most commonly used for panels and terminal boards. Excellent electrical grade and dimensional stability. Max. operating temp. continuous 250 deg. F.

NEMA GRADE G-10, MIL-P-18177B-GEE, color green **GLASS CLOTH EPOXY**. Superior chemical resistance, excellent mechanical and electrical properties. Max. operating temp. continuous 300 deg. F.

COPPER CLAD LAMINATES, XXXP MIL-P-13949 TYPE PP and **GLASS EPOXY MIL-P-13949B TYPE FL-GE**, are used mainly for printed circuitry. The copper foil serves as the conductor and the laminate provides the insulating support. 2-ounce copper foil is laminated to one or both sides of the insulator. We catalog both types in XXXP and G-10.

FIBERGLASS REINFORCED POLYESTER NEMA GRADE GPD-1 with a class 155C (300°F) rating. Color is Tan. Excellent mechanical and electrical properties. Fabricates similar to Phenolic and can be punched cold.

• SPECIFIED SIZES CUT TO ORDER

Size Width & Length	XXXP Natural	Glass Epoxy	XXXP Cop. Clad (1 Side)	XXXP Cop. Clad (2 Sides)	Glass Epoxy Cop. Clad (1 Side)	Glass Epoxy Cop. Clad (2 Sides)	Fiber-glass Polyester
	Cat. No.	Cat. No.	Cat. No.	Cat. No.	Cat. No.	Cat. No.	Cat. No.
3/16 x 7 1/16	2006	2022	—	—	—	—	2304
3/4 x 7 1/16	2020	2023	—	—	—	—	2305
1 x 7 1/16	2021	2024	—	—	—	—	2306
2 x 4 1/2	1970	1978	1985	1992	1999	2013	2307
2 1/4 x 3	1971	1979	1986	1993	2007	2014	2308
3 x 4 1/2	1972	1980	1987	1994	2008	2015	2309
4 1/2 x 6 1/2	1973	1981	1988	1995	2009	2016	2310
4 1/2 x 8 1/2	1974	1982	1989	1996	2010	2017	2311
8 1/2 x 17	1975	1983	1990	1997	2011	2018	2312
9 x 12	1976	1984	1991	1998	2012	2019	2313
3/32 THICK MATERIALS							
	Cat. No.	Cat. No.	Cat. No.	Cat. No.	Cat. No.	Cat. No.	Cat. No.
1/2 x 13 3/8	2025	2031	—	—	—	—	2314
1 1/4 x 13 3/8	2026	2032	—	—	—	—	2315
1 1/2 x 13 3/8	2027	2033	—	—	—	—	2316
2 x 13 3/8	2028	2034	—	—	—	—	2317
2 1/2 x 13 3/8	2029	2035	—	—	—	—	2318
3 x 13 3/8	2030	2036	—	—	—	—	2319

NOT SUPPLIED IN THESE TYPES



KEYBOARDS, STANDOFFS & SPACERS

MICRO-MINIATURE KEYBOARDS

WITH .042 DIA. HOLES

- PERMITS HIGHER COMPONENT DENSITY FOR SUBMINIATURE CIRCUITRY
- FOR MODULE STACKS
- SMALLER PLUG-IN CARDS POSSIBLE

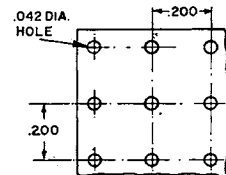
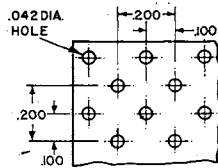
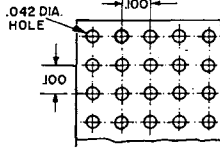

Material:
 GLASS EPOXY UNCLAD Mil-P-18177 G-10 (GEE) Temp. 300°F. Max.
 GLASS EPOXY Copper Clad Mil-P-13949B (GE) Temp. 300°F. Max.

Tolerance: Length and width overall dimension after fabrication Plus or Minus .015

"p" PATTERN .042 HOLES .100 x .100				"M" PATTERN .042 HOLES .100 x .200				"J" PATTERN .042 HOLES .200 x .200			
Width & Length	No. Holes W & L	Glass Epoxy	Glass Epoxy Cop. Clad (1 Side)	Width & Length	No. Holes W & L	Glass Epoxy	Glass Epoxy Cop. Clad (1 Side)	Width & Length	No. Holes W & L	Glass Epoxy	Glass Epoxy Cop. Clad (1 Side)
1/32" Thick Material				1/32" Thick Material				1/32" Thick Material			
2x4½	19x44	4225	4234	2x4½	9x22x2	4242	4250	2x4½	9x22	4258	4266
2x6	19x59	4226	4235	2x6	9x29x2	4243	4251	2x6	9x29	4259	4267
4½x6	44x59	4227	4236	4½x6	22x29x2	4244	4252	4½x6	22x29	4260	4268
6x17	59x169	4228	4237	6x17	29x84x2	4245	4253	6x17	29x84	4261	4269
3/64" Thick Material				3/64" Thick Material				3/64" Thick Material			
2x4½	19x44	4229	4238	2x4½	9x22x2	4246	4254	2x4½	9x22	4262	4270
2x6	19x59	4230	4239	2x6	9x29x2	4247	4255	2x6	9x29	4263	4271
4½x6	44x59	4231	4240	4½x6	22x29x2	4248	4256	4½x6	22x29	4264	4272
6x17	59x169	4232	4241	6x17	29x84x2	4249	4257	6x17	29x84	4265	4273

EYELET KEYBOARDS

An essential building block that will assist the designer and engineer in planning and layout of electronic circuitry. Eyelets are tinned for each soldering. Boards can be stored indefinitely and will retain soldering characteristics.

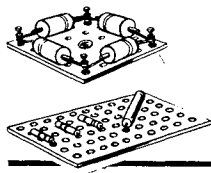

- Replaces Costly Terminal Board Assemblies
- For Lab or Production Use

Material: PBE XXXP Phenolic MIL-P-3115C.
Eyelets: Brass QQ626 Comp. 22 — ½" Spacing in Both Directions
Finish: Tinned, Mil-P-14072, Type 221.

FOR MINIATURE CIRCUITRY

- Available from Stock
- Construct Modules—Bridge Circuits—Printed Circuit Layout

Cat. No.	No. of Holes W & L	Width	Length	No. of Eyelets
4283	5x5	1¼	1¼	25
4284	6x10	1½	2½	60
4285	10x13	2½	3¼	130
4286	13x18	3¼	4½	234
4287	14x16	3½	4	224
4288	16x24	4	6	384

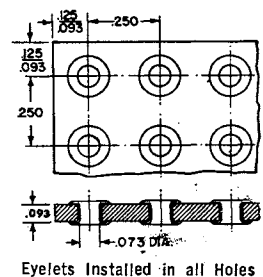

Eyelets Installed in all Holes

MODULE WAFER SOCKETS FOR .040 PINS

Precision drilled wafers hold contacts in perfect alignment. Insertion is easy and pins are grasped firmly.

Most Standard Encapsulated Operational Amplifiers and Module Circuits

Material: 1400 and 1401 made with G-10 Glass Epoxy. Bakelite
 1402 is made with PBE Phenolic Natural color



Cat. No. 1400

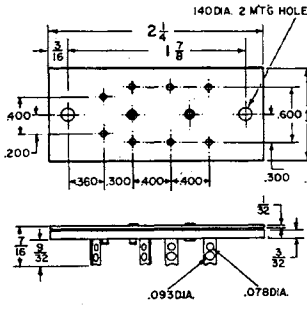
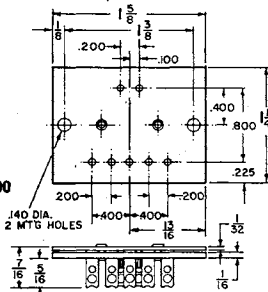

Cat. No. 1401

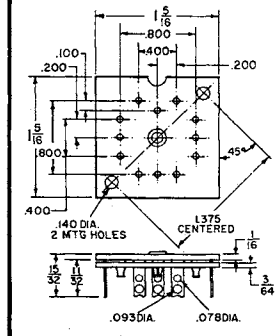

Cat. No. 1402

PHENOLIC SPACERS

- Good Mechanical Strength
 - Resists Abrasions & Chemicals
 - Excellent Dielectric
 - Low Moisture Absorption
- Material:** PBE Grade MIL-P-79A Natural Color Phenolic — Special Sizes Made to Order — Promptly Quoted

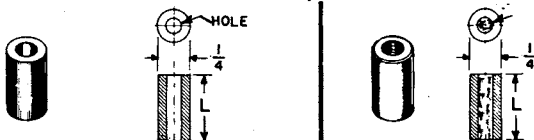

SPACERS — DRILLED HOLE ONLY

SPACERS — WITH TAPPED HOLE

Length Inches	For #4 Screw .120 Hole Cat. No.	For #6 Screw .140 Hole Cat. No.	For #8 Screw .171 Hole Cat. No.	4-40 Thread Cat. No.	6-32 Thread Cat. No.	8-32 Thread Cat. No.
¼ (.250)	360	367	1490	376	383	390
⅜ (.375)	361	368	1491	377	384	391
½ (.500)	362	369	1492	378	385	392
⅝ (.750)	363	370	1493	379	386	393
1 (1.000)	364	371	1494	380	387	394
1½ (1.500)	365	372	374	381	389	395
2 (2.000)	366	373	375	382	389	396

1.500 and 2" are tapped ⅜ deep each end

ALUMINUM ECONOMY SPACERS

FOR No. 4, 6 or 8 SCREWS

- Precision Formed
- No Burrs

Made of flat strip aluminum and rolled on precision equipment. Assures maximum bearing surface, square ends.



Tight Joint on Outside Diameter

Description and Tol.

Spacer For	I.D. ±.005	D.D. ±.007
#4	.125	.167
#6	.151	.193
#8	.178	.232

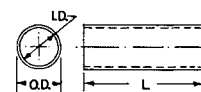

L Length Inches	For #4 Cat. No.	For #6 Cat. No.	For #8 Cat. No.	L Length Inches	For #4 Cat. No.	For #6 Cat. No.	For #8 Cat. No.
⅜	397	—	—	¾	418	425	432
½	398	405	412	⅞	419	426	433
⅝	399	406	413	1	420	427	434
¾	400	407	414	1¼	421	428	435
⅞	401	408	415	1½	422	429	436
1	402	409	416	1¾	—	430	437
1½	403	410	417	2	—	—	438

mueller clips

a complete line of
ALLIGATOR TEST & BATTERY CLIPS

Mueller Electric Co.



"60 SERIES" ALLIGATOR CLIPS

U.S. Patent No. 3,321,736

No. 60—CONVENTIONAL TYPE

New slim design with full-meshing teeth. Convenient, round thumb grip, barrel connection for banana plug. Equipped with small soldering lip. Strong spring with a hard bite. Cadmium plated. 2" long.



EACH NET.....\$0.08 LOTS OF 10.....\$0.054

No. 60-S—SCREW CONNECTION

Eliminates necessity for soldering. Otherwise same as No. 60.



EACH NET.....\$0.09 LOTS OF 10.....\$0.063

No. 60-CS—COPPER ALLIGATOR CLIP

Solid copper version of No. 60-S. Screw connection. 2" long. 10 per box.

EACH NET.....\$0.14 LOTS OF 10.....\$0.096

No. 60PR-2—SPECIAL BARREL

FOR TEST PROD OR PHONE TIP

Barrel crimped to provide friction fit on standard test prod or phone tip. Holds prod on test, frees hand for other work.



EACH NET.....\$0.11 LOTS OF 10.....\$0.078

No. 62 FLEXIBLE VINYL INSULATOR

Red and black insulators for Alligator Clips 60, 60-S, 60-CS, 60PR-2.

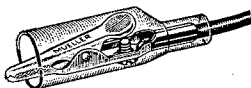

EACH NET.....\$0.06 LOTS OF 10.....\$0.04

No. 60-HS—STEEL ALLIGATOR CLIP WITH INSULATED HANDLE

Same as No. 60-S except equipped with red and black insulating sleeves on end. Very convenient for distinguishing leads. Has screw connection also. Cadmium plated. 2 1/32" long. Shipped half red, half black.

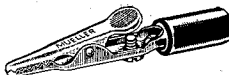

EACH NET.....\$0.13 LOTS OF 10.....\$0.089

No. 60-CHS—COPPER ALLIGATOR CLIP, INSULATED HANDLE

Solid copper version of No. 60-HS. Screw connection. Shipped with half red, half black insulating sleeves. 10 per box.

EACH NET.....\$0.17 LOTS OF 10.....\$0.118

"70 SERIES" ALLIGATOR CLIPS

U.S. Patent No. 2,762,028

A trim, modern Alligator Clip. Features simplified design, fast connection of wire with cord strain relief ears, patented hinge construction and lower cost. Mueller's traditionally snappy spring, full jaw spread, fine meshing teeth, round thumb grip and trim shape give most wanted features for test work in close quarters.

No. 70—FOR SOLDERED CONNECTION

Steel, cadmium plated. 1 1/2" long.

EACH NET.....\$0.07 LOTS OF 10.....\$0.045



No. 70-S—SCREW CONNECTION

Otherwise same as No. 70.

EACH NET.....\$0.08 LOTS OF 10.....\$0.054



No. 70-CS—COPPER SCREW CONNECTION

Solid copper version of No. 70-S.

EACH NET.....\$0.12 LOTS OF 10.....\$0.085

No. 72—SKIN-TIGHT INSULATOR

FOR 70 SERIES ALLIGATOR CLIPS:



For the first time complete, skin-tight, one-piece insulation for a standard size Alligator Clip! Covers entire clip right down to nose. Special tip slot permits full jaw opening without exposing teeth.

EACH NET.....\$0.06 LOTS OF 10.....\$0.04

MICRO-GATOR CLIP

(Smallest Insulated Clip Ever Made)

U.S. Patent No. 2,762,028

Trademark Reg.



Micro-Gator



Micro-Gator with Insulator

The alligator clip with the microscopic tip! This is the alligator clip you now can use where no other clip will do... on printed circuits, in tight spots and on tiny terminals too crowded for anything but its microscopic tip. Including separate skin-tight insulator the tip is no bigger than the head of a pin! Yet the Micro-gator has ample thumb grip, and plenty of bite to stand up straight on the smallest terminals. Ample 7/8" jaw spread. 1 1/2" long. Solder connection. Skin-tight flexible vinyl insulator (sold separately) has "lip-action" tip slot so that jaws stay covered whether open or closed.

No. 34 (Steel, cadmium plated)

EACH NET.....\$0.06 LOTS OF 10.....\$0.041

No. 34-C (Solid Copper)

EACH NET.....\$0.08 LOTS OF 10.....\$0.053

No. 36 (Insulator for Nos. 34 and 34-C)

EACH NET.....\$0.05 LOTS OF 10.....\$0.033

MINI-GATOR CLIP

U.S. Patent No. 3,321,736

Trademark Reg.



Mini-gator



Mini-gator with Insulator

Indispensable for testing or incorporation into miniaturized equipment. New design features rivet hinge for greater strength, full-meshing teeth to grip finest wires. Skin-tight flexible Vinyl insulator (sold separately) covers completely — has slotted "lip action" tip. Clip weighs 1/20th oz., has tiny 1/16" O.D. nose, but ample 3/8" jaw spread 1 1/4" long. Crimping ears. Solder connection. Surprisingly strong bite penetrates corrosion and coatings.

No. 30 (Steel, cadmium plated)

EACH NET.....\$0.07 LOTS OF 10.....\$0.05

No. 30-C (Solid Copper)

EACH NET.....\$0.09 LOTS OF 10.....\$0.061

No. 32 (Insulator for Nos. 30 and 30-C)

EACH NET.....\$0.05 LOTS OF 10.....\$0.033

COMPLETELY INSULATED ALLIGATOR CLIPS

Patent Pending

No. 63 or 63-C Clip

Sold only as a unit, with factory-applied insulators.

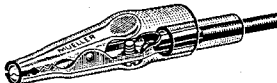

Completely insulated right down to the nose. Flexible 2-piece skin-type vinyl insulator of high dielectric strength with "lip action" slotted tip that permits opening of clip without exposing metal. Insulator nose is only 13/64" O.D. The tight fitting sheath preserves all the slimmness of the Alligator Clip, still giving complete protection against shorts in even the tightest spots. Screw connection easily made by slipping insulator forward. 2 1/8" long.

No. 63—INSULATED ALLIGATOR CLIP (STEEL)

Composed of Mueller No. 60-S Alligator Clip steel, cadmium plated, screw connection, complete with 2-piece vinyl insulator. Shipped half with red insulators, half black. 10 per box.

EACH NET.....\$0.19 LOTS OF 10.....\$0.13

No. 63-C—INSULATED ALLIGATOR CLIP (COPPER)

Composed of Mueller No. 60-CS Alligator Clip, solid copper, screw connection. Shipped half with red insulators, half black. 10 per box.

EACH NET.....\$0.22 LOTS OF 10.....\$0.15

CROCODILE CLIPS



No. 85 or 85-C Clip with No. 87 Insulator



No. 85-T Clip

No. 85—A very small clip with slender, elongated jaws for getting into tight places in radio or electrical test work. Screw connection. 2 1/8" long.

EACH NET.....\$0.11 LOTS OF 10.....\$0.076

No. 85-C—Same as No. 85, except solid copper with phosphor bronze spring, brass screw. A radio frequency, entirely non-ferrous test clip. 10 per box.

EACH NET.....\$0.21 LOTS OF 10.....\$0.148

No. 85-T—Crocodile "Tip-Clip"—equipped with standard phone tip on one jaw, otherwise same as No. 85. Ideal for use as a prod, for ordinary clip connections and for connections to insulated binding posts having non-removable heads. 2 1/8" long. 10 per box.

EACH NET.....\$0.27 LOTS OF 10.....\$0.187

Use No. 87 Insulators for clips 85, 85-C and 85-T. Red and Black. Cover entire clip except nose. Protect against short and shock. Help to distinguish leads.

mueller clips

a complete line of

ALLIGATOR TEST & BATTERY CLIPS

Mueller Electric Co.



BUBBLE PACKED CLIPS AND INSULATORS

The most popular Mueller clips and insulators attractively packaged on display cards. Clean design and concise copy invite attention. Bright pumpkin colored background makes these cards an eye-catching standout on pegboard or similar display panels.

Only three card sizes. Most items packaged on smallest card (2" x 7"). Where included, insulators are half red, half black. Standard package ten cards.

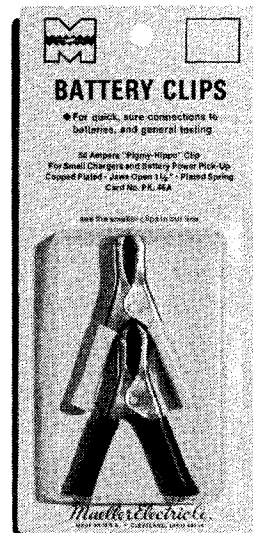
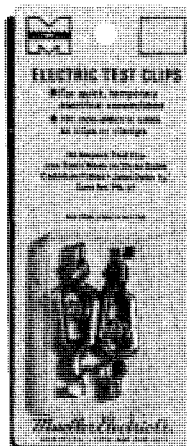

Card No.	Description and Quantity of Merchandise on Each Card (See Preceding Pages for Additional Information)	Length of Clip	Clip Jaws Open	Amp. Capacity	Clips Made Of	CARD PRICE
						Suggested USA List
ALLIGATOR CLIPS						
PK60S	4 No. 60-S Clips, Screw Connection	2"	5/16"	5	Steel	.65
PK60S62	2 No. 60-S Clips and 2 No. 62 Insulators	2"	5/16"	5	Steel	.56
PK60CS	4 No. 60-CS Clips, Screw Connection	2"	5/16"	5	Copper	.78
PK60CS62	2 No. 60-CS Clips and 2 No. 62 Insulators	2"	5/16"	5	Copper	.63
PK60HS	4 No. 60-HS Clips with Insulated Handles 2 Red, 2 Black. Screw Connection	2-11/32"	5/16"	5	Steel	.79
PK60CHS	4 No. 60-CHS Clips with Insulated Handles 2 Red, 2 Black. Screw Connection	2-11/32"	5/16"	5	Copper	.93
PK63	2 No. 63 Completely Insulated Clips, 1 Red, 1 Black. Screw Connection	2-1/8"	5/16"	5	Steel	.58
MINI-GATOR CLIPS (Very Small Alligators)						
PK30	4 No. 30 Clips	1-1/16"	3/16"	5	Steel	.58
PK3032	2 No. 30 Clips and 2 No. 32 Insulators	1-1/16"	3/16"	5	Steel	.51
PK30C	4 No. 30-C Clips	1-1/16"	3/16"	5	Copper	.65
PK30C32	2 No. 30-C Clips and 2 No. 32 Insulators	1-1/16"	3/16"	5	Copper	.54
MICRO-GATOR CLIPS (Very Small Alligators with Tiny, Flat Jaws)						
PK34	4 No. 34 Clips	1-3/32"	7/32"	5	Steel	.53
PK3436	2 No. 34 Clips and 2 No. 36 Insulators	1-3/32"	7/32"	5	Steel	.48
PK34C	4 No. 34-C Clips	1-3/32"	7/32"	5	Copper	.60
PK34C36	2 No. 34-C Clips and 2 No. 36 Insulators	1-3/32"	7/32"	5	Copper	.52
CROCODILE CLIPS (Long Jaws With Nesting Teeth)						
PK85	4 No. 85 Clips	2-1/8"	5/16"	5	Steel	.73
PK8587	2 No. 85 Clips and 2 No. 87 Insulators	2-1/8"	5/16"	5	Steel	.63
GENERAL PURPOSE TEST CLIPS						
PK45	4 No. 45 Clips	1-1/2"	5/16"	5	Steel	.64
PK4547	2 No. 45 Clips and 2 No. 47 Insulators	1-1/2"	5/16"	5	Steel	.59
PK48B	4 No. 48-B Clips	2"	1/2"	10	Steel	.79
PK27	2 No. 27 Clips	2-7/16"	5/8"	20	Steel	.56
NEEDLE CLIP (Piercing Contact Thru Wire Insulation)						
PK50C49	2 No. 50-C Clips and 2 No. 49 Insulators	2-1/4"	1/2"	20	Copper	1.08
BATTERY CLIPS						
PK24A	2 No. 24-A Clips, Lead Plated	2-7/8"	3/4"	25	Steel	.77
PK21A	2 No. 21-A Clips, Lead Plated	4"	1-1/16"	50	Steel	1.28
PK46A	2 No. 46-A Plier-Type Clips, Bright Copper Plated, 1 Red, 1 Black.	3"	1-1/8"	50	Steel	.80
BATTERY BOOSTER CLIPS (In Poly Bags)						
PK41A	2 No. 41-A Plier-Type Clips, Bright Copper Plated, 1 Red, 1 Black.	6"	1-9/16"	100	Steel	2.08
PK41C	2 No. 41-C Plier-Type Clips, Solid Copper, 1 Red, 1 Black.	6"	1-9/16"	200	Copper	4.88

SEE FULL LINE ON PRECEDING PAGES.



A DIVISION OF

NATIONAL TEL-TRONICS CORP.

The complete, economical line of hardware with many important extra features. NT•T Sales Co., Inc. offers a fully comprehensive and extensive line of electronic hardware and components to meet all the needs of the distributor and manufacturer. Every item offers important features, is excellently packaged, and is economically priced.

PHONE PLUGS

PHONE JACKS

ILLUSTRATION	DIMENSIONS	DESCRIPTION	Catalog Number	Std. 10 Pack		ILLUSTRATION	DIMENSIONS	DESCRIPTION	Catalog Number	Std. 10 Pack	
				Color	USA Net Each					Color	USA Net Each
		TWO CONDUCTOR Screw Type Two conductor screw type, accommodates two conductor jacks #336 and #337.	300B 300R 300M	Black Red Metal	.45 .45 .63			ULTRA-MINIATURE JACK Two conductor closed circuit jack for miniaturized applications. Used on many transistor radios. Accommodates plug #308.	310	Metal	.27
		TWO CONDUCTOR Solder Type Two conductor solder type, accommodates two conductor jacks #336 and #337.	301B 301R 301M	Black Red Metal	.39 .39 .60			SUB-MINIATURE JACKS Subminiature phone jack, two conductor closed circuit will accommodate plug #307.	311	Metal	.27
		THREE CONDUCTOR Solder Type Three conductor solder type, accommodates three conductor jacks #338 and #339.	302B 302R 302M	Black Red Metal	.63 .63 .78			SUB-MINIATURE JACKS Subminiature jacks, two conductor open circuit will accommodate plug #307.	313	Metal	.24
		THREE CONDUCTOR Screw Type Three conductor screw terminal phone plug. Accommodates jacks #338 and #339.	303-B 303-R 303-M	Black Red Metal	.72 .72 .84			2-CONDUCTOR THICK PANEL JACK For walls, floor or thick panel installation. 2-1/4" length.	345	Metal	.81
		TWO CONDUCTOR Type P1055 Two conductor solder type, made to military specifications. Solder terminals are silver plated to facilitate soldering.	304B 304R	Black Red	.81 .81			THREE CONDUCTOR THICK PANEL JACK Use same as 345. Can accommodate stereo plugs. Use with plugs 302, 303, and 306.	346	Metal	.90
		TWO CONDUCTOR Type P1054 Two conductor solder type, made to military specifications. Solder terminals are silver plated to facilitate soldering.	305B 305R	Black Red	.81 .81			TWO CONDUCTOR Open Circuit Two conductor, open circuit; will accommodate plugs #300, 301 and 304.	336	Metal	.24
		MINIATURE TWO CONDUCTOR Solder Type Two conductor solder type, accommodates sub-miniature jacks #311 and #313.	307B 307R 307M	Black Red Metal	.42 .42 .63			TWO CONDUCTOR Closed Circuit Two conductor, closed circuit; will accommodate plugs #300, 301 and 304.	337	Metal	.27
		ULTRA-MINIATURE, TWO CONDUCTOR Solder Type Two conductor solder type, accommodates ultra-miniature jack #310. Utilized on many tape recorders and transistor radios.	308B 308R 308T	Black Red Beige	.45 .45 .45			THREE CONDUCTOR Open Circuit Three conductor, open circuit; will accommodate plug #302.	338	Metal	.33
		RIGHT ANGLE PHONE PLUGS 2-conductor. Screw type. Accommodates two conductor jacks #336 and 337.	309B 309R 309M	Black Red Metal	.54 .54 .63			THREE CONDUCTOR Open Circuit Three conductor open circuit with bright brass bushing. Will accommodate plug #302.	338-B	Metal	.36
		RIGHT ANGLE PHONE PLUGS - SOLDERLESS 3-conductor. Screw type. Accommodates three conductor jacks 338 Series, 339.	306B 306R 306M	Black Red Metal	.78 .78 .90			THREE CONDUCTOR Open Circuit Three conductor, open circuit with 210 I.D. Will accommodate plug #P1068.	338-A	Metal	.42
								THREE CONDUCTOR Closed Circuit Three conductor closed circuit; will accommodate plug #302.	339	Metal	.45

PHONO PLUGS

ILLUSTRATION	DIMENSIONS	A	B	C	D	Catalog Number	Std. 10 Pack		ILLUSTRATION	DIMENSIONS	A	B	C	D	Catalog Number	Std. 10 Pack	
							Color	USA Net Each								Color	USA Net Each
		1/8	.175	11/16	15/16	36A	Metal	.06			1/8	.145	3/8	1- 1/8	44B	Metal	.09
		1/8	.175	3/8	5/8	36B	Metal	.06			1/8	.145	11/16	1- 3/32	42A	Metal	.17
		1/8	.145	11/16	1- 7/16	44A	Metal	.09			1/8	.145	3/8	25/32	42B	Metal	.17



A DIVISION OF NATIONAL TEL-TRONICS CORP.

ALLIGATOR CLIPS

TEST PRODS

ILLUSTRATION	DIMENSIONS	DESCRIPTION	Catalog Number	Std. 10 Pack																										
				Color	USA Net Each																									
TEST PROD; SOLDERLESS THREADED TYPE																														
	<table border="1"> <tr> <th>PART NO.</th> <th>"A" HANDLE</th> <th>"B" OVERALL</th> <th>"C" I.D.</th> <th>"D" O.D.</th> </tr> <tr> <td>894</td> <td>4</td> <td>5 1/4</td> <td>3/16</td> <td>3/8</td> </tr> <tr> <td>895</td> <td>4</td> <td>5 1/4</td> <td>1/4</td> <td>3/8</td> </tr> <tr> <td>991</td> <td>5 1/2</td> <td>6 1/2</td> <td>3/16</td> <td>3/8</td> </tr> <tr> <td>992</td> <td>5 1/2</td> <td>6 1/2</td> <td>1/4</td> <td>3/8</td> </tr> </table>	PART NO.	"A" HANDLE	"B" OVERALL	"C" I.D.	"D" O.D.	894	4	5 1/4	3/16	3/8	895	4	5 1/4	1/4	3/8	991	5 1/2	6 1/2	3/16	3/8	992	5 1/2	6 1/2	1/4	3/8	Handle: Moulded plastic, red or black #805 solderless tip; nickel plated brass solderless tip plug. Wire fits through body and is then wrapped around threaded portion and knurled collar tightened. Fits standard phone tip jacks and is threaded for easier assembly into handle.	894-B 894-R 895-B 895-R 991-B 991-R 992-B 992-R	Black Red Black Red Black Red Black Red	.30 .30 .24 .24 .33 .33 .27 .27
PART NO.	"A" HANDLE	"B" OVERALL	"C" I.D.	"D" O.D.																										
894	4	5 1/4	3/16	3/8																										
895	4	5 1/4	1/4	3/8																										
991	5 1/2	6 1/2	3/16	3/8																										
992	5 1/2	6 1/2	1/4	3/8																										
SOLDERLESS TEST PROD — Force Fit Type																														
	<table border="1"> <tr> <th>PART NO.</th> <th>"A" HANDLE</th> <th>"B" OVERALL</th> <th>"C" I.D.</th> <th>"D" O.D.</th> </tr> <tr> <td>896</td> <td>4</td> <td>5 1/4</td> <td>3/16</td> <td>3/8</td> </tr> <tr> <td>904</td> <td>4</td> <td>5 1/4</td> <td>1/4</td> <td>3/8</td> </tr> <tr> <td>993</td> <td>5 1/2</td> <td>6 1/2</td> <td>3/16</td> <td>3/8</td> </tr> <tr> <td>994</td> <td>5 1/2</td> <td>6 1/2</td> <td>1/4</td> <td>3/8</td> </tr> </table>	PART NO.	"A" HANDLE	"B" OVERALL	"C" I.D.	"D" O.D.	896	4	5 1/4	3/16	3/8	904	4	5 1/4	1/4	3/8	993	5 1/2	6 1/2	3/16	3/8	994	5 1/2	6 1/2	1/4	3/8	Handle: Moulded plastic, red or black #806 solderless tip; force fit nickel plated brass tip plug. Fits standard phone tip jacks. Solderless wire fits through tip body and then wraps around screw portion. Knurled collar for tightening.	896-B 896-R 904-B 904-R 993-B 993-R 994-B 994-R	Black Red Black Red Black Red Black Red	.24 .24 .24 .24 .27 .27 .27 .27
PART NO.	"A" HANDLE	"B" OVERALL	"C" I.D.	"D" O.D.																										
896	4	5 1/4	3/16	3/8																										
904	4	5 1/4	1/4	3/8																										
993	5 1/2	6 1/2	3/16	3/8																										
994	5 1/2	6 1/2	1/4	3/8																										
TEST PROD — HEAVY DUTY SOLDER TYPE																														
	<table border="1"> <tr> <th>PART NO.</th> <th>"A" HANDLE</th> <th>"B" OVERALL</th> <th>"C" I.D.</th> <th>"D" O.D.</th> </tr> <tr> <td>897</td> <td>4</td> <td>5 1/4</td> <td>3/16</td> <td>3/8</td> </tr> <tr> <td>898</td> <td>4</td> <td>5 1/4</td> <td>1/4</td> <td>3/8</td> </tr> <tr> <td>995</td> <td>5 1/2</td> <td>6 1/2</td> <td>3/16</td> <td>3/8</td> </tr> <tr> <td>996</td> <td>5 1/2</td> <td>6 1/2</td> <td>1/4</td> <td>3/8</td> </tr> </table>	PART NO.	"A" HANDLE	"B" OVERALL	"C" I.D.	"D" O.D.	897	4	5 1/4	3/16	3/8	898	4	5 1/4	1/4	3/8	995	5 1/2	6 1/2	3/16	3/8	996	5 1/2	6 1/2	1/4	3/8	Handle: Moulded plastic, red or black #802 solder tip; heavy duty nickel plated brass with exceptionally large well for soldering, threaded for easy assembly in handle. Fits standard phone tip jack.	897-B 897-R 898-B 898-R 995-B 995-R 996-B 996-R	Black Red Black Red Black Red Black Red	.30 .30 .30 .30 .33 .33 .33 .33
PART NO.	"A" HANDLE	"B" OVERALL	"C" I.D.	"D" O.D.																										
897	4	5 1/4	3/16	3/8																										
898	4	5 1/4	1/4	3/8																										
995	5 1/2	6 1/2	3/16	3/8																										
996	5 1/2	6 1/2	1/4	3/8																										
TEST PROD — PHONO NEEDLE TYPE																														
	<table border="1"> <tr> <th>PART NO.</th> <th>"A" HANDLE</th> <th>"B" OVERALL</th> <th>"C" I.D.</th> <th>"D" O.D.</th> </tr> <tr> <td>901</td> <td>4</td> <td>4 7/8</td> <td>3/16</td> <td>3/8</td> </tr> <tr> <td>902</td> <td>4</td> <td>4 7/8</td> <td>1/4</td> <td>3/8</td> </tr> <tr> <td>997</td> <td>5 1/2</td> <td>6 1/2</td> <td>3/16</td> <td>3/8</td> </tr> <tr> <td>998</td> <td>5 1/2</td> <td>6 1/2</td> <td>1/4</td> <td>3/8</td> </tr> </table>	PART NO.	"A" HANDLE	"B" OVERALL	"C" I.D.	"D" O.D.	901	4	4 7/8	3/16	3/8	902	4	4 7/8	1/4	3/8	997	5 1/2	6 1/2	3/16	3/8	998	5 1/2	6 1/2	1/4	3/8	Handle: Moulded plastic, red or black #866 tip; phono needle type with nickel plated steel needle. Chuck is removable for easy replacement. Needle pierces plating or corrosion for positive reading.	901-B 901-R 902-B 902-R 997-B 997-R 998-B 998-R	Black Red Black Red Black Red Black Red	.30 .30 .30 .30 .33 .33 .33 .33
PART NO.	"A" HANDLE	"B" OVERALL	"C" I.D.	"D" O.D.																										
901	4	4 7/8	3/16	3/8																										
902	4	4 7/8	1/4	3/8																										
997	5 1/2	6 1/2	3/16	3/8																										
998	5 1/2	6 1/2	1/4	3/8																										

TEST LEAD SETS

ILLUSTRATION	DESCRIPTION	Catalog Number	Color	Std. 10 Pack USA Net Each
	4 types: 8401-894 prods to 801 tip plugs;	8401	One	.87
	8440-894 prods to 740 alligator clips; 8451-894 prods to 851 banana plugs; 8470-894 prods to 870 spade lugs. 50 inches long. 5000 volts dielectric strength. Rubber covered.	8440	Red	.93
		8451	One	1.50
		8470	Black	.87

ILLUSTRATION	DIMENSIONS	DESCRIPTION	Catalog Number	Std. 10 Pack	
				Color	USA Net Each
		ALLIGATOR CLIP Solder Type Cadmium-plated steel with 3/8" jaw opening. Accurately matched jaws grip securely.	740 740C	Steel Copper	.08 .12
		ALLIGATOR CLIP Screw Type Screw supplied for solderless connection. Accurately matched, cadmium-plated steel jaws with 3/8" opening provide secure grip.	741 741C	Steel Copper	.09 .135
		INSULATED ALLIGATOR CLIP Solder Type Accurately matched, cadmium-plated steel jaws, with 3/8" opening provide secure grip. Red and black moulded plastic handles. Accepts standard banana plug in back.	742-B 742-R	Black Red	.12 .12
		INSULATED ALLIGATOR CLIP Screw Type Supplied with screw for solderless connection. All other features the same as clip #742.	743-B 743-R	Black Red	.15 .15
		ALLIGATOR CLIP Special Screw Type Jaws of cadmium-plated steel open to 3/8" and grip securely. Supplied with screw for solderless connection.	744	Metal	.144
		ALLIGATOR CLIP Fully Insulated Type Cadmium-plated steel jaws open to 3/8" and grips securely. Accepts standard banana plug in back. Can be supplied in red or black.	745-B 745-R	Black Red	.48 .48
		ALLIGATOR CLIP ADAPTER Insulated handle. Flanged. Accepts tip jack in rear. Cadmium plated steel or copper. Handles in red and black.	746 746C	Steel Copper	.33 .36
		MINIATURE CLIP Solder type clip where space is a factor. Excellent for all labs, shops, and hobbyists.	748 748C	Metal Copper	.06 .09
		STANDARD INSULATORS Insulators for clips #740 and #741. Made of flexible polyvinyl and allows for full jaw opening. Completely insulates clips.	749-B 749-R	Black Red	.05 .05
		MINIATURE INSULATORS Insulators for clips #748. Made of flexible polyvinyl which allow for full jaw opening. Completely insulates clips.	750-B 750-R	Black Red	.05 .05

TIP PLUGS

ILLUSTRATION	DIMENSIONS	DESCRIPTION	Catalog Number	Std. 10 Pack	
				Color	USA Net Each
		PHONE TIPS Solder Type A nickel-plated brass solder type phone tip 1" long.	801	Metal	.021
		TIP PLUG Threaded, Heavy Duty Nickel-plated brass with exceptionally large well for soldering. Threaded for easy assembly in plastic handle. Accepts standard phone tip jacks. Rear of plug accepts standard banana plugs.	802	Metal	.12
		SOLDERLESS TIP PLUG Large, Threaded A nickel-plated brass solderless tip plug. Wire fits through body of tip and is then wrapped around threaded portion and knurled collar tightened. Fits standard phone tip jacks and is threaded for easier assembly in plastic handle.	805	Metal	.12

A DIVISION OF











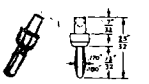

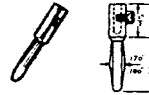
NATIONAL TEL-TRONICS CORP.

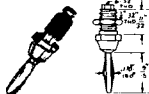
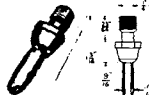

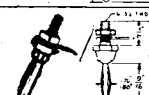

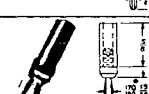

A DIVISION OF NATIONAL TEL-TRONICS CORP. ntt SALES

National Tel-tronics is a reliable, service oriented company devoted to the cost-conscious manufacture of component hardware for the electronics industry. We are equipped, experienced and eager to serve you with the largest, most comprehensive stocks of standard and custom designed items. Complete engineering assistance is at your service.



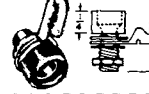

BANANA PLUGS

ILLUSTRATION	DIMENSIONS	DESCRIPTION	Catalog Number	Std. 10 Pack	
				Color	USA Net Each
		MIDGET BANANA PLUG Rivet Type Nickel or silver-plated brass body with phosphor bronze spring. Fits all standard banana jacks.	809	Metal	.162
		BANANA PLUGS Nickel plated hex brass body with phosphor bronze spring supplied with or without soldering lug and nut. Threaded stud for panel mounting.	811	Metal	.18
		BANANA PLUG Solderless Nickel-plated phosphor bronze spring. Side screw holes wire eliminating soldering. Accepts standard banana jacks. Threaded shank to fit plastic handle.	812	Metal	.18
		MIDGET BANANA PLUG Threaded Type Nickel or silver-plated brass body with phosphor bronze spring.	814	Metal	.162
		BANANA PLUG Phosphor Bronze Nickel-plated hex brass body with phosphor bronze spring. Wire can be directly soldered to brass stud or directly to plug. Solderless connection is made possible because stud locks wire to plug.	815	Metal	.18
		BANANA PLUGS Nickel plated hex brass body with phosphor bronze spring. Wire can be fed through side hole or can be soldered to brass stud. Threaded to facilitate the use of an insulated handle.	816	Metal	.18
		BANANA PLUG Threaded Hole Nickel-plated brass banana plug fitting standard banana jacks. Four-leaf phosphor bronze spring. Threaded male enables it to be used on all size panels. Supplied with screw and tinnead brass lug.	819	Metal	.18
		BANANA PLUG 6-32 Thread, Lug, Nut Nickel-plated brass banana plug which fits standard banana jack. Four-leaf, nickel-plated phosphor bronze spring. A hex nut and phosphor bronze lug are supplied. Stud is threaded for panel mounting.	821	Metal	.18
		INSULATED BANANA PLUG Meter-Type, Push Button Nickel-plated brass body with nickel-phosphor bronze, slotted spring. Molded Bakelite handle in Red or Black. (Indicate color desired.) Push button, then lead conductor through hole. Release button, conductor is locked in position. Fits standard banana jacks.	836B 836R	Black Red	.54 .54
		INSULATED BANANA PLUG Miniature Type Fits standard banana jacks with wire soldered directly into stud. Molded Plastic handle in Red or Black. Indicate color desired. Nickel-plated brass plug with nickel-plated phosphor bronze spring.	840-B 840-R	Black Red	.19 .19
		INSULATED BANANA PLUG Fits all standard banana jacks. Molded bakelite handle in Red, Black and Blue. Four-leaved spring is made of phosphor bronze and is nickel-plated.	851-B 851-BL 851-R	Black Blue Red	.19 .19 .19
		INSULATED BANANA PLUG With Side Screw Fitting standard banana jacks, set screw holes wire without soldering. This Banana Plug has Molded Bakelite handle in Red, White, Black, Blue, Yellow or Green. Indicate color desired. Plug is nickel-plated brass with four-leaved phosphor bronze spring.	852-B 852-BL 852-GR 852-Y 852-R 852-W	Black Blue Green Yellow Red White	.19 .19 .19 .19 .19 .19
		INSULATED BANANA PLUG Molded Bakelite handles in Red, White, Blue, Black, Yellow, Green. Indicate desired color. Nickel-plated brass body. Knurled collar when tightened holds wire which has been passed through body tip and wrapped around screw portion. Fits standard phone tip jacks.	853-B 853-BL 853-GR 853-Y 853-R 853-W	Black Blue Green Yellow Red White	.22 .22 .22 .22 .22 .22
		DUAL BANANA PLUGS Molded polystyrene. Brass, nickel plated. 4-leaf phosphor bronze springs. Mates with standard dual binding post with 3/4" centers. Polarity indicated on top and side. Can be stacked for multiple connections.	841B 841R	Black Red	.72 .72

BANANA JACKS

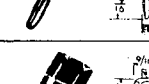
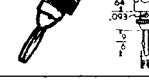
ILLUSTRATION	DIMENSIONS	DESCRIPTION	Catalog Number	Std. 10 Pack	
				Color	USA Net Each
		BANANA JACK Non-Insulated Type Mounting in 1/4" hole in any panel up to 3/8" thick. It will accept standard banana plug. Its body is HEX Brass, nickel-plated and is supplied with hex nut and tinnead brass lug.	813	Metal	.11
		BANANA JACK Insulated Type Nickel-plated brass body. Accepts standard banana plug. Mounts in any panel up to 3/8" thick in 5/16" hole. Supplied with hex nut, fibre washer lock washer and tinnead brass lug.	844-B 844-BL 844-R	Black Blue Red	.16 .16 .16
		BANANA JACK Insulated Type Molded Bakelite head. Nickel-plated brass body. Accepts standard banana plugs. Mounts in any panel up to 3/8" thick, in 5/16" hole. Supplied with hex nut, fibre washer and tinnead brass lug.	845-B 845-BL 845-GR 845-R 845-Y 845-W	Black Blue Green Red Yellow White	.14 .14 .14 .14 .14 .14
		BANANA JACK Insulated Type With wrap-around terminal. Molded bakelite. Available in red, white, blue, green, yellow, black, Brass, nickel plated.	846-B 846-BL 846-GR 846-R 846-Y 846-W	Black Blue Green Red Yellow White	.15 .15 .15 .15 .15 .15
		INSULATED JACK Combination Type Accepts standard phone tip plugs or standard banana plugs. Molded Bakelite head in Red, Blue, Black, Yellow, Green, White. Indicate color desired. Nickel-plated brass body with phosphor bronze spring. Supplied with hex nut and fibre washer.	848-B 848-BL 848-GR 848-R 848-Y 848-W	Black Blue Green Red Yellow White	.17 .17 .17 .17 .17 .17

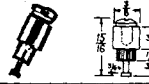
BINDING POSTS

ILLUSTRATION	DIMENSIONS	DESCRIPTION	Catalog Number	Std. 10 Pack	
				Color	USA Net Each
		COMBINATION BINDING POST AND BANANA PLUG Converts any standard jack into 5-way binding post. Molded fluted captive nylon head. Phosphor Bronze, nickel plated spring. Available in red or black.	863-B 863-R	Black Red	.30 .30
		COMBINATION BINDING POST AND BANANA PLUG Molded captive nylon hex head. Converts any standard jack into 5-way binding post. Phosphor Bronze, nickel plated spring. Available in red or black.	864-B 864-R	Black Red	.30 .30
		METAL BINDING POST Combination Terminal Stake-In Binding Post Similar to 1-872 but smaller in size. Screw-head, turret terminal. Knurled shank. Lock-washer. Brass nickel plated. Knurled end. 8-32 x 1/4" BHS. For 1/8" thick panel.	872	Metal	.114
		METAL BINDING POST Combination Terminal Stake-In Binding Post Screw head, brass, nickel plated, turret terminal. Knurled shank. Knurled end. 10-32 x 1/4" long BHS. For 3/16" thick panel.	1-872	Metal	.114
		METAL BINDING POST Captive head. Wrap-around terminal. Hex shape. Brass, nickel plated. Accepts phone tip, crane lug, banana plug, slinger clip, or wire.	873	Metal	.25
		METAL BINDING POST Gold plated. Fluted brass. Molded black nylon insulator. 5-way will accept phone tip, crane lug, banana plug, slinger clip, or wire.	1-873	Metal	.30

A DIVISION OF

NATIONAL TEL-TRONICS CORP.



National Tel-tronics is a reliable, service oriented company devoted to the cost-conscious manufacture of component hardware for the electronics industry. We are equipped, experienced and eager to serve you with the largest, most comprehensive stocks of standard and custom designed items. Complete engineering assistance is at your service.

BINDING POST TERMINALS

ILLUSTRATION	DIMENSIONS	DESCRIPTION	Catalog Number	Std. 10 Pack	
				Color	USA Net Each
		.032 BRASS 6-32x5/16 SCREW	4403	Metal	.0396
		SHORTING LINK 7/16" Centers	4515	Metal	.018
		SHORTING LINK 1/2" Centers	4516	Metal	.018
		.050 BRASS 8-32x3/8 SCREW	4418	Metal	.054

BINDING POST BOARDS

ILLUSTRATION	DIMENSIONS		TERMINAL POSITIONS	Cat. #	Std. 10 Pack USA Net Each
	A	B			
	1-1/2"	1"	• • • • •	2551	.042
	2"	1-1/2"	• • • • •	2552	.066
	2-1/2"	2"	• • • • •	2553	.09
	3"	2-1/2"	• • • • •	2554	.114
	3-1/2"	3"	• • • • •	2555	.132
	4"	3-1/2"	• • • • •	2556	.174
	4-1/2"	4"	• • • • •	2557	.216
	5"	4-1/2"	• • • • •	2558	.234
	5-1/2"	5"	• • • • •	2559	.252
	6"	5-1/2"	• • • • •	2560	.270

BINDING POST BOARDS

ILLUSTRATION	DIMENSIONS		LUG POSITIONS (As Per View "2")	Cat. #	Std. 10 Pack USA Net Each
	A	B			
	1-1/4"	7/8"	• •	2401	.04
	1-11/16"	1-5/16"	• • •	2402	.06
	2-1/8"	1-3/4"	• • • •	2403	.09
	2-9/16"	2-3/16"	• • • • •	2404	.114
	3"	2-5/8"	• • • • •	2405	.132
	3-7/16"	3-1/16"	• • • • •	2406	.168
	3-7/8"	3-1/2"	• • • • •	2407	.21
	4-5/16"	3-15/16"	• • • • •	2408	.234
	4-3/4"	4-3/8"	• • • • •	2409	.246
	5-3/16"	4-13/16"	• • • • •	2410	.262
	5-5/8"	5-1/4"	• • • • •	2411	.286
	6-1/16"	5-11/16"	• • • • •	2412	.32

Utilized as replacements for antenna terminals on the rear of many television receivers, and as speaker terminals on many amplifiers. Makes an excellent replacement and is ideal for the engineer or hobbyist in the construction of new equipment.

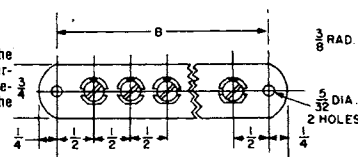

FUSE MOUNTING BASES

ILLUSTRATION	DIMENSIONS	DESCRIPTION	Catalog Number	Std. 10 Pack	
				Color	USA Net Each
		PANEL MOUNTED HOLDERS 3AG Type Fuses Molded from black, general purpose phenolic powder. All metal parts are plated to resist corrosion and solder lugs are plated to facilitate soldering. Rated at 15 amps, 250 volts and is Underwriter Laboratories approved.	450	Black	.43
		Bases are manufactured from XP laminated phenolic, clips are made from .020 spring brass, cadmium or silver plated. Two .140 diameter mounting holes.	403	Black	.24
		Bases are manufactured from XP laminated phenolic, clips are made from .020 spring brass, cadmium or silver plated. Three pole unit with mounting holes for #6 screws.	405	Black	.48
		Bases are manufactured from XP laminated phenolic, clips are made from .020 spring brass, cadmium or silver plated. Two pole unit with mounting holes for #6 screws.	406	Black	.36
		Bases are manufactured from XP laminated phenolic, clips are made from .020 spring brass, cadmium or silver plated. Single pole unit with .140 diameter mounting holes.	408	Black	.13
		Bases are manufactured from XP laminated phenolic, clips are made from .020 spring brass, cadmium or silver plated. Single pole with solder connector below base.	410	Black	.13

ANTENNA BINDING POSTS

ILLUSTRATION	DIMENSIONS	DESCRIPTION	Catalog Number	Std. 10 Pack	
				Color	USA Net Each
		UHF CONVERTER STRIP Replacement on many UHF converters on the market today.	001-3	--	.36
		STANDARD STRIP Used on many receivers providing only VHF reception. Tuner antenna wire plugs into strip allowing fast disconnect.	001-4	--	.18
		UHF-VHF STRIP Used on many of the new receivers with combination UHF-VHF tuners.	001-12	--	.28



A DIVISION OF

NATIONAL TEL-TRONICS CORP.

National Tel-tronics is a reliable, service oriented company devoted to the cost-conscious manufacture of component hardware for the electronics industry. We are equipped, experienced and eager to serve you with the largest, most comprehensive stocks of standard and custom designed items. Complete engineering assistance is at your service.

MOLDED TERMINAL BLOCKS



No. 900-10

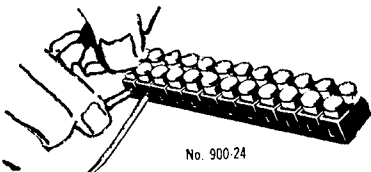

No. 900-24

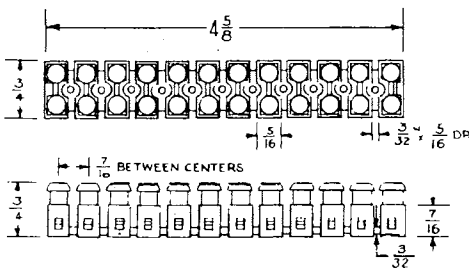

Catalog Number	Color	Std. 10 Pack		Bulk Pack*
		USA Net Each	Qty.	USA Net Each
900-4	Black	.52	100	.468
900-6	Black	.75	100	.675
900-8	Black	.98	100	.882
900-10	Black	1.28	100	1.08
900-12	Black	1.49	100	1.34
900-14	Black	1.64	100	1.48
900-16	Black	1.88	100	1.69
900-18	Black	2.11	100	1.90
900-20	Black	2.33	100	2.10
900-24	Black	2.79	100	2.51

Like Type No. 905, the No. 900 terminal block is solderless, and is molded of hard black polyvinylchloride. Push buttons are molded of red polyvinylchloride.

These terminal blocks have extremely high dielectric properties and are approved to resist 440 volts or 500 volts when mounted on insulated surface. Maximum current 27 amperes, maximum heat capacity 70° C. Maximum wire size applicable AWG #12. Maximum contact pressure: 13.22 lbs. Connection of conductor is extremely fast. Press the red button and insert the wire. Release pressure for locking. The beryllium copper contacts are molded into the block. Type 900 is available for 24 connectors. It may be cut to smaller size if required.

910 SERIES PUSH TYPE RELEASE

Catalog Number	Color	Std. 10 Pack		Bulk Pack*
		USA Net Each	Qty.	USA Net Each
910-4	Clear	.25	100	.225
910-6	Clear	.48	100	.432
910-8	Clear	.71	100	.639
910-10	Clear	.94	100	.846
910-12	Clear	1.17	100	1.05
910-14	Clear	1.40	100	1.26
910-16	Clear	1.63	100	1.47
910-18	Clear	1.86	100	1.67
910-20	Clear	2.09	100	1.88
910-24	Clear	2.55	100	2.30

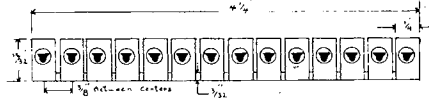
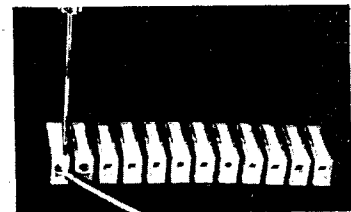

Solderless, flexible, Thermoplastic Terminal Block. Accepts stranded tinned or solid wire to 13 AWG. Just press wire into opening. No wrapping, no soldering. Place small blade screw driver in top slot and press to release wire. Contacts are Copper nickel-plated. Maximum operating temperature 212° F. Transit resistance 0.7 Ohms. Units are rated at 380-440 Volts D.C. Ideal for labs, schools, and hobbyists. Type 910 is available up to 24 connectors and may be cut down as desired.

905 SERIES • FLEXIBLE

Catalog Number	Color	Std. 10 Pack USA Net Each
905	Gray	1.95

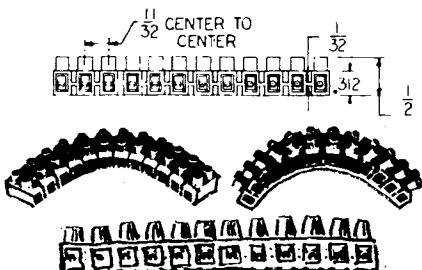

Type No. 905 Solderless Terminal Blocks are specially designed for applications where space and weight conservation are important factors. Because they are molded of flexible polyvinylchloride material they may be bent in any direction to fit contours and sharp angles. Typical applications for these terminal blocks include missile guidance systems, computers, aircraft communications, underwater detecting equipment, etc.

The shortest distance between the live parts of Type No. 905 Terminal Block is 3/8". Its brass terminals will accommodate a #10 wire as a maximum. The polyester material of which the blocks are made is rated at max. of 30 amps, 380 volts, or 440 volts if mounted on insulated surface. Maximum heat capacity: 60° C. Insert conductor in block and tighten the set screw.

Flexible Terminal Block No. 905 measures 3-3/4" long, 5/8" wide, 1/2" high and 11/32" between terminal centers. It may be cut to smaller sizes as required.

- No. 910-4 — Four-connector terminal block
- No. 910-6 — Six-connector terminal block
- No. 910-8 — Eight-connector terminal block
- No. 910-10 — Ten-connector terminal block
- No. 910-12 — Twelve-connector terminal block
- No. 910-14 — Fourteen-connector terminal block
- No. 910-16 — Sixteen-connector terminal block
- No. 910-18 — Eighteen-connector terminal block
- No. 910-20 — Twenty-connector terminal block
- No. 910-24 — Twenty-four-connector terminal block

NATIONAL TEL-TRONICS CORP.

TERMINAL BLOCKS

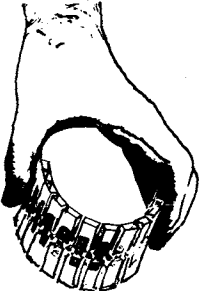
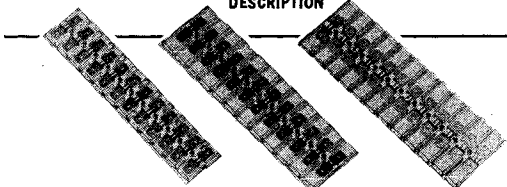
ILLUSTRATION	DESCRIPTION	Catalog No.	Size	Standard 10 Pack	
				Color	U.S.A. Net Ea.
		915-12	5-5/8 x 1-3/32 x 1/4	CLEAR	\$.68
		915-24			1.23
		920-12	5-21/32 L x 1-21/32 x 1/4		\$.71
		920-24			1.28
		925-12	5-21/32 L x 1-3/4 x 1/4		\$.73
925-24	1.33				

Unique terminal block for use with quick-disconnect type terminals. Ideal for breadboarding, test strips, simplifying installations. Solderless, exceptionally flexible. Available in 6 and 12 cell (12 and 24 connectors) that may be easily cut to match and in three overall and connector sizes. Molded from transparent Polyvinyl chloride. Rated at 250 VDC, 20A, 80°C.

CONTACT CONNECTORS

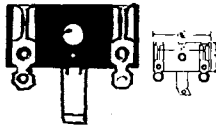
ILLUSTRATION	DIMENSIONS	DESCRIPTION	Catalog Number	Std. 10 Pack	
				Color	USA Net Each
		<p>TWO CONTACT STRIP—Used on many television receivers for speaker hook-up or on the tuners to connect such circuits as AGC, pilot lights, or other voltage sources.</p>	002-5	---	.066*

CHEMICALS

ILLUSTRATION	DESCRIPTION	Catalog Number	Standard Pack	USA Net Each
	<p>LECTRO-KLEEN Tuner-Contact Cleaner—There is no longer a need to stock contact cleaner for controls and another type for tuners. LECTRO-KLEEN will do all of your electronic cleaning jobs. LECTRO-KLEEN cleans, lubricates, and protects at the same time. Due to the low viscosity, UHF and VHF tuners will not drift. One swish shows the difference. Most important, LECTRO-KLEEN will not harm plastic . . . and it's non-toxic . . . safe for you, too. Insist on LECTRO-KLEEN.</p>	7-001	24-6 oz. Cans	1.17

MAGNETIC MICROPHONE HOLDER

ILLUSTRATION	DESCRIPTION	Catalog Number	Std. 10 Pack	
			Color	USA Net Each
	<p>Ideal for mobile communication. No more fumbling to find the microphone holder. NT • T's Magnetic-Microphone holder will adhere to most metal surfaces such as dash boards, and the sides of set. This holder was designed not only for standard CB type applications, but also for heavy two-way radio work such as cat ambulances, and industrial communication. This convenience allows the driver to keep his eye on the road and avoid accidents. Fits most microphones.</p>	3-006	Metal	.99

TERMINAL BOARDS

To your custom design or N.T.T. standard. Under-one-roof fabrication from any material, with any type terminals. Paper; cloth; glass; nylon laminates bonded with phenolic resins, silicon or melamine resins. MIL, Jan, Commercial Specs. Lacquered, varnished or plain. Imprinted all ways.

FABRICATED PARTS

Terminal boards (without terminals), Jack panels boards, front panel plates, etc., all the above terminal board materials as well as aluminum, brass, copper, and steel. Metal parts may be finished in cadmium, anodized, iridite, lacquer, etc. All types of printing.

NEW DISTRIBUTOR CATALOG—Complete, including resale prices and cross references. Thousands of items. Pictures, dimension drawings, full specification. Covers all the items sold by ntt Sales Co.

NEW OEM CATALOG— For engineering and purchasing departments. 56 pages of complete detailed information on the wide line of components, connectors, and hardware that is manufactured by National Tel-tronics, Inc.

POMONA ELECTRONICS

NEW ITEMS

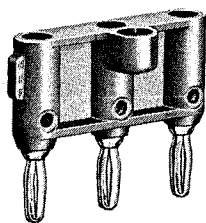

TRIPLE BANANA PLUG
PAGE 608

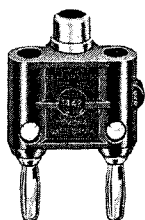

ADAPTER — PHONO
JACK TO DOUBLE
PLUG — PAGE 613



ADAPTER — BNC
RECEPTACLE TO
BANANA PLUG
PAGE 613

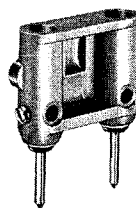

COMPONENT
MOUNTING
DOUBLE PIN TIP
PLUG — PAGE 619

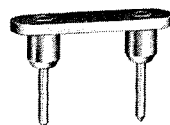

PIN TIP
SHORTING BAR
PAGE 619



BINDING POST
TO BANANA PLUG
PAGE 609

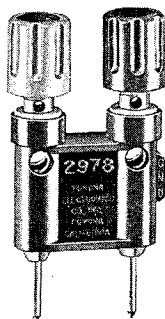
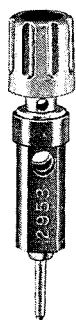

BINDING POSTS TO PIN
TIP PLUGS — PAGE 619



PAGE 615 PAGE 613
ADAPTERS
BNC RECEPTACLE
TO PHONE PLUGS

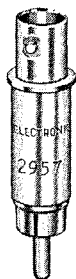

ADAPTER — BNC
RECEPTACLE TO
PHONO PLUG
PAGE 613



MINIATURE — SOLDERLESS
BANANA PLUGS — PAGE 620

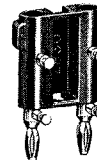

MINIATURE — ISOLATION PLUGS
PAGE 622



MINIATURE
SHORTING BAR
PAGE 622

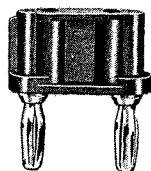

ADAPTER — MINIATURE
JACKS TO STANDARD
PLUGS — PAGE 622

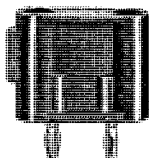

ADAPTER — STANDARD
JACKS TO MINIATURE
PLUGS — PAGE 622



MINIATURE BANANA PLUG
PATCH CORD — PAGE 622



MINIATURE RIGHT ANGLE STACK-UP
PATCH CORD — PAGE 622

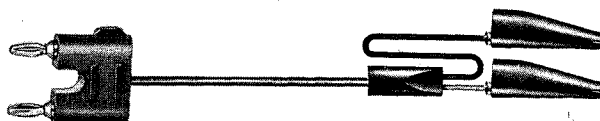

MINIATURE
TEST CABLE WITH CLIPS — PAGE 623

POMONA ELECTRONICS

3/4" SPACED MOLDED BANANA PLUGS

Pomona Banana Plug and stack-up accessories are of the highest quality — tough thermoplastic — molded directly on to the metal body of plugs and connectors for maximum strength, moisture resistance and insulative properties:

General Specifications listed below apply to items using banana plugs in this catalog.

FEATURES . . .

- One piece beryllium copper heat treated spring for maximum long life.
- Rounded spring design results in maximum contact area.
- STACK-UP feature allows an unlimited number of connections at the same electrical point.

SPECIFICATIONS . . .

- Fits standard 0.166 dia. banana jacks.
- Spring, beryllium copper alloy 170 per QQ-C-533.
- Plug body, Brass per QQ-B-626. Comp. 22.
- Nickel plated per QQ-N-290, Class 2.
- Contact resistance less than 0.001 ohms per banana plug.

ACTUAL SIZE

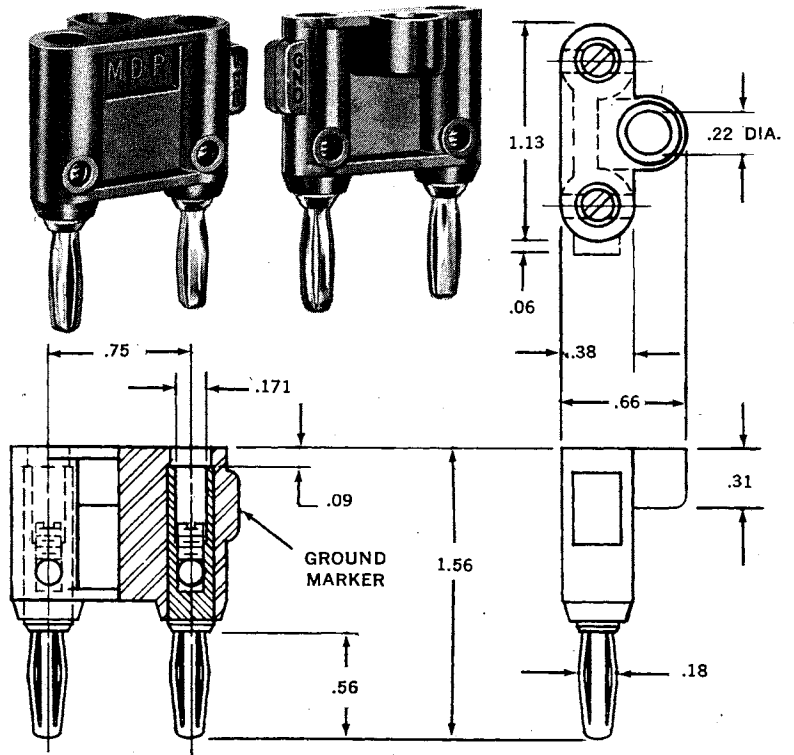

RATINGS	Models: MDP; MDP-ST; 1330; 1330-ST; 2970
■ Capacity :	0.8 pf to 10 MC
■ Current :	15 Amps. Cont., 30 Amps. Int.
■ Voltage :	5000 W.V. D.C.
■ Temperature :	-25°C to +85°C, operating temp.

NEW

DOUBLE BANANA PLUG

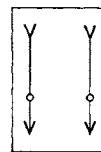
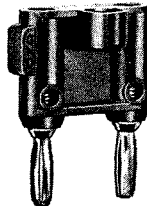

Double banana plug on 3/4" centers; set screws secure leads; simplifies cable construction or component mounting; banana jacks permit top Stack-Up for multiple connections.

COLORS: Black, Brown, Red, Orange, Yellow, Green, Blue, Violet, Gray, White.

MODEL MDP (Specify Color)

QUANTITY DISC. CODE **A** NET .75

TRIPLE BANANA PLUG

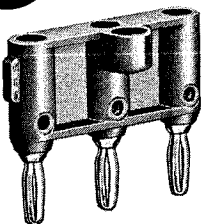

Triple banana plug on 3/4" centers; set screws secure leads. Ideal for balanced line 2 conductor shielded cable assemblies. Banana jacks permit top Stack-Up for multiple connections.

COLORS: Black, Red.

MODEL 2970 (Specify Color) QUANTITY DISC. CODE **A** NET 1.25

COMPONENT MOUNTING DOUBLE BANANA PLUG

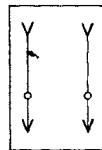
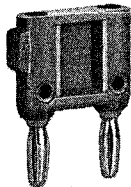

Double banana plug on 3/4" centers; set screws secure leads; features recess for mounting small components; banana jacks permit top Stack-Up for multiple connections.

COLORS: Black, Red

MODEL 1330 (Specify Color)

QUANTITY DISC. CODE **A** NET .75

DOUBLE BANANA PLUG WITH SOLDER TURRET TERMINALS

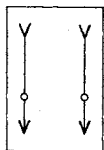
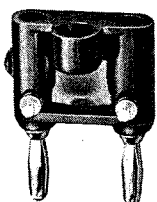

Similar to Model MDP, except has solder turret terminals for permanent noise-free connections of cables and components. Double banana plug on 3/4" centers; banana jacks permit top Stack-Up for multiple connections.

COLOR: Black

MODEL MDP-ST QUANTITY DISC. CODE **A** NET .85

COMPONENT PLUG WITH SOLDER TURRET TERMINALS

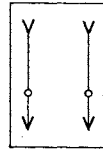
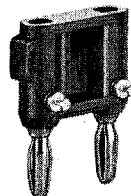

Similar to Model 1330, except has solder turret terminals for permanent noise-free connections of components, etc. Double banana plug on 3/4" centers; Banana jacks permit top Stack-Up for multiple connections.

COLORS: Black, Red.

MODEL 1330-ST (Specify Color)

QUANTITY DISC. CODE **A** NET .85

POMONA ELECTRONICS

BNC ADAPTERS

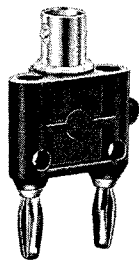

ADAPTER — BNC RECEPTACLE TO DOUBLE BANANA PLUG

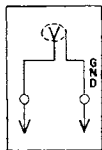

Permits BNC plug to be used with equipment having banana jacks. Excellent for adapting laboratory VTVM, oscilloscopes and signal generator inputs to readily available coaxial cables.

UPPER: BNC receptacle.
LOWER: Double banana plug, on 3/4" centers. Cross holes (.166 dia.) in body provide side Stack-Up connections.
COLOR: Black.

MODEL 1269

QUANTITY DISC. CODE **A** NET 2.85

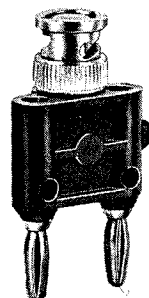

ADAPTER — BNC PLUG TO DOUBLE BANANA PLUG

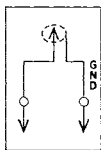

Permits BNC receptacle to be used with equipment having banana jacks. Minimizes number of coaxial connections for maximum efficiency.

UPPER: BNC plug.
LOWER: Double banana plug, on 3/4" centers. Cross holes (.166 dia.) in body provide side Stack-Up connections.
COLOR: Black.

MODEL 1270

QUANTITY DISC. CODE **A** NET 3.85

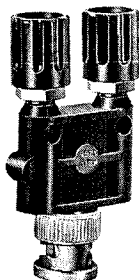

ADAPTER — BINDING POSTS TO BNC PLUG

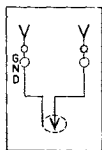

Permits single or double banana plugs to be used with equipment having BNC receptacle. Excellent for use with laboratory oscilloscopes.

UPPER: Insulated binding posts, on 3/4" centers with .166 dia. banana jacks. Cross holes (.166 dia.) in body provide side Stack-Up connections.
LOWER: BNC plug.
COLOR: Body, Black. Binding Posts: Black/Red.

MODEL 1296

QUANTITY DISC. CODE **A** NET 4.85

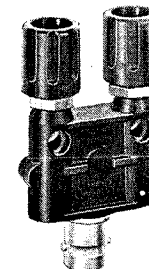

ADAPTER — BINDING POSTS TO BNC RECEPTACLE

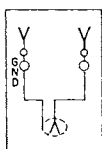

Permits single or double banana plugs to be used with equipment having BNC plug.

UPPER: Insulated binding posts, on 3/4" centers with .166 dia. banana jacks. Cross holes (.166 dia.) in body provide side Stack-Up connections.
LOWER: BNC receptacle.
COLOR: Body, Black. Binding Posts: Black/Red.

MODEL 1452

QUANTITY DISC. CODE **A** NET 4.85

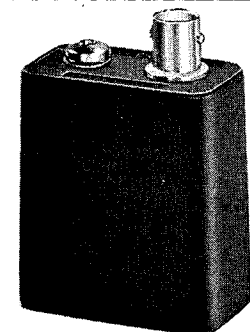

ADAPTER — BNC RECEPTACLE TO SHIELDED BANANA PLUGS

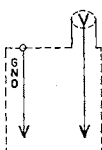

Permits BNC plug to be used with equipment having banana jack binding posts. Black anodized aluminum shield reduces noise Pick-up more than 70 DB. Ideal for low level inputs to oscilloscopes, wave analyzers, etc.

UPPER: BNC receptacle.
LOWER: Shielded double banana plug, on 3/4" centers.

MODEL 1645

QUANTITY DISC. CODE **A** NET 3.45

Now! Increase the flexibility of your laboratory with the use of POMONA molded test accessories.

Minimize the necessity of stocking a large quantity and variety of coaxial cables by using POMONA molded adapters.

Tough thermo-plastic material molded to plug body or connectors insures maximum strength, moisture resistance and excellent insulative properties.

POMONA ELECTRONICS adapters are designed and engineered with you in mind, from the selection of the best in materials, incorporated with a quality control program that enables us to offer to you, products that are unequalled in reliability and quality.

Complete engineering facilities are offered to our customers for special adapter problems that may arise.

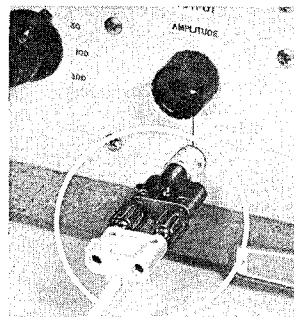
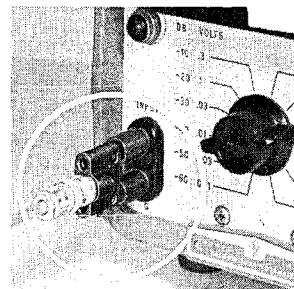

ADAPTER — SIGNAL ISOLATOR — BNC RECEPTACLE TO DOUBLE BANANA PLUG

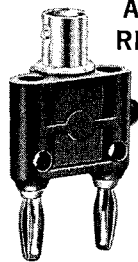

Permits BNC male connector to be used with equipment having banana jacks. General purpose ceramic capacitor molded internally. Rated @ .01 mfd ±20%, 200 WVDC. Insulation resistance 10,000 megohms min. Ideal for isolating DC signals from VTVM inputs and signal generator outputs.

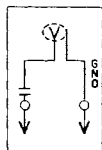

UPPER: BNC receptacle.
LOWER: Double banana plug, on 3/4" centers. Cross holes (.166 dia.) in body provide side Stack-Up connections.

MODEL 1868

COLOR: Blue. QUANTITY DISC. CODE **A** NET 7.85

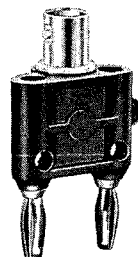

ADAPTER — BNC MATCHING PAD

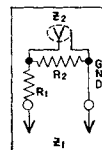

Adapts 600 OHM sources to 50, 75 or 93 OHM cables. Excellent for matching signal generators and VTVM's to standard coaxial cables. Ideal for receiver alignment. Molded in deposited carbon resistors 1%, 1/4W.

UPPER: BNC receptacle.
LOWER: Double banana plug, on 3/4" centers. Cross holes (.166 dia.) in body provide side Stack-Up connections.

MODEL 1656-1
1656-2
1656-3

COLOR Yellow
Red
White

RANGE — OHMS 600 to 50
600 to 75
600 to 93

NET 10.85
10.85
10.85 QUANTITY DISC. CODE **A**

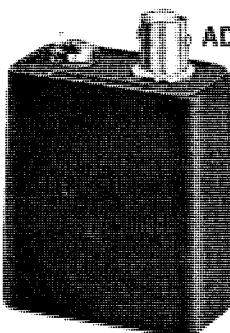

ADAPTER — BNC RECEPTACLE TO SHIELDED BANANA JACKS

Permits BNC plug to be used with equipment having banana plugs. Black anodized aluminum shield reduces noise pick-up more than 70 DB. Ideal for low level inputs to oscilloscopes, wave analyzers, etc.

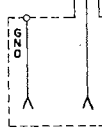

UPPER: BNC receptacle.
LOWER: Shielded double banana jacks, on 3/4" centers.
COLOR: Black.

MODEL 1681

QUANTITY DISC. CODE **A** NET 3.45

POMONA ELECTRONICS

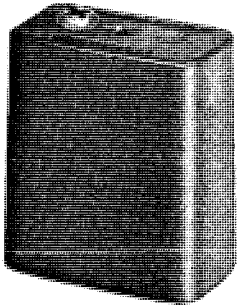

SHIELDED DOUBLE BANANA PLUG IN-LINE CABLE ENTRY

RATED: 15A CONTINUOUS
1200 WVDC
3400 VDC BREAKDOWN
2.5 PF @ 1 MC

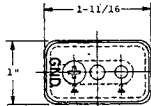
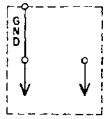

- Shielded double plug $\frac{3}{4}$ " spaced
- Die cast aluminum shell, black anodized
- Noise pick-up reduced 70 DB
- Gold flashed solder turret terminals for positive reliable cable connections
- One piece nickel plated beryllium copper springs for use with standard 0.166 dia. banana jack binding posts.
- Rounded banana spring design results in maximum contact area and minimum contact resistance
- GND clearly molded in shell
- Cable opening, $\frac{7}{32}$ " diameter

MODEL 1433

QUANTITY DISC. CODE **A** NET 2.25

SHIELDED DOUBLE BANANA PLUG RIGHT ANGLE CABLE ENTRY

RATED: 15A CONTINUOUS
2800 PEAK WV
5000 VDC BREAKDOWN
2.0 PF @ 1 MC.

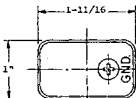
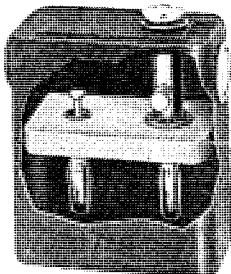
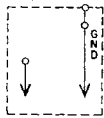

- Shielded double plug, $\frac{3}{4}$ " spaced
- Ceramic insulating base
- Die cast aluminum shell, black anodized
- GND clearly molded in shell
- Noise pick-up reduced 70 DB
- One piece nickel plated beryllium copper springs for use with 0.166 diameter banana jack binding posts.
- Rounded banana spring design results in maximum contact area and minimum contact resistance
- Vinyl grommet and nickel plated snap button supplied

MODEL 1791

QUANTITY DISC. CODE **A** NET 2.95

BALANCED LINE SHIELDED DOUBLE BANANA PLUG

- Unique 3 terminal design allows connection to shielded two conductor cable while maintaining balanced conditions
- Minimizes ground loop errors in low signal level applications
- Die cast aluminum shell, black anodized
- Noise pick-up reduced at least 70 DB
- Gold flashed solder turret terminals for reliable noise free connections
- One piece nickel plated beryllium copper springs for use with standard 0.166 dia. banana jack binding posts.

RATED:
15A Continuous
1000 WV Peak; line to shield
2000 WV peak; line to line
2500 V peak breakdown; line to shield
5000 V peak breakdown, line to line
2.0 pf @ 1 MC Capacity; line to line
3.0 pf @ 1 MC. capacity; both lines to shield.

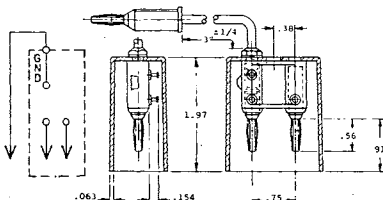
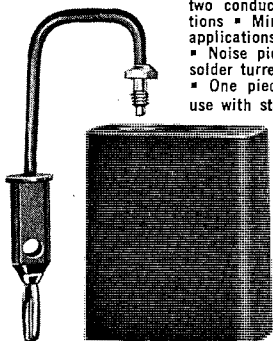

MODEL 1921

QUANTITY DISC. CODE **A** NET 4.85

SHIELDED BANANA PLUGS UHF ADAPTERS

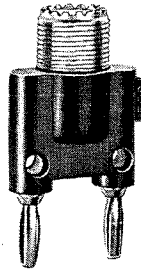

ADAPTER — UHF RECEPTACLE TO DOUBLE BANANA PLUG

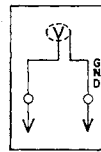

Permits UHF plug to be used with equipment having banana jacks.

UPPER: UHF receptacle, $\frac{5}{8}$ " dia.
LOWER: Double banana plug, on $\frac{3}{4}$ " centers. Cross holes (.166 dia.) in body provide side Stack-Up connections.
COLOR: Black.

MODEL 1707

QUANTITY DISC. CODE **A** NET 4.85

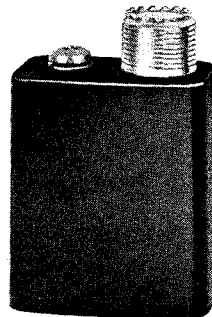

ADAPTER — UHF RECEPTACLE TO SHIELDED BANANA PLUGS

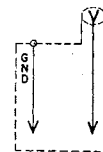

Permits UHF plug to be used with equipment having banana binding posts. Black anodized shield reduces noise pick-up at least 70 DB.

UPPER: UHF receptacle, $\frac{5}{8}$ " dia.
LOWER: Double banana plug on $\frac{3}{4}$ " centers.
COLOR: Black.

MODEL 1708

QUANTITY DISC. CODE **A** NET 4.85

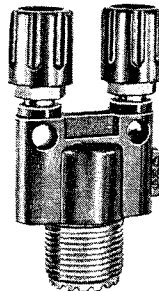

ADAPTER — BINDING POSTS TO UHF RECEPTACLE

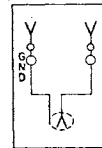

Permits single or double banana plugs to be used with equipment having UHF plug.

UPPER: Insulated binding posts, on $\frac{3}{4}$ " centers with .166 dia. jacks. Cross holes (.166 dia.) in body provide side Stack-Up connections.

LOWER: UHF receptacle, $\frac{5}{8}$ " dia.
COLOR: Body, Black. Binding posts: Black/Red.

MODEL 1792

QUANTITY DISC. CODE **A** NET 5.85

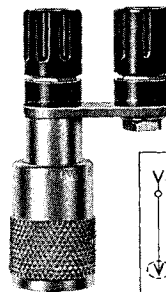

ADAPTER — BINDING POSTS TO UHF PLUG

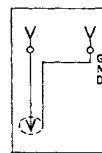

Permits single or double banana plugs to be used with equipment having a UHF receptacle, $\frac{5}{8}$ " dia. Convenient for use with modern oscilloscopes. Center conductor binding post Red; Ground, Black.

UPPER: Insulated binding posts, on $\frac{3}{4}$ " centers with .166 dia. jacks.
LOWER: UHF plug.

MODEL 1699

QUANTITY DISC. CODE **A** NET 4.85



ADAPTER — BINDING POST TO UHF PLUG



Permits single banana plug to be used with equipment having a UHF receptacle, $\frac{5}{8}$ " dia. Adds flexibility to your oscilloscope.

UPPER: Insulated binding post with .166 dia. banana jack.
LOWER: UHF plug.

MODEL 1698

QUANTITY DISC. CODE **A** NET 3.85

POMONA ELECTRONICS

ISOLATION PLUGS — COMPONENT MOUNTINGS

CREATE passive and active networks, voltage dividers, isolation networks or attenuators with the Split-Terminal isolation plugs described below.

Gold flashed solder turret terminals provide permanent, reliable noise-free connections for component mounting.

Tough thermo-plastic material molded to plug body and connectors insures maximum strength, moisture resistance and excellent insulative properties.

Specifications for MDP-X, 1390, 1837, 1468:

- Fits standard 0.166 dia. banana jack.
- Spring, heat treated beryllium copper alloy 25 per QQ-C-533.
- Plug body, Brass per QQ-B-626 Comp. 22.
- Nickel plated per QQ-N-290, Class 2.
- Contact resistance less than 0.001 ohms per banana plug.

TYPICAL APPLICATION

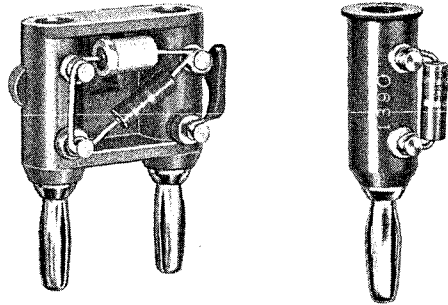

ACTUAL SIZE

MODEL MDP-X

MODEL 1390

DOUBLE BANANA PLUG, FOUR TERMINAL ISOLATION

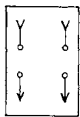
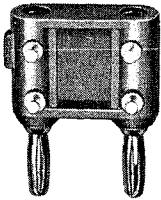

Provides four terminal isolation. Top Stack-Up receptacles isolated from lower plugs. Ideal for insertion of matching networks in laboratory VTVM's, signal generators, etc. Gold flashed solder turret terminals for permanent noise-free connections.

UPPER: Double banana jacks, .166 dia., on 3/4" centers.
LOWER: Double banana plug on 3/4" centers.
COLOR: Red.

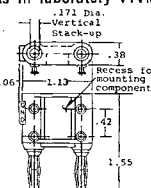

MODEL MDP-X

QUANTITY DISC. CODE **A** NET 3.25

DOUBLE BANANA PLUG, THREE TERMINAL ISOLATION

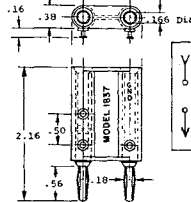
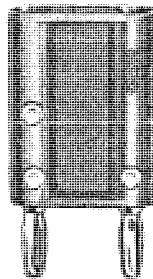

Provides three terminal isolation. Excellent for "L" and "Pi" networks. Plug and receptacle nickel plated. Gold flashed solder turret terminals for permanent noise-free connections. "Ground" is straight feed-thru. Hot side isolated.

UPPER: Banana jacks, .166 dia. on 3/4" centers.
LOWER: Double banana plug on 3/4" centers.
COLOR: Blue.

QUANTITY DISC. CODE **A** NET 2.50

MODEL 1837

ADAPTER — BINDING POSTS TO BNC PLUG, ISOLATION

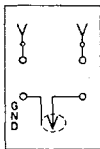
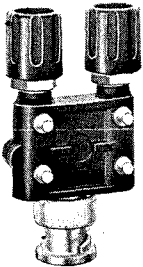

Permits single or double banana plugs to be used with equipment having BNC receptacle. Provides isolation for a four terminal network. Binding posts facilitate connections of test leads or additional components. Gold flashed solder turret terminals provide permanent noise-free connections.

UPPER: Insulated binding posts, on 3/4" centers with .166 dia. jacks.
LOWER: BNC plug.
COLOR: Body, Black.
 Binding Posts: Black/Red.

MODEL 1469

QUANTITY DISC. CODE **A** NET 10.85

ADAPTER — BNC RECEPTACLE TO DOUBLE BANANA PLUG, ISOLATION

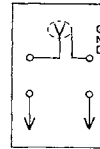
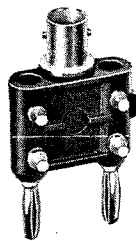

Permits BNC plug to be used with equipment having banana jacks. Provides isolation for a four terminal network. Excellent for matching pad networks. Gold flashed solder turret terminals for permanent noise-free connections.

UPPER: BNC receptacle.
LOWER: Double banana plug, on 3/4" centers.
COLOR: Black.

MODEL 1468

QUANTITY DISC. CODE **A** NET 9.85

PLUG — SINGLE BANANA, ISOLATION

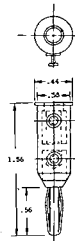
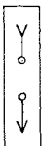
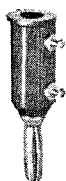

Provides two terminal isolation. Top Stack-Up receptacle is isolated from lower plug to permit addition of series resistors, diodes, etc. Ideal for computers, lab. circuit design and testing. Gold flashed solder turret terminals for permanent noise-free connections.

UPPER: Banana jack, .166 dia.
LOWER: Banana plug.
COLORS: Black, Red.

MODEL 1390 (Specify color)

QUANTITY DISC. CODE **A** NET .95

PLUG — PIN TIP, ISOLATION



Pin tip jack is isolated from .080 pin tip plug. Provides for addition of series components. Ideal for use with computer boards, lab circuit designs, etc. Gold flashed solder turret terminals for permanent noise-free connections.

UPPER: Tip jack, beryllium copper, gold flashed; accepts .080 dia. pin.
LOWER: Pin tip, .080 dia. Brass, nickel plated.
COLORS: Black Red.

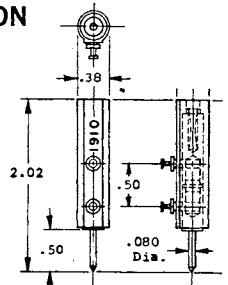

MODEL 1910 (Specify color)

QUANTITY DISC. CODE **A** NET .95

POMONA ELECTRONICS

"BLACK BOXES"

CREATE passive and active networks, voltage dividers, isolation networks or attenuators with these units. Solder turret terminals for permanent noise-free connection of components, etc. Entire unit may be potted or encapsulated.

APPLICABLE SPECIFICATIONS:

Operating Temp: -25°C to +125°C. Working Voltage: 5000 VDC. Current: 15 Amps Cont., 30 Amps Int.

Housing molded of thermosetting electrical grade phenolic. Cover, punched XXP laminated paper base phenolic. Color, housing and cover, BLACK. Cover plate and 2 each #2-56 cover screws included.

COMPONENT MOUNTING—ACROSS BANANA PLUGS

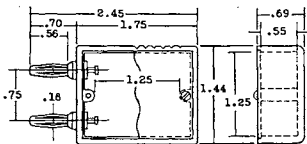
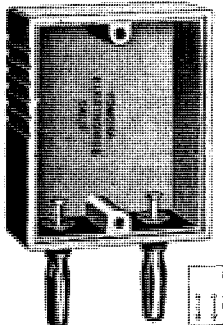

UPPER: No Connection.

LOWER: Banana plugs on 3/4" centers. One piece beryllium copper spring, heat treated, nickel plated. Plug body and solder turret terminals, brass, nickel plated. For use with standard .166" dia. banana jacks.

MODEL 2096

QUANTITY DISC. CODE **A** NET 1.95

COMPONENT MOUNTING—ACROSS BANANA PLUGS—KING SIZE

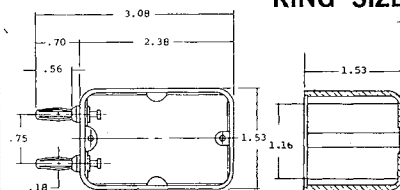
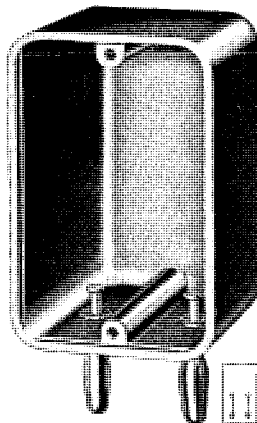

UPPER: No Connection.

LOWER: Banana plugs on 3/4" centers. One piece beryllium copper spring, heat treated, nickel plated. Plug body and solder turret terminals, brass, nickel plated. For use with standard .166" dia. banana jacks.

MODEL 1177

QUANTITY DISC. CODE **A** NET 1.95

COMPONENT MOUNTING—BANANA JACKS TO DOUBLE BANANA PLUG—JUNIOR SIZE

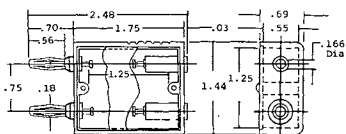
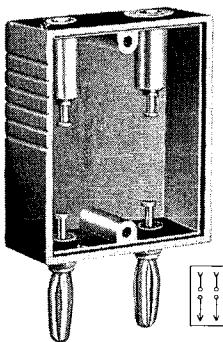

UPPER: Banana jacks, .166" dia. and solder turret terminals on 3/4" centers. Brass, nickel plated. Polarity indicator on top, color, RED.

LOWER: Banana plugs on 3/4" centers. One piece beryllium copper spring, heat treated, nickel plated. Plug body and solder turret terminals, brass, nickel plated. For use with standard .166" dia. banana jacks.

MODEL 2098

QUANTITY DISC. CODE **A** NET 3.45

COMPONENT MOUNTING—BANANA JACKS TO DOUBLE BANANA PLUG—KING SIZE

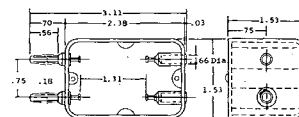
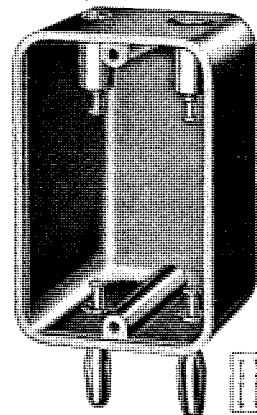

UPPER: Banana jacks, .166" dia. and solder turret terminals on 3/4" centers. Brass, nickel plated. Polarity indicator on top, color, RED.

LOWER: Banana plugs on 3/4" centers. One piece beryllium copper spring, heat treated, nickel plated. Plug body and solder turret terminals, brass, nickel plated. For use with standard .166" dia. banana jacks.

MODEL 2224

QUANTITY DISC. CODE **A** NET 3.45

COMPONENT MOUNTING—BINDING POSTS TO DOUBLE BANANA PLUG—JUNIOR SIZE

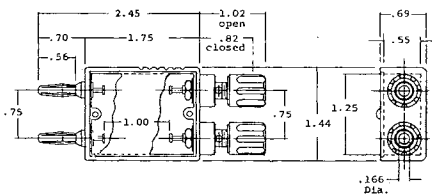
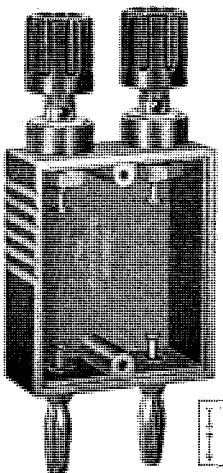

UPPER: Banana jack binding posts with solder turret terminals, on 3/4" centers. Red and Black.

LOWER: Banana plugs on 3/4" centers. One piece beryllium copper spring, heat treated, nickel plated. Plug body and solder turret terminals, brass, nickel plated. For use with standard .166" dia. banana jacks.

MODEL 2259

QUANTITY DISC. CODE **A** NET 4.85

COMPONENT MOUNTING—BINDING POSTS TO DOUBLE BANANA PLUG—KING SIZE

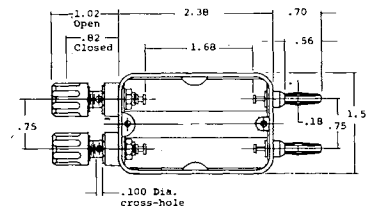
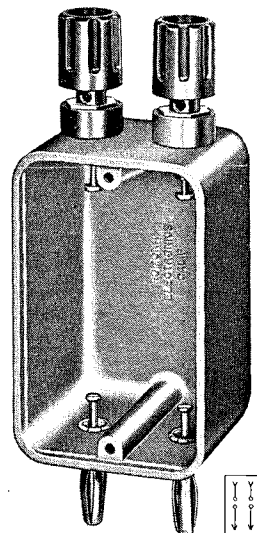

UPPER: Banana jack binding posts with solder turret terminals, on 3/4" centers. Red and Black.

LOWER: Banana plugs on 3/4" centers. One piece beryllium copper spring, heat treated, nickel plated. Plug body and solder turret terminals, brass, nickel plated. For use with standard .166" dia. banana jacks.

MODEL 2262

QUANTITY DISC. CODE **A** NET 4.85

POMONA ELECTRONICS

Boxes of unlimited uses for packaging of components and circuitry. Also ideal for potting and encapsulating. Available in three sizes as shown below. Housing molded of thermosetting electrical grade phenolic. Cover, punched XXP laminated paper base phenolic. Color, Housing and cover, Black. Cover plate and 2 each #2-56 cover screws included.

Operating Temperature: -25°C to $+125^{\circ}\text{C}$.

BLACK BOX—JUNIOR SIZE

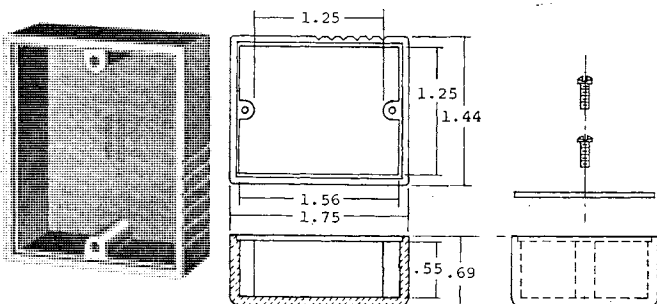

MODEL 2105

QUANTITY DISC. CODE **A** NET .75

BLACK BOX—QUEEN SIZE

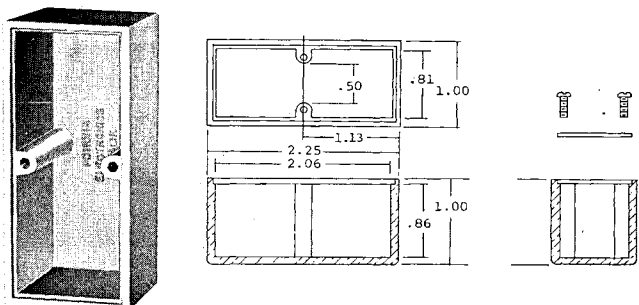

MODEL 2103

QUANTITY DISC. CODE **A** NET .75

BLACK BOX—KING SIZE

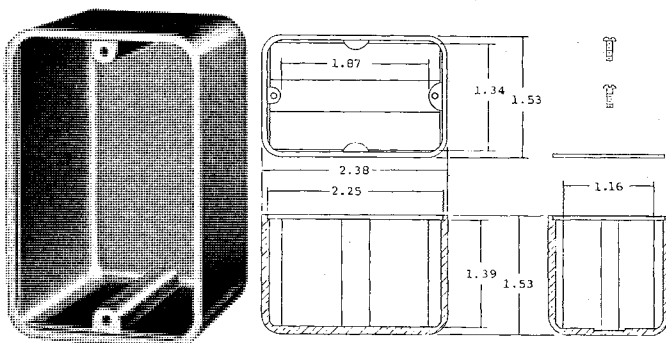

MODEL 2104

QUANTITY DISC. CODE **A** NET .75

"BLACK BOXES"

CREATE passive and active networks, voltage dividers, isolation networks or attenuators with these units. Solder turret terminals for permanent noise-free connection of components, etc. Entire unit may be potted or encapsulated.

Housing molded of thermosetting electrical grade phenolic. Cover, punched XXP laminated paper base phenolic. Color, housing and cover, BLACK. Cover plate and 2 each #2-56 cover screws included.

COMPONENT MOUNTING—ACROSS PIN TIP PLUGS

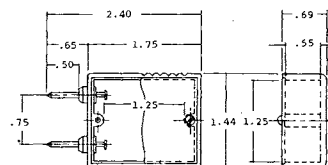
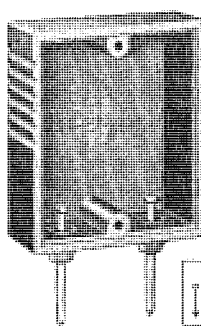

UPPER: No Connection.

LOWER: Pin tip plugs, .080 dia. on $\frac{3}{4}$ " centers. Plug bodies and solder turret terminals, brass, nickel plated.

APPLICABLE SPECIFICATIONS:

Operating Temp.: -25°C to $+125^{\circ}\text{C}$.

Working Voltage: 5000 VDC.

Current: 5 Amps Cont., 10 Amps Int.

MODEL 2268 QUANTITY DISC. CODE **A** NET 1.95

COMPONENT MOUNTING—PIN TIP JACKS TO DOUBLE PIN TIP PLUG—JUNIOR SIZE

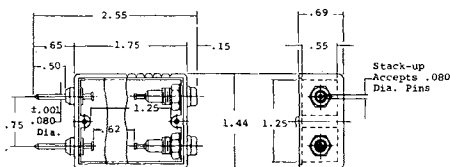
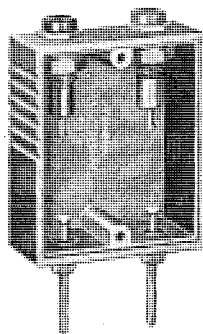

UPPER: Tip jacks, on $\frac{3}{4}$ " centers, per MS-16108. One Red, one Black.

LOWER: Pin tip plugs, .080 dia. on $\frac{3}{4}$ " centers. Plug bodies and solder turret terminals, brass, nickel plated.

APPLICABLE SPECIFICATIONS:

Operating Temp.: -25°C to $+125^{\circ}\text{C}$.

Working Voltage: 5000 VDC.

Current: 5 Amps Cont., 10 Amps Int.

MODEL 2260 QUANTITY DISC. CODE **A** NET 4.85

COMPONENT MOUNTING—(3) $\frac{3}{4}$ " SPACED BANANA PLUGS—KING SIZE

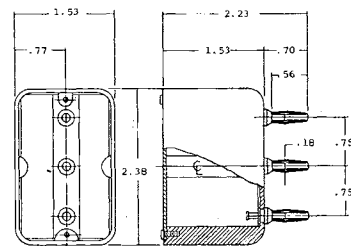
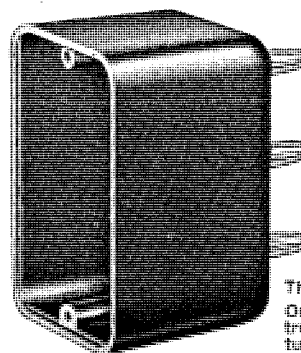

Three-in-line $\frac{3}{4}$ " Spaced Banana Plugs.

One piece beryllium copper spring, heat treated, nickel plated. Plug body and solder turret terminals, brass, nickel plated. For use with standard .166" dia. banana jacks.

APPLICABLE SPECIFICATIONS:

Operating Temp.: -25°C to $+125^{\circ}\text{C}$.

Working Voltage: 5000 VDC.

Current: 15 Amps Cont., 30 Amps Int.

MODEL 1943

QUANTITY DISC. CODE **A** NET 2.75

POMONA ELECTRONICS

MINIATURE—DOUBLE BANANA PLUG—4 TERMINAL ISOLATION

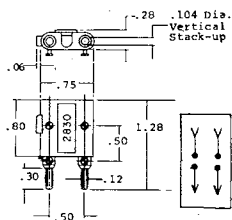
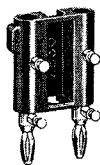

Provides four terminal isolation. Top Stack-up receptacles isolated from lower plugs. Ideal for insertion of matching networks in computer boards, circuit design and testing. Gold flashed solder turret terminals for permanent noise-free connections. **UPPER:** Miniature double banana jack, .104 Dia. Brass, gold flashed. **LOWER:** Miniature double banana plug on 1/2" centers. Gold flashed one piece beryllium copper spring. **COLOR:** Red. **NET 3.85**

MODEL 2830 QUANTITY DISC. CODE **A**

MINIATURE—SINGLE BANANA PLUG ISOLATION

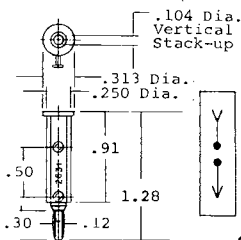

Provides two terminal isolation. Allows for addition of series components. Excellent for circuit design and testing. Gold flashed solder turret terminals for permanent noise-free connections. **UPPER:** Miniature banana jack, .104 dia. Brass, gold flashed. **LOWER:** Miniature banana plug, one piece gold flashed beryllium copper spring. **COLOR:** Black, Red.

MODEL 2831 (specify color) QUANTITY DISC. CODE **A** NET 1.25

MINIATURE—METAL SHORTING BAR



Low profile, gold flashed, brass shorting bar. Miniature banana plugs on 1/2" centers swaged to 1/16" thick brass bar. Center hole accepts #4-40 screw for easy removal. Current rating 5 Amps. cont., 10 Amps INT.

MODEL 3030 QUANTITY DISC. CODE **A** NET .85

ADAPTER—STANDARD DOUBLE BANANA JACK TO MINIATURE DOUBLE BANANA PLUG

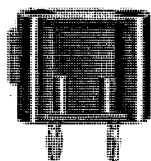

Permits standard double banana plug on 3/4" centers to be used with equipment having miniature double banana jacks on 1/2" centers. **UPPER:** Standard double banana jacks .166 dia. on 3/4" centers. Brass, nickel plated. **LOWER:** Miniature double banana plug on 1/2" centers. One piece nickel plated beryllium copper spring for use with .104 dia. miniature banana jacks. **COLOR:** Black.

MODEL 2952 QUANTITY DISC. CODE **A** NET .95

ADAPTER—MINIATURE DOUBLE BANANA JACK TO STANDARD DOUBLE BANANA PLUG

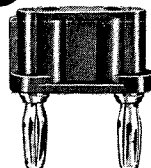

Permits miniature double banana plug on 1/2" centers to be used with equipment having standard double banana jacks on 3/4" centers. **UPPER:** Miniature double banana jacks, .104 dia. on 1/2" centers. Brass, nickel plated. **LOWER:** Standard double banana plug on 3/4" centers. One piece nickel plated beryllium copper spring for use with .166 dia. standard banana jacks. **COLOR:** Black.

MODEL 2943 QUANTITY DISC. CODE **A** NET .95

ADAPTER—STANDARD BANANA JACK TO MINIATURE BANANA PLUG



Permits standard banana plug to be used with equipment having miniature banana jacks. **UPPER:** Banana jack, .166 dia.; Brass, nickel plated. **LOWER:** Miniature banana plug, one piece nickel plated beryllium copper spring for use with .104 dia. miniature banana jacks. **COLORS:** Black, Red.

MODEL 2138-0 Black NET .50
2138-2 Red

ADAPTER—MINIATURE BANANA JACK TO STANDARD BANANA PLUG



Permits miniature banana plugs to be used with equipment having standard banana jacks. **UPPER:** Miniature banana jack, .104 dia.; Brass, nickel plated. **LOWER:** Standard banana plug, one piece nickel plated beryllium copper spring for use with .166 dia. banana jacks. **COLORS:** Black, Red.

MODEL 2477-0 Black NET .50
2477-2 Red

MINIATURE TEST ACCESSORIES AND PATCH CORDS

MINIATURE BANANA PLUG PATCH CORDS

Miniature patch cords for use with .104 dia. miniature banana jacks. Excellent for miniaturization of test equipment and high density packaging for patch systems.

Banana plug springs precision formed of one piece beryllium copper, heat treated for maximum life and low contact resistance. Tough thermoplastic molded to plug body and wire.

FEATURES:

- Fits .104 dia. miniature banana jacks
- Plug body brass, per QQ-B-626, Comp. #22
- Gold flashed per MIL-G-45204 Type II (.00002/.00003)
- Spring, one piece heat treated beryllium copper, alloy 170 per QQ-C-533.

SPECIFICATIONS:

- WIRE: 20 AWG, Strand. 41 x 36 T.C. Extra flexible poly-vinyl insulation .087" O.D.
- RATED: 5 A. Cont., 10 A. Int., 5,000 V.D.C.
- OPERATING TEMP.: -0° C to +105° C.

MINIATURE—BANANA PLUG STACK-UP PATCH CORD

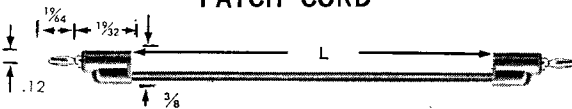

COLORS: Black, Brown, Red, Orange, Yellow, Green, Blue, Violet, Gray, White.

MODEL	LENGTH	NET	MODEL	LENGTH	NET
1081-4	4"	1.50	1081-24	24"	1.50
1081-8	8"	1.50	1081-36	36"	1.50
1081-12	12"	1.50	1081-48	48"	1.55
1081-18	18"	1.50	1081-60	60"	1.60

MODEL 1081 (Specify Color) ★ QUANTITY DISC. CODE **A**

MINIATURE—RIGHT ANGLE BANANA PLUG PATCH CORD STACK-UP

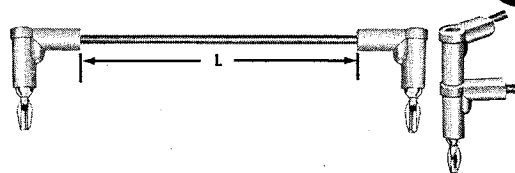
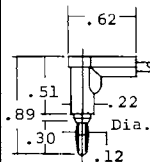

COLORS: Black, Brown, Red, Orange, Yellow, Green, Blue, Violet, Gray, White.

MODEL	LENGTH	NET	MODEL	LENGTH	NET
2860-4	4"	1.50	2860-24	24"	1.50
2860-8	8"	1.50	2860-36	36"	1.50
2860-12	12"	1.50	2860-48	48"	1.55
2860-18	18"	1.50	2860-60	60"	1.60

MODEL 2860 (Specify Color) ★ QUANTITY DISC. CODE **A**

MINIATURE—BANANA PLUG PATCH CORD

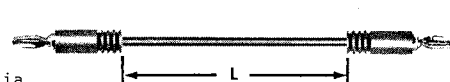
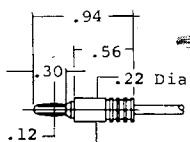

COLORS: Black, Brown, Red, Orange, Yellow, Green, Blue, Violet, Gray, White.

MODEL	LENGTH	NET	MODEL	LENGTH	NET
2842-4	4"	1.00	2842-24	24"	1.00
2842-8	8"	1.00	2842-36	36"	1.00
2842-12	12"	1.00	2842-48	48"	1.05
2842-18	18"	1.00	2842-60	60"	1.10

MODEL 2842 (Specify Color) ★ QUANTITY DISC. CODE **A**

★ Various lengths may be aggregated for best quantity price.

POMONA ELECTRONICS

NOW AVAILABLE, *SHIELDED* "BLACK BOXES." Boxes that fulfill the requirement for RF applications.

Ideal for compact packaging, eg., voltage dividers, isolation networks, impedance matching networks, and other varied uses.

Cover and self-tapping screws included.

APPLICABLE SPECIFICATIONS: (ALL MODELS)

Operating Temp.: -55°C to +150°C.

Working Voltage: 500 V Peak (Model 2415, 1500 V Peak).

Noise Rejection: Greater than 70DB.

SHIELDED "BLACK" BOXES

FEATURES:

- SHIELDED HOUSING; Die Cast Aluminum. FINISH: BLUE baked enamel per Federal Standard 595 #25109 over phosphoric etch per MIL-C-15328A.
- COVER; .040 Thick Aluminum #6061-T6 with clear anodized finish per MIL-A-8625A.
- Four screws secure cover for proper shielding.
- Solder turret terminals for permanent noise free connection of components.

COMPONENT MOUNTING— BNC RECEPTACLE BOTH ENDS

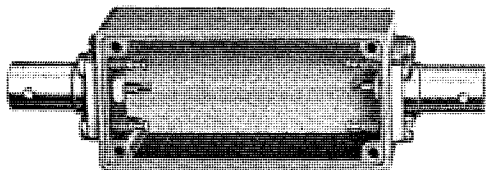

CONN: } BNC Receptacle Jack,
1st END } UG290A/U.
CONN: } BNC Receptacle Jack,
2nd END } UG290A/U.

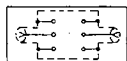
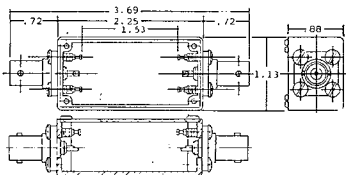

MODEL 2390

QUANTITY DISC. CODE **A**

NET 6.85

COMPONENT MOUNTING— BNC RECEPTACLE "T"

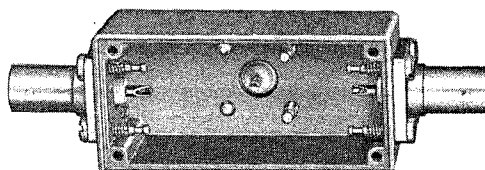

CONN: } BNC Receptacle Jack,
1st END } UG290A/U.
CENTER: BNC Receptacle Jack,
UG290A/U.
CONN: } BNC Receptacle Jack,
2nd END } UG290A/U.

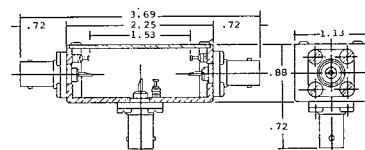

MODEL 2392

QUANTITY DISC. CODE **A**

NET 9.50

COMPONENT MOUNTING— BNC RECEPTACLE TO BNC PLUG

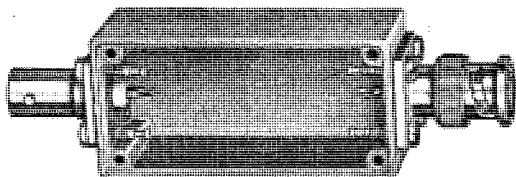

CONN: } BNC Receptacle Jack,
1st END } UG290A/U.
CONN: } BNC Receptacle Plug,
2nd END } UG1104A/U.

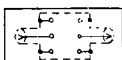
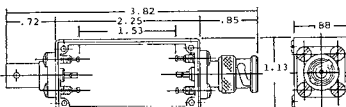

MODEL 2391

QUANTITY DISC. CODE **A**

NET 7.85

COMPONENT MOUNTING— TNC RECEPTACLE BOTH ENDS

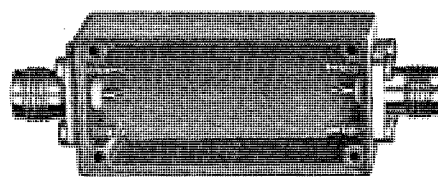

CONN: } TNC Receptacle Jack.
1st END }
CONN: } TNC Receptacle Jack.
2nd END }

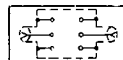
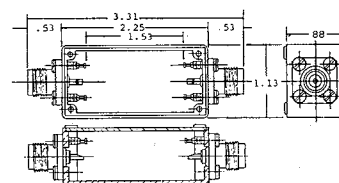

MODEL 2396

QUANTITY DISC. CODE **A**

NET 7.85

COMPONENT MOUNTING—BNC RECEPTACLE TO BNC PLUG WITH BINDING POSTS

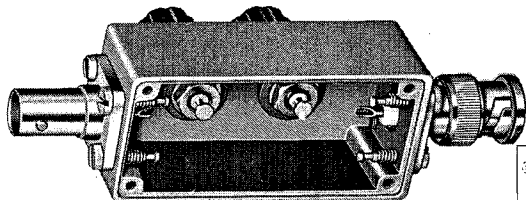

CONN: } BNC Receptacle Jack,
1st END } UG290A/U.
CENTER: Banana jack binding
posts with solder turret
terminals. Red and Black.
CONN: } BNC Receptacle Plug,
2nd END } UG1104A/U.

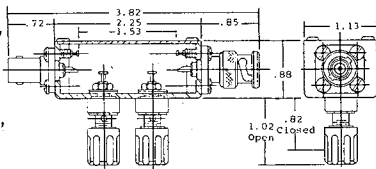

MODEL 2393

QUANTITY DISC. CODE **A**

NET 10.85

COMPONENT MOUNTING— TNC RECEPTACLE TO TNC PLUG

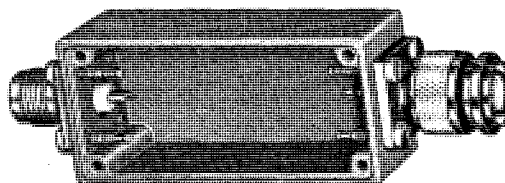

CONN: } TNC Receptacle Jack.
1st END }
CONN: } TNC Receptacle Plug.
2nd END }

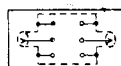
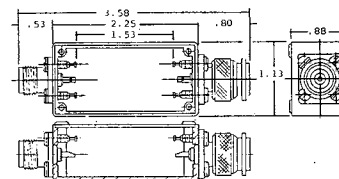

MODEL 2395

QUANTITY DISC. CODE **A**

NET 9.50

POMONA ELECTRONICS

SHIELDED "BLACK BOXES"

NEW

COMPONENT MOUNTING —
OSM* RECEPTACLE BOTH ENDS

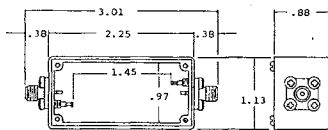
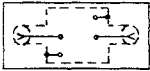
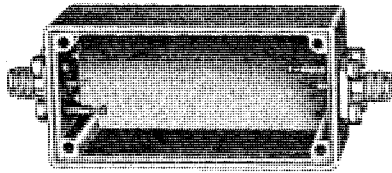

CONN: 1st END } OSM Receptacle Jack.
CONN: 2nd END } OSM Receptacle Jack.

MODEL 2399 QUANTITY DISC. CODE **A** NET 17.95

NEW

COMPONENT MOUNTING —
OSM* RECEPTACLE TO OSM* PLUG

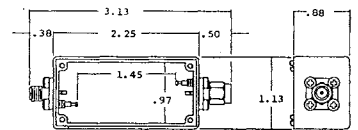
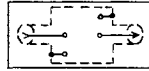
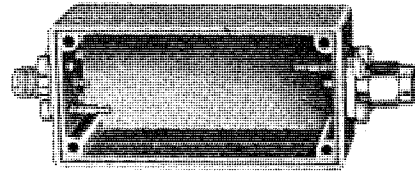

CONN: 1st END } OSM Receptacle Jack.
CONN: 2nd END } OSM Receptacle Plug.

MODEL 2398 QUANTITY DISC. CODE **A** NET 22.95

NEW

COMPONENT MOUNTING — UHF RECEPTACLE
TO UHF PLUG WITH BINDING POSTS

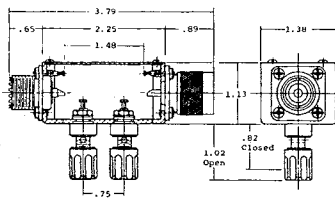
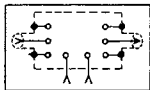
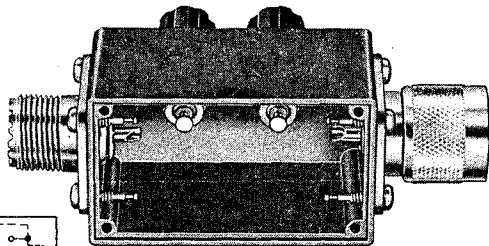

CONN: 1st END } UHF Receptacle Jack.
CENTER: Banana jack binding posts with solder turret terminals. Red and Black.
CONN: 2nd END } UHF Receptacle Plug.

MODEL 2422 QUANTITY DISC. CODE **A** NET 13.85

NEW

COMPONENT MOUNTING TYPE "N" RECEPTACLE
TO TYPE "N" PLUG WITH BINDING POSTS

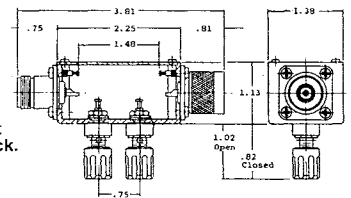
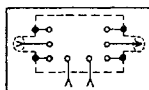
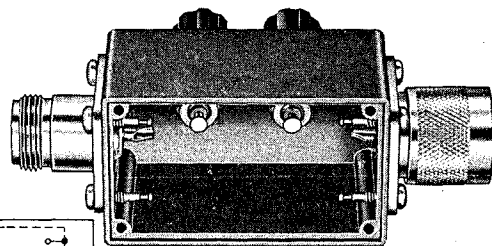

CONN: 1st END } Type "N" Receptacle Jack, UG58A/U.
CENTER: Banana jack binding posts with solder turret terminals. Red and Black.
CONN: 2nd END } Type "N" Receptacle Plug.

MODEL 2423 QUANTITY DISC. CODE **A** NET 12.85

NEW

COMPONENT MOUNTING — CROSS CONNECTIONS

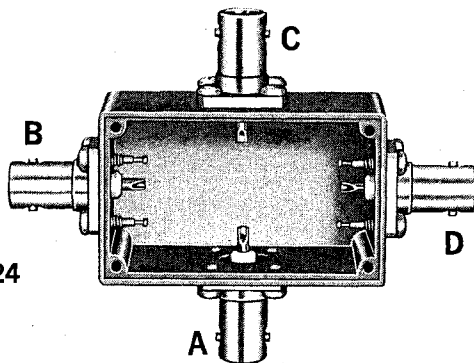

MODEL 2424

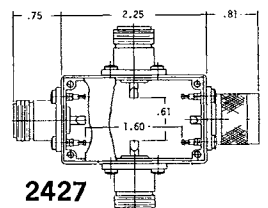
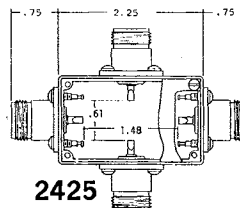
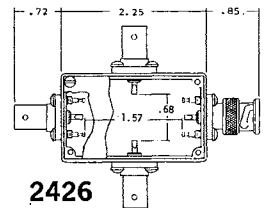
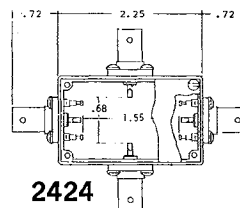

MODEL	CONNECTION A, B AND C	CONNECTION D	Quantity Disc. Code	NET
2424	BNC Receptacle Jack, UG290A/U.	BNC Receptacle Jack, UG290A/U.	A	11.75
2425	Type "N" Receptacle Jack, UG58A/U.	Type "N" Receptacle Jack, UG58A/U.	A	11.75
2426	BNC Receptacle Jack, UG290A/U.	BNC Receptacle Plug, UG1104A/U.	A	12.85
2427	Type "N" Receptacle Jack, UG58A/U.	Type "N" Receptacle Plug.	A	12.85

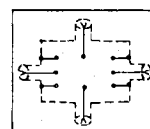

2424,
2425

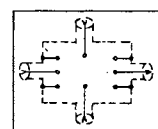

2426,
2427

POMONA ELECTRONICS

SHIELDED "BLACK BOXES"

**COMPONENT MOUNTING —
TYPE "C" RECEPTACLE TO TYPE "C" PLUG**

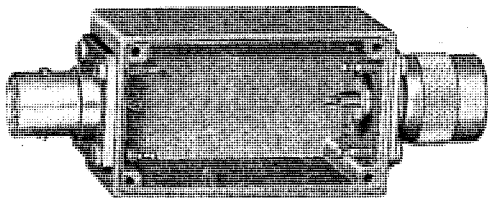

CONN: } Type "C" Receptacle
1st END } Jack, UG568/U.
CONN: } Type "C" Receptacle
2nd END } Plug.

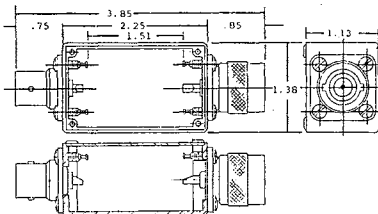

MODEL 2415

QUANTITY DISC. CODE **A**

NET 11.75

**COMPONENT MOUNTING —
BNC RECEPTACLE TO TYPE "N" PLUG**

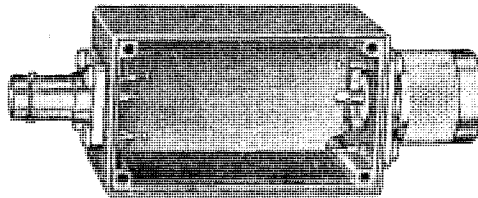

CONN: } BNC Receptacle Jack,
1st END } UG290A/U.
CONN: } Type "N" Receptacle
2nd END } Plug.

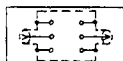
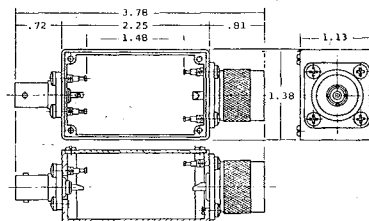

MODEL 2420

QUANTITY DISC. CODE **A**

NET 9.85

**COMPONENT MOUNTING —
GR-874 CONNECTOR BOTH ENDS**

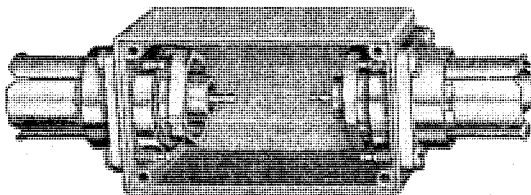

CONN: } Type GR-874 Connector.
1st END }
CONN: } Type GR-874 Connector.
2nd END }

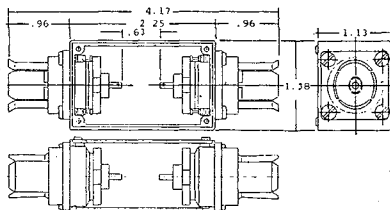

MODEL 2416

QUANTITY DISC. CODE **A**

NET 24.75

**COMPONENT MOUNTING —
TYPE "N" RECEPTACLE TO BNC PLUG**

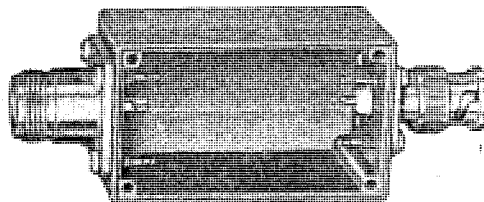

CONN: } Type "N" Receptacle
1st END } Jack, UG58A/U.
CONN: } BNC Receptacle Plug,
2nd END } UG1104A/U.

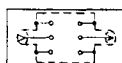
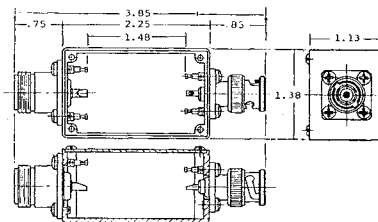

MODEL 2421

QUANTITY DISC. CODE **A**

NET 7.85

EMPTY — SHIELDED "BLACK BOX"

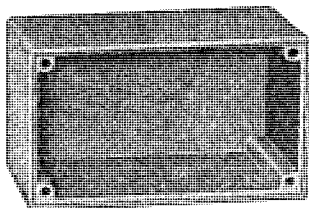

MODEL 2417
FINISH: Blue Baked Enamel.
Includes cover with part number on cover and four cover screws.

MODEL 2428
FINISH: None
Includes unmarked cover and four cover screws.

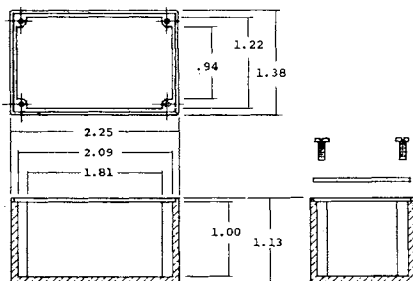

MODEL 2417
MODEL 2428

QUANTITY DISC. CODE **A**

NET 1.50

EMPTY — SHIELDED "BLACK BOX"

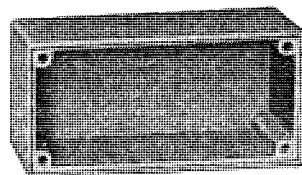

MODEL 2397
FINISH: Blue Baked Enamel.
Includes cover with part number on cover and four cover screws.

MODEL 2400
FINISH: None
Includes unmarked cover and four cover screws.

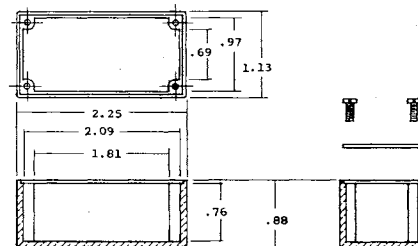

MODEL 2397
MODEL 2400

QUANTITY DISC. CODE **A**

NET 1.50

POMONA ELECTRONICS

PATCH CORDS BANANA PLUGS

POMONA BANANA PLUG PATCH CORDS

Tough thermoplastic insulation molds the plug and leads into a strong moisture resistant integral unit. Excellent for computer board and test equipment applications. Used by leading industries in applications where extreme reliability is of prime importance.

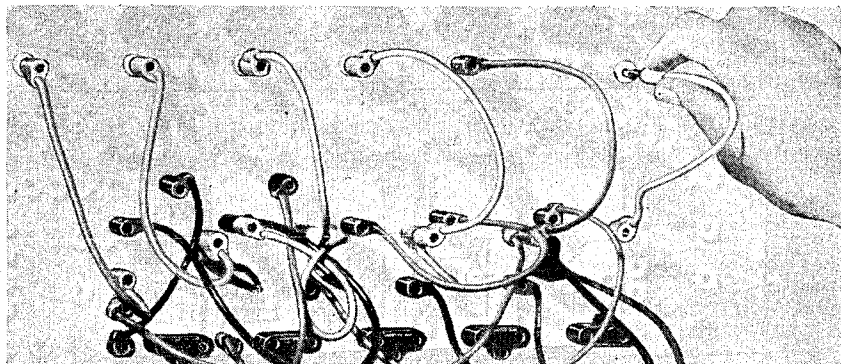

FEATURES

- One piece beryllium copper heat treated spring for maximum long life.
- Rounded spring design results in maximum contact area.
- Extra flexible polyvinyl insulation used on all leads.

SPECIFICATIONS

- Fits standard 0.166 dia. banana jacks.
- Spring, beryllium copper alloy 170 per QQ-C-533.
- Plug body, brass per QQ-B-626, Comp. 22.
- Nickel plated per QQ-N-290, Class 2.
- Contact resistance less than 0.001 ohms per banana plug.
- Operating Temp.: -0°C to +105°C.
- Wire, 18 AWG, stranding 65 x 36 T.C.
- Insulation, polyvinyl .144" O.D.
- Ratings: 15 A. Cont., 30 A. Int. 10,000 W.V.D.C.

MODEL	LENGTH	NET
B-4	4"	1.50
B-8	8"	1.50
B-12	12"	1.50
B-18	18"	1.50
B-24	24"	1.50
B-36	36"	1.50
B-48	48"	1.55
B-60	60"	1.60

STACK-UP BANANA PLUG PATCH CORD

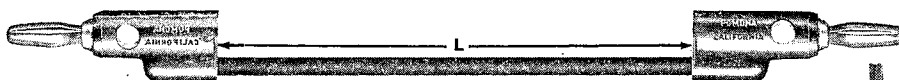

Multiple stacking feature accommodates the most complex stacking; keeps circuitry neater. Greatly simplifies circuit connections and changes. Reliable solder-bonded connections withstand pull test in excess of 50 lbs. Banana plugs both ends.

COLORS: Black, Brown, Red, Orange, Yellow, Green, Blue, Violet, Gray, White.

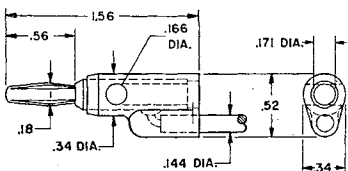
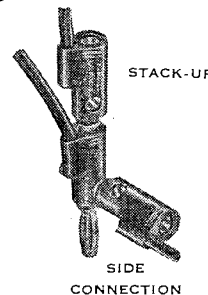

MODEL B (Specify Color) QUANTITY DISC. CODE **A** ★

MODEL	LENGTH	NET
HB-4	4"	1.75
HB-8	8"	1.75
HB-12	12"	1.75
HB-18	18"	1.75
HB-24	24"	1.75
HB-36	36"	1.75
HB-48	48"	1.80
HB-60	60"	1.85

EXTENSION STACKING BANANA PLUG PATCH CORD

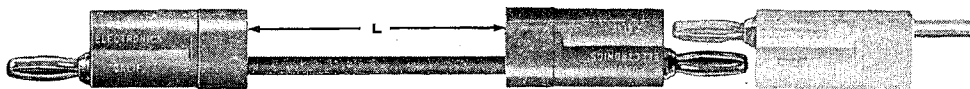

Dual purpose. Insulates all hot leads when used as an extension cord. Endless extension couplings possible with any banana plug patch cord. Provides vertical stacking from any jack. Reliable solder-bonded connections withstand pull test in excess of 50 lbs. Banana plugs both ends.

COLORS: Black, Brown, Red, Orange, Yellow, Green, Blue, Violet, Gray, White.

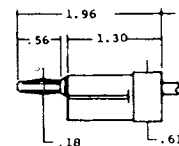

MODEL HB (Specify Color) QUANTITY DISC. CODE **A** ★

MODEL	LENGTH	NET
1440-4	4"	1.00
1440-8	8"	1.00
1440-12	12"	1.00
1440-18	18"	1.00
1440-24	24"	1.00
1440-36	36"	1.00
1440-48	48"	1.05
1440-60	60"	1.10

HORIZONTAL STACKING BANANA PLUG PATCH CORD

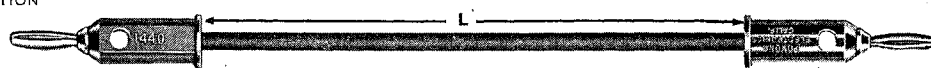
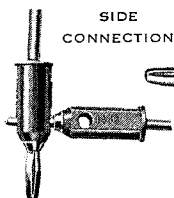

Ideal as an interconnecting lead between power supplies, test equipment, etc. Horizontal stacking feature. Banana plugs on both ends.

COLORS: Black, Brown, Red, Orange, Yellow, Green, Blue, Violet, Gray, White.

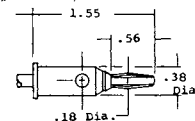

MODEL 1440 (Specify Color) QUANTITY DISC. CODE **A** ★

★ Various lengths may be aggregated for best quantity price.

OTHER LENGTHS AVAILABLE TO ORDER

POMONA ELECTRONICS

PATCH CORDS .080 TIP

MODEL	LENGTH	NET
P-4	4"	1.75
P-8	8"	1.75
P-12	12"	1.75
P-18	18"	1.75
P-24	24"	1.75
P-36	36"	1.75
P-48	48"	1.80
P-60	60"	1.85

PIN TIP VERTICAL STACKING PATCH CORD



A must in circuit designing and testing, with instruments that utilize tip jacks. **PIN TIP:** .080 dia., 1/2" long, brass, gold flashed. **TIP JACK, STACK-UP:** Beryllium copper, gold flashed. Accepts .080 dia. pin.

WIRE: 20 AWG, Strand. 41 x 36 T.C. Extra flexible polyvinyl insulation .087" O.D. **RATED:** 5 A. Cont., 10 A. Int. 5,000 W.V.D.C. **OPERATING TEMP.:** -0°C to +105°C. **COLORS:** Black, Brown, Red, Orange, Yellow, Green, Blue, Violet, Gray, White.

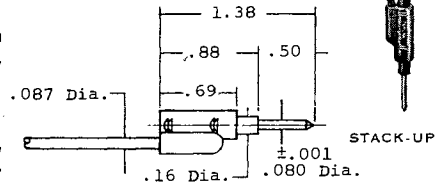

MODEL P
(Specify Color)

★ QUANTITY DISC. CODE **A**

MODEL	LENGTH	NET
1727-4	4"	1.85
1727-8	8"	1.85
1727-12	12"	1.85
1727-18	18"	1.85
1727-24	24"	1.85
1727-36	36"	1.85
1727-48	48"	1.90
1727-60	60"	1.95

PIN TIP EXTENSION STACKING PATCH CORD



Dual purpose, insulates exposed leads when used as an extension cord. Endless extension coupling possible. Also provides stacking from .080 jack. **PIN TIP:** .080 dia., 1/2" long, brass, gold flashed. **TIP JACK:** Beryllium copper, gold flashed. Accepts .080 dia. pin.

WIRE: 20 AWG, Strand. 41 x 36 T.C. Extra flexible polyvinyl insulation .087" O.D. **RATED:** 5 A. Cont., 10 A. Int. 5,000 W.V.D.C. **OPERATING TEMP.:** -0°C to +105°C. **COLORS:** Black, Brown, Red, Orange, Yellow, Green, Blue, Violet, Gray, White.

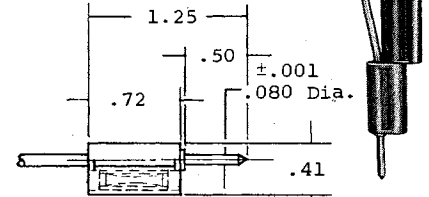

MODEL 1727
(Specify Color)

★ QUANTITY DISC. CODE **A**

MODEL	LENGTH	NET
1990-4	4"	.75
1990-8	8"	.75
1990-12	12"	.75
1990-18	18"	.75
1990-24	24"	.75
1990-36	36"	.75
1990-48	48"	.80
1990-60	60"	.85

PIN TIP PATCH CORD



Heavy Duty patch cord. Excellent for general lab work. Permits interconnection between test instruments that utilize tip jacks. **PIN TIP:** .080 dia., 1/2" long, brass, nickel plated.

RATED: 5 A. Cont., 10 A. Int. 10,000 W.V.D.C. **OPERATING TEMP.:** -0°C to +105°C. **COLORS:** Black, Brown, Red, Orange, Yellow, Green, Blue, Violet, Gray, White.

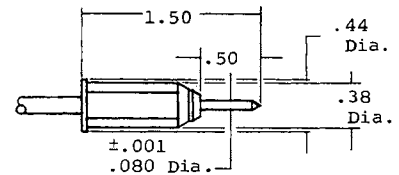

MODEL 1990
(Specify Color)

WIRE: 18 AWG, Strand. 65 x 36 T.C. Extra flexible polyvinyl insulation .144" O.D. ★ QUANTITY DISC. CODE **A**

MODEL	LENGTH	NET	PIN TIP:
PT063-4	4"	.85	Brass, gold flashed.
PT063-8	8"	.85	WIRE: 22 AWG, Strand. 19 x 34 T.C. Insulation, polyvinyl .064" O.D.
PT063-12	12"	.85	RATED: 3 A. Cont., 7.5 A. Int. 1,000 W.V.D.C.
PT063-18	18"	.85	OPERATING TEMP.: -0°C to +105°C.
PT063-24	24"	.85	
PT063-36	36"	.85	
PT063-48	48"	.90	
PT063-60	60"	.95	

COLORS: PTO63 and PMO80—Red and Black only.
PTO80 — Black, Brown, Red, Orange, Yellow, Green, Blue, Violet, Gray, White.

MODEL PT & PM
(Specify Color)

★ QUANTITY DISC. CODE **A**

PIN TIP PATCH CORD



MODEL PT 063 — PIN .063 DIA. X 7/16" LONG



MODEL PT 080 — PIN .080 DIA. X 1/2" LONG



MODEL PM 080 — PIN .080 DIA. X 1/4" LONG

Small body style permits usage in equipment having receptacles spaced closely together. Three models shown.

MODEL	LENGTH	NET
1126-4	4"	1.75
1126-8	8"	1.75
1126-12	12"	1.75
1126-18	18"	1.75
1126-24	24"	1.75
1126-36	36"	1.75
1126-48	48"	1.80
1126-60	60"	1.85

BANANA PLUG TO PIN TIP STACK-UP PATCH CORD

Adapts to equipment using banana jacks and pin jacks. Banana plug and pin tip allow vertical stack-up.

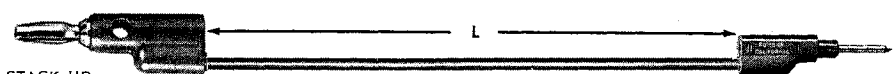
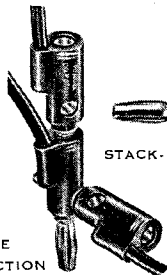

BANANA PLUG: Spring, one piece beryllium copper, heat treated, nickel plated. **PIN TIP:** .080 dia. 1/2" long, brass, gold flashed.

TIP JACK, STACK-UP: Beryllium copper, gold flashed. Accepts .080 Dia. pin. **WIRE:** 20 AWG, Strand. 41 x 36 T.C. Extra flexible

polyvinyl insulation .087" O.D. **RATED:** 5 A. Cont., 10 A. Int. 5,000 W.V.D.C. **OPERATING TEMP.:** -0°C to +105°C. **COLORS:** Black, Red.

MODEL 1126
(Specify Color) SIDE CONNECTION

★ QUANTITY DISC. CODE **A**

★ Various lengths may be aggregated for best quantity price.

OTHER LENGTHS AVAILABLE TO ORDER

POMONA ELECTRONICS

JUMPERS — CLIP LEADS

MODEL	LENGTH	NET
MG-B-4	4"	.95
MG-B-8	8"	.95
MG-B-12	12"	.95
MG-B-24	24"	.95
MG-B-36	36"	.95
MG-B-48	48"	1.00
MG-B-60	60"	1.05

(Specify Color)

QUANTITY
DISC. CODE**A** ★

CLIP: Minigator, steel, cad plated.
WIRE: 18 AWG, Strand. 65 x 36 T.C. Extra flexible
polyvinyl insulation .144" O.D.

INSULATOR: Red vinyl with red wire. Black on all other colors.
OPERATING TEMP.: -25°C to +105°C.
COLORS: Black, Red.

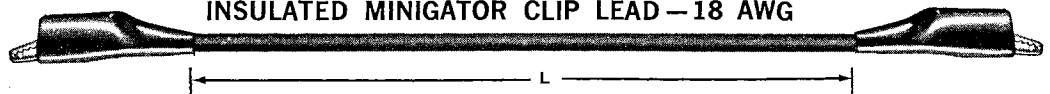

MODEL	LENGTH	NET
1236-4	4"	.95
1236-8	8"	.95
1236-12	12"	.95
1236-24	24"	.95
1236-36	36"	.95
1236-48	48"	1.00
1236-60	60"	1.05

(Specify Color)

QUANTITY
DISC. CODE**A** ★

CLIP: Minigator, steel, cad. plated.
WIRE: 20 AWG, Strand. 41 x 36 T.C. Extra flexible
polyvinyl insulation, .087" O.D.

INSULATOR: Red Vinyl with Red Wire. Black on all other colors.
OPERATING TEMP.: -25°C to +105°C.
COLORS: Black, Red.

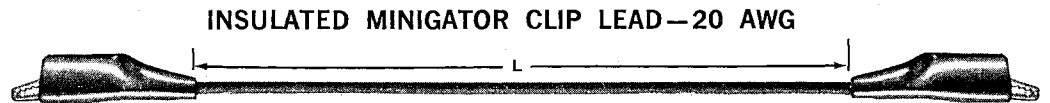

MODEL	LENGTH	NET
1613-4	4"	.95
1613-8	8"	.95
1613-12	12"	.95
1613-24	24"	.95
1613-36	36"	.95
1613-48	48"	1.00
1613-60	60"	1.05

(Specify Color)

QUANTITY
DISC. CODE**A** ★

CLIP: Microgator, solid copper.
WIRE: 20 AWG, Strand. 41 x 36 T.C. Extra flexible
polyvinyl insulation, .087" O.D.

INSULATOR: Red Vinyl with Red Wire. Black on all other colors.
OPERATING TEMP.: -25°C to +105°C.
COLORS: Black, Red.

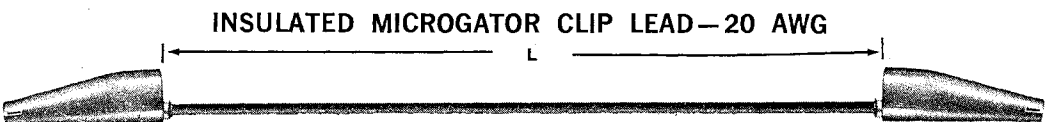

MODEL	LENGTH	NET
AL-B-4	4"	.95
AL-B-8	8"	.95
AL-B-12	12"	.95
AL-B-24	24"	.95
AL-B-36	36"	.95
AL-B-48	48"	1.00
AL-B-60	60"	1.05

(Specify Color)

QUANTITY
DISC. CODE**A** ★

CLIP: Alligator, steel, cad plated.
WIRE: 18 AWG, Strand. 65 x 36 T.C. Extra flexible
polyvinyl insulation .144" O.D.

INSULATOR: Red vinyl with red wire. Black on all other colors.
OPERATING TEMP.: -25°C to +105°C.
COLORS: Black, Red.

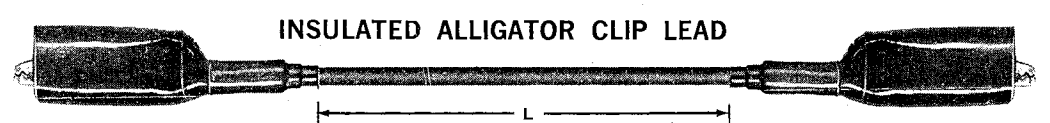

MODEL	LENGTH	NET
1743-12	12"	.95
1743-24	24"	.95
1743-36	36"	.95
1743-48	48"	1.00
1743-60	60"	1.05

(Typical Dimensions
spade lug)

(Specify Color)

QUANTITY
DISC. CODE**A** ★

Spade lug heavy duty machined one piece brass.
Tough thermo-plastic molded to spade lug body.
SPADE LUGS: Brass $\frac{1}{16}$ " thick, nickel plated.
WIRE: 18 AWG, Strand. 65 x 36 T.C. Extra flexible
polyvinyl insulation .144" O.D.

RATED: 15 A. Cont., 30 A. Int. 10,000 W.V.D.C.
OPERATING TEMP.: -25°C to +105°C.
COLORS: Black, Red, Green, White.

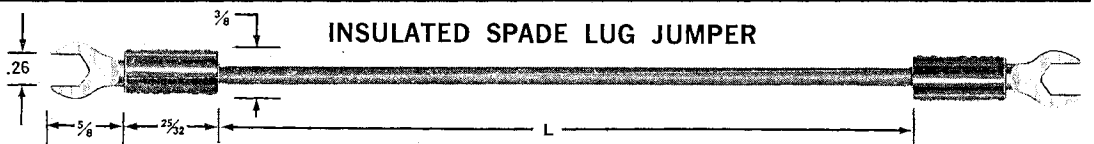

MODEL	LENGTH	NET
1987-12	12"	.95
1987-24	24"	.95
1987-36	36"	.95
1987-48	48"	1.00
1987-60	60"	1.05

(Specify Color)

QUANTITY
DISC. CODE**A** ★

Spade lug, heavy duty machined one piece brass. Tough thermo-plastic molded to spade lug and banana plug body.
SPADE LUG: Brass $\frac{1}{16}$ " thick, nickel plated.
BANANA PLUG: Spring one piece beryllium copper heat treated, nickel plated.

WIRE: 18 AWG, Strand. 65 x 36 T.C. Extra flexible polyvinyl insulation .144" O.D.
RATED: 15 A. Cont., 30 A. Int. 10,000 W.V.D.C.
OPERATING TEMP.: -25°C to +105°C.
COLORS: Black, Red

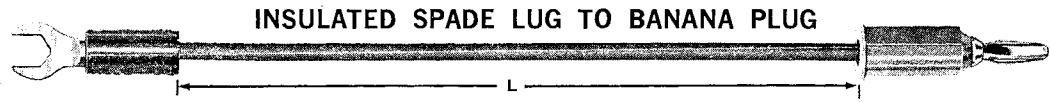

MODEL	LENGTH	NET
1370-12	12"	1.00
1370-24	24"	1.00
1370-36	36"	1.00
1370-48	48"	1.05
1370-60	60"	1.10

(Specify Color)

QUANTITY
DISC. CODE**A** ★

Spade lug, heavy duty machined one piece brass. Tough thermo-plastic molded to spade lug and banana plug body.
SPADE LUG: Brass $\frac{1}{16}$ " thick, nickel plated.
BANANA PLUG: Spring one piece beryllium copper heat treated, nickel plated.

WIRE: 18 AWG, Strand. 65 x 36 T.C. Extra flexible polyvinyl insulation .144" O.D.
RATED: 15 A. Cont., 30 A. Int. 10,000 W.V.D.C.
OPERATING TEMP.: -25°C to +105°C.
COLORS: Black, Red, Green, White.

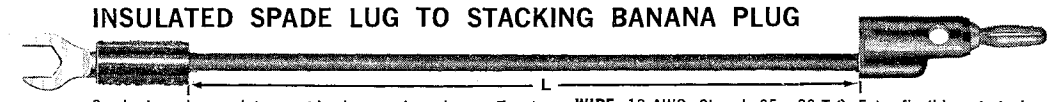

MODEL	LENGTH	NET
1960-12	12"	.95
1960-24	24"	.95
1960-36	36"	.95
1960-48	48"	1.00
1960-60	60"	1.05

(Specify Color)

QUANTITY
DISC. CODE**A** ★

Spade lug, heavy duty machined one piece brass. Tough thermo-plastic molded to spade lug body.
SPADE LUG: Brass $\frac{1}{16}$ " thick, nickel plated.
CLIP: Alligator, steel, cad plated.

INSULATOR: Red vinyl with red wire. Black on all other colors.
WIRE: 18 AWG, Strand. 65 x 36 T.C. Extra flexible polyvinyl insulation .144" O.D.
OPERATING TEMP.: -25°C to +105°C.
COLORS: Black, Red

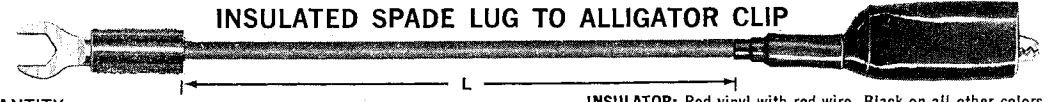

OTHER LENGTHS AVAILABLE TO ORDER

POMONA ELECTRONICS

TEST PROBES

TEST PROBE TO BANANA JACK

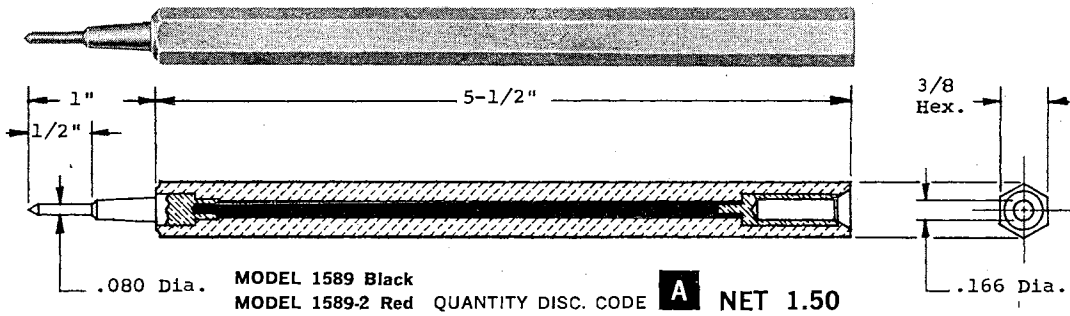

Banana jack in handle connected to tip. Permits use of standard banana plugs for circuit testing as a test prod. Heavy duty insulated handle molded to banana jack and tip.

PIN TIP: .080 dia. x 1/2" long, brass nickel plated.

BANANA JACK: .166 dia. Brass nickel plated. Accepts standard banana plug.

MODEL 1589 Black
MODEL 1589-2 Red
QUANTITY DISC. CODE **A** NET 1.50

NEEDLE TIP PROBE TO BANANA JACK

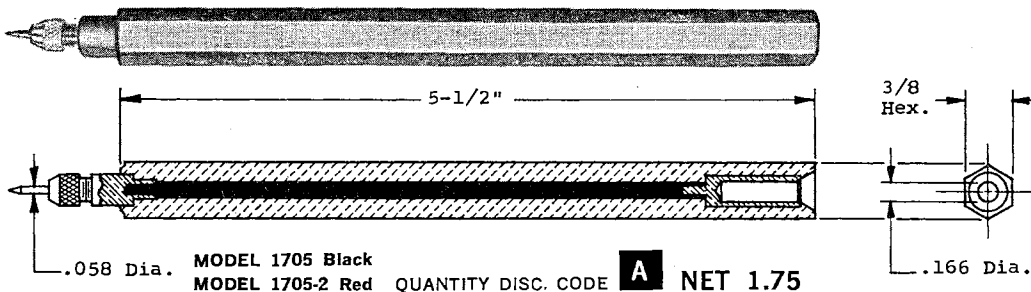

Sharp replaceable needle tip allows testing of encapsulated circuits. Banana jack in handle connected to tip. Permits use of standard banana plugs for circuit testing as a test prod. Heavy duty insulated handle molded to banana jack and tip.

PIN TIP: Replaceable needle tip, steel nickel plated.

BANANA JACK: .166 dia. Brass nickel plated. Accepts standard banana plug.

MODEL 1705 Black
MODEL 1705-2 Red
QUANTITY DISC. CODE **A** NET 1.75

TEST PROBE TO BANANA PLUG

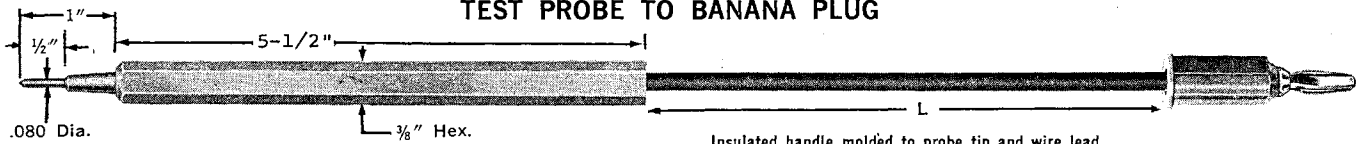

Insulated handle molded to probe tip and wire lead.
PROBE PIN TIP: .080 dia. x 1/2" long. Brass nickel plated.
WIRE: 18 AWG, Strand. 65 x 36 T.C. Extra flexible polyvinyl insulation, .144" O.D.
BANANA PLUG: Spring, one piece beryllium copper, heat treated, nickel plated. Tough thermo-plastic molded to body.
COLORS: Black, Red.

MODEL 1986-48-B | 48" Long | Black | NET 1.75
MODEL 1986-48-R | 48" Long | Red | NET 1.75

QUANTITY DISC. CODE **A**

TEST PROBE TO STACKING BANANA PLUG

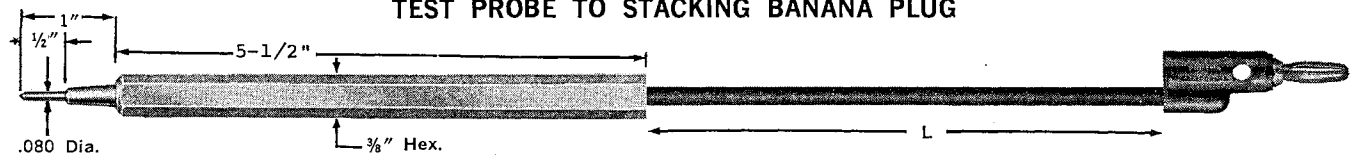

Insulated handle molded to probe tip and wire lead.
PROBE PIN TIP: .080 dia. x 1/2" long. Brass nickel plated
WIRE: 18 AWG, Strand. 65 x 36 T.C. Extra flexible polyvinyl insulation, .144" O.D.
BANANA PLUG: Spring, one piece beryllium copper, heat treated, nickel plated.
Tough thermo-plastic molded to plug body and wire.
COLORS: Black, Red.

MODEL 1382-48B | 48" Long | Black | NET 1.95
MODEL 1382-48R | 48" Long | Red | NET 1.95

QUANTITY DISC. CODE **A**

SHIELDED TEST PROBE TO DOUBLE BANANA PLUG

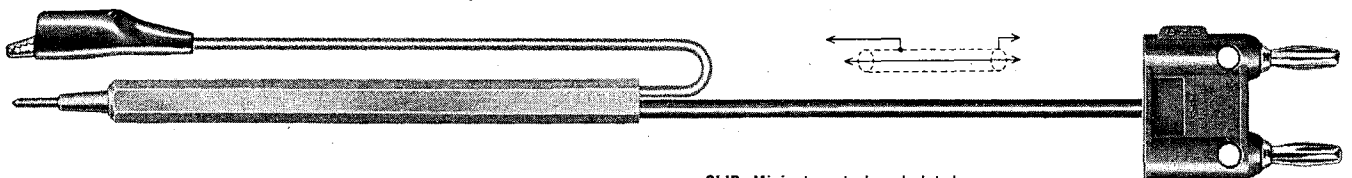

A shielded test probe with the shield extending to within 1/2" of the probe tip end. One piece molded construction. Insulated handle molded to probe tip and cable. Insulated minigator clip connected to shield lead.

PROBE PIN TIP: .080 dia. x 1/2" long. Brass nickel plated.

DOUBLE BANANA PLUG: On 3/4" centers. Spring, one piece beryllium copper, heat treated, nickel plated. Tough thermo-plastic molded to double plug body. Color, Gray.

CLIP: Minigator, steel, cad plated.
INSULATOR, VINYL: Color, Black.
CABLE: Shielded microphone cable: Polyethylene insulation. Vinyl jacket. Nom. capacity 25 pf./ft. .205" O.D. Color, Gray.
HANDLE: Color, red, molded of tough thermo-plastic.
MODEL 1569-B-48 48" Long

QUANTITY DISC. CODE **B**

NET 6.85

OTHER LENGTHS AVAILABLE TO ORDER

POMONA ELECTRONICS

PATCH CORDS DOUBLE BANANA PLUGS

POMONA MOLDED DOUBLE BANANA PLUG PATCH CORDS AND TEST LEADS

... indispensable for bridge transformer connections, three terminal capacitor measurements and general hook-up for two wire systems. They are horizontally and vertically stackable in parallel.

Tough thermo-plastic material molded to plug body and cable insures maximum strength, moisture resistance and excellent insulative properties.

Used by leading industries in applications where extreme reliability is of prime importance.

FEATURES . . .

- One piece beryllium copper heat treated spring for long life.
- Rounded spring design results in maximum contact area.
- GND., clearly molded on plug body and shell.
- Solder-bonded noise-free connections.

SPECIFICATIONS . . .

- Fits standard 0.166 dia. banana jacks, on 3/4" centers.
- Contact resistance less than 0.001 ohms per plug.
- Spring beryllium copper alloy 170 per QQ-C-533.
- Plug body brass per QQ-B-625, Comp. 22.
- Nickel plated per QQ-N-290, Class 2.

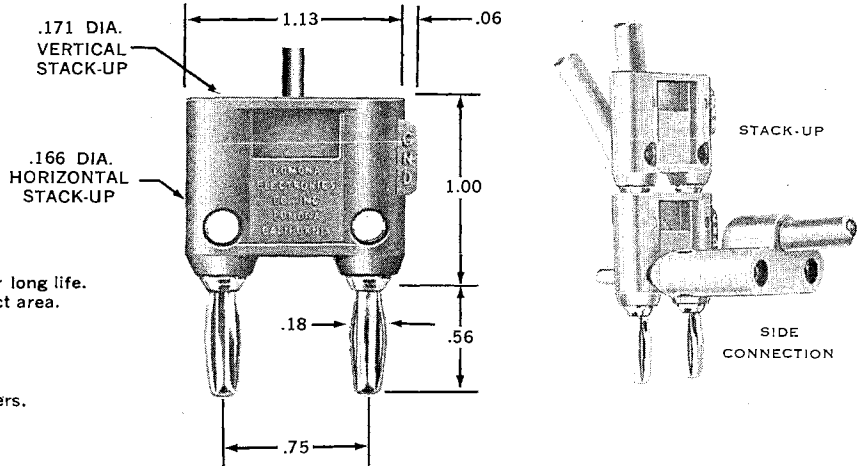

CABLE TYPE DESCRIPTION

TWO COND. TWISTED PAIR
18 AWG, Strand. 65 x 36 T.C.
Vinyl insulation. Vinyl jacket, .250"
O.D. Nom. Cap. 30 pf/ft.
COLOR: Gray.

SHIELDED MICROPHONE CABLE
Polyethylene insulation. Vinyl jacket,
.205" O.D. Nom. Cap. 25 pf/ft.
COLOR: Gray.

SHIELDED COAXIAL CABLE
RG58C/U Polyethylene insulation.
Vinyl jacket, .195" O.D.
Nom. Cap. 28.5 pf/ft. **COLOR: Black.**

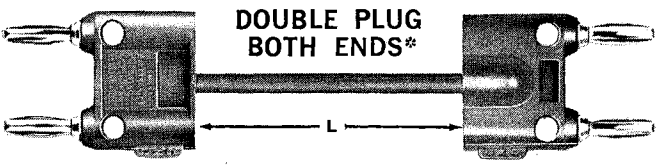

TWO COND. TWISTED PAIR	SHIELDED MIC. CABLE	SHIELDED COAX. CABLE	LENGTH	NET	
2BA-18	2BB-18	2BC-18	18"	4.85	★ QUANTITY DISC. CODE B
2BA-24	2BB-24	2BC-24	24"	4.85	
2BA-30	2BB-30	2BC-30	30"	4.85	
2BA-36	2BB-36	2BC-36	36"	4.85	
2BA-48	2BB-48	2BC-48	48"	5.00	
2BA-60	2BB-60	2BC-60	60"	5.15	

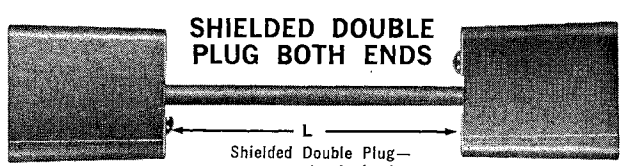

SHIELDED COAX. CABLE	LENGTH	NET	
1550-C-18	18"	5.85	★ QUANTITY DISC. CODE B
1550-C-24	24"	5.85	
1550-C-30	30"	5.85	
1550-C-36	36"	5.85	
1550-C-48	48"	6.00	
1550-C-60	60"	6.15	

TWO COND. SHIELDED BALANCED LINE

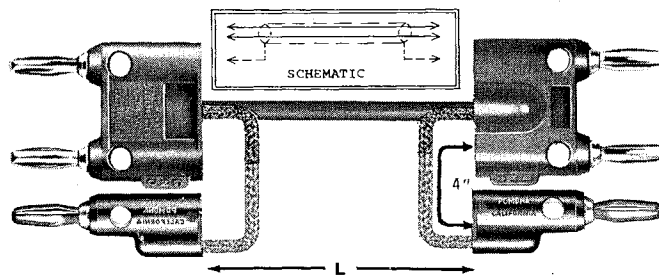

CABLE DESCRIPTION	MODEL	LENGTH	NET
2-Cond. shielded mic. cable. Polyethylene insulation. Vinyl jacket, .231" O.D. Nom. Cap. between cond. 18 pf./ft. Nom. Cap. between one cond. and remaining cond. connected to shield, 32 pf./ft. COLOR: Cable and double plug, Gray. Single ground plug, Green.	1167-18	18"	7.85
	1167-24	24"	7.85
	1167-30	30"	7.85
	1167-36	36"	7.85
	1167-48	48"	8.10
	1167-60	60"	8.35

★ QUANTITY DISC. CODE **B**

DOUBLE PLUG TO SINGLE BANANA PLUGS

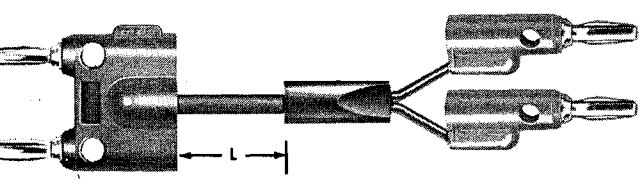

CABLE DESCRIPTION	MODEL	LENGTH	NET
TWO COND. TWISTED PAIR 18 AWG, Strand. 65 x 36 T.C. Vinyl insulation. Vinyl jacket, .250" O.D. Nom. Cap. 30 pf/ft. COLOR: Double Plug: Gray Single Plugs: Red, Black	1368-A-18	18"	5.85
	1368-A-24	24"	5.85
	1368-A-30	30"	5.85
	1368-A-36	36"	5.85
	1368-A-48	48"	6.00
	1368-A-60	60"	6.15

★ QUANTITY DISC. CODE **B**

*NOTE: Molded double plug matches color of cable.
Two cond. Twisted pair, GRAY. Shielded mic. cable, GRAY.
Coaxial RG58C/U Cable, BLACK.

★ Various lengths may be aggregated for best quantity price.

1. Other cable colors available to order on the Two Cond. Twisted Pair and Shielded Mic. cable models with plug to match.
COLORS: Black, Brown, Red, Orange, Yellow, Green, Blue, Violet, Gray, White.
2. Other lengths and cable types available to order.

POMONA ELECTRONICS

BNC MALE TO SINGLE BANANA PLUGS

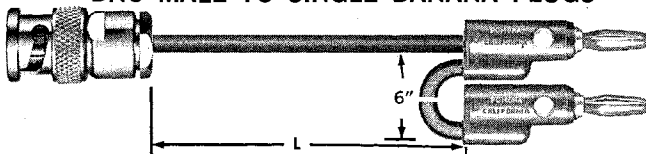

CONN: } UG88E/U
1st END } Male BNC

CABLE: Shielded Coax.,
RG58C/U

CONN: } Single Banana Plugs
2nd END } Color: 1 Black, 1 Red.

CABLE DESCRIPTION:

MODEL	LENGTH	NET
2241-C-18	18"	5.85
2241-C-24	24"	5.85
2241-C-36	36"	5.85
2241-C-48	48"	6.00

★ QUANTITY DISC. CODE **B**

BNC MALE TO GR-874

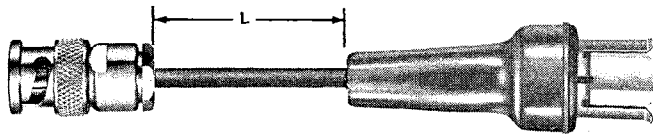

CONN: } UG88E/U
1st END } Male BNC

CABLE: Shielded Coax.,
RG58C/U

CONN: } GR-874
2nd END }

CABLE DESCRIPTION:

MODEL	LENGTH	NET
1703-C-24	24"	9.85
1703-C-36	36"	9.85
1703-C-48	48"	10.00

★ QUANTITY DISC. CODE **B**

BNC MALE TO SERIES "N" MALE

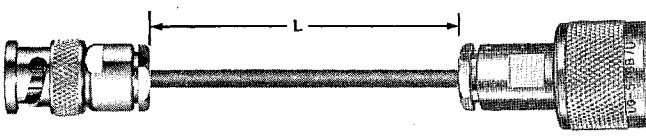

CONN: } UG88E/U
1st END } Male BNC

CABLE: Shielded coax.,
RG58C/U

CONN: } UG536B/U
2nd END } "N" Male

CABLE DESCRIPTION:

MODEL	LENGTH	NET
1366-C-24	24"	6.85
1366-C-36	36"	6.85
1366-C-48	48"	7.00

★ QUANTITY DISC. CODE **B**

BNC MALE TO BNC FEMALE

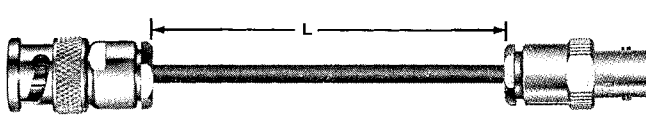

CONN: } UG88E/U
1st END } Male BNC

CABLE: Shielded coax.,
RG58C/U

CONN: } UG89C/U
2nd END } Female BNC

CABLE DESCRIPTION:

MODEL	LENGTH	NET
2223-C-12	12"	6.85
2223-C-24	24"	6.85
2223-C-36	36"	6.85
2223-C-48	48"	7.00
2223-C-60	60"	7.15

★ QUANTITY DISC. CODE **B**

BNC FEMALE BOTH ENDS

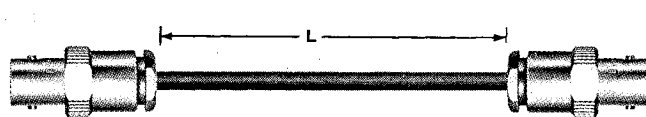

CONN: } UG89C/U
1st END } Female BNC

CABLE: Shielded Coax.,
RG58C/U

CONN: } UG89C/U
2nd END } Female BNC

CABLE DESCRIPTION:

MODEL	LENGTH	NET
1808-C-12	12"	6.85
1808-C-24	24"	6.85
1808-C-36	36"	6.85
1808-C-48	48"	7.00
1808-C-60	60"	7.15

★ QUANTITY DISC. CODE **B**

PATCH CORDS CONNECTING LEADS

TNC MALE BOTH ENDS

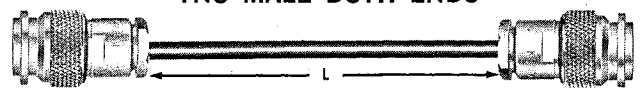

CONN: } Male TNC
1st END }

CABLE: Shielded coax.,
RG58C/U

CONN: } Male TNC
2nd END }

CABLE DESCRIPTION

MODEL	LENGTH	NET
1944-C-12	12"	7.85
1944-C-24	24"	7.85
1944-C-36	36"	7.85
1944-C-48	48"	8.00
1944-C-60	60"	8.15

★ QUANTITY DISC. CODE **B**

BNC MALE TO TNC MALE

NEW

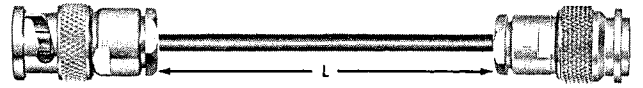

CONN: } UG88E/U
1st END } Male BNC

CABLE: Shielded coax.,
RG58C/U

CONN: } Male TNC
2nd END }

CABLE DESCRIPTION:

MODEL	LENGTH	NET
1948-C-12	12"	6.85
1948-C-24	24"	6.85
1948-C-36	36"	6.85
1948-C-48	48"	7.00
1948-C-60	60"	7.15

★ QUANTITY DISC. CODE **B**

DOUBLE PLUG TO GR-874

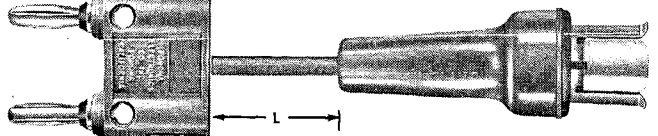

CONN: } Double Banana Plug,
1st END } on 3/4" Centers.

CABLE: Shielded Coax.,
RG58C/U

CONN: } GR-874
2nd END }

CABLE DESCRIPTION

MODEL	LENGTH	NET
2243-C-24	24"	9.50
2243-C-36	36"	9.50
2243-C-48	48"	9.65

COLOR: Cable and double plug, Black. ★ QUANTITY DISC. CODE **B**

DOUBLE PLUG TO SINGLE PIN TIPS

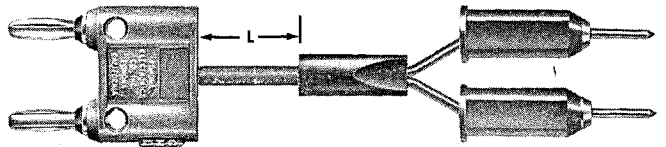

CONN: } Double Banana
1st END } Plug, on 3/4" Centers.

CABLE: Two Cond.
Twisted Pair

CONN: } Single Pin Tip
2nd END } Plugs, .080 Dia.
Color: 1 Black, 1 Red

CABLE DESCRIPTION

MODEL	LENGTH	NET
2184-A-24	24"	5.85
2184-A-36	36"	5.85
2184-A-48	48"	6.00

COLOR: Cable and Double plug, Gray. ★ QUANTITY DISC. CODE **B**

DOUBLE PLUG TO STACK-UP PIN TIPS

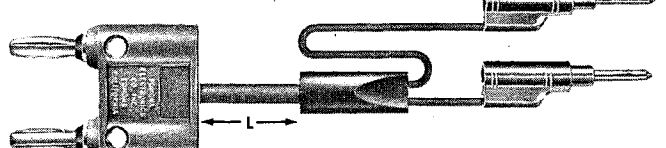

CONN: } Double Banana
1st END } Plug, on 3/4" Centers.

CABLE: Shielded
Coax., RG58C/U

CONN: } Single Stack-Up
2nd END } Pin Tip Plugs, .080 Dia.
Color: 1 Black, 1 Red.

CABLE DESCRIPTION

MODEL	LENGTH	NET
2BC-PP-18	18"	7.50
2BC-PP-24	24"	7.50
2BC-PP-36	36"	7.50
2BC-PP-48	48"	7.65

COLOR: Cable and Double Plug, Black. ★ QUANTITY DISC. CODE **B**

★ Various lengths may be aggregated for best quantity price.

OTHER LENGTHS AVAILABLE TO ORDER

POMONA ELECTRONICS

SERIES "N" MALE BOTH ENDS

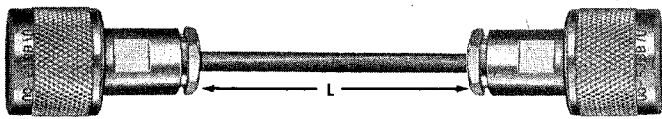

CONN: } UG536B/U
1st END } "N" Male

CABLE: Shielded Coax.,
RG58C/U.

CONN: } UG536B/U
2nd END } "N" Male

CABLE DESCRIPTION:	MODEL	LENGTH	NET
Shielded coax., RG58C/U, Polyethylene insulation. Vinyl jacket, .195" O.D., Nom. Cap. 28.5 pf/ft.	2256-C-24	24"	7.85
	2256-C-36	36"	7.85
	2256-C-48	48"	8.00
	2256-C-60	60"	8.15

★ QUANTITY DISC. CODE **B**

SERIES "N" MALE BOTH ENDS



CONN: } UG21E/U
1st END } "N" Male

CABLE: Coax., RG213/U
or RG214/U

CONN: } UG21E/U
2nd END } "N" Male

CABLE TYPES		LENGTH	NET	
RG213/U	NET		RG214/U	NET
1658-S-18	10.85	18"	1658-T-18	12.85
1658-S-24	10.85	24"	1658-T-24	12.85
1658-S-36	10.85	36"	1658-T-36	12.85
1658-S-48	11.35	48"	1658-T-48	13.60
1658-S-60	11.85	60"	1658-T-60	14.35

★ QUANTITY DISC. CODE **B**

SERIES "N" MALE TO GR-874

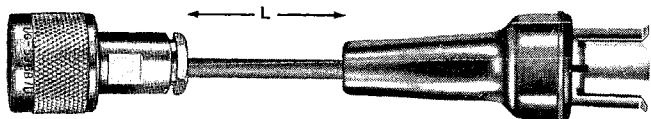

CONN: } UG536B/U
1st END } "N" Male

CABLE: Shielded Coax.,
RG58C/U

CONN: } GR-874
2nd END }

CABLE DESCRIPTION:	MODEL	LENGTH	NET
Shielded coax., RG58C/U, Polyethylene Insulation. Vinyl jacket, .195" O.D., Nom. Cap. 28.5 pf/ft.	2438-C-24	24"	10.85
	2438-C-36	36"	10.85
	2438-C-48	48"	11.00
	2438-C-60	60"	11.15

★ QUANTITY DISC. CODE **B**

GR-874 TO GR-874

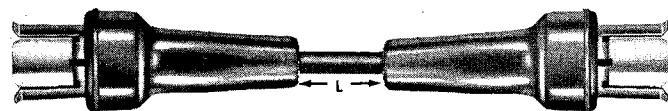

CONN: } GR-874
1st END }

CABLE: Shielded coax.,
RG58C/U

CONN: } GR-874
2nd END }

CABLE DESCRIPTION:	MODEL	LENGTH	NET
Shielded coax., RG58C/U, Polyethylene Insulation. Vinyl jacket, .195" O.D., Nom. Cap. 28.5 pf/ft.	2316-C-24	24"	16.85
	2316-C-36	36"	16.85
	2316-C-48	48"	17.00
	2316-C-60	60"	17.15

★ QUANTITY DISC. CODE **B**

*NOTE: Molded double plug matches color of cable. Two cond. Twisted pair, GRAY. Shielded mic. cable, GRAY. Coaxial RG58C/U cable, BLACK.

★ Various lengths may be aggregated for best quantity price.

PATCH CORDS CONNECTING LEADS

PJ-051* PHONE PLUG BOTH ENDS

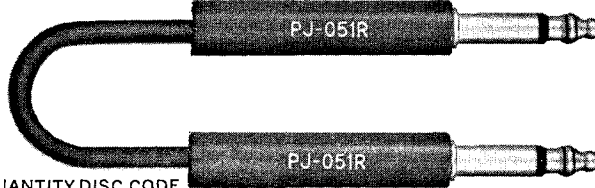

★ QUANTITY DISC. CODE **B**

CONN.: } PJ-051*
1ST END }

CABLE: TWO COND.
TWISTED PAIR

CONN.: } PJ-051*
2ND END }

*PJ-051 interchangeable with WE310.
Patch Cord is wired tip to tip, and ring to ring. No sleeve connection.

CABLE DESCRIPTION	MODEL	LENGTH	NET
Two Cond. Twisted pair, 18 AWG, Strand.	2524-A-18	18"	7.85
65 x 36 T.C. Vinyl Insulation Vinyl jacket	2524-A-24	24"	7.85
250" O.D., Nom. Cap. 30 pf/ft.	2524-A-36	36"	7.85
	2524-A-48	48"	8.00
COLOR: Cable, Gray. Phone Plug Handle, Red.	2524-A-60	60"	8.15

DOUBLE PLUG BALANCED LINE TO PJ-068

CONN: } Double and Single
1st END } Banana Plug

CABLE: 2 Cond. Shielded
Microphone

CONN: } PJ-068
2nd END } Plug

MODEL 2174-36 LENGTH 36" NET 9.85

★ QUANTITY DISC. CODE **B**

CABLE DESCRIPTION
2 Cond. shielded microphone cable. Polyethylene insulation. Vinyl jacket, .231" O.D. Nom. Cap. between cond. 18 pf/ft. Nom. Cap. between one cond. and remaining cond. connected to shield, 32 pf/ft.
COLORS: Cable and double plug, GRAY. Single ground plug, GREEN.

SINGLE BANANA PLUGS BOTH ENDS

CONN: } Single Banana
1st END } Plugs
Colors: Inner
Conductor plug, Red.
Ground Plug, Black.

CABLE: Shielded
Coax., RG122/U

CONN: } Single Banana Plugs.
2nd END } Colors: Inner
Conductor Plug,
Red. Ground
Plug, Black.

CABLE DESCRIPTION:	MODEL	LENGTH	NET
Shielded coax., RG122/U polyethylene insulation. Vinyl jacket, .160" O.D., Nom. Cap. 29.5 pf/ft.	2239-R-24	24"	4.85
	2239-R-36	36"	4.85
	2239-R-48	48"	5.00
	2239-R-60	60"	5.15

★ QUANTITY DISC. CODE **B**

ALLIGATOR CLIPS BOTH ENDS

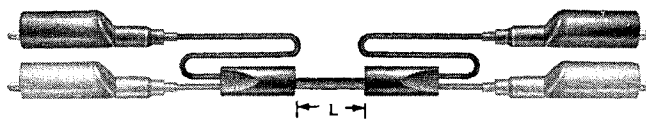

CONN: } Alligator Clips,
1st END } Steel, cad plated
Insulators, Vinyl:
Black/Red.

CABLE: Shielded
Coax., RG58C/U

CONN: } Alligator Clips,
2nd END } Steel, cad plated
Insulators, Vinyl:
Black/Red.

CABLE DESCRIPTION:	MODEL	LENGTH	NET
Shielded coax., RG58C/U, Polyethylene Insulation Vinyl jacket, .195" O.D. Nom. Cap. 28.5 pf/ft.	1152-C-12	12"	5.85
	1152-C-24	24"	5.85
	1152-C-36	36"	5.85
	1152-C-48	48"	6.00
	1152-C-60	60"	6.15

★ QUANTITY DISC. CODE **B**

COLORS: Black, Brown, Red, Orange, Yellow, Green, Blue, Violet, Gray, White.

2. Other lengths and cable types available to order.

POMONA ELECTRONICS

SOCKET SAVERS CRT CONVERSION ADAPTERS

The Socket Saver® is designed to be installed on tube checkers and other electronic equipment to prevent wear and tear of sockets on original equipment. They are easy to install and remove. This eliminates the necessity

of replacing and rewiring sockets on original equipment. Built of quality materials. BERYLLIUM COPPER LONG LIFE CONTACTS to give maximum service.

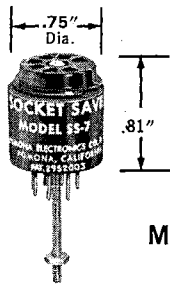

MODEL SS-7
SEVEN PIN
MINIATURE
NET 1.75

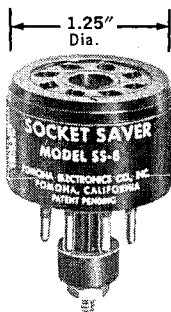

MODEL SS-8
EIGHT PIN
OCTAL
NET 1.75

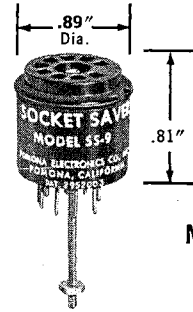

MODEL SS-9
NINE PIN
MINIATURE
NET 1.75

U.S. PAT.
NO. 2952003

MODEL SS-789 KIT SET OF THREE 5.25
(SS-7, SS-8, SS-9)

QUANTITY DISC. CODE **C**

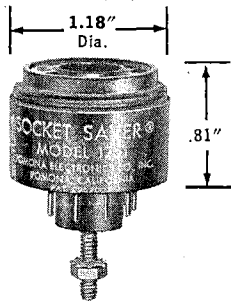

MODEL 1751
9 PIN
NOVAR
NET 1.95

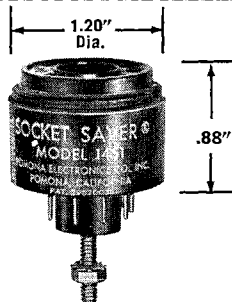

MODEL 1451
9 PIN
MAGNOVAL
NET 2.25

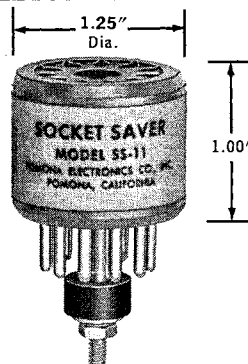

MODEL SS-11
11 PIN
OCTAL STYLE
NET 1.95

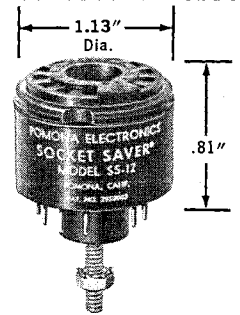

MODEL SS-12
12 PIN
COMPACTRON
NET 2.25

QUANTITY DISC. CODE **C**

MINIATURIZED SOCKET SAVERS®

For use in applications where vertical height is restricted. Contacts made of beryllium copper, heat treated. Models 1847 and 1849 closed entry receptacles, contact and pin one piece formed beryllium copper, molded of black phenolic electrical grade.

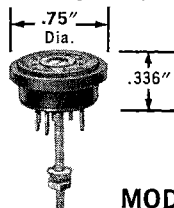

MODEL 1847
7 PIN MINIATURE
NET 1.95

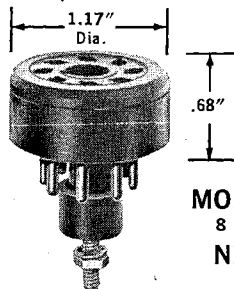

MODEL 1848
8 PIN OCTAL
NET 1.95

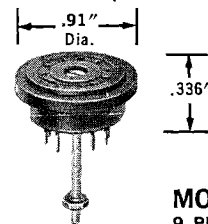

MODEL 1849
9 PIN MINIATURE
NET 1.95

QUANTITY DISC. CODE **C**

COLOR-TUBE SOCKET CONVERSION ADAPTER

NEW

Converts Color 70° 21AXP22A CRT base to 90° 25AP22A CRT base.

Socket End: Neo-Diheptal Socket, 14AL/AU Basing.
Plug End: Miniature Diheptal Plug, 14BE Basing.

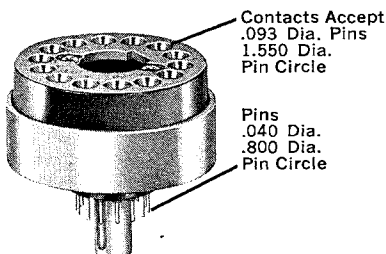

MODEL 3020 QUANTITY DISC. CODE **D** NET 5.95

COLOR - TUBE SOCKET CONVERSION ADAPTER

Converts color 90° 25AP22A CRT base to 70° color 21-AXP22A CRT base. Provision for accepting bases equipped with spark gaps.

Socket End: Miniature Diheptal Socket, 14BE Basing.
Plug End: Neo-Diheptal Base, 14AL/AU Basing.

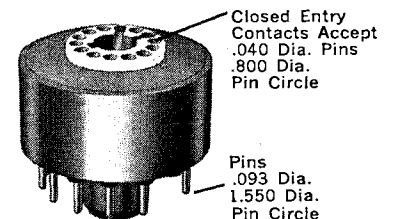

MODEL 2276 QUANTITY DISC. CODE **D** NET 5.95

SEAELECTRO PRESS-FIT® TEFLON* TERMINALS

†Reg. Trademark, E. I. Du Pont de Nemours & Co.

PRESS-FIT® TEFLON* CLOVERLEAF® RECEPTACLES

... providing the economies of dip-soldering with the inherent reliability of wired chassis construction

The "Press-Fit" Cloverleaf Receptacle provides economical yet uniformly perfect solder joints by means of dip soldering on a metal chassis. The unique Cloverleaf configuration permits insertion of four or more wire leads, plus an optional center post for mounting additional components after the dip-soldering operation. This design provides an encompassing hold on the leads, while providing for excellent capillary flow of solder. The Cloverleaf receptacle is a Seaelectro "Press-Fit" design. Virgin Teflon

insulation, precisely machined to "Press-Fit" into the chassis provides fast, positive and economical installation.

The reliability of dip solder joints made with the Cloverleaf receptacle, combined with the inherent dependability and repairability of metal chassis construction makes it ideal for use in high density, complex electronic instrumentation packaging, while the low cost of the terminal and its simple installation provides a new and outstanding assembly technique for premium quality radio and television manufacturing.

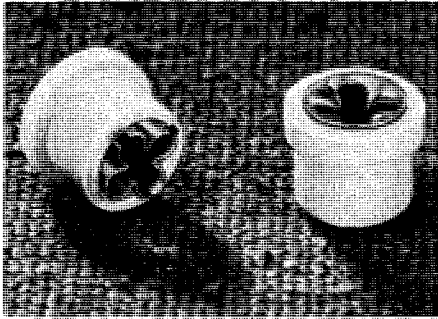

***FT-E-12**

INSTALLATION DATA:
 Break Installation Edge $\pm .002$ Dia. Hole with $\pm .010$
 60° C'Sink to a .160 $\pm .000$ Dia. in .040 or Thicker Chassis. Use 82° C'Sink Under .040 Chassis. Teflon Should Protrude a Min. of .040 Beneath Chassis.
 Insertion Tool: B-9-4

***FT-E-15**

INSTALLATION DATA:
 Break Installation Edge $\pm .002$ Dia. Hole with $\pm .010$
 60° C'Sink to a .195 $\pm .000$ Dia. in .040 or Thicker Chassis. Use 82° C'Sink Under .040 Chassis. Teflon Should Protrude a Min. of .040 Beneath Chassis.
 Insertion Tool: B-9-5

***FT-E-16**

INSTALLATION DATA:
 Break Installation Edge $\pm .002$ Dia. Hole with $\pm .010$
 60° C'Sink to a .160 $\pm .000$ Dia. in .040 or Thicker Chassis. Use 82° C'Sink Under .040 Chassis. Teflon Should Protrude a Min. of .040 Beneath Chassis.
 Insertion Tool: T-8800020 and B-8X-1

***FT-E-17**

INSTALLATION DATA:
 Break Installation Edge $\pm .002$ Dia. Hole with $\pm .010$
 60° C'Sink to a .195 $\pm .000$ Dia. in .040 or Thicker Chassis. Use 82° C'Sink Under .040 Chassis. Teflon Should Protrude a Min. of .040 Beneath Chassis.
 Insertion Tool: B-18-X3

***FT-E-19**

INSTALLATION DATA:
 Break Installation Edge $\pm .002$ Dia. Hole with $\pm .010$
 60° C'Sink to a .230 $\pm .000$ Dia. in .040 or Thicker Chassis. Use 82° C'Sink Under .040 Chassis. Teflon Should Protrude a Min. of .040 Beneath Chassis.
 Insertion Tool: B-22-X1

PRESS-FIT® TEFLON** SPACER/BUSHINGS

The Newest and Best Way to Mount P.C. Boards to Metal Panels and Chassis

Mount and insulate P.C. boards on metal chassis or panels without nuts, bolts, or lock washers. The new Press-Fit Teflon* Spacer/Bushings save assembly time while providing an economical and mechanically secure mounting device.

Machined from pure Teflon*, these new units are designed for various thickness P.C. boards and chassis or panels. Insertion in the chassis is a simple, one-step operation. The grommet end of each Spacer/Bushing is simply snapped in pre-drilled or punched metal chassis holes with entrance edge broken. Once inserted, they're in for good. P.C. boards require only mating holes for the opposite end of the Spacer/Bushing and may be snapped on and off of the mother board at will.

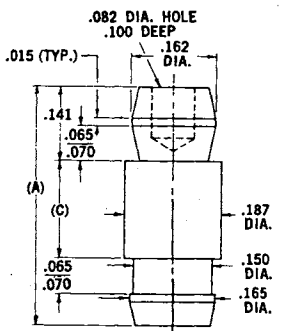
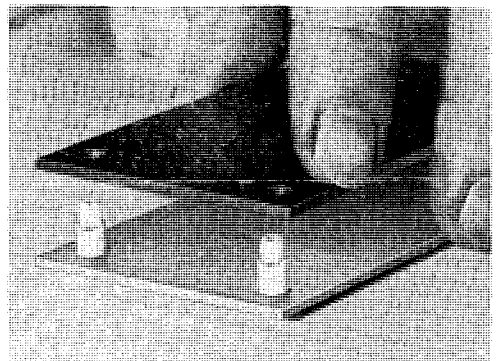

NOTE: Mtg. Hole .152 $\pm .002$ Dia. in .062 $\pm .006$ thick chassis.

*Part No.	A	C
227298	1.021	.750
227294	.958	.687
227290	.896	.625
227286	.833	.562
227282	.771	.500
227278	.708	.437
227274	.646	.375
227270	.583	.312
227266	.521	.250
227262	.458	.187
227258	.396	.125

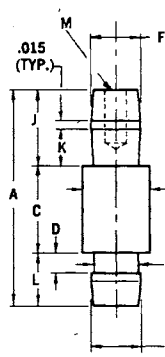

*Part No.	A	C	D	E	F	G	H	J	K	L	M
228004	.782	.500	.045	.151	.151	.136	.187	.175	.098	.107	.082 Dia. x .130 deep
228006	.674	.375	.093	.165	.162	.150	.187	.141	.065	.050	.082 Dia. x .100 deep
228005	.657	.375	.045	.151	.151	.136	.187	.175	.098	.107	.082 Dia. x .100 deep
228007	.544	.250	.055	.165	.162	.150	.187	.177	.098	.047	.082 Dia. x .100 deep
228002	.490	.250	.030	.098	.100	.084	.125	.140	.068	.100	.041 Dia. x .100 deep
228000	.400	.160	.036	.092	.092	.084	.125	.140	.068	.100	.041 Dia. x .100 deep
228009	.400	.093	.065	.165	.162	.150	.187	.177	.098	.040	.082 Dia. x .100 deep
228001	.392	.160	.028	.092	.092	.084	.125	.140	.068	.100	.082 Dia. x .100 deep

* Available off-the-shelf from Authorized Local Seaelectro Distributors (white only).

** Registered Trademark, E. I. DuPont deNemours & Co.



SEALECTRO

PRESS-FIT®

TEFLON* TERMINALS

†Reg. Trademark, E. I. Du Pont de Nemours & Co.

STAND-OFFS MICROMINIATURE and SUBMINIATURE

FIG.	PART No.	TOOL NO.	CAPACITANCE mmf	V _{RMS} 60 CPS		A	B	B ₁	B ₂	C	D	E	E ₁	F	G	K	K ₁
				NOMINAL RATING	FLASHOVER SEA LEVEL												
51	RST-SM-3-C1	B-3-B	0.40	1000	3000	.250	.130			.031	.089	.040		.125	.093		
51	*RST-SM-16	B-3-2X	0.40	1000	3000	.350	.210			.040	.100	.040		.125	.093		
51	RST-SM-3	B-3-B	0.30	1000	3000	.250	.130			.031	.089	.040		.125	.104		
51	RST-SM-11C1	B8-G	0.45	1500	4000	.350	.210			.020	.120	.040		.172	.112		
51	RST-SM-39-C1	B-8-M	0.35	1000	3000	.350	.210			.015	.125	.040		.172	.112		
51	RST-SM-13	B6-X1	0.50	500	2000	.310	.210			.040	.060	.040		.150	.125		
51	*RST-SM-1	B8-X1	0.40	1200	3500	.350	.210			.040	.100	.040		.172	.148		
51	*RST-SM-1B2	B8-G	0.40	1200	3500	.330	.210			.020	.100	.040		.172	.148		
51	RST-SM-1-CB	B8-X1	0.30	1000	3000	.330	.210			.046	.074	.040		.170	.148		
51	*RST-SM-1C6	B8-X1	0.40	2000	5000	.500	.210			.040	.250	.040		.172	.148		
51	RST-SM-1L2	B8-X1	0.50	1200	3500	.265	.125			.040	.100	.040		.172	.148		
51	RST-SM-1L8	B8-X1	0.50	1200	3500	.750	.610			.040	.100	.040		.172	.148		
51	RST-SM-2	B8-X2	0.40	1000	3000	.310	.210			.050	.050	.040		.172	.148		
51	RST-SM-6	B8-X	0.35	1200	3500	.345	.210			.060	.075	.040		.172	.148		
51	RST-SM-7C2	B8-X1	0.30	1200	3500	.382	.210			.040	.132	.045		.172	.148		
51	*RST-SM-11	B8-G	0.30	1200	3500	.350	.210			.020	.120	.040		.172	.148		
51	RST-SM-28	B8-X1	0.35	1500	4000	.390	.218			.040	.132	.040		.172	.148		
51	RST-SM-39	B-8-M	0.30	1200	3500	.350	.210			.015	.125	.040		.172	.148		
51	RST-SM-3CD3	B-15-X	0.45	1000	3000	.500	.360			.040	.100	.040		.195	.172		
52	RST-SM-3SL	B3-2X	0.50	500	2000	.350	.210			.040	.100	.080		.125	.104	.036	.180
52	RST-SM-41SL	B6-C	0.30	750	2500	.150	.062			.025	.063	.050		.150	.125	.020	.047
53	RST-SM-47-TUR	B8-X-1	0.40	1000	3000	.328	.210	.020	.120	.040	.078	.040	.080	.172	.148		
53	RST-SM-47-TUR-C2	B8-X-1	0.40	1200	3500	.350	.210	.020	.120	.040	.100	.040	.080	.172	.148		
54	*RST-MM-10-TUR	B1-2	0.40	500	2000	.310	.170	.020	.060	.040	.100	.030	.060	.125	.093		
54	*RST-SM-25-TUR-C4	B8-X-1	0.40	1500	4000	.295	.156	.020	.046	.040	.100	.046	.093	.172	.148		
54	*RST-SM-38-TUR	B10	0.40	1500	4000	.405	.210	.020	.100	.040	.155	.040	.080	.188	.171		
54	*RST-SM-1-TUR	B8-X-1	0.40	1200	3500	.350	.210	.020	.100	.040	.100	.040	.080	.172	.148		
54	RST-SM-4-TUR	B16	0.40	1500	4000	.350	.210	.020	.100	.040	.100	.040	.080	.200	.179		
54	RST-SM-20-TUR	B18	0.40	1500	4000	.350	.210	.020	.100	.040	.100	.040	.080	.218	.185		
54	*RST-SM-21-TUR	B18	0.30	1700	4500	.375	.210	.020	.100	.040	.125	.040	.080	.218	.185		
54	RST-SM-23-TUR	B22-X-2	0.30	1500	4000	.350	.210	.020	.100	.040	.100	.040	.080	.250	.204		
55	*RST-SM-31-TUR	B8-X-1	0.50	1700	4500	.455	.227	.020	.187	.040	.187	.040	.080	.172	.148		
55	RST-SM-31-TUR-CD1	B8-3	0.35	1500	4000	.382	.227	.020	.187	.025	.130	.040	.080	.172	.148		
55	RST-SM-31-TUR-L2	B8-X-1	0.40	1200	3500	.296	.156	.020	.116	.040	.100	.046	.093	.172	.148		
55	RST-SM-352-TUR	B8-X-1	0.40	1200	3500	.250	.110	.020	.080	.040	.100	.040	.080	.172	.148		
55	RST-SM-350-TUR	B10	0.20	1500	4000	.320	.125	.020	.080	.040	.155	.040	.080	.188	.171		

Terminal Lug: Brass, Solder Finish (40 to 70% Tin Content) Electro-Plate .0003" Minimum Thickness.
Capacitance and voltage measured with terminals installed in .050" thick aluminum chassis.

‡ Gold flash over silver.

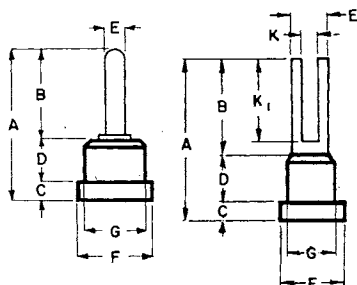

Fig. 51

Fig. 52

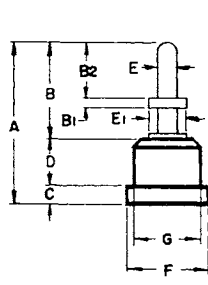

Fig. 53

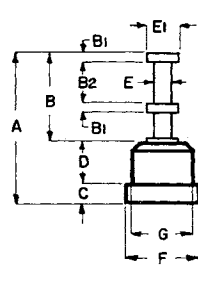

Fig. 54

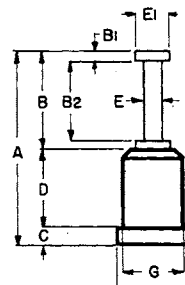

Fig. 55

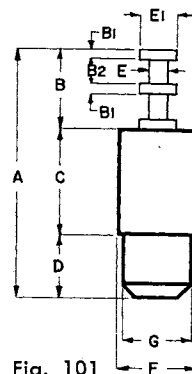

Fig. 101

* Available off-the-shelf from Authorized Local Sealectro Distributors (white only).

SEAELECTRO PRESS-FIT® TEFLON* TERMINALS

*Reg. Trademark, E. I. Du Pont de Nemours & Co.

STAND-OFFS MINIATURE and SUBMINIATURE

FIG.	PART No.	TOOL NO.	CAPACITANCE mmf	V,RMS		A	B	B ₁	B ₂	C	D	E DIA.	E ₁ DIA.	F DIA.	+.002 -.000 G DIA.	J DIA.	K	K ₁
				NOM- INAL RAT. ING	FLASH OVER SEA LEVEL													
102	ST-1150	B12	0.60	2500	6000	.555	.218	.020	.046	.187	.150	.046	.093	.187	.171			
103	ST-1500TUR	E12-3	0.20	2700	6500	.520	.120	.020		.250	.150	.048	.090	.187	.165			
103	ST-1600-TUR	E13-3B	0.20	2000	6000	.519	.120	.020		.187	.212	.048	.090	.187	.171			
104	ST-251†	B13-3	0.45	2000	5000	.485	.210			.125	.150	.040		.187	.165			
104	ST-1020L5†	B13-3	0.40	2200	5500	.547	.210			.187	.150	.040		.187	.165			
105	ST-1500SL-C3	B11	0.50	2700	6500	.603	.203			.250	.150	.148		.187	.165	.078		.156
105	*ST-250SL	B11	0.70	2000	5000	.478	.203			.125	.150	.148		.187	.171	.078		.156
105	ST-250SL-1L	B11	0.70	2000	5000	.478	.203			.125	.150	.148		.187	.171	.046		.161
105	ST-1000SL	B11	0.70	2300	5600	.540	.203			.187	.150	.148		.187	.171	.078		.156
105	ST-1000SL-1L	B11	0.70	2300	5600	.540	.203			.187	.150	.148		.187	.171	.046		.161
105	ST-1150SL-1L	B11	0.50	2300	5600	.555	.203			.187	.165	.148		.187	.171	.046		.156
105	ST-1180SL	B11	0.70	2300	5600	.602	.203			.187	.212	.148		.187	.171	.078		.156
105	ST-1180SL-C2	B11	0.80	2300	5600	.620	.203			.187	.230	.148		.187	.171	.078		.156
105	*ST-1500SL	B11	0.45	2700	6500	.603	.203			.250	.150	.148		.187	.171	.078		.156
105	ST-1500SL-1L	B11	0.45	2700	6500	.603	.203			.250	.150	.148		.187	.171	.046		.156
105	*ST-2000SL	B11	0.30	4200	9500	.753	.203			.400	.150	.148		.187	.171	.078		.156
105	ST-2000SL-1L	B11	0.30	4200	9500	.753	.203			.400	.150	.148		.187	.171	.046		.161
105	ST-2000SL-C2	B11	0.30	4200	9500	.703	.203			.400	.100	.148		.187	.171	.078		.156
105	ST-2000SL-C1	B25	0.30	5000	11000	.890	.203			.500	.187	.148		.250	.171	.078		.156
105	ST-2500SL	B25	0.30	5000	11000	.890	.203			.500	.187	.148		.250	.171	.078		.156
105	ST-4000SL	B25	0.20	6000	13000	1.190	.203			.800	.187	.148		.250	.171	.078		.156
106	ST-35ML	B11-C	0.85	2000	5000	.633	.296			.187	.150	.150		.187	.171		.090	.234
151	*RST-1	B18-1B	0.40	3000	7000	.487	.154	.020	.046	.046	.287	.046	.093	.218	+.185			
151	*RST-1L2	B18-1B	0.20	3000	7000	.583	.250	.020	.093	.046	.287	.046	.093	.218	+.185			
152	RST-2	B18	0.15	3200	7500	.543	.210			.046	.287	.040		.218	.185			
152	RST-2C2	B18-1B	0.50	4000	9000	.756	.210			.046	.500	.040		.218	.185			
152	RST-2L2	B18	0.70	2500	6000	1.133	.800			.046	.333	.040		.218	.185			
153	RST-1150	B13-X	0.70	1200	3500	.555	.218	.020	.046	.187	.150	.046	.093	.187	.171			
154	RST-15ML	B13-X-2	0.75	2000	5000	.629	.296			.093	.240	.150		.187	.171		.090	.234
155	RST-250SL	B12-X	0.75	1900	4800	.478	.203			.125	.150	.148		.187	.165	.078		.156
201	DST-SM-110†	B8-16	0.20	1000	3000	.560	.180			.040	.160	.040		.172	.148			
201	DST-SM-110-L4†	B8-11	0.15	1500	4000	.600	.155			.080	.210	.040		.172	.148			
201	DST-1010-C2†	B13-3-1	0.20	2700	6400	.819	.210			.187	.212	.040		.187	.148			
201	DST-1010-C4†	B9	0.20	2700	6400	.819	.210			.187	.212	.040		.172	.148			
201	DST-SM-105†	B17	0.25	1000	3000	.640	.210			.050	.170	.040		.205	.169			
201	DST-900†	B12	0.15	2000	5000	.572	.110			.140	.212	.040		.187	.171			
201	DST-1010†	B13-3-1	0.20	2700	6500	.819	.210			.187	.212	.040		.187	.171			
202	DST-1001†	B13	0.20	2000	6000	.819	.210	.020	.120	.187	.212	.040	.080	.187	.171			
203	DST-1000-C2†	B13	0.20	2000	5000	.819	.210	.020	.100	.187	.212	.040	.080	.187	.148			
203	DST-SM-105-TUR†	B17	0.20	1000	3000	.640	.210	.020	.100	.050	.170	.040	.080	.205	.169			
203	*DST-1000†	B13	0.20	2500	6000	.819	.210	.020	.100	.187	.212	.040	.080	.187	.171			
203	*DST-1015†	B20	0.20	2700	6500	.819	.210	.020	.100	.187	.212	.040	.080	.218	.187			
203	DST-1550	B24-1	0.40	3500	8000	1.187	.281	.031	.093	.250	.375	.046	.125	.250	.218			
204	DST-2560	B28	0.15	4000	9000	1.377	.176			.500	.525	.085		.312	.217	.062	.156	
205	DTS-SM-101SL†	B10-3	0.20	1000	3000	.480	.140			.040	.160	.060	.093	.185	.165		.032	.110
205	DST-SM-100SL†	B17	0.20	1000	3000	.480	.140			.040	.160	.060	.093	.205	.169		.032	.110

Terminal Lug: Brass, Silver Plate .0003" Min. Thick.

† Solder Finish (40 to 70% Tin Content) Electro-Plate .0003" Min. Thick.

Capacitance and voltage measured with terminals installed in .050" thick aluminum chassis.

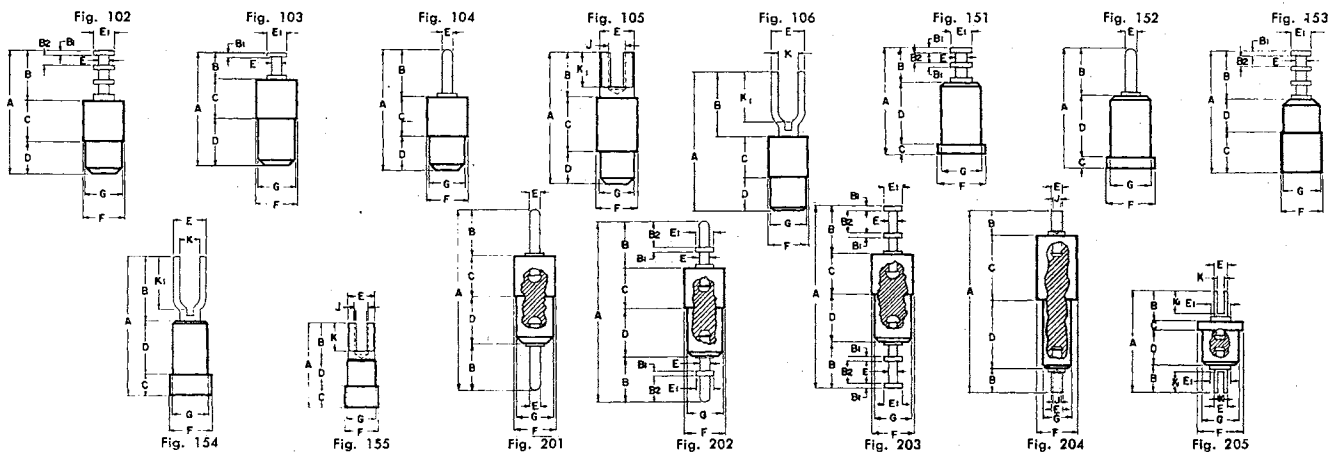

SEAELECTRO PRESS-FIT® TEFLON* TERMINALS

†Reg. Trademark, E. I. Du Pont de Nemours & Co.

FEED-THRUS SUBMINIATURE

FIG.	PART No.	TOOL NO.	CAPACITANCE mmf	V.RMS 60 CPS		A	B	B ₁	B ₂	C	D	E DIA.	E ₁ DIA.	F DIA.	+.002 -.000 G DIA.	K	K ₁
				NOMINAL RATING	FLASHOVER SEA LEVEL												
352	FT-SM-17		—	—	—	.375	.200			.140		.040		.180			
353	FT-SM-80	B9-X	0.70	1700	4500	.531	.031			.156	.218	.050		.172	.148		
353	FT-SM-81	B9-X1	0.70	1000	3000	.281	.031			.040	.100	.040		.172	.148		
354	FT-SM-125	B3-1	0.50	500	2000	.306	.078			.040	.075	.040	.050	.125	.093		
354	FT-SM-021	B18	0.40	1200	3500	.449	.250			.046	.060	.051	.060	.218	.185		
355	FT-SM-706	B3-5	0.40	500	2000	.218	.031			.040	.060	.030	.040	.125	.093		
357	FT-M-9L4	B10-2	0.80	1000	3000	.593	.250			.062	.140	.050		.187	.148		
357	FT-SM-9L6	B8-15-2	0.60	1000	3000	.479	.250			.040	.070	.050		.172	.148		
358	FT-SM-1SL	B3-1	0.60	500	2000	.312	.116			.040	.100	.040		.125	.106	.010	.020
358	FT-SM-100SL	B17	0.65	1500	4000	.480	.140			.040	.160	.060		.205	.169	.032	.110
359	FT-SM-1SL-1	B3-1	0.50	500	2000	.312	.116			.040	.100	.040		.125	.106	.010	.020
360	*FT-SM-16-TUR	B-3-2B	0.70	500	2000	.500	.210	.020	.100	.040	.100	.040	.080	.125	.093		
360	FT-SM-1-TUR-C6	B8	0.70	1000	3000	.500	.210	.020	.100	.040	.100	.040	.080	.172	.116		
360	FT-SM-028-TUR	B8	0.60	1000	3000	.550	.245	.020	.070	.040	.125	.040	.080	.172	.148		
360	FT-SM-029-TUR	B8	0.50	1000	3000	.812	.210	.020	.100	.040	.165	.040	.080	.172	.148		
360	*FT-SM-1-TUR	B8	0.50	1000	3000	.500	.210	.020	.100	.040	.100	.040	.080	.172	.148		
360	*FT-SM-1-TUR-C4	B8	0.50	1000	3000	.500	.210	.020	.100	.040	.165	.040	.080	.172	.148		
360	FT-SM-1-TUR-C10	B8	0.40	1000	3000	.438	.210	.020	.100	.040	.083	.040	.080	.172	.148		
360	*FT-SM-1-TUR-L2	B8	0.50	1000	3000	.438	.210	.020	.100	.040	.100	.040	.080	.172	.148		
360	FT-SM-1-TUR-L6	B8	0.70	1000	3000	.609	.210	.020	.100	.040	.165	.040	.080	.172	.148		
360	FT-SM-22-TUR-C2	B9	0.70	1200	3500	.609	.210	.020	.100	.093	.158	.040	.080	.172	.148		
360	FT-SM-4-TUR	B16	0.50	1200	3500	.500	.210	.020	.100	.040	.100	.040	.080	.200	.179		
360	FT-SM-1TUR-C8	B18	0.50	1200	3500	.438	.210	.020	.100	.040	.100	.040	.080	.218	.185		
360	FT-SM-33-TUR	B22	0.50	1500	4000	.500	.210	.020	.100	.040	.100	.040	.080	.250	.234		
361	FT-SM-2-TUR-C1	B8	0.50	1000	3000	.531	.210	.020	.100	.040	.100	.040	.080	.172	.112		
361	FT-SM-23-TUR	B6	0.50	750	2500	.500	.210	.020	.100	.040	.060	.040	.080	.150	.125		
361	*FT-SM-025-TUR	B8	0.65	1000	3000	.609	.210	.020	.100	.040	.165	.040	.080	.172	.148		
361	FT-SM-026-TUR	B8-A	0.55	1000	3000	.437	.156	.020	.047	.040	.065	.040	.080	.172	.148		
361	FT-SM-1-TUR-C2	B8	0.45	1000	3000	.500	.210	.020	.100	.040	.060	.040	.080	.172	.148		
361	*FT-SM-2-TUR	B8	0.70	1000	3000	.531	.210	.020	.100	.040	.100	.040	.080	.172	.148		
361	*FT-SM-2-TUR-C2	B8	0.70	1000	3000	.531	.210	.020	.100	.040	.125	.040	.080	.172	.148		
361	*FT-SM-22-TUR	B9	0.65	1200	3500	.609	.210	.020	.100	.093	.125	.040	.080	.172	.148		
361	FT-SM-51-TUR-C2	B8-A	0.65	1000	3000	.500	.156	.020	.047	.040	.150	.047	.093	.172	.152		
361	FT-SM-51-TUR-C4	B8-A	0.60	1000	3000	.437	.156	.020	.047	.040	.100	.047	.093	.172	.152		
361	FT-SM-20-TUR-C1	B18	0.55	1200	3500	.531	.210	.020	.100	.040	.100	.040	.080	.218	.175		
361	FT-SM-20-TUR	B18	0.65	1200	3500	.531	.210	.020	.100	.040	.100	.040	.080	.218	.185		
361	*FT-SM-21-TUR	B18	0.65	1200	3500	.531	.210	.020	.100	.040	.125	.040	.080	.218	.185		
361	FT-SM-34-TUR	B19-A	0.55	1500	4000	.609	.210	.020	.100	.093	.125	.040	.080	.218	.185		
361	FT-SM-26-TUR	B28-A	0.50	1500	4000	.531	.210	.020	.100	.040	.100	.040	.080	.312	.264		
362	FT-SM-1-TUR-L4	B8	0.50	1000	3000	.500	.210	.020	.100	.040	.100	.040	.080	.172	.148		
363	FT-SM-28-TUR	B6	0.45	750	2500	.350	.125	.020	.095	.040	.060	.040	.080	.150	.125		
363	FT-SM-18-TUR	B8	0.60	1000	3000	.443	.093	.020	.062	.040	.100	.040	.080	.172	.148		
363	FT-SM-37-TUR-C1	B8-G-1	0.65	750	2500	.493	.093	.020	.063	.020	.170	.040	.080	.172	.148		
363	FT-SM-84-TUR	B8	0.60	1000	3000	.640	.250	.020	.210	.040	.125	.040	.080	.172	.148		
363	FT-SM-36-TUR	B16	0.60	1200	3500	.500	.120	.020	.080	.075	.125	.048	.090	.200	.172		
363	FT-SM-36-TUR-L1	B16-1-A	1.00	1000	3000	.500	.120	.020	.080	.075	.125	.080	.125	.200	.172		
364	FT-SM-16-TUR-L2	B3-5	0.60	500	2000	.350	.125	.020	.085	.040	.100	.040	.080	.125	.093		
364	*FT-SM-32-TUR	B8	0.50	1000	3000	.350	.125	.020	.095	.040	.100	.040	.080	.172	.148		
364	FT-SM-32-TUR-L2	B8	0.60	1000	3000	.385	.160	.020	.130	.040	.100	.040	.093	.172	.148		
364	FT-SM-47-TUR-L2	B8	0.50	1000	3000	.380	.090	.020	.060	.040	.100	.040	.080	.172	.148		
365	FT-SM-47-TUR	B8	0.55	1000	3000	.500	.210	.020	.120	.040	.100	.040	.080	.172	.148		
365	FT-SM-47-TUR-L1	B8	0.50	1000	3000	.500	.210	.020	.120	.040	.100	.040	.080	.172	.148		
366	FT-SM-6-TUR-SL	B3-4-1	0.70	750	2500	.346	.093	.020	.060	.030	.130	.040	.080	.125	.106	.015	.047

Terminal Lug: Brass, Solder Finish (40 to 70% Tin Content) Electro-Plate .0003" Minimum Thick
Capacitance and voltage measured with terminals installed in .050" thick aluminum chassis.

* Available off-the-shelf from Authorized Local Seaelectro Distributors (white only).

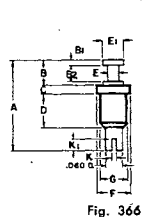
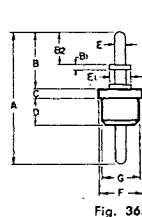
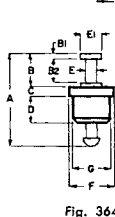
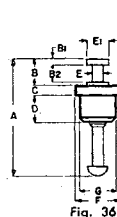
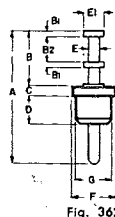
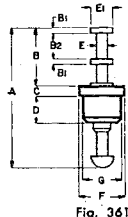
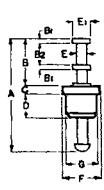
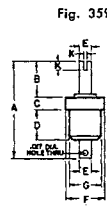
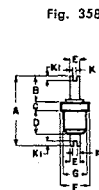
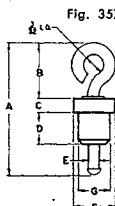
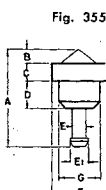
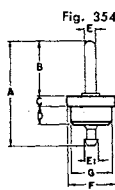
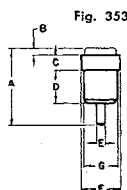
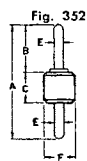

SEAELECTRO PRESS-FIT® TEFLON* TERMINALS

†Reg. Trademark, E. I. Du Pont de Nemours & Co.

FEED-THRUS SUBMINIATURE (TUBULAR)

FIG.	PART No.	TOOL No.	CAPACITANCE mmf	V _{RMS} 60 CPS		A	B	B ₁	B ₂	C	D	E DIA.	E ₁ DIA.	F DIA.	+ -.002 G DIA.	J DIA.	K	K ₁
				NOMINAL RATING	FLASHOVER SEA LEVEL													
507	FT-SM-56SL	B8-13-A	0.25	1000	3000	.367	.207			.050	.110	.040		.172	.148	.030	.010	.125
509	FT-SM-702	B3-5	0.50	500	2000	.215	.125	.020		.040	.050	.040	.080	.125	.093	.030		
509	FT-SM-79	B6-A	0.50	750	2500	.273	.133	.020		.060	.080	.060	.090	.150	.125	.030		
509	FT-SM-79C4	B6-B	0.65	750	2500	.273	.133	.020	.093	.040	.100	.060	.090	.150	.125	.030		
509	FT-SM-71C2	B8-A	0.60	1000	3000	.303	.133	.020		.040	.130	.060	.090	.172	.148	.030		
509	FT-SM-72L2	B8-13	0.50	1000	3000	.293	.133	.020	.093	.050	.110	.060	.093	.172	.148	.030		
509	FT-SM-71L2	B8-A	0.50	1000	3000	.273	.133	.020		.040	.100	.060	.090	.172	.148	.030		
509	FT-SM-35D	B23-1	0.35	1200	3500	.273	.133	.020		.065	.075	.060	.090	.250	.218	.030		
510	*FT-SM-74	B9-1	0.75	1000	3000	.351	.133	.020	.093	.093	.125	.082	.125	.172	.148	.062		
510	FT-SM-77	B10	0.80	1500	4000	.381	.133	.020	.093	.093	.155	.082	.125	.188	.171	.062		
511	*FT-SM-71	B8-A	0.50	1000	3000	.303	.133	.020	.093	.040	.100	.060	.090	.172	.148	.030		
511	FT-SM-71L8	B8-A	0.70	1000	3000	.460	.133	.020	.093	.040	.100	.060	.090	.172	.148	.040		
511	*FT-SM-72	B8-13	0.60	1200	3500	.333	.133	.020	.093	.050	.110	.060	.090	.172	.148	.030		
511	FT-SM-74L2	B8-13	0.85	1000	3000	.411	.133	.020		.093	.125	.082	.125	.172	.148	.062		
512	FT-SM-76SL	B17	0.75	1200	3500	.333	.133	.020	.093	.040	.160	.060	.093	.205	.169	.030	.032	.080
513	FT-SM-75		0.40	750	2500	.313	.120	.020	.080			.047	.090	.172		.031		
551	FT-MM-8	B3-2X	0.50	750	2500	.360	.055			.045	.260	.045		.125	.090	.030		
551	FT-SM-96	B3-2X	0.30	750	2500	.252	.100			.040	.110	.043		.125	.093	.030		
551	RFT-SM-40	B6-C	0.30	750	2500	.193	.105			.025	.063	.050		.150	.125	.030		
551	RFT-SM-52B2	B6-C	0.30	750	2500	.225	.125			.025	.075	.040		.150	.125	.030		
551	RFT-SM-52B4	B6-C	0.30	500	2000	.247	.147			.025	.075	.040		.150	.125	.030		
551	RFT-SM-50	B8	0.40	1000	3000	.310	.207			.050	.053	.040		.172	.148	.030		
551	RFT-SM-50B2	B8-X-1	0.30	1000	3000	.250	.147			.045	.053	.040		.172	.148	.030		
551	RFT-SM-50L2	B8-X-2	0.30	1000	3000	.250	.147			.050	.053	.040		.172	.148	.030		
551	RFT-SM-55	B8-X	0.45	1000	3000	.296	.136			.060	.100	.040		.172	.148	.063		
551	RFT-SM-62	B8-X-2	0.70	1000	3000	.367	.207			.050	.110	.085		.172	.148	.063		
551	RFT-SM-62L2	B8-X-2	0.70	950	2900	.310	.150			.050	.110	.085		.172	.148	.063		
551	RFT-SM-60	B18-X	0.70	1000	3000	.367	.207			.050	.110	.085		.218	.171	.063		
552	RFT-SM-1B4SL	B2-5	0.40	500	2000	.266	.146			.020	.100	.060		.125	.105	.030	.015	.130
552	RFT-SM-41SL	B6-C	0.30	500	2000	.150	.062			.025	.063	.050		.150	.125	.030	.030	.047
552	RFT-SM-52B2-SL	B6-C	0.40	750	2500	.310	.160			.025	.125	.060		.150	.135	.030	.028	.100
553	RFT-SM-602	B3-6	0.40	500	2000	.200	.100	.010		.020	.080	.050	.070	.125	.093	.030		
553	RFT-SM-78D1	B6-C	0.35	750	2500	.200	.100	.010	.080	.025	.075	.060	.090	.150	.123	.030		
553	RFT-SM-74	B9	1.00	750	2500	.351	.133	.020	.093	.093	.125	.082	.125	.172	.148	.062		
554	RFT-SM-72BC-2	B9	0.60	1200	3500	.392	.162	.020	.130	.100	.130	.060	.093	.172	.148	.042		
554	RFT-SM-77	B10	0.60	1200	3500	.381	.133	.020	.093	.093	.155	.090	.125	.188	.177	.062		
555	RFT-SM-71	B8	0.60	1000	3000	.333	.133	.020	.093	.040	.100	.060	.093	.172	.148	.030		
555	RFT-SM-71L2	B8-X-1	0.50	750	2500	.273	.133	.020	.093	.040	.100	.060	.093	.172	.148	.030		
555	RFT-SM-72C4	B8	0.50	1000	3000	.333	.133	.020		.040	.130	.060	.093	.172	.148	.030		
556	RFT-SM-602SL	B3-6	0.40	500	2000	.200	.100	.010	.080	.020	.080	.050	.070	.125	.093	.030	.030	.080
556	RFT-SM-602SL-C2	B3-6	0.50	750	2500	.260	.100	.010	.080	.020	.140	.050	.070	.125	.093	.030	.030	.040
556	RFT-SM-78SL	B7-B	0.55	500	2000	.200	.100	.010	.080	.020	.080	.085	.115	.160	.143	.060	.030	.090

Terminal Lug: Brass, Solder Finish (40 to 70% Tin Content) Electro-Plate .0003" Minimum Thick
 Capacitance and voltage measured with terminals installed in .050" thick aluminum chassis.

† ±.005

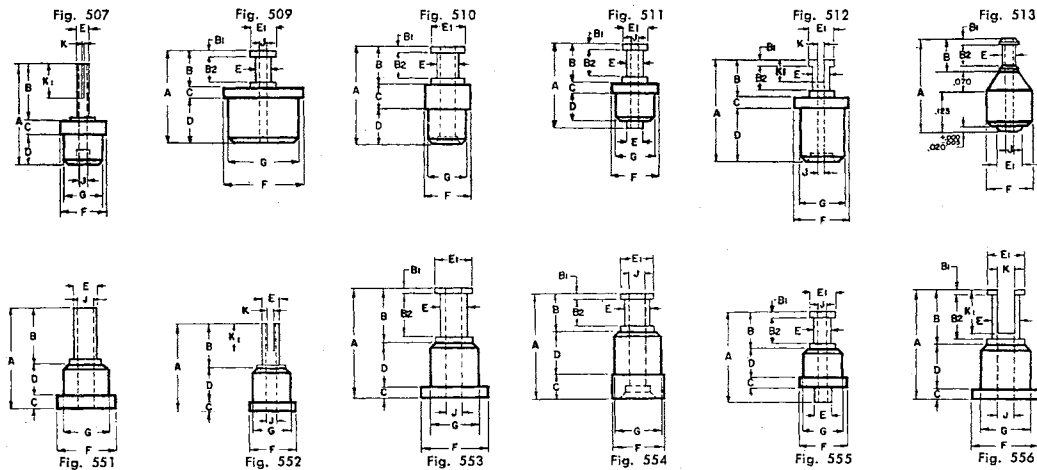

* Available off-the-shelf from Authorized Local Seaelectro Distributors (white only).

SEALLECTRO PRESS-FIT® TEFLON* TERMINALS

*Reg. Trademark, E. I. Du Pont de Nemours & Co.

FEED-THRUS MINIATURE

FIG.	PART No.	TOOL No.	CAPACITANCE mmf	V.RMS		A	B	C	D	E DIA.	E ₁ DIA.	F DIA.	+.002 - .000 G DIA.	J DIA.	K	K ₁	L Class 2
				NOMINAL RATING	60 CPS FLASHOVER SEA LEVEL												
612	FT-E-4‡	B19	1.00	1500	4000	.500		.281	.100	.050	.062	.218	.185				4-40
613	FT-1000T	B13-2	0.80	2000	5000	.899	.281	.187	.212	.050		.187	.171				4-36
613	FT-1000T1	B13-2	0.80	2000	5000	.899	.281	.187	.212	.050		.187	.171				4-40
613	FT-1500T	B13-2	0.90	2500	6000	1.024	.281	.250	.275	.050		.187	.171				4-36
613	FT-1500T1	B13-2	0.90	2500	6000	1.024	.281	.250	.275	.050		.187	.171				4-40
613	FT-1800T1	B13-6	0.90	2000	5000	1.039	.421	.187	.212	.050		.187	.171				4-40#
615	*FT-1000SL	B11	0.80	2000	5000	.821	.203	.187	.212	.148		.187	.171	.078		.156	
615	FT-1000SL-1L	B11	0.75	2000	5000	.821	.203	.187	.212	.148		.187	.171	.046		.156	
615	FT-1000SL-C2	B11	0.80	2000	5000	.821	.203	.187	.230	.148		.187	.171	.078		.156	
615	*FT-1500SL	B13-X-3	0.90	2500	6000	.947	.203	.250	.275	.148		.187	.171	.078		.156	
615	FT-2000SL	B11	1.20	3500	8000	1.197	.203	.375	.400	.148		.187	.171	.078		.156	
615	FT-2035SL	B11	1.00	2500	6000	1.197	.203	.250	.525	.148		.187	.171	.078		.156	
616	*FT-900SL	B11	0.90	1000	3000	.593	.203	.150	.100	.148		.187	.171	.078		.156	
617	FT-1500ML	B13-B	0.90	2500	6000	1.040	.296	.250	.275	.148		.187	.171		.110	.250	
618	FT-35ML	B11-C	1.40	2000	5000	1.015	.296	.187	.427	.150		.187	.171		.090	.234	
619	FT-2010ML†	B33	1.35	2500	6000	1.285	.281	.562	.250	.050		.250	.171				
625	FT-1600T10	B32-1	1.80	2000	5000	.737	.050	.125	.250	.125	.187	.375	.312	##			
630	FT-E-2‡	B10	0.85	1000	3000	.225	.020	.040	.150	.125		.187	.165	**			
630	FT-E-1	B23-X-1	0.90	1000	3000	.225	.015	.040	.155	.195		.250	.203	.096			
630	FT-E-5	B23-X-1	0.75	1000	3000	.210	.010	.040	.155	.170		.250	.203	.072			
651	RFT-195SL	B10	0.60	1000	3000	.477	.125	.040	.187	.148		.187	.171	.078		.078	
651	RFT-200SL	B10	0.70	1000	3000	.532	.125	.040	.187	.148		.187	.171	.078		.078	
652	RFT-1000SL	B13	0.80	2000	5000	.821	.203	.187	.212	.148		.187	.171	.078		.156	
652	RFT-1500SL	B13-X-1	1.00	2500	6000	.947	.203	.250	.275	.148		.187	.171	.078		.156	
652	RFT-2000SL	B13	1.00	3500	8000	1.197	.203	.375	.400	.148		.187	.171	.078		.156	

Terminal Lug: Brass, Silver Plated .0003" Min. Thick.
 Capacitance and voltage measured with terminals installed in .050" thick aluminum chassis.
 ‡ Gold Flash over Silver. # .156 Hex Brass Base.

** 0-80 Thread.
 ## 10/32 Thread.
 † Solder dip on tail only.

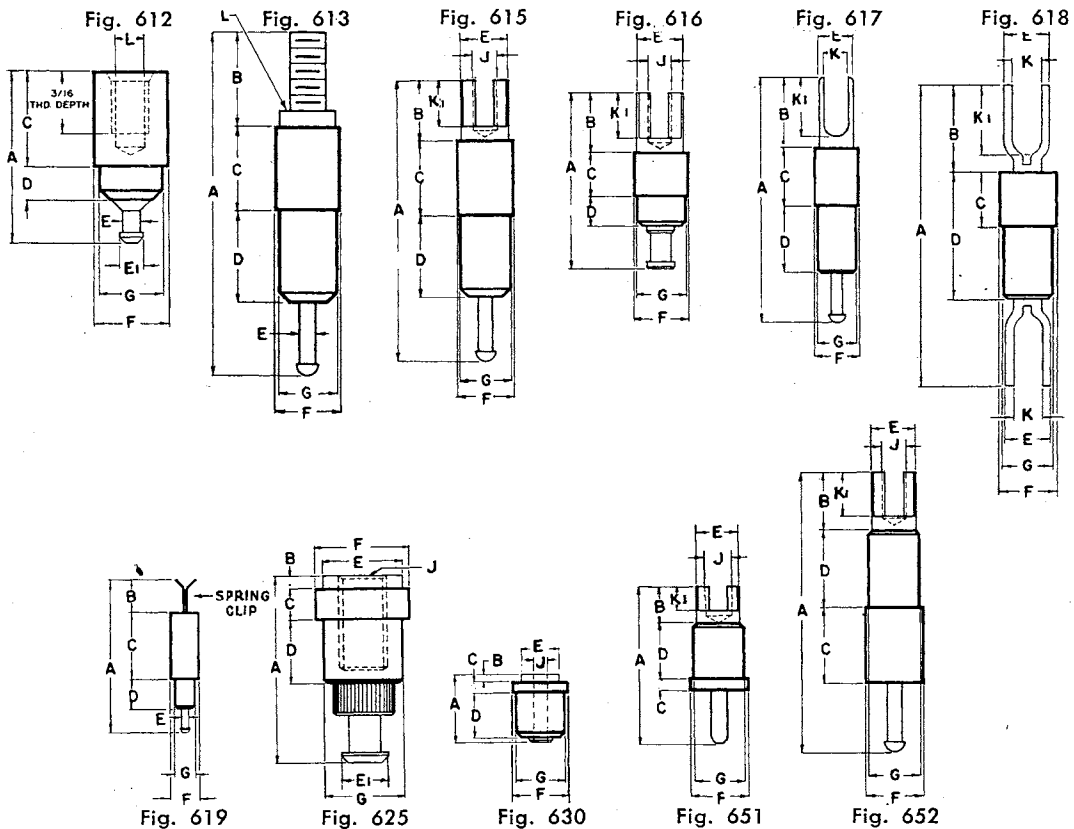

* Available off-the-shelf from Authorized Local Seallectro Distributors (white only).

SEAELECTRO PRESS-FIT® TEFLON* TERMINALS

†Reg. Trademark, E. I. Du Pont de Nemours & Co.

TEST POINT JACKS

FIG.	PART No.	TOOL No.	CAPACITANCE mmf	V _{RMS}		REF. A	B	B ₁	B ₂	C	D	E DIA.	E ₁ DIA.	F DIA.	+.002 -.000 G DIA.	J* PROBE DIA.	J ₁ PROBE LENGTH	K	K ₁
				NOMINAL RATING	60 CPS FLASHOVER SEA LEVEL														
701	SKT-13C3	S13-1	0.45	500	2000	.203	.060	.010	.040	.030	.113	.046	.080	.150	.120	.040	.078		
701	SKT-22	S4	0.20	1500	4000	.449	.120	.030	.060	.046	.283	.040	.060	.142	.120	.040	.245		
701	SKT-22C2	S22	0.30	1500	4000	.410	.120	.030	.060	.046	.244	.040	.060	.142	.120	.040	.205		
701	SKT-13B2	S14	0.30	750	2500	.253	.060	.010	.040	.050	.143	.046	.080	.172	.140	.040	.125		
701	SKT-14B2	S14	0.30	1000	3000	.345	.120	.023	.077	.046	.179	.040	.060	.172	.140	.040	.140		
701	SKT-13B4	S13	0.40	750	2500	.203	.060	.010	.040	.046	.097	.046	.080	.172	.148	.040	.078		
701	SKT-13L2	S13	0.40	750	2500	.190	.050	.010	.030	.046	.094	.046	.080	.172	.148	.040	.078		
701	*SKT-14	S5	0.35	1000	3000	.345	.120	.023	.077	.046	.179	.040	.060	.172	.148	.040	.140		
701	*SKT-2Bc	S2	0.70	1000	3000	.437	.120	.037	.053	.046	.271	.054	.074	.218	.185†	.090	.195		
701	*SKT-5Bc	S2	0.60	1000	3000	.437	.120	.037	.053	.046	.271	.054	.074	.218	.185†	.080	.195		
701	SKT-5Bc-C2	S35	0.45	1000	3000	.453	.120	.037	.053	.046	.287	.054	.074	.218	.185†	.050	.195		
701	*SKT-10	S1	0.70	1200	3500	.640	.187	.037	.104	.050	.400	.054	.074	.218	.185†	.080	.287		
701	*SKT-37C1	S12	0.55	1000	3000	.340	.120	.023	.077	.046	.174	.054	.074	.218	.185†	.090	.140		
701	*SKT-41	S2	0.55	1200	3500	.467	.120	.035	.047	.046	.301	.054	.074	.218	.185†	.080	.225		
701	SKT-42	S23-1	0.40	2000	5000	.455	.105	.020	.065	.050	.300	.080	.125	.218	.185†	.080	.315		
701	SKT-27	S11	0.80	3200	7500	.761	.187	.035	.116	.187	.386	.054	.074	.218	.200	.093	.455		
701	SKT-27L1	S12	0.70	2000	5000	.699	.187	.035	.116	.125	.386	.054	.074	.218	.200	.093	.390		
701	SKT-0930	S37	0.70	3200	7500	.834	.187	.035	.116	.230	.417	.054	.074	.375	.200	.093	.518		
701	*SKT-3Bc	S2	0.60	1000	3000	.437	.120	.037	.053	.046	.271	.054	.074	.250	.204	.080	.195		
701	SKT-19	S9	0.60	1200	3500	.400	.060	.010	.037	.046	.294	.066	.098	.250	.218	.105	.250		
702	SKT-35	B8-14	0.25	1200	3500	.400	.150			.046	.204	.040		.172	.148	.032	.200		
703	*SKT-1	S31	0.55	1200	3500	.687	.354			.046	.287	.115		.218	.185†	.050	.250	.140	.042
703	SKT-4	S30	0.40	1200	3500	.687	.354			.046	.287	.104		.218	.185†	.041	.250	.140	.050
703	*SKT-8	S1	0.50	1200	3500	.687	.330			.046	.287	.103		.218	.185†	.080	.250	.156	.046
703	SKT-8B2	S1	0.55	2000	5000	.711	.354			.070	.287	.103		.218	.185†	.080	.274	.156	.048
703	SKT-18	S25	0.50	1500	4000	.687	.354			.052	.281	.115		.218	.185†	.050	.250	.140	.042
703	SKT-20	S27	0.80	1000	3000	.687	.330			.187	.146	.103		.218	.185†	.080	.187	.156	.046
703	SKT-20L1	S25	0.75	1000	3000	.687	.330			.187	.146	.110		.218	.185†	.050	.250	.156	
703	SKT-23	S28	0.65	1000	3000	.625	.355			.046	.224	.115		.218	.185†	.050	.200	.140	.042
703	SKT-26	S26	0.60	1000	3000	.718	.316			.046	.356	.104		.218	.185†	.060	.315	.125	.052
704	SKT-15	S32	0.60	3500	8000	.732	.188			.157	.387	.110		.250	.220	.050	.320	.140	.042
705	SKT-36	S28	0.80	1000	3000	.620	.287			.046	.287	.115		.218	.185†	.050	.250	.156	.052
706	SKT-31	S17	0.45	1000	3000	.408	.187			.046	.175	.060		.172	.148	.040	.135		
707	SKT-38C1					1.000	.060	.010			.940	.046	.078	.187	.125#	.090	.825		
707	SKT-13					.203	.060	.010			.143	.046	.080	.140		.040	.075		
707	SKT-13C1					.203	.060	.010			.143	.046	.080	.120		.040	.075		
707	SKT-13L1					.203	.060	.010			.143	.046	.080	.140		.025	.075		

Terminal Lug: Beryllium Copper — Gold Flash over Silver Plate.
Capacitance and voltage measured with terminals installed in .050" thick aluminum chassis.

†±.001
#±.005

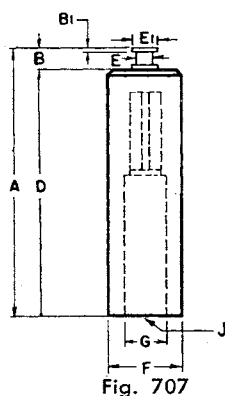
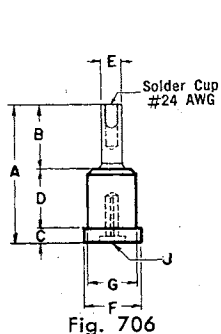
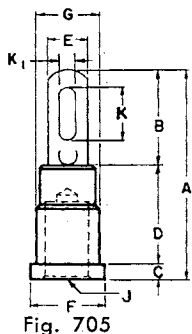
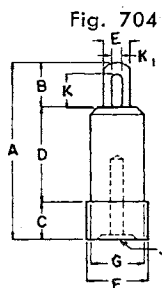
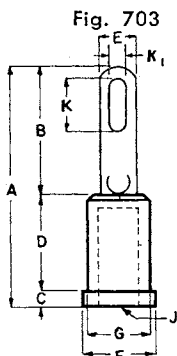
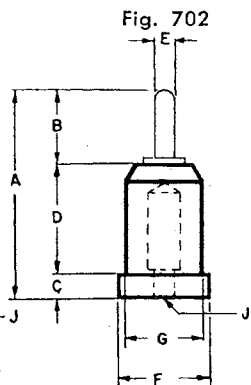
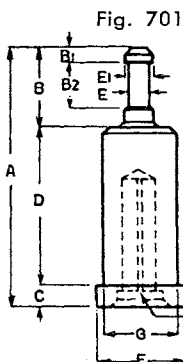

*SKT-0804—GUIDED ENTRY TEST POINT JACK FOR INCREASED CHASSIS PULL-OUT STRENGTH

Featuring a beryllium-copper formed lug with unique design configuration, the SKT-0804 test point jack offers greater pull-out strength and high torque resistance. The jack is designed to provide guided-entry for an .080" diameter probe. The SKT-0804 construction permits uniform retention and greater support of the Teflon bushing by the lug.

Insertion Tool No. S-38

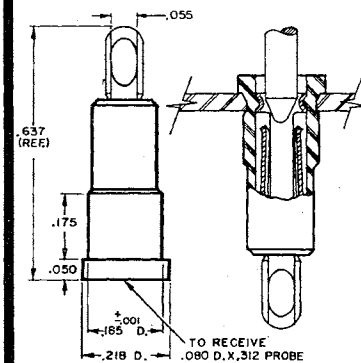

* Available off-the-shelf from Authorized Local Seaelectro Distributors (white only).

SEAELECTRO PRESS-FIT® TEFLON* TERMINALS

†Reg. Trademark, E. I. Du Pont de Nemours & Co.

PROBES AND PLUGS

FIG.	PART No.	TOOL No.	CAPACITANCE mmf	V.RMS		A	B	B ₁	C	D	±.001 E DIA.	E ₁ DIA.	F DIA.	+.002 —.000 G DIA.	J DIA.	J ₁ DIA.	K ₁
				NOMINAL RATING	60 CPS FLASHOVER SEA LEVEL												
801	*FT-M-9	B18-1B	1.0	1000	3000	1.937	.250		.046	.141	.050		.218	.185†			
801	*FT-M-2	B18-1B	1.10	1000	3000	2.083	.250		.046	.287	.050*		.218	.185†			
801	FT-M-2L2	B18-1B	0.70	1000	3000	.906	.250		.046	.287	.050		.218	.185†			
801	FT-M-2L4	B18-1B	0.85	1000	3000	1.531	.250		.046	.287	.050*		.218	.185†			
801	FT-M-19	B18-1B	1.0	1000	3000	1.870	.120		.046	.250	.040		.218	.185†			
802	PR-15	B-23	0.90	3000	7000	1.531			.157	.375	.050*	.125	.250	.220			
803	RFT-M-14	B-18-1C	0.90	1700	4500	1.940	.120		.046	.320	.040*		.218	.185†			
804	FT-M-4#	B18-1B	0.80	1000	3000	.739	.281		.046	.287	.081*		.218	.185†			
804	FT-M-12	B-10	0.65	1000	3000	.687	.272		.040	.212	.040		.187	.171			
804	*FT-M-7	B18-1B	0.80	1000	3000	.739	.281		.046	.287	.081*		.218	.185†			
804	*FT-M-8	B18-1B	0.90	1000	3000	.562	.250		.046	.141	.050*		.218	.185†			
804	FT-M-8-L1	B18-E	0.90	1000	3000	.562	.250		.046	.141	.081		.218	.185†			
804	FT-M-14	B18-E	0.80	1000	3000	.906	.250		.046	.287	.050		.218	.185			
804	FT-M-16	B18-1B	0.80	1000	3000	.648	.190		.046	.287	.090*		.218	.185†			
804	FT-M-17	B18-1B	0.80	1000	3000	.612	.250		.046	.141	.062*		.218	.185†			
805	RFT-M-11	B18-E	0.80	1000	3000	.562	.250		.052	.135	.050*		.218	.185†			
806	FT-M-6###	B13-2	0.85	2000	5000	.867	.250		.187	.212	.100**		.187	.171			.203
807	*PR-10	B8-14	0.70	1000	3000	.538	.130		.046	.175	.040		.172	.148			
807	PR-13	B-8	0.65	1000	3000	.416	.080		.040	.135	.040		.172	.148			
807	PR-13C1	B-8	0.65	1000	3000	.416	.080		.040	.135	.040		.172	.148			
808	*PR-400	B13-3	0.55	1000	3000	.407	.125		.065	.090	.040		.187	.148			
808	PR-620	B18-1	0.55	1200	3500	.559	.187		.065	.176	.062		.218	.171			
808	*PR-800	B23-A	0.70	1200	3500	.559	.187		.065	.169	.080		.250	.185†			
809	*PR-300					.645	.270		.375		.080		.218		.062	.128	
809	PR-0900					.645	.270		.375		.090		.218		.062	.128	
810	*PR-302	B22-X1				.645	.270		.050	.325	.080		.250	.218	.062	.128	
811	PR-100**	B6-X	0.75	750	2500	.365	.194		.046	.125	.077**		.150	.120	.030		
812	FT-M-5	B18-1B	0.70	1000	3000	.833	.250		.046	.287	.050		.218	.185			
812	FT-M-9L2	B18-1B	0.65	1000	3000	.682	.250		.046	.141	.050		.218	.185			

Terminal Lug: Gold Flash over Silver Plate.
 Capacitance and voltage measured with terminals installed in .050" thick aluminum chassis.
 # No ball on end of Lug.
 ## Silver Plate .0003" Min. Thick.

**Beryllium Copper — E Dimension +.003 —.002

***Gold over Copper.

†±.001

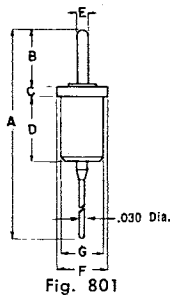

Fig. 801

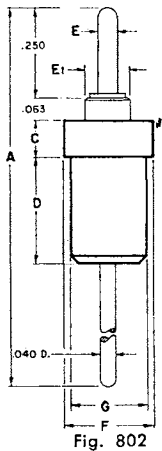

Fig. 802

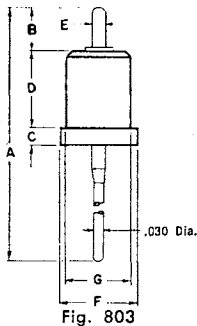

Fig. 803

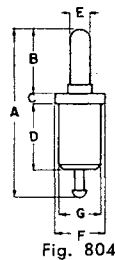

Fig. 804

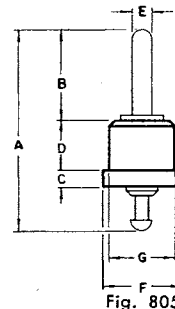

Fig. 805

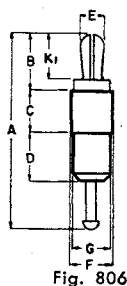

Fig. 806

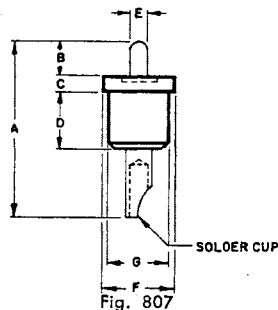

Fig. 807

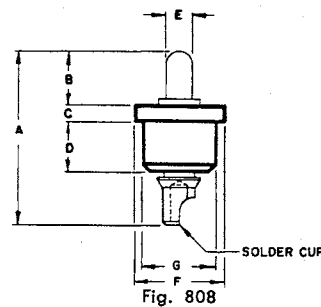

Fig. 808

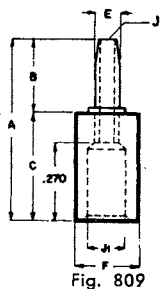

Fig. 809

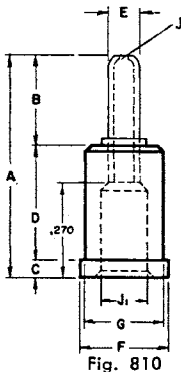

Fig. 810

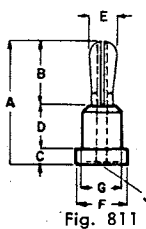

Fig. 811

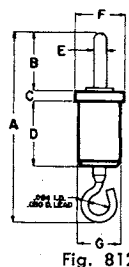

Fig. 812

* Available off-the-shelf from Authorized Local Seaelectro Distributors (white only).

SEAELECTRO PRESS-FIT® TEFLON* TERMINALS

†Reg. Trademark, E. I. Du Pont de Nemours & Co.

TRANSISTORS AND IC HARDWARE

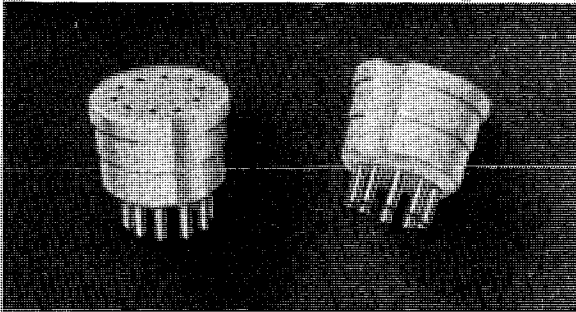

SOCKETS AND HOLDERS

Low cost, high precision sockets and holders for transistors and integrated circuit packages are now available with virgin Teflon bodies that Press-Fit into chassis. The Seaelectro Series 60 Sockets permit you to plug-in and remove various TO-18, TO-5 can and I.C. packages at will. The precise contact design provides a positive mechanical grip while making electrical contact with minimum resistance. Seaelectro offers a complete off-the-shelf line. Write for catalog.

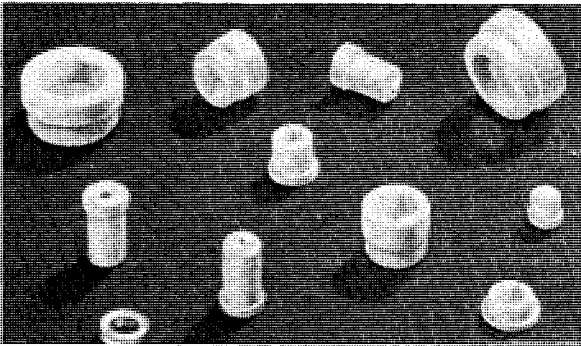

BUSHINGS AND PADS

Included in the Press-Fit line of Transistor and I.C. Hardware is a complete selection of Teflon bushings and pads to fit virtually every transistor and I.C. package. Press-Fit or grommet style bushings which provide support for transistor can or thru chassis hole for leads are offered. Pads to relieve strain on glass seals are also available. They are designed for use where semiconductor units are wired directly into the circuit and to insulate it from the mounting surface. Write for complete catalogs.

TEFLON BUSHINGS

SINGLE SHOULDER

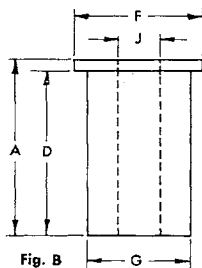
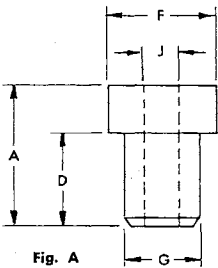

GROMMET TYPE

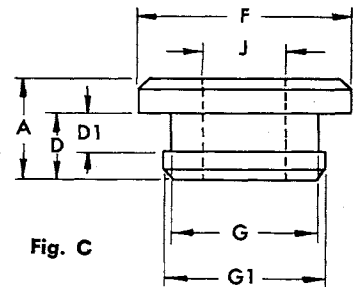

Fig.	Part No.	G	A	D	J	F	Fig.	Part No.	G	A	D	J	F
A	B-1555	.045	.106	.075	.025	.080	A	B-1514	.172	.200	.125	.071	.200
A	B-1519	.067	.120	.080	.031	.093	A	B-1487	.175	.312	.250	.093	.210
A	B-1516	.075	.140	.100	.042	.093	A	B-1445	.179	.140	.100	.085	.200
A	B-1520	.075	.140	.100	.025	.095	A	B-1423	.185	.333	.287	.041	.218
A	B-1440	.093	.140	.100	.040	.125	A	B-1434	.185	.380	.287	.050	.218
A	B-1440-1	.093	.140	.100	.035	.125	A	B-1447	.185	.225	.185	.120	.218
A	B-1441	.093	.100	.060	.037	.125	A	B-1447-1	.185	.130	.090	.120	.218
A	B-1464	.093	.100	.080	.038	.125	A	B-1451-1	.185	.327	.140	.128	.218
A	B-1553	.093	.100	.080	.048	.125	A	B-1469	.185	.303	.210	.046	.215
A	B-1576	.095	.060	.040	.038	.125	A	B-1473	.185	.450	.400	.150	.218
A	B-1461	.109	.085	.059	.032	.128	A	B-1486	.185	.333	.287	.093	.218
A	B-1422	.120	.103	.053	.040	.130	A	B-1490	.185	.330	.250	.074	.218
A	B-1410	.125	.060	.040	.030	.150	A	B-1598	.188	.170	.130	.080	.218
A	B-1448	.125	.120	.095	.080	.145	A	B-1590	.188	.130	.100	.080	.218
A	B-1477	.136	.140	.100	.060	.169	A	B-1442	.200	.195	.155	.125	.250
A	B-1460	.140	.100	.080	.089	.160	A	B-1479	.203	.140	.100	.060	.226
A	B-1414	.148	.140	.100	.060	.172	A	B-1428	.214	.437	.375	.090	.250
A	B-1435	.148	.140	.100	.040	.172	A	B-1412	.241	.150	.110	.187	.281
A	B-1439	.148	.160	.120	.073	.172	A	B-1512	.245	.250	.157	.156	.308
A	B-1455	.148	.165	.125	.084	.172	A	B-1480	.250	.140	.100	.060	.273
A	B-1465-1	.148	.140	.100	.060	.220	A	B-1552	.265	.312	.250	.136	.312
A	B-1465-2	.148	.140	.100	.090	.220	A	B-1483	.287	.140	.100	.060	.310
A	B-1475	.148	.140	.100	.073	.172	A	B-1549	.395	.170	.130	.312	.437
A	B-1485	.148	.140	.100	.065	.172	B	B-1563	.120	.120	.060	.060	.180
A	B-1498	.148	.140	.100	.030	.172	B	B-1578	.120	.118	.058	.050	.180
A	B-1508	.148	.150	.125	.084	.172	B	B-1575	.123	.124	.093	.086	.281
A	B-1543	.148	.140	.100	.052	.172	B	B-1567	.150	.221	.175	.118	.250
A	B-1539	.148	.220	.125	.052	.172	B	B-1597	.150	.091	.045	.118	.250
A	B-1573	.148	.170	.100	.059	.172	B	B-1585	.203	.062	.031	.144	.320
A	B-1404	.157	.093	.078	.089	.172	B	B-1506	.242	.093	.047	.375	.157
A	B-1405	.157	.074	.059	.089	.172	B	B-1556	.247	.178	.128	.140	.500
A	B-1478	.165	.140	.100	.060	.186	B	B-1429	.296	.500	.469	.120	.120
A	B-1456	.171	.160	.110	.063	.218	B	B-1430	.296	.500	.469	.210	.210
A	B-1474	.172	.200	.125	.089	.200	B	B-1568	.304	.045	.015	.204	.375
A	B-1489	.172	.140	.100	.051	.195							

Fig.	Part No.	G	A	D	D1	G1	F	J
C	B-1453	.103	.081	.041	.017	.115	.145	.067
C	B-1449	.123	.070	.040	.020	.143	.187	.052
C	B-1401	.154	.104	.054	.025	.164	.218	.085
C	B-1403	.154	.104	.069	.040	.164	.218	.120
C	B-1406	.154	.094	.044	.015	.164	.218	.099
C	B-1407	.154	.104	.069	.040	.164	.218	.085
C	B-1408	.154	.094	.044	.015	.164	.218	.085
C	B-1413	.154	.094	.044	.015	.164	.218	.120
C	B-1416	.154	.104	.069	.040	.164	.218	.099
C	B-1418	.154	.085	.035	.015	.164	.195	.085
C	B-1419	.154	.134	.099	.070	.164	.218	.120
C	B-1420	.154	.104	.054	.025	.164	.218	.099
C	B-1421	.154	.104	.069	.040	.164	.218	.120
C	B-1424	.154	.094	.044	.025	.164	.195	.085
C	B-1432	.154	.104	.054	.025	.164	.218	.120
C	B-1437	.154	.125	.075	.060	.164	.218	.120
C	B-1463	.154	.104	.054	.035	.164	.218	.099
C	B-1466	.154	.140	.105	.075	.164	.218	.120
C	B-1472	.154	.135	.085	.060	.164	.218	.085
C	B-1482	.154	.104	.054	.035	.164	.218	.128
C	B-1462	.168	.156	.106	.076	.178	.218	.089
C	B-1431	.184	.104	.069	.040	.194	.248	.150
C	B-1467	.190	.104	.054	.035	.200	.250	.157
C	B-1467-1	.190	.104	.054	.035	.200	.250	.120
C	B-1436	.199	.104	.069	.040	.210	.260	.128
C	B-1450	.199	.190	.140	.120	.210	.230	.128
C	B-1459	.204	.104	.069	.040	.214	.268	.170
C	B-1459-1	.204	.104	.069	.040	.214	.268	.125
C	B-1545	.204	.124	.089	.060	.214	.268	.099
C	B-1558	.204	.124	.089	.060	.214	.268	.170



SEALECTRO



SUB-MINIATURE R. F. CONNECTORS

See listing below for typical cables.	50 OHM	75 OHM	See listing below for typical cables.	50 OHM	75 OHM
	51-011-0000 51-111-0000 A 19/32 C 15/64 HEX D #10-32, UNF-2A J 15/64 HEX K 3/4 approx.	11/16 5/8 HEX #9/32-40, UNS-2A 11/32 HEX 27/32 approx.		50-027-0000 50-127-0000 A 1-1/8 approx. C 7/32 HEX F .425 G 1/4 HEX H #10-32, UNF-2A J 7/32 approx. M .375	1-5/32 approx. 5/16 HEX .425 3/8 HEX #5/16-32, UNEF-2A 11/32 HEX .400
	51-051-0000 51-151-0000 A .448 J 5/16 HEX O .040 (Typ.) P .200 Q .038D R .155	.448 3/8 HEX .040 (Typ.) .200 .038D .155		50-028-0000 50-128-0000 A 39/64 approx. B 15/64 HEX C 15/64 HEX E #10-32, UNF-2B K 5/8 approx. M .375	21/32 approx. 11/32 HEX 11/32 HEX #5/16-32, UNEF-2B 23/32 approx. .400
	51-053-0000 51-153-0000 A 17/32 approx. J 5/16 HEX K 19/32 O .040 (Typ.) P .200 Q .038D R .155 S .215	19/32 approx. 3/8 HEX 21/32 .040 (Typ.) .200 .038D .155 .247		55-031-0000 55-131-0000 A 47/64 approx. F .228 G 1/4 HEX H #10-32, UNF-2A J 7/32 HEX L .067D M .375	51/64 approx. .228 3/8 HEX #5/16-32, UNEF-2A 11/32 HEX .111D .400
	51-047-0000 51-147-0000 A 3/4 approx. F .228 G 1/4 HEX H #10-32, UNEF-2A J 5/16 HEX K 19/32 N .038 O.D. x .025 I.D. x .078 Deep S .215 T .372	13/16 approx. .228 3/8 HEX #5/16-32, UNEF-2A 3/8 HEX 21/32 .038 O.D. x .025 I.D. x .078 Deep .247 .435		51-024-0000 50-124-0000 A 1-1/64 approx. C 7/32 HEX J 7/32 HEX M .375	1-3/64 approx. 5/16 HEX 11/32 HEX .400
	51-085-0000 51-185-0000 A .860 B 41/64 C 1.456	.923 45/64 .488		51-025-0000 51-125-0000 A 63/64 approx. C 7/32 HEX J 7/32 HEX M .375	1-1/64 approx. 5/16 HEX 5/16 HEX .400
	50-024-0000 50-124-0000 A 1-1/32 approx. B 15/64 HEX C 7/32 HEX E #10-32, UNF-2B M .375	1-1/16 approx. 11/32 HEX 5/16 HEX #5/16-32, UNEF-2B .400		51-027-0000 51-127-0000 A 1-1/8 approx. C 7/32 HEX F .425 G 1/4 HEX H #10-32, UNF-2A J 7/32 HEX M .375	1-5/32 approx. 5/16 HEX .425 3/8 HEX #5/16-32, UNEF-2A 11/32 HEX .400
	50-025-0000 50-125-0000 A 63/64 approx. C 7/32 HEX E #10-32, UNF-2A J 7/32 HEX M .375	1-1/64 approx. 5/16 HEX 5/16 HEX 5/16 HEX .400		51-028-0000 51-128-0000 A 19/32 J 15/64 HEX K 5/8 approx. M .375	41/64 11/32 HEX 23/32 approx. .400

CRIMP-ON ASSEMBLY TOOL — Part No. CT-6

TYPICAL SPEC CABLES FOR USE WITH "CONHEX" CONNECTORS

Standard 50 ohm **clamp-type** connectors accept:
RG-161/U, 174/U, 179/U, 188/U and 316/U cables.

Standard 50 ohm **crimp-type** connectors accept:
RG-161/U, 174/U, 179/U, 187/U, 188/U and 316/U cables.

Other cables having the same component diameters as those listed can also be used in the same series of connectors.

Standard 75 ohm **clamp-type** connectors accept:
RG-180/U and 195/U cables.

Standard 75 ohm **crimp-type** connectors accept:
RG-180/U and 195/U cables.



SEAELECTRO PROGRAMMING DEVICES

SEAELECTRO PROGRAM SWITCHING

SEAELECTROBOARD™ MODULAR CORDLESS PROGRAM BOARDS*

"Sealectroboard" programming and switching provides complete ease and simplicity of operation with drastic reductions in hardware and space. The units consist of two decks of bussed contacts running at right angles to each other in the X and Y directions, forming an electrical matrix. A single shorting or component holding pin is used to complete the program circuit... move the pin to a new location and a new program function is generated.

The "Modular Sealectroboard" provides an extremely flexible means of program system expansion with a built-in appearance. The system consists of only four standard component assemblies, designed such that when installed in a standard E.I.A. 19" relay rack, or bench cabinet, they result in a very attractive unit.

The "Modular Sealectroboard" can be expanded from a 10 x 10 hole matrix to a 10 x 60 hole matrix in one standard 5 1/2" x 19" rack panel. Additional panels can be added and interwired to expand program capacity as system requirements dictate.

SHORTING PIN

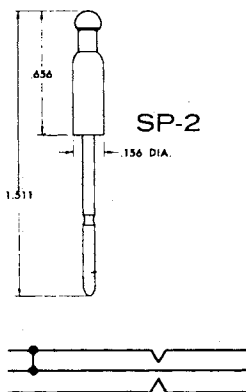

COMPONENT PIN

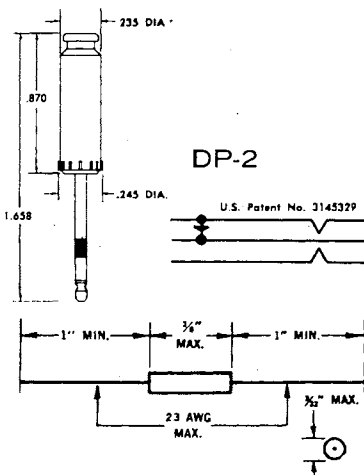

BLANK PANEL Cat. No. SBX-106-2. Fills in unused width. May be used for mounting other components or associated equipment. Black plastic with white filler for engraving.

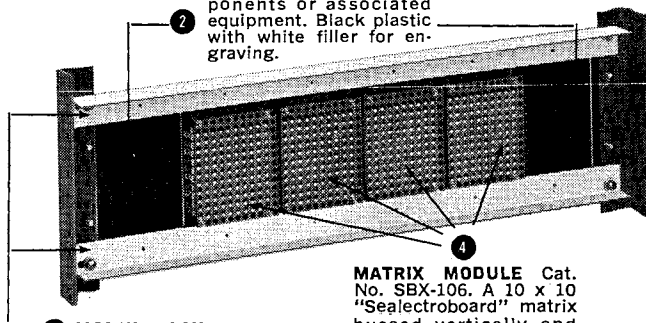

MODULE RAIL Cat. No. SBX-106-1. Rails are designed for mounting on standard 19" relay racks. Offset is provided for flush panel installation. Mounting holes are provided for any combination (up to 6) of blank panels and "Sealectroboard" modules.

MATRIX MODULE Cat. No. SBX-106. A 10 x 10 "Sealectroboard" matrix bussed vertically and horizontally. Terminals are combination solder and Klip-on. Contact strips are silver plated.

SIDE PLATE Cat. No. SBX-106-3. Provides end dressing, or return to relay rack frame.

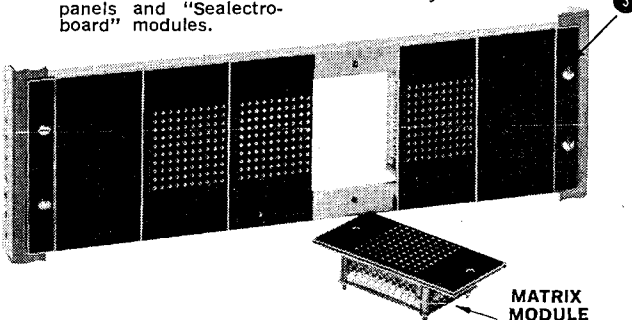

* Available off-the-shelf from Authorized Local Sealectro Distributors.

SEAELECTROSWITCH™ FIELD ADJUSTABLE PROGRAMMING SWITCHES*

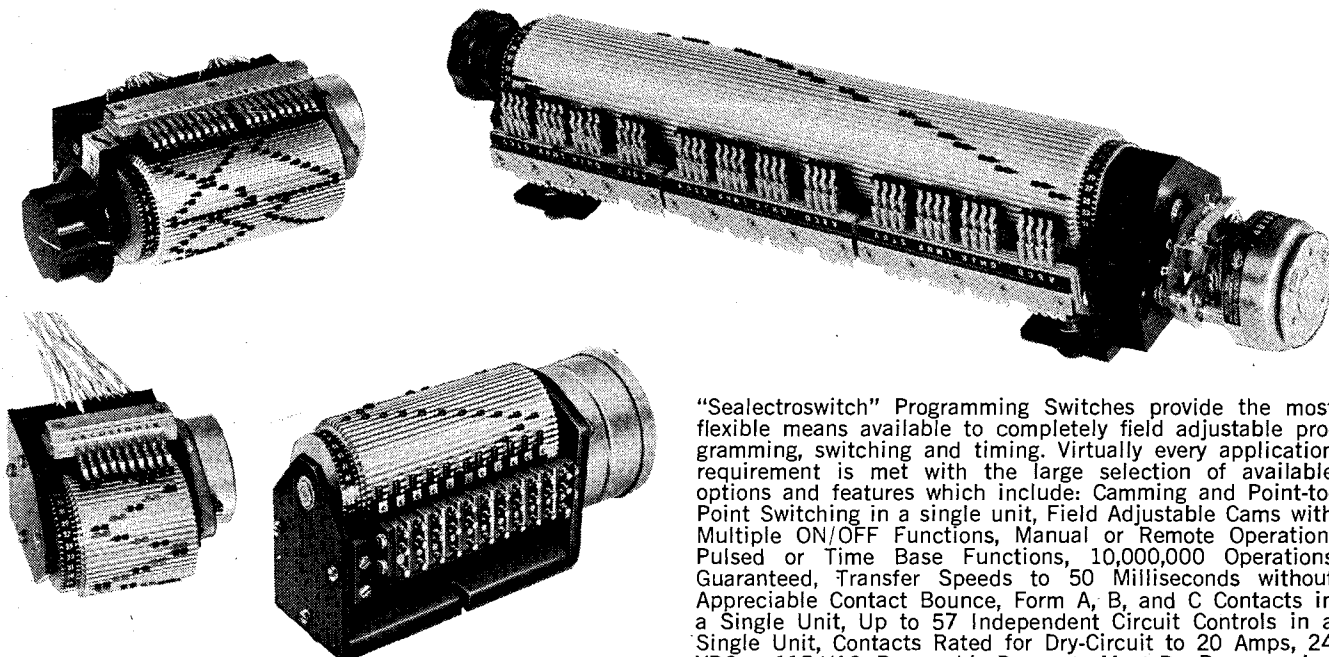

"Sealectroswitch" Programming Switches provide the most flexible means available to completely field adjustable programming, switching and timing. Virtually every application requirement is met with the large selection of available options and features which include: Camming and Point-to-Point Switching in a single unit, Field Adjustable Cams with Multiple ON/OFF Functions, Manual or Remote Operation, Pulsed or Time Base Functions, 10,000,000 Operations Guaranteed, Transfer Speeds to 50 Milliseconds without Appreciable Contact Bounce, Form A, B, and C Contacts in a Single Unit, Up to 57 Independent Circuit Controls in a Single Unit, Contacts Rated for Dry-Circuit to 20 Amps, 24 VDC or 115 VAC, Removable Drums to Meet Pre-Programming Requirements, and Self-Homing on Timing Motor Drive Units.

* Available through Authorized Local Sealectro Distributors.

specify SMITH

HERMAN H. SMITH, INC.



ELECTRONIC COMPONENTS

INSULATED TIP PLUG Solderless

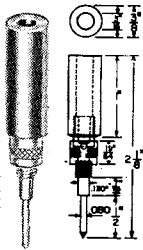

HANDLE: MOLDED THERMOSETTING plastic, Red and Black per MIL-M-14 CFG. Yellow, Green, Blue, White per LC-726-1. **SPECIFY COLOR**

BODY: Brass, nickel plated.

RATING: 12 Amps AC for 10°C Temp. rise, continuous duty.

DESCR.: Solderless: wire fits through body of tip then wrapped around screw portion and tightened with knurled collar. Threaded tube. Fits standard phone tip jacks.

No. 200	Type Senior	NET Per C \$15.00
---------	-------------	-------------------

INSULATED TIP PLUG Solderless

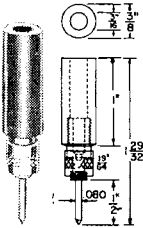

HANDLE: MOLDED THERMOSETTING plastic, Red and Black per MIL-M-14 CFG. Yellow, Green, Blue, White per LC-726-1. **SPECIFY COLOR**

BODY: Brass, nickel plated.

RATING: 12 Amps AC for 10°C Temp. rise, continuous duty.

DESCR.: Solderless: wire fits through body of tip then wrapped around screw portion and tightened with knurled collar. Threaded tube. Fits standard phone tip jacks.

No. 201	Type Junior	NET Per C \$15.00
---------	-------------	-------------------

INSULATED TIP PLUG Signal Corps Approved

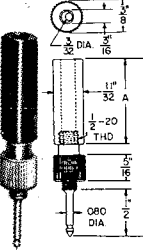

HANDLE: ETHYL CELLULOSE. Type EM-1, per MIL-P-3412. Red, Black. **SPECIFY COLOR**

PLUG: Steel, case hardened to Signal Corps specs.

RATING: 10 Amps AC for 10°C Temp. rise, continuous duty.

DESCR.: Recess at end of prod tip holds plugs more firmly in jack spring. Prevents tip from falling out when in an inverted position.

No. 250	Handle (A) 1 inch	Overall (B) 2 3/8"	NET Per C \$54.00
358	3 inch	4 3/8"	84.00

INSULATED TIP PLUG Solder Type

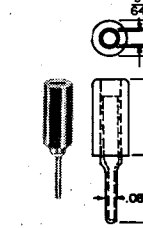

HANDLE: MOLDED BUTYRATE, per FED. SPEC. L-P349A, Type 3, Class MS. Red or Black. **SPECIFY COLOR**

BODY: Brass, nickel plated or No. 158.

RATING: 12 Amps AC for 10°C Temp. rise, continuous duty.

DESCR.: Drawn hollow tip for easy soldering. Fits standard phone tip jack.

No. 237	NET Per C \$11.00
---------	-------------------

INSULATED TIP PLUG Heavy Duty Type

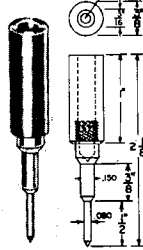

HANDLE: MOLDED THERMOSETTING plastic, Red and Black per MIL-M-14 CFG. Yellow, Green, Blue, White per LC-726-1. **SPECIFY COLOR**

PLUG: Brass, nickel plated.

RATING: 12 Amps AC for 10°C Temp. rise, continuous duty.

DESCR.: Large diameter well enables soldering of heavy duty wire directly into plug. Fits standard phone tip jacks.

No. 229	NET Per C \$15.00
---------	-------------------

SUB-MINIATURE TIP PLUG

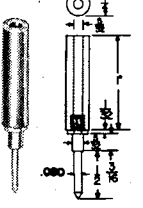

HANDLE: FIBRE, per MIL-F-148A. Grade CH. Red, Black. **SPECIFY COLOR**

TIP: Brass, nickel plated.

RATING: 12 Amps AC for 10°C Temp. rise, continuous duty.

DESCR.: Ideally suited for checking sub-miniature equipment. Fits standard phone tip jacks.

No. 270	NET Per C \$18.00
---------	-------------------

INSULATED SHORT TIP PLUG

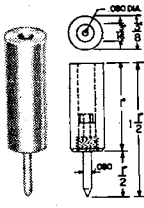

HANDLE: MOLDED THERMOSETTING plastic, Red & Black per MIL-M-14 CFG. Yellow, Green, Blue, White per LC-726-1. **SPECIFY COLOR**

PLUG: Brass, nickel plated.

RATING: 12 Amps AC for 10°C Temp. rise, continuous duty.

DESCR.: Inserts flush to insulate handle, no metal exposed; eliminates possibility of shock or grounding. Fits standard phone tip jacks.

No. 203	NET Per C \$12.00
---------	-------------------

INSULATED SHORT TIP PLUG Solderless

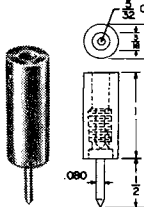

HANDLE: MOLDED THERMOSETTING plastic, Red & Black per MIL-M-14 CFG. Yellow, Green, Blue, White per LC-726-1. **SPECIFY COLOR**

PLUG: Brass, nickel plated.

RATING: 12 Amps AC for 10°C Temp. rise, continuous duty.

DESCR.: Solderless: wire fits through handle and body of tip then wrapped around screw portion. Inserts flush to insulate handle, no metal exposed, eliminates possibility of shock or grounding. Fits standard phone tip jacks.

No. 285	NET Per C \$14.00
---------	-------------------

INSULATED TIP PLUG Phono Needle

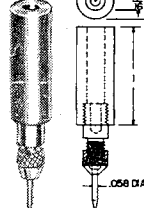

HANDLE: MOLDED THERMOSETTING plastic, Red & Black per MIL-M-14 CFG. Yellow, Green, Blue, White per LC-726-1. **SPECIFY COLOR**

BODY: Brass, nickel plated.

RATING: 12 Amps AC for 10°C Temp. rise, continuous duty.

DESCR.: Removable chunk for easy replacement of broken needle. Needle pierces corrosion or plating for positive reading.

No. 216	NET Per C \$20.00
---------	-------------------

ADAPTER Banana Plug to Tip Plug

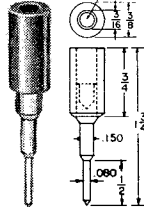

HANDLE: MOLDED BUTYRATE, per FED. SPEC. L-P349A, Type 3, Class MS. Red or Black. **SPECIFY COLOR**

BODY: Brass, nickel plated.

RATING: 12 Amps AC for 10°C Temp. rise, continuous duty.

DESCR.: Accepts standard banana plugs, adapts to standard tip plug.

No. 215	NET Per C \$15.00
---------	-------------------

SUB-MINIATURE TIP PLUG AND TEST PROD

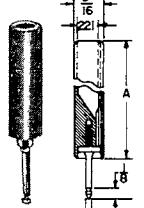

HANDLE: Molded Nylon, per MIL-P-20693A. Available in Red or Black. **SPECIFY COLOR**

TIP: Brass, Silver plated.

DESCR.: Solderless assembly. Ideal for use with sub-miniature printed-circuit tip jacks. Sharp tip breaks flux or oxide coating on printed-circuit pattern for positive contact when used as prod. Grooved head or prod makes positive contact when laid across wires. Fits all standard .080" tip jacks.

No. 348	Handle (A) 1 inch	Overall (B) 1 1/2"	NET Per C \$33.00
349	4 inches	4 1/2"	42.00

METER TIP PLUG

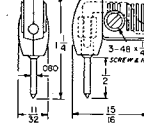

HANDLE: MOLDED THERMOSETTING plastic, per MIL-M-14 CFG. Red and Black. **SPECIFY COLOR**

TIP: Brass, nickel plated.

RATING: 12 Amps AC for 10°C Temp. rise, continuous duty.

DESCR.: Molded in two halves for easy assembly with screw and nut. Fits standard phone tip jacks.

No. 235	NET Per C \$27.00
---------	-------------------

INSULATED BANANA PLUG

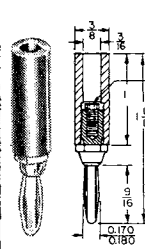

HANDLE: MOLDED THERMOSETTING plastic, Red & Black per MIL-M-14 CFG. Yellow, Green, Blue, White per LC-726-1. **SPECIFY COLOR**

PLUG: Hex brass, nickel or silver plated.

SPRING: Four-leaved phosphor bronze or beryllium copper, nickel or silver plated.

RATING: 15 Amps AC for 10°C Temp. rise, continuous duty.

DESCR.: Wire can be soldered to brass stud or directly into plug itself. Stud also locks wire to plug for solderless connection. Fits standard banana jacks.

No. 212	Spring Material Phosphor Bronze	Plating Nickel	NET Per C \$23.00
232	Phosphor Bronze	Silver	25.00
242	Beryllium Copper	Nickel	32.00
262	Beryllium Copper	Silver	35.00

INSULATED BANANA PLUG

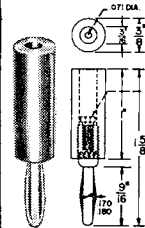

HANDLE: MOLDED THERMOSETTING plastic, Red & Black per MIL-M-14 CFG. Yellow, Green, Blue, White per LC-726-1. **SPECIFY COLOR**

PLUG: Brass, nickel or silver plated.

SPRING: Four-leaved phosphor bronze or beryllium copper, nickel or silver plated.

RATING: 15 Amps AC for 10°C Temp. rise, continuous duty.

DESCR.: Wire can be soldered to brass stud or directly into plug itself. Stud also locks wire to plug for solderless connection. Fits standard banana jacks.

No. 211	Spring Material Phosphor Bronze	Plating Nickel	NET Per C \$19.00
261	Phosphor Bronze	Silver	21.00
271	Beryllium Copper	Nickel	24.00
281	Beryllium Copper	Silver	27.00

INSULATED BANANA PLUG Solderless

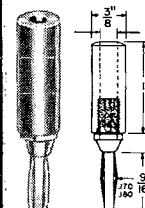

HANDLE: MOLDED THERMOSETTING plastic, Red & Black per MIL-M-14 CFG. Yellow, Green, Blue, White per LC-726-1. **SPECIFY COLOR**

PLUG: Hex brass, nickel or silver plated.

SPRING: Four-leaved phosphor bronze or beryllium copper, nickel or silver plated.

RATING: 15 Amps AC for 10°C Temp. rise, continuous duty.

DESCR.: Solderless: Wire fits through handle and body of tip then wrapped around screw portion. Fits standard banana jacks.

No. 295	Spring Material Phosphor Bronze	Plating Nickel	NET Per C \$26.00
296	Phosphor Bronze	Silver	27.00
297	Beryllium Copper	Nickel	33.00
298	Beryllium Copper	Silver	36.00

INSULATED BANANA PLUG Solderless

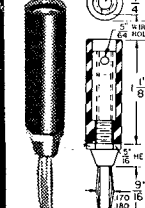

HANDLE: MACHINED BUTYRATE, per MIL-P-10408A, Type I, Class II. Red, Black. **SPECIFY COLOR**

BODY: Hex brass, nickel plated with mating brass spacer.

SPRING: Four-leaved phosphor bronze, nickel plated.

RATING: 15 Amps AC for 10°C Temp. rise, continuous duty.

DESCR.: Cross drilled hole in spacer enables quick solderless connection of wire to plug. Fits standard banana jacks.

No. 236	NET Per C \$35.00
---------	-------------------

METER BANANA PLUG

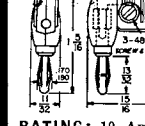

HANDLE: MOLDED THERMOSETTING plastic, per MIL-M-14 CFG. Red and Black. **SPECIFY COLOR**

PLUG: Brass, nickel plated.

SPRING: Four-leaved phosphor bronze, nickel plated.

RATING: 10 Amps AC for 10°C Temp. rise, continuous duty.

DESCR.: Molded in two halves for easy assembly with screw and nut. Fits standard banana jacks.

No. 255	NET Per C \$36.00
---------	-------------------

specify SMITH

HERMAN H. SMITH, INC.  ELECTRONIC COMPONENTS

INSULATED PHONE TIP JACK
HEAD: MOLDED THERMOSETTING plastic, Red and Black per MIL-M-14 CFG. Yellow, Green, Blue, White per LC-726-1.
SPECIFY COLOR
BODY: Brass, nickel plated.
SPRING: Phosphor bronze.
RATING: 15 Amps AC for 10°C Temp. rise, continuous duty. 750 Volts 60 cycle AC continuous working voltage. CAPACITANCE 4.0 mmfd.
DESCR.: Positive contact with standard phone tip plugs. Supplied complete with hex nut and fibre washer. Mounts in 5/16" hole in panels up to 3/8" thick. Accepts standard phone tip plugs. Std. Pkg. 100
NET Per C
 No. 202 \$14.00

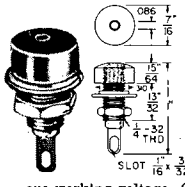

INSULATED PHONE TIP JACK
HEAD: MACHINED BUTYRATE, per MIL-P-10408A, Type I, Class II. Red, Black, Yellow, Green. **SPECIFY COLOR**
BODY: Brass, nickel plated.
SPRING: Phosphor bronze.
RATING: 15 Amps AC for 10°C Temp. rise, continuous duty. 750 Volts 60 cycle AC continuous working voltage. CAPACITANCE 4.0 mmfd.
DESCR.: Complete with hex nut and fibre washer. Mounts in 5/16" hole in panels up to 3/8" thick. Accepts standard phone tip plugs. Std. Pkg. 50
NET Per C
 No. 223 \$21.00

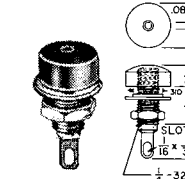

MOLDED NYLON TIP JACK
BODY: MOLDED NYLON, per MIL-P-20693A. Red, Black, Yellow, Green, Blue. **SPECIFY COLOR**
CONTACT: Phosphor bronze.
CAP: Brass, nickel plated.
RATING: 10 Amps AC for 10°C Temp. rise, continuous duty. 5 K Volts 60 cycle AC continuous working voltage. CAPACITANCE 3.0 mmfd.
DESCR.: Mounts in 5/16" hole in panels up to 3/8" thick. Accepts standard phone tip plugs. Std. Pkg. 100
NET Per C
 No. 240 \$18.00

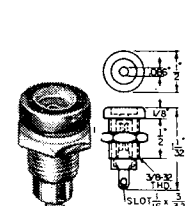

INSULATED PHONE TIP JACK
HEAD: Fluted Head, MOLDED NYLON, per MIL-P-20693A. With molded nylon washer. Red, Black, Yellow, Green, Blue. **SPECIFY COLOR**
BODY: Brass, nickel plated.
SPRING: Phosphor bronze.
RATING: 12 Amps AC for 10°C Temp. rise, continuous duty. 750 Volts 60 cycle AC continuous working voltage. CAPACITANCE 4.0 mmfd.
DESCR.: Extruded portion of head and washer provides excellent insulation from panel. Supplied with hex nut. Mounts in 5/16" hole in panels up to 3/8" thick. Accepts standard tip plugs. Std. Pkg. 100
NET Per C
 No. 241 \$25.00

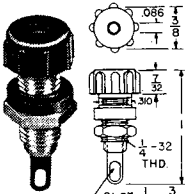

INSULATED TIP JACK Meter Type
HEAD: MOLDED THERMOSETTING plastic, Red and Black per MIL-M-14 CFG. Yellow, Green, Blue per LC-726-1.
SPECIFY COLOR
BODY: Brass, nickel plated.
SPRING: Phosphor bronze.
RATING: 15 Amps AC for 10°C Temp. rise, continuous duty. 750 Volts 60 cycle AC continuous working voltage. CAPACITANCE 4.0 mmfd.
DESCR.: Supplied complete with hex nut and fibre washer. Mounts in 5/16" hole in panels up to 3/8" thick. Recessed jack body prevents possibility of shock or grounding. Accepts standard phone tip plugs. Std. Pkg. 50
NET Per C
 No. 282 \$17.00

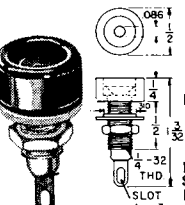

"SPEEDI-MOUNT" BANANA JACKS

#398—Small Head
#399—Large Head

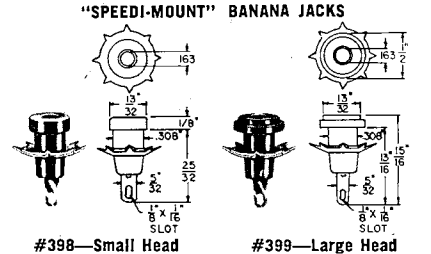

BODY: MOLDED THERMOSETTING plastic, Red and Black per MIL-M-14 CFG. Yellow, Green, Blue, White per LC-726-1. **SPECIFY COLOR**
CONTACT: Brass, cadmium plated.
WASHER: Steel cadmium plated, internal and external tooth.
RATING: 12 Amps AC for 10°C Temp. rise, continuous duty. 3 K Volts 60 cycle AC continuous working voltage. CAPACITANCE 4.0 mmfd.
DESCR.: Unusual dished lockwasher permits fast assembly. Teeth embed into jack and panels, prevent pulling out and turning. Mounts in 5/16" hole in panels up to 3/16" thick. Accepts standard banana plugs.
NET Per C
 No. 398 Small Head 13/32" \$6.60
 No. 399 Large Head 1/2" \$6.60

"SPEEDI-MOUNT" TIP JACKS

#279—Small Head
#299—Large Head

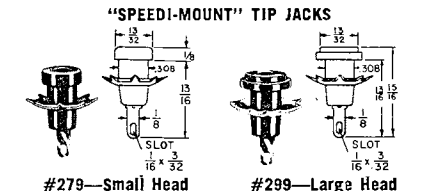

BODY: MOLDED THERMOSETTING plastic, Red and Black per MIL-M-14 CFG. Yellow, Green, Blue, White per LC-726-1. **SPECIFY COLOR**
SPRING: Phosphor bronze.
WASHER: Steel cadmium plated, internal and external tooth.
RATING: 12 Amps AC for 10°C Temp. rise, continuous duty. 3 K Volts 60 cycle AC continuous working voltage. CAPACITANCE 3.0 mmfd.
DESCR.: Unusual dished lockwasher permits fast assembly. Teeth embed into jack and panels, prevents pulling out and turning. Mounts in 5/16" hole in panels up to 3/16" thick. Accepts standard phone tip plugs.
NET Per C
 No. 279 Small Head 13/32" \$6.60
 No. 299 Large Head 1/2" \$6.60

GIANT BANANA JACK

BODY: HEX BRASS, nickel plated.
RATING: 25 Amps AC for 10°C Temp. rise, continuous duty.
DESCR.: Supplied with hex nut and brass tinned lug.
NET Per C
 No. 187 3/8" Mtg. Hole 1/2" Panel \$30.00
 No. 157 1/2" Mtg. Hole 5/8" Panel 30.00

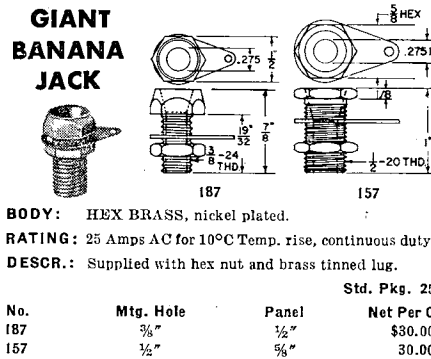

NYLON BANANA JACKS

"DOUBLE-D" BODY
BODY: MOLDED NYLON, per MIL-P-20693A. Specify color as coded above.
CONTACT: Brass, cadmium plated.
RATING: 15 Amps AC for 10°C Temp. rise, continuous working voltage. CAPACITANCE 5.5 mmfd.
DESCR.: Mounts in 5/16" hole in panels up to 5/16" thick. Accepts standard banana plugs. Wide temperature and humidity range. "Double-D" body mounts in round or punched hole to fit.
NET Per C
 No. 1499 As above but completely enclosed jack with solder turret terminals. \$12.00
 No. 1509 \$15.00

FULL ROUND BODY
BODY: MOLDED NYLON, per MIL-P-20693A. Specify color as coded above.
CONTACT: Brass, cadmium plated.
RATING: 15 Amps AC for 10°C Temp. rise, continuous duty. 1 K Volts 60 cycle AC continuous working voltage. CAPACITANCE 5.0 mmfd.
DESCR.: Mounts in 5/16" hole in panels up to 5/16" thick. Accepts standard banana plugs. Wide temperature and humidity range.
NET Per C
 No. 1498 As above but completely enclosed jack with solder turret terminals. \$12.00
 No. 1498 \$15.00

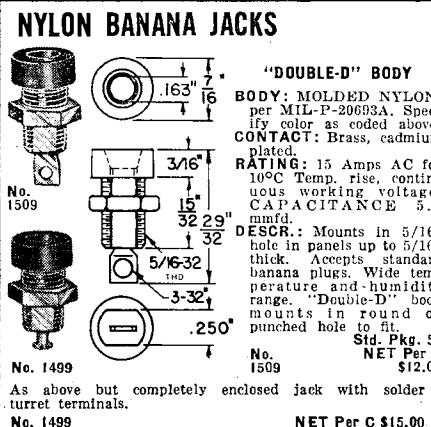

INSULATED BANANA JACK
HEAD: MOLDED THERMOSETTING plastic, Red and Black per MIL-M-14 CFG. Yellow, Green, Blue, White per LC-726-1.
SPECIFY COLOR
BODY: Brass, nickel plated.
RATING: 15 Amps AC for 10°C Temp. rise, continuous duty. 750 Volts 60 cycle AC continuous working voltage. CAPACITANCE 4.0 mmfd.
DESCR.: Supplied with hex nut, fibre washer, and brass tinned lug. Mounts in 5/16" hole in panels up to 3/8" thick. Accepts standard banana plugs. Std. Pkg. 100
NET Per C
 No. 205 \$14.00

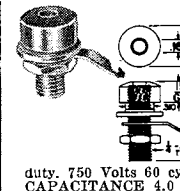

INSULATED BANANA JACK With Solder Tab
HEAD: MOLDED THERMOSETTING plastic, Red and Black per MIL-M-14 CFG. Yellow, Green, Blue, White per LC-726-1. **SPECIFY COLOR**
BODY: Brass, nickel plated.
TAB: Brass, cadmium plated.
RATING: 15 Amps AC for 10°C Temp. rise, continuous duty. 750 Volts 60 cycle AC continuous working voltage. CAPACITANCE 4.0 mmfd.
DESCR.: Supplied with hex nut and fibre washer. Mounts in 5/16" hole in panels up to 3/8" thick. Solder direct to tab. Accepts standard banana plugs. Std. Pkg. 100
NET Per C
 No. 256 \$15.00

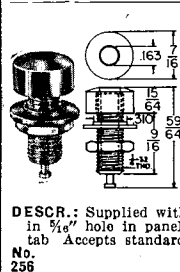

INSULATED BANANA JACK
HEAD: MOLDED THERMOSETTING plastic, Red and Black per MIL-M-14 CFG. Yellow, Green, Blue per LC-726-1. **SPECIFY COLOR**
BODY: Brass, nickel plated.
RATING: 15 Amps AC for 10°C Temp. rise, continuous duty. 750 Volts 60 cycle AC continuous working voltage. CAPACITANCE 4.0 mmfd.
DESCR.: Supplied with hex nut, fibre washer, lockwasher and brass tinned lug. Mounts in 5/16" hole in panels up to 3/8" thick. Jack body recessed for snug contact. Accepts standard banana plugs. Std. Pkg. 100
NET Per C
 No. 219 \$16.00

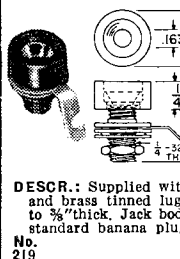

INSULATED MIDGET BANANA JACK
HEAD: Fluted Head, MOLDED NYLON, per MIL-P-20693A. With molded nylon washer. Red, Black, Yellow, Green, Blue. **SPECIFY COLOR**
BODY: Brass, nickel plated.
RATING: 15 Amps AC for 10°C Temp. rise, continuous duty. 1 K Volts 60 cycle AC continuous working voltage. CAPACITANCE 4.0 mmfd.
DESCR.: Extruded portion of head and washer provides excellent insulation from panel. Supplied with hex nut, brass tinned lug. Mounts in 5/16" hole in panels up to 3/8" thick. Accepts standard banana plugs. Std. Pkg. 100
NET Per C
 No. 221 \$24.00

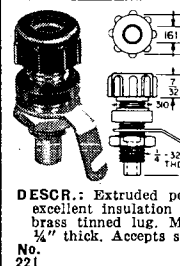

INSULATED JACK Combination Type
HEAD: MOLDED THERMOSETTING plastic, Red and Black per MIL-M-14 CFG. Yellow, Green, Blue, White per LC-726-1. **SPECIFY COLOR**
BODY: Brass, nickel plated.
SPRING: Phosphor bronze.
RATING: 12 Amps AC for 10°C Temp. rise, continuous duty. 750 Volts 60 cycle AC continuous working voltage. CAPACITANCE 4.0 mmfd.
DESCR.: Supplied with hex nut and fibre washer. Accepts standard phone tip plugs or standard banana plugs. Std. Pkg. 100
NET Per C
 No. 206 \$17.00

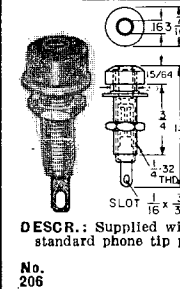

COLOR CODE SUFFIX — Add to Catalog Number as required

- 101 WHITE
- 102 RED
- 103 BLACK
- 104 GREEN
- 105 BLUE
- 106 ORANGE
- 107 YELLOW
- 108 BROWN
- 112 PURPLE
- 113 GREY

specify SMITH

HERMAN H. SMITH, INC.



ELECTRONIC COMPONENTS

SOLDERLESS TIP PLUG
BODY: Brass, nickel plated.
RATING: 12 Amps AC for 10°C Temp. rise, continuous duty.
DESCR.: Solderless; wire fits through body of tip then wrapped around screw portion and tightened with knurled collar. Force fit type. Fits standard phone tip jacks.
 No. 105 Type Senior NET Per C \$12.00

specify SMITH

HERMAN H. SMITH, INC.



ELECTRONIC COMPONENTS

BINDING POST - Multipurpose

NOTES:

- A Banana Plug Receptacle, .161 I.D.
- B Head non-removable from stud
- C Molded-in Brass Bushing in Head
- D Molded-in Brass Bushing in Washers.
- E For Panels 1/16" to 1/4" thick.
- F Drill 1/2" hole for mounting washers.
- G Wire Hole is at right angle to Flat on Insulated Washers.
- H Production Punch for keyed Slot for mounting Washers. (Sample Washer Sent on Request.)

RATING: 30 Amps AC for 10°C Temp. rise, continuous working voltage. CAPACITANCE 5.0 mfmfd.

CURRENT: 30 amps safe current carrying capacity.

ACCEPTS: Phone tip plug, spade lug, banana plug, alligator clip or wire strand.

DESCR.: MOLDED NYLON, per MIL-P-20693A, head and washer completely insulates post from panel. Mounts in 1/2" or keyed hole as indicated. Wrap around type—direct solder connection to stud. Metal parts brass.

COLORS: Red, Black, Yellow, Green, Blue, White. Specify color. **Std. Pkg. 100**
NET Per C \$40.00

MIL-SPEC BINDING POST

Same as our #257 above, made to meet MIL-P-55149/1. **Std. Pkg. 50**
NET Per C \$50.00

PIN JACK TYPE

Same as above, with Beryllium copper, gold plated pin tip receptacle replacing Note "A" above. All other specifications apply. **Std. Pkg. 100**
NET Per C \$46.00

NYLON BINDING POST

Insulated

HEAD: CAPTIVE, MOLDED NYLON, per MIL-P-20693A, with brass Gold-Plated Insert.

BODY: Brass, Gold Plated

WASHERS: MOLDED NYLON, per MIL-P-20693A, with brass Gold-plated inserts.

ACCEPTS: Phone tip plug, spade lug, banana plug, alligator clip, or wire strand.

RATING: 15 Amps AC for 10°C Temp. rise, continuous duty. 1 K Volts 60 cycle AC continuous working voltage. CAPACITANCE 3.0 mfmfd.

DESCR.: Molded washers completely insulate post from panel. Miniature washers and narrow fluted head require minimum panel space. Mounts in 3/8" round or "D" hole in panel as indicated. Wrap-around solder terminal stud for direct connection.

COLORS: Red, Black, Yellow, Green, Blue, White. Specify color. **Std. Pkg. 100**
NET Per C \$40.00

BINDING POST

Five-Way Grounding Type

HEAD: CAPTIVE, MOLDED BUTYRATE, per Fed. Spec. L-P349A, Type 3, Class MS. Red or Black.

BODY: Brass, nickel plated.

ACCEPTS: Phone tip plug, spade lug, banana plug, alligator clip or wire strand.

RATING: 15 Amps AC for 10°C Temp. rise, continuous duty. 1 K Volts 60 cycle AC continuous working voltage, when insulated from panel as recommended. CAPACITANCE 5.0 mfmfd.

DESCR.: Can be insulated from panel with our 2155 and 2163 fibre washers. Supplied with 2 hex nuts.

No.	Description	NET Per C
220	8-32 x 1/2 Stud	\$22.00
230	6-32 x 3/8 Stud	22.00
391	Rivet Type	17.00
With brass nickel plated insert in head		
260	8-32 Stud	\$26.00
264	6-32 Stud	26.00
394	Rivet Type	21.00

All Insulated Type

HEAD: As above.

BODY: As above.

WASHERS: MOLDED BUTYRATE, per Fed. Spec. L-P349A, Type 3, Class MS. With brass inserts.

ACCEPTS: Phone tip plug, spade lug, banana plug, alligator clip or wire strand.

RATING: 15 Amps AC for 10°C Temp. rise, continuous duty. 1 K Volts 60 cycle AC continuous working voltage. CAPACITANCE 3.0 mfmfd.

DESCR.: Mounts in 1/2" hole in panel with milled slot for locking, supplied with two hex nuts.

No.	Description	NET Per C
260	8-32 Stud	\$40.00
269	6-32 Stud	40.00
With brass nickel plated insert in head		
290	8-32 Stud	\$45.00
291	6-32 Stud	45.00

NYLON BINDING POSTS

Grounding Type

HEAD: CAPTIVE: MOLDED NYLON, per MIL-P-20693A. Red or Black with brass nickel plated insert.

WASHER: Molded nylon with brass nickel plated insert.

BODY: Brass, nickel plated.

RATING: 15 Amps AC for 10°C Temp. rise, continuous duty. 1 K Volts 60 cycle AC continuous working voltage, when insulated from panel as recommended. CAPACITANCE 6.0 mfmfd.

DESCR.: Supplied with 2 hex nuts. Grounds to panel but supplied with nylon washer for uniformity of height with No. 378 when used on same panel. Can be insulated from panel by using our No. 2150 shoulder washer.

Std. Pkg. 100
NET Per C \$35.00

ALL INSULATED

HEAD: CAPTIVE: MOLDED NYLON, per MIL-P-20693A. Red or Black with brass nickel plated insert.

WASHER: Molded nylon with brass nickel plated insert.

BODY: Brass, nickel plated.

RATING: 15 Amps AC for 10°C Temp. rise, continuous duty. 1 K Volts 60 cycle AC continuous working voltage. CAPACITANCE 4.0 mfmfd.

DESCR.: Supplied with two hex nuts. Boss washer insulates post from chassis when used with bakelite washer supplied.

Min. Panel Stud, Pkg. 100
Thickness **NET Per C**
1/16" \$35.00
1/32" 35.00

GROUNDING TYPE

HEAD: CAPTIVE: MOLDED NYLON, per MIL-P-20693A. Red or Black with brass nickel plated insert.

BODY: Brass, nickel plated.

RATING: 15 Amps AC for 10°C Temp. rise, continuous duty. 1 K Volts 60 cycle AC continuous working voltage, when insulated from panel as recommended. CAPACITANCE 7.0 mfmfd.

DESCR.: Supplied with two hex nuts. Can be insulated from panel by using our No. 2150 shoulder washer and 2162 flat washer.

Std. Pkg. 100
NET Per C \$30.00

COMBINATION TERMINALS

MATERIAL: BRASS, alloy

DESCR.: Combination Screw and Turret Terminal. Knurled shank prevents turning. Supplied complete with BIMS and internal plate with BIMS and internal Tooth Lockwasher, assembled.

No.	A	B	C	D	E	F	G	BIMS	Thk C	Panel Per
2045	3/16	1/4	1/8	9/64	1 1/4	1/2	.220	6-32	3/16	\$11.40
2046	1/8	3/16	3/16	1/4	1 1/4	3/8	.250	8-32	3/16	11.40
2047	3/16	3/8	3/8	1/4	1 1/4	3/8	.257	10-32	3/16	11.40

SPRING LOADED BINDING POSTS

HEAD: CAPTIVE, Brass nickel plated.

CAP: STYRENE, per Fed. Spec. L-P416, Type I, Black.

BODY: Brass, nickel plated.

PIN: Nickel Silver.

ACCEPTS: Standard phone tip or wire in place hole and locks them in place on release of pressure on cap.

RATING: 15 Amps AC for 10°C Temp. rise, continuous duty.

DESCR.: Side dowel pin locates and prevents post from turning when mounted in panel.

With Dowel Pin		Less Dowel Pin	
A	B	No.	NET Per C
1/4"	1/2"	2701	\$45.00
3/8"	5/8"	2702	47.00
1/2"	3/4"	2703	49.00
5/8"	1"	2704	50.00
3/4"	1 1/8"	2705	52.00
1"	1 1/4"	2706	55.00
1 1/8"	1 3/4"	2707	58.00
1 1/4"	2"	2708	60.00

Same as above less threaded stud. Supplied with 6-32 internal mounting thread.

No.	Description	NET Per C
2701	With 1/2" lg. Dowel Pin	\$40.00
2809	Without Dowel Pin	36.00

BINDING POST

Five-Way With Molded Mounting Washers

All Insulated Type

HEAD: CAPTIVE: MOLDED BUTYRATE, per Fed Spec. L-P349A, Type 3, Class MS. Red or Black.

BODY: Brass, nickel plated.

WASHERS: MOLDED BUTYRATE, per Fed Spec. L-P349A, Type 3, Class MS.

ACCEPTS: Phone tip plug, spade lug, banana plug, alligator clip or wire strand.

RATING: 15 Amps AC for 10°C Temp. rise, continuous duty. 1 K Volts 60 cycle AC continuous working voltage. CAPACITANCE 5.0 mfmfd.

DESCR.: Mounts in 1/2" hole in panel. Supplied with one hex nut. **Std. Pkg. 100**
NET Per C \$25.00

Grounding Type

HEAD: CAPTIVE: MOLDED BUTYRATE, per Fed Spec. L-P349A, Type 3, Class MS. Red or Black.

BODY: Brass, nickel plated.

WASHERS: MOLDED BUTYRATE, per Fed Spec. L-P349A, Type 3, Class MS. Mounting Washer Molded plastic. Back-up Washer—Brass, nickel plated.

RATING: 15 Amps AC for 10°C Temp. rise, continuous duty.

DESCR.: Mounts in 1/2" hole in panel. Grounds to panel by back-up washer. Supplied with one hex nut.

Std. Pkg. 100
NET Per C \$25.00

METAL BINDING POST

Grounded

HEAD: CAPTIVE, Fluted Brass, Gold-plated.

BODY: Brass, Gold-plated.

WASHER: MOLDED BLACK NYLON, per MIL-P-20693A, with brass Gold-plated insert.

ACCEPTS: Phone tip plug, spade lug, banana plug, alligator clip, or wire strand.

RATING: 15 Amps AC for 10°C Temp. rise, continuous duty.

DESCR.: Fluted-head metal post to match our No. 1517. For use where direct ground connection is made to panel or chassis. Supplied with brass, gold-plated flat metal washer for grounding.

Std. Pkg. 100
NET Per C \$45.00

METAL BINDING POST

Insulated

HEAD: CAPTIVE, Fluted Brass, Gold-plated.

BODY: Brass, Gold-plated.

WASHER: MOLDED BLACK NYLON, per MIL-P-20693A, with brass Gold-plated insert.

ACCEPTS: Phone tip plug, spade lug, banana plug, alligator clip, or wire strand.

RATING: 15 Amps AC for 10°C Temp. rise, continuous duty. 1 K Volts, 60 cycle AC continuous working voltage. CAPACITANCE 3.0 mfmfd.

DESCR.: Fluted-head metal post to match our No. 1517. Molded washers insulate post from panel for use where internal ground circuit is isolated from chassis or panel.

Std. Pkg. 100
NET Per C \$50.00

BINDING POST - Metal Five-Way

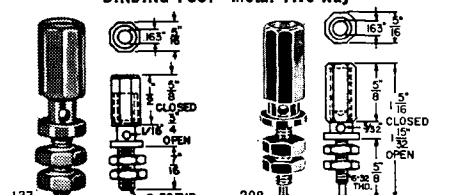

HEAD: CAPTIVE: octagonal brass, nickel plated.

BODY: Brass, nickel plated.

ACCEPTS: Phone tip, spade lug, banana plug, alligator clip or wire strand.

RATING: 15 Amps AC for 10°C Temp. rise, continuous duty. 1 K Volts 60 cycle AC continuous working voltage, when insulated from panel as recommended. CAPACITANCE 5.0 mfmfd.

DESCR.: Can be completely insulated from panel by using our 2155 and 2163 fibre washers. Supplied with two hex nuts.

No.	Description	NET Per C
137	Standard	\$25.00
208	Wrap-around	33.00

specify **SMITH**

HERMAN H. SMITH, INC.



ELECTRONIC COMPONENTS

SOLDERLESS TIP TEST LEAD
 HANDLE: MOLDED BUTYRATE, per Fed. Spec. L-P349A, Type 3, Class MS. Red and Black.
 TIP: Solderless: Brass, nickel plated.

No.	Meter End	Std. Pkg. 6 NET Per Pr.
600	Phone Tips	\$1.05
601	Spade Lugs	1.05
602	Alligator Clips	1.10

PHONO NEEDLE TEST LEAD
 HANDLE: MOLDED BUTYRATE, per Fed. Spec. L-P349A, Type 3, Class MS. Red and Black.
 BODY: Brass, nickel plated.
 NEEDLE: Steel, nickel plated, Std. Pkg. 6

No.	Meter End	NET Per Pr.
613	Phone Tips	\$1.05
614	Spade Lugs	1.05
615	Alligator Clips	1.10

ALL SOLDERLESS TEST LEAD
 HANDLE: MOLDED BUTYRATE, per Fed. Spec. L-P349A, Type 3, Class MS. Red and Black.
 PLUG: MOLDED THERMOSETTING plastic, Red and Black per MIL-M-14 CFG.
 TIP: Solderless: Brass, nickel plated.

No.	Meter End	NET Per Pr.
603		1.35

HIGH TENSION TEST LEAD
 HANDLE: FIBRE, per MIL-F-1148A, Grade CH. Red and Black.
 PLUG: FIBRE, per MIL-F-1148A, Grade CH. Red and Black.
 TIP: Brass, nickel plated.

No.	Meter End	NET Per Pr.
620	Ins. Phone Tips	\$2.20
621	Ins. Spade Lugs	2.20
622	Ins. Alligator Clips	2.40

SHORT TIP TEST LEAD
 HANDLE: MOLDED BUTYRATE, per Fed. Spec. L-P349A, Grade CH. Red and Black.
 PLUG: MOLDED THERMOSETTING plastic, Red and Black per MIL-M-14 CFG.
 TIP: Brass, nickel plated.

No.	Meter End	NET Per Pr.
624		\$1.10

SLIM HANDLE TEST LEAD
 HANDLES: MACHINED BUTYRATE, per MIL-P10408A, Type 1, Class 2. Red and Black.
 TIPS: Prod: Brass, Nickel Plated. Meter End: Drawn Brass Nickel Plated.

No.	NET Per Pr.
670	\$85

BANANA PLUG TEST LEAD
 HANDLE: MOLDED BUTYRATE, per Fed. Spec. L-P349A, Type 3, Class MS. Red and Black.
 PLUG: MOLDED THERMOSETTING plastic, Red and Black per MIL-M-14 CFG.
 TIP: Solderless: Brass, nickel plated.
 BODY: Brass, nickel plated.
 SPRING: Four leaved phosphor bronze, nickel plated.

No.	Std. Pkg. 6	NET Per Pr.
623		\$1.50

SUB MINIATURE TEST LEAD
 HANDLE: FIBRE, per MIL-F-1148A, Grade CH. Red and Black.
 PLUG: FIBRE, per MIL-F-1148A, Grade CH. Red and Black.
 TIPS: Brass, nickel plated.

No.	Std. Pkg. 6	NET Per Pr.
676		\$1.26

TEST LEAD KIT
 DESCR.: Each kit is supplied with one pair of test leads. One end test prods, other end ins. banana plugs.
 FITTINGS: Two each: Phone tips, alligator clips, spade lugs.

No.	Type	NET Ea.
810	Solderless Prods	\$1.90
811	Needle Tip Prods	1.90

SHIELDED TEST LEADS
 HANDLE: MOLDED BUTYRATE, per Fed. Spec. L-P349A, Type 3, Class MS. Red and Black.
 TIP: Prod tip brass, nickel plated. Meter end, see type.
 DESCR.: Plugs insert flush to insulated handle. Prods have retractable cover leaving no metal exposed. Eliminates possibility of shock or grounding. Supplied with either phone tip or banana plug meter ends. Other variations on special order.

No.	Type	NET Per Pr.
616	Phone Tip End	\$1.90
817	Banana Plug End	2.00

ALLIGATOR CLIP TEST LEAD
 HANDLES: MOLDED BUTYRATE, per Fed. Spec. L-P349A, Type 3, Class MS. Red and Black.
 TIPS: Solderless: Brass, nickel plated.
 CLIPS: Steel, cadmium plated (No. 300).
 BOOT: Vinyl Plastic. Red and Black

No.	NET Per Pr.
672	\$1.26

ALLIGATOR CLIP TEST LEAD
 CLIPS: STEEL, cadmium plated.

No.	Wire	Std. Pkg. 6 NET Per Pr.
604	12 inches	\$1.72
605	24 inches	.75
606	36 inches	.78
607	48 inches	.81

ALLIGATOR CLIP TEST LEAD With Boots
 CLIPS: Steel, Cadmium Plated
 BOOTS: Vinyl plastic Red and Black.

No.	Wire	NET Per Pr.
629	12 inches	\$1.92
657	24 inches	.96
658	36 inches	.99
659	48 inches	1.02

ALLIGATOR CLIP TEST LEAD
 CLIP HANDLES: MOLDED BUTYRATE, per Fed. Spec. L-P349A, Type 3, Class MS. Red and Black.
 PLUG HANDLES: MOLDED THERMOSETTING PLASTIC, per MIL-M-14 CFG. Red and Black
 CLIPS: Steel, cadmium plated
 TIPS: Solderless: Brass, nickel plated.

No.	NET Per Pr.
627	\$1.99

ALLIGATOR CLIP TEST LEAD
 CLIP HANDLES: MOLDED BUTYRATE, per Fed. Spec. L-P349A, Type 3, Class MS. Red and Black
 CLIPS: Steel, cadmium plated.
 ELBOWS: MOLDED THERMOSETTING PLASTIC, per MIL-M-14 CFG. Red and Black
 TIPS: Brass, nickel plated.

No.	NET Per Pr.
628	\$1.20

ALLIGATOR CLIP TEST LEAD
 CLIP HANDLES: MOLDED BUTYRATE, per Fed. Spec. L-P349A, Type 3, Class MS, Red and Black
 CLIPS: Steel, cadmium plated.
 ELBOWS: MOLDED THERMOSETTING PLASTIC, per MIL-M-14 CFG. Red and Black

No.	NET Per Pr.
647	\$1.30

ALLIGATOR CLIP TEST LEAD
 CLIP HANDLES: MOLDED BUTYRATE, per Fed. Spec. L-P349A, Type 3, Class MS, Red and Black
 CLIPS: Steel, cadmium plated.
 LUGS: Steel, hot tinned

No.	Std. Pkg. 6 NET Per C
649	\$1.20

CROCODILE CLIP TEST LEAD
 CLIP: STEEL, cadmium plated.
 BOOT: Vinyl plastic. Red and Black.
 HANDLE: MOLDED BUTYRATE, per Fed. Spec. L-P349A, Type 3, Class MS. Red and Black
 LUG: Steel, Hot tinned

No.	NET Per Pr.
671	\$1.20

CROCODILE CLIP TEST LEAD
 CLIPS: Steel, Cadmium plated.
 BOOTS: Vinyl plastic, Red and Black.
 ELBOWS: MOLDED THERMOSETTING PLASTIC, per MIL-M-14 CFG. Red and Black

No.	Std. Pkg. 6 NET Per Pr.
648	\$1.30

CROCODILE CLIP TEST LEAD
 CLIPS: STEEL, cadmium plated.
 BOOT: Vinyl plastic. Red and Black.
 ELBOW: MOLDED THERMOSETTING PLASTIC, per MIL-M-14 CFG. Red and Black
 TIP: Brass, nickel plated.

No.	NET Per Pr.
675	\$1.20

"UNIVERSAL TEST LEAD" Completely Interchangeable
 Fifty Leads In One! One lead can make any required test lead combination. All parts adapt into prod handle or tip handle. Complete as shown. With plastic kit. Std. Pkg. 6

No.	NET Ea.
699	\$3.00

"UNIVERSAL TEST LEAD" Miniature Accessories Completely Interchangeable
 Fifty Leads In One. One lead can make any required test lead combination. All parts adapt into prod handle or meter tip. Supplied with miniature tips, clips, banana plugs and spade tips. Complete as shown. With plastic kit.

No.	NET Ea.
679	\$3.00

METER TEST LEADS Solderless Prod
 HANDLE: MOLDED BUTYRATE, per Fed. Spec. L-P349A, Type 3, Class MS. Red and Black.
 TIP: Solderless: Brass, nickel plated.
 ELBOW: MOLDED THERMOSETTING plastic, per MIL-M-14 CFG. Red and Black.
 BODY: Brass, nickel plated.
 SPRING: Four leaved, phosphor bronze, nickel plated.

No.	Type	NET Per Pr.
625	Phone Tip Meter Tip	\$1.50
685	Banana Meter Tip	1.70

NEEDLE PROD
 HANDLE: MOLDED BUTYRATE, per Fed. Spec. L-P349A, Type 3, Class MS. Red and Black.
 NEEDLE: Steel, nickel plated.
 ELBOW: MOLDED THERMOSETTING plastic, per MIL-M-14 CFG. Red and Black.
 BODY: Brass, nickel plated.
 SPRING: Four leaved, phosphor bronze, nickel plated.

No.	Type	NET Per Pr.
626	Phone Tip Meter Tip	\$1.50
686	Banana Meter Tip	1.70

SLIM JIM TEST LEAD
 HANDLE: MOLDED BUTYRATE, per Fed. Spec. L-P349A, Type 3, Class MS. Red and Black.
 PROBE: Steel, cadmium plated.
 INSULATOR: Vinyl spaghetti tubing, Red and Black.
 ELBOWS: MOLDED THERMOSETTING plastic, per MIL-M-14 CFG. Red and Black.
 TIPS: Brass, nickel plated.

No.	NET Per Pr.
698	\$1.35

MIDGET ALLIGATOR CLIP TEST LEAD
 CLIPS: STEEL, Cadmium plated
 BOOTS: Vinyl plastic Red and Black.

No.	Wire	Std. Pkg. 6 NET Per Pr.
716	12 inches	\$1.92
717	18 inches	.94
718	24 inches	.96
719	36 inches	.99

RETRACTILE ALL SOLDERLESS TEST LEAD
 HANDLE: MOLDED BUTYRATE per Fed. Spec. L-P349A, Type 3, Class MS. Red and Black.
 PLUG: MOLDED THERMOSETTING plastic, Red and Black per MIL-M-14 CFG.
 TIP: Solderless brass, nickel plated.
 WIRE #20 gauge, 41/36 strand, 4000 volt, nom. O.D. .165. Retracts to 12". Extends to 6 ft. Std. Pkg. 6

No.	NET Per Pr.
618	\$3.00

TEST LEAD WIRE SPECIFICATIONS
 All test leads on this page are supplied with extra-flexible rubber-covered kinkless wire, 50-in. long, unless specified otherwise. #20 wire, 26/34 strands, 5000 Volts, .125" O.D.

specify SMITH

HERMAN H. SMITH, INC.



ELECTRONIC COMPONENTS

STANDARD PHONE PLUGS

BODY: Body, tip, and sleeve—Brass, nickel plated.
RATING: 5 Amps AC for 10°C Temp. rise, continuous duty. 750 Volts 60 cycle AC working voltage.
DESCR.: Fits standard phone jacks. Molded styrene separator insures maximum insulation between elements.
LUGS: 2 circuit plugs are screw terminals with ribbed clips and cord anchor. 3 circuit plugs are solder lugs. Std. Pkg. 25

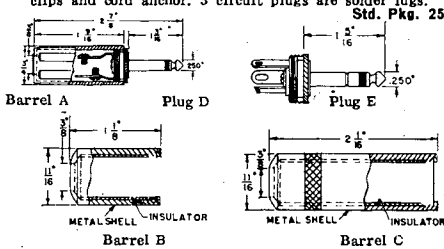

Bakelite Barrel

BARREL: MOLDED THERMOSETTING plastic, per MIL-M-14 CFG. Red and Black. SPECIFY COLOR

No.	Circuit	Terminals	Plug	Barrel	NET Per C
222	2	Screw	D	A	\$51.00
227	3	Solder	E	A	69.00

Shielded Barrel

BARREL: BRASS, nickel plated with tubular insert.

No.	Circuit	Terminals	Plug	Barrel	NET Per C
252	2	Screw	D	B	\$66.00
272	2	Screw	D	C	84.00
228	3	Solder	E	B	90.00
288	3	Solder	E	C	105.00

STANDARD PHONE PLUG

Baby Bakelite Barrel

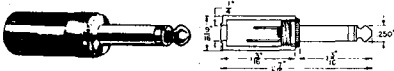

BARREL: MOLDED THERMOSETTING plastic, per MIL-M-14 CFG. Red and Black. SPECIFY COLOR
BODY: Body, tip, sleeve—Brass, nickel plated.
RATING: 5 Amps AC for 10°C Temp. rise, continuous duty. 750 Volts 60 cycle AC continuous working voltage.
DESCR.: Molded styrene separator insures maximum insulation between conductors. Fits standard phone jacks. Std. Pkg. 25

No.	Circuit	Terminals	NET Per C
243	Two	Solder	\$39.00

PJ055 AND PJ068 PLUGS

BARREL: MOLDED plastic.
BODY: Body, tip, sleeve—Machined brass.
TERM.: Brass, hot tinned.
INSUL.: Ethyl cellulose type EM-1 MIL-P-3412.
DESCR.: Designed especially for high quality communications equipment and to meet the exacting requirements of the armed services. Parts are assembled together in a mold, providing a finished plug with complete continuity of thermo plastic insulation between the tip rod and plug sleeve. Std. Pkg. 25

No.	Type	Each
217	PJ055B	\$.95
247	PJ068B	2.19

CORD CLAMP STRAIN RELIEF

MATERIAL: Cold Rolled Steel, per QQ-S-636. Finish zinc per Spec. 7253, Table II, Type 1.
DESCR.: Used on Government cord assemblies. Made in accordance with Signal Corps. Spec. SC-A-7674. Std. Pkg. 100

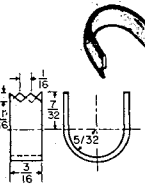

No.	NET Per C
747	\$1.80

TELEPHONE CORD SLEEVE

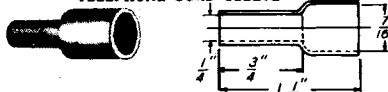

MATERIAL: Neoprene in accordance with Grade SC415A FF per MIL-R-3065.
DESCR.: Used on Government cord assemblies, for Strain Relief, Dust and Moisture Seal. Std. Pkg. 100

No.	NET Per C
749	\$9.00

PHONE PLUG ADAPTER

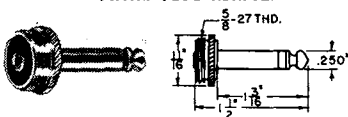

BODY: Body, Tip, Sleeve—Brass, nickel plated.
INSUL.: XXXP Bakelite.
DESCR.: Mates with No. 116 microphone connector. Fits standard phone jacks. Std. Pkg. 25

No.	NET Per C
113	\$33.00

TELEPHONE JACKS

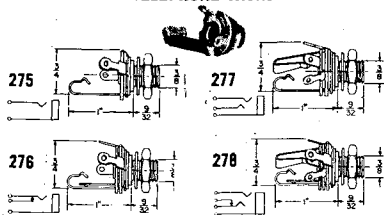

BUSHING: BRASS, nickel plated.
INSUL.: Bakelite, type PBE-P per MIL-P-3115B.
SPRING: Nickel-Silver alloy, spring temper. New tapered design provides for ease of insertion while eliminating possibility of shorts.
SLEEVE TERM.: Brass, hot tinned.
RATING: 10 Amps AC for 10°C Temp. rise, continuous duty. 1.2 K Volts 60 cycle AC continuous working voltage.
DESCR.: Notched insulating washers accurately locate all parts, and eliminate possibility of shorts and arc-over. Springs designed for firm, low-resistance electrical contact. Bushings 1/4" long, threaded 3/32". Mounts in 3/8" hole in panels up to 1/2" thick. Overall diameter 3/8". require 1" clearance behind panel. Supplied with 1/2" nickel hex brass nut and 3/8" steel panel washer. Std. Pkg. 50

No.	Circuit	NET Per C
275	Two Conductor Open	\$27.00
276	Two Conductor Closed	30.00
277	Three Conductor Open	36.00
278	Three Conductor Closed	51.00

IN-LINE EXTENSION JACK

Bakelite Barrel

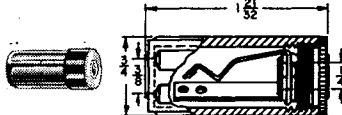

BARREL: MOLDED THERMOSETTING plastic, per MIL-M-14 CFG. Red and Black. SPECIFY COLOR
BODY: Brass, nickel plated.
RATING: 10 Amps AC for 10°C Temp. rise, continuous duty. 1 K Volts 60 cycle AC continuous working voltage.
SPRING: Nickel, silver, special alloy, spring temper.
INSUL.: XXP Bakelite.
DESCR.: For microphone and Hi-Fi extension cords. Mates with standard phone plugs. Std. Pkg. 50

No.	Type	NET Per C
274	Solder Connection	\$66.00
288	Screw Connection	75.00

Shielded Barrel

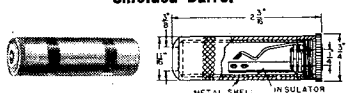

BARREL: Brass, nickel plated, with tubular insulator.
BODY: Brass, nickel plated.
RATING: 10 Amps AC for 10°C Temp. rise, continuous duty. 1 K Volts 60 cycle AC continuous working voltage.
SPRING: Nickel, silver, special alloy, spring temper.
INSUL.: XXP Bakelite.
DESCR.: For microphone and Hi-Fi extension cords. Mates with standard phone plugs. Std. Pkg. 25

No.	Type	NET Per C
273	Solder Connection	\$93.00
289	Screw Connection	102.00

MINIATURE MICROPHONE CONNECTORS

3/32 THREAD

DESCR.: Ideal for lapel microphone, musical instruments, etc., wherever small cable is used. Accepts cable up to 3/16" diameter. Std. Pkg. 50

No.	Type	Length	NET Per C
484	Single Contact Female	1 1/4"	\$39.00
485	Single Contact Male	1 1/4"	30.00

CHASSIS CONNECTOR

Mounts in 3/16" hole ground; 1/4" hole insulated with shoulder washer.

No.	Length	NET Per C
486	Single Contact Male	30.00

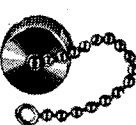

CAP AND CHAIN

DESCR.: Brass, nickel plated. Seals chassis connectors against dust. Eliminates noisy connections. Used with any threaded one or two conductor chassis unit. Std. Pkg. 10

No.	NET Per C
118	\$45.00

"SPECIALS are STANDARD with SMITH!"

For VARIATIONS of these standard parts to meet your SPECIAL requirements, or for entirely NEW parts made to your specifications, WE WELCOME YOUR INQUIRY!

SLIM PHONE PLUGS

Cable Clamp Style

BODY: Body, tip, and sleeve—Brass, nickel plated.
RATING: 5 Amps AC for 10°C Temp. rise, continuous duty. 750 Volts 60 cycle AC continuous working voltage.
DESCR.: Fits standard phone jacks. Molded styrene separator insures maximum insulation between elements. Std. Pkg. 25

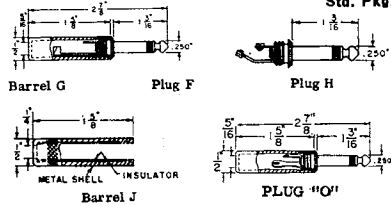

Bakelite Barrel

BARREL: MOLDED THERMOSETTING plastic, per MIL-M-14 CFG. Red and Black. SPECIFY COLOR

No.	Circuit	Terminals	Plug	Barrel	NET Per C
225	2	Solder	F	G	\$48.00
307	2	Screw	H	G	51.00

Shielded Barrel

BARREL: BRASS, nickel plated with tubular insert.

No.	Circuit	Terminals	Plug	Barrel	NET Per C
226	2	Solder	F	J	\$69.00
316	2	Screw	H	J	72.00

ECONOMY TYPE

BODY: Body, tip, sleeve—Brass, nickel plated.
RATING: 5 Amps AC for 10°C Temp. rise, continuous duty. 750 Volts 60 cycle AC continuous working voltage.
DESCR.: An inexpensive modified version of our popular #225 and 225 plugs shown above. Features two small solder lugs. Std. Pkg. 25

Bakelite Barrel

BARREL: MOLDED THERMOSETTING plastic, per MIL-M-14 CFG. Red and Black. SPECIFY COLOR

No.	Circuit	Terminals	Plug	Barrel	NET Per C
320	2	Solder	O	G	\$39.00

Shielded Barrel

BARREL: BRASS, nickel plated with tubular insert.

No.	Circuit	Terminals	Plug	Barrel	NET Per C
330	2	Solder	O	J	\$51.00

MINIATURE PHONE PLUG

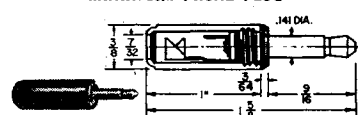

HANDLE: MOLDED plastic. Black.
BODY: Body, tip, sleeve—Brass, nickel plated.
TERM.: Brass, hot tin dipped.
RATING: 5 Amps AC for 10°C Temp. rise, continuous duty. 350 Volts 60 cycle AC continuous working voltage.
DESCR.: Designed for use with hearing aids, small meters, etc. Solder terminals. Std. Pkg. 50

No.	NET Per C
480	50.00

Shielded Barrel

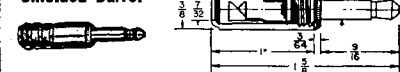

BARREL: BRASS, nickel plated with tubular insulator.
BODY: Body, tip, sleeve—Brass, nickel plated.
RATING: 5 Amps AC for 10°C Temp. rise, continuous duty. 350 Volts 60 cycle AC continuous working voltage.
DESCR.: Designed for use with hearing aids, small meters, etc. Solder terminals. Std. Pkg. 50

No.	Circuit	NET Per C
481	Two Conductor	\$58.00

MICROPHONE CONNECTORS

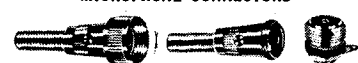

BODY: Brass, chrome plated.
SPRING: Steel cadmium plated.
INSUL.: XXXP Bakelite.
EYELET: Brass, hot tinned for easy soldering. Standard Type 3/27 Thread

DESCR.: Designed for use with single conductor cable. Microphone connectors provided with flexible protector spring. Cable clamped firmly to connector by hollow point set screw. Std. Pkg. 50

No.	Type	Length	NET Per C
115	Single Contact Male	1 3/4"	\$39.00
116	Single Contact Female	2"	39.00

CHASSIS CONNECTORS

Mount in .385 hole ground; .500 hole insulated with shoulder washer.

No.	Length	NET Per C
117	Single Contact Male	30.00

specify **SMITH**

HERMAN H. SMITH, INC.



ELECTRONIC COMPONENTS

DOUBLE BANANA PATCH CORDS

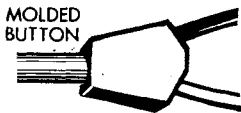
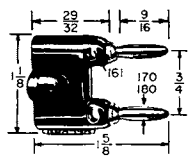

CABLE TYPES AVAILABLE

	WIRE "A"	WIRE "B"	WIRE "C"
DESCRIPTION	2-cond. tw. 18 ga. 65/36 str.	Shielded audio cable	Coaxial Cable RG58/U.
INSULATION	Vinyl	Polyethylene	Polyethylene
JACKET	Vinyl, Color Grey	Vinyl, Color Grey	Vinyl, Color Black
NOM. CAP.	30 mmf./ft.	25 mmf./ft.	28.5 mmf./ft.

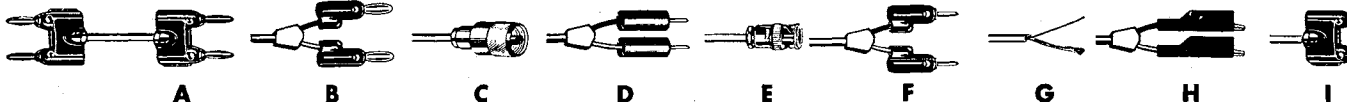

A DOUBLE PLUG BOTH ENDS
 HANDLE: MOLDED BUTYRATE, per Fed. Spec. L-P349A, Type 3, Class MS. Color to match wire.
 PLUG: Brass, nickel plated.
 SPRING: Four-leaved beryllium copper, nickel plated.
 WIRE: As specified above.
 DESCR.: Mates with standard dual binding post having 3/4" center. Polarity indicated by the word GROUND molded on side. Interconnects unlimited number of multiple circuits top and side. Each end terminates with molded double banana plug. Std. Pkg. 10

No. Wire "A"	No. Wire "B"	No. Wire "C"	Lgth.	NET Ea.
1530-12	1540-12	1580-12	12"	\$4.35
1530-24	1540-24	1580-24	24"	4.45
1530-36	1540-36	1580-36	36"	4.55
1530-48	1540-48	1580-48	48"	4.65
1530-60	1540-60	1580-48	60"	4.75

B DOUBLE PLUG TO "CROSS-PATCH" BANANA PLUGS
 HANDLE: MOLDED BUTYRATE, per Fed. Spec. L-P349A, Type 3, Class MS. Color to match wire.
 BODY: Brass, nickel plated.
 SPRING: Four-leaved beryllium copper, nickel plated.
 WIRE: As specified above.
 PLUG: Our No. 1510.
 DESCR.: Mates with standard dual binding post having 3/4" center. Polarity indicated by the word GROUND molded on side. Interconnects unlimited number of multiple circuits on top and side. One end terminates with double banana plug, other end with "Cross-Patch" banana plugs, color coded Red and Black. Std. Pkg. 10

No. Wire "A"	No. Wire "B"	No. Wire "C"	Lgth.	NET Ea.
1523-12	1524-12	1525-12	12"	\$5.35
1523-24	1524-24	1525-24	24"	5.45
1523-36	1524-36	1525-36	36"	5.55
1523-48	1524-48	1525-48	48"	5.65
1523-60	1524-60	1525-60	60"	5.75

C DOUBLE PLUG TO UHF MALE
 HANDLE: MOLDED BUTYRATE, per Fed. Spec. L-P349A, Type 3, Class MS. Color to match wire.
 PLUG: Brass, nickel plated.
 SPRING: Four-leaved beryllium copper, nickel plated.
 WIRE: As specified above.
 CONN.: PL-259A.
 DESCR.: Mates with standard dual binding post having 3/4" center. Polarity indicated by the word GROUND molded on side. One end terminates with double banana plug, other end with PL-259A. Std. Pkg. 10

No. Wire "A"	No. Wire "B"	No. Wire "C"	Lgth.	NET Ea.
1545-12	1545-12	1585-12	12"	\$5.35
1545-24	1545-24	1585-24	24"	5.45
1545-36	1545-36	1585-36	36"	5.55
1545-48	1545-48	1585-48	48"	5.65
1545-60	1545-60	1585-60	60"	5.75

D DOUBLE PLUG TO PHONE TIP
 HANDLE: MOLDED BUTYRATE, per Fed. Spec. L-P349A, Type 3, Class MS. Color to match wire.
 PLUG: Brass, nickel plated.
 SPRING: Four-leaved beryllium copper, nickel plated.
 WIRE: As specified above.
 PLUG: Our No. 203.
 DESCR.: Mates with standard dual binding post having 3/4" center. Polarity indicated by the word GROUND molded on side. One end terminates with double banana plug, other end with insulated tip plug, one red and one black. Std. Pkg. 10

No. Wire "A"	No. Wire "B"	No. Wire "C"	Lgth.	NET Ea.
1533-12	1543-12	1583-12	12"	\$4.35
1533-24	1543-24	1583-24	24"	4.45
1533-36	1543-36	1583-36	36"	4.55
1533-48	1543-48	1583-48	48"	4.65
1533-60	1543-60	1583-60	60"	4.75

E DOUBLE PLUG TO UG 88C/U
 HANDLE: MOLDED BUTYRATE, per Fed. Spec. L-P349A, Type 3, Class MS. Color to match wire.
 PLUG: Brass, nickel plated.
 SPRING: Four-leaved beryllium copper, nickel plated.
 WIRE: As specified above.
 CONN.: UG 88C/U.
 DESCR.: Mates with standard dual binding post having 3/4" center. Polarity indicated by the word GROUND molded on side. One end terminates with double banana plug, other end with UG 88 C/U. Std. Pkg. 10

No. Wire "A"	No. Wire "B"	No. Wire "C"	Lgth.	NET Ea.
1544-12	1544-12	1584-12	12"	\$5.35
1544-24	1544-24	1584-24	24"	5.45
1544-36	1544-36	1584-36	36"	5.55
1544-48	1544-48	1584-48	48"	5.65
1544-60	1544-60	1584-60	60"	5.75

F DOUBLE PLUG TO "CROSS-PATCH" PIN PLUGS
 HANDLE: MOLDED BUTYRATE, per Fed. Spec. L-P349A, Type 3, Class MS. Color to match wire.
 BODY: Brass, nickel plated.
 SPRING: Four-leaved beryllium copper, nickel plated.
 WIRE: As specified above.
 PLUG: Our No. 1595.
 DESCR.: Mates with standard dual binding post having 3/4" center. Polarity indicated by the word GROUND molded on side. Interconnects unlimited number of multiple circuits on top and side. One end terminates with double banana plug, other end with "Cross-Patch" Pin plugs with standard .080" tip and jack in rear, banana jack in side, color coded Red and Black. Std. Pkg. 10

No. Wire "A"	No. Wire "B"	No. Wire "C"	Lgth.	NET Ea.
1592-12	1593-12	1594-12	12"	\$5.35
1592-24	1593-24	1594-24	24"	5.45
1592-36	1593-36	1594-36	36"	5.55
1592-48	1593-48	1594-48	48"	5.65
1592-60	1593-60	1594-60	60"	5.75

G DOUBLE PLUG TO TINNED LEADS
 HANDLE: MOLDED BUTYRATE, per Fed. Spec. L-P349A, Type 3, Class MS. Color to match wire.
 PLUG: Brass, nickel plated.
 SPRING: Four-leaved beryllium copper, nickel plated.
 WIRE: As specified above.
 DESCR.: Mates with standard dual binding post having 3/4" center. Polarity indicated by the word GROUND molded on side. One end terminates with double banana plug, other end stripped and tinned. Std. Pkg. 10

No. Wire "A"	No. Wire "B"	No. Wire "C"	Lgth.	NET Ea.
1532-12	1542-12	1582-12	12"	\$3.35
1532-24	1542-24	1582-24	24"	3.45
1532-36	1542-36	1582-36	36"	3.55
1532-48	1542-48	1582-48	48"	3.65
1532-60	1542-60	1582-60	60"	3.75

H DOUBLE PLUG TO ALLIGATOR CLIPS
 HANDLE: MOLDED BUTYRATE, per Fed. Spec. L-P349A, Type 3, Class MS. Color to match wire.
 PLUG: Brass, nickel plated.
 SPRING: Four-leaved beryllium copper, nickel plated.
 CLIP: Steel cadmium plated (No. 300).
 INSUL.: Molded vinyl plastic (No. 331).
 WIRE: As specified above.
 DESCR.: Mates with standard dual binding post having 3/4" center. Polarity indicated by the word GROUND molded on side. One end terminates with double banana plug, other end with insulated alligator clips, one red, one black. Std. Pkg. 10

No. Wire "A"	No. Wire "B"	No. Wire "C"	Lgth.	NET Ea.
1531-12	1541-12	1581-12	12"	\$5.35
1531-24	1541-24	1581-24	24"	5.45
1531-36	1541-36	1581-36	36"	5.55
1531-48	1541-48	1581-48	48"	5.65
1531-60	1541-60	1581-60	60"	5.75

I DOUBLE PLUG TO DOUBLE JACK
 HANDLE: MOLDED BUTYRATE, per Fed. Spec. L-P349A, Type 3, Class MS. Color to match wire.
 PLUG: Brass, nickel plated.
 SPRING: Four-leaved beryllium copper, nickel plated.
 WIRE: As specified above.
 DESCR.: Mates with standard dual binding post having 3/4" center. Polarity indicated by the word GROUND molded on side. Interconnects unlimited number of multiple circuits top and side. One end terminates with molded double banana plug, other end in double extension jack. Std. Pkg. 10

No. Wire "A"	No. Wire "B"	No. Wire "C"	Lgth.	NET Ea.
1881-12	1822-12	1883-12	12"	\$4.35
1881-24	1822-24	1883-24	24"	4.45
1881-36	1822-36	1883-36	36"	4.55
1881-48	1822-48	1883-48	48"	4.65
1881-60	1822-60	1883-60	60"	4.75

COMBINATION BINDING POST AND BANANA PLUG
 HEAD: CAPTIVE, Molded Butyrate, per Fed. Spec. L-P349A, Type 3, Class MS. Red or Black.
 SPECIFY COLOR
 BODY: Brass, nickel plated.
 SPRING: Four-leaved phosphor bronze, nickel plated.
 RATING: 15 AMPS AC for 10°C Temp. rise, continuous duty.
 DESCR.: Converts any panel-mounted banana jack into a five-way binding post termination. Accepts phone tip, spade lug, banana plug, alligator clip, or solid or stranded wire. Std. Pkg. 25

No.	NET Per C
239	\$30.00

COMBINATION NYLON BINDING POST AND BANANA PLUG
 HEAD: CAPTIVE, Molded Nylon, per MIL-P-20693A. Available in Red, Black, Yellow, Green, Blue, White. Molded-in brass nickel plated insert.
 SPECIFY COLOR
 BODY: Brass, nickel plated.
 SPRING: Four-leaved phosphor bronze, nickel plated.
 RATING: 15 Amps AC for 10°C Temp. rise, continuous duty.
 DESCR.: Converts any panel-mounted banana jack into a nylon five-way binding post termination. Accepts phone tips, spade lugs, banana plug, alligator clips, or solid or stranded wires. Std. Pkg. 25

No.	NET Per C
234	\$30.00

COMBINATION PUSH POST AND BANANA PLUG
 HEAD: Captive, brass nickel plated.
 CAP: Molded Styrene, per Fed. Spec. L-P416, Type 3, Black.
 BODY: Brass, nickel plated.
 SPRING: Four-leaved phosphor bronze, nickel plated.
 RATING: 15 Amps AC for 10°C Temp. rise, continuous duty.
 DESCR.: Converts any panel-mounted banana jack into a spring loaded push-post. Accepts standard phone tip, solid or stranded wire, and locks them in place on release of pressure on cap. Std. Pkg. 25

No.	NET Per C
2714	\$75.00

FOR YOUR SPECIAL REQUIREMENTS IN PATCH CORDS • JUMPERS • TEST LEADS consult **HERMAN H. SMITH, INC.**

specify SMITH

HERMAN H. SMITH, INC.



ELECTRONIC COMPONENTS

JUMPERS & PATCH CORDS

STANDARD ALLIGATOR CLIP TO PIN PLUG



CLIPS: STEEL, Cadmium plated.
 BOOTS: Vinyl plastic. Boot colors match wire.
 RATING: 5 Amps AC for 10°C Temp. rise, continuous duty.
 WIRE: 10 KV PVC flexible wire, 65 strands #36 copper, #18 AWG, insulated to an O.D. of .140". Available in Red, Black, Yellow, Green, Blue, and White.

SPECIFY COLOR
 Std. Pkg. 10
 Net Ea.

No.	Length	Net Ea.
1596-12	12 inches	\$.47
1596-24	24 inches	.49
1596-36	36 inches	.51
1596-48	48 inches	.53
1596-60	60 inches	.55

MINIATURE ALLIGATOR CLIP BOTH ENDS

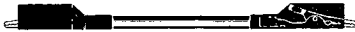

CLIPS: STEEL, Cadmium plated.
 BOOTS: Vinyl plastic. Boot colors match wire.
 RATING: 5 Amps AC for 10°C Temp. rise, continuous duty.
 WIRE: General purpose, PVC insulated 1/64" wall, #18 AWG, 16/30 stranded conductor, Available in Red, Black, Yellow, Green, Blue, and White.

SPECIFY COLOR
 Std. Pkg. 10
 Net Ea.

No.	Length	Net Ea.
1597-12	12 inches	\$.47
1597-18	18 inches	.48
1597-24	24 inches	.49
1597-36	36 inches	.51
1597-48	48 inches	.53
1597-60	60 inches	.55

STANDARD ALLIGATOR CLIP TO BANANA PLUG



HANDLES: MOLDED THERMOSETTING plastic, Red and Black per MIL-M-14 CFG. Yellow, Green, Blue, White per LC-726-1. SPECIFY COLOR

PLUG: Hex brass, nickel plated.
 SPRING: Four-leaved phosphor bronze, nickel plated.
 CLIPS: STEEL, Cadmium plated.
 BOOTS: Vinyl plastic. Boot colors match wire.
 RATING: 15 Amps AC for 10°C Temp. rise, continuous duty.

WIRE: 10 KV PVC flexible wire, 65 strands #36 copper, #18 AWG, insulated to an O.D. of .140". Std. Pkg. 10

No.	Length	Net Ea.
1866-12	12 inches	\$.57
1866-24	24 inches	.59
1866-36	36 inches	.61
1866-48	48 inches	.63
1866-60	60 inches	.65

STANDARD ALLIGATOR CLIP TO SPADE LUG



HANDLES: MOLDED BUTYRATE, per Fed. Spec. L-P349A, Type 3, Class MS. Red, Black, Green, assemblies. SPECIFY COLOR

LUG: Brass, .050 thick, nickel plated.
 CLIPS: STEEL, Cadmium plated.
 BOOTS: Vinyl plastic. Boot colors match wire.
 RATING: 15 Amps AC for 10°C Temp. rise, continuous duty

WIRE: 10 KV PVC flexible wire, 65 strands #36 copper, #18 AWG, insulated to an O.D. of .140". Std. Pkg. 10

No.	Length	Net Ea.
1867-12	12 inches	\$.52
1867-24	24 inches	.54
1867-36	36 inches	.56
1867-48	48 inches	.58
1867-60	60 inches	.60

SPADE LUG BOTH ENDS



HANDLES: MOLDED BUTYRATE, per Fed. Spec. L-P349A, Type 3, Class MS. Red, Black, Green, assemblies. SPECIFY COLOR

LUG: Brass, .050 thick, nickel plated.
 RATING: 25 Amps AC for 10°C Temp. rise, continuous duty.

WIRE: 10 KV PVC flexible wire, 65 strands #36 copper, #18 AWG, insulated to an O.D. of .140". Std. Pkg. 10

No.	Length	Net Ea.
1864-12	12 inches	\$.52
1864-24	24 inches	.54
1864-36	36 inches	.56
1864-48	48 inches	.58
1864-60	60 inches	.60

STANDARD ALLIGATOR CLIP TO PIN PLUG



HANDLES: MOLDED THERMOSETTING plastic, Red and Black per MIL-M-14 CFG. Yellow, Green, Blue, White per LC-726-1. SPECIFY COLOR

PLUG: Brass, nickel plated.
 CLIPS: STEEL, Cadmium plated.
 BOOTS: Vinyl plastic. Boot colors match wire.
 RATING: 12 Amps AC for 10°C Temp. rise, continuous duty.

WIRE: 10 KV PVC flexible wire, 65 strands #36 copper, #18 AWG insulated to an O.D. of .140". Std. Pkg. 10

No.	Length	Net Ea.
1865-12	12 inches	\$.52
1865-24	24 inches	.54
1865-36	36 inches	.56
1865-48	48 inches	.58
1865-60	60 inches	.60

PIN PLUG BOTH ENDS



HANDLES: MOLDED THERMOSETTING plastic, Red and Black per MIL-M-14 CFG. Yellow, Green, Blue, White per LC-726-1. SPECIFY COLOR

PLUGS: Brass, nickel plated.
 RATING: 12 Amps AC for 10°C Temp. rise, continuous duty.

WIRE: 10 KV PVC flexible wire, 65 strands #36 copper, #18 AWG, insulated to an O.D. of .140". Std. Pkg. 10

No.	Length	Net Ea.
1862-12	12 inches	\$.62
1862-24	24 inches	.64
1862-36	36 inches	.66
1862-48	48 inches	.68
1862-60	60 inches	.70

PIN PLUG TO BANANA PLUG



HANDLES: MOLDED THERMOSETTING plastic, Red and Black per MIL-M-14 CFG. Yellow, Green, Blue, White per LC-726-1. SPECIFY COLOR

PLUGS: Brass, nickel plated.
 SPRING: Four-leaved phosphor bronze, nickel plated.
 RATING: 12 Amps AC for 10°C Temp. rise, continuous duty.

WIRE: 10 KV PVC flexible wire, 65 strands #36 copper, insulated to an O.D. of .140". Std. Pkg. 10

No.	Length	Net Ea.
1868-12	12 inches	\$.67
1868-24	24 inches	.69
1868-36	36 inches	.71
1868-48	48 inches	.73
1868-60	60 inches	.75

BANANA PLUG BOTH ENDS



HANDLES: MOLDED THERMOSETTING plastic, Red and Black per MIL-M-14 CFG. Yellow, Green, Blue, White per LC-726-1. SPECIFY COLOR

PLUGS: Brass, nickel plated.
 SPRINGS: Four-leaved phosphor bronze, nickel plated.
 RATING: 15 Amps AC for 10°C Temp. rise, continuous duty.

WIRE: 10 KV PVC flexible wire, 65 strands #36 copper, #18 AWG, insulated to an O.D. of .140". Std. Pkg. 10

No.	Length	Net Ea.
1863-12	12 inches	\$.72
1863-24	24 inches	.74
1863-36	36 inches	.76
1863-48	48 inches	.78
1863-60	60 inches	.80

MINIATURE MOLDED PATCH CORDS



HANDLE: MOLDED BUTYRATE, per Fed. Spec. L-P349A, Type 3, Class MS. Red, Yellow, Black, Green, assemblies. SPECIFY COLOR

BODY: Brass, nickel plated.
 SPRING: Four-leaved beryllium copper, nickel plated.
 WIRE: 10 KV PVC flexible wire, 65 strands #36 copper, insulated to an O.D. of .140".

DESCR.: Interconnects banana jacks on closely spaced centers where space is at a premium. Fits standard banana jacks. Std. Pkg. 10

No.	WIRE	NET PER C
1860-8	8 inches	\$65.00
1860-12	12 inches	65.00
1860-24	24 inches	70.00
1860-36	36 inches	75.00

COLOR CODE SUFFIX

Add to Catalog Number as required
 —101 WHITE —103 BLACK —105 BLUE
 —102 RED —104 GREEN —107 YELLOW

"CROSS PATCH" BANANA PLUG CORD



HANDLE: MOLDED BUTYRATE, per Fed. Spec. L-P349A, Type 3, Class MS. Red, Black, Yellow, Green, Blue, White. SPECIFY COLOR

BODY: Brass, nickel plated.
 WIRE: 10 KV PVC flexible wire, 65 strands #36 copper, #18 AWG, insulated to an O.D. of .140".

DESC.: Interconnects unlimited number of multiple circuits. Positive, lasting contact for all banana plugs on top and side. Std. Pkg. 10

WITH PLUG SPRING 9/16" LONG

No.	Length ("A")	NET PER C
1510-8	8 inches	\$130.00
1510-12	12 inches	130.00
1510-25	24 inches	135.00
1510-36	36 inches	140.00

WITH PLUG SPRING 13/32" LONG

No.	Length ("A")	NET PER C
1515-8	8 inches	\$130.00
1515-12	12 inches	130.00
1515-24	24 inches	135.00
1515-36	36 inches	140.00

"CROSS PATCH" PIN TIP CORD

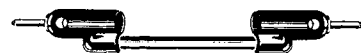

HANDLE: MOLDED BUTYRATE, per Fed. Spec. L-P349A, Red, Black, Yellow, Green, Blue, White. SPECIFY COLOR

BODY: Brass, nickel plated.
 CONTACT: Beryllium copper.
 WIRE: 10 KV PVC flexible wire, 65 strands #36 copper, insulated to an O.D. of .140".

DESC.: Interconnects an unlimited number of multiple circuits .080" tip plug and female jack in rear of body fits all standard phone tips and jacks. Side holes accept standard banana plugs. Std. Pkg. 10

No.	Length ("A")	NET PER C
1595-8	8 inches	\$140.00
1595-12	12 inches	140.00
1595-24	24 inches	145.00
1595-36	36 inches	150.00

"CROSS PATCH" CORD

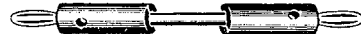

HANDLE: MACHINED BUTYRATE, per MIL-P-10408A, Type I, Class II. Red, Black assemblies. SPECIFY COLOR

BODY: Brass, nickel plated.
 SPRING: Four-leaved, beryllium copper, nickel plated.

WIRE: 10 KV PVC flexible wire, 65 strands #36 copper, #18 AWG, insulated to an O.D. of .140".

DESCR.: Provides a never ending banana plug receptacle, and can be used to interconnect an unlimited amount of multiple circuits. Accepts standard banana plug in side. Std. Pkg. 10

No.	Length ("A")	NET PER C
680	8 inches	\$95.00
681	12 inches	95.00
682	24 inches	100.00
683	36 inches	105.00

FOR YOUR SPECIAL REQUIREMENTS IN

- PATCH CORDS
- JUMPERS
- TEST LEADS

WHAT DO YOU NEED?

We are equipped to manufacture Patch Cords, Jumpers and Test Leads in every conceivable combination of terminal ends —plugs, jacks, clips and connectors—to be found in our entire line.

What are YOUR special requirements? We welcome your inquiry!

specify **SMITH**

HERMAN H. SMITH, INC.



ELECTRONIC COMPONENTS

DUAL INSTRUMENT TEST ADAPTERS

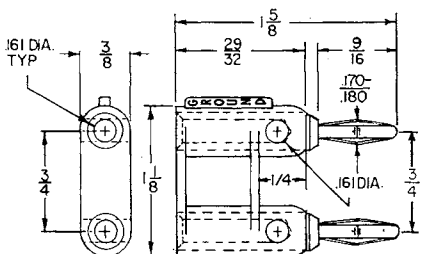

MATERIALS:
BODY: Molded Butyrate, per Fed Spec. L-P349A, Type 3, Class MS. Color BLACK unless otherwise specified.
CONDUCTOR: Brass, per QQ-B-626, Comp. 22, 1/2 hard.
HEAD: Molded Nylon, per MIL-P-20693A.
SHIELD: Drawn Aluminum.
SCREWS: Steel, cadmium plated.

FINISHES:
CONDUCTOR: Nickel plate, per QQ-N-290, Class I, Type VII.
SPRING: Nickel plate, as above.
TERMINAL: Gold washed.
CONNECTOR: Non-tarnish.
SHIELD: Black Anodized.

COLOR CODE SUFFIX
 Add to Catalog Number as required

- 101 WHITE
- 102 RED
- 103 BLACK
- 104 GREEN
- 105 BLUE
- 106 ORANGE
- 107 YELLOW
- 108 BROWN
- 112 PURPLE
- 113 GREY

RATINGS:
CURRENT: 15 Amps AC for 10°C Temp. Rise, continuous duty, except where limited by co-axial connectors.
VOLTAGE: 5 KV, 60 cycle AC continuous working voltage, except where limited by co-axial connectors.
CAPACITY: 1.0 mmfd nominal between 3/4" spaced conductors.
RESISTANCE: 1 milliohm or less per conductor.

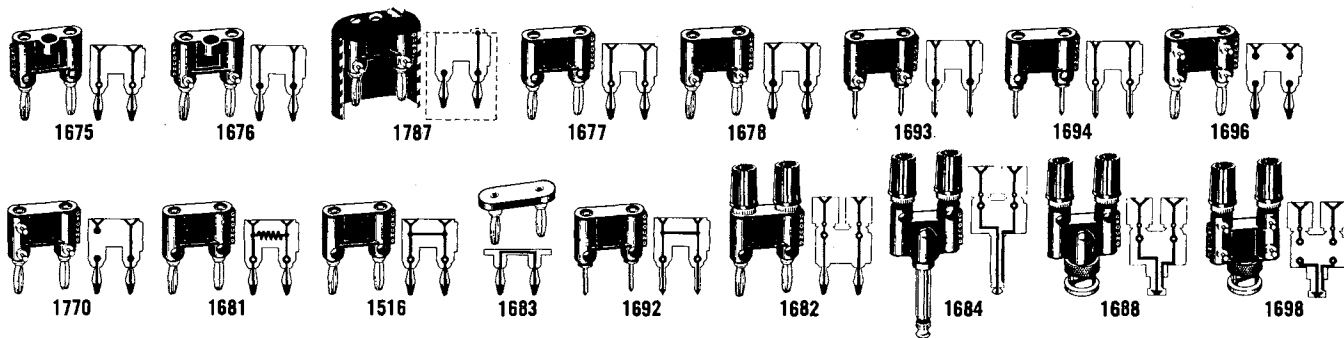

CABLE MOUNTED DUAL BANANA PLUGS

SET-SCREW TYPE

REAR: 7/32 Dia. cable guide. Dual banana jacks on 3/4" centers.
FRONT: Dual banana plugs on 3/4" centers. Set-screws secure leads to conductors.
COLORS: Available in 10 std. colors as coded above.
 No. Std. Pkg. 10 NET Ea.
 1675 \$.72

TURRET-TERMINAL TYPE

REAR: 7/32 Dia. cable guide. Dual banana jacks on 3/4" centers.
FRONT: Dual banana plugs on 3/4" centers. Turret terminals for permanent solder connection of leads.
COLORS: Available in 10 std. colors as coded above.
 No. Std. Pkg. 10 NET Ea.
 1676 \$.81

SHIELDED TYPE

REAR: Mounting screw and locating boss. Inline cable entry with flush cable guide.
FRONT: Dual banana plugs 3/4" centers. Turret terminals for permanent solder connection of leads.
SHIELD: Aluminum shield electrically connected to GND conductor fully enclosed plug and mating binding posts to reduce noise pickup.
 No. Std. Pkg. 1 NET Ea.
 1787 \$ 2.25

COMPONENT MOUNTING DUAL PLUGS SET-SCREW TYPE

REAR: Dual banana jacks on 3/4" centers for stacking.
FRONT: Dual banana jacks on 3/4" centers. Set-screws secure component leads to conductors.
COLORS: Available in 10 std. colors as coded above. (Specify color)
 No. Std. Pkg. 10 NET Ea.
 1677 \$.72

TURRET-TERMINAL TYPE

REAR: Dual banana jacks on 3/4" centers for stacking.
FRONT: Dual banana plugs on 3/4" centers. Turret terminals for permanent solder connection of component leads.
COLORS: Available in 10 std. colors as coded above. (Specify color)
 No. Std. Pkg. 10 NET Ea.
 1678 \$.81

.080" PHONE TIP TYPE

REAR: Dual phone tip jacks on 3/4" centers for stacking.
FRONT: Dual .080" phone tips on 3/4" centers. Turret terminals for permanent solder connections of component leads.
COLORS: Available in Red or Black only. (Specify color)
 No. Std. Pkg. 10 NET Ea.
 1693 \$.81

COMPONENT MOUNTING DUAL PLUGS

SET-SCREW PHONE TIP ADAPTER TYPE

REAR: Dual banana jacks on 3/4" centers for stacking.
FRONT: Dual .080" phone tips on 3/4" centers. Set-screws secure component leads to conductors.
COLORS: Available in Red or Black only. (Specify color)
 No. Std. Pkg. 10 NET Ea.
 1694 \$.72

FOUR TERMINAL ISOLATION TYPE

REAR: Dual banana jacks on 3/4" centers for stacking.
CENTER: Turret-terminal connections to isolated front and rear conductors in both GND and HOT circuits allow insertion of matching pad or other 4-terminal networks in input circuits of instruments.
FRONT: Dual banana plugs on 3/4" centers.
COLORS: Available in 10 colors as coded above. (Specify color)
 No. Std. Pkg. 1 NET Ea.
 1696 \$ 3.25

THREE TERMINAL ISOLATION TYPE

REAR: Dual banana jacks on 3/4" centers for stacking.
CENTER: Turret-terminal connections to isolated front and rear conductors in HOT circuit, and straight-thru connection of GND circuit, with terminal, allow insertion of "T" and "P" networks in input-output circuits in instruments.
FRONT: Dual banana plugs on 3/4" centers.
COLORS: Available in 10 colors as coded above.
 No. Std. Pkg. 1 NET Ea.
 1770 \$ 2.50

INTERNALLY-MOLDED COMPONENT DUAL PLUGS

MOLDED-IN PRECISION RESISTORS

(Note: Items shown below are representative stock units. Plugs can be molded to order with a variety of resistor, capacitor, or molded inductor values. Please write, detailing your requirements, for quotation.)
REAR: Dual banana jacks on 3/4" centers for stacking.
INTERNAL: 1% precision deposited-carbon, 1/2 watt resistors, value as shown below. Resistors are shunted across line.
FRONT: Dual banana plugs on 3/4" centers. Banana jack side holes for stacking.
RESISTANCE: (Value stamped on plug) Following values are stock:

Ohms	Ohms	K ohm	K ohm	Meg ohm
50	200	1	100	1
75	250	5	200	2
120	500	10	250	5
180	600	20	500	10
150	900	50		

(Specify resistance value)
 No. Std. Pkg. 1 NET Ea.
 1691 \$ 2.75

DUAL BANANA PLUG SHORTING TYPE

REAR: Dual banana jacks on 3/4" centers for stacking.
INTERNAL: Busbar shorted across line.
FRONT: Dual banana plugs on 3/4" centers. Banana jack holes for side stacking.
COLORS: Available in Red, Black, Yellow, and Green. (Specify color)
 No. Std. Pkg. 25 NET Ea.
 1516 \$.72

METAL SHORTING BAR TYPE

REAR: 4/32" thick brass busbar. 15 amps. continuous duty.
FRONT: Dual banana plugs on 3/4" centers. Unit sits flush to panel.
 No. Std. Pkg. 10 NET Ea.
 1683 \$.66

.080" PHONE TIP SHORTING TYPE

REAR: Dual banana jacks on 3/4" centers for stacking.
INTERNAL: Busbar shorted across line.
FRONT: Dual .080" phone tips on 3/4" centers. Banana jack holes for side stacking.
COLORS: Available in Red, Black, Yellow, and Green. (Specify color)
 No. Std. Pkg. 10 NET Ea.
 1692 \$.72

DUAL BINDING POST ADAPTERS

BINDING POSTS TO DUAL BANANA PLUGS

REAR: Insulated dual 5-way binding posts. Red and Black heads on 3/4" centers. Banana jack holes for side stacking.
 No. Std. Pkg. 10 NET Ea.
 1682 \$ 2.25

BINDING POSTS TO 2-CIRCUIT PHONE PLUG

REAR: Insulated dual 5-way binding posts. Red and Black heads on 3/4" centers. Banana jack holes for side stacking.
FRONT: Standard 1/2" 2-circuit phone plug.
 No. Std. Pkg. 1 NET Ea.
 1684 \$ 4.60

BINDING POSTS TO BNC MALE CONNECTOR

REAR: Insulated dual 5-way binding posts. Red and Black heads on 3/4" centers. Banana jack holes for side stacking.
FRONT: BNC series co-axial plug.
 No. Std. Pkg. 1 NET Ea.
 1688 \$ 4.60

BINDING POSTS TO ISOLATED BNC MALE CONNECTOR

REAR: Insulated dual 5-way binding posts. Red and Black heads on 3/4" centers.
CENTER: Turret-terminal connections to isolated front and rear conductors in both GND and HOT circuits allow insertion of matching pad or other 4-terminal networks in input circuits.
FRONT: BNC series co-axial plug.
 No. Std. Pkg. 1 NET Ea.
 1698 \$ 10.00

specify **SMITH**

HERMAN H. SMITH, INC.



ELECTRONIC COMPONENTS

SMITH MINIATURE COMPONENTS

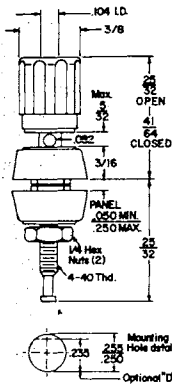

MINIATURE BINDING POST

HEAD: Captive, Molded Nylon, per MIL-P-20693A, with Brass, Gold plated insert.
BODY: Brass, Gold Plated.
WASHERS: Molded Nylon, per MIL-P-20693A, with Brass Gold Plated inserts.
ACCEPTS: Standard .080" phone tip, #6 spade lug, miniature banana plug, alligator clip or wire.
RATING: 5 Amps AC for 10° C. Temp. rise, continuous working voltage. Capacitance 2.5 pf.

DESCR.: Compact Binding Post designed for use with miniaturized equipment. Molded washers completely insulate post from panel. Mounts in 1/4" round or "D" hole in panel as indicated. Wrap-around solder turret for direct wire connection.
COLORS: Available in Red, Black, Yellow, Green, Blue, and White. SPECIFY COLOR by adding Color Code suffix to basic Catalog No.

Std. Pkg. 100
 No. 3015 NET Per C \$40.00

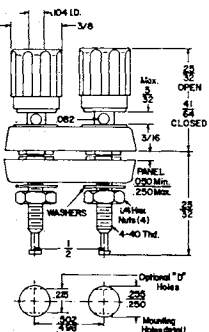

MINIATURE DUAL BINDING POST

INSUL: MOLDED Black STYRENE, Octagonal - keyed to align cross-holes at alternate 90° position.
BODIES: Brass, Gold-Plated.
HEADS: Captive, Molded Nylon, per MIL-P-20693A, with Brass Gold Plated inserts.
RATING: 5 Amps AC for 10° C. Temp. Rise, continuous duty. 2 KV 60 cycle AC, continuous working voltage. Capacitance 3.5 pf between conductors, 3.0 pf to panel.

DESCR.: Compact Dual Binding Post designed for use with miniaturized equipment. Mounts in two 1/4" round, single or double "D" holes on 1/2" centers, in panels up to 1/4" thick. 1/2" center spacing designed for use with miniature dual connectors. Also accepts single miniature #6 spade lugs, alligator clips or wire. Wraparound solder turret for direct wire connections. Supplied with two hex nuts and flat washers.

No.	Description	NET Per C
3016BB	Two Black Heads	\$70.00
3016BR	Two Red Heads	70.00
3016RB	One Red, One Black Head	70.00

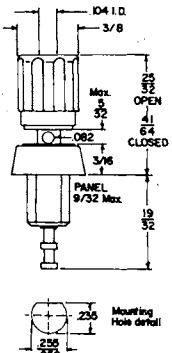

MINIATURE PRESS-FIT TEFLON* BINDING POST

HEAD: Captive Molded Nylon, per MIL-P-20693A, with Brass, Gold plated insert.
WASHER BODY: Virgin Teflon per MIL-P-19468.
ACCEPTS: Standard .080" phone tip, #6 spade lug, miniature Banana Plug, alligator clip or wire.
RATING: 5 Amps AC for 10° C. Temp. rise, continuous duty. 1 KV, 60 cycle AC, continuous working voltage. Capacitance 2.5 pf.

DESCR.: Unique binding post mounts in 1/4" "D" punched hole without any mounting hardware. "Memory" characteristic of Teflon locks unit hole after insertion and "D" flat prevents rotation. Compact binding post head for use with miniaturized equipment. Wrap-around solder turret for direct wire connection.
COLORS: Available in Red, Black, Yellow, Green, Blue, and White. SPECIFY COLOR by adding Color Code suffix to basic catalog No.

No. 3017 NET Per C \$55.00

*Reg. Trademark E. I. DuPont Co.

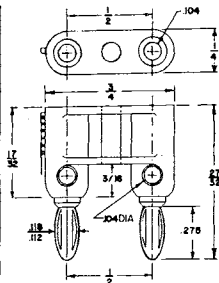

SPECIFICATIONS FOR DUAL ADAPTERS

CAPACITY: 3.0 pf. nominal between 1/2" spaced conductors.
RESISTANCE: 1 milliohm or less per conductor.

MATERIALS:
BODY: Molded Butyrate, per Fed. Spec. L-P349A, Type 3, Class MS. Color BLACK unless otherwise specified.
CONDUCTOR: Brass, per QQ-B-626, Comp. 22, 1/2 hard.
SPRING: Four-leaved beryllium copper, heat treated.
HEAD: Molded Nylon, per MIL-P-20693A.
SCREWS: Steel, cadmium plated.

SPRING: Nickel plated.
TERMINAL: Gold washed.
CONNECTOR: Non-tarnish Plate.

RATINGS:
CURRENT: 5 Amps AC for 10° C Temp. Rise, continuous duty, except where limited by co-axial connectors.
VOLTAGE: 2 KV, 60 cycle AC continuous working voltage, except where limited by co-axial connectors.

FINISHES:
CONDUCTOR: Nickel plate, per QQ-N-290, Class I, Type VII.

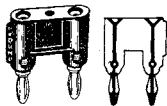

SET SCREW CONNECTION BANANA PLUGS

REAR: Dual banana jacks on 1/2" centers for stacking.
FRONT: Dual banana plugs on 1/2" centers. Set-screws secure leads to conductors.
COLORS: Available in Red or Black (Specify color.)
 No. 1749 NET Pkg. 10 \$.72

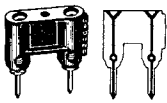

SET SCREW CONNECTION PHONE TIP

REAR: Dual banana jacks on 1/2" centers for stacking.
FRONT: Dual .080" phone tips on 1/2" centers. Set-screws secure component leads to conductors.
COLORS: Available in Red or Black (Specify color.)
 No. 1754 NET Pkg. 10 \$.72

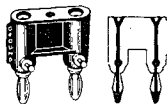

TURRET TERMINAL CONNECTION

REAR: Dual banana jacks on 1/2" centers for stacking.
FRONT: Dual banana plugs on 1/2" centers. Turret terminals for permanent solder connection of component leads.
COLORS: Available in Red or Black (Specify color.)
 No. 1750 NET Pkg. 10 \$.81

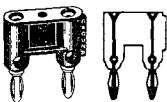

PHONE TIP ADAPTER

REAR: Dual .080" phone tip jacks on 1/2" centers for stacking.
FRONT: Dual banana plugs on 1/2" centers. Banana jack holes for side stacking.
COLORS: Available in Red or Black (Specify color.)
 No. 1751 NET Pkg. 10 \$.81

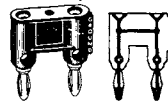

MOLDED-IN SHORTING TYPE BANANA PLUGS

REAR: Dual banana jacks on 1/2" centers for stacking.
INTERNAL: Busbar shorted across line.
FRONT: Dual banana plugs on 1/2" centers. Banana jack holes for side stacking.
COLORS: Available in Red or Black (Specify color.)
 No. 1752 NET Ea. \$.72

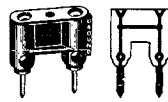

MOLDED-IN SHORTING TYPE .080 PHONE TIP

REAR: Dual banana jacks on 1/2" centers for stacking.
INTERNAL: Busbar shorted across line.
FRONT: Dual .080 phone tips on 1/2" centers. Banana jack holes for side stacking.
COLORS: Available in Red or Black (Specify color.)
 No. 1753 NET Ea. \$.72

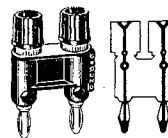

BINDING POSTS TO DUAL BANANA PLUGS

REAR: Insulated dual 5-way binding posts, Red and Black heads on 1/2" centers. Banana jack holes for side stacking.
FRONT: Dual banana plugs on 1/2" centers.
 No. 1755 Black only NET Ea. \$2.25

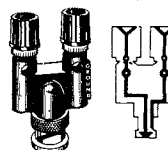

BINDING POSTS TO BNC MALE

REAR: Insulated dual 5-way binding posts, Red and Black heads on 1/2" centers. Banana jack holes for side stacking.
FRONT: BNC series co-axial plug.
 No. 1756 Black only NET Ea. \$4.60

specify SMITH

HERMAN H. SMITH, INC.



ELECTRONIC COMPONENTS

ALLIGATOR CLIPS Solder Connection

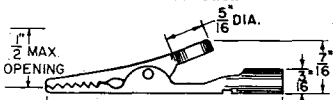

RATING: 5 Amps AC for 10°C Temp. rise, continuous duty.
DESCR.: 1/2" jaw opening. Jaws match accurately and grip securely, accepts standard banana plugs in rear.
 Std. Pkg. 100

No.	Type	NET Per C
300	Steel, Cad. Pl.	\$4.70
380	Solid Copper	6.50
332	Brass N.P.	8.40

Screw Connection

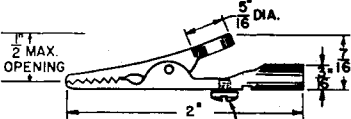

RATING: 5 Amps AC for 10°C Temp. rise, continuous duty.
DESCR.: 1/2" jaw opening. Supplied with screw for solderless connection when required. Jaws match accurately and grip securely. Accepts standard banana plugs in rear.
 Std. Pkg. 100

No.	Type	NET Per C
350	Steel, Cad. Pl.	\$5.40
360	Solid Copper	8.20
339	Brass N.P.	9.90

JUMBO ALLIGATOR CLIP Solder Connection

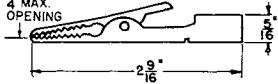

RATING: 10 Amps AC for 10°C Temp. rise, continuous duty, #392.
 15 Amps AC for 10°C Temp. rise, continuous duty, #396.
DESCR.: 3/4" jaw opening. Jaws match accurately. For heavy terminal use.
 Std. Pkg. 100

No.	Type	NET Per C
392	Steel, Cad. Pl.	\$15.00
396	Solid Copper	18.00

Screw Connection

RATING: STEEL: 10 Amps AC for 10°C Temp. rise, continuous duty.
 COPPER: 15 Amps AC for 10°C Temp. rise, continuous duty.
DESCR.: 3/4" jaw opening. Jaws match accurately. Supplied with screw for solderless connection. For heavy terminal use.
 Std. Pkg. 100

No.	Type	NET Per C
368	Steel, Cad. Pl.	\$18.00
356	Solid Copper	21.00



ALLIGATOR CLIP BOOTS

MATERIAL: MOLDED VINYL PLASTIC, Red, Black, Yellow, Green, Blue or White. SPECIFY COLOR
RATING: 1 K Volts 60 cycle AC continuous working voltage.
DESCR.: Fully insulated clip while allowing maximum jaw opening. No. 331 for use on standard size alligator clips such as our No. 300, No. 389 for use on miniature alligator clips, such as our No. 338. Std. Pkg. 100

No.	Description	NET Per C
389	Miniature	\$3.30
331	Standard	2.90

MIDGET ALLIGATOR CLIP

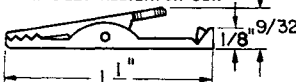

DESCR.: 1/4" jaw opening. Jaws match accurately and grip securely. Unique SMITH spring construction. Solder connection and ears for crimping.
 Std. Pkg. 100

No.	Type	NET Per C
398	Steel, Cad. Pl.	\$4.30
367	Copper	5.30

TL137 TEST CLIP Signal Corps Approved

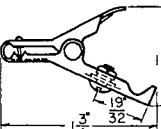

RATING: 10 Amps AC for 10°C Temp. rise, continuous duty.
DESCR.: Steel, nickel plated, made in accordance with government specifications. 1/2" jaw opening. Needle for piercing corrosion.
 Std. Pkg. 25

No.	NET Per C
315	\$42.00

INSULATED ALLIGATOR CLIPS Solder Connection

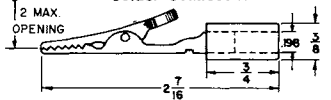

HANDLE: MOLDED BUTYRATE, per Fed. Spec. L-P349A, Type 3, Class MS. Red or Black. SPECIFY COLOR
RATING: 5 Amps AC for 10°C Temp. rise, continuous duty.
DESCR.: 1/2" jaw opening. Jaws match accurately and grip securely, accepts standard banana plugs in rear.
 Std. Pkg. 100

No.	Type	NET Per C
301	Steel, Cad. Pl.	\$7.50
381	Solid Copper	9.00
354	Brass N.P.	11.40

Screw Connection

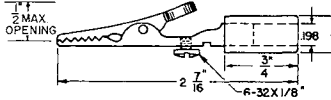

HANDLE: MOLDED BUTYRATE, per Fed. Spec. L-P349A, Type 3, Class MS. Red or Black. SPECIFY COLOR
RATING: 5 Amps AC for 10°C Temp. rise, continuous duty.
DESCR.: 1/2" jaw opening. Supplied with screw for solderless connection when required. Jaws match accurately and grip securely. Accepts standard banana plugs in rear.
 Std. Pkg. 100

No.	Type	NET Per C
351	Steel, Cad. Pl.	\$7.60
361	Solid Copper	10.10
362	Brass N.P.	12.40

INSULATED JUMBO ALLIGATOR CLIPS Solder Connection

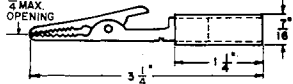

HANDLE: MACHINED BUTYRATE, per MIL-P-10408A, Type I, Class II, Red or Black. SPECIFY COLOR
RATING: 10 Amps AC for 10°C Temp. rise, continuous duty, #393.
 15 Amps AC for 10°C Temp. rise, continuous duty, #397.
DESCR.: 3/4" jaw opening. Jaws match accurately. For heavy terminal use.
 Std. Pkg. 100

No.	Type	NET Per C
393	Steel, Cad. Pl.	\$21.00
397	Solid Copper	24.00

Screw Connection

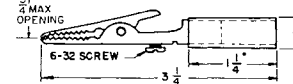

HANDLE: MACHINED BUTYRATE, per MIL-P-10408A, Type I, Class II, Red or Black. SPECIFY COLOR
RATING: 10 Amps AC for 10°C Temp. rise, continuous duty, #369.
 15 Amps AC for 10°C Temp. rise, continuous duty, #357.
DESCR.: 3/4" jaw opening. Jaws match accurately. Supplied with screw for solderless connection. For heavy terminal use.
 Std. Pkg. 100

No.	Type	NET Per C
369	Steel, Cad. Pl.	\$24.00
357	Solid Copper	27.00

MINIATURE INSULATION PIERCING ALLIGATOR CLIP

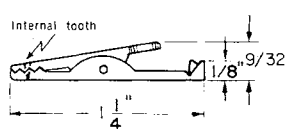

RATING: 1 Amp AC for 10°C Temp. rise, continuous duty.
DESCR.: 3/16" jaw opening. Jaws match accurately and grip securely. Internal tooth for piercing wire insulation. Solder connection and ears for crimping.
 Std. Pkg. 100

No.	NET Per C
326	\$11.00

INSULATION PIERCING ALLIGATOR CLIP

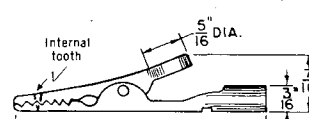

RATING: 5 Amps AC for 10°C Temp. rise, continuous duty.
DESCR.: 1/2" jaw opening. Jaws match accurately and grip securely. Internal tooth for piercing wire insulation. Accepts standard banana plug in rear.
 Std. Pkg. 100

No.	NET Per C
347	\$11.00

All Insulated Clip

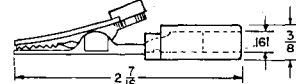

INSULA.: MOLDED BUTYRATE, per Fed. Spec. L-P349A, Type 3, Class MS. Red or Black. SPECIFY COLOR
RATING: 10 Amps AC for 10°C Temp. rise, continuous duty. 1 K Volts 60 cycle AC continuous working voltage.
DESCR.: All metal parts fully insulated with molded plastic. Insures against shock or grounding. Solder type connection.
 Std. Pkg. 25
 No. 397 NET Per C \$24.00

ALL INSULATED ADAPTERS

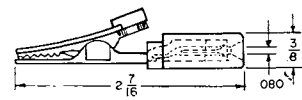

Phone Tip to Alligator Clip
INSULA.: MOLDED BUTYRATE, per Fed. Spec. L-P349A, Type 3, Class MS. Red or Black. SPECIFY COLOR
CLIP: Steel, cadmium plated.

BODY: Brass.
CONTACT: Phosphor bronze.
RATING: 5 Amps AC for 10°C Temp. rise, continuous duty.
DESCR.: All metal parts fully insulated with molded plastic. Insures against shock or grounding. Jack in rear permits adapting standard phone tip plugs to alligator clips.
 Std. Pkg. 25
 No. 336 NET Per C \$36.00

ALLIGATOR CLIP ADAPTERS

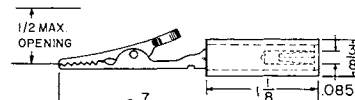

Phone Tip to Alligator Clip
HANDLE: MOLDED BUTYRATE, per Fed. Spec. L-P349A, Type 3, Class MS. Red or Black. SPECIFY COLOR
CAP: MOLDED THERMOSETTING plastic, Red and Black per MIL-M-14 CFG.
CLIP: Steel, cadmium plated or solid copper.
BODY: Brass.
SPRING: Phosphor bronze.
RATING: 5 Amps AC for 10°C Temp. rise, continuous duty.
DESCR.: Jack in rear permits adapting standard phone tip plugs to alligator clips.
 Std. Pkg. 25
 No. 334 NET Per C \$35.00
 No. 334 Steel Clip \$35.00
 No. 334 Copper Clip \$6.00

Phone Tip or Banana Plug to Alligator Clip

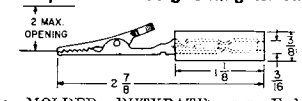

HANDLE: MOLDED BUTYRATE, per Fed. Spec. L-P349A, Type 3, Class MS. Red or Black. SPECIFY COLOR
CLIP: Steel, cadmium plated or solid copper.
BODY: Brass.
SPRING: Phosphor bronze.
RATING: 5 Amps AC for 10°C Temp. rise, continuous duty.
DESCR.: Combination jack in rear, permits the adapting standard phone tip plug or banana plugs to alligator clip.
 Std. Pkg. 25
 No. 305 NET Per C \$39.00
 No. 335 Steel Clip \$35.00
 No. 335 Copper Clip \$4.00

ALLIGATOR CLIP ADAPTER

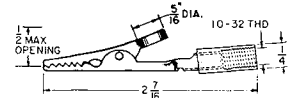

BUSHING: Brass, nickel plated.
CLIP: Steel cadmium plated.
RATING: 5 Amps AC for 10°C Temp. rise, continuous duty.
DESCR.: Adapts standard solderless tips to alligator clip. This novel quick-adaptor is a must for all types of bench work.
 Std. Pkg. 50
 No. 310 NET Per C \$19.20

MORE THAN TEN THOUSAND

ELECTRONIC COMPONENT PARTS MANUFACTURED UNDER ONE ROOF

specify SMITH

HERMAN H. SMITH, INC.



ELECTRONIC COMPONENTS

TEFLON TERMINALS by SMITH

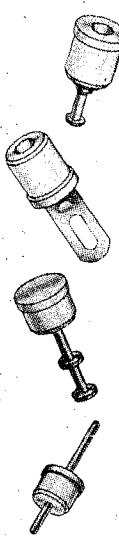

- Miniature
- Subminiature
- Microminiature
- Standoff — Feed-thru
- Probes — Test Jacks
- Connectors — Sockets
- Custom Fabrication

ALL SIZES • ALL TYPES
• TEN COLORS

FULL LINE

Meets MIL Specifications

SMITH
COMPLETE 12-PAGE
TEFLON TERMINALS
CATALOG
FREE ON REQUEST!

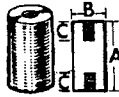

CERAMIC STANDOFFS

MADE TO JAN. SPECS.
Grade L-6 Ceramic made to JAN 1-8 and JAN 1-10 Specs. Outside of ceramic is glazed.

No.	Type	A	B	C	Thd.	NET Per C
2600	NL633W01-004	1/2"	3/8"	3/2"	6-32	\$16.70
2601	NL633W01-005	5/8"	3/8"	1/4"	6-32	18.20
2602	NL633W01-006	3/4"	3/8"	1/4"	6-32	19.00
2603	NL633W01-008	1"	3/8"	3/8"	6-32	19.70
2604	NL633W01-010	1 1/4"	3/8"	3/8"	6-32	21.80
2605	NL633W01-012	1 1/2"	3/8"	3/8"	6-32	22.70
2606	NL633W01-016	2"	3/8"	3/8"	6-32	23.00
2607	NL633W02-005	3/4"	1/2"	3/4"	8-32	16.70
2608	NL633W02-008	1"	1/2"	1/4"	8-32	17.20
2609	NL633W02-008	1"	1/2"	3/8"	8-32	17.40
2610	NL633W02-010	1 1/4"	1/2"	3/8"	8-32	20.00
2611	NL633W02-012	1 1/2"	1/2"	3/8"	8-32	25.00
2612	NL633W02-016	2"	1/2"	3/8"	8-32	30.00
2613	NL633W02-020	2 1/2"	1/2"	3/8"	8-32	30.00
2614	NL633W02-024	3"	1/2"	3/8"	8-32	31.50
2615	NL633W03-008	1"	3/4"	3/8"	10-32	26.00
2616	NL633W03-010	1 1/4"	3/4"	3/8"	10-32	28.00
2617	NL633W03-012	1 1/2"	3/4"	3/8"	10-32	34.40
2618	NL633W03-016	2"	3/4"	3/8"	10-32	39.00
2619	NL633W03-020	2 1/2"	3/4"	3/8"	10-32	40.00
2620	NL633W03-024	3"	3/4"	3/8"	10-32	45.00
2621	NL633W03-032	4"	3/4"	3/8"	10-32	51.00
2622	NL633W04-010	1 1/4"	1"	3/4"	1/4-20	37.50
2623	NL633W04-012	1 1/2"	1"	3/4"	1/4-20	48.00
2624	NL633W04-016	2"	1"	5/8"	1/4-20	54.00
2625	NL633W04-020	2 1/2"	1"	5/8"	1/4-20	55.00
2626	NL633W04-024	3"	1"	5/8"	1/4-20	62.00
2627	NL633W04-032	4"	1"	5/8"	1/4-20	75.00
2628	NL633W04-040	5"	1"	5/8"	1/4-20	92.00
2629	NL633W04-048	6"	1"	5/8"	1/4-20	103.00

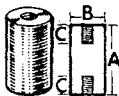

CERAMIC STANDOFFS

Grade L5 Ceramic with outside glazed. Std. Pkg. 50

No.	A	B	C	Thd.	NET Per C
2640	1/4"	1/4"	Thru	6-32	\$13.40
2641	1/2"	1/4"	3/4"	6-32	13.70
2642	3/8"	3/8"	3/4"	6-32	14.20
2643	1/2"	3/8"	3/4"	6-32	16.90
2644	1/2"	1/2"	3/4"	6-32	18.50
2645	3/4"	1/2"	1/4"	6-32	19.50
2646	1"	1/2"	3/8"	6-32	21.50
2647	1 1/2"	1/2"	3/8"	6-32	24.50
2648	2 1/2"	1/2"	1/2"	6-32	26.70
2649	2 1/2"	3/4"	3/4"	1/4-20	36.00
2650	4"	3/4"	3/4"	1/4-20	54.00

BRASS STANDOFFS
SEE SMITH PAGE 26

TEFLON* SPAGHETTI TUBING



COLOR CODE CHART

- 101 WHITE
- 102 RED
- 103 BLACK
- 104 GREEN
- 105 BLUE
- 106 ORANGE
- 107 YELLOW
- 108 BROWN
- 112 PURPLE
- 113 GREY
- 115 NATURAL

(If no color is specified, Natural Teflon (-115) will be supplied.)

Meets and exceeds MIL-E-22129B. Ideal for slip-on insulation, and provides greater reliability and resistance to high temperatures. Shrink-back is virtually eliminated. Individually packed in dust-proof bags. SPECIFY COLOR

CAT. NO.	AWG WIRE SIZE	NOM. I.D.	NOM. WALL THK.	STD. PKG. FT.	NET EA.
7701-24	24	.022	.012	100	\$11.68
7701-22	22	.027	.012	100	12.95
7701-20	20	.034	.016	100	17.75
7701-19	19	.038	.016	100	19.38
7701-18	18	.042	.016	100	20.88
7701-17	17	.047	.016	100	22.93
7701-16	16	.053	.016	100	24.63
7701-15	15	.059	.016	100	25.30
7701-14	14	.066	.016	100	27.25
7701-13	13	.076	.016	100	30.30
7701-12	12	.085	.016	100	32.75
7701-11	11	.095	.016	100	36.38
7701-10	10	.106	.016	100	40.00
7701-09	9	.118	.020	100	57.10
7701-81	1/8"	.125	.020	100	61.00
7701-08	8	.133	.020	50	31.25
7701-07	7	.148	.020	50	33.69
7701-06	6	.166	.020	50	36.44
7701-05	5	.186	.020	50	40.10
7701-04	4	.208	.020	50	43.56
7701-03	3	.234	.020	50	49.88
7701-01	1/4"	.250	.020	50	52.88
7701-02	2	.263	.020	50	54.82
7701-01	1	.294	.020	50	60.94
7701-51	5/16"	.312	.020	50	67.50
7701-00	0	.330	.020	50	68.57

STANDARD WALL

THINWALL

7702-30	30	.012	.009	100	\$10.53
7702-28	28	.015	.009	100	9.20
7702-26	26	.018	.009	100	8.88
7702-24	24	.022	.010	100	9.63
7702-22	22	.027	.010	100	10.75
7702-20	20	.034	.012	100	13.63
7702-19	19	.038	.012	100	14.68
7702-18	18	.042	.012	100	15.75
7702-17	17	.047	.012	100	17.38
7702-16	16	.053	.012	100	19.00
7702-15	15	.059	.012	100	19.63
7702-14	14	.066	.012	100	21.00
7702-13	13	.076	.012	100	23.75
7702-12	12	.085	.012	100	25.50
7702-11	11	.095	.012	100	28.38
7702-10	10	.106	.012	100	30.50
7702-09	9	.118	.015	100	44.00
7702-81	1/8"	.125	.015	100	45.00
7702-08	8	.133	.015	50	24.32
7702-07	7	.148	.015	50	26.63
7702-06	6	.166	.015	50	29.75
7702-05	5	.186	.015	50	33.50
7702-04	4	.208	.015	50	36.75
7702-03	3	.234	.015	50	40.75
7702-01	1/4"	.250	.015	50	43.75
7702-02	2	.263	.015	50	45.50
7702-01	1	.294	.015	50	50.69
7702-51	5/16"	.312	.015	50	55.12
7702-00	0	.330	.015	50	56.12

LIGHTWEIGHT

7703-28	28	.015	.006	100	\$ 7.53
7703-26	26	.018	.006	100	7.75
7703-24	24	.022	.006	100	8.13
7703-22	22	.027	.006	100	9.38
7703-20	20	.034	.006	100	11.13
7703-19	19	.038	.006	100	12.38
7703-18	18	.042	.006	100	13.38
7703-17	17	.047	.006	100	14.88
7703-16	16	.053	.006	100	16.13
7703-15	15	.059	.006	100	16.75
7703-14	14	.066	.008	100	19.50
7703-13	13	.076	.008	100	22.25
7703-12	12	.085	.008	100	24.38
7703-11	11	.095	.008	100	27.38
7703-10	10	.106	.008	100	29.50
7703-09	9	.118	.008	50	16.50
7703-81	1/8"	.125	.008	50	17.88
7703-08	8	.133	.008	50	18.44
7703-07	7	.148	.008	50	20.00
7703-06	6	.166	.010	50	25.88
7703-05	5	.186	.010	50	28.38
7703-04	4	.208	.010	50	31.38
7703-03	3	.234	.010	50	34.50
7703-01	1/4"	.250	.010	50	36.69
7703-02	2	.263	.010	50	37.57
7703-01	1	.294	.010	50	41.19
7703-51	5/16"	.312	.012	50	48.69
7703-00	0	.330	.012	50	49.63

*Reg. Trademark E. I. DuPont Co.

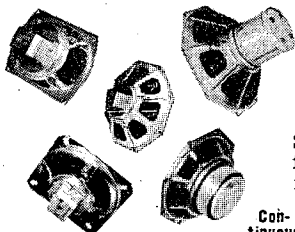

Norelco Loudspeakers

featuring The World's Most Powerful Magnets

Standard EIA mounting • Tropic-proof cadmium-plated frames • Designed for use in original equipment and as replacements in Radio, TV, Hi-Fidelity, Car Radio, etc.

Smith No.	Size	Shape	Imped. Ohms	Power Watts	Height	Width	Depth	Free Air Reso-		Cone Types	Magnet Type	Magnet Wgt. Oz.	Std. Pkg.	NET Each
								Freq. Resp. CPS	nance CPS					
4300	2"	Round	3.2	0.3	2 1/4"	2 1/4"	1 1/4"	500-4500	590	Single	Tic.	0.36	3	\$2.16
4301	2 1/2"	Round	8	0.5	2 3/4"	2 3/4"	1 3/4"	400-7000	350	Single	Fer.	0.72	3	2.25
4302	3"	Square	3.2	2.0	3 1/4"	3 1/4"	1 1/2"	200-7000	275	Single	Tic.	0.72	6	2.22
4303	3"	Square	3.2	1.0	3 1/4"	3 1/4"	1 1/4"	265-6000	285	Single	Fer.	1.44	6	2.40
4304	4"	Square	3.2	3.0	4 1/8"	4 1/8"	1 3/8"	140-16500	165	Single	Tic.	0.72	6	2.22
4305	4"	Square	3.2	1.0	4 1/8"	4 1/8"	1 1/8"	200-6000	250	Single	Fer.	1.44	6	2.40
4306	4"	Square	3.2	3.0	4 1/2"	4 1/2"	1 5/8"	170-7000	165	Single	Fer.	5.35	6	3.36
4307	5"	Octag.	3.2	3.0	4 3/4"	4 3/4"	2"	100-14000	130	Single	Tic.	0.27	3	2.34
4308	5"	Octag.	3.2	3.0	4 3/4"	4 3/4"	2 1/4"	95-18000	124	Dual	Fer.	5.00	3	3.27
4309	8"	Octag.	3.2	6.0	7 3/4"	7 3/4"	3 1/4"	60-18000	72	Dual	Tic.	1.50	3	3.27
4310	8"	Octag.	8	0.6	7 3/4"	7 3/4"	2 7/8"	60-18000	72	Dual	Fer.	5.00	3	\$3.84
4311	8"	Octag.	8	6.0	7 3/4"	7 3/4"	4 5/8"	55-18000	60	Dual	Tic.	13.20	1	14.40
4312	10"	Round	8	10.0	10 1/4"	10 1/4"	5 3/4"	45-18000	50	Dual	Tic.	15.10	1	15.75
4313	12"	Round	3.2	10.0	12 3/8"	12 3/8"	4 1/4"	40-18000	45	Dual	Tic.	9.30	1	10.65
4314	12"	Round	8	20.0	12 3/8"	12 3/8"	6 1/8"	35-17000	45	Dual	Tic.	15.10	1	16.05
4315	3x8	Oval	3.2	3.0	8 5/8"	3 1/4"	2 1/16"	120-12000	130	Single	Tic.	2.50	1	3.84
4316	4x6	Oval	3.2	3.0	6 3/8"	4 3/8"	2 1/8"	110-11000	130	Single	Tic.	1.50	3	2.70
4317	4x6	Oval	3.2											

specify SMITH

HERMAN H. SMITH, INC.



ELECTRONIC COMPONENTS

SEMICONDUCTORS

Replace over 2800 Semiconductors with just 25 SMITH Types! The most versatile replacement program of dependable, high quality, low cost semiconductors, covering the most-often-used Transistors, Diodes, and Rectifiers used in today's entertainment equipment. SMITH Replacement & Interchangeability Guide available.

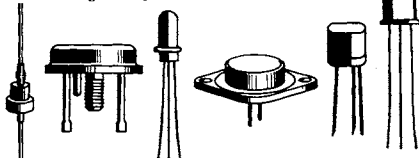

TRANSISTORS

3501	Mixer, Osc., Converter PNP	\$1.47
3502	I.F. Amplifier PNP	1.17
3503	A.F. Amplifier 6 V. PNP	0.99
3504	A.F. Amplifier 12 V. PNP	1.20
3505	A.F. Amplifier 9 V. PNP	0.99
3506	A.F. Automobile Power Amp. PNP	1.77
3507	Hi Power Automobile Amp. PNP	3.57
3508	Mixer, Osc., Converter NPN	1.50
3509	I.F. Amplifier NPN	1.50
3510	A.F. Amplifier 9 V. NPN	1.17
3511	A.F. Amplifier 12 V. NPN	1.17
3512	Hi Freq. R.F. I.F., Mixer, Osc., Converter PNP	1.50
3513	Hi Current (15 Amps.) for Ignition and D. C. Converters TO-3 Case	3.00
3514	Hi Current (15 Amps.) for Ignition and D. C. Converters TO-36 Case	3.57

RECTIFIERS, Silicon

3560	400 P.I.V. 750 Ma. Silicon Top Hat Rectifier	0.54
3561	600 P.I.V. 750 Ma. Silicon Top Hat Rectifier	0.75
3562	800 P.I.V. 750 Ma. Silicon Top Hat Rectifier	1.08
3563	1000 P.I.V. 750 Ma. Silicon Top Hat Rectifier	1.35
3564	400 P.I.V. 750 Ma. Silicon Epoxy Rectifier	0.42
3565	600 P.I.V. 750 Ma. Silicon Epoxy Rectifier	0.60
3566	800 P.I.V. 750 Ma. Silicon Epoxy Rectifier	0.90
3567	1000 P.I.V. 750 Ma. Silicon Epoxy Rectifier	1.35

DIODES, Germanium

3586	Gen. Purpose Germanium Diode	0.33
3587	Video Detector Germanium Diode	0.33
3588	50 Mc. Detector Germanium Diode	0.33

PILOT LIGHT SOCKETS

Clip-On Type

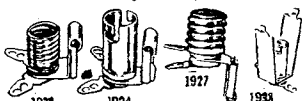

Can be used by clipping on to variable condenser or chassis. All brackets are cadmium plated.

No.	Type	Std. Pkg. 50	NET Per C
1922	Miniature Screw Up Clip	\$13.00	
1924	Miniature Screw Down Clip	13.00	
1924	Miniature Bayonet Up Clip	13.00	
1925	Miniature Bayonet Down Clip	13.00	
1926	Candelabra Up Clip	13.00	
1927	Candelabra Down Clip	13.00	
1938	Clip-in Socket	13.00	

PILOT LIGHT SOCKETS

Bracket Type

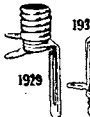

No.	Type	NET Per C
1928	Miniature Screw Up Bracket	\$13.00
1929	Miniature Screw Down Bracket	13.00
1930	Miniature Bayonet Up Bracket	13.00
1931	Miniature Bayonet Down Bracket	13.00
1932	Candelabra Up Bracket	13.00
1933	Candelabra Down Bracket	13.00

UNMOUNTED TYPE SOCKETS



No.	Type	NET Per C
1934	Miniature Screw Base	\$13.00
1935	Miniature Bayonet Base	13.00
1936	Candelabra Base	13.00

NAVY TYPE LAMP SOCKETS

75W-125V

Bayonet Base



Vibration-proof socket for surface mounting. Made to rigid specifications of black phenolic. Has bayonet sleeve of brass and double contacts of heavy spring phosphor bronze. Std. Pkg. 10 No. 1950 NET Per C \$135.00

SCREW BASE

Made of black phenolic to strict requirements. Instead of usual screw shell has phosphor bronze wire coiled spring for perfect contact and elimination of vibration. Designed for soldering wire leads. Std. Pkg. 10 No. 1951 NET Per C \$84.00



SCREW BASE

Easily wired and mounted. A very practical unit made of black phenolic to rigid specifications. Has phosphor bronze spring contact to assure positive contact and elimination of vibration. Std. Pkg. 10 No. 1952 NET Per C \$84.00



MINI-SHIELDS FOR MINI-TUBES



These Mini-Shields fit snugly on all Mini-Tubes. Serrations in base clip prevent shielded tube from jiggling or working loose. Available in two sizes for 1 1/2" & 2" long tubes. Std. Pkg. 50 NET Per C 550 for 2" tube 1 1/2" \$7.80 551 for 1 1/2" tube 1 1/4" 6.60

MINI-SPRING FOR MINI-TUBES



Maintains a direct axial pressure downwards plus a sideways support that keeps the tube upright and perpendicular to the chassis. The spring action is constant and resilient permanently. Std. Pkg. 50 No. 560 Short \$11.40 No. 561 Medium 11.40 No. 562 Long 11.40 No. 563 9 Prong 11.63

MINIATURE WAFER SOCKETS



Miniature bakelite sockets, with brass cadmium plated contacts. XP bakelite top plate 1/16" thick, bottom plate 3/64" thick; high grade spring brass cadmium plated contact; .095 dia. mounting holes. Std. Pkg. 50 SEVEN PIN NET Per C

No.	Description	MTG. Gen.	NET Per C
880	Eyelet only	7/8"	\$7.00
881	Eyelet and Shield	7/8"	6.90
882	Grd Strap and Shield	7/8"	7.50
887	Eyelet only	1"	7.00
888	Eyelet and Shield	1"	6.90
889	Grd Strap and Shield	1"	8.00

NINE PIN

No.	Description	MTG. Gen.	NET Per C
890	Eyelet only	1 1/8"	\$ 8.55
891	Eyelet and Shield	1 1/8"	8.85
892	Grd Strap and Shield	1 1/8"	9.50

MOLDED

MINIATURE SOCKETS



Saddle Type

Molded from either high dielectric black general purpose bakelite or low loss mica-filled bakelite.

Both types supplied with center pin. .098 dia. mtg. holes. Std. Pkg. 50

GENERAL PURPOSE BLACK BAKELITE

No.	Type	Pin	Mtg. Ctrs.	Mtg. Hole	NET Per C
895	Bottom Mount	7	7/8"	5/8"	\$9.00
896	Top Mount	7	7/8"	5/8"	9.00
897	Bottom Mount	9	1 1/8"	5/8"	10.80
898	Top Mount	9	1 1/8"	5/8"	10.80

LOW LOSS MICA-FILLED BAKELITE

No.	Type	Pin	Mtg. Ctrs.	Mtg. Hole	NET Per C
883	Bottom Mount	7	7/8"	5/8"	\$11.40
884	Top Mount	7	7/8"	5/8"	11.40
885	Bottom Mount	9	1 1/8"	5/8"	13.20
886	Top Mount	9	1 1/8"	5/8"	13.20

CRYSTAL SOCKET

Suitable for Citizen's Band

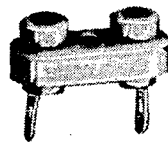

Glazed ceramic base. Phosphor bronze silver plated contacts spaced .486". Pin diameter .051. mtg. hole .125. Std. Pkg. 25 NET Per C No. 1945 \$15.00

COOLING FAN

An exceptionally efficient fan for cooling tubes, rectifiers, etc. for industrial equipment, Amateur Transmitters, and other devices, requiring assisted convection flow of air. Permits more efficient RP shielding of equipment without depending on convection cooling. Shaded pole induction motor with Nylon Fan Blade runs 3000 RPM on 105-125 Volts, 60 cycle AC. Blade diameter 2 1/2", over-all size 3 1/2" x 2 1/2" x 3". Mounts either horizontally or vertically. Supplied complete with two 8-32 x 1 1/2" screws and nuts, and two 1" fibre standoffs.

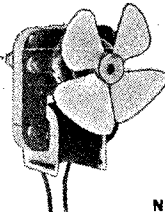

No. 2427

NET Each \$6.00

SNAP-IN BULB CONNECTOR

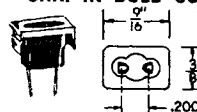

Designed for use with the new Twin Pin Baseless Miniature Lamps (G.E. #10-25 volts, #12-6.3 volts, or #15-7.0 volts). Easily assembled to any unit for indicating purposes. Withstands excessive temperatures. Snaps into a .500x.296 rectangular hole in panels .032 to .062 thick. Bezel - brass, cad. plated; contacts - brass, silver plated. Std. Pkg. 25 No. 1504 NET Per C \$17.00

PILOT

LIGHT

SHIELD

DESCR.: Prevents glare when used in radio receiver meters, etc. Ribbed bottom holds shield securely in place on bulb. Std. Pkg. 100

No.	Type	NET Per C
1963	Brass Cad. Plate	\$3.60
1968	Plain Brass	3.30
1969	Flared Brass Cad. Plate	4.20

GRID CAPS



No.	Std. Pkg. 100	NET Per C
1454	Tube Type 1/4" Mini Tubes	\$1.20

"IT'S SOUND PLANNING TO SPECIFY SMITH!"

specify SMITH

HERMAN H. SMITH, INC.



ELECTRONIC COMPONENTS

JUMPER CORDS

Male Phono Plug with finger grip handle on each end. Std. Pkg. 6

No.	Length	NET Ea.
631	18 inches	\$.75
632	24 inches	.78
633	36 inches	.84
634	48 inches	.96
635	72 inches	1.05
636	120 inches	1.50
745	180 inches	1.78

Right Angle Phono Plug to Right Angle Phono Plug. Std. Pkg. 6

No.	Length	NET Ea.
2720	18 inches	\$.75
2721	24 inches	.78
2722	36 inches	.84
2723	48 inches	.96
2724	72 inches	1.05
2725	120 inches	1.50
2726	180 inches	1.78

EXTENSION CORDS

Male Phono Plug with finger grip handle one end; Female In-line Jack other end. Std. Pkg. 6

No.	Length	NET Ea.
641	18 inches	\$.99
642	24 inches	1.02
643	36 inches	1.08
644	48 inches	1.20
645	72 inches	1.29
646	120 inches	1.62

Right Angle Phono Plug to In-line Jack. Std. Pkg. 6

No.	Length	NET Ea.
2728	18 inches	\$.99
2729	24 inches	1.02
2730	36 inches	1.08
2731	48 inches	1.20
2732	72 inches	1.29
2733	120 inches	1.62

Male Phono Plug one end; In-line Jack other end. Std. Pkg. 6

No.	Length	NET Ea.
639	72 inches	NET ea. \$1.44

Right Angle Phono Plug to In-line Jack. Std. Pkg. 6

No.	Length	NET Ea.
2740	72 inches	NET ea. \$1.44

INPUT-OUTPUT CORDS

Male Phono Plug with finger grip handle one end; Male Phono Plug other end. Std. Pkg. 6

No.	Length	NET Ea.
662	72 inches	NET Ea. \$1.38

Right Angle Phone Plug to Straight Phono Plug. Std. Pkg. 6

No.	Length	NET Ea.
2786	6 feet	NET Ea. \$1.38

Male Phono Plug with Molded Finger grip handle one end; Miniature Phone Plug other end. Std. Pkg. 6

No.	Length	NET Ea.
715	72 inches	NET Ea. \$1.38

Right Angle Phono Plug to Phone Plug. Std. Pkg. 6

No.	Length	NET Ea.
2739	72 inches	NET Ea. \$1.38

Right Angle Phone Plug to Right Angle Phono Plug. Std. Pkg. 6

No.	Length	NET Ea.
2787	6 feet	NET Ea. \$1.38

Right Angle Phono Plug to Miniature Phone Plug. Std. Pkg. 6

No.	Length	NET Ea.
2741	72 inches	NET Ea. \$1.38

STEREO CONNECTOR CABLES

Twin shielded audio cables, individually color coded with molded connectors, for neat, simultaneous connections of both channels in Stereo Hi-Fi equipment.



Male Phono Plugs with finger grip handle on each end.

No.	Length	NET Each
754	36 inches	\$1.80
755	72 inches	2.04
756	144 inches	2.70



Male Phono Plugs with finger grip handle, one end. Other end stripped and tinned with color-coded insulation.

No.	Length	NET Each
757	36 inches	\$1.59
758	72 inches	1.74
759	144 inches	2.25



Male Phono Plugs with finger grip handle, one end. Female molded in-line jacks other end.

No.	Length	NET Each
760	36 inches	\$2.25
761	72 inches	2.40
762	144 inches	3.00

PHONO PLUG CONNECTOR CORDS

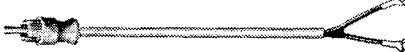

Male Phono Plug with finger grip handle one end; Spade Lugs other end. Std. Pkg. 6

No.	Length	NET Ea.
668	72 inches	NET Ea. \$.72

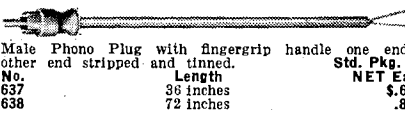

Male Phono Plug with finger grip handle one end; other end stripped and tinned. Std. Pkg. 6

No.	Length	NET Ea.
637	36 inches	\$.66
638	72 inches	.84

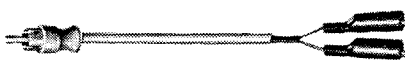

Male Phono Plug with finger grip handle one end; Insulated Alligator Clips other end. Std. Pkg. 6

No.	Length	NET Ea.
673	36 inches	\$.72
674	72 inches	.90

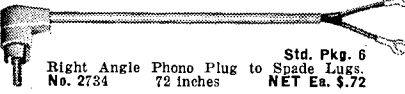

Right Angle Phono Plug to Spade Lugs. Std. Pkg. 6

No.	Length	NET Ea.
2734	72 inches	NET Ea. \$.72

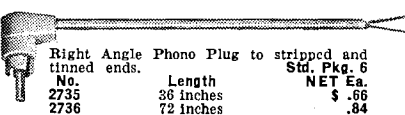

Right Angle Phono Plug to stripped and tinned ends. Std. Pkg. 6

No.	Length	NET Ea.
2735	36 inches	\$.66
2736	72 inches	.84

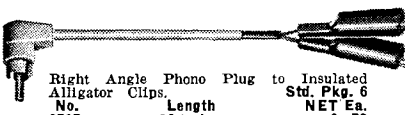

Right Angle Phono Plug to Insulated Alligator Clips. Std. Pkg. 6

No.	Length	NET Ea.
2737	36 inches	\$.72
2738	72 inches	.90

PHONE PLUG JUMPER CORDS

Male Phone Plugs on each end. Std. Pkg. 6

No.	Length	NET Ea.
677	72 inches	NET Ea. \$1.38

Right Angle Phone Plug to Right Angle Phone Plug. Std. Pkg. 6

No.	Length	NET Ea.
2784	6 feet	\$1.38
2785	10 feet	1.71

Right Angle Phone Plug to Straight Phone Plug. Std. Pkg. 6

No.	Length	NET Ea.
2783	6 feet	NET Ea. \$1.38

PHONE PLUG EXTENSION CORDS

Male Phone Plug one end; Female In-line Jack other end. Std. Pkg. 6

No.	Length	NET Ea.
663	72 inches	NET Ea. \$1.80

Right Angle Phone Plug to In-line Phone Jack. Std. Pkg. 6

No.	Length	NET Ea.
2788	6 feet	NET Ea. \$1.80

Male Phone Plug one end; In-line Jack other end. Std. Pkg. 6

No.	Length	NET Ea.
669	72 inches	NET Ea. \$1.98

Right Angle Phone Plug to In-line Phone Jack. Std. Pkg. 6

No.	Length	NET Ea.
2789	6 feet	NET Ea. \$1.98

PHONE PLUG CONNECTOR CORDS

Male Phone Plug one end; Spade Lugs other end. Std. Pkg. 6

No.	Length	NET Ea.
665	72 inches	NET Ea. \$1.08

Male Phone Plug one end; other end stripped and tinned. Std. Pkg. 6

No.	Length	NET Ea.
667	72 inches	NET Ea. \$1.20

Male Phone Plug one end; insulated Alligator Clips other end. Std. Pkg. 6

No.	Length	NET Ea.
664	72 inches	NET Ea. \$1.29

Right Angle Phone Plug to Insulated Spade Lug. Std. Pkg. 6

No.	Length	NET Ea.
2780	6 feet	NET Ea. \$1.08

Right Angle Phone Plug to Stripped and Tinned Ends. Std. Pkg. 6

No.	Length	NET Ea.
2781	6 feet	NET Ea. \$1.20

Right Angle Phone Plug to Insulated Alligator Clips. Std. Pkg. 6

No.	Length	NET Ea.
2782	6 feet	NET Ea. \$1.29

specify SMITH

HERMAN H. SMITH, INC.



ELECTRONIC COMPONENTS

COUPLERS

Brass and Insulated

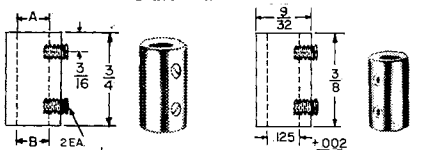

No.	A	B	C	Material	NET Per C
120	1/4"	1/4"	1/2"	Brass N.P.	\$22.00
140	1/4"	1/4"	1/2"	Fibre	22.00
131	3/8"	3/8"	1/2"	Brass N.P.	25.00
141	3/8"	3/8"	1/2"	Fibre	25.00
133	3/8"	3/8"	1/2"	Brass N.P.	25.00
142	3/8"	3/8"	1/2"	Fibre	25.00
138	1/4"	1/4"	1/2"	Brass N.P.	30.00
180	1/8"	1/8"	3/8"	Brass N.P.	\$40.00

EXTENDERS

Brass and Insulated

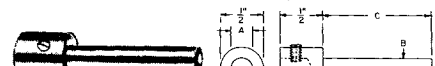

No.	A	B	C	Material	NET Per C
150	1/4"	1/4"	1/2"	Brass N.P.	\$35.00
150	1/4"	1/4"	1/2"	Fibre	35.00
152	3/8"	3/8"	1/2"	Brass N.P.	35.00
154	3/8"	3/8"	1/2"	Fibre	35.00
160	1/4"	1/4"	1/2"	Brass N.P.	\$25.00
161	1/4"	1/4"	1/2"	Fibre	22.00
162	3/8"	3/8"	1/2"	Brass N.P.	30.00
163	3/8"	3/8"	1/2"	Fibre	27.00
169	1/8"	1/8"	3/8"	Brass N.P.	\$35.00

SHAFT EXTENDERS For Volume Controls

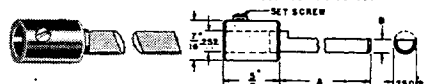

No.	A	B	Material	NET Per C
2356	2"	.250"	Brass, Nickel Plated	\$30.00
2357	3"	.250"	Brass, Nickel Plated	31.00
2358	4"	.250"	Brass, Nickel Plated	33.00
2359	2"	.219"	Brass, Nickel Plated	34.00
2360	3"	.219"	Brass, Nickel Plated	35.00
2361	4"	.219"	Brass, Nickel Plated	45.00
2362	2"	.156"	Brass, Nickel Plated	34.00
2363	3"	.156"	Brass, Nickel Plated	35.00
2364	4"	.156"	Brass, Nickel Plated	50.00

BUSHING EXTENDERS For Volume Controls

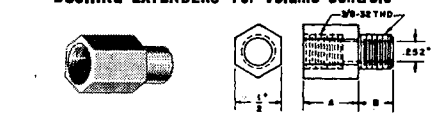

No.	A	B	Material	NET Per C
2350	3/8"	3/8"	Brass, Nickel Plated	\$25.00
2351	3/8"	3/8"	Brass, Nickel Plated	30.00
2352	3/8"	3/8"	Brass, Nickel Plated	33.00
2353	1 1/8"	3/8"	Brass, Nickel Plated	34.00
2354	1 1/8"	3/8"	Brass, Nickel Plated	35.00
2355	1 1/8"	3/8"	Brass, Nickel Plated	36.00

BRASS THREADED RODS

1-Ft. Length		2-Ft. Length	
No.	NET Ea.	No.	NET Ea.
1400-1	\$3.50	1400-2	\$1.00
1401-1	.50	1401-2	1.00
1402-1	.50	1402-2	1.00
1403-1	.55	1403-2	1.10

NYLON THREADED RODS

1-Ft. Length		2-Ft. Length	
No.	NET Ea.	No.	NET Ea.
1420-1	\$1.00	1420-2	\$2.20
1421-1	1.20	1421-2	2.40
1422-1	1.50	1422-2	3.00
1423-1	1.80	1423-2	3.60

Brass Fibre and Nylon PLAIN RODS

1/8" DIA		3/16" DIA	
No.	NET Ea.	No.	NET Ea.
1404	\$35	1431	\$3.30
1405	.70	1432	.60
1406	.15	1433	.15
1407	.30	1434	.30
1408	.24	1440	.24
1409	.48	1441	.24

SHAFT LOCKS Brass Nickel Plated

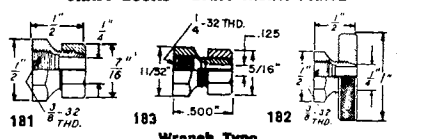

No.	Shaft	Std. Pkg.	NET Per C
181	3/4"	100	\$27.00
185	1/8"	25	20.00
182	1/4"	25	45.00

DIAL LOCK

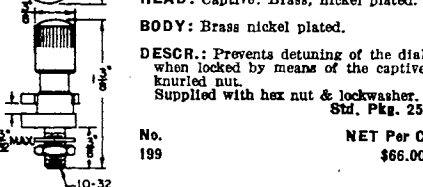

No.	NET Per C
199	\$66.00

CAPTIVE SCREW & BUSHING Large Head

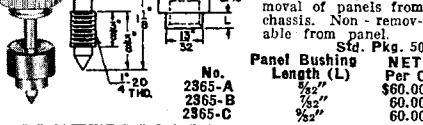

No.	Panel Bushing Length (L)	NET Per C
2365-A	1/2"	\$60.00
2365-B	3/8"	60.00
2365-C	5/16"	60.00

CAPTIVE SCREW & BUSHING Small Head

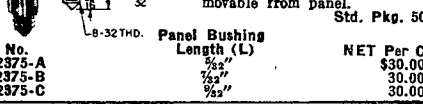

No.	Thread	NET Per C
2366	6-32	\$15.00
2367	8-32	15.00
2368	10-32	15.00

PANEL BEARINGS Brass, Nickel Plated

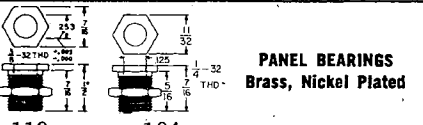

No.	Type	Std. Pkg.	NET Per C
119	Standard	100	\$15.00
184	Miniature	25	15.00

PANEL BEARING ASSEMBLY

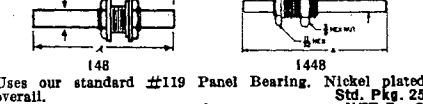

No.	Length "A"	NET Per C
1448	2"	\$35.00
1449	4"	50.00

MINIATURE PANEL BEARING ASSEMBLY

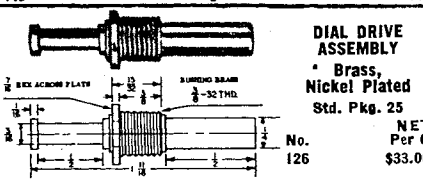

No.	NET Per C
1448	\$35.00
1449	50.00

DIAL DRIVE ASSEMBLY

No.	NET Per C
126	\$33.00

FLEXIBLE SHAFTS

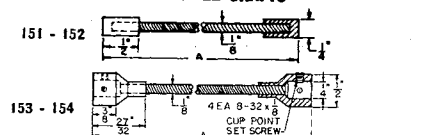

No.	Size "A"	Description	Std. Pkg.	NET Per C
151	3"	With 1/4" hub	25	\$60.00
152	6"	With 1/4" hub	25	65.00
153	3"	With 1/4" coupler	25	105.00
154	6"	With 1/4" coupler	25	110.00

BI-DIRECTIONAL FLEXIBLE SHAFT AND PANEL BEARING

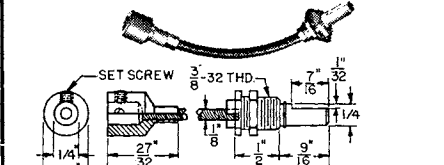

No.	Length "A"	NET Ea.
165	4 1/2"	\$1.35
166	7 1/2"	1.50

FLEXIBLE SHAFT ASSEMBLY With Casing

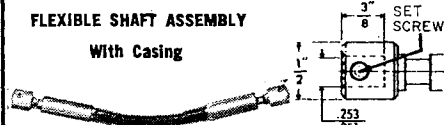

No.	Length	NET Ea.
169	12"	\$6.30
170	12"	7.50

NYLON FLEXIBLE SHAFT COUPLING

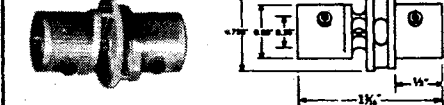

No.	NET Ea.
164	\$1.65

SHAFT WRENCH

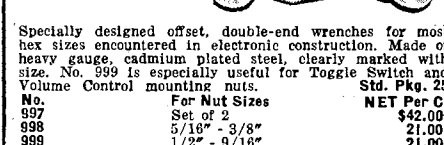

Specially designed offset, double-end wrenches for most hex sizes encountered in electronic construction. Made of heavy gauge, cadmium plated steel, clearly marked with size. No. 999 is especially useful for Toggle Switch and Volume Control mounting nuts.

No.	For Nut Sizes	NET Per C
997	Set of 2	\$42.00
998	5/16" - 3/8"	21.00
999	1/2" - 9/16"	21.00

NYLON LOCKING CLAMP

Wedge and ratchet design makes for positive holding and locking. Accommodates cables from 1/8" to 1 1/4". No knot tying, just slip clamp around cable, insert tongue and pull tight.

No.	Std. Pkg.	NET Per C
800	100	\$9.00

NYLON MOUNTING TABS

For use with No. 800 locking clamp when pre-mounted assembly points are desired. Furnished with .203 mounting hole.

No.	NET Per C
801	\$3.00

NYLON PERFORATING STRAPPING

For bundling of wire, cable and tubing. Time saver for harnessing. Use No. 803 ratchet buckle for fast assembly. Supplied on 50' rolls.

No.	NET Per Roll
802	\$16.00

NYLON RATCHET BUCKLE

For No. 802 strapping. Quick and easier assembly with this ingenious item.

No.	NET Per C
803	\$10.20

TIGHTENING TOOL

Used with strapping for fast assembly.

No.	NET Ea.
804	\$18.00



COLOR CODE: RED: 22-18 AWG; BLUE: 16-14 AWG; YELLOW: 12-10 AWG

WIRE SIZE 22-18 AWG UL APPROVED
030 ELECTROLYTIC COPPER
TIN PLATED

Smith Cat.No.	Material	Stud Size	W	Dimensions C	L	Net Per C
RING TERMINAL — NON-INSULATED						
4801	Butted Seam	4-6	1/4	7/32	19/32	\$2.00
4802	Butted Seam	8	21/64	1/4	11/16	2.00
4803	Butted Seam	10	21/64	1/4	11/16	2.00
4804	Brazed	4-6	1/4	7/32	19/32	3.20
4805	Brazed	8	21/64	1/4	11/16	3.20
4806	Brazed	10	21/64	1/4	11/16	3.20

Smith Cat.No.	Material	Stud Size	W	Dimensions C	L	Net Per C
RING TERMINAL — INSULATED						
4809	Vinyl	4-6	1/4	7/32	25/32	4.00
4810	Vinyl	8	21/64	1/4	7/8	4.00
4811	Vinyl	10	21/64	1/4	7/8	4.00
4812	Nylon	4-6	1/4	7/32	25/32	6.50
4813	Nylon	8	21/64	1/4	7/8	6.50
4814	Nylon	10	21/64	1/4	7/8	6.50

Smith Cat.No.	Material	Stud Size	W	Dimensions C	L	Net Per C
FLAG TERMINAL — NON-INSULATED						
4815	Butted Seam	8-10	3/8	11/32	21/32	\$3.00

Smith Cat.No.	Material	Stud Size	W	Dimensions C	L	Net Per C
SPADE TERMINAL — NON-INSULATED						
4816	Butted Seam	4-6	21/64	1/4	11/16	\$2.00
4817	Butted Seam	8	21/64	1/4	11/16	2.00
4818	Butted Seam	10	21/64	1/4	11/16	2.00
4819	Brazed	4-6	21/64	1/4	11/16	3.20
4820	Brazed	8	21/64	1/4	11/16	3.20
4821	Brazed	10	21/64	1/4	11/16	3.20

Smith Cat.No.	Material	Stud Size	W	Dimensions C	L	Net Per C
SPADE TERMINAL — INSULATED						
4822	Vinyl	4-6	21/64	1/4	7/8	4.00
4823	Vinyl	8	21/64	1/4	7/8	4.00
4824	Vinyl	10	21/64	1/4	7/8	4.00
4825	Nylon	4-6	21/64	1/4	7/8	6.50
4826	Nylon	8	21/64	1/4	7/8	6.50
4827	Nylon	10	21/64	1/4	7/8	6.50

Smith Cat.No.	Material	Stud Size	W	Dimensions C	L	Net Per C
BLOCK SPADES — NON-INSULATED						
4829	Butted Seam	4-6	19/64	1/4	21/32	\$2.00
4830	Butted Seam	8	19/64	1/4	21/32	2.00
4831	Butted Seam	10	19/64	1/4	21/32	2.00
4832	Brazed	4-6	19/64	1/4	21/32	3.20
4833	Brazed	8	19/64	1/4	21/32	3.20
4834	Brazed	10	19/64	1/4	21/32	3.20

Smith Cat.No.	Material	Stud Size	W	Dimensions C	L	Net Per C
BLOCK SPADES — INSULATED						
4835	Vinyl	4-6	19/64	1/4	27/32	4.00
4836	Vinyl	8	19/64	1/4	27/32	4.00
4837	Vinyl	10	19/64	1/4	27/32	4.00
4838	Nylon	4-6	19/64	1/4	27/32	6.50
4839	Nylon	8	19/64	1/4	27/32	6.50
4840	Nylon	10	19/64	1/4	27/32	6.50

WIRE SIZE 22-18 AWG UL APPROVED
030 ELECTROLYTIC COPPER
TIN PLATED

Smith Cat.No.	Material	Stud Size	W	Dimensions C	L	Net Per C
BLOCK SPADES FLANGED — NON-INSULATED						
4841	Butted Seam	4-6	19/64	1/4	21/32	\$2.00
4842	Butted Seam	8	19/64	1/4	21/32	2.00
4843	Butted Seam	10	19/64	1/4	21/32	2.00
4844	Brazed	4-6	19/64	1/4	21/32	3.20
4845	Brazed	8	19/64	1/4	21/32	3.20
4846	Brazed	10	19/64	1/4	21/32	3.20

Smith Cat.No.	Material	Stud Size	W	Dimensions C	L	Net Per C
BLOCK SPADES FLANGED — INSULATED						
4847	Vinyl	4-6	19/64	1/4	27/32	4.00
4848	Vinyl	8	19/64	1/4	27/32	4.00
4849	Vinyl	10	19/64	1/4	27/32	4.00
4850	Nylon	4-6	19/64	1/4	27/32	6.50
4851	Nylon	8	19/64	1/4	27/32	6.50
4852	Nylon	10	19/64	1/4	27/32	6.50

Smith Cat.No.	Material	Stud Size	W	Dimensions C	L	Net Per C
HOOK TERMINAL — NON-INSULATED						
4853	Butted Seam	4-6	21/64	1/4	11/16	\$2.00
4854	Butted Seam	8	21/64	1/4	11/16	2.00
4855	Butted Seam	10	21/64	1/4	11/16	2.00
4856	Brazed	4-6	21/64	1/4	11/16	3.20
4857	Brazed	8	21/64	1/4	11/16	3.20
4858	Brazed	10	21/64	1/4	11/16	3.20

Smith Cat.No.	Material	Stud Size	W	Dimensions C	L	Net Per C
HOOK TERMINAL — INSULATED						
4859	Vinyl	4-6	21/64	1/4	7/8	4.00
4860	Vinyl	8	21/64	1/4	7/8	4.00
4861	Vinyl	10	21/64	1/4	7/8	4.00
4862	Nylon	4-6	21/64	1/4	7/8	6.50
4863	Nylon	8	21/64	1/4	7/8	6.50
4864	Nylon	10	21/64	1/4	7/8	6.50

WIRE SIZE 16-14 AWG UL APPROVED
030 ELECTROLYTIC COPPER
TIN PLATED

Smith Cat.No.	Material	Stud Size	W	Dimensions C	L	Net Per C
RING TERMINAL — NON-INSULATED						
4865	Butted Seam	4-6	1/4	7/32	19/32	\$2.00
4866	Butted Seam	8	21/64	1/4	11/16	2.00
4867	Butted Seam	10	21/64	1/4	11/16	2.00
4868	Butted Seam	12 1/2	15/32	13/32	57/64	2.50
4869	Brazed	4-6	1/4	7/32	19/32	3.20
4870	Brazed	8	21/64	1/4	11/16	3.20
4871	Brazed	10	21/64	1/4	11/16	3.20
4872	Brazed	12 1/2	15/32	13/32	57/64	4.00

Smith Cat.No.	Material	Stud Size	W	Dimensions C	L	Net Per C
RING TERMINAL — INSULATED						
4873	Vinyl	4-6	1/4	7/32	25/32	4.00
4874	Vinyl	8	21/64	1/4	7/8	4.00
4875	Vinyl	10	21/64	1/4	7/8	4.00
4876	Vinyl	12 1/2	15/32	13/32	1-3/16	4.05
4877	Nylon	4-6	1/4	7/32	25/32	6.50
4878	Nylon	8	21/64	1/4	7/8	6.50
4879	Nylon	10	21/64	1/4	7/8	6.50
4880	Nylon	12 1/2	15/32	13/32	1-3/16	7.50

Smith Cat.No.	Material	Stud Size	W	Dimensions C	L	Net Per C
FLAG TERMINAL — NON-INSULATED						
4881	Butted Seam	8-10	3/8	11/32	11/16	\$3.00

WIRE SIZE 16-14 AWG UL APPROVED
030 ELECTROLYTIC COPPER
TIN PLATED

Smith Cat.No.	Material	Stud Size	W	Dimensions C	L	Net Per C
SPADE TERMINAL — NON-INSULATED						
4882	Butted Seam	4-6	21/64	1/4	11/16	\$2.00
4883	Butted Seam	8	21/64	1/4	11/16	2.00
4884	Butted Seam	10	21/64	1/4	11/16	2.00
4885	Brazed	4-6	21/64	1/4	11/16	3.20
4886	Brazed	8	21/64	1/4	11/16	3.20
4887	Brazed	10	21/64	1/4	11/16	3.20

Smith Cat.No.	Material	Stud Size	W	Dimensions C	L	Net Per C
SPADE TERMINAL — INSULATED						
4888	Vinyl	4-6	21/64	1/4	7/8	4.00
4889	Vinyl	8	21/64	1/4	7/8	4.00
4890	Vinyl	10	21/64	1/4	7/8	4.00
4891	Nylon	4-6	21/64	1/4	7/8	6.50
4892	Nylon	8	21/64	1/4	7/8	6.50
4893	Nylon	10	21/64	1/4	7/8	6.50

Smith Cat.No.	Material	Stud Size	W	Dimensions C	L	Net Per C
BLOCK SPADES — NON-INSULATED						
4894	Butted Seam	4-6	19/64	1/4	21/32	\$2.00
4895	Butted Seam	8	19/64	1/4	21/32	2.00
4896	Butted Seam	10	19/64	1/4	21/32	2.00
4897	Brazed	4-6	19/64	1/4	21/32	3.20
4898	Brazed	8	19/64	1/4	21/32	3.20
4899	Brazed	10	19/64	1/4	21/32	3.20

Smith Cat.No.	Material	Stud Size	W	Dimensions C	L	Net Per C
BLOCK SPADES — INSULATED						
4901	Vinyl	4-6	19/64	1/4	27/32	4.00
4902	Vinyl	8	19/64	1/4	27/32	4.00
4903	Vinyl	10	19/64	1/4	27/32	4.00
4904	Nylon	4-6	19/64	1/4	27/32	6.50
4905	Nylon	8	19/64	1/4	27/32	6.50
4906	Nylon	10	19/64	1/4	27/32	6.50

Smith Cat.No.	Material	Stud Size	W	Dimensions C	L	Net Per C
BLOCK SPADES FLANGED — NON-INSULATED						
4907	Butted Seam	4-6	19/64	1/4	21/32	\$2.00
4908	Butted Seam	8	19/64	1/4	21/32	2.00
4909	Butted Seam	10	19/64	1/4	21/32	2.00
4910	Brazed	4-6	19/64	1/4	21/32	3.20
4911	Brazed	8	19/64	1/4	21/32	3.20
4912	Brazed	10	19/64	1/4	21/32	3.20

Smith Cat.No.	Material	Stud Size	W	Dimensions C	L	Net Per C
BLOCK SPADES FLANGED — INSULATED						
4913	Vinyl	4-6	19/64	1/4	27/32	4.00
4914	Vinyl	8	19/64	1/4	27/32	4.00
4914	Vinyl	10	19/64	1/4	27/32	4.00
4916	Nylon	4-6	19/64	1/4	27/32	6.50
4917	Nylon	8	19/64	1/4	27/32	6.50
4918	Nylon	10	19/64	1/4	27/32	6.50

Smith Cat.No.	Material	Stud Size	W	Dimensions C	L	Net Per C
HOOK TERMINAL — NON-INSULATED						
4919	Butted Seam	4-6	21/64	1/4	11/16	\$2.00
4920	Butted Seam	8	21/64	1/4	11/16	2.00
4921	Butted Seam	10	21/64	1/4	11/16	2.00
4922	Brazed	4-6	21/64	1/4	11/16	3.20
4923	Brazed	8	21/64	1/4	11/16	3.20
4924	Brazed	10	21/64			

specify SMITH

HERMAN H. SMITH, INC.



ELECTRONIC COMPONENTS

SOLDERLESS TERMINALS



"SOLISTRAND"
Non-Insulated

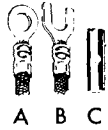

The only terminal designed for use with solid, stranded or irregularly shaped wires, or combinations of wires. Corrosion resistant, high strength, electro-tinned; versatile — widely adaptable.
Std. Pkg. 100

RING TONGUE (A)

Wire Size	AMP No.	Stud Size	Tongue Width	Overall Length	Stud Clear.	Per C	NET Per C
22	2850 32989	4	1/32	1/32	3/32		\$4.50
22	2851 34194	6	1/32	1/32	3/32		4.50
to	2852 32990	8	1/32	1/32	3/32		4.50
to	2853 33214	10	1/32	1/32	3/32		5.50
to	2854 33215	1/4	1/16	1/16	3/32		7.50
16	2855 33452	1/4	1/32	1/32	2/64		7.50
to	2856 33453	3/8	1/16	1/32	1/32		7.50
16	2857 32991	4	1/4	1/16	1/16		\$5.50
16	2858 34197	6	1/4	1/16	1/16		5.50
to	2859 32992	8	1/4	1/16	1/16		5.50
to	2860 320093	10	1/4	1/16	1/16		5.50
to	2861 33218	1/4	1/32	1/16	1/16		7.50
14	2862 33454	3/8	1/32	1/16	1/16		7.50
to	2863 33455	3/8	1/32	1/16	1/32		7.50

SPADE TONGUE (B)

Wire Size	AMP No.	Stud Size	Tongue Width	Overall Length	Stud Clear.	Per C	NET Per C
22	2864 32897	6	1/32	5/8	1/64		\$4.50
to	2865 32898	8	1/32	5/8	1/64		4.50
16	2866 32899	10	1/32	5/8	1/64		4.50
16	2867 32903	6	1/32	5/8	1/64		\$4.50
to	2868 32904	8	1/32	5/8	1/64		4.50
14	2869 32905	10	1/32	5/8	1/64		4.50

BUTT CONNECTOR (C)

2870	31818	22-16	.140 I.D.	3/64	\$5.50
2871	31819	16-14	.170 I.D.	3/64	5.50

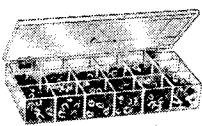

SOLDERLESS TERMINAL ASSORTMENTS

A basic assortment of the most commonly used Ring Tongue and Spade terminals for wire sizes 22 thru 14. Packed in a re-usable clear plastic compartmented box.

No.	Approx. Quantity of Terminals	Style	NET
1526	200	"PLASTI-GRIP"	\$18.00
1527	300	"PLASTI-GRIP"	26.00
1528	200	"SOLISTRAND"	13.00
1529	300	"SOLISTRAND"	19.00
1577	200	"P.I.D.G."	24.00
1578	300	"P.I.D.G."	35.00



Pre-Insulated
Diamond Grip

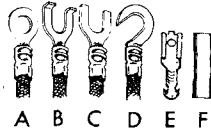

Color-coded for wire size. Std. Pkg. 100

RING TONGUE (A)

Wire Size	No.	AMP No.	Stud Size	Tongue Width	Overall Length	Stud Clear.	Per C
22	1550	320882	4	3/64	2/32	5/32	\$10.50
to	1551	31881	6	3/64	2/32	5/32	10.50
to	1552	31886	8	3/64	2/32	5/32	10.50
to	1553	31887	10	3/64	2/32	5/32	10.50
16	1554	31894	1/4	1/32	1/16	2/64	11.50
14	1555	32441	4	1/4	1/16	1/64	10.50
to	1556	32442	6	1/4	1/16	1/64	10.50
to	1557	31902	8	1/4	2/32	3/32	10.50
to	1558	322238	10	3/64	2/32	1/4	10.50
16	1559	31900	1/4	1/32	1/16	3/16	11.50

FLANGED SPADE (B)

22-16	1560	32562	6	1/64	2/32	1/64	\$10.50
to	1561	32498	8	2/64	1/16	1/4	11.50
14-16	1562	320861	6	1/64	2/32	1/64	10.50
to	1563	320862	8	1/64	2/32	1/64	10.50
to	1564	320863	10	1/64	2/32	1/64	10.50

SPADE TONGUE (C)

22-16	1565	34541	6	1/4	5/64	1/64	\$11.50
to	1566	32053	8	3/8	5/64	1/64	10.50
to	1567	32054	10	9/8	5/64	1/64	10.50
14-16	1568	35559	6	1/4	4/64	1/64	10.50
to	1569	321233	8	1/4	4/64	1/64	11.50
to	1570	32060	10	9/8	5/64	3/16	10.50

HOOK TONGUE (D)

22-16	1571	34313	6	1/32	4/64	1/64	\$10.50
to	1572	32456	8	1/32	5/64	2/32	10.50
14-16	1573	320381	6	1/32	2/32	3/32	\$10.50
to	1574	320306	8	1/32	2/32	3/32	12.50
to	1575	35481	10	1/32	2/32	3/32	12.50

18-14 1576 42781-2 .250 Faston Receptacle (E) w/insulation support \$4.50

BUTT CONNECTOR (F)

22-16	1548	320559	.125 I.D.		\$9.00
16-14	1549	320562	.150 I.D.		9.00



"PLASTI-GRIP" (P.G.)

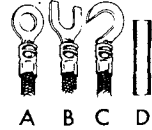

Insulated, strong, special plastic has high dielectric strength. Applied with single operation of press dies or hand tools. High tensile strength. High conductivity copper, electro-tinned. Color coded for wire size. Std. Pkg. 100

RING TONGUE (A)

Wire Size	AMP No.	Stud Size	Tong. W.	L.	Clear.	NET Per C
22	2750 34141	4	1/32	1/32	5/32	\$7.50
to	2751 34142	6	1/32	1/32	5/32	7.50
to	2752 34145	8	1/32	1/32	5/32	7.50
to	2753 34146	10	1/32	1/32	5/32	7.50
to	2754 34150	1/4	1/32	1/16	2/64	8.50
16	2755 34151	1/4	1/32	1/16	2/64	8.50
to	2756 34152	3/8	1/32	1/16	2/64	8.50
16	2757 34157	4	1/4	1/16	1/32	\$7.50
to	2758 34158	6	1/4	1/16	1/32	7.50
to	2759 34160	8	1/4	1/16	1/32	7.50
to	2760 34161	10	1/4	1/16	1/32	7.50
to	2761 34162	1/4	1/32	1/16	1/64	8.50
14	2762 34163	3/8	1/32	1/16	2/64	8.50
to	2763 34164	3/8	1/32	1/16	3/64	8.50

SPADE TONGUE (B)

Wire Size	AMP No.	Stud Size	Tong. W.	L.	Clear.	NET Per C
22	2764 34153	6	1/32	4/64	1/64	\$7.50
to	2765 34155	8	3/8	5/64	1/64	7.50
16	2766 34156	10	3/8	5/64	1/64	7.50
16	2767 34165	6	3/8	5/64	1/64	\$7.50
to	2768 34166	8	3/8	5/64	1/64	7.50
14	2769 34167	10	9/8	5/64	1/64	7.50

HOOK TONGUE (C)

20-16	2770 34501	6	3/32	4/64	3/16	\$7.50
to	2771 321699	8	1/32	5/64	3/32	7.50
16-14	2772 320263	8	1/32	5/64	1/64	\$10.50

BUTT CONNECTOR (D)

2773	34070	22-16	.140 I.D.	1	\$9.00
2774	34071	16-14	.170 I.D.	1 1/4	9.00

HAND CRIMPING TOOL



Makes strong, solderless connections; cuts and strips wire, and has threaded bit cutter.

No.	Type	NET Ea.
1579	For P.I.D.G. & P.G.	\$ 8.00
2872	For Solistrand Type	10.50

SMITH BARREL STYLES NON-INSULATED TERMINALS



BUTTED SEAM

- Electrolytic pure copper, tin plated.
- Open end for visual inspection of wire contact.
- Tight grip, multiple barrel serrations for full wire contact.



BRAZED — Same as above except silver brazed barrel.

INSULATED TERMINALS



VINYL INSULATED

- Electrolytic pure copper, tin plated.
- Plated for easy wire insertion.
- Vinyl insulation, butted seam.
- Nylon insulation.
- Butted seam with seamless brass sleeve attached.
- Color coded for proper wire selection.



NYLON INSULATED

- Electrolytic pure copper, tin plated.
- Plated for easy wire insertion.
- Nylon insulation.
- Butted seam with seamless brass sleeve attached.
- Color coded.

AUTO RADIO CONDENSERS



Eliminates radio interference caused by auto electrical system. Fits all cars — Proven quality — Guaranteed long life. Std. Pkg. 25

No.	Cap. Type	NET Per C
811	.5 MFD General Univ.	\$35.00
812	.25 MFD Universal	\$42.00

TV SNAP-ON FUSE HOLDER



Snap fuse clip over burned out fuse. Insert new fuse without soldering. Std. Pkg. 50

No.	NET Each
529	\$.16

FUSE MOUNTING BASES



Black bakelite, panel mount type. Will accommodate the 3 A G Auto type cartridge fuse. Std. Pkg. 25

No.	Type	NET Per C
530	Single	\$14.00
531	Double	26.00

Auto Radio IGNITION SUPPRESSORS

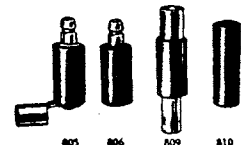

Std. Pkg. 50	Cat. No.	Type	NET Per C
	805	Snap-On Type Suppressor	\$40.00
	806	Univ. Type with Double Thrd.	40.00
	809	Distributor Plug-in Type	50.00
	810	Double Screw Type	25.00

MOTOROLA PLUGS & JACKS

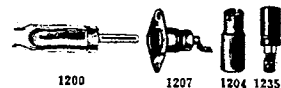

Std. Pkg. 50	No.	Type	NET Per C
	1200	Motorola Type Plug	\$10.20
	1207	Antenna Connector, Takes 1200 Plug	18.00
	1204	Lead-in Adapter, converts Motorola pin plug to Delco	9.00
	1235	Female for #1200 plug, without flange	7.20

MORE THAN TEN THOUSAND
ELECTRONIC COMPONENT PARTS MANUFACTURED UNDER ONE ROOF!

specify **SMITH**
HERMAN H. SMITH, INC.  **ELECTRONIC COMPONENTS**

 **ROUND HEAD STEEL MACHINE SCREWS**
CADIUM PLATED

Size	No.	Net per C	No.	Net per M
2-56 x 1/4"	1173C	\$.59	1173M	\$5.30
2-56 x 1/2"	1174C	.62	1174M	5.60
2-56 x 3/8"	1175C	.72	1175M	6.50
3-48 x 1/4"	1176C	.76	1176M	6.85
4-36 x 1/4"	1177C	.62	1177M	5.60
4-36 x 1/2"	1178C	.65	1178M	5.85
4-36 x 3/8"	1183C	.68	1183M	6.15
4-36 x 1/2"	1184C	.87	1184M	7.85
4-36 x 3/8"	1185C	1.00	1185M	9.00
4-40 x 1/4"	1350C	.62	1350M	5.60
4-40 x 1/2"	1351C	.65	1351M	5.85
4-40 x 3/8"	1352C	.69	1352M	6.20
4-40 x 1/2"	1353C	.74	1353M	6.65
4-40 x 3/8"	1354C	1.01	1354M	9.00
6-32 x 1/4"	1000C	.70	1000M	5.85
6-32 x 1/2"	1001C	.84	1001M	7.00
6-32 x 3/8"	1002C	.94	1002M	7.80
6-32 x 1/2"	1355C	.88	1355M	8.00
6-32 x 3/8"	1356C	1.04	1356M	9.40
6-32 x 1"	1357C	1.08	1357M	9.80
6-32 x 1 1/8"	1358C	1.95	1358M	17.55
8-32 x 1/4"	1006C	.94	1006M	7.80
8-32 x 1/2"	1007C	.97	1007M	8.10
8-32 x 3/8"	1008C	1.02	1008M	8.50
8-32 x 1/2"	1359C	1.21	1359M	10.90
10-32 x 1/2"	1360C	1.24	1360M	11.20
10-32 x 3/8"	1361C	1.46	1361M	13.15
10-32 x 1"	1362C	1.63	1362M	14.70

 **BRASS MACHINE SCREWS**
Round Head Nickel Plated

Size	No.	NET per C	No.	NET per M
4-36 x 1/4"	1044C	\$1.02	1044M	\$8.50
4-36 x 3/8"	1045C	.94	1045M	7.80
4-36 x 1/2"	1046C	1.32	1046M	11.20
4-40 x 1/4"	1047C	1.06	1047M	8.80
4-40 x 3/8"	1048C	1.26	1048M	10.50
4-40 x 1/2"	1049C	1.32	1049M	11.20
6-32 x 1/4"	1050C	1.56	1050M	13.00
6-32 x 3/8"	1051C	1.62	1051M	13.50
6-32 x 1/2"	1052C	1.50	1052M	12.50
8-32 x 1/4"	1056C	1.92	1056M	16.00
8-32 x 3/8"	1057C	2.30	1057M	19.20
8-32 x 1/2"	1058C	2.70	1058M	22.50

 **BINDING HEAD STEEL MACHINE SCREWS**
CADIUM PLATED

Size	No.	Net per C	No.	Net per M
2-56 x 1/4"	1369C	\$.59	1369M	\$5.30
2-56 x 1/2"	1370C	.62	1370M	5.60
2-56 x 3/8"	1371C	.72	1371M	6.50
4-40 x 1/4"	1372C	.62	1372M	5.60
4-40 x 1/2"	1373C	.69	1373M	6.20
4-40 x 3/8"	1374C	1.01	1374M	9.10
6-32 x 1/4"	1375C	.72	1375M	6.50
6-32 x 1/2"	1425C	.77	1425M	6.40
6-32 x 3/8"	1426C	.84	1426M	7.00
6-32 x 1/2"	1427C	.85	1427M	7.15
6-32 x 3/8"	1376C	.88	1376M	7.95
6-32 x 1/2"	1377C	1.04	1377M	9.40
8-32 x 1/4"	1428C	.77	1428M	6.40
8-32 x 3/8"	1378C	.96	1378M	8.65
8-32 x 1/2"	1429C	.97	1429M	8.10
8-32 x 3/8"	1430C	1.01	1430M	8.40
8-32 x 1/2"	1379C	1.21	1379M	10.90
10-32 x 1/2"	1380C	1.24	1380M	11.20
10-32 x 3/8"	1381C	1.34	1381M	12.10

 **STEEL SPADE BOLTS**

Size	No.	Net per C	No.	Net per M
6-32 x 3/8"	1500C	\$2.30	1500M	\$19.00

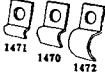
 **CABLE CLAMPS**
Steel Cadmium Plated with No. 8 Mtg. Hole. Std. Pkg. 100

No.	Length	Width	Cable	NET Per C
1471	3/8"	3/8"	3/8"	\$.78
1470	1/2"	3/8"	3/8"	.84
1472	1"	3/8"	3/8"	.90

SELF TAPPING SCREWS
ROUND HEAD—TYPE A—Sharp Point

Size	No.	NET per C	No.	NET per M
4 x 1/2"	1801C	\$.77	1801M	\$6.00
6 x 1/4"	1802C	.83	1802M	6.67
6 x 3/8"	1803C	.87	1803M	7.00
6 x 1/2"	1804C	.98	1804M	8.10
8 x 3/8"	1805C	.92	1805M	7.50
8 x 1/2"	1806C	1.12	1806M	9.45

ROUND HEAD—TYPE Z—Blunt Point

Size	No.	NET per C	No.	NET per M
4 x 1/2"	1807C	\$.87	1807M	\$7.00
6 x 1/4"	1808C	.87	1808M	7.00
6 x 3/8"	1809C	.87	1809M	7.00
6 x 1/2"	1810C	.98	1810M	8.10
8 x 3/8"	1811C	.92	1811M	7.50
8 x 1/2"	1812C	1.12	1812M	9.45

SLOTTED HEX HEAD—TYPE Z
Blunt Point

Size	No.	NET per C	No.	NET per M
6 x 1/4"	1830C	\$1.12	1830M	\$9.45
6 x 3/8"	1831C	1.12	1831M	9.45
6 x 1/2"	1832C	1.12	1832M	9.45
8 x 3/8"	1833C	.92	1833M	7.50
8 x 1/2"	1834C	1.12	1834M	9.45

 **PAN HEAD SHEET METAL SCREWS**
CADIUM PLATED

Size	No.	Net per C	No.	Net per M
4 x 1/2"	1389C	\$1.13	1389M	\$10.20
6 x 1/2"	1390C	1.13	1390M	10.20
6 x 3/8"	1391C	1.17	1391M	10.55
6 x 1/2"	1392C	1.20	1392M	10.80
6 x 3/4"	1393C	1.30	1393M	11.70
8 x 1/2"	1394C	1.30	1394M	11.70
8 x 3/8"	1395C	1.37	1395M	12.35
8 x 1/2"	1396C	1.40	1396M	12.60
8 x 1"	1397C	1.80	1397M	16.20

 **ROUND HEAD STEEL WOOD SCREWS**

Size	No.	Net per C	No.	Net per M
4 x 1/2"	1384C	\$1.01	1384M	\$9.10
4 x 3/4"	1385C	1.17	1385M	10.50
6 x 3/2"	1386C	1.26	1386M	11.35
6 x 1"	1387C	1.56	1387M	14.00
8 x 3/4"	1388C	1.50	1388M	13.50

 **OVAL HEAD STEEL NICKEL PLATED RACK SCREWS**

Size	No.	Net per C	No.	Net per M
6-32 x 3/8"	1382C	\$.98	1382M	\$8.85
8-32 x 3/4"	1383C	1.24	1383M	11.20
10-32 x 1/2"	1111C	1.14	1111M	9.50
10-32 x 3/4"	1112C	1.16	1112M	9.74

 **COUNTER SUNK WASHERS BRASS**
NICKEL PLATED

Size	No.	Net per C	No.	Net per M
#6	1115C	\$.61	1115M	\$5.10
#8	1116C	.91	1116M	6.75
#10	1117C	.94	1117M	7.80

FAHNESTOCK SPRING BATTERY CLIPS

Clips are made of brass, nickel plated and are available in the single and double clip types. Std. Pkg. 100

No.	Type	Length	NET Per C
539	Single	3/8"	\$2.80
538	Single	1/2"	2.80
534	Single	1"	4.00
535	Double	1 1/8"	11.00
536	Double	2 1/8"	13.00

 **HEXAGON NUTS**
Brass Nickel Plated

Size	No.	NET per C	No.	NET per M
4-36x1/4"	1188C	\$1.10	1188M	\$9.33
4-40x1/4"	1168C	1.10	1168M	9.25
6-32x1/4"	1189C	1.68	1189M	14.00
6-32x5/16"	1190C	1.28	1190M	11.08
8-32x5/16"	1192C	1.28	1192M	11.08
10-32x5/16"	1193C	1.70	1193M	14.00
1/4-32"	1187C	1.20	1187M	10.00

Steel Nickel Plated
1/4-32" 1186C 1.50 1186M \$13.20

 **HEX NUTS STEEL**
CADIUM PLATED

Size	No.	Net per C	No.	Net per M
2-56 x 3/8"	1363C	.68	1363M	5.05
3-48 x 3/8"	1364C	.68	1364M	5.05
4-36 x 1/4"	1365C	.67	1365M	5.00
6-32 x 1/4"	1179C	.70	1179M	5.25
6-32 x 3/8"	1180C	.72	1180M	5.55
8-32 x 1/4"	1366C	.73	1366M	5.60
8-32 x 3/8"	1181C	.96	1181M	8.00
10-32 x 3/8"	1367C	.97	1367M	8.00
1/4-20 x 3/8"	1368C	1.33	1368M	11.50
1/4-32 x 3/8"	1186C	.75	1186M	16.00

 **VOL CONTROL & TOGGLE SWITCH NUTS**
Nickel Plated

Type	No.	NET Per C	No.	NET Per M
Vol. Cont. Brass*	1195C	\$1.65	1195M	\$15.00
Vol. Cont. Steel*	1199C	1.32	1199M	12.00
Toggle Sw. Hex†	1196C	1.98	1196M	18.00
Toggle Sw. Ring‡	1197C	3.30	1197M	30.00

*3/8-32 x 1/2 x 3/32 †1 1/2 x 3/8 x 3/8 ‡1 1/2 x 3/8 x 3/8

 **FLAT STEEL WASHERS**
STEEL PLATED

Size	No.	Net per C	No.	Net per M
For #2 Screw	1138C	.65	1138M	4.80
For #4 Screw	1149C	1.02	1149M	8.50
For #6 Screw	1150C	.83	1150M	6.60
For #8 Screw	1151C	.65	1151M	4.80
For #10 Screw	1152C	.83	1152M	6.60
For 1/4" Screw	1147C	.83	1147M	6.60
For 3/8" Screw	1148C	.90	1148M	7.25

 **INTERNAL TOOTH LOCKWASHERS STEEL**
CADIUM PLATED

Size	No.	Net per C	No.	NET per C
#4	1127C	\$.51	1127M	\$3.50
#6	1128C	.51	1128M	3.50
#8	1129C	.55	1129M	3.83
#10	1130C	.55	1130M	3.83
1/4"	1132C	.67	1132M	5.00
3/8"	1131C	1.02	1131M	8.50
Narrow Rim 3/8"	1145C	1.02	1145M	8.50
Narrow Rim 1/2"	1146C	1.32	1146M	11.00

 **EXTERNAL TOOTH LOCKWASHERS STEEL**
CADIUM PLATED

Size	No.	Net per C	No.	Net per M
#4	1139C	.51	1139M	3.50
#6	1140C	.51	1140M	3.50
#8	1141C	.55	1141M	3.83
#10	1142C	.55	1142M	3.83
1/4"	1144C	.67	1144M	5.00
3/8"	1143C	1.02	1143M	8.50

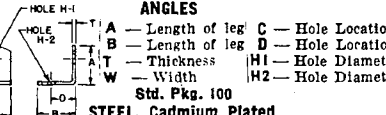

No.	A	B	C	D	W	T	H1	H2	Per C
1444	7/16	7/16	17/64	3/4	3/8	.032	3/16	#4	\$7.72
1445	1/2	1/2	17/64	29/64	1/2	.050	#6	#4	.90
1446	19/64	27/64	39/64	19/64	5/16	.032	#6	#6	.90
1447	19/64	1/2	61/64	23/64	5/16	.050	#8	#8	1.02
1476	11/16	13/16	1/2	1/2	3/8	.032	#6		

specify SMITH



ELECTRONIC COMPONENTS

HERMAN H. SMITH, INC.

ARROW, HART & HEGEMAN "SNAP ACTING" MOMENTARY CONTACT SWITCHES

PRECISION SNAP-ACTING SWITCH A precision snap-acting switch is a mechanically operated electric switch having predetermined and accurately controlled characteristics, and having contacts other than the blade and jaw, or mercury type, where the maximum separation between any butting contacts is 1/8 inch.

MOMENTARY CONTACT SWITCH A momentary contact switch is a switch which returns from the operated

condition to its normal circuit condition when the actuating force is removed.

ACTUATOR An actuator is the mechanism of the switch or enclosure which, when moved as intended, will operate the contacts.

OPERATING FORCE Operating force is that straight line force in the designated direction applied to the actuator to cause the switch contacts to snap to the operated contact position.

PRETRAVEL Pretravel is the distance or angle through which the actuator moves from the actuator free position to the actuator operating position.

OVERTRAVEL Overtravel is the movement of the actuator beyond the operating position.

MOVEMENT DIFFERENTIAL Movement differential is the distance or angle from the operating position to the releasing position.

Std. Pkg. 5

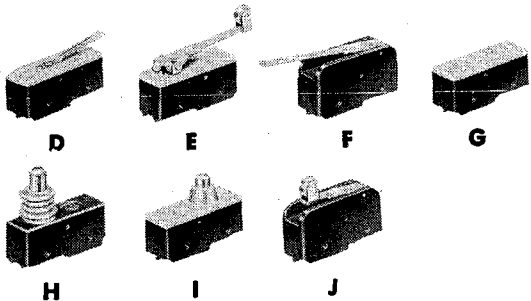

TERMINAL CODE: L = screws, lock washers C = screws, cup washers
S = solder lugs Q = quick disconnect

FLEXIBLE LEAF ACTUATOR (D)

General Purpose 15 amp

RATINGS
15 Amp., 480 V., A.C.
½ Amp., 125 V., D.C.
¼ Amp., 250 V., D.C.

Operating Characteristics
Operating Force..... 5 oz. max.
Pretravel..... 5/32" max.
Overtravel..... not over 1/16 in.
Diff. Travel..... .050" max.

WITH TERMINALS	S.P. NORM. OPEN		S.P. NORM. CLOSED		S.P.D.T.	
	No.	NET Ea.	No.	NET Ea.	No.	NET Ea.
S	4505	\$1.79	4537	\$1.79	4569	\$2.15
C	4506	1.85	4538	1.85	4570	2.28
L	4507	1.85	4539	1.85	4571	2.28
Q	4508	1.79	4540	1.79	4572	2.15

Heavy Duty 20 Amp

RATINGS
20 A., 480 V., A.C.
10 A., 125 V., A.C. "L" Load
¼ A., 250 V., D.C.
1 H.P., 120 V., A.C.
2 H.P., 240 V., A.C.

Operating Characteristics
Operating Force..... 9 oz. max.
Pretravel..... 11/32" max.
Overtravel..... not over 1/16 in.
Diff. Travel..... .065" max.

WITH TERMINALS	S.P. NORM. OPEN		S.P. NORM. CLOSED		S.P.D.T.	
	No.	NET Ea.	No.	NET Ea.	No.	NET Ea.
S	4605	\$1.85	4637	\$1.85	4669	\$2.28
C	4606	1.92	4638	1.92	4670	2.34
L	4607	1.92	4639	1.92	4671	2.34
Q	4608	1.85	4640	1.85	4672	2.28

STANDARD ROLLER (E)

General Purpose 15 Amp

RATINGS
15 Amp., 480 V., A.C.
½ Amp., 125 V., D.C.
¼ Amp., 250 V., D.C.

Operating Characteristics
Operating Force..... 3½ oz. max.
Pretravel..... 9/32" max.
Overtravel..... .156" min.
Diff. Travel..... .004 to .040 in.

WITH TERMINALS	S.P. NORM. OPEN		S.P. NORM. CLOSED		S.P.D.T.	
	No.	NET Ea.	No.	NET Ea.	No.	NET Ea.
S	4521	\$2.78	4553	\$2.78	4585	\$3.17
C	4522	2.91	4554	2.91	4586	3.30
L	4523	2.91	4555	2.91	4587	3.30
Q	4524	2.78	4556	2.78	4588	3.17

Heavy Duty 20 Amp

RATINGS
20 A., 480 V., A.C.
10 A., 125 V., A.C. "L" Load
¼ A., 250 V., D.C.
1 H.P., 120 V., A.C.
2 H.P., 240 V., A.C.

Operating Characteristics
Operating Force..... 2½ oz. max.
Pretravel..... 15/32" max.
Overtravel..... 1/16" min.
Diff. Travel..... .085" max.

WITH TERMINALS	S.P. NORM. OPEN		S.P. NORM. CLOSED		S.P.D.T.	
	No.	NET Ea.	No.	NET Ea.	No.	NET Ea.
S	4621	\$2.71	4653	\$2.71	4685	\$3.30
C	4622	2.98	4654	2.98	4686	3.37
L	4623	2.98	4655	2.98	4687	3.37
Q	4624	2.71	4656	2.71	4688	3.30

RIGID HINGE (F)

General Purpose 15 Amp

RATINGS
15 Amp., 480 V., A.C.
½ Amp., 125 V., D.C.
¼ Amp., 250 V., D.C.

Operating Characteristics
Operating Force..... 2½ oz.
Pretravel..... ¾" max.
Overtravel..... .219" min.
Diff. Travel..... .007 to .050 in.

WITH TERMINALS	S.P. NORM. OPEN		S.P. NORM. CLOSED		S.P.D.T.	
	No.	NET Ea.	No.	NET Ea.	No.	NET Ea.
S	4525	\$2.15	4557	\$2.15	4589	\$2.55
C	4526	2.22	4558	2.22	4590	2.61
L	4527	2.22	4559	2.22	4591	2.61
Q	4528	2.15	4560	2.15	4592	2.55

Heavy Duty 20 Amp

RATINGS
20 A., 480 V., A.C.
10 A., 125 V., A.C. "L" Load
¼ A., 250 V., D.C.
1 H.P., 120 V., A.C.
2 H.P., 240 V., A.C.

Operating Characteristics
Operating Force..... 2½ oz. max.
Pretravel..... ¾" max.
Overtravel..... .078" min.
Diff. Travel..... .109" max.

WITH TERMINALS	S.P. NORM. OPEN		S.P. NORM. CLOSED		S.P.D.T.	
	No.	NET Ea.	No.	NET Ea.	No.	NET Ea.
S	4625	\$2.27	4657	\$2.27	4689	\$2.61
C	4626	2.34	4658	2.34	4690	2.67
L	4627	2.34	4659	2.34	4691	2.67
Q	4628	2.27	4660	2.27	4692	2.61

PIN TYPE (G)

General Purpose 15 Amp

RATINGS
15 Amp., 480 V., A.C.
½ Amp., 125 V., D.C.
¼ Amp., 250 V., D.C.

Operating Characteristics
Operating Force..... 9 to 13 oz.
Pretravel..... .015" max.
Overtravel..... .005" min.
Diff. Travel..... .0004 to .002 in.

WITH TERMINALS	S.P. NORM. OPEN		S.P. NORM. CLOSED		S.P.D.T.	
	No.	NET Ea.	No.	NET Ea.	No.	NET Ea.
S	4529	\$1.65	4561	\$1.65	4593	\$1.95
C	4530	1.72	4562	1.72	4594	2.08
L	4531	1.72	4563	1.72	4595	2.08
Q	4532	1.65	4564	1.65	4596	1.95

Heavy Duty 20 Amp

RATINGS
20 A., 480 V., A.C.
10 A., 125 V., A.C. "L" Load
¼ A., 250 V., D.C.
1 H.P., 120 V., A.C.
2 H.P., 240 V., A.C.

Operating Characteristics
Operating Force..... 14 to 22 oz.
Pretravel..... .050" max.
Overtravel..... .010" min.
Diff. Travel..... .002 to .0075 in.

WITH TERMINALS	S.P. NORM. OPEN		S.P. NORM. CLOSED		S.P.D.T.	
	No.	NET Ea.	No.	NET Ea.	No.	NET Ea.
S	4629	\$1.72	4661	\$1.72	4693	\$2.05
C	4630	1.79	4662	1.79	4694	2.15
L	4631	1.79	4663	1.79	4695	2.15
Q	4632	1.72	4664	1.72	4696	2.05

PANEL MOUNTED TYPE (H)

General Purpose 15 Amp

RATINGS
15 Amp., 480 V., A.C.
½ Amp., 125 V., D.C.
¼ Amp., 250 V., D.C.

Operating Characteristics
Operating Force..... 9 to 13 oz.
Pretravel..... 1/64" max.
Overtravel..... 7/32" min.
Diff. Travel..... .0004 to .002 in.

WITH TERMINALS	S.P. NORM. OPEN		S.P. NORM. CLOSED		S.P.D.T.	
	No.	NET Ea.	No.	NET Ea.	No.	NET Ea.
S	4509	\$3.90	4541	\$3.90	4573	\$4.36
C	4510	3.93	4542	3.93	4574	4.43
L	4511	3.93	4543	3.93	4575	4.43
Q	4512	3.90	4544	3.90	4576	4.36

Heavy Duty 20 Amp

RATINGS
20 A., 480 V., A.C.
10 A., 125 V., A.C. "L" Load
¼ A., 250 V., D.C.
1 H.P., 120 V., A.C.
2 H.P., 240 V., A.C.

Operating Characteristics
Operating Force..... 14 to 22 oz.
Pretravel..... .050" max.
Overtravel..... .219" min.
Diff. Travel..... .002 to .0075 in.

WITH TERMINALS	S.P. NORM. OPEN		S.P. NORM. CLOSED		S.P.D.T.	
	No.	NET Ea.	No.	NET Ea.	No.	NET Ea.
S	4609	\$4.00	4641	\$4.00	4673	\$4.49
C	4610	4.06	4642	4.06	4674	4.56
L	4611	4.06	4643	4.06	4675	4.56
Q	4612	4.00	4644	4.00	4676	4.49

SHORT OVERTRAVEL BUTTON (I)

General Purpose 15 Amp

RATINGS
15 Amp., 480 V., A.C.
½ Amp., 125 V., D.C.
¼ Amp., 250 V., D.C.

Operating Characteristics
Operating Force..... 9 to 13 oz.
Pretravel..... 1/64" max.
Overtravel..... 1/16" min.
Diff. Travel..... .0004 to .002 in.

WITH TERMINALS	S.P. NORM. OPEN		S.P. NORM. CLOSED		S.P.D.T.	
	No.	NET Ea.	No.	NET Ea.	No.	NET Ea.
S	4513	\$2.04	4545	\$2.04	4577	\$2.41
C	4514	2.08	4546	2.08	4578	2.48
L	4515	2.08	4547	2.08	4579	2.48
Q	4516	2.04	4548	2.04	4580	2.41

Heavy Duty 20 Amp

RATINGS
20 A., 480 V., A.C.
10 A., 125 V., A.C. "L" Load
¼ A., 250 V., D.C.
1 H.P., 120 V., A.C.
2 H.P., 240 V., A.C.

Operating Characteristics
Operating Force..... 14 to 22 oz.
Pretravel..... .050" max.
Overtravel..... .083" min.
Diff. Travel..... .002 to .0075 in.

WITH TERMINALS	S.P. NORM. OPEN		S.P. NORM. CLOSED		S.P.D.T.	
	No.	NET Ea.	No.	NET Ea.	No.	NET Ea.
S	4613	\$2.08	4645	\$2.08	4677	\$2.48
C	4614	2.15	4646	2.15	4678	2.55
L	4615	2.15	4647	2.15	4679	2.55
Q	4616	2.08	4648	2.08	4680	2.48

SHORT ROLLER (J)

General Purpose 15 Amp

RATINGS
15 Amp., 480 V., A.C.
½ Amp., 125 V., D.C.
¼ Amp., 250 V., D.C.

Operating Characteristics
Operating Force..... 6 oz. max.
Pretravel..... 9/64" max.
Overtravel..... 3/32" min.
Diff. Travel..... .003 to .020 in.

WITH TERMINALS	S.P. NORM. OPEN		S.P. NORM. CLOSED		S.P.D.T.	
	No.	NET Ea.	No.	NET Ea.	No.	NET Ea.
S	4517	\$2.78	4549	\$2.78	4581	\$3.17
C	4518	2.91	4550	2.91	4582	3.30
L	4519	2.91	4551	2.91	4583	3.30
Q	4520	2.78	4552	2.78	4584	3.17

Heavy Duty 20 Amp

RATINGS
20 A., 480 V., A.C.
10 A., 125 V., A.C. "L" Load
¼ A., 250 V., D.C.
1 H.P., 120 V., A.C.
2 H.P., 240 V., A.C.

Operating Characteristics
Operating Force..... 6 oz. max.
Pretravel..... 1/32" max.
Overtravel..... 3/64" min.
Diff. Travel..... .003 to .020 in.

WITH TERMINALS	S.P. NORM. OPEN		S.P. NORM. CLOSED		S.P.D.T.	
	No.	NET Ea.	No.	NET Ea.	No.	NET Ea.
S	4617	\$2.91	4649	\$2.91	4681	\$3.30
C	4618	2.97	4650	2.97	4682	3.37
L	4619	2.97	4651	2.97	4683	3.37
Q	4620	2.91	4652	2.91	4684	3.30

specify SMITH

HERMAN H. SMITH, INC.



ELECTRONIC COMPONENTS



SINGLE RECORD
33-1/3 R.P.M.
 TEN LESSONS
 UP TO 15 WORDS
 PER MINUTE
 Complete on Two Sides

This twelve inch long play record contains all ten of the Code Course Lessons listed above. Five on each side. 20-Page SMITH Instruction Book is included, and the record is housed in attractive, sturdy jacket with International Morse Code table on reverse side.
 No. 2420 NET Each \$4.80



ADVANCED CODE COURSE
 Single Record—
 33 1/3 R.P.M.
 TWELVE LESSONS
 15 to 25 Words
 Per Minute

Specially prepared to increase skills in copying code at high speeds. 12 step-by-step lessons are provided plus specific directions with each. Record comes in sturdy jacket with International Morse Code table on reverse side.
 No. 2435 Advanced Code Course complete with 20 page instruction BookNET \$4.80

20 page Advanced Code Instruction Book included. Record comes in sturdy jacket with International Morse Code table on reverse side.
 No. 2435 Advanced Code Course complete with 20 page instruction BookNET \$4.80

BEGINNERS AND ADVANCED CODE COURSES IN COMBINATION PACKAGE

Advanced Code Course #2435 PLUS Beginners' Code Course #2420 (see above) both complete with 20-page instruction books, attractively packaged in combination carton.
 No. 2436 NET \$9.00

SMITH CODE INSTRUCTION KIT



The SMITH NO. 2442 Code Instruction Kit contains a Code Oscillator (Self Keyed) in kit form, complete with all instructions, Code Record and Headphone.

The oscillator is housed in a sturdy black plastic case with a gold front panel and utilizes a single transistor blocking oscillator circuit that provides audio regeneration or oscillation. The oscillator is supplied with its own Key and is battery powered by means of any 9 Volt transistor type battery which is not furnished with the kit.

The Code Record, 12"-33-1/3 RPM, is individually sleeved and contains 10 lessons up to 15 WPM on two sides. Also included is a 20 page instruction booklet containing all lessons and information as to how to use the record for best results.

The No. 2442 Code Instruction Kit is the ideal and most complete package for any individual desiring to learn the Code.

No. 2442 Net Each \$16.95

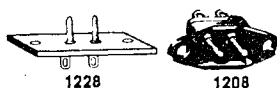

INTERLOCK PLUGS

No.	Std. Pkg. 100 Type	NET Per C
1228	Recessed	\$8.00
1228	Flush	7.00

"CLEAPS"
 (Connectors for Joining Severed Wires)



MATERIAL: Brass, cadmium plated.
WIRE SIZE: For wires, .010" to .050" (B&S Gauge 16 to 30).
DESCR.: Used to splice cut leads of condensers, resistors, etc., in process of trouble-shooting. Insert wire in each tapered end and solder thru center opening. Std. Pkg. 100
 No. 1270 NET Per C \$1.00

HIGH SENSITIVITY HEADPHONES

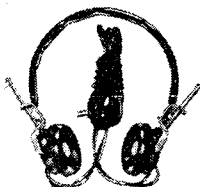

The latest in deluxe design, with many features of more expensive types. Featherweight construction assures fatigue-free use. Alnico V magnets, dual coil construction provide excellent tonal fidelity. Adjustable vinyl covered headband, molded plastic cases. Cord equipped with phone tips.

No.	Description	Ohms	NET Each
2441	Single	1000	\$1.89
2440	Double	2000	3.45
2446	Single	2-4	1.69
2447	Double	4-8	3.45
2448	Single	2000	2.10
2449	Double	4000	3.75

FOR STEREO USE

Same as above, except each Phone has leads brought out separately.

2477	Double	2000	\$3.75
2478	Double	4-8	3.75
2479	Double	4000	4.20

RUBBER EAR CUSHIONS



Finest quality soft rubber ear cushions, fit all standard ear-phones. For comfortable listening over long periods of time.
 No. 2410 Per Pair \$1.50

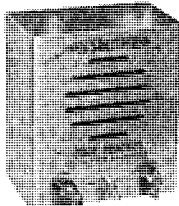

CODE PRACTICE OSCILLATOR & MONITOR

Ideal for the beginner as well as the experienced operator, this versatile instrument can be used as a code practice oscillator, as a keying monitor to check ICW signals, or as a monitor for phone signals.

Two tubes are used, in an up to date circuit that provides continuously variable tone and volume. Self-contained PM speaker affords ample volume for group use, with phone jack available for individual headphone listening. The handsome Hammertone finish cabinet has additional provision for wall mounting, an exclusive SMITH feature that eliminates need for valuable desk space. The unit is designed for use on 110 Volts AC or DC, and is supplied complete with two tubes.

No.	Description	NET Each
2425	Kit	\$13.50
2426	Wired	18.00

HEX AND SPLINE KEYS

Made of special alloy steel, tempered to avoid brittleness and impose maximum resistance to torsional strain. Ends ground for easy insertion.

No.	Screw	Std. Pkg. 50	O. D. NET Per C
340	No. 2	.034	\$7.80
341	No. 3, 4	.050	7.80
342	No. 5, 6	.062	7.80
343	No. 8	.078	7.80
344	No. 10	.093	9.00
345	No. 1/8"	.125	9.00
346	No. 3/16"	.156	9.00

SPLINE KEYS

No.	Screw	O. D.	NET Per C
370	No. 4	.058	\$7.80
371	No. 5	.068	7.80
372	No. 6	.075	7.80
373	No. 8	.093	7.80
374	No. 10	.109	9.00
375	No. 1/8"	.143	9.00
376	No. 3/16"	.182	9.00

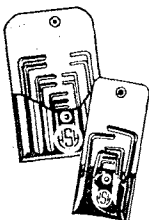

HEX AND SPLINE KEY KITS

Attractive tearproof vinyl plastic kit with individual pockets for each of six keys in kit. Std. Pkg. 5

Kit of 6 hex keys for screws from No. 3 to 3/16"
 No. 355 \$60.00 NET Per C
 Kit of 6 spline keys for screws from No. 5 to 3/16"
 No. 385 \$60.00 NET Per C
 Combination Kit of 3 hex and 3 spline keys for No. 6-8-10 screws.
 No. 390 \$60.00 NET Per C
 Kit of 7 hex keys for screws from No. 2 to 5/16" and 4 spline keys Nos. 4, 6, 8, and 10.

HEX KEYS SPLINE KEYS No. 395 \$120.00 NET Per C

DISPLAY CARDS

No.	Description	NET Each
355D	Display of 24 Hex Kits No. 355	\$14.40
385D	Display of 24 Spline Kits No. 385	14.40
390D	Display of 24 Comb. Kits No. 390	14.40
395D	Display of 20 Comb. Kits No. 395	24.00

"PANELABELS"

Modern Panel Title Decals



New size type face on all word titles to match modern instrument panels and sound equipment. Packaged individually in clear plastic boxes — instant selection — box

itself can be used as water tray for applying the decals. Standard Packages of 6. Please order by catalog number.

NET, EACH PACKAGE \$1.50

TRANSMITTER

For industrial prototype use, Hams, Citizens' Banders. Also for Microwave and Broadcast stations.
 No. 3700 BLACK
 No. 3701 WHITE

RECEIVER

Hams, Citizens' Banders, industrial prototypes, Hi-Fi and Experimenter applications.
 No. 3702 BLACK
 No. 3703 WHITE
 No. 3704 RED
 No. 3705 GOLD

DIALS

For all uses in transmitters, Ham and Citizens' Band industrial prototypes, Hi-Fi, electricians, experimenters.
 No. 3706 BLACK
 No. 3707 WHITE
 No. 3708 RED
 No. 3709 GOLD

ALPHABETS

Most popular item in the line! For all general uses above.
 3710 2-inch BLACK
 3711 2-inch WHITE
 3712 2-inch RED
 3713 2-inch GOLD
 3714 1/2-inch BLACK
 3715 1/2-inch WHITE
 3716 1/2-inch RED
 3717 1/2-inch GOLD
 3718 Assorted BLACK
 3719 Assorted WHITE
 3720 Assorted RED
 3721 Assorted GOLD

INSTRUMENTS

Primarily for Technicians, Hams and industrial use.
 No. 3722 BLACK
 No. 3723 WHITE

HI-FI AND STEREO

For experimenters, commercial sound distributors, industrial prototypes.
 No. 3724 BLACK
 No. 3725 WHITE
 No. 3726 RED
 No. 3727 GOLD

SOUND SYSTEMS

For industrial use by commercial sound distributors, custom installers, electricians and experimenters.
 No. 3728 BLACK
 No. 3729 WHITE
 No. 3730 RED
 No. 3731 GOLD

TRANSISTORS AND DIODES

Used by Hams, experimenters, technicians, and industrial prototype use. Includes complete list of transistor and diode numbers plus symbols of PNP, NPN, 4 and 5 element transistors, diode symbols.
 No. 3732 BLACK
 No. 3733 WHITE

ELECTRICAL DISTRIBUTION

Used primarily by electricians and custom installers on the job and in distribution panel design.
 No. 3734 BLACK
 No. 3735 WHITE

BOOKLET OF COMPLETE TITLE LISTS OF ALL PANELABELS AVAILABLE ON REQUEST

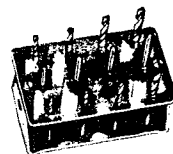

DRILL & TAP KIT for

- Hams
- Laboratories
- Servicemen

Specially designed for electronic bench duty, this kit contains the most popular sizes of taps and corresponding tap and body drills for precise and speedy work. Drill and tap size identifications are engraved on the steel cadmium plated drill stand to facilitate correct replacement as needed. Contains: 4-40, 6-32, 8-32, 10-32 Taps with eight corresponding tap and body drills.

No.	Kit	NET Ea.
750	Stand Only	\$15.00
749	Stand Only	.66

5-way[®] BINDING POSTS

5 WAYS TO CONNECT • GOLD-PLATED BRASS PARTS • RANGE OF COLORS

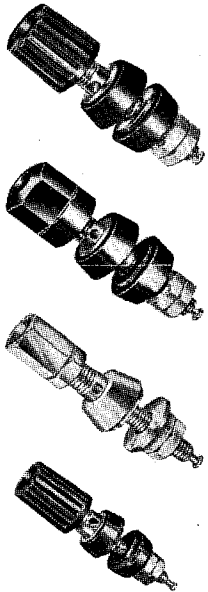

FLUTED NUT TYPES

Plastic parts of standard (not miniature) size types molded of Lexan polycarbonate resin; brass parts are gold-plated. Rated for 30 amperes, 1000 volts working. Nickel-plated brass types available on special order.

HEX NUT TYPES

Rated for 30 amperes, 1000 volts working. Brass parts are gold-plated; plastic parts are of nylon compounded to meet military specifications MIL-M-20693A, Type IV. Nickel-plated brass types available on order.

GROUNDING TYPE

For making rapid connections to ground. Made of finely machined brass nickel-plated and polished. Panel grounding collar frozen to shaft has "D" type shoulder for locking in keyed panel hole.

MINIATURE TYPES

Fluted nut design only. Rated for 15 amperes, 1000 volts working. Gold-plated brass parts; nylon plastic parts compounded to meet military specification MIL-P-20693A, Type IV. Types with nickel-plated brass available also.

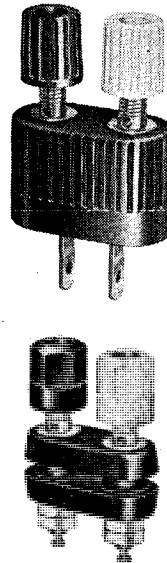

DUAL ADAPTER TYPE

Designed to facilitate line voltage connections from output receptacles to binding posts. Has integral parallel-blade plug. Rating is 15 amperes, 125 volts. Body is black; captive black and white thumbnuts are mounted on 3/4" centers. Brass parts are gold-plated. Ideal for safe, rigid connections to equipment lacking a parallel-blade plug and cord assembly.

DOUBLE ASSEMBLY TYPES

For instrument and equipment panels requiring binding posts mounted on 3/4" centers. Rated for a current capacity of 30 amperes and a working voltage of 1000 volts. Brass parts are gold-plated; panel insulators in black only. Rugged, self-contained assembly makes mounting more accurate, faster and easier than two individual binding posts and gives maximum strength where connections are frequently made.

STYLE	TYPE	STYLE	TYPE
BINDING POSTS		DUAL ADAPTER TYPE	
FLUTED NUT — STANDARD	DF31*	BLACK & WHITE FLUTED NUTS	DAP15BWC
HEX NUT — STANDARD	DF30*	DOUBLE ASSEMBLY TYPES	
GROUNDING — ALL METAL	GP30NC	BLACK & WHITE HEX NUTS	DF30-2-BWTC
FLUTED NUT — MINIATURE	DF21*	TWO BLACK HEX NUTS	DF30-2-BBC
		BLACK & RED HEX NUTS	DF30-2-BRC

*Add desired color suffix to series designation number: BC (black), BLC (blue), RC (red), WTC (white), YC (yellow), GNC (green). For example: DF21BLC.

SUPERCON[®] ELECTRICAL CONNECTORS

• GOLD-PLATED CURRENT CARRYING PARTS • SIMPLIFIED, QUICK ASSEMBLY

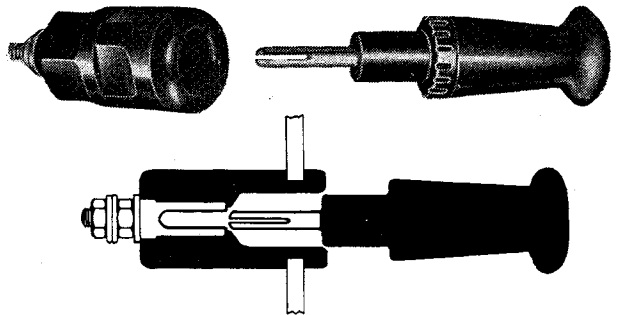
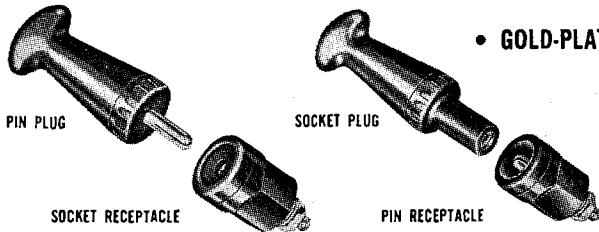

Nylon plastic parts, gold-plated brass current-carrying parts. Plugs accommodate either soldered or solderless connections to a wide range of cable sizes. Plug grips are of a simple, two-piece threaded construction for quick assembly. Receptacles have color-matched nylon caps and bodies. 25, 50 and 100 ampere types are rated 125-250 volts a-cord-c current rupturing, 600 volts disconnect use only. 250 ampere types are rated 600 volts disconnect use only.

AMPERES	PIN PLUGS TYPE†	SOCKET RECEPTACLES TYPE†	SOCKET PLUGS TYPE†	PIN RECEPTACLES TYPE†
25	PP25G	RS25G	PS25G	RP25G
50	PP50G	RS50G	PS50G	RP50G
100	PP100G	RS100G	PS100G	RP100G
250	PP250G	RS250G	PS250G	RP250G

†Add desired color suffix to series designation number: B (black), BL (blue), R (red), WT (white), Y (yellow), GN (green). For example: PS25GWT.

EXTRA-SAFE "L" TYPE

"L" types have all current-carrying parts insulated to remove any possibility of physical contact when making connections. Rated same as 50 ampere conventional types. When ordering, add available color suffix to type number: B (black), R (red), WT (white).

SOCKET RECEPTACLES	PIN PLUGS
LSR50G	LPP50G



THE SUPERIOR ELECTRIC COMPANY

SEE OTHER SUPERIOR ELECTRIC PRODUCT PAGES IN SECTIONS 3500, 4000, AND 5600

Phone Jacks

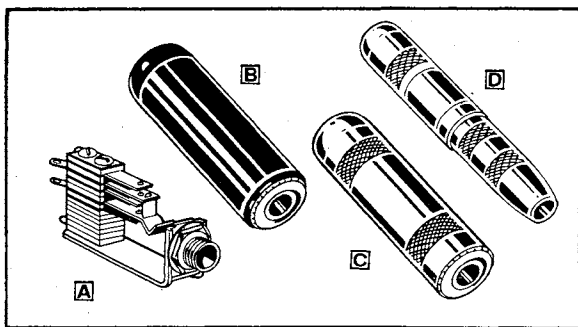

"LF-JAX" LONG FRAME JACKS

A Quality long frame phone jacks with a ground lug that is an integral part of the frame. Fine silver contacts rated at 3 amp., 300 watts, A.C., non-inductive load. Frame also available with a non-turn device, prefix Part No. with letter "R". Standard types mount in single $\frac{3}{8}$ " dia. hole in panels up to $\frac{3}{16}$ " thick. Depth behind panel, only $2\frac{3}{4}$ ".

Part No.	Schematic No.	Typical Mating Plug	Conductors	U.S.A. List Price
31	I	250	2	\$0.80
32	II	250	2	1.05
32A	III	250	2	1.05
32B	IV	267	3	1.05
33	V	250	2	1.15
33A	VI	250	2	1.15
33B	VII	267	3	1.15
33C	VIII	267	3	1.15
33E	IX	250	2	1.15
34	X	267	3	1.30
34A	XI	250	2	1.30
34B	XII	267	3	1.30
35	XIII	250	2	1.60
36	XIV	267	3	1.85

"EXTENSION JAX" CABLE EXTENSION JACKS

Standard $\frac{1}{4}$ ", 2 and 3-conductor extension phone jacks with solder lugs or screw type terminals. Size $1\frac{1}{8}$ " O.D., $2\frac{3}{8}$ " long; 121 and 131 $\frac{1}{2}$ " O.D., $2\frac{1}{2}$ " long. Black handles are durable plastic. Shielded handles are brass, bright nickel plated.

Part No.	Fig.	Cond.	Typical Mating Plug	Term.	Handle	U.S.A. List Price
80	B	2	250	Screw	Black	\$1.25
88	B	2	250	Solder	Black	1.10
120	C	2	270	Screw	Shielded	1.70
121	D	2	270	Solder	Shielded	1.80
126	C	2	R-280	Solder	Shielded	1.90
128	C	2	270	Solder	Shielded	1.55
S-128	C	2	S-250	Solder	Shielded	1.65
131	D	3	290	Solder	Shielded	2.25
830	B	3	267	Screw	Black	1.70
S-830	B	3	480	Screw	Black	2.25
838	B	3	267	Solder	Black	1.55
1230	C	3	290	Screw	Shielded	2.20
S-1230	C	3	480	Screw	Shielded	2.75
1238	C	3	290	Solder	Shielded	2.00

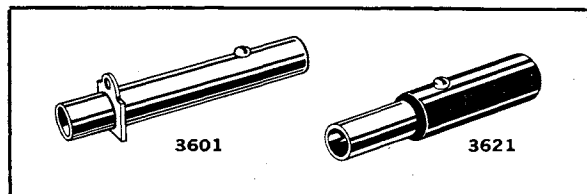

CV JAX AND PLUGS

High quality coaxial-video jacks and plugs designed for use in patching high frequency signals, microwave, telemetry and data transmitting applications. Jacks are made for 50 and 70 ohm circuits and use standard RG cables. No. 3601 accepts RG59/U; No. 3602 accepts RG62/U. Mate with Switchcraft CV Plugs. Mount in single $\frac{1}{8}$ " hole. Depth behind panel is $2\frac{3}{4}$ ". No. 3621, terminating plug with 75 ohm $\pm 1\%$ $\frac{1}{2}$ watt resistor; No. 3622, feed through plug; No. 3623 same as 3621 but with tip jack for incircuit testing.

JACKS		PLUGS	
Part No.	U.S.A. List Price	Part No.	U.S.A. List Price
3601	\$10.00	3621	\$ 4.75
3602	10.00	3622	4.25
		3623	5.75

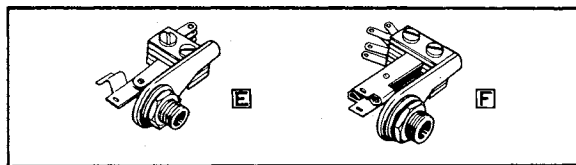

"SF-JAX" SHORT FRAME PHONE JACKS

E Series 20—High quality commercial jacks, solder lugs parallel to mounting surface. Mount in $\frac{3}{8}$ " dia. holes, panels up to $\frac{3}{16}$ " thick.

F Series 50—Similar to Series 20, except solder lug location necessitates more depth but requires less panel space. Mount in panels up to $\frac{1}{4}$ " thick.

Series C-20 and C-50—MIL Types with Military insulation and finishes, otherwise similar to commercial Series 20 and 50; both will mount in panels up to $\frac{1}{4}$ " thick.

SERIES 20 and C-20

Part No.	Schematic No.	Typical Mating Plug	Mil-Type	U.S.A. List Price
21	I	250	—	\$0.70
22	II	250	—	.90
22A	III	250	—	.90
22B	IV	267	—	.90
23	V	250	—	1.05
C-23	V	440	JJ-099	1.50
23A	VI	250	—	1.05
C-23A	VI	440	JJ-098	1.50
23B	VII	267	—	1.05
23C	VIII	267	—	1.05
23E	IX	250	—	1.05
C-23E	IX	440	JJ-102	1.50
24	X	267	—	1.20
24A	XI	250	—	1.20
24B	XII	267	—	1.20
25	XIII	250	—	1.45
26	XIV	267	—	1.55

SERIES 50 and C-50

51	I	250	—	\$0.70
C-51	I	440	JJ-096	1.30
52	II	250	—	.90
52A	III	250	—	.90
C-52A	III	440	JJ-097	1.45
52B	IV	267	—	.90
C-52B	IV	482	JJ-103	1.45
53	V	250	—	1.05
53A	VI	250	—	1.05
C-53A	VI	440	JJ-092	1.70
53B	VII	267	—	1.05
53C	VIII	267	—	1.05
53E	IX	250	—	1.05
54	X	267	—	1.20
54A	XI	250	—	1.20
C-54A	XI	440	JJ-093	1.75
54B	XII	267	—	1.20
C-54B	XII	482	JJ-101	1.75
55	XIII	250	—	1.45
C-55B	XV	482	JJ-095	2.05
56	XIV	267	—	1.55

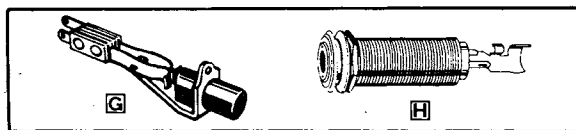

"LAMP JAX" SWITCHBOARD PANEL TYPES

G Quality long frame panel type lamp jacks. No. LT-47, black nylon lamp housing completely insulates lamp from frame. Interchangeable with W.E. Nos. 47A, 47B. Accepts std. lamps and lamp caps, W.E. Nos. 2, 72, etc. No. LT-48, new Ballast Lamp-Jax for use in circuits subjected to increasing temperature and wattage. Steel frame and bushing, Teflon sleeve. Accepts std. telephone lamps or ballast lamp No. 60XA. Both lamp jacks mount in std. Switchcraft jack panels. Switchcraft Part No. LT-47 U.S.A. List Price \$1.40
Switchcraft Part No. LT-48 U.S.A. List Price \$2.00

"THICK PANEL JAX"

H Phone jacks with long bushing. Mount in single $\frac{1}{8}$ " dia. hole in panels up to $1\frac{1}{4}$ " thick. Solder lug terminals. Ideal for use with microphones; extra shielding virtually eliminates audio hum. No. 151, 2-conductor mates with 240, 245, 250, 255, 270 and 280 Plugs. No. 152B, 3-conductor mates with 260, 267, 269 and 297 Plugs.

Part No.	Description	U.S.A. List Price
151	2-cond. Brass Nickel Plated	\$1.50
152B	3-cond. Brass Nickel Plated	1.65

Jack Panels, Plugs, Patch Cords

"JACK PANELS"

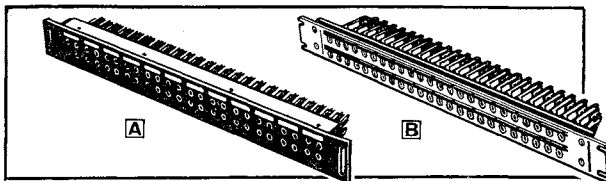

Rugged, heavy-duty jack panels for switching, distribution and control of audio signals in broadcasting stations, theaters, P. A. systems installations, etc. Series 1200, Fig. A, black phenolic panels reinforced with steel for the utmost rigidity. Mounting brackets slotted to fit all standard 19" relay racks. Panel includes plastic covered designation strips. Series 2800, Fig. B, clear anodized aluminum panel. Extremely rugged, yet lightweight. Includes new narrow designation strip for each row. Add Prefix "X" to part numbers to indicate offset ground lugs on jacks. Aluminum panels available only with offset lugs.

Part No.	Fig.	Rows	Number of Jacks	Size, In. W x D x H	U.S.A. List Price
1200	A	Single	24 *	19x1 1/4x1 3/8	\$ 14.50
1232A	A	Single	24 T-332A	19x1 1/4x1 3/8	40.00
1332A	A	Single	24 MT-332A	19x1 1/4x1 3/8	45.00
1400	A	Single	26 *	19x 5/8x1 3/8	15.00
1432A	A	Single	26 T-332A	19x 5/8x1 3/8	43.00
1532A	A	Single	26 MT-332A	19x 5/8x1 3/8	49.00
2400	A	Double	48 *	19x1 1/4x2 1/8	15.00
2432A	A	Double	48 T-332A	19x1 1/4x2 1/8	70.00
2532A	A	Double	48 MT-332A	19x1 1/4x2 1/8	83.00
2600	A	Double	52 *	19x 5/8x1 3/8	18.00
2632A	A	Double	52 T-332A	19x 5/8x1 3/8	79.00
2732A	A	Double	52 MT-332A	19x 5/8x1 3/8	92.00
2800	B	Double	48 *	19x 5/8x1 3/8	40.00
X2832A	B	Double	48 T-332A	19x 5/8x1 3/8	95.00
X2932A	B	Double	48 MT-332A	19x 5/8x1 3/8	108.00

*Supplied less jacks.

MILITARY TYPE "TWIN-PLUGS"

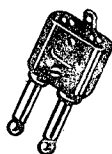

412

Meet exact industrial and military requirements. No. 411, both design and materials, is manufactured in accordance with MIL-P-642(A) specs. Nos. 412 and 413, use identical materials. "Twin-Plug" sleeves spaced 3/8" center to center with self-aligning feature.

Part No. 411—Two electrically independent 2-conductor plugs in black plastic handle. Has provision for Cord Clamp No. S-2674. Military Type PJ-327 (Old Navy No. 491242). Interchangeable with W.E. 327. U.S.A. List Price \$5.25

Part No. 412—Two electrically independent 2-conductor plugs in black plastic handle. Has external cord clamp. Old Military Type PJ-289. Similar to W.E. 289B. U.S.A. List Price \$4.90

Part No. 413—Three circuit plug with two electrically independent tip circuits in heavy duty die cast frame. Molded black phenolic handle notched to indicate polarity. Interchangeable with MIL-Type PJ-421 and W.E. 241. U.S.A. List Price \$4.90

Part No. 414—Six circuit plug. Two electrically independent 3 conductor 1/4" dia. fingers. Black polarized handle. Interchangeable with WE-338A. U.S.A. List Price \$9.25

Part No. 415—Six circuit plug. Two electrically independent 3 conductor fingers. One 1/4" dia. finger, one .206" dia. For automatic polarization. Black handle. U.S.A. List Price \$10.25

Part No. S-2674—Strain relief clamp, natural brass. For use with Nos. 411, 414, 415 "Twin-Plug". Pkg. of 10. U.S.A. List Price \$0.50

"DUMMY PLUGS"



C

D

E

Low cost, 2- and 3-conductor molded plastic, dummy plugs for use in switchboards, jack panels. Inserts in jack as does a phone plug to switch circuits, but can not couple incoming signals. Can also be used to plug up unused phone jacks to prevent accidental insertion of a phone plug. Series 491, 3-conductor, .207" dia. finger. Series 492, 3-conductor, .250" dia. finger. Series 493, 2-conductor, .250" dia.

Part No.	Fig.	Handle	Typical Mating Jack	U.S.A. List Price
491-01	C	Red	MT-342B	\$0.50
491-02	C	Black	MT-342B	.50
491-05	C	White	MT-342B	.50
492-01	D	Red	MT-332B	.50
492-02	D	Black	MT-332B	.50
492-05	D	White	MT-332B	.50
493-01	E	Red	MT-331	.50
493-02	E	Black	MT-331	.50
493-05	E	White	MT-331	.50

SWITCHCRAFT

PATCH CORD SETS

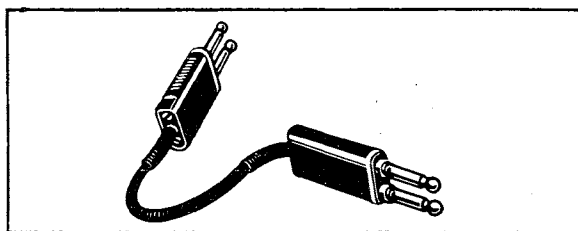

All patch cords are constructed of bronze tinsel conductors, insulated and shielded, with a heavy black nylon braid overall.

Series 17Q—2-conductor patch cords have No. 413 "Twin-Plug" at each end with shields grounded both ends.

Series 17P—Same as 17Q, except shield grounded one plug only.

Series 18Q—2-conductor patch cords use Military Plug PJ-051 (Switchcraft Part No. 482) at each end with shields grounded both ends.

Series 19Q—Single conductor patch cords utilize Military Plug PJ-047B (Switchcraft Part No. 420) connected to each end with shield grounded both ends.

Part No.	Length	Plugs Used	U.S.A. List Price
17QA17	6 inch	413	\$11.00
17QB17	1 foot	413	11.25
17QD17	2 feet	413	11.50
17QF17	3 feet	413	11.75
17QH17	4 feet	413	12.15
17QK17	6 feet	413	13.00
17QN17	10 feet	413	13.75
17PA17	6 inch	413	11.00
17PB17	1 foot	413	11.25
17PD17	2 feet	413	11.50
17PF17	3 feet	413	11.75
17PH17	4 feet	413	12.15
17PK17	6 feet	413	13.00
17PN17	10 feet	413	13.75
18QA18	6 inch	482	11.50
18QB18	1 foot	482	12.00
18QD18	2 feet	482	12.50
18QF18	3 feet	482	13.00
18QH18	4 feet	482	13.50
18QK18	6 feet	482	14.50
18QN18	10 feet	482	16.50
19QA19	6 inch	420	6.00
19QB19	1 foot	420	6.25
19QD19	2 feet	420	6.75
19QF19	3 feet	420	7.25
19QH19	4 feet	420	7.75
19QK19	6 feet	420	9.10
19QN19	10 feet	420	10.50

REPLACEMENT PATCH CORDS

Patch cords are made of bronze tinsel conductors, insulated and shielded, with a heavy black nylon braid overall. Cords designed for use with Switchcraft plugs 413, 420 and 482 or equivalents. When used with No. 420, clip off unnecessary lead.

Series 89Q—2-conductor shielded cord with shield termination at both ends.

Series 89P—2-conductor shielded cord with shield termination at one end only.

Part No. Both Ends Shielded	Part No. One End Shielded	Length	U.S.A. List Price
89QA89	89PA89	6 inch	\$2.25
89QB89	89PB89	1 foot	2.75
89QD89	89PD89	2 feet	3.00
89QF89	89PF89	3 feet	3.25
89QH89	89PH89	4 feet	3.50
89QK89	89PK89	6 feet	4.50
89QN89	89PN89	10 feet	6.50

JACK PANEL ACCESSORIES



HOLE PLUG

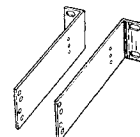

BRACKET KIT

Hole Plug, P-1801, molded nylon, fits all Switchcraft jack panels, Series 1200, 1400, 2400, 2600, 2800. Designed to plug unused holes in jack panels. Bracket Kit, K-107, consists of 2 long L-shaped steel, stand-off brackets and eight No. 6-32 self-tapping screws. To hold jack panels, Series 1400, 2600, 7" in front of mounting rack.

Part No.	Description	U.S.A. List Price
P-1801	Hole Plug	\$0.30
K-107	Bracket Kit	4.50

SWITCHCRAFT® Switches



Switchcraft switches give you unlimited latitude in the selection of switching functions and actuations for customizing your equipment designs. Whether you choose pushbutton, slide or lever actuated switches, OUR specialized sales personnel can aid you in the selection and specification of the proper switch to fill your particular requirements. Call on us. We can supply any lever switch, or any size "Multi-Slide" and/or "Multi-Switch", with virtually unlimited functions, from stock, immediately, at factory prices.

Only Switchcraft offers 3 complete lines of slide, multiple station pushbutton, and lever switches . . . 3 proven solutions to man-machine interface problems.

SLIDE ACTION . . . Series 39000 "Multi-Slide" switches provide design engineers with an entirely new switching method to solve man-machine system problems. "Multi-Slide" switches help eliminate operating confusion inherent in constant manipulation of pushbutton matrices by providing slide-switch variety. **Series 39000 Switches** offer 3 types of actuation: interlock, all-lock, non-lock.

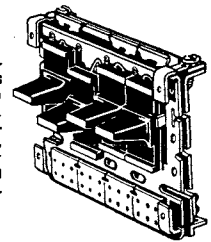

PUSHBUTTON ACTION . . . Whatever your requirements for switching, you will find Switchcraft "Multi-Switch" switches enable you to design a cybernetically correct, error-reducing panel. Both illuminated and non-illuminated types are available with non-lock, all-lock, interlock, push-to-lock, push-to-release functions. Illuminated types offer single or multiple lighting effects. **Series 7000 and 21000** frames are available from 1 to 37 stations in a row. **Little "Multi-Switch" Series 35000, 36000, 37000**, are compact switching units offering 1 to 18 stations in a row.

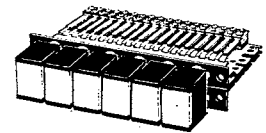

LEVER ACTION . . . Switchcraft offers the largest selection of illuminated and non-illuminated lever-type switches in the industry. They come in a wide choice of sizes, 2 or 3 position, locking and non-locking types. They range in size and style from miniaturized "Feather Lever", featuring changeable push-on color knobs to "Lever-Lite", a 3-color illuminated type lever switch; to the industry standard "Telever", a telephone type switch featuring field changeable functions.

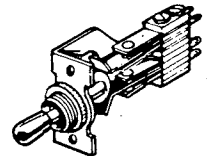

DW "MULTI-SWITCH"™ SERIES 65000

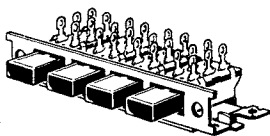

Rugged, versatile, multiple-station pushbutton switch requires only 1 1/8" depth behind panel. Overall switch height of 2 1/2" allows stacking in tight parallel rows. Three standard functions available: **Interlock**—actuating a button automatically restores to normal the button previously actuated; **Non-Lock**—each button

has momentary action; **All-Lock**—all buttons, except release, lock when depressed. Standard on all interlock switches is a **Lock-Out** feature which prevents operation of more than one button at a time; this is also available on special order for non-lock and all-lock switches*. Single row assemblies are available from 1 to 12 stations with interlock or all-lock functions; up to 18 stations, non-lock. These switches utilize a specially-designed switching module consisting of a switch housing, pushbutton actuator, terminal board assembly and contactors. Features "U"-shaped, double-wipe bifurcated contactors for extra reliability. Silver-plated contactors rated 3 amps, 125 VAC, non-inductive; 0.5 amp, 125 VDC. Pushbutton, on 5/8" centers, is an integral part of

plunger and cannot be lost or pilfered. Assemblies to 18 stations mount with only two #6 screws (not furnished). Frame notched to accept Tinnerman No. 7888-632-1 speed nuts with 6-32 machine screws (not furnished). Switches listed are fully assembled and factory-tested; have black pushbutton actuators and 2-C (DPDT) switch modules at each station. **Only the more commonly used switches are listed here; for complete engineering information, request Switchcraft Bulletin 174.**

No. of Stations	Interlock (With Lock-Out) Part No.	All-Lock Function Part No.*	List Price	Non-Lock Function Part No.*	List Price
2	65021K-206	65023-206	\$ 2.80	65022-206	\$ 2.65
4	65041K-206	65043-206	5.00	65042-206	4.85
6	65061K-206	65063-206	7.20	65062-206	7.00
8	65081K-206	65083-206	9.40	65082-206	9.20
10	65101K-206	65103-206	11.55	65102-206	11.30
12	65121K-206	65123-206	13.75	65122-206	13.50

*For **Lock-Out** function, omit hyphen in part number and replace with letter **K** (e.g., 65023K206), and add 10% to List Price.

"GLO-BUTTONS" FOR "MULTI-SWITCH" SWITCHES SERIES X, Y, Z

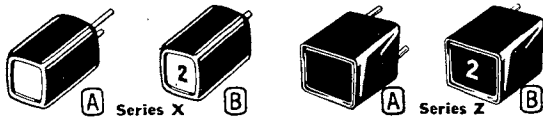

Economy of non-illuminated buttons with the vivid color-legend display of illuminated buttons. "Glo-Buttons" look and function like an illuminated button, but require no lamp or power. Mount on all pushbutton switches with std. .050" x .187" plungers, as Switchcraft Series 7000, 8000, and 35000 "Multi-Switch", and other switches having maintained plunger action with a max. of 1/16" fallback. "Glo-Buttons" have a translucent front screen on which a legend is marked in an opaque color. The opaque color provides a background for the legend while the legend itself remains clear (Figs. A). An internal fluorescent illuminator is carried on a pusher which has two legs extending from the rear. When the

button is depressed, the rear legs of the pusher bring the fluorescent illuminator flush with the screen which then lights up due to reflected ambient light, and projects a clearly visible legend, see Figs. B. All "Glo-Buttons" have black button housings and are available with std. legends: "A" thru "Z", "0" thru "50", and "ON", "OFF". Eight basic types of buttons are offered: To order, specify part number and add suffix letter or numeral to part number which describes desired legend. Example: To order 1/2" sq. "Glo-Button" with black screen, orange-red illuminator and numeral "7", part number would read X21248-7.

Series No.	Size	Screen Color	Illuminator Color
X21248	1/2" square	Black	Orange-Red
X51248	1/2" square	White	Orange-Red
Y21248	3/4" h. x 3/4" w.	Black	Orange-Red
Y28248	3/4" h. x 3/4" w.	Black	Chartreuse
Y51248	3/4" h. x 3/4" w.	White	Orange-Red
Z21248	3/4" h. x 3/4" w.	Black	Orange-Red
Z28248	3/4" h. x 3/4" w.	Black	Chartreuse
Z51248	3/4" h. x 3/4" w.	White	Orange-Red

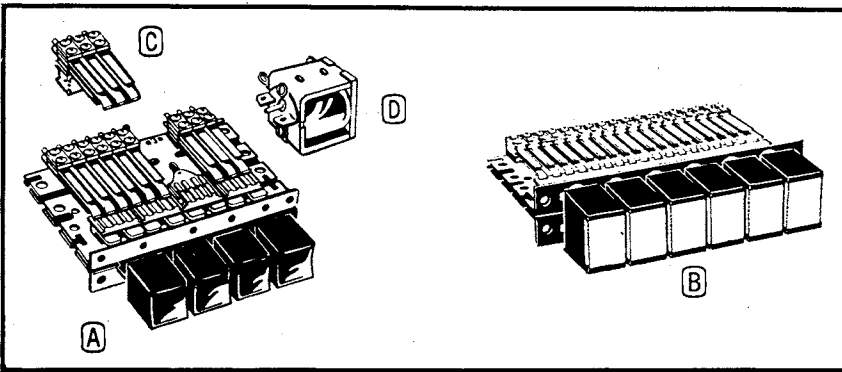

SERIES 35000 NON-ILLUMINATED FRAMES

A Switch frames mount on panels up to $\frac{1}{8}$ " thick. Permits 6 PDT switching in .6 sq. in. Narrow rectangular silhouette permits stacking in parallel rows on $\frac{3}{4}$ " centers. Only $2\frac{1}{4}$ " depth behind panel. End brackets have four 6-32 tapped mounting holes. A square black pushbutton is furnished for each station and an extra red button is supplied for use when switch requires a release. The following part numbers cover basic frames only. To complete assembly, order switch stacks for each station, solenoid releases, and snap-switch modules if required. Only the most commonly used frames are listed here:

Part Numbers For Functions				
Interlock	Non-Lock	All-Lock	Push-to-Lock, Push-to-Release	No. of Stations
35021	35022	35023	35027	2
35041	35042	35043	35047	4
35061	35062	35063	35067	6
35081	35082	35083	35087	8
35101	35102	35103	35107	10
35121	35122	35123	35127	12

SERIES 37000 SINGLE LAMP ILLUMINATED FRAMES

B Identical in switching functions and characteristics as non-illuminated Series 35000, but feature large rectangular shaped pushbuttons which serve as a color or legend coded panel indicator light which actuates up to 6 PDT switching. Switch frames mount in parallel rows from 1" centers and up. Depth behind panel $2\frac{1}{4}$ ". Pushbuttons with large transparent clear display screen and white legend insert, which can be hot stamped or engraved, are furnished for switching and release stations. A single 6 V or 28 V lamp can be used at each station. Lighting, such as "L"—pushbuttons light in "IN" position; "M"—pushbuttons light in "OUT" position; and "N"—pushbuttons light in both "IN" and "OUT" positions, can be effected by direct wiring to the lamp terminals or through the use of Series H Lighting Stacks. The following part numbers cover basic frames only. To complete assembly, order switch stacks, lighting stacks, and lamps for each station. Only the most commonly used frames are listed here:

Part Numbers For Functions				
Interlock	Non-Lock	All-Lock	Push-to-Lock, Push-to-Release	No. of Stations
37021	37022	37023	37027	2
37041	37042	37043	37047	4
37061	37062	37063	37067	6
37081	37082	37083	37087	8
37101	37102	37103	37107	10
37121	37122	37123	37127	12

SERIES 38000 TWIN LAMP ILLUMINATED FRAMES

B Same compact assembly and versatility as Series 37000, except features twin lamp illumination at each station for redundant or two color, split-face lighting. Uses Series H lighting stacks and two long life Part No. P-1890, 6 V lamps for choice of "L", "M", or "N" lighting. Each button serves as a color legend coded indicator light which actuates up to 3 PDT switching where Series H lighting stacks are used. Switches can be stacked in parallel rows on 1" centers with only $2\frac{1}{4}$ " depth behind panel. The following part numbers cover basic frames only. For complete switch assembly order switch stacks, lighting stacks, lamps for each station, plus solenoid release, if needed. Only the most commonly used frames are listed here:

Part Numbers For Functions				
Interlock	Non-Lock	All-Lock	Push-to-Lock, Push-to-Release	No. of Stations
38021	38022	38023	38027	2
38041	38042	38043	38047	4
38061	38062	38063	38067	6
38081	38082	38083	38087	8
38101	38102	38103	38107	10
38121	38122	38123	38127	12

BASIC CONTACT FORMS

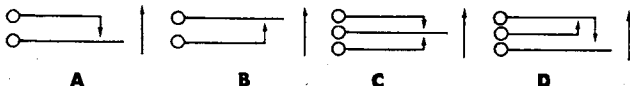

Compact, versatile, low-cost multiple station pushbutton switches. Four standard functions available: **Interlock**—actuating a button automatically restores to normal the button previously actuated. **Lock-Out**—prevents operation of more than one button at a time. This feature is included on all interlock frames. **Non-Lock**—each button has momentary action. **All-Lock**—all buttons, except release, lock when depressed. All buttons restored to normal by actuating release button. **Push-to-Lock, Push-to-Release**—button locks when depressed and is released when again depressed. Buttons on $\frac{3}{8}$ " centers. **Frames available from 1 to 18 stations.**

SWITCH STACKS

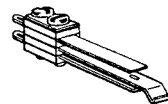

C Interchangeable switch stacks for littell "Multi-Switch" switches. **Series 35000, 37000, 38000, Series 80P**, constructed with cross-bar welded palladium contacts. For use where switch contacts of a released station will return to normal before contacts of a newly operated station are actuated. **Series 800P**, same as 80P, except designed to be used on push-to-lock, push-to-release function. Both Series rated 3 amps, 300 watts max., AC non-inductive load. Switch stacks fasten direct to removable switch mounting brackets. Supplied with two mounting screws and one pressure plate.

Series 80P		Series 800P		Series 80P		Series 800P	
Part No.	Part No.	Circuits	Part No.	Part No.	Circuits	Part No.	Part No.
81P	801P	1-A	83P	803P	1-C	81PD	803PD
82P	802P	1-B	83PD	803PD	1-D		

LIGHTING SWITCH STACKS

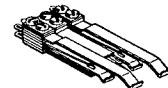

Two lighting switch stacks, **Part Nos. H-83P and H-803P** are available for convenient rear-of-frame lamp circuit wiring on **Series 37000 and 38000** frames. Stacks consist of standard Series 80P and 800P switch stacks with an extra long contact leaf spring on top. Use **No. H-83P** for all functions except push-to-lock, push-to-release; **No. H-803P** for push-to-lock, push-to-release. Each provide 1-C circuitry. Furnished with two screws and pressure plate.

"PIGGY-BACK" SNAP-SWITCH MODULES

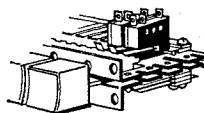

Increases the switching load capacity of littell "Multi-Switch" switches from 3 amps to 15 amps. Module consists of snap-action switch, actuator and mounting bracket. Two types available: Miniature types **No. 83SA**, for all switching functions except push-to-lock, push-to-release; **No. 803SA**, for push-to-lock, push-to-release function. Both rated at 15 amps, $\frac{1}{2}$ HP, 125/250 VAC. Subminiature types **Nos. 83SC and 83SD**, are similar to No. 83SA in function, and **Nos. 803SC, 803SD** are similar to No. 803SA in function. Subminiature types are rated at 10 amps, $\frac{1}{4}$ HP, 125 VAC. All supplied with mounting hardware. Solder terminals.

Part No.	SPDT Circuits	Part No.	SPDT Circuits	Part No.	SPDT Circuits
83SA	1	83SC	1	803SC	1
803SA	1	83SD	2	803SD	2

SERIES NJ SOLENOID RELEASE

D A simple solenoid assembly which can be added to the end of a standard **Series 35000, 37000, or 38000**, littell "Multi-Switch" frame to provide electrical release of activated stations. **No. NJ-1** designed for use with up to 18 interlock stations; **No. NJ-3** will handle up to 12 all-lock stations. Both are for use in 115 V, 60 cycle AC circuits. Mounting instructions and hardware furnished with each solenoid.

LAMP ADAPTER



Lamp Adapter, **Part No. T-1**, converts Series 21000 and 37000 lamp sockets that accommodate P-1593-2, -1 lamps, to accept the **P-1890** subminiature lamps. Order a **Part No. T-1** lamp adapter for each station of a Series 21000 and 37000 if long-life P-1890 lamp is specified.

LAMPS FOR littell "MULTI-SWITCH" SWITCHES

Lamps are not furnished with **Series 37000, or 38000** switches. Series 37000 will accept lamps P-1593-2 (6 V) and P-1593-1 (28 V). Series 37000 uses long life P-1890 (6 V) lamp when used with **T-1** lamp adapter. Series 38000 accepts only the **P-1890** lamp. For initial order or replacement, specify: **Part No. P-1593-2**, 6 V flange base lamp—Ind. No. 328; **Part No. P-1890**, subminiature 6 V flange base lamp—Ind. No. 718; **Part No. P-1593-1**, 28 V flange base lamp—Ind. No. 327.

Pushbutton Switches

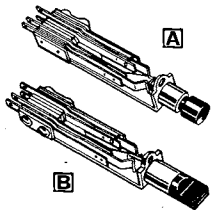

"T-SWITCH" SWITCHES

Rugged, long frame switches for quality communication equipment. Welded cross bar palladium contacts rated at 3 amps, 300 watts max., A.C., non-inductive load. Requires minimum of panel space, only $\frac{3}{8}$ " x $\frac{1}{2}$ " x $\frac{2}{8}$ " depth behind panel. Series 11000, Fig. A, push button T-Switch. Available in momentary action and push-to-lock, pull-to-release action. Series 11200, Fig. B, two position turn button T-Switch. Available in non-locking and locking action. Black button with white arrow to indicate switching position.

*Add Suffix "L" to Part Numbers to Indicate Locking Type.

A PUSH BUTTON—SERIES 11000

Part No. Non-Locking*	Action	Schematic Circuit	U.S.A. List Price
11001	S.P.S.T. n.o.	1-A	\$3.50
11002	S.P.S.T. n.c.	1-B	3.50
11003	S.P.D.T.	1-C	4.00
11003D	S.P.D.T.	1-D	4.00
11004	D.P.S.T. n.o.	2-A	4.50
11005	D.P.S.T. n.c.	2-B	4.50
11006	D.P.D.T.	2-C	5.00
11006D	D.P.D.T.	2-D	5.00
11008	4 P.S.T. n.o.	4-A	5.60
11009	3 P.D.T.	3-C	6.00
11012	4 P.D.T.	4-C	6.80

B TURN BUTTON—SERIES 11200

Part No. Non-Locking*	Action	Schematic Circuit	U.S.A. List Price
11201	S.P.S.T. n.o.	1-A	\$3.50
11202	S.P.S.T. n.c.	1-B	3.50
11203	S.P.D.T.	1-C	4.00
11203D	S.P.D.T.	1-D	4.00
11204	D.P.S.T. n.o.	2-A	4.50
11205	D.P.S.T. n.c.	2-B	4.50
11206	D.P.D.T.	2-C	5.00
11206D	D.P.D.T.	2-D	5.00
11208	4 P.S.T. n.o.	4-A	5.60
11209	3 P.D.T.	3-C	6.00
11212	4 P.D.T.	4-C	6.80

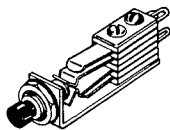

MINIATURE "TF" BUTTON SWITCHES

"Tiny Frame" switches. Small, sturdily constructed, provides simple, direct acting push button switching for use where space is at a premium. Available in Series 970L push-to-lock, pull-to-release; or Series 970, momentary action. Nickel silver springs, integral contacts, recommended for low level circuits where contact resistance is unimportant. Requires only $1\frac{1}{2}$ " depth behind panel; mounts in single $\frac{1}{4}$ " hole in panels up to $\frac{1}{2}$ " thick.

SERIES 970—NON-LOCKING

Part No.	Action	Schematic Circuit	U.S.A. List Price
974	D.P.S.T. n.o.	2-A	\$1.30
975	D.P.S.T. n.c.	2-B	1.30
976	D.P.D.T.	2-C	1.30

SERIES 970L—LOCKING

Part No.	Action	Schematic Circuit	U.S.A. List Price
974L	D.P.S.T. n.o.	2-A	\$1.55
975L	D.P.S.T. n.c.	2-B	1.55
976L	D.P.D.T.	2-C	1.55

"CordMASTER" PENDANT SWITCH

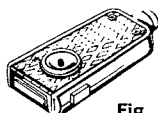

Fig. A

Fig. B

Extremely versatile pendant (cord) switch with top or edge operated pushbutton operation, illuminated and non-illuminated. Attractively patterned stainless steel sheath fits over white shock resistant thermoplastic switch housing to provide greater strength. Series 42000, Fig. A, has top operated pushbutton action. Three standard functions available: non-lock—momentary action; locking—button locks when depressed, releases when side button is depressed; push-to-lock, push-to-release—button locks when depressed and is released when depressed again. Series 42000E, Fig. B, has edge operation; supplied with "L" type illumination (top jewel lights when button is depressed). Illumination supplied by Ind. No. 377, 6 V miniature, T-1 $\frac{3}{4}$ flange base lamp (not supplied with switch). Part No. listed has locking function with front button release. Both Series have spring tempered nickel silver contact springs with cross-bar welded palladium contacts rated at 2 amps, 200 watts, max. A.C., non-inductive load. This switch is not recommended for 120 V A.C. line switching. Switches accept cables up to .270" dia. Overall dimensions: $1\frac{3}{4}$ "W. x $3\frac{1}{16}$ "L. x $\frac{5}{8}$ "H.

Part No.	Function	Action	Schematic	U.S.A. List Price
42206	Non-Lock	DPDT	2-C	\$ 9.00
42306	Locking	DPDT	2-C	9.50
42706	Push-to-Lock, Push-to-Release	DPDT	2-C	10.00
42306E	Locking	DPDT	2-C	10.50



"CORD SWITCHES"

An attractive bright nickel plated housing supports Series 903 and 913 button switches. Ideal for cord mounted or pendant switch on remote control applications. Sleeve $\frac{1}{16}$ " diameter, $2\frac{3}{16}$ " long.

Part Nos. Red Button	Black Button	Action	Schematic Circuit	U.S.A. List Price
E-903	E-913	S.P.D.T.	1-C	\$2.25
E-903D	E-913D	"Break-Make" S.P.D.T.	1-D	2.25
		"Make-Break"		



"CORDETTE" PENDANT SWITCHES

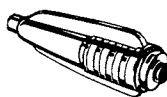

Small lightweight pendant, momentary action (cord) switches provide remote switching of industrial and commercial instrumentation and control devices. Attractive one-piece grey molded body protects switching controls from dirt and dust. Switch has 1-A (S.P.S.T.) circuit. Integral brass, hard gold contacts rated at 500 MA., 50 watts max., A.C. non-inductive load. Not recommended for use in high voltage circuits. Part No. 921 has phono jack termination molded to body. Mates with Switchcraft molded cable assemblies with phono plug terminations such as 3501, 3501MC, etc. or industry standard phono plugs. Part No. 921K same as 921 except 6' of 2-cond. unshielded cable molded to switch body. Stripped and tinned cable termination. Overall dimensions $1\frac{1}{8}$ " wide by $2\frac{1}{8}$ " long (not including cable).

Switchcraft Part No. 921..... U.S.A. List Price \$4.25
Switchcraft Part No. 921K..... U.S.A. List Price \$5.00

"HI-D SWITCH" SWITCHES

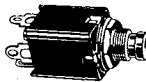

Series H-100, H-200—compact momentary action switches. Molded box body protects contact springs. Low electrical leakage, low capacity. Integral fine-silver plated contacts for use in circuits where contact resistance is not critical. One piece plastic button and shaft in Red—Series H-100, and Black—Series H-200. Mounts on $\frac{3}{8}$ " centers in either of two planes; in a single $\frac{3}{8}$ " hole in panels up to $\frac{1}{2}$ " thick. Depth behind panel $1\frac{1}{2}$ ".

Part Nos. Red Button	Black Button	Action	Schematic Circuit	U.S.A. List Price
H-101	H-201	S.P.S.T.n.o.	1-A	\$1.00
H-102	H-202	S.P.S.T.n.c.	1-B	1.09
H-103	H-203	S.P.D.T.	1-C	1.15
H-103D	H-203D	S.P.D.T.	1-D	1.15

SERIES DA SWITCH



Series DA. Completely enclosed, momentary action push-button switch. Anodized aluminum body protects switch contacts from dirt, dust and from being bent. A-B contact arrangement provides a 1-A, 1-B or 1-C circuit when externally wired. Integral hard gold plated contacts rated at 500 MA., 50 watts max., A.C., non-inductive load. Terminals accept AMP Series 53 taper pins. Mount in $\frac{1}{8}$ " hole on $1\frac{1}{2}$ " centers. Depth behind panel $1\frac{1}{2}$ ".

Part No.	Button Color	Part No.	Button Color	U.S.A. List Price
DA-01-3	Red	DA-04-3	Blue	\$2.25
DA-02-3	Black	DA-05-3	White	2.25
DA-03-3	Green	DA-08-3	Yellow	2.25

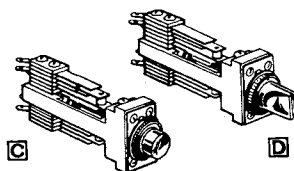

"T-LITE" SWITCHES

Series 32000, 32000TL. High-quality illuminated switches, ideal for instrumentation, communication equipment and telephone apparatus. Lightweight, extremely rugged aluminum "T-Beam" frame construction. Frame includes a non-turn device. "Frosted" plastic push-buttons give quick visual indication of switching function or circuit condition. Series 32000, Fig. C, momentary action, pushbutton can be engraved. Series 32000TL, Fig. D, momentary push with turn-to-lock feature. Button has black indicator line to indicate switching position. Utilize T-2 telephone slide base lamp. Relamp from front of panel. Lamps not supplied with switch. Long leaf nickel silver springs with cross-bar palladium contacts rated at 3 amps, 300 watts, max., A.C. non-inductive load. Mount in single $\frac{3}{8}$ " hole on $\frac{1}{8}$ " centers in panels $\frac{1}{8}$ " thick. Depth behind panel $3\frac{1}{8}$ ".

SERIES 32000 PUSHBUTTON

Part No.	Action	Schematic Circuit	U.S.A. List Price
32004	D.P.S.T.n.o.	2-A	\$10.00
32006	D.P.D.T.	2-C	10.75
32008	4P.S.T.n.o.	4-A	11.50
32012	4P.D.T.	4-C	13.00

SERIES 32000TL TURN BUTTON

Part No.	Action	Schematic Circuit	U.S.A. List Price
32004TL	D.P.S.T.n.o.	2-A	10.50
32006TL	D.P.D.T.	2-C	11.25
32008TL	4P.S.T.n.o.	4-A	12.00
32012TL	4P.D.T.	4-C	13.50

Lever Switches



"TELEVER" SWITCHES

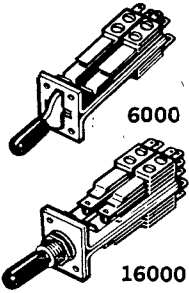

Series 6000 and 16000. Rugged telephone type lever switches featuring "T-Beam" frame construction which results in a relatively light construction with sturdiness of a structural "T-Beam". Available in two and three positions, locking and non-locking types. Nylon rollers on the lever actuate the special nickel silver springs, providing smooth action; assures long dependable spring life. Welded cross bar palladium contacts are standard, rated at 3 amps, 300 watts max., A.C., non-inductive load. Series 6000 mounts with four No. 3-48 machine screws. Mounting centers $1\frac{1}{2}$ " x $1\frac{1}{4}$ ", mounts in panels up to $\frac{1}{4}$ " thick. Series 16000 features single hole mounting; $1\frac{3}{8}$ "-32 threaded bushing. Mounts in $\frac{1}{2}$ " dia. hole in panels up to $\frac{1}{4}$ " thick. Part No. 545; "Stop Plate" provides positive "stops" for two position action. Part No. 540,

"Stop Plate" provides non-locking or momentary action. The "Stop Plates" can be changed in the field. Both Series switches supplied with black insulated knob. All have tinned solder lug terminals. *Add suffix letter "L" to Part No. to indicate locking type. Series 16000 non-locking type can be converted to locking type by removing "Stop Plate".

SERIES 6000 TWO POSITION TYPES

Part No. Non-Locking*	Action	Schematic Circuit Pos. 1 Pos. 2	U.S.A. List Price
6006	D.P.D.T.	2-C	\$5.00
6006D	D.P.D.T.	2-D	5.60
6008	4 P.S.T. n.o.	4-A	5.60
6009	3 P.D.T.	3-C	6.00
60012	4 P.D.T.	4-C	6.80
60012D	4 P.D.T.	4-D	7.50
60024	8 P.D.T.	8-C	10.00

THREE POSITION TYPES

6036	S.P.D.T. Ea. Sec.	1-C 1-C	\$5.00
6036D	S.P.D.T. Ea. Sec.	1-D 1-D	5.60
6038	D.P.S.T. n.o. Ea. Sec.	2-A 2-A	5.60
60312	D.P.D.T. Ea. Sec.	2-C 2-C	6.80
60312D	D.P.D.T. Ea. Sec.	2-D 2-D	7.50
60316	4 P.S.T. n.o. Ea. Sec.	4-A 4-A	8.80
60324	4 P.D.T. Ea. Sec.	4-C 4-C	10.00

SERIES 16000 TWO POSITION TYPES

16006	D.P.D.T.	2-C	\$5.00
16006D	D.P.D.T.	2-D	5.60
16008	4 P.S.T. n.o.	4-A	5.60
16009	3 P.D.T.	3-C	6.00
160012	4 P.D.T.	4-C	6.80
160012D	4 P.D.T.	4-D	7.50
160024	8 P.D.T.	8-C	10.00

THREE POSITION TYPES

16036	S.P.D.T. Ea. Sec.	1-C 1-C	\$5.00
16036D	S.P.D.T. Ea. Sec.	1-D 1-D	5.60
16038	D.P.S.T. n.o. Ea. Sec.	2-A 2-A	5.60
160312	D.P.D.T. Ea. Sec.	2-C 2-C	6.80
160312D	D.P.D.T. Ea. Sec.	2-D 2-D	7.50
160316	4 P.S.T. n.o. Ea. Sec.	4-A 4-A	8.80
160324	4 P.D.T. Ea. Sec.	4-C 4-C	10.00

Part No. 530 Escutcheon Plate. For Series 6000 Telever switches with 4 mounting screws. U.S.A. List Price \$0.60

Part No. 540 Stop Plate. For Series 16000 Telever switches. To convert from locking to non-locking action. Includes two mounting screws. U.S.A. List Price \$0.25

Part No. 545 Stop Plate. For Series 16000 Telever switches. To convert from 3-position to 2-position. Includes two mounting screws. U.S.A. List Price \$0.25

"LEV-R" SWITCHES

"LEV-R Switches." Series 28000. Compact, lever action switch in two and three position, locking and non-locking types. Smooth, easier lever action assured with special nylon roller. Supplied with locknut, non-turn ring (slips over slotted bushing

to prevent switch from turning in mounting hole), and a black knob which is molded directly to the lever. Eliminates loose or lost knobs. Fine silver contacts rated at 3 amps, 300 watts, max., A.C., non-inductive load. Mounts on $\frac{1}{4}$ " centers in panels up to $\frac{1}{2}$ " thick. Requires only one $\frac{1}{4}$ " dia. mounting hole for bushing and one $\frac{1}{8}$ " dia. hole for non-turn device; depth behind panel, $2\frac{1}{4}$ ". *Add suffix letter "L" to Part No. to indicate locking type. †Center position open (OFF).

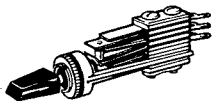

TWO POSITION TYPES

Part No. Non-Locking*	Action	Schematic Circuit Pos. 1 Pos. 2	U.S.A. List Price
28201	S.P.S.T. n.o.	1-A	\$2.80
28203	S.P.D.T.	1-C	3.25
28204	D.P.S.T. n.o.	2-A	3.50
28206	D.P.D.T.	2-C	2.75

THREE POSITION TYPES

28304	S.P.S.T. n.o. ea. sec.	1-A 1-A	\$3.60
28306	S.P.D.T. ea. sec.	1-C 1-C	3.90
28307	S.P.D.T. n.o. ea. sec.	1-C† 1-C†	3.95
28312	D.P.D.T. ea. sec.	2-C 2-C	4.75

SERIES 26000 "LEVER-LOCK" SWITCHES

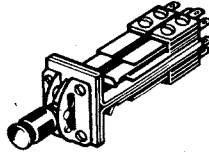

Rugged telephone-type lever switches. "Lever-Lock" feature guards against accidental switching due to shock, vibrations, operator fatigue, or unintended operation. Ideal for mobile communication equipment. Index bracket and release plunger "locks" lever in any position. Turning actuator knob to extreme left actuator will be permanently locked. To unlock, turn knob to the right. Pressing release plunger frees actuator from index bracket and allows actuator to be moved to another switching position. Welded cross bar palladium contacts rated at 3 amps, 300 watts max., A.C., non-inductive load. Mounts with four No. 3-48 screws in panels up to $\frac{1}{2}$ " thick. Requires $3\frac{1}{4}$ " depth behind panel.

TWO POSITION TYPES

Part No. Locking Type Only	Action	Schematic Circuits Pos. 1 Pos. 2	U.S.A. List Price
26206L	D.P.D.T.	2-C	\$8.50
26208L	4 P.S.T. n.o.	4-A	9.10
26212L	4 P.D.T.	4-C	10.30
26212DL	4 P.D.T.	4-D	11.00

THREE POSITION TYPES

26306L	S.P.D.T. Ea. Sec.	1-C 1-C	\$8.50
26308L	D.P.S.T. n.o. Ea. Sec.	2-A 2-A	9.10
26312L	D.P.D.T. Ea. Sec.	2-C 2-C	10.30
26312DL	D.P.D.T. Ea. Sec.	2-D 2-D	11.00
26316L	4 P.S.T. n.o. Ea. Sec.	4-A 4-A	12.30
26324L	4 P.D.T. Ea. Sec.	4-C 4-C	13.50

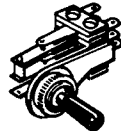

"LEV-R" SWITCHES, SERIES 12000

Small right-angle action switches requiring minimum of depth behind panel. Available in two and three position, locking and non-locking types. Long leaf-type springs insure long switch life. Fine silver contacts rated at 3 amps, 300 watts max., A.C., non-inductive load. Requires only $\frac{1}{8}$ " depth behind panel; single $\frac{1}{2}$ " dia. mounting hole; mounts in panels up to $\frac{3}{8}$ " thick. Supplied with nickel plated locknut and removable black plastic knob. †n.o. center position off. *Add suffix letter "L" to Part No. to indicate locking type.

TWO POSITION TYPES

Part No. Non-Locking*	Action	Schematic Circuit Pos. 1 Pos. 2	U.S.A. List Price
12001	S.P.S.T. n.o.	1-A	\$1.80
12002	S.P.S.T. n.c.	1-B	1.80
12003	S.P.D.T.	1-C	2.10
12003D	S.P.D.T.	1-D	2.35
12004	D.P.S.T. n.o.	2-A	2.35
12005	D.P.S.T. n.c.	2-B	2.35
12006	D.P.D.T.	2-C	2.60
12006D	D.P.D.T.	2-D	2.85

THREE POSITION TYPES

12033	S.P.D.T. n.o.	1-C†	\$2.35
12034	S.P.S.T. n.o. Ea. Sec.	1-A 1-A	2.45
12035	S.P.S.T. n.c. Ea. Sec.	1-B 1-B	2.45
12036	S.P.D.T. Ea. Sec.	1-C 1-C	2.75
12036D	S.P.D.T. Ea. Sec.	1-D 1-D	2.95
12037	S.P.D.T. Ea. Sec.	1-C† 1-C†	2.85

THREE POSITION TYPES LOCKING ONE SIDE—NON-LOCKING OTHER SIDE

12033T	S.P.D.T. n.o.	1-C†	\$2.35
12037T	S.P.D.T. Ea. Sec.	1-C† 1-C†	2.85



"BOX SWITCH"

Series BX. "Miniature, momentary action, push-button switch offers broad switching capabilities in minimum panel space. $1\frac{1}{8}$ " square switch requires $\frac{3}{8}$ " min. to $1\frac{1}{4}$ " max. depth behind panel. Molded plastic body protects against damaging dust and dirt and prevents bending or disfiguring of contacts caused by excessive handling. Attractive bezel frames pushbutton and acts as built-in escutcheon plate. Unique "Adjust-A-Clips" provide snap-in, front of panel, mounting in panels from $\frac{1}{4}$ " to $1\frac{1}{4}$ " thick in .615" sq. holes. Red, black, green, or white pushbuttons. $\frac{1}{4}$ " button stroke. Integral slide contacts of special spring tempered phosphor bronze, silver plated, rated at: 250 ma., 30 watts max., A.C. non-inductive load. Evenly spaced solder lug terminals are clearly identified for ease of wiring.

Part Nos.				Action	Schematic Circuit	U.S.A. List Price
Red Button	Black Button	Green Button	White Button			
BX-01-1	BX-02-1	BX-03-1	BX-05-1	S.P.S.T. n.o.	1-A	\$3.25
BX-01-3	BX-02-3	BX-03-3	BX-05-3	S.P.D.T.	1-C	\$3.40
BX-01-6	BX-02-6	BX-03-6	BX-05-6	D.P.D.T.	2-C	\$3.75
BX-01-10	BX-02-10	BX-03-10	BX-05-10	D.P.D.T.-D.P.S.T. n.o.	2-C & 2-A	\$4.25

BASIC SCHEMATIC CIRCUITS

Switch circuitry can be described as combinations of basic schematic circuits as shown below. N.O. means normally open; N.C. means normally closed.

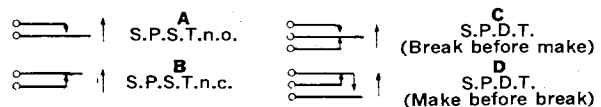

"double-wipe" Slide Switches

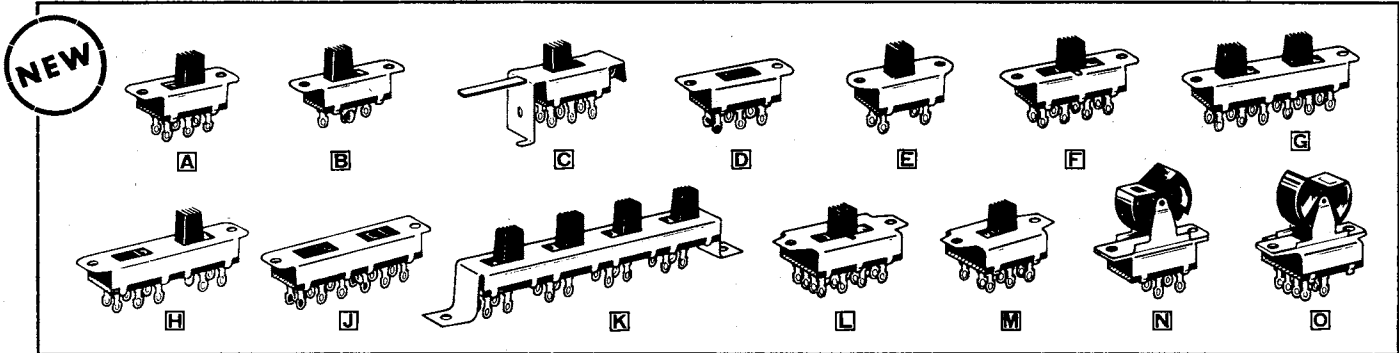

New low-cost, precision "double-wipe" slide switches. Switches use special U-shaped, bifurcated sliders to assure continuous wiping action. Contacts rated at 0.5 amp. D.C., 3 amps. A.C., 125 volts non-inductive load. Standard solder lug terminals have a 3/16" dia. center hole and wrap-around notch for wiring ease. Most switches furnished with black 1 1/2" knob and .140" (5/64") dia. mounting holes. Nos. 46206LF, 46256LF and 47227LF flush screwdriver actuated knob. All slide and rocker switches are U.L. approved unless otherwise noted. See next page for slide switch contact arrangement.

SERIES 46000 2 AND 3 POSITION GENERAL PURPOSE TYPE

Rated 0.5 amp. D.C., 3 amps. A.C., 125 volts non-inductive load; except shorting types 46203LS and 46206LS, rated 0.5 amp., 125 volts, D.C. only. No. 46206MP 2 position momentary switch with 1 1/2" plunger and extruded and tapped 6-32 mounting holes. Nos. 46206LF, 46256LF flush, screwdriver slotted knob. No. 46204MB pushbutton actuated switch with 3/8" knob.

Part No.	Action	Schematic	Fig.	U.S.A. List Price
46202L	SPST Locking	II	A	.35
46202M	SPST Momentary	I	B	.50
46203L	SPDT Locking	III	A	.40
46203LS	SPDT Locking	III	A	.45
46203M	SPDT Momentary	III	B	.55
46204L	DPST Locking	2-II	A	.45
46206L	DPDT Locking	2-III	A	.50
46206LS	DPDT Locking	2-III	A	.55
46206M	DPDT Momentary	2-III	B	.65
46206MP	DPDT Momentary	2-III	C	.75
46206LF	DPDT Locking	2-III	D	.55
46256LF	DPDT Locking	V	D	.75
46204MB*	DPST Momentary	IV	E	.70

Three position slide switches with positive center detent action. Locking in all positions. Nos. 46311LD and 46313LD have shutter type dust cover.

46311L	SPTT Locking	VI	F	.55
46311LD*	SPTT Locking	VI	F	.60
46313L	DPTT Locking	2-VI	F	.60
46313LD*	DPTT Locking	2-VI	F	.65

SERIES 47000 TANDEM SLIDE SWITCHES

Compact, two-gang, slide switches. Series 47000L two independent knobs; Series 47000LC, single knob construction with coupling link between knobs. One knob 1 1/2" other flush screwdriver operated. No. 47227LF two knobs flush with switch housing, one knob screwdriver actuated. Knobs are coupled. Shorting bar each section. Rated at 0.5 amp. D.C., 3 amps. A.C., 125 volts non-inductive load.

47202L	SPST-SPST Locking	II II	G	.65
47202LC	SPST-SPST Locking	II II	H	.65
47203L	SPDT-SPDT Locking	III III	G	.75
47203LC	SPDT-SPDT Locking	III III	H	.75
47204L	DPST-DPST Locking	2-II 2-II	G	.85
47204LC	DPST-DPST Locking	2-II 2-II	H	.85
47206L	DPDT-DPDT Locking	2-III 2-III	G	.90
47206LC	DPDT-DPDT Locking	2-III 2-III	H	.90
47215L	SPST-SPDT Locking	II III	G	.70
47215LC	SPST-SPDT Locking	II III	H	.70
47217L	SPST-DPST Locking	II 2-II	G	.75
47217LC	SPST-DPST Locking	II 2-II	H	.75
47219L	SPST-DPDT Locking	II 2-III	G	.80
47219LC	SPST-DPDT Locking	II 2-III	H	.80
47221L	SPDT-DPST Locking	III 2-II	G	.80
47221LC	SPDT-DPST Locking	III 2-II	H	.80
47223L	SPDT-DPDT Locking	III 2-III	G	.85
47223LC	SPDT-DPDT Locking	III 2-III	H	.85
47225L	DPST-DPDT Locking	2-II 2-III	G	.90
47225LC	DPST-DPDT Locking	2-II 2-III	H	.90
47227LF	DPDT-DPDT Locking	V V	J	1.40

*Not submitted for U.L. approval.

SERIES 48000 QUADNUM SLIDE SWITCHES

Four-gang slide switches with independent knob operation. 1 1/2" knob height and .153 mounting holes.

Part No.	Action	Schematic	Fig.	U.S.A. List Price
48208L*	4-SPST Locking	4-II	K	\$1.20
48212L*	4-SPDT Locking	4-III	K	1.40
48214L	4-DPST	8-II	K	1.60
48224L*	4-DPDT Locking	8-III	K	1.80

SERIES 49000 3 POSITION GENERAL PURPOSE TYPE

Large, heavy duty 3 and 4 pole slide switches. Knob height 1 1/2". Mounting holes 3/16". Series 49000L, non-shorting; Series 49000LS, with shorting contacts.

49309L	3PDT Locking	3-III	L	.85
49309LS	3PDT Locking	3-III	L	.90
49329L	3PTT Locking	3-VI	L	.90
49329LS	3PTT Locking	3-VI	L	.95
49312L	4PDT Locking	4-III	L	.90
49312LS	4PDT Locking	4-III	L	.95
49331L	4PTT Locking	4-VI	L	.95
49331LS	4PTT Locking	4-VI	L	1.00

SERIES 50000 2 POSITION GENERAL PURPOSE TYPE

Series 50000L and M, non-shorting; Series 50000LS and MS; with shorting contacts.

50207L	3PST Locking	3-II	M	.60
50207M	3PST Momentary	3-II	M	.75
50208L	4PST Locking	4-II	M	.65
50209L	3PDT Locking	3-III	M	.70
50209LS	3PDT Locking	3-III	M	.75
50209M	3PDT Momentary	3-III	M	.85
50209MS	3PDT Momentary	3-III	M	.90
50212L	4PDT Locking	4-III	M	.75
50212LS	4PDT Locking	4-III	M	.80

SERIES 51000 2 POSITION ROCKER SWITCHES

Compact rocker switches offer same quality and dependability as standard slide switches. Rugged rocker bracket is precision welded to standard slide switch housing. Rocket pivots between bracket members to allow free actuation of switch mechanism. Black rocker.

51202L	SPST Locking	II	N	.75
51203L	SPDT Locking	III	N	.80
51204L	DPST Locking	2-II	N	.85
51206L	DPDT Locking	2-III	N	.90

SERIES 52000 2 POSITION ROCKER SWITCHES

Larger than Series 51000, offering 3 and 4 poles of switching. Series 52000L, non-shorting; Series 52000LS with shorting contacts.

52207L	3PST Locking	3-II	O	.90
52208L	4PST Locking	4-II	O	.95
52209L	3PDT Locking	3-III	O	1.00
52209LS	3PDT Locking	3-III	O	1.05
52212L	4PDT Locking	4-III	O	1.05
52212LS	4PDT Locking	4-III	O	1.10



Audio Connectors

Patent No. 3,219,961



AUDIO CONNECTORS WITH COMPLETE GROUNDING PROVISIONS!

Switchcraft's* "Quick-Ground" connectors feature a separate "Ground-Terminal" electrically integral with the connector shell. Ground continuity between mating plugs automatically accomplished through the exclusive "Ground Connectors." Possible loss of insert screw is eliminated by new "Captive Design" Insert Screw. Socket and pin assemblies utilize "wedge-action" to insure firm, reliable positioning in connector shell. Q-G* Series 3 and 4-contact audio connectors, offer 4 and 5-contact versatility when "Ground Terminal" is utilized. Can be used interchangeably with Cannon type XLR-3, XLR-4 and Amphenol type 91-850 Series. *Number of insert contacts or pins must be specified to complete Part Number.

A(*)*F CORD PLUGS

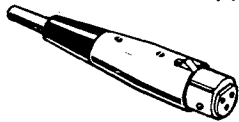

Fresh, streamlined design includes rugged, diecast zinc body, satin nickel finish, high-impact resistant thermosetting plastic socket insert, molded latchlock, dual pressure plates, keyed neoprene relief bushing. Features "Ground Terminal" and "Ground Connectors" offers 4 and 5-contact versatility. Mates with Switchcraft A(*)*M and other connectors with similar contact arrangements. Takes 1/4" O.D. cable. Overall length 3 3/8"; dia. 3/4".

Part No.	Insert Contacts	U.S.A. List Price
A3F	3	\$2.30
A4F	4	2.85

A(*)*M CORD PLUGS



Has "Captive Design" insert screw, one-piece pin insert assembly easily removable for fast soldering. Polarizing groove. Die-cast zinc shell, satin nickel finish. Mates with Switchcraft A(*)*F and other connectors with similar contact arrangements. Brass, silver plated chromate dipped pins to resist tarnishing. Overall length 2 3/8"; dia. 3/4".

Part No.	Insert Pins	U.S.A. List Price
A3M	3	\$2.00
A4M	4	2.10

B(*)*M RECEPTACLES



For panel or chassis mounting; locknut accommodates panels up to 1/4" thick. Single hole mounting, can be keyed by using "D" shaped panel hole or S-3519 mounting adapter. Pin insert features "Captive Design" insert screw and "Ground Terminal." Mates with Switchcraft A(*)*F and other connectors with similar contact arrangements. Diecast zinc shell, satin nickel finish. Dimensions: Flange 1 1/4" dia.; Barrel 1 3/8" overall; pin extensions 3/8".

Part No.	Insert Pins	U.S.A. List Price
B3M	3	\$2.90
B4M	4	3.00

C(*)*M RECEPTACLES

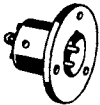

Mounts on wall, panel or chassis with three .136" dia. mounting holes. High impact thermosetting plastic pin insert. "Captive Design" insert screw, "Ground Terminal." Pins, brass, silver plated, chromate dipped; resists tarnishing. Mates with Switchcraft A(*)*F and other connectors with similar contact arrangements. Dimensions: Flange 1 1/8" dia.; Barrel 1 3/8" overall; pin extensions 3/8".

Part No.	Insert Pins	U.S.A. List Price
C3M	3	\$1.40
C4M	4	1.50

C(*)*F RECEPTACLES

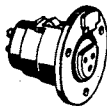

For panel or chassis mounting; has socket insert, push-type latch locking device. Flange has three .136" holes for mounting screws. Mates with Switchcraft A(*)*M and other connectors with similar contact arrangements. Dimensions: Flange 1 1/4" dia.; Barrel 1 3/8" overall; pin extension 1/4".

Part No.	Insert Pins	U.S.A. List Price
C3F	3	\$3.10
C4F	4	3.20

D(*)*F RECEPTACLES

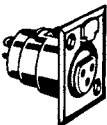

Rectangular flange design receptacle permits close mounting on crowded panel or chassis. Features "Captive Design" loss-proof insert screw, positive latch locking device and high impact thermosetting socket insert. Mates with Switchcraft A(*)*M and other connectors with similar contact arrangements. Dimensions: Flange 1 1/8" x 1 1/8"; Barrel 1 3/8" overall; pin extension 3/4".

Part No.	Insert Contacts	U.S.A. List Price
D3F	3	\$3.20
D4F	4	3.30

D(*)*M RECEPTACLES

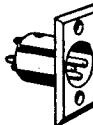

Narrow, rectangular flange design receptacle for mounting on compact panel or chassis. Mates with Switchcraft A(*)*F and other connectors with similar contact arrangements. Dimensions: Flange 1/8" x 1 1/8"; Barrel 1 3/8" overall; pin extension 3/4".

Part No.	Insert Pins	U.S.A. List Price
D3M	3	\$1.90
D4M	4	2.00



G(*)*M TYPE WALL PLATES

Single gang wall plates with a B(*)*M male receptacle. Fits standard electrical outlet box. Wall plates available in brushed brass or brushed stainless steel. Dimensions: Wall Plate 4 1/2"H x 2 3/4"W.

Part No.	Finish	Insert Pins	U.S.A. List Price
G3M	Brass	3	\$5.00
G4M	Brass	4	4.75
G3MS	Stainless Steel	3	5.00
G4MS	Stainless Steel	4	5.25

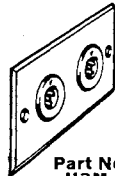

H(*)*M TYPE WALL PLATES

Two gang wall plates with two B(*)*M male receptacles. Mounts in standard electrical switch box (single). Wall plates available in brushed brass or brushed stainless steel. Dimensions: Wall Plate 4 1/2"H x 2 3/4"W. Six contacts.

Part No.	Finish	Insert Pins	U.S.A. List Price
H3M	Brass	3 ea.	\$6.50
H4M	Brass	4 ea.	7.00
H3MS	Stainless Steel	3 ea.	7.00
H4MS	Stainless Steel	4 ea.	7.50



J(*)*F TYPE WALL PLATES

Single gang wall plates with a D(*)*F female receptacle. Fits standard electrical outlet box. Wall plates available in brushed brass or brushed stainless steel. Dimensions: 4 1/2"H x 2 3/4"W.

Part No.	Finish	Insert Contacts	U.S.A. List Price
J3F	Brass	3	\$4.70
J3FS	Stainless Steel	3	5.20
J4F	Brass	4	4.95
J4FS	Stainless Steel	4	5.45

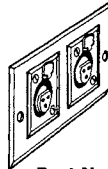

K(*)*F TYPE WALL PLATES

Two gang wall plates with two D(*)*F female receptacles. Mounts in standard electrical outlet junction box. Wall plates available in brushed brass or brushed stainless steel. Dimensions: 4 1/2"H x 2 3/4"W.

Part No.	Finish	Insert Contacts	U.S.A. List Price
K3F	Brass	3 ea.	\$6.90
K3FS	Stainless Steel	4 ea.	7.40
K4F	Brass	3 ea.	7.40
K4FS	Stainless Steel	4 ea.	7.90

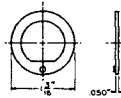

MOUNTING ADAPTER

For use with B3M panel and chassis receptacle. Eliminates necessity of providing a flattened "D" shaped hole in panel to prevent turning of receptacle.

Switchcraft Part No. S-3519..... U.S.A. List Price \$0.40

"SLIM-LINE" CONNECTORS



New, small 4-contact connectors for audio and communication equipment. Barrel insert assembly of high-impact, thermo-plastic. No. 2504M, Fig. A, 4-pin male plug with coupling ring. "D-Shaped" barrel assembly polarized for proper mating. Large, husky cable clamp. No. 2504FP, Fig. B, 4-contact female receptacle, only 9/16" dia., 3/4" depth behind panel. For front panel mount. No. 2504FR, same as 2504FP, except rear panel mount. All "Slim-Line" connectors bright nickel plated.

Switchcraft Part No. 2504M..... U.S.A. List Price \$2.50
 Switchcraft Part No. 2504FP..... U.S.A. List Price \$2.50
 Switchcraft Part No. 2504FR..... U.S.A. List Price \$2.50

AC RECEPTACLES



Highly dependable 3-pin receptacles for use in all electrical/electronic equipment. "Chassis hugging" recessed type mounting. Brass contact pins are silver plated, chromate dipped. No. AC3, ungrounded; No. AC3G, grounded, includes self-aligning feature. Pins #1 and #3 move, #2 is stationary. Receptacles mate with Belden cord No. 17258. Rating: 115V, 7 amps.

Switchcraft Part No. AC3..... U.S.A. List Price \$0.80
 Switchcraft Part No. AC3G..... U.S.A. List Price .75

Connectors



MICROPHONE CONNECTORS

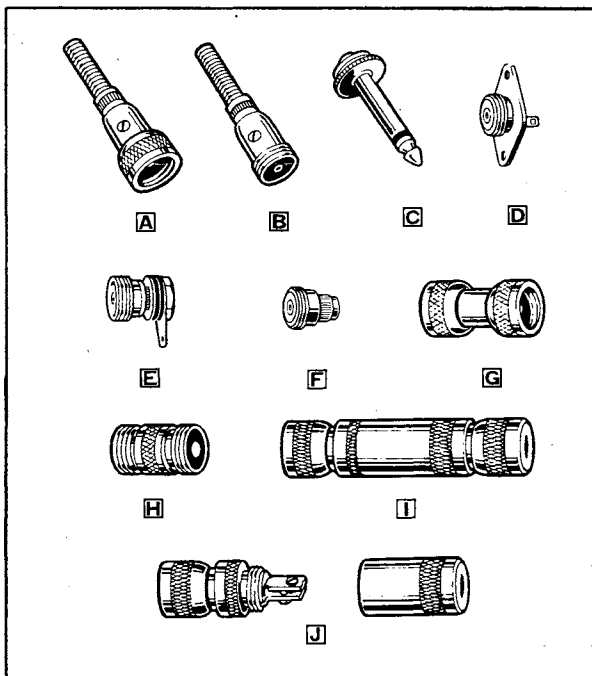

Standard connectors with $\frac{1}{8}$ "-27 threads. Designed for use with single conductor microphone cable with $\frac{3}{16}$ " max. O.D. **Coupling ring** on 2501F removable for fast change of female to male type. Spring clamped into body, cable braid and spring clamped by hollow set screw. No. 44 adapts 2501F to fit standard 2-cond. phone jack. No. 2501MP mounts in $\frac{3}{8}$ " dia. hole. *No. 2501MPC same as 2501MP except closed circuit type. No. 2501FT, coupler, two female connectors at each end. No. 2501MT, coupler, two male connectors at each end. Nos. 2501FL, 2501FS, for attaching cable to female connector without soldering; screw terminals. No. 2501MBL, insulated male panel receptacle. No. 2501MPF, male panel receptacle for PRESS-FIT mounting. **Cable clamp.

Part No.	Fig.	Description	U.S.A. List Price
2501F	A	Female Connector	\$.65
2501M	B	Male Connector	.50
44	C	Phone Plug Adapter	.55
2501MBL	D	Panel Receptacle	.60
2501MP	E	Panel Receptacle	.50
*2501MPC	F	Panel Receptacle	.60
2501MPF	F	Panel Receptacle	.50
2501FT	G	Double Female Connector	1.25
2501MT	H	Double Male Connector	1.25
**2501FL	I	Screw Term. Female Connector	2.50
2501FS	J	Screw Term. Female Connector	1.80

"MINI-CON" MINIATURE CONNECTORS

Popular "Mini-Con" microphone-type connectors used with miniaturized audio equipment, lapel microphones, musical instruments, etc. About $\frac{1}{2}$ the size of standard microphone connectors. Accepts single conductor shielded cables up to $\frac{1}{16}$ " O.D. Nickel plated brass bodies. Coupling ring on 5501F removable for quick change of female to male type. Cable-braid spring clamped to body by hollow point set screw. 5501MF mounts by lock-nut front side of panel, in $\frac{3}{8}$ " dia. hole. 5501MP mounts back side of panel in $\frac{3}{16}$ " dia. hole. 5501MPC same as 5501MP except shorting type

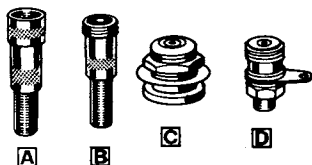

Part Number	Fig.	Description	U.S.A. List Price
5501F	A	Female Cord Connector	\$0.65
5501M	B	Male Cord Connector	.50
5501MF	C	Panel Connector, Male	.50
5501MP	D	Panel Connector, Male	.40
5501MPC	D	Panel Connector, Male	.80

PHONO JACKS AND PLUGS

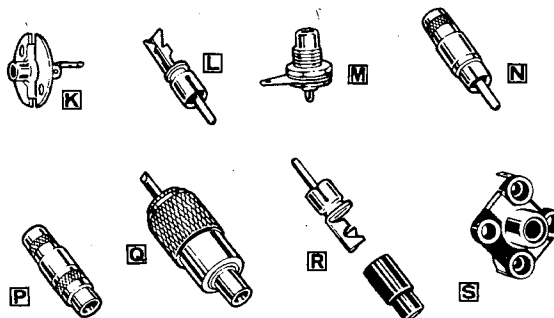

Low cost 2-cond. jacks and plugs for record players, FM-AM tuners, tape recorders, test equipment, etc. 3501MC has $\frac{3}{8}$ " O.D. shell and cable clamp. 3501FP for front panel mount in $\frac{1}{4}$ " hole, in panels up to $\frac{1}{8}$ " thick. 3501FR for rear panel mount in $\frac{1}{4}$ " hole, in panels up to $\frac{1}{8}$ " thick. 3502 has unique cable clamp with $\frac{15}{32}$ " O.D. shielded removable handle. 3503 ext. jack has shielded removable handle, $\frac{15}{32}$ " O.D. with cable clamp. 3508 Series, new color coded phono plugs with cable clamp and "snap-on" plastic handles in Red, Black, and White. Series 3511 "4-Leaf Clover" Jack. Molded phono Jack with dual contact surfaces for minimum shunt resistance, greater reliability. Open and closed circuit types. Mate with all Switchcraft phono plugs.

Part No.	Fig.	Description	U.S.A. List Price
3501F	K	Chassis jack	\$0.15
3501M	—	Plug, less cable clamp	.10
3501MC	L	Plug with cable clamp	.15
3501FP	M	Chassis jack	.35
3501FR	—	As above, chassis jack	.40
3502	N	Plug	.50
3503	P	Extension jack	.65
3508-1	R	Plug, Red handle	.25
3508-2	R	Plug, Black handle	.25
3508-5	R	Plug, White handle	.25
3511	S	Chassis jack, open circuit	.30
3511A	S	Chassis jack, open circuit, grounded	.30
3512	S	Chassis jack, closed circuit	.35
3512A	S	Chassis jack, closed circuit, grounded	.35

RF-JACKS and RF-PLUGS

Standard phono jacks and plugs with nylon insulation. For use in radio frequency applications—low cost, max. insulation resistance. No. 3504M, $\frac{3}{8}$ " O.D. No. 3505F mounts front of panel in $\frac{3}{8}$ " hole—fits panel up to $\frac{1}{8}$ " thick. No. 3506 adapter has coaxial connector (Amphenol 83-1SP) one end; 3505F at other end. No. 3507 has $\frac{15}{32}$ " O.D. shielded, screw-on handle with cable clamp.

Part No.	Fig.	Description	U.S.A. List Price
3504M	L	Plug	\$0.20
3505F	M	Chassis jack	.60
3506	O	Adapter	2.25
3507	N	Plug	.80

"SLIM-LINE" CONNECTORS



New, small 4-contact connectors for audio and communication equipment. Barrel insert assembly of high-impact, thermo-plastic. No. 2504M, Fig. A, 4-pin male plug with coupling ring. "D-Shaped" barrel assembly polarized for proper mating. Large, husky cable clamp. No. 2504FP, Fig. B, 4-contact female receptacle, only $\frac{1}{8}$ " dia., $\frac{1}{8}$ " depth behind panel. For front panel mount. No. 2504FR, same as 2504FP, except rear panel mount. All "Slim-Line" connectors bright nickel plated.

Switchcraft Part No. 2504M U.S.A. List Price \$2.50
 Switchcraft Part No. 2504FP U.S.A. List Price \$2.50
 Switchcraft Part No. 2504FR U.S.A. List Price \$2.50

AC RECEPTACLES



Highly dependable 3-pin receptacles for use in all electrical/electronic equipment. "Chassis hugging" recessed type mounting. Brass contact pins are silver plated, chromate dipped. No. AC3, ungrounded; No. AC3G, grounded, includes self-aligning feature. Pins #1 and #3 move, #2 is stationary. Receptacles mate with Belden cord No. 17258. Rating: 115V, 7 amps.

Switchcraft Part No. AC3 U.S.A. List Price \$0.80
 Switchcraft Part No. AC3G U.S.A. List Price .75

Adapters

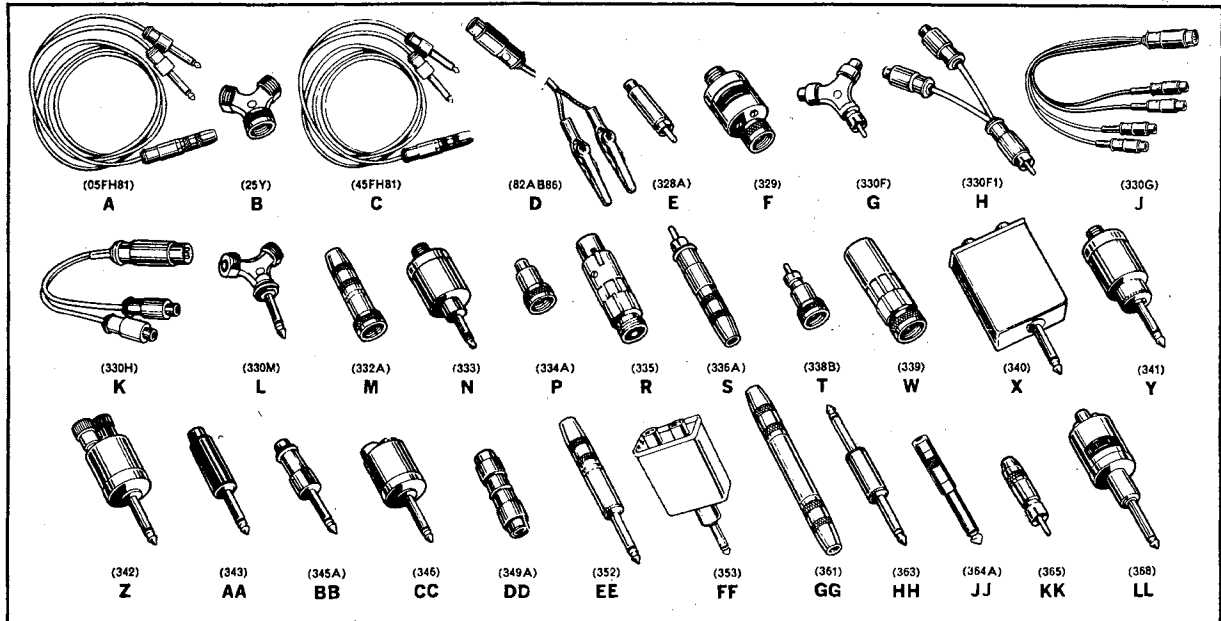

A versatile and complete line of adapters for interconnecting components that do not have mating jacks and/or plugs. For hi-fi stereo, phonographs, tuners, tape recorders, amplifiers, P.A. systems, etc. Positive mating contacts of high quality material prevent resistive line-losses. Nickel plated finish for long life. No. 328A, audio equalizer, converts ceramic phono cartridge to magnetic input. No. 329 Volume Control Adapter for use in high impedance circuits. No. 330G adapts European-type 5-contact sockets to standard Switchcraft phono plugs, color coded. Fits Norelco, Korting, Grundig, Sony, Elber tape recorders; Grundig radios. No. 330H, adapts 3-pin European type plug to standard Switchcraft phono plugs. No. 335 has unsoldered internal wire at one end to permit user to convert terminal needed. No. 341, silent plug adapter, includes a circuit closing device to eliminate amplifier "squeals" when disconnecting. No. 352, converts stereo headphones and/or microphones to a monaural input. No. 353 adapts stereo recorder for two headphones. Nos. 332A, 334A, 338B can be used as male or female connector; coupling ring screws back, converting to male mike connector.

Part No.	Fig.	Description	U.S.A. List Price	Part No.	Fig.	Description	U.S.A. List Price
05FH81	A	Stereo Headphone Adapter Cable. Two std. 2-cond. phone plugs wired to a 3-cond. phone jack. Shielded, 4 ft. stereo cable.	\$4.80	336A	S	2-cond. phone jack input to phono plug output. Shielded.	\$1.95
25Y	B	Y-Adapter, two male mike connectors in parallel to one female mike connector.	2.10	336B	—	Same as above, but 2-cond. phone jack input to phono jack output.	1.95
45FH81	C	Stereo Headphone Adapter Cable. Similar to 05FH81, except two 2-cond. "Tini-Plugs" wired to a 3-cond. std. 1/4" phone jack. Shielded.	4.30	338A	—	Phono plug input to male mike connector output. Shielded. Similar to 338B.	1.25
82AB86	D	Speaker Adapter Cable. Two alligator clips to a molded phono extension jack. 12" cable. Shielded.	1.20	338B	T	Phono plug input to female mike connector output. Shielded.	1.40
328A	E	Audio Equalizer. Phone jack input to phone plug output.	3.30	339	W	Same as 335, but output connector Switchcraft 2501F to input connector Cannon XL-3-12.	3.50
329	F	Volume Control, female mike connector to male mike connector.	6.95	340	X	Two 2-cond. phone jack inputs in parallel to a 2-cond. phone plug output. Shielded.	4.00
330F	G	Y-Adapter. Two phono jacks in parallel to a phono plug. Shielded.	1.95	341	Y	Silent-Plug Adapter. 2-cond. phone jack input to 2-cond. phone plug output.	3.30
330F1	H	Flexible Y-Adapter, phono plug in parallel to 2 phono jacks. Shielded 4" cable.	2.25	342	Z	Dual purpose binding post/banana jack input to 2-cond. phone plug output.	2.95
330F2	—	Same as above, but phono plug and phono jack to a phono plug.	2.25	343	AA	Phono jack input to phone plug output. Built-in limiting resistor for Webcor tape recorders.	1.95
330F3	—	Same as above, but 2 phono plugs to 1 phono plug.	2.25	345A	BB	Phone plug output to phono jack input.	1.45
330G	J	Stereo Adapter Cable. 5-pin European-type plug to four phono jacks. Shielded stereo cables, each 1 ft.	6.00	346	CC	Tip jack input to 2-cond. phone plug output.	2.50
330H	K	Flexible Y-Adapter. 3-pin European-type plug to 2 phono jacks. Shielded 5" cable.	3.75	349A	DD	Phono plug coupler, mates with phono plug at each end. Shielded.	1.25
330M	L	Y-Adapter, two male mike connectors in parallel to a 2-cond. phone plug.	2.25	352	EE	Stereo to monaural adapter. 3-cond. phone jack to 2-cond. phone plug output. Shielded.	2.25
330PJ	—	Y-Adapter, as above, except two phono jacks in parallel to a 2-cond. phone plug. Shielded.	2.25	353	FF	Stereo headphone adapter. 3-circuit plug wired to two 3-circuit jacks. Housed in shielded, metal case, tan finish.	4.75
332A	M	Phone jack input to female mike connector output.	1.95	361	GG	Coupler. 2-cond. phone jack at each end. Shielded.	2.50
333	N	Phone jack input to special 2-cond. plug for American Geloso recorders.	2.60	362	—	Same as above, but 3-cond. phone jack at each end.	3.00
334A	P	Phono jack input to female mike connector output. Shielded.	1.60	363	HH	Coupler. 2-cond. phone plug at each end. Shielded.	2.25
334B	—	Same as above, but phono jack input to male mike connector output. Shielded.	1.45	364A	JJ	2-cond. "Tini-Jax" 9/64" dia. sleeve, to 2-cond. 1/4" O.D. phone plug. Shielded.	1.75
335	R	2-cond. input has Switchcraft 2501MP to output connector Cannon XL-3-11.	3.50	365	KK	2-cond. "Tini-Jax" (as above) input to phono jack output. Shielded.	1.75
				368	LL	Input volume control. Phono jack input to a 2-cond. phone plug output. Shielded.	4.95

TRIMM / INC.

A SELECTED LISTING FROM OVER 2500 TRIMM-MANUFACTURED COMPONENTS.

PLUGS AND JACKS: General Purpose Audio, Miniature, Adapters

"511" and "513" STANDARD PHONE PLUGS

General purpose. To fit standard 0.250" I.D. jacks. "511" two-conductor plugs have screw terminals and ribbed bakelite or knurled metal shell. The "513" three-conductor plugs use an identical shell, but the terminals are solder lug type only. All metal parts are bright plated brass. Stay cord anchorage is provided.

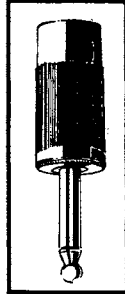

Two-Circuit Type		Three-Circuit Type	
511	Black plastic shell	513	Black plastic shell
	\$0.80		\$1.10
511-1	Red plastic shell	513-1	Red plastic shell
	0.80		1.10
511-2	Metal one piece shell	513-2	Metal, one piece shell
	1.35		1.70
511-3	Metal two piece shell (With cable clamp)	513-3	Metal, two piece shell (With cable clamp)
	1.85		2.20
511-4	Metal stubby shell	513-4	Metal stubby shell
	1.00		1.45
511-5	Metal stubby. Has long tip to sleeve insulator which leaves "ring" spring open when inserted in 3-ckt. jack.	515	Adapter. Couples Amphenol mike plug to standard jacks.
	1.25		0.55

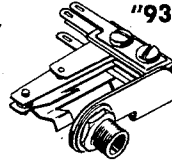
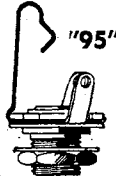

"93" and "95" JACKS

Threaded bushing 3/8" in diameter mounts jack to panel or chassis. Ideal for limited space and depth. The "95" is only 1/8" deep behind panel. The "93" is offset to one side. Nickel silver springs, tinned terminals. Jack circuits described below.

95-01	Open ckt., two conductor	\$0.45	93-01	\$0.70
95-02	Closed ckt., two conductor	0.50	93-02	0.90
95-25	Open ckt., three conductor (0.250" dia. plugs)	0.60	93-06	1.05
95-50	Open ckt., three conductor (0.206" dia. plugs)	0.70	93-07	1.20
			93-25	0.90
			93-26	1.20
			93-27	1.30

TELEPHONE TYPE PLUGS

"516" and "517" PLUGS

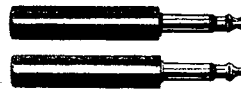

The three circuit 516 has been the accepted standard for telephone switchboards, instrument systems, and in other communication areas. Supplied on TRIMM 851 series patch cords. Red, black or green shell which can be attached without removing cord. Interchangeable with WE 310. The three-circuit 517 plugs are identical with 516 types, but with a special tip contour that reduces "clicks" in service.

Net Prices

516	Red	\$1.50	517	Red	\$1.70	516-10	Red, marked PJ-051	\$1.60
516-1	Black	1.50	517	Black	1.70	516-11	Black, marked PJ-051B	1.60

"506" TWIN 3-CKT. PLUG



A broadcast standard now widely used in instrumentation and missile control. Supplied on 840 patch cords. Electrically common plug shafts spaced 5/8" C to C. Self aligning. Bakelite shell notched on one edge to indicate polarization. Interchangeable with WE 241 and MIL PJ-241.

506	Black	\$2.60	Net
506-1	Red	\$2.60	Net

"512" FLAT PLUG

Compact, non protruding. Adapts phone pin tips, or any two conductors, to a two-circuit plug. One piece molded phenolic plastic. Fits standard jacks 0.250" I.D.

512	Black	\$1.10	512-2	With headset hanger	\$1.60
512	Red	1.10			

"514" MIN-A-PLUG

Small size for use with shielded microphone cable. Two conductor types, plastic or metal shell. Shield connection clamp.

TWO CONDUCTOR TYPES (0.250" dia.) SOLDER TERMINALS

	List		List	
514	Black plastic	514-2	Shielded \$1.15	
514-1	Red plastic	0.80	514-4	Shielded, stubby 0.90

"518" PLUG — "562" JACK

Two circuit miniature disconnect plug and jack. Unshielded. Parallel pin plug locks into jack springs. No. 518 and 562 acetate shells are cemented together. No. 518-7 and 562-7 bakelite shells are held together with screws. No. 518-8 plug set is polarized (one male and one female terminal per plug).

518	Plug	\$0.80	518-7	Plug	\$1.10	518-8	\$1.20
562	Jack	1.00	562-7	Jack	1.35		



No. 562 No. 518

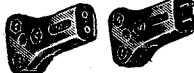

No. 562-7 No. 518-7

"525" CONNECTOR

Adapts headset cords, or any two wires, to single contact microphone plugs — such as Amphenol 75MC series. Same shell as No. 511.

525	Black Plastic	\$1.60
525-1	Red Plastic	1.60
525-2	Shielded one piece shell	2.00
525-3	Shielded, two piece shell (With cable clamp)	2.50
525-4	Shielded stubby shell	1.80

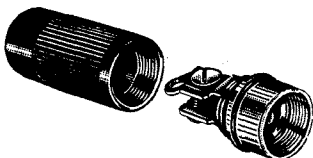

"536" - "537" MINIATURE PLUGS

Used with "94" series jacks and "866"- "867" patch cords. Both two-circuit 536 and three-circuit 537 have molded in place insulation and screw terminals. Contact your distributor for miniature line prices.

536	Black
536-1	Red

537	Black
537-1	Red

"500" and "501" (PJ-055) TWO-CIRCUIT PLUGS

The 500 telephone plug — long the two-circuit switchboard standard, has been replaced, for the most part, by the slightly shorter 501. The 501 has been widely used on high quality military communication equipment. Commonly referred to as PJ-055. Black or Red plastic shell or nickel plated brass for shielded types.

Net Prices

501	Black	\$0.72	501-10	Black, marked PJ-055B	\$0.76
501-1	Red	.72	501-11	Red, marked PJ-055R	.76
501-2	Metal shell	1.00	501-12	Metal, marked PJ-055M	1.00
500	Red	.90	500-10	Red, marked PJ-047R	.95
500-1	Black	.90	500-11	Black, marked PJ-047B	.95

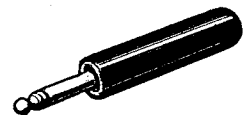

TRIMM / INC.

A SELECTED LISTING FROM OVER 2500
TRIMM - MANUFACTURED COMPONENTS.

COAXIAL JACKS, PLUGS AND PANELS: Video Patch Cords, Hybrid Audio/Visual

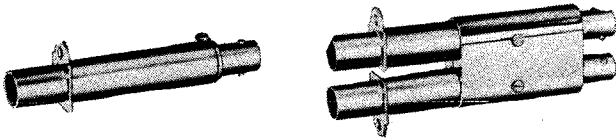

COAXIAL JACKS: "89" SERIES

Developed for a wide range of RF applications including video frequencies, carrier and UHF frequencies. Triple layer plating of silver, palladium and hard gold on female contact assures extremely low contact resistance and long wear.

	Net		Net
SINGLE JACKS			
89-01 RG 58 Cable	\$ 6.20	89-32 Female BNC fitting	\$ 6.80
89-02 RG 59 Cable	6.20	89-33 Female C fitting	16.00
89-04 RG 62 Cable	6.20	89-715 (*)	5.25
89-05 RG 11 Cable	6.20	89-731 (*) Fem. UHF fitting	20.00
89-06 RG 8, 9 Cable	6.25	89-732 (*) Fem. BNC fitting	6.80
89-07 RG 54 (Also fits WE 724, Belden 8281. Jack similar to WE 477B.)	6.20	89-733 (*) Fem. C fitting	16.00
89-08 RG 54 Cable Jack similar to WE 477C	10.00	(*) RCA Compatible, otherwise WE	
89-09 RG 2-59. Paralleling 2-RG-59	6.50	TWIN TYPES, Non-Switching	
89-11 RG 187	\$ 6.20	89-51 RG 58 Cable	13.00
89-12 RG 11, 13	6.50	89-52 RG 59 Cable	13.00
89-14 Amphenol 2-597	6.20	89-57 RG 54, WE 724, Belden 8281. Equiv. WE 465C	13.50
89-15 Equiv. to WE 470B	5.00	89-82S Single BNC at rear for paralleling	15.00
89-31 Female UHF fitting	20.00	TWIN TYPES, Switching	
		89-132 Double BNC rear	18.00
		89-1010 Single BNC plus turret terminal	17.00
		89-1011 Double turret terminal at rear	16.50

COAXIAL PLUGS: "530" SERIES

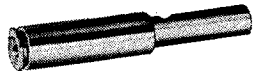

For use with "89" series jacks. Assembled on cords to form "849" series patch cords. Silver and hard gold plated contact pin assures minimum resistance and long wear.

Part No.	Cable	Notes	Net
530-1	RG-58		4.80
530-2	RG-59		4.80
530-4	RG-62		4.80
530-5	RG-11		5.40
*530-6	{ RG-54 Belden 8281 W.E. 724	Equiv. to W.E. 358A	4.00
530-7	RG-8 & 9		5.40
*530-9	RG-59	Similar to W.E. 337C	15.00
530-10	RG-55		5.40
*530-15	RG-58 & 59		4.20
530-15RG-58			4.80
530-16RG-59			4.80
*530-32A	N/A	{ Mates with male BNC connection at rear end	6.00
†530-701	RG-58		4.80
†530-702	RG-59		4.80
†530-705	RG-11 & 13		5.40

†Compatible with RCA; other types W.E.

COAXIAL BRIDGING PLUG: "531"

A twin coaxial plug (sometimes called a looping plug). Internally wired to connect two adjacent coaxial jacks spaced 5/8" C to C. Two plugs essentially similar to "530" series mounted in a plastic handle-like shell.

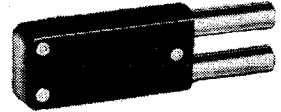

Part No.	Imp.	Notes	Net	Part No.	Imp.	Net
531-1	52 ohm	Compatible	\$6.80	531-702	75 ohm	\$6.80
531-2	75 ohm	with and	6.80	531-7	75 ohm	29.00
531-3	90 ohm	Equiv. to	6.80	531-707	75 ohm	29.00
531-701	50 ohm	W.E. 477B	6.80			

COAXIAL PATCH CORDS: "849"

The following cords use two, 530-2 (for WE), or two 530-702 (for RCA), plugs and RG59/U cable (75 ohm).

	W.E.	Net	RCA	Net
849-05X-PPG	\$ 9.60		849-1X-700PPG	\$ 9.60
849-1X-PPG	9.60		849-105X-700PPG	9.60
849-105X-PPG	9.60		849-2X-700PPG	9.80
849-2X-PPG	9.80		849-3X-700PPG	10.00
849-3X-PPG	10.00			
849-4X-PPG	10.20			

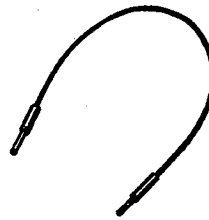

The following cords, as above, but with RG-58C/U cable (50 ohm).

	W.E.	Net	RCA	Net
84-1X58-PPG	\$ 9.60		849-1X58-700PPG	\$ 9.60
849-105X58-PPG	9.60		849-105X58-700PPG	9.60
849-2X58-PPG	9.80		849-2X58-700PPG	10.20
849-3X58-PPG	10.00		849-3X58-700PPG	10.00

HYBRID PATCH CORDS: "869" SERIES

Audio and Video patch cord. Twin plug contains a coax and a three-circuit telephone plug. On 5/8" centers. Will fit combination panels with "89" series coaxial jacks and "90" series telephone jacks. 75 ohm cable on section (RG-187) and audio is carried by two additional conductors with shield overall (but not common to coax shield).

	Net
869-1X-PPG	\$30.00
869-105X-PPG	30.00
869-2X-PPG	30.00

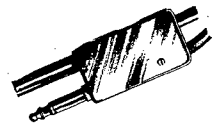

COAXIAL JACK PANEL ASSEMBLIES

The "89" series coaxial jacks can be mounted on the "96" or "99" series strips in almost any specified configuration. Listed below are some of the more standard types already produced. Consult factory for information regarding price or your special requirements.

W.E.	RCA	Qty/Row	Rows	Jack Type	Jack Mtg. Strip
99-80		12	1	89-32	99-20
	99-780	12	1	89-732	99-20
98-84		24	2	89-02	96-24
	96-784	24	2	89-702	96-24
*96-94-2		24	2	89-02	96-524-2
	*96-794-2	24	2	89-702	96-524-2
96-85		12	2	89-02	96-25
	96-785	12	2	89-702	96-25
*96-95-2		12	2	89-02	96-525-2
	*96-795-2	12	2	89-702	96-525-2
*96-98-2		Top 24	2	89-02	96-528-2
		Bottom 12			
	*96-798-2	Top 24	2	89-702	96-528-2
		Bottom 12			

*Denotes sub-chassis with 24 UHF connectors.



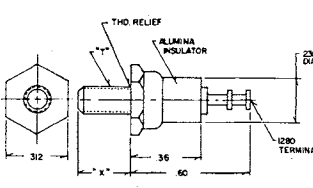
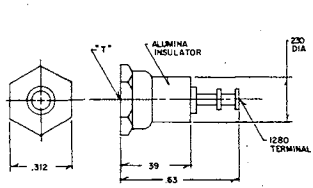
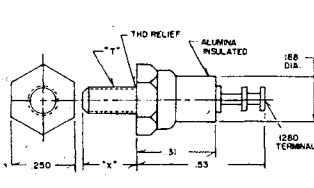
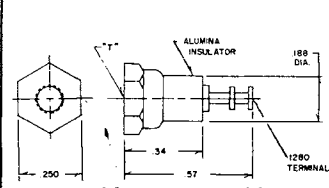
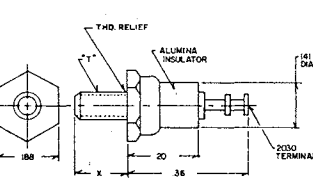
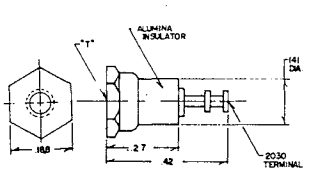
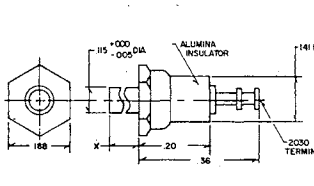
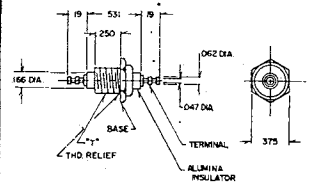

STANDARDIZED ELECTRONIC HARDWARE
LITTON INDUSTRIES/USECO DIVISION

INSULATED TERMINALS • Hi-Alumina

 <p>Part No. 1460</p> <p>VOLTAGE BREAKDOWN: 3000 VOLTS A.C. RESISTANCE (TERMINAL TO BASE) (10)¹² OHMS.</p>	 <p>Part No. 1461</p> <p>VOLTAGE BREAKDOWN: 3000 VOLTS A.C. RESISTANCE (TERMINAL TO BASE) (10)¹² OHMS.</p>	 <p>Part No. 1440</p> <p>VOLTAGE BREAKDOWN: 1500 VOLTS A.C. RESISTANCE (TERMINAL TO BASE) (10)¹² OHMS.</p>	 <p>Part No. 1441</p> <p>VOLTAGE BREAKDOWN: 1500 VOLTS A.C. RESISTANCE (TERMINAL TO BASE) (10)¹² OHMS.</p>
 <p>Part No. 1480</p> <p>VOLTAGE BREAKDOWN: 1000 VOLTS A.C. RESISTANCE (TERMINAL TO BASE) (10)¹² OHMS.</p>	 <p>Part No. 1481</p> <p>VOLTAGE BREAKDOWN: 1000 VOLTS A.C. RESISTANCE (TERMINAL TO BASE) (10)¹² OHMS.</p>	 <p>Part No. 1482</p> <p>VOLTAGE BREAKDOWN: 1000 VOLTS A.C. RESISTANCE (TERMINAL TO BASE) (10)¹² OHMS.</p>	 <p>Part No. 1483</p> <p>VOLTAGE BREAKDOWN: 2500 VOLTS A.C. RESISTANCE (TERMINAL TO BASE) (10)¹² OHMS.</p>

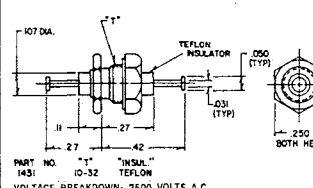
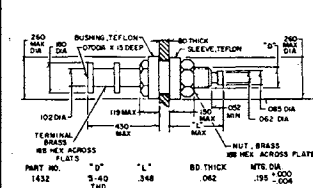
INSULATED TERMINALS • Teflon

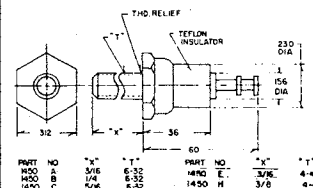
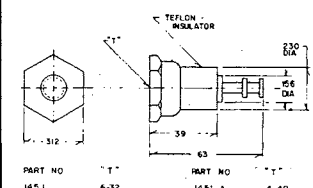
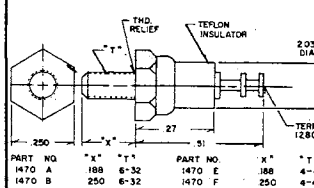
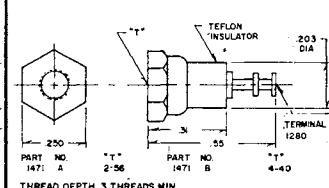
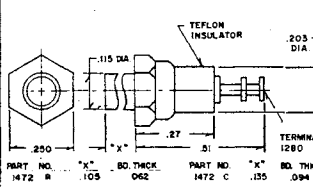
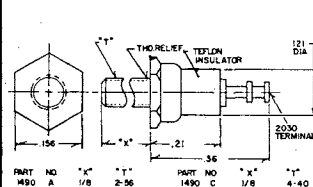
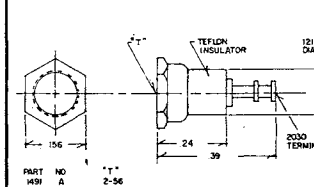
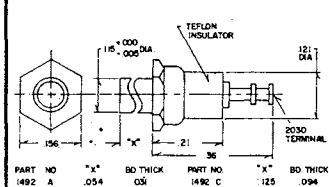
 <p>Part No. 1431</p> <p>VOLTAGE BREAKDOWN: 2500 VOLTS A.C. RESISTANCE (TERMINAL TO BASE) (10)¹² OHMS FOR USE WITH .094 (MAX) THICK MTG BOARD</p>	 <p>Part No. 1432</p> <p>VOLTAGE BREAKDOWN: 1500 VOLTS A.C. RESISTANCE (TERMINAL TO BASE) (10)¹² OHMS.</p>	 <p>Part No. 1451</p> <p>VOLTAGE BREAKDOWN: 2500 VOLTS A.C. RESISTANCE (TERMINAL TO BASE) (10)¹² OHMS.</p>	 <p>Part No. 1471</p> <p>VOLTAGE BREAKDOWN: 2500 VOLTS A.C. RESISTANCE (TERMINAL TO BASE) (10)¹² OHMS.</p>
 <p>Part No. 1450</p> <p>VOLTAGE BREAKDOWN: 5000 VOLTS A.C. RESISTANCE (TERMINAL TO BASE) (10)¹² OHMS.</p>	 <p>Part No. 1470</p> <p>VOLTAGE BREAKDOWN: 2500 VOLTS A.C. RESISTANCE (TERMINAL TO BASE) (10)¹² OHMS.</p>	 <p>Part No. 1491</p> <p>VOLTAGE BREAKDOWN: 2000 VOLTS A.C. RESISTANCE (TERMINAL TO BASE) (10)¹² OHMS.</p>	 <p>Part No. 1492</p> <p>VOLTAGE BREAKDOWN: 2000 VOLTS A.C. RESISTANCE (TERMINAL TO BASE) (10)¹² OHMS.</p>
 <p>Part No. 1472</p> <p>VOLTAGE BREAKDOWN: 2500 VOLTS A.C. RESISTANCE (TERMINAL TO BASE) (10)¹² OHMS.</p>	 <p>Part No. 1490</p> <p>VOLTAGE BREAKDOWN: 2000 VOLTS A.C. RESISTANCE (TERMINAL TO BASE) (10)¹² OHMS.</p>	 <p>Part No. 1491</p> <p>VOLTAGE BREAKDOWN: 2000 VOLTS A.C. RESISTANCE (TERMINAL TO BASE) (10)¹² OHMS.</p>	 <p>Part No. 1492</p> <p>VOLTAGE BREAKDOWN: 2000 VOLTS A.C. RESISTANCE (TERMINAL TO BASE) (10)¹² OHMS.</p>

Plating: Terminal, 0.00010/0.00020 gold over 0.00030/0.00050 silver; Base, 0.00030/0.00050 cadmium

Tolerance: .XX ± .010; .XX ± .016 before plating



SECTION 2100 STANDARDIZED ELECTRONIC HARDWARE LITTON INDUSTRIES/USECO DIVISION

INSULATED TERMINALS • MIL-T-55155

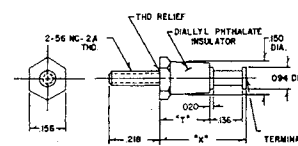
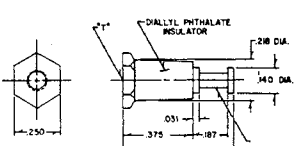
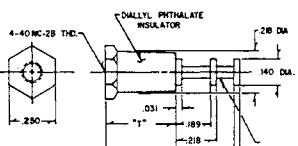
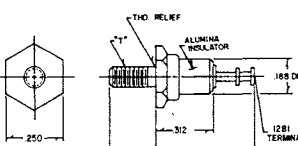
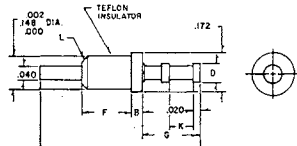
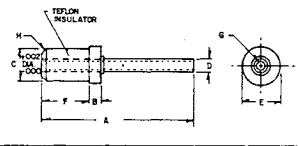
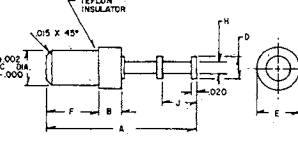
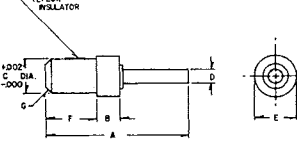
<p>MIL-T-55155 Configurations, materials, platings and specifications conform to requirements of MIL-T-55155. SPECIFICATIONS</p> <p>Terminals Material: Brass 1/2 hard, composition 22, per QQ-B-626 Finish: Standard -4 (0.0005 Solder Plate) Optional at additional cost -10 (0.00003 gold)</p> <p>Bases Material: Brass 1/2 hard, composition 22, per QQ-B-626 Finish: Standard -11.2 (0.0003 Cadmium with iridescent yellow coating) Insulating Materials TEFLON per MIL-M-14077 HI-ALUMINA per MIL-I-10 DIALLYL PHTHALATE per MIL-M-14F Type SDG-F</p>	 <p style="text-align: center;">PART NO. "1" "2" PART NO. "1" "2" 4550 A .219 .375 4550 B .375 .532</p> <p style="text-align: center;">MIL-T-55155/18-1 & 2 USECO Part No. 4550</p>	 <p style="text-align: center;">PART NO. "1" 4551 4-40</p> <p style="text-align: center;">MIL-T-55155/19-1 USECO Part No. 4551</p>																																																													
 <p style="text-align: center;">PART NO. "1" "2" PART NO. "1" "2" 4552 A .375 .718 4552 B .394 .937</p> <p style="text-align: center;">MIL-T-55155/20-1 & 2 USECO Part No. 4552</p>	 <p style="text-align: center;">PART NO. "1" "2" PART NO. "1" "2" 4553 A .250 4-40 4553 B .375 4-40</p> <p style="text-align: center;">MIL-T-55155/21-1 & 2 USECO Part No. 4553</p>	 <table border="1" style="width: 100%; text-align: center; font-size: small;"> <tr><th>LTR</th><th>A</th><th>B</th><th>D</th><th>F</th><th>G</th><th>K</th><th>L</th></tr> <tr><td>A</td><td>.500</td><td>.040</td><td>.080</td><td>.100</td><td>.210</td><td>.100</td><td>.015 X .45"</td></tr> <tr><td>B</td><td>.856</td><td>.125</td><td>.093</td><td>.230</td><td>.290</td><td>.295</td><td>.052 X .45"</td></tr> </table> <p style="text-align: center;">MIL-T-55155/4-1 & 2 USECO Part No. 4550</p>	LTR	A	B	D	F	G	K	L	A	.500	.040	.080	.100	.210	.100	.015 X .45"	B	.856	.125	.093	.230	.290	.295	.052 X .45"																																					
LTR	A	B	D	F	G	K	L																																																								
A	.500	.040	.080	.100	.210	.100	.015 X .45"																																																								
B	.856	.125	.093	.230	.290	.295	.052 X .45"																																																								
 <table border="1" style="width: 100%; text-align: center; font-size: small;"> <tr><th>LTR</th><th>A</th><th>B</th><th>C</th><th>D</th><th>E</th><th>F</th><th>G</th><th>H</th></tr> <tr><td>A</td><td>.225</td><td>.040</td><td>.093</td><td>.040</td><td>.125</td><td>.060</td><td>.030</td><td>.010 X .45"</td></tr> </table> <p style="text-align: center;">MIL-T-55155/21-1 & 2-3 USECO Part No. 4502</p>	LTR	A	B	C	D	E	F	G	H	A	.225	.040	.093	.040	.125	.060	.030	.010 X .45"	 <table border="1" style="width: 100%; text-align: center; font-size: small;"> <tr><th>LTR</th><th>A</th><th>B</th><th>C</th><th>D</th><th>E</th><th>F</th><th>N</th><th>J</th></tr> <tr><td>A</td><td>.359</td><td>.040</td><td>.148</td><td>.080</td><td>.172</td><td>.110</td><td>.040</td><td>.120</td></tr> <tr><td>B</td><td>.421</td><td>.125</td><td>.165</td><td>.093</td><td>.187</td><td>.190</td><td>.045</td><td>.068</td></tr> </table> <p style="text-align: center;">MIL-T-55155/7-1 & 2 USECO Part No. 4504</p>	LTR	A	B	C	D	E	F	N	J	A	.359	.040	.148	.080	.172	.110	.040	.120	B	.421	.125	.165	.093	.187	.190	.045	.068	 <table border="1" style="width: 100%; text-align: center; font-size: small;"> <tr><th>LTR</th><th>A</th><th>B</th><th>C</th><th>D</th><th>E</th><th>F</th><th>G</th></tr> <tr><td>A</td><td>.350</td><td>.040</td><td>.148</td><td>.040</td><td>.172</td><td>.100</td><td>.015 X .45"</td></tr> </table> <p style="text-align: center;">MIL-T-55155/B-1 USECO Part No. 4505</p>	LTR	A	B	C	D	E	F	G	A	.350	.040	.148	.040	.172	.100	.015 X .45"
LTR	A	B	C	D	E	F	G	H																																																							
A	.225	.040	.093	.040	.125	.060	.030	.010 X .45"																																																							
LTR	A	B	C	D	E	F	N	J																																																							
A	.359	.040	.148	.080	.172	.110	.040	.120																																																							
B	.421	.125	.165	.093	.187	.190	.045	.068																																																							
LTR	A	B	C	D	E	F	G																																																								
A	.350	.040	.148	.040	.172	.100	.015 X .45"																																																								

LOC-FIT® TERMINALS

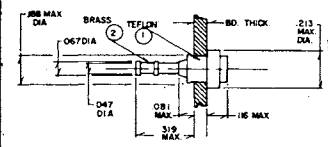
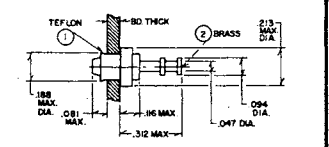
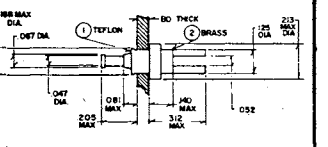
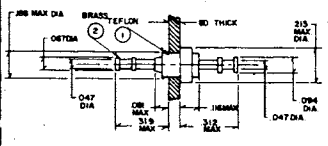
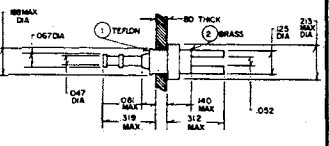
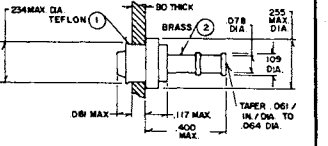
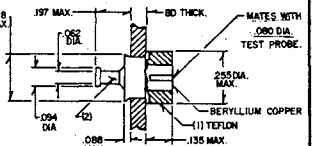
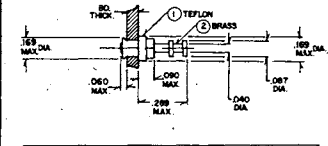
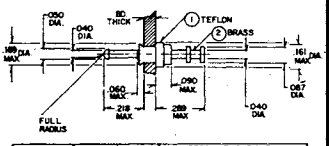
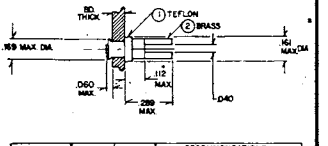
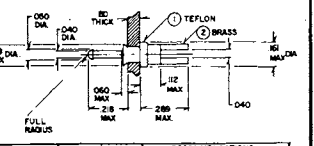
 <table border="1" style="width: 100%; text-align: center; font-size: x-small;"> <tr><th>ORDER BY PART NO.</th><th>D</th><th>NOM.</th><th>L</th><th>NOM.</th><th>RECOMMENDATIONS</th></tr> <tr><td>4430 A</td><td>.125</td><td>.001</td><td>.003</td><td>.003</td><td>SWAGE BRASS</td></tr> <tr><td>4430 B</td><td>.125</td><td>.001</td><td>.003</td><td>.003</td><td>SWAGE BRASS</td></tr> <tr><td>4430 C</td><td>.125</td><td>.001</td><td>.003</td><td>.003</td><td>SWAGE BRASS</td></tr> </table> <p style="text-align: center;">Part No. 4430</p>	ORDER BY PART NO.	D	NOM.	L	NOM.	RECOMMENDATIONS	4430 A	.125	.001	.003	.003	SWAGE BRASS	4430 B	.125	.001	.003	.003	SWAGE BRASS	4430 C	.125	.001	.003	.003	SWAGE BRASS	 <table border="1" style="width: 100%; text-align: center; font-size: x-small;"> <tr><th>ORDER BY PART NO.</th><th>D</th><th>NOM.</th><th>L</th><th>NOM.</th><th>RECOMMENDATIONS</th></tr> <tr><td>4440 A</td><td>.142</td><td>.001</td><td>.003</td><td>.003</td><td>SWAGE BRASS</td></tr> <tr><td>4440 B</td><td>.142</td><td>.001</td><td>.003</td><td>.003</td><td>SWAGE BRASS</td></tr> <tr><td>4440 C</td><td>.142</td><td>.001</td><td>.003</td><td>.003</td><td>SWAGE BRASS</td></tr> </table> <p style="text-align: center;">Part No. 4440</p>	ORDER BY PART NO.	D	NOM.	L	NOM.	RECOMMENDATIONS	4440 A	.142	.001	.003	.003	SWAGE BRASS	4440 B	.142	.001	.003	.003	SWAGE BRASS	4440 C	.142	.001	.003	.003	SWAGE BRASS	 <table border="1" style="width: 100%; text-align: center; font-size: x-small;"> <tr><th>ORDER BY PART NO.</th><th>D</th><th>NOM.</th><th>L</th><th>NOM.</th><th>RECOMMENDATIONS</th></tr> <tr><td>4444 A</td><td>.142</td><td>.001</td><td>.003</td><td>.003</td><td>SWAGE BRASS</td></tr> <tr><td>4444 B</td><td>.142</td><td>.001</td><td>.003</td><td>.003</td><td>SWAGE BRASS</td></tr> <tr><td>4444 C</td><td>.142</td><td>.001</td><td>.003</td><td>.003</td><td>SWAGE BRASS</td></tr> </table> <p style="text-align: center;">Part No. 4444</p>	ORDER BY PART NO.	D	NOM.	L	NOM.	RECOMMENDATIONS	4444 A	.142	.001	.003	.003	SWAGE BRASS	4444 B	.142	.001	.003	.003	SWAGE BRASS	4444 C	.142	.001	.003	.003	SWAGE BRASS																									
ORDER BY PART NO.	D	NOM.	L	NOM.	RECOMMENDATIONS																																																																																														
4430 A	.125	.001	.003	.003	SWAGE BRASS																																																																																														
4430 B	.125	.001	.003	.003	SWAGE BRASS																																																																																														
4430 C	.125	.001	.003	.003	SWAGE BRASS																																																																																														
ORDER BY PART NO.	D	NOM.	L	NOM.	RECOMMENDATIONS																																																																																														
4440 A	.142	.001	.003	.003	SWAGE BRASS																																																																																														
4440 B	.142	.001	.003	.003	SWAGE BRASS																																																																																														
4440 C	.142	.001	.003	.003	SWAGE BRASS																																																																																														
ORDER BY PART NO.	D	NOM.	L	NOM.	RECOMMENDATIONS																																																																																														
4444 A	.142	.001	.003	.003	SWAGE BRASS																																																																																														
4444 B	.142	.001	.003	.003	SWAGE BRASS																																																																																														
4444 C	.142	.001	.003	.003	SWAGE BRASS																																																																																														
 <table border="1" style="width: 100%; text-align: center; font-size: x-small;"> <tr><th>ORDER BY PART NO.</th><th>D</th><th>NOM.</th><th>L</th><th>NOM.</th><th>RECOMMENDATIONS</th></tr> <tr><td>4442 A</td><td>.142</td><td>.001</td><td>.003</td><td>.003</td><td>SWAGE BRASS</td></tr> <tr><td>4442 B</td><td>.142</td><td>.001</td><td>.003</td><td>.003</td><td>SWAGE BRASS</td></tr> <tr><td>4442 C</td><td>.142</td><td>.001</td><td>.003</td><td>.003</td><td>SWAGE BRASS</td></tr> </table> <p style="text-align: center;">Part No. 4442</p>	ORDER BY PART NO.	D	NOM.	L	NOM.	RECOMMENDATIONS	4442 A	.142	.001	.003	.003	SWAGE BRASS	4442 B	.142	.001	.003	.003	SWAGE BRASS	4442 C	.142	.001	.003	.003	SWAGE BRASS	 <table border="1" style="width: 100%; text-align: center; font-size: x-small;"> <tr><th>ORDER BY PART NO.</th><th>D</th><th>NOM.</th><th>L</th><th>NOM.</th><th>RECOMMENDATIONS</th></tr> <tr><td>4445 A</td><td>.142</td><td>.001</td><td>.003</td><td>.003</td><td>SWAGE BRASS</td></tr> <tr><td>4445 B</td><td>.142</td><td>.001</td><td>.003</td><td>.003</td><td>SWAGE BRASS</td></tr> <tr><td>4445 C</td><td>.142</td><td>.001</td><td>.003</td><td>.003</td><td>SWAGE BRASS</td></tr> </table> <p style="text-align: center;">Part No. 4445</p>	ORDER BY PART NO.	D	NOM.	L	NOM.	RECOMMENDATIONS	4445 A	.142	.001	.003	.003	SWAGE BRASS	4445 B	.142	.001	.003	.003	SWAGE BRASS	4445 C	.142	.001	.003	.003	SWAGE BRASS	 <table border="1" style="width: 100%; text-align: center; font-size: x-small;"> <tr><th>ORDER BY PART NO.</th><th>D</th><th>NOM.</th><th>L</th><th>NOM.</th><th>RECOMMENDATIONS</th></tr> <tr><td>4447 A</td><td>.142</td><td>.001</td><td>.003</td><td>.003</td><td>SWAGE BRASS</td></tr> <tr><td>4447 B</td><td>.142</td><td>.001</td><td>.003</td><td>.003</td><td>SWAGE BRASS</td></tr> <tr><td>4447 C</td><td>.142</td><td>.001</td><td>.003</td><td>.003</td><td>SWAGE BRASS</td></tr> </table> <p style="text-align: center;">Part No. 4447</p>	ORDER BY PART NO.	D	NOM.	L	NOM.	RECOMMENDATIONS	4447 A	.142	.001	.003	.003	SWAGE BRASS	4447 B	.142	.001	.003	.003	SWAGE BRASS	4447 C	.142	.001	.003	.003	SWAGE BRASS	 <table border="1" style="width: 100%; text-align: center; font-size: x-small;"> <tr><th>ORDER BY PART NO.</th><th>D</th><th>NOM.</th><th>L</th><th>NOM.</th><th>RECOMMENDATIONS</th></tr> <tr><td>4451 A</td><td>.142</td><td>.001</td><td>.003</td><td>.003</td><td>SWAGE BRASS</td></tr> <tr><td>4451 B</td><td>.142</td><td>.001</td><td>.003</td><td>.003</td><td>SWAGE BRASS</td></tr> <tr><td>4451 C</td><td>.142</td><td>.001</td><td>.003</td><td>.003</td><td>SWAGE BRASS</td></tr> </table> <p style="text-align: center;">Part No. 4451</p>	ORDER BY PART NO.	D	NOM.	L	NOM.	RECOMMENDATIONS	4451 A	.142	.001	.003	.003	SWAGE BRASS	4451 B	.142	.001	.003	.003	SWAGE BRASS	4451 C	.142	.001	.003	.003	SWAGE BRASS
ORDER BY PART NO.	D	NOM.	L	NOM.	RECOMMENDATIONS																																																																																														
4442 A	.142	.001	.003	.003	SWAGE BRASS																																																																																														
4442 B	.142	.001	.003	.003	SWAGE BRASS																																																																																														
4442 C	.142	.001	.003	.003	SWAGE BRASS																																																																																														
ORDER BY PART NO.	D	NOM.	L	NOM.	RECOMMENDATIONS																																																																																														
4445 A	.142	.001	.003	.003	SWAGE BRASS																																																																																														
4445 B	.142	.001	.003	.003	SWAGE BRASS																																																																																														
4445 C	.142	.001	.003	.003	SWAGE BRASS																																																																																														
ORDER BY PART NO.	D	NOM.	L	NOM.	RECOMMENDATIONS																																																																																														
4447 A	.142	.001	.003	.003	SWAGE BRASS																																																																																														
4447 B	.142	.001	.003	.003	SWAGE BRASS																																																																																														
4447 C	.142	.001	.003	.003	SWAGE BRASS																																																																																														
ORDER BY PART NO.	D	NOM.	L	NOM.	RECOMMENDATIONS																																																																																														
4451 A	.142	.001	.003	.003	SWAGE BRASS																																																																																														
4451 B	.142	.001	.003	.003	SWAGE BRASS																																																																																														
4451 C	.142	.001	.003	.003	SWAGE BRASS																																																																																														
 <table border="1" style="width: 100%; text-align: center; font-size: x-small;"> <tr><th>ORDER BY PART NO.</th><th>D</th><th>NOM.</th><th>L</th><th>NOM.</th><th>RECOMMENDATIONS</th></tr> <tr><td>4482 A</td><td>.125</td><td>.001</td><td>.003</td><td>.003</td><td>SWAGE BRASS</td></tr> <tr><td>4482 B</td><td>.125</td><td>.001</td><td>.003</td><td>.003</td><td>SWAGE BRASS</td></tr> </table> <p style="text-align: center;">Part No. 4482</p>	ORDER BY PART NO.	D	NOM.	L	NOM.	RECOMMENDATIONS	4482 A	.125	.001	.003	.003	SWAGE BRASS	4482 B	.125	.001	.003	.003	SWAGE BRASS	 <table border="1" style="width: 100%; text-align: center; font-size: x-small;"> <tr><th>ORDER BY PART NO.</th><th>D</th><th>NOM.</th><th>L</th><th>NOM.</th><th>RECOMMENDATIONS</th></tr> <tr><td>4487 A</td><td>.126</td><td>.001</td><td>.003</td><td>.003</td><td>SWAGE BRASS</td></tr> <tr><td>4487 B</td><td>.126</td><td>.001</td><td>.003</td><td>.003</td><td>SWAGE BRASS</td></tr> </table> <p style="text-align: center;">Part No. 4487</p>	ORDER BY PART NO.	D	NOM.	L	NOM.	RECOMMENDATIONS	4487 A	.126	.001	.003	.003	SWAGE BRASS	4487 B	.126	.001	.003	.003	SWAGE BRASS	 <table border="1" style="width: 100%; text-align: center; font-size: x-small;"> <tr><th>ORDER BY PART NO.</th><th>D</th><th>NOM.</th><th>L</th><th>NOM.</th><th>RECOMMENDATIONS</th></tr> <tr><td>4484 A</td><td>.126</td><td>.001</td><td>.003</td><td>.003</td><td>SWAGE BRASS</td></tr> <tr><td>4484 B</td><td>.126</td><td>.001</td><td>.003</td><td>.003</td><td>SWAGE BRASS</td></tr> </table> <p style="text-align: center;">Part No. 4484</p>	ORDER BY PART NO.	D	NOM.	L	NOM.	RECOMMENDATIONS	4484 A	.126	.001	.003	.003	SWAGE BRASS	4484 B	.126	.001	.003	.003	SWAGE BRASS	 <table border="1" style="width: 100%; text-align: center; font-size: x-small;"> <tr><th>ORDER BY PART NO.</th><th>D</th><th>NOM.</th><th>L</th><th>NOM.</th><th>RECOMMENDATIONS</th></tr> <tr><td>4489 A</td><td>.126</td><td>.001</td><td>.003</td><td>.003</td><td>SWAGE BRASS</td></tr> <tr><td>4489 B</td><td>.126</td><td>.001</td><td>.003</td><td>.003</td><td>SWAGE BRASS</td></tr> </table> <p style="text-align: center;">Part No. 4489</p>	ORDER BY PART NO.	D	NOM.	L	NOM.	RECOMMENDATIONS	4489 A	.126	.001	.003	.003	SWAGE BRASS	4489 B	.126	.001	.003	.003	SWAGE BRASS																								
ORDER BY PART NO.	D	NOM.	L	NOM.	RECOMMENDATIONS																																																																																														
4482 A	.125	.001	.003	.003	SWAGE BRASS																																																																																														
4482 B	.125	.001	.003	.003	SWAGE BRASS																																																																																														
ORDER BY PART NO.	D	NOM.	L	NOM.	RECOMMENDATIONS																																																																																														
4487 A	.126	.001	.003	.003	SWAGE BRASS																																																																																														
4487 B	.126	.001	.003	.003	SWAGE BRASS																																																																																														
ORDER BY PART NO.	D	NOM.	L	NOM.	RECOMMENDATIONS																																																																																														
4484 A	.126	.001	.003	.003	SWAGE BRASS																																																																																														
4484 B	.126	.001	.003	.003	SWAGE BRASS																																																																																														
ORDER BY PART NO.	D	NOM.	L	NOM.	RECOMMENDATIONS																																																																																														
4489 A	.126	.001	.003	.003	SWAGE BRASS																																																																																														
4489 B	.126	.001	.003	.003	SWAGE BRASS																																																																																														

Loc Fit Specifications — Plating: 0.00010/0.00020 gold over 0.00030/0.00050 silver
Tolerance: .XXX ± .010 .XX ± .016 before plating



SECTION 2100

STANDARDIZED ELECTRONIC HARDWARE

LITTON INDUSTRIES/USECO DIVISION

TERMINALS

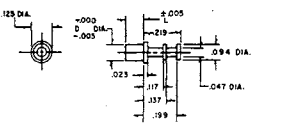
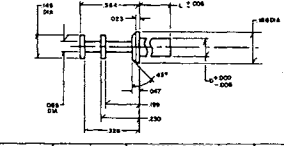
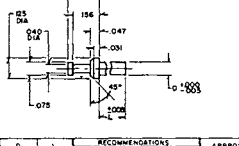
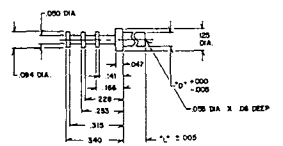
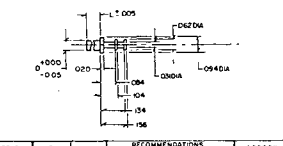
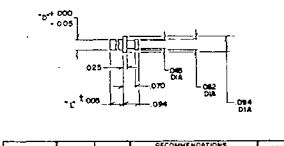
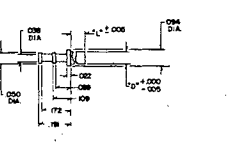
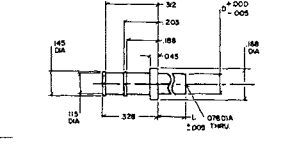
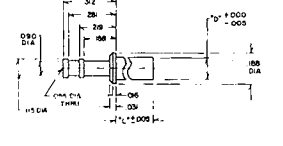
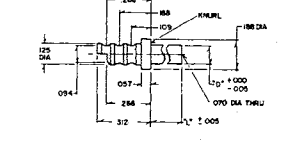
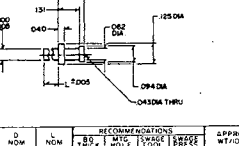
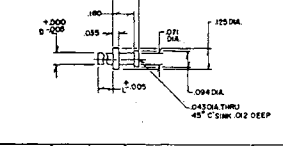
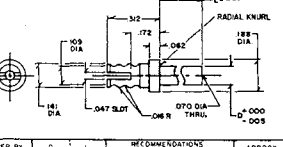
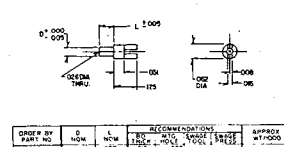
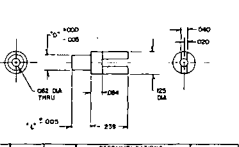
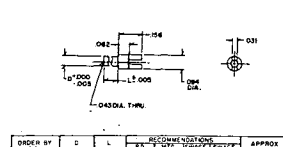
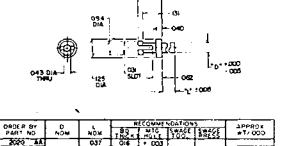
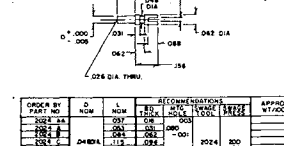
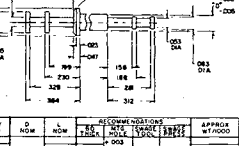
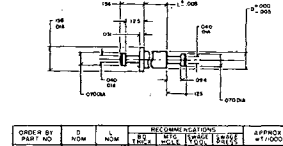
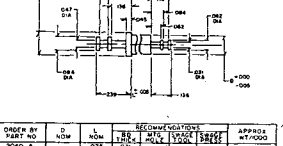
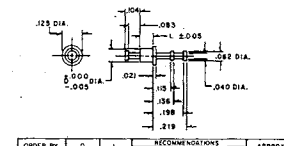
 <table border="1" style="width: 100%; border-collapse: collapse; margin-top: 10px;"> <thead> <tr> <th>ORDER BY PART NO.</th> <th>D</th> <th>L</th> <th>RECOMMENDATIONS</th> <th>APPROX WT/1000</th> </tr> <tr> <th></th> <th>NOM</th> <th>NOM</th> <th>ST. MTC. TYPICAL</th> <th></th> </tr> </thead> <tbody> <tr> <td>1281 A</td> <td>.023</td> <td>.023</td> <td>.003</td> <td>1.8</td> </tr> <tr> <td>1281 B</td> <td>.023</td> <td>.023</td> <td>.003</td> <td>1.8</td> </tr> <tr> <td>1281 C</td> <td>.023</td> <td>.023</td> <td>.003</td> <td>1.8</td> </tr> <tr> <td>1281 D</td> <td>.023</td> <td>.023</td> <td>.003</td> <td>1.8</td> </tr> </tbody> </table> <p style="text-align: center;">Part No. 1281</p>	ORDER BY PART NO.	D	L	RECOMMENDATIONS	APPROX WT/1000		NOM	NOM	ST. MTC. TYPICAL		1281 A	.023	.023	.003	1.8	1281 B	.023	.023	.003	1.8	1281 C	.023	.023	.003	1.8	1281 D	.023	.023	.003	1.8	 <table border="1" style="width: 100%; border-collapse: collapse; margin-top: 10px;"> <thead> <tr> <th>ORDER BY PART NO.</th> <th>D</th> <th>L</th> <th>RECOMMENDATIONS</th> <th>APPROX WT/1000</th> </tr> <tr> <th></th> <th>NOM</th> <th>NOM</th> <th>ST. MTC. TYPICAL</th> <th></th> </tr> </thead> <tbody> <tr> <td>1300 A</td> <td>.023</td> <td>.023</td> <td>.003</td> <td>1.8</td> </tr> <tr> <td>1300 B</td> <td>.023</td> <td>.023</td> <td>.003</td> <td>1.8</td> </tr> <tr> <td>1300 C</td> <td>.023</td> <td>.023</td> <td>.003</td> <td>1.8</td> </tr> <tr> <td>1300 D</td> <td>.023</td> <td>.023</td> <td>.003</td> <td>1.8</td> </tr> </tbody> </table> <p style="text-align: center;">Part No. 1300</p>	ORDER BY PART NO.	D	L	RECOMMENDATIONS	APPROX WT/1000		NOM	NOM	ST. MTC. TYPICAL		1300 A	.023	.023	.003	1.8	1300 B	.023	.023	.003	1.8	1300 C	.023	.023	.003	1.8	1300 D	.023	.023	.003	1.8	 <table border="1" style="width: 100%; border-collapse: collapse; margin-top: 10px;"> <thead> <tr> <th>ORDER BY PART NO.</th> <th>D</th> <th>L</th> <th>RECOMMENDATIONS</th> <th>APPROX WT/1000</th> </tr> <tr> <th></th> <th>NOM</th> <th>NOM</th> <th>ST. MTC. TYPICAL</th> <th></th> </tr> </thead> <tbody> <tr> <td>1340 A</td> <td>.023</td> <td>.023</td> <td>.003</td> <td>1.8</td> </tr> <tr> <td>1340 B</td> <td>.023</td> <td>.023</td> <td>.003</td> <td>1.8</td> </tr> <tr> <td>1340 C</td> <td>.023</td> <td>.023</td> <td>.003</td> <td>1.8</td> </tr> <tr> <td>1340 D</td> <td>.023</td> <td>.023</td> <td>.003</td> <td>1.8</td> </tr> </tbody> </table> <p style="text-align: center;">Part No. 1340</p>	ORDER BY PART NO.	D	L	RECOMMENDATIONS	APPROX WT/1000		NOM	NOM	ST. MTC. TYPICAL		1340 A	.023	.023	.003	1.8	1340 B	.023	.023	.003	1.8	1340 C	.023	.023	.003	1.8	1340 D	.023	.023	.003	1.8	 <table border="1" style="width: 100%; border-collapse: collapse; margin-top: 10px;"> <thead> <tr> <th>ORDER BY PART NO.</th> <th>D</th> <th>L</th> <th>RECOMMENDATIONS</th> <th>APPROX WT/1000</th> </tr> <tr> <th></th> <th>NOM</th> <th>NOM</th> <th>ST. MTC. TYPICAL</th> <th></th> </tr> </thead> <tbody> <tr> <td>2035 A</td> <td>.023</td> <td>.023</td> <td>.003</td> <td>1.8</td> </tr> <tr> <td>2035 B</td> <td>.023</td> <td>.023</td> <td>.003</td> <td>1.8</td> </tr> <tr> <td>2035 C</td> <td>.023</td> <td>.023</td> <td>.003</td> <td>1.8</td> </tr> <tr> <td>2035 D</td> <td>.023</td> <td>.023</td> <td>.003</td> <td>1.8</td> </tr> </tbody> </table> <p style="text-align: center;">Part No. 2035</p>	ORDER BY PART NO.	D	L	RECOMMENDATIONS	APPROX WT/1000		NOM	NOM	ST. MTC. TYPICAL		2035 A	.023	.023	.003	1.8	2035 B	.023	.023	.003	1.8	2035 C	.023	.023	.003	1.8	2035 D	.023	.023	.003	1.8
ORDER BY PART NO.	D	L	RECOMMENDATIONS	APPROX WT/1000																																																																																																																							
	NOM	NOM	ST. MTC. TYPICAL																																																																																																																								
1281 A	.023	.023	.003	1.8																																																																																																																							
1281 B	.023	.023	.003	1.8																																																																																																																							
1281 C	.023	.023	.003	1.8																																																																																																																							
1281 D	.023	.023	.003	1.8																																																																																																																							
ORDER BY PART NO.	D	L	RECOMMENDATIONS	APPROX WT/1000																																																																																																																							
	NOM	NOM	ST. MTC. TYPICAL																																																																																																																								
1300 A	.023	.023	.003	1.8																																																																																																																							
1300 B	.023	.023	.003	1.8																																																																																																																							
1300 C	.023	.023	.003	1.8																																																																																																																							
1300 D	.023	.023	.003	1.8																																																																																																																							
ORDER BY PART NO.	D	L	RECOMMENDATIONS	APPROX WT/1000																																																																																																																							
	NOM	NOM	ST. MTC. TYPICAL																																																																																																																								
1340 A	.023	.023	.003	1.8																																																																																																																							
1340 B	.023	.023	.003	1.8																																																																																																																							
1340 C	.023	.023	.003	1.8																																																																																																																							
1340 D	.023	.023	.003	1.8																																																																																																																							
ORDER BY PART NO.	D	L	RECOMMENDATIONS	APPROX WT/1000																																																																																																																							
	NOM	NOM	ST. MTC. TYPICAL																																																																																																																								
2035 A	.023	.023	.003	1.8																																																																																																																							
2035 B	.023	.023	.003	1.8																																																																																																																							
2035 C	.023	.023	.003	1.8																																																																																																																							
2035 D	.023	.023	.003	1.8																																																																																																																							
 <table border="1" style="width: 100%; border-collapse: collapse; margin-top: 10px;"> <thead> <tr> <th>ORDER BY PART NO.</th> <th>D</th> <th>L</th> <th>RECOMMENDATIONS</th> <th>APPROX WT/1000</th> </tr> <tr> <th></th> <th>NOM</th> <th>NOM</th> <th>ST. MTC. TYPICAL</th> <th></th> </tr> </thead> <tbody> <tr> <td>2030 A</td> <td>.023</td> <td>.023</td> <td>.003</td> <td>1.8</td> </tr> <tr> <td>2030 B</td> <td>.023</td> <td>.023</td> <td>.003</td> <td>1.8</td> </tr> <tr> <td>2030 C</td> <td>.023</td> <td>.023</td> <td>.003</td> <td>1.8</td> </tr> <tr> <td>2030 D</td> <td>.023</td> <td>.023</td> <td>.003</td> <td>1.8</td> </tr> </tbody> </table> <p style="text-align: center;">Part No. 2030</p>	ORDER BY PART NO.	D	L	RECOMMENDATIONS	APPROX WT/1000		NOM	NOM	ST. MTC. TYPICAL		2030 A	.023	.023	.003	1.8	2030 B	.023	.023	.003	1.8	2030 C	.023	.023	.003	1.8	2030 D	.023	.023	.003	1.8	 <table border="1" style="width: 100%; border-collapse: collapse; margin-top: 10px;"> <thead> <tr> <th>ORDER BY PART NO.</th> <th>D</th> <th>L</th> <th>RECOMMENDATIONS</th> <th>APPROX WT/1000</th> </tr> <tr> <th></th> <th>NOM</th> <th>NOM</th> <th>ST. MTC. TYPICAL</th> <th></th> </tr> </thead> <tbody> <tr> <td>2060 A</td> <td>.023</td> <td>.023</td> <td>.003</td> <td>1.8</td> </tr> <tr> <td>2060 B</td> <td>.023</td> <td>.023</td> <td>.003</td> <td>1.8</td> </tr> <tr> <td>2060 C</td> <td>.023</td> <td>.023</td> <td>.003</td> <td>1.8</td> </tr> <tr> <td>2060 D</td> <td>.023</td> <td>.023</td> <td>.003</td> <td>1.8</td> </tr> </tbody> </table> <p style="text-align: center;">Part No. 2060</p>	ORDER BY PART NO.	D	L	RECOMMENDATIONS	APPROX WT/1000		NOM	NOM	ST. MTC. TYPICAL		2060 A	.023	.023	.003	1.8	2060 B	.023	.023	.003	1.8	2060 C	.023	.023	.003	1.8	2060 D	.023	.023	.003	1.8	 <table border="1" style="width: 100%; border-collapse: collapse; margin-top: 10px;"> <thead> <tr> <th>ORDER BY PART NO.</th> <th>D</th> <th>L</th> <th>RECOMMENDATIONS</th> <th>APPROX WT/1000</th> </tr> <tr> <th></th> <th>NOM</th> <th>NOM</th> <th>ST. MTC. TYPICAL</th> <th></th> </tr> </thead> <tbody> <tr> <td>2520 A</td> <td>.023</td> <td>.023</td> <td>.003</td> <td>1.8</td> </tr> <tr> <td>2520 B</td> <td>.023</td> <td>.023</td> <td>.003</td> <td>1.8</td> </tr> <tr> <td>2520 C</td> <td>.023</td> <td>.023</td> <td>.003</td> <td>1.8</td> </tr> <tr> <td>2520 D</td> <td>.023</td> <td>.023</td> <td>.003</td> <td>1.8</td> </tr> </tbody> </table> <p style="text-align: center;">Part No. 2520</p>	ORDER BY PART NO.	D	L	RECOMMENDATIONS	APPROX WT/1000		NOM	NOM	ST. MTC. TYPICAL		2520 A	.023	.023	.003	1.8	2520 B	.023	.023	.003	1.8	2520 C	.023	.023	.003	1.8	2520 D	.023	.023	.003	1.8	 <table border="1" style="width: 100%; border-collapse: collapse; margin-top: 10px;"> <thead> <tr> <th>ORDER BY PART NO.</th> <th>D</th> <th>L</th> <th>RECOMMENDATIONS</th> <th>APPROX WT/1000</th> </tr> <tr> <th></th> <th>NOM</th> <th>NOM</th> <th>ST. MTC. TYPICAL</th> <th></th> </tr> </thead> <tbody> <tr> <td>1200 A</td> <td>.023</td> <td>.023</td> <td>.003</td> <td>1.8</td> </tr> <tr> <td>1200 B</td> <td>.023</td> <td>.023</td> <td>.003</td> <td>1.8</td> </tr> <tr> <td>1200 C</td> <td>.023</td> <td>.023</td> <td>.003</td> <td>1.8</td> </tr> <tr> <td>1200 D</td> <td>.023</td> <td>.023</td> <td>.003</td> <td>1.8</td> </tr> </tbody> </table> <p style="text-align: center;">Part No. 1200</p>	ORDER BY PART NO.	D	L	RECOMMENDATIONS	APPROX WT/1000		NOM	NOM	ST. MTC. TYPICAL		1200 A	.023	.023	.003	1.8	1200 B	.023	.023	.003	1.8	1200 C	.023	.023	.003	1.8	1200 D	.023	.023	.003	1.8
ORDER BY PART NO.	D	L	RECOMMENDATIONS	APPROX WT/1000																																																																																																																							
	NOM	NOM	ST. MTC. TYPICAL																																																																																																																								
2030 A	.023	.023	.003	1.8																																																																																																																							
2030 B	.023	.023	.003	1.8																																																																																																																							
2030 C	.023	.023	.003	1.8																																																																																																																							
2030 D	.023	.023	.003	1.8																																																																																																																							
ORDER BY PART NO.	D	L	RECOMMENDATIONS	APPROX WT/1000																																																																																																																							
	NOM	NOM	ST. MTC. TYPICAL																																																																																																																								
2060 A	.023	.023	.003	1.8																																																																																																																							
2060 B	.023	.023	.003	1.8																																																																																																																							
2060 C	.023	.023	.003	1.8																																																																																																																							
2060 D	.023	.023	.003	1.8																																																																																																																							
ORDER BY PART NO.	D	L	RECOMMENDATIONS	APPROX WT/1000																																																																																																																							
	NOM	NOM	ST. MTC. TYPICAL																																																																																																																								
2520 A	.023	.023	.003	1.8																																																																																																																							
2520 B	.023	.023	.003	1.8																																																																																																																							
2520 C	.023	.023	.003	1.8																																																																																																																							
2520 D	.023	.023	.003	1.8																																																																																																																							
ORDER BY PART NO.	D	L	RECOMMENDATIONS	APPROX WT/1000																																																																																																																							
	NOM	NOM	ST. MTC. TYPICAL																																																																																																																								
1200 A	.023	.023	.003	1.8																																																																																																																							
1200 B	.023	.023	.003	1.8																																																																																																																							
1200 C	.023	.023	.003	1.8																																																																																																																							
1200 D	.023	.023	.003	1.8																																																																																																																							
 <table border="1" style="width: 100%; border-collapse: collapse; margin-top: 10px;"> <thead> <tr> <th>ORDER BY PART NO.</th> <th>D</th> <th>L</th> <th>RECOMMENDATIONS</th> <th>APPROX WT/1000</th> </tr> <tr> <th></th> <th>NOM</th> <th>NOM</th> <th>ST. MTC. TYPICAL</th> <th></th> </tr> </thead> <tbody> <tr> <td>1330 A</td> <td>.023</td> <td>.023</td> <td>.003</td> <td>1.8</td> </tr> <tr> <td>1330 B</td> <td>.023</td> <td>.023</td> <td>.003</td> <td>1.8</td> </tr> <tr> <td>1330 C</td> <td>.023</td> <td>.023</td> <td>.003</td> <td>1.8</td> </tr> <tr> <td>1330 D</td> <td>.023</td> <td>.023</td> <td>.003</td> <td>1.8</td> </tr> </tbody> </table> <p style="text-align: center;">Part No. 1330</p>	ORDER BY PART NO.	D	L	RECOMMENDATIONS	APPROX WT/1000		NOM	NOM	ST. MTC. TYPICAL		1330 A	.023	.023	.003	1.8	1330 B	.023	.023	.003	1.8	1330 C	.023	.023	.003	1.8	1330 D	.023	.023	.003	1.8	 <table border="1" style="width: 100%; border-collapse: collapse; margin-top: 10px;"> <thead> <tr> <th>ORDER BY PART NO.</th> <th>D</th> <th>L</th> <th>RECOMMENDATIONS</th> <th>APPROX WT/1000</th> </tr> <tr> <th></th> <th>NOM</th> <th>NOM</th> <th>ST. MTC. TYPICAL</th> <th></th> </tr> </thead> <tbody> <tr> <td>1380 A</td> <td>.023</td> <td>.023</td> <td>.003</td> <td>1.8</td> </tr> <tr> <td>1380 B</td> <td>.023</td> <td>.023</td> <td>.003</td> <td>1.8</td> </tr> <tr> <td>1380 C</td> <td>.023</td> <td>.023</td> <td>.003</td> <td>1.8</td> </tr> <tr> <td>1380 D</td> <td>.023</td> <td>.023</td> <td>.003</td> <td>1.8</td> </tr> </tbody> </table> <p style="text-align: center;">Part No. 1380</p>	ORDER BY PART NO.	D	L	RECOMMENDATIONS	APPROX WT/1000		NOM	NOM	ST. MTC. TYPICAL		1380 A	.023	.023	.003	1.8	1380 B	.023	.023	.003	1.8	1380 C	.023	.023	.003	1.8	1380 D	.023	.023	.003	1.8	 <table border="1" style="width: 100%; border-collapse: collapse; margin-top: 10px;"> <thead> <tr> <th>ORDER BY PART NO.</th> <th>D</th> <th>L</th> <th>RECOMMENDATIONS</th> <th>APPROX WT/1000</th> </tr> <tr> <th></th> <th>NOM</th> <th>NOM</th> <th>ST. MTC. TYPICAL</th> <th></th> </tr> </thead> <tbody> <tr> <td>2010 A</td> <td>.023</td> <td>.023</td> <td>.003</td> <td>1.8</td> </tr> <tr> <td>2010 B</td> <td>.023</td> <td>.023</td> <td>.003</td> <td>1.8</td> </tr> <tr> <td>2010 C</td> <td>.023</td> <td>.023</td> <td>.003</td> <td>1.8</td> </tr> <tr> <td>2010 D</td> <td>.023</td> <td>.023</td> <td>.003</td> <td>1.8</td> </tr> </tbody> </table> <p style="text-align: center;">Part No. 2010</p>	ORDER BY PART NO.	D	L	RECOMMENDATIONS	APPROX WT/1000		NOM	NOM	ST. MTC. TYPICAL		2010 A	.023	.023	.003	1.8	2010 B	.023	.023	.003	1.8	2010 C	.023	.023	.003	1.8	2010 D	.023	.023	.003	1.8	 <table border="1" style="width: 100%; border-collapse: collapse; margin-top: 10px;"> <thead> <tr> <th>ORDER BY PART NO.</th> <th>D</th> <th>L</th> <th>RECOMMENDATIONS</th> <th>APPROX WT/1000</th> </tr> <tr> <th></th> <th>NOM</th> <th>NOM</th> <th>ST. MTC. TYPICAL</th> <th></th> </tr> </thead> <tbody> <tr> <td>2011 A</td> <td>.023</td> <td>.023</td> <td>.003</td> <td>1.8</td> </tr> <tr> <td>2011 B</td> <td>.023</td> <td>.023</td> <td>.003</td> <td>1.8</td> </tr> <tr> <td>2011 C</td> <td>.023</td> <td>.023</td> <td>.003</td> <td>1.8</td> </tr> <tr> <td>2011 D</td> <td>.023</td> <td>.023</td> <td>.003</td> <td>1.8</td> </tr> </tbody> </table> <p style="text-align: center;">Part No. 2011</p>	ORDER BY PART NO.	D	L	RECOMMENDATIONS	APPROX WT/1000		NOM	NOM	ST. MTC. TYPICAL		2011 A	.023	.023	.003	1.8	2011 B	.023	.023	.003	1.8	2011 C	.023	.023	.003	1.8	2011 D	.023	.023	.003	1.8
ORDER BY PART NO.	D	L	RECOMMENDATIONS	APPROX WT/1000																																																																																																																							
	NOM	NOM	ST. MTC. TYPICAL																																																																																																																								
1330 A	.023	.023	.003	1.8																																																																																																																							
1330 B	.023	.023	.003	1.8																																																																																																																							
1330 C	.023	.023	.003	1.8																																																																																																																							
1330 D	.023	.023	.003	1.8																																																																																																																							
ORDER BY PART NO.	D	L	RECOMMENDATIONS	APPROX WT/1000																																																																																																																							
	NOM	NOM	ST. MTC. TYPICAL																																																																																																																								
1380 A	.023	.023	.003	1.8																																																																																																																							
1380 B	.023	.023	.003	1.8																																																																																																																							
1380 C	.023	.023	.003	1.8																																																																																																																							
1380 D	.023	.023	.003	1.8																																																																																																																							
ORDER BY PART NO.	D	L	RECOMMENDATIONS	APPROX WT/1000																																																																																																																							
	NOM	NOM	ST. MTC. TYPICAL																																																																																																																								
2010 A	.023	.023	.003	1.8																																																																																																																							
2010 B	.023	.023	.003	1.8																																																																																																																							
2010 C	.023	.023	.003	1.8																																																																																																																							
2010 D	.023	.023	.003	1.8																																																																																																																							
ORDER BY PART NO.	D	L	RECOMMENDATIONS	APPROX WT/1000																																																																																																																							
	NOM	NOM	ST. MTC. TYPICAL																																																																																																																								
2011 A	.023	.023	.003	1.8																																																																																																																							
2011 B	.023	.023	.003	1.8																																																																																																																							
2011 C	.023	.023	.003	1.8																																																																																																																							
2011 D	.023	.023	.003	1.8																																																																																																																							
 <table border="1" style="width: 100%; border-collapse: collapse; margin-top: 10px;"> <thead> <tr> <th>ORDER BY PART NO.</th> <th>D</th> <th>L</th> <th>RECOMMENDATIONS</th> <th>APPROX WT/1000</th> </tr> <tr> <th></th> <th>NOM</th> <th>NOM</th> <th>ST. MTC. TYPICAL</th> <th></th> </tr> </thead> <tbody> <tr> <td>1250 A</td> <td>.023</td> <td>.023</td> <td>.003</td> <td>1.8</td> </tr> <tr> <td>1250 B</td> <td>.023</td> <td>.023</td> <td>.003</td> <td>1.8</td> </tr> <tr> <td>1250 C</td> <td>.023</td> <td>.023</td> <td>.003</td> <td>1.8</td> </tr> <tr> <td>1250 D</td> <td>.023</td> <td>.023</td> <td>.003</td> <td>1.8</td> </tr> </tbody> </table> <p style="text-align: center;">Part No. 1250</p>	ORDER BY PART NO.	D	L	RECOMMENDATIONS	APPROX WT/1000		NOM	NOM	ST. MTC. TYPICAL		1250 A	.023	.023	.003	1.8	1250 B	.023	.023	.003	1.8	1250 C	.023	.023	.003	1.8	1250 D	.023	.023	.003	1.8	 <table border="1" style="width: 100%; border-collapse: collapse; margin-top: 10px;"> <thead> <tr> <th>ORDER BY PART NO.</th> <th>D</th> <th>L</th> <th>RECOMMENDATIONS</th> <th>APPROX WT/1000</th> </tr> <tr> <th></th> <th>NOM</th> <th>NOM</th> <th>ST. MTC. TYPICAL</th> <th></th> </tr> </thead> <tbody> <tr> <td>2002 A</td> <td>.023</td> <td>.023</td> <td>.003</td> <td>1.8</td> </tr> <tr> <td>2002 B</td> <td>.023</td> <td>.023</td> <td>.003</td> <td>1.8</td> </tr> <tr> <td>2002 C</td> <td>.023</td> <td>.023</td> <td>.003</td> <td>1.8</td> </tr> <tr> <td>2002 D</td> <td>.023</td> <td>.023</td> <td>.003</td> <td>1.8</td> </tr> </tbody> </table> <p style="text-align: center;">Part No. 2002</p>	ORDER BY PART NO.	D	L	RECOMMENDATIONS	APPROX WT/1000		NOM	NOM	ST. MTC. TYPICAL		2002 A	.023	.023	.003	1.8	2002 B	.023	.023	.003	1.8	2002 C	.023	.023	.003	1.8	2002 D	.023	.023	.003	1.8	 <table border="1" style="width: 100%; border-collapse: collapse; margin-top: 10px;"> <thead> <tr> <th>ORDER BY PART NO.</th> <th>D</th> <th>L</th> <th>RECOMMENDATIONS</th> <th>APPROX WT/1000</th> </tr> <tr> <th></th> <th>NOM</th> <th>NOM</th> <th>ST. MTC. TYPICAL</th> <th></th> </tr> </thead> <tbody> <tr> <td>1309 A</td> <td>.023</td> <td>.023</td> <td>.003</td> <td>1.8</td> </tr> <tr> <td>1309 B</td> <td>.023</td> <td>.023</td> <td>.003</td> <td>1.8</td> </tr> <tr> <td>1309 C</td> <td>.023</td> <td>.023</td> <td>.003</td> <td>1.8</td> </tr> <tr> <td>1309 D</td> <td>.023</td> <td>.023</td> <td>.003</td> <td>1.8</td> </tr> </tbody> </table> <p style="text-align: center;">Part No. 1309</p>	ORDER BY PART NO.	D	L	RECOMMENDATIONS	APPROX WT/1000		NOM	NOM	ST. MTC. TYPICAL		1309 A	.023	.023	.003	1.8	1309 B	.023	.023	.003	1.8	1309 C	.023	.023	.003	1.8	1309 D	.023	.023	.003	1.8	 <table border="1" style="width: 100%; border-collapse: collapse; margin-top: 10px;"> <thead> <tr> <th>ORDER BY PART NO.</th> <th>D</th> <th>L</th> <th>RECOMMENDATIONS</th> <th>APPROX WT/1000</th> </tr> <tr> <th></th> <th>NOM</th> <th>NOM</th> <th>ST. MTC. TYPICAL</th> <th></th> </tr> </thead> <tbody> <tr> <td>2000 A</td> <td>.023</td> <td>.023</td> <td>.003</td> <td>1.8</td> </tr> <tr> <td>2000 B</td> <td>.023</td> <td>.023</td> <td>.003</td> <td>1.8</td> </tr> <tr> <td>2000 C</td> <td>.023</td> <td>.023</td> <td>.003</td> <td>1.8</td> </tr> <tr> <td>2000 D</td> <td>.023</td> <td>.023</td> <td>.003</td> <td>1.8</td> </tr> </tbody> </table> <p style="text-align: center;">Part No. 2000</p>	ORDER BY PART NO.	D	L	RECOMMENDATIONS	APPROX WT/1000		NOM	NOM	ST. MTC. TYPICAL		2000 A	.023	.023	.003	1.8	2000 B	.023	.023	.003	1.8	2000 C	.023	.023	.003	1.8	2000 D	.023	.023	.003	1.8
ORDER BY PART NO.	D	L	RECOMMENDATIONS	APPROX WT/1000																																																																																																																							
	NOM	NOM	ST. MTC. TYPICAL																																																																																																																								
1250 A	.023	.023	.003	1.8																																																																																																																							
1250 B	.023	.023	.003	1.8																																																																																																																							
1250 C	.023	.023	.003	1.8																																																																																																																							
1250 D	.023	.023	.003	1.8																																																																																																																							
ORDER BY PART NO.	D	L	RECOMMENDATIONS	APPROX WT/1000																																																																																																																							
	NOM	NOM	ST. MTC. TYPICAL																																																																																																																								
2002 A	.023	.023	.003	1.8																																																																																																																							
2002 B	.023	.023	.003	1.8																																																																																																																							
2002 C	.023	.023	.003	1.8																																																																																																																							
2002 D	.023	.023	.003	1.8																																																																																																																							
ORDER BY PART NO.	D	L	RECOMMENDATIONS	APPROX WT/1000																																																																																																																							
	NOM	NOM	ST. MTC. TYPICAL																																																																																																																								
1309 A	.023	.023	.003	1.8																																																																																																																							
1309 B	.023	.023	.003	1.8																																																																																																																							
1309 C	.023	.023	.003	1.8																																																																																																																							
1309 D	.023	.023	.003	1.8																																																																																																																							
ORDER BY PART NO.	D	L	RECOMMENDATIONS	APPROX WT/1000																																																																																																																							
	NOM	NOM	ST. MTC. TYPICAL																																																																																																																								
2000 A	.023	.023	.003	1.8																																																																																																																							
2000 B	.023	.023	.003	1.8																																																																																																																							
2000 C	.023	.023	.003	1.8																																																																																																																							
2000 D	.023	.023	.003	1.8																																																																																																																							
 <table border="1" style="width: 100%; border-collapse: collapse; margin-top: 10px;"> <thead> <tr> <th>ORDER BY PART NO.</th> <th>D</th> <th>L</th> <th>RECOMMENDATIONS</th> <th>APPROX WT/1000</th> </tr> <tr> <th></th> <th>NOM</th> <th>NOM</th> <th>ST. MTC. TYPICAL</th> <th></th> </tr> </thead> <tbody> <tr> <td>2020 A</td> <td>.023</td> <td>.023</td> <td>.003</td> <td>1.8</td> </tr> <tr> <td>2020 B</td> <td>.023</td> <td>.023</td> <td>.003</td> <td>1.8</td> </tr> <tr> <td>2020 C</td> <td>.023</td> <td>.023</td> <td>.003</td> <td>1.8</td> </tr> <tr> <td>2020 D</td> <td>.023</td> <td>.023</td> <td>.003</td> <td>1.8</td> </tr> </tbody> </table> <p style="text-align: center;">Part No. 2020</p>	ORDER BY PART NO.	D	L	RECOMMENDATIONS	APPROX WT/1000		NOM	NOM	ST. MTC. TYPICAL		2020 A	.023	.023	.003	1.8	2020 B	.023	.023	.003	1.8	2020 C	.023	.023	.003	1.8	2020 D	.023	.023	.003	1.8	 <table border="1" style="width: 100%; border-collapse: collapse; margin-top: 10px;"> <thead> <tr> <th>ORDER BY PART NO.</th> <th>D</th> <th>L</th> <th>RECOMMENDATIONS</th> <th>APPROX WT/1000</th> </tr> <tr> <th></th> <th>NOM</th> <th>NOM</th> <th>ST. MTC. TYPICAL</th> <th></th> </tr> </thead> <tbody> <tr> <td>2024 A</td> <td>.023</td> <td>.023</td> <td>.003</td> <td>1.8</td> </tr> <tr> <td>2024 B</td> <td>.023</td> <td>.023</td> <td>.003</td> <td>1.8</td> </tr> <tr> <td>2024 C</td> <td>.023</td> <td>.023</td> <td>.003</td> <td>1.8</td> </tr> <tr> <td>2024 D</td> <td>.023</td> <td>.023</td> <td>.003</td> <td>1.8</td> </tr> </tbody> </table> <p style="text-align: center;">Part No. 2024</p>	ORDER BY PART NO.	D	L	RECOMMENDATIONS	APPROX WT/1000		NOM	NOM	ST. MTC. TYPICAL		2024 A	.023	.023	.003	1.8	2024 B	.023	.023	.003	1.8	2024 C	.023	.023	.003	1.8	2024 D	.023	.023	.003	1.8	 <table border="1" style="width: 100%; border-collapse: collapse; margin-top: 10px;"> <thead> <tr> <th>ORDER BY PART NO.</th> <th>D</th> <th>L</th> <th>RECOMMENDATIONS</th> <th>APPROX WT/1000</th> </tr> <tr> <th></th> <th>NOM</th> <th>NOM</th> <th>ST. MTC. TYPICAL</th> <th></th> </tr> </thead> <tbody> <tr> <td>1301 A</td> <td>.023</td> <td>.023</td> <td>.003</td> <td>1.8</td> </tr> <tr> <td>1301 B</td> <td>.023</td> <td>.023</td> <td>.003</td> <td>1.8</td> </tr> <tr> <td>1301 C</td> <td>.023</td> <td>.023</td> <td>.003</td> <td>1.8</td> </tr> <tr> <td>1301 D</td> <td>.023</td> <td>.023</td> <td>.003</td> <td>1.8</td> </tr> </tbody> </table> <p style="text-align: center;">Part No. 1301</p>	ORDER BY PART NO.	D	L	RECOMMENDATIONS	APPROX WT/1000		NOM	NOM	ST. MTC. TYPICAL		1301 A	.023	.023	.003	1.8	1301 B	.023	.023	.003	1.8	1301 C	.023	.023	.003	1.8	1301 D	.023	.023	.003	1.8	 <table border="1" style="width: 100%; border-collapse: collapse; margin-top: 10px;"> <thead> <tr> <th>ORDER BY PART NO.</th> <th>D</th> <th>L</th> <th>RECOMMENDATIONS</th> <th>APPROX WT/1000</th> </tr> <tr> <th></th> <th>NOM</th> <th>NOM</th> <th>ST. MTC. TYPICAL</th> <th></th> </tr> </thead> <tbody> <tr> <td>1290 A</td> <td>.023</td> <td>.023</td> <td>.003</td> <td>1.8</td> </tr> <tr> <td>1290 B</td> <td>.023</td> <td>.023</td> <td>.003</td> <td>1.8</td> </tr> <tr> <td>1290 C</td> <td>.023</td> <td>.023</td> <td>.003</td> <td>1.8</td> </tr> <tr> <td>1290 D</td> <td>.023</td> <td>.023</td> <td>.003</td> <td>1.8</td> </tr> </tbody> </table> <p style="text-align: center;">Part No. 1290</p>	ORDER BY PART NO.	D	L	RECOMMENDATIONS	APPROX WT/1000		NOM	NOM	ST. MTC. TYPICAL		1290 A	.023	.023	.003	1.8	1290 B	.023	.023	.003	1.8	1290 C	.023	.023	.003	1.8	1290 D	.023	.023	.003	1.8
ORDER BY PART NO.	D	L	RECOMMENDATIONS	APPROX WT/1000																																																																																																																							
	NOM	NOM	ST. MTC. TYPICAL																																																																																																																								
2020 A	.023	.023	.003	1.8																																																																																																																							
2020 B	.023	.023	.003	1.8																																																																																																																							
2020 C	.023	.023	.003	1.8																																																																																																																							
2020 D	.023	.023	.003	1.8																																																																																																																							
ORDER BY PART NO.	D	L	RECOMMENDATIONS	APPROX WT/1000																																																																																																																							
	NOM	NOM	ST. MTC. TYPICAL																																																																																																																								
2024 A	.023	.023	.003	1.8																																																																																																																							
2024 B	.023	.023	.003	1.8																																																																																																																							
2024 C	.023	.023	.003	1.8																																																																																																																							
2024 D	.023	.023	.003	1.8																																																																																																																							
ORDER BY PART NO.	D	L	RECOMMENDATIONS	APPROX WT/1000																																																																																																																							
	NOM	NOM	ST. MTC. TYPICAL																																																																																																																								
1301 A	.023	.023	.003	1.8																																																																																																																							
1301 B	.023	.023	.003	1.8																																																																																																																							
1301 C	.023	.023	.003	1.8																																																																																																																							
1301 D	.023	.023	.003	1.8																																																																																																																							
ORDER BY PART NO.	D	L	RECOMMENDATIONS	APPROX WT/1000																																																																																																																							
	NOM	NOM	ST. MTC. TYPICAL																																																																																																																								
1290 A	.023	.023	.003	1.8																																																																																																																							
1290 B	.023	.023	.003	1.8																																																																																																																							
1290 C	.023	.023	.003	1.8																																																																																																																							
1290 D	.023	.023	.003	1.8																																																																																																																							
 <table border="1" style="width: 100%; border-collapse: collapse; margin-top: 10px;"> <thead> <tr> <th>ORDER BY PART NO.</th> <th>D</th> <th>L</th> <th>RECOMMENDATIONS</th> <th>APPROX WT/1000</th> </tr> <tr> <th></th> <th>NOM</th> <th>NOM</th> <th>ST. MTC. TYPICAL</th> <th></th> </tr> </thead> <tbody> <tr> <td>2040 A</td> <td>.023</td> <td>.023</td> <td>.003</td> <td>1.8</td> </tr> <tr> <td>2040 B</td> <td>.023</td> <td>.023</td> <td>.003</td> <td>1.8</td> </tr> <tr> <td>2040 C</td> <td>.023</td> <td>.023</td> <td>.003</td> <td>1.8</td> </tr> <tr> <td>2040 D</td> <td>.023</td> <td>.023</td> <td>.003</td> <td>1.8</td> </tr> </tbody> </table> <p style="text-align: center;">Part No. 2040</p>	ORDER BY PART NO.	D	L	RECOMMENDATIONS	APPROX WT/1000		NOM	NOM	ST. MTC. TYPICAL		2040 A	.023	.023	.003	1.8	2040 B	.023	.023	.003	1.8	2040 C	.023	.023	.003	1.8	2040 D	.023	.023	.003	1.8	 <table border="1" style="width: 100%; border-collapse: collapse; margin-top: 10px;"> <thead> <tr> <th>ORDER BY PART NO.</th> <th>D</th> <th>L</th> <th>RECOMMENDATIONS</th> <th>APPROX WT/1000</th> </tr> <tr> <th></th> <th>NOM</th> <th>NOM</th> <th>ST. MTC. TYPICAL</th> <th></th> </tr> </thead> <tbody> <tr> <td>2501 A</td> <td>.023</td> <td>.023</td> <td>.003</td> <td>1.8</td> </tr> <tr> <td>2501 B</td> <td>.023</td> <td>.023</td> <td>.003</td> <td>1.8</td> </tr> <tr> <td>2501 C</td> <td>.023</td> <td>.023</td> <td>.003</td> <td>1.8</td> </tr> <tr> <td>2501 D</td> <td>.023</td> <td>.023</td> <td>.003</td> <td>1.8</td> </tr> </tbody> </table> <p style="text-align: center;">Part No. 2501</p>	ORDER BY PART NO.	D	L	RECOMMENDATIONS	APPROX WT/1000		NOM	NOM	ST. MTC. TYPICAL		2501 A	.023	.023	.003	1.8	2501 B	.023	.023	.003	1.8	2501 C	.023	.023	.003	1.8	2501 D	.023	.023	.003	1.8																																																														
ORDER BY PART NO.	D	L	RECOMMENDATIONS	APPROX WT/1000																																																																																																																							
	NOM	NOM	ST. MTC. TYPICAL																																																																																																																								
2040 A	.023	.023	.003	1.8																																																																																																																							
2040 B	.023	.023	.003	1.8																																																																																																																							
2040 C	.023	.023	.003	1.8																																																																																																																							
2040 D	.023	.023	.003	1.8																																																																																																																							
ORDER BY PART NO.	D	L	RECOMMENDATIONS	APPROX WT/1000																																																																																																																							
	NOM	NOM	ST. MTC. TYPICAL																																																																																																																								
2501 A	.023	.023	.003	1.8																																																																																																																							
2501 B	.023	.023	.003	1.8																																																																																																																							
2501 C	.023	.023	.003	1.8																																																																																																																							
2501 D	.023	.023	.003	1.8																																																																																																																							

Plating: 0.00030/0.00050 silver. Tolerance: .XXX ± .010 before plating.



STANDARDIZED ELECTRONIC HARDWARE
LITTON INDUSTRIES/USECO DIVISION

INSTRUMENT PANEL HARDWARE • Handles — Brass

PART NO. "A" "B" PART NO. "A" "B" PART NO. "A" "B"
1004 6.44 150 1010 4.25 150 1015 3.00 150
1005 6.44 175 1011 4.25 150 1016 3.00 131
1006 3.00 131 1012 4.00 150 1017 2.00 150
1007 6.00 150 1013 4.56 150 1018 8.00 150

FINISH: (STANDARD) NICKEL; BLACK OXIDE; CHROME OPTIONAL AT ADDITIONAL COST
* SUPPLIED WITH 8-32 THREAD
Part No. 1004 thru 1019

PART NO. "A" "B" PART NO. "A" "B"
1070 1.25 1.00 1072 2.25 1.00

FINISH: (STANDARD) NICKEL; BLACK OXIDE; CHROME OPTIONAL AT ADDITIONAL COST
Part No. 1070 thru 1072

FINISH: (STANDARD) NICKEL; BLACK OXIDE; CHROME OPTIONAL AT ADDITIONAL COST
Part No. 1020

SUPPLIED WITH 3/8-24 HEX NUT
FINISH: (STANDARD) NICKEL; BLACK OXIDE; CHROME OPTIONAL AT ADDITIONAL COST
Part No. 1032

MAY BE USED WITH HANDLES 1004 THROUGH 1019
FINISH: (STANDARD) NICKEL; BLACK OXIDE; CHROME OPTIONAL AT ADDITIONAL COST
Part No. 900

MAY BE USED WITH HANDLES 1070/1072
FINISH: (STANDARD) NICKEL; BLACK OXIDE; CHROME OPTIONAL AT ADDITIONAL COST
Part No. 903

SUPPLIED WITH 3/8-24 HEX NUT
FINISH: (STANDARD) NICKEL; BLACK OXIDE; CHROME OPTIONAL AT ADDITIONAL COST
Part No. 1031

PART NO. "A" "B" PART NO. "A" "B"
1026 2.50 150 1028 4.25 150
1029 4.50 150

FINISH: (STANDARD) NICKEL; BLACK OXIDE; CHROME OPTIONAL AT ADDITIONAL COST
Part No. 1026 thru 1029

PART NO. "A" "B" PART NO. "A" "B"
1033 3.00 128 1034 4.56 150

FINISH: (STANDARD) NICKEL; BLACK OXIDE; CHROME OPTIONAL AT ADDITIONAL COST
Part No. 1033 thru 1036

Handles — Aluminum

PART NO. "A" "B" PART NO. "A" "B" PART NO. "A" "B"
1062 6.00 150 1065 3.00 150 1069 1000 150
1063 4.25 150 1066 4.25 150 1071 1000 150

STANDARD FINISH BUFFED — ANODIZED FINISH AVAILABLE
Part No. 1060 thru 1069

MAY BE USED WITH HANDLES 1004 THROUGH 1069
STANDARD FINISH BUFFED — ANODIZED FINISH AVAILABLE
Part No. 901

Handles — Stainless Steel

PART NO. "A" "B" PART NO. "A" "B" PART NO. "A" "B"
1093 4.00 150 1096 6.00 150
1094 4.25 150 1097 4.00 150
1095 4.56 150

FINISH: BRIGHT; BRIGHT PASSIVATE PER MIL-F-14072 (E300) (STD. 17); NON-REFLECTIVE BLACK; BLACK PASSIVATE PER MIL-C-13924 CL III (14.1)
* SUPPLIED WITH 8-32 THD FOR MTO
Part No. 1090

FINISH: BRIGHT; BRIGHT PASSIVATE PER MIL-F-14072 (E300) (STD. 17); NON-REFLECTIVE BLACK; BLACK PASSIVATE PER MIL-C-13924 CL III (14.1)
TOL (STD.): .XXX ± .010, .XX ± .008 BEFORE FINISH
PART MAY BE USED WITH HANDLES NO. 1090, 1091, 1092, 1093, 1094, 1095, 1096, 1097, 1098
Part No. 904

PART NO. "A" "B" PART NO. "A" "B"
1050 3.00 128 1052 6.44 176
1051 4.56 150

STANDARD FINISH BUFFED — ANODIZED FINISH AVAILABLE
Part No. 1050

Shaft Locks — Brass

PART NO. MAX SHAFT DIA. MIN. SHAFT EXT.
150 2.00 .32

STANDARD PLATING — 12
Part No. 1510

PART NO. MAX SHAFT DIA. MIN. SHAFT EXT.
1512 1.25 .32

STANDARD PLATING — 12
Part No. 1512

PART NO. MAX SHAFT DIA. MIN. SHAFT EXT.
1513 1.25 .32

STANDARD PLATING — 12
Part No. 1513

PART NO. MAX SHAFT DIA. MIN. SHAFT EXT.
1520 2.50 .32

STANDARD PLATING — 12
Part No. 1520

Tolerance: .XXX ± .010; .XX ± .016 before plating

SOLDERLESS TERMINALS

Packaged Four Convenient Ways

Vaco offers convenient packaging for every type and size of terminal user.

All Vaco Paks are shown with stock number, actual size illustration of terminal, and wire and stud size for easy shelf identification.



\$ PAK
(5 Paks to Master Carton). Use prefix "D" when ordering.







"C" PAK
(100 per Pak—5 Paks to Master Carton). Use prefix "C" when ordering.



"MB" PAK
(Contains 1000 of a number.) Use prefix "MB" when ordering.

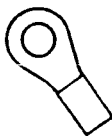
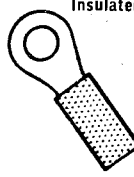
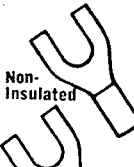

69¢ PAK
For small quantity user.

	Wire Size	Stud Size	Series 10000		Series 30000		Series 40000		Series 50000		Series 60000		Series 90000	
			Stock No.	Qty. per \$ Pack	Stock No.	Qty. per \$ Pack	Stock No.	Qty. per \$ Pack	Stock No.	Qty. per \$ Pack	Stock No.	Qty. per \$ Pack	Stock No.	Qty. per \$ Pack
RING TONGUE  Non-Insulated  Insulated	22-18	4	11204	32	31204	★	41204	★	51204	16	61204	14	91204	★
	22-18	5-6	11205*	32	31205		41205		51205	16	61205	14	91205	
	22-18	5-6	11206	32	31206		41206		51206	16	61206	14	91206	
	22-18	8	11208*	32	31208		41208		51208	16	61208	14	91208	
	22-18	10	11210*	32	31210		41210		51210	16	61210	14	91210	
	22-18	12-1/4	11214	25	31214		41214		51214	14	61214	12	91214	
	22-18	3/8	11238	25	31238		41238		51238	14	61238	12	91238	
	16-14	4	11304	32	31304		41304		51304	16	61304	14	91304	
	16-14	5-6	11305*	32	31305		41305		51305	16	61305	14	91305	
	16-14	5-6	11306	32	31306		41306		51306	16	61306	14	91306	
	16-14	8	11308*	32	31308		41308		51308	16	61308	14	91308	
	16-14	10	11310*	32	31310		41310		51310	16	61310	14	91310	
	16-14	12-1/4	11314	25	31314		41314		51314	14	61314	12	91314	
	16-14	3/8	11338	25	31338		41338		51338	14	61338	12	91338	
	12-10	4-6	11406	25	31406		41406		51406	14	61406	12	91406	
	12-10	8	11408	25	31408		41408		51408	14	61408	12	91408	
12-10	10	11410	25	31410		41410		51410	14	61410	12	91410		
12-10	12-1/4	11414	19	31414		41414		51414	13	61414	10	91414		
12-10	3/8	11438	19	31438		41438		51438	13	61438	10	91438		
SPADE TONGUE  Non-Insulated  Insulated	22-18	4	13204	36	33204		43204		53204	16	63204	14	93204	
	22-18	5-6	13206	36	33206		43206		53206	16	63206	14	93206	
	22-18	8	13208	32	33208		43208		53208	16	63208	14	93208	
	22-18	10	13210	32	33210		43210		53210	16	63210	14	93210	
	16-14	4-6	13306	32	33306		43306		53306	16	63306	14	93306	
	16-14	8	13308	32	33308		43308		53308	16	63308	14	93308	
	16-14	10	13310	32	33310		43310		53310	16	63310	14	93310	
	12-10	4-6	13406	25	33406		43406		53406	14	63406	12	93406	
	12-10	8	13408	25	33408		43408		53408	14	63408	12	93408	
	12-10	10	13410	25	33410		43410		53410	14	63410	12	93410	
22-18	4-6	14206	36	44206		54206	16	64206	14	94206				
HOOK TONGUE  Non-Insulated  Insulated	22-18	4-6	15206	32	35206		45206		55206	16	65206	14	95206	
	22-18	8	15208	32	35208		45208		55208	16	65208	14	95208	
	22-18	10	15210	32	35210		45210		55210	16	65210	14	95210	
	16-14	4-6	15306	32	35306		45306		55306	16	65306	14	95306	
	16-14	8	15308	32	35308		45308		55308	16	65308	14	95308	
	16-14	10	15310	32	35310		45310		55310	16	65310	14	95310	
	12-10	4-6	15406	25	35406		45406		55406	14	65406	12	95406	
	12-10	8	15408	25	35408		45408		55408	14	65408	12	95408	
12-10	10	15410	25	35410		45410		55410	14	65410	12	95410		
FLAG TONGUE Non-Insulated	22-18	8-10	16210	32										
	16-14	8-10	16310	32										
	12-10	8-10	16410	25										

*Available in High Temperature Material (substitute 2 for 1st digit instead of 1) Example: 21205

★Note: not available in \$ pack.



Vector Electronic Company

INCORPORATED



Prices subject to change without notice.

VECTORBORD*

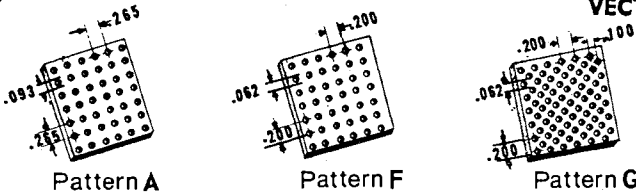

Pattern	Spacing	Pattern	Spacing	Pattern	Spacing
A	.265 Centers	B	.188 Centers	H	.100 Centers
C	.200 Centers	E	.141 Centers	G	.20 x .10
		F	.200 Centers	L	.250 Centers

Vectorbord* (Pre-Punched Terminal Board) has precision pre-punched holes at various spacings on tan XXXP phenolic type PBE-P (Mil-P-3115), ivory EXXXP Epoxy Paper type PEE (Mil-P-22324), G-10 Epoxy Glass type GEE (Mil-P-18177), Copper clad G-10 Epoxy Glass type FL-GE (Mil-P-13949C), copper clad XXXP phenolic type PP (Mil-P-13949) and copper clad Epoxy Paper (Mil-P-13949). Ideal for prototypes and many production uses. Vector Push-In Terminals or standard turned terminals and eyelets fit pre-punched holes. User can make own etched circuits with listed copper clad boards. May be sawed, drilled or punched.

Cat. No.	Pat-tern	Hole Size	Dimensions	No. of Holes	Price 1-19
XXXP Phenolic					
18A18	A	.093	4.80 x 4.80 x 1/16	18 x 18	\$.43
32A9	A	.093	8.51 x 2.41 x 1/16	32 x 9	.45
32AA18	A	.093	8.51 x 4.80 x 3/32	32 x 18	.84
64A18	A	.093	16.99 x 4.8 x 1/16	64 x 18	1.25
64AA18	A	.093	16.99 x 4.8 x 3/32	64 x 18	1.60
64AA32	A	.092	16.99 x 8.51 x 3/32	64 x 32	2.75
45B30	B	.062	8.51 x 5.69 x 1/16	45 x 40	.84
90B30	B	.062	16.97 x 5.69 x 1/16	90 x 30	1.62
85C24	C	.093	16.99 x 4.80 x 1/16	85 x 23	1.25
95G175	G	.093	35.00 x 19.00 x 1/16	(94 x 175) x 2	7.62
26L18	L	.093	6.5 x 4.5 x 1/16	26 x 18	.70
34L19	L	.093	8.5 x 4.8 x 1/16	34 x 19	.75
68L34	L	.093	16.99 x 8.5 x 1/16	68 x 34	1.95
68LL19	LL	.093	16.99 x 4.8 x 3/32	68 x 19	1.60

*Vectorbord is a registered trade-mark of Vector Electronic Co., Inc.

Cat. No.	Pat-tern	Hole Size	Dimensions	No. of Holes	Price 1-19
Epoxy Paper					
32AA18EP	A	.093	8.51 x 4.80 x 3/32	32 x 18	\$1.40
64AA18EP	A	.093	16.99 x 4.80 x 3/32	64 x 18	2.73
64AA32EP	A	.093	16.99 x 8.51 x 3/32	64 x 32	4.39
85F24EP	F	.062	16.99 x 4.80 x 1/16	85 x 23	2.06
85G24EP	G	.062	16.99 x 4.80 x 1/16	(85 x 23) x 2	2.06
85G42EP	G	.062	16.99 x 8.5 x 1/16	(85 x 42) x 2	3.17
120E33EP	E	.062	16.99 x 4.80 x 1/16	120 x 33	2.23
Epoxy Glass					
32A18WE	A	.093	8.51 x 4.80 x 1/16	32 x 18	1.89
42G24WE	G	.062	8.5 x 4.80 x 1/16	(42 x 23) x 2	1.89
85G24WE	G	.062	16.99 x 4.80 x 1/16	(85 x 23) x 2	3.81
170H48WE	H	.062	17.00 x 4.80 x 1/16	170 x 47	4.07
120E33WE	E	.062	16.99 x 4.80 x 1/16	120 x 33	3.99
Copper Clad XXXP Phenolic					
42F22C1	F	.062	8.5 x 4.5 x 1/16	42 x 22	1.00
42F22C2**	F	.062	8.5 x 4.5 x 1/16	42 x 22	1.32
3070-1XXXP**	F	.062	6.5 x 4.5 x 1/16	28 x 22	.84
3070-2XXXP**	F	.062	6.5 x 4.5 x 1/16	28 x 22	1.04
3106-1XXXP**	F	.062	4.5 x 3" x 1/16	18 x 14	.44
3106-2XXXP**	F	.062	4.5 x 3" x 1/16	18 x 14	.55
Copper Clad Epoxy Paper					
3070-1EP*	F	.062	6.5 x 4.5 x 1/16	28 x 22	1.39
3070-2EP**	F	.062	6.5 x 4.5 x 1/16	28 x 22	1.67
Copper Clad Epoxy Glass					
42G22WEC1*	G	.062	8.5 x 4.5 x 1/16	(42 x 22) x 2	2.55
42G22WEC2**	G	.062	8.5 x 4.5 x 1/16	(42 x 22) x 2	2.60
85F42WEC1*	F	.062	16.99 x 8.51 x 1/16	85 x 42	9.33
85F42WEC2**	F	.062	16.99 x 8.51 x 1/16	85 x 42	10.25
Copper Clad Unperforated					
			CU, 1 Side	Price 1-19	Price 1-19
4 1/2" x 3"	XXXP Phenolic	CU45/30-1		\$.30	CU45/30-2 \$.40
6 1/2" x 4 1/2"	XXXP Phenolic	CU65/45-1		.60	CU65/45-2 .77
8 1/2" x 4 1/2"	XXXP Phenolic	CU85/45-1		.70	CU85/45-2 .98
4 1/2" x 3"	Epoxy Glass	CU45/30WE-1		.69	CU45/30WE-2 .77
6 1/2" x 4 1/2"	Epoxy Glass	CU65/45WE-1		1.34	CU65/45WE-2 1.52
8 1/2" x 4 1/2"	Epoxy Glass	CU85/45WE-1		1.71	CU85/45WE-2 1.95
* Indicates 2 oz. Copper Clad 1 Side					
** Indicates 2 oz. Copper Clad 2 Sides					

MICRO-VECTORBORD

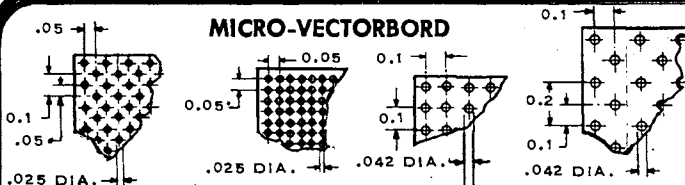

Cat. No.	Pat-tern	Hole Size	Dimension	No. of Holes	Price 1-19
59P19/032	P	.042"	6" x 2" x 1/32"	59 x 19	\$1.09
64P44/062EP	P	.042"	4 1/2" x 6 1/2" x 1/16"	64 x 44	1.75
169P47/062EP	P	.042"	4.8" x 17" x 1/16"	169 x 47	3.40
169P59/032	P	.042"	17" x 6" x 1/32"	169 x 59	4.82
29Q9/032	Q	.042"	6" x 1" x 1/32"	(29 x 9) x 2	.90
84Q29/032	Q	.042"	17" x 6" x 1/32"	(84 x 29) x 2	4.39
76M38/032	M	.025"	4" x 2" x 1/32"	76 x 38	1.52
336M76/032	M	.025"	17" x 4" x 1/32"	336 x 76	8.50
38K19/032	K	.025"	4" x 2" x 1/32"	(38 x 19) x 2	1.30
168K38/032	K	.025"	17" x 4" x 1/32"	(168 x 38) x 2	6.42
EPOXY GLASS COPPER CLAD ONE SIDE					
169P59/032C1	P	.042"	17" x 6" x 1/32"	169 x 59	6.61
336M76/032C1	M	.025"	17" x 4" x 1/32"	336 x 76	9.69

Micro-Vectorbord has been specially designed for the denser packaging required by cordwood construction and mounting micro-miniature components. All boards listed are G-10 Epoxy Glass type GEE (MIL-P-18177), or G-10 Epoxy Glass type FL-GE (MIL-P-13949) except "EP" types which are epoxy paper type PEE grade EXXXP per MIL-P-22324.

PUSH-IN TERMINALS

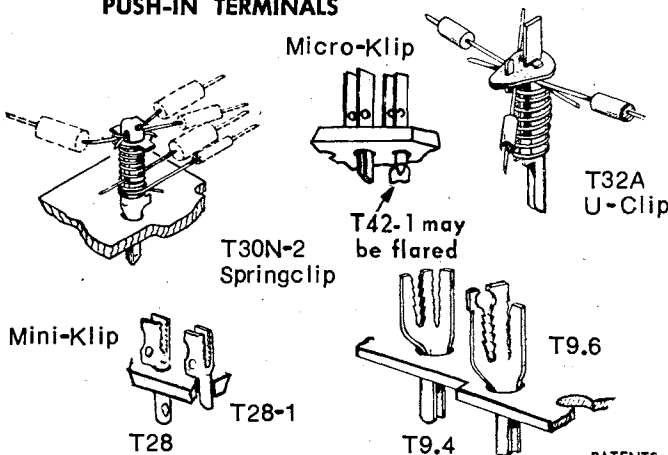

SOLDERLESS SPRINGCLIP TERMINALS—Reliable truly solderless terminals for fast setup of experimental circuitry. May be used over and over—permits reusing expensive components by eliminating heat damage. Extremely low contact resistance, e.g. less than .002 ohms for T30-2. Suggested board thickness: 3/32" for best support of T30 and T32 series.

SOLDERABLE TYPES T9.4, T9.6, T28, T28-1 are brite tin or silver plated for easy soldering.

Cat. No.	Fits Holes	Description	Quan. Per Bag	Net Price 1-19	1-4 Bags (1000 Per Bag)
T9.4	.093"	Brass, Tin Pltg.	100	\$1.38	\$9.79
T9.4A	.093"	Brass, Tin Pltg. w/o slot serr.	100	1.38	9.79
T9.6	.093"	Beryllium Copper, Tin Pltg.	100	2.31	15.06
P122B		Inserting tool for T9.4, T9.4A & T9.6	1	1.40	Any Quan.
T28	.062"	Beryllium Copper, Tin Pltg.	100	1.55	11.00
T28S	.062"	Beryllium Copper, Silver Pltg.	100	1.65	12.99
T28-1	.062"	Beryllium Copper, Tin Pltg. except .325 O/A height	100	1.55	11.00
P91		Inserting tool for T28 series	1	.50	1-49 Pcs.
T30-2	.093"	Brass, Silver Pltg.	10	.99	
T30-2	.093"	Brass, Silver Pltg.	100	7.40	52.86
T30N-2	.093"	Brass, Nickel Pltg.	10	.95	
T30N-2	.093"	Brass, Nickel Pltg.	100	6.95	48.50
P92A		Inserting tool for T30-2 series	1	.50	1-49 Pcs.
T32A	.093"	Brass, Nickel Pltg.	100	9.90	75.00
T32A-1	.062"	Brass, Nickel Pltg.	100	9.90	75.00
P136		Inserting tool for T32 series	1	1.20	Any Quan.
T42-1	.042"	Beryllium Copper, Tin Pltg.	100	1.75	12.99
P149A		Inserting tool for T42-1 series	1	1.50	1-49 Pcs.

Vector FRAME-LOC RAILS

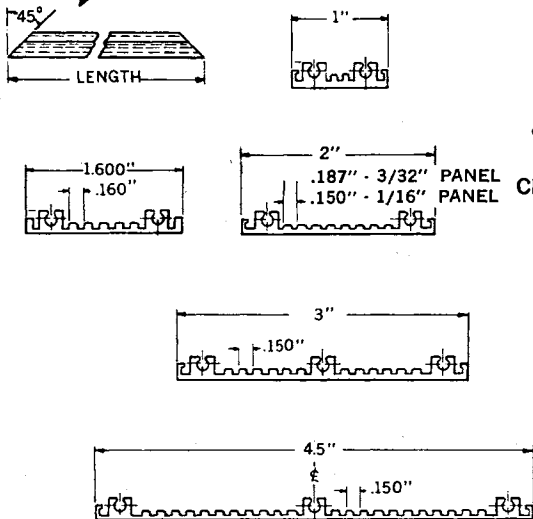

P147 CRIMPING TOOL

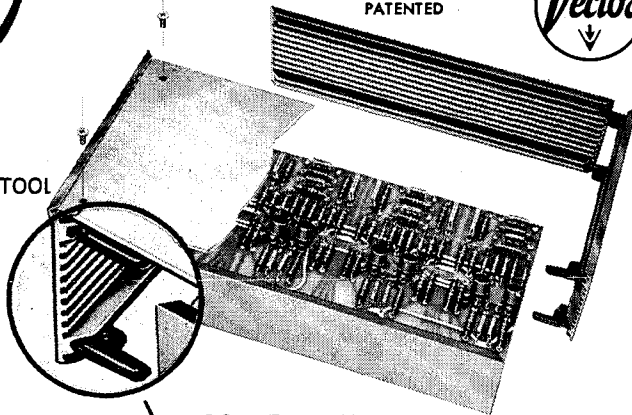

CORNER FASTENER BRACKET DETAIL

Make handsome, sleek aluminum cases for circuit boards in seconds with these new extruded aluminum rails. Each rail has extruded grooves running lengthwise so boards may be "stacked" if desired or shielded between with aluminum plates. Unique corner brackets, lockwashers and screws furnished with all mitred rails fasten corners together for chassis or complete boxes, or furnish your own covers, 24" unmitred pieces supplied for making required lengths. P147 Tool crimps corner joints permanently on inside of case.

FRAME-LOC CASE AND CHASSIS RAILS FOR 1/16" AND 3/32" BOARDS

PRICES ARE PER PAIR

Overall Length	End Type	1" Wide for 1/16" Boards	Price 1-49 Pr.	1.6" Wide for 1/16" Boards	Price 1-49 Pr.	2" Wide for 1/16" Boards	Price 1-49 Pr.	2" Wide for 3/32" Boards	Price 1-49 Pr.	3" Wide for 1/16" Boards	Price 1-49 Pr.	4.5" Wide for 1/16" Boards	Price 1-49 Pr.
2.87"	Mitred	SR1-29-062	\$1.05	SR16-29-062	\$1.18	SR2-29-062	\$1.21			SR3-29-062	\$1.28	SR45-29-062	\$1.55
3.11"	Mitred	SR1-31-062	1.07	SR16-31-062	1.21	SR2-31-062	1.23	SR2-30-093	\$1.23	SR3-31-062	1.31	SR45-31-062	1.59
4.61"	Mitred	SR1-46-062	1.18	SR16-46-062	1.39	SR2-46-062	1.44	SR2-46-093	1.44	SR3-46-062	1.52	SR45-46-062	1.91
4.91"	Mitred	SR1-49-062	1.19	SR16-49-062	1.40	SR2-49-062	1.46	SR2-48-093	1.46	SR3-49-062	1.53	SR45-49-062	1.95
6.61"	Mitred	SR1-66-062	1.40	SR16-66-062	1.68	SR2-66-062	1.72	SR2-66-093	1.72	SR3-66-062	1.85	SR45-66-062	2.40
8.0"	Mitred	SR1-80-062	1.51	SR16-80-062	1.83	SR2-80-062	1.86	SR2-80-093	1.86	SR3-80-062	2.02	SR45-80-062	2.67
8.61"	Mitred	SR1-86-062	1.53	SR16-86-062	1.87	SR2-86-062	1.92	SR2-85-093	1.92	SR3-86-062	2.06	SR45-86-062	2.76
10.0"	Mitred	SR1-100-062	1.71	SR16-100-062	2.10	SR2-100-062	2.21	SR2-100-093	2.21	SR3-100-062	2.30	SR45-100-062	3.10
14.0"	Mitred	SR1-140-062	2.12	SR16-140-062	2.67	SR2-140-062	2.79	SR2-140-093	2.79	SR3-140-062	2.96	SR45-140-062	4.10
17.1"	Mitred	SR1-171-062	2.44	SR16-171-062	3.13	SR2-171-062	3.20	SR2-170-093	3.20	SR3-171-062	3.49	SR45-171-062	4.93
24.0"	*Square	SR1-240-062	2.93	SR16-240-062	3.76	SR2-240-062	3.84	SR2-240-093	3.84	SR3-240-062	4.19	SR45-240-062	5.92

P147 Corner Crimping Tool — Any Quantity \$6.59 each.

*24" Lengths supplied square cut and no fasteners — all others 45° mitred with corner brackets, lockwashers and screws. (Supplied in pairs.) Other square cut lengths available — see Vector General Catalog.

COVER PLATES (.064" Thick Aluminum)

Catalog No.	Length	Width	Price 1-49	Catalog No.	Length	Width	Price 1-49
PL2746	4.5	2.750	\$.48 each	PL4597	9.7	4.500	\$1.22 each
PL4546	4.5	4.500	.63 each	PL8097	9.7	8.000	1.71 each
PL8046	4.5	8.000	1.01 each	PL27140	14.0	2.750	1.19 each
PL2766	6.5	2.750	.52 each	PL45140	14.0	4.500	1.31 each
PL4566	6.5	4.500	.69 each	PL80140	14.0	8.000	2.45 each
PL8066	6.5	8.000	1.25 each	PL48-170-Pkg 2	17.0	4.800	4.14 pair
PL48-85-Pkg 2	8.5	4.800	2.74 pair	PL85-170-Pkg 2	17.0	8.500	6.29 pair
PL2797	9.7	2.750	.70 each				

MULTI-MOD CASES

These quietly handsome and strong aluminum cases with internally grooved surfaces for 1/16" panels can rest on any face and provide table top housings for instruments, circuitry, controls, miscellaneous small equipment. Bases remove quickly for ready access; good R.F.I. shielding is provided by overlapping cover joints. 14 standard sizes from 1.6" x 3.1" x 3.1" to 4.5" x 14" x 8" are available.

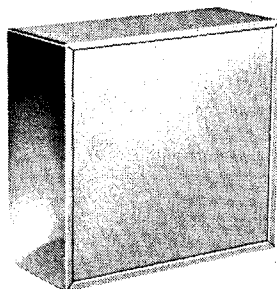

W20-46-46

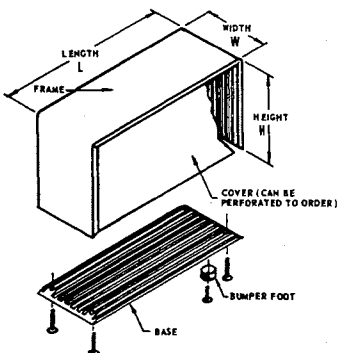

PATENTED FEATURES

CAT. No.	WIDTH	LENGTH	HEIGHT	PRICE 1-49
W16-31-31	1.6"	3.10"	3.10"	\$ 3.41
W20-46-31	2.0"	4.61"	3.10"	3.93
W20-46-46	2.0"	4.61"	4.61"	4.34
W20-66-46	2.0"	6.61"	4.61"	5.15
W30-66-46	3.0"	6.61"	4.61"	5.25
W30-86-46	3.0"	8.61"	4.61"	5.56
W30-100-46	3.0"	10.00"	4.61"	6.20
W30-100-66	3.0"	10.00"	6.61"	7.80
W30-100-80	3.0"	10.00"	8.00"	8.05
W30-140-80	3.0"	14.00"	8.00"	10.10
W45-66-46	4.5"	6.61"	4.61"	5.94
W45-86-46	4.5"	8.61"	4.61"	6.95
W45-100-46	4.5"	10.00"	4.61"	7.36
W45-140-80	4.5"	14.00"	8.00"	11.78
FT-1-Pkg 8		Rubber Bump Feet		.58 Pkg

Vector TUBE SOCKET TEST ADAPTERS

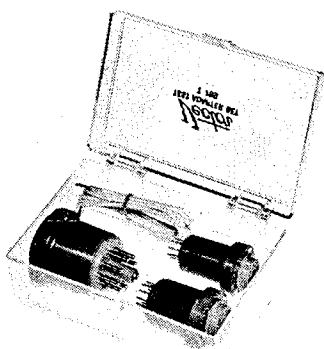

T-789

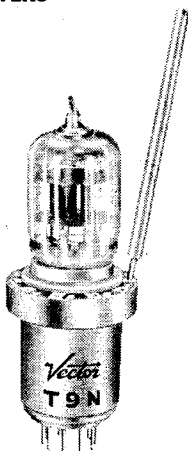

T9N

TUBE SOCKET TEST ADAPTERS are ideal for making voltage resistance and wave form measurements from the tube side of electronic equipment. To use, insert adapter between tube and socket, and replace tube in adapter socket. Special test tabs are recessed on the adapter skirt and have a hole to grip test probe and protect operator's fingers during insertion and withdrawal. Regular alligator test-clipped probes also hold on tab and socket. Castings are low loss phenolic and fit all shield bases for miniature and noval type or into standard tube clamps. Reduced body diameter permits insertion into new telescoping shields. Adapter socket contacts are beryllium copper, silver plated for long life and low resistance. Electrostatic capacity between adjacent leads of the adapter is approximately 1 micro-micro-farad. Flash over voltage between adjacent terminals is in excess of 1500 volts DC.

Kit T789 consists of the three popular "must have" sizes, 7-pin miniature, 8-pin octal, 9-pin noval and a P1 probe in a handy clear plastic carrying case.

Ordering Information

Cat. No.	Tube Type	Body Dia.	Skirt Dia.	Length Less Prongs	Price 1-19
T-4	4 Pin	1.26	1.56	1.50	\$3.18
T-5	5 Pin	1.26	1.56	1.50	3.10
T-6	6 Pin	1.26	1.56	1.50	3.18
T-7-0	7 Pin Small	1.26	1.56	1.50	3.25
T-7-L	7 Pin Large	1.45	1.75	1.50	3.25
T-7-M	7 Pin Min.	0.75	1.03	1.50	1.65
T-8-0	8 Pin Octal	1.25	1.56	1.50	1.75
T-9-N	9 Pin Noval	0.87	1.16	1.50	1.85
T789	Set of types T-7-M, T-8-0, T-9-N, P1, in case.				5.90
P1	Plug-in Probe with 30" lead.				.52

Special Adapters Designed to Customer Specifications—Write Factory.

EXPERIMENTER'S TEST ADAPTERS SOCKET EXTENDERS

EXPERIMENTER'S TEST ADAPTERS. These are similar to the Socket Test Adapter but are less the shells and tabs so that connections can be cross-connected in any desired way. User must solder connections.

SOCKET EXTENDERS provide a replaceable unit for use in tube testers and expensive meters. Wear is shifted from the socket in the tester to the one in the extender. Sockets have beryllium copper silver plated contacts for long life. An all molded outside shell is used with socket leads soldered to plug pins.



TX-8-0
OCTAL



1264
7 P. MINIATURE

Experimenter's Test Adapters

Cat. No.	Socket Type	Net Price 1-19
TX-8-0	Octal	\$2.47
TX-7-M	Miniature	.88
TX-9-N	Noval	.94
TX-789	Set of above three in kit	4.62

Socket Extenders

Cat. No.	Socket Type	Net Price 1-19
1262	Octal 8	\$1.75
1263	9 P. Noval	1.75
1264	7 P. Miniature	1.75

EXTENDED TUBE SOCKET TEST ADAPTERS

For most work the short, unshielded adapters are adequate. For hard to reach locations or where surrounding equipment restricts use of regular test adapters, the 3 to 4 inch extended adapter may be used. In these the leads between plug and socket are individually shielded to minimize coupling. The shield is brought out to a lug on the wall of the adapter and should be connected to the chassis being tested. Capacity to shield is approx. 8 mmf. per lead.

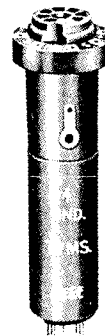

T7MS

Ordering Information

Cat. No.	Tube Type	Body Dia.	Skirt Dia.	Length Less Prongs	Price 1-19
T-7-M-S	7 Pin Min.	0.75	1.03	3.25	\$5.91
T-8-0-S	8 Pin Octal	1.25	1.56	4.00	6.60
T-9-N-S	9 Pin Noval	0.87	1.16	3.25	6.60
P1	Plug-in Probe with 30" lead				.52
T-789-S	Set of above in case				19.47

CURRENT TEST ADAPTERS

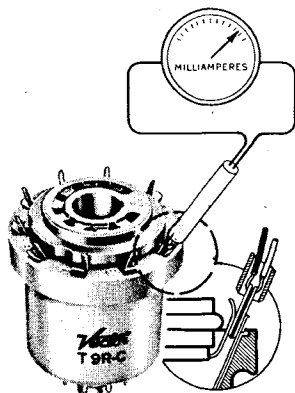

T9R-C
WITH P-2 PROBE

Versatile VECTOR CURRENT TEST ADAPTERS make possible tube circuit current or voltage measurements without cutting leads or making computations. All measurements may be made from the tube side of the electronic equipment without disturbing the chassis.

VECTOR CURRENT TEST ADAPTERS have two spring test tab elements for each pin. These test tab elements break the circuit when a dual-sided probe is inserted in test position. Probes are gripped by the test tabs and need not be held in position. Current is read at the meter where the two test leads are connected. The same test adapters and probe also permit voltage and wave form readings on any pin position, merely by connecting the leads jointly to the meter. The adapters have mica-filled shell and keyways, and may be used in a horizontal or vertical position.

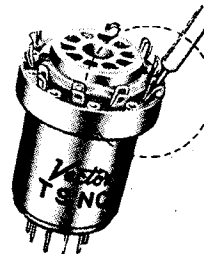

Ordering Information

Cat. No.	Type	Net Price 1-19
T-7-M-C	7 Pin Min.	\$2.53
T-8-0-C	8-Pin Octal	3.19
T-9-N-C	9 Pin Noval	2.70
T-9-R-C	9 Pin Noval	3.65
T-12-C	12 Pin Compactron	3.85
P-2	Dual Sided Plug-in Probe, Required for above. Any Quantity	.79
T-789-C	Set of First 3 Adapters With P-2 Probe in Case	9.74
T-912-C	Set of Noval and Compactron Adapters With P-2 Probe in Case	8.29

Compact OUTLET BOXES

waber
E L E C T R O N I C S I N C

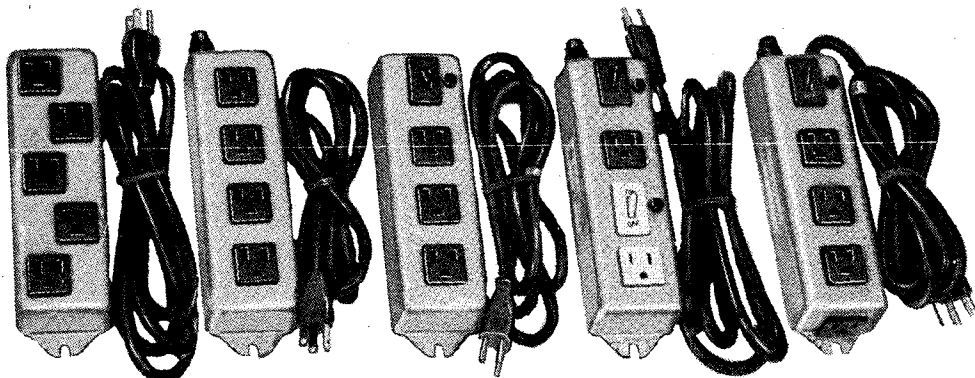

Model 602 Model 603 Model 605 Model 606 Model 608

CHOOSE THE WABER "COMPACT" TAILOR MADE FOR YOUR APPLICATION FROM THESE POPULAR HEAVY-DUTY MODELS

Compact in size, these sturdy Waber units provide quality "U" ground type outlets in a variety of configurations for schools, labs, or industry. They are particularly useful for OEM applications. Custom variations can be made to meet your specific needs.

MODEL 602 SERIES, 5 "U" Ground Outlets Only

	Net
Model 602 (6' cord-set)	\$4.80
Model 602-15 (15' cord-set)	5.80

MODEL 603 SERIES, 4 "U" Ground Outlets,

Fuse or Push-To-Reset Circuit Breaker

Model 603 (fuse, 6' cord-set)	\$5.25
Model 603-15 (fuse, 15' cord-set)	6.25
Model 603CB (circuit breaker, 6' cord-set)	6.25
Model 603CB-15 (circuit breaker, 15' cord-set)	7.25

MODEL 605 SERIES, 3 "U" Ground Outlets,

Pilot Light, On-Off Switch, Fuse or Push-To-Reset Circuit Breaker

Model 605 (fuse, 6' cord-set)	\$5.95
Model 605-15 (fuse, 15' cord-set)	6.95
Model 605CB (circuit breaker, 6' cord-set)	6.95
Model 605CB-15 (circuit breaker, 15' cord-set)	7.95

MODEL 606 SERIES, 2 Color-Coded Sets

(Switch, Pilot Light, Outlet)

Fuse or Push-To-Reset Circuit Breaker

Model 606 (fuse, 6' cord-set)	\$5.95
Model 606-15 (fuse, 15' cord-set)	6.95
Model 606CB (circuit breaker, 6' cord-set)	6.95
Model 606CB-15 (circuit breaker, 15' cord-set)	7.95

MODEL 608 SERIES, Pilot Light, On-Off Switch,

Fuse or Push-To-Reset Circuit Breaker, and 4 "U" Ground Outlets. Outlet On One End and Cord-Set Out Other End For Series-String Wiring.

Model 608 (fuse, 6' cord-set)	\$6.50
Model 608-15 (fuse, 15' cord-set)	7.50
Model 608CB (circuit breaker, 6' cord-set)	7.50
Model 608CB-15 (circuit breaker, 15' cord-set)	8.50

SPECIFICATIONS: Tough HSI UL approved cord-set ■ Rated at 15 amperes, 130 volts continuous duty ■ Steel case finished in silver gray textured hammertone ■ Your choice of UL approved fuse or push-to-reset circuit breaker ■ All 600 series models have 8¼" mounting centers, Size 8¾" x 2¼" x 1½".

NEW! U-GROUND PLUG-IN WALL OUTLET

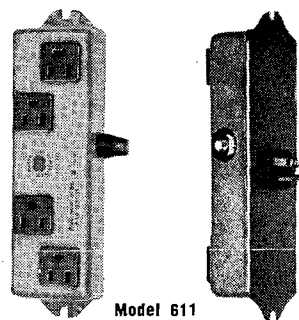

Model 611

Get four "U" ground outlets from one wall outlet with this new Waber Model 611 outlet box. Mounting ears enable you to fasten unit to wall securely. Fuse or push-to-reset circuit breaker.

	Net
Model 611 (fuse)	\$4.75
Model 611CB (circuit breaker)	5.75
Model 611B (no fuse or crct. bkr.)	4.25

6 OUTLETS FROM ONE WALL OUTLET

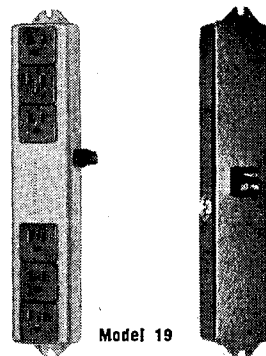

Model 19

Male plug-in base enables you to multiply your outlets. Plug-in male outlet and secure mounting ears. You get 6 heavy duty "U" ground outlets, protected by a panel mounted fuse or circuit breaker.

Model 19 (fuse)	\$6.75
Model 19CB (circuit breaker)	7.75
Model 19B	6.25

PHOTO AIDS

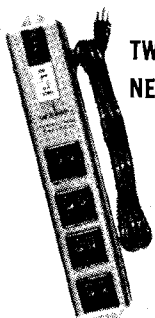

**TWO WABER MODELING SWITCHES
NEWEST PHOTO STUDIO ACCESSORIES**

Photofloods last longer...lots, lots longer! And it licks the heat problem, too. Flick the switch to "low" and you have the shadows you need to properly position and focus your subject. When you're ready to shoot, flick the switch to "high" and the lights come on at maximum brilliance.

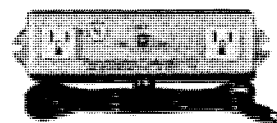

NET

Model 210 (for two bulbs of the same type. Up to 1650 watts, total).....	\$5.97
Model 211 (for up to four bulbs of any type. Max. 1650 watts, total).....	10.89



DeLuxe OUTLET BOXES

waber
E L E C T R O N I C S I N C

NEED A SPECIAL?

Tell us what you need and we will design a unit to meet your exact requirements . . . quickly and economically.

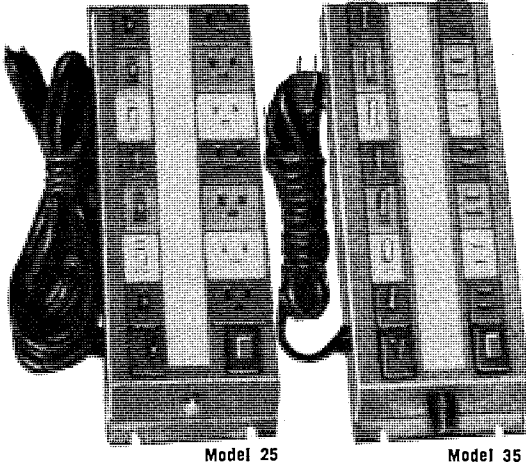

Model 25

Model 35

**WABER HEAVY-DUTY OUTLET BOXES
FEATURE INDIVIDUAL AND MASTER CONTROL
IN CONTRASTING COLORS**

Waber Deluxe Models 25 and 35 provide 7 color-keyed switch-outlet groups, a panel mounted fuse or circuit breaker, pilot light, and a master "on-off" switch. These models feature a center "write-on" strip for immediate identification. The 25 series is the "U" ground type with your choice of a 6 or 15-foot Waber HSJ cord-set. Model 35 is the 2-wire type with 10-foot neoprene cord-set.

Waber Deluxe Models 25P and 35P series have the same configuration as the 25 and 35, with the addition of a bright pilot light for each switch-outlet set. All Waber outlet boxes are pre-wired, ready for use.

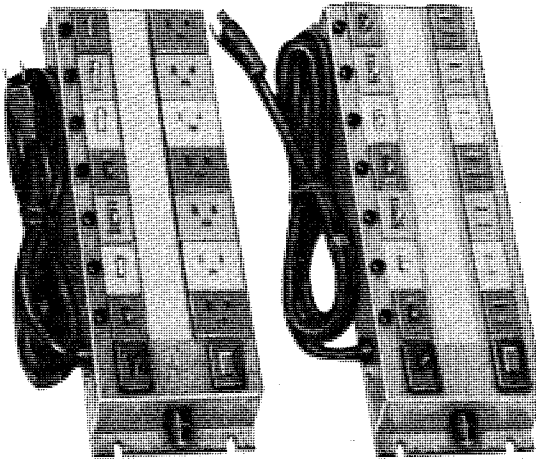

Model 25P

Model 35P

	NET		NET
Model 25 (fuse, 6' cord-set)	\$15.50	Model 25P (fuse, 6' cord-set)	\$19.50
Model 25-15 (fuse, 15' cord-set)	16.50	Model 25P-15 (fuse, 15' cord-set)	20.50
Model 25CB (circuit breaker, 6' cord-set)	16.50	Model 25PCB (circuit breaker 6' cord-set)	20.50
Model 25CB-15 (circuit breaker, 15' cord-set)	17.50	Model 25PCB-15 (circuit breaker, 15' cord-set)	21.50
Model 35 (fuse, 10' cord-set)	13.50	Model 35P (fuse, 10' cord-set)	17.50
Model 35CB (circuit breaker, 10' cord-set)	14.50	Model 35PCB (circuit breaker, 10' cord-set)	18.50

SPECIFICATIONS — Models 25 and 35 Series • Panel Mounted Fuse Or Circuit Breaker • Bright Neon Pilot Light • Seven Color Keyed Switch-Outlet Groups • Tough Waber H5J Cord-Set • UL Approved Components • 13 x 2 7/8" Mounting Centers • Rated at 15 Amperes, 130 Volts Continuous Duty • Steel Case Finished in Silver Gray Textured Hammertone • Shipping Weight: 4 Pounds.

**NEW! THESE HANDSOME WABER DELUXE OUTLET BOXES
FEATURE OUTLETS CONTROLLED BY 12 HOUR TIMERS**

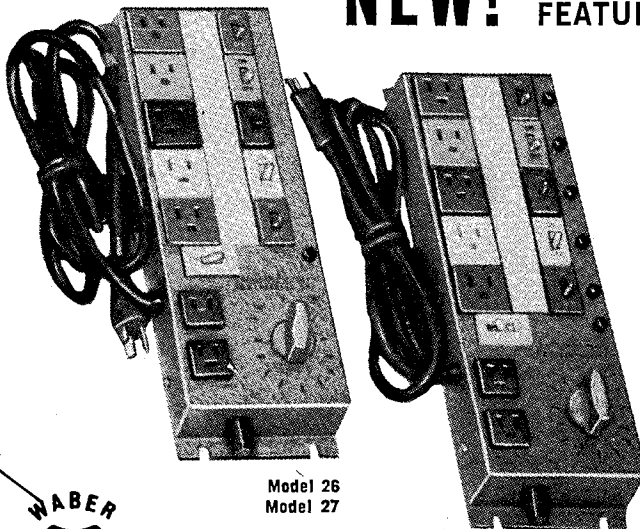

Model 26
Model 27

Model 26P
Model 27P

Now you can have the popular Waber Deluxe Models with timers. You can set the timer for up to 12 hours. Two types are available. The timer in Model 26 Series turns power to the unit "on" at the end of the preset time and Model 27 is designed to turn power off at the end of the pre-set time.

	NET
Model 26 (fuse, 6' cord-set)	\$24.00
Model 26-15 (fuse, 15' cord-set)	25.00
Model 26CB (circuit breaker, 6' cord-set)	25.00
Model 26CB-15 (circuit breaker, 15' cord-set)	26.00
Model 26P (fuse, 6' cord-set)	28.00
Model 26P-15 (fuse, 15' cord-set)	29.00
Model 26PCB (circuit breaker, 6' cord-set)	29.00
Model 26PCB-15 (circuit breaker, 15' cord-set)	30.00
Model 27 (fuse, 6' cord-set)	24.00
Model 27-15 (fuse, 15' cord-set)	25.00
Model 27CB (circuit breaker, 6' cord-set)	25.00
Model 27CB-15 (circuit breaker, 15' cord-set)	26.00
Model 27P (fuse, 6' cord-set)	28.00
Model 27P-15 (fuse, 15' cord-set)	29.00
Model 27PCB (circuit breaker, 6' cord-set)	29.00
Model 27PCB-15 (circuit breaker, 15' cord-set)	30.00



**RACK MOUNT
OUTLET BOXES**



**POWER UP YOUR RACKS WITH THESE
PRE-WIRED WABER OUTLET PANELS**

Waber pre-wired, ready-to-use, master power controls provide a quick and easy power source for standard relay racks. You have your choice from this great variety of configurations with outlets on the outside, inside, or combinations of both. Choose the Waber pre-wired panel you need from the many standard units shown here. UL Cord-set is of durable, high quality HSJ heater type. All rack panels are 3½" x 19" in size except series 903, 911, 912, 913 which are 1¾" x 19". All Waber outlet boxes are rated at 15 amperes, 130 volts continuous duty.

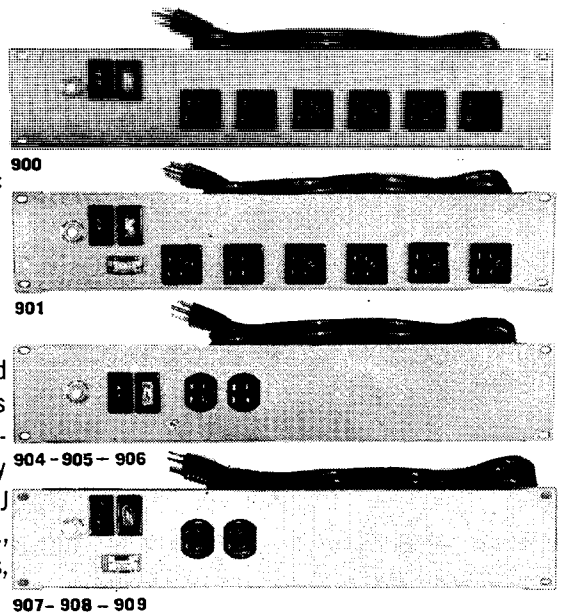

**WABER MODEL 900 SERIES RACK PANEL
OUTLET BOXES**

These units feature an "on-off" switch, pilot light, fuse or push-to-reset circuit breaker, 6 "U" ground outlets, and your choice of a 6 or 15-foot neoprene cord-set. All component parts UL approved.

	Net
Model 900 (fuse, 6' cord-set)	\$10.95
Model 900-15 (fuse, 15' cord-set)	11.95
Model 900CB	
(circuit breaker, 6' cord-set)	11.95
Model 900CB-15	
(circuit breaker, 15' cord-set)	12.95

**WABER 901 RACK MOUNT FEATURES
AC VOLTMETER**

This unit has all of the features of the 900 series, plus a handsome, edgewise reading AC Voltmeter for monitoring voltages of from 0 to 150 volts AC.

Model 901 (fuse, 6' cord-set)	\$14.50
Model 901-15 (fuse, 15' cord-set)	15.50
Model 901CB	
(circuit breaker, 6' cord-set)	15.50
Model 901CB-15	
(circuit breaker, 15' cord-set)	16.50

**WABER MODEL 904 SERIES IN "U" GROUND,
CROW'S FOOT, OR LOCKING TYPE**

This popular series features an "on-off" switch pilot light, fuse or push-to-reset circuit breaker, 6 or 15-foot HSJ cord-set, and 6 outlets (2 in front and 4 in back). Size: 3½" x 19". All component parts UL approved.

"U" GROUND TYPE	Net
Model 904 (fuse, 6' cord-set)	\$12.95
Model 904-15 (fuse, 15' cord-set)	13.95
Model 904CB	
(circuit breaker, 6' cord-set)	13.95
Model 904CB-15	
(circuit breaker, 15' cord-set)	14.95

LOCKING TYPE

Model 905 (fuse, 6' cord-set)	23.95
Model 905-15 (fuse, 15' cord-set)	24.95
Model 905CB	
(circuit breaker, 6' cord-set)	24.95
Model 905CB-15	
(circuit breaker, 15' cord-set)	25.95

CROW'S FOOT TYPE

Model 906 (fuse, 6' cord-set)	24.95
Model 906-15 (fuse, 15' cord-set)	25.95
Model 906CB	
(circuit breaker, 6' cord-set)	25.95
Model 906CB-15	
(circuit breaker, 15' cord-set)	26.95

**WABER MODELS 907-908-909 EQUIPPED WITH
AC VOLTMETER**

These Waber Models have all of the features of the 904-905-906 series with the addition of an edgewise reading 0-150 volt AC voltmeter.

"U" GROUND TYPE	Net
Model 907 (fuse, 6' cord-set)	\$16.50
Model 907-15 (fuse, 15' cord-set)	17.50
Model 907CB	
(circuit breaker, 6' cord-set)	17.50
Model 907CB-15	
(circuit breaker, 15' cord-set)	18.50

LOCKING TYPE

Model 908 (fuse, 6" cord-set)	27.50
Model 908-15 (fuse, 15" cord-set)	28.50
Model 908CB	
(circuit breaker, 6' cord-set)	28.50
Model 908CB-15	
(circuit breaker, 15' cord-set)	29.50

CROW'S FOOT TYPE

Model 909 (fuse, 6' cord-set)	28.50
Model 909-15 (fuse, 15' cord-set)	29.50
Model 909CB	
(circuit breaker, 6' cord-set)	29.50
Model 909CB-15	
(circuit breaker, 15' cord-set)	30.50

WABER POPULAR SPACE SAVING MODELS ONLY 1¾" WIDE



903

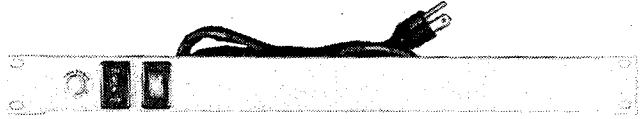

911-912-913

Waber Model 903 series features 6 "U" ground outlets (in the front) "on-off" switch, pilot light, fuse or circuit breaker, 6 or 15-foot neoprene cord-set. Models 911, 912, 913 have the same features except that the outlets are in the back and are available in "U" ground, locking, or crow's foot types. Component parts UL approved. Size: 1¾"x19".

**WANT SOMETHING
SPECIAL?
WE'LL MANUFACTURE
TO YOUR SPECS.**

	Net
Model 903 (fuse, 6' cord-set)	\$10.95
Model 903 (fuse, 15' cord-set)	11.95
Model 903CB	
(circuit breaker 6' cord-set)	11.95
Model 903CB-15	
(circuit breaker, 15' cord-set)	12.95
"U" GROUND TYPE	
Model 911 (fuse, 6' cord-set)	12.95
Model 911-15 (fuse, 15' cord-set)	13.95
Model 911CB	
(circuit breaker, 6' cord-set)	13.95
Model 911CB-15	
(circuit breaker, 15' cord-set)	14.95

LOCKING TYPE	Net
Model 912 (fuse, 6' cord-set)	\$23.95
Model 912-15 (fuse, 15' cord-set)	24.95
Model 912CB	
(circuit breaker, 6' cord-set)	24.95
Model 912CB-15	
(circuit breaker, 15' cord-set)	25.95
CROW'S FOOT TYPE	
Model 913 (fuse, 6' cord-set)	24.95
Model 913-15 (fuse, 15' cord-set)	25.95
Model 913CB	
(circuit breaker, 6' cord-set)	25.95
Model 913CB-15	
(circuit breaker, 15' cord-set)	26.95

**"STRING BEAN"
OUTLET BOXES**

w a b e r
E L E C T R O N I C S I N C

**POPULAR WABER "STRING-BEAN" OUTLET BOXES
STREAMLINED FOR SPACE SAVING APPLICATIONS**

These popular Waber "String-Bean" models offer eight variations in two convenient lengths, four foot and six foot. Only 1½" wide and 1⅝" deep, these units are especially valuable where space is at a premium.

WABER MODEL 1000 SERIES

This unit provides 12 "U" ground outlets, "on-off" switch, neon pilot light, fuse or push-to-reset circuit breaker, and 6 or 15-foot HSJ cord-set.

	Net
Model 1000 (fuse, 6' cord-set)	\$15.95
Model 1000-15 (fuse, 15' cord-set)....	16.95
Model 1000CB (circuit breaker, 6' cord-set)	16.95
Model 1000BC-15 (circuit breaker, 15' cord-set)	17.95

WABER MODEL 1001 SERIES

Provided with this model are 12 "U" ground outlets, with fuse or circuit breaker protection, and 6 or 15-foot neoprene cord-set.

Model 1001 (fuse, 6' cord-set)	\$14.95
Model 1001-15 (fuse, 15' cord-set)....	15.95
Model 1001CB (circuit breaker, 6' cord-set)	15.95
Model 1000CB-15 (circuit breaker, 15' cord-set)	16.95

WABER MODEL 1002 SERIES

This unit has 12 "U" ground outlets only. UL approved components.

Model 1002 (6' cord-set)	\$13.95
Model 1002-15 (15' cord-set)	14.95

WABER DELUXE MODEL 1010 SERIES

This handsome model has 8 outlets, each individually controlled by its own switch and pilot light, with a master "on-off" switch and pilot light. Fuse or push-to-reset circuit breaker, and choice of 6 or 15-foot HSJ cord-set.

Model 1010 (fuse, 6' cord-set)	\$19.95
Model 1010-15 (fuse, 15' cord-set) ..	20.95
Model 1010CB (circuit breaker, 6' cord-set)	20.95
Model 1010CB-15 (circuit breaker, 15' cord-set)	21.95

WABER SIX FOOT PRE-WIRED OUTLET BOXES

WABER MODEL 1040 SERIES

This unit provides 15 "U" ground outlets, on-off switch, neon pilot light, fuse or push-to-reset circuit breaker, and 6 or 15 foot HSJ cord-set.

Model 1040 (fuse, 6' cord-set)	\$19.95
Model 1040-15 (fuse, 15' cord-set) ..	20.95
Model 1040CV (circuit breaker, 6' cord-set)	20.95
Model 1040CB (circuit breaker, 15' cord-set)	21.95

WABER MODEL 1041 SERIES

Fifteen "U" ground outlets are provided with a pilot light to show when power is on. Available in either a 6 or 15 foot HSJ cord-set.

	Net
Model 1041 (6' cord-set)	\$16.95
Model 1041-15 (15' cord-set)	17.95

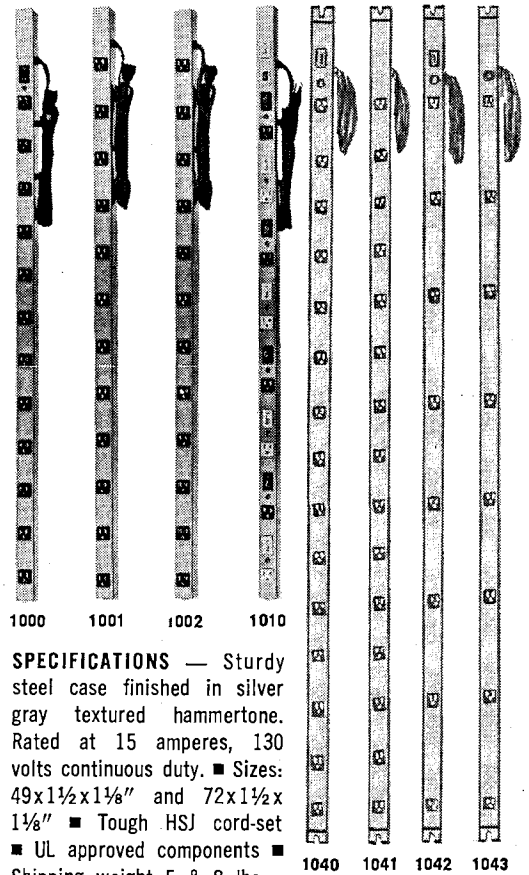

SPECIFICATIONS — Sturdy steel case finished in silver gray textured hammertone. Rated at 15 amperes, 130 volts continuous duty. ■ Sizes: 49x1½x1⅝" and 72x1½x1⅝" ■ Tough HSJ cord-set ■ UL approved components ■ Shipping weight 5 & 8 lbs.

WABER MODEL 1042 SERIES

This model features 8 "U" ground outlets, on-off switch, pilot light, fuse or circuit breaker protection, and choice of 6' or 15' HSJ cord-set.

	Net
Model 1042 (fuse, 6' cord-set)	\$16.95
Model 1042-15 (fuse, 15' cord-set)	17.95
Model 1042CB (circuit breaker, 6' cord-set)	17.95
Model 1042CB-15 (circuit breaker, 15' cord-set)	18.95

WABER MODEL 1043 SERIES

A neon pilot light indicates power is on at each of the eight "U" ground outlets provided in this 72" outlet box. Available with either a 6' or 15' cord-set

	Net
Model 1043 (6' cord-set)	\$13.95
Model 1043-15 (15' cord-set)	14.95

INSTANT WIRING!

Waber Outlet Boxes Are Pre-Wired... Ready To Use.



WABER 24" MODELS PACK GIANT FEATURES IN STURDY BOX

The new Waber 764 and 770 "Short John" series are similar to Waber series 707 and 711. This convenient two foot length provides a desirable in-between length to supplement our one foot and four foot series. These new units are ideal for racks, benches, and test set-ups where its 22"x2"x1½" size is advantageous. Mounting centers are 23¾". Shipping weight 5 lbs.

	NET
Model 764 (fuse, 6' cord-set)	\$13.35
Model 764-15 (fuse, 15' cord-set)	14.35
Model 764CB (circuit breaker, 6' cord-set)	14.35
Model 764CB-15 (circuit breaker, 15' cord-set)	15.35
Model 770 (6' cord-set)	11.90
Model 770-15 (15' cord-set)	12.90

762 • The MASTER — 33rd Edition

Net

© United Technical Publications

OUTLET BOXES
Ready To Wire In

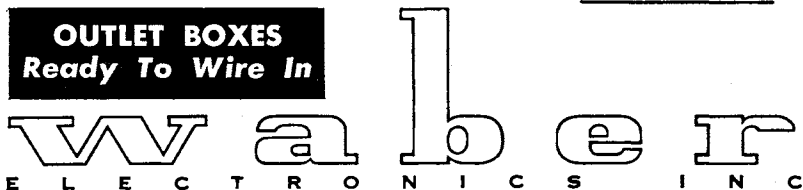

NEW! WABER OUTLET STRIPS WITH BX CONNECTOR.. READY TO WIRE IN

When the application calls for an outlet strip to be wired into a fixed installation the Waber Model 4000 Series are ideal for this purpose. Make your choice from the wide range shown here. Many "U" ground outlets or few outlets... long strip or short strip... the choice is yours.

Mounting is easy. Bottom cover is screwed to bench, back wall, or wherever outlet strip is wanted. After connections are made, top cover is mounted to bottom plate with self tappers. Size is 1 5/8" wide by 1 3/8" wide. Lengths are as shown. Case is of sturdy steel finished in hammertone gray. Outlets are "U" ground type and UL approved.

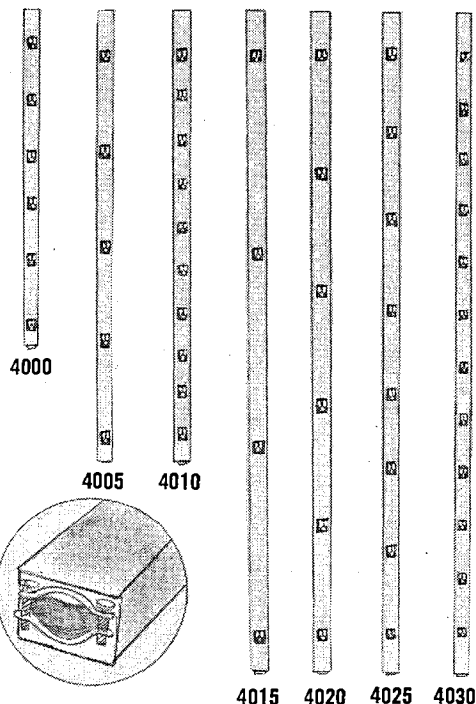

MODEL NO.	LENGTH FT.	NO. OF OUTLETS	CENTERS	SHIPPING WT.	NET
4000	3	6	6"	4	\$ 9.95
4005	5	5	10"	7	10.95
4010	5	10	6"	7	14.95
4015	6	4	14"	7	12.50
4020	6	6	10"	7	14.95
4025	6	8	8"	7	15.95
4030	6	12	5"	7	17.95

NEW BEAUTIFULLY CHROME FINISHED "ICEBERG"® OUTLET STRIPS MADE TO RECESS INTO DESKS, CABINETS AND HI-FI INSTALLATIONS

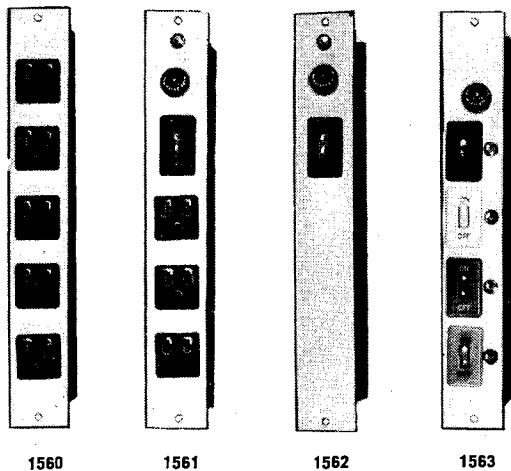

The new Waber "Iceberg"® line is a handsome addition to our growing family of outlet boxes. These units are made to be recessed into desks, counters, cabinets, and hi-fi installations of all types. Just like the iceberg, which has most of its bulk submerged and out of sight, only the handsome chrome plated face plate shows in the new Waber "Iceberg"® Outlet Box line.

Four units are available in this new line. Two of the units have outlets available on the surface plate, and the other two have the outlets on the back with control from the face plate. Size of the unit is 1 1/2" wide x 10" long x 1 1/2" deep. Mounting hole size is 9 1/2" x 1 1/32". These units are available with fuse or circuit breaker protection and six or fifteen foot neoprene cord-sets. Rating is 15 amps, 130 volts continuous duty.

Model 1560 consists of five "U" ground outlets only, surface mounted with your choice of a 6 or 15-foot neoprene cord-set. Model 1561 has three surface mounted "U" ground outlets controlled by a switch and pilot light. You have a choice between a fuse post or circuit breaker, 6 or 15-foot neoprene cord-set. Model 1562 has the switch, protective device, and pilot light surface mounted with access to the three "U" ground outlets from the back. You have a choice between a fuse post or circuit breaker, 6 or 15 foot neoprene cord-set. Model 1563 is the deluxe unit with four color coded switches, pilot lights and protective device surface mounted, and with access to the four "U" ground outlets from the back. Each outlet is individually controlled by its own switch.

	Net		Net
Model 1560 (6' cord-set)	\$5.75	Model 1562CB (6' cord-set, circuit breaker)	\$7.95
Model 1560-15 (15' cord-set)	6.75	Model 1562CB-15 (15' cord-set, circuit breaker)	8.95
Model 1561 (fuse, 6' cord-set)	6.95	Model 1563 (6' cord-set, fuse)	8.50
Model 1561-15 (fuse, 15' cord-set)	7.95	Model 1563-15 (15' cord-set, fuse)	9.50
Model 1561CB (6' cord-set, circuit breaker)	7.95	Model 1563CB (6' cord-set, circuit breaker)	9.50
Model 1561CB-15 (circuit breaker, 15' cord-set)	8.95	Model 1563CB-15 (15' cord-set, circuit breaker)	10.50
Model 1562 (6' cord-set, fuse)	6.95		
Model 1562-15 (15' cord-set, fuse)	7.95		



• CORD SETS
• ACCESSORIES

waber

ELECTRONICS INC



WABER EXTRA FINE QUALITY CORD SETS AND EXTENSION CORDS IN CONVENIENT LENGTHS

Need a cord-set or extension cord? Choose from these well made UL approved units. Made of the finest materials, these cords have molded male and female parts. Ideal for industrial "Work-horse" applications.

WABER TIPOVER SWITCH — This unit installs easily in automobiles, trucks, buses, and tractors. The mercury operated switches automatically shut off the motor when the vehicle is tipped past a forty-five degree angle. In addition to minimizing the danger of fire or explosion, this unit is especially valuable in stalling moving blades, wheel and parts found on many farm vehicles. This unit will operate with either 6 or 12 volt ignition systems. Installation is permanent. Nothing to burn out or replace.

3067\$5.97 Net

CATALOG NO.	DESCRIPTION	LENGTH FT.	CONDUCTORS	SIZE AWG	TYPE	NET PRICE
3071	"U" Ground Cord-Set	6	3	16	HSJ	\$2.25
3072	"U" Ground Cord-Set	15	3	16	HSJ	4.20
3073	"U" Ground Extension Cord	7	3	16	Neoprene	2.61
3074	"U" Ground Extension Cord	16	3	16	Neoprene	4.43
3075	2 Wire Cord-Set	10	2	16	HPN	1.56
3076	"U" Ground Cord-Set	15	3	12	S	6.20
3077	"U" Ground Cord-Set	20	3	18	SJT	3.60
3078	20A - 250 V Cord-Set	15	3	12	S	6.20
3079	"U" Ground Cord-Set	6	3	12	S	3.25

WABER REPLACEMENT PARTS AND ELECTRICAL ACCESSORIES

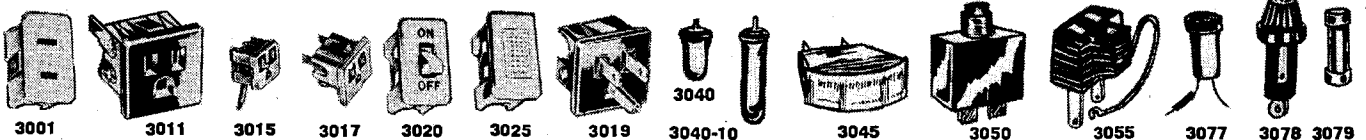

SNAP-IN CONVENIENCE OUTLET — Polarized with male, quick connect terminals. UL rated 15 A, 125 V. Takes polarized and non-polarized caps. Mounting hole 1 1/2 x 3/4".

- 3001 (Black)\$.32 Net
- 3001-W (White)\$.36 Net
- 3001-G (Gray)\$.36 Net
- 3001-R (Red)\$.36 Net

SNAP-IN "U" GROUND CONVENIENCE OUTLET — UL. Quick connect terminals. Rated 15 A, 125 V. Mounting size: 1 1/2 x 1 1/4".

- 3011 (Black)\$.42 Net
- 3011-W (White)\$.48 Net
- 3011-G (Gray)\$.48 Net
- 3011-R (Red)\$.48 Net

SNAP-IN "U" GROUND CONVENIENCE OUTLET — UL. Wire leads or male quick connect terminals with ground lead. Rated 15 A, 125 V. Mounting hole 3/2 x 3/4".

- 3015 (Black with wire leads)\$.34 Net
- 3015-W (White with wire leads)\$.38 Net
- 3017 (Black with quick connect terminals)\$.34 Net
- 3017-W (White with quick connect terminals)\$.38 Net

SNAP-IN ON-OFF SWITCH — With male quick connect terminals. UL rated 20 A, 125 V. Mounting hole 1 1/2 x 3/4".

- 3020 (Black)\$.56 Net
- 3030-W (White)\$.74 Net
- 3020-R (Red)\$.62 Net
- 3020-G (Gray)\$.62 Net

SNAP-IN PILOT-LIGHT — Brilliant red nylon lens. Male, quick connect terminals. UL. Strong spring steel mounting clip. Mounting hole 1 1/2 x 3/4". 125 VAC.

- 3025 (Black)\$.68 Net
- 3025-W (White)\$.75 Net
- 3025-R (Red)\$.74 Net
- 3025-G (Gray)\$.74 Net

MALE LOAD PLUGS — UL. With male quick connect terminals. Rated 15 A, 125 V. Mounting hole 3/4 x 3/4". Black body.

- 3019\$.74 Net

MERCURY TILT SWITCHES — Contacts in rugged all steel body. Unequaled durability for all fields including switching of heavy loads and highly inductive circuits. Low contact resistance. All steel body acts as one side of the circuit. Provides practically limitless life where a tilt action is required. Part No. 3040 is rated at 1 A, 115 VAC, and Part No. 3040-10 is rated at 10 A, 115 VAC.

- 3040 (package of 3)\$ 1.25 Net
- 3040-10 (package of 2)\$ 2.10 Net

EDGEWISE READING AC VOLTMETER KIT — Modern space-saving edgewise reading meter, spring clamp, diode and series resistor. Scale reads from 0 to 150 volts AC. Mounting hole 3/4 x 1 1/4".

- 3045\$.375 Net

PUSH TO RESET CIRCUIT BREAKER — Protect from overloads with this thermal time circuit breaker. Mounts easily in 3/4" hole. Plunger pops out on overloads. Push in to reset.

- 3050 (15 Amperes, 125 Volts)\$ 1.35 Net
- 3051 (20 Amperes, 125 Volts)\$ 1.35 Net

2 WIRE TO 3 WIRE ADAPTER — Polarized with "U" ground slot and green grounding lead equipped with convenient spade lug. UL rated 15 A, 125 V. Molded body. Automatically converts any standard 2 wire parallel outlet to a 3 wire "U" ground outlet.

- 3055\$.30 Net

BRIGHT NEON PILOT LIGHTS — These handsome pilot lights, in a compact space saving size, mount easily in a 3/4" diameter hole. Included is a spring clip to lock pilot firmly in place.

- 3077 (Package of three)\$ 1.35 Net

FUSE POST — UL approved. Mounting hole 5/8" dia.

- 3078\$.36 Net

FUSE — UL approved. Heavy duty. 15 Amp rating.

- 3079\$.14 Net

WABER RADIO AND TELEVISION ACCESSORIES

BALUN TYPE COUPLERS — Two, three and four-set FM-TV multi-couplers operate with high efficiency and low loss. Transformer coupling provides the isolation needed to prevent interaction between sets. Low loss design assures full strength signals to the receiver. Dependable, sure contact screw terminals. Convenient mounting ears. For 300 Ohm Standard Twinlead.

- 3062 (Two Set Coupler)\$ 1.17 Net
- 3063 (Three Set Coupler)\$ 1.95 Net
- 3064 (Four Set Coupler)\$ 2.97 Net

INDOOR FM-TV ANTENNA — This easy to install antenna is very effective for moderate

signal areas. Folded dipole type especially suited for FM. Place behind cabinet, under rug, or any other suitable place where antenna can be concealed. Made of high quality twin lead with spade lugs attached to six foot lead-in. Attaches easily to tuner.

- 3030\$ 1.20 Net

OEM CUSTOM REQUIREMENTS
Need a special? Send us your specs
— Tell us what you need — We can do a good job for you.

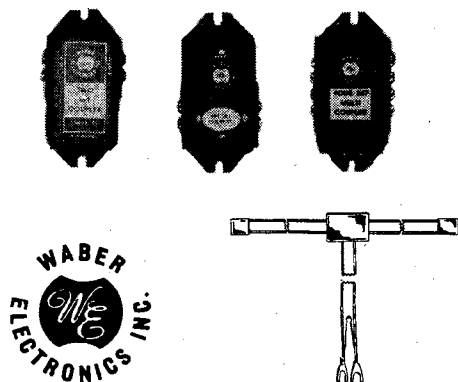

**WABER
LAB-ON-WHEELS®**

w a b e r
E L E C T R O N I C S I N C

**THESE CHROME PLATED BEAUTIES
EQUIPPED WITH WABER OUTLET BOXES**

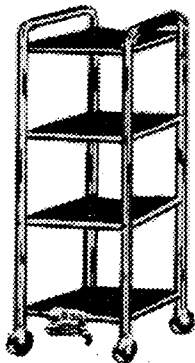

WABER MODEL LOW-11 CARRIER

This sturdy, versatile instrument cart provides ample area for instruments on a free moving carrier. The 4 sturdy shelves are fabricated of durable half-inch plywood laminated with black ribbed non-slip facing.

Construction of the carrier is of 1-inch square steel tubing beautifully finished in gleaming chrome plate. Also included is an outlet box providing 3 "U" ground outlets, neon pilot light, on-off switch, fuse protection, and an HSJ cord-set. Rating is 15 amperes, 130 volts continuous duty. Two middle shelves are adjustable to desired position.

Casters are 5-inch heavy duty rubber, all swiveling. Shelf size: 21" x 21", 40" H. Cap.: 600 pounds.

Model LOW-11\$125.00 Net

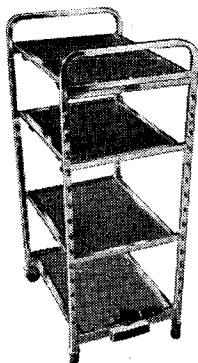

WABER MODEL LOW-12 CARRIER

Here is a highly useful instrument carrier built for years of service. The 4 sturdy shelves are made of half-inch plywood with a thick ribbed non-slip laminated top.

This carrier is well constructed of 1-inch square steel tubing handsomely finished in bright chrome plate. Included with this unit is an outlet box with 3 "U" ground outlets, neon pilot light, on-off switch, fuse protection, and an HSJ cord-set. Rating is 15 amperes, 130 volts continuous duty. Two middle shelves are adjustable to desired positions.

Casters are 5-inch rubber, all swiveling. Shelf size: 21" x 29", 60" H. Cap.: 600 pounds.

Model LOW-12\$125.00 Net

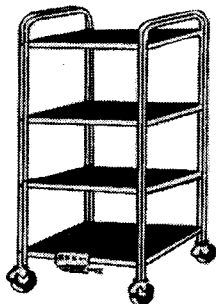

WABER MODEL LOW-13 CARRIER

As useful as it is handsome. Same specifications as LOW-12 above except guard rail on top shelf is the longer dimension.

Construction is of 1-inch square steel tubing finished in bright chrome plate. Included is an outlet box with 3 "U" ground outlets, neon pilot light, on-off switch, fuse protection, and an HSJ cord-set. Rating is 15 amperes, 130 volts continuous duty. Two middle shelves are adjustable to desired positions.

Casters are 5 inches, all swiveling. Shelf size: 21" x 29". 60" H. Capacity: 600 pounds.

Model LOW-13\$125.00 Net

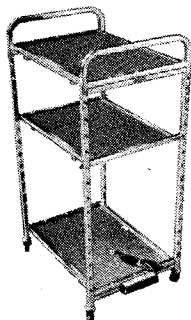

WABER MODEL LOW-14 CARRIER

This popular 3-shelf model provides easy mobility for your instruments. Shelves are made of half-inch plywood faced with a thick ribbed non-slip laminated top.

Framework is made of 1-inch square steel tubing finished in bright chrome plate. Included is an outlet box with 3 "U" ground outlets, neon pilot light, on-off switch, fuse protection, and an HSJ cord-set. Rating is 15 amperes, 130 volts continuous duty. Middle shelf is adjustable to desired position.

Casters are 5 inches, all swiveling. Shelf size: 21" x 29". 58" H. Capacity: 600 pounds.

Model LOW-14\$120.00 Net

**NEW! WABER "WHEEL 'N' REEL"®
MOBILE WIRE RACK**

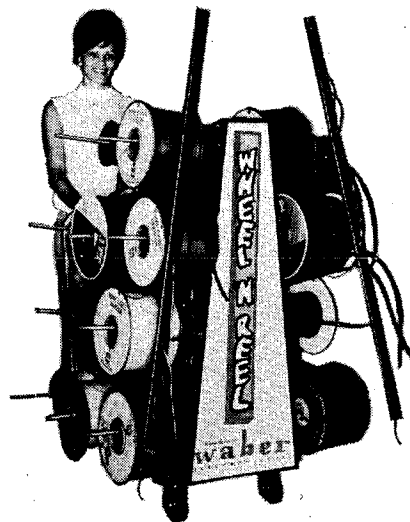

Here's the answer to your wire handling problems. This new Waber "Wheel 'N' Reel"® Mobile Wire Rack holds up to 20 generous size reels of wire, each one in position to be dispensed easily and effortlessly. Move it into position for cable assemble; store it out of the way when not in use. Unlike fixed position wire racks, you can take a large assortment of wire to the area where needed. The "Wheel 'N' Reel" will pay for itself in time saved. Constructed of sturdy 1-inch square tubing, handsomely finished in silver grey hammertone. Equipped with brakes for stability.

Model LOW-10\$140.00 Net
1900 pound load capacity

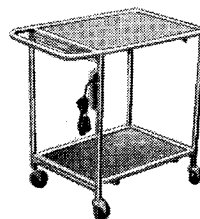

WABER MODEL LOW-15 CARRIER

Just picture this handy cart in your lab giving your instruments and equipment mobility. The 2 decks are made of half-inch plywood laminated with a heavy ribbed facing.

This cart is constructed of 1-inch square steel tubing finished in bright chrome plate. Included is an outlet box with 3 "U" ground outlets, neon pilot light, on-off switch, fuse protection, and an HSJ cord-set. Rating is 15 amperes, 130 volts continuous duty.

Casters are 5 inches, all swiveling. Shelf size: 22" x 36", 36" H. Capacity: 600 pounds.

Model LOW-15\$110.00 Net



**whatever electronic products
you require...**



**...you'll find it
faster in
this catalog...**

**...the world's largest catalog
of electronic
products
sold through
distributors**



SOLDERLESS TERMINALS AND CONNECTORS

waldom



26-24 WIRE RANGE

NEW NEW NEW

TERMINALS FOR SMALL WIRE RANGE APPLICATIONS

Now you can meet your wire needs in the 26-24 wire range with WALDOM High Quality, Dependable Terminals.

Five terminal tongue styles are available in both uninsulated KRIMPTITE® and nylon insulated AVIKRIMP®

These terminals feature: Serrated barrels for extra wire-gripping strength — Funnel action chamfered edge for easy wire insertion — Controlled atmosphere annealing insures easy crimping — Highest conductivity because they are made from pure electrolytic copper with an electro-tin plating. The nylon insulated AVIKRIMP will operate continuously at from -40° to 250°F.—intermittently up to 350°.

Ideal for use in electronic industry, aircraft, instrument manufacturing, or any industry use with precise circuitry requirements.

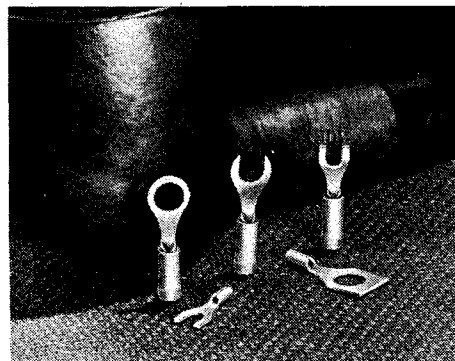

.018 STOCK — INSULATION COLOR YELLOW

RING TONGUE TERMINALS — BARREL LENGTH: AVIKRIMP* 23/64", KRIMPTITE* 1/8"

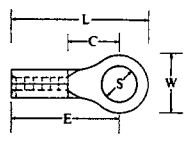

RING TONGUE

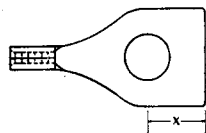

RECTANGULAR TONGUE

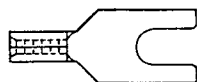

SPADE TONGUE

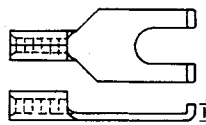

FLANGED SPADE TONGUE

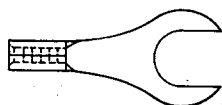

SLOTTED RING TONGUE

Basic Dimensions			Insulated				Uninsulated			Price Code See Below
Stud Size S	Width W	Clearance C	AVIKRIMP* .075 Max. Insulation Diameter				Krimptite*			
			Part No.	Length L	Barrel Extension E	Tongue Length X	Part No.	Length L	Barrel Extension	
0	9/64	1/8	N-5925	33/64	7/16	—	S-1925	23/64	17/64	A
	9/64	1/8	N-5926	33/64	7/16	—	S-1926	23/64	17/64	A
2	13/64	7/32	N-5927	21/32	17/32	—	S-1927	31/64	23/64	A
	9/64	7/32	N-5928	39/64	17/32	—	S-1928	29/64	23/64	A
4	13/64	7/32	N-5929	21/32	17/32	—	S-1929	31/64	23/64	A
6	13/64	7/32	N-5930	21/32	17/32	—	S-1930	31/64	23/64	A
	1/4	19/64	N-5931	3/4	39/64	—	S-1931	37/64	7/16	A
8	1/4	19/64	N-5932	3/4	39/64	—	S-1932	37/64	7/16	A
10	1/4	19/64	N-5933	3/4	39/64	—	S-1933	37/64	7/16	A

RECTANGULAR TONGUE — BARREL LENGTH: AVIKRIMP* 23/64", KRIMPTITE* 1/8"

2	3/16	7/32	N-5934	21/32	17/32	7/64	S-1934	31/64	23/64	A
6	5/16	19/64	N-5935	13/16	39/64	3/16	S-1935	41/64	7/16	A
8	5/16	19/64	N-5936	13/16	39/64	3/16	S-1936	41/64	7/16	A
10	5/16	19/64	N-5937	13/16	39/64	3/16	S-1937	41/64	7/16	A

SPADE TONGUE — BARREL LENGTH: AVIKRIMP* 23/64", KRIMPTITE* 1/8"

0	9/64	1/8	N-5938	23/64	7/16	1/16	S-1938	23/64	17/64	A
2	3/16	7/32	N-5939	21/32	17/32	7/64	S-1939	31/64	23/64	A
4	13/64	7/32	N-5940	41/64	17/32	3/32	S-1940	31/64	23/64	A

FLANGED SPADE TONGUE — BARREL LENGTH: AVIKRIMP* 23/64", KRIMPTITE* 1/8"

2	3/16	7/32	N-5941	21/32	17/32	7/64	S-1941	31/64	23/64	A
---	------	------	--------	-------	-------	------	--------	-------	-------	---

SLOTTED RING TONGUE — BARREL LENGTH: AVIKRIMP* 23/64", KRIMPTITE* 1/8"

6	1/4	19/64	N-5942	3/4	39/64	—	S-1942	37/64	7/16	A
---	-----	-------	--------	-----	-------	---	--------	-------	------	---

NET PRICES 26-24 WIRE RANGE TERMINALS

WRITE FOR QUOTATION ON LARGER QUANTITIES

Price Code Letter	KRIMPTITE*			AVIKRIMP*		
	Pkg. of 100	BULK		Pkg. of 100	BULK	
		1000-4999 Per M	5000 or more Per M		1000-4999 Per M	5000 or more Per M
A	2.27	16.35	12.75	7.57	61.45	46.10

* TRADEMARK



waldom

SOLDERLESS TERMINALS AND CONNECTORS

22-18 WIRE RANGE (Continued)

SPADE TYPE TERMINALS—SHORT (5/32") BARREL LENGTH

PRICING FOLLOWS THIS WIRE RANGE LISTING

BASIC DIMENSIONS			KRIMPTITE*		INSULKRIMP*		VERSAKRIMP*			VIBRAKRIMP*		AVIKRIMP*		Price Code See Page 8
Stud Size S	Width W	Clearance C	Part Number	Length L	.125 Max. Ins. Dia. Pt. No.	.145 Max. Ins. Dia. Pt. No.	Length L	Part Number	Length L	.145 Max. Ins. Dia. Pt. No.	Length L	.145 Max. Ins. Dia. Pt. No.	Length L	
3-4	1/4	7/32	SS-1116	17/32	ST-2116	ST-2116X	47/64	SB-3116	17/32	SD-4116	11/16	SN-5116	47/64	A
	19/64	7/32	SS-1803	17/32	ST-2803	ST-2803X	47/64	SB-3803	17/32	SD-4803	11/16	SN-5803	47/64	A
	21/64	1/4	SS-1804	5/8	ST-2804	ST-2804X	53/64	SB-3804	5/8	SD-4804	25/32	SN-5804	53/64	A
5-6	1/4	7/32	SS-1118	17/32	ST-2118	ST-2118X	47/64	SB-3118	17/32	SD-4118	11/16	SN-5118	47/64	A
	19/64	7/32	SS-1014	17/32	ST-2014	ST-2014X	47/64	SB-3014	17/32	SD-4014	11/16	SN-5014	47/64	A
	5/16	5/16	SS-1029	21/32	ST-2029	ST-2029X	55/64	SB-3029	21/32	SD-4029	13/16	SN-5029	55/64	A
	21/64	1/4	SS-1501	5/8	ST-2501	ST-2501X	53/64	SB-3501	5/8	SD-4501	25/32	SN-5501	53/64	A
	3/8	1/4	SS-1503	5/8	ST-2503	ST-2503X	53/64	SB-3503	5/8	SD-4503	25/32	SN-5503	53/64	A
27/64	1/4	SS-1805	5/8	ST-2805	ST-2805X	53/64	SB-3805	5/8	SD-4805	25/32	SN-5805	53/64	A	
8	19/64	7/32	SS-1030	17/32	ST-2030	ST-2030X	47/64	SB-3030	17/32	SD-4030	11/16	SN-5030	47/64	A
	5/16	5/16	SS-1031	21/32	ST-2031	ST-2031X	55/64	SB-3031	21/32	SD-4031	13/16	SN-5031	55/64	A
	21/64	1/4	SS-1806	5/8	ST-2806	ST-2806X	53/64	SB-3806	5/8	SD-4806	25/32	SN-5806	53/64	A
	3/8	1/4	SS-1504	5/8	ST-2504	ST-2504X	53/64	SB-3504	5/8	SD-4805	25/32	SN-5504	53/64	A
27/64	1/4	SS-1507	5/8	ST-2507	ST-2507X	53/64	SB-3507	5/8	SD-4507	25/32	SN-5507	53/64	A	
10	5/16	5/16	SS-1032	21/32	ST-2032	ST-2032X	55/64	SB-3032	21/32	SD-4032	13/16	SN-5032	55/64	A
	3/8	1/4	SS-1505	5/8	ST-2505	ST-2505X	53/64	SB-3505	5/8	SD-4505	25/32	SN-5505	53/64	A
	27/64	1/4	SS-1907	5/8	ST-2807	ST-2807X	53/64	SB-3807	5/8	SD-4807	25/32	SN-5807	53/64	A

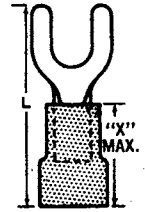

Full Barrel X=7/16"
Short Barrel X=23/64"
INSULKRIMP*

FLANGED SPADE TERMINALS—FULL (1/4") BARREL LENGTH

3-4	19/64	7/32	S-1125	5/8	T-2125	T-2125X	13/16	B-3125	5/8	D-4125	25/32	N-5125	13/16	A
	21/64	1/4	S-1808	23/32	T-2808	T-2808X	29/32	B-3808	23/32	D-4808	7/8	N-5808	29/32	A
5-6	19/64	7/32	S-1080	5/8	T-2080	T-2080X	13/16	B-3080	5/8	D-4080	25/32	N-5080	13/16	A
	21/64	1/4	S-1510	23/32	T-2510	T-2510X	29/32	B-3510	23/32	D-4510	7/8	N-5510	29/32	A
	3/8	1/4	S-1809	23/32	T-2809	T-2809X	29/32	B-3809	23/32	D-4809	7/8	N-5809	29/32	A
	27/64	1/4	S-1810	23/32	T-2810	T-2810X	29/32	B-3810	23/32	D-4810	7/8	N-5810	29/32	A
8	19/64	7/32	S-1081	5/8	T-2081	T-2081X	13/16	B-3081	5/8	D-4081	25/32	N-5081	13/16	A
	21/64	1/4	S-1811	23/32	T-2811	T-2811X	29/32	B-3811	23/32	D-4811	7/8	N-5811	29/32	A
	3/8	1/4	S-1812	23/32	T-2812	T-2812X	29/32	B-3812	23/32	D-4812	7/8	N-5812	29/32	A
	27/64	1/4	S-1516	23/32	T-2516	T-2516X	29/32	B-3516	23/32	D-4516	7/8	N-5516	29/32	A
10	3/8	1/4	S-1582	23/32	T-2582	T-2582X	29/32	B-3582	23/32	D-4582	7/8	N-5582	29/32	A
	27/64	1/4	S-1813	23/32	T-2813	T-2813X	29/32	B-3813	23/32	D-4813	7/8	N-5813	29/32	A

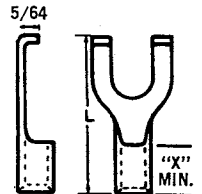

Full Barrel X=1/4"
Short Barrel X=5/32"
VERSAKRIMP*

FLANGED SPADE TERMINALS—SHORT (5/32") BARREL LENGTH

3-4	19/64	7/32	SS-1125	17/32	ST-2125	ST-2125X	47/64	SB-3125	17/32	SD-4125	11/16	SN-5125	47/64	A
	21/64	1/4	SS-1808	5/8	ST-2808	ST-2808X	53/64	SB-3808	5/8	SD-4808	25/32	SN-5808	53/64	A
5-6	19/64	7/32	SS-1080	17/32	ST-2080	ST-2080X	47/64	SB-3080	17/32	SD-4080	11/16	SN-5080	47/64	A
	21/64	1/4	SS-1510	5/8	ST-2510	ST-2510X	53/64	SB-3510	5/8	SD-4510	25/32	SN-5510	53/64	A
	3/8	1/4	SS-1809	5/8	ST-2809	ST-2809X	53/64	SB-3809	5/8	SD-4809	25/32	SN-5809	53/64	A
	27/64	1/4	SS-1810	5/8	ST-2810	ST-2810X	53/64	SB-3810	5/8	SD-4810	25/32	SN-5810	53/64	A
8	19/64	7/32	SS-1081	17/32	ST-2081	ST-2081X	47/64	SB-3081	17/32	SD-4081	11/16	SN-5081	47/64	A
	21/64	1/4	SS-1811	5/8	ST-2811	ST-2811X	53/64	SB-3811	5/8	SD-4811	25/32	SN-5811	53/64	A
	3/8	1/4	SS-1812	5/8	ST-2812	ST-2812X	53/64	SB-3812	5/8	SD-4812	25/32	SN-5812	53/64	A
	27/64	1/4	SS-1516	5/8	ST-2516	ST-2516X	53/64	SB-3516	5/8	SD-4516	25/32	SN-5516	53/64	A
10	3/8	1/4	SS-1582	5/8	ST-2582	ST-2582X	53/64	SB-3582	5/8	SD-4582	25/32	SN-5582	53/64	A
	27/64	1/4	SS-1813	5/8	ST-2813	ST-2813X	53/64	SB-3813	5/8	SD-4813	25/32	SN-5813	53/64	A

HOOK TONGUE TERMINALS—FULL (1/4") BARREL LENGTH

5-6	5/16	5/16	S-1018	23/32	T-2018	T-2018X	29/32	B-3018	23/32	D-4018	7/8	N-5018	29/32	A
8	5/16	5/16	S-1036	23/32	T-2036	T-2036X	29/32	B-3036	23/32	D-4036	7/8	N-5036	29/32	A
10	5/16	5/16	S-1037	23/32	T-2037	T-2037X	29/32	B-3037	23/32	D-4037	7/8	N-5037	29/32	A

HOOK TONGUE TERMINALS—SHORT (5/32") BARREL LENGTH

5-6	5/16	5/16	SS-1018	5/8	ST-2018	ST-2018X	53/64	SB-3018	5/8	SD-4018	25/32	SN-5018	53/64	A
8	5/16	5/16	SS-1036	5/8	ST-2036	ST-2036X	53/64	SB-3036	5/8	SD-4036	25/32	SN-5036	53/64	A
10	5/16	5/16	SS-1037	5/8	ST-2037	ST-2037X	53/64	SB-3037	5/8	SD-4037	25/32	SN-5037	53/64	A

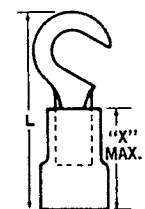

Full Barrel X=13/32"
Short Barrel X=5/16"
VIBRAKRIMP*

*TRADEMARK



waldom

SOLDERLESS TERMINALS AND CONNECTORS

16-14 WIRE RANGE (Continued)

RING TONGUE TERMINALS—SHORT (5/32") BARREL LENGTH

PRICING FOLLOWS THIS WIRE RANGE LISTING

BASIC DIMENSIONS			KRIMPTITE*		INSULKRIMP*			VERSAKRIMP*		VIBRAKRIMP*		AVIKRIMP*		Price Code See Page 8
Stud Size S	Width W	Clearance C	Part Number	Length L	.155 Max. Ins. Dia. Pt. No.	.175 Max. Ins. Dia. Pt. No.	Length L	Part Number	Length L	.175 Max. Ins. Dia. Pt. No.	Length L	.175 Max. Ins. Dia. Pt. No.	Length L	
1-2	1/4	7/32	SS-1102	1/2	ST-2102	ST-2102X	45/64	SB-3102	1/2	SD-4102	21/32	SN-5102	45/64	D
3-4	1/4	7/32	SS-1048	1/2	ST-2048	ST-2048X	45/64	SB-3048	1/2	SD-4048	21/32	SN-5048	45/64	D
	5/16	9/32	SS-1823	39/64	ST-2823	ST-2823X	13/16	SB-3823	39/64	SD-4823	49/64	SN-5823	13/16	D
5-6	1/4	7/32	SS-1006	1/2	ST-2006	ST-2006X	45/64	SB-3006	1/2	SD-4006	21/32	SN-5006	45/64	D
	5/16	9/32	SS-1007	39/64	ST-2007	ST-2007X	13/16	SB-3007	39/64	SD-4007	49/64	SN-5007	13/16	D
	11/32	5/16	SS-1092	41/64	ST-2092	ST-2092X	27/32	SB-3092	41/64	SD-4092	51/64	SN-5092	27/32	D
8	1/4	7/32	SS-1824	1/2	ST-2824	ST-2824X	45/64	SB-3824	1/2	SD-4824	21/32	SN-5824	45/64	D
	5/16	9/32	SS-1024	39/64	ST-2024	ST-2024X	13/16	SB-3024	39/64	SD-4024	49/64	SN-5024	13/16	D
	11/32	5/16	SS-1093	41/64	ST-2093	ST-2093X	27/32	SB-3093	41/64	SD-4093	51/64	SN-5093	27/32	D
10	5/16	9/32	SS-1008	39/64	ST-2008	ST-2008X	13/16	SB-3008	39/64	SD-4008	49/64	SN-5008	13/16	D
	11/32	5/16	SS-1094	41/64	ST-2094	ST-2094X	27/32	SB-3094	41/64	SD-4094	51/64	SN-5094	27/32	D
	15/32	.400	SS-1106	51/64	ST-2106	ST-2106X	1	SB-3106	51/64	SD-4106	61/64	SN-5106	1	B
1/4	15/32	.400	SS-1009	51/64	ST-2009	ST-2009X	1	SB-3009	51/64	SD-4009	61/64	SN-5009	1	B
	9/16	9/16	SS-1826	1- 1/64	ST-2826	ST-2826X	1- 7/32	SB-3826	1- 1/64	SD-4826	1-11/64	SN-5826	1- 7/32	C
5/16	15/32	.400	SS-1041	51/64	ST-2041	ST-2041X	1	SB-3041	51/64	SD-4041	61/64	SN-5041	1	B
	9/16	9/16	SS-1827	1- 1/64	ST-2827	ST-2827X	1- 7/32	SB-3827	1- 1/64	SD-4827	1-11/64	SN-5827	1- 7/32	C
3/8	9/16	9/16	SS-1147	1- 1/64	ST-2147	ST-2147X	1- 7/32	SB-3147	1- 1/64	SD-4147	1-11/64	SN-5147	1- 7/32	C

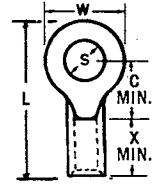

Full Barrel X=1/4"
Short Barrel X=5/32"

KRIMPTITE*
Ring Tongue

SPADE TONGUE TERMINALS—FULL (1/4") BARREL LENGTH

3-4	1/4	7/32	S-1121	5/8	T-2121	T-2121X	13/16	B-3121	5/8	D-4121	25/32	N-5121	13/16	D
	19/64	7/32	S-1828	5/8	T-2828	T-2828X	13/16	B-3828	5/8	D-4828	25/32	N-5828	13/16	D
	21/64	1/4	S-1829	23/32	T-2829	T-2829X	29/32	B-3829	23/32	D-4829	7/8	N-5829	29/32	D
5-6	1/4	7/32	S-1123	5/8	T-2123	T-2123X	13/16	B-3123	5/8	D-4123	25/32	N-5123	13/16	D
	19/64	7/32	S-1015	5/8	T-2015	T-2015X	13/16	B-3015	5/8	D-4015	25/32	N-5015	13/16	D
	21/64	1/4	S-1529	23/32	T-2529	T-2529X	29/32	B-3529	23/32	D-4529	7/8	N-5529	29/32	D
	23/64	9/32	S-1051	3/4	T-2051	T-2051X	15/16	B-3051	3/4	D-4051	29/32	N-5051	15/16	D
	3/8	1/4	S-1531	23/32	T-2531	T-2531X	29/32	B-3531	23/32	D-4531	7/8	N-5531	29/32	D
	27/64	1/4	S-1830	23/32	T-2830	T-2830X	29/32	B-3830	23/32	D-4830	7/8	N-5830	29/32	D
8	19/64	7/32	S-1033	5/8	T-2033	T-2033X	13/16	B-3033	5/8	D-4033	25/32	N-5033	13/16	D
	21/64	1/4	S-1831	23/32	T-2831	T-2831X	29/32	B-3831	23/32	D-4831	7/8	N-5831	29/32	D
	23/64	9/32	S-1052	3/4	T-2052	T-2052X	15/16	B-3052	3/4	D-4052	29/32	N-5052	15/16	D
	3/8	1/4	S-1532	23/32	T-2532	T-2532X	29/32	B-3532	23/32	D-4532	7/8	N-5532	29/32	D
	27/64	1/4	S-1535	23/32	T-2535	T-2535X	29/32	B-3535	23/32	D-4535	7/8	N-5535	29/32	D
10	23/64	9/32	S-1016	3/4	T-2016	T-2016X	15/16	B-3016	3/4	D-4016	29/32	N-5016	15/16	D
	3/8	1/4	S-1533	23/32	T-2533	T-2533X	29/32	B-3533	23/32	D-4533	7/8	N-5533	29/32	D
	27/64	1/4	S-1832	23/32	T-2832	T-2832X	29/32	B-3832	23/32	D-4832	7/8	N-5832	29/32	D

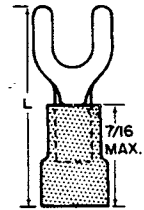

Full Barrel X=7/16"

INSULKRIMP*
Spade Tongue
Full Barrel

SPADE TONGUE TERMINALS—SHORT (5/32") BARREL LENGTH

3-4	1/4	7/32	SS-1121	17/32	ST-2121	ST-2121X	47/64	SB-3121	17/32	SD-4121	11/16	SN-5121	47/64	D
	19/64	7/32	SS-1828	17/32	ST-2828	ST-2828X	47/64	SB-3828	17/32	SD-4828	11/16	SN-5828	47/64	D
	21/64	1/4	SS-1829	5/8	ST-2829	ST-2829X	53/64	SB-3829	5/8	SD-4829	25/32	SN-5829	53/64	D
5-6	1/4	7/32	SS-1123	17/32	ST-2123	ST-2123X	47/64	SB-3123	17/32	SD-4123	11/16	SN-5123	47/64	D
	19/64	7/32	SS-1015	17/32	ST-2015	ST-2015X	47/64	SB-3015	17/32	SD-4015	11/16	SN-5015	47/64	D
	21/64	1/4	SS-1529	5/8	ST-2529	ST-2529X	53/64	SB-3529	5/8	SD-4529	25/32	SN-5529	53/64	D
	23/64	9/32	SS-1051	21/32	ST-2051	ST-2051X	55/64	SB-3051	21/32	SD-4051	13/16	SN-5051	55/64	D
	3/8	1/4	SS-1531	5/8	ST-2531	ST-2531X	53/64	SB-3531	5/8	SD-4531	25/32	SN-5531	53/64	D
	27/64	1/4	SS-1830	5/8	ST-2830	ST-2830X	53/64	SB-3830	5/8	SD-4830	25/32	SN-5830	53/64	D
8	19/64	7/32	SS-1033	17/32	ST-2033	ST-2033X	47/64	SB-3033	17/32	SD-4033	11/16	SN-5033	47/64	D
	21/64	1/4	SS-1831	5/8	ST-2831	ST-2831X	53/64	SB-3831	5/8	SD-4831	25/32	SN-5831	53/64	D
	23/64	9/32	SS-1052	21/32	ST-2052	ST-2052X	55/64	SB-3052	21/32	SD-4052	13/16	SN-5052	55/64	D
	3/8	1/4	SS-1532	5/8	ST-2532	ST-2532X	53/64	SB-3532	5/8	SD-4532	25/32	SN-5532	53/64	D
	27/64	1/4	SS-1535	5/8	ST-2535	ST-2535X	53/64	SB-3535	5/8	SD-4535	25/32	SN-5535	53/64	D
10	23/64	9/32	SS-1016	21/32	ST-2016	ST-2016X	55/64	SB-3016	21/32	SD-4016	13/16	SN-5016	55/64	D
	3/8	1/4	SS-1533	5/8	ST-2533	ST-2533X	53/64	SB-3533	5/8	SD-4533	25/32	SN-5533	53/64	D
	27/64	1/4	SS-1832	5/8	ST-2832	ST-2832X	53/64	SB-3832	5/8	SD-4832	25/32	SN-5832	53/64	D

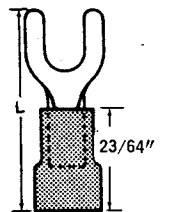

Short Barrel X=23/64"

INSULKRIMP*
Spade Tongue
Short Barrel

*TRADEMARK



waldom

SOLDERLESS TERMINALS AND CONNECTORS

16-14 WIRE RANGE (Continued)

RECTANGULAR TONGUE TERMINALS—SHORT (5/32") BARREL LENGTH PRICING FOLLOWS THIS WIRE RANGE LISTING

BASIC DIMENSIONS			KRIMPTITE*		INSULKRIMP*			VERSAKRIMP*		VIBRAKRIMP*		AVIKRIMP*		Price Code (See Pricing Below)
Stud Size S	Width W	Clearance C	Part Number	Length L	155 Max. Ins. Dia. Pt. No.	175 Max. Ins. Dia. Pt. No.	Length L	Part Number	Length L	175 Max. Ins. Dia. Pt. No.	Length L	175 Max. Ins. Dia. Pt. No.	Length L	
3-4	19/64	7/32	SS-1839	49/64	ST-2839	ST-2839X	51/32	SB-3839	49/64	SD-4839	59/64	SN-5839	31/32	D
	21/64	1/4	SS-1840	5/8	ST-2840	ST-2840X	53/64	SB-3840	5/8	SD-4840	25/32	SN-5840	53/64	D
5-6	19/64	7/32	SS-1074	49/64	ST-2074	ST-2074X	31/32	SB-3074	49/64	SD-4074	59/64	SN-5074	31/32	D
	21/64	1/4	SS-1546	5/8	ST-2546	ST-2546X	53/64	SB-3546	5/8	SD-4546	25/32	SN-5546	53/64	D
	3/8	1/4	SS-1841	5/8	ST-2841	ST-2841X	53/64	SB-3841	5/8	SD-4841	25/32	SN-5841	53/64	D
	27/64	1/4	SS-1842	5/8	ST-2842	ST-2842X	53/64	SB-3842	5/8	SD-4842	25/32	SN-5842	53/64	D
8	19/64	7/32	SS-1075	49/64	ST-2075	ST-2075X	31/32	SB-3075	49/64	SD-4075	59/64	SN-5075	31/32	D
	21/64	1/4	SS-1843	5/8	ST-2843	ST-2843X	53/64	SB-3843	5/8	SD-4843	25/32	SN-5843	53/64	D
	3/8	1/4	SS-1550	5/8	ST-2550	ST-2550X	53/64	SB-3550	5/8	SD-4550	25/32	SN-5550	53/64	D
	27/64	1/4	SS-1553	5/8	ST-2553	ST-2553X	53/64	SB-3553	5/8	SD-4553	25/32	SN-5553	53/64	D
10	21/64	1/4	SS-1844	5/8	ST-2844	ST-2844X	53/64	SB-3844	5/8	SD-4844	25/32	SN-5844	53/64	D
	3/8	1/4	SS-1551	5/8	ST-2551	ST-2551X	53/64	SB-3551	5/8	SD-4551	25/32	SN-5551	53/64	D
	27/64	1/4	SS-1845	5/8	ST-2845	ST-2845X	53/64	SB-3845	5/8	SD-4845	25/32	SN-5845	53/64	D

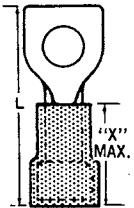

Full Barrel X=7/16"
Short Barrel X=23/64"
AVIKRIMP*
Rectangular Tongue

HEAVY DUTY RING TONGUE TERMINALS—FULL (1/4") BARREL LENGTH—.050" STOCK USE 12-10 TOOLING

BASIC DIMENSIONS			KRIMPTITE*		INSULKRIMP*			VIBRAKRIMP*		AVIKRIMP*		Price Code (See Pricing Below)		
Stud Size S	Width W	Clearance C	Part Number	Length L	275 Max. Ins. Dia. Pt. No.	255 Max. Ins. Dia. Pt. No.	Length L	275 Max. Ins. Dia. Pt. No.	255 Max. Ins. Dia. Pt. No.	Length L	275 Max. Ins. Dia. Pt. No.		255 Max. Ins. Dia. Pt. No.	
3-4	9/32	5/16	S-1401H	45/64	T-2401H	T-2401HX	1- 1/64	D-4401H	D-4401HX	1- 1/64	N-5401H	N-5401HX	1- 3/64	L
	3/8	5/16	S-1402H	3/4	T-2402H	T-2402HX	1- 1/16	D-4402H	D-4402HX	1- 1/16	N-5402H	N-5402HX	1- 3/64	L
5-6	9/32	5/16	S-1403H	45/64	T-2403H	T-2403HX	1- 1/64	D-4403H	D-4403HX	1- 1/64	N-5403H	N-5403HX	1- 3/64	L
	3/8	5/16	S-1404H	3/4	T-2404H	T-2404HX	1- 1/16	D-4404H	D-4404HX	1- 1/16	N-5404H	N-5404HX	1- 3/64	L
8	9/32	5/16	S-1432H	45/64	T-2432H	T-2432HX	1- 1/64	D-4432H	D-4432HX	1- 1/64	N-5432H	N-5432HX	1- 3/64	L
	3/8	5/16	S-1405H	3/4	T-2405H	T-2405HX	1- 1/16	D-4405H	D-4405HX	1- 1/16	N-5405H	N-5405HX	1- 3/64	L
10	3/8	5/16	S-1407H	3/4	T-2407H	T-2407HX	1- 1/16	D-4407H	D-4407HX	1- 1/16	N-5407H	N-5407HX	1- 3/64	L
	17/32	13/32	S-1408H	59/64	T-2408H	T-2408HX	1-15/64	D-4408H	D-4408HX	1-11/64	N-5408H	N-5408HX	1- 7/32	M
	19/32	31/64	S-1409H	1- 1/32	T-2409H	T-2409HX	1-11/32	D-4409H	D-4409HX	1- 9/32	N-5409H	N-5409HX	1-21/64	N
1/4	17/32	13/32	S-1410H	59/64	T-2410H	T-2410HX	1-15/64	D-4410H	D-4410HX	1-11/64	N-5410H	N-5410HX	1- 7/32	M
	19/32	31/64	S-1411H	1- 1/32	T-2411H	T-2411HX	1-11/32	D-4411H	D-4411HX	1- 9/32	N-5411H	N-5411HX	1-21/64	N
	3/4	5/8	S-1433H	1-17/64	T-2433H	T-2433HX	1-37/64	D-4433H	D-4433HX	1-33/64	N-5433H	N-5433HX	1- 9/16	O
5/16	17/32	13/32	S-1413H	59/64	T-2413H	T-2413HX	1-15/64	D-4413H	D-4413HX	1-11/64	N-5413H	N-5413HX	1- 7/32	M
	19/32	31/64	S-1414H	1- 1/32	T-2414H	T-2414HX	1-11/32	D-4414H	D-4414HX	1- 9/32	N-5414H	N-5414HX	1-21/64	N
	3/4	5/8	S-1434H	1-17/64	T-2434H	T-2434HX	1-37/64	D-4434H	D-4434HX	1-33/64	N-5434H	N-5434HX	1- 9/16	O
3/8	18/32	31/64	S-1516H	1- 1/32	T-2416H	T-2416HX	1-11/32	D-4416H	D-4416HX	1- 9/32	N-5416H	N-5416HX	1-21/64	N
	3/4	5/8	S-1417H	1-17/64	T-2417H	T-2417HX	1-37/64	D-4417H	D-4417HX	1-33/64	N-5417H	N-5417HX	1- 9/16	O
7/16	3/4	5/8	S-1435H	1-17/64	T-2435H	T-2435HX	1-37/64	D-4435H	D-4435HX	1-33/64	N-5435H	N-5435HX	1- 9/16	O
1/2	3/4	5/8	S-1419H	1-17/64	T-2419H	T-2419HX	1-37/64	D-4419H	D-4419HX	1-33/64	N-5419H	N-5419HX	1- 9/16	O

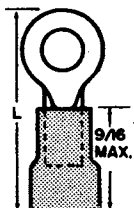

INSULKRIMP*
Heavy Duty Ring Tongue

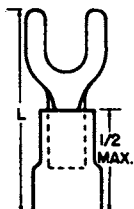

VIBRAKRIMP*
Heavy Duty Spade Tongue

HEAVY DUTY SPADE TONGUE TERMINALS—FULL (1/4") BARREL LENGTH—.050" STOCK

5-6	3/8	5/16	S-1420H	25/32	T-2420H	T-2420HX	1- 3/32	D-4420H	D-4420HX	1- 1/32	N-5420H	N-5420HX	1- 5/64	L
8	3/8	5/16	S-1421H	25/32	T-2421H	T-2421HX	1- 3/32	D-4421H	D-4421HX	1- 1/32	N-5421H	N-5421HX	1- 5/64	L
10	3/8	5/16	S-1422H	25/32	T-2422H	T-2422HX	1- 3/32	D-4422H	D-4422HX	1- 1/32	N-5422H	N-5422HX	1- 5/64	L
1/4	17/32	13/32	S-1427H	59/64	T-2427H	T-2427HX	1-15/64	D-4427H	D-4427HX	1-11/64	N-5427H	N-5427HX	1- 7/32	M
5/16	17/32	13/32	S-1428H	59/64	T-2428H	T-2428HX	1-15/64	D-4428H	D-4428HX	1-11/64	N-5428H	N-5428HX	1- 7/32	M

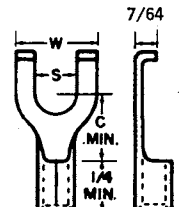

KRIMPTITE*
Heavy Duty Flanged Spade

HEAVY DUTY FLANGED SPADE TERMINALS—FULL (1/4") BARREL LENGTH—.050" STOCK

5-6	3/8	5/16	S-1423H	3/4	T-2423H	T-2423HX	1- 1/16	D-4423H	D-4423HX	1	N-5423H	N-5423HX	1- 3/64	L
8	3/8	5/16	S-1424H	3/4	T-2424H	T-2424HX	1- 1/16	D-4424H	D-4424HX	1	N-5424H	N-5424HX	1- 3/64	L
10	3/8	5/16	S-1425H	3/4	T-2425H	T-2425HX	1- 1/16	D-4425H	D-4425HX	1	N-5425H	N-5425HX	1- 3/64	L

NET PRICES — 16-14 WIRE RANGE TERMINALS

WRITE FOR QUOTATIONS ON LARGER QUANTITIES

Price Code Letter	KRIMPTITE*		INSULKRIMP* No Suffix		INSULKRIMP* Suffix (X)		VERSAKRIMP*		VIBRAKRIMP*		AVIKRIMP*							
	Pkg. of 100	1000-5000 or more per M	Pkg. of 100	1000-5000 or more per M	Pkg. of 100	1000-5000 or more per M	Pkg. of 100	1000-5000 or more per M	Pkg. of 100	1000-5000 or more per M	Pkg. of 100	1000-5000 or more per M						
													BULK	BULK	BULK	BULK	BULK	BULK
B	3.11	22.35	17.50	5.79	42.80	33.45	6.13	45.35	35.40	4.87	39.15	29.35	6.76	54.10	40.55	9.47	75.75	56.85
C	4.08	29.45	23.00	5.79	42.80	33.45	6.13	45.35	35.40	4.87	39.15	29.35	6.76	54.10	40.55	9.47	75.75	56.85
D	2.37	17.05	13.35	4.47	33.05	25.85	5.02	37.10	29.00	3.50	28.00	21.00	5.30	42.40	31.80	7.57	61.45	46.10
L	3.53	28.20	21.15	6.64	53.15	39.85	6.64	53.15	39.85		8.89	71.10	53.35	12.00	95.95	72.00		
M	4.55	36.40	27.30	7.33	58.60	43.95	7.33	58.60	43.95		9.36	74.90	56.20	13.08	104.70	78.50		
N	5.01	40.10	30.10	7.95	63.65	47.65	7.95	63.65	47.65		10.29	82.20	61.70	13.86	110.85	83.15		
O	7.97	63.75	47.85	11.44	91.45	68.55	11.44	91.45	68.55		12.85	100.60	75.45	14.89	119.20	89.35		

*TRADEMARK



waldom

SOLDERLESS TERMINALS AND CONNECTORS

8 WIRE RANGE

BUREAU OF SHIPS 14
CIRCULAR MIL AREA 13,100-20,800

.050" STOCK • INSULATION COLOR CODED RED

PRICING FOLLOWS THIS WIRE RANGE LISTING

RING TONGUE TERMINALS

(AVAILABLE IN RING TONGUE ONLY)

BASIC DIMENSIONS			VERSAKRIMP*		INSULKRIMP*			NYLAKRIMP*		Price Code See Page 12
Stud Size S	Width W	Clearance C	Part Number	Length L	.300 Max. Ins. Dia. Pt. No.	.385 Max. Ins. Dia. Pt. No.	Length L	.300 Max. Ins. Dia. Pt. No.	Length L	
6	15/32	11/32	B-3851	61/64	T-2851	T-2851X	1-17/64	N-5851	1-17/64	P
	3/8	11/32	B-3852	29/32	T-2852	T-2852X	1- 7/32	N-5852	1- 7/32	P
8	15/32	11/32	B-3201	61/64	T-2201	T-2201X	1-17/64	N-5201	1-17/64	P
	3/8	11/32	B-3225	29/32	T-2225	T-2225X	1-17/32	N-5225	1- 7/32	P
10	15/32	11/32	B-3202	61/64	T-2202	T-2202X	1-17/64	N-5202	1-17/64	P
	19/32	13/32	B-3205	1- 5/64	T-2205	T-2205X	1-25/64	N-5205	1-25/64	Q
	13/16	19/32	B-3853	1- 3/8	T-2853	T-2853X	1-11/16	N-5853	1-11/16	R
	3/8	11/32	B-3226	29/32	T-2226	T-2226X	1- 7/32	N-5226	1- 7/32	P
1/4	15/32	11/32	B-3203	61/64	T-2203	T-2203X	1-17/64	N-5203	1-17/64	P
	19/32	13/32	B-3206	1- 5/64	T-2206	T-2206X	1-25/64	N-5206	1-25/64	Q
	13/16	19/32	B-3854	1- 3/8	T-2854	T-2854X	1-11/16	N-5854	1-11/16	R
	1- 1/8	31/32	B-3855	1-29/32	T-2855	T-2855X	2- 7/32	N-5855	2- 7/32	R
	3/8	11/32	B-3856	29/32	T-2856	T-2856X	1- 7/32	N-5856	1- 7/32	P
5/16	15/32	11/32	B-3204	61/64	T-2204	T-2204X	1-17/64	N-5204	1-17/64	P
	19/32	13/32	B-3207	1- 5/64	T-2207	T-2207X	1-25/64	N-5207	1-25/64	Q
	13/16	19/32	B-3857	1- 3/8	T-2857	T-2857X	1-11/16	N-5857	1-11/16	R
	1- 1/8	31/32	B-3218	1-29/32	T-2218	T-2218X	2- 7/32	N-5218	2- 7/32	R
3/8	19/32	13/32	B-3208	1- 5/64	T-2208	T-2208X	1-25/64	N-5208	1-25/64	Q
	13/16	19/32	B-3858	1- 3/8	T-2858	T-2858X	1-11/16	N-5858	1-11/16	R
	1- 1/8	31/32	B-3219	1-29/32	T-2219	T-2219X	2- 7/32	N-5219	2- 7/32	R
7/16	19/32	13/32	B-3859	1- 5/64	T-2859	T-2859X	1-25/64	N-5859	1-25/64	Q
	13/16	19/32	B-3860	1- 3/8	T-2860	T-2860X	1-11/16	N-5860	1-11/16	R
	1- 1/8	31/32	B-3861	1-29/32	T-2861	T-2861X	2- 7/32	N-5861	2- 7/32	R
1/2	13/16	19/32	B-3862	1- 3/8	T-2862	T-2862X	1-11/16	N-5862	1-11/16	R
	1- 1/8	31/32	B-3221	1-29/32	T-2221	T-2221X	2- 7/32	N-5221	2- 7/32	R
5/8	13/16	19/32	B-3863	1- 3/8	T-2863	T-2863X	1-11/16	N-5863	1-11/16	R
	1- 1/8	31/32	B-3222	1-29/32	T-2222	T-2222X	2- 7/32	N-5222	2- 7/32	R
3/4	1- 1/8	31/32	B-3223	1-29/32	T-2223	T-2223X	2- 7/32	N-5223	2- 7/32	R

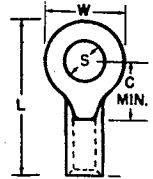

VERSAKRIMP*
Ring Tongue

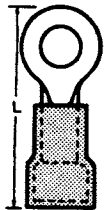

INSULKRIMP*
(Flared)
Ring Tongue

6 WIRE RANGE

BUREAU OF SHIPS 23-30
CIRCULAR MIL AREA 20,800-33,100

.057" STOCK • INSULATION COLOR CODED BLUE

RING TONGUE TERMINALS

(AVAILABLE IN RING TONGUE ONLY)

BASIC DIMENSIONS			VERSAKRIMP*		INSULKRIMP*			NYLAKRIMP*		Price Code See Page 12
Stud Size S	Width W	Clearance C	Part Number	Length L	.360 Max. Ins. Dia. Pt. No.	.440 Max. Ins. Dia. Pt. No.	Length L	.360 Max. Ins. Dia. Pt. No.	Length L	
8	5/8	1/2	B-3864	1- 1/4	T-2864	T-2864X	1- 5/8	N-5864	1- 5/8	S
	15/32	1/2	B-3865	1-11/64	T-2865	T-2865X	1-35/64	N-5865	1-35/64	S
10	5/8	1/2	B-3228	1- 1/4	T-2228	T-2228X	1- 5/8	N-5228	1- 5/8	S
	13/16	19/32	B-3866	1- 7/16	T-2866	T-2866X	1-13/16	N-5866	1-13/16	U
	15/32	1/2	B-3248	1-11/64	T-2248	T-2248X	1-35/64	N-5248	1-35/64	S
1/4	5/8	1/2	B-3229	1- 1/4	T-2229	T-2229X	1- 5/8	N-5229	1- 5/8	S
	13/16	19/32	B-3867	1- 7/16	T-2867	T-2867X	1-13/16	N-5867	1-13/16	U
	1- 1/8	31/32	B-3868	1-31/32	T-2868	T-2868X	2-11/32	N-5868	2-11/32	T
	15/32	1/2	B-3249	1-11/64	T-2249	T-2249X	1-35/64	N-5249	1-35/64	S
5/16	5/8	1/2	B-3230	1- 1/4	T-2230	T-2230X	1- 5/8	N-5230	1- 5/8	S
	13/16	19/32	B-3869	1- 7/16	T-2869	T-2869X	1-13/16	N-5869	1-13/16	U
	1- 1/8	31/32	B-3241	1-31/32	T-2241	T-2241X	2-11/32	N-5241	2-11/32	T
	15/32	1/2	B-3870	1-11/64	T-2870	T-2870X	1-35/64	N-5870	1-35/64	S
3/8	5/8	1/2	B-3231	1- 1/4	T-2231	T-2231X	1- 5/8	N-5231	1- 5/8	S
	13/16	19/32	B-3871	1- 7/16	T-2871	T-2871X	1-13/16	N-5871	1-13/16	U
	1- 1/8	31/32	B-3242	1-31/32	T-2242	T-2242X	2-11/32	N-5242	2-11/32	T
7/16	5/8	1/2	B-3232	1- 1/4	T-2232	T-2232X	1- 5/8	N-5232	1- 5/8	S
	13/16	19/32	B-3872	1- 7/16	T-2872	T-2872X	1-13/16	N-5872	1-13/16	U
	1- 1/8	31/32	B-3873	1-31/32	T-2873	T-2873X	2-11/32	N-5873	2-11/32	T
1/2	13/16	19/32	B-3238	1- 7/16	T-2238	T-2238X	1-13/16	N-5238	1-13/16	U
	1- 1/8	31/32	B-3244	1-31/32	T-2244	T-2244X	2-11/32	N-5244	2-11/32	T
5/8	13/16	19/32	B-3874	1- 7/16	T-2874	T-2874X	1-13/16	N-5874	1-13/16	U
	1- 1/8	31/32	B-3245	1-31/32	T-2245	T-2245X	2-11/32	N-5245	2-11/32	T
3/4	1- 1/8	31/32	B-3246	1-31/32	T-2246	T-2246X	2-11/32	N-5246	2-11/32	T

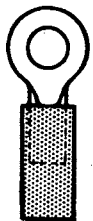

(Nylon Insulated)
NYLAKRIMP*
Ring Tongue

*TRADEMARK

Note: Large size INSULKRIMP* and NYLAKRIMP* parts have brazed barrels of VERSAKRIMP style.



waldom

SOLDERLESS TERMINALS AND CONNECTORS

1/0 WIRE RANGE

BUREAU OF SHIPS 100
CIRCULAR MIL AREA 83,700-119,500

.075" STOCK • INSULATION COLOR CODED BLUE •
RING TONGUE (AVAILABLE IN RING TONGUE ONLY)

BASIC DIMENSIONS			VERSAKRIMP*		NYLAKRIMP*		Price Code (See Pricing Below)
Stud Size S	Width W	Clearance C	Part Number	Length L	595 Max. Ins. Dia. Pt. No.	Length L	
1/4	13/16	5/8	B-3307	1-59/64	N-5307	2-35/64	AB
	7/8	5/8	B-3310	1-61/64			AC
5/16	13/16	5/8	B-3308	1-59/64	N-5308	2-35/64	AB
	7/8	5/8	B-3311	1-61/64			AC
3/8	13/16	5/8	B-3309	1-59/64	N-5309	2-35/64	AB
	7/8	5/8	B-3312	1-61/64	N-5312	2-37/64	AC
	1- 1/4	1- 1/8	B-3315	2-11/16	N-5315	3- 5/16	AD
7/16	7/8	5/8	B-3313	1-61/64	N-5313	2-37/64	AC
1/2	7/8	5/8	B-3314	1-61/64	N-5314	2-37/64	AC
	1- 1/4	1- 1/8	B-3316	2-11/16	N-5316	3- 5/16	AD
5/8	1- 1/4	1- 1/8	B-3317	2-11/16	N-5317	3- 5/16	AD
3/4	1- 1/4	1- 1/8	B-3318	2-11/16	N-5318	3- 5/16	AD
7/8	1- 1/4	1- 1/8	B-3319	2-11/16	N-5319	3- 5/16	AD

2/0 WIRE RANGES

BUREAU OF SHIPS 125
CIRCULAR MIL AREA 119,500-150,500

.083" STOCK • INSULATION COLOR CODED YELLOW •
RING TONGUE (AVAILABLE IN RING TONGUE ONLY)

BASIC DIMENSIONS			VERSAKRIMP*		NYLAKRIMP*		Price Code (See Pricing Below)
Stud Size S	Width W	Clearance C	Part Number	Length L	675 Max. Ins. Dia. Pt. No.	Length L	
1/4	29/32	5/8	B-3322	1-15/16			AE
	15/16	5/8	B-3327	2	N-5327	2- 5/8	AF
5/16	29/32	5/8	B-3323	1-15/16			AE
	15/16	5/8	B-3328	2	N-5328	2- 5/8	AF
3/8	29/32	5/8	B-3324	1-15/16			AE
	15/16	5/8	B-3329	2	N-5329	2- 5/8	AF
7/16	29/32	5/8	B-3325	1-15/16			AE
	15/16	5/8	B-3330	2	N-5330	2- 5/8	AF
1/2	29/32	5/8	B-3326	1-15/16			AE
	15/16	5/8	B-3331	2	N-5331	2- 5/8	AF
5/8	1- 1/4	1- 1/8	B-3332	2-43/64	N-5332	3-19/64	AG
	1- 1/4	1- 1/8	B-3333	2-43/64	N-5333	3-19/64	AG
3/4	1- 1/4	1- 1/8	B-3334	2-43/64	N-5334	3-19/64	AG
7/8	1- 1/4	1- 1/8	B-3335	2-43/64	N-5335	3-19/64	AG

3/0 WIRE RANGE

BUREAU OF SHIPS 150
CIRCULAR MIL AREA 150,500-190,000

.095" STOCK • INSULATION COLOR CODED RED •
RING TONGUE (AVAILABLE IN RING TONGUE ONLY)

BASIC DIMENSIONS			VERSAKRIMP*		NYLAKRIMP*		Price Code (See Pricing Below)
Stud Size S	Width W	Clearance C	Part Number	Length L	735 Max. Ins. Dia. Pt. No.	Length L	
5/16	1- 3/64	3/4	B-3898	2- 7/64	N-5898	2-57/64	BO
	1- 3/64	3/4	B-3899	2- 7/64	N-5899	2-57/64	BO
7/16	1- 3/64	3/4	B-3900	2- 7/64	N-5900	2-57/64	BO
	1- 3/64	3/4	B-3901	2- 7/64	N-5901	2-57/64	BO
5/8	1- 3/64	3/4	B-3902	2- 7/64	N-5902	2-57/64	BO
	1- 1/4	1- 1/8	B-3903	2-11/16	N-5903	3-15/32	BP
	1- 3/64	3/4	B-3904	2- 7/64	N-5904	2-57/64	BO
3/4	1- 1/4	1- 1/8	B-3905	2-11/16	N-5905	3-15/32	BP
	1- 1/4	1- 1/8	B-3906	2-11/16	N-5906	3-15/32	BP

4/0 WIRE RANGE

BUREAU OF SHIPS 200
CIRCULAR MIL AREA 190,000-231,000

.105" STOCK • INSULATION COLOR CODED BLUE •
RING TONGUE (AVAILABLE IN RING TONGUE ONLY)

BASIC DIMENSIONS			VERSAKRIMP*		NYLAKRIMP*		Price Code (See Pricing Below)
Stud Size S	Width W	Clearance C	Part Number	Length L	835 Max. Ins. Dia. Pt. No.	Length L	
3/8	1- 1/8	11/16	B-3907	2-11/64	N-5907	2-61/64	BQ
7/16	1- 1/8	11/16	B-3908	2-11/64	N-5908	2-61/64	BQ
1/2	1- 1/8	11/16	B-3910	2-11/64	N-5910	2-61/64	BQ
5/8	1- 1/4	1- 1/8	B-3911	2-45/64	N-5911	3-31/64	BR
3/4	1- 1/4	1- 1/8	B-3912	2-45/64	N-5912	3-31/64	BR
7/8	1- 1/4	1- 1/8	B-3913	2-45/64	N-5913	3-31/64	BR

NET PRICES — LARGE WIRE RANGE TERMINALS (8, 6, 4 & 2 Wire Ranges)

WRITE FOR QUOTATIONS ON LARGER QUANTITIES

Code Letter	VERSAKRIMP*				INSULKRIMP* Straight Insulation				INSULKRIMP* Flared Insulation				NYLAKRIMP*			
	Pkg. of (A)25 (B)20	100-999, per C	1000-4999, per M	5000 or more, per M	Pkg. of (A)25 (B)20	100-999, per C	1000-4999, per M	5000 or more, per M	Pkg. of (A)25 (B)20	100-999, per C	1000-4999, per M	5000 or more, per M	Pkg. of (A)25 (B)20	100-999, per C	1000-4999, per M	5000 or more, per M
P	(A)2.40	7.70	67.55	57.90	(A)3.43	11.00	96.15	82.40	(A)3.67	11.75	102.80	88.10	(A)4.62	15.30	135.45	109.50
Q	(A)3.21	10.25	89.80	76.95	(A)4.22	13.55	118.35	101.50	(A)4.47	14.30	125.05	107.15	(A)5.44	18.05	159.90	129.25
R	(A)4.70	15.05	131.50	112.70	(A)5.72	18.30	160.10	137.25	(A)5.95	19.05	166.65	142.85	(A)7.06	23.40	207.25	167.60
S	(A)3.72	11.90	104.05	89.20	(A)4.92	15.70	137.50	117.90	(A)5.26	16.80	147.00	126.00	(A)6.43	21.30	188.80	160.65
T	(A)5.09	16.30	142.65	122.30	(A)6.29	20.15	176.15	151.05	(A)6.59	21.10	184.90	158.05	(A)7.88	26.00	231.20	196.75
U	(A)4.38	14.00	122.05	125.15	(A)5.58	17.85	156.10	133.80	(A)5.87	18.80	164.40	140.80	(A)7.17	23.50	209.20	178.05
V	(B)4.27	17.05	149.20	127.90	(B)6.82	21.80	190.65	163.40	(B)7.12	22.70	198.80	170.40	(B)6.30	26.10	231.40	196.95
W	(B)5.27	21.10	184.45	158.10	(B)8.09	25.80	225.90	193.60	(B)8.37	26.75	234.05	200.60	(B)7.35	30.45	270.20	229.95
X	(B)5.59	22.35	195.45	167.50	(B)8.47	27.05	236.90	203.05	(B)8.77	28.00	245.00	210.00	(B)7.69	31.80	282.25	240.20
Y	(B)5.84	23.35	204.35	175.20	(B)9.15	29.25	255.90	219.35	(B)9.49	30.30	265.20	227.35	(B)9.45	39.15	347.10	295.35
Z	(B)7.86	32.50	288.60	245.60	(B)9.27	38.65	342.65	291.60	(B)9.70	39.80	348.70	297.45	(B)11.58	47.95	425.35	362.05
AA	(B)8.57	34.30	299.90	257.05	(B)12.57	40.15	351.45	301.25	(B)12.90	41.25	360.80	309.20	(B)12.32	50.99	452.20	384.85

NET PRICES — (1/0 & 2/0 Wire Ranges)

(3/0 & 4/0 Wire Ranges)

WRITE FOR QUOTATIONS ON LARGER QUANTITIES

Code Letter	VERSAKRIMP*				NYLAKRIMP*			
	Pkg. of 20	100-999, per C	1000-4999, per M	5000 or more, per M	Pkg. of 20	100-999, per C	1000-4999, per M	5000 or more, per M
AB	7.10	28.40	249.45	213.80	13.55	52.45	466.00	377.60
AC	6.80	27.15	287.75	203.80	13.55	52.45	466.00	377.60
AD	8.99	35.95	315.50	270.45	17.18	66.35	589.40	477.60
AE	9.05	36.20	318.15	272.70				
AF	9.06	36.25	318.30	272.80	15.23	59.05	524.50	424.95

Code Letter	VERSAKRIMP*				NYLAKRIMP*			
	Pkg. of 20	100-999, per C	1000-4999, per M	5000 or more, per M	Pkg. of 20	100-999, per C	1000-4999, per M	5000 or more, per M
AG	12.29	49.10	404.60	346.80	19.43	75.15	667.00	540.40
BO	11.55	44.70	397.00	321.70	18.11	70.45	625.00	506.80
BP	13.90	54.00	479.00	388.60	21.89	85.05	755.60	612.20
BQ	13.65	52.85	469.20	380.10	22.68	88.05	781.90	633.45
BR	17.60	68.30	606.75	491.55	33.02	126.10	1,119.45	907.05

SOLID SILVER-BRAZED BARRELS

The barrel seam of the parts in Wire Ranges 8 thru 4/0 is closed with a 35% Silver Brazing Alloy to insure a solid one-piece barrel which will not open when crimped or under any stress or wire pull.

EXTRA WIRE-GRIPPING POWER

Specially designed indentations in the form of inverted truncated pyramids provide the interior of the barrels of all parts in Wire Ranges 8 thru 4/0 with extra wire-grIPPING power & greater contact area.

BENT TONGUES AVAILABLE

Terminal tongues can be bent to any angle for special applications. Although 90° and 45° angle bends are the most popular, we will form terminal tongues to your particular specifications.

Note: Large size INSULKRIMP* and NYLAKRIMP* parts have brazed barrels of VERSAKRIMP* style.



waldom

SOLDERLESS TERMINALS AND CONNECTORS

3-WAY & 4-WAY CONNECTORS

WRITE FOR QUOTATIONS ON LARGER QUANTITIES

"Y" and "X" Connectors are made up of ring terminals joined to form a 3-way or 4-way splice. The wire ranges apply to each terminal. Material is tin-plated copper with a plated steel rivet. Other combinations of standard terminals can be supplied on special order.

3-WAY "Y" CONNECTORS

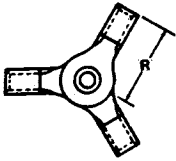

Wire Range	Stock	KRIMPTITE*		INSULKRIMP*			VERSAKRIMP*		VIBRAKRIMP*		AVIKRIMP*			Price Code (See pricing below)			
		Part Number	Ref. Length R	Part Number	Max. Ins. Dia.	Part Number	Max. Ins. Dia.	Ref. Length R	Part Number	Ref. Length R	Part Number	Max. Ins. Dia.	Ref. Length R		Part Number	Max. Ins. Dia.	Ref. Length R
22-16	.032	S-1065	33/64	T-2065	.125	T-2065X	.145	45/64	B-3065	33/64	D-4065	.145	43/64	N-5065	.145	45/64	BF
16-14	.032	S-1066	35/64	T-2066	.155	T-2066X	.175	47/64	B-3066	35/64	D-4066	.175	45/64	N-5066	.175	47/64	BF
12-10	.040	S-1067	37/64	T-2067	.215	T-2067X	.255	57/64	B-3067	37/64	D-4067	.235	53/64	N-5067	.235	7/8	BG

4-WAY "X" CONNECTORS

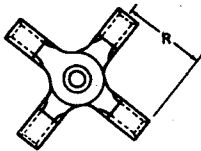

Wire Range	Stock	KRIMPTITE*		INSULKRIMP*			VERSAKRIMP*		VIBRAKRIMP*		AVIKRIMP*			Price Code (See pricing below)			
		Part Number	Ref. Length R	Part Number	Max. Ins. Dia.	Part Number	Max. Ins. Dia.	Ref. Length R	Part Number	Ref. Length R	Part Number	Max. Ins. Dia.	Ref. Length R		Part Number	Max. Ins. Dia.	Ref. Length R
22-16	.032	S-1068	33/64	T-2068	.125	T-2068X	.145	45/64	B-3068	33/64	D-4068	.145	43/64	N-5068	.145	45/64	BH
16-14	.032	S-1069	35/64	T-2069	.155	T-2069X	.175	47/64	B-3069	35/64	D-4069	.175	45/64	N-5069	.175	47/64	BH
12-10	.040	S-1070	37/64	T-2070	.215	T-2070X	.255	57/64	B-3070	37/64	D-4070	.235	53/64	N-5070	.235	7/8	BI

NET PRICES — 3-WAY AND 4-WAY CONNECTORS

WRITE FOR QUOTATIONS ON LARGER QUANTITIES

Code No.	Pkg. of 25	KRIMPTITE*		INSULKRIMP* Straight Insulation		INSULKRIMP* Flared Insulation			VERSAKRIMP*		VIBRAKRIMP*		AVIKRIMP*					
		Bulk		Bulk		Bulk			Bulk		Bulk		Bulk					
		500-1499, per M	1500 or more, per M	Pkg. of 25	500-1499, per M	1500 or more, per M	Pkg. of 25	500-1499, per M	1500 or more, per M	Pkg. of 25	500-1499, per M	1500 or more, per M	Pkg. of 25	500-1499, per M	1500 or more, per M	Pkg. of 25		
BF	1.88	60.25	45.20	4.21	134.85	101.20	4.69	149.80	112.40	3.43	109.90	82.45	5.05	161.50	121.10	6.92	221.30	165.95
BG	2.60	83.05	62.30	5.38	172.25	129.05	5.91	188.85	141.70	4.09	131.00	98.30	6.32	202.15	151.55	8.44	270.25	202.65
BH	2.47	74.85	59.25	5.50	175.90	131.90	6.13	195.80	146.85	4.48	143.35	107.45	6.60	211.25	158.45	9.09	290.70	218.05
BI	3.56	113.85	85.40	7.04	225.40	169.05	7.66	245.20	183.90	6.57	210.10	157.55	8.30	265.20	198.90	11.12	355.95	267.00

FOLD-OVER SOLDERLESS TERMINALS

Designed to give a trim appearance to otherwise unsightly wire connections. They fold neatly over the stranding and confine it directly under binding screw or nut and automatically insure greatest possible contact. The cushion-like con-

struction when closed permits binding nut or screw to sink into the soft copper and so serve the purpose of a lock nut and is therefore vibration proof. Each is adaptable to a wide range of wire sizes. For standard, extra flexible or solid wire.



FIG. 1

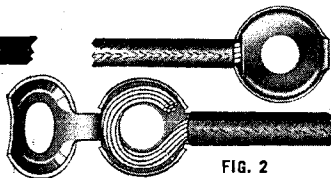

FIG. 2

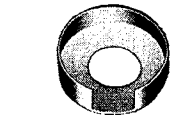

FIG. 3

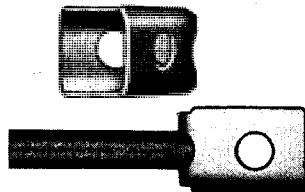

FIG. 4

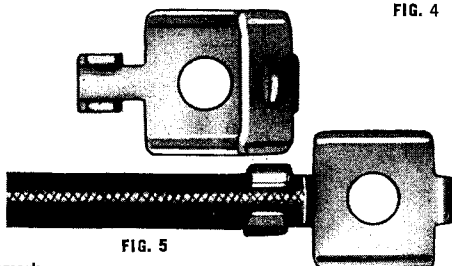

FIG. 5

CIRCULAR FOLDING TERMINALS WITH INSULATION GRIP (FIG. 1)

Wire Range	Stud Size	Width	Length	Part No.	Price Per 100	1000-4999 Per M	5000-over Per M
18-14	6-8	5/16	9/16	KH-100	\$2.72	\$23.10	\$19.65
18-14	6-10	3/8	11/16	KH-101	2.90	24.70	21.00
16-10	6-8	7/16	13/16	KH-102	3.07	26.10	22.20
16-10	6-10	9/16	15/16	KH-103	3.42	29.10	24.75
16-10	12-1/4	9/16	15/16	KH-104	3.42	29.10	24.75
10-6	1/4-3/8	21/32	1-1/8	KH-105	5.96	50.70	43.10
10-6	3/8-9/8	13/16	1-1/4	KH-106	13.12	111.50	94.80
10-6	3/8-3/8	1	1-5/16	KH-107	24.50	208.30	177.05

CIRCULAR FOLDING TERMINALS WITHOUT INSULATION GRIP (FIG. 2)

Wire Range	Stud Size	Width	Length	Part No.	Price Per 100	1000-4999 Per M	5000-over Per M
18-10	6-10	9/16	9/16	KH-120	1.57	13.40	11.40
12-8	12-1/4	21/32	11/16	KH-121	1.67	14.20	12.10
18-10	6-8	7/16	7/16	KH-122	1.75	14.90	12.20
18-10	6-10	1/2	1/2	KH-123	1.84	15.60	13.25
18-14	6-10	3/8	3/8	KH-124	2.10	17.90	15.22
18-14	6-8	5/16	5/16	KH-125	3.32	28.20	24.00

SINGLE CUP WASHER TERMINALS (FIG. 3)

Wire Range	Stud Size	Width	Length	Part No.	Price Per 100	1000-4999 Per M	5000-over Per M
18-14	4-6	1/4	1/4	KH-130	1.22	10.40	8.85
16-10	6-10	9/16	9/16	KH-131	1.32	11.20	9.50
16-10	6-8	7/16	7/16	KH-132	1.39	11.80	10.00
18-14	6-10	3/8	3/8	KH-133	1.57	13.40	11.40
18-14	6-8	5/16	5/16	KH-134	1.70	14.50	12.35
18-14	4-6	1/4	1/4	KH-135	1.84	15.60	13.25

RECTANGULAR FOLDING TERMINALS WITHOUT INSULATION GRIP (FIG. 4)

Wire Range	Stud Size	Width	Length	Part No.	Price Per 100	1000-4999 Per M	5000-over Per M
6-10	10-12	15/32	3/4	KH-140	4.02	34.20	29.05
8-4	12-1/4	11/16	7/8	KH-141	6.12	52.00	44.20

RECTANGULAR FOLDING TERMINALS WITH INSULATION GRIP (FIG. 5)

Wire Range	Stud Size	Width	Length	Part No.	Price Per 100	1000-4999 Per M	5000-over Per M
18-10	6-10	1/2	1	KH-150	8.75	74.40	63.25
12-6	12-1/4	11/16	1-1/8	KH-151	3.50	29.80	25.35

* Trademark



waldom

SOLDERLESS TERMINALS AND CONNECTORS

QUICK DISCONNECT DEVICES

SNAP PLUGS

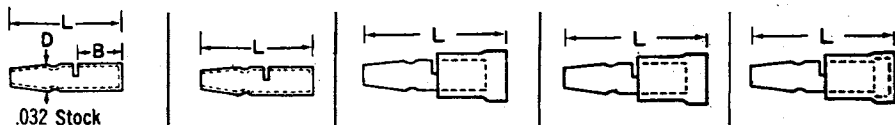

Cat. No. PR-1426
INSULATED SNAP PLUG RECEPTACLE
 An insulated connector for use with S-1055, T-2055, T-2055X, or D-4055 only. One snap plug is inserted in either end of the receptacle. Tubular Shell is high impact transparent Styrene.

BASIC DIMENSIONS				KRIMPTITE*		INSULKRIMP*			VIBRAKRIMP*		AVIKRIMP*		Price Code (See Pricing Below)
Wire Range	Length L	Barrel Length B	Diameter D	Part Number	Length L	.155 Max. Ins. Dia. Pt. No.	.175 Max. Ins. Dia. Pt. No.	Length L	.175 Max. Ins. Dia. Pt. No.	Length L	.175 Max. Ins. Dia. Pt. No.	Length L	
16-14	35/64	3/16	.176	S-1056	35/64	T-2056	T-2056X	51/64	D-4056	49/64	N-5056	51/64	AW
16-14	19/32	3/16	.157	S-1055	19/32	T-2055	T-2055X	21/32	D-4055	13/16	N-5055	27/32	AV

Part No.	Pkg. of 100	BULK	
		1000-4999 per M	5000 or more per M
PR-1426	2.98	54.70	50.35

QUICK-DISCONNECT PUSH-ON TYPE TERMINALS

18-14 WIRE RANGE (USE 22-18 SHORT BARREL TOOLING) FEMALE IN LINE

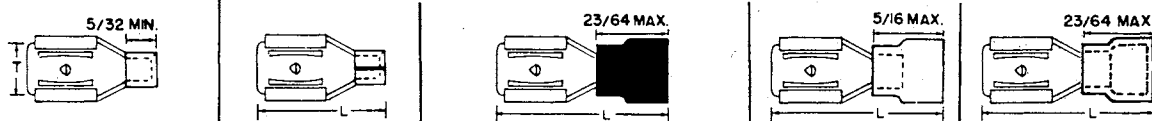

BASIC DIMENSIONS			KRIMPTITE*		INSULKRIMP*			VIBRAKRIMP*		AVIKRIMP*		Price Code Letter (See Pricing Below)
Fits Male Tab T	Stock		Part Number	Length L Max.	.155 Max. Ins. Dia. Pt. No.	.175 Max. Ins. Dia. Pt. No.	Length L Max.	.175 Max. Ins. Dia. Pt. No.	Length L Max.	.175 Max. Ins. Dia. Pt. No.	Length L Max.	
.110	.125 x .020	.016	SS-1186	29/64	ST-2186	ST-2186X	21/32	SD-4186	39/64	SN-5186	27/32	AX
	.187 x .020	.020	SS-1187	17/32	ST-2187	ST-2187X	47/64	SD-4187	11/16	SN-5187	47/64	AX
	.250 x .032	.020	SS-1090	41/64	ST-2090	ST-2090X	27/32	SD-4090	51/64	SN-5090	27/32	AX

18-14 WIRE RANGE (USE 16-14 REGULAR TOOLING) MALE

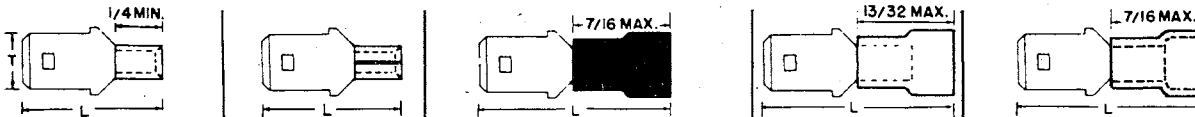

BASIC DIMENSIONS			KRIMPTITE*		INSULKRIMP*			VIBRAKRIMP*		AVIKRIMP*		Price Code Letter (See Pricing Below)
Tab Width T	Stock		Part Number	Length L Max.	.155 Max. Ins. Dia. Pt. No.	.175 Max. Ins. Dia. Pt. No.	Length L Max.	.175 Max. Ins. Dia. Pt. No.	Length L Max.	.175 Max. Ins. Dia. Pt. No.	Length L Max.	
.187	.020		S-1190	1/2	T-2190	T-2190X	25/32					AX
.250	.032		S-1089	21/32	T-2089	T-2089X	27/32	D-4089	13/16	N-5089	27/32	AX

16-12 WIRE RANGE (USE 16-14 SHORT BARREL TOOLING) FEMALE IN LINE

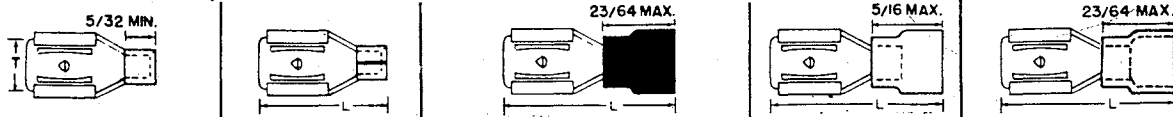

BASIC DIMENSIONS			KRIMPTITE*		INSULKRIMP*			VIBRAKRIMP*		AVIKRIMP*		Price Code Letter (See Pricing Below)
Fits Male Tab T	Stock		Part Number	Length L Max.	.155 Max. Ins. Dia. Pt. No.	.175 Max. Ins. Dia. Pt. No.	Length L Max.	.175 Max. Ins. Dia. Pt. No.	Length L Max.	.175 Max. Ins. Dia. Pt. No.	Length L Max.	
.250 x .032	.020		SS-1188	41/64	ST-2188	ST-2188X	27/32	SD-4188	51/64	SN-5188	27/32	AX

*Crimp these parts with tool indenter on side of barrel opposite seam.

NET PRICES — SNAP PLUGS AND QUICK DISCONNECT PUSH ON TYPE TERMINALS

Price Code Letter	KRIMPTITE*			INSULKRIMP* No Suffix		INSULKRIMP* Suffix (X)			VIBRAKRIMP*			AVIKRIMP*			
	Pkg. of 100	BULK		Pkg. of 100	BULK		Pkg. of 100	BULK		Pkg. of 100	BULK		Pkg. of 100	BULK	
		1000-4999 per M	5000 or more per M		1000-4999 per M	5000 or more per M		1000-4999 per M	5000 or more per M		1000-4999 per M	5000 or more per M		1000-4999 per M	5000 or more per M
AV	2.14	15.40	12.00	4.47	33.05	25.85	5.02	37.10	29.00	5.30	42.40	31.80	7.57	61.45	46.10
AW	2.23	16.05	12.55	4.47	33.05	25.85	5.02	37.10	29.00	5.30	42.40	31.80	7.57	61.45	46.10
AX	2.60	18.75	14.65	4.80	35.50	27.75	5.41	40.05	31.30	5.30	42.40	31.80	7.57	61.45	46.10

*TRADEMARK



waldom

SOLDERLESS TERMINALS AND CONNECTORS

PERMANENT CONNECTORS

NYLON INSULATED CLOSED END CONNECTORS

Connectors are annealed, tin-plated, seamless brass for 22-14 wire range, and annealed tin-plated copper for 16-10 wire range. Insulation is natural-color translucent DuPont Nylon. Underwriters' Laboratories approved. UL temperature rating of 105°C maximum. 600 Volts maximum in building wire and 1,000 Volts inside a sign or fixture.

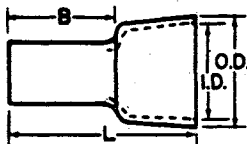

Wire Range	Part Number	Outside Diameter O.D.	Overall Length L	Barrel Length B	Inside Diameter I.D.	Circular Mil Area	Pkg. of 100	BULK	
								1000-4999, per M	5000 or more, per M
22-14	CE-2214	5/16	39/64	11/32	1/4	600- 5,180	3.89	27.95	21.85
16-10	CE-1610	7/16	23/32	3/8	3/8	2,400-13,000	5.68	40.90	31.95

PARALLEL CONNECTORS

BUTT CONNECTORS

Wire Range	KRIMPITITE*				INSULKRIMP*				VERSAKRIMP*				NYLAKRIMP*				Price Code Letter (see Below)		
	Part Number	Length L	Straight Ins. Dia. Pt. No.	Flared Ins. Dia. Pt. No.	Part Number	Length L	Straight Ins. Dia. Pt. No.	Flared Ins. Dia. Pt. No.	Part Number	Length L	Straight Ins. Dia. Pt. No.	Flared Ins. Dia. Pt. No.	Part Number	Length L	Straight Ins. Dia. Pt. No.	Flared Ins. Dia. Pt. No.			
22-18	S-1105	5/16	T-2105	T-2105X	11/16	†B-3105S	5/16	N-5105S	5/8	S-1019	9/16	T-2019	T-2019X	15/16	†B-3019S	21/32	N-5019S	1- 3/64	AH
16-14	S-1063	5/16	T-2063	T-2063X	11/16	†B-3063S	5/16	N-5063S	5/8	S-1020	9/16	T-2020	T-2020X	15/16	†B-3020S	21/32	N-5020S	1- 3/64	AH
12-10	S-1064	5/16	T-2064	T-2064X	25/32	†B-3064S	5/16	N-5064S	5/8	S-1046	9/16	T-2046	T-2046X	1- 1/16	†B-3046S	13/16	N-5046S	1- 3/64	AI
8			T-2260	T-2260X	1	B-3260	3/8	N-5260S	1			T-2263	T-2263X	1- 7/16	B-3263	53/64	N-5263S	1- 7/16	AJ
6			T-2261	T-2261X	1- 3/16	B-3261	7/16	N-5261S	1-13/16			T-2264	T-2264X	1- 3/4	B-3264	1- 1/64	N-5264S	1- 3/4	AK
4			T-2262	T-2262X	1-13/32	B-3262	17/32	N-5262S	1-13/32			T-2265	T-2265X	2	B-3265	1- 1/8	N-5265S	2	AL
2			T-2303	T-2303X	1- 5/8	B-3303	41/64	N-5303S	1- 5/8			T-2304	T-2304X	2- 1/4	B-3304	1- 1/4	N-5304S	2- 1/4	AM
1/0			The INSULKRIMP and NYLAKRIMP Parts in Wire Ranges 8 thru 2 have Brazed Barrels.				†B-3321	47/64	†N-5321S	1-61/64	The INSULKRIMP and NYLAKRIMP Parts in Wire Ranges 8 thru 2 have Brazed Barrels.				†B-3320	1-27/64	†N-5320S	2-41/64	AN
2/0							†B-3336	47/64	†N-5336S	1-61/64					†B-3337	1- 7/16	†N-5337S	2-41/64	AO
3/0							†B-3338S	3/4	†N-5338S	2-19/64					†B-3339S	1-31/64	†N-5339S	3	AP
4/0							†B-3340S	3/4	†N-5340S	2-19/64					†B-3341S	1-31/64	†N-5341S	3	AQ

To find Wire Range needed for Parallel Connectors, compute the total Circular Mil Area of Wires involved and consult Conversion and Wire Combination Charts at back of Solderless Terminal Listing. †Formed from solid copper tubing.

NET PRICES — PERMANENT CONNECTORS

WRITE FOR QUOTATIONS ON LARGER QUANTITIES

Wire Ranges 22-10

Type	Price Code Letter	KRIMPITITE*			INSULKRIMP* No Suffix			INSULKRIMP* Suffix (X)			VERSAKRIMP*			NYLAKRIMP*		
		Pkg. of 100	BULK		Pkg. of 100	BULK		Pkg. of 100	BULK		Pkg. of 100	BULK		Pkg. of 100	BULK	
			1000-4999, per M	5000 or more, per M		1000-4999, per M	5000 or more, per M		1000-4999, per M	5000 or more, per M		1000-4999, per M	5000 or more, per M		1000-4999, per M	5000 or more, per M
Parallel Connectors	AH	2.16	15.55	12.15	3.98	29.45	23.00	3.98	29.45	23.00	3.00	24.10	18.10	4.24	35.55	32.05
	AI	2.87	20.65	16.10	5.31	39.30	30.70	5.31	39.30	30.70	3.73	29.75	22.35	5.70	50.55	43.00
Butt Connectors	AH	2.50	17.95	14.00	5.28	39.05	30.55	5.28	39.05	30.55	3.96	31.70	23.75	6.74	54.75	41.05
	AI	4.43	31.90	24.95	7.21	53.35	41.65	7.21	53.35	41.65	5.62	44.90	33.90	8.76	71.10	53.35

Wire Ranges 8 thru 2

Type	Price Code No.	INSULKRIMP* Straight Insulation Prefix (T) No Suffix				INSULKRIMP* Flared Insulation Prefix (T) Suffix (X)				VERSAKRIMP* Prefix (B)				NYLAKRIMP* Prefix (N)			
		Pkg. of (A)25 (B)20	100-999, per C	1000-4999, per M	5000 or more, per M	Pkg. of (A)25 (B)20	100-999, per C	1000-4999, per M	5000 or more, per M	Pkg. of (A)25 (B)20	100-999, per C	1000-4999, per M	5000 or more, per M	Pkg. of (A)25 (B)20	100-999, per C	1000-4999, per M	5000 or more, per M
Parallel Connectors	AJ	(A)2.67	8.55	74.90	64.20	(A)2.92	9.30	81.60	69.95	(A)1.56	5.00	43.65	37.40	(A) 3.78	12.55	111.25	94.65
	AK	(A)3.94	12.60	110.25	94.50	(A)4.20	13.45	117.65	100.85	(A)2.65	8.45	74.10	63.55	(A) 5.57	18.38	162.95	139.35
	AL	(B)4.06	16.25	142.00	121.75	(B)4.29	17.15	150.00	128.60	(B)2.77	11.10	97.15	83.25	(B) 5.74	23.78	210.90	179.45
	AM	(B)4.98	19.90	174.25	149.35	(B)5.25	21.00	183.55	157.35	(B)3.39	13.55	118.40	101.50	(B) 7.05	29.19	311.35	220.30
Butt Connectors	AJ	(A)4.37	14.00	122.30	104.80	(A)4.60	14.75	128.90	110.50	(A)3.09	9.90	86.60	74.25	(A) 6.18	20.48	181.55	154.50
	AK	(A)6.04	19.35	169.20	145.05	(A)6.30	20.15	176.50	151.30	(A)4.72	15.10	132.20	113.30	(A) 8.55	28.35	251.20	213.85
	AL	(B)6.28	25.10	219.70	188.30	(B)4.51	26.45	227.80	195.30	(B)4.92	19.65	172.05	147.45	(B) 8.88	36.78	326.20	277.60
	AM	(B)7.91	31.65	276.80	237.25	(B)8.17	32.70	286.10	245.25	(B)6.18	24.70	216.35	185.40	(B)11.19	46.35	411.00	349.80

Wire Ranges 1/0 thru 4/0

Type	Price Code No.	VERSAKRIMP* Prefix (B)				NYLAKRIMP* Prefix (N)			
		Pkg. of 20	100-999, per C	1000-4999, per M	5000 or more, per M	Pkg. of 20	100-999, per C	1000-4999, per M	5000 or more, per M
Parallel Connectors	AN	3.51	14.00	122.65	105.15	6.86	28.40	251.80	214.30
	AO	3.86	15.45	135.20	115.90	6.65	27.51	244.20	207.80
	AP	5.30	21.20	185.50	159.00	8.64	35.80	317.40	270.10
	AQ	6.69	26.70	233.85	200.45	11.36	47.09	417.50	355.30
Butt Connectors	AN	8.10	32.40	285.40	244.65	16.62	68.84	610.40	519.55
	AO	9.65	38.55	338.50	290.15	16.32	67.55	599.00	509.80
	AP	12.09	48.35	424.40	363.80	18.51	76.63	679.55	578.35
	AQ	14.43	57.70	506.55	434.25	23.87	98.81	876.15	745.70

SOLDERLESS TERMINALS AND CONNECTORS

waldom



SOLDERLESS BATTERY TERMINALS AND LUGS

MARINE BATTERY TERMINALS

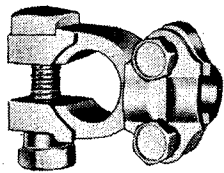

Simple to install...you need only a wrench to bolt down clamp. Designed for both positive and negative posts, and covers cable range 8 thru 2/0.

Part No.	PRICE EACH	
	1 - 99	100 - Up
BL-805	.89	.76

UNIVERSAL BATTERY TERMINALS

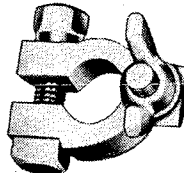

Both positive and negative, each featuring different size stud and wing nut. Dimensional difference prevents cross polarity when attaching cable to battery post.

Part No.	PRICE EACH	
	1 - 99	100 - Up
BL-809(Positive)	.89	.76
BL-810(Negative)	.89	.76

WRITE FOR QUOTATIONS ON LARGER QUANTITIES

SOLDERLESS BATTERY LUGS

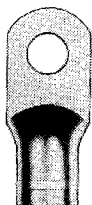

Four lugs, designed especially for starter motor applications on diesel equipment, but can be used anywhere a 3/8" or 1/2" stud hole is required.

Part No.	Wire Size	Stud Size	PRICE EACH	
			1-99	100-Up
SBTL-46	4-6	3/8"	.24	.19
SBTL-12	1-2	3/8"	.24	.19
SBTL-20	1/0-2/0	3/8"	.45	.36
SBTL-201	1/0-2/0	1/2"	.45	.36

Use SKT-840 Tool For Crimping (Page 22)

SOLDERLESS BATTERY TERMINALS

Choose from eight terminals for the following wire sizes and battery posts.

Part No.	Wire Size	Post Type	PRICE EACH	
			1-99	100-Up
SBL-6	6	Universal	.99	.87
SBL-4	4	Universal	.99	.87
*SBL-1P	1	Positive	.99	.87
*SBL-1N	1	Negative	.99	.87
SBL-10P	1/0	Positive	1.09	.98
SBL-10N	1/0	Negative	1.09	.98
SBL-20P	2/0	Positive	1.16	1.03
SBL-20N	2/0	Negative	1.16	1.03

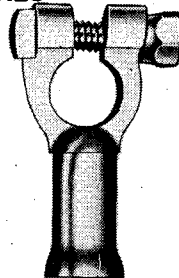

Use SKT-840 Tool For Crimping (Page 22) *designed to also take #2 AWG

TERMINAL STRIPS

STANDARD TERMINAL STRIPS

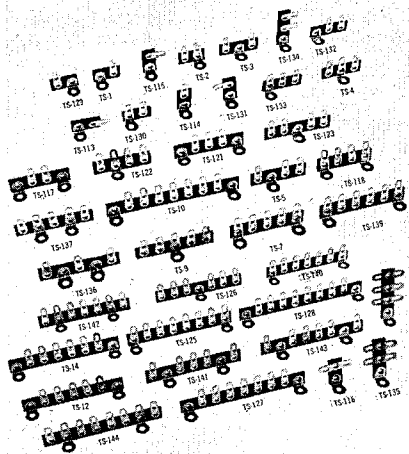

Standard type lug mounting terminal strips. Fabricated from X Grade bakelite 1/16" thick, 3/8" wide. Square barrelled construction prevents twisting and slippage. End terminals are spaced 3/16" from end of strip. All strips are furnished with lug holes spaced 3/8" center to center.

Part No.	Bag of 25	100-Over per/C	Part No.	Bag of 25	100-Over per/C	Part No.	Bag of 25	100-Over per/C
2 and 3 Position			4, 5 and 6 Position			7, 8 and 9 Position		
TS-1	.88	2.40	TS-117	1.70	4.55	TS-141	2.55	6.80
TS-129	.88	2.40	TS-5	1.43	3.90	TS-12	2.55	6.80
TS-2	.95	2.50	TS-122	1.50	4.00	TS-126	2.33	6.15
TS-130	.95	2.50	TS-118	1.80	4.75	TS-142	2.63	7.00
TS-113	1.03	2.90	TS-136	2.00	5.30	TS-140	2.63	7.00
TS-114	1.03	2.90	TS-121	2.00	5.30	TS-143	2.83	7.55
TS-115	1.03	2.90	TS-123	1.78	4.65	TS-14	2.83	7.55
TS-131	.88	2.40	TS-9	1.78	4.75	TS-144	2.93	7.75
TS-3	1.20	3.15	TS-137	2.08	5.50	TS-125	2.93	7.75
TS-132	1.20	3.15	TS-7	2.08	5.50	TS-127	3.13	8.30
TS-4	1.20	3.25	TS-10	2.25	6.05	TS-128	3.38	9.05
TS-133	1.20	3.25	TS-139	2.33	6.25	TS-116	1.33	3.45
TS-134	1.20	3.15				TS-135	2.00	5.30
						TS-138	2.70	7.15

SCREW TYPE TERMINAL STRIPS

Standard bakelite screw type terminal strips. Terminals are hot-tinned dipped for easy soldering. All are 5/8" wide, with .136 dia., mounting holes 1/16" thick 7/16" spacing between screws; 7/16" from end screw to mounting hole.

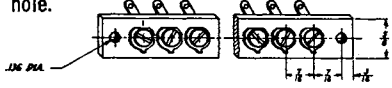

QUICK DISCONNECT TERMINAL STRIPS

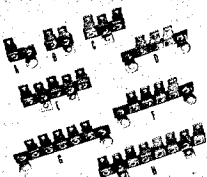

Part No.	No. of Ter.	Length	Mtg. Centers	Pkg. of 25	100 - Over
BTS-19	2	1-11/16"	1-5/16"	2.73	7.60
BTS-20	3	2-1/8"	1-3/4"	4.10	11.40
BTS-21	4	2-9/16"	2-3/16"	5.19	14.40
BTS-22	5	3"	2-5/8"	6.01	16.70
BTS-23	6	3-7/16"	3-1/16"	7.66	21.25
BTS-24	7	3-7/8"	3-1/2"	9.56	26.55

Tabs are 1/4" Brass, Cadmium Plated. Strip is 1/16" Bakelite (XP), 3/8" wide, spaced 3/8" center to center. See page 18 for female terminals.

Part No.	Fig.	Pkg. of 25	Net 100	Part No.	Fig.	Pkg. of 25	Net 100
TS-301	A	1.86	5.05	TS-305	E	5.95	16.25
TS-302	B	2.45	6.65	TS-306	F	5.98	16.25
TS-303	C	3.61	9.80	TS-307	G	7.15	19.50
TS-304	D	4.80	13.05	TS-308	H	9.48	25.90



waldom

SOLDERLESS TERMINALS AND CONNECTORS

SOLDERLESS TERMINAL & QUICK DISCONNECT ASSORTMENTS

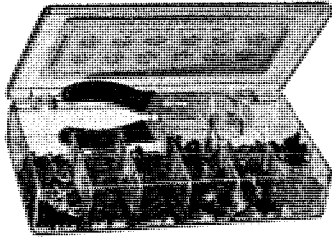

FIG. A
(Includes Crimping Tool No. CT-4050)

Waldom offers a wide variety of terminals and connectors specially packaged for maintenance and repair work. Figure A illustrates a 13 compartment re-usable plastic box containing 12 different items, plus a universal crimping tool. Figure B illustrates a smaller box containing an assortment of 8 different items. No tool is included with this assortment. Following are the contents and description of various assortments available.

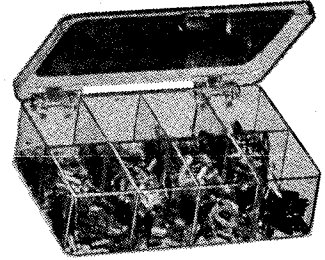

FIG. B

**ELECTRONIC ASSORTMENTS
NON-INSULATED TERMINALS**

Contains 215 pieces of most popular ring, spade, flanged spade, hook, quick disconnect terminals and butt connectors in wire ranges 22-18 through 12-10.

Part No. K-170 (Fig. A)\$9.85 ea.

INSULATED TERMINALS

Contains 138 pieces of most popular flanged spade, ring, spade, quick disconnect terminals and butt and closed-end connectors in wire ranges 22-18 through 12-10.

Part No. K-180 (Fig. A)\$12.05 ea.

**ELECTRICAL ASSORTMENTS
NON-INSULATED TERMINALS**

Contains 214 pieces of most popular flanged spade, ring, spade, hook, and quick disconnect terminals and butt connectors in wire ranges 22-18 through 12-10.

Part No. K-150 (Fig. A)\$9.85 ea.

INSULATED TERMINALS

Contains 132 pieces of most popular flanged spade, ring, spade, quick disconnect terminals and butt and closed-end connectors in wire ranges 22-18 through 12-10.

Part No. K-160 (Fig. A)\$12.05 ea.

DELUXE ASSORTMENTS

NON-INSULATED TERMINALS

Contains 620 pieces of most popular ring, flanged spade, spade terminals and butt, quick disconnect and closed-end connectors in wire ranges 22-18 through 16-14.

Part No. K-120 (Fig. A)\$16.45 ea.

Insulated & Non-Insulated Terminals

Contains 630 pieces of most popular ring, flanged spade, spade terminals and butt, quick disconnect and closed-end connectors in wire ranges 22-18 through 16-10.

Part No. K-130 (Fig. A)\$23.05 ea.

INSULATED TERMINALS

Contains 640 pieces of most popular ring, flanged spade, spade terminals and butt, quick disconnect and closed-end connectors in wire ranges 22-18 through 16-10.

Part No. K-140 (Fig. A)\$29.65 ea.

SMALLER ASSORTMENTS

NON-INSULATED TERMINALS

Contains 200 pieces of most popular ring, spade, and hook terminals in wire ranges 22-18 through 16-14.

Part No. HD-4007 (Fig. B)\$3.98 ea.

INSULATED TERMINALS

Contains 96 pieces of most popular ring, spade, and hook terminals in wire ranges 22-18 through 16-14.

Part No. HD-4021 (Fig. B)\$3.98 ea.

QUICK DISCONNECT ASSORTMENTS

NON-INSULATED

Contains 200 pieces of most popular male and female disconnect devices in wire ranges 18-14 through 16-12.

Part No. HD-4022 (Fig. B)\$3.98 ea.

INSULATED

Contains 72 pieces of most popular male and female disconnect devices in wire ranges 18-14 through 16-12.

Part No. HD-4023 (Fig. B)\$3.98 ea.

**DELUXE ASSORTMENT
NON-INSULATED & INSULATED**

Contains 480 pieces of most popular male and female insulated and non-insulated quick disconnect terminals in wire ranges 18-14 through 16-12.

Part No. K-220 (Fig. A)\$12.05 ea.

**ECONO-LINE ASSORTMENT
NON-INSULATED**

Contains 120 pieces of most popular econo-line male and female disconnect devices in wire ranges 20-16 through 16-12.

Part No. HD-4025 (Fig. B)\$4.98 ea.

PERMANENT CONNECTOR ASSORTMENT

Contains 48 pieces of most popular butt, parallel, and closed-end insulated connectors in wire ranges 22-18 through 12-10.

Part No. HD-4024 (Fig. B)\$3.98 ea.

WIRE CONNECTOR ASSORTMENT



Contains 169 wire connectors in individually-compartmented, re-usable plastic box.

Part No. K-210\$2.74 ea.

WIRE NUTS IN OTHER PACKAGING

Part Number	Trade Equivalent	Wire Combinations		Rating	Pkg. of 25 (ea.)	100-999 per C	1000-4999 per M	5000 or more per M
		Minimum	Maximum					
WN-18*	A0	2 #24	2 #18	300V	.27	.85	7.30	6.65
WN-16A	A1	2 #18	1 #16 & 2 #18	300V	.27	.85	7.30	6.65
WN-16	72B	2 #18	3 #16	300-600(a)	.50	1.65	13.85	12.75
WN-14	73B	1 #18 & 1 #16	5 #16	300-600(a)	.51	1.65	14.40	13.15
WN-12	74B	1 #14 & 1 #18	2 #12 & 1 #18	300V	.55	1.75	15.25	13.95
WN-10	76B	1 #14 & 1 #16	3 #10	300V	.96	3.20	27.70	25.35

SOCKETS

waldom



TRANSISTOR SOCKETS

UNIVERSAL TRANSISTOR SOCKETS

Made of mica-filled phenolic with phosphor bronze contacts. Cadmium plated. Mounting centers .590", chassis mounting hole, .400" mounting holes, .100" diameter.



VTS-325

Part No.	No. of Contacts*	Pkg. of 5	Pkg. of 100
VTS-325	3	1.23	14.70
VTS-326	4	1.23	14.70
VTS-327	5	1.23	14.70

* Contact Arrangements



3-Contact



4-Contact



5-Contact

SUBMINIATURE TRANSISTOR SOCKETS



.350 Long x .281 Deep x .156 Thick. Black Phenolic.

Part No.	No. of Contacts*	Pkg. of 5	Pkg. of 100
VTS-331	3	1.14	13.50

Part No. PC-285

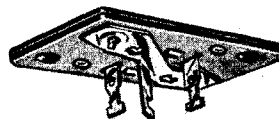

Universal type suitable for two-lead transistors of any size. Laminated bakelite construction with plated steel backing plate for increased rigidity. Backing plate has extra solder lug for use as a grounded type tie terminal. Mounts from top of chassis, 1-11/32" x 1". Mounting centers diagonally using bakelite holes only, 9/32". Mounting centers diagonally using steel backing plate holes, 1-6/32".

Part No. PC-265

Pkg. of 5 \$.85
Pkg. of 100 10.25

MINIATURE TRANSISTOR SOCKETS

Made of mica-filled phenolic with phosphor bronze contacts. Cadmium plated. .395" diameter. Supplied with mounting rings.



VTS-328

Part No.	No. of Contacts*	Pkg. of 5	Pkg. of 100
VTS-328	3	1.50	18.00
VTS-329	4	1.65	19.80
VTS-330	5	1.80	21.60

CRYSTAL SOCKETS

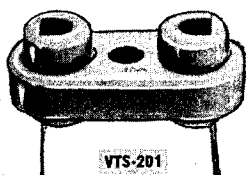

VTS-201

JAN TYPE LOW LOSS

Low-loss steatite crystal socket. Contacts are phosphor bronze, hot tinned. Pin spacing .486" for .050" pins. Overall size 55/64" long 3/8" high exclusive of contacts and 3/8" wide.

Pkg. of 5 \$ 1.14
Part No. VTS-201Pkg. of 100 11.70

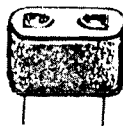

PRINTED CIRCUIT LOW LOSS

Part No.	Pins	Pin Centers	Pkg. of 5	Pkg. of 100
VTS-202	.040"	.192"	.65	10.60
VTS-203	.040"	.273"	.55	9.45

TV ACCESSORIES

TELEVISION SAFETY CORD

Identical replacement cord as used in most television receivers. One end has standard A Plug, while other end is conventional safety plug. Power automatically disconnected when cord is pulled from receiver chassis. 6 ft. cord, all molded construction. UL approved.



LC-111

Net Each \$.44

Part No. LC-111100 or more 39.15/C

REPLACEMENT CORD SET

LC-112

Replacement cord of all-molded construction. For general repair and maintenance on all electronic equipment. Cord is brown, 6 ft. long with tips stripped and tipped for ease of installation. UL approved.

Net Each \$.41

Part No. LC-112100 or more 36.25/C

TV INTERLOCK SOCKET

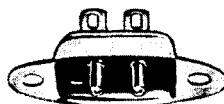

Conventional male interlock TV socket. Standard type used on all television receivers. Heavily plated contact pins. Mounting centers 1-1/4".

Pkg. of 5 \$.78

Part No. VTS-61Pkg. of 100 9.05

PLASTIC BOXES

For storing small parts of all sorts. Compartmented for neat arrangement. Made of highest quality, fully transparent rigid plastic. All types reliably hinged, and with clasps.

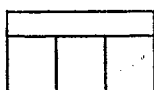
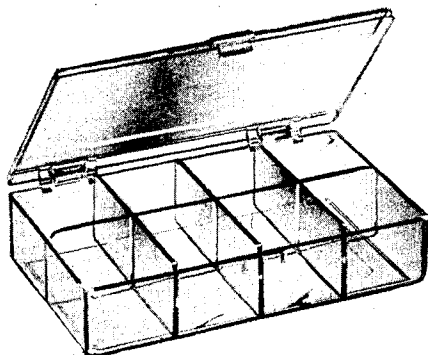

4 Compartment

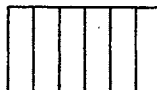

6 Compartment

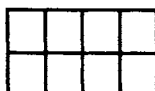

8 Compartment

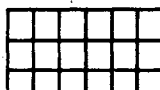

18 Compartment

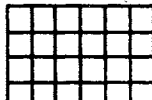

24 Compartment

4 COMPARTMENTS

Part No.	Inside Dimensions	Net, Ea.
PB-90	4-5/8" x 2-3/4" x 1"	.33

6 COMPARTMENTS

PB-115	7" x 3-1/2" x 1-1/8"	.66
--------	----------------------	-----

8 COMPARTMENTS

PB-100	4-5/8" x 2-3/4" x 1"	.33
PB-103A	5-5/32" x 3-3/16" x 1-1/16"	.40

18 COMPARTMENTS

PB-500	10-3/8" x 6" x 2"	2.48
--------	-------------------	------

24 COMPARTMENTS

PB-800	13-1/8" x 9" x 2-5/16"	4.24
--------	------------------------	------

AUTOMATIC FIRE DETECTION & ALARM SYSTEMS

#SC-600R CONTROL UNIT

UNDERWRITERS' LABORATORIES APPROVED
MEETS & EXCEEDS NATIONAL FIRE CODES

FOR: Homes, Schools, Churches, Recreation Centers, Public Buildings, Nursing Homes, Restaurants, Stores, Motels, Clubs, Factories, Warehouses, Military, etc.

#SC-600R CONTROL UNIT\$192.00

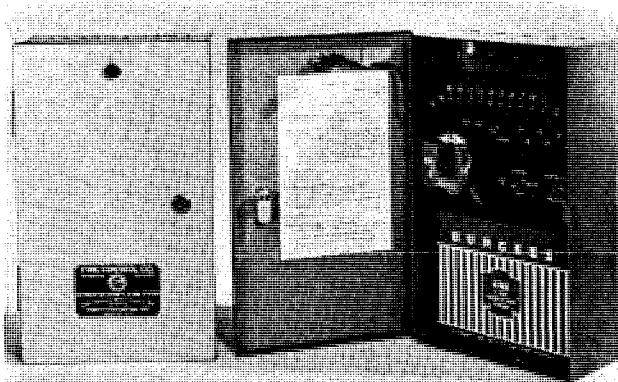

MAIN POWER SUPPLY

Input 115 V/AC, 60 cy. 0.25 amp. Transformed/rectified to 6 V/DC, maximum load 2.0 amp. The Supply is **Electrically Supervised**, so that a failure immediately sounds trouble alarms, and the System automatically transfers to Emergency Power, thus assuring continuity of fire protection. The Main Supply automatically returns when power is restored. Use #14 approved wire.

EMERGENCY POWER SUPPLY

6 Volt Battery: Burgess #4F4H; Eveready #706; or equivalent. Maximum load under alarm condition 2.0 amp. Obtain from local electrical or radio wholesale house.

CABINET

14" x 9" x 4". Gray Hammertone. Surface mount. Cylinder lock, 2 keys.

DETECTOR CIRCUIT

6 V/DC, 0.15 amp. Safety-Loop Circuit is **Electrically Supervised**, so that a wire break immediately sounds trouble alarms. Emergency circuits compensate for such fault (See N/E Switch), thus assuring continuity of fire protection. Maximum wire run 5000 ft. #FA-18/2 Approved Fire Detector Cable.

NORMAL/EMERGENCY SWITCH

Provides Emergency Operation:

- Compensates for wire break in Detector Loop, permitting full response from all detectors until repairs are made.
- Silences Trouble Buzzer, but maintains Red Lamp to show the emergency condition.

ALARM CIRCUITS

6 V/DC, maximum load 1.5 amp. If only one bell is used, it is **Electrically Supervised**, so that a failure immediately sounds trouble alarms. If two or more bells and/or #A-604 Annunciator are used, they are alternately connected to the two alarm circuits provided and the last operable alarm device is **Electrically Supervised**. Use #14 approved wire.

TEST/RESET/SILENCE SWITCH

Provides Simple Test Procedure:

- Test The System (once monthly)
- Silence all Firegongs.
- Reset to normal operation.

APPROVED FIRE ALARM SYSTEM

National Fire Codes Pamphlet 72A details the 'Local Automatic Fire Protective Signalling System' and its installation, acceptable to the Board of Fire Underwriters, and to Federal, State and Municipal authorities. This Standard is applicable to all industrial, commercial and military installations. Best practice throughout the country uses it in homes as well. Consult your Fire Chief.

Equipment bearing the UL Label has passed rigid inspection requirements and is of high professional quality.

Proper and correct tally of Automatic Fire Detectors is basic. The Code requires detectors in each room, hall, closet, stairwell, storage area, furnace room, basement, attic, loft, shaft, chute, etc. Do not exceed the space ratings given for each type of detector.

All wiring should be done in conduit as the best insurance for longevity and trouble-free service.

PRICING: FOB FACTORY

Pricing shown is Net. Standard Trade Discount to Electrical Contractors and Dealer-Installers. Subject to change without notice.

HOW TO ORDER

- Order #SC-600R Control Unit.
- Order #T111N Disconnect Switch Unit.
- Order #A-(6"; 8"; 10" gong size) Inside Underdome Firegongs. Specify #AP for Weatherproof.
- Order correct tally of Automatic Fire Detectors. Use Spot Fire Locators for industrial, commercial, and military installations. Use FyrGuard Detectors for homes.
- Order #FA-18/2 Fire Detector Cable. A 250 ft. reel will cover the average three bedroom ranch home.
- Optional equipment: #A-604 Annunciator; #529 Manual Pull Stations; #SFA-1 Smoke/Fire Alarms; #AR-2 Adapter Plates; etc.

TERMS

Net 30 days to accredited accounts. Check with order to others.

Our sole warranty is to repair or replace any equipment found defective in workmanship or materials within one year of invoice date. Tampering voids this obligation.

No merchandise may be returned without prior authorization from the Factory.

FIRE CONTROL CO.



GENERAL TIME

Progress in the World of Time

INDUSTRIAL CONTROLS DIVISION

Full line of...

- Electromagnetic and electronic timing devices
- The WIDE ETI's*

*Elapsed Time Indicators

Series DA Time Delay Timers, Rear Mounting

Type DA11. Manually adjustable by knob. Apply wherever delay, interval or repeat cycle timing functions are required (repeat cycle requires two units). Internal clutch engages and disengages when motor is energized and de-energized. Resets to start position when power is removed. SPDT switch rated 20 amps, 125 or 250 VAC resistive; solder lug terminals. Min. setting 0 sec. Repeat accuracy $\pm\frac{1}{4}$ of 1% of total time range. 5 watt motor. 120 VAC, 60 Hz. U/L listed. Size: $3\frac{3}{8}$ " W x $2\frac{13}{16}$ " D x $3\frac{3}{8}$ " H. Weight: $\frac{1}{2}$ lbs.

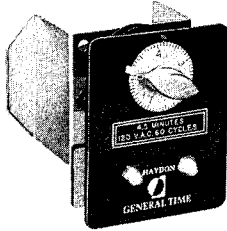

Type DA21. Same as DA11 but with locknut adjustment to eliminate tampering. When ordering, specify model number, voltage and frequency.

MFR'S MODEL NO.		MAX. TIME SETTING	MAX. RESET TIME
DA11-036		5.7 sec.	0.25 sec.
DA11-031	DA21-001	14 sec.	1.0 sec.
DA11-032	DA21-002	57 sec.	1.5 sec.
DA11-035	DA21-005	114 sec.	9.0 sec.
DA11-033	DA21-003	4.5 min.	15 sec.
DA11-034	DA21-004	9.5 min.	120 sec.

NET EACH, LOTS OF

1-4	5-9	10-24	25-49	50-99	100-249	250 & over
\$15.30	\$14.54	\$13.77	\$13.01	\$12.24	\$11.48	\$10.71

Series BN Adjustable Reset Timers

Panel or rear mounting; interval or delay timing. Built-in relay, adjustable time range. Apply to machine tools, production and processing equipment or other operations requiring a compact, dependable unit for direct control of electrical loads.

BN41 (Interval) and BN42 (Delay) Panel Mount Dial and setting knob with readout of elapsed time, by pointer in center of knob. SPDT relay rated 10 amps at 125 or 250 VAC. Timing motor rated 5 watts max. 120 VAC, 60 Hz. Repeat accuracy $\pm\frac{1}{4}$ of 1% of total time range. Screw terminal block. Size: $3\frac{5}{16}$ " square x $4\frac{3}{8}$ " deep; behind panel. Requires $3\frac{3}{16}$ " dia. mounting hole.

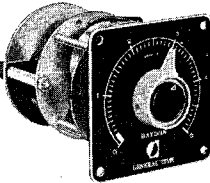

BN25 (Interval) and BN22 (Delay) Rear Mount Same specifications as BN41 and BN42 except have chassis or back panel mount. Locknut setting adjustment, where only occasional time period changes are required. Size: 3.375" W x 4.202" H x 3.750" D.

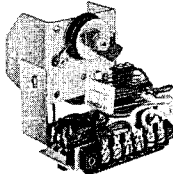

PANEL MOUNTING

MFR'S MODEL NO.		TIME SETTING		MAX. RESET TIME	DIAL GRADS.	
INTERVAL	DELAY	MAX.	MIN.		MAJOR	MINOR
BN41-001	BN42-001	6 sec.	0.3 sec.	0.5 sec.	1 sec.	0.1 sec.
BN41-003	BN42-003	15 sec.	0.8 sec.	1.0 sec.	1 sec.	0.2 sec.
BN41-004	BN42-004	30 sec.	1.5 sec.	1.5 sec.	5 sec.	0.5 sec.
BN41-005	BN42-005	60 sec.	3.0 sec.	1.5 sec.	10 sec.	1.0 sec.
BN41-006	BN42-006	120 sec.	6.0 sec.	10 sec.	20 sec.	2.0 sec.
BN41-007	BN42-007	5 min.	0.2 min.	15 sec.	1 min.	0.1 min.
BN41-008	BN42-008	10 min.	0.4 min.	120 sec.	1 min.	0.2 min.

REAR MOUNTING

MFR'S MODEL NO.		TIME SETTING		MAX. RESET TIME	DIAL GRADS.	
INTERVAL	DELAY	MAX.	MIN.		MAJOR	MINOR
BN25-006	BN22-006	5.4 sec.	0.3 sec.	0.5 sec.	1 sec.	0.1 sec.
BN25-001	BN22-001	13.5 sec.	0.7 sec.	0.5 sec.	1 sec.	0.5 sec.
BN25-002	BN22-002	54 sec.	3.0 sec.	1.5 sec.	5 sec.	1.0 sec.
BN25-005	BN22-005	108 sec.	6.0 sec.	2.5 sec.	10 sec.	1.0 sec.
BN25-003	BN22-003	4.5 min.	15 sec.	5.0 sec.	1 min.	5.0 sec.
BN25-004	BN22-004	9.5 min.	30 sec.	120 sec.	1 min.	5.0 sec.

NET EACH, LOTS OF

MOUNTING	1-4	5-9	10-24	25-49	50-99	100-249	250 & over
Panel	\$25.93	\$24.63	\$23.33	\$22.04	\$20.74	\$19.44	\$18.15
Rear	21.46	20.39	19.32	18.24	17.17	16.10	15.02

Series DP11 Panel Mounting Reset Timer

Adjustable time range by simple pointer knob. Apply wherever delay, interval or repeat cycle timing are needed (repeat cycle requires two timers). Readout of elapsed time by pointer in center of knob. Unit resets to start position when power is removed. SPDT switch rated 10 amps, 125 or 250 VAC resistive. Timing motor rated 5 watts max. 120 VAC, 60 Hz. Repeat accuracy $\pm 1\%$ of total time range. Screw terminals. Size: $3\frac{5}{16}$ " square x $3\frac{3}{2}$ " deep, behind panel. Requires $3\frac{3}{16}$ " dia. mounting hole cut. When ordering, specify model number, voltage and frequency.



MFR'S MODEL NO.	TIME SETTING			DIAL GRADS.	
	MAX.	MIN.	RESET TIME	MAJOR	MINOR
DP11-007	6 sec.	0.3 sec.	0.5 sec.	1 sec.	1.0 sec.
DP11-001	15 sec.	0.8 sec.	1.0 sec.	1 sec.	0.2 sec.
DP11-006	30 sec.	1.5 sec.	1.5 sec.	5 sec.	0.5 sec.
DP11-002	60 sec.	3.0 sec.	1.5 sec.	10 sec.	1.0 sec.
DP11-005	120 sec.	6.0 sec.	10 sec.	20 sec.	2.0 sec.
DP11-003	5 min.	0.2 min.	15 sec.	1 min.	0.1 min.
DP11-004	10 min.	0.4 min.	120 sec.	1 min.	0.2 min.

NET EACH, LOTS OF

1-4	5-9	10-24	25-49	50-99	100-249	250 & over
\$19.55	\$18.57	\$17.60	\$16.62	\$15.64	\$14.66	\$13.69

Series BJ Push-Button Interval Timer

Dependable, rugged panel-mount timer. Timing interval is initiated by manually setting knob to selected position and manually depressing the push button. For control of mixers, ovens, tumbling and plating equipment, copy machines, photographic equipment, etc. Readout of elapsed time by pointer in center of setting knob. Instant reset to start position automatically. SPDT switch rated 15 amps, 125 or 250 VAC resistive. Timing motor rated 5 watts max. 120 VAC, 60 Hz. Repeat accuracy $\pm\frac{1}{2}$ of 1% of full scale. Combination spade and solder lugs. Size: $3\frac{5}{16}$ " square x $2\frac{23}{32}$ " deep, behind panel. Requires $3\frac{3}{16}$ " dia. mounting hole. Weight: $\frac{1}{2}$ lbs. When ordering, specify model number, voltage and frequency.

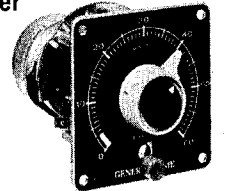

MFR'S MODEL NO.	TIME SETTING		DIAL GRADS.	
	MAX.	MIN.	MAJOR	MINOR
BJ12-004	30 sec.	1.5 sec.	5 sec.	0.5 sec.
BJ12-005	60 sec.	3.0 sec.	10 sec.	1.0 sec.
BJ12-006	120 sec.	6.0 sec.	20 sec.	2.0 sec.
BJ12-007	5 min.	0.2 min.	1 min.	0.1 min.
BJ12-008	10 min.	0.4 min.	1 min.	0.2 min.
BJ12-009	15 min.	0.8 min.	1 min.	0.2 min.
BJ12-010	30 min.	1.5 min.	5 min.	0.5 min.
BJ12-011	60 min.	3.0 min.	10 min.	1.0 min.

NET EACH, LOTS OF

1-4	5-9	10-24	25-49	50-99	100-249	250 & over
\$17.43	\$16.55	\$15.68	\$14.81	\$13.94	\$13.09	\$12.20

Series RG21 Repeat Cycle Timers

Cam-actuated, single switch timers for rear mounting. Run continuously, repeating a set cycle of make-break switching operations as long as motor is energized. Also operates a single time cycle. Cam adjustable from 7° min. to 169° max. ($\pm 3\%$). SPDT switch rated 20 amps resistive. Timing motor 3.7 watts max., 120 VAC, 60 Hz. Solder lug terminals. 6" leads. U/L listed. Size: $2\frac{1}{16}$ " W x $3\frac{3}{8}$ " H x $2\frac{1}{2}$ " D. Weight: 1 lb.

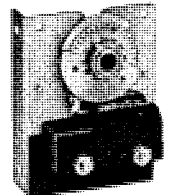

MFR'S MODEL NO.	TIME RANGE	MFR'S MODEL NO.	TIME RANGE
RG21-090	7 $\frac{1}{2}$ sec.	RG21-095	10 min.
RG21-091	15 sec.	RG21-096	15 min.
RG21-092	30 sec.	RG21-097	30 min.
RG21-093	1 min.	RG21-098	60 min.
RG21-094	5 min.	RG21-099	4 hrs.

NET EACH, LOTS OF

1-4	5-9	10-24	25-49	50-99	100-249	250 & over
\$12.96	\$12.31	\$11.67	\$11.02	\$10.37	\$ 9.72	\$ 9.07

time delay timers

Three basic methods are employed to generate a Time Delay: synchronous motor, Thermal Bi-Metal, and electronic. The Series GTD, MTD, TD/CTD, H/CH, SF/CSF, TDAB, and Series RB generate the Delay function from a synchronous motor. This Delay is created by applying power to the timer motor/clutch circuit with a sustained switch closure (sustained is interpreted as simply being longer in length than the desired delay). When the timer receives power it begins a delay period, at the end of which occurs a switch operation. The load switch remains in the operated condition until power is removed from the timer, at which time the timer auto-

SERIES GTD

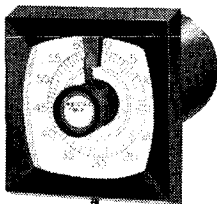

The Series GTD is an appearance engineered timer designed to compliment today's modern machinery. This unit provides a switch closure at the completion of a timed delay in an extremely wide selection of time cycles from 3 seconds to 60 hours or more. A clutching mechanism between the heavy duty synchronous motor and the load switch assures instant start, and immediate reset. Mounting is simple. A 3 inch hole in your panel is all that is required. A single screw under the flange of the timer face tightens a bracket against the edge of the panel hole.

As an optional feature the GTD can be supplied with a reverse clutching mechanism. This feature permits the unit to remain in the operate position if the control circuit is de-energized due to a power failure.

Load contacts are snap action SPDT, isolated. Contacts are rated at 10 amps. non-inductive. The GTD is available for 115/60, 115/50, 220/60 or 230/50. Other voltages available, contact factory.

TIME CYCLE CHART

Model	Max. Time	Min. Time & Calibration
GTD-3S	3 seconds	1/20 second
GTD-6S	6 seconds	1/10 second
GTD-15S	15 seconds	1/4 second
GTD-30S	30 seconds	1/2 second
GTD-60S	60 seconds	1 second
GTD-3M	3 minutes	3 seconds
GTD-5M	5 minutes	5 seconds
GTD-15M	15 minutes	15 seconds
GTD-30M	30 minutes	30 seconds
GTD-60M	60 minutes	1 minute
GTD-3H	3 hours	3 minutes

Note: Time cycles exceeding three hours are available. Please consult factory for details.

115/60 — \$39.50

120/60 — \$41.50

matically resets.

In Models TD, H, MTD, SF, and RB in time cycles under 5 minutes a clutch/motor is used and the operating circuit is illustrated as "Circuit A".

In Models GTD, CTD, CH, CSF, TDAF and TDAB an external clutch is used to couple the motor to the timing mechanism during the time cycle. Model MTD above 30 seconds also is equipped with the external clutch, and this and the forementioned timers operate with the "Circuit B".

SERIES MTD

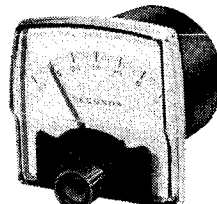

The Series MTD Time Delay Timer represents a new appearance concept for timing controls. This new timer is designed to match modern panel instruments, so commonly found on the finest automatic machines. The MTD features a rugged plastic face which protects the setting and progress indicators from dust and damage. When used alone or in conjunction with other instruments, the Series MTD will contribute to equipment appearance as well as performing its control function.

The control function of the Series MTD is one of providing a pre-determined timed delay between the closing of one load circuit and the subsequent operation of the timer isolated load switch. The load contacts are 10 amp. SPDT snap action and are brought out to snap on terminals located at the rear of the timer. Mounting is through a 3" round hole in a panel and secured by means of a bracket screwed to the rear of the timer.

TIME CYCLE CHART

Model	Max. Time	Min. Time
MTD-6S	6 seconds	1/10 second
MTD-15S	15 seconds	1/4 second
MTD-30S	30 seconds	1/2 second
*MTD-60S	60 seconds	1 second
*MTD-3M	3 minutes	3 seconds
*MTD-5M	5 minutes	5 seconds
*MTD-15M	15 minutes	15 seconds
*MTD-30M	30 minutes	30 seconds
*MTD-60M	60 minutes	1 minute
*MTD-3H	3 hours	3 minutes

Note: All dials have 60 calibrations regardless of time cycle. *Models with clutch external to synchronous motor.

115/60 — \$30.50

220/60 — \$31.50

SERIES TD/CTD

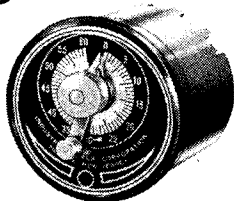

The Series TD is a cased time delay timer which mounts through a 3 3/15" hole in a panel. The timer is secured to the panel with a bracket which mounts to the rear of the timer and clamps the unit to the panel. The TD offers 10 amp. SPDT snap action load contacts, isolated from the timing movement. Two models within the TD category are available, dependent upon time cycle. The models under 1 minute use a clutch/motor, whereas 1 minute up to 5 minutes use an external clutch that provides rapid reset. Voltages of 115/60, 115/50, 220/60, or 220/50 are available.

115/60 — \$30.50

220/60 — \$31.50

SERIES H/CH

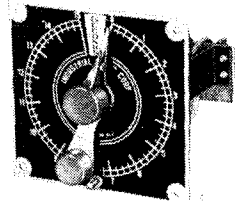

The Series H time delay timer is designed for panel mounting with the dial of the timer fastened to the panel with four screws. Wiring is accomplished to a terminal strip at the rear of the unit. Load circuit rating is 10 amps., non-inductive 115/60 through SPDT snap action contacts. The Series H is available with an external clutch for time cycles above 1 minute; those models with time cycles below one minute employ a clutch/motor. Voltages are 115/60, 115/50, 220/60 or 220/50.

115/60 — \$26.50

220/60 — \$27.50

Time Cycle Chart For Series TD/CTD • H/CH • SF/CSF

**INDUSTRIAL
TIMER**
CORPORATION

Model Number	Time Cycle	Dial Division
TD-6S	6 sec.	1/10 sec.
TD-15S	15 sec.	1/4 sec.
TD-30S	30 sec.	1/2 sec.
CTD-1M	60 sec.	1 sec.
CTD-3M	3 min.	3 sec.
CTD-5M	5 min.	5 sec.
H-6S	S F-6S	
H-15S	S F-15S	
H-30S	S F-30S	
CH-1M	CS F-1M	
CH-3M	CS F-3M	
CH-5M	CS F-5M	

Note: For longer time cycles, consult factory.

programming cam timers

motors

Heavy duty synchronous motors, U/L and CSA approved. These motors are available in any of thirteen standard speeds. In cases where short time cycles are required of a higher torque motor is used. On the MC-O and RC-O Multi Cam Timers a High Torque motor is standard. These motors are built and guaranteed for long trouble-free performance.

switches

Single pole double throw snap action, U/L and CSA approved, totally enclosed. The switches are mounted on individual brackets, permitting removal of each switch without disassembling the entire switch bank. The switch contacts are rated at 10 amps non-inductive AC.

electrical characteristics

The Cam Timer Series can be supplied for 115 volt or 220 volt AC operation on 25, 50, 60 or 400 cycle frequencies. (As well as 6, 12, 24, & 30 volts DC)

gear rack assemblies

50 standard ratio gear and rack assemblies are stocked for changing overall time cycles on the Cam Timer Series. These assemblies may be changed by removing a 5/40 screw, setting the rack into the recess, and retightening the screw. Refer to chart for particular time cycle and gear rack assembly.

individual cam adjustment (series CM, MC, RC only)

Standard cam construction is such that the ON or OFF periods may be adjusted from 2% to 98% of the total time cycle. Cam adjustment consists of loosening the nut on the face of the plate, rotating the movable cam segment to the percentage of ON or OFF period desired, and then tightening the nut. The cams are made of corrosion resistant aluminum.

timing sequence (MC, RC only)

Each cam is individually mounted on the shaft by means of a heavy duty friction disc which allows easy finger adjustment of timing sequences. Individual positioning of the cam is also made possible without the use of set screws and wrenches, and permits rapid adjustment. On the Series MC and RC Multi Cam models a drum calibrated from 0% to 100% is mounted on each cam, this drum in conjunction with a mounted pointer acts as a guide when setting related programmed sequences; thus providing a reference point for use during the cycle.

ordering information

When ordering a Cam Timer please specify the following information:

1. Voltage and frequency of motor current.
2. Number of switches desired.
3. Time cycle selected from chart. (refer to motor number plus gear rack number. Example: MC4 Timer with C-12. Gear Rack.)

■ single cycle multi-cam timer

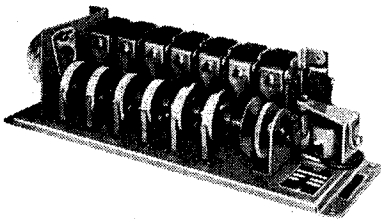

SERIES RC

The Series RC Timer is designed to provide a single timed electrical cycle upon momentary actuation from a remote position. The cam is a circular plate notched at one point in its circumference. Coincident with this notch is a small plate or a pawl. This plate is contoured to the periphery of the cam, and pressed against the cam face by a spring and a stud. Upon actuation, the relay mechanically disengages a lever from the cam notch, simultaneously starting the motor. During the revolution of the cam, the relay lever rides on the circumference of the cam. At the end of the revolution, the pawl guides the lever into the notch, stopping the motor after completing one revolution. The single switch handles the timer motor and the external load circuits, limited only by switch rating. The RC Multi Cam Timer operates from 1 to 20 additional circuits. This design enables the user to have all the advantages of the Series MC, plus single cycle homing control.

\$42.50 up to \$201.00

■ recycling timer

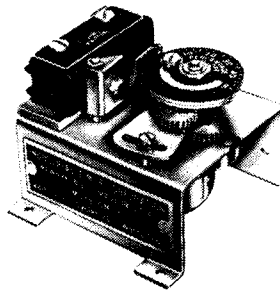

SERIES CM

The Series CM Timer repeats a continuous, adjustable ON and OFF electrical cycle. This timer consists of a heavy duty synchronous motor, adjustable cam, and single pole, double throw snap action switch, assembled on a base mount chassis. The cam is coupled to the motor by means of a simple gear and rack assembly, which can be changed by the user. Standard cam construction is such that the ON-OFF cycle may be adjusted from 2% to 98% of the total time cycle. The cam is calibrated in percentage for quick accurate adjustment. 50 stocked gear and rack assemblies are available for time cycles from 40 cycles (2/3 of a second) to 1 rev. in 72 hours.

115/60 — **\$20.50**
220/60 — **\$21.50**

■ multi-cam recycling timer

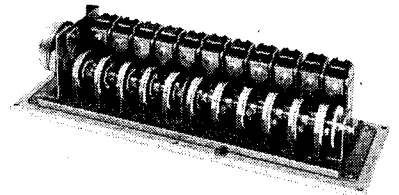

SERIES MC

The MC Multi Cam Timer is identical in operation to the CM timer but controls from 2 to 20 circuits. The cams are mounted on a single driving shaft, coupled to the motor by a gear and rack assembly. Each cam is independently adjustable for 2% to 98% of the total time cycle. Individual cam adjustability enables the timer to be used as a programming device. The cams can be adjusted in any combination of timed sequences rapidly and easily. Total revolution time is determined by motor speed and the interchangeable gear and rack assembly.

	115/60	220/60
2 SW	\$ 35.50	\$ 37.00
6 SW	69.00	70.50
10 SW	106.50	108.00

**INDUSTRIAL
TIMER**
CORPORATION

interval timer

An interval timer closes its load circuit immediately upon the start of the time period. This circuit is closed (or opened) during the time that the timer is running for the pre-selected period. When this is completed, the load circuit opens and the timer automatically resets. Interval timers are designed to start from a momentary

pulse. However, a sustained start circuit can be used. If the start circuit is still closed at the end of the time cycle, the load circuit will return to its normal position, but the timer will not reset until the start circuit is broken. At this time, the reset will occur and the timer is again ready for another cycle.

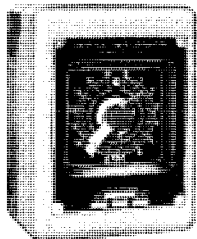

SERIES PAB (PAF)

The Series PAB Timer is an extremely accurate timing mechanism built to stand up under the hard usage and demanding standards that modern manufacturing processes require.

Due to the simplicity and reliability of a special clutching mechanism, it is possible to offer the Series PAB with a range of timing from the PAB 1S with a 1 second overall range in 1/60 second increments, to the PAB 3H timer with a range of 3 minutes to 3 hours, calibrated in 3 minute steps.

The series PAF is similar in construction but is panel mounted.

115/60	220/60
\$55.00	\$58.00

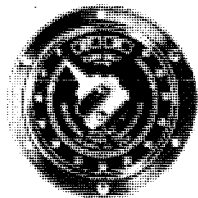

SERIES RS

The Series RS Interval timer is a manual set timer capable of handling a full 20 ampere load without the use of external relays. The Series RS is completely enclosed, silent in operation and has a simple knob for time setting and elapsed time indication. Available in the variety of time cycles shown on chart. Available in 115, or 230 volt, 25, 50, 60, or 400 cycle current. (Also 6-30 VDC) 18" color coded leads provided through back of housing. Knockout housing available as optional equipment.

Shipping weight—2 pounds—in case
3 pounds

115/60	220/60
\$18.50	\$19.00

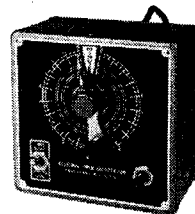

SERIES P/M

The Series P Timer is a multi-purpose interval timer, equipped with an A.C. input cord, built in manual start push button, and two receptacles. The RED receptacle is provided on the side of the case for REMOTE STARTING. The BLACK receptacle receives plug in LOAD circuits. Keyholes are provided in the back of the case for wall mounting. Load contact rating is 15 amps, non-inductive.

Available for 115, 230 volts, 60, 50, or 25 cycles.

Series M Timers follow the same description as the Series P except that they are not equipped with a remote start and have a load rating of 10 amps. 115, 230 volts, 60, 50, or 25 cycles.

Shipping weight—3 pounds



SERIES S

The Series S Signaling timer is a multi-purpose process timer that provides an audible signal at the end of either a time interval or a time delay. Two receptacles are provided on the side of the case: a black receptacle for a load or remote signal to operate at the end of the cycle, and a red receptacle to operate a load circuit during the time cycle. Timer is also equipped with a time cord. Snap action contacts are rated at 10 amps. 115, 230 volts, 60, 50, or 25 cycles.

Shipping weight—3 pounds

115/60	220/60
\$29.00	\$31.50

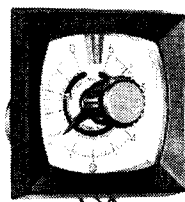

SERIES PBM

pushbutton start

The Series PBM is an automatic reset, pushbutton operated interval timer. The unit is panel mounted through a square hole, and secured with four screws. The PBM features extreme repeat accuracy and exceptional long life; both made possible through the use of a positive acting infinite engagement clutch which connects the switch actuator with the heavy duty synchronous motor. The unit also features an attractive glass faced dial with adjustment knob and start button combined in one assembly. Time interval or progress indication is located in the dial with a moving red pointer.

115/60 — \$19.25	220/60 — \$20.50
------------------	------------------

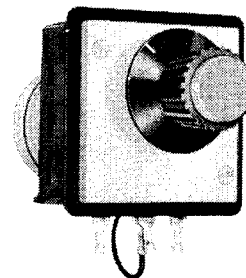

SERIES LVR

pushbutton interval

The Series LVR is a pushbutton Interval Timer specifically designed for OEM applications. This timer operates a set of 25 amp. SPDT contacts when the pushbutton is depressed and released, and opens the contacts at the completion of a pre-set time interval. The timer automatically resets and restarts when the pushbutton is again operated.

The timer is mounted through a panel with only the pushbutton and setting knob appearing on the panel. The dial of the timer would then be etched or affixed to the panel itself. Dials available on special order, please contact factory for details.

**INDUSTRIAL
TIMER**
CORPORATION

HARREL

PRECISION SOLID STATE TEMPERATURE CONTROLLERS

GENERAL

Harrel temperature controllers are intended for the precision temperature control of ovens, test fixtures, and all kinds of industrial machinery. They are arranged for easy mounting on any panel and are designed to require minimum panel space.

Temperature sensing is by means of a wire-type resistance sensor. This gives long-term stability and sensitivity which cannot be equalled by any other method of temperature sensing. The temperature sensor may be located as much as several hundred feet from the controller if desired. No special lead wires or shielding are required between controller and sensor.

ON-OFF RELAY CONTROLLERS

Utilize a rugged, solid state amplifier controlling a 10-ampere relay. Relay is easily replaceable in the field.

TIME PROPORTIONING RELAY TYPES

Similar to regular on-off controller, but controller operates on a regular cycle of on to off and back again, and it is the proportion of on-to-off time which is varied to control the temperature. Gives a characteristic which approximates true proportional control and in general gives greatly improved performance over regular on-off controllers.

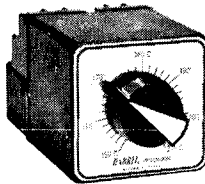

TRUE PROPORTIONAL TYPES

Completely solid state. No relays, contacts, or moving parts whatsoever in the power control circuits. Output does not cycle on and off but remains steady at exactly the amount necessary to hold the temperature at precisely the desired value. True stepless control gives closest temperature control of any type of controller. Elimination of contacts and moving parts means life measured in years.

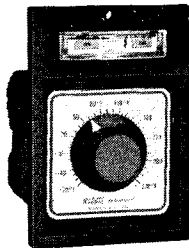

STANDARD MODELS 115 volt, 60 cycle operation

Form		Type	Temperature Range	Switching or Proportional Band*	Power Output	Price	
Non-indicating	Indicating					Non-indicating	Indicating
TC-115Q	TC-115S	on-off	100-300°F	1°C	0 amps	75.00	92.00
TC-115R	TC-115T	on-off	100-500°F	1°C	10 amps	75.00	92.00
TC-116L	TC-116AF	Time Proportioning, Relay	100-300°F	1.5°C	10 amps	80.00	97.00
TC-116M	TC-116AB	Time Proportioning, Relay	100-500°F	1.5°C	10 amps	80.00	97.00
TC-396D	TC-496D	True Proportional	100-300°F	1.5°C	1000 watts**	149.00	166.00
TC-396E	TC-496E	True Proportional	100-500°F	1.5°C	1000 watts**	149.00	166.00

* For on-off, temperature change at sensor to go from on to off and vice versa. For time proportioning, temperature change for 30% to 75% power output. For true proportional, temperature change from 10% to 80% full power output. Note that temperature performance for proportional types will in general be much better than figure shown; full proportional band is seldom required to compensate for changes in external conditions.

** At 25°C ambient temperature. Derate linearly to zero at 100°C ambient temperature. For indicating types, heater must be arranged so that steady state power output (that is the power other than during warm-up and cool-down) is between 5% and 75% of full power output.

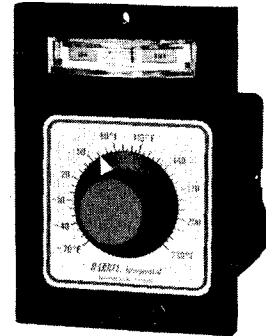

Indicating Controller

INDICATING FORMS

The system of display employed on indicating forms of the controller is designed especially for automated systems. The temperature is both set and read out on the large easy-to-read dial. The indicator is separate, and is of the go/no-go type which gives a visual alarm whenever the actual temperature is not at the set point. No skill or knowledge is required of the operator. All he has to do is be sure that the indicator stays out of the two red zones. Indicating forms are mounted on an attractive escutcheon arranged for easy panel mounting or indicator may be located remotely if desired.

SENSORS

A number of different forms of sensors are available for the above

- Patch Sensor:** For measuring the temperature of surfaces. Thin and flexible; may be attached by means of an adhesive or with tape (supplied).
- Oval:** Sensors wound on oval hollow ceramic core. Bracket mount for sensing air temperature.
- Tubular:** Cylindrical sensors in aluminum or stainless steel protecting jackets. May be mounted in solids, liquids, or gases.

SENSORS

Form	Type	Max. Temperature	Dimensions	Price
TS-100B	Patch	300°F	3/4" x 3/4" x 1/8"	\$19.80
TS-100F	Patch	500°F	1" x 1" x 1/8"	23.75
TS-103G	Oval	500°F	2" x 1/2" x 3/16"	4.50
TS-103J	Tubular, Aluminum Jacket	500°F	3/8" dia. x 1 1/2" long	9.35
TS-103K	Tubular, Stainless Jacket	500°F	3/8" dia. x 1 1/2" long	11.75

CR207A Temperature Indicator/Recorder. Compact, high accuracy nulling type instrument provides precise measurement of temperature. Expanded scale recording spreads temperature span of interest over entire track of recorder. Total recording time 1, 7, or 30 hours. May be used with any wire type resistance sensor. An ideal instrument for general purpose laboratory work.

Price \$585.00

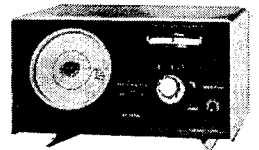

Other products manufactured by Harrel, Inc. — High Precision Proportional Temperature Controllers (ten-turn potentiometer forms), Controllers for Thermoelectric Coolers, Programmable Controllers, Temperature-Controlled Enclosures, Temperature Indicators, Temperature Sensors, Heaters. Write for further information.

HARREL, incorporated

PRECISION TEMPERATURE CONTROLS

- Recorders
- Indicators
- Sensors
- Heaters
- Programmers
- Alarms
- Thermoelectric Controllers
- Enclosures

LUTRON

POWERDIAL®

SCR* POWER CONTROLS

*Silicon Controlled Rectifier

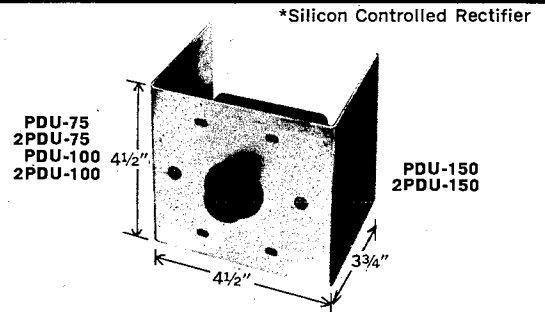
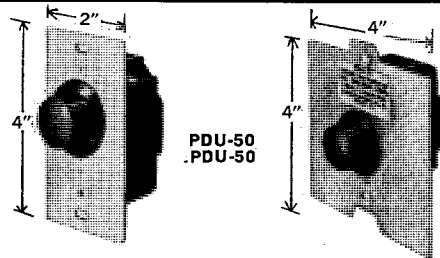
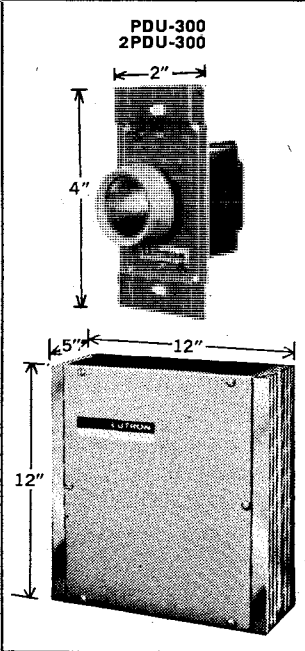

PDU SERIES

PDU Series is suitable for panel mounting. -- May be wired for AC or DC output. Two wire connection.

MODEL	MAX. AC WATTS	RMS. AMPS. AC	RMS. AMPS. DC	AC INPUT VOLTS	AC OUTPUT VOLTS	RMS-DC OUTPUT VOLTS	WEIGHT LBS.	TRADE NET
PDU-50	600	0-5	0-5	120	0-120	0-85	.25	\$ 15.75
PDU-75	900	0-7.5	0-7.5	120	0-120	0-85	.34	18.75
PDU-100	1200	0-10	0-7.5	120	0-120	0-85	.53	30.00
PDU-150	1800	0-15	0-10	120	C-120	0-85	1.0	60.00
PDU-300	3600	0-30	0-20	120	0-120	0-85	12.0	127.50
2PDU-50	1200	0-5	0-5	240	0-240	0-170	.25	30.00
2PDU-75	1800	0-7.5	0-7.5	240	0-240	0-170	.34	33.00
2PDU-100	2400	0-15	0-7.5	240	0-240	0-170	.53	39.00
2PDU-150	3600	0-15	0-10	240	0-240	0-170	1.0	78.00
2PDU-300	7200	0-30	0-20	240	0-240	0-170	12.0	162.00

NOTE: Above units are 60 cycle service. Please send 400 cycle or other special unit inquiries to our Engineering Dept.

POWERDIAL FEATURES

- Output is continuously adjustable AC or DC
- Rugged, reliable, solid state circuitry
- 1/10 the weight, 1/2 the size of conventional variable auto-transformer controls.
- No brushes to burn out or wear
- Lower installed cost

POWERDIAL WILL CONTROL:

- Universal and Series DC Motors
- Shaded Pole Motors*
- Permanent Split Capacitor Motors*
- Lamps
- Voltage
- Current
- Resistive Heaters & Infra-Red Lamps
- Soldering Irons
- Electric Solenoids & Brakes, D.C. Clutches
- Electroplaters
- Electric Punches & Actuators
- Vibratory Feeders
- Centrifuges

*Used only on fan and light loads, or where torque is proportional to speed.

PD SERIES BENCH MODELS

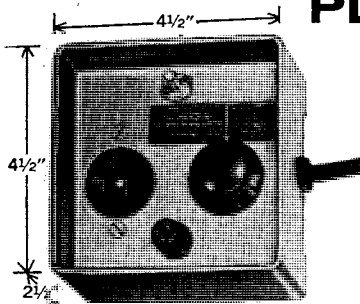

MODEL	MAX. AC WATTS	RMS. AMPS. AC OUT	RMS. AMPS. DC OUT	AC INPUT VOLTS	AC OUTPUT VOLTS	RMS-DC OUTPUT VOLTS	WEIGHT LBS.	TRADE NET
PD-50	600	0-5	0-5	120	0-120	0-85	2.0	\$24.00
PD-75	900	0-7.5	0-7.5	120	0-120	0-85	2.0	27.00
PD-100	1200	0-10	0-7.5	120	0-120	0-85	2.3	30.00
PD-150	1800	0-15	0-10	120	0-120	0-85	2.6	60.00
2PD-50	1200	0-5	0-5	240	0-240	0-170	2.0	33.00
2PD-75	1800	0-7.5	0-7.5	240	0-240	0-170	2.0	36.00
2PD-100	2400	0-10	0-7.5	240	0-240	0-170	2.3	39.00
2PD-150	3600	0-15	0-10	240	0-240	0-170	2.6	81.00

PD Series — Simply Switch to AC, DC or off. All units have fuse, 3 wire cord and receptacle.

Typical Waveforms

AC Output



DC Output



SCR Firing Angle 45° (low output) 90° (medium output) 170° (high output)

LUTRON ELECTRONICS CO., INC.

LUTRON LIGHT DIMMERS

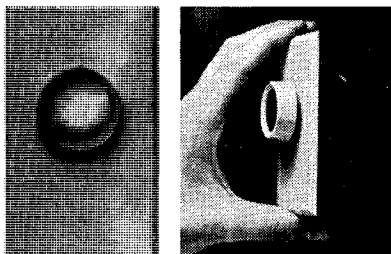

EAPRI ELECTRONIC LIGHT CONTROLS

Continuous dimming controls for residential, commercial and industrial use. A popular accessory for hi-fi and TV rooms, dining rooms, kitchen, nursery, bedroom and office. Excellent for use in equipment and visual displays. Quickly and easily installed in the same manner as an ordinary switch, they fit standard depth wall boxes. For single or multi-ganged installation.

INCANDESCENT DIMMERS

These solid state thyristor controls feature double-sized mounting brackets for longer life and to eliminate overheating. All switches have silver contacts. High-quality phenolic case is 1/4" shallower than conventional types, fits any GEM box. Manual and motor driven high-power dimmers are available for the 2,500 to 100,000 watt range. They utilize the exclusive new Lutron expandable modular building block system. For complete information, request our free High Power Dimmer Bulletin.

*3-way dimmer permits control of same light from two locations.

MODEL NO.	DESCRIPTION	INSTALLATION	TRADE NET
D-6P	600 Watts Push-On-Off	Single Gang Box, 2 Wires	\$ 5.97
D-63P	600 Watts 3-Way* Push-On-Off	Single Gang Box, 3 Wires	\$ 9.46
D-600P	600 Watts (UL), Push-On-Off	Single Gang Box, 2 Wires	\$ 7.30
D-603P	600 Watts (UL), 3-Way* Push-On-Off	Single Gang Box, 3 Wires	\$10.63
D-10P	1000 Watts Push-On-Off	Single Gang Box, 2 Wires	\$ 26.63
D-103P	1000 Watts 3-Way* Push-On-Off	Single Gang Box, 3 Wires	\$ 29.30

MODEL NO.	DESCRIPTION	INSTALLATION	TRADE NET
D-1000	1000 Watts (UL)	Single Gang Box 2 wires	\$ 26.63
D-1800P	1800 Watts Push-On-Off	Double Gang Box, 2 Wires	\$ 56.67
D-1803P	1800 Watts 3-Way* Push-On-Off	Double Gang Box, 2 Wires	\$ 59.98
D-2000	2000 Watts	Double Gang Box, 2 Wires	\$ 59.98
D-2500A	2500 Watts	Remote Control Single Gang Box	\$ 86.67
D-3600A	3600 Watts	Remote Control Single Gang Box	\$128.00

NEW! *Tu-Wire™ FLUORESCENT DIMMING SYSTEM

*Patent Pending

Exclusive! Features 500:1 Dimming Ratio!

Lutron introduces two-wire fluorescent dimming control using solid state thyristors with these outstanding advantages: **NEW INSTALLATIONS:** Quick and easy two-wire connection to dimmer. No third wire needed. No auxiliary ballast required. **CONVERSIONS:** Eliminates costly rewiring. Simple two-step installation — (1) Install Lutron BT-1 dimming ballast in place of existing ballast; (2)

Install Lutron Tu-Wire fluorescent dimmer in place of existing switch. **SPECIAL FEATURES:** All Tu-Wire systems have built-in minimum illumination level control which can be adjusted easily by the user, even after installation. Tu-Wire systems are easily installed in any standard single gang wall box. They are now available in two models, as specified below.

MODEL	DESCRIPTION	BALLAST	INSTALLATION	TRADE NET
T-8	1 to 8 Forty Watt lamps (rapid start only); 120 vac, 60 cps; rotary positive on/off action switch.	One approved BT-1 ballast per lamp (\$6.13 Trade Net)	Fits any single gang wall box — use any standard faceplate. Two-wire connection to dimmer.	\$11.99
T-14	4 to 14 Forty Watt lamps (rapid start only); 120 vac, 60 cps; rotary positive on/off action switch.	One approved BT-1 ballast per lamp (\$6.13 Trade Net)	Fits any single gang wall box—faceplate is supplied. Two-wire connection to dimmer.	\$26.65

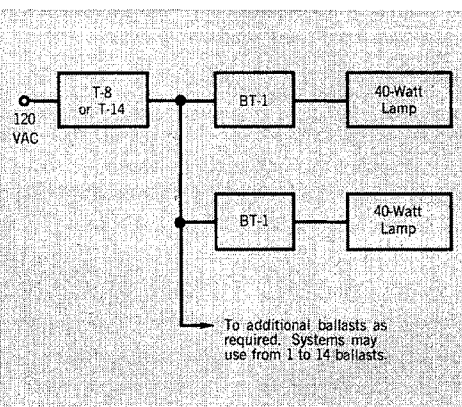

FLUORESCENT DIMMERS

All Lutron solid state fluorescent dimmers (except Tu-Wire) control fluorescent and incandescent lamps separately or together on the same circuit. Outstanding dimming performance is achieved with low-cost dimming ballasts of four different manufacturers; no auxiliary ballasts are required. Lutron dimmers and controls are all reliability tested through 40,000 full load cycles, equivalent to ten years of the severest residential use.

MODEL NO.	DESCRIPTION	INSTALLATION	TRADE NET
FD-600	3 to 12 Forty Watt lamps or 600 Watt incandescent	Single Gang Box 3 wires	\$ 22.00
FD-900	10 to 18 Forty Watt lamps or 900 Watt incandescent	Single Gang Box 3 wires	\$ 33.30

MODEL NO.	DESCRIPTION	INSTALLATION	TRADE NET
FD-1800	10 to 36 Forty Watt lamps or 1800 Watt incandescent	Remote Control Single Gang Box	\$ 96.67
FD-3600	10 to 72 Forty Watt lamps or 3600 Watt incandescent	Remote Control Single Gang Box	\$132.00

For proper fluorescent dimming with Lutron "FD" series dimmers, one of the following dimming ballasts must be used: Universal Nos. 661, 535, 550A, 502A; GE Nos. 6G5001, 6G3670, 89G718, 6G5007; Advance Nos. DIM-140L or RSD-140; Jefferson No. 254-1171.

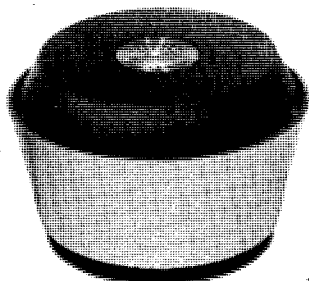

dim-liter™

SOLID STATE LAMP DIMMER

For home and office. Controls one or more incandescent lamps up to 600 w total. Features decorator styling, push-on, push-off, genuine walnut dial for fingertip remote control. Has concealed glow-light, visible only in the dark, to end groping for switches. Makes any lamp a night light. Cork bottom protects furniture. **Trade Net \$9.97**

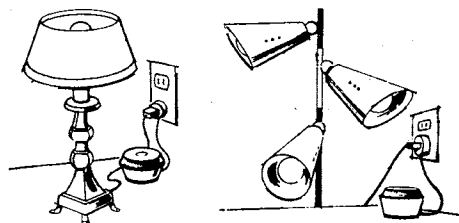

Dim-liter can be used with table lamps, desk lamps, pole lamps, swag lights, or any incandescent lamp.

**BRISTOL MOTORS**DIVISION OF
VOCALINE**SYNCHRONOUS MOTORS AND TIMERS**

Versatility is the characteristic which design engineers need — and find — in Bristol Synchronous Motors and Timing Devices. Bristol's unusually broad experience and range of design and manufacturing skills are particularly valuable where special requirements must be met.

The devices shown are among the most widely used. All can be mounted in any position, and take a minimum of space. Materials are selected on the basis of their suitability to provide long service, and perform well under a variety of conditions. Bristol engineering service is available for applications that require custom design and manufacture.

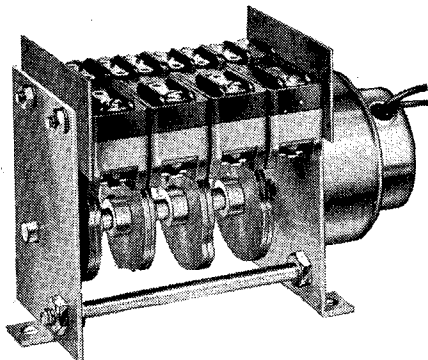

SERIES 31 REPEAT CYCLE TIMER. Low-cost multi-contact timer with high repeat accuracy. For vending machines, home appliances, industrial program controls. Speed Ranges: 1 Revolution Per Second to 1 Revolution Per Month. Motors standard, or high torque reversible. Switch Rating: 20 amp. at 115-230 V AC (also in 1/2 hp. at 125 V AC). Switches: enclosed snap action SPDT type. Cams: dual cams with set screws for field adjustment. Cut cams available on special order. Bulletin B-22. **One Switch Model \$8.25 approx.** **Four Switch Model \$16.75 approx.**



SERIES 6100 TIME DELAY RELAY. Universal Time Delay Relay provides self-holding solenoid starting with adjustable timed contact operation. Type 6110 provides three types of load contacts which give seven types of load circuit operation in a single unit. This model may be wired up to one of four basic types of operation: momentary start, automatic reset; momentary start, manual reset; sustained switching; and tandem or cascaded operation. Size 3" in diameter by 5 1/4" long. Timer case bezel 1 1/2 thick x 3 5/8 inches square. Universal mounting allows standard 3-stud or 4-stud panel mounting. For further information request Bulletin No. B-11. **\$44.00 approx.**

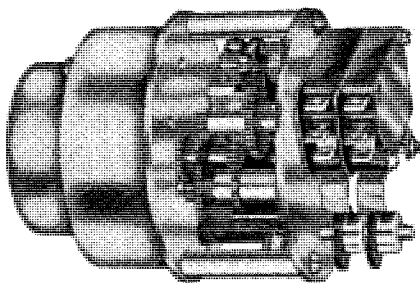

SERIES 21 TIME DELAY RELAY. General timer for instantaneous reset-type action, such as timers for photography, electronic safety, alarms, signals, etc. (Life expectancy over 1 million cycles.) Compact. Quick reset time (well under 1/5 second). Repeat accuracy better than 1% full scale. Time setting: 15 seconds to 3 months full scale. Rating: 10 amp (non-inductive load), Voltage: 115 V AC, 60 cycles standard. Optional adjustment feature available. Bulletin B-21. **One Switch Model \$19.00 approx.** **Two Switch Model \$22.50 approx.**

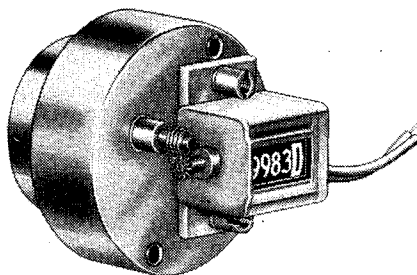

SERIES 41 ELAPSED TIME INDICATOR. Adaptable for panel or unit mounting, this low-cost series features simple installation, and a choice of four models with non-reset or reset counters. Maximum readings on both units from 9,999.9 minutes to 99,999 hours. 115 V AC, 60 Cycle standard. 50 Cycle and other voltages available. For further information on the three models above request Bulletin B-23. **Non-reset \$14.00 approx.** **Reset \$20.00 approx.**

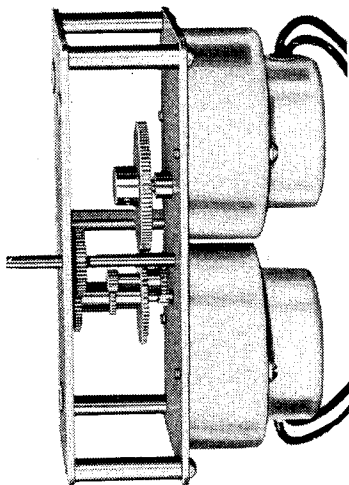

MODEL 42 DUAL SPEED UNIT. Consists of two motors assembled to a common output shaft through a differential. Output speed is the sum of the two motor input speeds. Therefore, two different speed unidirectional motors provide a choice of 3 output speeds (either motor speed or the sum of the two motor speeds). Available with reversible motors for further variations in output speed. Standard units also available incorporating 3 and 4 motors providing up to 40 output speeds by electrical switching. Dimensions depend on the design of the unit in question. For further information request Bulletin B-24. **Basic Unit \$18.75 approx.**

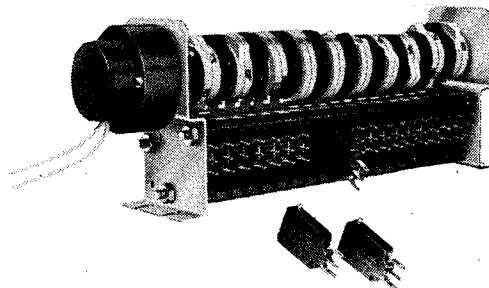

SERIES 47 REPLACEABLE SWITCH REPEAT CYCLE TIMER is a multi-contact program timer which permits easy switch replacement without the necessity of disassembling. In addition one turn of the calibrated adjusting screw provides a 2% variation of cam time sequence. Switches are rated at 6 amps-115 volts. Available in a wide range of switches and speed combinations. Request Bulletin B-20. **Two Switch Model \$14.00 approx.** **Six Switch Model \$24.00 approx.**

For Complete Bristol Line Write for Catalog

VOCALINE COMPANY OF AMERICA, INC., BRISTOL MOTOR/TIMER DIVISIONTimers and Motors to meet special applications are available from distributors.
See Vocaline Bristol Motors Catalog for complete line of motors and timers.IMMEDIATE DELIVERY FROM FRANCHISED
VOCALINE\BRISTOL MOTORS DISTRIBUTORS

PR Crystals

- AMATEUR • AIRCRAFT
- CITIZENS BAND • INDUSTRIAL
- RADIO CONTROL • DIATHERMY
- FREQUENCY STANDARD

FOR AMATEUR SERVICE



Z-9C

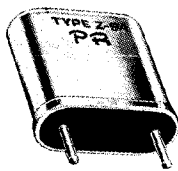

Z-9A

Z-9C and Z-9A Crystals are supplied ONLY in the following bands and calibrated INTEGRAL KILOCYCLES only, NO FRACTIONS. All Z-9C crystals are calibrated with a load of 32 mmfd.

Type	Frequency Range	For	Price
Z-9C Fundamental	1750 to 2000 Kc.	160M.	\$2.95
	±250 Cycles		
	3500 to 4000 Kc.	80M.	
	7000 to 7425 Kc.	40M.	
	8000 to 8222 Kc.	2M.	
8334 to 9000 Kc.	6M.		
	±500 Cycles		

Type	Frequency Range	Price
Z-9A 3rd Overtone	24000 to 24666 Kc. ±3 Kc. 28000 to 27000 Kc. ±5 Kc. 30000 to 50000 Kc. ±10 Kc.	3.95
Z-9A 5th Overtone	50000 to 54000 Kc. ±10 Kc.	4.95

CITIZENS BAND

Supplied in all 23 assigned frequencies. Be sure to specify channel desired, with name of manufacturer and model of equipment. Type Z-9R Crystals have .486" pin spacing; .050" pin diameter; .758" height above pins; width .720" and depth .309". Z-13 Crystals have .192" pin spacing; .040" pin diameter; .530" height above pins; width .402" and thickness .150". Z-13P Crystals are same as Z-13 except for having .017" wire leads instead of pins.

Calibrated	.005%	.002%
All Types	\$2.95	\$3.95

Type Z-9R, RADIO CONTROL

Supplied in all FCC assigned frequencies. Calibrated .005%. In ordering, be sure to specify frequency desired, with manufacturer and model number of equipment.

Type Z-9R—Radio Control	.005%	\$2.95
Type Z-9R—Radio Control	.002%	3.95

MARINE TYPES

(Pix Z-9 HC-6/U)

Available for all makes of Marine equipment. Frequency range 1600 Kc to 7000 Kc. Specify make of equipment and frequency desired.



	Transmitter	Receiver
Z-9	2000-3000Kc. \$6.00	\$6.00
Z-30	2000-3000Kc. 6.00	6.00

Type Z-1, TV MARKER

Channels 2 through 13	\$6.45
4.5 Mc. Intercarrier, .01%	2.95
5.0 Mc. Signal Generator, .01%	2.95
10.7 Mc. FM, IF, .01%	2.95

VHF Types, AIRCRAFT

For Lear, Narco and similar equipment operating in the 121 Mc. region, requiring crystals in 30 Mc. range. Z-9R Crystals have .486" pin spacing; .050" pin diameter; .758" height above pins; width .720" and depth .309". Z-13 Crystals have .192" pin spacing; .040" pin diameter; .530" height above pins; width .402" and thickness .150". Z-13P Crystals are same as Z-13, except for having .017 wire leads instead of pins.

Type Z-9R—Aircraft	\$4.95
Type Z-13—Aircraft	4.95
Type Z-13P—Aircraft	4.95



Type Z-6A, FREQUENCY STANDARD

Correlated in oscillator having load capacity of 32 mmfd. .486" pin spacing; .050" pins.

Type Z-6A—100 Kc. (.050" Pins) \$6.95

Z-1, MARS and CAP

Calibrated to .005% with 32 mmfd. crystal load capacity. Official assigned transmitter frequencies in the range.

1600 to 10000 Kc. \$3.45

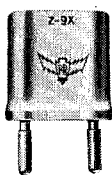

Z-9X, EXPERIMENTAL

Suitable for converters, experiment, etc.

1600 to 12000 Kc. ±5 Kc. (Fund.) \$3.45

12001 to 25000 Kc. ±10 Kc. (3rd Overtone) 4.45

TRANSISTORIZED OSCILLATOR PR 100

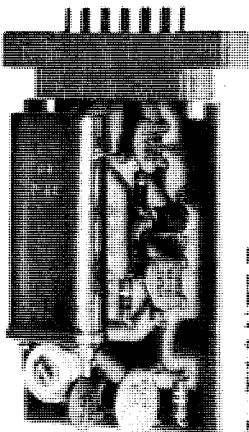

Fully wired, plug-in unit... Includes a Z-6A 100 Kc crystal. With it you can check harmonics from 100 Kc through 54 Mc.

PR 100 with crystal
Price \$16.95

COMMERCIAL TYPES

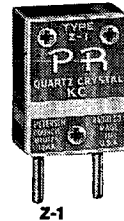

Z-1



Z-9, Z-9R



Z-13

SPECIFICATIONS

Type	Pin Spacing	Pin Diameter	Height Above Pins
Z-1	.486"	.093"	1 3/16"
Z-1A	3/4"	.125"	1 3/8"
Z-1B	3/4"	.125"	1 3/8"
Z-1D	1/2"	.125"	1 3/16"
Z-1H	3-Pin W.E.	.157"	2 1/16"
Z-1M	7/8"	Std. Banana	2 3/32"
Z-1R	1/2"	.093"	1 1/4"
Z-9	.486"	.050"	.758"
Z-9R	.486"	.050"	.758"
Z-13	.192"	.040"	.530"
Z-13P	.192"	.017 Wire	.530"
E-1	Interchange with FT164 and AC-95		
Z-21	3-Pin W.E.	.157"	2"
Z-22	3/4"	.125"	1 1/4"
Z-24	1/2"	.125"	1 1/4"
Z-30	3/4"	.125"	1 1/4"

Note: Z-1A can be supplied with Standard Banana Pins. Specify when ordering. Z-9 and Z-9R can be supplied with .093 Pins. All Fundamental Crystals are correlated in oscillator having load capacity of 32 mmfd. unless otherwise specified.

Commercial Type Crystals are available from 800 Kc. to 150 Mc. Prices depend upon specifications and quantities. Ask for quotations.

TRANSISTOR OSCILLATORS

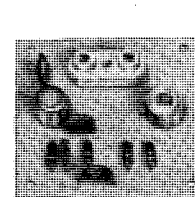

Temp. range -0°C./+35°C. Power req. 9V DC +10% @ 4 Ma. Min. R.F. voltage no load, 2V. I-1.5V. with max. load of 1.5 K ohms. Width 2", depth 2", height 1 15/16". Matching crystal required for frequency desired. Specify tolerance. Fully wired.

PR-455—Frequency range 455 Kc. to 1 Mc., Less Crystal	\$8.50
PR 1-5—Frequency range 1 Mc. to 5 Mc., Less Crystal	\$8.50

(Available to 17 Mc.)

OVEN PRO-26

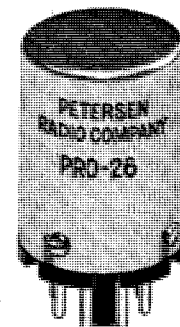

Precision built for long life. Heating element anchored in epoxy. Teflon coated interior inhibits formation of moisture. Internal cavity temperature: 65°C. to 100°C. Input voltage: 6.3 to 110V. AC or DC.

PRICE \$19.95

PRICE LIST • Subject to Change without Notice • **MINIMUM ORDER \$10.00**

CRYSTEK CRYSTALS... FOR EVERY PURPOSE

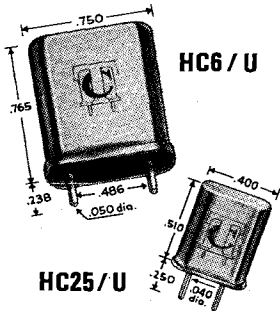

2⁹⁵
EACH

CLASS "D" CITIZEN BAND CRYSTALS

23 Frequencies — 3rd Overtone — .005% Tol.

All "Citizen Band" crystals supplied in Hermetically sealed holders for all 23 channels and C.A.P. When ordering, specify make and Model of UNIT and CHANNEL NUMBERS desired.

We supply crystals for every popular make of Citizen Band Transceivers.

LOW FREQUENCY CRYSTALS 80 KHZ - 999 KHZ

FREQUENCY	TYPE	
	STANDARD	SPECIAL
	CALIBRATION TOLERANCE ±.005%	CALIBRATION TOLERANCE ±.002%
80- 99 KHZ	\$10.00	\$12.00
100-199 KHZ	8.00	10.00
200-799 KHZ	7.00	9.00
800-999 KHZ	12.00	13.00

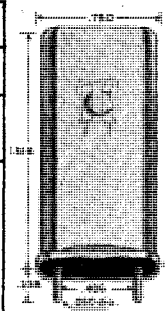

HC13/U
70 KHZ — 200 KHZ (70-99 KHZ is 2.5" in height)

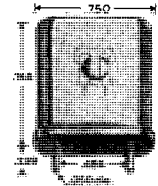

HC6/U
200 KHZ to 1000 KHZ

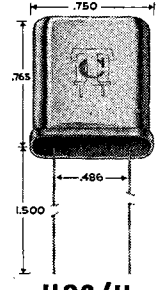

HC6/U
Also Available with Wire-leads

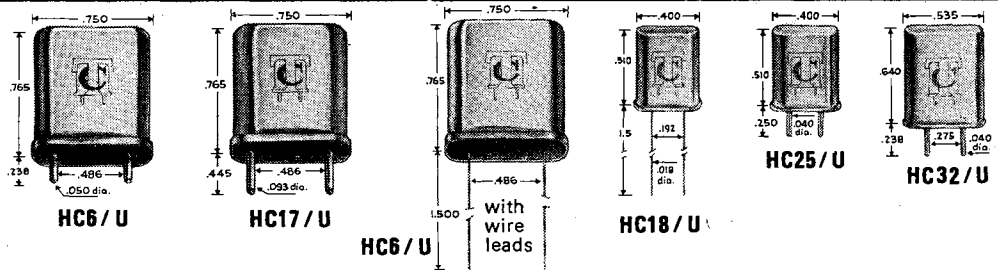

AMATEUR CRYSTALS
Hermetically Sealed HC6/U Holder

Supplied In Following Freq.	±.005% Tolerance
3501 to 3999KC.....	\$2.95 ea.
4667 to 4780KC.....	2.95 ea.
7000 to 7425KC.....	2.95 ea.
8001 to 8221KC.....	2.95 ea.
8334 to 8900KC.....	2.95 ea.

FUNDAMENTAL TYPE — 1000 KHZ - 22000 KHZ			
FREQUENCY	TYPE		
	STANDARD	SPECIAL	OVEN 75°C/85°C
	CALIBRATION TOLERANCE ±.002%	CALIBRATION TOLERANCE ±.001%	CALIBRATION TOLERANCE ±.002%
1000- 1499 KHZ	\$8.50	\$10.50	\$12.50
1500- 1999 KHZ	7.50	10.00	12.00
2000- 2999 KHZ	6.00	9.00	11.00
3000-10999 KHZ	4.50	7.00	9.00
11000-19999 KHZ	6.00	8.00	10.00
20000-22000 KHZ	8.00	10.00	12.00

MARINE CRYSTALS
2000 — 5000 KHZ

For most marine units, including Apelco, Bendix, Konisberg, Pearce-Simpson, Raytheon, Sonar and Kaar.

Type HC6/U Marine
2000 KHZ thru 5000 KHZ
\$5.50

Type HC17/U Marine
2000 KHZ thru 5000 KHZ
\$5.50

OVERTONE TYPE — 10 MHZ - 125 MHZ				
FREQUENCY	MODE	STANDARD	SPECIAL	OVEN 75°C/85°C
		CALIBRATION TOLERANCE ±.002%	CALIBRATION TOLERANCE ±.001%	CALIBRATION TOLERANCE ±.002%
		10- 60 MHZ	(3rd)	\$6.00
61- 75 MHZ	(5th)	7.50	11.00	13.00
76-125 MHZ	(5th)	9.00	13.00	15.00

HARRY DAVIES MOLDING CO.

MOLDERS OF PLASTICS

POINTER AND BAR KNOBS

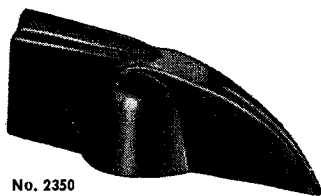

No. 2350

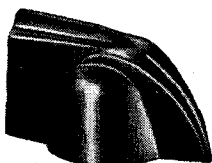

No. 2300



No. 2150



No. 1550

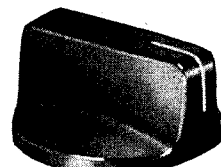

No. 1500, 1510 & 1520

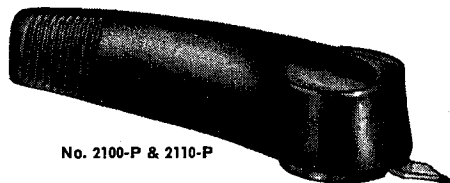

No. 2100-P & 2110-P

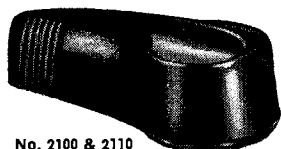

No. 2100 & 2110

No. 2350
Length 2", hgt. $\frac{5}{8}$ ", $\frac{1}{4}$ " molded hole or metal insert, set screw mounting, locknut recess.

No. 2300
Length $1\frac{1}{4}$ ", hgt. $\frac{5}{8}$ ", $\frac{1}{4}$ " molded hole, also $\frac{1}{4}$ " metal insert, set screw or knurled hole mounting, locknut recess.

No. 2150
Length $1\frac{1}{4}$ ", hgt. $\frac{5}{8}$ ", $\frac{1}{4}$ " molded hole, set screw mounting, locknut recess.

No. 1550
Dia. $1\frac{1}{8}$ ", hgt. $\frac{5}{8}$ ", $\frac{1}{4}$ " molded hole or metal insert, set screw, spring or knurled hole mounting, locknut recess.

No. 1500
Dia. $1\frac{1}{8}$ ", hgt. $\frac{5}{8}$ ", $\frac{1}{4}$ " molded hole. Set screw mounting. Locknut recess. Indicator line filled or unfilled.

No. 1510
Dia. $\frac{3}{4}$ ", Hgt. $\frac{3}{16}$ ", $\frac{1}{8}$ ", $\frac{3}{16}$ " or $\frac{1}{4}$ " Molded Hole and Set Screw, $\frac{1}{4}$ " Knurled Hole Mounting.

No. 1520
Dia. $1\frac{1}{2}$ ", Hgt. $\frac{3}{4}$ ", $\frac{1}{4}$ " Molded Hole or Brass Insert with Set Screw.

No. 2100-P
Length $2\frac{1}{2}$ ", hgt. $\frac{5}{8}$ ", width $\frac{3}{4}$ ", $\frac{1}{4}$ " metal insert and $\frac{5}{16}$ " pointer, set screw mounting.

No. 2110-P
Length $1\frac{5}{8}$ ", hgt. $1\frac{1}{2}$ ", width $\frac{3}{4}$ ", $\frac{1}{4}$ " metal insert and $\frac{5}{16}$ " pointer, set screw mounting.

No. 2100
Length $2\frac{1}{2}$ ", hgt. $\frac{5}{8}$ ", width $\frac{3}{4}$ ", $\frac{1}{4}$ " molded hole or metal insert, set screw mounting, locknut recess.

No. 2110
Length, $1\frac{5}{8}$ ", hgt. $1\frac{1}{2}$ ", width $\frac{3}{4}$ ", $\frac{1}{4}$ " molded hole or metal insert, set screw or knurled hole mounting, locknut recess.

CONTROL KNOBS



No. 1400

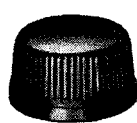

No. 1450

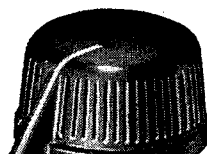

No. 1470

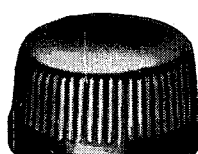

No. 1475

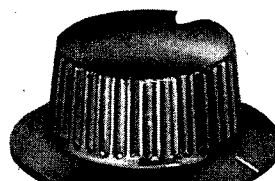

No. 1600

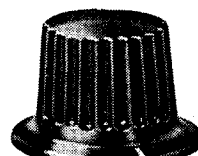

No. 1610

No. 1400
Dia. $1\frac{1}{16}$ ", hgt. $1\frac{1}{2}$ ", $\frac{1}{8}$ " or $\frac{1}{4}$ " molded hole or brass insert, set screw, spring or knurled hole mounting.

No. 1450
Dia. $1\frac{1}{16}$ ", hgt. $1\frac{1}{2}$ ", $\frac{1}{8}$ " or $\frac{1}{4}$ " molded hole or brass insert, set screw, spring or knurled hole mounting.

No. 1470
Dia. 1", hgt. $\frac{1}{2}$ ", $\frac{1}{4}$ " molded hole or brass insert, set screw, spring or knurled hole mounting, indicator line filled or unfilled, locknut recess.

No. 1475
Dia. 1", hgt. $\frac{1}{2}$ ", $\frac{1}{4}$ " molded hole or brass insert, set screw, spring or knurled hole mounting, locknut recess.

No. 1600
Dia. $1\frac{1}{2}$ ", hgt. $1\frac{1}{16}$ ", $\frac{1}{4}$ " molded hole or metal insert, set screw mounting, locknut recess, indicator line filled or unfilled.

No. 1610
Dia. $1\frac{5}{16}$ ", hgt. $\frac{5}{8}$ ", $\frac{1}{8}$ " or $\frac{1}{4}$ " molded hole or metal insert, set screw mounting, locknut recess, indicator line filled or unfilled.

No. 1700
Dia. $\frac{3}{4}$ ", hgt. $1\frac{1}{2}$ ", $\frac{1}{4}$ " molded hole or brass insert, set screw, spring or knurled hole mounting.

No. 2500
Dia. $\frac{3}{4}$ ", hgt. $\frac{3}{4}$ ", $\frac{1}{4}$ " molded hole, set screw, spring or knurled hole mounting.

No. 2600
Dia. $\frac{7}{8}$ ", hgt. $\frac{7}{8}$ ", $\frac{1}{4}$ " molded hole, set screw, spring or knurled hole mounting.

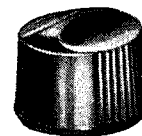

No. 1700

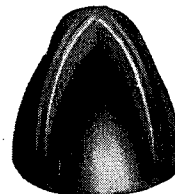

No. 2500 & 2600

PUSH BUTTONS



No. 5149-A



No. 1800



No. 1750 & 1770

No. 5149-A
Hgt. $\frac{5}{16}$ ", oval touch tuning. Push-on to fit flatted shaft. $.050$ " x $.187$ ".

No. 1800
Dia. $\frac{3}{16}$ ", hgt. 1 " to $1\frac{3}{8}$ ", touch tuning, plain or recessed top, push-on, to fit

flatted shaft $.050$ " x $.187$ " patented friction fit. Also with studs of various lengths.
No. 1750
Dia. $\frac{3}{16}$ ", hgt. $\frac{3}{16}$ " to $1\frac{1}{8}$ ", touch tuning, push on, to fit flatted shaft $.050$ " x $.187$ ".

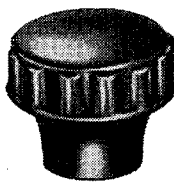

No. 2960

No. 1770
Dia. $\frac{3}{16}$ ", hgt. $\frac{1}{2}$ " to $\frac{7}{8}$ ", 6-32 or 8-32 female metal insert. 8-32 male stud.

No. 2960
Dia. $\frac{7}{8}$ ", hgt. $\frac{3}{4}$ ", 8-32 or 10-32 female metal insert, 10-24 or 10-32 male stud.

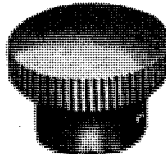

No. 2710, 2720, & 2730

No. 2710
Dia. $\frac{3}{4}$ ", hgt. $\frac{1}{2}$ ", 8-32, 10-32, 10-24 metal insert.

No. 2720
Dia. $\frac{5}{8}$ ", Hgt. $\frac{3}{16}$ ", 10-24, 10-32 Female Metal Insert.

No. 2730
Dia. $1\frac{1}{16}$ ", Hgt. $\frac{3}{4}$ ", 10-24, 10-32 Female Metal Insert, 10-32 Male Stud.

METER CASE AND COVERS

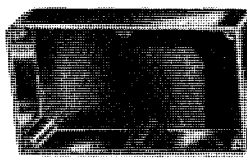

No. 240 Case
2" hgt. x $3\frac{3}{4}$ " wide x $6\frac{1}{4}$ " long. (Outside Dimensions) $\frac{1}{8}$ " (Wall Thickness).

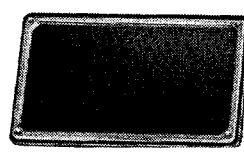

No. 241
Mating cover with interlocking lip for No. 240 series cases.

No. 220 Case
1 $\frac{1}{2}$ " hgt. x $2\frac{7}{8}$ " x 4" long (outside dimensions) $.109$ " (wall thickness).

No. 260 Case
 $2\frac{5}{16}$ " hgt. x $5\frac{1}{2}$ " w x $6\frac{1}{16}$ " l. (Outside Dimensions) $\frac{1}{16}$ " (Wall Thickness).

No. 261
Mating cover with interlocking lip for No. 260 case.

No. 221
Mating cover for 220 case. Laminated phenolic nests inside case.

LETRASET

instant lettering

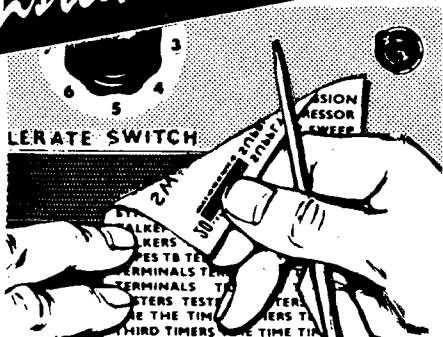

THE REVOLUTIONARY METHOD FOR MARKING ELECTRONIC EQUIPMENT

JUST RUB and it's PRINTED!

Sharp • Clean • Fast • Not a Decal • No Water • No Tapes

INSTANT LETTERING® marking kits bring you all the necessary elements for completely marking electronic equipment, prototypes, drawings, etc. in this fast new easy-to-use form. There's even a new drafting symbol kit for better more readable schematics.

Words, letters, numerals, switch patterns, arcs, drafting symbols, etc. are printed on a special transparent carrier film. Rubbing over one of these elements with a ballpoint pen releases it from the carrier film and adheres it to your working surface.

INSTANT LETTERING® words and symbols transfer to almost any surface including glass, plastic, even painted and bare metals. Now you can quickly mark all panels, even especially calibrated two-color nomenclatures, pilot light jewels, sub-assemblies, circuit boards, etc. Reproduction quality INSTANT LETTERING® transfers are clean and sharp, leave no background haze or film, make prototypes look like finished production equipment and give all equipment and drawings a professional look.

instant lettering

DRY TRANSFER MARKING KITS



TITLES for ELECTRONIC EQUIPMENT
NEW, REVISED; Now 20% more titles in a new easy-to-read typeface. Researched to give up to 95% of all electronic marking. For labeling, marking, titling all electronic control panels, drawings, prototypes, etc.
No. 9581—Complete Set (black) \$4.95
No. 9591—Complete Set (white) \$4.95
REFILL SETS—12 sheets per set
No. 9601—Alphabets (black) \$2.50
No. 9611—Alphabets (white) \$2.50
No. 9621—Numerals (black) \$2.50
No. 9631—Numerals (white) \$2.50

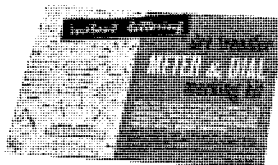

METER & DIAL MARKING KIT
Arcs, dial patterns, lines, wedges, graduation lines, switch symbols alphabets and numerals in black, white and red for marking standard and special rotary tap switches, potentiometers and prototype and specially calibrated meter dials. Colors provide contrast on scales and switches, simplifying usage of complex instruments.
No. 968—Complete Set \$4.95
REFILL SHEETS—set of four identical sheets
No. 968R—(specify sheet number) \$2.00

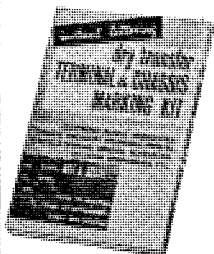

TERMINAL & CHASSIS MARKING KIT
All the necessary letters, letter combinations and numerals for marking chassis, printed circuit and terminal boards, rotating components, etc.
No. 966—Black \$4.95
No. 967—White \$4.95



ELECTRONIC SYMBOL DRAFTING SET
The quick way to more readable schematics. Contains 40 sheets of electronic symbols plus letters and numerals. Symbols designed to conform with MIL-STD-15-1A. Sheets have heat resistant adhesive for perfect reproduction in any blue- or white-printer. Also included is a complete guide to drawing with dry transfer symbols.
No. 970—Complete Set \$15.95
REFILL SHEETS—set of four identical sheets
No. 970R—(specify sheet number) \$2.00



DATAMARK KITS
Low cost dry transfer marking kits designed to provide useful preset words, symbols and alphabets for specific uses.
K58B—Audio, TV & Hi-Fi (black) \$1.25
K58W—Audio, TV & Hi-Fi (white) \$1.25
K59B—Amateur Radio & CB (black) \$1.25
K59W—Amateur Radio & CB (white) \$1.25
K60B—Experimenter, Home & Intercom (black) \$1.25
K60W—Experimenter, Home & Intercom (white) \$1.25
K61B—Test & Industrial Equipment (black) \$1.25
K61W—Test & Industrial Equipment (white) \$1.25
K62—Marks & Switch Patterns \$1.25
K63—Alphabets & Numerals (1/8") \$1.25
K64—Alphabets & Numerals (1/4") \$1.25
K65—Alphabets & Numerals (1/2") \$1.25

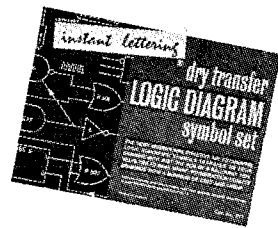

LOGIC DIAGRAM SYMBOL SET
NEW! The most modern and effective aid to drawing logic diagrams. Symbols transfer to your drawing in seconds. All you need do is add the connecting leads. Heat resistant adhesive allows perfect reproduction even in diazo and other high speed printers. Symbols conform fully to MIL-STD-806B and ASA-Y32.14.
No. 971—Complete Set \$3.50
REFILL SHEETS—set of four identical sheets
No. 971R—(specify sheet number) \$2.00

instant lettering

STANDARD SHEETS

Full 10" x 15" sheets of alphabets and numerals available in over 50 different typefaces in sizes ranging from 8 pt. to 3 in. display letters and in 6 colors. Also available are arrows, math symbols, chart symbols, line and dot rules, etc. Free sample and complete type chart available upon request.

instant lettering

HEAT RESISTANT SHEETS

Heat resistant letters allow your drawings to be reproduced with perfect results every time. Letters will not flake, peel or fray in any blue- or white-printer. Razor sharp letters are printed with a highly opaque ink so you get perfect results every time. Write for complete details.

instant lettering

SPECIAL SHEETS

Sheets made to your own specifications can include logos, drawings, symbols, preset words — anything that you use repeatedly. Hundreds of lettering and marking problems that were impossible or too expensive become practical with "Instant Lettering". Tell us your problem and let us suggest a "dry transfer" solution.

instant lettering

DATAKOAT

Clear Protective Coating

Specially designed to protect "Instant Lettering" transfers from abrasion and weathering. Datakoat is water-clear and dries quickly.

Protective Coating Kit contains a 1 oz. bottle of Datakoat with applicator brush in cap and a 1 oz. bottle of thinner.

No. 04176 \$1.00

Spray Coatings are the handy aerosol can form of Datakoat (16 oz. cans).

No. 04177 (Glossy) \$2.95
No. 04178 (Matte) \$2.95

THE DATAK CORPORATION

russell industries, inc.



DRI-TRANSFER LETTERING

EACH MARKIT® CONTAINS 27 3" X 6" PAGES IN LOOSE LEAF FORM BOUND WITH PLASTIC SPIRAL RING.

MARKIT® PRICES

1-5	\$4.95
6-11 Asst.	\$4.50
12 or more Asst.	\$4.25



ALPHABET MARKIT®

ALPHABET		NUMERALS		SIZE
BLACK	WHITE	BLACK	WHITE	
AM-1	AM-1W	NM-1	NM-1W	1/8"
AM-2	AM-2W	NM-2	NM-2W	1/4"
AM-3	AM-3W	NM-3	NM-3W	3/8"
AM-4	AM-4W	NM-4	NM-4W	1/2"
AM-5	AM-5W	NM-5	NM-5W	7/32"
AM-6	AM-6W	NM-6	NM-6W	15/32"

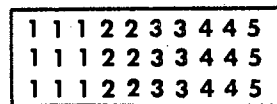

NUMERALS MARKIT®

Electronic Words MarKit®

An electronic glossary with over a thousand words from "AC" to "zooms" in alphabetical order for easy application to control panels, prototypes, drawings, terminal boards, electrical and mechanical components. Size 1/8" high.

EM-1 (black)

EM-1W (white)

ON JUMP IONIZATION JACKS J
PERS JUMPERS JUI
URDS KEYING KEYI
S KILOCYCLES KW
WATTS KILOWATTS
EAKAGE LEAK LEFT

ELECTRONIC WORDS MARKIT®

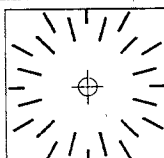

DIAL MARKING MARKIT®

Dial Marking Kit

Contains dial patterns, arcs, wedges, lines, dots, switch symbols, graduation lines, lines for rotary tap switches, potentiometers and calibrated meter dials.

DM-1 (14 Pages black)
(13 Pages white)



TERMINAL & CHASSIS MARKIT®

Terminal and Chassis MarKit®

Contains numbers (through 200, 1 through 0 and 01 through 09) plus complete alphabets. All numbers 3/8" high. For application in prototypes and production.

TC-1 (15 Pages black)
(12 Pages white)

Logic Diagram Symbols MarKit®

Contains flip flops, arrows, arrow heads, time delays, and, nand, or, nor, registers, shift registers, connection dots, Schmidt triggers, single shots.

LD-1 (black)

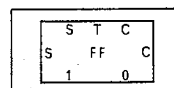

LOGIC DIAGRAM SYMBOLS MARKIT®

Printed Circuit Pads MarKit®

Thousands of printed circuit pads: circles (with center hole), teardrops, teardrops (with vanishing point), double end teardrops, double end teardrops (with vanishing points), elbows, elbow (terminal), T-connectors, fillets, ovals.

PC-1 (black)

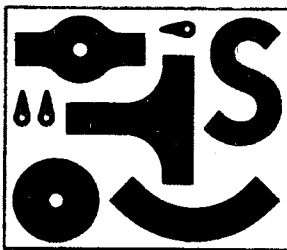

PRINTED CIRCUIT PADS MARKIT®

MARKETCH® ETCHING SOLUTION

Adhere any desired MarKit® symbol to copper surface of printed circuit board. Burnish thoroughly. Then deposit entire board into etching solution until all exposed copper is completely etched from board. Symbol will remain as it is, unaffected by etching solution. Wash board under running water. Wipe board dry. Then use thinner or fine sandpaper until bright copper is exposed.

PCE-1 — PRICE \$3.00

One pint liquid in unbreakable plastic container. Weight approx. 28 oz.

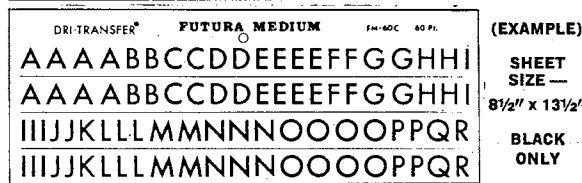

(EXAMPLE)
SHEET SIZE — 8 1/2" x 13 1/2"
BLACK ONLY

NATURAL BOLD

ABCDEFGHIJklmno

Cat. No. NOB16-CL/16 Pt. Capitals and Lower Case
Cat. No. NOB24-CL/24 Pt. Capitals and Lower Case

Cat. No. NOB36-CL/36 Pt. Capitals and Lower Case
Cat. No. NOB42-CL/42 Pt. Capitals and Lower Case

Cat. No. NOB48-L/48 Pt. Lower Case Letters Only
Cat. No. NOB48-C/48 Pt. Capital Letters Only

FUTURA BOLD

ABCDEFGHIJKlmnopqrs

Cat. No. FOB12-CL/12 Pt. Capitals and Lower Case
Cat. No. FOB24-CL/24 Pt. Capitals and Lower Case

Cat. No. FOB30-CL/30 Pt. Capitals and Lower Case
Cat. No. FOB36-CL/36 Pt. Capitals and Lower Case

Cat. No. FOB48-C/48 Pt. Capital Letters Only
Cat. No. FOB60-L/60 Pt. Lower Case Letters Only
Cat. No. FOB60-C/60 Pt. Capital Letters Only

FUTURA DEMI-BOLD

ABCDEFGHIghijkl

Cat. No. FDB24-CL/24 Pt. Capitals and Lower Case
Cat. No. FDB30-CL/30 Pt. Capitals and Lower Case
Cat. No. FDB36-CL/36 Pt. Capitals and Lower Case

Cat. No. FDB48-L/48 Pt. Lower Case Letters Only
Cat. No. FDB48-C/48 Pt. Capital Letters Only
Cat. No. FDB60-L/60 Pt. Lower Case Letters Only

Cat. No. FDB60-C/60 Pt. Capital Letters Only
Cat. No. FDB72-L/72 Pt. Lower Case Letters Only
Cat. No. FDB72-C/72 Pt. Capital Letters Only

FUTURA MEDIUM

ABCDefgh

Cat. No. FM36-CL/36 Pt. Capitals and Lower Case
Cat. No. FM48-L/48 Pt. Lower Case Letters Only

Cat. No. FM48-C/48 Pt. Capital Letters Only
Cat. No. FM60-L/60 Pt. Lower Case Letters Only

Cat. No. FM60-C/60 Pt. Capital Letters Only
Cat. No. FM72-L/72 Pt. Lower Case Letters Only
Cat. No. FM72-C/72 Pt. Capital Letters Only

CLARENDON

ABCDefg

Cat. No. CON24-CL/24 Pt. Capitals and Lower Case

Cat. No. CON36-CL/36 Pt. Capitals and Lower Case

Cat. No. CON48-L/48 Pt. Lower Case Only
Cat. No. CON48-C/48 Pt. Capital Letters Only

FRANKLIN GOTHIC COND.

ABCDEFghijk

Cat. No. FGC24-CL/24 Pt. Capitals and Lower Case
Cat. No. FGC36-CL/36 Pt. Capitals and Lower Case
Cat. No. FGC42-CL/42 Pt. Capitals and Lower Case

Cat. No. FGC48-L/48 Pt. Lower Case Letters Only
Cat. No. FGC48-C/48 Pt. Capital Letters Only
Cat. No. FGC60-L/60 Pt. Lower Case Letters Only

Cat. No. FGC60-C/60 Pt. Capital Letters Only
Cat. No. FGC72-L/72 Pt. Lower Case Letters Only
Cat. No. FGC72-C/72 Pt. Capital Letters Only

FRANKLIN GOTHIC

ABCDEFghijk

Cat. No. FG18-CL/18 Pt. Capitals and Lower Case
Cat. No. FG36-CL/36 Pt. Capitals and Lower Case

Cat. No. FG48-L/48 Pt. Lower Case Letters Only
Cat. No. FG48-C/48 Pt. Capital Letters Only
Cat. No. FG60-L/60 Pt. Lower Case Letters Only

Cat. No. FG60-C/60 Pt. Capital Letters Only
Cat. No. FG72-L/72 Pt. Lower Case Letters Only
Cat. No. FG72-C/72 Pt. Capital Letters Only

1 - 5 Sheets \$1.69 ea.
6 - 11 Sheets 1.59 ea.
12 or more Sheets 1.49 ea.

Assorted Sheets

ELECTRONIC SYMBOL SHEETS

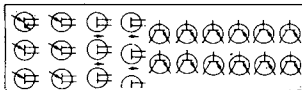

DST-1 Thermistors, photocells, Zener Diodes, SCR's.
BRS-1 Bridge Rectifiers, Diodes, SCR's.
UNP-1 FET, Unijunction, NPN and PNP Transistors.
RCT-1 Capacitors, Tubes, Resistors, Potentiometers, Varistors.
BFP-1 Plugs, Jacks, Switches, Lights, Fuses.

CC-1 Grounds, Shields, Contactors, Connections.
IRM-1 Relays, Contactors, Heaters, Reactors, Rotating Components, Thermal Delay Relays, Inductors, Transformers.
LAB-1 Antennas, Amplifiers, Speakers, Mikes, Boxes.

KNOBS

waldom



INSTRUMENT KNOBS (Continued)

WING TYPE KNOBS

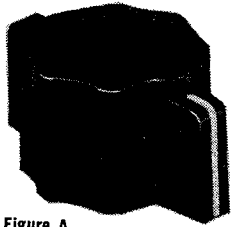

Figure A

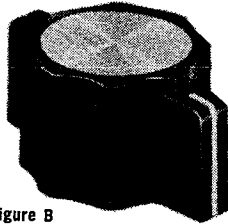

Figure B

Part No.	Dia.	Height	Figure	Net Ea.	100-Up, Ea.
WA-401	1-1/4"	19/32"	A	.99	.82
WA-402	1-1/4"	19/32"	B	1.33	1.10

Supplied with 1/4" brass insert and two #8-32 slotted head set screws, 135° apart.

BAR TYPE KNOBS

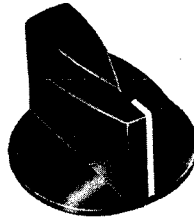

Figure C



Figure D

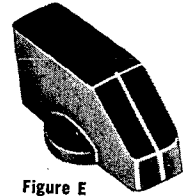

Figure E

Part No.	Dia.	Height	Figure	Net Ea.	100-Up, Ea.
WA-1560	1-1/8"	5/8"	C	.35	.29
WA-1580	1-1/2"	5/8"	D	.29	.24
WA-1590	1-1/8"	11/16"	E	.17	.14

MILITARY KNOBS PER MIL SPEC MS91531 SERIES

Dash No.	Part No.	Figure	Net Ea.	Dash No.	Part No.	Figure	Net Ea.
—2N2B	WA-2NB	1	1.14	—3F2M	WA-3FM	2	1.38
—2N2M	WA-2NM	1	.80	—4F2B	WA-4FB	2	2.71
—3N2B	WA-3NB	1	1.39	—4F2M	WA-4FM	2	1.72
—3N2M	WA-3NM	1	.98	—2P2B	WA-2PB	3	1.30
—4N2B	WA-4NB	1	1.72	—2P2M	WA-2PM	3	.94
—4N2M	WA-4NM	1	1.20	—3P2B	WA-3PB	3	1.51
—2F2B	WA-2FB	2	1.80	—3P2M	WA-3PM	3	1.08
—2F2M	WA-2FM	2	1.10	—4P2B	WA-4PB	3	1.87
—3B2B	WA-3FB	2	2.22	—4P2M	WA-4PM	3	1.36

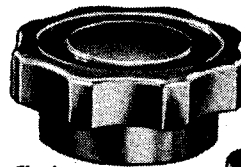

Fig. 1

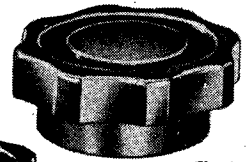

Fig. 3

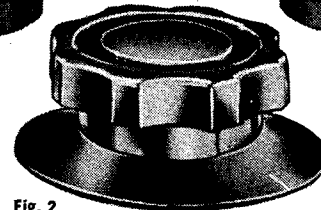

Fig. 2

DECORATIVE ALUMINUM KNOBS

Stocked standard with clear anodized finish, one slotted-head setscrew and black inlays, with or without indicator lines. Can be supplied with various anodized colors and inlays on special order.



Figure G



Figure F

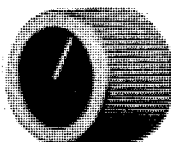

Figure H

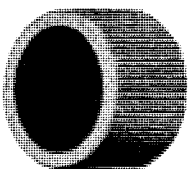

Figure I

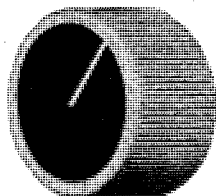

Figure J

Part No.	Figure	Inlay	Dia.	Height	Shaft Hole	Net Ea.	100-Up, Ea.
WA-1000A	F	w/o Indicator	7/16"	5/8"	1/8"	.75	.62
WA-1001A	F	w/Indicator	7/16"	5/8"	1/8"	.94	.77
WA-1002A	G	w/o Indicator	3/4"	9/16"	1/8"	.94	.77
WA-1003A	G	w/Indicator	3/4"	9/16"	1/8"	1.12	.92
WA-1004A	G	w/o Indicator	3/4"	9/16"	1/4"	.94	.77
WA-1005A	G	w/Indicator	3/4"	9/16"	1/4"	1.13	.93
WA-1006A	H	w/o Indicator	1"	11/16"	1/4"	1.12	.92
WA-1007A	H	w/Indicator	1"	11/16"	1/4"	1.31	1.08
WA-1008A	I	w/o Indicator	1-1/4"	3/4"	1/4"	1.42	1.17
WA-1009A	I	w/Indicator	1-1/4"	3/4"	1/4"	1.61	1.32
WA-1010A	J	w/o Indicator	1-1/2"	13/16"	1/4"	1.87	1.54
WA-1011A	J	w/Indicator	1-1/2"	13/16"	1/4"	2.06	1.69

DIALS & DIAL PLATES

waldom



DIALS (Continued) & DIAL PLATES

AZIMUTH DIALS

Precision Test Dial. For laboratory use on instruments requiring a dial of extreme accuracy in calibration. Calibrated through full 360°. Outer numerals read 0 to 360° in a counter-clockwise direction. Inner numerals read 0 to 360 in a clockwise direction. Etched on heavy aluminum-with black graduations and figures on handspun background.

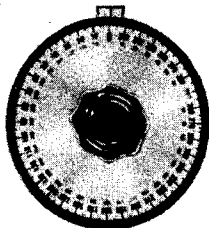

Part No. KD-12

Part No.	Fits Shaft Diam.	Net ea.	100 or more ea.
27010	3/8"	5.40	4.30
27011	1/4"	5.40	4.30

6" diameter dial with bakelite knob and skirt and single line indicator.

Part No.	Fits Shaft Diam.	Net ea.	100 or more ea.
KD-12	1/4"	3.62	2.80

4" diameter dial with bakelite knob and single line indicator.

ROUND DIALS

Made of black anodized aluminum and have embossed beaded edges for greater stiffness and better appearance. Highly polished backgrounds and silvery white figures and borders. Diameter of center hole is 13/32".

Part No. 550

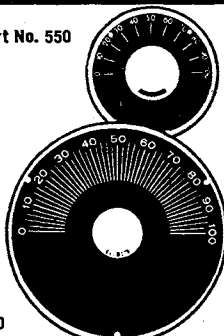

Part No. 260

Part No.	Diameter	Calibration	Net Ea.	100 or more ea.
550	1-7/8"	0-100 in 180°	.54	.45
551	1-7/8"	0-100 in 270°	.54	.45
651	1-7/8"	0-100 in 325°	.54	.45
552	2-7/8"	0-100 in 180°	1.02	.80
553	2-7/8"	0-100 in 270°	1.02	.80
654	2-7/8"	0-100 in 325°	1.02	.80

Dials below are made of Aluminum with a dull black-background. Have three mounting holes. Center hole is 1/2".

Part No.	Diameter	Calibration	Net Ea.	100 or more ea.
262	1-7/8"	0-100 in 180°	.52	.40
263	1-7/8"	0-100 in 270°	.52	.40
663	1-7/8"	0-100 in 325°	.52	.40
260	3"	0-100 in 180°	1.02	.80
261	3"	0-100 in 270°	1.02	.80
662	3"	0-100 in 325°	1.02	.80
264*	2-1/4"	0-100 in 300°	1.02	.80

* Titled "Gain"

LITHOGRAPHED ALUMINUM DIAL PLATES

These are high quality lithographed aluminum plates particularly designed for amplifiers and public address equipment. The black figures and letters are protected by a heavy varnish finish to assure long-lasting service. Horizontal 2 3/16" high x 2 5/8" wide.

Part No. 426A

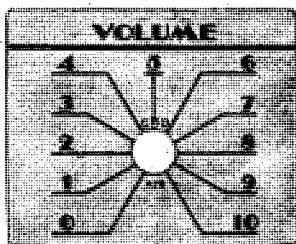

Part No.	Title and Calibration	Part No.	Title and Calibration	Net ea.	100 or more ea.
410A	Without Title 0-10	426A	Volume 0-10	.41	.30

ROUND CONTROL PLATES

1-3/4" Diam. Black Anodized Aluminum with natural razed letters. Center hole is 13/32" diam.



Part No. 25

Part No.	Title of Calibration	Net ea.	100 or more ea.
25	Volume	.34	.25
26	Off-tone Control	.34	.25
569	0-100 in 180°	.34	.25
905	0-100 in 270°	.34	.25

CIRCULAR PLATES FOR TOGGLE SWITCHES

1-1/8" in diameter with 15/32" hole. Polished aluminum with black-background. Locking lug fits groove in switch.



Part No. 272

Part No.	Title	Net ea.	100 or more ea.
272	Off-On	.20	.15
589	Off-On (Vert.)	.20	.15
573	Micro-Phono	.20	.15
581	Lo-Hi	.20	.15
582	Monitor	.20	.15

Plates below are 1" x 1-1/4" Polished Aluminum with black background. 15/32" hole. Two mounting holes.

Part No.	Title	Net ea.	100 or more ea.
584	Off-On	.28	.20
274	1-2	.28	.20
564	1-2-3	.28	.20



Part No. 278

HORIZONTAL SWITCH PLATES

Two styles "Off-On" Switch Plates made of etched aluminum with black background and polished aluminum letters and border with two mounting holes.



Part No. 275

Part No.	Size	Net ea.	100 or more ea.
278	11/16" x 1-11/16"	.20	.15
275	5/8" x 1-1/2"	.22	.20

PAMOTOR

MINIATURE AXIAL FANS

MODELS 4500 and 4550 (Shaded-pole Type) 4 11/16" x 4 11/16" x 1 1/2" • ALL-METAL • LOW-NOISE LEVEL

Provides 115 cfm with less than 37.5 dB SIL*

- All-metal precision hubs, impellers, and die-cast housings eliminate warping often found in plastic fans.
- Designed for applications in wide variety of electronic apparatus, such as computers, laboratory and office machines, industrial and military communications equipment, industrial control equipment, sound systems, power supplies, telephone equipment, etc.
- Designed to operate continuously at room temperature (25° C) for over 100,000 hours—even at uppermost limit of 55° C, 20,000 operational hours, continuous duty may be expected.
- Delivers more air at a lower noise level, yet priced under similar conventional plastic fans.
- Powerful shaded-pole motor operates with low internal heat rise—efficient inside-out design.
- Hand-fitted proven broached dual-sleeve bearing system assures longer, more reliable operation.
- Weighs just 1 1/4 lbs. and is interchangeable with similar, less reliable 4 11/16" fans.
- Operates over range of 105 to 125 VAC at dual frequency of 50/60 Hz.
- Has Underwriters' Laboratories Inc. Yellow Card Component Recognition Number E41168.
- Accessories available for use with this model include mounting brackets, filter, metal screen assembly, finger guard, plug and cord assembly.

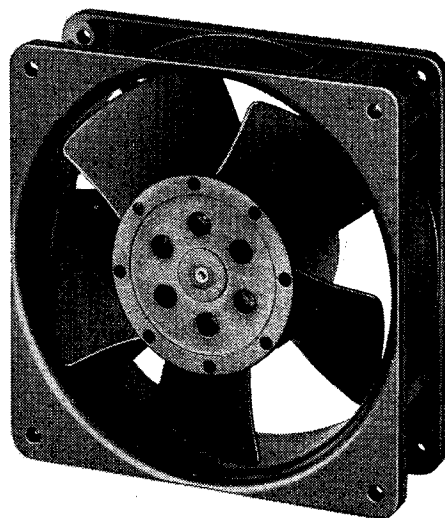

*Speech
Interference Level

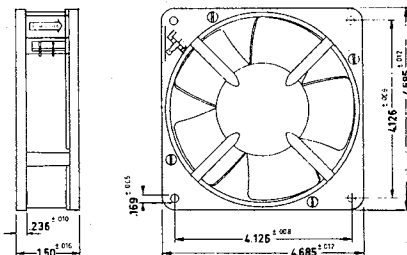

Characteristic	MODEL 4500	MODEL 4550
Voltage	117 volts	230 volts
Frequency*	60 Hz	60 Hz
Air Flow	115 cfm	115 cfm
Speed	2900 rpm	2850 rpm
Input Power	20 watts	17 watts
Weight	1 lb. 4 oz.	1 lb. 4 oz.

*These models also operate at 50 Hz.
Additional data available upon request.

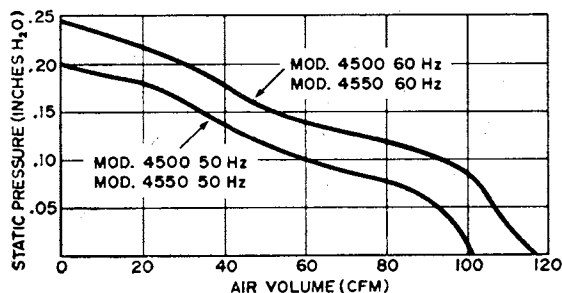

TYPICAL PERFORMANCE CURVE

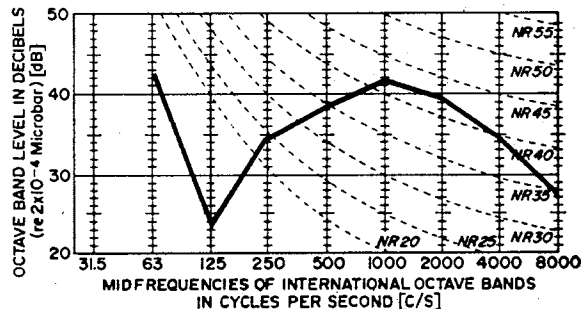

NOISE LEVEL CURVE

PAMOTOR FANS ARE STOCKED FOR IMMEDIATE DELIVERY FROM LEADING ELECTRONICS DISTRIBUTORS THROUGHOUT THE UNITED STATES AND CANADA. CONTACT YOUR LOCAL DISTRIBUTOR FOR COMPLETE ENGINEERING DATA AND PRICES.

PAMOTOR INC.

PAMOTOR

MINIATURE AXIAL FANS

MODELS 1500 and 1550 (Shaded-pole Type)

4 7/16" x 4 7/16" x 1 31/32" • ALL-METAL • 105 CFM

Universal 4 1/8" mounting
for interchangeability

- All-metal component parts are natural heat sinks, ensuring cooler operation.
- Special moisture resistant finish prevents corrosion or deterioration under humid atmospheric conditions or in extreme temperature variations.
- Long operating life without maintenance.
- UL recognition number E41168.
- Standard accessories include mounting brackets, filter, metal screen assembly, finger guard.

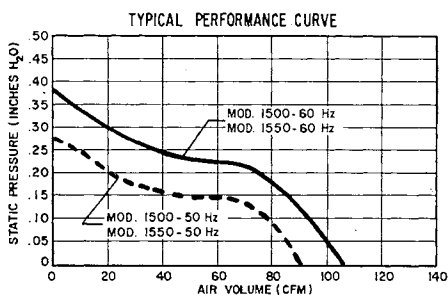
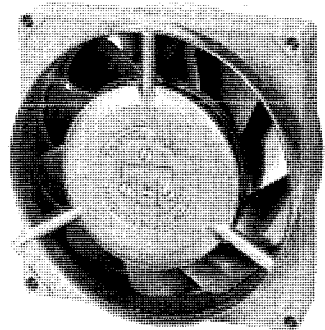
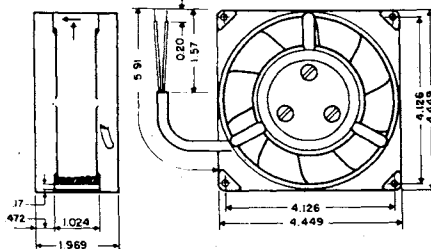

Characteristic	MODEL 1500		MODEL 1550	
Voltage	115 volts	115 volts	220 volts	220 volts
Frequency	60 Hz	50 Hz	60 Hz	50 Hz
Air Flow	105 cfm	90 cfm	105 cfm	90 cfm
Speed	3400 rpm	2850 rpm	3400 rpm	2850 rpm
Input Power	25 watts	27 watts	25 watts	27 watts
Weight	2 lbs. 10 oz.	2 lbs. 10 oz.	2 lbs. 10 oz.	2 lbs. 10 oz.

MODELS 2500 and 2550 (Shaded-pole Type)

4 7/16" x 4 7/16" x 1 31/32" • ALL-METAL • 115 CFM

Low-cost design with efficient
inside-out type motor

- Long operating life without maintenance.
- Universal 4 1/8" mounting for interchangeability.
- 50-60 Hz operation at 115 or 220 VAC.
- Standard accessories include mounting brackets, filter, metal screen assembly, finger guard.
- UL recognition number E41168.

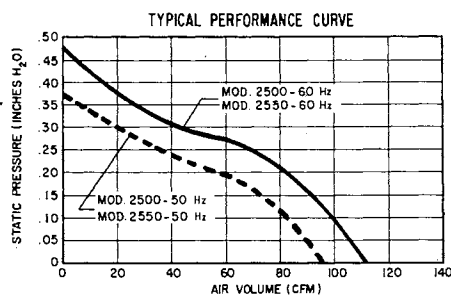
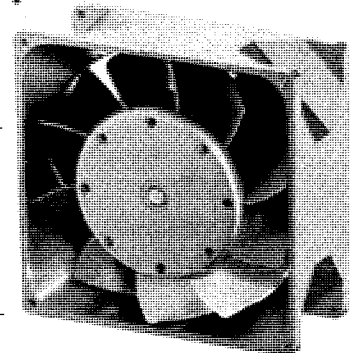
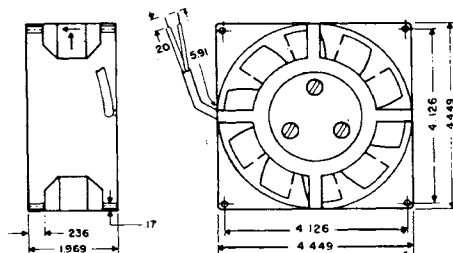

Characteristic	MODEL 2500		MODEL 2550	
Voltage	115 volts	115 volts	220 volts	220 volts
Frequency	60 Hz	50 Hz	60 Hz	50 Hz
Air Flow	115 cfm	95 cfm	115 cfm	95 cfm
Speed	3400 rpm	2850 rpm	3400 rpm	2850 rpm
Input Power	25 watts	27 watts	25 watts	27 watts
Weight	2 lbs. 1 oz.	2 lbs. 1 oz.	2 lbs. 1 oz.	2 lbs. 1 oz.

PAMOTOR FANS ARE STOCKED FOR IMMEDIATE DELIVERY FROM LEADING ELECTRONICS DISTRIBUTORS THROUGHOUT THE UNITED STATES AND CANADA. CONTACT YOUR LOCAL DISTRIBUTOR FOR COMPLETE ENGINEERING DATA AND PRICES.

PAMOTOR INC.

DABURN

DABURN ELECTRONICS & CABLE CORP.

WIRE • CABLE • TUBING • MIL/COMM • SWITCHES • ELECTRONIC HARDWARE

FASTENINGS, NYLON-FIBRE WASHERS, SPACERS, SCREWS, NUTS, SPAGHETTI PACKS, ALL-WAVE KITS, FIBERGLASS GUY WIRE

DABURN NYLON FASTENINGS
ZYTEL 101 PER MIL-P-17019B
AND MIL-P-20693A



Has outstanding insulation specs. hi-resistance to heat, shock, vibration, chemical. Is light in weight, superior torque strength. Corrosion resistant, non magnetic. Continuous service temperature to 300°F. All parts made to American thread standards to Class 2A or 2B fit. B18.2 (hex nuts), B18.6 (machine screws), B1.1 (thread specs.).

DABURN No.	Size	Type	DABURN No.	Size	Type
14-40	2-56 x 1/4"	Rd. Hd.	14-48B	6-32 x 1/2"	Fill. Hd.
14-40A	2-56 x 1/4"	Fill. Hd.	14-48C	6-32 x 1/2"	Flat. Hd.
14-40B	2-56 x 1/4"	Bind. Hd.	14-49	6-32 x 3/4"	Rd. Hd.
14-41	2-56 x 3/8"	Rd. Hd.	14-49A	6-32 x 3/4"	Fill. Hd.
14-41A	2-56 x 3/8"	Fill. Hd.	14-49B	6-32 x 3/4"	Bind. Hd.
14-41B	2-56 x 3/8"	Bind. Hd.	14-50	6-32 x 1"	Rd. Hd.
14-42	2-56 x 1/2"	Rd. Hd.	14-50C	6-32 x 1"	Flat. Hd.
14-42A	2-56 x 1/2"	Fill. Hd.	14-51	8-32 x 1/4"	Rd. Hd.
14-42B	2-56 x 1/2"	Bind. Hd.	14-51A	8-32 x 1/4"	Fill. Hd.
14-43	4-40 x 1/4"	Rd. Hd.	14-51B	8-32 x 1/4"	Bind. Hd.
14-43A	4-40 x 1/4"	Fill. Hd.	14-52	8-32 x 1/2"	Rd. Hd.
14-43B	4-40 x 1/4"	Bind. Hd.	14-52A	8-32 x 1/2"	Fill. Hd.
14-44	4-40 x 3/8"	Rd. Hd.	14-52B	8-32 x 1/2"	Bd. Hd.
14-44A	4-40 x 3/8"	Fill. Hd.	14-52C	8-32 x 1/2"	Flat. Hd.
14-44B	4-40 x 3/8"	Bind. Hd.	14-54	8-32 x 5/8"	Rd. Hd.
14-45	4-40 x 1/2"	Rd. Hd.	14-54A	8-32 x 5/8"	Fill. Hd.
14-45A	4-40 x 1/2"	Fill. Hd.	14-55	8-32 x 3/4"	Rd. Hd.
14-45B	4-40 x 1/2"	Bind. Hd.	14-55A	8-32 x 3/4"	Fill. Hd.
14-46	6-32 x 1/4"	Rd. Hd.	14-55B	8-32 x 3/4"	Bd. Hd.
14-46A	6-32 x 1/4"	Fill. Hd.	14-56A	8-32 x 1"	Fill. Hd.
14-46B	6-32 x 1/4"	Bind. Hd.	14-56C	8-32 x 1"	Flat. Hd.
14-47	6-32 x 3/8"	Rd. Hd.	14-57	10-32 x 3/8"	Rd. Hd.
14-47A	6-32 x 3/8"	Bind. Hd.	14-58	10-32 x 1/2"	Rd. Hd.
14-47B	6-32 x 3/8"	Fill. Hd.	14-58C	10-32 x 1/2"	Flat. Hd.
14-47C	6-32 x 3/8"	Flat. Hd.	14-59	10-32 x 5/8"	Rd. Hd.
14-48	6-32 x 1/2"	Rd. Hd.	14-60	10-32 x 1"	Rd. Hd.
14-48A	6-32 x 1/2"	Bind. Hd.	14-60C	10-32 x 1"	Flat. Hd.

STOCK COLOR: Natural Std. Pkg.: 100, 1000

Additional sizes available to order.

DABURN NYLON SHOULDER WASHERS

Natural Nylon Per MIL-P-20693A
Standard Package 1000

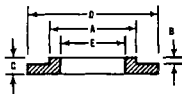

Catalog No.	E	Hole Size	O	C	B	A
14-540	.140	6	.375	.093	.031	.237
14-541	.110	4	.250	.062	.031	.187
14-542	.136	6	.250	.093	.031	.187
14-543	.136	6	.312	.093	.031	.187
14-544	.250	1/4"	.500	.068	.028	.312
14-545	.172	8	.375	.093	.031	.246
14-546	.196	10	.375	.093	.031	.308
14-547	.265	1/4"	.500	.097	.031	.365
14-548	.375	3/8"	.750	.093	.031	.500
14-549	.385	3/8"	.625	.093	.031	.500

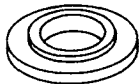

FIBRE SHOULDER WASHERS

Fibre Material Per NEMA Standard and ASTM
Spec. D-710

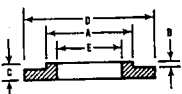

Catalog No.	E	Hole Size	O	C	B	A
14-530	.140	6	.375	.093	.031	.237
14-531	.110	4	.250	.062	.031	.187
14-532	.136	6	.250	.093	.031	.187
14-533	.136	6	.312	.093	.031	.187
14-534	.250	1/4"	.500	.068	.028	.312
14-535	.172	8	.375	.093	.031	.308
14-536	.196	10	.375	.093	.031	.308
14-537	.265	1/4"	.500	.097	.031	.365
14-538	.375	3/8"	.750	.093	.031	.500
14-539	.385	3/8"	.625	.093	.031	.500



FLAT FIBRE WASHERS NEMA STANDARD ASTM SPEC D-710

Cat. No.	Hole Size	I.D.	O.D.	Thick-ness
14-510	6	.136	.250	1/16
14-511	4	.110	.250	1/16
14-512	6	.140	.375	1/16
14-513	8	.172	.375	1/16
14-514	10	.196	.345	1/16
14-515	1/4"	.250	.500	1/16
14-516	1/4"	.250	.500	3/32
14-517	3/8"	.312	.500	1/16
14-518	3/8"	.385	.625	1/16
14-519	3/8"	.375	.750	1/16



Standard Package 1000

DABURN NYLON SPACER/BUSHINGS

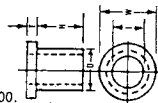

Wide flanges isolates screw from mounting surface. Has hi-tensile and torque strength.
COLOR: Natural. MIL-P-20693A. Std. Pkg.: 100, 1000.

Daburn No.	Screw Size I.D.	W	T	H	D
14-79	# 4 (.115")	.235"	3/4"	1/4"	.146"
14-79A	# 6 (.140")	.290"	3/4"	1/4"	.170"
14-79B	# 8 (.173")	.344"	1/2"	3/8"	.205"
14-79C	# 10 (.200")	.399"	1/2"	3/8"	.260"
14-79D	1/4" (.260")	.513"	1/2"	3/8"	.312"

DABURN NYLON HEX NUTS

Daburn No.	Size	Daburn No.	Size
14-85	2-56	14-88	8-32
14-86	4-40	14-89	10-32
14-87	6-32	14-90	1/4-20



COLOR: Natural. MIL-P-20693A. Std. Pkg.: 100, 1000

DABURN NYLON FLAT WASHERS



Daburn No.	For Screw Size	I.D.	O.D.	Thickness
14-92	2	3/16"	1/4"	.016"
14-93	4	1/8"	1/4"	.016"
14-94	6	3/16"	3/8"	.031"
14-95	8	.170"	3/8"	.031"
14-96	10	.195"	3/8"	.031"
14-97	1/4	3/8"	3/8"	.063"

COLOR: Natural Std. Pkg.: 100, 1000

NOTE: See Sections 2100, 3100 for additional Daburn Hardware Products. Section 6000, for our Insulated Tubing - Wire - Cable — including Heat Shrinkable Tubing.

DABURN ASSORTED SPAGHETTI PACKS

25-9" lengths per pack consists of varnished sleeving of assorted sizes and colors.



DABURN Cat. No.	Standard Package
9-07	Pack 25
9-08	25 Packs in Display Carton 1

DABURN ALL-WAVE ASSEMBLED ANTENNA KIT

Designed for reception of overseas radio signals & programs. Utilizes the Hertz principle — balanced line consists of:

- 2—30' coils 7/24 copper wire
- 1—40' coil transmission cable
- 1—Center insulator
- 2—Porcelain insulators
- 2—Lead-in strips
- 1—Ground clamp
- 2—Nail-on knobs

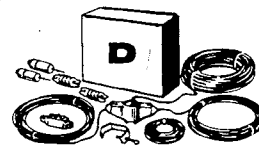

DABURN Cat. No.	Standard Package
9-09	All Wave Kit 12

DABURN FIBERGLASS GUY WIRE

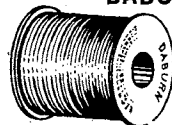

Gives complete isolation for any antenna system. Non-radiating, non-absorbing, no rot, no shrink, no sag. This non metallic guy wire has an overall (PVC) polyvinylchloride jacket.

DABURN No.	Put-Up	Tensile Strength	Color	Nom. O.D.
10-01	100', 500', 1000'	500 lbs.	Green	.125"
10-02	100', 500', 1000'	1000 lbs.	Gray	.218"
10-03	100', 500', 1000'	2500 lbs.	White	.313"

Doubling the cable will double the strength.

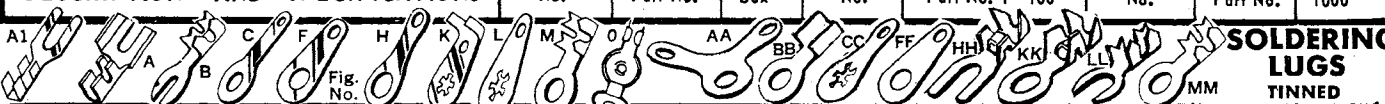

ELECTRONIC HARDWARE

DESCRIPTION AND SPECIFICATIONS		GC Part No.	Old Walsco Part No.	QTY. IN Box	GC Part No.	Old Walsco Part No.	Net Per 100	GC Part No.	Old Walsco Part No.	Net Per 1000
										
Hole Size #6, Length—19/32"	A1				8466-C	8466-C	1.90	8466-M	8466-M	15.19
Hole Size #6, Length—23/32"	A				8467-C	8467-C	3.42	8467-M	8467-M	27.32
Hole Size #8, Length—23/32"	A				8468-C	8468-C	3.22	8468-M	8468-M	25.72
Hole Size #6, Length—21/32"	B	H104-F	H104-F	25	1021-BC	7136-C	1.29	1021-BM	7136-M	10.26
Hole Size #8, Length—5/8"	B	H106-F	H106-F	25	7445-C	7138-CW	1.46	7445-M	7138-MW	11.60
Hole Size #10, Length—11/16"	B				8473-C	8473-C	1.42	8473-M	8473-M	11.33
Hole Size #6, Length—9/16"	C				5703-C	5703-C	1.09	5703-M	5703-M	8.66
Hole Size #8, Length—9/16"	C				5704-C	5704-C	2.04	5704-M	5704-M	16.26
Hole Size #10, Length—13/16"	C				5705-C	5705-C	2.04	5705-M	5705-M	16.26
Hole Size #6, Length—11/16"	C	H108-F	H108-F	30	1021-CC	1021-CC	1.12	1021-CM	1021-CM	8.93
Hole Size #6, Length—9/16"	F	H112-F	H112-F	30	1021-FC	1021-FC	1.12	1021-FM	1021-FM	8.93
Hole Size #8, Length—9/16"	F	H113-F	H113-F	30	7451-C	7168-C	1.07	7451-M	7168-M	8.53
Hole Size #6, Length—7/8"	F	H114-F	H114-F	25	7454-C	7454-C	.80	7454-M	7454-M	6.40
Hole Size #8, Length—7/8"	H	H117-F	H117-F	25	7455-C	7455-C	1.05	7455-M	7455-M	8.40
Hole Size #10, Length—7/8"	H	H118-F	H118-F	25	7456-C	7456-C	1.05	7456-M	7456-M	8.40
Hole Size #4, Length—25/32"	K				7458-C	7458-C	2.23	7458-M	7458-M	17.85
Hole Size #8, Length—25/32"	K				7460-C	7460-C	2.27	7460-M	7460-M	18.13
Hole Size #10, Length—13/16"	K				7461-C	7461-C	2.27	7461-M	7461-M	18.13
Hole Size #6, Length—5/8"	L	H122-F	H122-F	20	7462-C	7462-C	1.30	7462-M	7462-M	10.40
Hole Size #8, Length—5/8"	L				7463-C	7463-C	1.30	7463-M	7463-M	10.40
Hole Size #4, Length—9/16"	F				5706-C	5706-C	2.03	5706-M	5706-M	16.26
Hole Size #8, Length—13/16"	F				5707-C	5707-C	2.03	5707-M	5707-M	16.26
Hole Size #6, Length—13/16"	F				5708-C	5708-C	2.03	5708-M	5708-M	16.26
Hole Size #6, Length—11/16"	M	H124-F	H124-F	25	7441-C	7146-C	1.43	7441-M	7146-M	11.46
Hole Size #8, Length—11/16"	M	H134-F	H134-F	25	7442-C	7148-CW	1.35	7442-M	7148-MW	10.80
Hole Size #10, Length—11/16"	M	H102-F	H102-F	25	1021-AC	7149-C	1.35	1021-AM	7149-M	10.80
Solderless TV Line Lugs	O	H225-F	7190-F	10	8633-C	7199-C	2.00	8633-M	7199-M	15.99
Hole Size #6	AA				7116-C	7116-C	1.48	7116-M	7116-M	11.86
Hole Size #8	AA				7118-CW	7118-CW	1.57	7118-MW	7118-MW	12.53
Hole Size #6, Length—7/16"	BB				7126-C	7126-C	1.17	7126-M	7126-M	9.33
Hole Size #8, Length—5/8"	BB				7128-C	7128-C	1.53	7128-M	7128-M	12.26
Hole Size #6	CC				7156-C	7156-C	1.30	7156-M	7156-M	10.40
Hole Size #8, Length—13/16"	CC				7158-CW	7158-CW	1.30	7158-MW	7158-MW	10.40
Hole Size #6, Length—1/2"	FF				7166-C	7166-C	1.20	7166-M	7166-M	9.60
Hole Size #10, Length—11/16"	FF				7169-C	7169-C	1.02	7169-M	7169-M	8.13
Hole Size #10	HH	7170-F	7170-F	25	7179-C	7179-C	1.28	7179-M	7179-M	10.26
Hole Size #10	KK	7180-F	7180-F	15	7189-C	7189-C	2.05	7189-M	7189-M	16.39
Assorted #6-#10 Hole Size	B, C, F, M	H100-F	H100-F	30						
Assorted Types		7100-F	7100-F	36						
Assorted #6-#8 Hole Size	AA	7110-F	7110-F	20						
Assorted #6-#8 Hole Size	BB	7120-F	7120-F	20						
Assorted #6-#8 Hole Size	LL	7130-F	7130-F	25						
Assorted #6-#8 Hole Size	MM	7140-F	7140-F	16						
Assorted #6-#8 Hole Size	CC	7150-F	7150-F	15						
Assorted #6-#8 Hole Size	FF	7160-F	7160-F	35						
100 Assorted Terminals					1020	1020	1.30			



ROUND HEAD MACHINE SCREWS

STEEL — NICKEL PLATED

2-56 x 1/4"	H1022-F	H1022-F	40	7130-C	7130-C	.57	7130-M	7130-M	4.53
2-56 x 1/2"	H1024-F	8024-F	40	7131-C	8024-C	.60	7131-M	8024-M	4.80
2-56 x 3/4"	H1026-F	H1026-F	40	7132-C	7132-C	.72	7132-M	7132-M	5.73
3-48 x 3/4"	H1028-F	H1028-F	40	7124-C	7124-C	.72	7124-M	7124-M	5.73
4-36 x 1/4" Phono Cartridge Mounting Screw	H1032-F	8032-F	40	6005-C	8032-C	.60	6005-M	8032-M	4.80
4-36 x 3/8"	H1033-F	H1033-F	35	7138-C	7138-C	.65	7138-M	7138-M	5.20
4-36 x 1/2"	H1034-F	8034-F	35	6006-C	8034-C	.67	6006-M	8034-M	5.33
4-36 x 5/8"				5651-C	5651-C	.70	5651-M	5651-M	5.60
4-36 x 3/4"	H1036-F	8036-F	35	6007-C	8036-C	.85	6007-M	8036-M	6.80
4-40 x 1/4" Phono Cartridge Mounting Screw	H1042-F	8042-F	40	6005-AC	8042-C	.60	6005-AM	8042-M	4.80
4-40 x 1/2"	H1044-F	8044-F	35	6005-BC	8044-C	.67	6005-BM	8044-M	5.33
4-40 x 5/8"				5652-C	5652-C	.70	5652-M	5652-M	5.60
4-40 x 3/4"	H1046-F	H1046-F	35	6005-CC	6005-CC	.79	6005-CM	6005-CM	6.26
6-32 x 1/4"	H1062-F	8062-F	40	6008-C	8062-C	.65	6008-M	8062-M	5.20
6-32 x 1/2"	H1064-F	8064-F	30	6009-C	8064-C	.75	6009-M	8064-M	6.00
6-32 x 5/8"				5653-C	5653-C	.83	5653-M	5653-M	6.66
6-32 x 3/4"	H1066-F	8066-F	30	6010-C	8066-C	.88	6010-M	8066-M	7.06
6-32 x 1"	H1068-F	H1068-F	30	6011-C	8068-C	1.02	6011-M	8068-M	8.13
6-32 x 1-1/4"	H1070-F	H1070-F	30	7141-C	7141-C	1.24	7141-M	7141-M	9.86

WRITE FOR CATALOG #FR-69 FOR COMPLETE LISTINGS



ELECTRONIC HARDWARE

DESCRIPTION AND SPECIFICATIONS

GC Part No.	Old Walsco Part No.	QTY. IN Box	GC Part No.	Old Walsco Part No.	Net Per 100	GC Part No.	Old Walsco Part No.	Net Per 1000
-------------	---------------------	-------------	-------------	---------------------	-------------	-------------	---------------------	--------------



SHEET METAL SCREWS

HEX HEAD — SLOTTED SELF-TAPPING — NICKEL PLATED

#8 x 3/8"	H1383-F	8383-F	20	6095-C	8383-C	1.28	6095-M	8383-M	10.26
#8 x 1/2"	H1384-F	8384-F	20	6096-C	8384-C	1.32	6096-M	8384-M	10.53
#8 x 1"	H1388-F	8388-F	15	6097-C	8388-C	1.69	6097-M	8388-M	13.46
#10 x 3/8"	H1403-F	8403-F	15	6098-C	8403-C	1.43	6098-M	8403-M	11.46
#10 x 1/2"	H1404-F	8404-F	15	6099-C	8404-C	1.57	6099-M	8404-M	12.53
#10 x 3/4"	H1406-F	8406-F	12	6100-C	8406-C	1.70	6100-M	8406-M	13.59
#8 x 5/8"				5696-C	5696-C	1.33	5696-M	5696-M	10.66
#4 x 3/8"				6089-C	6089-C	.94	6089-M	6089-M	7.46
#4 x 1/2"	H1350-F	H1350-F	35	6090-C	6090-C	1.02	6090-M	6090-M	8.13
#6 x 1/4"	H1362-F	8362-F	30	6091-C	8362-C	1.07	6091-M	8362-M	8.53
#6 x 3/8"	H1363-F	8363-F	25	6092-C	8363-C	1.09	6092-M	8363-M	8.66
#6 x 1/2"	H1364-F	8364-F	25	6093-C	8364-C	1.15	6093-M	8364-M	9.20
#6 x 3/4"	H1366-F	8366-F	20	6094-C	8366-C	1.24	6094-M	8366-M	9.86
#8 x 1/4"	H1382-F	8382-F	20	8102-C	8382-C	1.24	8102-M	8382-M	9.86
#6 x 1"	8368-F	8368-F	20	8368-C	8368-C	1.67	8368-M	8368-M	13.33
#8 x 3/4"	8386-F	8386-F	15	8386-C	8386-C	1.60	8386-M	8386-M	12.79
Assorted	H1300-F	8300-F	25						

FLAT HEAD RACK AND CABINET SCREWS

6-32 x 1/2"				6540-C	6540-C	.75	6540-M	6540-M	6.00
6-32 x 5/8"	8265-F	8265-F	30	5691-C	8265-C	1.07	5691-M	8265-M	8.53
6-32 x 3/4"				6541-C	6541-C	.88	6541-M	6541-M	7.06
8-32 x 5/8"	8269-F	8269-F	25	5692-C	8269-C	1.15	5692-M	8269-M	9.20
8-32 x 3/4"				6542-C	6542-C	1.13	6542-M	6542-M	9.23
10-32 x 1/2"				8848-C	8848-C	1.15	8848-M	8848-M	9.20
10-32 x 5/8"				5693-C	5693-C	1.25	5693-M	5693-M	10.00
10-32 x 3/4"	8273-F	8273-F	20	6543-C	8273-C	1.35	6543-M	8273-M	10.80
12-24 x 5/8"				8278-C	8278-C	1.73	8278-M	8278-M	13.81
Assorted	H1005-F	8005-F	30						

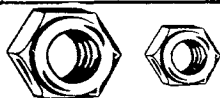

HEXAGON NUTS

STEEL — NICKEL PLATED

Thread 2-56, Width 3/16", Thickness 1/16"	H1802-F	8802-F	30	7225-C	8802-C	.83	7225-M	8802-M	6.66
Thread 3-48, Width 3/16", Thickness 1/16"	H1803-F	H1803-F	30	7226-C	7226-C	.83	7226-M	7226-M	6.66
Thread 4-36, Width 1/4", Thickness 3/32"	H1805-F	H1805-F	30	6041-C	8824-CW	.83	6041-M	8824-MW	6.66
Thread 4-40, Width 1/4", Thickness 3/32"	H1804-F	H1804-F	30	6041-AC	6041-AC	.83	6041-AM	6041-AM	6.66
Thread 6-32, Width 1/4", Thickness 3/32"	H1806-F	8806-F	30	6042-C	8806-C	.83	6042-M	8806-M	6.66
Thread 6-32, Width 5/16", Thickness 7/64"	H1807-F	H1807-F	30	7230-C	8826-C	.90	7230-M	8826-M	7.20
Thread 8-32, Width 1/4", Thickness 3/32"	H1808-F	H1808-F	30	6043-C	6043-C	.83	6043-M	6043-M	6.66
Thread 8-32, Width 5/16", Thickness 7/64"	8808-F	8808-F	30	7232-C	8808-C	.90	7232-M	8808-M	7.20
Thread 8-32, Width 11/32", Thickness 1/8"	H1809-F	H1809-F	30	7233-C	8828-C	.88	7233-M	8828-M	7.06
Thread 10-32, Width 3/8", Thickness 5/64"	H1810-F	H1810-F	30	6044-C	6044-C	1.17	6044-M	6044-M	9.33
Thread 10-32, Width 3/8", Thickness 1/8"				6049-C	8830-C	1.07	6049-M	8830-M	8.53
Thread 1/4-20, Width 7/16", Thickness 3/16"	H1820-F	H1820-F	25	7235-C	7235-C	1.48	7235-M	7235-M	11.86
Thread 11/32-32, Width 7/16", Thickness 1/16"				7236-C	7236-C	2.37	7236-M	7236-M	18.93
Thread 3/8-32, Width 9/16", Thickness 3/32"	H1923-F	H1923-F	15	6050-AC	6050-AC	1.78	6050-AM	6050-AM	14.26
Thread 7/16-27, Width 9/16", Thickness 1/8"				7238-C	7238-C	4.00	7238-M	7238-M	31.99
Thread 15/32-32, Width 9/16", Thickness 5/64"	H1924-F	8924-F	10	6050-BC	6050-BC	2.18	6050-BM	6050-BM	17.46
Thread 1/4-32, Width 3/8", Thickness 3/32"				7715-C	7715-C	1.62	7715-M	7715-M	12.93
Thread 5-40, Width 5/16", Thickness 7/64"				6045-BC	6045-BC	.88	6045-BM	6045-BM	7.06
Thread 10-32, Width 5/16", Thickness 7/64"	8810-F	8810-F	25	8810-C	8810-C	1.17	8810-M	8810-M	9.33
Assorted	H1800-F	8800-F	30						
Thread 4-40, Width 3/16", Thickness 1/16"	8804-F	8804-F	30	8804-C	8804-C	.80	8804-M	8804-M	6.40



MOUNTING NUTS

STEEL — NICKEL PLATED

Thread 11/32-32, Width 7/16", Thickness 1/16", Rotary Switch Size — Hex				7236-C	7236-C	2.37	7236-M	7236-M	18.93
Thread 3/8-32, Width 9/16", Thickness 3/32", Volume Control Size — Hex	H1923-F	H1923-F	15	6050-AC	6050-AC	1.78	6050-AM	6050-AM	14.26
Thread 7/16-27, Width 9/16", Thickness 1/8", Pilot Light Size — Hex				7238-C	7238-C	4.00	7238-M	7238-M	31.99
Thread 15/32-32, Width 9/16", Thickness 5/64", Toggle Switch Size — Hex	H1924-F	8924-F	10	6050-BC	8924-C	2.18	6050-BM	8924-M	17.46
Thread 15/32-32, Width 19/32", Thickness 1/16", Round Ring Nut, Knurled — Toggle Switch Size	H1926-F	H1926-F	8	6050-CC	6050-CC	4.20	6050-CM	6050-CM	33.59
Thread 3/8-32, Width 1/2", Thickness 3/32", Volume Control Switch — Hex	8923-F	8923-F	12	8923-C	8923-C	2.67	8923-M	8923-M	21.32
Thread 15/32-32, Width 19/32", Thickness 3/32", Round Ring Nut Knurled — Toggle Switch Size	8926-F	8926-F	8	8926-C	8926-C	5.70	8926-M	8926-M	45.58
Thread 3/8-32, Width 1/2", Thickness 3/32", Volume Control — Hex				8922-C	8922-C	4.83	8922-M	8922-M	38.68
Assorted	8920-F	8920-F	12						
Assorted	H1920-F	H1920-F	12						

WRITE FOR CATALOG #FR-69 FOR COMPLETE LISTINGS



DESCRIPTION AND SPECIFICATIONS

GC Part No.	Old Walsco Part No.	QTY. IN Box	GC Part No.	Old Walsco Part No.	Net Per 100	GC Part No.	Old Walsco Part No.	Net Per 1000
-------------	---------------------	-------------	-------------	---------------------	-------------	-------------	---------------------	--------------

CABLE HOLDER CLAMPS

NICKEL PLATED

Cable Dia. 1/8" to 3/16". Mounting Hole Size #6	H502-F	7502-F	25	6251-C	7502-C	1.25	6251-M	7502-M	10.00
Cable Dia. 1/4" to 5/16". Mounting Hole Size #6				7503-C	7503-C	1.60	7503-M	7503-M	12.79
Cable Dia. 5/16" to 1/2". Mounting Hole Size #6	H506-F	H506-F	15	6253-C	6253-C	1.54	6253-M	6253-M	12.26
Baseboard Wire Clips, Black, Parkerized	H509-F	H509-F	20	8345-C	8345-C	2.52	8345-M	8345-M	20.13
Cable Dia. 3/16" to 1/4". Mounting Hole Size #8	H503-F	7503-F	20	6252-C	7503-CW	1.43	6252-M	7503-MW	11.46
Cable Dia. 1/4" to 5/16". Mounting Hole Size #8	7505-F	7505-F	16	7505-C	7505-C	2.52	7505-M	7505-M	20.13
Assorted	H500-F	H500-F	20						
Assorted	7500-F	7500-F	20						



SNAP BUTTON HOLE PLUGS

For Hole Size 1/4" A—13/32", B—1/4", C—17/64", D—5/64"	H306-F	7306-F	8	1711-AC	7306-CW	2.70	1711-AM	7306-MW	21.59
For Hole Size 5/16" A—7/16", B—1/4", C—21/64", D—1/16"				1711-BC	1711-BC	2.90	1711-BM	1711-BM	23.19
For Hole Size 3/8" A—17/32", B—3/8", C—25/64", D—5/64"	H308-F	7308-F	8	1711-C	7308-CW	3.07	1711-M	7308-MW	24.52
For Hole Size 1/2" A—21/32", B—17/64", C—17/32", D—5/64"	H310-F	7310-F	6	1712-C	7310-C	3.72	1712-M	7310-MW	29.72
For Hole Size 5/8" A—51/64", B—9/32", C—41/64", D—5/64"	H312-F	7312-F	6	1713-C	7312-CW	4.00	1713-M	7312-MW	31.99
For Hole Size 3/4" A—15/16", B—19/64", C—49/64", D—3/32"	H314-F	7314-F	5	1714-C	7314-C	4.03	1714-M	7314-M	32.25
For Hole Size 7/8". Fits switch box knockout holes				1714-AC	7315-C	5.60	1714-AM	7315-M	44.78
For Hole Size 1-1/8" A—1-5/16", B—11/32", C—1-9/64", D—3/32"				1715-BC	7318-C	7.16	1715-BM	7318-M	57.31
For Hole Size 1-1/4" A—1-7/16", B—15/16", C—1-17/16", D—3/32"				1715-C	7320-C	7.81	1715-M	7320-M	62.51
For Hole Size 1-3/8" A—1-9/16", B—13/32", C—1-13/32", D—3/32"				5700-C	5700-C	8.61	5700-M	5700-M	68.91
For Hole Size 1-7/16" A—1-39/64", B—27/64", C—1-15/32", D—7/64"				5701-C	5701-C	8.80	5701-M	5701-M	70.37
For Hole Size 1-1/2" A—1-41/64", B—13/32", C—1-17/32", D—3/32"				5702-C	5702-C	11.35	5702-M	5702-M	90.76
For Hole Size 1" A—1-5/32", B—19/64", C—1-1/32", D—5/64"	H316-F	7316-F	5	1715-AC	7316-C	5.36	1715-AM	7316-M	42.92
For Hole Size 1/8" A—5/16", B—15/64", C—9/64", D—1/32"				7302-C	7302-C	3.88	7302-M	7302-M	31.02
For Hole Size 3/16" A—11/32", B—7/32", C—7/32", D—3/64"				7304-C	7304-C	3.68	7304-MW	7304-MW	29.50
Assorted	H300-F	7300-F	8						
Assorted 50 per box				1710	1710	2.01	(per box of 50)		



CUP FINISHING WASHERS

NICKEL PLATED

#6 (7/16" O.D.)	H806-F	7806-F	45	6161-C	7806-C	.57	6161-M	7806-M	4.53
#8 (1/2" O.D.)	H808-F	7808-F	45	6162-C	7808-C	.60	6162-M	7808-M	4.80
#10 (9/16" O.D.)	H810-F	7810-F	35	6163-C	7810-C	.68	6163-M	7810-M	5.46
#12 (5/8" O.D.)				7812-C	7812-C	1.45	7812-M	7812-M	5.90
Assorted screws and washers	H1005-F	8005-F	30						
Assorted washers	H805-F	H805-F	40						



EXTERNAL LOCK WASHERS

Screw Size #4				7354-C	7354-C	.53	7354-M	7354-M	4.26
Screw Size #6				7356-C	7356-C	.53	7356-M	7356-M	4.26
Screw Size #8				7358-C	7358-C	.58	7358-M	7358-M	4.66
Screw Size #10				7360-C	7360-C	.58	7360-M	7360-M	4.66
Screw Size 1/4", O. D. 1/2"				7361-C	7361-C	.77	7361-M	7361-M	6.13
Screw Size #3/8, O. D. 11/16"				7363-C	7363-C	1.15	7363-M	7363-M	9.20
Assorted	H950	H950	60						



INTERNAL LOCK WASHERS

Screw Size #2	H922-F	H922-F	35	7322-C	7322-C	.87	7322-M	7322-M	6.93
Screw Size #3				7323-C	7323-C	.75	7323-M	7323-M	6.00
Screw Size #4	H924-F	7924-F	50	7324-C	7924-CW	.55	7324-M	7924-M	4.40
Screw Size #6, O. D. 9/32"	H926-F	7926-F	50	7326-C	7926-CW	.53	7326-M	7926-M	4.26
Screw Size #8, O. D. 21/64"	H928-F	7928-F	50	7328-C	7928-CW	.58	7328-M	7928-M	4.66
Screw Size #10	H930-F	7930-F	45	7330-C	7930-CW	.58	7330-M	7930-M	4.66
Screw Size 1/4", O. D. 15/32"				7332-C	7932-CW	.77	7332-M	7932-M	6.13
Screw Size #5/16, O. D. 19/32"				7333-C	7333-C	.98	7333-M	7333-M	7.86
Screw Size 3/8", O. D. 11/16"				7334-C	7935-C	1.15	7334-M	7935-M	9.20
Screw Size 3/8", O. D. 9/16"	H938-F	7934-AF	25	7335-C	7934-C	1.52	7335-M	7934-M	12.13
Screw Size 15/32", O. D. 19/32"				7338-C	7338-C	1.90	7338-M	7338-M	15.19
Screw Size 5/16", O. D. .430"	7933-AF	7933-AF	20	7933-C	7933-C	.98	7933-M	7933-M	7.90
Asst. all types	H918-F	H918-F	45						
Assorted	H920-F	7920-F	50						

WRITE FOR CATALOG #FR-69 FOR COMPLETE LISTINGS



ELECTRONIC HARDWARE

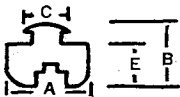

DESCRIPTION

GC Part No.

Old Walsco Part No.

QTY. IN Box

GC Part No.

Old Walsco Part No.

Net Per 100

GC Part No.

Old Walsco Part No.

Net Per 1000

RUBBER BUTTON BUMPERS

A—3/8", B—7/16", C—3/16", D—5/32"				7596-C	7596-C	1.72	7596-M	7596-M	13.73
A—1/2", B—7/16", C—1/4", D—1/4"	H058-F	H058-F	8	7597-C	7597-C	2.57	7597-M	7597-M	20.53
A—5/8", B—9/16", C—3/8", D—5/16"				7598-C	7598-C	4.13	7598-M	7598-M	33.05
Assorted	7083-F	7083-F	12						



RADIO KNOB FELTS

3/4" O. D. x 1/4" I. D., Brown	H760-F	7760-F	40	1065-C	7760-C	.47	7760-M	7760-M	3.73
--------------------------------	--------	--------	----	--------	--------	-----	--------	--------	------



GRID CAP AND CLIPS

1/4" High Voltage Spring Grid Clips				8838-1RC	7617-C	4.60	8838-1RM	7617-M	36.79
3/8" High Voltage Spring Grid Clips				8838-2RC	7616-C	4.80	8838-2RM	7616-M	38.38
1/4" Insulated High Voltage Grid Cap	H612-F	H612-F	1	8834-C	8834-C	30.39	8834-M	8834-M	243.10
3/8" Insulated High Voltage Grid Cap	H614-F	H614-F	1	8835-C	8835-C	30.39	8835-M	8835-M	243.10

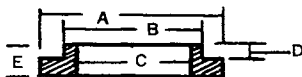

EXTRUDED FIBRE WASHERS

Screw Size #4 A—9/32", B—13/64", C—1/8", D—1/32", E—1/16"				6524-C	6524-C	1.07	6524-M	6524-M	8.53
Screw Size #6 A—5/16", B—3/16", C—9/64", D—1/32", E—1/16"				6525-C	6525-C	1.07	6525-M	6525-M	8.53
Screw Size #8 A—3/8", B—1/4", C—11/64", D—1/32", E—1/16"				6526-C	6526-C	1.07	6526-M	6526-M	8.53
Screw Size #10 A—7/16", B—1/4", C—13/64", D—1/32", E—1/16"				6527-C	6527-C	1.15	6527-M	6527-M	9.20
Screw Size #1/4 A—1/2", B—3/8", C—1/4", D—1/32", E—1/16"				6528-C	6528-C	1.15	6528-M	6528-M	9.20
Screw Size #3/8 A—5/8", B—7/16", C—3/8", D—1/32", E—1/16"	H864-F	H864-F	20	6529-C	6529-C	1.20	6529-M	6529-M	9.60
Screw Size #6 A—5/16", B—3/16", C—9/64", D—1/32", E—3/32"				7856-C	7856-C	1.07	7856-M	7856-M	8.53
Screw Size #10 A—3/8", B—5/16", C—13/64", D—1/32", E—3/32"				7860-C	7860-C	1.15	7860-M	7860-M	9.20
Screw Size #1/4 A—1/2", B—11/32", C—1/4", D—1/32", E—3/32"				7862-C	7862-C	1.15	7862-M	7862-M	9.20
Screw Size 3/8 A—5/8", B—1/2", C—3/8", D—1/32", E—3/32"				7864-C	7864-C	1.20	7864-M	7864-M	9.60
Screw Size #8 A—3/8", B—1/2", C—3/8", D—1/32", E—3/32"				7858-C	7858-C	1.07	7858-M	7858-M	8.53
Assorted	H855-F	H855-F	30						
Assorted	7824-F	7824-F	30						
Assorted									
Assorted	7825-F	7825-F	30						
Assorted									
Assorted	7826-F	7826-F	30						
Assorted									
Assorted	7827-F	7827-F	24						
Assorted									
Assorted	7828-F	7828-F	20						
Assorted									
Assorted	H854-F	7820-F	35						



FLAT FIBRE WASHERS

Screw size	I.D.	O.D.	Thickness									
No. 4	.120"	1/4"	1/32"	H824-F	H824-F	30	6512-C	6512-C	.60	6512-M	6512-M	4.80
No. 6	9/64"	1/4"	1/32"	H825-F	H825-F	30	6513-C	6513-C	.60	6513-M	6513-M	4.80
No. 8	11/64"	3/8"	1/32"	H826-F	H826-F	30	6514-C	7838-C	.60	6514-M	7838-M	4.80
No. 10	.196"	3/8"	1/32"	H827-F	H827-F	24	6515-C	7840-C	.60	6515-M	7840-M	4.80
No. 1/4"	1/4"	1/2"	3/64"	H827-F	H827-F	24	6516-C	7842-C	.65	6516-M	7842-M	5.20
No. 3/8"	25/64"	39/64"	3/64"	H828-F	H828-F	20	6517-C	7844-C	.94	6517-M	7844-M	7.46
No. 7/16"	.440"	3/4"	1/32"				6519-C	6519-C	1.02	6519-M	6519-M	8.13
No. 15/32"	15/32"	3/4"	1/32"				6518-C	6518-C	.94	6518-M	6518-M	7.46
Assorted							7836-C	7836-C	.52	7836-M	7836-M	4.13
				H820-F	H820-F	35						

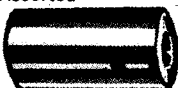

SPACERS INSULATED

1/4"	1/4"	8		6775-C	6775-C	5.00	6775-M	6775-M	45.00
1/4"	3/8"	8		6776-C	6776-C	5.00	6776-M	6776-M	45.00
1/4"	1/2"	8		6777-C	6777-C	5.00	6777-M	6777-M	45.00
1/4"	3/4"	8		6778-C	6778-C	7.00	6778-M	6778-M	56.00
3/8"	1/4"	12		6779-C	6779-C	5.00	6779-M	6779-M	45.00
3/8"	1/2"	12		6780-C	6780-C	5.00	6780-M	6780-M	45.00
3/8"	3/4"	12		6781-C	6781-C	5.00	6781-M	6781-M	45.00

WRITE FOR CATALOG #FR-69 FOR COMPLETE LISTINGS



DESCRIPTION

GC Part No.	Old Walsco Part No.	QTY. IN Box	GC Part No.	Old Walsco Part No.	Net Per 100	GC Part No.	Old Walsco Part No.	Net Per 1000		
NYLON BINDING HEAD MACHINE SCREWS										
2-56 UNC-2A	.176	.028	.013	.027	.027	1/4"	9915-C	3.69	9915-M	33.30
2-56 UNC-2A	.176	.028	.013	.027	.027	1/2"	9916-C	3.69	9916-M	33.30
4-40 UNC-2A	.229	.039	.021	.035	.038	1/4"	9917-C	3.69	9917-M	33.30
4-40 UNC-2A	.229	.039	.021	.035	.038	1/2"	9918-C	3.69	9918-M	33.30
4-40 UNC-2A	.229	.039	.021	.035	.038	3/4"	9919-C	3.79	9919-M	34.50
6-32 UNC-2A	.280	.047	.028	.044	.049	1/4"	9920-C	3.69	9920-M	33.30
6-32 UNC-2A	.280	.047	.028	.044	.049	3/8"	9921-C	3.79	9921-M	34.50
6-32 UNC-2A	.280	.047	.028	.044	.049	1/2"	9922-C	3.79	9922-M	34.50
6-32 UNC-2A	.280	.047	.028	.044	.049	5/8"	9923-C	3.79	9923-M	34.50
6-32 UNC-2A	.280	.047	.028	.044	.049	3/4"	9924-C	3.79	9924-M	34.50
8-32 UNC-2A	.337	.058	.034	.050	.060	3/8"	9925-C	3.86	9925-M	35.30
8-32 UNC-2A	.337	.058	.034	.050	.060	1/2"	9926-C	3.86	9926-M	35.30
8-32 UNC-2A	.337	.058	.034	.050	.060	3/4"	9927-C	3.86	9927-M	35.30
10-32 UNF-2A	.383	.068	.040	.055	.070	1/2"	9928-C	3.86	9928-M	35.30
10-32 UNF-2A	.383	.068	.040	.055	.070	1"	9929-C	4.02	9929-M	37.30



NYLON FLAT HEAD MACHINE SCREWS

A	H	J	T	D	L	GC Part No.	Old Walsco Part No.	Net Per 100	GC Part No.	Old Walsco Part No.	Net Per 1000
NYLON FLAT HEAD MACHINE SCREWS											
4-40 UNC-2A	.217	.062	.035	.025	81°	1/2"	9945-C	3.69	9945-M		33.30
6-32 UNC-2A	.267	.078	.044	.030	81°	3/8"	9946-C	3.79	9946-M		34.50
6-32 UNC-2A	.267	.078	.044	.030	81°	1/2"	9947-C	3.79	9947-M		34.50
6-32 UNC-2A	.267	.078	.044	.030	81°	5/8"	9948-C	3.79	9948-M		34.50
8-32 UNC-2A	.318	.094	.050	.037	81°	1/2"	9949-C	3.86	9949-M		35.30
8-32 UNC-2A	.318	.094	.050	.037	81°	3/4"	9950-C	3.86	9950-M		35.30
10-32 UNF-2A	.369	.108	.055	.045	81°	1/2"	9951-C	4.01	9951-M		37.30
10-32 UNF-2A	.369	.108	.055	.045	81°	1"	9952-C	4.31	9952-M		40.00



NYLON FILLISTER HEAD MACHINE SCREWS

A	H	F	J	T	L	GC Part No.	Old Walsco Part No.	Net Per 100	GC Part No.	Old Walsco Part No.	Net Per 1000
NYLON FILLISTER HEAD MACHINE SCREWS											
2-56 UNC-2A	.132	.058	.016	.027	.031	1/4"	9930-C	3.69	9930-M		33.30
2-56 UNC-2A	.132	.058	.016	.027	.031	1/2"	9931-C	3.69	9931-M		33.30
4-40 UNC-2A	.176	.074	.024	.035	.040	1/4"	9932-C	3.69	9932-M		33.30
4-40 UNC-2A	.176	.074	.024	.035	.040	1/2"	9933-C	3.69	9933-M		33.30
4-40 UNC-2A	.176	.074	.024	.035	.040	3/4"	9934-C	3.79	9934-M		34.50
6-32 UNC-2A	.218	.091	.030	.044	.055	1/4"	9935-C	3.69	9935-M		33.30
6-32 UNC-2A	.218	.091	.030	.044	.055	3/8"	9936-C	3.79	9936-M		34.50
6-32 UNC-2A	.218	.091	.030	.044	.055	1/2"	9937-C	3.79	9937-M		34.50
6-32 UNC-2A	.218	.091	.030	.044	.055	5/8"	9938-C	3.79	9938-M		34.50
6-32 UNC-2A	.218	.091	.030	.044	.055	3/4"	9939-C	3.79	9939-M		34.50
8-32 UNC-2A	.260	.108	.035	.050	.060	3/8"	9940-C	3.86	9940-M		35.30
8-32 UNC-2A	.260	.108	.035	.050	.060	1/2"	9941-C	3.86	9941-M		35.30
8-32 UNC-2A	.260	.108	.035	.050	.060	3/4"	9942-C	3.86	9942-M		35.30
10-32 UNF-2A	.302	.124	.042	.055	.070	1/2"	9943-C	3.86	9943-M		35.30
10-32 UNF-2A	.302	.124	.042	.055	.070	1"	9944-C	4.02	9944-M		37.30



NYLON HEX NUTS

A	B	GC Part No.	Old Walsco Part No.	Net Per 100	GC Part No.	Old Walsco Part No.	Net Per 1000
2-56	3/16"	1/16"	9953-C	5.84	9953-M		54.40
4-40	1/4"	3/32"	9954-C	5.96	9954-M		55.30
6-32	5/16"	7/64"	9955-C	6.07	9955-M		56.50
8-32	14/32"	1/8"	9956-C	6.18	9956-M		57.50
10-32	3/8"	1/8"	9957-C	6.26	9957-M		58.40



NYLON WASHERS

No.	A	B	C	GC Part No.	Old Walsco Part No.	Net Per 100	GC Part No.	Old Walsco Part No.	Net Per 1000
No. 4	.120	8/32"	.050	9958-C		.67	9958-M		6.20
No. 6	.150	5/16"	.050	9959-C		.74	9959-M		5.84
No. 8	.170	3/8"	.050	9960-C		.99	9960-M		9.00
No. 10	.195	7/16"	.060	9961-C		1.14	9961-M		10.50

DESCRIPTION AND SPECIFICATIONS

GC Part No.	QTY. IN Box	Net Per Box	GC Part No.	Old Walsco Part No.	Net Per 100	GC Part No.	Old Walsco Part No.	Net Per 1000
SOLDERLESS TERMINALS								
RING TONGUE - NON-INSULATED								
22-16	4-6	17/32"	13-000-C		2.68	13-000-M		21.46
22-16	4-6	23/32"	13-002-S	41	.99	13-002-C		21.46
22-16	8	41/64"	13-004-C		2.68	13-004-M		21.46
22-16	8	23/32"	13-006-C		3.00	13-006-M		23.99
22-16	8-10	23/32"	13-008-S	41	.99	13-008-C		21.46
16-14	4-6	19/32"	13-012-S	41	.99	13-012-C		21.59
16-14	8	45/64"	13-016-C		2.70	13-016-M		21.59
16-14	10	45/64"	13-018-C		2.70	13-018-M		21.59
16-14	12-1/4	57/64"	13-020-C		3.77	13-020-M		30.12
12-10	4-6	3/4"	13-022-C		3.77	13-022-M		30.12
12-10	1/4"	1-1/32"	13-026-C		4.70	13-026-M		37.58
16-14	10	55/64"	13-030-C		7.93	13-030-M		63.44

WRITE FOR CATALOG #FR-69 FOR COMPLETE LISTINGS



waldom

HARDWARE AND FASTENING DEVICES

PACKAGED HARDWARE

PACKAGED 3 WAYS — TO MEET ALL YOUR REQUIREMENTS



SHOW OFF PACKAGE

All packages are .59 Net. Quantity varies with item. (See listings.)



BLUE-LINE

All packages contain 100 pieces each, unless shown otherwise. Price varies with item. (See listings.)

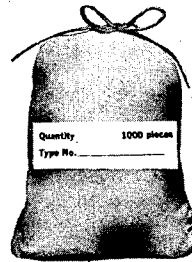

BULK PACK

Offers greatest economy. Each bag contains 1000 pieces. Price varies with item. (See listings.)

HOW TO ORDER: Simply use correct PART NO. for quantity desired.

ROUND HEAD STEEL MACHINE SCREWS Nickel Plated	SHOW OFF		BLUE LINE		BULK PACK		
	.59 per Pkg.		Pkg. of 100		Bag of 1000		
	Part No.	Quan.	Part No.	Per Pkg.	Part No.	1-4 Per Bag	5-9 Per Bag
2-56 x 1/8"	KF-579	60	F-579-C	.74	F-579-M	5.40	4.15
2-56 x 1/4"	KF-461	60	F-461-C	.55	F-461-M	4.10	3.10
2-56 x 1/2"	KF-462	60	F-462-C	.58	F-462-M	4.45	3.40
2-56 x 3/4"	KF-463	60	F-463-C	.67	F-463-M	5.15	3.95
3-48 x 3/4"	KF-464	60	F-464-C	.67	F-464-M	5.15	3.95
4-36 x 1/4"	KF-465	60	F-465-C	.58	F-465-M	4.45	3.40
4-36 x 3/8"	KF-466	50	F-466-C	.60	F-466-M	4.65	3.55
4-36 x 1/2"	KF-467	50	F-467-C	.62	F-467-M	4.85	3.70
4-36 x 5/8"	KF-580	50	F-580-C	.66	F-580-M	5.20	4.10
4-36 x 3/4"	KF-468	50	F-468-C	.74	F-468-M	5.80	4.40
4-40 x 1/4"	KF-469	50	F-469-C	.58	F-469-M	4.45	3.40
4-40 x 3/8"	KF-581	50	F-581-C	.60	F-581-M	4.65	3.55
4-40 x 1/2"	KF-470	50	F-470-C	.62	F-470-M	4.85	3.70
4-40 x 5/8"	KF-582	50	F-582-C	.66	F-582-M	5.25	4.00
4-40 x 3/4"	KF-471	50	F-471-C	.74	F-471-M	5.30	4.40
6-32 x 1/4"	KF-472	50	F-472-C	.61	F-472-M	4.95	3.75
6-32 x 3/8"	KF-583	45	F-583-C	.66	F-583-M	5.20	3.95
6-32 x 1/2"	KF-473	45	F-473-C	.71	F-473-M	5.65	4.35
6-32 x 5/8"	KF-584	45	F-584-C	.79	F-584-M	6.25	4.80
6-32 x 3/4"	KF-474	45	F-474-C	.83	F-474-M	6.75	5.20
6-32 x 1"	KF-475	45	F-475-C	.96	F-475-M	7.65	5.90
6-32 x 1-1/4"	KF-476	45	F-476-C	1.16	F-476-M	9.30	7.10
6-32 x 2"	KF-477	30	F-477-C	1.73	F-477-M	13.90	10.60
8-32 x 1/4"	KF-478	45	F-478-C	.81	F-478-M	6.45	4.95
8-32 x 3/8"	KF-479	35	F-479-C	.90	F-479-M	7.10	5.40
8-32 x 1/2"	KF-480	35	F-480-C	.95	F-480-M	7.55	5.80
8-32 x 5/8"	KF-585	35	F-585-C	1.01	F-585-M	8.05	6.15
8-32 x 3/4"	KF-481	35	F-481-C	1.07	F-481-M	8.50	6.50
8-32 x 1"	KF-482	30	F-482-C	1.24	F-482-M	9.80	7.50
8-32 x 1-1/4"	KF-483	30	F-483-C	1.42	F-483-M	11.50	8.75
10-32 x 1/2"	KF-484	30	F-484-C	1.10	F-484-M	8.70	6.65
10-32 x 5/8"	KF-586	30	F-586-C	1.19	F-586-M	9.45	7.25
10-32 x 3/4"	KF-485	30	F-485-C	1.29	F-485-M	10.40	7.95
10-32 x 1"	KF-486	25	F-486-C	1.45	F-486-M	11.45	8.75
10-32 x 1-1/2"	KF-487	20	F-487-C	1.91	F-487-M	15.15	11.55
12-24 x 3/4"			F-587-C	1.72	F-587-M	14.10	10.75
12-24 x 1"			F-588-C	2.00	F-588-M	16.85	12.85
12-24 x 1-1/2"			F-589-C	2.66	F-589-M	21.90	16.65
12-24 x 2"			F-590-C	3.13	F-590-M	25.65	19.60
1/4-20 x 1/2"			F-488-C	2.09	F-488-M	17.10	13.05
1/4-20 x 3/4"			F-489-C	2.38	F-489-M	19.55	14.85
1/4-20 x 1"			F-490-C	2.72	F-490-M	22.25	16.95
1/4-20 x 1-1/4"			F-491-C	3.09	F-491-M	25.30	19.25
1/4-20 x 1-3/4"			F-492-C	3.74	F-492-M	30.70	23.40

ROUND HEAD BRASS MACHINE SCREWS Nickel Plated	SHOW OFF		BLUE LINE		BULK PACK		
	.59 per Pkg.		Pkg. of 100		Bag of 1000		
	Part No.	Quan.	Part No.	Per Pkg.	Part No.	1-4 Per Bag	5-9 Per Bag
2-56 x 1/4"			F-461B-C	.81	F-461B-M	6.35	4.85
2-56 x 1/2"			F-462B-C	.92	F-462B-M	7.45	5.65
2-56 x 3/4"			F-463B-C	1.07	F-463B-M	8.80	6.70
3-48 x 3/4"			F-464B-C	1.22	F-464B-M	9.90	7.60
4-36 x 1/4"			F-465B-C	.92	F-465B-M	7.45	5.65
4-36 x 3/8"			F-466B-C	1.18	F-466B-M	9.35	7.15
4-36 x 1/2"			F-467B-C	1.29	F-467B-M	9.65	7.35
4-36 x 5/8"			F-580B-C	1.39	F-580B-M	10.40	7.95
4-36 x 3/4"			F-468B-C	1.47	F-468B-M	11.35	8.65
4-40 x 1/4"			F-469B-C	.92	F-469B-M	7.45	5.65
4-40 x 1/2"			F-470B-C	1.18	F-470B-M	9.35	7.15
4-40 x 5/8"			F-582B-C	1.39	F-582B-M	10.40	7.95
4-40 x 3/4"			F-471B-C	1.47	F-471B-M	11.35	8.65
6-32 x 1/4"			F-472B-C	1.25	F-472B-M	10.00	7.60
6-32 x 3/8"			F-583B-C	1.33	F-583B-M	10.65	8.15
6-32 x 1/2"			F-473B-C	1.50	F-473B-M	11.95	9.15
6-32 x 5/8"			F-584B-C	1.74	F-584B-M	13.25	10.15
6-32 x 3/4"			F-474B-C	1.83	F-474B-M	14.75	11.20
6-32 x 1"			F-475B-C	2.17	F-475B-M	17.35	13.25
6-32 x 1-1/4"			F-476B-C	2.52	F-476B-M	20.60	15.25
6-32 x 2"			F-477B-C	4.25	F-477B-M	33.95	25.90
8-32 x 1/4"			F-478B-C	1.95	F-478B-M	15.15	11.55
8-32 x 3/8"			F-479B-C	2.00	F-479B-M	15.50	11.85
8-32 x 1/2"			F-480B-C	2.22	F-480B-M	17.75	13.55
8-32 x 5/8"			F-585B-C	2.58	F-585B-M	20.05	15.35
8-32 x 3/4"			F-481B-C	2.72	F-481B-M	21.70	16.55
8-32 x 1"			F-482B-C	3.23	F-482B-M	25.85	19.70
8-32 x 1-1/4"			F-483B-C	3.79	F-483B-M	30.35	23.15
10-32 x 1/2"			F-484B-C	2.80	F-484B-M	22.50	17.15
10-32 x 5/8"			F-586B-C	3.12	F-586B-M	25.05	19.10
10-32 x 3/4"			F-485B-C	3.41	F-485B-M	27.20	20.75
10-32 x 1"			F-486B-C	4.06	F-486B-M	32.45	24.75
	OVAL HEAD STEEL MACHINE SCREWS Nickel Plated						
6-32 x 1/2"	KF-506	45	F-506-C	.71	F-506-M	5.65	4.35
6-32 x 3/4"	KF-507	45	F-507-C	.83	F-507-M	6.75	5.20
8-32 x 3/4"	KF-508	35	F-508-C	1.07	F-508-M	8.50	6.50
10-32 x 1/2"	KF-509	30	F-509-C	1.10	F-509-M	8.70	6.65
10-32 x 3/4"	KF-510	30	F-510-C	1.29	F-510-M	10.40	7.95



waldom

HARDWARE AND FASTENING DEVICES

PACKAGED HARDWARE (Continued)

SLOTTED HEX HEAD SHEET METAL SCREWS (Type A) Nick. Pl.	SHOW OFF		BLUE LINE		BULK PACK		
	.59 per Pkg.		Pkg. of 100		Bag of 1000		
	Part No.	Quan.	Part No.	Per Pkg.	Part No.	1-4 Per Bag	5-9 Per Bag
4 x 3/8"	KF-016	50	F-016-C	.89	F-016-M	7.25	5.50
4 x 1/2"	KF-523	50	F-523-C	.95	F-523-M	7.75	5.95
6 x 1/4"	KF-524	45	F-524-C	1.01	F-524-M	8.40	6.40
6 x 3/8"	KF-525	35	F-525-C	1.03	F-525-M	8.45	6.45
6 x 1/2"	KF-526	35	F-526-C	1.08	F-526-M	9.00	6.85
6 x 5/8"	KF-595	35	F-595-C	1.10	F-595-M	9.05	6.90
6 x 3/4"	KF-527	30	F-527-C	1.16	F-527-M	9.20	7.00
8 x 1/4"	KF-528	30	F-528-C	1.16	F-528-M	9.20	7.00
8 x 3/8"	KF-529	30	F-529-C	1.22	F-529-M	9.65	7.35
8 x 1/2"	KF-530	30	F-530-C	1.25	F-530-M	9.90	7.60
8 x 5/8"	KF-017	25	F-017-C	1.27	F-017-M	10.15	7.70
8 x 1"	KF-531	20	F-531-C	1.63	F-531-M	12.85	9.80
10 x 3/8"	KF-532	20	F-532-C	1.35	F-532-M	10.80	8.25
10 x 1/2"	KF-533	20	F-533-C	1.47	F-533-M	11.65	8.85
10 x 3/4"	KF-534	15	F-534-C	1.62	F-534-M	12.85	9.80



HEX WASHER HEAD SHEET METAL SCREWS (Type A) Steel-Indented Slotted Head Nickel Plated

6 x 1/4"	KF-056	35	F-056-C	1.05	F-056-M	8.05	6.50
6 x 3/8"	KF-057	35	F-057-C	1.08	F-057-M	9.00	6.85
6 x 1/2"	KF-050	35	F-050-C	1.14	F-050-M	9.15	6.95
6 x 5/8"	KF-058	30	F-058-C	1.18	F-058-M	9.65	7.35
6 x 3/4"	KF-054	25	F-054-C	1.24	F-054-M	10.15	7.70
8 x 1/4"	KF-051	25	F-051-C	1.24	F-051-M	10.15	7.70
8 x 3/8"	KF-052	25	F-052-C	1.29	F-052-M	10.60	8.10
8 x 1/2"	KF-053	25	F-053-C	1.34	F-053-M	9.80	7.50
8 x 5/8"	KF-055	25	F-055-C	1.37	F-055-M	11.20	8.55
8 x 3/4"	KF-059	25	F-059-C	1.52	F-059-M	12.50	9.55



PAN HEAD SHEET METAL SCREWS (TYPE A) Nickel Plated

4 x 1/2"	KF-596	45	F-596-C	.89	F-596-M	7.25	5.50
6 x 1/4"	KF-033	45	F-033-C	.95	F-033-M	7.75	5.95
6 x 3/8"	KF-597	35	F-597-C	.97	F-597-M	8.00	6.10
6 x 1/2"	KF-034	35	F-034-C	1.03	F-034-M	8.45	6.45
6 x 3/4"	KF-035	30	F-035-C	1.12	F-035-M	9.10	6.95
8 x 1/4"	KF-036	30	F-036-C	1.12	F-036-M	9.10	6.95
8 x 3/8"	KF-598	30	F-598-C	1.18	F-598-M	9.55	7.25
8 x 1/2"	KF-037	30	F-037-C	1.22	F-037-M	9.65	7.35
8 x 1"	KF-038	25	F-038-C	1.54	F-038-M	12.70	9.65



ROUND HEAD STEEL WOOD SCREWS Nickel Plated

4 x 1/2"	KF-514	35	F-514-C	.90	F-514-M	7.25	5.50
4 x 3/4"	KF-515	35	F-515-C	1.04	F-515-M	8.35	6.35
6 x 3/4"	KF-516	30	F-516-C	1.12	F-516-M	9.00	6.85
6 x 1"	KF-517	30	F-517-C	1.39	F-517-M	11.10	8.45
8 x 3/4"	KF-518	25	F-518-C	1.33	F-518-M	10.60	8.10
8 x 1"	KF-047	25	F-047-C	1.53	F-047-M	12.80	9.75
8 x 1-1/4"	KF-519	15	F-519-C	1.83	F-519-M	14.70	11.20
10 x 1-1/2"	KF-520	15	F-520-C	2.45	F-520-M	19.65	14.95
12 x 1-1/2"	KF-521	10	F-521-C	3.12	F-521-M	25.05	19.10
14 x 1-3/4"	KF-522	10	F-522-C	4.39	F-522-M	35.30	26.90



FLAT HEAD STEEL WOOD SCREWS Nickel Plated

8 x 1/2"	KF-027	35	F-027-C	.90	F-027-M	7.25	5.50
8 x 1"	KF-048	25	F-048-C	1.56	F-048-M	12.80	9.75
8 x 1-1/4"	KF-032	15	F-032-C	1.83	F-032-M	14.70	11.20
10 x 1-1/2"	KF-044	15	F-044-C	2.45	F-044-M	19.65	14.95

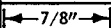

STEEL SPADE BOLT Nickel Plated

6-32 x 5/16"	KF-620	15	F-620-C	1.29	F-620-M	10.55	8.10
--------------	--------	----	---------	------	---------	-------	------

FLAT STEEL WASHERS Nickel Plated				SHOW OFF		BLUE LINE		BULK PACK		
Screw Size	I. D. In.	O. D. In.	Thk. In.	.59 per Pkg.		Pkg. of 100		Bag of 1000		
				Part No.	Quan.	Part No.	Per Pkg.	Part No.	1-4 Per Bag	5-9 Per Bag
2	.092	7/32	.018	KMW-400	150	MW-400-C	.49	MW-400-M	4.10	3.15
4	.125	9/32	.025	KMW-401	150	MW-401-C	.38	MW-401-M	3.20	2.40
6	.150	3/8	.032	KMW-402	150	MW-402-C	.38	MW-402-M	3.20	2.40
8	.170	3/8	.032	KMW-403	150	MW-403-C	.38	MW-403-M	3.20	2.40
10	.204	7/16	.032	KMW-404	140	MW-404-C	.43	MW-404-M	3.60	2.75
1/4	.281	5/8	.050	KMW-408	90	MW-408-C	.78	MW-408-M	6.15	4.75
3/8	.392	11/16	.050	KMW-410	60	MW-410-C	.81	MW-410-M	6.50	5.00



FLAT BRASS WASHERS Nickel Plated

2	.092	7/32	.018			MW-400B-C	.53	MW-400B-M	4.25	3.25
4	.125	9/32	.025			MW-401B-C	.55	MW-401B-M	4.45	3.40
6	.150	3/8	.032			MW-402B-C	.71	MW-402B-M	5.65	4.35
8	.170	3/8	.032			MW-403B-C	.71	MW-403B-M	5.65	4.35
10	.204	7/16	.032			MW-404B-C	.78	MW-404B-M	6.15	4.75



FLAT FIBER WASHERS

4	.120	1/4	1/32	KFW-374	50	FW-374-C	.48	FW-374-M	3.95	3.05
6	.145	1/4	1/32	KFW-375	45	FW-375-C	.48	FW-375-M	3.95	3.05
8	3/16	3/8	1/32	KFW-376	45	FW-376-C	.52	FW-376-M	4.25	3.25
10	.192	3/8	1/32	KFW-377	45	FW-377-C	.52	FW-377-M	4.25	3.25
1/4	.255	1/2	1/32	KFW-378	35	FW-378-C	.57	FW-378-M	4.45	3.40
3/8	3/8	5/8	1/32	KFW-379	30	FW-379-C	.85	FW-379-M	6.75	5.15
7/16	.440	3/4	1/32	KFW-380	25	FW-380-C	.91	FW-380-M	7.45	5.65



EXTRUDED FIBER WASHERS

4	1/8	9/32	5/64	KFW-384	35	FW-384-C	.96	FW-384-M	7.60	5.80
6	9/64	5/16	5/64	KFW-385	35	FW-385-C	.96	FW-385-M	7.60	5.80
8	11/64	3/8	3/32	KFW-386	30	FW-386-C	.96	FW-386-M	7.60	5.80
10	13/64	7/16	3/32	KFW-387	30	FW-387-C	1.05	FW-387-M	8.30	6.35
1/4	.256	1/2	3/32	KFW-388	30	FW-388-C	1.05	FW-388-M	8.30	6.35
3/8	.375	5/8	3/32	KFW-389	30	FW-389-C	1.08	FW-389-M	8.55	6.55



STEEL CUP WASHERS Nickel Plated

6				KCW-6	60	CW-6-C	.56	CW-6-M	4.55	3.45
8				KCW-6	60	CW-8-C	.59	CW-8-M	4.90	3.75
10				KCW-10	50	CW-10-C	.67	CW-10-M	5.30	4.00



STEEL SPLIT LOCK WASHERS Zinc Plated

#4 Screw				KMW-411	120	MW-411-C	.66	MW-411-M	5.20	4.00
#6 Screw				KMW-412	120	MW-412-C	.55	MW-412-M	4.45	3.40
#8 Screw				KMW-413	120	MW-413-C	.54	MW-413-M	4.35	3.30
#10 Screw				KMW-414	100	MW-414-C	.61	MW-414-M	4.95	3.75
#1/4 Screw				KMW-415	75	MW-415-C	.92	MW-415-M	7.35	5.60



METAL CABLE CLAMPS Cadmium Plated

Mtl. In.	Ht. In.	W. In.	Wire Hold Area							
.020B	7/16	1/4	3/32	KC-201	30	C-201-C	.89	C-201-M	7.30	5.60
.032S	5/8	3/8	10/64	KC-202	30	C-202-C	1.12	C-202-M	9.20	7.00
.032S	11/16	3/8	1/4	KC-203	25	C-203-C	1.29	C-203-M	10.55	8.05
.032S	15/16	3/8	10/32	KC-204	15	C-204-C	1.43	C-204-M	11.70	8.95



SPRING CLIPS Brass, Nickel Plated

Thick-ness	Ht. In.	W. In.	Mtg. Hole In.							
.016	45/64	7/32	.130	KC-101	20	C-101-C	1.66	C-101-M	13.15	10.00
.020	25/32	5/16	.144	KC-102	20	C-102-C	2.20	C-102-M	17.40	13.25
.022	1	3/8	.144	KC-103	10	C-103-C	3.23	C-103-M	26.90	20.50



waldom

HARDWARE AND FASTENING DEVICES

PACKAGED HARDWARE (SHAKEPROOF® PRODUCTS)



LIVE-ACTION INTERNAL LOCKWASHERS

 <p>Spring-steel cadmium-plated</p> <p>Bite on both sides, to lock tight, stay tight, where others fail.</p>	Screw Size	Shakeproof® Part No.	O.D.	Material Thickness	SHOW OFF		BLUE LINE		BULK PACK		
					.59 per Pkg.		Pkg. of 100		Bag of 1000		
					Part No.	Quan.	Part No.	Per Pkg.	Part No.	Per Bag	5-9 Per Bag
	2	1202	.185-.175	.013	KMW-428	70	MW-428-C	.84	MW-428-M	5.20	3.60
	4	1204	.265-.255	.015	KMW-416	90	MW-416-C	.50	MW-416-M	3.30	2.30
	6	1206	.288-.278	.018	KMW-417	90	MW-417-C	.50	MW-417-M	3.30	2.30
	8	1208	.336-.325	.020	KMW-418	80	MW-418-C	.56	MW-418-M	3.45	2.40
	10	1210	.381-.370	.022	KMW-419	80	MW-419-C	.56	MW-419-M	3.45	2.40
	1/4	1214	.478-.466	.025	KMW-420	50	MW-420-C	.72	MW-420-M	4.65	3.25
	3/8	1220	.692-.678	.035	KMW-421	35	MW-421-C	1.08	MW-421-M	8.20	5.65

LIVE-ACTION EXTERNAL LOCKWASHERS

 <p>Spring-steel, cadmium-plated.</p> <p>Bite on both sides, to lock tight, stay tight, where others fail.</p>	Screw Size	Part No.	O.D.	Material Thickness	SHOW OFF		BLUE LINE		BULK PACK		
					.59 per Pkg.		Pkg. of 100		Bag of 1000		
					Part No.	Quan.	Part No.	Per Pkg.	Part No.	Per Bag	5-9 Per Bag
	4	1104	.255-.245	.015	KMW-422	90	MW-422-C	.50	MW-422-M	3.30	2.30
	6	1106	.317-.306	.020	KMW-423	90	MW-423-C	.50	MW-423-M	3.30	2.30
	8	1108	.381-.370	.020	KMW-424	80	MW-424-C	.56	MW-424-M	3.45	2.40
	10	1110	.406-.395	.022	KMW-425	80	MW-425-C	.56	MW-425-M	3.45	2.40
	1/4	1114	.506-.494	.025	KMW-426	50	MW-426-C	.72	MW-426-M	4.65	3.25
	3/8	1120	.695-.680	.035	KMW-427	35	MW-427-C	1.08	MW-427-M	8.20	5.65

LOCKING TERMINALS Bronze hot tin-dipped, .018 thickness

<p>Provide the economy and efficiency of a combination wire terminal and Shakeproof® lockwasher.</p>	Screw Size	Shakeproof® Part No.	Length	Form 1.  2. 	SHOW OFF		BLUE LINE		BULK PACK		
					.59 per Pkg.		Pkg. of 100		Bag of 1000		
					Part No.	Quan.	Part No.	Per Pkg.	Part No.	Per Bag	5-9 Per Bag
Style 4	4	2101-04-00	7/8	1	KT-196	30	T-196-C	1.41	T-196-M	9.75	7.85
	6	2101-06-00	7/8	1	KT-197	30	T-197-C	1.41	T-197-M	9.75	7.85
	8	2101-08-00	7/8	1	KT-198	30	T-198-C	1.41	T-198-M	9.75	7.85
	10	2101-10-00	57/64	1	KT-223	30	T-223-C	1.43	T-223-M	9.85	8.00
Style 10	4	2103-04-00	13/16	2			T-247-C	1.41	T-247-M	9.75	7.85
	6	2103-06-00	13/16	2			T-248-C	1.41	T-248-M	9.75	7.85
	8	2103-08-00	13/16	2			T-249-C	1.41	T-249-M	9.75	7.85
	10	2103-10-00	53/64	2			T-250-C	1.57	T-250-M	10.35	8.35
Style 9	4	2106-04-00	5/8	1			T-229-C	1.32	T-229-M	9.55	7.75
	6	2106-06-00	5/8	1	KT-194	30	T-194-C	1.32	T-194-M	9.55	7.75
	8	2106-08-00	5/8	1	KT-195	30	T-195-C	1.32	T-195-M	9.55	7.75
Style 11	4	2102-04-00	23/32	1			T-230-C	1.32	T-230-M	9.55	7.75
	6	2102-06-00	23/32	1			T-231-C	1.32	T-231-M	9.55	7.75
	8	2102-08-00	23/32	1			T-232-C	1.32	T-232-M	9.55	7.75
	4	2104-04-00	5/8	2			T-233-C	1.32	T-233-M	9.55	7.75
	6	2104-06-00	5/8	2			T-234-C	1.32	T-234-M	9.55	7.75
	8	2104-08-00	5/8	2			T-235-C	1.32	T-235-M	9.55	7.75
	10	2104-10-00	41/64	2			T-236-C	1.43	T-236-M	9.85	8.00
	6	2108-06-00	25/32	1			T-237-C	1.55	T-237-M	10.30	8.35
	10	2108-10-00	51/64	1			T-238-C	1.62	T-238-M	10.50	8.55

PLAIN TERMINALS Brass hot tin-dipped, .018 thickness

<p>Style 1</p> <p>Style 4</p> <p>Style 7</p>	Screw Size	Part No.	Length	Form	SHOW OFF		BLUE LINE		BULK PACK		
					.59 per Pkg.		Pkg. of 100		Bag of 1000		
					Part No.	Quan.	Part No.	Per Pkg.	Part No.	Per Bag	5-9 Per Bag
Style 1	4	2522-04-00	21/32	1			T-239-C	.84	T-239-M	6.15	5.00
	6	2522-06-00	21/32	1			T-240-C	.84	T-240-M	6.15	5.00
Style 4	6	2501-06-00	7/8	1			T-241-C	.89	T-241-M	6.55	5.35
	8	2501-08-00	7/8	1			T-242-C	.89	T-242-M	6.55	5.35
	10	2501-10-00	57/64	1			T-243-C	.89	T-243-M	6.55	5.35
Style 7	6	2506-06-00	5/8	1			T-244-C	.89	T-244-M	6.55	5.35
	8	2506-08-00	5/8	1			T-245-C	.89	T-245-M	6.55	5.35
	10	2506-10-00	5/8	1			T-246-C	.89	T-246-M	6.55	5.35

EXTERNAL LOCKWASHER KEPS®—STANDARD SIZES

 <p>American Standard Machine Screw Nut Series, Nut, SAE20 steel; Washer, spring steel, cadmium-plated. Lockwasher and nut are pre-assembled. Reusable, free-spinning, they drive easily, cut assembly time, lock securely.</p>	Diameter and Thread	Shakeproof® Part No.	Across Flats	Nut Thickness	SHOW OFF		BLUE LINE		BULK PACK		
					.59 per Pkg.		Pkg. of 100		Bag of 1000		
					Part No.	Quan.	Part No.	Per Pkg.	Part No.	Per Bag	5-9 Per Bag
	4-40	511-041800-00	1/4	3/32			511-041800-00-C	2.87	511-041800-00-M	21.15	17.15
	6-32	511-061800-00	5/16	7/64			511-061800-00-C	2.27	511-061800-00-M	16.75	13.55
	8-32	511-081800-00	11/32	1/8			511-081800-00-C	2.33	511-081800-00-M	17.15	14.00
	10-32	511-101800-50	3/8	1/8			511-101800-50-C	2.45	511-101800-50-M	18.00	14.70
	1/4-20	511-251800-00	7/16	3/16			511-251800-00-C	3.09	511-251800-00-M	22.70	18.50

*TRADEMARK



waldom HARDWARE AND FASTENING DEVICES

MOLDED NYLON HARDWARE

NYLON SCREWS



ROUND HEAD



BINDER HEAD



FILLISTER HEAD



FLAT HEAD

Description	Part No.				Net Prices	
	Round Head	Binder Head	Fillister Head	Flat Head	Pkg. of 100	Bulk 1000 or More, Per M
2-56 x 1/4"	FN-800	FN-815	FN-830		3.30	25.85
2-56 x 1/2"	FN-801	FN-816	FN-831		3.30	25.85
4-40 x 1/4"	FN-802	FN-817	FN-832		3.30	26.15
4-40 x 1/2"	FN-803	FN-818	FN-833	FN-845	3.30	26.25
4-40 x 3/4"	FN-804	FN-819	FN-834		3.39	26.65
6-32 x 1/4"	FN-805	FN-820	FN-835		3.30	26.30
6-32 x 3/8"	FN-806	FN-821	FN-836	FN-846	3.39	26.55
6-32 x 1/2"	FN-807	FN-822	FN-837	FN-847	3.39	26.80
6-32 x 5/8"	FN-808	FN-823	FN-838	FN-848	3.39	27.05
6-32 x 3/4"	FN-809	FN-824	FN-839		3.47	27.30
8-32 x 3/8"	FN-810	FN-825	FN-840		3.47	27.30
8-32 x 1/2"	FN-811	FN-826	FN-841	FN-849	3.47	27.70
8-32 x 3/4"	FN-812	FN-827	FN-842	FN-850	3.47	28.05
10-32 x 1/2"	FN-813	FN-828	FN-843	FN-851	3.61	28.75
10-32 x 1"	FN-814	FN-829	FN-844	FN-852	3.87	30.75

NYLON HEX NUTS

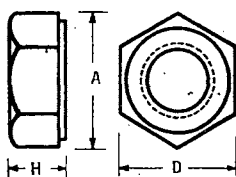
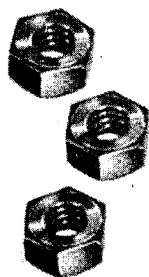

Part No.	Thread	D		A		H		Net Prices	
		Max.	Min.	Max.	Min.	Max.	Min.	Pkg. of 100	Bulk 1000 or More, Per M
FN-853	2-56	3/16	.180	.214	.208	.090	.086	5.28	42.65
FN-854	4-40	1/4	.240	.279	.272	.124	.120	5.36	43.05
FN-855	6-32	5/16	.300	.350	.343	.146	.138	5.49	44.20
FN-856	8-32	11/32	.331	.386	.379	.170	.162	5.57	44.80
FN-857	10-32	3/8	.360	.420	.412	.196	.188	5.62	45.45

WEDGE LOCKING NYLON WIRE CLAMP

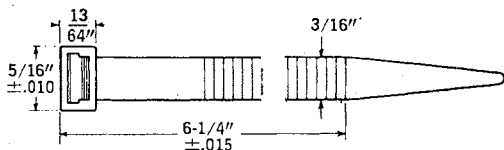

Positive holding and locking action ratchet teeth on the band engage with matching teeth inside the clamp loop. A small, floating wedge, which cannot fall out, locks the teeth together. Slip clamp around cable, insert tongue, pull tight, push in wedge, and cut off extra material. It's a permanently locked, neat cable clamp. Accommodates from 1/8" to 1-3/4" diameter wire bundles. Natural color.

Part No.	Pkg. of 100	1000 or more Per M
BCN-25	9.90	76.55

NYLON FINISHING WASHERS



These Molded Nylon Finishing Washers are made to be used with No. 6, No. 8, No. 10 and 1/4" countersunk metal or nylon screws. They prevent cutting and scratching of instrument and control panels, cover misaligned holes, can be used as glides, protective feet, bumpers, insulators, spacers. Smooth glossy finish. Natural nylon; special quotations for color coding.

Part No.	I.D.	O.D.	Thick-ness	NET PRICES	
				Pkg. of 100	Bulk 1000 or More, Per M
NW-879	#6(.143)	.437	.100	4.02	32.10
NW-890	#8(.171)	.515	.115	4.24	33.85
NW-891	#10(.191)	.580	.152	4.53	36.20

SEPARATE NYLON MOUNTING TABS

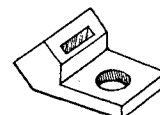

For clamp at left. May be pre-mounted at support points, with band clamps inserted later, or slipped on band clamp when bundling wires and mounted later. Never in the way when not needed.

Part No. BCN-12	Pkg. of 100—\$3.30	1000 or more, per M—\$24.75
-----------------	--------------------	-----------------------------

FORKED TOOL FOR WEDGING BAND CLAMP



Part No. FT-27	Net Ea. \$2.20
----------------	----------------

NYLON FLAT WASHERS



Stamped from extruded nylon strip. Use as insulating or cushioning washers, spacers, thrust washers. Natural color from stock, color coding at slight additional cost.

Part No.	I.D.	O.D.	Thick-ness	NET PRICES	
				Pkg. of 100	Bulk 1000 or More, Per M
NW-875	#4(.120)	9/32	.050	.58	4.80
NW-876	#6(.150)	5/16	.050	.64	5.25
NW-877	#8(.170)	3/8	.060	.87	7.15
NW-878	#10(.195)	7/16	.060	.99	8.10

AMPROBE INSTRUMENT®

DIVISION OF SOSS MANUFACTURING COMPANY

ROTARY SCALE MODELS

Offer you these outstanding features. • Only the Ohms scale plus one voltage scale or current scale is visible at any one time, providing greater reading speed and accuracy; on models other than RS-3, RS-3A or RS-1000 only scale selected appears. • Magnified unbreakable window. • Pointer-lock "freezes" pointer at reading. • Accurate within $\pm 3\%$ full scale reading. • One hand operation.



G Case



A Case

MODEL	RANGES		PRICE
	VOLTS, AC	AMPS, AC	
RS-1	0-150/600	0-6/15/40/100	\$44.85
RS-2	0-150/300	0-6/15/40/100	44.85
RS-3	0-150/300/600	0-6/15/40/100/300	58.50
RS-300	0-150/300/600	0-6/15/40/100/300	53.50
RS-1000	0-150/300/600	0-15/40/100/300/1000	77.50

RS-3 and RS-1000 OHMMETER RANGE: 25 Ohms Mid-Scale
Price includes "G" carrying case (RS-1000 includes "E" Case) and Test Leads VL-11.

MODEL	VOLTS, AC	AMPS, AC	PRICE
RS-1A	0-150/600	0-6/15/40/100	\$49.85
RS-2A	0-150/300	0-6/15/40/100	49.85
RS-3A	0-150/300/600	0-6/15/40/100/300	63.50
RS-300A	0-150/300/600	0-6/15/40/100/300	58.50

RS-3A OHMMETER RANGE: 25 Ohms Mid-Scale
Price includes Extendo-Lead Pack VLK-311 and special "A" Case with space for Amprobe Energizer A-45L

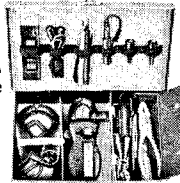

TM-43A
U Case

AMPROBE® TEST-MASTER KITS

Truly the sign of the professional, these good-looking rugged, sturdy cases contain all the equipment you need to do all your electrical testing jobs with precision and accuracy.

CONTAINS:	MODEL TM-33	MODEL TM-33A	MODEL TM-43	MODEL TM-43A	MODEL TM-60	MODEL TM-63	MODEL TM-53
RS-3	one	one	one	one	—	one	one
Extendo Leads	—	one	—	one	one	one	—
PSA-1	—	—	one	one	—	—	one
Energizer	one	one	one	one	one	one	one
Deca Tran	one	one	one	one	—	—	—
A Case	—	—	—	—	one	one	—
U Case	one	one	one	one	—	—	—
V Case	—	—	—	—	—	—	one
Price	\$97.50	\$98.50	\$106.85	\$107.85	\$15.85	\$69.85	\$76.85

EXTENDO-LEADS

Ends awkward, 3 handed voltage readings. Eliminates need for someone or something to hold the instrument while test probes are applied to the circuit. VLK-311 for RS (except RS-1000) VLK-355 for Juniors. \$3.95

PHASE SEQUENCE ADAPTOR

The Model PSA-1 Phase Sequence Adaptor is used to determine the phase sequence of polyphase circuits. When used in conjunction with any AMPROBE model it permits you to determine phase sequence of motors and other electrical equipment using three phase lines up to 550 volts. Price w/ case: \$12.85

AMPROBE® DECA-TRAN, A50-1

Extends current range 10 times, up to 1200 Amps intermittent, 600 Amps continuous. \$30.50

AMPROBE® ENERGIZER



The Model A-45L ENERGIZER permits current readings on permanently wired low-current electrical equipment by simplifying series connection. It increases the sensitivity of your ammeter 5x or 10x for more precise readings directly at outlets by "splitting" double conductor line cords while the appliance is connected to the line. Capacity 10 amps. Price w/weatherproof pouch: \$7.25

AMPROBE® JUNIOR MODELS

Advanced, precision snap around testers that anyone can afford. These compact Juniors measure voltage, current and resistance (YO Models) instantly and accurately on easy to read scales. New "B" Case available for all Junior models. Holds Extendo-Leads VLK-355 and has space for Amprobe Energizer A-45L.

YO MODELS 1 current range, 2 voltage ranges, 25 Ohms Mid-Scale. Price w/test leads \$29.50

MODEL	AMPS, AC	VOLTS, AC
YO "525"	0-25	0-150/600
YO "550"	0-50	0-150/600
YO "500"	0-100	0-150/600
YO "50"	0-50	0-125/250

Y MODELS 1 current range, 2 voltage ranges. Price w/test leads \$24.50

MODEL	AMPS, AC	VOLTS, AC
Y25	0-25	0-125/250
Y50	0-50	0-125/250
Y500	0-100	0-150/600
Y525	0-25	0-150/600
Y550	0-50	0-150/600

YT MODELS 2 current ranges, 2 voltage ranges. Price with test leads \$28.50

MODEL	AMPS, AC	VOLTS, AC
YT1025	0-10/25	0-150/300
YT25100	0-25/100	0-150/300

YTB MODELS Versatile YT Jr. and Extendo-Lead Pack VLK-355 in handy "B" case, with space for Energizer A-45L. Price \$34.50

MODEL	AMPS, AC	VOLTS, AC
YTB1025	0-10/25	0-150/300
YTB25100	0-25/100	0-150/300

AMPROBE® JUNIOR TEST-MASTER KITS

The AMPROBE Jr. Test-Master Kit consists of a specially designed case that contains one of the YO AMPROBE Jr. voltage testers, an AMPROBE Energizer, battery attachment and test leads.

The YO models are precision instruments that measure voltage, amperage and resistance, instantly and accurately on a calibrated scale. Price: \$39.85

MODEL	3 AMMETER RANGES (full scale) BASIC INST.		2 VOLTAGE RANGES
	AMPS, AC	VOLTS, AC	
TM-YO "525"	0-25	0-150/600	0-150/600
TM-YO "550"	0-50	0-150/600	0-150/600
TM-YO "500"	0-100	0-150/600	0-150/600
TM-YO "25"	0-25	0-125/250	0-125/250
TM-YO "50"	0-50	0-125/250	0-125/250
TM-YO "100"	0-100	0-125/250	0-125/250

OHMMETER RANGE: 25 Ohms Mid-Scale

AMPROBE® JUNIOR LINE PROBE

Unique, versatile...traces up to 10 circuits at one time, measures voltage and current without interrupting service, checks for continuity. Furnished with 10 station markers, 2 station marker holders, voltage leads, grounding leads, fused battery attachment and case. Price \$41.50

MODEL	VOLTS, AC	AMPS, AC
ALP50	0-125/250	0-50
ALP550	0-150/600	0-50

AMPROBE® VOLTPROBE™ VOLTAGE TESTER

Visual readout by series of lit windows corresponding to each Voltage level; ends guesswork. Retractable coil and probe. Lightweight, fits in shirt pocket. Price: \$9.50

Model VT-100 indicates nominal Voltage Levels	
Voltage levels: 115-220-277-440-550 AC	
115-220-400-600-750 DC	

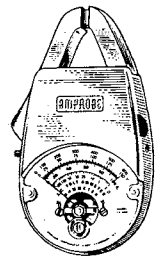

B CASE (Closed)

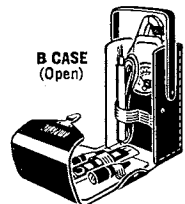

B CASE (Open)

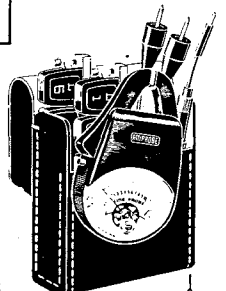
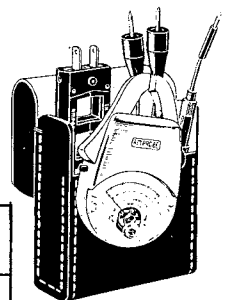

Fast, accurate point to point circuit testing

PARAGON PRO-GLO Circuit Testers are simple, inexpensive, easy-to-use instruments for checking non-energized circuits. This little pen-size unit accurately checks for polarity, shorts and opens and continuity in circuits with resistance up to 10 ohms.

The PARAGON PRO-GLO tester consists simply of a plastic case containing two AA penlight batteries and a #222 lamp, a pointed probe and a three-ft. lead wire with alligator. The lead wire holds a new probe protector.

Servicemen and home repairmen appreciate the ease of use of this simple tester. Signal light at point of contact eliminates necessity for shifting eyes to read meter. Speed and accuracy of testing is increased.

Low cost of device makes it practical for mass distribution in large service centers. Long operating life is assured—probe and battery contact spring are tin-plated beryllium copper, case is high-impact plastic and wire is heavy-duty, flexible test lead.

DEALER NET PRICE \$1.33

- FOR SERVICE SHOPS • HOME TESTING • GARAGES • HOBBYISTS
- FARM USES

Probe-Protector Included

New! Vinyl extrusion Probe - Protector glides easily on the cord—can't be mislaid. Slips over Probe when circuit tester is not being used. This prevents accidental contact with metal that could create a circuit thus minimizing unnecessary battery burn-out.

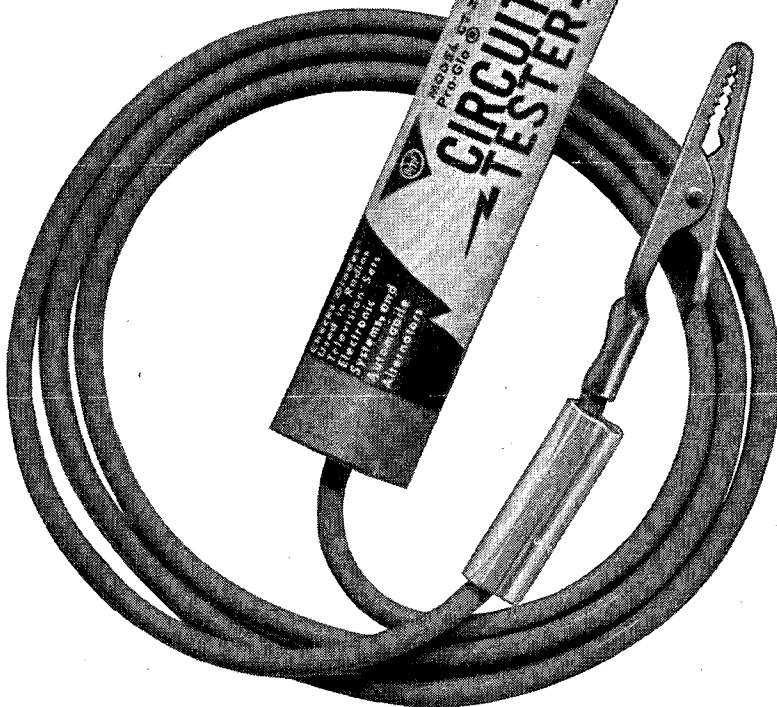
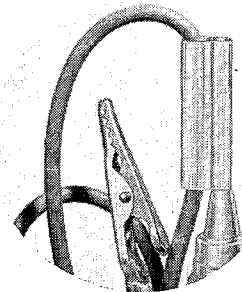

AMF
PARAGON

Beckman®

TEST AND

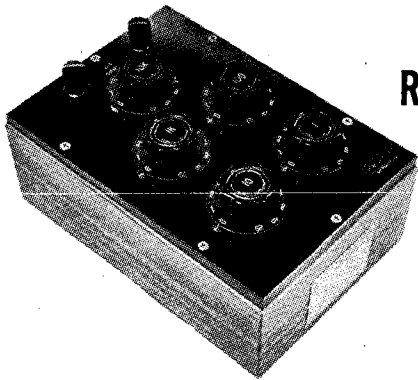

RESISTANCE DECADES Model DR Series

High Precision and Stability — Low Zero Resistance — Long Life Switches

DR units provide convenient selection of precise resistance values. Typical applications are found in the areas of circuit design in simulation of various factors and as standard in bridge-type measurements.

Standard units are available with 3, 5, or 7 dials. Each decade inserts a precise ohmic resistance in series with the terminals. The basic

ohmic value of any decade may be multiplied by factors of 0, 1, 2, 3, thru 10 by setting its dial at the appropriate step. Switches are 12 position, 360-degree type. Actual resistance is the sum of zero-resistance and indicated resistance. Model DR units provide zero-resistance of less than 0.003 ohm per decade.

Model No.	Maximum Resistance	Decade Steps	Accuracy	Overall Dimensions	Weight Lbs.		Price
					Net	Ship	
DR-4D	1,110	10 x (1+10+100)	±0.25 & ±0.1%	8 x 5½ x 4½	4	6	\$ 78.00
DR-50D	11,111	10 x (0.1+1+10+100+1K)	±0.25 & ±0.01%	9 x 6 x 4½	5	7	100.00
DR-51D	111,110	10 x (1+10+100+1K+10K)	±0.25 & ±0.1%	9 x 6 x 4½	5	7	105.00
DR-52D	1,111,100	10 x (10+100+1K+10K+100K)	±0.1%	9 x 6 x 4½	5	7	115.00
DR-70D	1,111,111	10 x 0.1+1+10+100+1K+10K+100K)	±0.25 & ±0.1%	17¼ x 5 x 4½	6	8	165.50
DR-71D	11,111,110	10 x (1+10+100+1K+10K+100K+1M)	±0.25 & ±0.1%	17¼ x 5 x 4½	6	8	215.25

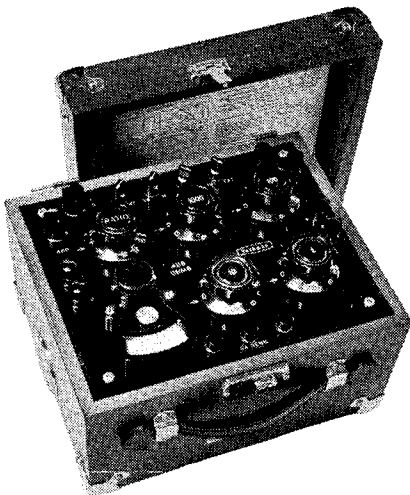

WHEATSTONE BRIDGES Model RN

Universally used for the measurement of all types of resistance devices and circuits where high accuracy is required. Models available for performing Murray-Varley Loop tests. Decade accuracy essentially ±0.1%, ratios are ±0.05%. May also be used as a 4-dial precision decade resistance.

Model	Total Resistance of Decade	Ratio Dial Settings	Circuits	Dimensions	Price
RN-1	9 x (1+10+100+1000)	.001, .01, .1, 1, 10, 100, 1000	—	9"8"x6½"	\$195.00
RN-2	9 x (1+10+100+1000)	.001, .01, .1, 1, 10, 100, 1000, M10, M100, M1000	Murray & Varley	9"8"x6½"	210.00
RN-3	10 x (1+10+100+9(1000))	1/1000, 1/100, 1/10, 1/9, 1/4, 1/1, 10/1, 100/1, 1000/1, M10, M100, M1000	Murray & Varley	9½"x8"x6½"	250.00

Model L MEGOHMMETERS

Type L Megohmmeters are used for both laboratory and high speed production testing of motor and transformer winding insulation, cable insulation, high value resistors, capacitor insulation, and for the measurement of surface and volume leakage of insulating materials. These instruments meet the requirements for testing insulation resistance in accordance with ASTM D-257, and Federal Specification LP-406B, Method 4041.

Model	Test Voltage	Resistance Range		Power Consumption	Weight Lbs.		Size	Price
		Low	High		Net	Ship		
L-4B	200 or 500 fixed	1 meg. 2.5 meg.	100,000 meg. 250,000 meg.	50 watts	14	17	15"x8"x10"	\$225.00
L-6C	100 to 600*	1 meg.	100,000 meg.	80 watts	15	18	15"x8"x10"	325.00
L-7	100 to 600*	1 meg.	5 x 10 ¹³ ohms	75 watts	20	24	8"x10½"x11½"	400.00
L-8	10 to 1000**	10 ⁵ ohms	10 ¹⁶ ohms	35 watts	18	22	7½"x11"x13"	480.00

* Continuously variable, built-in voltmeter for accurate setting.

** Continuously variable, selectable by switch.



PRICES

All prices listed in The MASTER are subject to change without notice — they should not be considered final.

Get quick-on-the-spot quotations from your distributor who subscribes to the up-to-the-minute .

UNITED *Pricing Reports*

The Perpetual Pricing System for Electronic Parts and Equipment

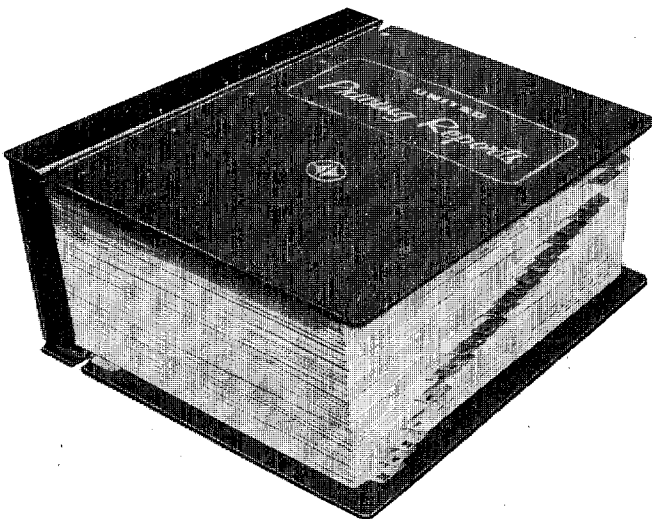

- Over 750 manufacturers
- Over 400,000 catalog numbers tabulated with current prices
- Revised pages mailed semi-weekly: insert new pages—discard old pages
- Compression type loose-leaf binder for rapid replacement of revised pages
- Weekly summary sheet—Ups, Downs, Additions, Deletions

For complete details and subscription rates write to:



UNITED PRICING REPORTS

A UNITED TECHNICAL PUBLICATION

645 STEWART AVENUE, GARDEN CITY, N. Y. 11530

DELIVERY

Delivery is often dependent on availability of raw materials. Check with your distributor for delivery information at the time you place your order.

Tracks 'em Down Dead or Alive



ONLY THE VERSATILE

Circuitracer*

GIVES YOU A 3-IN-1 ELECTRICAL TEST LABORATORY

Satisfaction Unconditionally Guaranteed

DON'T SEND A MAN TO DO A BOY'S JOB!

Are the technicians in your laboratories and shops using expensive meters and instruments for simple continuity and voltage checks? Speed up production through the use of the tool specifically designed for this application. A meter should be used only when the value of voltage, resistance or current must be known. Under any other conditions a Circuitracer will provide the required information faster and easier than expensive, bulky meters.

CIRCUIT TESTING WITH A CIRCUITRACER IS FASTER because the signal light is in the tip at the point of contact. This makes it possible to determine the existence of a circuit or voltage without removing the eyes from the test point to read a meter.



LIST PRICE

\$5.95

Model CT1-1

Weights only 2 1/2 ozs.

SAVE METER REPAIR MONEY BY USING DESCO CIRCUITRACERS. An overvoltage across a meter usually results in extensive damage which takes the meter out of service until repaired or replaced. The worst that can happen to your Circuitracer is a burned out lamp that can be replaced by the operator in less than a minute. Total cost, ten or fifteen cents for the lamp!

*T.M. Reg.

The **CIRCUITRACER** is the only electrical tester (other than expensive meters) that can test dead circuits, low voltage live circuits **AND** high voltage live circuits. It is made of the finest materials available and is designed for long life.

ORDER DESCO CIRCUITRACER MODEL CT2-2 FOR USE WITH THESE FITTINGS



WS-12
Socket to fit 12 ga. connector pin



WS-16
Socket to fit 16 ga. connector pin



WS-20
Socket to fit 20 ga. connector pin



WP-12
Pin to fit 12 ga. connector socket



WP-16
Pin to fit 16 ga. connector socket



WP-20
Pin to fit 20 ga. connector socket

DESCO TEST PROBE ADAPTERS

INSURE CONNECTOR RELIABILITY

Manual probing of harness connectors while circuit testing can damage connectors and impair reliability. Desco Test Probe Adapters were developed to provide a test fitting identical to the pins and sockets in the connectors being tested. They make the same electrical and mechanical contact as the mating connector, and insure against scratching, bending and warping.

The adapters are made in three sizes to fit connectors using #12, #16 and #20 wire gauges. The sockets are gold plated copper with a brass sheath which retains a beryllium copper spring. The pins are stainless steel to insure long life. All are made to rigid MIL-SPECS. The adapters will fit Desco Jumper Wires and the Desco Circuitracer® Tester interchangeably.

*
DESCO

Several aircraft and missile manufacturers specify Desco Test Probe Adapters for most manual test connections. (names on request)

DESCO MFG. CO.

EMICO**PRECISION-PLUS****PRECISION***the Recognized Leader . . .***PRICE LIST**

PRICES—Prices listed are net and include all hardware and individual boxing. Resistance approximate. If important request factory engineering confirmation.

DC AMMETERS

Range	Approximate Resist. Ohms	MODEL NF-2C		MODEL RF-2C		MODEL RF-2¼C		MODEL 13		
		Catalog Number	Dealers' Net Price	Catalog Number	Dealers' Net Price	Catalog Number	Dealers' Net Price	Approximate Resist. Ohms	Catalog Number	Dealers' Net Price
0-1	.15	2101	\$2.15	2201	\$2.25	2301	\$2.60			
0-3	.032	2101-A	2.15	2201-A	2.25	2301-A	2.60			
0-5	.016	2102	2.15	2202	2.25	2302	2.60			
0-10	.00115	2103	2.15	2203	2.25	2303	2.60	.0025	2403	\$2.60
0-15	.00115	2103-A	2.15	2203-A	2.25	2303-A	2.60	.0025	2403-A	2.60
0-20	.00115	2104	2.15	2204	2.25	2304	2.60			
0-25	.00115	2104-A	2.15	2204-A	2.25	2304-A	2.60			
0-30	.00115	2105	2.15	2205	2.25	2305	2.60	.0006	2405	2.60
0-60	.000116	2106-A	2.85	2206-A	2.95	2306-A	3.30			
1-0-1	.08	2109	2.15	2209	2.25	2309	2.60			
3-0-3	.00115	2110	2.15	2210	2.25	2310	2.60			
6-0-6	.00115	2111	2.15	2211	2.25	2311	2.60			
10-0-10	.00115	2112	2.15	2212	2.25	2312	2.60			
15-0-15	.00115	2113	2.15	2213	2.25	2313	2.60			
20-0-20	.00115	2114	2.15	2214	2.25	2314	2.60	.0006	2414	2.60
30-0-30	.00115	2115	2.15	2215	2.25	2315	2.60	.0006	2415	2.60
75-0-75	.000116	2116-A	3.25	2216-A	3.35	2316-A	3.75			

DC MILLIAMMETERS

0-1	850	2120	\$3.70	2220	\$3.80	2320	\$4.05	950	2420	\$4.05
0-3	425	2121	2.90	2221	3.00	2321	3.25			
0-5	925	2125	2.65	2225	2.75	2325	3.00	130	2425	3.00
0-5	1300									
0-10	300	2126	2.50	2226	2.60	2326	2.85	75	2426	2.85
0-10	350									
0-20	95	2127	2.15	2227	2.25	2327	2.60	23	2427	2.60
0-20	105									
0-25	65	2127-A	2.15	2227-A	2.25	2327-A	2.60			
0-30	37	2128	2.15	2228	2.25	2328	2.60	12	2428	2.60
0-30	45									
0-50	14.5	2129	2.15	2229	2.25	2329	2.60	5.5	2429	2.60
0-50	18.0									
0-100	7.0	2130	2.15	2230	2.25	2330	2.60	1.8	2430	2.60
0-100	8.3									
0-150	1.8	2130-A	2.15	2230-A	2.25	2330-A	2.60	1.0	2430-A	2.60
0-150	2.15									
0-200	1.5	2130-B	2.15	2230-B	2.25	2330-B	2.60	.5	2430-B	2.60
0-200	1.7									
0-300	.61	2131	2.15	2231	2.25	2331	2.60	.35	2431	2.60
0-300	.8									
0-500	.21	2132	2.15	2232	2.25	2332	2.60	.12	2432	2.60
0-500	.27									

DC VOLTMETERS (HIGH RESISTANCE)

(100 ohms/volt except 150 and 300 volt ranges are 200 ohms per volt)

0-10	1050	2140	\$3.00	2240	\$3.10	2340	\$3.40			
0-30	2800	2141	3.00	2241	3.10	2341	3.40			
0-50	4000	2142	3.25	2242	3.35	2342	3.75			
0-150	28000	2143	3.35	2243	3.45	2343	3.85			
0-300	55000	2144	3.45	2244	3.55	2344	4.00			
0-1	33	2134	\$2.15	2234	\$2.25	2334	\$2.60			
0-3	100	2135	2.15	2235	2.25	2335	2.60	150	2435	\$2.60
3-0-3	30	2136	2.15	2236	2.25	2336	2.60			
0-5	140	2136-A	2.15	2236-A	2.25	2336-A	2.60			
0-8	225	2136-B	2.15	2236-B	2.25	2336-B	2.60			
0-10	280	2137	2.15	2237	2.25	2337	2.60	500	2437	2.60
0-15	450	2137-A	2.15	2237-A	2.25	2337-A	2.60	750	2437-A	2.60
0-20	600	2137-B	2.15	2237-B	2.25	2337-B	2.60	1000	2437-B	2.60
0-30	1000	2137-C	2.15	2237-C	2.25	2337-C	2.60	1500	2437-C	2.60
0-50	1400	2138	2.15	2238	2.25	2338	2.60	2500	2438	2.60

AC AMMETERS

0-1	.365	6101	\$3.35	6201	\$3.45	6301	\$3.75			
0-3	.078	6102	3.35	6202	3.45	6302	3.75			
0-5	.023	6103	3.35	6203	3.45	6303	3.75	.023	6403	\$3.75
0-10	.013	6104	3.35	6204	3.45	6304	3.75			

AC MILLIAMMETERS

0-25	750	6125	\$3.35	6225	\$3.45	6325	\$3.75			
0-50	175	6126	3.35	6226	3.45	6326	3.75			
0-100	58	6127	3.35	6227	3.45	6327	3.75			
0-250	12	6128	3.35	6228	3.45	6328	3.75			
0-500	1.75	6129	3.35	6229	3.45	6329	3.75	1.15	6429	\$3.75

AC VOLTMETERS

0-5	50	6135	\$3.35	6235	\$3.45	6335	\$3.75			
0-10	175	6136	3.35	6236	3.45	6336	3.75			
0-15	300	6137	3.35	6237	3.45	6337	3.75	300	6437	\$3.75
0-25	920	6137-A	3.35	6237-A	3.45	6337-A	3.75			
0-50	1800	6138	3.35	6238	3.45	6338	3.75			
0-150	9530	6139	3.90	6239	4.00	6339	4.45	15000	6439	4.45
0-300	32000	6140	4.50	6240	4.55	6340	4.95	32000	6440	4.95

ELECTRO-MECHANICAL INSTRUMENT CO., INC.

FREED TRANSFORMER CO., INC.

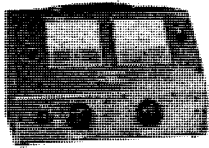

1620-A-B-C-E

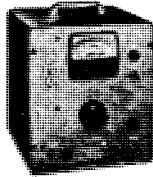

1020-C

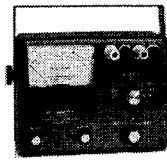

2030

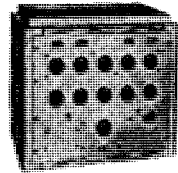

1110-C

MEGOHMMETERS

Freed manufactures a complete range of insulation resistance measuring equipment with fixed and variable d.c. test voltages from 5 to 2500 volts. Insulation and leakage measurements can

be made on transformers, motors, cables, electronic assemblies and components, dielectric materials, electrical appliances and tools, capacitors and resistors.

Type	Resistance Range	Test Voltage	Accuracy	Power Requirements	Size and Weight	Price
1620	0.1 to 4,000,000 megohms 1 to 2,000,000 megohms @ 500 volts	Variable 50 to 1000 volts d.c.	±5% at full scale	105-125 volts 50-60 cycles	15" x 9" x 7½" 24 lbs.	350.00
1620-A	0.01 to 4,000,000 megohms 0.1 to 200,000 megohms @ 50 volts 1 to 2,000,000 megohms @ 500 volts	Variable 5-100 volts d.c. 100-1000 volts d.c.	±5% at full scale	105-125 volts 50-60 cycles	15" x 9" x 7½" 24 lbs.	365.00
1620-B	1 to 2,000,000 megohms 10 to 2,000,000 megohms @ 2500 volts	Variable 250-2500 volts d.c.	±5% at full scale	105-125 volts 50-60 cycles	15" x 9" x 7½" 24 lbs.	395.00
1620-C	All features same as Type 1620 with additional circuitry for capacitor measurements	Variable 50 to 1000 volts d.c.	±5% at full scale	105-125 volts 50-60 cycles	15" x 9" x 7½" 24 lbs.	375.00
1620-D	0.01 to 40,000,000 megohms 0.1 to 2,000,000 megohms @ 50 volts 1 to 20,000,000 megohms @ 500 volts	Variable 5-100 volts d.c. 100-1000 volts d.c.	±5% at full scale except highest range ±10%	105-125 volts 50-60 cycles	15" x 9" x 7½" 25 lbs.	415.00
1020-C	0.1 to 2,000,000 megohms 0.1 to 200,000 megohms @ 50 or 100 volts d.c. 1 to 2,000,000 megohms @ 500 volts d.c.	Fixed 50, 100, 500 volts Regulated	±3% all ranges except highest range ±5%	105-125 volts 50-60 cycles	9½" x 10½" x 8" 18 lbs.	280.00
1020-D	0.1 to 2,000,000 megohms 0.1 to 200,000 megohms @ 100 or 200 volts d.c. 1 to 2,000,000 megohms @ 500 volts d.c.	Fixed 100, 200, 500 volts Regulated	±3% all ranges except highest range ±5%	105-125 volts 50-60 cycles	9½" x 10½" x 8" 18 lbs.	290.00
2030-A	10 to 2,000,000 megohms	Fixed 500 volts d.c.	±5% full scale	battery operated transistor supply	6" x 8" x 4" 8 lbs.	205.00
2030-B	1 to 20,000,000 megohms	Fixed 500 volts d.c.	±5% full scale	battery operated transistor supply	6" x 8" x 4" 8 lbs.	250.00
2030-C	0.1 to 2,000,000 megohms	Fixed 50 volts d.c.	±5% full scale	battery operated transistor supply	6" x 8" x 4" 8 lbs.	225.00
2030-D	1 to 2,000,000 megohms	Fixed 100 volts d.c.	±5% full scale	battery operated transistor supply	6" x 8" x 4" 8 lbs.	225.00
2030-E	1 to 2,000,000 megohms	Fixed 200 volts d.c.	±5% full scale	battery operated transistor supply	6" x 8" x 4" 8 lbs.	225.00

*Rack models available, 19" x 10½" x 9½". Weight 25 lbs.

Freed invites requests for quotations on special insulation testing instruments, either deviations of above listed standard units or new designs for system applications.

INCREMENTAL INDUCTANCE BRIDGES

Direct in-line readings of inductance and conductance of iron core component at audio frequencies with or without superimposed direct current. The bridge uses the Owens circuit with provisions for measuring the series or parallel inductance and conductance of the unknown inductor; five precision resistance

and capacitance decades are provided to indicate these values. "Q" or storage factor can be measured as the product of the inductive reactance and the conductance.

Type	Inductance Range	Conductance Range	Frequency Range	D.C. Current	Accuracy	Dimensions and Weight	Price
1110-C	1111.1 h to 1 mh 5 decades 1.1 h to 1 μh 2 decades	0.015 μmho—100 mho "Q" = 600 max @ 100 cycles	20 cycles to 10KC	up to 2 amperes	±0.5% to 5 KC ±2% to 10 KC	21¾" x 17½" x 15¼" 50 lbs.	525.00
1115	111.1 h to 100 μh 5 decades 0.11 h to 0.1 μh 2 decades	0.15 μmho—1000 mho "Q" = 600 max @ 100 cycles	20 cycles to 10 KC	up to 15 amperes	±1% to 5 KC ±3% to 10 KC	21¾" x 28" x 15¼" 80 lbs.	825.00
1185	111.1 h to 100 μh 5 decades 0.11 h to 0.1 μh 2 decades	0.15 μmho—1000 mho "Q" = 600 max @ 100 cycles	20 cycles to 10 KC	up to 30 amperes	±1% to 5 KC ±3% to 10 KC	21¾" x 33¼" x 15¼" 100 lbs.	1250.00

UNIVERSAL BRIDGE

The Freed Type 1150-A Universal Bridge offers the laboratory a combination of eight bridges in one instrument. This bridge will measure the reactive and resistive component of impedances, capacitance, resistance and phase angle.

In the Hay and/or Owen bridge configuration the incremental permeability of an inductance can be measured.

Type	Inductance Range	Capacitance Range	Resistance Range	"D" Hay Bridge	Price
1150-A	5 μh 1110 h	5 pf-10 mf	0.05 Ω-1 MΩ	0.001-10 Q = 0.1-1000	825.00
	"Q" Maxwell 0.01-50	"Q" Series Owen 0.01-600 @ 100 cycles	"Q" Parallel Owen 80 @ 100 cycles	"Q" Parallel Resistor-Capacitor Bridge 0.01-11.1	
Accuracy Inductance ±0.5% up to 1 KC. ±2% to 10 KC. Capacitance ±1% @ 1 KC. "D", "Q" ±5% @ 1 KC. Resistance (ac.) ±1% @ 1 KC.				Dimensions and Weight 21¾" x 24½" x 17" 65 lbs.	

Prices quoted are subject to change without notice

FREED TRANSFORMER COMPANY, INC.



PANEL METERS

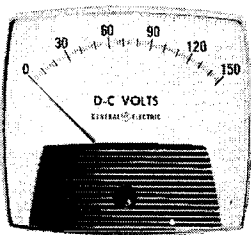

BIG LOOK

Handsome, easy-to-read meters in two styles for all panel and control applications. All DC meters have self-shielded movement with pivot and jewel or taut-band suspension. Taut-band designs give great resistance to shock and increased sensitivity. Zener-diode, expanded-scale voltmeters available for improved narrow-range accuracy on 3 1/2" and 4 1/2" sizes. Snap-on, snap-off covers on meters. All types meet ASA Specification C-39.1.

Accuracy: ±2% FS, all DC and AC iron vane; ±3% FS, AC rectifier type (with 60-cycle sine wave at 25° C); ±0.5% of midspan, expanded-scale types. **Overload:** 20% momentary and sustained, voltmeters; 10 times rated current for 10 consecutive intervals of 1/2-sec. with 1-min. interval between successive applications, momentary; 20% for 8 hours, sustained, ammeters. **Scale:** Pivot and jewel, 90° rotation; taut-band, 100°.

Insulation: 2600 V rms hi-pot for all but 1 1/2" models (1600 V rms). **Response Time:** Meet or exceed ASA requirements: 3 sec. max. for microammeters; 2 sec. max. all other DC ratings; 2.5 sec. max. AC ratings. **Damping:** 40% max. overshoot; 2.5 min. damping factor. **Burden:** 5 amps, 0.5 VA, 0.5 power factor for AC ammeter; unity power factor, AC voltmeter.

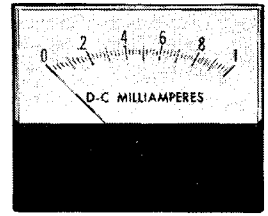

HORIZON LINE

BIG LOOK PANEL METERS

Accurate, quick reading with wide, border-to-border scales; free from shadows. Most popular meter design with low-profile, easy-to-read sense. Aluminum frame holds reflections to a minimum. Big, bold numerals over cleanly marked divisions for fast reading. Tapered pointers assure high accuracy. Taut-band suspension provided on all models except 1 1/2" size. Standard 2 1/2" and 3 1/2" models come with sealed cases to protect against hair, dust, chemicals or other foreign particles. Shelf-shielded DC mechanisms; snap-on, snap-off covers.

Meter Size and Type	Scale Length		Max. Meter Dimensions, Inches			
	Pivot Jewel	Taut-band	Face Size H. x W.	Cutout O.D.	Back* Depth	Front* Depth
1 1/2" DW-90	1.400"	1.750 x 1.750	1.530	1.230	0.375
2 1/2" DW-91§	2.100"	2.300"	2.702 x 2.702	2.195	2.002	0.478
3 1/2" DO-91†	2.900"	3.200"	3.512 x 3.512	2.786	2.002	0.478
4 1/2" DO-92‡	3.930"	4.360"	4.408 x 4.846	2.786	1.965	0.573

§Or AW-91. †Or AO-91. ‡Or AO-92. *Back-of-panel and front-of-panel, respectively.

HORIZON LINE PANEL METERS

Distinctive, low profile design for sophisticated styling. Best readability with swept-back windows to deflect light from line of sight. Both 3 1/2" and 4 1/2" meters may be mounted semi-flush or back-of-panel, recessed with face silhouetted by half-bezel frame to conserve space and improve readability. DC types have core-magnet d'Arsonval movement with pivot and jewel, or taut-band suspensions; self-shielded for use on any panel. Zener-diode, expanded-scale voltmeters available. Snap-on, snap-off covers supplied on 4 1/2" size.

G.E. No. 1012K11702 Bezel — For flush mtg. 2 1/2" size. List.....\$1.25
 G.E. No. 1012K11700 Bezel — For flush mtg. 3 1/2" size. List..... 1.50
 G.E. No. 1012K11701 Bezel — For flush mtg. 4 1/2" size. List..... 1.50

Meter Size and Type	Scale Length		Max. Meter Dimensions, Inches			
	Pivot Jewel	Taut-band	Face Size H. x W.	Cutout O.D.	Back* Depth	Front* Depth
2 1/2" NO. 157	2.013"	2.284"	2.256 x 2.892	2.031	2.048	0.545
3 1/2" NO. 167	2.725"	2.725"	3.060 x 3.756	2.781	1.963	0.740
4 1/2" NO. 178	3.502"	3.800"	3.756 x 4.632	2.781	1.963	0.831

*Back-of-panel and front-of-panel, respectively.

DC VOLTMETERS ZERO-LEFT, SELF CONTAINED

Scale Volts	Scale Div.	Term. Resis., Ohms	§ Add Suffix	BIG LOOK List Price				HORIZON LINE List Price		
				1 1/2" DW-90 Prefix: 50-188 011§	2 1/2" DW-91 Prefix: 50-152 011§	3 1/2" DO-91 Prefix: 50-162 011§	4 1/2" DO-92 Prefix: 50-171 011§	2 1/2" No. 157 Prefix: 50-157 011§	3 1/2" No. 167 Prefix: 50-167 011§	4 1/2" No. 178 Prefix: 50-178 011§
0-1	50		LALA	\$18.00	\$18.00	\$19.00	\$21.00	\$18.00	\$19.00	\$21.00
0-1.5	75†		LCLC	18.00	18.00	19.00	21.00	18.00	19.00	21.00
0-3	60		LJLJ	18.00	18.00	19.00	21.00	18.00	19.00	21.00
0-5	50		LSLS	18.00	18.00	19.00	21.00	18.00	19.00	21.00
0-8	40		MJMJ	18.00	18.00	19.00	21.00	18.00	19.00	21.00
0-10	50		MTMT	18.00	18.00	19.00	21.00	18.00	19.00	21.00
0-15	75†		NDND	18.00	18.00	19.00	21.00	18.00	19.00	21.00
0-30	60	1000 ohms	NLNL	18.00	18.00	19.00	21.00	18.00	19.00	21.00
0-50	50	per volt	NTNT	18.00	18.00	19.00	21.00	18.00	19.00	21.00
0-80	40		PDPD	18.00	18.00	19.00	21.00	18.00	19.00	21.00
0-100	50		PKPK	18.00	18.00	19.00	22.00	18.00	19.00	22.00
0-150	75†		PZPZ	18.00	18.00	19.00	22.00	18.00	19.00	22.00
0-200	40		RLRL	18.00	18.00	19.00	22.00	18.00	19.00	22.00
0-250	50		RSRs	18.00	18.00	19.00	22.00	18.00	19.00	22.00
0-300	60		RXRr	19.00	19.00	20.00	23.00	19.00	20.00	23.00
0-500	50		SFSF	21.00	24.00	21.00	24.00
0-600	60		SJSJ	21.00	24.00	21.00	24.00
0-500*	50	125	FASF	17.00	17.00	17.00
0-600*	60	125	FASJ	17.00	17.00	17.00
0-750*	75†	125	FASM	17.00	17.00	18.00	20.00	17.00	18.00	20.00

ZERO-CENTER, SELF CONTAINED

Scale Volts	Scale Div.	Term. Resis., Ohms	§ Add Suffix	BIG LOOK List Price				HORIZON LINE List Price		
				1 1/2" DW-90 Prefix: 50-188 012§	2 1/2" DW-91 Prefix: 50-152 012§	3 1/2" DO-91 Prefix: 50-162 012§	4 1/2" DO-92 Prefix: 50-171 012§	2 1/2" No. 157 Prefix: 50-157 012§	3 1/2" No. 167 Prefix: 50-167 012§	4 1/2" No. 178 Prefix: 50-178 012§
5-0-5	50		LSLS	\$18.00	\$18.00	\$19.00	\$21.00	\$18.00	\$19.00	\$21.00
10-0-10	40		MTMT	18.00	18.00	19.00	21.00	18.00	19.00	21.00
30-0-30	60	1000 ohms	NLNL	18.00	18.00	19.00	21.00	18.00	19.00	21.00
50-0-50	50	ohms	NTNT	18.00	18.00	19.00	21.00	18.00	19.00	21.00
80-0-80	40	per volt	PDPD	18.00	18.00	19.00	21.00	18.00	19.00	21.00
150-0-150	60		PZPZ	18.00	18.00	19.00	22.00	18.00	19.00	22.00
300-0-300	60		RXRr	19.00	19.00	20.00	23.00	19.00	20.00	23.00
500-0-500	50		SFSF	21.00	24.00	21.00	24.00
600-0-600	60		SJSJ	21.00	24.00	21.00	24.00
500-0-500*	50	64	FASF	17.00	17.00	17.00
600-0-600*	60	64	FASJ	17.00	17.00	17.00
750-0-750*	60	64	FASM	17.00	17.00	18.00	20.00	17.00	18.00	20.00

EXPANDED-SCALE, SELF CONTAINED

Scale Volts	Scale Div.	Term. Resis., Ohms	§ Add Suffix	BIG LOOK List Price				HORIZON LINE List Price		
				1 1/2" DW-90 Not Available	2 1/2" DW-91 Not Available	3 1/2" DO-91 Prefix: 50-162 091§	4 1/2" DO-92 Prefix: 50-171 091§	2 1/2" No. 157 Not Available	3 1/2" No. 167 Prefix: 50-167 091§	4 1/2" No. 178 Prefix: 50-178 091§
24-30	60	100	NNNN	\$52.00	\$55.00	\$52.00	\$55.00
110-130	40	ohms/volt	PNNP	52.00	55.00	52.00	55.00
220-260	40		RTRT	52.00	55.00	52.00	55.00

*Not self contained, for use with external resistor, not supplied; rated 0-1 mADC (or 1-0-1 mADC, center scale types); when ordering, change last prefix indicator to 111 or 112 (i.e., 50-152 111 FASF; 50-162 112 FASM; etc.).

†75 divisions on all 3 1/2" and 4 1/2" meters; 30 divisions on 2 1/2" and 1 1/2".

§When ordering show complete number, prefix plus suffix; example: 50-157 012 LSLS for 5-0-5 self contained 2 1/2" HORIZON LINE DC voltmeter.

†Trade-mark of General Electric Co.



PANEL METERS



DC AMMETERS (CONT'D) ZERO-LEFT, SHUNT-RATED

For use with 2-way shunt-lead resistance .065 ohm. Does not include shunt or shunt leads.

Scale Amps	Scale Div.	Term. Resis., Ohms	§ Add Suffix	BIG LOOK List Price				HORIZON LINE List Price		
				1½" DW-90 Prefix: 50-188 121§	2½" DW-91 Prefix: 50-152 121§	3½" D0-91 Prefix: 50-162 121§	4½" D0-92 Prefix: 50-171 121§	2½" No. 157 Prefix: 50-157 121§	3½" No. 167 Prefix: 50-167 121§	4½" No. 178 Prefix: 50-178 121§
0-20	40		ECNG	\$17.00	\$17.00	\$18.00	\$17.00	\$18.00	\$20.00
0-30	60		ECNL	17.00	17.00	18.00	17.00	18.00	20.00
0-50	50		ECNT	17.00	17.00	18.00	\$20.00	17.00	18.00	20.00
0-75	75†		ECPB	17.00	17.00	18.00	20.00	17.00	18.00	20.00
0-100	50		ECPK	17.00	17.00	18.00	20.00	17.00	18.00	20.00
0-150	75†	50 mV	ECPZ	17.00	17.00	18.00	20.00	17.00	18.00	20.00
0-200	40	shunt-	ECRL	17.00	17.00	18.00	20.00	17.00	18.00	20.00
0-250	50	rated	ECRS	17.00	17.00	18.00	20.00	17.00	18.00	20.00
0-300	60	12.5	ECRX	17.00	17.00	18.00	20.00	17.00	18.00	20.00
0-400	40	ohms	ECSC	17.00	17.00	18.00	20.00	17.00	18.00	20.00
0-500	50		ECSF	17.00	17.00	18.00	20.00	17.00	18.00	20.00
0-600	60		ECSJ	17.00	17.00	18.00	20.00	17.00	18.00	20.00
0-800	40		ECSN	17.00	17.00	18.00	20.00	17.00	18.00	20.00
0-1000	50		ECVA	17.00	17.00	18.00	20.00	17.00	18.00	20.00
0-1500	75†		ECVC	17.00	17.00	18.00	20.00	17.00	18.00	20.00
0-2000	40		ECVE	17.00	17.00	18.00	20.00	17.00	18.00	20.00
0-20	40		GBNG	17.00	17.00	18.00	17.00	18.00	20.00
0-40	40		GBNP	17.00	17.00	18.00	17.00	18.00	20.00
0-50	50		GBNT	17.00	17.00	18.00	20.00	17.00	18.00	20.00
0-75	75†		GBPB	17.00	17.00	18.00	20.00	17.00	18.00	20.00
0-100	50		GBPK	17.00	17.00	18.00	20.00	17.00	18.00	20.00
0-150	75†	100 mV	GBPZ	17.00	17.00	18.00	20.00	17.00	18.00	20.00
0-200	40	shunt-	GBRL	17.00	17.00	18.00	20.00	17.00	18.00	20.00
0-250	50	rated	GBRS	17.00	17.00	18.00	20.00	17.00	18.00	20.00
0-300	60	25	GBRX	17.00	17.00	18.00	20.00	17.00	18.00	20.00
0-400	40	ohms	GBSC	17.00	17.00	18.00	20.00	17.00	18.00	20.00
0-500	50		GBSF	17.00	17.00	18.00	20.00	17.00	18.00	20.00
0-600	60		GBSJ	17.00	17.00	18.00	20.00	17.00	18.00	20.00
0-800	40		GBSN	17.00	17.00	18.00	20.00	17.00	18.00	20.00
0-1000	50		GBVA	17.00	17.00	18.00	20.00	17.00	18.00	20.00
0-2000	40		GBVE	17.00	17.00	18.00	20.00	17.00	18.00	20.00

ZERO-CENTER, SELF CONTAINED

Scale Amps	Scale Div.	Term. Resis., Ohms	§ Add Suffix	BIG LOOK List Price				HORIZON LINE List Price		
				1½" DW-90 Prefix: 50-188 112§	2½" DW-91 Prefix: 50-152 112§	3½" D0-91 Prefix: 50-162 112§	4½" D0-92 Prefix: 50-171 112§	2½" No. 157 Prefix: 50-157 112§	3½" No. 167 Prefix: 50-167 112§	4½" No. 178 Prefix: 50-178 112§
1-0-1	40	.0500	LALA	\$17.00	\$17.00	\$18.00	\$20.00	\$17.00	\$18.00	\$20.00
2-0-2	40	.0250	LELE	17.00	17.00	18.00	20.00	17.00	18.00	20.00
5-0-5	50	.010	LSLI	17.00	17.00	18.00	20.00	17.00	18.00	20.00
10-0-10	40	.0050	MTMT	17.00	17.00	18.00	20.00	17.00	18.00	20.00
15-0-15	60	.0033	NDND	17.00	18.00	20.00	17.00	18.00	20.00
20-0-20	40	.0025	NGNG	17.00	18.00	20.00	17.00	18.00	20.00
30-0-30	60	.00167	NLNL	17.00	18.00	20.00	17.00	18.00	20.00
50-0-50	50	.00100	NTNT	18.00	17.00	18.00	20.00

ZERO-CENTER, 50 mV SHUNT-RATED

For use with 2-way shunt-lead resistance of .065 ohm. Does not include shunt or shunt leads.

Scale Amps	Scale Div.	Term. Resis., Ohms	§ Add Suffix	BIG LOOK List Price				HORIZON LINE List Price		
				1½" DW-90 Prefix: 50-188 122§	2½" DW-91 Prefix: 50-152 122§	3½" D0-91 Prefix: 50-162 122§	4½" D0-92 Prefix: 50-171 122§	2½" No. 157 Prefix: 50-157 122§	3½" No. 167 Prefix: 50-167 122§	4½" No. 178 Prefix: 50-178 122§
20-0-20	40		ECNG	\$17.00
50-0-50	50	25	ECNT	17.00	\$17.00	\$18.00	\$20.00	\$17.00	\$18.00	\$20.00
75-0-75	60	ohms	ECPB	17.00	17.00	18.00	20.00	17.00	18.00	20.00
100-0-100	40		ECPK	17.00	17.00	18.00	20.00	17.00	18.00	20.00
150-0-150	60		ECPZ	17.00	17.00	18.00	20.00	17.00	18.00	20.00

AC VOLTMETERS SELF CONTAINED, IRON VANE

Scale Volts	Scale Div.	Term. Resis., Ohms	§ Add Suffix	BIG LOOK List Price				HORIZON LINE List Price		
				1½" DW-90 Not Available	2½" AW-91 Prefix: 50-152 031§	3½" A0-91 Prefix: 50-162 031§	4½" A0-92 Prefix: 50-171 031§	2½" No. 157 Prefix: 50-157 031§	3½" No. 167 Prefix: 50-167 031§	4½" No. 178 Prefix: 50-178 031§
0-3	60	11.1	LJLJ	\$16.00	\$17.00	\$20.00	\$16.00	\$17.00	\$20.00
0-5	50‡	29	LSLI	16.00	17.00	20.00	16.00	17.00	20.00
0-10	50	110	MTMT	16.00	17.00	20.00	16.00	17.00	20.00
0-15	75†	251	NDND	16.00	17.00	20.00	16.00	17.00	20.00
0-30	60	779	NLNL	16.00	17.00	20.00	16.00	17.00	20.00
0-50	50	2,500	NTNT	17.00	18.00	21.00	17.00	18.00	21.00
0-150	75†	15,000	PZPZ	18.00	19.00	22.00	18.00	19.00	22.00
0-300	60	70,260	RXRK	20.00	21.00	24.00	20.00	21.00	24.00
0-500	50	117,260	SFSF	26.00	29.00	26.00	29.00
0-600	60	140,000	SJSJ	26.00	29.00	26.00	29.00

SELF CONTAINED, 400 CYCLES

Scale Volts	Scale Div.	Term. Resis., Ohms	§ Add Suffix	BIG LOOK List Price				HORIZON LINE List Price		
				1½" DW-90 Not Available	2½" AW-91 Prefix: 50-152 061§	3½" A0-91 Prefix: 50-162 061§	4½" A0-92 Prefix: 50-171 061§	2½" No. 157 Prefix: 50-157 061§	3½" No. 167 Prefix: 50-167 061§	4½" No. 178 Prefix: 50-178 061§
0-150	75†	15,000	PZPZ	\$18.00	\$19.00	\$22.00	\$18.00	\$19.00	\$22.00
0-300	60	70,260	RXRK	20.00	21.00	24.00	20.00	21.00	24.00

†75 divisions, 3½" and 4½" sizes; 30 divisions, 1½" and 2½" sizes.

‡50 divisions, 3½" and 4½" sizes; 25 divisions, 2½" size.

§When ordering show complete number, prefix plus suffix; example: 50-171 031 LJLJ for 4½" BIG LOOK 0-3 voltmeter.

¶Trade-mark of General Electric Co.



PANEL METERS

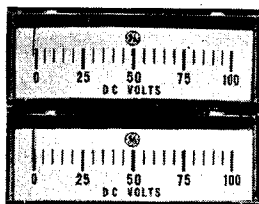

NEW 185 SERIES EDGEWISE METERS

Slim, miniature design can be mounted individually or in space-saving clusters. Choice of horizontal or vertical placement. Flush sides assure tight, case-to-case stacking without mechanism bulge. Magnetically shielded to prevent interaction between meters; no need for special calibration. Optional bezel and mounting brackets available for one, two or three-unit stacking. Meet applicable portions of ASA C-39.1. Accuracy: $\pm 2\%$ of full scale, DC meters; $\pm 3\%$ with 60-cycle sine wave at 25°C, AC rectifier-type meters. **Overload:** 20% momentary and sustained, voltmeter; 1000% momentary and 20% sustained, ammeter. **Insulation:** 1800 V rms hi-pot. **Scale:** 1.785" long, 53° rotation. **Response Time and Damping:** Meet or exceed ASA requirements. Response time 3 sec. max., μ A meters; 2 sec. max., all other DC ratings; 2.5 sec. max., AC ratings. Damping 40% max. overshoot; damping factor, 2.5 minimum. **Size:** 0.92" w. x 2.258" lg. x 3.44" D., overall. Bezel 1.255" w. x 3.005" lg., single; 2.155" w., double; 3.055" w., triple-unit mounting.

DC VOLTMETERS (SELF CONTAINED)

Scale Range	Term. Resis., Ohms	Horizontal Zero-Left* Number	Vertical Zero-Bottom* Number	List Price
0-10	1000 ohms/volt	50-185 011 MTMT	50-185 013 MTMT	\$19.00
0-15		50-185 011 NDND	50-185 013 NDND	19.00
0-30		50-185 011 NLNL	50-185 013 NLNL	19.00
0-50		50-185 011 NNTN	50-185 013 NNTN	19.00
0-100		50-185 011 PKPK	50-185 013 PKPK	19.00
0-150		50-185 011 PZPZ	50-185 013 PZPZ	19.00
0-300		50-185 011 RRRR	50-185 013 RRRR	20.00
15-0-15	2000 ohms/volt	50-185 012 NDND	50-185 014 NDND	19.00
50-0-50		50-185 012 NNTN	50-185 014 NNTN	19.00
150-0-150		50-185 012 PZPZ	50-185 014 PZPZ	20.00

DC VOLTMETERS (FOR EXTERNAL RESISTORS)

Rated 0-1 mA for use with external resistor, not supplied.

0-500	40	50-185 111 FASF	50-185 113 FASF	\$18.00
0-600	40	50-185 111 FASJ	50-185 113 FASJ	18.00
0-750	40	50-185 111 FASM	50-185 113 FASM	18.00

DC MICROAMMETERS (SELF CONTAINED)

0-20	2030	50-185 111 CFCF	50-185 113 CFCF	\$31.00
0-50	1625	50-185 111 CYCY	50-185 113 CYCY	25.00
0-100	1350	50-185 111 DRDR	50-185 113 DRDR	21.00
0-500	200	50-185 111 EMEM	50-185 113 EMEM	18.00
50-0-500	1350	50-185 112 CYCY	50-185 114 CYCY	21.00
	40	50-185 112 EMEM	50-185 114 EMEM	18.00

DC MILLIAMMETERS (SELF CONTAINED)

0-1	40	50-185 111 FAFA	50-185 113 FAFA	\$18.00
0-5	2.0	50-185 111 FXFX	50-185 113 FXFX	18.00
0-10	1.0	50-185 111 GZGZ	50-185 113 GZGZ	18.00
0-20	0.5	50-185 111 HFHF	50-185 113 HFHF	18.00
0-50	1.0	50-185 111 HYHY	50-185 113 HYHY	18.00
0-100	0.5	50-185 111 JRJR	50-185 113 JRJR	18.00
0-300	0.167	50-185 111 KGKG	50-185 113 KGKG	18.00
0-500	0.099	50-185 111 KMKM	50-185 113 KMKM	18.00
5-0-5	1.0	50-185 112 FXFX	50-185 114 FXFX	18.00
10-0-10	0.5	50-185 112 GZGZ	50-185 114 GZGZ	18.00
50-0-50	0.5	50-185 112 HYHY	50-185 114 HYHY	18.00
500-0-500	0.049	50-185 112 KMKM	50-185 114 KMKM	18.00

DC AMMETERS (SELF CONTAINED)

0-1	0.049	50-185 111 LALA	50-185 113 LALA	\$18.00
0-5	0.0099	50-185 111 LSLS	50-185 113 LSLS	18.00
0-10	0.0049	50-185 111 MTMT	50-185 113 MTMT	18.00
5-0-5	0.0049	50-185 112 LSLS	50-185 114 LSLS	18.00

DC AMMETERS (50 mV SHUNT-RATED)

Shunt not supplied. Calibrated for use with 2-way shunt-lead resistance of 0.065 ohm.

0-20	12.5	50-185 121 ECNG	50-185 123 ECNG	\$18.00
0-50	12.5	50-185 121 ECNT	50-185 123 ECNT	18.00
0-300	12.5	50-185 121 ECRX	50-185 123 ECRX	18.00
0-500	12.5	50-185 121 ECFS	50-185 123 ECFS	18.00

AC RECTIFIER TYPE INSTRUMENTS

Self-contained with linear scale. Accuracy, $\pm 3\%$.

0-10 V		50-185 051 MTMT	50-185 053 MTMT	\$24.00
0-15 V		50-185 051 NDND	50-185 053 NDND	24.00
0-30 V		50-185 051 NLNL	50-185 053 NLNL	24.00
0-50 V	1000 ohms/volt	50-185 051 NNTN	50-185 053 NNTN	24.00
0-100 V		50-185 051 PKPK	50-185 053 PKPK	25.00
0-150 V		50-185 051 PZPZ	50-185 053 PZPZ	25.00
0-50 μ A	985	50-185 151 EMEM	50-185 153 EMEM	23.00
0-1 mA	570	50-185 151 FAFA	50-185 153 FAFA	23.00
0.5 mA	139	50-185 151 FXFX	50-185 153 FXFX	23.00
0-10 mA	90	50-185 151 GZGZ	50-185 153 GZGZ	23.00
0-20 mA	62	50-185 151 HFHF	50-185 153 HFHF	23.00

*Zero-center as listed.

† Trade-mark of General Electric Co.

TYPE 236

BIG LOOK ELAPSED TIME METERS

Offers distinctive appearance and excellent readability; designed to match ammeters and voltmeters with "Big Look" styling. Models are available for every time-measuring application. Both 2 1/2" and 3 1/2" sizes for panel mounting, plus 2 1/2" size for use with conduit type case or portable stand. All panel mounted timers meet requirements of ASA specification C39.1 for four-stud mounting. Available in reset and non-reset types, measuring either minutes or hours. Types listed are 60 cps operation, for 50 cps, add \$1.00 to list price. For 208-volt type specify model desired and add \$1.50 to list price of 240-volt model.

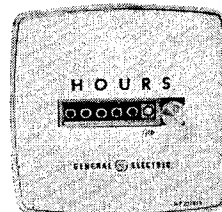

NONRESET TYPE — COMMERCIAL CASE

G.E. Model Number		Size	Voltage	List Price
Minutes	Hours	In.	VAC	
50-236401AAAA1	50-236402AAAA1	2 1/2	120	\$23.00
50-236401ABAA1	50-236402ABAA1	2 1/2	240	24.00
50-236401ACAA1	50-236402ACAA1	2 1/2	480	25.00
50-236301AAAA1	50-236302AAAA1	3 1/2	120	23.00
50-236301ABAA1	50-236302ABAA1	3 1/2	240	24.00
50-236301ACAA1	50-236302ACAA1	3 1/2	480	25.00

SEALED CASE

50-236421AAAA1	50-236422AAAA1	2 1/2	120	\$26.00
50-236421ABAA1	50-236422ABAA1	2 1/2	240	27.00
50-236421ACAA1	50-236422ACAA1	2 1/2	480	28.00
50-236321AAAA1	50-236322AAAA1	3 1/2	120	26.00
50-236321ABAA1	50-236322ABAA1	3 1/2	240	27.00
50-236321ACAA1	50-236322ACAA1	3 1/2	480	28.00

RESET KNOB TYPE — COMMERCIAL CASE

50-236411AAAA1	50-236412AAAA1	2 1/2	120	\$31.00
50-236411ABAA1	50-236412ABAA1	2 1/2	240	32.00
50-236411ACAA1	50-236412ACAA1	2 1/2	480	33.00
50-236311AAAA1	50-236312AAAA1	3 1/2	120	31.00
50-236311ABAA1	50-236312ABAA1	3 1/2	240	32.00
50-236311ACAA1	50-236312ACAA1	3 1/2	480	33.00

TYPE KT-11 TIME METERS

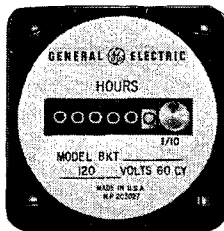

Ideal indicator for proper servicing and preventive maintenance in industry or for indicating component life. Available in 2 1/2" and 3 1/2" sizes, round or square cases, for flush mounting on panel board or in equipment case. Diecast zinc bezel with aluminized dial face. Wide temperature operating range with 6-digit register. Extra large counter numbers, white on black background for excellent readability. Last digit in contrasting color to indicate tenths. Bezel and plastic case provide dust-resistant enclosure for mechanism. Available with or without reset knob. Meet ASA panel mounting specifications. For 60 cps operation. For 50 cps operation, add \$1.00 to list price. For 208-volt type specify

model desired and add \$1.50 to list price of 240-volt model.

NON-RESET TYPE — ROUND CASE

G.E. Model Number		Size	Voltage	List Price
Minutes	Hours	In.	VAC	
50-235011AAAA1	50-235012AAAA1	2 1/2	120	\$26.00
50-235011ABAA1	50-235012ABAA1	2 1/2	240	27.00
50-235011ACAA1	50-235012ACAA1	2 1/2	480	28.00
50-235091AAAA1	50-235092AAAA1	3 1/2	120	26.00
50-235091ABAA1	50-235092ABAA1	3 1/2	240	27.00
50-235091ACAA1	50-235092ACAA1	3 1/2	480	28.00

SQUARE CASE

50-235051AAAA1	50-235052AAAA1	2 1/2	120	\$26.00
50-235051ABAA1	50-235052ABAA1	2 1/2	240	27.00
50-235051ACAA1	50-235052ACAA1	2 1/2	480	28.00
50-235131AAAA1	50-235132AAAA1	3 1/2	120	26.00
50-235131ABAA1	50-235132ABAA1	3 1/2	240	27.00
50-235131ACAA1	50-235132ACAA1	3 1/2	480	28.00

RESET KNOB TYPE — ROUND CASE

50-235021AAAA1	50-235022AAAA1	2 1/2	120	\$34.00
50-235021ABAA1	50-125012ABAA1	2 1/2	240	35.00
50-235021ACAA1	50-235012ACAA1	2 1/2	480	36.00
50-235101AAAA1	50-235102AAAA1	3 1/2	120	34.00
50-235101ABAA1	50-235102ABAA1	3 1/2	240	35.00
50-235101ACAA1	50-235102ACAA1	3 1/2	480	36.00

SQUARE CASE

50-235061AAAA1	50-235062AAAA1	2 1/2	120	\$34.00
50-235061ABAA1	50-235062ABAA1	2 1/2	240	35.00
50-235061ACAA1	50-235062ACAA1	2 1/2	480	36.00
50-235141AAAA1	50-235142AAAA1	3 1/2	120	34.00
50-235141ABAA1	50-235142ABAA1	3 1/2	240	35.00
50-235141ACAA1	50-235142ACAA1	3 1/2	480	36.00

HICKOK

TEST EQUIPMENT

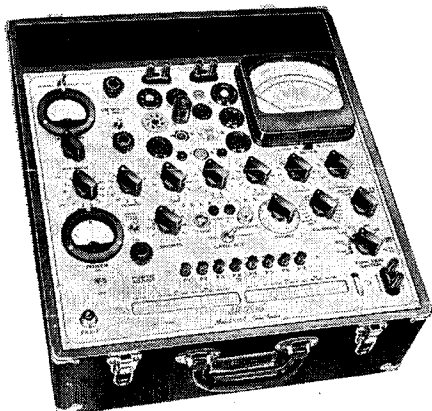

MODEL 539C

New Industrial and Laboratory Portable Tube Tester

Tests VR tubes, low power thyratrons, "4 digit" types. VR test evaluates voltage regulator tubes under actual operating conditions. Tests Nuvisitors, Novars, Compactrons, 10-pin types. Provision for separate monitoring of plate current. Panel terminals provide access to grid, plate, cathode and heater circuits, permitting direct measurement of voltages and current for "non-standard" or "tailored" tests. Covers 600 to 60,000 umhos in six ranges. Dual leakage readings: directly on meter or by neon short indicators (Sensitivity to 50 megohms). Complete with socket savers. In black leatherette portable case. 16 $\frac{3}{4}$ " x 18 $\frac{3}{8}$ " x 7 $\frac{1}{2}$ ". 105-125v, 50-400 cycles, .40 watts. Shipping weight, 35 lbs.

Model 539C Industrial and Laboratory Tube Tester—
Net Each\$595.00

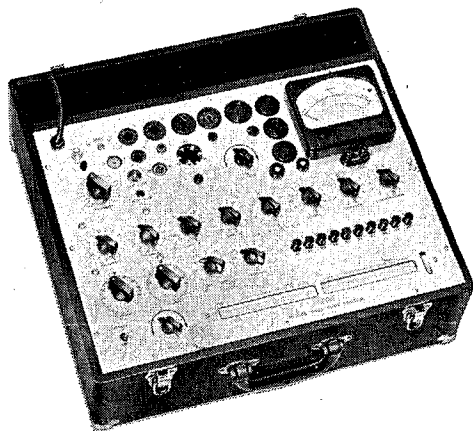

NEW MODEL 752A

New Industrial Communications Portable Tube Tester

Designed for use in maintaining communications equipment and industrial electronic apparatus. New voltage regulator test circuit tests VR tubes to handbook specifications, including firing point, regulating voltage and current range. Tests Nuvisitors, Compactrons, Novars, 10-pin types. Push button test for dual-section tubes speeds selection of tubes for balanced or matched characteristics. Covers 1500 to 30,000 umhos in five ranges. Interelement leakage read directly on the meter (Sensitivity to 10 megohms). Illuminated meter and roll chart. Complete with socket savers and pin-straighteners. In black leatherette portable case, 18 $\frac{3}{8}$ " x 16 $\frac{1}{4}$ " x 7 $\frac{1}{2}$ ". 105-125v, 50-60 cycles, 40-70 watts. Shipping weight, 27 lbs.

Model 752A Industrial and Communication Portable
Tube Tester—Net Each\$415.00

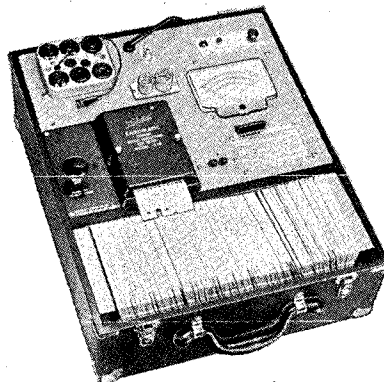

MODEL 123R

Cardmatic® Automatic Tube Tester

Ideal for Industrial and laboratory application. A genuinely complete tube tester, card-programs complete "fringe" tests, saturation and cut-off tests, in addition to basic Gm measurement. Gm ranges: 500-26,000 umhos; Current ranges: 100 ua to 510MA. Complete with pin straighteners, socket savers and 500 selected cards. In black leatherette portable case, 19 $\frac{1}{2}$ " x 16 $\frac{1}{2}$ " x 9 $\frac{1}{4}$ ". 105-125v, 50-60 cycles, 55 watts. Shipping weight, 57 lbs.

Model 123R—Cardmatic® Automatic Tube Tester—
Net Each\$725.00

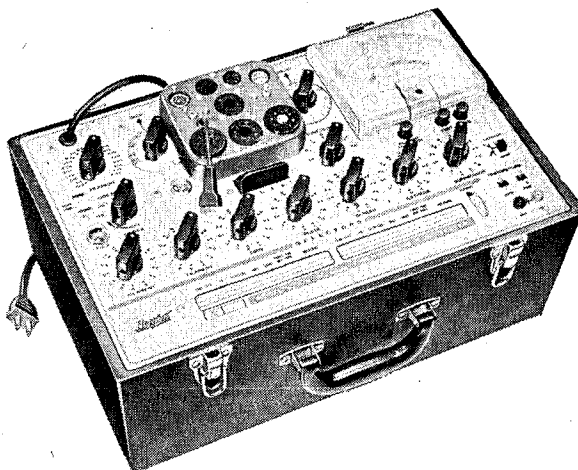

MODEL 6000A

Service Technician's Deluxe Portable Tube and Transistor Tester

Has replaceable socket plate for obsolescence protection. Sensitive, instantaneous inter-element leakage and shorts test (Sensitivity — in excess of 3 megohms) filament continuity test. Covers 3,000 to 15,000 umhos in 3 ranges. Tests Compactrons, Nuvisitors, Novars and 10-pin types. 14-position selector switches, no paralleled elements. Also tests transistors and diodes. In red leatherette portable case, 16 $\frac{3}{4}$ " x 11 $\frac{3}{4}$ " x 7 $\frac{1}{2}$ ". 105-125v, 50-70 cycles, 40 watts. Shipping weight, 21 lbs.

Model 6000A Deluxe Portable Tube and Transistor
Tester—Net Each\$279.50

Model 799 Multi-Socket Tube Tester—Net Each\$199.95

THE HICKOK ELECTRICAL INSTRUMENT CO.

HICKOK

TEST EQUIPMENT

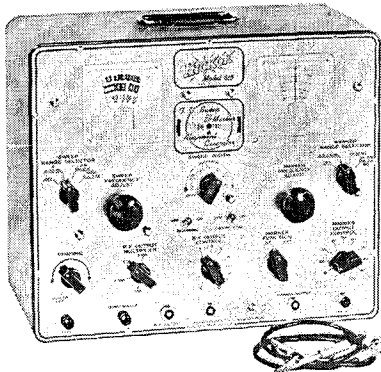

MODEL 615
Sweep and Marker
Alignment Generator

For complete TV, IF and RF alignment, including color TV alignment. Also provides harmonic output on UHF. All electronic Sweep with no moving parts. Amplitude modulation less than 0.1db/MC. 110-120v, 60 cycles, 40 watts. Furnished in steel carrying case, 16 $\frac{1}{4}$ " x 8" x 13 $\frac{1}{2}$ " complete with leads. Shipping weight 39 lbs.

Model 615 Sweep and
Marker Alignment Gen-
erator—Net Each\$429.50

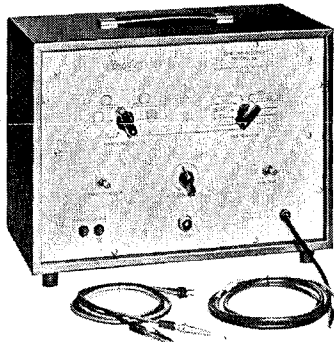

MODEL 661
Chrom-Aligner NTSC Color
Bar-White Dot Generator

Generates individual 100% saturated color bars to NTSC standards. Provides the following demodulator alignment signals: R-Y, B-Y, G-Y, G-Y at 90°, RF output on channels 3 or 4. Crystal-controlled chroma and sync. Separate video output. 110v, 60 cycles, 20 watts. Complete with leads and 3.58MC crystal. Shipping weight, 20 lbs.

Model 661 Chrom-
Aligner Generator—
Net Each\$379.50

MODEL GC660
Color Bar Dot/Crosshatch Generator

A completely new design that sets a new standard of stability through liberal use of high-speed silican switching devices and unijunction transistors. Uses 300-dot, shortstep timer system to assure complete screen coverage, especially important on rectangular tubes. "No flicker" crosshatch pattern because of 60-cycle time base. Dot size based on 0.1 usec pulse is only one line thick and one line wide for maximum convergence accuracy. Standard 10-bar pattern with controllable chroma level for color sync and killer threshold checks. Gun killer permits fast purity checks and actually allows use of picture tube as a 'scope for chroma demodulator alignment. Tunable RF output at 300 mhz, \pm video output, special sync output for Zenith receivers, 10 $\frac{3}{4}$ " x 10 $\frac{3}{8}$ " x 5". Shipping weight, 6 $\frac{1}{4}$ lbs.

Model GC660 Color Bar Dot/Crosshatch
Generator—Net Each\$179.50

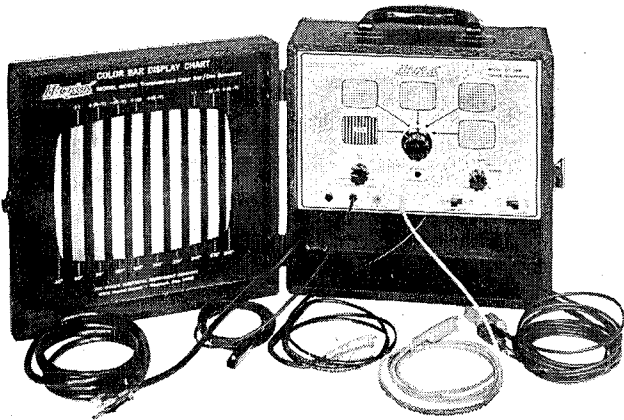

MODEL 288AX
Crystal Controlled AM-
FM Sweep and Marker
Generator

A complete alignment instrument with built-in decibel meter and crystal frequency standard (100KC and 1000KC). Covers 35KC to 110MC in 8 bands frequency modulated and 35KC to 160MC in 8 bands amplitude modulated. Includes new ultrasonic range from 35KC to 125KC. Supplied with 100KC/1000KC crystal, cable assembly and meter leads. Case size 16" x 7" x 13". Shipping weight, 33 lbs.

Model 288AX Crystal Con-
trolled AM-FM Sweep and
Marker Generator — Net
Each\$385.00

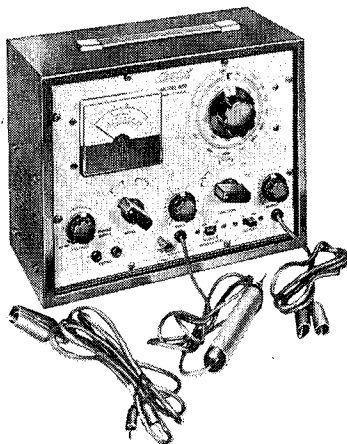

MODEL 860
"Injecto-Tracer"
Signal Tracer

An all solid-state instrument for complete trouble shooting of all types of AM and FM radios, including auto radios, and TV sound circuits. Unlike other signal tracers that only inject the test signal, the 860 also picks up, amplifies and detects signals through a tuneable amplifier and allows a complete job of signal tracing. Covers range from 200KC to 1700KC, plus 10.7 MC IF. Regulated, high-current power supply is variable to permit checking distortion, oscillator drop-out, etc. 11" x 8 $\frac{1}{2}$ " x 5 $\frac{1}{2}$ ". Shipping weight, 9 $\frac{1}{2}$ lbs.

Model 860 "Injecto-Tracer"
Signal Tracer—Net
Each\$149.50

THE HICKOK ELECTRICAL INSTRUMENT CO.

HIPOTRONICS AC/DC HIPOT TESTERS & MEGOHMMETERS

MODEL 306B

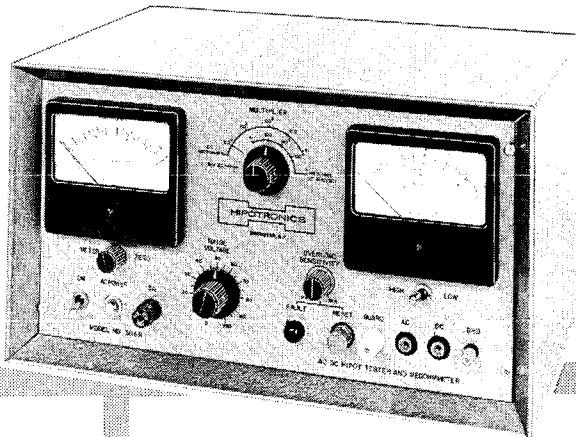

300 SERIES

The 300 series of Hipot Testers and Megohmmeters are voltage test sets which perform three different functions. They may be used for AC Hipot, DC Hipot and DC megohm tests. The "A" units perform IR tests to 1000 megohms and the "B" units to 100,000 megohms at 500 volts. Megohms at any other voltage may be determined from the volt and current meter readings.

- The sensitive thyatron operated overload relay adjustable from 20 microamperes to 5 milliamperes, will in many applications, permit non-destructive hipot tests to be performed.
- When the overload is set to 20 ua, the high voltage will generally trip on the build-up of leakage current before actual arc-over occurs.
- The "B" series has a quadruple range current meter which permits leakage currents as low as 0.01 ua to be read.
- The "A" series permits the reading of currents down to 1.0 ua.
- The KV meter has two ranges and is connected directly at the output for maximum accuracy.
- Other features include an AC input switch, fuse and pilot light, front panel output jacks, continuously adjustable output control, guard circuit on "B" series, and a failure light with reset button.
- Housed in a totally enclosed dust-proof cabinet.

Size: 17" W x 9½" H x 11" D

Input: 115 volts, 60 cps, 1 ampere — all models

Weight: 20 pounds

- Voltage to 6 KV, megohms to 100,000
- Overload adjustable from 20 microamperes to 5 ma.
- Performs non-destructive quantitative tests.
- continuously adjustable output from 0 to maximum
- Overload light with reset button, 2% meter accuracies

SPECIFICATIONS & MODELS

Model No.	Voltage KV		DC Current Meter ua.	AC Current Meter	Megohms at 500V	Size		
	DC	RMS				Ranges	W x H x D"	Price
301A	1.5	1.0	0-50/500	5 ma.	1-1000	2	17 x 9½ x 11	\$375
301B	1.5	1.0	0-.5/5/50/500	5 ma.	1-100,000	4	17 x 9½ x 11	510
303A	3	2.5	0-50/500	5 ma.	1-1000	2	17 x 9½ x 11	395
303B	3	2.5	0-.5/5/50/500	5 ma.	1-100,000	4	17 x 9½ x 11	530
306A	6	5	0-50/500	5 ma.	1-1000	2	17 x 9½ x 11	425
306B	6	5	0-.5/5/50/500	5 ma.	1-100,000	4	17 x 9½ x 11	565

SEND FOR CATALOG **HIPOTRONICS, INC.**

HIPOTRONICS MEGOHMMETERS

for production or laboratory testing of cables,
capacitors, printed circuits, transformers,
electronic assemblies, etc.

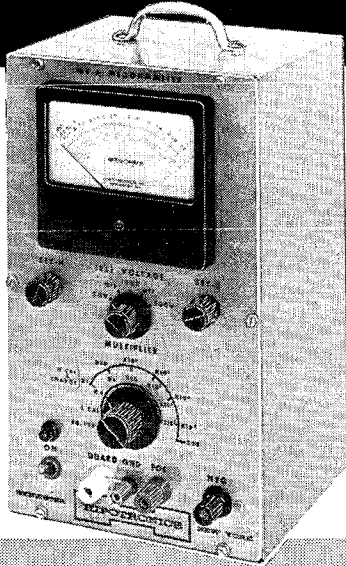

- The output voltages are both regulated with a ferro-resonant line and a solid state electronic regulator. Even with large capacitive loads on the 20 million range, there is no bounce.
- The indicating device is a high quality Weston with better than 2% accuracies on all ranges below 1 million and 3% on 10 million. The VTVM circuit driving the meter on the higher range models has no zero shift on any range.
- The short circuit protection is such that the output may be continuously shorted without injury to any component.
- Self contained calibrating resistors in the quadruple range models permit the operator to periodically verify the calibration.
- A three terminal output network (positive, negative and guard) permits grounded or ungrounded tests to be made.
- Dual color scale on multiple output voltage models improves readability.
- The units also contain a resistor and switch position for discharging both the internal and load capacitance.
- Available in 7 models, all with 115 Volt, 60 cps input and AC input switch, fuse and pilot light.

OUTPUT VOLTAGES	MEGOHMS	RANGES	MODEL	PRICE
500	1-1000	2	M-1	\$150
1000	2-2000	2	M-2	160
500/1000	1-2000	2	M-4	170
50/500	.1-100 50V	2	M-1A	160
100/1000	1-1000 500V	2	M-2A	175
	2-200 100V	2		
50/100/500	2-2000 1000V	2	M-6	235
	.1-10 million	7		
50/100/500/1000	.1-20 million	7	M-3	295

OPTIONAL EXTRAS
Lever switches for mandatory two hand hold operation and rapid discharge \$25
Wood instrument case \$35

HIPOTRONICS HIGH VOLTAGE TRANSFORMERS

FEATURES

- Corona Free
- Small, Compact
- Epoxy encapsulated coils on Air Units
- 50 - 400 Hz input

All designed with start insulated for full voltage. May be used in one end ground, full wave bridge or full wave doubler.

TRANSFORMERS

AIR INSULATED, 115 V 50 - 400 Hz PRIMARY

Output Voltage	Current	Price
1 KV	10 ma.	\$10
2 KV	10 ma.	12
2.5 KV	10 ma.	13
3 KV	10 ma.	15
4 KV	10 ma.	17
5 KV	10 ma.	19
6 KV	10 ma.	21
7 KV	10 ma.	23
8 KV	10 ma.	25
9 KV	10 ma.	27
10 KV	10 ma.	30
12 KV	10 ma.	35
15 KV	10 ma.	40
20 KV	10 ma.	50

TRANSFORMERS FOR OIL IMMERSION

ONE END NEAR GROUND

Output Voltage	Power	Price
30 KV	1 KVA	\$ 60
40 KV	1 KVA	90
50 KV	1 KVA	110
60 KV	1 KVA	130
75 KV	2 KVA	200
100 KV	2 KVA	300

FULL WAVE DOUBLER @ 20 ma.

AC	DC out of Doubler	Price
20 KV	50 KV	\$ 50
30 KV	75 KV	75
40 KV	100 KV	100
60 KV	150 KV	175
80 KV	200 KV	300
100 KV	250 KV	500
120 KV	300 KV	600

SEND FOR CATALOG **HIPOTRONICS, INC.**



VIBRATING REED FREQUENCY METERS

J-B-T INSTRUMENTS, INC.

30th Year

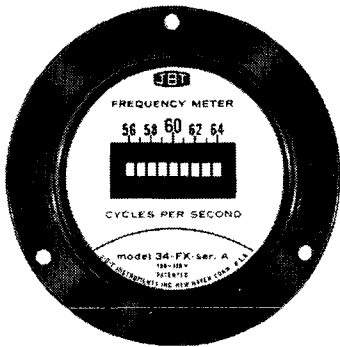

MODEL 34-FX-ser. A.
a popular 9 reed meter,
shown half actual size.

• **USES, Commercial and Military** — J-B-T Vibrating Reed Frequency Meters are used extensively in radio, telephone, television, and radar service, on engine-generator sets and standby equipment, in laboratories, in many types of aviation and electronic equipment, on panel and control boards, in inspection setups, and in high-cycle power sources — wherever constant or known frequency is important to accurate and efficient operation of equipment.

Superior performance for commercial and military applications is assured by more than 27 years of continuous experience and know-how covering the design and complete manufacturing of hundreds of thousands of these instruments in our Connecticut plant. Current production incorporates several innovations covered by recent J-B-T patents.

• **ADVANTAGES** — At reference temperature of 77°F most models have guaranteed accuracy of 0.3% or better of the frequency being measured, but the tables that follow indicate that certain models may be ordered with accuracy of ±0.1%. Accuracy on interrupted DC may be somewhat less. High fatigue strength provides a safety factor for continuous operation. Temperature compensations are not required as frequency change per °F is only .0075%, negative. For example, a 50°F temperature rise causes a 60 cps reed to read only 0.2 cps lower than at reference temperature.

• **OPERATING PRINCIPLE** — The patented, simplified design used in the J-B-T meter operates on AC or interrupted DC. Each reed is adjusted to respond by resonance to the frequency shown on the dial. As the current excites the driving coil, the reed "in tune" with the frequency in the coil will respond by vibrating rapidly because of permanent magnet polarization and induced magnetism from the coil. The instrument is adapted to specified operating voltage by a series resistor. To determine frequency, simply read the reed.

• **RESPONSE PATTERNS** — Breadth of actuation differs with the increments of frequency between reeds. For example, at 60 cycles, half-cycle steps give the broad response shown below at left, whereas full cycle steps bring the sharp response at right. In general, the lower the frequency the greater the amplitude, the higher the frequency the less the amplitude. Thus a 25 cycle reed normally will have substantially greater amplitude than a 400 cycle or a 1000 cycle reed.

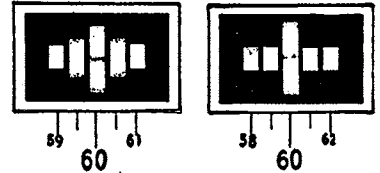

• **STABILITY** — All meters are permanently calibrated at the factory and do not require subsequent adjustment. J-B-T reeds have relatively high Q characteristics, an especially desirable factor in electronic circuits. Wave form or external fields do not ordinarily have an adverse effect. Built with no pivoted parts and with lock washers at every critical point, these rugged meters can take rougher treatment than many instruments.

• **TRUST THE METER** — If a meter plugged in on a 60-cycle AC power line does not indicate exactly 60 cycles, trust the meter. Power supply may momentarily be off-frequency due to changing load conditions. All J-B-T Frequency Meters are meticulously calibrated at the factory, entirely independent of frequency of power supply. Production and inspection equipment are checked regularly against National Bureau of Standards frequency signals.

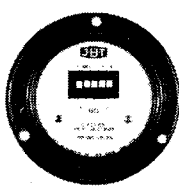

MODEL 21-FX,
5 reeds,
matches other
2½" panel
instruments.

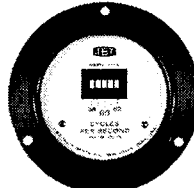

MODEL 31-FX,
5 reeds, standard.
For appearance
when operating, see
"RESPONSE PATTERNS," above.

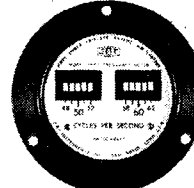

MODEL 30-FX,
5 reeds in
each of two
frequency
ranges.

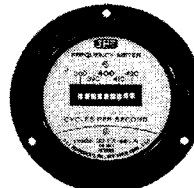

MODEL 33-FX-ser. A.
9 reeds for
measuring frequency
of high-cycle
power sources.



MODEL 36-FX-21,
21 reeds for
close reading
over 380-420
cycle band
Shown operating at 400 cy.

3½" and 2½" ROUND MOLDED CASE REED METERS

Model	Range, cps (Hz)	No. of Reeds	CPS Between Reeds	Stand. Voltage	Ohms Per Volt†	Power Consumed Watts‡	Accuracy # ± %	Case	Drawing No.	Table of Dimens.	Price Net, Each
*30-FX	48-52 & 58-62	10	1	100-130	140	0.9	0.3	3½"	SK-154	Line 5	\$29.00
30-FX-18	46-54 & 56-64	18	1	100-130	180	0.7	0.3	3½"	SK-154	Line 5	49.80
*31-FX	58-62	5	1	100-130	120	1.0	0.3	3½"	SK-50	Line 5	24.85
31-FX	59-63	5	1	100-130	120	1.0	0.3	3½"	SK-50	Line 5	24.85
*31-FX-7	57-63	7	1	100-130	140	0.9	0.3	3½"	SK-154	Line 5	27.10
*33-FX	380-420	9	5	100-130	130	0.7	0.3	3½"	SK-156	Line 5	35.80
33-FX-11	360-440**	11	**	100-130	130	0.7	0.3	3½"	SK-156	Line 5	38.00
33-FX-11	350-450***	11	***	100-130	130	0.7	0.3	3½"	SK-156	Line 5	38.00
*34-FX	56-64	9	1	100-130	140	0.9	0.3	3½"	SK-154	Line 5	28.65
*34-FX-Z	58-62	9	½	100-130	140	0.9	0.2	3½"	SK-154	Line 5	30.50
34-FX-11	55-65	11	1	100-130	140	0.9	0.3	3½"	SK-154	Line 5	31.00
34-FX-Z-11	57.5-62.5	11	½	100-130	140	0.9	0.2	3½"	SK-154	Line 5	33.75
34-FX-21	45-65	21	1	100-130	180	0.7	0.3	3½"	SK-154	Line 5	42.50
36-FX-21	380-420	21	2	28	40	0.4	0.3†	3½"	SK-156	Line 5	45.90
*36-FX-21-115	380-420	21	2	100-130	130	0.7	0.3†	3½"	SK-156	Line 5	47.25
21-FX	58-62	5	1	100-130	525	0.25	0.3	2½"	MD-20	Line 2	23.75
21-FX	116-124	5	2	100-130	525	0.7	0.3	2½"	MD-20	Line 2	26.50
23-FX	380-420	5	10	100-130	120	0.75	0.3	2½"	MD-20	Line 2	28.90
23-FX-54	390-410	5	5	100-130	120	0.75	0.3	2½"	MD-20	Line 2	28.90

†Accuracy of 0.1% at reference temperature available at necessarily higher cost. Quotation on request.
*Most popular models — normally stocked.

**360-370-380-390-395-400-405-410-420-430-440
***350-370-380-390-395-400-405-410-420-430-450

‡Approximate values; reflect minor changes based on most recent design.

#At reference temperature, see paragraph "ADVANTAGES."

Prices Net, F.O.B. Factory; Individually Boxed, Domestic Packed, Effective May 1, 1968, subject to change.



VIBRATING REED FREQUENCY METERS—REED RELAYS

J-B-T INSTRUMENTS, INC.

30th Year

3" SQUARE-CASED FREQUENCY METERS

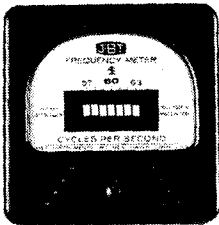

FS SERIES. Matching other 3" x 3" meters on a panel with square black molded cases, these meters are otherwise the same as the FX Series. For instance, 33-FS is the same as 33-FX except for the case. See Table of Dimensions, Line 10.

33-FS, 380-420 cps, 9 reeds, 3" square molded case \$36.90

34-FS, 56-64 cps, 9 reeds, 3" square molded case 29.80

PORTABLE FREQ. TESTERS

FP SERIES, METAL OR MOLDED CASE. Accuracy of $\pm 0.3\%$ meets the exacting test requirements of aviation, signal, and communication equipment. **M-Types** use anodized gray aluminum case, 6 $\frac{3}{4}$ " long x 4" wide x 3-9/32" deep. Leads permanently attached. See Print SK-63-10. With pertinent name plate, **33-FP-9M** is known as **TS-328 A/U.** **L-Types,** sturdy molded case within top grain leather carrying case 6-3/32" x 4 $\frac{1}{4}$ " x 2 $\frac{3}{4}$ "; 4' leads with 5" test picks and banana plugs.

33-FP-9M, (illustrated) 380-420 cy., 9 reeds, 100-130 volts, 130 ohms per volt, 1.0 watts power consumption; coml. quality and packing... \$52.00

34-FP-9M, 56-64 cy., 9 reeds, 100-130 volts, 140 ohms per volt, 0.9 watt power consumption, coml. quality and packing \$44.50

33-FP-9L, 380-420 cy., 9 reeds, 100-130 volts \$50.00

34-FP-9L, 56-64 cy., 9 reeds, 100-130 volts \$42.75

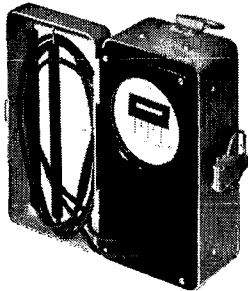

42- AND 50-REED 400 CYCLE INDICATORS

MODEL 41-FX-42 and **41-FX-50.** Both are widely used in commercial and military testing especially in aviation-electronic trouble-shooting. Model 41-FX-42 (supercedes Model 41-FX) has two banks of 21 reeds: one for 300-500 cps in 10 cycle steps, and for vernier effect, one for 380-420 cps in 2 cycle steps. Model 41-FX-50 has two banks of 25 reeds giving a continuous coverage from 355-600 cps in 5 cycle steps. Black molded case, flush front is 4-3/64" x 4-3/64" x 2-17/32" deep behind panel over studs. Power consumption is 2 watts at 30 volts, 4 watts at 115 volts, and 8 watts at 200 volts. For 41-FX-42, see Print MD-38-11; for 41-FX-50, Print SK-79.

41-FX-42, 100-130 volts only \$131.00

41-FX-42, 3 voltages: 200-240; 115; and 30; 4 studs (without switch) 147.00

41-FX-50, 3 voltages: 200-240; 115; and 30; 4 studs (without switch) 189.00

RUGGEDIZED AND ILLUMINATED METERS

Model with "RUG"—Sealed vibrating reed frequency meters and sealed elapsed time meters are available, when so ordered, to the intent of MIL-M-10304B, covering ruggedization of other kinds of meters, and usually are specified only for extra-severe shock and vibration.

LL Construction—Requirements for lighted meter dials have led to illuminating the 3 $\frac{1}{2}$ " FHXX Series of sealed meters. Light from a source behind the panel is admitted through a sealed window built into the meter case. Inquiries are invited.

400 CYCLES, IN 1 CYCLE STEPS; 800 CYCLES

Among the variations which J-B-T produces on special order, are 21-reed, 390-410 cycles in 3 $\frac{1}{2}$ " case; and 11-reed; 780-820 cycles with 4-cycle increments. Quotations on request.

NOTE ON METER VOLTAGE

J-B-T Vibrating Reed Frequency Meters of all sizes normally are made with two reeds and are designed to be connected across one phase of a multi-phase line. The single phase voltage where the meter will be used thus becomes the voltage to be specified for the meter. Special meters with extra studs are made for the purpose of using at two or more voltages, not additional phases.

RESONANT—REED RELAYS (Decoders) AND OSCILLATOR CONTROLS (Encoders)



Typical Frequency Sensitive Relays RR-A11A-138.5

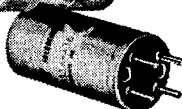

Typical Sealed Oscillator Control RO-B10B-186.0

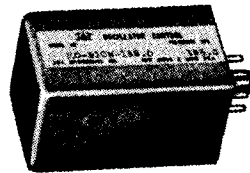

For technical description of J-B-T frequency-sensitive electromechanical control devices, see Bulletins 162R and D664A; for representative models and prices, see Section 5100 of this book.

New

FG SERIES for Modern Design; Picture Window Frame Optional

FG FREQUENCY METERS. Thoroughly modern in appearance, the sparkling clear-plastic front and the bright textured metal insert below the dial add zest to any panel. FG meters not only match the 3 $\frac{1}{2}$ " wide x 3" high front of the New EG elapsed time meters on the next page, but are interchangeable as to mounting with other kinds of panel meters. Standard voltage is 100-130 volts; accuracy and electrical characteristics are the same as corresponding FX frequency meters in the table on preceding page. For example, Model 30-FG differs from Model 30-FX only in the case. FG mounting details appear in line 9 of the Table of Dimensions below and in Prints SK-160 and SK-164, available on request. Further design flexibility is provided by use of the half-bezel adapter sketched below, in which a black plastic picture window frame outlines a panel area 3.83" wide x 2.27" high. . . . Three typical FG models are catalogued, but others are available on special order.

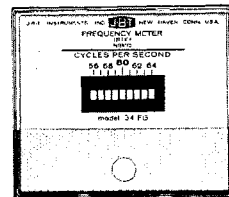

MODEL 34-FG for standard flush-type mounting (match makers) →

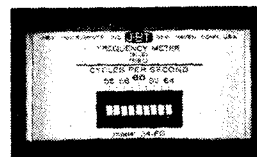

Same model with 13A-234 molded half-bezel

30-FG, 48-52 and 58-62 cps, 10 reeds \$32.50

33-FG, 380-420 cps, 9 reeds... 39.25

34-FG, (illus.) 56-64 cps, 9 reeds 32.25

13A-234 Half-bezel adapter, separate black molded frame and hardware for picture window appearance on any FG or EG meter \$2.75

13A-239 Half-bezel adapter, separate black metal frame particularly recommended for all 3 $\frac{1}{2}$ " FG frequency meters and EG elapsed time meters; with hardware \$2.75

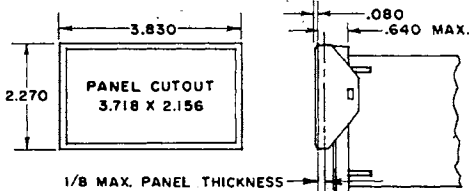

Panel dimensions for picture window mounting of FG and EG meters.

FREQUENCY METERS, TABLE OF DIMENSIONS, INCHES

Model	A	B	C	D	D ₁	E	F	G	H	J	K	L
Line 9 30-FG to 36-FG	1 $\frac{3}{32}$	2 $\frac{1}{32}$	3 $\frac{3}{32}$	3 $\frac{1}{2}$	3	2 $\frac{3}{4}$	$\frac{3}{16}$	1	1 $\frac{1}{8}$	$\frac{3}{16}$	10-32NF-2A	4-40NC-2A
Line 10 30-FS to 36-FS	$\frac{1}{4}$	2 $\frac{3}{64}$	2 $\frac{3}{32}$	3	3	2 $\frac{3}{4}$	$\frac{3}{16}$	$\frac{7}{8}$	1 $\frac{1}{8}$	$\frac{3}{16}$	10-32NF-2A	4-40NC-2A

Prices Net, F.O.B. Factory; Individually Boxed, Domestic Packed, Effective May 1, 1968, subject to change.



TEMPERATURE TESTERS AND ACCESSORIES

J-B-T INSTRUMENTS, INC.

30th Year

FOR APPLIANCE SERVICING, QUALITY INSPECTION, AND LABORATORY SET-UPS

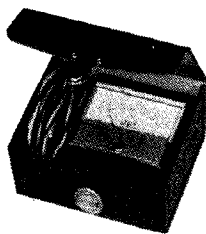

OVEN OR HEAT CHAMBER TESTERS

MODEL 23-JP-1. This popular portable indicating pyrometer saves time and furnishes reliable information in testing and setting thermostats on electric or gas ranges and other appliances by showing oven temperatures as they change. 0-650°F. dial with 23/8" scale arc is covered by clear-plastic front (may be shipped as rectangular instead of round as illustrated). Sturdy, pliable, scuff-resistant black case is 4 1/2" x 2 7/8" x 4 1/4". Characteristic of more expensive pyrometers, the 23-JP-1 is automatically compensated for ambient temperature. Thus the tester eliminates calculations, avoids likelihood of serious error, as temperature changes inside the instrument itself, and gives reliable direct readings. Supplied with attached SA-116, 5 1/2" calibrated thermocouple, clip, and convection shield **\$30.00**

MODEL 32-JP-3. This time-tested model has an instrument-type carrying case of natural finished mahogany 6 1/8" x 3 7/8" x 4 1/2" over hardware. The glass-covered indicator shows 0-650°F. range in 10° divisions readable to 2 1/2° on a 23/8" scale arc. Exceptionally fast, continuous response. Automatic compensation for ambient temperature is a valuable feature whether the tester is used for service work, sales demonstrations, or inspection. Attached SA-116, 5 1/2" thermocouple, clip for affixing to grill and convection shield included **\$32.50**

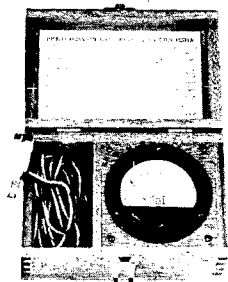

MULTI-PURPOSE TESTER

MODEL 61-JRT. A 9-in-1 tester to speed accurate temperature adjustment and electrical analysis of ranges, refrigerators, test apparatus, etc. Rapidly reads four cold zones —100°F, +80°F, up to 14" distant; two heat zones 0-600°F, up to 5 1/2" distant; one voltage range 0-300 AC; and, with transformer, two current ranges, 0.30 and 0.60 amps, AC. Sturdy, polished walnut case, 15 1/2" x 10-3/16" x 4 9/16". Two color etched metal panel. Separate switches protect bulb and ammeter circuits. Requires one standard flashlight cell, replaceable in the field. Temperature accuracy ±2% of full scale; rectified AC readings ±5%. Accessories as listed may be added for testing appliances. Includes two SA-162 resistance bulbs, two SA-116 thermocouples, electrical leads, and AS-TR-2 built-in transformer. **\$135.00**

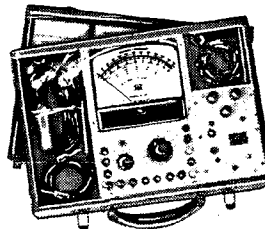

MODEL 61-JRT (LESS TRANSFORMER). Same unit, same scales except no reading in amperes; AS-TR-2 transformer omitted. **\$120.00**

AS-TR-2 Transformers for use with Model 61-JRT to provide readings of two current ranges: 0.30 and 0.60 amp. AC **\$19.00**

HEAT INDICATORS

MODEL 32-J PYROMETER IN SN-7 STAND. Mounted in sloping front black metal stand, 4 1/4" high x 4 3/8" deep x 4 1/8" wide. Compensated for ambient temperature. Medium resistance system, damped for quick reading on 23/8" scale, assures ruggedness and pointer stability. For ±2% accuracy, use only the type and resistance of thermocouple and lead provided; if extra length—coil it—to maintain calibration. A protection tube usually is not required. For convenience keep an extra thermocouple and lead on hand.

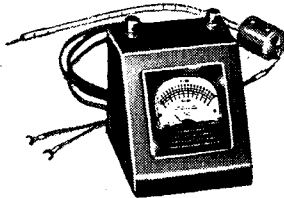

MODEL 32-J IN SN-7 STAND (Supersedes SN-3 Stand)
 0° — 650°F-350°C, includes SA-91 thermocouple, SA-84 lead, and CB-1 connector block **\$37.00**
 0°-1200°F-650°C, includes SA-87, SA-82, and CB-1 **\$37.00**
 0°-2000°F-1100°C, includes SA-87, SA-82, and CB-1 **\$37.00**
MODEL 32-J IN SN-8 STAND (not illustrated). With 3 binding posts to accommodate flexible extra lead and thermocouple for hard-to-reach locations. 0°-650°F including SA-91 thermocouple, SA-84 lead, CB-1 connector block, and SA-86 flexible leads and thermocouple. **\$41.00**

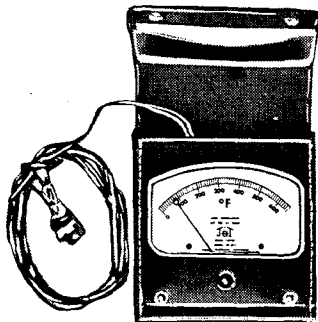

MODEL 32-JP-7. This model is recommended as the most versatile and easiest to read of this J-B-T series. The 0-650°F. scale is more than 4" long. Automatic compensation for ambient temperature is included, so that temperatures are read directly and without calculations. The 32-JP-7 also provides color-coded external binding posts. These permit quick attachment or interchanging of various J-B-T thermocouples placed in one or more of the heat zones to be checked. An SA-116 5 1/2" thermocouple with attachment clip and convection shield is supplied and is left attached when the tester is carried. For maximum usefulness in checking irons, washers, toasters, clothes dryers, etc., use appropriate accessory thermocouples. Tester price includes stitched Ever ready case, 5" wide x 5 1/2" high x 2 3/4" deep, of sturdy, scuff resistant black vinyl. **\$35.00**

ness in checking irons, washers, toasters, clothes dryers, etc., use appropriate accessory thermocouples. Tester price includes stitched Ever ready case, 5" wide x 5 1/2" high x 2 3/4" deep, of sturdy, scuff resistant black vinyl. **\$35.00**

TEMPERATURE TESTER ACCESSORIES

Model No.	Range F°	CONDUCTORS				Use With	Construction	Price	
		Length	Wire Gage Size	Positive	Negative				
LEAD WIRES†									
SA-82	194°	6'	14 Ga. Stranded	Red-Copper	Yellow-Const.	32-J in SN-7; 60-JP; 60-JPS 70-J	Compensating Lead for use with chromel-alumel thermocouples; flexible duplex with moisture and flameproof outer braid.	\$2.25	
SA-83	194°	26'	14 Ga. Stranded	Red-Copper	Yellow-Const.			32-J in SN-7; 32-J in SN-8 70-J	6.00
SA-84	392°	6'	14 Ga. Stranded	White-Iron*	Red-Const.				2.25
SA-85	392°	26'	14 Ga. Stranded	White-Iron*	Red-Const.			6.00	
THERMOCOUPLES†									
AS-TH-1	0-1200	30"	20 Ga. Solid	Iron-Black*	Const.-Yellow	31-JPP; 31-JPP-C	Welded inside seamless steel tube 1/4" O.D. for immersion in molten metal.	On Appl.	
IT-1	0-650	—	—	—	—	32-JP-7; 61-JRT	Accessory Iron Tester, same as 32-JIT except there is no meter.	20.00	
SA-86	0-650	7'	20 Solid	Iron-Black*	Const.-Yellow	32-J in SN-8; 60-JP; 60-JPS	General purpose combination thermocouple and lead.	2.50	
SA-87	0-1200, 0-2000	12"	14 Solid	Chromel	Alumel	32-J in SN-7	For high temperatures, insulated and protected with 2-hole ceramic beads; fits 3/16" hole.	3.75	
SA-88	0-1200, 0-2000	24"	14 Solid	Chromel	Alumel	60-JP; 60-JPS	For intermediate temperatures, insulated and protected with 2-hole ceramic beads; fits 3/16" hole.	4.75	
SA-91	0-650, 0-1200	12"	14 Solid	Iron-Black*	Const.-Yellow	32-J in SN-7; 32-J in SN-8 70-J	Disc-type junction for attachment flush to surface.	3.50	
SA-92	0-650, 0-1200	24"	14 Solid	Iron-Black*	Const.-Yellow	Former Model 32-J	Needle-type junction for soft material or crevices.	4.25	
SA-113	0-650	35'	20 Ga. Solid	Iron-Black*	Const.-Yellow	Former Model 32-J	Ball-type, all-purpose junction.	6.50	
SA-114	0-650	35'	20 Ga. Solid	Iron-Black*	Const.-Yellow	Former Model 32-J	Connection shield & clip for attachment.	6.25	
SA-115	0-650	35'	20 Ga. Solid	Iron-Black*	Const.-Yellow	23-JP-1;	Ball-type tip, for roasters, waffle irons, etc.	5.00 #	
SA-116	0-650	5 1/2"	22 Ga. Solid	Iron-Black*	Const.-Yellow	32-JP-3; 32-JP-7	Disc-type tip, for toasters, etc.	3.50	
SA-175	0-650	5 1/2"	22 Ga. Solid	Iron-Black*	Const.-Yellow	60-JRT; 61-JRT	Copper tube enclosed tip, for automatic washers, etc.	5.00 #	
SA-176	0-650	5 1/2"	22 Ga. Solid	Iron-Black*	Const.-Yellow		Shield and clip, duplex nonfraying glass braid, for frequent use above 400°F.	6.00 #	
SA-188	0-650	5 1/2"	22 Ga. Solid	Iron-Black*	Const.-Yellow		Spring type in transit tip with handle, for rapid reading of surfaces.	9.00	
SA-199	0-650	5 1/2"	22 Ga. Solid	Iron-Black*	Const.-Yellow		Disc-type junction for attachment flush to surface.	6.00	
SA-300	0-650	5'	22 Ga. Solid	Iron-Black*	Const.-Yellow	32-JD in SN-7	Needle-type junction for soft material or crevices.	6.00	
SA-304	0-650	25'	20 Ga. Solid	Iron-Black*	Const.-Yellow	32-JD in SN-7	Ball-type, all-purpose junction.	5.75	
SA-305	0-650	25'	20 Ga. Solid	Iron-Black*	Const.-Yellow		Thin, flat, copper clad bulb 3x1 1/2x1/4"; with polyethylene ribbon lead. Doors of appliances may be closed without damaging it.	6.85	
SA-306	0-650	25'	20 Ga. Solid	Iron-Black*	Const.-Yellow		Thin, fast-responding, plastic-sheathed bulb.	6.85	
RESISTANCE BULBS									
SA-142	—100 to +160	14'	Polyethylene Ribbon Lead	No Polarity		60-JRT only	Lava block, includes heavy brass connectors for low contact resistance.	6.85	
SA-162	—100 to +160	14'				61-JRT		6.85	
SA-190**	—100 to +160	8'				Custom		6.85	
SA-308	—100 to +160	8'				Custom		5.50	
SA-309	—100 to +160	8'				Custom		4.75	
CONNECTOR BLOCKS									
CB-1	0-2000	1 1/2"lg. x 1 3/8" Dia.	—	As marked	As marked	All ceramic bead type thermocouples		2.25	

NOTE: *Iron constantan is RP1080 calibration. **Has plug terminals; all other accessories have spade terminals. †For best results thermocouples and leads should be as stated on instrument dials. #Price includes two in standard package.

J-B-T INSTRUMENTS, INC.

Electrical Instruments, Testers, Switches and Other Components

For other J-B-T Products, see Sec. 5100

Prices shown are NET, F.O.B. New Haven, Conn. Domestic Packing, Effective October 1, 1968, subject to change.

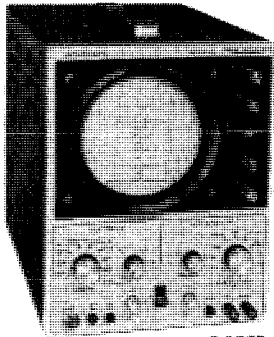

FINEST QUALITY TEST EQUIPMENT... for SERVICE—LABORATORY—INDUSTRY

249⁹⁵

Model CRO-4—5" WIDE BAND OSCILLOSCOPE & VECTORSCOPE

The only 5 Mc oscilloscope in the medium-low cost class which permits the technician to measure the amplitude of waveforms (as in TV servicing) as easily as using a VTVM or Volt-Ohm-Milliammeter. The "Readout" is an instant-removable graticule with 2 sets of calibrations exactly like a Meter scale-plate. Model CRO-4 is also a complete VECTORSCOPE. It incorporates simplified vectorscope calibration facilities to insure correct Horizontal/Vertical vectorscope pattern proportion. In addition to standard graticule, model CRO-4 includes a special graticule only for vectorscope use. Size: 9" W x 16" D x 11 $\frac{1}{4}$ " H. Weight: 23 lbs.

Model X-100—SOLID STATE COLOR GENERATOR

Extraordinary wide range of patterns (NTSC type colors) for faster, more accurate Color TV installation and servicing. Solid State stability under extreme temperatures • Pushbutton selector switches • Horizontal lines can be adjusted from double to single line thickness • Small uniform dot pattern for more simple and accurate convergence • Gun killer switches • Color video control • Video output • RF output on channels 3 and 4 controlled with convenient switch—adjusts for channels 2 and 5 through opening on panel • Line isolated. Size: 10" W x 6 $\frac{1}{4}$ " H x 4 $\frac{1}{2}$ " D. Weight: 9 lbs.

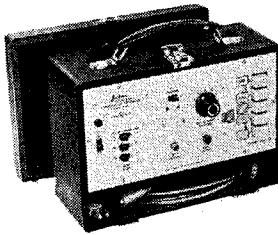
149⁹⁵

Model 658-1—DYNAMIC OUTPUT TUBE TESTER

Designed for the engineer, laboratory technician and serviceman who want the finest tube tester available. Applies variable DC bias and AC signal voltage to the control grid and variable DC voltages to the plate and screen. A low impedance bridge circuit measures only the AC component of the plate current. Checks the entire output curve of the tube. • AC rectification test for diodes • 231 heater voltage settings • Grid leakage test up to 80 megohms • Tests striking point and operating range for thyratron, VR, and reference tubes • Pushbutton sequence switching for rapid set-up • Triple shorts sensitivity test • Angled view zig-zag roll chart. • Line voltage control. Size: 20 $\frac{3}{8}$ " W x 13" D x 7 $\frac{3}{8}$ " H. Weight: 25 lbs.

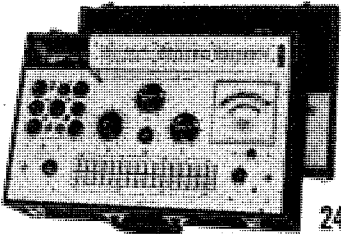
249⁹⁵

Model 806—VACUUM TUBE VOLTMETER—7" METER

0.5 volt full scale DC range for today's solid state servicing needs. Provides direct reading of true Peak-to-Peak voltages of complex waveforms including TV sync, video pulses, color gating pulses, etc. $\pm 3\%$ accuracy fs on both AC and DC. **MODEL 806 VTVM MEASURES:** Complex waveforms directly from 0.2 V to 4200 V P-P in 7 overlapping ranges • RMS values of Sine waves from 0.1 V to 1500 V in 7 overlapping ranges • DC voltages from 0.01 to 1500 volts on 2 scales in 8 overlapping 3-to-1 ranges • Input Resistance—11 megohms DC • Resistance from 0.2 ohm to 1000 megohms • 1% multiplier resistors. Size: 7 $\frac{1}{2}$ " W x 7 $\frac{3}{4}$ " H x 4 $\frac{3}{8}$ " D. Weight: 7 lbs.

79⁹⁵

Accessory Probe: 85 HV High Voltage Probe
\$19.95

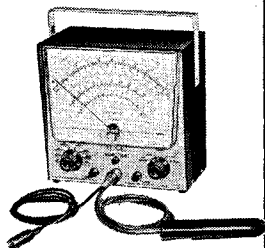

Model 648-1—DYNAMIC TUBE TESTER

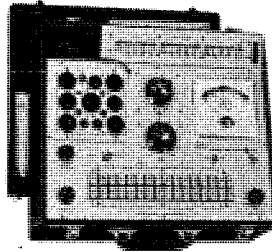
199⁹⁵

Exclusive color keyed panel makes this unit faster to set up, easier to use • Best for servicemen — more accurate and completely versatile for all new tubes • First with pushbutton sequence switching • Semiconductor rectifier for instant warm-up • 23 separate heater voltages from .75 to line voltage • Variable sensitivity shorts tests . . . up to 2 megohms • Automatic line voltage indicator • Angled view zig-zag exclusive color keyed roll chart. Size: 16 $\frac{1}{4}$ " W x 14" D x 6 $\frac{3}{4}$ " H. Weight: 21 $\frac{1}{2}$ lbs.

Model 607D—VARIABLE REGULATED POWER SUPPLY

A compact, easy-to-use, complete laboratory power supply. Provides heater, bias and variable regulated B+ voltages in one package. **DC Regulated Output:** Low position 150 to 225 VDC, 0 to 100 ma max. High position 225 to 300 VDC, 0 to 100 ma. Regulation—within 1.5%, no load to 100 ma. at 300V • **Ripple:** Bias supply—less than 0.003% at 20 ma. Regulated supply—less than 0.005% at 100 ma. • **Metered Output:** For Bias and Regulated B+ supply • **AC Heater Output:** 6.3 VAC at 3a • **DC Bias Output:** 30 to 275 VDC, no load; 15 to 150 VDC at 20 ma. Size: 5 $\frac{1}{8}$ " W x 10 $\frac{1}{8}$ " D x 7 $\frac{3}{8}$ " H. Weight: 11 $\frac{1}{2}$ lbs.

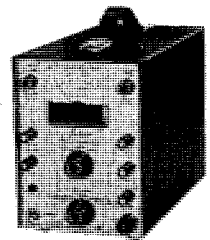
79⁹⁵

Model 605D—AUDIO SINE/SQUARE WAVE OSCILLATOR

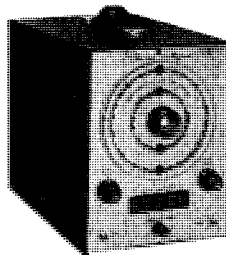
144⁹⁵

A precision Sine/Square audio generator. Square output generated by special Schmitt Trigger circuit. Pushbutton range selection and variable output. **Range:** 20 Hz to 200,000 Hz, Sine or Square wave in 4 ranges • **Output:** Sine wave 0 to 5.0 RMS volts; Square wave 20 mv to 7.0 P-P • Less than 1% distortion Sine • **Output Level:** ± 1 db over full range • **Hum:** More than 50 db down • **Square Wave Rise Time:** Less than 0.2 μ sec • **Square Wave Tilt:** 5% at 60 Hz. Less than 1% above 200 Hz. Size: 7 $\frac{3}{8}$ " W x 13 $\frac{1}{8}$ " D x 10 $\frac{1}{8}$ " H. Weight: 17 $\frac{1}{2}$ lbs.

Model 810—DYNAMIC IN-CIRCUIT TRANSISTOR TESTER

Tests all transistors for A.C. BETA in circuit or out of circuit. Tests for leakage (Icbo). Tests diodes in and out of circuit. Exclusive . . . fast, simple pushbutton operation • Exclusive . . . Built-in transistorized signal-tracer generator • Transistor socket mounted on panel for fast, easy quantity testing • Zener regulated power supply • Wide Angle 200 microamp meter. Size: 7 $\frac{1}{2}$ " W x 7 $\frac{3}{4}$ " H x 4 $\frac{3}{8}$ " D. Weight: 4 $\frac{1}{2}$ lbs.

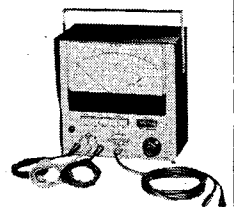
89⁹⁵

JACKSON ELECTRICAL INSTRUMENT COMPANY

W PARKER INSTRUMENTS

COMMON TO ALL MODELS IS THE UNIQUELY THIN PARKER MOVEMENT

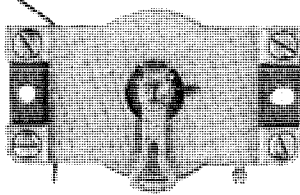

CONSISTING OF AN ETCHED COIL, RING MAGNET, ANTI-SHOCK SUSPENSION AND SELF-SHIELDING. HIGH RESISTANCE TO SHOCK, VIBRATION.

CONTINUOUS OVERLOAD UP TO 10,000% FDS. ALL THIS AND ONLY $\frac{3}{8}$ " THIN.

INDICATING PANEL METER S, SB SERIES $2\frac{1}{2}$ ", $3\frac{1}{2}$ ", $4\frac{1}{2}$ "

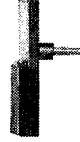
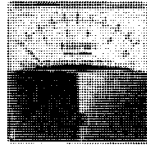
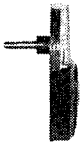

THE BARREL'S GONE TWO $\frac{3}{8}$ " HOLES AND IT'S MOUNTED

EDGEWISE INDICATING METERS E-SERIES $1\frac{1}{2}$ ", 3", $3\frac{1}{2}$ ", $4\frac{1}{2}$ "

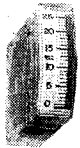

HORIZONTAL OR VERTICAL MOUNTING

CONTACTLESS CONTROL METERS ER 35 $3\frac{1}{2}$ "

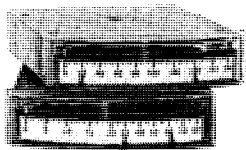

- POSITIVE REPEATABLE SWITCHING OVER ENTIRE RANGE
- $\frac{7}{8}$ " THIN; HORIZONTAL OR VERTICAL MOUNTING
- CDSE OR LIGHT ACTIVATED SCR CELLS
- DUAL OR SINGLE CONTROL POINTS WITH SIMULTANEOUS SWITCHING
- INTERNAL SWITCHING CAPABILITY TO 300 MA AT 100 V

EDGEWISE ILLUMINATED METERS EMI

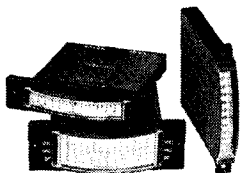

- RUGGED
- LIGHT WEIGHT
- DEPENDABLE
- DESIGNED TO MEET ENVIRONMENTAL REQUIREMENTS OF MIL STD.'S 810A, 10304-C

RCA**TEST EQUIPMENT
MEASURING INSTRUMENTS****WV-98C SENIOR VOLTOHMYST® (Kit or Wired)**

Application: provides direct reading of peak-to-peak voltages of complex waveforms found in video, sync and deflection circuits. Includes an improved circuit providing $\pm 3\%$ accuracy full scale on both ac and dc measurements with less than 1% tracking error. Separate color-coded, peak-to-peak and rms-voltage scales in two distinctive colors simplify readings. Features die-cast aluminum case; high input resistance; electronic protection against burnout; rugged 200-microampere meter movement; precision multiplier resistors with accuracy of $\pm 1\%$ and 0.5-volt full scale dc range for checking transistor circuits.

NEW . . . MIRRORED SCALE

- Large 6½" easy-to-read, full vision meter (26 sq. in.).
- Measures complex waveforms directly from 0.2 volt to 4200 volts peak-to-peak in 7 overlapping ranges.
- Measures rms values of sine waves from 0.1 volt to 1500 volts in 7 overlapping ranges.
- Measures from 0.01 to 1500 volts dv on two scales in 8 overlapping "3-to-1" ranges.
- INPUT RESISTANCE—11 megohms on all dc ranges.
- Measures resistance from 0.2 ohm to 1000 megohms on single scale, with 7 overlapping ranges.
- FREQUENCY RESPONSE—30 Hz to 250 MHz with WG-301A Crystal-Diode Accessory Probe.
- Compact design: 7" wide, 3¾" deep, 6½" high. Weight: 6 lbs.

Kit features pre-assembled DC/AC-OHMS probe — WG-361, Current Measuring Adaptor, permits current measurement with WV-98C from 1 microamp to 5 amps. \$4.95*

**\$57.95***

WV-98C(K) Senior VoltOhmyst Kit

\$88.50*WV-98C Senior VoltOhmyst
(Factory Wired)

\$38.00*
WV-77E(K)
VoltOhmyst Kit

\$52.00*
WV-77E
VoltOhmyst
(Factory Wired)

WV-77E VOLTOHMYST® (Kit or Wired)

The WV-77E features flat frequency response $\pm 5\%$ from 40 Hz to 5 MHz on the 1.5, 5, and 15-volt rms ranges and the 4, 14, and 40-volt peak-to-peak ranges. The WV-77E measures dc from 0.02 volt to 1500 volts, rms ac from 0.1 volt to 1500 volts, peak-to-peak ac from 0.2 volt to 4000 volts, and resistance from 0.2 ohm to 1000 megohms — all in seven overlapping ranges. Full-scale accuracy is $\pm 3\%$ on dc and $\pm 5\%$ on ac. Meter is electronically protected against burnout. Separate scales are provided for low ac measurements. Input resistance is standard 11 megohms. Width 5½", Height 7¾", Depth 4¾", Weight 5 lbs.

- Fuse in ohms circuit prevents accidental burnout.
- Circuit minimizes effect of residual gas in tube of circuit bridge.
- Color-coded scales for easier, faster readings.
- Ultra-slim probes and extra-flexible cables.

(Prices for WV-77E(K) and WV-77E include dc probe and cable, ac/ohms probe and cable, ground lead and clip, and instruction booklet. Assembly instruction sheet is provided with the WV-77E(K) VoltOhmyst Kit.)

**WV-76A HIGH-SENSITIVITY
AC VACUUM-TUBE VOLTMETER**

This RCA high-sensitivity AC Vacuum-Tube Voltmeter is designed for audio application in industry, laboratories and schools. It is also useful in broadcast, design and development, production, and servicing applications. Typical uses include frequency response test of preamplifiers, power amplifiers and tone-control circuits; feedback circuit design, signal tracing, audio-level and power-level measurements, gain measurements, amplifier balancing application and general audio voltage measurements.

- Nine overlapping AC voltage ranges — from 10 millivolts to 100 volts full scale. When the WG-300B input probe is set in the "Low-Cap" position, up to 500 volts or +56 db may be measured.
- Frequency response is flat from 10 Hz to 500 MHz with "Low-Cap" probe; 10 Hz to 1.5 MHz with "Direct" probe.
- May be used as preamplifier: 38 db maximum gain on 10-millivolt range.
- High input impedance — permits measurements in circuits sensitive to loading.
- Probe and cable shielded throughout its length — eliminates pick-up from stray fields.
- Feedback loop from metering circuit provides additional stability and linearity.
- Heavy filtering in power-supply section keeps hum to extremely low level.
- Separate decibel scale for measurements of levels from -40 to +40 db.
- Dimensions: 5¾" W x 7¾" H x 4¾" D. Weight: 5 lbs.

EQUIPMENT SUPPLIED:

The RCA WG-300B (shielded) Direct/Low Capacitance Probe and Cable is supplied with the WV-76A. A switch in the probe housing provides for switching from direct to low-capacitance input. In "DIRECT" position, probe measures up to 100 volts; in "LOW-CAP" position, probe can be used to measure up to 500 volts or +56 db.

* Optional distributor resale price. All prices subject to change without notice. Prices may be slightly higher in Alaska, Hawaii and the West.

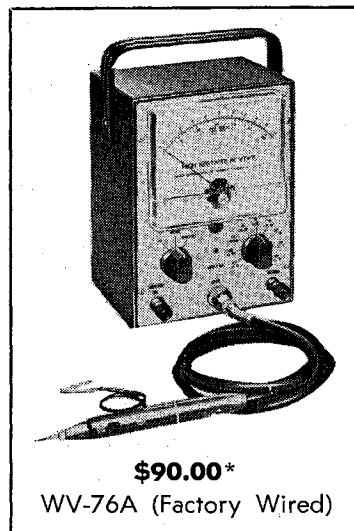
**\$90.00***

WV-76A (Factory Wired)

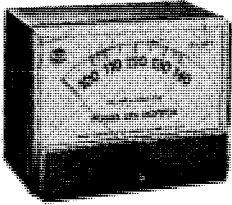
RCA**TEST EQUIPMENT**
MEASURING INSTRUMENTS • OSCILLOSCOPES**WV-120A and WV-503A POWER LINE MONITORS****\$18.50***

WV-120A

120-Volt Power Line Monitor

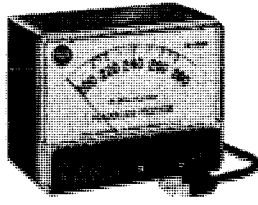
**\$18.50***

WV-503A

240-Volt Power Line Monitor

The RCA WV-120A and WV-503A Power-Line Monitors are designed for use by industries, laboratories, and radio-TV appliance repair shops where it is important to know the power-line voltage at all times. These instruments provide a continuous, accurate indication of the ac line voltage without the inconvenience of handling probes and switches or the necessity of selecting one of several scales to select the proper meter reading.

Used in conjunction with a variable isolation transformer, they are a valuable aid in selecting line voltages for TV and appliance servicing, test equipment calibration, and the operation of electronic equipment that requires a known line-voltage supply.

Both instruments feature:

- Expanded 2-Color Scale (WV-120A . . . 100-140V; WV-503A . . . 200-240V).
- High Accuracy — $\pm 2\%$ center scale; $\pm 3\%$ Ends of scale.
- True RMS Reading — Moving vane type meter gives accurate RMS readings, even when line-voltage is not pure sine wave.
- Fast Meter Action — Reveals "bounces" and fluctuations in line-voltage.
- Wide Frequency Range — From 25 to 400 Hz.
- Large Numerals, Large Pointer, Large Scale — Provides easy reading from a distance.
- Convenient Wall Mounting — Mounting holes in rear of case.

WO-33A SUPER PORTABLE OSCILLOSCOPE
(Kit or Wired)

The WO-33A 3-inch Oscilloscope is the "all purpose" scope. All the bandwidth you need for servicing color-TV, video broadcast monitors and cameras; and for square-wave testing of audio and ultrasonic equipment. All the gain you need for low-level audio work — servicing pickups, microphones, preamps; plus signal-tracing radios, amplifiers — trouble shooting communications signaling systems, ham radio and hi-fi equipment, industrial electronics machinery and other applications.

With vertical amplifier in narrow-band position, sensitivity is 3 rms millivolts/inch; bandwidth within -3 db, 20 Hz to 150 kHz. Wide band position: sensitivity 100 rms millivolts/inch; bandwidth within -3 db, 5.5 Hz to 5.5 MHz. Sweep circuit: Sawtooth range from 15 Hz to 75 kHz; sync: external, \pm internal; line sweep — 160° adjustable phase; sync range to 4.5 MHz.

- For accuracy — voltage-calibrated frequency-compensated, 3-to-1 step attenuator.
- For measurements — scaled graph screen and calibrating voltage source allows direct reading of peak-to-peak voltages.
- For stability — "plus-minus" internal sync . . . holds sync to 4.5 MHz.
- For completeness — shielded input cable with low-capacitance probe included.
- For portability — compact size — W $6\frac{1}{2}$ " x H $8\frac{3}{4}$ " x D $10\frac{1}{4}$ " — weight only 14 lbs. Plus built-in brackets to hold power cord and cables.

(Prices for the WO-33A(K) and WO-33A include WG-349A Direct/Low-Cap Probe and Cable, and instruction booklet.)

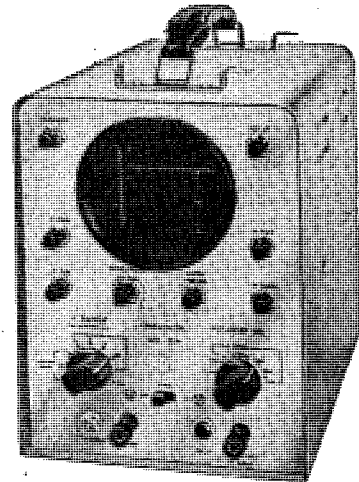
**\$108.00***

WO-33A(K) Oscilloscope Kit

\$139.00*

WO-33A Oscilloscope (Factory Wired)

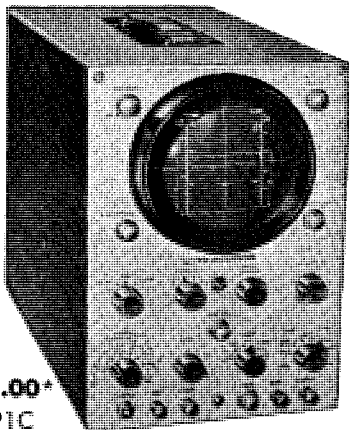
**\$269.00***

WO-91C

Complete with WG-300B two-way Direct/Low-Capacitance Probe and Cable, Alligator Clip and Insulator, Ground Cable; Green Graph Screen and Instruction booklet.

WO-91C 5" OSCILLOSCOPE**NEW FEATURE:**

• Provision for connecting signals directly to the vertical deflection plates of the CRT. Application: for production and servicing both black-and-white and color TV receivers. Used to measure color burst signals and for trouble-shooting wide-band color circuits, signal tracing and aligning wide-band video amplifiers, and chrominance circuits. A multi-scale graph screen makes peak-to-peak voltage measurements as simple as with a VTVM. Response: Wide-band within ± 1 db from 10 Hz to 4.5 MHz; High sensitivity within -1 db from 10 Hz to 0.5 MHz; within -6 db to 1.5 MHz. Sensitivity: 0.05 volt peak-to-peak per inch (0.018 rms volts) in high-sensitivity position; 0.15 volt peak-to-peak per inch (0.053 rms volts) in wide-band position.

- Voltage-calibrated, frequency-compensated, 3-to-1 step attenuator for "V" amplifier.
- Shielded vertical-input connector and shielded cable minimize hum, stray field pickup.
- Input Resistance — 1 megohm shunted by 40 pF. Low capacitance position — 10 megohms shunted by 11 pF.
- Z-Axis input 12 rms volts minimum for blanking.
- Preset "V" and "H" sweep positions.
- "Plus" or "Minus" internal-sync selector.
- Positive-lock internal sync.
- Sweep Frequency: 10 Hz to 100 kHz.
- Maximum ac input: 600 volts peak-to-peak.
- Weight: 30 lbs. Size $13\frac{1}{2}$ " x $16\frac{1}{2}$ " x 9".

* Optional distributor resale price. All prices subject to change without notice. Prices may be slightly higher in Alaska, Hawaii and the West.

RCA**TEST EQUIPMENT
SIGNAL GENERATORS****WR-99A CRYSTAL-CALIBRATED
MARKER GENERATOR**

Application: supplies a fundamental frequency rf carrier of crystal accuracy for use in aligning and trouble-shooting TV (color and black-and-white) and FM receivers, and other electronic equipment operating in the range of 19 to 260 MHz in 8 bands on fundamental frequencies. Built-in crystal calibrator, heterodyne detector, amplifier and speaker provide calibrating beats at 1 MHz or 10 MHz intervals throughout entire tuning range which is covered by 8 bands. A built-in 4.5 MHz crystal provides necessary accuracy for alignment of intercarrier-if amplifiers and discriminators.

- At least 0.1 volt output VFO ranges; 0.05 volt crystal frequencies, into a termination of 90 ohms.
- Provides signals for adjusting vertical or horizontal linearity.
- Precision matched impedance/resistance pad attenuator, 0-60 db in 5 db steps.
- Special modulation input available for re-transmission.
- Provision for use as Heterodyne Frequency Meter.
- Provides dual markers 4.5 MHz apart for band-width checks and rf alignment.
- Triple markers for sound-if alignment and bandwidth checks.
- Adjustable dial pointer for accurate registration with crystal-calibration check points.
- Size: 13½" x 10" x 7". Weight: 17 lbs.

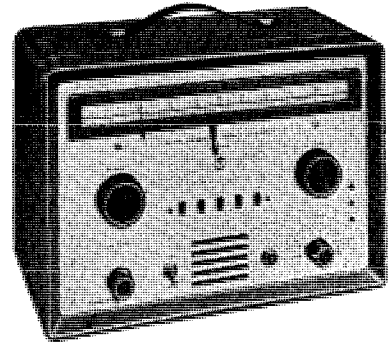
**\$256.50*****WR-99A**

(Complete with rf output cable, instruction booklet.)

WR-70A RF/IF/VF MARKER ADDER

Application: for rf, if and video sweep alignment of both color and black-and-white TV receivers. Provides sharp, easy-to-read markers for alignment. A choice of four different marker shapes is available, permitting use of marker type best suited to the response curve. Designed for use with conventional marker and sweep generators, such as the RCA WR-39 and WR-89 series marker generators and the WR-59 and WR-69 series TV sweep generators. With the WR-70A, the marker signal is added to the sweep-response curve after the sweep signal is taken out of the receiver under test.

- Eliminates or reduces distortion of sweep curve by the marker.
- Permits trap alignment without marker "suckout."
- Hi-Q markers — high in amplitude, narrow in width.
- Four marker choices — positive peak, negative peak, positive and negative peaks (wide band), positive and negative peaks (narrow band).
- Voltage stabilized for rock-steady trace display.

SPECIFICATIONS:

IF/VF sweep input — 50 kHz to 50 MHz. RF input — 50 MHz to 250 MHz.

MINIMUM INPUT VOLTAGES — IF/VF sweep input — 0.1 volts rms. RF Sweep sample input — 0.005 volts rms. Marker input — 0.1 volts rms. Maximum demodulator signal input — 8 volts peak-to-peak.

MAXIMUM SIGNAL OUTPUT — Marker signal — 2.5 volts rms. Demodulator sweep signal — 10 volts peak-to-peak. Input and output impedances all 100 ohms except demodulator signal input of 0.5 megohm.

Weight: 8 lbs. Size: 7½" x 10½" x 6¼".

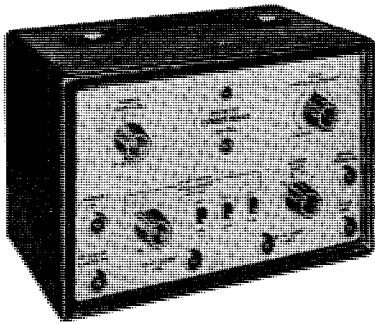
**\$96.00*****WR-70A**

(Complete with four coaxial cables and instruction booklet.)

**WR-69A
TELEVISION/FM SWEEP GENERATOR**

Tops for visual alignment of both TV and FM receivers, the WR-69A has preset switch positions for all VHF TV channels, the FM broadcast band, and TV video, chrominance, and if frequencies. VHF output is on fundamental frequencies only; no beat notes or harmonics are used. Exceptionally good linearity is provided by a precision vibrator capacitor. Continuously adjustable sweep width and flat output make for accurate sweep response portrayals. The WR-69A is especially suited to alignment of color receivers. Special sample-voltage terminal on panel permits use with marker-adder units in alignment. Dual-piston attenuator provides smooth even attenuation over 60 db range for TV and FM channels and 70 db range for if and video. Width 13⅝", Height 10", Depth 7". Weight: 16 lbs.

- IF/Video output frequency continuously tunable from 50 kHz to 50 MHz in 6 ranges.
- Sweep-frequency bandwidth continuously adjustable from 50 kHz to 20 MHz on if/video and fm; 12 MHz max. on TV channels.
- Return trace blanking.
- Two continuously adjustable bias voltages, 0 to -12; available on front panel.

* Optional distributor resale price. All prices subject to change without notice. Prices may be slightly higher in Alaska, Hawaii and the West.

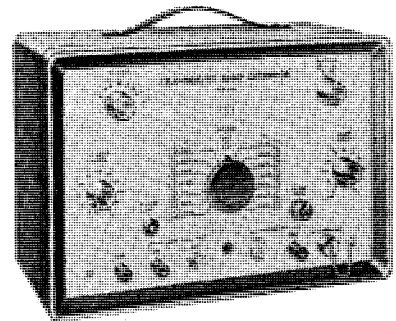
**\$295.00*****WR-69A**

(Complete with RF Output cable, IF/Video Output cable and instruction booklet.)

RCA**TEST EQUIPMENT
TESTERS**

\$66.75*
WT-501A

Factory wired and calibrated. (Batteries not included.)

**WT-501A IN-CIRCUIT/OUT-OF-CIRCUIT
TRANSISTOR TESTER**

Completely portable and requiring no external power source, RCA's new WT-501A tests transistors both in-circuit and out-of-circuit, tests both low and high power transistors, and has both NPN and PNP sockets to allow convenient transistor matching for complementary symmetry applications.

The instrument tests out-of-circuit transistors for dc beta from 1 to 1000, collector-to-base leakage as low as 2 microamperes, and collector-to-emitter leakage from 20 microamperes to 1 ampere. Special low impedance circuitry assures reliable in-circuit testing.

Collector current is adjustable from 20 microamperes to 1 ampere in four ranges, permitting most transistors to be tested at rated current level. A complete DC Forward Current Transfer Ratio Curve can be plotted. The three color-coded test leads are provided for in-circuit testing, and for out-of-circuit testing of those transistors that will not fit into the panel socket.

WC-506A TRANSISTOR/DIODE CHECKER

The RCA WC-506A Transistor/Diode Checker is a compact, battery-operated instrument providing quick, simple checks of relative gain and leakage levels of out-of-circuit transistors. Tests NPN and PNP types. Panel switch provides checking high-leakage transistors, such as most germanium power types. Includes a transistor socket, color coded test leads, and a large, easy-to-read meter with a single red/green scale. Check relative front-to-back current ratio of diodes by connecting to special spring terminals on the panel. MOS and FET type transistors cannot be checked with the WC-506A. Power supplied by two 1.5 volt penlite batteries. 3 $\frac{3}{4}$ " x 6 $\frac{1}{4}$ " x 2". Weight 14 ounces.

- Checks NPN and PNP types.
- Tests out-of-circuit transistors.
- Large, easy-to-read meter.

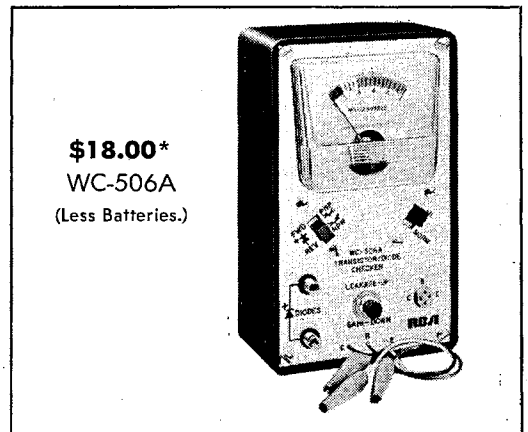

\$18.00*
WC-506A

(Less Batteries.)



\$75.00*
WT-115A

(Complete with sturdy laminated vinyl case with convenient cable storage compartment.)

WT-115A COLOR PICTURE TUBE TESTER

The RCA WT-115A Color Picture Tube Tester is designed specifically for the testing of color picture tubes, including types 21AXP22, 21AXP22A, 21CYP22, 21CYP22A, 21FBP22, 21FKP22, and 21FJP22 includes a socket adaptor which permits testing of the 19EXP22, 19EYP22, 25AP22, A, and 25BP22, A color picture tubes. The RCA WT-115A offers a quick, reliable means of testing each gun of the color picture tube for emission quality (including warm-up performance), interelectrode leakage, and shorted elements. Readily portable, the WT-115A provides distributors and dealers with an accurate instrument for the testing of color picture tubes in the customer's home or in the store.

- Designed specifically for testing TV color picture tubes.
- Tests each gun for emission quality, interelectrode leakage, and shorts.
- Large, 3-color, sensitive meter with two scales:
 - Red/green "quality" scale, with reference marks from 0 to 10.
 - Separate yellow scale to indicate interelectrode leakage.
- Sensitive meter and cut-off adjustment control for evaluating the true emission of each gun.
- Neon shorts indicator.
- AC line-voltage adjustment for accurate measurements.
- Test procedure includes 2-minute and 4-minute tests for determining warm-up performance of tube.
- Tests color picture tube in-set or out-of-set.
- Built-in cable and socket assembly.

* Optional distributor resale price. All prices subject to change without notice. Prices may be slightly higher in Alaska, Hawaii and the West.



TEST EQUIPMENT ACCESSORIES



WG-411A SLIP-ON HIGH-VOLTAGE PROBE

The WG-411A high-voltage slip-on probe was designed for use with either the WG-401A or WG-299D ac/dc ohms probes. It extends the dc voltage range of VoltOhmysts to 50,000 volts when used with WG-206 multiple-resistor. The extremely high impedance of the WG-411A is especially desirable when it is necessary to measure voltages found in geiger-counter tubes, television, and other high-impedance circuits which would not function properly if loaded down with a low-impedance voltmeter.

\$13.50*



WG-289, WG-297 HIGH-VOLTAGE PROBES

The WG-289 extends the d-c voltage range of the WV-77A, WV-77B, WV-77C, WV-87A, WV-87B, WV-97A, WV-98A, WV-98B and WV-98C VoltOhmysts to 50,000 volts. The WG-297 extends the range of the WV-77E VoltOhmyst and WV-38A Volt-Ohms-Milliammeter to 50,000 volts dc. The WG-289 is provided with a microphone-type connector, and the WG-297 is provided with banana-plugs for use with appropriate Volt-Ohmysts and other VTVM's, VOM's.

A choice of three multiplier resistors is available, enabling these probes to be used with many popular electronic and non-electronic volt-ohm-meters.

- WG-206 — 1090-megohm multiplier resistor for VTVM's having 11-megohm input (multiplying factor 100). Use WG-206 for the WV-77, WV-87, and WV-98 series VoltOhmysts@.
- WG-210 — 900-megohm resistor multiplies 5000-volt dc range of 20,000-ohms-per-volt VOM's by a factor of 10.
- WG-211 — 495-megohm resistor multiplies 250-volt dc range of 20,000-ohms-per-volt VOM's by a factor of 100.
- WG-289 or WG-297, Probe only, less resistor **\$13.50***
- WG-206 or WG-210, Multiplier Resistor (each) **\$ 3.75***
- WG-211 — Multiplier Resistor **\$ 3.50***

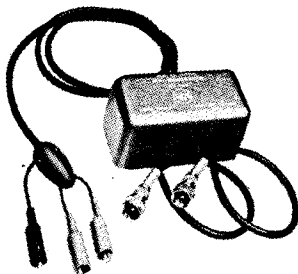

WG-304B RF MODULATOR

An accessory used to check the over-all frequency response of TV receivers from antenna to picture tube grid. The unit permits modulation of an rf marker signal from a marker generator (such as WR-89A or WR-99A) by a signal from a video sweep generator (such as WR-59C or WR-69A)..... **\$18.00***

WG-349A DIRECT/LOW-CAPACITANCE PROBE

A 48-inch, small diameter, extremely flexible shielded cable designed for use with the WO-33A Oscilloscope. The probe consists of three short leads with alligator clips for ground, direct, and low-capacitance connections. For convenient use, the WG-349A eliminates the need for switching. It connects to the oscilloscope by means of a miniature-type microphone connector. Increases input characteristics to 10 megohms, 12 pF capacitance, when used with the WO-33A and WO-33A(K). **\$6.75***

WG-301A CRYSTAL-DIODE PROBE



"Slip-on" type for use with the WG-299A, B, C, or DC/AC Ohms Probe and Cable extending the frequency range of Volt-Ohmysts® to 250 MHz ...**\$8.25***

WG-302A RF/IF/VF SIGNAL TRACING PROBE



"Slip-on" type high-frequency probe designed for use with the WG-300A and B probe and cable to permit visual signal tracing for rapid isolation of trouble in radio receivers and in television if and video stages **\$9.00***

WG-299D DC/AC OHMS PROBE AND CABLE



The WG-299D is a single-unit probe for use with VoltOhmysts® except WV-77E. Switch provides instant selection of dc or ac/ohms operation. The WG-299D replaces the WG-299A, WG-299B and WG-299C **\$9.00***

WG-350A DEMODULATOR PROBE

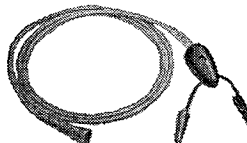

For use with the WO-33A Super-Portable Oscilloscope for demodulation and signal tracing of radio/TV rf and if signals. **\$5.25***

WG-300B DIRECT/LOW-CAPACITANCE PROBE AND CABLE



Designed for use with the RCA Scopes. Cable is 48" long, completely shielded from microphone connector to probe tip to minimize hum and stray field

pick-up. Built-in switch provides instant selection of direct or low-capacitance operation. Input characteristics: 10 megohms resistance, less than 1.25 pF capacitance in low capacitance position. Includes ground lead and clip **\$11.00***

WG-351A CRYSTAL DIODE PROBE



For extending the rf. measuring capability of the WV 77E Volt-Ohmyst, and WV77E(K) Volt-Ohmyst Kit, to over 100 MHz. **\$5.25***

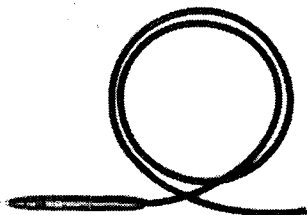

WG-410A DC/AC OHMS PROBE AND CABLE

The WG-410A is supplied with the WV-500A Transistorized VoltOhmyst®, and is also available as a replacement accessory. It is a single-unit probe and cable equipped with a sliding switch to permit changing the probe characteristics to suit the type of measurement being made. It is identical to the WG-299D with the exception of the connector. **\$9.00***

WG-354A CAPACITOR-TYPE VOLTAGE DIVIDER PROBE



The RCA WG-354A Capacitance-Type Voltage Divider Probe is a slip-on accessory for use with the WG-300B Direct/Low Capacitance Oscilloscope Probe. The WG-354A used with the WG-300B Probe and Cable extends the range of oscilloscopes such as the RCA WO-33A† and WO-91C so that signal pulse amplitudes up to 5000 volts can be observed. **\$11.00***

† The WG-300B and WG-354A can be used with the WO-33A if the WG-271A Connector Adaptor is employed.

* Optional distributor resale price. All prices subject to change without notice. Prices may be slightly higher in Alaska, Hawaii and the West.

PANEL METERS

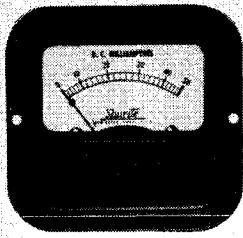

MODEL 950 SERIES
(metal case)
ZERO ADJUSTER
OPTIONAL ON DC

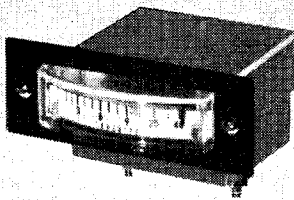

MODEL 350 SERIES
(crystal clear front)
EDGEWISE METER

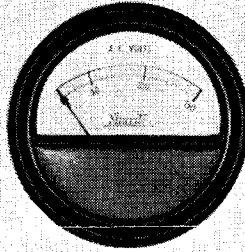

MODEL 550 SERIES
(metal case)
RIMLESS ROUND TYPE

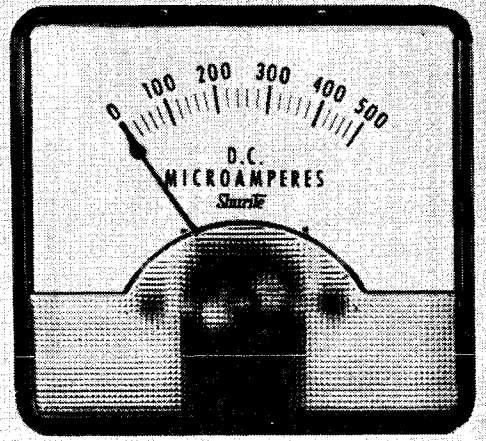

MODEL 850 (actual size) ZERO ADJUSTER OPTIONAL

Manufactured in SHURITE'S new Connecticut plant, Shurite meters are attractive, rugged, dependable instruments with accuracy well within $\pm 5\%$, and the ability to duplicate readings. DC meters are polarized-vane solenoid type (moving-magnet or bridge-type construction where indicated); AC meters are double-vane repulsion type with jeweled bearing. The jewel construction costs more to build, but it pays off in continuing accuracy during a longer useful life. Models 550 and 950 fit 2-5/32" hole; Model 850 fits 2-5/32" to 2-1/32" hole. All are guaranteed.

*****NEW PRODUCTS**—More sensitive meters which retain high torque-to-weight ratio without sacrifice of ruggedness, include: *A) three 0-500 DC Microammeters, 1000 ohms int. res.; *B) 0-1 DC Milliammeter, Stock No. 8336, 1000 ohms int. res., with bridge-type design to minimize effects of external magnetic forces; and *C) 0-2 DC Milliammeter, Stock No. 8835, 500 ohms int. res. A handy new Cold-Zone Tester priced at less than \$21.00, and a pocket type Lighting Level Indicator, calibrated for 0-300 foot candles, are listed on the opposite page.

FEATURES

GUARANTEE: Meters are guaranteed to users against defective workmanship and material, and will be repaired or replaced if sent to the factory postpaid with 50¢ handling charge within one year after purchase . . . **ALL METAL DIALS**—age and moisture resistant, lithographed in black on white for high visibility . . . **STURDY DESIGN**—with husky coil frames designed to prevent breakage, rigidly mounted in cases with anti-turning square head studs . . . **VISCOSITY DAMPING**—careful application of new silicone compound on bearing surfaces damps pointer overtravel . . . **WIDE SELECTION**—Shurite offers the broadest line of standard meters in the economy-priced field. Distributor stocks are backed by an extensive factory inventory.

CLEAR PLASTIC INSTRUMENTS

. . . The 850 snap-on front of crystal-clear high temperature polystyrene 2-17/32" wide by 2-5/16" high, admits light from all sides and accentuates the appearance of the dial which has the longest scale arc in its field. The case back is black, but of similar high-temperature, high-impact material.

TYPICAL USES

Amateur radio rigs . . . Citizens Band equipment . . . battery eliminators . . . battery chargers . . . volt-ohm-milliammeters and kits . . . model train equipment . . . tuning circuits for stereo and tape recorders . . . burglar, fire alarm, or emergency lighting systems . . . transistor testers . . . plating equipment . . . voltage regulators . . . detergent strength analyzers . . . demonstrators . . . many other applications.

DC MICROAMMETERS

RANGE	RESIST. Approx. Ohms	Model 550* Stock No.	Model 950* Stock No.	Model 850* Net Each	Model 550* Stock No.	Model 950* Stock No.	Model 850* Net Each
0-500**	1000	5902	9902	\$4.40	8902		\$4.50

*For zero adjuster, add 35c to price and Z to stock number.
**Sensitive type, note internal resistance. DC bridge-type construction.

DC MILLIAMMETERS

RANGE	RESIST. Approx. Ohms	Model 550* Stock No.	Model 950* Stock No.	Model 950* Net Each	Model 850* Stock No.	Model 850* Net Each
0-14	1000	5336	9336	\$4.15	8336	\$4.25
0-24	500	—	—	—	8335	4.25
0-3	4460	5301	9301	3.35	8301	3.45
0-5	3740	5302	9302	3.05	8302	3.15
0-10	1380	5303	9303	2.85	8303	3.05
0-15	600	5304	9304	2.75	8304	2.85
0-25	230	5305	9305	2.75	8305	2.85
0-50	58	5306	9306	2.75	8306	2.85
0-100	14.7	5307	9307	2.75	8307	2.85
0-150	7.0	5308	9308	2.75	8308	2.85
0-200	4.7	5309	9309	2.75	8309	2.85
0-300	1.7	5310	9310	2.75	8310	2.85
0-400	.84	5311	9311	2.75	8311	2.85
0-500	.7	5312	9312	2.75	8312	2.85

*For zero adjuster add 35c to price and Z to stock number.
†Bridge-type construction; internal magnet design minimizes effects of external magnetic forces. Price does not include zero adjuster.

AC MILLIAMMETERS

RANGE	RESIST. Approx. Ohms	Model 550 Stock No.	Model 950 Stock No.	Model 950 Net Each	Model 850* Stock No.	Model 850* Net Each
0-10	4800	5607	9607	\$4.05	8607	\$4.15
0-25	750	5601	9601	3.95	8601	4.05
0-50	150	5602	9602	3.95	8602	4.05
0-100	37	5603	9603	3.95	8603	4.05
0-250	5.4	5604	9604	3.95	8604	4.05
0-500	1.34	5605	9605	3.95	8605	4.05

NO ZERO ADJUSTER ON AC METERS, EXCEPT ON MODEL 850.
*For zero adjuster add 35c to price and Z to stock number.

DC AMMETERS

RANGE	RESIST. Approx. Ohms	Model 550* Stock No.	Model 950* Stock No.	Model 950* Net Each	Model 850* Stock No.	Model 850* Net Each
0-1	.105	5201	9201	\$2.75	8201	\$2.85
0-3	.02 Max.	5202	9202	2.75	8202	2.85
0-5	.02 Max.	5203	9203	2.75	8203	2.85
0-8	.02 Max.	5204	9204	2.75	8204	2.85
0-10	.02 Max.	5205	9205	2.75	8205	2.85
0-15	.02 Max.	5206	9206	2.75	8206	2.85
0-25	.02 Max.	5207	9207	3.05	8207	3.15
0-50	.02 Max.	5208	9208	3.05	8208	3.15
3-0-3	.02 Max.	5210	9210	2.85	—	—
5-0-5	.022	5211	9211	2.85	—	—
6-0-6	.02 Max.	5212	9212	2.85	—	—
10-0-10	.02 Max.	5213	9213	3.05	8213	3.15
20-0-20	.02 Max.	5214	9214	3.05	8214	3.15
30-0-30	.02 Max.	5215	9215	3.05	8215	3.15
50-0-50	.02 Max.	5216	9216	3.25	8216	3.35

*For zero adjuster add 35c to price and Z to stock number.

AC AMMETERS

RANGE	RESIST. Approx. Ohms	Model 550 Stock No.	Model 950 Stock No.	Model 950 Net Each	Model 850* Stock No.	Model 850* Net Each
0-1	.42 Max.	5501	9501	\$3.90	8501	\$4.00
0-3	.072 Max.	5502	9502	3.90	8502	4.00
0-5	.041 Max.	5503	9503	3.90	8503	4.00
0-10	.02 Max.	5504	9504	3.90	8504	4.00
0-15	.02 Max.	5508	9508	3.90	8508	4.00
0-30	.02 Max.	5505	9505	4.15	8505	4.25
0-50	.02 Max.	5506	9506	4.50	8506	4.60
0-80	.02 Max.	—	—	—	8507	4.90

NO ZERO ADJUSTER ON AC METERS, EXCEPT ON MODEL 850.
*For zero adjuster, add 35c to price and Z to stock number.

Prices Effective May 1, 1968; F.O.B. Factory; Individually Boxed; (Subject to Change.)

The New Standard in Meters... FET Meters... BY SENCORE

- Only Sencore makes a true field effect meter
- Less circuit loading than VTVM/obsoletes VOM
- Greater frequency responses than most scopes
- Zero warm-up time — instant stability
- Complete circuit and meter protection
- Complete portability

FE149 SENIOR FET METER

The only true Senior FET meter available today with outstanding accuracy and unbelievable ease of operation.

- **Unmatched Accuracy.** 1.5% on DC, 3% on AC, plus large 7-in. meter and mirrored scale, assure the most accurate tests possible.
- **Eight AC and DC ranges** .5V to 1500V full scale.
- **Zero center scale** with .25 v. either side assures measurements to less than .1 v. for transistor bias measurements.
- **AC peak to peak** readings to 4500V maximum with freq. response of 10HZ to 10MHZ \pm 3DB.
- **Eight resistance ranges** to R x 10 megohms with 6 OHMS center scale.
- **Nine DC and nine AC current ranges** 150ma to 5 amps.
- **Eight decibel ranges** for audio measurements.
- **Three HI-Voltage ranges**, 5 KV, 15 KV, 50KV with 39A21 high voltage probe. \$14.95
- **Absolute meter and circuit protection** against circuit overload.
- Non-breakable, scuff-proof, vinyl-clad steel case.
- **Three-way power.** Operates on AC, on self-contained rechargeable batteries, or on AC with batteries plugged in. Same readings all three ways.

\$149.50

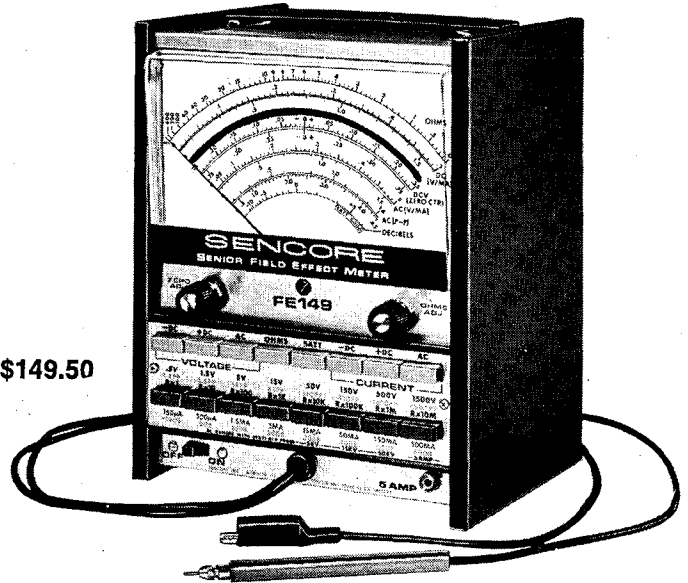

Exclusive push-button design. Just push two buttons for any test — top row selects function, bottom row selects range. Action is instant and automatic.



\$69.95

FE14 — STANDARD FET METER

ACCURACY DC \pm 2.5%
AC \pm 4.5%

- 4½-inch meter, vinyl-clad steel case.

FE14 and FE16 popular 4 1/2 inch FET Meters

- **Hi Accuracy.** For unsurpassed measurements. Mirrored scales prevent parallax errors.
- **Minimum circuit loading.** 15 megohm input resistance on DC; 10 megohm on AC.
- **Zero center scale** \pm 0.5 v. readings for transistor bias measurement.
- **Full meter & circuit protection** against possible circuit overload.
- **7 DC & AC voltage ranges** 1 to 1000 volts full scale.
- **AC peak to peak readings** 2800 v. maximum with freq. response of 10HZ to 10MHZ \pm 3DB.
- **5 resistance ranges** to 1000 megohms.
- **5 DC current ranges** 100ma to 1 amp.
- **3 Hi-Voltage ranges**, 3 KV, 10 KV, 30 KV, extended with 39A19 (\$9.95) high voltage probe.



\$84.50

FE16 HI ACCURACY FET METER

ACCURACY DC \pm 1.5%
AC \pm 3%

- 4½-inch high-styled meter, high-styled knobs, and special meter-tilting metal handle. Vinyl-clad steel case.



SENCORE
STANDARD OF THE ELECTRONIC INDUSTRY

Simpson wide-vue® panel meters...

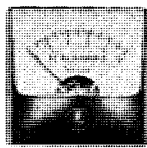

1 1/2"



2 1/2"



3 1/2"

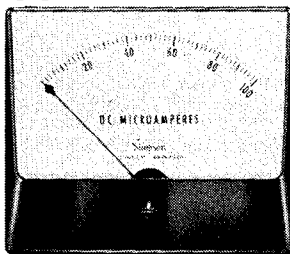

4 1/2"

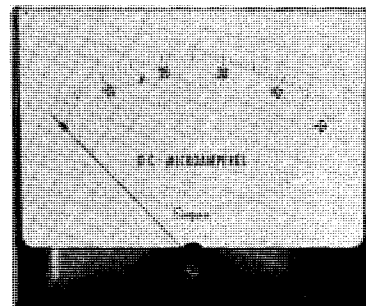

8"

The original Wide-Vue® design by Simpson is modern, yet rugged. Specially formulated plastic covers won't yellow or develop hairline cracks. Spring-loaded pivot & jewel and Taut Band movements are shock-proof.

The Simpson self-shielded movement (calibration not affected by stray magnetic fields or magnetic mounting). All AC Wide-Vue meters have the Simpson Iron-vane type movement. AC Milliammeters and Ammeters are calibrated for use on 25 through 800 Hz. All AC Voltmeters are calibrated for use on 25 through 125 Hz. Calibration at frequencies up to 800 Hz. can be made. Contact your local Distributor for prices.

CALIBRATION AND DIALS — All DC Wide Vue® meters listed below have

SELF-SHIELDING METER MOVEMENTS

Range	APPROX. RESISTANCE (ohms)	1 1/2" Case Style	2 1/2" Case Style	3 1/2" Case Style	4 1/2" Case Style
		MODEL 1212	MODEL 1227	MODEL 1327	MODEL 1329

Range	APPROX. RESISTANCE (ohms)	1 1/2" Case Style	2 1/2" Case Style	3 1/2" Case Style	4 1/2" Case Style	8" Case Style
		MODEL 1212	MODEL 1227	MODEL 1327	MODEL 1329	MODEL 728

DC VOLTMETERS

Range	APPROX. RESISTANCE (ohms)	1 1/2" Case Style	2 1/2" Case Style	3 1/2" Case Style	4 1/2" Case Style
0-5	1000 ohms per volt	\$16.95	\$18.15	\$18.90	\$20.70
0-8		—	—	18.90	20.70
0-10		16.95	18.15	18.90	20.70
0-15		16.95	18.15	18.90	20.70
0-25		16.95	18.15	18.90	20.70
0-30		16.95	18.15	18.90	20.70
0-50		16.95	18.15	18.90	20.70
0-100		16.95	18.15	18.90	20.70
0-150		16.95	18.15	18.90	20.70
0-200		—	18.15	18.90	20.70
0-250	—	18.15	18.90	20.70	
0-300	—	18.15	18.90	20.70	
0-300	2000 ohms per volt	16.95	—	—	—
0-500		21.15	18.90	19.65	21.30
0-750		—	23.10	19.65	21.30
0-1000		—	23.55	24.45	26.10

DC MILLIAMMETERS

Range	APPROX. RESISTANCE (ohms)	1 1/2" Case Style	2 1/2" Case Style	3 1/2" Case Style	4 1/2" Case Style	8" Case Style
0-1	43	\$16.35	\$17.10	\$17.70	\$18.90	\$32.10
0-3	2.0	—	17.10	17.70	18.90	32.10
0-5	2.0	16.35	17.10	17.70	18.90	—
0-10	10.0	16.35	17.10	17.70	18.90	—
0-15	6.6	16.35	17.10	17.70	18.90	—
0-20	5.0	—	17.10	17.70	18.90	—
0-25	4.0	16.95	17.40	18.15	19.65	—
0-50	2.0	16.95	17.40	18.15	19.65	—
0-100	1.0	16.95	17.40	18.15	19.65	—
0-150	.66	16.95	17.40	18.15	19.65	—
0-200	.5	16.95	17.40	18.15	19.65	—
0-250	.4	16.95	17.40	18.15	19.65	—
0-300	.33	16.95	17.40	18.15	19.65	—
0-500	.2	16.95	17.40	18.15	19.65	—
0-750	.13	—	—	18.15	19.65	—
0-1000	.05	—	17.40	18.15	19.65	—

DC AMMETER

Range	APPROX. RESISTANCE (ohms)	1 1/2" Case Style	2 1/2" Case Style	3 1/2" Case Style	4 1/2" Case Style
0-1	.050	\$16.95	\$17.40	\$18.15	\$19.65
0-1.5	.033	—	17.40	18.15	19.65
0-2	.025	16.95	17.40	18.15	19.65
0-3	.0166	16.95	17.40	18.15	19.65
0-5	.010	16.95	17.40	18.15	19.65
0-10	.005	16.95	17.40	18.15	19.65
0-15	.0033	16.95	17.40	18.15	19.65
0-25	.0020	16.95	17.40	18.15	19.65
0-30	.0017	—	17.40	18.15	19.65
0-50	.001	16.95	17.40	18.15	19.65
0-100	10.0	—	17.40	18.15	19.65
0-150	10.0	—	17.40	18.15	19.65
0-200	10.0	—	17.40	18.15	19.65
0-300	10.0	—	17.40	18.15	19.65
0-500	10.0	—	—	18.15	19.65
15-0-15	.0033	—	—	19.20	—
30-0-30	.0017	—	—	19.20	—
50-0-50	.001	—	—	19.20	—

DC MICROAMMETERS

Range	APPROX. RESISTANCE (ohms)	1 1/2" Case Style	2 1/2" Case Style	3 1/2" Case Style	4 1/2" Case Style	8" Case Style
0-50µ	1800	\$21.30	\$22.05	\$22.50	\$24.30	—
0-100	1800	19.05	19.65	20.70	22.95	—
0-200	1100	17.25	18.00	18.90	20.70	—
0-500µ	90	16.95	17.70	18.60	20.10	—
25-0-25µ	1800	21.45	—	22.65	24.45	—
50-0-50	1800	19.20	20.10	20.70	23.10	—
100-0-100	1100	17.40	18.15	19.05	21.00	—
500-0-500	43	16.50	17.25	18.00	19.05	—

TAUT BAND DC MICROAMMETERS

Range	APPROX. RESISTANCE (ohms)	MODEL 1212T	MODEL 1227T	MODEL 1327T	MODEL 1329T	MODEL 728T
0-5	5750	—	—	\$42.00	\$44.55	—
0-10	4900	—	—	36.90	39.90	—
0-15	1960	\$32.10	32.10	33.00	36.00	—
0-25	1960	30.00	30.45	31.95	34.65	\$40.05
0-50	1100	23.40	24.00	24.45	26.25	35.25
0-100	500	21.00	21.75	22.50	24.75	34.05
0-200	234	19.35	20.40	21.15	23.40	—

* External Multipliers, Model 183, are furnished on 1 1/2" DC meters 500 volts or higher; on 2 1/2" DC meters 750 volts or higher; and on 3 1/2" DC meters 1000 volts or higher. All others are self-contained. † 1 1/2" DC Ammeters are self-contained through 10 amps. 15 amps and higher are supplied as 50 MV meters to be used with external shunts. 2 1/2", 3 1/2" and 4 1/2" DC ammeters are self-contained through 50 amps. Higher range DC ammeters are 50 MV meters to be used with external shunts. Shunts listings are on page 19. ■ Resistance of 0-50 and 25-0-25 Mic Meters in Model 1212 is 5500 ohms, Resistance of 0-500 Mic Meter in Model 1212 is 190 ohms. ‡ High flux annular taut band meter movement. * New Panel Meter Addition.

NEW BEHIND PANEL BEZELS FOR 3 1/2" AND 4 1/2" WIDE VUE METERS

Integral built-in look. Designed for behind panel mounting on material thickness of 1/8" to 3/8". Black satin finish.

SEE PAGE 808

Meter Size	For Models	Price
3 1/2"	1327, 1337, 1347, 1357	\$2.25
4 1/2"	1329, 1339, 1349, 1359, 1379	2.25
	Illumination Kit	2.10

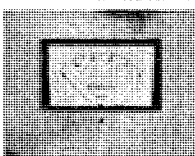

Simpson wide-vue® panel meters CONTINUED

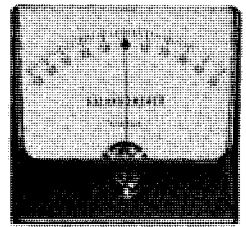

RANGE	APPROX. RESISTANCE (ohms)	2½" Case Style MODEL 1257	3½" Case Style MODEL 1357	4½" Case Style MODEL 1359
-------	---------------------------	---------------------------	---------------------------	---------------------------

AC VOLTMETERS Iron Vane Type Movement

0-5	33		\$17.25	\$19.35
0-10	133	\$16.50	17.25	19.35
0-15	300	16.50	17.25	19.35
0-25	833	16.50	17.25	19.35
0-50	3,333	16.50	17.25	19.35
0-100	16,666	16.95	18.00	19.35
0-150	25,000	17.25	18.60	19.65
0-250	41,166	17.25	18.60	19.65
0-300	50,000	17.25	18.60	19.65
0-500*	83,333	22.05	23.55	25.20

AC AMMETERS Iron Vane Type Movement

0-1	.287	\$15.60	\$16.50	\$19.20
0-1.5	.185	15.60	16.50	19.20
0-2	.115	—	16.50	19.20
0-3	.027	15.60	16.50	19.20
0-5	.012	15.60	16.50	19.20
0-10	.0031	15.60	16.50	19.20
0-15	.0022	15.60	16.50	19.20
0-25	.0003	16.35	17.10	19.65
0-30	.0003	16.35	17.10	19.65
0-50	.0006	16.35	17.10	19.65
0-75	.0005	—	18.60	21.15
0-100	.012	15.60	16.50	19.20
0-150	.012	15.60	16.50	19.20
0-200	.012	15.60	16.50	19.20
0-300	.012	15.60	16.50	19.20

RANGE	APPROX. RESISTANCE (ohms)	2½" Case Style MODEL 1257	3½" Case Style MODEL 1357	4½" Case Style MODEL 1359
-------	---------------------------	---------------------------	---------------------------	---------------------------

AC MILLIAMMETERS Iron Vane Type Movement

0-10	2,000	\$15.60	\$16.50	\$19.20
0-50	80	15.60	16.50	19.20
0-100	20	15.60	16.50	19.20
0-250	5	15.60	16.50	19.20
0-500	.9	15.60	16.50	19.20

WATTMETERS DYNAMOMETER TYPE Single Phase

Wattmeters calibrated for either magnetic or non-magnetic panels and for a frequency range of 25-125 Hz.

RANGE WATTS	RANGE VOLTS	MAX. AMPS	ACCURACY ±2% F.S.	MODEL 1379
0-75	150	1.0	—	\$45.90
0-150	150	2.0	—	45.90
0-300	150	4.0	—	45.90
0-750	150	10.0	—	45.90
0-600	300	4.0	—	49.05
0-1500	300	10.0	—	49.05
0-3000	300	20.0	—	49.05

COMPENSATED WATTMETERS — ACCURACY ±3% F.S.

0-10	300	.175	—	\$61.35
0-20	300	.400	—	61.35
0-30	300	.650	—	61.35

* External Multipliers, Model 183, are furnished on AC meters having a range of 500 volts or higher. All others are self contained.
 † 2½" AC ammeters are self-contained through 50 amps. 3½" and 4½" AC ammeters self-contained through 75 amps. Higher range AC ammeters are 5 amp meters to be used with external current transformers. See page 19 for current transformer listings.
 ‡ WIDE-VUE® DIMENSIONS ON PRECEDING PAGE.

new wide-vue® mounting bezel and illumination kits

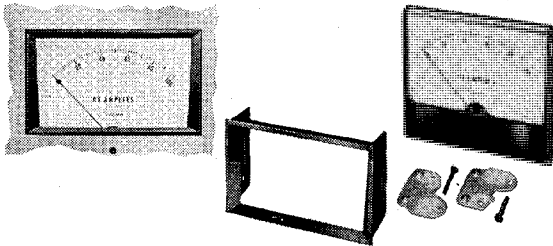

WIDE VUE BEZEL KITS

METER SIZE	FOR MODELS	PART NO.	PRICE
3½"	1327, 1337, 1347, 1357	1253	\$2.25
4½"	1329, 1339, 1349, 1359, 1379	1123	2.25
	Illumination Kit	1165	2.10

NEW WIDE-VUE MOUNTING BEZEL AND ILLUMINATION KITS

For that modern, streamlined appearance — Mounting Bezels, made for wide-vue panel meters and interchangeable with flush and recess type meters of many popular styles. Designed for behind panel mounting on material thickness of 1/8" to 3/16". Groove and flange style construction. Each bezel of die cast metal has an attractive black enamel satin finish and is supplied with mounting hardware and template.
 Bezel Mount Kit consists of bezel brackets and screws and installation instructions.

3½" WIDE-VUE, BEHIND PANEL METER MOUNTING, with BEZEL

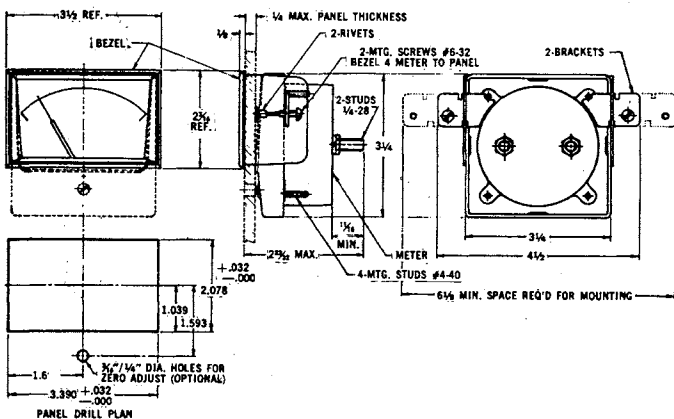

4½" WIDE-VUE, BEHIND PANEL METER MOUNTING, with BEZEL

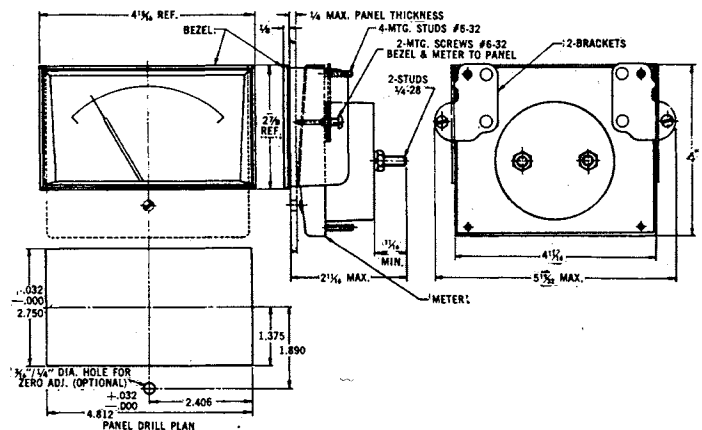

Simpson standard round and rectangular meters...

6 SIZES AND CASE STYLES...

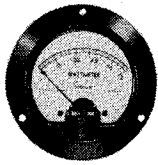

2 1/2"



2 1/2"

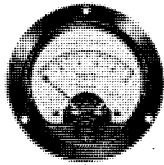

3 1/2"

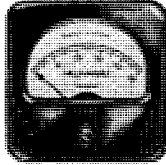

3 1/2"

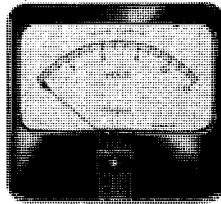

4 1/2"

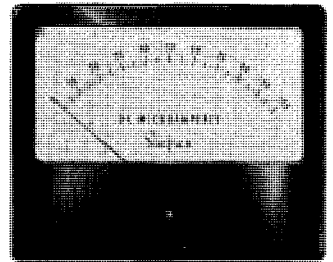

6"

CALIBRATION AND DIALS—All DC meters listed below have the Simpson self-shielding movement. (Calibration not affected by stray magnetic fields or magnetic mounting). All AC meters have the Simpson Iron Vane type movement. AC Ammeters and Milliammeters are calibrated for use on 25 through 800 Hz. AC Voltmeters are calibrated for use on 25-125 Hz. Calibration at frequencies up through 800 Hz. can be made. Contact your local Distributor for prices.

Wattmeters listed below have the Simpson dynamometer movement calibrated for either magnetic or non-magnetic panels and for a frequency range of 25-125 Hz. Standard wattmeters $\pm 2\%$, compensated wattmeters $\pm 3\%$.

SELF-SHIELDING METER MOVEMENT

RANGE	APPROX. RESISTANCE Ohms	2 1/2"	3 1/2"	4 1/2"
		Case Styles MODEL 125 127	Case Styles MODEL 25 27	Case Styles MODEL 29

RANGE	APPROX. RESISTANCE Ohms	2 1/2"	3 1/2"	4 1/2"
		Case Styles MODEL 125 127	Case Styles MODEL 25 27	Case Styles MODEL 29

RANGE	APPROX. IMPEDANCE (Ohms) @ 60 Hz	2 1/2"	3 1/2"	4 1/2"
		Case Styles MODEL 135 137	Case Styles MODEL 35 37	Case Styles MODEL 39

DIMENSIONS ON NEXT PAGE.

DC MILLIVOLTMETERS

0-50	10	\$17.25	\$18.15	\$19.65
0-100	20	—	18.15	19.65

DC MILLIAMMETERS

0-1	43	\$17.10	\$17.70	\$18.90
0-1.5	2.0	17.10	17.70	18.90
0-3	2.0	17.10	17.70	18.90
0-5	2.0	17.10	17.70	18.90
0-10	10.0	17.10	17.70	18.90
0-15	6.6	17.10	17.70	18.90
0-20	5.0	—	17.70	18.90
0-25	4.0	17.40	18.15	19.65
0-50	2.0	17.40	18.15	19.65
0-75	1.3	17.40	18.15	19.65
0-100	1.0	17.40	18.15	19.65
0-150	.66	17.40	18.15	19.65
0-200	.5	17.40	18.15	19.65
0-250	.4	17.40	18.15	19.65
0-300	.33	17.40	18.15	19.65
0-500	.2	17.40	18.15	19.65
0-750	.13	17.40	18.15	19.65
0-1000	.05	17.40	18.15	19.65

DC MICROAMMETERS

0-50	1800	\$22.05	\$22.50	\$24.30
0-100	1800	19.65	20.70	22.95
0-200	1100	18.00	18.90	20.70
0-500	90	17.70	18.60	20.10
25-0-25	1800	22.95	22.65	24.45
50-0-50	1800	20.10	20.70	23.10
100-0-100	1100	18.15	19.05	21.00
500-0-500	43	17.25	18.00	19.05

TAUT BAND DC MICROAMMETERS

		MODEL 125T 127T	MODEL 25T 27T	MODEL 29T
0-5	5750	—	\$42.00	\$44.55
0-10	4900	\$35.40	36.90	39.90
0-15	1960	32.10	33.00	36.00
0-25	1960	30.45	31.95	34.65
0-50	1100	24.00	24.45	26.25
0-100	500	21.75	22.50	24.75

DC VOLTMETERS

0-1.5	1000 ohms per volt	\$18.15	\$18.90	\$20.70
0-3		18.15	18.90	20.70
0-5		18.15	18.90	20.70
0-8		18.15	18.90	20.70
0-10		18.15	18.90	20.70
0-15		18.15	18.90	20.70
0-25		18.15	18.90	20.70
0-30		18.15	18.90	20.70
0-50		18.15	18.90	20.70
0-100		18.15	18.90	20.70
0-150		18.15	18.90	20.70
0-200		18.15	18.90	20.70
0-250		18.15	18.90	20.70
0-300		18.90	18.90	20.70
0-500		18.90	19.65	21.30
0-750	2000 ohms per volt	—	19.65	21.30
0-1000		—	24.75	26.10
0-1500		—	24.75	26.40
0-2000		23.55	25.35	27.00
0-2500		—	25.65	27.30
0-3000		—	25.95	27.60
0-4000		—	—	27.90
0-5000		—	26.70	28.35

DC AMMETERS

0-1	.050	\$17.40	\$18.15	\$19.65
0-1.5	.033	17.40	18.15	19.65
0-2	.025	17.40	18.15	19.65
0-3	.0166	17.40	18.15	19.65
0-5	.010	17.40	18.15	19.65
0-10	.005	17.40	18.15	19.65
0-15	.0033	17.40	18.15	19.65
0-25	.0020	17.40	18.15	19.65
0-30	.0017	17.40	18.15	19.65
0-50	.001	17.40	18.15	19.65
0-75	10.0	17.40	18.15	19.65
0-100	10.0	17.40	18.15	19.65
0-150	10.0	17.40	18.15	19.65
0-200	10.0	17.40	18.15	19.65
0-250	10.0	—	18.15	19.65
0-300	10.0	17.40	18.15	19.65
0-500	10.0	17.40	18.15	19.65
0-750	10.0	—	18.15	19.65
0-1000	10.0	—	18.15	19.65
15-0-15	.0033	—	19.20	20.25
30-0-30	.0017	17.70	19.20	20.25
50-0-50	.001	17.70	19.20	20.25

RF AMMETERS Self-Shielding Meter Movement Internal Thermocouple Type

0-1	.343	\$19.05	\$21.00	\$24.00
0-1.5	.200	19.05	21.00	24.00
0-2	.120	19.05	21.00	24.00
0-2.5	.10	19.05	21.00	24.00
0-3	.08	19.05	21.00	24.00
0-5	.045	19.05	21.00	24.00
0-8	.031	19.05	21.00	24.00
0-10	.023	19.05	21.00	24.00

RF MILLIAMMETERS Self-Shielding Meter Movement Internal Thermocouple Type

0-115	4.0	—	\$37.80	\$39.60
0-150	4.5	—	24.60	27.90
0-250	3.5	—	24.60	27.90
0-500	.63	—	24.60	27.90

WATTMETERS Dynamometer Type Single Phase

Range	Volts	Amps	MODEL 175 177	MODEL 75 77	MODEL 79
			ACCURACY $\pm 2\%$		
0-75	150	1.0	\$35.10	\$36.90	\$45.90
0-150	150	2.0	35.10	36.90	45.90
0-300	150	4.0	35.10	36.90	45.90
0-750	150	10.0	35.10	36.90	45.90
0-600	300	4.0	38.40	40.05	49.05
0-1500	300	10.0	38.40	40.05	49.05
0-3000	300	20.0	38.40	40.05	49.05

COMPENSATED WATTMETERS Single Phase

Range	Volts	Amps			
0-10	300	.175	—	\$58.95	\$61.35
0-20	300	.400	—	58.95	61.35
0-20	500	.175	—	58.95	61.35
0-30	300	.650	—	58.95	61.35
0-30	500	.300	—	58.95	61.35
0-50	500	.500	—	58.95	61.35

DC GALVANOMETERS

Scale	Sensitivity Micro-Amps.	Res. Ohms	MODEL 125 127	MODEL 25 27	MODEL 29
50-0-50	500-0-500	43	\$17.10	\$18.00	\$19.05
50-0-50	75-0-75	1800	18.60	20.10	22.05

† External Multipliers, Model 183, are furnished on 2 1/2" DC meters 750 volts or higher, and on 3 1/2" and 4 1/2" DC meters 1000 volts and higher. All others are self-contained.

‡ DC ammeters are self-contained for ranges up to and including 50 amperes. Higher range DC ammeters (50MV) listed above are calibrated for 5 ft. leads and require external shunts. Write for bulletin no. 2079.

¶ 0-100 Linear Scale.

Simpson elapsed time indicators

SECTION 2900

Widely used by research labs, manufacturing plants, and broadcast stations . . . to keep life and performance records based on operating time. Models 55ET and 57ET match standard 3½" Simpson meters. New model 105 has modern appearance, with clear lucite cover. New DC model 106 gives accurate (±2%) time readouts where synchronous AC power is not available. Model 106 withstands ambient temperatures from -40°C to +65°C (-40°F to +149°F). Models 105 and 106 manufactured in West Germany.

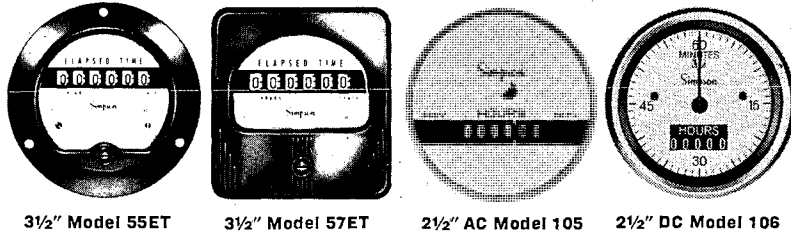

Operating Voltage	Maximum Indication (Hours)	Power Consumption	Accuracy	Model Size	Model Number	Cat. No.	Price
6V DC	99,999	15 mA (max.)	±2%	2½"	105	13520	\$20.00
+30% to -20%	—	—	—	—	Adapter*	13535	1.00
12V DC	—	—	—	—	Adapter*	13538	1.00
+30% to -20%	—	—	—	—	—	—	—
24V DC	—	—	—	—	—	—	—
+30% to -20%	—	—	—	—	—	—	—
120V AC (±15%), 60 Hz	9,999.99	2 watts	synchronous	2½"	105	13520	15.00
120V AC (±10%), 60 Hz	99,999.9	5 watts	synchronous	3½"†	55ET	03580	25.35
120V AC (±10%), 60 Hz	99,999.9	5 watts	synchronous	3½"†	57ET	03590	25.35
240V AC (±15%), 60 Hz	9,999.99	2 watts	synchronous	2½"	105	13525	15.00
240V AC (±10%), 60 Hz	99,999.9	5 watts	synchronous	3½"†	55ET	03600	25.65
240V AC (±10%), 60 Hz	99,999.9	5 watts	synchronous	3½"†	57ET	03610	25.65

* Adapter for model 106. Simply screws onto one terminal.
† Matches standard model 47 rectangular panel meters.
‡ Matches standard model 45 round panel meters.

segmental panel meters for frequency and voltage

IN . . .

- WIDE-VUE®
- RUGGED SEAL®
- STANDARD PHENOLIC
- RUGGEDIZED

. . . MODELS

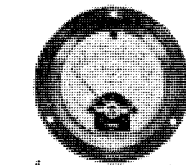

2½", 3½", 4½" Models

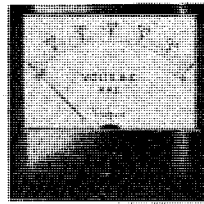

3½", 4½" Models

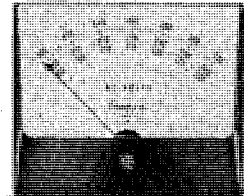

MULTI-RANGE
4½" Model 1349

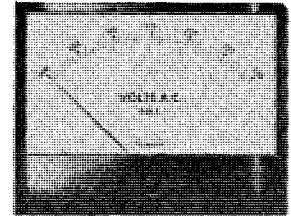

4" x 6" Models

AVERAGE SENSING, TRUE RMS & DC SEGMENTAL INSTRUMENTS

Segmental Voltmeters and frequency meters make it possible to measure very small changes in input conditions. The significant portion of the overall voltage or frequency range is expanded to occupy the full scale length. Thus, only that segment of the range that is important appears. In addition to the standard expansions and accuracies shown, special segmental voltmeters can be built on order. Write the factory for a quotation.

The A.C. segmental voltmeters are available in either average sensing or true R.M.S. sensing units. When working with sine wave currents or when other measurements will be made with average sensing equipment, the average sensing meters are preferred. When working with distorted waveforms, as would be encountered in constant voltage transformers, S.C.R. circuits, D.C. to A.C. solid state inverters or similar equipment, the true R.M.S. sensing meter would probably be preferred.

GENERAL SPECIFICATIONS

WIDE-VUE and PHENOLIC CASE STYLES	RUGGED-SEAL and RUGGEDIZED METAL CASE STYLES						
	AVERAGE SENSING AC SEGMENTAL VOLTMETERS		RMS SENSING AC SEGMENTAL VOLTMETERS			DC SEGMENTAL VOLTMETERS	FREQUENCY METERS
RANGE	100-130 AC Volts	100-130 AC Volts 200-260 AC Volts 400-520 AC Volts	100-300 AC Volts	105-125 AC Volts	110-120 AC Volts	—	—
ACCURACY (% of Center Scale Value)	±.5%	{ 100-130 ±.5% 200-260 ±.75% 400-520 ±.75%	±1.0%	±.5%	±.3%	±.5%	±.25%
FREQUENCY RANGE	20-2000 Hz.	50-1000 Hz.	55-550 Hz.			—	—
CENTER SCALE VALUE	115 Volts	115/230/460 Volts	115 Volts	115 Volts	115 Volts	27 Volts	60 Hz. 400 Hz.
SENSITIVITY OR POWER CONSUMPTION	.6 to 1.3 VA (Sensitivity decreases as input voltage increases)		50 OPV	65 OPV	80 OPV	100 OPV	3 VA Max.
MAX. INPUT VOLTAGE (10 Seconds)	150 Volts RMS	150/300/600 Volts RMS	150 Volts RMS			40 Volts	140 Volts RMS
WAVEFORM INFLUENCE	Square Wave 11% Triangular Wave 5%		2.5%	2.0%	1.0%	—	.1%
VOLTAGE INFLUENCE	105-125 Volts		—	—	—	—	.25%
MOVEMENT TYPE	Self-Shielding		Shielded External Magnet				

* Supplied with external potential transformer.

WIDE-VUE® and BAKELITE SEGMENTAL PANEL METERS Single, Multi-Range

AC VOLTMETERS			3½" Case Style	4½" Case Styles	
Range	Center Scale Value	Accuracy †	MODEL 1347	MODEL 1349	MODEL 49
100-130	115V	.5%	\$54.45	\$54.75	\$54.45
100-130	115V	.5%	—	\$67.65	—
200-260	230V	.75%	—	—	—
400-520	460V	.75%	—	—	—

† Accuracy is in percent of center scale value.

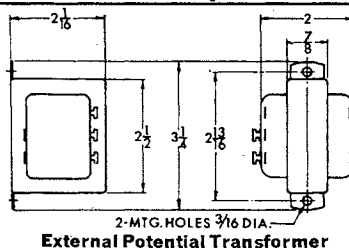

2-MTG. HOLES 3/16 DIA.
External Potential Transformer

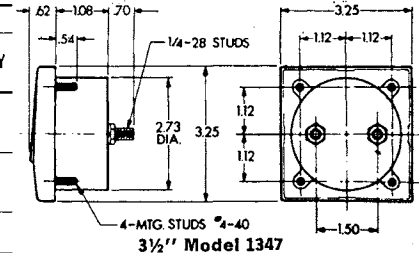

3½" Model 1347

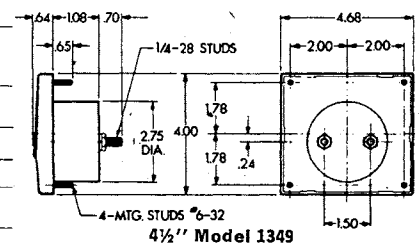

4½" Model 1349

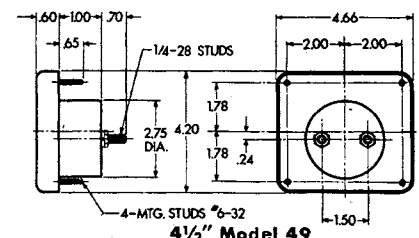

4½" Model 49

MORE SEGMENTAL METERS ON THE NEXT PAGE . . .

Simpson standard round and rectangular meters CONTINUED

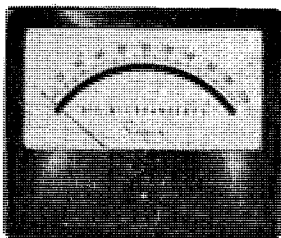

1% and 2% Tolerance SELF SHIELDING METER MOVEMENT

6" RECTANGULAR CASE STYLE

MODELS 1150 and 1150-1

Feature long, easy-to-read 4.6" scales. 1% accuracy models have mirror scales for precise readings. Movements are self-shielding, with spring-loaded jewels. SPECIFICATIONS AND DIMENSIONS ON PRECEDING PAGE.

RANGE	APPROX. RESISTANCE Ohms	1150-1 MODEL
-------	-------------------------	--------------

DC MICROAMMETERS 1%

Mirrored Scale

0-50	5200	\$39.30
0-100	2100	37.80
0-200	1100	33.90
0-500	90	33.00

DC MILLIAMMETERS 1%

Mirrored Scale

0-1	43	\$31.95
0-100	1.0	31.95
0-500	.2	31.95

RANGE	APPROX. RESISTANCE Ohms	MODEL 1150
-------	-------------------------	------------

DC MICROAMMETERS 2%

0-15	5500	\$40.05
0-25	5500	35.85
0-50	5200	32.70
0-100	2100	31.35
0-200	1100	27.30
0-500	90	26.70

DC MILLIAMMETERS 2%

0-1	43	\$25.35
0-10	10	25.35
0-50	2.0	25.35
0-100	1.0	25.35
0-500	.2	25.35

RANGE	APPROX. RESISTANCE Ohms	MODEL 1150
-------	-------------------------	------------

DC VOLTMETERS 2%

0-10	1000 OHMS PER VOLT	\$25.35
0-25		25.35
0-50		25.35
0-100	2000 Ω/V	25.35
0-150		25.35
0-300		25.35
0-500		26.10

DC MILLIVOLTMETERS 2%

0-50	10	\$26.40
------	----	---------

DC AMMETERS 2%

0-1	.050	\$26.40
0-5	.010	26.40
0-10	.005	26.40
0-15	.0033	26.40
0-25	.0020	26.40
0-30	.0016	26.40
0-50	.001	26.40

4 1/2" pyrometers 2% ACCURACY

Available in two versions: Standard bakelite Model 29 and Model 3324 Rugged Seal for extreme conditions. Both models are compensated for ambient temperature changes and include copper circuit compensation.

Each pyrometer is furnished with an external adjustable series resistor to permit use of lower resistance thermocouples in the field.

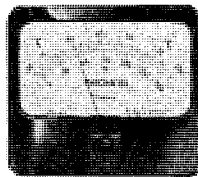

4 1/2" Model 29

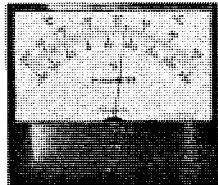

4 1/2" Model 3324

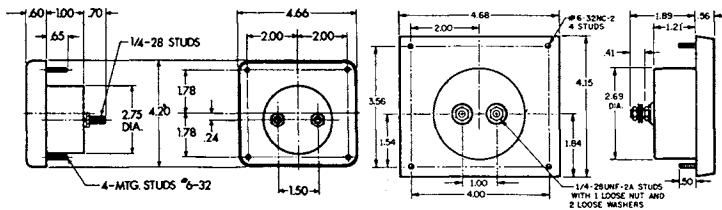

MODEL 29

Temperature Range		Type Thermocouple†	External Resistance Ohms (max.)	Current Sensitivity MA Approx.	Cat. No.	Price
°F	°C					
-150 to +250	-100 to +120	I/C	10Ω	.40	21200	\$36.30
0 to +300	-20 to +150	I/C	5Ω	.40	21202	36.30
0 to +500	-20 to +260	I/C	10Ω	.35	21204	36.30
0 to +750	-20 to +400	I/C	10Ω	.30	21206	36.30
0 to +1000	-20 to +540	C/A	10Ω	.28	21208	36.30
0 to +1500	-20 to +820	C/A	10Ω	.42	21209	33.75
0 to +2000	-20 to +1200	Pt/Rh	10Ω	.43	21210	33.75
0 to +2500	-20 to +1380	Pt/Rh	10Ω	.40	21211	33.75

MODEL 3324

-150 to +250	-100 to +120	I/C	10Ω	.40	21201	\$49.50
0 to +300	-20 to +150	I/C	5Ω	.40	21203	49.50
0 to +500	-20 to +260	I/C	10Ω	.35	21205	49.50
0 to +750	-20 to +400	I/C	10Ω	.30	21207	49.50
0 to +1000	-20 to +540	C/A	10Ω	.28	21212	49.50
0 to +1500	-20 to +820	C/A	10Ω	.42	21213	46.95
0 to +2000	-20 to +1200	Pt/Rh	10Ω	.43	21214	46.95
0 to +2500	-20 to +1380	Pt/Rh	10Ω	.40	21215	46.95

† Thermocouple not supplied with Pyrometer. I/C types are available from stock as accessory items (see below).

THERMOCOUPLES

Stack thermocouples are iron-constantan, calibrated to 5 or 10 ohms ±1% per table.

Types 21221 and 21224 are iron constantan thermocouple wire in a stainless steel overbraid for rugged service application where flexing or abrasion would cause deterioration of standard thermocouples.

Types 21222 and 21223 are iron-constantan thermocouples with a glass cloth overbraid. These thermocouples are suited for most general purpose use or for permanent mounting in protected sheaths or conduit.

Cat. No.	Resistance	Overbraid*	Length	Gauge	Price
21221	5 ohms	SS	162 in.	20	\$14.10
21222	10 ohms	GC	137 in.	24	4.95
21223	10 ohms	GC	34 in.	30	4.20
21224	10 ohms	SS	325 in.	20	25.65

*SS-Stainless Steel GC-Glass Cloth.

Simpson meter relays

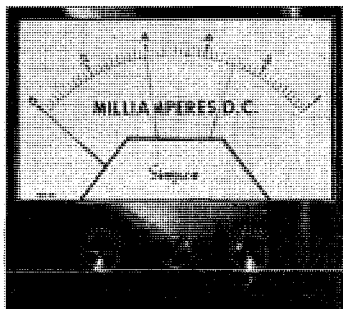

Rugged Seal

Contactless Meter Relays

Maximum reliability design

Intended for control, alarm, and limit applications — with utmost dependability. Photoconductor sensing eliminates all interference with the indicating meter. High gain transistor switch circuit provides solid state reliability, accurate switching, and extremely small dead band. Control points are adjusted from the front panel thru a gear drive. The solid-state switching circuit triggers internal 10-ampere DPDT relays (one for each control point). Ideal for unattended operation, they can be obtained from stock in a wide selection of ranges, with either dual or single control points, and in three sizes.

		3 1/2" MODELS		4 1/2" MODELS		4 x 6" MODELS	
Range	Approx. Resistance (Ohms)	Single Control	Double* Control	Single Control	Double* Control	Single Control	Double* Control
DC MICROAMPERES							
		MODEL 3323XA		MODEL 3324XA		MODEL 3326XA	
0-50	3000	\$116.55	\$146.70	\$119.85	\$150.00	\$123.15	\$153.30
0-100	1300	113.10	143.25	116.40	146.55	119.70	149.85
0-200	570	—	—	116.40	146.55	—	—
0-500	220	—	—	116.40	146.55	—	—
		MODEL 3323TXA (Taut Band)		MODEL 3324TXA (Taut Band)		MODEL 3326TXA (Taut Band)	
0-10	5500	134.70	164.85	138.00	168.15	141.30	171.45
0-25	3000	124.80	154.95	128.10	158.25	131.40	161.55
0-50	2000	119.85	150.00	123.15	153.30	126.45	156.60
0-100	570	116.55	146.70	119.80	150.00	123.60	153.15
DC MILLIAMPERES							
		MODEL 3323XA		MODEL 3324XA		MODEL 3326XA	
0-1	80	111.90	142.20	115.20	145.50	118.50	148.80
DC MILLIVOLTS							
		MODEL 3323XA		MODEL 3324XA		MODEL 3326XA	
0-50	10	112.20	142.50	115.50	145.80	118.80	149.10
AC AMPERES							
		MODEL 3344XA					
0-5	.5 VA MAX.	—	—	127.05	157.35	—	—
AC VOLTS							
		MODEL 3344XA					
0-10	1000Ω/V.	—	—	124.35	154.50	—	—

* Double control models use external power supply.

3 1/2" 4 1/2" 4" x 6" SIZES

3 1/2 INCH

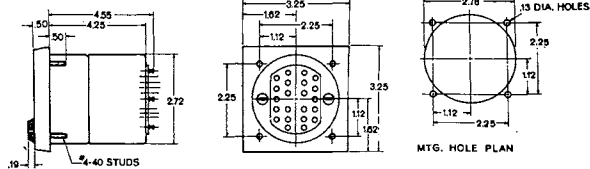

4 1/2 INCH

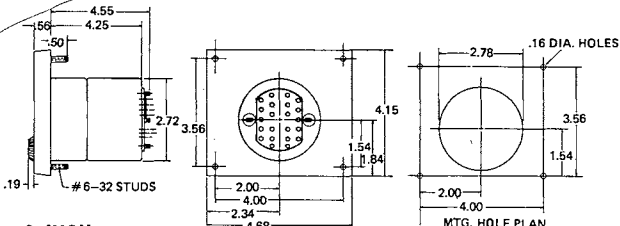

4 x 6 INCH

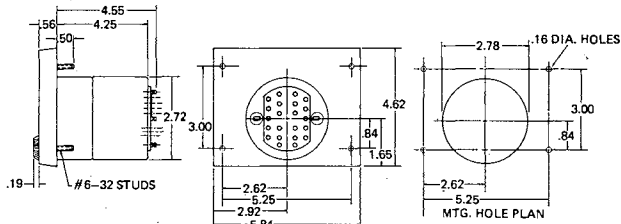

SPECIFICATIONS (Stock Models)

CALIBRATION ACCURACY: ±2% of Full Scale.

CONTROL POINT ADJUSTMENT: The single control is adjustable over the complete 100% arc. The double control limit is variable from 0-95% while the high limit can be located from 5% to 100%. The control points on a double control can be adjusted within 4° of each other. Control point indication is within 1% of control switching.

CONTROL POINT DIFFERENTIAL: Difference between "on" and "off" is within .5% of Full Scale.

POWER REQUIREMENTS: 115 Volts A.C. 50-500 CPS D.C. power required for sensing and switching is provided by the external power module furnished with dual control models. Single control models have self-contained power supply.

OUTPUT: D.P.D.T. relay contacts for each control point. Contacts rated @ 10 amperes, 115 A.C. resistive.

METER INDICATION: Continuous, unaffected by control point setting.

CONTROL CIRCUITRY: Fail safe. Both slave relays. "open" in event of power failure.

MOVEMENT: Self-shielding pivot and jewel or Taut Band.

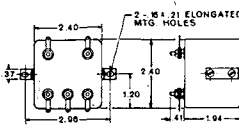

EXTERNAL POWER SUPPLY — Used with all two-control models (supplied with unit).

Contact Type Meter Relays

Model 29XA

for alarm control or limit applications on equipment designed for unattended applications

Contact making types are well suited to most general purpose applications in which cost and reasonable reliability are primary considerations. The contacts are the non-locking type and may be positioned along the scale arc by an external, front adjusted gear drive. Styling and mounting dimensions are designated as the Model 29XA.

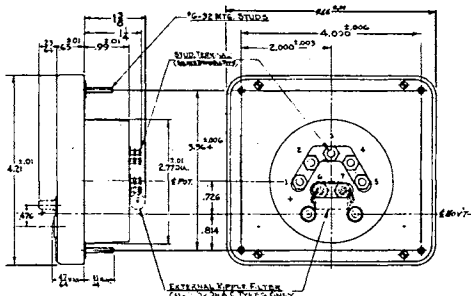
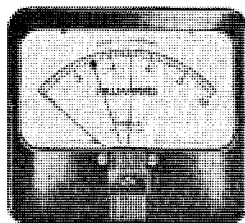

SPECIFICATIONS

GENERAL: Model 29XA Relays are of the D'Arsonval Type. Externally adjusted limit setting contacts are non-locking and intended for circuits with external locking provisions or for light duty non-locking applications.

CALIBRATION: Accuracies ±2% of full scale.

CONTACTS: Gold Alloy. For use @ 15 volts DC, 10 milliamperes maximum, on resistive or diode protected inductive loads.

CONTACT ADJUSTMENT: Contacts are externally adjustable over 95° of 100° scale arc, and within 5° of each other. The pointer will indicate the contact make position within 2° of actual contact intercept.

CONTACT DIFFERENTIAL: Normally, contacts will close within 2% of full scale value and break within 10% of full scale value.

INSULATION: Breakdown 300 volts AC from Relay contacts to meter circuit, 3 KV AC from Relay terminals to mounting panel. (All Tests at 60 cycles.)

RANGE	APPROX. RESIST. (Ohms)	PRICE
DC MICROAMMETERS		
0-50	5200	58.95
0-100	1800	56.40
0-200	1000	52.80
0-500	280	52.05
DC MILLIAMMETER		
0-1	140	50.85
DC MILLIVOLTMETER		
0-50	10	51.00

Simpson new! improved 160 Handi-VOM®

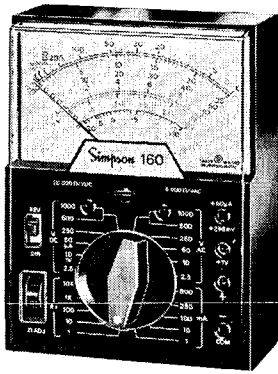

±2% DC, ±3% AC
20,000 Ω/V DC, 5,000 Ω/V AC

Complete with test leads and operator's manual.
160 Handi-VOM®

\$53.00

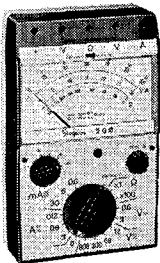

NEW Model 208 and 209 AC-DC VOMs

Bright new ideas in hand-size VOM packages:

- AC current ranges built-in
- Illuminated scales
- Combined current-voltage measurement
- Light-up continuity checker

Both of these new Simpson VOMs have **AC current** ranges built-in. Separate inputs for voltage and current allow easy combined measurements using two sets of leads. All you need do to read current or voltage is flip the range switch. Built with Simpson's "stay accurate" dependability, both models feature shock proof self-shielding movements. Simpson 208 and 209 VOM ranges and specifications are shown in the chart below. Complete with test leads and operator's manual.

208 \$27.50
209 \$68.00

Models 208 and 209 manufactured in West Germany.



Model 355 MIDGETESTER®

So small (2¾"x4½"x1") it easily slips into your shirt pocket. No wonder the 355 Midgetester® — Simpson's smallest test instrument—is popular with

those who must make basic voltage and resistance measurements "in the field." Features self-shielding movement, and 10,000 Ω-volt sensitivity on AC and DC ranges.

Complete with test leads and operator's manual.
355 Midgetester® \$50.00

SPECIFICATIONS	160	208	209	355
Ranges				
DC Volts	0-0.25, 1.0, 2.5, 10, 50, 250, 500, 1000	0-0.6, 3, 12, 60, 300, 600	0-0.06, 12, 60, 300, 600	0.3, 12, 60, 300, 1200
AC Volts	0-2.5, 10, 50, 250, 500, 100	0-12, 60, 300, 600	0-12, 60, 300, 600	0.3, 12, 60, 300, 1200
DC Microamperes	0-50	NONE	NONE	NONE
DC Milliamperes	0-1, 10, 100, 500	0-0.6, 6, 30, 120, 600	0-120, 600	NONE
DC Amperes	NONE	0-3	0-3, 12	NONE
AC Milliamperes	NONE	0-0.6, 6, 30, 120, 600	0-6, 30, 120, 600	NONE
AC Amperes	NONE	0-3	0-3, 12	NONE
DB Scale (1 mW into 600 Ω)	-20 to +10, -8 to +22, +6 to +36, +20 to +50	NONE	NONE	NONE
Resistance	R x 1 (30 Ω center), R x 10, R x 100, R x 1k, R x 10k	R x 1 (128 Ω center), R x 100	R x 1 (43.9 Ω center), R x 100	R x 1 (120 Ω center), R x 10, R x 100, R x 1k
Accuracy				
DC	±2%	±1.5%	±1.5%	±3%
AC	±3%	±2.5%	±2.5%	±5%
Sensitivity				
DC	20,000 Ω/volt	10,000 Ω/volt	1,666 Ω/volt	10,000 Ω/volt
AC	5,000 Ω/volt	10,000 Ω/volt	1,666 Ω/volt	10,000 Ω/volt
Movement Type	Taut Band	Pivot and Jewel	Pivot and Jewel	Pivot and Jewel
Illuminated Scale	NO	YES	YES	NO
Light-Up Continuity Indicator	NO	YES	YES	NO
Scale Length	3.0"	3.75"	3.75"	2.26"
Dimensions (HxWxD)	4⅞" x 3⅜" x 1⅜"	6 x 3⅝" x 1⅜"	6 x 3⅝" x 1⅜"	4½" x 2¼" x 1"
Net Weight	12 ounces	18 ounces	18 ounces	8 ounces
Price	\$53.00	\$72.50	\$68.00	\$50.00

Simpson temperature testers

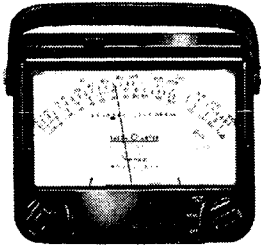

MODELS
388-3L,
389-3L



MODEL
385-3L

RANGE & ACCURACY	PROBES, LEADS & CARRYING CASES	
—50°F. to +70°F. ±1°F. @ Center Scale ±2°F. @ Either End	Description Surface Temperature Probe 0790 \$ 7.50 Free Air Temperature Probe 0789 11.00 Additional Thermistor Lead 0010 7.50 30 Ft. Thermistor Lead 0216 9.00 50 Ft. Thermistor Lead 0415 10.00 100 Ft. Thermistor Lead 0416 13.00 150 Ft. Thermistor Lead 0417 17.00 Ever-Redy Leather Carrying Case .. 8073 11.00	MODEL 385-3L TEMPERATURE METER Model 385-3L is ideal for those fast, accurate temperature checks from —50°F. to +70°F. Lightweight, portable, fits easily in your hand. Three lead model. Takes temperature readings in three different locations with a simple flick of the selector knob. Standard Model has Fahrenheit scale. Supplied with one No. 0010, 15 ft. thermistor lead and operator's manual. Size: 3"x5 ⁷ / ₈ "x2 ¹ / ₂ ". Wt. 1 ¹ / ₂ lbs. \$43.00
	General Purpose Type 0190 \$ 6.50 Surface Temperature Probe Type (1000°F. Max.) 0187 10.75 Rugged Service Lead (8 ft.) 0496 9.00 Ever-Redy Vinyl Carrying Case 5262 13.00	MODEL 388-3L THERM-O-METER® Simpson's popular wide range Therm-O-Meter tester measures the temperature of practically anything within —50°F. to +1000°F. Standard model has combination °C. and °F. scale. Sensing Element: Thermocouple (Iron-Constantan). Supplied with internal battery and one 8' general purpose probe No. 0190 and operator's manual. Order additional probes as required. Size: 7 ¹ / ₄ "x6"x2 ¹ / ₁₆ ". Weight: 4 lbs. Model 388-3L for three probes \$80.00
—50°F. to +1000°F. —40°C. to +500°C. ±1 ¹ / ₂ Scale Divisions	Surface Temperature Probe 0790 \$ 7.50 Free Air Temperature Probe 0789 11.00 Additional Thermistor Lead 0010 7.50 30 Ft. Thermistor Lead 0216 9.00 50 Ft. Thermistor Lead 0415 10.00 100 Ft. Thermistor Lead 0416 13.00 150 Ft. Thermistor Lead 0417 17.00 Ever-Redy Vinyl Carrying Case 5262 13.00	MODEL 389-3L DUAL RANGE THERM-O-METER® Model 389-3L temperature tester, using three leads, makes temperature readings in three different locations at the same time; i.e., in a refrigerator, one lead could be connected to the evaporator plate, another to the wall of the food compartment and the third in the center of the food compartment. Readings are made quickly in 15 to 30 seconds depending on the medium being checked. Supplied with °C. and °F. scale.
	Test Prods and Spade Terminals .. 8379 \$ 3.25 Alligator Clips and Spade Terminals 8376 2.75 Ever-Redy Vinyl Carrying Case 8073 11.00	MODEL 389-3L DUAL RANGE THERM-O-METER® Model 389-3L temperature tester, using three leads, makes temperature readings in three different locations at the same time; i.e., in a refrigerator, one lead could be connected to the evaporator plate, another to the wall of the food compartment and the third in the center of the food compartment. Readings are made quickly in 15 to 30 seconds depending on the medium being checked. Supplied with °C. and °F. scale.
0-10, 0-30, 0-100, 0-300, 0-1000 Millivolts ±3% of Full Scale	APPLIANCE TESTER MODEL 387 MILLIVOLTMETER Make gas unit servicing faster, more accurate. Use Simpson's Millivoltmeter. Simply place the probe across the thermocouple terminals and test for the correct value. Checks Safety Thermocouples on Gas-Fired Units. • Furnaces • Boilers • Hot Water Heaters • Heaters • Dryers • Refrigerators Size: 3"x5 ⁷ / ₈ "x2 ¹ / ₂ ". Wt.: 1 ¹ / ₂ lbs. \$37.00	MODEL 385-3L —50°F. to +100°F. —40°C. to +35°C. +100°F. to +250°F. +40°C. to +120°C. Within ±2°F.

NEW! Model 313 solid-state VOM

VTVM FEATURES...with VOM CONVENIENCE!

Now... accuracy and high impedance in a portable instrument. Operates for over 300 hours on inexpensive, easily obtained batteries. Switch allows battery condition to be checked instantly. A "power on" indicator is also provided. Built for rugged use, the self-shielding movement is shock proof and overload protected. All voltage range inputs are fully protected, too. Even AC line voltage can be applied on ohms ranges without damage to the Field Effect Transistor input. Readouts are quick and easy on the large 7" scale. Accuracy of the new 313 is assured with built-in frequency and temperature compensation.

Model 313 complete with test leads, isolating probe, and operator's manual **\$100.00**
 Carrying Case, Vinyl with Lead Storage Space, Cat. No. 00577 **16.00**
 Sponge Lined Vinyl Case, Cat. No. 01565 **16.00**

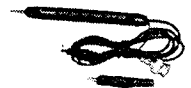
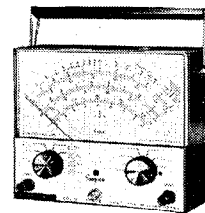

VOLTAGE RANGES

DC: 0-0.3, 1, 2, 10, 30, 100, 300, 1000 volts (11 Megohms input resistance)
 AC: 0-0.3, 1, 2, 10, 30, 100, 300, 1000 volts (10 Megohms input resistance)

CURRENT RANGES

DC: 0-0.1, 1, 10, 100, 1000 milliamperes

RESISTANCE RANGES

RX1 (10 ohm center), RX10, RX100, RX1K, RX10K, RX100K, RX1M

FREQUENCY RESPONSE

±0.5 db from 20 Hz to 100 kHz on 0-0.3, 1, 3 volt ranges
 ±0.5 db from 20 Hz to 20 kHz on 0-10, 30, 100 volt ranges.

ACCURACY

DC: ±3% of full scale AC: ±3% of full scale Resistance: ±3° of arc

Simpson industrial radio and TV test equipment

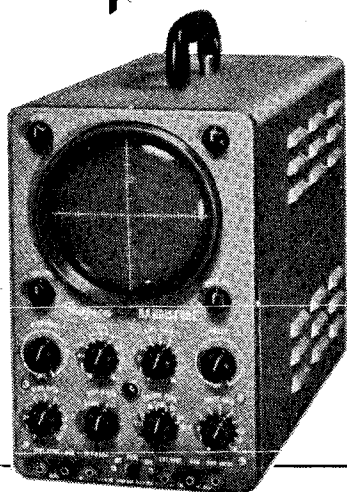

Model 466 HANDISCOPE® with 5" Screen

- Compact—Light Weight
- Rugged Construction

Ideal for general purpose applications in radio and TV servicing and for industrial use. The Handiscope® contains horizontal push-pull amplification for the X axis, vertical push-pull amplification for the Y axis, and an intensity modulation input for the Z axis. Horizontal deflection may be obtained from either the internal sweep circuits or from the external signal voltage. Rugged construction... yet the Handiscope® weighs just 19 lbs.

466 HANDISCOPE® Complete with operator's manual and No. 00100 test leads (for 110 VAC operation) \$190.00

Dual voltage 466 Handiscope® for use on 220/110 volts, 50/60 Hertz 214.00

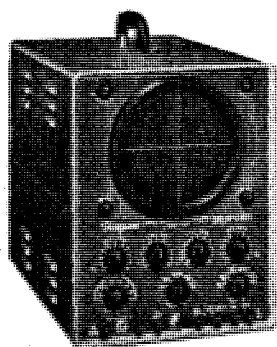

Model 458 — 7" COLORSCOPE®

FEATURES:

- 7" Cathode Ray Tube.
- Wide band operation, the frequency response is flat within ± 1.0 db to 4.5 MHz. Faithfully displays COLOR BURST frequency with a sensitivity greater than 40 Mv rms per inch of vertical deflection.
- Narrow band operation, the frequency response is flat within ± 2 db from 10 Hz to 300 kHz with a sensitivity greater than 15 Mv rms per inch.
- Good square wave response provides accurate representation of sync pulses and composite wave-form pattern for trouble-shooting video, sync, and sweep circuits.
- Horizontal sweep, to 250 kHz, for expansion of high frequency wave-form detail and color burst.
- Vernier and Compensated Decimal Step Attenuator for better signal controls.
- Provision for Intensity Modulation of CRT.
- 1 volt peak to peak calibrating voltage.

458 Colorscope® Complete with operator's manual \$420.00

Accessory probes: See Model 739 in accessory section on back cover.

Dual Voltage 458 Colorscope® for use on 220/110 volts, 50/60 Hertz 430.00

OSCILLOSCOPE SPECIFICATIONS	466 HANDISCOPE®	458 COLORSCOPE®
Tube Size	5"	7"
Frequency Response	15 Hz —100 kHz: Flat to within ± 1 db At 250 kHz: 6 db down Useable to 1 MHz	In Wide-Band operation: Up to 4.5 MHz: Flat to within ± 1 db In Narrow-Band operation: 10 Hz —300 kHz: Flat to within ± 2 db
Vertical Deflection Sensitivity	30 mV RMS/inch	In Wide-Band operation: 40 mV RMS/inch In Narrow-Band operation: 15 mV RMS/inch (minimum)
Calibrating Voltage	1 volt peak-to-peak	1 volt peak-to-peak
Line Voltage Required	110 volts, 50-60 Hz (220 volt model available)	105-125 volts, 50-60 Hz. (220 volt model available)
Size	7 $\frac{7}{8}$ " x 12 $\frac{1}{4}$ " x 16 $\frac{1}{8}$ "	11" x 16 $\frac{1}{2}$ " x 14 $\frac{1}{2}$ "
Net Weight	19 lbs.	29 lbs.
Shipping Weight	27 lbs.	38 lbs.
Price	\$190.00	\$420.00

Model 383A CAPACOHMETER® IN-CIRCUIT Capacitor Leakage Tester

"ONE PACKAGE FLEXIBILITY"

- Measures the leakage resistance of defective paper, mica, or ceramic capacitors
- Indicates directly the capacitance of good paper, mica, or ceramic capacitors over a range of 10.0 pf to 10.0 mf

A pulse technique detects many marginal capacitors. All measurements are made under load conditions. No adjusting of a bridge circuit and balancing controls. Borderline capacitors which cause costly "call backs" are detected immediately with the pulse test.

Line Voltage: 105/125v, 60 Hz.

Shipping Weight 12 lbs.

Complete with test leads and operator's manual \$139.00

Test Lead Assembly — Cat. No. 7509 3.25

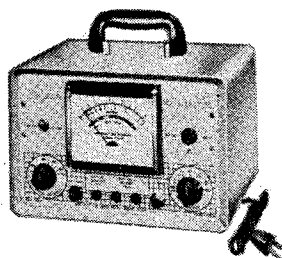

Simpson multi-range standards

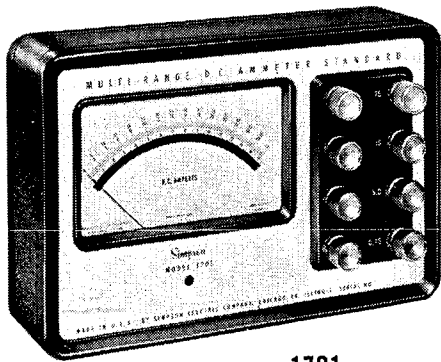

1701

MODEL 1699

This instrument was designed to measure low values of resistance accurately, rapidly, and at low cost. It compensates for the shortcomings of the conventional ohmmeter in the area of low-resistance measurement, while retaining the ohmmeter's simplicity of operation.

The Model 1699 Milliohmmeter determines the value of an unknown resistance by comparing it with a known standard internal resistance.

In low resistance measurements, the contact resistance of the meter probes and the resistance of the test leads become significant sources of error. These errors are avoided by using test leads terminating in Kelvin Clips coupled with a unique circuit which has separate current and voltage paths. This results in $\pm 1\%$ of full scale accuracy — even on the 0-0.05 ohm range.

SPECIFICATIONS

FUNCTION	OHMS	DC VOLTS	DC AMPS	DC MILLIAMPS	DC MICROAMPS	DC MILLIVOLTS
Ranges	0-0.05, 0.1, 0.25, 0.5, 1.0, 5.0, 10.0, 50.0	0-1.5, 3, 7.5, 15, 30, 75, 150, 300, 750, 1500	0-0.75, 1.5, 3.0, 7.5, 15, 30, 75	0-1.5, 3, 7.5, 15, 30, 75, 150, 300, 750, 1500	0-75, 150, 300, 750, 1500	0-30, 75, 150, 300, 750, 1500
Model Number	1699	1700	1701	1702	1703	1704†
Accuracy	$\pm 1.0\%$ fs	$\pm 0.5\%$ fs	$\pm 0.5\%$ fs	$\pm 0.5\%$ fs	$\pm 0.5\%$ fs	$\pm 0.5\%$ fs
Maximum Loss	7.95 mW*	1 milliampere	45 mv	50 to 150 mv	.16 to .58 v	5 ma
Sensitivity	0.001 ohm	1000 Ω/v	—	—	—	200 Ω/v
Scale Length	5.5"	5.5"	5.5"	5.5"	5.5"	5.5"
Enclosure	Steel case with etched aluminum panel, 11 $\frac{1}{8}$ " x 7 $\frac{3}{8}$ " x 3 $\frac{1}{4}$ " deep†					
Net Weight	5 $\frac{3}{4}$ lbs.	5 $\frac{1}{2}$ lbs.	8 lbs.	5 $\frac{1}{2}$ lbs.	5 $\frac{1}{2}$ lbs.	5 $\frac{1}{2}$ lbs.
Catalog Number	13299	13300	13305	13310	13315	13316
Price	\$175	\$180	\$190	\$180	\$185	\$185

*Maximum dissipation in sample.

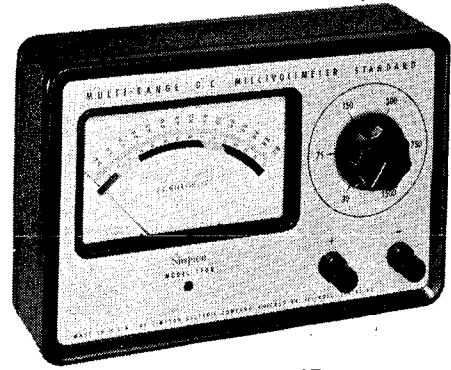

1704

1700 SERIES

These standards are designed for long-term accuracy under maximum usage. Spring-loaded sapphire jewels and hardened pivots insure high shock resistance and minimum friction. A high damping factor, added to high torque, provides rapid response to input level variations and minimizes overshoot.

The combination of a self-shielded, deep-core movement and a steel case makes these instruments impervious to most external magnetic fields found in industry.

These standards use a knife-edge pointer and mirror scale to eliminate parallax errors.

A large-diameter, ceramic rotary switch with solid silver contacts provides range-change in Models 1700, 1702, 1703 and 1704 so that only two binding posts are necessary. On the Model 1701 Ammeter a separate set of 3-way binding posts is provided for each range.

All 1700-series standards are temperature-compensated for operation from 15°C. to 35°C.

NEW amp-clamp for 260° VOMs

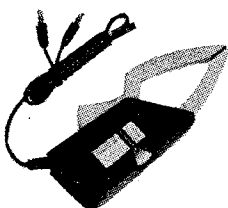

MODEL
150

PLUG-IN ADAPTER FOR AC AMPERE MEASUREMENTS

Clamp-on AC ammeter adapter allows measurement to be made without breaking circuit being tested. Simply plugs into 260°, 261, 270, 250, or 255 VOM. Ranges: 0-5, 10, 25, 50, 100, 250 AC Amperes. Readout is on VOM's 0-2.5 VAC scale. May be used with any VOM having 0-2.5, or 0-3 VAC range. (When used with 0-3 VAC adapter ranges are from 0-6 to 0-300 AC Amperes). Rugged construction, and easy to use.

Model 150 — \$30.00

Carrying Case No. 00548 — \$4.80

Simpson strip chart recorders

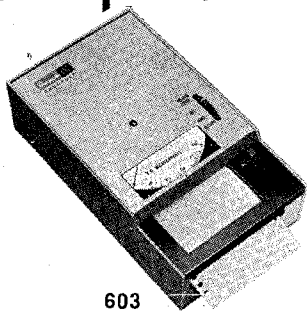

603

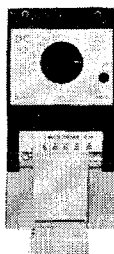

604

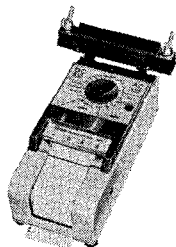

605

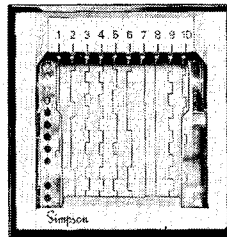

2750

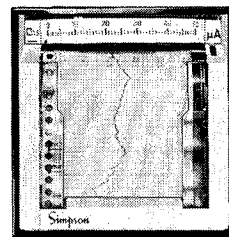

2755

SPECIFICATIONS	603	604	605	2750	2755
Accuracy of Recording					
DC Range	±2.5% of Full Scale	±2.5% of Full Scale	±2.5% of Full Scale	±1.5% of Full Scale	—
AC Range	±4.0% of Full Scale	±2.5% of Full Scale	±2.5% of Full Scale	±1.5% of Full Scale	—
Event channel Response Time	10 milliseconds (nominal)	—	—	—	10 milliseconds (nominal)
Event Indicator Voltage	115 volts/60 Hz.	—	—	—	115 volts/60 Hz.
Built-in Chart Speeds (Switch Selected)	3/12/24/36 in.-per hour (76/305/610/914 mm-per-hour)	1/3/12 inches-per-hour (25/76/305 mm-per-hour)		0.79/4.72 inches-per-hour (20/120 mm-per-hour)	
Impression Rate	2 seconds	2 seconds	2 seconds	3 seconds	Continuous
Chart Paper	Pressure Sensitive, 3" wide, 63 feet long	Pressure Sensitive, 2.6" wide, 50 feet long			
Take-up Reel	Optional	—	—	Built-in	
Motor Drive	Synchronous, 115 volts/60 Hz.				
Size	7½" x 4¾" x 2½"	9¾" x 4¾" x 4"		3¾" x 9½" x 3¾"	
Weight	2½ lbs.	5½ lbs.		4 lbs.	

MODEL 2750 and 2755 MINIATURE RECORDERS

Panel mount, using just 3¾ x 3¾ inches of panel space. Model 2755 has ten event channels. Model 2750 is available in a selection of ranges, including a dual channel version. Both models have two built-in chart speeds.

Range	Catalog Number	Price
Model 2755 Event Recorder 10 channels, 115 volts at 60 Hz.	22200	\$175.00
Model 2750 Recorders		
0-10 DC Microamperes	22000	167.00
0-50 DC Microamperes	22002	153.00
0-100 DC Microamperes	22003	147.50
0-500 DC Microamperes	22004	142.00
0-1 DC Milliampere	22005	140.00
0-1/0-1 DC Milliampere DUAL CHANNEL	22022	185.00
0-50 DC Millivolts	22008	142.00
0-150 AC Volts	22110	148.00

ACCESSORIES for 2750 and 2755 RECORDERS

Portable carrying handle	22392	\$6.35
Plastic window for direct paper feedout	22395	2.00
Gear unit for 30/180 mm-per-hour speeds	22303	7.50
Gear unit for 60/300 mm-per-hour speeds	22302	7.50
Gear unit for 100/600 mm-per-hour speeds	22303	7.50

CHART PAPER for 2750 and 2755 RECORDERS

Calibration	2755 Cat. No.	2750 Cat. No.	per box of 10 rolls
20 mm-per-hour, 30 divisions*	22380	22310	\$18.00
20 mm-per-hour, 50 divisions	—	22311	18.00
30 mm-per-hour, 30 divisions*	22381	22312	18.00
30 mm-per-hour, 50 divisions	—	22313	18.00
60 mm-per-hour, 30 divisions*	22382	22314	18.00
60 mm-per-hour, 50 divisions	—	22315	18.00
100 mm-per-hour, 30 divisions*	22383	22316	18.00
100 mm-per-hour, 50 divisions	—	22317	18.00

* 2755 paper has 10 channel markings.

MODEL 604 and 605 MULTICORDERS®

Both models give dependable inkless recording at less than \$10 per range! One trace indicates measured value; second trace indicates range selected. Model 604: 20,000 Ω/V DC; 5,000 Ω/V AC. Model 605: 666 Ω/V DC and AC.

RANGES	MODEL 604	MODEL 605
DC Millivolts	0-100, 500	0-12, 30, 60
DC Volts	0-2.5, 10, 25, 100, 250, 500	0-3, 15, 60, 300, 600
AC Volts	0-10, 25, 100, 250, 500	0-6, 30, 150, 300, 600
DC Microamperes	0-50, 250	0-600
DC Milliampere	0-1, 5, 25, 100, 250	0-1.5, 3, 6, 30, 150
DC Amperes	0-1	0-1.2, 6
AC Microamperes	0-200	None

MODEL 604 and 605 MULTICORDERS® (Cont'd)

AC Milliampere	None	0-3, 15, 60, 300
AC Amperes	None	0-1.2, 6
Price	\$200.00	\$235.00

ACCESSORIES for model 604 and 605 recorders

	Cat. No.	Price
Ever-Ready Vinyl Carrying Case	02611	\$27.00
Special Gear Unit, 30/60/90 inches-per-hour	00682	30.00

Easy to use plug-in shunts for both models 604 and 605.

Amperes	5	25	50	100
Cat. No.	6526	6527	6528	6531
Price	15.00	15.00	15.00	15.00

CHART PAPER for model 604 and 605 recorders

Calibrations: 50 divisions	Cat. No.	Price per box of 10 rolls
	02612	\$19.50

MODEL 603 RECORDERS

Available in a wide selection of ranges. All use inkless pressure sensitive paper. Four built-in chart speeds are switch selected. Has event channel in addition to listed range. Each 603 recorder is supplied with panel mounting bracket.

RANGE	CATALOG NUMBER			
	Standard Speed	Optional Speed* Medium	Optional Speed* Low	
0-50 DC μA	20001	20201	20101	\$107.00
0-100 DC μA	20002	20202	20102	102.00
0-250 DC μA	20003	20203	20103	98.00
0-1 DC mA	20005	20205	20105	90.00
0-5 DC mA	20007	20207	20107	97.00
0-50 DC mA	20011	20211	20111	97.00
0-500 DC mA	20015	20215	20115	97.00
0-5 DC Amps	20018	20218	20118	98.00
0-50 DC mV	20019	20219	20119	93.00
0-15 DC Volts	20025	20225	20125	97.00
0-50 DC Volts	20027	20227	20127	97.00
0-150 DC Volts	20030	20230	20130	96.00
0-5 AC Amps	20050	20250	20150	120.00
0-5 AC Volts	20070	20270	20170	102.00
0-150 AC Volts	20080	20280	20180	102.00
0-300 AC Volts	20085	20285	20185	104.00
100-130 AC Volts	20086	20286	20186	105.00

*Optional Intermediate Speed Models: 1½/6/12/18 inches-per-hour.
Optional Low Speed Models: ¼/1/2/3 inches-per-hour.

ACCESSORIES for 603 RECORDERS CHART PAPER for 603 RECORDERS

	Cat. No.	Price	Calibration	Cat. No.	Price per box of 6 rolls
Automatic take-up reel	20195	\$16.00	50 divisions	20097	\$14.50
			60 divisions	20099	14.50
Carrying case, vinyl	20196	21.40	75 divisions	20098	14.50

*You can depend on your local
ELECTRONIC DISTRIBUTOR for ...*

- *Instant off-the-shelf delivery*
- *In-depth inventories*
- *Wide varieties*
- *Prompt service*
- *Technical assistance*
- *Availability of the latest products*
- *Speedy purchasing — one order does the job*

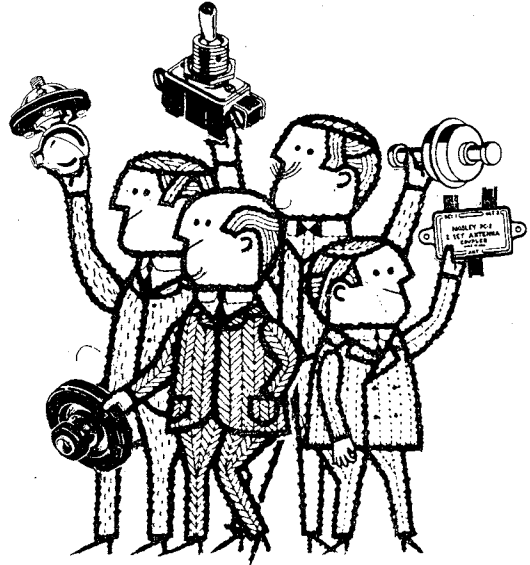

*Contact your local **ELECTRONIC DISTRIBUTOR**
for all your requirements!*

STICHT INSTRUMENTS

"STANDCO" VIBRATING REED FREQUENCY METERS



PANEL MOUNTING

3 1/2" Bakelite Case

- Rugged
- Dependable
- Accuracy ±0.5%
- Reeds aged

HERMETICALLY SEALED

2 1/2" and 3 1/2"

All MIL-Specs. Also Ruggedized Types.

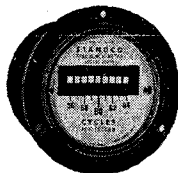

Cat. No.	No. Reeds	Interv. CPS	Range CPS
351	5	1	48-52
352	7	1	47-53
349	9	0.5	48-52
353	11	0.5	47.5-52.5
348	11	1	45-55

356	9	0.5	58-62
357	11	0.5	57.5-62.5
358	21	0.5	55-65

359	5	1	58-62
360	7	1	57-63
361	9	1	56-64
362	11	1	55-65
363	21	1	50-70

Cat. No.	No. Reeds	Interv. CPS	Range CPS
----------	-----------	-------------	-----------

DUAL RANGE

369	5	1	{48-52
	5	1	{58-62

400 CYCLES

374	5	10	380-420
380	5	5	390-410
364	9	5	380-420
366	11	4	380-420

365	11	5	375-425
379	11	8	360-440
376	11	2	390-410
375	17	2.5	380-420

378	17	5	360-440
367	21	2	380-420
368	21	4	360-440

Bulletin 806

"STANDCO" COMBINATION FREQUENCY AND RUNNING TIME METERS

In 3 1/2" flush mounting, round bakelite cases

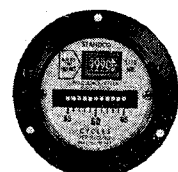

Bulletin 811

Cat. No.	Freq. Range	No. of Reeds.	Time Range
TF-362	55-65 CPS	11 Reeds	9999.9 hrs.
TF-356	58-62 CPS	9 Reeds	9999.9 hrs.
TF-360	57-63 CPS	7 Reeds	9999.9 hrs.
TF-359	58-62 CPS	5 Reeds	9999.9 hrs.

"STANDCO" RUNNING TIME METERS

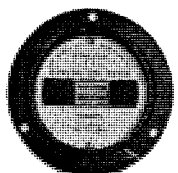

Bulletin 810

ALTERNATING CURRENT

3 1/2" Round Flush	2 1/2" Round Flush with U-Clamp
Type T-1 9999.9 hrs.	Type T-45 9999.99 Hours
Type T-3 99,999 hrs.	115 V 60 cycles
Type T-4 99,999 min.	230 V 60 cycles
115V, 220V, 440V, 60 or 50 cycles	



DIRECT CURRENT TYPE T-60

2 1/2" Round Flush with U-Clamp
Reading Minutes and Hours to 99999 Hours
Standard 12 volts DC
Specials 6, 24, 36 volts DC

Bulletin 9160

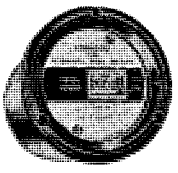

Bulletin 810

AC HERMETICALLY SEALED TYPE

3 1/2" Round Flush	2 1/2" Round Flush
Type T-1 9999.9 hrs.	Type T-25 9999.9 hrs.
Type T-3 99,999 hrs.	Type T-30 99,999 hrs.
Type T-4 99,999 min.	Type T-35 99,999 min.
115V, 220V, 440V, 60 or 50 cycles	



AC MINIATURE TYPE T-40

1 1/8" x 1 1/8" Square Flush with U-Clamp
Register to 9999.99 Hours
115 V 60 cycles
230 V 60 cycles
24 V 60 cycles

Bulletin 9140



VIBRATION TYPE T-75

2 1/2" Round Flush
Operates without electric power source.
Application wherever vibrations occur during operation.

Bulletin 9175

99999 Hours

"STANDCO" TACHOMETERS

HIGH INTENSITY STROBOSCOPE

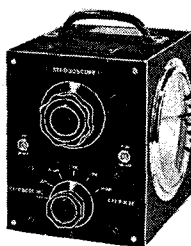

MODEL 510-AL
STOPS MOTION
MEASURES RPM
without contact

With brilliant daylight flasher unit for maximum readability.
With 4 ranges - 60-15,000 RPM
"Industry's Seeing Eye"

Bulletin 781

PORTABLE HAND TACHOMETERS

CENTRIFUGAL AND CHRONOMETRIC TYPES

With one, two, three, five or six ranges in one instrument. All speeds 0-100,000 RPM.

Bulletins 735, 750, 751, 756, 765, 790

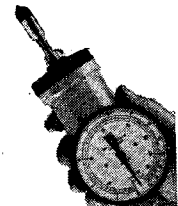

"MEGOHMER" INSULATION TESTERS

DC GENERATOR (HAND CRANK) TYPES

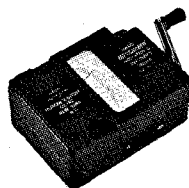

"DWARF" Megohmer, 500 volts DC

Cat. No. 701, 0.1-100 megohms
Cat. No. 702, 0.1-100 megohms
0-10,000 ohms

Bulletin 420

HIGH RESISTANCE MEGOHMMETER

MODEL 29-U

20,000,000 MEGOHMS

Direct Reading: Unusual stability, fast in operation, high accuracy.

11 Ranges: From 300,000 ohms to 20 million megohms.

Power Supply: 115 volts DC, 60 cycles.

Test Potentials: 100 volts DC and 500 volts DC.
Also: 0.5 volts to 1000 volts by external supply.

Bulletin 1029U

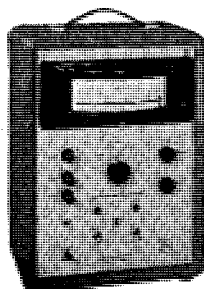

HERMAN H. STICHT COMPANY, INC.

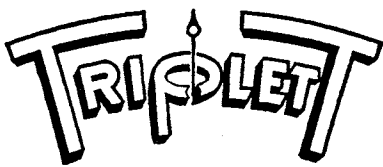

INSTRUMENTS

SELF-CONTAINED DC AMMETERS

For higher ranges, use external shunts (below).

2.5" MODELS 220-G, 221-T AND 227-T

Range	Scale Div.	220-G, 221-T, 227-T			Net Each, Lots of		
		220-G Number	221-T Number	227-T Number	1-24	25-49	50 Up
0-1	50	1029602	1022502	1022802	\$17.00	\$13.60	\$12.75
0-3	60*	1029608	1022506	1022806	17.00	13.60	12.75
0-5	50	1029608	1022506	1022806	17.00	13.60	12.75
0-10	50	1029610	1022510	1022810	17.00	13.60	12.75
0-15	75*	1029611	1022511	1022811	17.00	13.60	12.75
0-25	50	1029613	1022513	1022813	17.00	13.60	12.75
0-30	60*	1029614	1022514	1022814	17.00	13.60	12.75
0-50	50	1029615	1022515	1022815	17.00	13.60	12.75

*For 220-G only: scale division, 30 for 221-T and 227-T.

3.5" MODELS 320-G, 321-T AND 327-T

Range	Scale Div.	320-G, 321-T, 327-T			Net Each, Lots of		
		320-G Number	321-T Number	327-T Number	1-24	25-49	50 Up
0-1	50	1029702	1025602	1025702	\$18.00	\$14.40	\$13.50
0-3	60	1029706	1025606	1025706	18.00	14.40	13.50
0-5	50	1029708	1025608	1025708	18.00	14.40	13.50
0-10	50	1029710	1025610	1025710	18.00	14.40	13.50
0-15	75	1029711	1025611	1025711	18.00	14.40	13.50
0-25	50	1029713	1025613	1025713	18.00	14.40	13.50
0-30	60	1029714	1025614	1025714	18.00	14.40	13.50
0-50	50	1029715	1025615	1025715	18.00	14.40	13.50

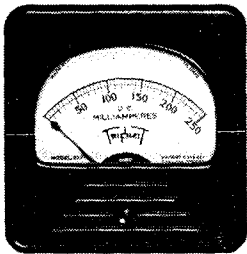

DC 227-T, 327-T
AC 237-S, 337-S

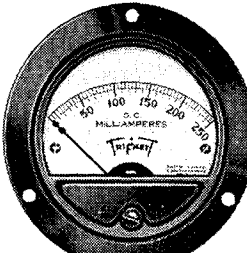

DC 221-T, 321-T
AC 231-S, 331-S

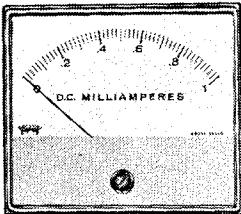

DC 220-G, 320-G, 420-G
AC 230-G, 330-G, 430-G

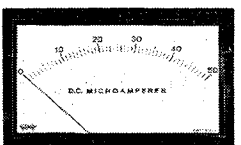

DC 220-G, 320-G, 420-G
AC 230-E, 330-G, 430-G
BEZEL MOUNTED

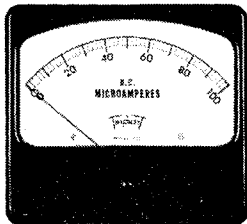

DC 420, AC 430

4.5" MODELS 420-G AND 420

Range	Scale Div.	420-G, 420		Net Each, Lots of		
		420-G Number	420 Number	1-24	25-49	50 Up
0-1	50	1029802	1026202	\$19.00	\$15.20	\$14.25
0-3	60	1029806	1026206	19.00	15.20	14.25
0-5	50	1029808	1026208	19.00	15.20	14.25
0-10	50	1029810	1026210	19.00	15.20	14.25
0-15	75	1029811	1026211	19.00	15.20	14.25
0-25	50	1029813	1026213	19.00	15.20	14.25
0-30	60	1029814	1026214	19.00	15.20	14.25
0-50	50	1029815	1026215	19.00	15.20	14.25

DC AMMETER SHUNTS

Number	Amps	mV	Net*	Number	Amps	mV	Net*
91A-589	0-1	50	\$ 9.40	91A-608	0-500	50	\$ 16.50
91A-600	0-2	50	9.40	91A-609	0-600	50	19.30
91A-601	0-5	50	9.40	91A-610	0-750	50	22.90
91A-602	0-10	50	9.40	91A-611	0-800	50	23.90
91A-603	0-20	50	9.40	91A-585	0-1000	50	41.60
91A-604	0-30	50	9.40	91A-586	0-1200	50	43.00
91A-605	0-100	50	9.40	91A-587	0-1500	50	50.20
91A-606	0-150	50	9.40	91A-588	0-2000	50	60.20
91A-607	0-200	50	9.40	91A-589	0-2500	50	77.90
91A-593	0-250	50	9.90	91A-590	0-3000	50	92.30
91A-594	0-300	50	10.90	91A-591	0-4000	50	152.20
91A-595	0-400	50	13.50	91A-592	0-5000	50	180.00

NULL METERS

Suspension-type, in G-Series case. Sensitivity at null point, 0.3 μA per degree. End scale value is 40-0-40 (±20%). Center spot mirrored to eliminate parallax. Resistance, 1700 ohms.

Triplet Number 806937 - Model 320-G, 3/4" Net Ea. \$39.00*

Triplet Number 8069852 - Model 420-G, 1/2" Net Ea. 40.40*

DC VOLTMETERS

Film type resistors: 1000 ohms/volt.

2.5" MODELS 220-G, 221-T AND 227-T

Range	Scale Div.	220-G, 221-T, 227-T			Net Each, Lots of		
		220-G Number	221-T Number	227-T Number	1-24	25-49	50 Up
0-1	50	1049602	1042502	1042802	\$18.00	\$14.40	\$13.50
0-3	60*	1049606	1042506	1042806	18.00	14.40	13.50
0-5	50	1049608	1042508	1042808	18.00	14.40	13.50
0-10	50	1049610	1042510	1042810	18.00	14.40	13.50
0-15	75*	1049611	1042511	1042811	18.00	14.40	13.50
0-25	50	1049613	1042513	1042813	18.00	14.40	13.50
0-30	60	1049614	1042514	1042814	18.00	14.40	13.50
0-50	50	1049615	1042515	1042815	18.00	14.40	13.50
0-100	50	1049618	1042518	1042818	18.00	14.40	13.50
0-150	75*	1049619	1042519	1042819	18.00	14.40	13.50
0-200	40	1049620	1042520	1042820	18.00	14.40	13.50
0-250	50	1049621	1042521	1042821	18.00	14.40	13.50
0-300	60*	1049622	1042522	1042822	18.00	14.40	13.50
0-500*	50	1049625	1042525	1042825	18.50	14.80	13.87
0-750*	75*	1049627	1042527	1042827	18.50	14.80	13.87
0-1000*	50	1049629	1042529	1042829	23.50	18.80	17.62
0-2000*	40	1049630	1042530	1042830	23.50	18.80	17.62
0-3000*	60*	1049631	1042531	1042831	23.50	18.80	17.62
0-5000*	50	1049633	1042533	1042833	23.50	18.80	17.62

3.5" MODELS 320-G, 321-T AND 327-T

Range	Scale Div.	320-G, 321-T, 327-T			Net Each, Lots of		
		320-G Number	321-T Number	327-T Number	1-24	25-49	50 Up
0-1	50	1049702	1045602	1045702	\$19.00	\$15.20	\$14.25
0-3	60	1049706	1045606	1045706	19.00	15.20	14.25
0-5	50	1049708	1045608	1045708	19.00	15.20	14.25
0-10	50	1049710	1045610	1045710	19.00	15.20	14.25
0-15	75	1049711	1045611	1045711	19.00	15.20	14.25
0-25	50	1049713	1045613	1045713	19.00	15.20	14.25
0-30	60	1049714	1045614	1045714	19.00	15.20	14.25
0-50	50	1049715	1045615	1045715	19.00	15.20	14.25
0-100	50	1049718	1045618	1045718	19.00	15.20	14.25
0-150	75	1049719	1045619	1045719	19.00	15.20	14.25
0-200	40	1049720	1045620	1045720	19.00	15.20	14.25
0-250	50	1049721	1045621	1045721	19.00	15.20	14.25
0-300	60	1049722	1045622	1045722	19.00	15.20	14.25
0-500	50	1049725	1045625	1045725	19.50	15.60	14.62
0-750*	75	1049727	1045627	1045727	19.50	15.60	14.62
0-1000*	50	1049729	1045629	1045729	24.50	19.60	18.37
0-2000*	40	1049730	1045630	1045730	24.50	19.60	18.37
0-3000*	60	1049731	1045631	1045731	24.50	19.60	18.37
0-5000*	50	1049733	1045633	1045733	24.50	19.60	18.37

4.5" MODELS 420-G AND 420

Range	Scale Div.	420-G, 420		Net Each, Lots of		
		420-G Number	420 Number	1-24	25-49	50 Up
0-1	50	1049802	1046202	\$20.00	\$16.00	\$15.00
0-3	60	1049806	1046206	20.00	16.00	15.00
0-5	50	1049808	1046208	20.00	16.00	15.00

DC VOLTMETERS

4.5" MODELS 420-G AND 420 (continued)

Range	Resis., Ohms	220-G, 221-T, 227-T			Net Each, Lots of		
		220-G Number	221-T Number	227-T Number	1-24	25-49	50 Up
0-10	50	1049810	1046210	20.00	16.00	15.00	
0-15	75	1049811	1046211	20.00	16.00	15.00	
0-25	50	1049813	1046213	20.00	16.00	15.00	
0-30	60	1049814	1046214	20.00	16.00	15.00	
0-50	50	1049815	1046215	20.00	16.00	15.00	
0-100	50	1049818	1046218	20.00	16.00	15.00	
0-150	75	1049819	1046219	20.00	16.00	15.00	
0-200	40	1049820	1046220	20.00	16.00	15.00	
0-250	50	1049821	1046221	20.00	16.00	15.00	
0-300	60	1049822	1046222	20.00	16.00	15.00	
0-500	50	1049825	1046225	20.50	16.40	15.37	
0-750	75	1049827	1046227	20.50	16.40	15.37	
0-1000*	50	1049829	1046229	25.50	20.40	19.12	
0-2000*	40	1049830	1046230	25.50	20.40	19.12	
0-3000*	60	1049831	1046231	25.50	20.40	19.12	
0-5000*	50	1049833	1046233	25.50	20.40	19.12	

*2000 ohms/volt; external resistor board supplied. †Scale division for 220-G only; 30 divisions for 221-T and 227-T.

DC MILLIVOLTMETERS

2.5" MODELS 220-G, 221-T AND 227-T

Range	Resis., Ohms	220-G, 221-T, 227-T			Net Each, Lots of		
		220-G Number	221-T Number	227-T Number	1-24	25-49	50 Up
0-50	6.7	1039615	1032515	1032815	\$17.00	\$13.60	\$12.75
0-100	13.						

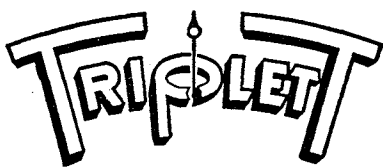

INSTRUMENTS

RF THERMOAMMETERS

2.5" MODELS 240-G, 241-T AND 247-T

Range	Resis., Ohms	Net Each, Lots of		
		240-G Number	241-T Number	247-T Number
0-0.5	.93	1079601	1072501	1072801
0-1	.35	1079602	1072502	1072802
0-1.5	.21	1079603	1072503	1072803
0-2.5	.13	1079605	1072505	1072805
0-5	.06	1079608	1072508	1072808
0-10	.03	1079610	1072510	1072810

3.5" MODELS 340-G, 341-T AND 347-T

Range	Resis., Ohms	Net Each, Lots of		
		340-G Number	341-T Number	347-T Number
0-0.5	.93	1079701	1075601	1075701
0-1	.35	1079702	1075602	1075702
0-1.5	.21	1079703	1075603	1075703
0-2.5	.13	1079705	1075605	1075705
0-5	.06	1079708	1075608	1075708
0-10	.03	1079710	1075610	1075710

4.5" MODELS 440-G AND 440

Range	Resis., Ohms	Net Each, Lots of		
		440-G Number	440 Number	440 Number
0-0.5	.93	1079801	1076201	\$22.50
0-1	.35	1079802	1076202	\$18.00
0-1.5	.21	1079803	1076203	\$18.00
0-2.5	.13	1079805	1076205	\$18.00
0-5	.06	1079808	1076208	\$18.00
0-10	.03	1079810	1076210	\$18.00

EDGEWISE 3 1/2" AND 4 1/2" METERS

Two popular sizes, designed for strikingly clean appearance. Occupy minimum panel space, with the performance of conventional meters. Bar-Ring movement permits meter stacking for maximum instrument space. Anti-parallax pointer minimizes reading error. Scale Length: 3 1/2" models, 2.75"; 4 1/2" models, 3.87". Panel Hole Required: 3 1/2" models, 3.421" x 1.281"; 4 1/2" models, 4.25" x 1.5". Depth Behind Panel: 3 1/2" models, 2.583"; 4 1/2" models, 3.53".

To Order: Specify both Model and Triplet Part Number from tables below. Example: Model 320-E, Number 1013502, is a 3 1/2" DC milliammeter, range 0-1 mA.

Mounting Bezels for Edgewise Meters: For behind-panel mtg. Triplet Number 11977A—For 3 1/2" meter, Net Each... \$1.10 Triplet Number 11967A—For 4 1/2" meter, Net Each... 1.60

DC MILLIAMMETERS

Range	Resis., Ohms	3 1/2" Edgewise Model 320-E		4 1/2" Edgewise Model 420-E	
		Number	Net	Number	Net
0-1	55	1013502	\$27.00	1017002	\$28.00
0-5	8.5	1013508	27.00	1017008	28.00
0-10	3.1	1013510	27.00	1017010	28.00
0-50	1.0	1013515	27.00	1017015	28.00
0-100	.5	1013518	27.00	1017018	28.00
0-200	.25	1013520	27.00	1017020	28.00
0-300	.17	1013522	27.00	1017022	28.00
0-500	.1	1013525	27.00	1017025	28.00

DC MILLIVOLTMETERS

0-50	6.7	1033515	\$27.50	1037015	\$28.50
------	-----	---------	---------	---------	---------

DC MICROAMMETERS (PIVOT AND JEWEL)

0-50	2000	1063515	\$32.00	1067015	\$33.00
0-100	825	1063518	30.50	1067018	31.50
0-200	360	1063520	29.00	1067020	30.00
0-500	156	1063525	28.00	1067025	29.00

DC MICROAMMETERS (SUSPENSION TYPE)

Range	Resis., Ohms	3 1/2" Model 320-E		4 1/2" Model 420-E		
		Triplet Number	Net Each	Resis., Ohms	Triplet Number	Net Each
0-10	7500	8063510	\$46.00	15000	8067010	\$47.00
0-20	2500	8063512	41.00	7500	8067012	42.00
0-50	825	8063515	34.50	2300	8067015	35.50
0-100	360	8063518	32.00	825	8067018	33.00
0-200	156	8063520	31.00	360	8067020	32.00
0-500	40	8063525	30.50	156	8067025	31.50

DC AMMETERS (50 MILLIVOLT)

Range	Scale Div.	3 1/2" Edgewise Model 320-E		4 1/2" Edgewise Model 420-E	
		Number	Net	Number	Net
0-1	50	1023502	\$27.50	1027002	\$28.50
0-5	50	1023508	27.50	1027008	28.50
0-10	50	1023510	27.50	1027010	28.50
0-25	50	1023513	27.50	1027013	28.50
0-50	50	1023515	27.50	1027015	28.50

DC VOLTMETERS (1000 OHMS/VOLT)

0-5	50	1043508	\$28.50	1047008	\$29.50
0-10	50	1043510	28.50	1047010	29.50
0-25	50	1043513	28.50	1047013	29.50
0-50	50	1043515	28.50	1047015	29.50
0-150	75	1043519	28.50	1047019	29.50
0-300	60	1043522	28.50	1047022	29.50
0-500	50	1043525	28.50	1047025	29.50

AC EDGEWISE METERS

Range	Resis., Ohms/Volt	3 1/2" Edgewise Model 330-E		4 1/2" Edgewise Model 430-E	
		Number	Net	Number	Net
0-1 amps	.38	1103502	\$26.50	1107002	\$27.50
0-10 mA	4000	1123510	26.50	1127010	27.50
0-150 V	125	1113519	27.50	1117019	28.50

R-SERIES 3 1/2"-4 1/2" AND G-SERIES 5 1/2" METERS

R-Series (Fig. A): Distinctive modern design in transparent and black molded plastic. Provides dominant scale in limited panel space. Self-shielded for accuracy and reliability. DC meters have Bar-Ring movement for high torque, fast response. Plated shroud, shatterproof window, screw-fastened front.

G-Series (Fig. B): 5 1/2" meter with modern design for greater flexibility and interchangeability. DC meters have self-shielded Bar-Ring magnet and one-piece diecast frame.

To Order: Specify both Model and Triplet Number. Example: Model 320-R, No. 1015102, a 3 1/2" R-Series 0-1 DC milliammeter.

Model	Meter Type	Nom. Size	Fig.	Scale Lgth.	Flange Size, In. x H.	Body Size, In. Dia. x Depth
320-R	DC	3 1/2"	A	2.96"	3.954 x 2.673	2.156 x 1.311
420-R	DC	4 1/2"	A	3.456"	4.500 x 2.970	2.203 x 1.311
520-G	DC	5 1/2"	B	5.00"	5.611 x 4.484	2.750 x 1.390
330-R	AC	3 1/2"	A	2.5"	3.954 x 2.673	2.156 x 1.311
430-R	AC	4 1/2"	A	2.874"	3.500 x 2.970	2.203 x 1.311
530-G	AC	5 1/2"	B	4.25"	5.611 x 4.484	2.750 x 1.390

G-Series Half Bezel: For behind-panel mtg. in panels to 1/8". Size, 5.060" x 3.300". For panel hole, 5.875" x 3.156". Triplet Number 13A-240—Net Each... \$2.10

DC MILLIAMMETERS

Range	Resis., Ohms	3 1/2" R-Series Model 320-R		4 1/2" R-Series Model 420-R		5 1/2" G-Series Model 520-G	
		Number	Net	Number	Net	Number	Net
0-1	55	1015102	\$17.50	1017802	\$18.50	1019902	\$25.00
0-5	8.5	1015108	17.50	1017808	18.50	1019908	25.00
0-10	3.1	1015110	17.50	1017810	18.50	1019910	25.00
0-50	1.0	1015115	17.50	1017815	18.50	1019915	25.00
0-100	.5	1015118	17.50	1017818	18.50	1019918	25.00
0-200	.25	1015120	17.50	1017820	18.50	1019920	25.00
0-300	.17	1015122	17.50	1017822	18.50	1019922	25.00
0-500	.1	1015125	17.50	1017825	18.50	1019925	25.00

DC MICROAMMETERS (PIVOT AND JEWEL)

0-50	2000	1065115	\$22.50	1067815	\$23.50	1069915	\$30.00
0-100	825	1065118	21.00	1067818	22.00	1069918	28.50
0-200	360	1065120	19.50	1067820	20.50	1069920	27.00
0-500	156	1065125	18.50	1067825	19.50	1069925	26.00

DC MICROAMMETERS (SUSPENSION TYPE)

0-5	15000	8065108	\$42.50	8067808	\$43.50	8069910	\$44.00
0-10	7500	8065110	36.50	8067810	37.50	8069912	39.00
0-20	2500	8065112	31.50	8067812	32.50	8069914	34.00
0-50	825	8065115	25.00	8067815	26.00	8069915	32.50
0-100	360	8065118	22.50	8067818	23.50	8069918	30.00
0-200	156	8065120	21.50	8067820	22.00	8069920	29.00
0-500	40	8065125	21.00	8067825	22.00	8069925	28.50

DC MILLIVOLTMETERS

0-50	6.7	1035115	\$18.00	1037815	\$19.00	1039915	\$25.50
------	-----	---------	---------	---------	---------	---------	---------

DC AMMETERS (50 MILLIVOLT)

Range	Scale Div.	3 1/2" R-Series Model 320-R		4 1/2" R-Series Model 420-R		5 1/2" G-Series Model 520-G	
		Number	Net	Number	Net	Number	Net
0-1	50	1025102	\$18.00	1027802	\$19.00	1029902	\$25.50
0-5	50	1025108	18.00	1027808	19.00	1029908	25.50
0-10	50	1025110	18.00	1027810	19.00	1029910	25.50
0-25	50	1025113	18.00	1027813	19.00	1029913	25.50
0-50	50	1025115	18.00	1027815	19.00	1029915	25.50

DC VOLTMETERS (1000 OHMS/VOLT)

0-5	50	1045108	\$19.00	1047808	\$20.00	1049908	\$26.50
0-10	50	1045110	19.00	1047810	20.00	1049910	26.50
0-25	50	1045113	19.00	1047813	20.00	1049913	26.50
0-50	50	1045115	19.00	1047815	20.00	1049915	26.50
0-150	75	1045119	19.00	1047819	20.00	1049919	26.50
0-300	60	1045122	19.00	1047822	20.00	1049922	26.50
0-500	50	1045125	19.00	1047825	20.00	1049925	26.50

AC AMMETERS

Range	Resis., Ohms	3 1/2" R-Series Model 330-R		4 1/2" R-Series Model 430-R		5 1/2" G-Series Model 530-G	
		Number	Net	Number	Net	Number	Net
0-1	.38	1105102	\$17.00	1107802	\$18.00	1109902	\$24.50
0-5	.014	1105108	17.00	1107808	18.00	1109908	24.50
0-10	.004	1105110	17.00	1107810	18.00	1109910	24.50
0-15	.003	1105111	17.00	1107811	18.00	1109911	24.50
0-25	.002	1105113	17.00	1107813	18.00	1109913	24.50
0-30	.001	1105114	17.00	1107814	18.00	1109914	24.50
0-50	.00035	1105115	17.00	1107815	18.00	1109915	24.50

AC MILLIAMMETERS

0-10	4000	1125110	\$17.00	1127810	\$18.00	1129910	\$24.50
0-100	40	1125118	17.00	1127818	18.00	1129918	24.50
0							

WORLD'S MOST POPULAR MINIATURE V-O-M

Volt-Ohm-Milliammeter

MODEL 310

1. Hand size V-O-M with provision for attaching AC clamp-on ammeter.
2. 20,000 Ohms per volt DC sensitivity; 5,000 AC.
3. One selector switch minimizes chance of incorrect settings and burnouts.

Self-shielded for checking in strong magnetic fields.
Rugged, high torque, bar-ring instrument.
Unbreakable plastic meter window.
Fitting interchangeable test prod into top of tester makes it the common probe, freeing one hand.
Standard sensitivity 20,000 ohms per volt DC, and 5,000 ohms per volt AC.

Spring-backed instrument jewels for ruggedness.
Accuracy 3% DC, 4% AC.

RANGES

DC Volts: 0-3-12-60-300-1,200 (at 20,000 ohms per volt). AC Volts: 0-3-12-60-300-1,200 (at 5,000 ohms per volt).
Ohms: 0-20,000-200,000. Megohms: 0-2-20.
DC Microamperes: 0-600 at 250 millivolts. DC Milliampers: 0-6-60-600 at 250 millivolts. Weight—Approx. 14 oz., complete with batteries.

Case—Molded, black, 2 3/4" x 4 1/4" x 1 1/2".

Complete with leads, battery and instruction manual. Shipping wt. 2 lbs.
Model 310 Catalog No. 3018 \$44.00

Volt-Ohm-Milliammeter

MODEL 310-C

New 310-C is the same as Model 310, above, (except 600 volt ranges replace 1200 volt ranges of model 310) plus the following features:

1. Hand size V-O-M with provision for attaching AC clamp-on ammeter.

2. 15,000 Ohms per volt AC sensitivity; (20,000 DC same as 310).
3. Single fully enclosed lever range switch, plus DC polarity reversing.

Model 310-C Catalog No. 3022 \$56.00

V-O-M and Clamp-On Ammeter Set

MODEL 100

Handsomely packaged set includes: Model 310 V-O-M, Model 10 Clamp-on Ammeter Adapter; Model 101 Line Separator; Model 379 Leather Case; Model 311 Leads. (\$83.20 Value Separate Unit Purchase Price.)

Model 100, as above, you save \$5.20 over individual purchase price. Shipping wt. 7 lbs.

Model 100 Catalog No. 3014 \$78.00

Model 100-C Same as above but with Model 310-C.

Model 100-C Catalog No. 3010 \$88.00

Clamp-On Adapter

MODEL 10

CHECKS LINE LOADS WITH MODEL 310 OR 310-C

(Also can be used with Models 630, 630-A, 630-NA, 631, 630-PL, 630-APL, 630-M, 630-NS, 630-PLK, 630-L by means of 611 leads.)

Checks all line loads instantly, accurately, safely—without breaking the circuit or interrupting work. Easy range switching. Model 10 Clamp-On Adapter AC Ammeter ranges: 0-6-12-30-60-120-300. Clips around single wire to read A.C.

Amperes direct. Used with Adapter 101 to divide instantly two-conductor cords. A lever securely locks the Model 10 to Model 310 when used in combination. Model 10 can be left attached to Model 310 when the latter tester is used as an AC-DC V-O-M only. The only change is to remove the lead plug from the Model 310 V-O-M jack and insert it in the jack provided in the Model 10 housing. Case black molded plastic with engraved white markings.
Model 10 Catalog No. 60211 \$20.00

No. 611 LEADS

In addition to use with the Model 310, the No. 10 Adapter also can be used as a Clamp-On Ammeter with any Volt-Ohm-Milliammeter having a 3 AC Volt scale at 5,000 Ohms per Volt or above, such as Triplett Models 630, 630-A, 630-

NA, 630-PL, 630-APL, 630-NS, 630-M, 630-PLK, 630-L, 631, etc. (see illustration). This is done by means of a long lead attachment (No. 611) making possible easy readings in difficult locations.
611 Leads Catalog No. 79-160 \$3.20

No. 311 LEADS

The Model 10 can be separated from the Model 310 (in the same way as above) by using No. 311 lead attach-

ment. This permits readings in difficult locations.

311 Leads Catalog No. 79-161 \$3.20

Line Separator

MODEL 101

Plugs into AC outlet to divide instantly two-conductor cords. Increases ammeter sensitivity 10X and 20X. Use up to 30 AC Amperes from 0.3 to 30 in nine steps. Also has provision for Voltmeter

prods for voltage measurements. Case, black molded plastic with engraved markings.

Model 101 Catalog No. 60218 \$8.00

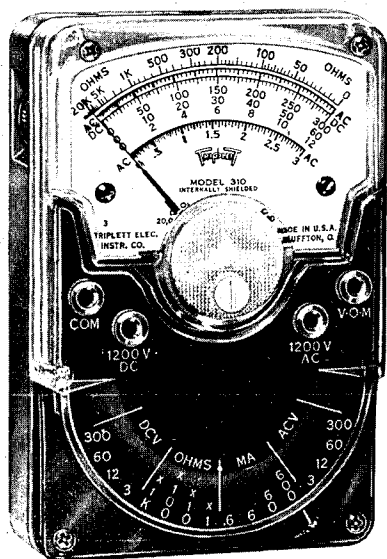

310

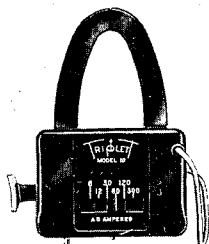

Model 10

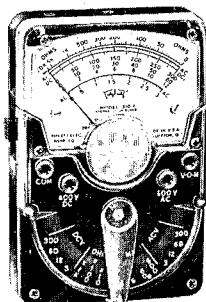

310-C



100

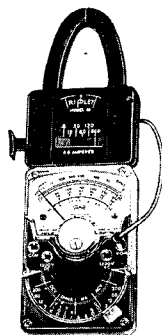

310-10

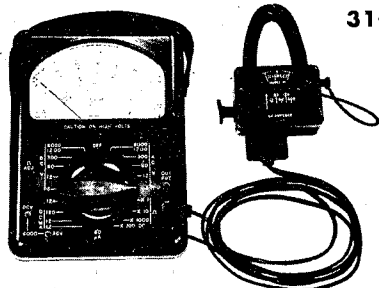

630 Series VOM & Model 10

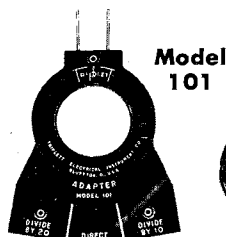

Model 101



611 Leads

All Prices Are Suggested U.S.A. User Net Subject To Change. Specifications Subject To Revision. (Slightly Higher West of Rockies and in Canada)

LABORATORY ACCURACY V-O-Ms

ONE MILLION OHMS PER VOLT SENSITIVITY

Volt-Ohm-Milliammeter

MODEL 630-M

TYPE 1

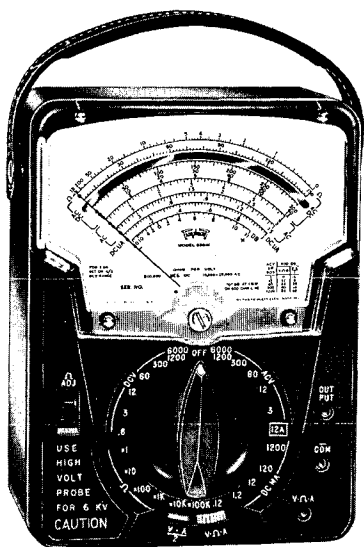

630-M

- 1,000,000 Ohms per volt DC for greater accuracy on high resistance circuits. 20,000 ohms per volt AC.
- 1 μ a Suspension Meter Movement. No pivots, bearings, or rolling friction. Extremely rugged. Greater sensitivity and repeatability.
- 61 Ranges, usable with frequencies through 100 kHz. Temperature compensated. 1 1/2% DC accuracy, 3% AC in horizontal position.

Now the input impedance of a VTVM with the convenience of a V-O-M. Reads as low as 20 nanoamperes. Components mounted on quality glass epoxy etched circuit board. Meter protected by diodes against accidental overload.

RANGES

DC Volts: 0-0.6-3-12-60-300 at 500,000 Ohms/Volt.
0-0.3-1.5-6-30-150 at 1,000,000 Ohms/Volt.

0-1200 at 125,000 Ohms/Volt.
0-600 at 250,000 Ohms/Volt.
AC Volts: 0-3-12-60-300-1200 at 10,000 Ohms/Volt.
0-1.5-6-30-150-600 at 20,000 Ohms/Volt.
DB: -20 to +63 in 10 ranges
DC Microamperes: 0-1 at 300 M.V.
0-60-600 at 300 M.V.
0-120 at 600 M.V.
DC Milliamperes: 0-6-60-600 at 300 M.V.
0-1.2-12-120-1200 at 600 M.V.
DC Amperes: 0-6 at 300 M.V.
0-12 at 600 M.V.
Ohms: 0-1K-10K-100K (4.4-44-440 at center scale)
Megohms: 0-1-10-100 (4400-44,000-440,000 Ohms center scale)
Output: Condenser in series with AC Volt ranges
Case—Heavy, malded black case, 3-11/32" x 5 1/2" x 7 1/2", with removable black leather strap handle. Shipping wt. 5 lbs.

Model 630-M Cat. No. 3108 \$220.00

NOT 20,000 BUT 200,000 OHMS PER VOLT

Volt-Ohm-Milliammeter

MODEL 630-NS

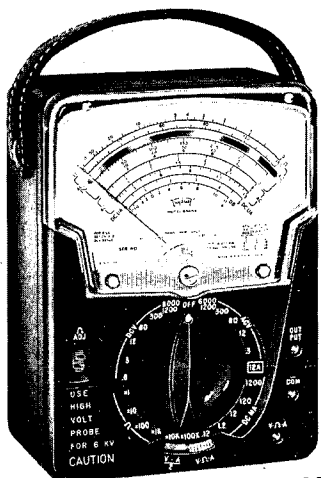

630-NS

- 200,000 Ohms per volt DC sensitivity for greater accuracy on high resistance circuits. 20,000 ohms per volt AC.
- Suspension Meter Movement. No pivots, no bearings, no hair-springs; no rolling friction. Extremely rugged.
- 62 Ranges. Temperature and frequency compensated. $\pm 1\frac{1}{2}\%$ DC Accuracy, $\pm 3\%$ AC.

The unit is precision designed to give maximum coverage, to withstand accidental overloads and to offer greater reading accuracy. Usable with frequencies through 100 kHz. Accuracy 1 1/2% DC, 3% AC.

RANGES

DC Volts: 0-0.6-3-12-60-300-1200 at 100,000 Ohms/Volt.

0-0.3-1.5-6-30-150-600 at 200,000 Ohms/Volt.
0-0.150 at 60 microamperes.
AC Volts: 0-3-12-60-300-1200 at 10,000 Ohms/Volt.
0-1.5-6-30-150-600 at 20,000 Ohms/Volt.
DB: -20 to +63 in 10 ranges.
DC Microamperes: 0-60-600 at 150 Mv.
0-5-120 at 300 Mv.
DC Milliamperes: 0-6-60-600 at 150 Mv.
0-1.2-12-120-1200 at 300 Mv.
DC Amperes: 0-6 at 150 Mv.
0-12 at 300 Mv.
Ohms: 0-1K-10K-100K (4.4-44-440 at center scale).
Megohms: 0-1-10-100 (4400-44,000-440,000 Ohms center scale).
Output: Condenser in series with AC Volt ranges.
CASE—Molded, black, 3-11/32" x 5 1/2" x 7 1/2". Shipping wt. 5 lbs.
Model 630-NS Cat. No. 3102 \$110.00

Volt-Ohm-Milliammeter

MODEL 630-NA

TYPE 2

Suspension Movement

- One selector switch minimizes chance of incorrect settings and burnouts.
- 70 Ranges: 1 1/2% DC accuracy on meter; with mirrored scale and diode overload protection.
- Temperature and frequency compensation.

The super deluxe of V-O-Ms. Usable with frequencies through 500 kHz. Large open front meter easy to read. Unbreakable window. Mirrar scale. Meter has special diode protection against the most severe overloads. A fuse affords protection to resistors in the ohmmeter circuit (especially the X1 setting) should too high a voltage be applied.
Accuracy 1 1/2% DC, 3% AC.

RANGES

DC Volts: 0-6-3-12-60-300-1,200-6,000 at 10,000 ohms per volt.
0-3-1.5-6-30-150-600-3,000 at 20,000 ohms per volt.

0-0.120 at 60 microamperes.
AC Volts: 0-3-12-60-300-1,200-6,000 at 5,000 ohms per volt.
0-1.5-6-30-150-600-3,000 at 10,000 ohms per volt.
Ohms: 0-1K-10K-100K.
Megohms: 0-1-10-100.
DC Microamperes: 0-120 at 240 millivolts.
0-60-600 at 120 millivolts.
DC Milliamperes: 0-1.2-12-120-1,200 at 240 millivolts.
0-6-60-600 at 120 millivolts.
DC Amperes: 0-12 at 240 millivolts.
0-6 at 120 millivolts.
DB: -20 to +77 (600 ohm line at 1 MW).
Output Volts: 0-3-12-60-300-1,200; jack with condenser in series with AC ranges.
Case—Molded, black, 3-11/32" x 5 1/2" x 7 1/2".
Complete with leads, alligator clips, rubber feet, batteries and instruction manual. Shipping wt. 5 lbs.
Model 630-NA Cat. No. 3042 \$93.00

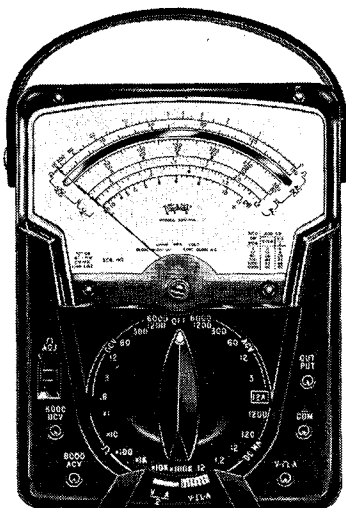

630-NA Type 2

TVO TRANSISTORIZED VOLT-OHMMETER

MODEL 600

1. F-E-T Circuitry — Battery Operated with 11 Megohm Input Impedance (Field Effect Transistor).
2. 400 DC Mv range at 2.7 Megohm Impedance for Solid State circuit testing.
3. One Selector Switch with 23 ranges plus a Polarity Reversing Switch.

Superior voltage Measuring Capabilities plus resistance ranges to 100 Megohms. .4 Volt full scale range on DC. Exceptional for use in low voltage solid state circuits with greater overlapping of ranges providing better reading accuracy. Accuracy is $\pm 3\%$ on both

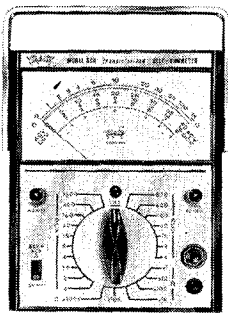

600

ELECTRONIC VOLT-OHMMETER

1. Long 7" easy-to-read scale.
2. .5 DCV range for transistor circuits.
3. High stability — meter connected in cathode circuit of 12AU7.

This extremely versatile Electronic Volt-Ohmmeter has superior voltage measuring capabilities, plus resistance ranges to 1000 Megohms.

ELECTRICAL PROTECTION of meter against burn-out. FREQUENCY RANGE — from 15 Hz to 3 MHz. SEPARATE SCALE on easy-view meter for Peak-to-peak readings. SINGLE UNIT PROBE — with built-in switch for AC/DC/OHMS. 11 MEGOHM INPUT RESISTANCE on all DC Voltage ranges. Line voltage: 115 VAC 50-60 cycles. Ground type plug. Spring-backed instrument jewels for ruggedness. Accurate within $\pm 3\%$ on AC and DC. Ohms accurate within $\pm 3\%$ of full scale based on DC scale.

RANGES

Eight DC Volts Ranges: 0-.5-1.5-5-15-50-150-500-1,500.

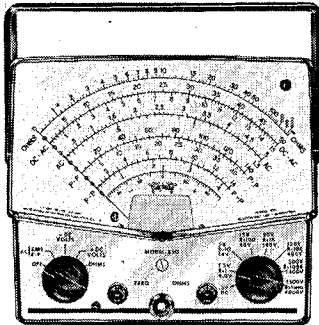

850

AC and DC. Single unit probe with built-in switch for AC/DC/OHMS. 11 Megohm input resistance on all DC Voltage ranges except .4 and .8. AC impedance is minimum of .75 megohms.

RANGES

DC Volts: 0-0.4-0.8-1.6-4-8-16-40-160-400-1,600.

AC Volts: 0-4-8-16-40-160-400-800.

Ohms: 0-1,000-10,000-100,000-1 Meg.-10 Meg-100 Meg. Center scale value 10 Ohms at X1. Complete with leads, batteries, and instruction manual.

Model 600 Catalog No. 3032 **\$82.00**

MODEL 850

Seven AC RMS Volts Ranges: 0-1.5-5-15-50-150-500-1,500.

Seven Peak-to-Peak Volts Ranges: 0-4-14-40-140-400-1,400-4,000.

Seven Resistance Ranges: 0-1,000-10,000-100,000-1 Meg-10 Meg-100 Megohms-1,000 Megohms.

Frequency Range: 15 Hz to 3 MHz; (up to 250 MHz with accessory diode probe available extra).

Input Impedance: DC Volts 11 Megohms; AC Volts minimum of .83 Megohms.

CASE — Molded black case, 7 $\frac{1}{2}$ " x 6 $\frac{1}{8}$ " x 3 $\frac{3}{8}$ ". Carrying handle also can be used to place the tester at 25° angle for ease in reading.

PANEL — Etched aluminum. Shipping wt. 7 lbs.

Model 850 Catalog No. 3074 **\$93.00**

Model 850 (Foreign — 220V, 50 to 60 Hz.) Catalog No. 3075 **\$100.00**

Auxiliary Diode Probe for voltages to 20 volts with frequencies to 250 MHz. Catalog No. 79-215 **\$9.00**

High Voltage Probe for DC voltages to 50 KV. Catalog No. 79-196 **\$25.20**

BURN-OUT PROOF VOLT-OHM-MILLIAMMETER

1. Burnout proof solid state overload protection.
2. One selector switch minimizes chance of incorrect settings. DC polarity reversing.
3. 4.4 Ohm center scale, 0.1 ohm to 100 megohms resistance in 4 ranges.

Transistorized electronic switching circuit (patent #3,359,457) guards against accidental burn-outs. Now you can virtually eliminate bent pointers, burned-out resistors, damaged pivots, overheated springs, burned-out coils, changes in accuracy due to overheating, in fact nearly any need for repairs. Life of transistor circuit battery is nearly that of shelf-life. Automatically checked by using X100K ohms range. Overload protection on meter in addition to transistorized circuit that protects tester.

Accuracy $\pm 2\%$ on DC, $\pm 3\%$ AC. High sensitivity: 20,000 Ω/V DC; 5,000 Ω/V AC. Shipping weight 5 lbs.

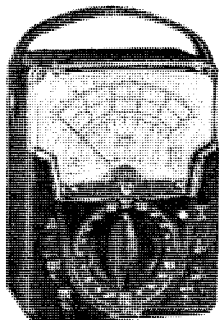

630-PLK

MODEL 630-PLK TYPE 3

RANGES

DC Volts: 0-2.5-10-50-250-1,000-5,000 at 20,000 ohms/volts; 0-0.25 at 100 microamperes.

AC Volts: 0-3-10-250-1,000-5,000 at 5,000 ohms/volt.

Decibels: -20 to +11, +21, +35, +49, +61, +75; "0" DB at 1 MW on 600 ohm line.

DC Microamperes: 0-100 at 250 Mv.

DC Milliamperes: 0-10-100-1000 at 250 Mv.

DC Amperes: -10 at 250 Mv.

Ohms: 0-1,000,000 (4.4-44 at center scale).

Megohms: 0-1-100 (4,400-440,000 at center scale)

Output Volts (AC): 0-3-10-50-250-1,000 at 5,000 ohms/volt; jack with condenser in series with AC ranges.

Case: Molded, black, 3 $\frac{1}{2}$ " x 5 $\frac{1}{2}$ " x 7 $\frac{1}{2}$ ".

Complete with leads, alligator clips, rubber feet, batteries and instruction manual. Shipping wt. 5 lbs. Model 630-PLK Cat. No. 3055 **\$93.00**

LOW OHMS V-O-M VOLT-OHM-MILLIAMMETER

1. 2 Low power ohms ranges (X1 and X10). 140 Mv. ohmmeter circuit voltage.
2. One selector switch minimizes chance of incorrect settings and burnouts.
3. Designed for testing in solid-state circuitry.

RANGES

DC Volts: 0-2.5-10-50-250-1,000-5,000 at 20,000 ohms/volt.

AC Volts: 0-3-10-50-250-1,000-5,000 at 5,000 ohms per volt.

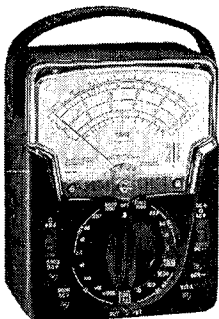

630-L

MODEL 630-L

Decibels: -20 to +75; "0" Db at 1 Mw on 600 ohm line.

DC Microamperes: 0-100 at 120 millivolts.

DC Amperes: 0-10 at 120 millivolts.

Ohms: 0-1,000-10,000 (13-130 at center scale).

Megohms: -1-100 (4,400-440,000 at center scale).

Output V (AC): 0-3-10-50-250-1,000 at 5,000 ohms/volt, jack with condenser in series with AC ranges.

Case: Black molded, 3 $\frac{1}{2}$ " x 5 $\frac{1}{2}$ " x 7 $\frac{1}{2}$ ".

Model 630-L Cat. No. 3040 **\$66.00**

VTVM COMBINATION V-O-M AND VTVM

1. Combination Volt-Ohm-Milliammeter and battery operated Vacuum Tube Voltmeter.
2. 11 Megohm input to VTVM.
3. One selector switch, 34 ranges.

Two fundamental units at the price of a single tester; VTVM stability assured by long life battery operation. Sensitivity plus — sensitivity of the 1.2 volt (VTVM) range is equal to over nine million ohms per volt. Usable with frequencies through 500 kHz.

A V-O-M for general use and a VTVM when needed; ranges entirely adequate for servicing needs.

Spring-backed instrument jewels for ruggedness. Accuracy 3% DC, 4% AC, VTVM 4%.

V-O-M RANGES

DC Volts: 0-3-12-60-300-1,200 (20,000 ohms per volt).

AC Volts: 0-3-12-60-300-1,200 (5,000 ohms per volt).

Ohms: 0-1,500-15,000.

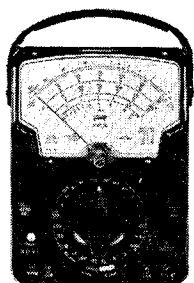

631

Megohms: 0-1.5-150.

DC Microamperes: 0-60 at 250 MV.

DC Milliamperes: 0-1.2-12-120-1,200 at 250 MV.

DC Amperes: 0-12 at 250 MV.

DB: -20 to +63. (600 ohm line at 1 MW).

Output Volts: 0-3-12-60-300-1,200; jack with condenser in series with AC ranges.

VTVM RANGES

DC Volts: 0-1.2-6-30-120.

Case: Molded, black, 3 $\frac{1}{2}$ " x 5 $\frac{1}{2}$ " x 7 $\frac{1}{2}$ ".

Complete with leads, alligator clips, rubber feet, batteries and instruction manual. Shipping wt. 5 lbs.

Model 631 Catalog No. 3058 **\$82.00**

RF PROBE FOR 631

With this probe and Model 631 RF measurements can be made up to 20 volts at 250 MHz.

RF Probe Catalog No. 79-145 **\$9.50**

All Prices Are Suggested U.S.A. User Net Subject To Change. Specifications Subject To Revision. (Slightly Higher West of Rockies and in Canada)

TRIPLETT ELECTRICAL INSTRUMENT COMPANY

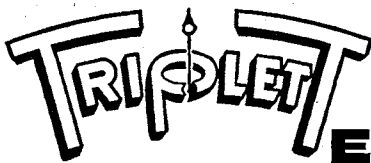

TEST EQUIPMENT

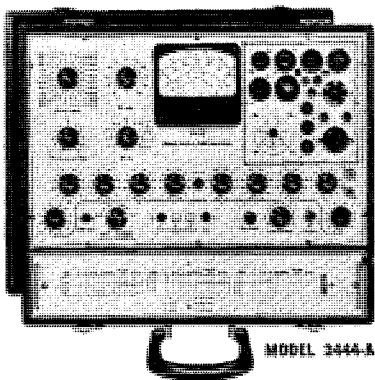

MODEL 3444-A

TRUE DYNAMIC MUTUAL CONDUCTANCE TUBE ANALYZER MODEL 3444-A

1. Measures the characteristics at variable currents and voltages.
2. Snap-in roll chart in separate compartment for easy removal and updating.
3. Reads directly in micromhos with a self-checking true Gm circuit.

The only tube tester under \$1,000 that is simple and fast to operate and will measure tube characteristics at KNOWN readable potentials. Provides readings to: (a) Plot the tube characteristic curves. (b) Measure grid current at known potentials. (c) Compare cut-off characteristics of dual tubes. Reads directly in micromhos with a self checking Gm circuit.

CHECKS PLATE current cutoff. CHECKS GAS under actual operating conditions (measures to approximately one UA of gas current). CHECKS RECTIFIERS under load. CHECKS THYRATRON firing voltage and grid current. (To 50 ma. anode current.) CHECKS DUAL section tubes with only one lever movement. PROVIDES SHORTS and leakage measurements from 0-10 megohms using a filtered DC supply of 85 volts. PROVIDES cutoff measurements on voltage amplifiers. RECESSED SOCKET SAVERS (under-the-panel-mounted) are easily removable for replacement.
Case: Wood, gray leatherette covered, 15 $\frac{3}{16}$ " x 18 $\frac{1}{16}$ " x 7 $\frac{3}{4}$ ". Shipping wt. 30 lbs. **\$470.00**

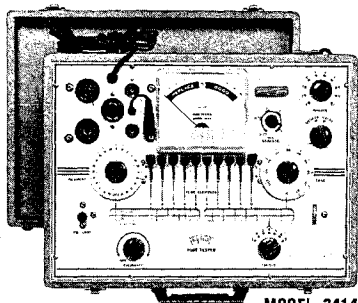

MODEL 3414

FASTER, FLEXIBLE TUBE TESTER

MODEL 3414

1. Fast, easy to use, GO-NO-GO testing.
2. Input filament continuity test.
3. Wide range of filament voltages prevents obsolescence.

Modified circuit for better correlation on Gm. Rejects burned out tubes instantly without waiting for the filament to heat. NEON INDICATOR SHORTS TEST, new, fast and accurate. Full range filament voltages—0.65 to 117 in 23 steps. Improved lever switching for com-

plete control of each tube element. Quick-change roll chart. TV picture tube test by means of adapter (available extra, see below) without removing tube from receiver. Large, clearview meter has three-color GOOD-?-BAD scale.

COUNTER-PORTABLE TYPE CASE. Ultra-professional appearance; Wood, dark gray leatherette covered; 15 $\frac{7}{8}$ " x 11 $\frac{1}{2}$ " x 6 $\frac{1}{2}$ ". Hinged removable cover. Chrome hardware and feet. Etched panel. Shipping wt. 17 lbs. **\$132.00**

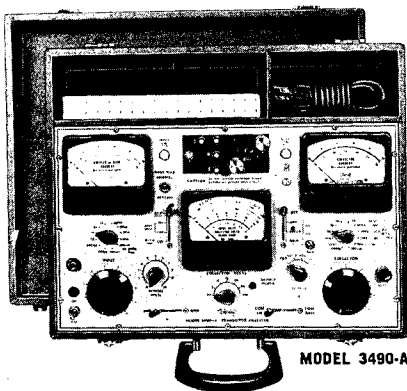

MODEL 3490-A

TRANSISTOR ANALYZER FOR COMPLETE TRANSISTOR ANALYSES MODEL 3490-A

1. Ideal for schools and labs. Makes H parameter measurements.
2. High current and high voltage AC and DC beta measurements.
3. Reads leakage current in NANO-AMPERE region.

Test DC Beta, AC Beta at 1KC, leakages (Ico, Ieo, Iceo), Alpha, Reach Through Voltage, Saturation Voltage, Floating Potential. The 3490-A's flexibility allows plotting of transistor characteristic curves along with setting up nearly any type of transistor test. Input bias reversing switch gives added versatility. THREE INDEPENDENT Power Supplies. Model 3490-A also tests diodes, rectifiers, zener diodes, SCR, etc.

Input Current (Emitter or Base): 0-100-300 ua, 0-1-3-10-30 Ma, 0-1-3-1-3 Amp.
Collector Current: 0-300 ua, 0-1-10-30 Ma, 0-1-3-1-3-10-30 Amp.

Ico, Ieo (Iceo): 0-6 Ma, 0-600 ua, 0-60 ua, 0-6 ua.

Collector Voltage: 0-120 V, 0-60 V, 0-30 V, 0-12 V, 0-6 V, 0-3 V, 0-1.2 V.

Emitter or Base Voltage: 0-12 V, 0-1.2 V.

Tetrode: 0-10 V Calibrated Control. Shipping wt.: 30 lbs.

Case: Wood, gray leatherette covered, 18 $\frac{1}{16}$ " x 15 $\frac{1}{16}$ " x 8" with removable cover, and sloping etched aluminum panel. **\$441.00**

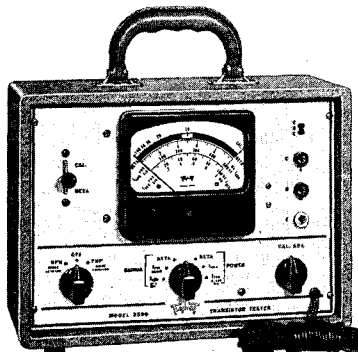

MODEL 2590

TRANSISTOR TESTER

MODEL 2590

1. Tests Beta amplification, Ico, Ieo for both power and signal type transistors. Tests for shorts and leakage. Checks and forward currents on diodes.
2. Simulated operating test conditions.
3. Simple and straightforward operation. No roll chart or special data needed, always up-to-date.

Case: 11 $\frac{5}{8}$ " x 8 $\frac{5}{8}$ " x 5 $\frac{1}{8}$ ".

FIVE SCALES

0-1 MA for Signal Transistor ICEO
0-100 MA for Power Transistor ICEO
0-500 Microamp for Signal Transistor ICBO
0-1 MA for Power Transistor ICBO
5-100 Beta Range; also shows on GOOD-?-BAD scale
Shipping wt. 9 lbs. Power—115 volts, 50-60 cycle AC. **\$71.00**

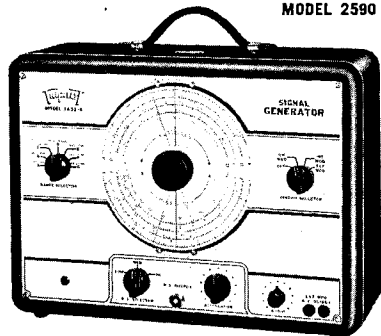

MODEL 3432-A

SIGNAL GENERATOR

MODEL 3432-A

1. High RF output.
2. Fundamentals to 110 MHz, harmonics to 220.
3. Ideal as marker generator for TV alignment.

Complete frequency coverage 160 KC to 10 MC fundamental with seven bands (220 MC harmonics). R.F. circuits are double shielded with copper steel shields. Large easily read etched aluminum dial. Cathode follower output provides good stability by acting as a buffer to the oscillator. 400 cycle audio frequency with variable control for 0-100 per cent modulation.

Band

A160-370 KC
B360-735 KC
C715-1875 KC
D1825-4950 KC
E4.85-13 MC
F12.5-35 MC
G34-110 MC
G (Harmonics)68-220 MC

Case: Metal with black baked enamel suede finish, 15 $\frac{1}{32}$ " x 11 $\frac{1}{32}$ " x 6 $\frac{1}{4}$ ". Black leather strap handle, rubber feet. Shipping wt. 30 lbs.

\$144.00

All Prices Are Suggested U.S.A. User Net Subject To Change. Specifications Subject To Revision.

DABURN

DABURN ELECTRONICS & CABLE CORP.
WIRE • CABLE • TUBING • MIL/COMM • SWITCHES • ELECTRONIC HARDWARE

INSULATORS

Ceramic • Steatite • Standoffs • Feed-thrus • Antenna • Beads

DABURN FEED-THRU INSULATORS

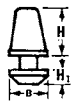

These are quality porcelain insulators smoothly glazed. Heavy nickel plated brass hardware used. Cushion washers supplied.

DABURN No.	Hgt. H	B	H ₁	Mounting Hole	H'dwe	Std. Pkg.
10-58	5/8"	1 1/4"	1 1/4"	3/8"	6-32	50
10-78	1"	1 3/8"	5/8"	7/16"	10-32	25
10-125	1 1/4"	7/8"	3/8"	7/16"	10-32	25
10-234	2 3/4"	2"	1"	1 1/4"	1/4-20	10

CORRUGATED FEED-THRU INSULATOR



These numbers have twice the leakage path of the straight type due to the increased surface area. Brass nickel plated hardware and cushion washers supplied.

DABURN No.	Hgt. H	B	H ₁	Mounting Hole	H'dwe	Std. Pkg.
10-79	1 3/8"	1 1/4"	1 1/4"	3/8"	10-32	25
10-76	2 3/4"	1 3/8"	1"	3/4"	1/4-20	10
10-52	4 1/2"	2 1/8"	1 1/2"	1"	1/4-20	5

DABURN METAL BASE INSULATORS



Made of hi tensile strength, low absorption ceramic, fully glazed corrugated surface. Provides longer leakage path. Drawn metal bases.

Daburn No.	Hgt. H	B	D	Mtg. Screw	H'dwe	Std. Pkg.
10-67	1 3/8"	1 7/8" x 1 1/4"	1 1/2"	2 #8	10-32	25
10-176	2 3/4"	1 3/4" x 1 3/4"	1 3/8"	4 #10	1/4-20	10
10-451	4 1/2"	2 1/4" x 2 1/4"	1 3/4"	4 #10	1/4-20	5

DABURN STEATITE CONE INSULATORS



Steatite cones have smooth glaze white. Come complete with brass nickel plated screws and cushion washers

Daburn No.	Hgt. H	B	B ₁	T	Mtg. Hole	Std. Pkg.
10-30	5/8"	5/8"	7/16"	6-32	3/32"	100
10-31	1"	1 1/4"	1 1/2"	8-32	3/16"	50
10-32	1 1/2"	3/4"	5/8"	10-32	1/32"	50
10-33	2 3/4"	1 1/4"	3/4"	1/4-20	1/32"	25

DABURN LEADIN INSULATORS



Sections are each 2 3/4" high hi vitrified porcelain glazed. Comes thru with 2 additional bushings 1/4" and 1/2" long, permitting complete insulation of the threaded rod of any length in multiples of 1/4". Complete with brass nickel plated hardware. Lead and cushion washers permit a water tight seal.

Daburn No.	Description	Std. Pkg.
10-237	10" Rod/Bushings	10
10-238	15" Rod/Bushings	10

DABURN STANDOFF INSULATORS



Quality glazed porcelain insulators — mounting surface ground flat. Brass nickel plated hardware supplied.

Daburn No.	A	B	C	D	Hole	Mtg. H'dwe	Std. Pkg.
10-16	1"	1 3/8"	7/8"	1"	3/32"	8-32	50
10-17	1 1/2"	1 3/4"	1 1/8"	1 1/4"	3/16"	10-32	25

STEATITE FEED-THRU INSULATORS

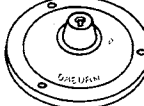

Suitable for hi-dielectric and mechanical strength. Made of L5 glazed Steatite. No hardware included.

Daburn No.	Figure	Hgt. H	Base Diam.	Screw Size Max.	Std. Pkg.
10-200	I	7/8"	1 1/4"	10-32	25
10-201	I	1 1/8"	1 3/4"	1/4-20	25
10-202	II	1 5/8"	2 1/2"	3/8-16	25
10-203	III	1"	3 1/8"	8-32	12

DABURN STEATITE FEED-THRU INSULATORS



Feedthrus come thru with tops and bottoms for chassis, panel, shields, rack mounting. No hardware included. Made of L5 glazed Steatite.

Daburn No.	Hgt. Top	Hole Diam.	T'kness Panel To	Screw Size Max.	Std. Pkg.
10-204	1/8"	1/2"	3/16"	1/8"	6-32 50
10-205	3/32"	5/8"	3/16"	1/8"	8-32 50
10-206	3/8"	1/2"	1/4"	3/16"	6-32 50
10-207	3/8"	5/8"	3/8"	3/8"	8-32 50
10-208	3/4"	1 1/8"	3/4"	3/8"	10-32 50
10-209	1 5/8"	1 1/4"	1 1/2"	2"	10-32 50

DABURN FISH SPINE BEADS



Made of L5 Steatite. Suitable for buss and heavy lines insulation. Beads follow bends and curves because of ball and socket style interlocks. Four beads cover approximately 1". 100 will cover 25" of wire. Size: 3/4" O.D. x 1/8" I.D. Beads treated with Dow Corning compound to prevent accumulation of surface moisture.

Daburn No.	Description	Std. Pkg.
10-215	Fish Spine Beads	100, 1000

DABURN AIRPLANE INSULATORS

Suitable for mobile and aircraft or guy wire application. compression type strain insulators. Nos. 10-73, 10-74 made of white glazed low absorption porcelain. No. 10-72 made of wet process porcelain.



10-73, 10-74



10-72

Daburn No.	Description	Std. Pkg.
10-73	2" White	100
10-74	1 1/2" White	100
10-72	2 1/4" Brown	25

DABURN STEATITE AIRPLANE INSULATOR



Compression type Steatite insulator has small wind resistance. Fully glazed.

Daburn No.	Description	Std. Pkg.
10-63	1 1/2" Lgth.; 1/2" Diam. 3/4" Line Spacing	25

DABURN STEATITE STANDOFFS JAN-I-8 AND JAN-I-10 SPECS.

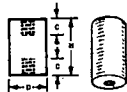

These threaded Steatite pillars are made of L5 glazed Steatite with threaded holes on both sides have one hole mounting. COLOR: White

Daburn No.	Conforms to NEW Type	Hgt.	Diam.	L'gth of Thr'd	Thr'd
10-41		1 1/4"	1 1/4"	All	6-32
10-41B		3/8"	1 1/4"	5/2"	6-32
10-41A		1/2"	1 1/4"	3/2"	6-32
10-44A		3/4"	1 1/4"	1 1/4"	6-32
10-45A		1"	1 1/4"	1 1/4"	6-32
10-42		3/8"	3/8"	5/2"	6-32
10-42A	NL633W01-004	1/2"	3/8"	3/2"	6-32
10-43A	NL633W01-005	5/8"	3/8"	3/4"	6-32
10-44B	NL633W01-006	3/4"	3/8"	1 1/4"	6-32
10-45B	NL644W01-008	1"	3/8"	3/8"	6-32
10-46B	NL633W01-010	1 1/4"	3/8"	3/8"	6-32
10-46A	NL633W01-012	1 1/2"	3/8"	3/8"	6-32
10-46C	NL633W01-016	2"	3/8"	3/8"	6-32
10-43		1 1/2"	1 1/2"	1 1/4"	6-32
10-44		3/4"	1 1/2"	1 1/4"	6-32
10-45		1"	1 1/2"	3/8"	6-32
10-46		1 1/2"	1 1/2"	3/8"	6-32
10-47		2 1/2"	1 1/2"	3/8"	6-32
10-40	NL633W02-005	5/8"	1 1/2"	3/4"	8-32
10-40A	NL633W02-006	3/4"	1 1/2"	1 1/4"	8-32
10-40B	NL633W02-008	1"	1 1/2"	3/4"	8-32
10-40C	NL633W02-010	1 1/4"	1 1/2"	3/8"	8-32
10-40D	NL633W02-012	1 1/2"	1 1/2"	3/8"	8-32
10-40E	NL633W02-016	2"	1 1/2"	3/8"	8-32
10-40F	NL633W02-020	2 1/2"	1 1/2"	3/8"	8-32
10-40G	NL633W02-024	3"	1 1/2"	3/8"	8-32
10-44C		3/4"	3/4"	1 1/4"	10-32
10-45C	NL633W03-002	1"	3/4"	3/8"	10-32
10-45D	NL633W03-010	1 1/4"	3/4"	3/8"	10-32
10-45E	NL633W03-012	1 1/2"	3/4"	3/8"	10-32
10-45F	NL633W03-016	2"	3/4"	3/8"	10-32
10-45G	NL633W03-020	2 1/2"	3/4"	3/8"	10-32
10-45H	NL633W03-024	3"	3/4"	3/8"	10-32
10-45S	NL633W03-032	4"	3/4"	3/8"	10-32
10-47B	NL633W04-012	1 1/2"	1"	1 1/2"	1/4-20
10-47D	NL633W04-016	2"	1"	5/8"	1/4-20
10-47E	NL633W04-020	2 1/2"	1"	5/8"	1/4-20

STD. PKG: 100 except 10-47B, D, E, which are 50.

ANTENNA STRAIN INSULATORS

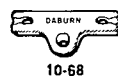

10-68

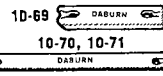

10-69, 10-71

Porcelain glazed to prevent moisture absorption. All have long leakage path — small cross section strength under continuous tension — white glaze prevents accumulation of dirt and ice.

Daburn No.	Description	Std. Pkg.
10-68	4 1/2" Long Center Ins.	10
10-69	4 1/4" Long	25
10-70	7" Long	10
10-71	12" Long	10

FEEDER SPREADER INSULATORS

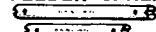

Made of highly vitrified — low absorption — hi tensile strength porcelain, with white glaze overall.

Daburn No.	Description	Std. Pkg.
10-62	2" Long Spreader	25
10-64	4" Long Spreader	25
10-65	6" Long Spreader	25

ANTENNA INSULATORS



10-06



10-0

Daburn No.	Description	Std. Pkg.
10-0	Glass Insulator	100
10-06	Porcelain Insulator — White	100



VINYL ELECTRICAL TAPE

DIVISION OF TRW INC.



- Saves space in confined areas . . . ends "twice-around" wraps with bulky tapes,
- Provides a tight insulated plastic seal . . . resistant to abrasion, water, acids, alkalies, corrosion and aging.
- Gives a neater wrap . . . adheres readily to irregular surfaces and contours.
- Makes an excellent wrap for insulating tools.

NEW TAPE-AND-TEAR DISPENSER. For one-hand taping IRC Vinyl Electrical Tape. Comes in a sturdy tape-and-tear dispenser that keeps tape clean and prevents stretching. Cutting blade is shielded. New shape is easy to hold, won't roll. Dispenser is loaded with 66 feet of $\frac{3}{4}$ " tape. Also available in cellophane wrapped rolls:

STOCK NUMBER	SIZE	PACKAGING
VT 104 "All-Weather"	$\frac{3}{4}$ " x 66'	Dispenser
VT 103	$\frac{3}{4}$ " x 66'	Dispenser
VT 103	$\frac{3}{4}$ " x 20'	Cellophane Wrapped
VT 103	$\frac{3}{8}$ " x 20'	Cellophane Wrapped
VT 103	$\frac{3}{8}$ " x 36 YDS.	Cellophane Wrapped

PROPERTIES OF IRC VINYL ELECTRICAL TAPE

DESCRIPTION	GENERAL PURPOSE TYPE 103	ALL-WEATHER TYPE 104
PHYSICAL PROPERTIES		
Thickness007"	.0085"
Tensile Strength	19 lb./in. of width	22 lb./in. of width
Elongation at Break	150%	200%
Adhesion to Steel	32 oz./in. of width	20 oz./in. of width
Low Temperature (4 hrs. @ -20°C)		Unrolling & Application Excellent
ELECTRICAL PROPERTIES		
Dielectric Strength	10,000v/mil (min.)	12,000v/mil (min.)
Power Factor @ 60 Cycles07	.07
Power Factor @ 10^6 Cycles03	.03
Dielectric Constant at 60 Cycles	3.2	3.2
Dielectric Constant at 10^6 Cycles	2.3	2.3
Insulation Resistance	Over 10^6 Megohms	Over 10^6 Megohms
Electrolytic Corrosion Factor	1.0	1.0
Resistance to Penetration at Elevated Temperatures	50°C (Avg.)	90°C (Avg.)
CHEMICAL PROPERTIES		
Sunlight	Not Affected	Not Affected
Corrosive Effect on Electrical Conductors	None	None
Resistance to Water	Excellent	Excellent
Resistance to Acids	Excellent	Excellent
Resistance to Alkalies	Excellent	Excellent
Resistance to Oils	Excellent	Excellent
Resistance to Aging at Room Temperature	Excellent	Excellent

Both Types 103 and 104 Meet MIL-I-7798A

SAVES TIME. Quicker than friction and rubber tape combinations. Takes only one operation instead of two. Adheres readily to irregular surfaces and contours. Makes a neater job.

SPRAGUE SEMICONDUCTORS

Type Number	Case	Description
-------------	------	-------------

COMPATIBLE LOW-POWER TTL ELEMENTS (-55C to +125C)

SE415J	TO-88	Dual 5-Input DTL NAND Gate—No Collector Load
SE416J	TO-88	Dual 4-Input Expandable DTL NAND Gate
SE417J	TO-88	Dual 3-Input Expandable DTL NAND Gate—No Collector Load
SE424J	TO-88	Dual A-C DTL Binary Element
SE440J	TO-88	Dual AND-OR-Invert TTL Gate
SE455J	TO-88	Dual 4-Input TTL NAND Buffer Gate
SE470J	TO-88	Triple 3-Input TTL NAND Gate
SE471J	TO-88	Triple 3-Input TTL NAND Gate—No Collector Load
SE480J	TO-88	Quad 2-Input NAND TTL Gate
SE481J	TO-88	Quad 2-Input NAND TTL Gate—No Collector Load

LINEAR CIRCUITS (-55C to +125C)

SE501G	TO-91	Video Amplifier
SE501K	TO-100	Video Amplifier
SE518G	TO-91	Voltage Comparator
SE518K	TO-100	Voltage Comparator

COMPATIBLE DCL HIGH-SPEED LOW-POWER ELEMENTS (-55C to +125C)

SE8162A	DIP	One-Shot Multivibrator
SE8280A	DIP	Decade Counter
SE8281A	DIP	Binary Counter
SE8415A	DIP	Dual 5-Input DTL NAND Gate—No Collector Load
SE8416A	DIP	Dual 4-Input Expandable DTL NAND Gate
SE8417A	DIP	Dual 3-Input Expandable DTL NAND Gate—No Collector Load
SE8424A	DIP	Dual A-C DTL Binary Element
SE8440A	DIP	Dual AND-OR-Invert TTL Gate
SE8455A	DIP	Dual 4-Input TTL NAND Buffer Gate
SE8470A	DIP	Triple 3-Input TTL NAND Gate
SE8471A	DIP	Triple 3-Input TTL NAND Gate—No Collector Load
SE8480A	DIP	Quad 2-Input TTL NAND Gate
SE8481A	DIP	Quad 2-Input TTL NAND Gate—No Collector Load
SE8731A	DIP	Quad 2-Input Diode Expander
SE8806A	DIP	Dual 4-Input TTL Expander
SE8808A	DIP	Single 8-Input TTL NAND Gate
SE8816A	DIP	Dual 4-Input TTL NAND Gate
SE8825A	DIP	D-C Clocked J-K TTL Binary Element
SE8826A	DIP	Dual J-K TTL Binary Element
SE8828A	DIP	Dual Delay TTL Binary Element
SE8840A	DIP	Dual 2-Wide 2-Input AND-OR-Invert TTL Gate
SE8855A	DIP	Dual 4-Input TTL NAND Buffer Gate
SE8870A	DIP	Triple 3-Input TTL NAND Gate
SE8880A	DIP	Quad 2-Input TTL NAND Gate

COMPATIBLE TTL HIGH-SPEED LOW-POWER ELEMENTS (-55C to +125C)

SE8162J	TO-88	One-Shot Multivibrator
SE8280J	TO-88	Decade Counter
SE8281J	TO-88	Binary Counter
SE8415J	TO-88	Dual 5-Input DTL NAND Gate—No Collector Load
SE8416J	TO-88	Dual 4-Input Expandable DTL NAND Gate
SE8417J	TO-88	Dual 3-Input Expandable DTL NAND Gate—No Collector Load
SE8424J	TO-88	Dual A-C DTL Binary Element
SE8440J	TO-88	Dual AND-OR-Invert TTL Gate
SE8455J	TO-88	Dual 4-Input TTL NAND Buffer Gate
SE8470J	TO-88	Triple 3-Input TTL NAND Gate
SE8471J	TO-88	Triple 3-Input TTL NAND Gate—No Collector Load
SE8480J	TO-88	Quad 2-Input TTL NAND Gate
SE8481J	TO-88	Quad 2-Input TTL NAND Gate—No Collector Load
SE8731J	TO-88	Quad 2-Input Diode Expander
SE8806J	TO-88	Dual 4-Input TTL Expander
SE8808J	TO-88	Single 8-Input TTL NAND Gate
SE8816J	TO-88	Dual 4-Input TTL NAND Gate
SE8825J	TO-88	D-C Clocked J-K TTL Binary Element
SE8826J	TO-88	Dual J-K TTL Binary Element

Type Number	Case	Description
-------------	------	-------------

SE8828J	TO-88	Dual Delay TTL Binary Element
SE8840J	TO-88	Dual 2-Wide 2-Input AND-OR-Invert TTL Gate
SE8855J	TO-88	Dual 4-Input TTL NAND Buffer Gate
SE8870J	TO-88	Triple 3-Input TTL NAND Gate
SE8880J	TO-88	Quad 2-Input TTL NAND Gate

COMPATIBLE DTL ELEMENTS (+15C to +55C)

SP616A	DIP	Dual 4-Input Expandable NAND Gate
SP620A	DIP	J-K Binary Element
SP629A	DIP	RST Binary Element—Split Clock
SP631A	DIP	Quad 2-Input Gate Expander
SP659A	DIP	Dual 4-Input Expandable Buffer/Driver
SP670A	DIP	Triple 3-Input NAND Gate
SP680A	DIP	Quad 2-Input NAND Gate

UTILOGIC ELEMENTS (-20C to +85C)

SU300G	TO-91	Dual 3-Input Gate Expander
SU305G	TO-91	6-Input AND Gate
SU306G	TO-91	Dual 3-Input AND Gate
SU314G	TO-91	7-Input NOR Gate
SU315G	TO-91	Dual 3-Input NOR Gate
SU316G	TO-91	Dual 2-Input NOR Gate*
SU320G	TO-91	J-K Binary Element
SU331G	TO-91	Dual 2-Input OR Gate*
SU332G	TO-91	Dual 3-Input OR Gate

UTILOGIC ELEMENTS (-20C to +85C)

SU300K	TO-100	Dual 3-Input Gate Expander
SU305K	TO-100	6-Input AND Gate
SU306K	TO-100	Dual 3-Input AND Gate
SU314K	TO-100	7-Input NOR Gate
SU315K	TO-100	Dual 3-Input NOR Gate
SU316K	TO-100	Dual 2-Input NOR Gate*
SU320K	TO-100	J-K Binary Element
SU331K	TO-100	Dual 2-Input OR Gate*
SU332K	TO-100	Dual 3-Input OR Gate

DIGITAL-TO-ANALOG CONVERSION CIRCUITS (-55C to +125C)

UD4001	TO-91	4 Bit Ladder Switch
UD4024	TO-87	4 Bit Buffer Amplifier
UD4036	TO-87	5 Bit Ladder Switch
UD4037	TO-87	5 Bit Buffer Amplifier
UD4074	FLAT PACK	Dual Positive Reference Buffer Switch
UD4080	FLAT PACK	Dual Positive Reference Buffer Switch
UD4131	FLAT PACK	Quad Power Driver

LINEAR CIRCUITS

ULN-2111A	DIP	FM Detector and Limiter
ULN-2300M	DIP	8-Lead Amplifier—SCR Firing Circuit
ULX-2102A	DIP	Variable Electronic Attenuator
ULX-2102J	TO-88	Variable Electronic Attenuator

COMPATIBLE DTL ELEMENTS (-55C to +125C)

US720J**	TO-88	Quadruple 2-Input NAND Gate—No Collector Load
US721J**	TO-88	Triple 3-Input NAND Gate—No Collector Load
US727J**	TO-88	Triple 2-Input NAND Gate*
US729J**	TO-88	RST Binary Element
US730J**	TO-88	Dual 5-Input NAND Gate
US731J**	TO-88	Quadruple 2-Input Gate Expander
US732J**	TO-88	12-Input Gate Expander

COMPATIBLE LOW-POWER RTL ELEMENTS (-55C to +125C)

US-0908D	TO-78	Adder (A)
US-0909D	TO-78	Buffer (B)
US-0910D	TO-78	Dual 2-Input Gate (D)
US-0911D	TO-78	4-Input Gate (G)
US-0912D	TO-78	Half Adder (H)
US-0913D	TO-78	Register (R)
US-0921D	TO-78	Expander (E)
US-0940D	TO-78	J-K Binary Element (JK)
US-0960D	TO-78	Twin Buffer (T)

**Completely interchangeable with Signetics parts prefixed by CS, e.g., Sprague US720J and CS720J are identical except for part numbers.

*Element incorporates fan-in expansion provision.

Copyright 1968, Sprague Products Company

IND-REM-68-6832

Sizes subject to change without notice.

**whatever electronic products
you require...**



**...you'll find it
faster in
this catalog...**

**...the world's largest catalog
of electronic
products
sold through
distributors**



SLO-SYN[®]

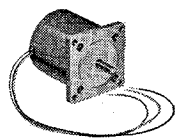

TYPE SS25

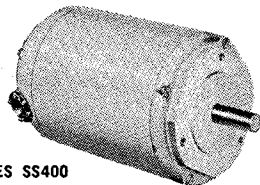

TYPES SS400 & SS402

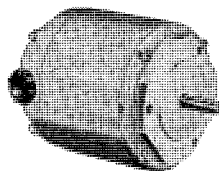

TYPES SS150 & SS152

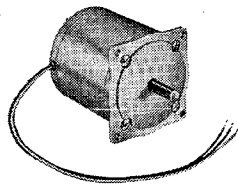

TYPES HS50 & HS52

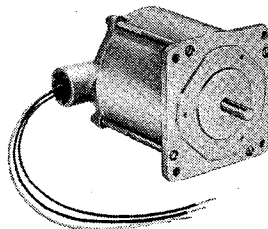

TYPES X250 & X252

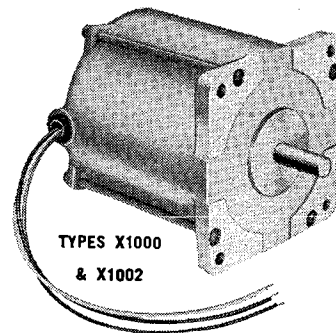

TYPES X1000 & X1002

A-C OPERATION — Standard SLO-SYN Synchronous/Stepping Motors are permanent magnet a-c motors having extremely rapid starting, stopping and reversing characteristics and a slow basic shaft speed of 72 rpm synchronous with a line frequency of 60 hertz. Three-lead types need only a single-pole, three-position switch for complete forward, reverse and "off" control. No excessive inrush current when energized because starting and operating current are nearly identical. Can be completely stalled without overheating and with no harmful effects on components. Starts or stops in less than 5° of shaft rotation; no need for mechanical or electrical braking. When used with an auxiliary high speed motor, the SLO-SYN motor can remain coupled to the load and safely overdriven. Phase shifting resistor and capacitor must be used when operating from a single-phase source but not from two-phase. All standard motors are rated for continuous duty at maximum ambient temperature of 40°C. Types SS150 and SS152 use Class A insulation; all others have Class B.

D-C STEPPING — When used for phase-switched d-c stepping, the motors can be connected to provide either 100 or 200

steps per revolution. Accuracy of the steps is ±.09° non-cumulative. Three-lead types require a center-tapped d-c supply and single-pole, double-throw switching; four-lead types require a single-ended power supply and single pole, double-throw switching. Bifilar motors can also be used with transistorized switching circuits. With a suitable control potentiometer instead of switches, a SLO-SYN motor can be made to rotate steplessly, permitting extremely accurate positioning. All motors have lubricated-for-life bearings.

PRECISION STEPPING

For phase-switched d-c stepping, types HS25, HS50, HS50D and HS50L make 200 steps per shaft revolution. Each 1.8° step is accurate within ±3% (.06°) noncumulative. May be operated at speeds greater than 500 steps per second if accelerating and decelerating circuits are used. With proper circuitry, the motors may be operated at speeds of 1000 steps per second or higher without missing any steps.

200 RPM

Types TS25, TS50 and TS52 are similar to standard models but operate at synchronous speeds of 200 rpm and take 36 or 72 steps per revolution when used for d-c stepping.

RATINGS AND SPECIFICATIONS FOR A-C APPLICATIONS

TYPE	MAXIMUM AMPERES	TORQUE (Oz-In)	MAXIMUM MOMENT OF INERTIA OF A RIGIDLY ATTACHED LOAD (Lb-In ²)	PHASE-SHIFTING COMPONENTS*				APPROXIMATE MOTOR WEIGHT (POUNDS)	
				RESISTOR	RESISTOR PART NUMBER	CAPACITOR	CAPACITOR PART NUMBER	NET	SHIPPING
120 Volts, 50/60 hertz, 1 Phase, 200 RPM at 60 hertz									
TS25	0.2	25	0.12	300 ohm ±5%, 25 watt	R-TS25/50	1.5 mfd ±6%, 330 VAC	C-TS25	2	2½
TS50	0.3	50	0.25	300 ohm ±5%, 25 watt	R-TS50	3.75 mfd ±6%, 330 VAC	C-SS150/TS50	4¾	5¾
120 Volts, 50/60 hertz, 1 phase, 72 RPM at 60 hertz									
SS25§	0.1	25	0.15	500 ohm ±5%, 5 watt	R-SS25	0.75 mfd ±6%, 330 VAC	C-SS25	1¼	1½
SS50§	0.3	50	0.5	250 ohm ±5%, 25 watt	R-SS50/150	2.6 mfd ±6%, 330 VAC	C-SS50	3	3½
SS50M†§	0.3	50	0.5	250 ohm ±5%, 25 watt	R-SS50M/150M	2.6 mfd ±6%, 330 VAC	C-SS50M	3	3½
SS150	0.4	150	1.5	250 ohm ±5%, 25 watt	R-SS50/150	3.75 mfd ±6%, 330 VAC	C-SS150/TS50	6½	8
SS150M†	0.4	150	1.5	250 ohm ±5%, 25 watt	R-SS50M/150M	3.75 mfd ±6%, 330 VAC	C-SS150M	6½	8
SS250	0.6	250	3	150 ohm ±5%, 50 watt	R-SS250/400	6.5 mfd ±6%, 330 VAC	C-SS250/400	6½	8
SS250M†	0.6	250	3	150 ohm ±5%, 50 watt	R-SS250M	6.5 mfd ±6%, 330 VAC	C-SS250M	6½	8
X250‡	0.6	250	3	150 ohm ±5%, 50 watt	R-SS250/400	6.5 mfd ±6%, 330 VAC	C-SS250/400	7¾	9
SS400	0.6	400	4.5	150 ohm ±5%, 50 watt	R-SS250/400	6.5 mfd ±6%, 330 VAC	C-SS250/400	12¼	13¾
X1000‡	3.0	1000	9	65 ohm ±5%, 160 watt	R-X1000	30 mfd ±6%, 330 VAC	C-X1000	31	33
X1500	3.0	1500	12	50 ohm ±5%, 375 watt	R-X1500	30 mfd ±5%, 330 VAC	C-X1000/1500	38	41
SS1800	4.0	1800	16	40 ohm ±5%, 375 watt	R-SS1800	60 mfd ±6%, 330 VAC	C-SS1800	45	50
240 Volts, 50/60 hertz, 1 Phase, 200 RPM at 60 hertz									
TS52	0.2	50	0.25	1200 ohm ±5%, 25 watt	R-SS152/TS52	1.0 mfd ±6%, 660 VAC	C-SS152/TS52	4¾	5¾
240 Volts, 50/60 hertz, 1 Phase, 72 RPM at 60 hertz									
SS52§	0.2	50	0.5	1000 ohm ±5%, 10 watt	R-SS52	0.67 mfd ±6%, 660 VAC	C-SS52	3	3½
SS152	0.2	150	1.5	1200 ohm ±5%, 25 watt	R-SS152/TS52	1.0 mfd ±6%, 660 VAC	C-SS152/TS52	6½	8
SS252	0.3	250	3	500 ohm ±5%, 50 watt	R-SS252/402	1.75 mfd ±6%, 660 VAC	C-SS252/402	6½	8
X252‡	0.3	250	3	500 ohm ±5%, 50 watt	R-SS252/402	1.75 mfd ±6%, 660 VAC	C-SS252/402	7¾	9
SS402	0.3	400	4.5	500 ohm ±5%, 50 watt	R-SS252/402	1.75 mfd ±6%, 660 VAC	C-SS252/402	12¼	13¾
X1002‡§	1.5	1000	9	250 ohm ±5%, 200 watt	R-X1002	8 mfd ±6%, 660 VAC	C-X1002	31	33
SS1802	2.0	1800	16	130 ohm ±5%, 320 watt	R-SS1802	15 mfd ±6%, 660 VAC	C-SS1802	45	50

*External resistor and capacitor must be ordered separately. †Militarized. ‡Explosion-proof. §For 60 hertz. Other phase-shifting components required for 50 hertz.



THE SUPERIOR ELECTRIC COMPANY

SEE OTHER SUPERIOR ELECTRIC PRODUCT

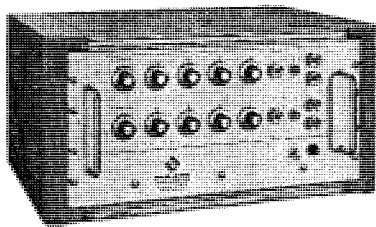
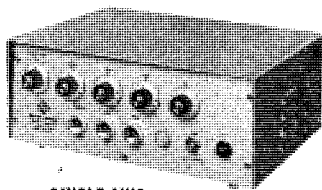
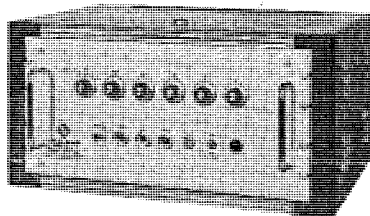
SLO-SYN® Preset IndexersTWO-AXIS
TYPE 2SP1800-4SINGLE-AXIS
TYPE SP1800B-4ABSOLUTE
TYPE SA1800-5

Used to control indexing of SLO-SYN bifilar motors. The index angle, or position, can be preset by dial setting on the control panel the number of 1.8° steps to be driven. Have provision for actuating any external equipment needed to perform related operations. Index, jog and free run can be initiated manually from the control panel or from an external switch. Can be made to cycle automatically with proper external switching. Single- and two-axis models are available with counting ranges to 99,999 steps. Two-axis models provide independent control of two SLO-SYN motors. Speed adjustable from 4 steps/second up to maximum possible with motor used. Optional backlash take-up circuit.

ABSOLUTE PRESET INDEXERS permit either absolute or incremental positioning modes. In the absolute positioning mode, the number set on the controls determines the final position of the motor relative to the starting, or "zero" point. When incremental positioning is used, the motor will move the preselected number of steps each time the INDEX button is pressed. Optional backlash take-up circuit.

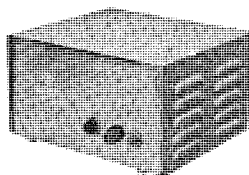
SLO-SYN®*Translator*

TYPE ST1800B

Pulse-to-step converter designed for use with appropriate bifilar SLO-SYN motors converted for incremental stepping. Convert low level signal pulses or square waves into the correct switching sequence needed to step a SLO-SYN motor at 200 steps/revolution (1.8° per step). Input is 105-125 volts a-c, 1 ampere. Signal input impedance is 500 ohms. Used for programmed positioning, indexing and indicating operations.

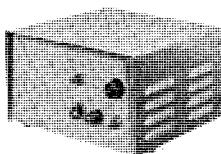
SLO-SYN®*Adjustable Speed Drive*

TYPE ST1800BV

Essentially, SLO-SYN Adjustable Speed Drive type ST1800BV is a translator which includes a built-in oscillator to supply the triggering signals. Oscillator frequency can be adjusted to vary the speed from 4 steps/second up to the maximum permissible with the motor used. Direction of rotation can be controlled either from the front panel or from a remotely located switch.

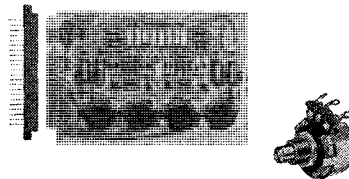
SLO-SYN®*Translator Module*

TYPE STM1800V

Plug-in circuit boards with logic capabilities for stepping a SLO-SYN motor in 1.8° increments. Type STM1800 is a basic translator which will provide bidirectional motor operation. Type STM1800V is similar but includes a built-in oscillator which can be adjusted to drive the motor at speeds from 4 steps/second up to maximum at which the motor will drive the load.

SLO-SYN® High Speed Drives*Translator*

Drive SLO-SYN Precision Stepping Motors up to 2000 steps per second without losing any steps. Triggering the translator circuits is an internal oscillator which can supply a variable frequency range adjustable from 50 to 2000 steps per second. Triggering pulses can be supplied by tape readers, computers, oscillators, pulse generators and other signal producing equipment.

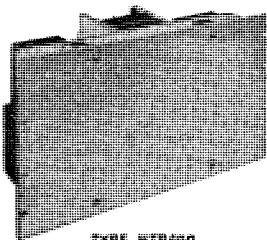

TYPE HTR400

Preset Indexer

Drive SLO-SYN Precision Stepping Motors in indexing and other positioning operations. Acceleration and deceleration circuits permit driving motors up to 2000 steps per second without missing any steps. Decade counter controls on front panel allow the operator to select any desired positioning increment. Optional backlash take-up circuit.

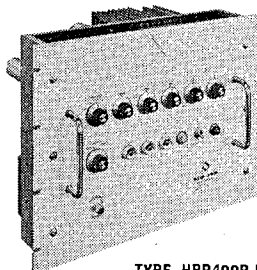

TYPE HPR400R-5



THE SUPERIOR ELECTRIC COMPANY

SEE OTHER SUPERIOR ELECTRIC PRODUCT PAGES IN SECTIONS 2100, 4000 AND 5600



Transistorized A725 ON/OFF Control A750 and A750DA Timing Controls

AUTOTRON, INC.,

Features of

A725, A750 and A750DA

One connection changes from LIGHT- to DARK-energized operation (or vice versa). 5.8, 4.7, 3.3, 2.5, 2.2 and 1.1 Light Source Voltages makes available minimum suitable voltage for maximum lamp life and maximum speed of sensing cell response.

- Rugged, 5-amp DPDT Plug-in Relay.
 - a. Plug-in mounting permits replacement in seconds without special skill or tools
 - b. Transparent enclosure protects against dust, physical injury and tampering.

Quieted output current for positive and QUIET operation of control relay.
Transistors protected from transient voltages.

Cad Cells are exceptionally well shielded from extraneous light.

All circuit components are securely mounted on a modern circuit board.

All contacts of the DPDT Relay wired to large, screw type terminals.

Operate at ambient temperatures to 115°F. In JIC enclosures at \$12.50 extra.

Operate from 234, 208 and 117 V, 50-60 c.

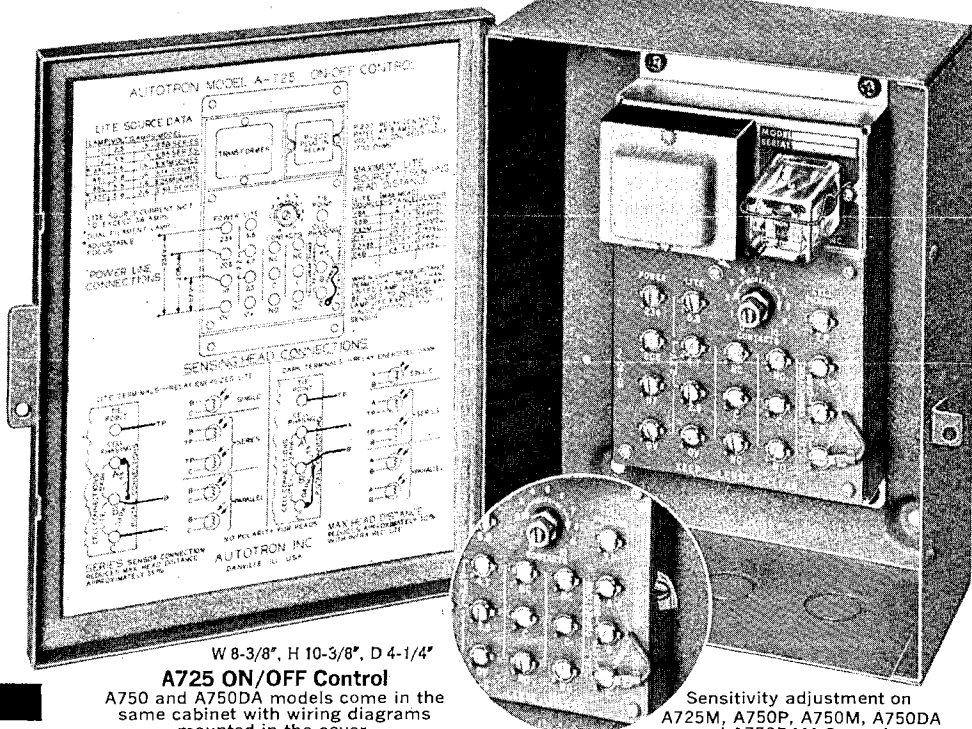

W 8-3/8", H 10-3/8", D 4-1/4"

A725 ON/OFF Control

A750 and A750DA models come in the same cabinet with wiring diagrams mounted in the cover.

Sensitivity adjustment on A725M, A750P, A750M, A750DA and A750DAM Controls

A725 ON/OFF Control

FAST ACTING - .025 sec. light time and .025 sec. dark time minimum.

SENSITIVE - Adjustment has shaft lock.

Power Consumption, 25 VA.

Energizes LIGHT connected to LIGHT terminals.

Energized DARK connected to DARK terminal.

A725 ON/OFF Control less heads.....\$69.50

■A725M ON/OFF Control less heads..... 79.50

Control-Pak Numbers Control-Sensor-Light Source	Max. Feet betw. heads	Control-Pak Net Price
A725-E8AAP10LC-E8AC	2	\$102.50#
A725-E8AP9LC-E8AC	2	102.50#
A725-E8BAP9LC-E8BAC	10	102.50#
A725-E8BP9LC-E8BC	20	102.50#
●A725-E8ZP10-E8Z10	20	159.50
■A725M-E8BP5AC-E8BC	20	127.50
●A725M-E8ZP5A-E8Z10	20	184.50
A725-EXPM9LC-EX3ME	50	109.50
A725-EIAP10LC-EIAE	45	104.50
A725-EPB10LC-E3BE	100	109.50
A725-EPB10LC-E4CE	20	127.50
A725-EBP10LC-EBC	2	102.50
A725-EAP12G-ELG	3 in.	93.00
A725-PF10LC-LFE	5	157.50
A725-ELA10TH	††10	▲98.25
A725-A700EH-7C		107.00

A750 Timing Control

Timing Ranges (specify)

Range No. .7 adjustable 1 to 8 seconds, approx. Range No. 1.0-2 to 16 seconds, approx. (other ranges available-tell us what you need) Timing adjustment has shaft lock.

Energizes LIGHT and times out DARK connected to LIGHT terminal. Recycle time is almost instant (.015 sec. max.) and is independent of light level on the sensing cell. Timing control is voltage regulated and variation in timing between 100 and 130 volts is negligible.

Energizes DARK and times out LIGHT connected to DARK terminal. Recycle time is 50 milliseconds min. depending on light intensity on the sensing cell. For minimum recycle time reduce light intensity to minimum operating value. Power consumption, 25 VA.

A750 Timing Control less heads.....\$88.00

■A750M Timing Control less heads..... 98.00

Control-Pak Numbers Control-Sensor-Light Source	Max. Feet betw. heads	Control-Pak Net Price
A750-E8AAP10C-E8AC	1	\$121.00#
A750-E8AP9LC-E8AC	1	121.00#
A750-E8BAP9LC-E8BAC	7.5	121.00#
A750-E8BP9LC-E8BC	15	121.00#
●A750-E8ZP10-E8Z10	15	178.00
■A750M-E8BP5AC-E8BC	15	146.00
●A750M-E8ZP5A-E8Z10	15	203.00
A750-EXPM9LC-EX3ME	35	128.00
A750-EIAP10LC-EIAE	30	123.00
A750-EPB10LC-E3BE	75	126.50
A750-EPB10LC-E4CE	12	146.00
A750-EBP10LC-EBC	1	121.00
A750-EAP12G-ELG	1.5 in.	111.50
A750-PF10LC-LFE	2.5	176.00
□A750P-ELA10TH	††6	▲126.75
A750-A700EH-7C		125.50

■The suffix "M" in A725M, A750M, and A750DAM identifies extremely sensitive controls with sensitivity adjustment that operate with very short light change. The "M" type controls have been developed for operation by photo sensors that have the "5A Feature" described on the opposite page. This combination is used for scanning register marks; for sensing fast moving objects and other applications where light change is short. Sensors with the 5A Feature are also used where the sensing head is exposed to high temperature.

**A750DA Extra Fast Timed Output
Pulse Width Control**

Timing Ranges same as A750

The Control Relay of the A750DA energizes instantaneously with adequate light change and de-energizes at expiration of pre-set timing period as follows:

With LIGHT Terminal connection the control relay energizes instantly when the cell receives enough light; remains energized even though the cell goes dark and de-energizes when the Timing Period expires, except: while the relay is energized, if the cell goes DARK and then goes LIGHT before the Timing Period expires the relay remains energized and a NEW Timing Period starts.

With DARK terminal connection, DARK on the cell produces the same relay action as LIGHT does in the above.

Timing and Sensitivity Adjustments are inside cabinet.

Adjustable time delay repeat accuracy 1%. Time Delay adjustment has shaft lock.

Power consumption, 25 VA.

A750DA Timing Control less heads.....\$124.00

■A750DAM Timing Control less heads.. 134.00

Control-Pak Numbers Control-Sensor-Light Source	Max. Feet betw. heads	Control-Pak Net Price
A750DA-E8AAP10LC-E8AC	2	\$157.00#
A750DA-E8AP9LC-E8AC	2	157.00#
A750DA-E8BAP9LC-E8BAC	10	157.00#
A750DA-E8BP9LC-E8BC	20	157.00#
●A750DA-E8ZP10-E8Z10	20	214.00
■A750DAM-E8BP5AC-E8BC	20	182.00
●A750DAM-E8ZP5A-E8Z10	20	239.00
A750DA-EXPM9LC-EX3ME	50	164.00
A750DA-EIAP10LC-EIAE	45	159.00
A750DA-EPB10LC-E3BE	100	162.50
A750DA-EPB10LC-E4CE	20	180.50
A750DA-EBP10LC-EBC	2	157.00
A750DA-EAP12G-ELG	3 in.	147.50
A750DA-PF10LC-LFE	5	212.00
A750DA-ELA10TH	††10	▲152.75

●E8ZP10, E8ZP5A and E8Z10 Heads are UL listed explosion proof but the control is not. Information on explosion proof enclosures furnished on request. †Distance between Scanner Lens and Reflector †When used with No. P380 Retro-Reflector □No. P380 Retro-Reflector, 3" diameter, \$1.50 additional. □A750P has sensitivity adjustment with shaft lock.

All Sensors and Light Sources listed in these tables are illustrated and described on the opposite page.

**A870
Solid State
AC Switch**

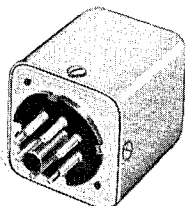

Replaces plug-in relay to convert all models of A725, A750 and A750DA series for solid state operation from 117 VAC power supply ONLY. Wiring diagram included with each switch.

Output: 117 VAC; 400 watt, 3.4 amperes maximum load, 100 milliamperes minimum.

Ambient Temperature: 115° maximum.

Module temperature increases with load current. At 3 amp. load current, case temperature is normally 130° max.

A870 Solid State AC Switch including Jumper Wires and Fuse Holder with Fuse.....\$52.50

A870 Solid State Switch can also be furnished for other applications. Information on request.



A766 Photo-Control with Solid State Switching A741B High-Speed Counting Eye

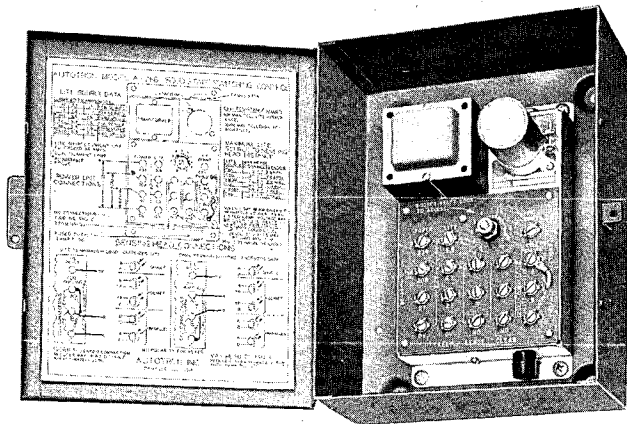

A766 - W 8-3/4", H 10-3/8", D 4-1/4"

A766 Transistorized Photo Control with Solid State Switching

A766 Photoelectric Control uses Solid State Switching instead of conventional relays, thereby avoiding weaknesses inherent with mechanical contactors.

Features

- 24 VDC Fused Output, 30 watt max.—20-ohm load min.
- LIGHT- or DARK-actuated—a single connection adjusts phasing.
- FAST ACTING—.04 second DARK time; .02 second LIGHT time.
- Sensitivity Adjustment with shaft lock.
- Transistors are protected from transient voltage.
- Choice of 5.8, 4.7, 3.3, 2.5, 2.2 and 1.1 Light Source Voltage provides optimum operating voltage for prolonged lamp life and increased speed of sensing cell response.
- All circuit components are securely mounted on printed circuit board.
- Operates at ambient temperatures up to 115°F.
- Furnished in JIC enclosures at \$12.50 extra.
- Power consumption, 45 watts, maximum.
- Operates from 234, 208, and 117 V, 50-60 C.

A766 Control without pick-up.....\$88.50

Control-Pak Numbers	Max. Feet betw. heads	Control-Pak Net Prices
A766-E8AP9LC-E8AC	2 ft.	\$121.50#
A766-E8BP9LC-E8BC	20 ft.	121.50#
●A766-E8ZP10-E8Z10	20 ft.	178.50
A766-EXPM9LC-EX3ME	50 ft.	128.50
A766-E1AP10LC-E1AE	45 ft.	123.50
A766-EPB10LC-E3BE	100 ft.	127.00
A766-EPB10LC-E4CE	20 ft.	145.00

Reflective Sensors

A766-ELA10TH	††10 ft.	▲117.25
A766-E8LP12G*	3 in.	117.25
A766-E8S12G*	3 in.	117.25
A766-E8S12G-6A*	fl 3/4 in.	120.75
A766-E8S12G-4A*	fl 1/2 in.	120.75

*Described on page 3
 †Distance between Scanner Lens and Reflector
 ††When used with No. P380 Retro-Reflector
 ▲No. P380 Retro-Reflector, 3" diameter, \$1.50 additional.
 fl Focal length
 #Mounting bracket and cord grip are standard. Furnished with cord assembly potted inside housing, without mounting bracket at no extra charge when specified.
 Use of infrared filters reduces maximum distance between heads approximately 50%
 All sensing, light source and reflector type heads are equipped with factory installed 6-foot cables for connecting to controls.
 D⊙ Dimension in direction of Light Beam

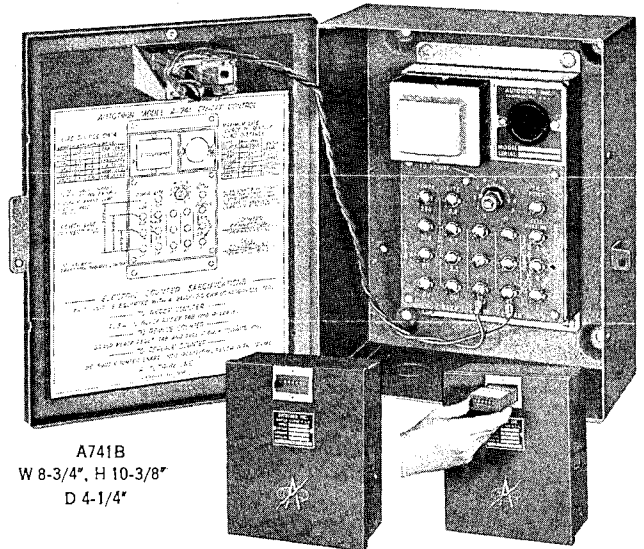

A741B
W 8-3/4", H 10-3/8"
D 4-1/4"

A741B Hi-Speed Transistorized Counting Eye

Rectified output current for positive DC actuation of F043 Counter—no relay contacts to maintain.
 25 counts per sec. (.015 sec. min. Light, .025 sec. min. Dark).
 Instant Reset 6-digit Plug-in Counter—counts up to 40 million counts without missing a count. Life expectancy 150 million counts. Easily removed for inspection or replacement.
 Provides 5.8, 4.7, 3.3, 2.5, 2.2, and 1.1 Light Source Voltages.
 Transistors are protected from transient voltages.
 All circuit components are securely mounted on printed circuit board.
 Operate at ambient temperatures up to 115°F.
 Operate from 234, 208 and 117 v, 50-60 c.
 Power Consumption 20 watts.
 A741B—Includes A741 Control with F043C Counter, Socket and Frame assembly mounted in Control Door Panel and wired as illustrated. \$122.00

Counting Eye Pack No.	Maximum distance	Counting Eye Pack Prices
A741B-E8AP9C-E8AC	1 ft.	\$155.00#
A741B-E8BP9C-E8BC	8 ft.	155.00#
●A741B-E8ZP10-E8Z10	8 ft.	212.00
A741B-EXPM9C-EXME	15 ft.	162.00
A741B-E1AP10C-E1AE	10 ft.	157.00
A741B-EPB10C-E3BE	30 ft.	162.00
A741B-EPB10C-E4CE	12 ft.	180.00

Reflective Sensors

A741B-E8LP12G*	3 in.	150.75
A741B-E8S12G*	3 in.	150.75
A741B-E8S12G-6A*	fl 3/4 in.	154.25
A741B-E8S12G-4A*	fl 1/2 in.	154.25

E8LP12G Specular Reflective Scanner Head

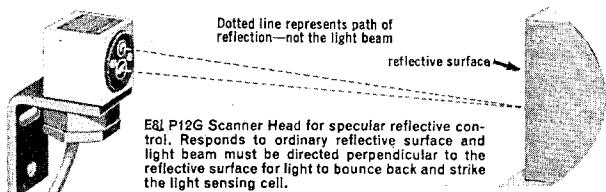

For high speed scanning service in minimum space. E8LP12G Scanner Head combines the fast acting cadmium selenide cell and the light source lamp in a single miniature housing (approximately 7/8 inch in all three dimensions plus 1/2" male pipe thread connection. See dimensional diagram below.)

The light sensing element is a fast response, cadmium selenide cell. The lamp has a built-in lens. An infrared filter helps protect against ambient light. The lamp rating is 2.5 volts at .5 amperes—life expectancy up to 75,000 hours depending on operating voltage.

E8LP12G Scanner Head including mounting bracket, also 6-foot factory-connected cable with cable grip and seal for connecting to 800 control. \$28.75

E8S12G Retro-Reflective Scanner Head

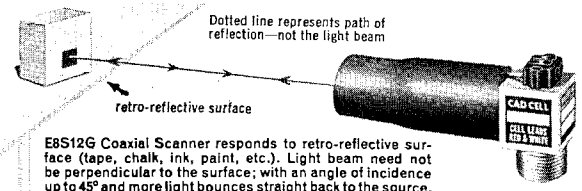

For use with retro-reflective tape or other retro-reflective material. May be used with a retro-reflective mirror when it acts as a sort of limit switch or for detecting or identifying objects with retro-reflective markings, code marks, labels, etc.

The light beam does not need to be perpendicular to the retro-reflective surface; beams at angles up to 15° and more (depending on conditions) bounce straight back to the cell.

E8S12G Scanner Head† with mounting bracket, 6-foot factory connected cable, cable grip and seal for connection to the control.....\$28.75
 E8S12G-6A has a fixed pin-point beam; focal size 1/16x5/16 at 3 3/4"
 E8S12G-4A has 1/32x3/8" focal size at 7/8" from the end of the light shield.
 E8S12G-6A and E8S12G-4A complete with mounting bracket, 6-foot factory connected cable, cable seal and grip.....each \$32.25



Retro-Reflective Photoelectric Controls Tube Type Photoelectric Controls

A990 ON/OFF and A990P Timing Controls

A900 and A900P each is a Control-Pak in one case. Sensing cell, light source, amplifiers, sensitivity adjustment and control relay are all in the same housing. Only one connection to power is required. A retro-reflective surface completes the installation.

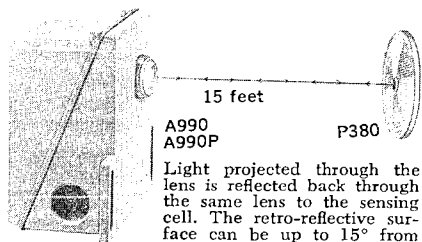

beam. Retro-reflective tape, paint, etc. may be used. Retro-reflective quality of the target affects operating distance.

A990 and A990P Features

High Sensitivity. Available with and without sensitivity adjustment.

Provides dependable operation when objects block the light beam; also with limited light change such as may be provided by retro-reflective tape on a moving carton.

Transistorized.

Rugged 5-amp DPDT plug-in relay, with dust cover.

Rectified output for DC operation of Relay.

Transistors protected from transient voltage.

All circuit components securely mounted on modern printed circuit board.

All Relay Contacts wired to screw type terminals.

Maximum ambient operating temperature, 115°F.

Gasket-sealed cast aluminum case tapped for 3/4" conduit.

D (direction of light beam) 3 1/4", W 6 1/4", H 5 1/6". Shipping weight, 3 1/2 lbs.

Power Consumption; 10 VA. For 115/230 v, 50-60 c.

A990 ON/OFF Controls

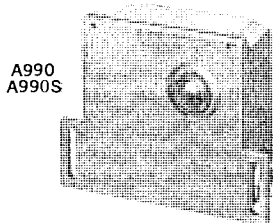

A990
A990S

Control relay energizes LIGHT; de-energizes DARK.

Fast Acting; .02 second light; .03 second dark, minimum.

Maximum distance, lens to P380 Retro-reflector, 15 feet.

A990 Retro-Reflective ON/OFF Control

Has pre-adjusted sensitivity.....\$59.00*

A990S Retro-Reflective ON/OFF Control

Has sensitivity adjustment from

outside case.....\$65.00*

*P380 Retro-reflector is \$1.50 additional

A990P Timing Controls

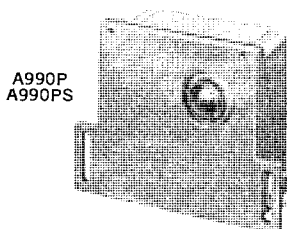

A990P
A990PS

Control relay energizes LIGHT; times out DARK

Timing Range

No. 0.5 - 0.5 to 4.5 seconds

No. 0.7 - 1 to 8 seconds

Maximum distance, lens to P380 Retro-reflector 15 feet.

A990P Retro-Reflective Timing Control

Has pre-adjusted sensitivity.....\$69.00*

A990PS Retro-Reflective Timing Control

Has sensitivity adjustment from

outside case.....\$75.00*

Retro-Reflective Control-Paks

ELA10SH
described
on Page 2

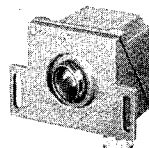

ELA10SH is a remote Retro-reflective Sensing Head designed for use with A990A and A990PA Controls described below.

A990A and A990PA have the same features as A990 and A990P respectively except the sensing element is omitted and terminals are provided for connecting ELA10SH Retro-reflective Scanner Head. For 115-230 v., 50-60 c. Power consumption 10 VA.

A990A \$54.00
A990AS 60.00
A990PA 64.00
A990PAS 70.00

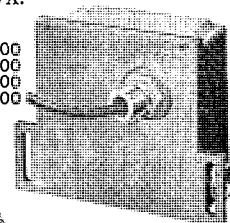

ELA10SH
\$28.75
Dø 2 7/8

P380
3" dia.
\$1.50

Retro-Reflective ON/OFF C Paks

A990A-ELA10SH A990A has pre-adjusted sensitivity\$82.75*

A990AS-ELA10SH A990AS has sensitivity adjustment from outside case.....\$88.75*

Retro-Reflective Timing C-Paks

A990PA-ELA10SH A990PA has pre-adjusted sensitivity\$92.75*

A990PAS-ELA10SH A990PAS has sensitivity adjustment from outside case.....\$98.75*

With above controls maximum distance between ELA10SH and P380 Retro-reflector is 15 feet.

ON/OFF and Timing Photo Controls with Tube Type Sensors

S Series ON/OFF Controls

Rugged, industrial Photoelectric Controls, factory adjusted for use where object interrupts the light beam 100%. Minimum dark time, .06 second; minimum light time, .06 second. Control relay contacts, SPDT, rated 8 amps. at 115 VAC, noninductive load. Splashproof cast aluminum case with adjustable bracket; tapped for 3/4" conduit. Power consumption 10 watts.

S1A and S4A1 ON/OFF Controls

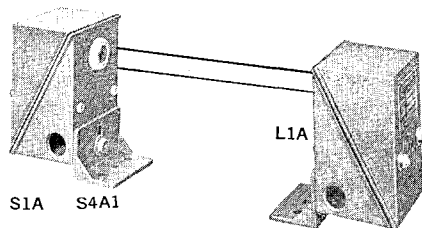

S1A S4A1

All above controls have 3/4" lens mounted in flexible silicon rubber. Require 20 foot-candles minimum light. Weight, 2 lb. Dimensions, diagram 24A.

DARK† energized	LIGHT† energized	50-60 cycles VOLTS	NET each
S1A	S4A1	115/220	\$43.75

S Series Control-Paks

Control-Paks energized		max. ft. between lenses	Min. Dark Time	Min. Light Time	Net per Set
DARK	LIGHT				
S1A-L1A	S4A1-L1A	8	.06	.06	\$63.50
S1A-L2B	S4A1-L2B	8	.06	.06	67.55
S2B-L1A	S5B1-L1A	12	.06	.06	69.50
S2B-L2B	S5B1-L2B	20	.06	.06	73.55
S2B-L3B	S5B1-L3B	20	.06	.06	77.25
S2B-L4	S5B1-L4	(norm. 12) low 4	.06	.06	99.25

S2B and S5B1 ON/OFF Controls

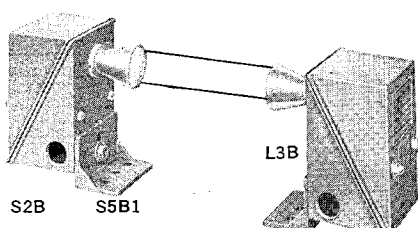

S2B S5B1

All above controls have 1 1/2" lens mounted in aluminum lens tube. Requires 10 foot-candles minimum light. Weight, 3 lb. Dimensions, diagram 24B.

DARK† energized	LIGHT† energized	50-60 cycles VOLTS	NET each
S2B	S5B1	115/230	\$49.75

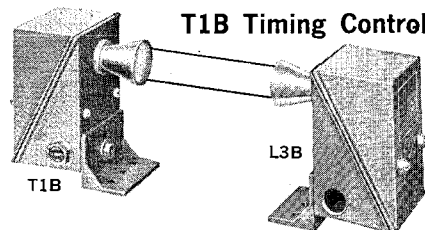

T1B

L3B

Relay energizes DARK—unit times out DARK. Time delay with shaft lock adjustment from 1 to 10 seconds. Repeat accuracy 4% Minimum light 40 foot-candles. Control Relay contacts SPDT, rated 8 amps at 115 VAC, non-inductive. Splashproof aluminum case tapped for 3/4" conduit. Adjustable mounting bracket. Lens dia. 1 1/2" Power consumption 10 watts. 115/230 V., 50-60 cycles. Weight 3 lbs. Dimensions, Diagram 24B.

T1B Timing Control.....\$62.50

T1B Timing Control-Paks

Control-Paks	max. ft. between lenses	Min. dark time	Min. light time	Price per set
T1B-L1A	5 ft.	—	.5	\$82.25
T1B-L2B	10 ft.	—	.5	86.30
T1B-L3B	10 ft.	—	.5	90.00

Light Sources are described on page 6



Specialized Electronic Controls

Electronic Liquid Level Control

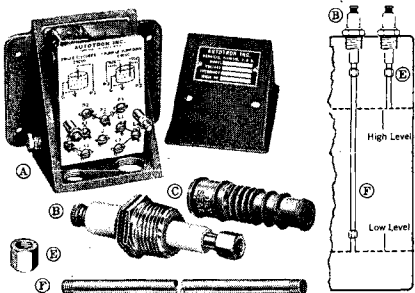

For use with liquids up to 750,000 ohms resistance such as acids, bases, salts, milk, beer, water, alcohols, ammonia, distilled water, anti-biotics.

- Ⓐ A744 Control supplies 20VDC (safe for personnel) maximum probe voltage. Stepless sensitivity adjustment with shaft lock. Plug-in 5 amp. SPDT relay, plastic enclosed. Gasket-sealed cast aluminum case 6-3/16" wide, 5 3/8" high, 3 3/8" deep. 4 mounting holes for 1/4" bolts on 5 1/8" x 3" centers. Power Consumption, 5 W. For 115 or 230v (specify) 50-60c.....Each \$74.50
- Ⓑ P-304 Electrode has 1/2" pipe threads—may be installed in top or side of tank.....Each \$10.60
- Ⓒ P-305 Elastic Seal for electrode wiring connection..... Each \$1.00
- Ⓓ P-310 hex nut, stainless steel, 5/8" long—1/4-20 thread.....Each \$1.00
- Ⓔ P-309 18-8 stainless steel rod 1/4" x 12"—1/4-20 thread both ends.....Each \$1.50

Type of System Components	One Electrode Quan.	Price	Two Electrode Quan.	Price
Ⓐ A744 Control	1	\$74.50	1	\$74.50
Ⓑ P-304 Electrode	1	10.60	2	21.20
Ⓒ P-305 Dri-Seal	1	1.00	2	2.00
Connecting Cable	10 ft.	3.00	20 ft.	6.00
Price Totals		\$89.10*		\$103.70*

*P-309 Rod and P-310 Nuts not included

A2BX Solar ON/OFF Control

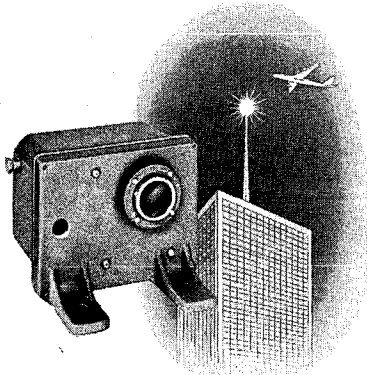

Automatically turns lights "ON" at preset light value—and turns lights "OFF" when light exceeds preset value.

DPDT Control Relay energizes when light exceeds intensity for which control is set; de-energizes when light falls below the preset level.

In case of tube failure the relay de-energizes; providing same control action as when light falls below preset level.

Dual Time Delays prevent operation by either momentary light flashes or shadows. Modern, simple circuitry uses one rugged, premium type power tube. Light intensity adjustment from outside of housing. Gasket-sealed cast aluminum housing, tapped for 1/2" conduit. For 115/230 v, 50-60 c. Power consumption, 20 watts

Available with three adjustment ranges:
 No. A2BX-2; 1 to 5 fc for street lighting, parking lots
 No. A2BX-5; 15 to 50 fc for signs, parking lots
 No. A2BX-1; 20 to 150 fc for obstruction or tower lights

A2BX Solar Control (all models) Net \$76.95

Current Surge Overload Protection

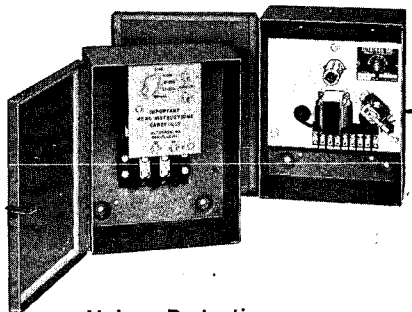

Unique Protection for tools, equipment, personnel

The Surj-Switch uses electronic amplification for instant reaction to variations from normal load current. Easily adjusted on the job to operate at the desired value.

The 10-amp, SPDT Control Relay may operate a warning signal, a lubricating circuit, feeding rate control, etc. without interrupting operation or may be used to stop operation.

Used on surface grinders to warn when excessive pressures are applied; on machine tools to warn when tools become dull; on automated installations; whenever load change indicates trouble.

Model K1 Surj-Pick-up. Required for operation of Surj-Switch Controls—for 50-60 cycle, 0 to 80 amperes, one or 3-phase, any voltage..\$35.00

Model J Surj-Switch. For overloads.....\$55.00

Model JA Surj-Switch. For under loads....\$65.00

Impak-Switch Die Protection

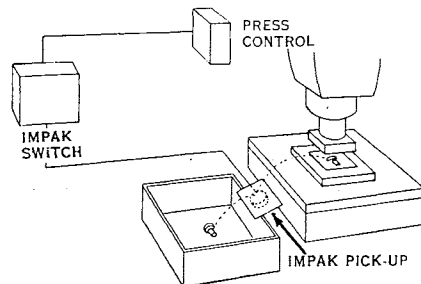

In the above diagram each piece properly ejected from the die strikes the impact sensing plate which actuates the Impak Control and the Control re-cycles the press control for another stroke.

The impact of falling parts against the sensing plate of the Impak-Pick-up activates the Impak-Switch. Objects may be of practically any reasonably uniform size, ranging from ball bearings to heavy stampings, etc.

In other die protection applications the Impak Control has time delay set to barely exceed the complete stroke cycle of the press. Each properly ejected piece re-cycles the Impak Control before the timing period expires.

Model V Impak-Pick-up—with 6-ft. shielded plastic-covered cable.....Net \$30.00

Model Z Impak-Switch—for use where impact is not less than one ounce falling 2 inches and each object strikes only once.....Net \$60.00

Model C3 Impak-Switch—for use where impact force is limited, where high speed is required or where objects may strike more than once. Net \$145.00

Tubeless Bin Level Control

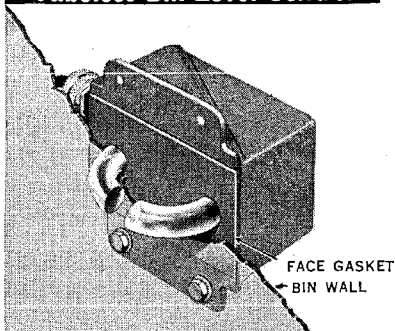

Tubeless Photoelectric actuation—unaffected by pressure of material in the bin. Only rigid, non-moving Lucite probes project into the bin. Cast aluminum, gasket-sealed housing mounts to bin wall as shown. Removal of cover makes all parts accessible. Dust-covered plug-in DPDT 8-ampere relay provides ON/OFF control for either high or low bin level. All wiring connections brought out of case in 3-foot oil-proof cable. For 115/230V, 50-60 C.

A700—Relay operates from cad cell output, light-energized. Power Consumption, 10 watts.....Net \$68.00

A700S—has transistor circuit and sensitivity adjustment—dark-energized. Power Consumption, 5 watts.....Net \$98.75
 Includes 3-ft cable, face gasket and template.

AUTOTRON Counting Eye

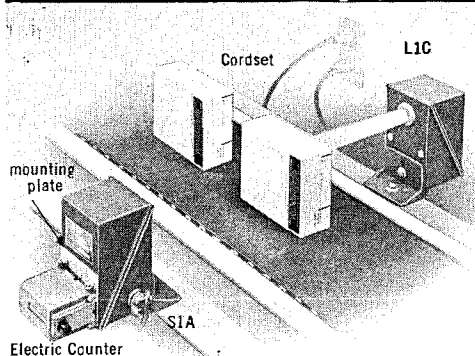

Counts anything—Automatically—without touching the object. Each object must interrupt the light beam .06 second or more. Space between objects must permit restoration of the light beam .06 second or more. Max. distance between lenses, 8 feet.

Counting Eye Components
 SIA Photoelectric Control (see page 5) \$43.75
 LIA Light Source (see page 6) 19.75
 Cordset: two 6-foot rubber covered cords with plugs and attachment clamps 3.00
 Plate and hardware for mounting counter (4 mounting holes on 3-15/16 x 1-23/64" centers) 1.50
 CE-600AS602 Electric Counter (6-digit, knob reset) 34.60
A-138A Counting Eye, 115v, 50-60c. Net \$108.50
 Includes above items wired ready to plug in.

Photoelectric Controls with Infrared Light Beams

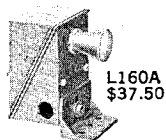

For burglar alarms, safety and other applications where an invisible light beam offers advantages. The control lens is shielded from normal light so operation continues night or day whether lights are on or off.
A880-L160A Infrared Control-Pak.....\$121.00
 For 115/230v, 50-60c. Daylight Range, 50 feet; Night Range, 100 feet.

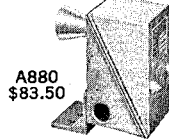



WORNER ELECTRONIC DEVICES

NET PRICES

INDUSTRIAL APPLICATIONS

EASY-TO-FOLLOW INSTALLATION INSTRUCTIONS • REQUEST ENGINEERING BULLETINS

THREE-UNIT CONTROLS

For All General Applications

Model 63 Series represents a line of four high speed, precision Amplifiers; each engineered for a highly specialized use. Selection enables the user to get the amplification his application requires. Each amplifier is designed for amplification of energy developed by one set of Series 33/23 Fotoelectric Heads listed below. Each Amplifier will also respond to light radiance (other than light projected from a Light Source unit) when reflected to the Photocell. Model 63 Series Amplifiers are heavy duty construction throughout, size 9 1/4" x 1 1/2" x 5". Engineered for 110/120v. 50/60 cy. a.c.

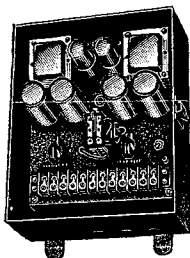

Model 63 Amplifier Door removed to show components.

- Model 63, the Worner Master Unit, serves most industrial uses. It is generally recommended for supervising fast moving objects and will operate normally up to 750 times a minute.....Each \$144.12
- Model 63-A, equipped with Time Delay Circuit giving delay from 0 to 45 seconds.....Each \$160.77
- Model 63-B, has added amplification to operate on less active change of light.....Each \$171.87
- Model 63-C, same as Model 63 but is "dark-energized", and operates when the photocell is dark.....Each \$146.73
- Model 64. Economy Unit. Operates up to 450 times a minute.....Each \$87.90

WIDE RANGE OF FOTOLECTRIC HEADS



Series 33 Light Sources
Series 23 Photocells

Sharp Detection

Selection of any of the following seven combinations, with current flow amplified by a choice of any of the above Amplifiers, provides unbeatable control supervision. Both units are alike externally. Mounting brackets supplied.

Model 33 Series Light Sources and Model 23 Series Photocells are heavy duty units. Components are housed in solid metal castings equipped with conduit fitting. Size of case 3" x 3" x 4 1/2".

CROSS-OVER BEAM supervises small objects under 2" square at high speed. Distances listed are from lens to (cross-over) point of supervision. Moisture-proof units.

DISTANCE	LIGHT SOURCE	EACH	PHOTOCELL	EACH
Up to 3"	Model 33-3	\$28.95	use with Model 23-3	\$36.00
3" to 6"	Model 33-6	28.95	use with Model 23-10	28.80
6" to 9"	Model 33-9	28.95	use with Model 23-10	28.80
9" to 12"	Model 33-12	28.95	use with Model 23-10	28.80

DIRECTIONAL BEAM for objects over 2" square. Distances listed cover area of supervision (between units).

DISTANCE	LIGHT SOURCE	EACH	PHOTOCELL	EACH
1 to 10 ft.	Model 33-10	\$23.40	use with Model 23-10	\$28.80
Made moisture-proof upon order at \$7.50 per unit.				
10 to 25 ft.	Model 33-25w	\$39.78	use with Model 23-25w	\$40.32
These units are moisture-proof.				

FOR SUPERVISING LARGE OBJECTS UP TO 75 FT.

Model 33-C Light Source and Model 23-C Photocell supervise over an indoor distance over 25 ft. up to 75 ft. from unit to unit. 6 1/4" x 7" x 4 1/2". Use with any of the above Amplifiers.

Model 33-C.....each \$23.88.....use with Model 23-C.....each \$32.76

THE ELECTRONIC RECEPTIONIST

Model 61 Fotoelectric Announcer is a three-piece set. Projects light beam across entrance to signal entry or departure of persons. Breaking beam activates Chime, located where signal is desired. Efficient grid controlled rectifier circuit. Mirror reflects beam to Photocell in the unit. Case 8 1/2" x 6 1/2" x 3 3/4". Lamp-life rating 1000 hours.

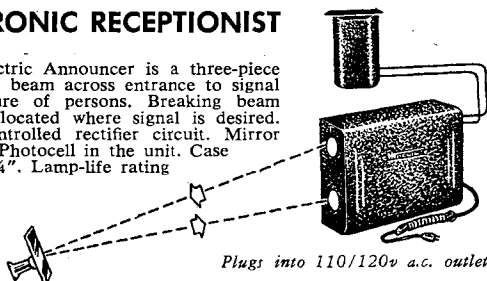

- Model 61. Fotoelectric Announces.....Per Set \$56.25
- Model 61-T. Fully transistorized. Size 7 3/4" x 5 3/4" x 3 3/8".....Per Set \$64.80

AMPLIFIERS FOR MINIATURE HEADS

Model 66/67 Series Amplifiers are available in a choice of four units. For positive and accurate performance, the maximum speed rating of each unit can be regulated provided light projected to the Photocell will have an "on-period" equal to the "off-period" with wiring to Photocell having zero (0) capacity. 110/120v. 50/60 cy. a.c.

Model 67 Amplifier for general applications where fine detection at high speeds is not a factor or Relay is not required to operate in excess of 450 times per minute.....Each \$97.83

Model 66 Amplifier, operates up to 900 counts a minute. Double-pole, double-throw relay with contact rating 110v. 60 cy. a.c., 10 amp.-non-inductive and 5 amp. inductive. Has light beam intensity control.....Each \$154.80

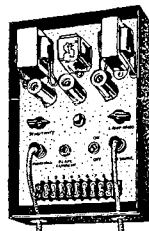

Model 66 Amplifier Door removed to show components.

Model 66-A Amplifier, designed for use with ultra high speed electronic decade counters. Accurate counts of light beam interruption or variation of intensity up to 10,000 counts per minute. Output pulses up to 50 volts d.c. regulated by the sensitivity control.....Each \$166.95

Model 66-T Amplifier, same operating features as Model 66 with added Time Delay circuit to give regulated time delay from 0 to 45 seconds. Efficient for synchronizing operations.....Each \$186.45

"MINIATURE" FOTOLECTRIC HEADS

Designed for use with Models 66/67 Amplifiers

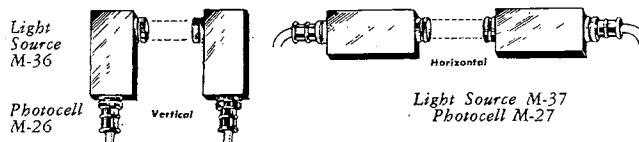

Machined out of solid aluminum blocks. Light weight, unbreakable, one-piece, dependable. Only 1 1/4" x 2 1/2" x 3/4". Unsurpassed for pin-point detection. Distance to cross-over point 3" to 12". Distance of directional beam up to 8 feet. For desired speed, select Amplifier accordingly. Six-foot cable equipped both ends with prong-type connectors having screw-band tighteners. For 110/120v. 50/60 cy. a.c.

- Model M-36 Vertical Light Source.....\$37.23
- Model M-26 Vertical Photocell Receiver.....41.34
- Model M-37 Horizontal Light Source.....37.23
- Model M-27 Horizontal Photocell Receiver.....41.34

TWO-UNIT CONTROL

For Industrial Applications (Indoors)



Light Source

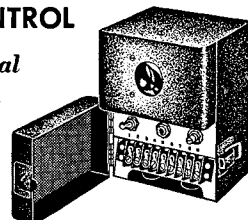

Amplifier

Amplifier includes photocell, Relay and components. Efficient for distances from a few inches to 75 ft. For use where Relay is not required to operate over 400 times a minute, such as; counting, sorting large objects; limit switches; start, stop operations; opening doors, etc.

Model 62 R & L "Two-Unit Set".....Per Set \$110.25

STOP FIRE BEFORE IT SPREADS

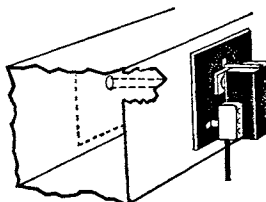

Automatic Control when light beam projected across duct, detects smoke.

Most catastrophic fires are due to sparks drawn into or originating in air-conditioning ducts, resulting in flames fan-driven throughout a building. The Worner Fan Motor Stop minimizes this hazard by early detection, stopping of fans and sounding alarm. Consists of Light Source, Photocell Receiver and Control Cabinet. Meets requirements of National Board of Fire Underwriters, Factory Insurance Ass'n. Listed by U.L. Send for Bulletin 650.

Write For information On Solid State Equipment

The Complete Line of

DIALCO

Indicator Lights

DIALIGHT CORPORATION

Foremost Manufacturer of Indicator Lights

(Illustrations are approx. actual size)

See Catalog L-160

DATALITES® — Ultra-Miniature Indicator Lights with Data Caps

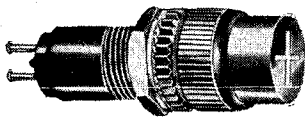

250-8738-1471-504

INCANDESCENT

MOUNT IN 3/8" CLEARANCE HOLE

INCANDESCENT ■ COMPLETE ASSEMBLIES WITH TURRET TERMINALS		
▲ DATA CAP LENS COLOR	SHORT CYLINDRICAL FOR USE WITH HOT-STAMPED LEGENDS (TRANSLUCENT)	SHORT CYLINDRICAL WITH DIFFUSING RINGS (TRANSPARENT)
Red	250-8738-1471-504	250-8738-3331-504

■ To obtain solder cup terminals change "87" in catalog number to "75". For amp "53" taper pin receptacles, change to "90".

Example: 250-9038-1471-504.

DATALAMP CARTRIDGES

INCANDESCENT DATALAMP CARTRIDGES FOR USE IN DATA CAP ASSEMBLIES				
CATALOG NOS. SHORT CYLINDRICAL LENS SHAPE TRANSPARENT-COLORLESS	VOLTS	MA.	C.P.*	LIFE HOURS
LONG LIFE—HIGH RELIABILITY				
507-3907-1437-600	6.3	40	.03	50,000
507-3909-1437-600	6.3	200	.40	50,000
507-3914-1437-600	14.0	80	.30	50,000
507-3918-1437-600	28.0	40	.30	25,000
STANDARD RATINGS				
507-3902-1437-600	2.5	200	.20	500
507-3906-1437-600	6.0	200	.60	1,000
507-3908-1437-600	6.3	75	.23	500
507-3913-1437-600	14.0	80	.50	750
507-3916-1437-600	18.0	40	.15	1,000
507-3917-1437-600	28.0	40	.34	1,000

*C.P. is the mean spherical candle power of the lamp used. Values are useful for relative effectiveness.

▲ LENS COLOR:

To obtain Data Cap with color other than red, change digit before last dash in catalog number (-1471-) to: Green-2; Amber-3; White Translucent-5; Clear Colorless-7.

Example: 250-8738-1473-504 (Amber)

Note: Green is not recommended for use with Neon lamps.



250-8745-1631-504

NEON

MOUNT IN 3/8" CLEARANCE HOLE

FEATURES

A Datalite Indicator consists of three parts: (a) the main body or **Datalamp Holder** which is adapted for permanent mounting on the panel; (b) the **Datalamp cartridge** which telescopes into the Datalamp Holder and makes electrical contact as the pins enter the receptacle in the holder; and (c) the screw-on **Data Cap**. The Data Cap secures the Datalamp and its lens controls the light emission.



NEON DATALAMP CARTRIDGES		
LAMP BRIGHTNESS	CARTRIDGES WITH BUILT-IN RESISTOR	CARTRIDGES WITH NO RESISTOR
HIGH	507-4538-0937-610	507-3836-0937-600
STANDARD	507-4537-0937-640	507-3835-0937-600

SHORT CYLINDRICAL DATA CAP with diffusing rings.

NEON ■ COMPLETE ASSEMBLIES WITH TURRET TERMINALS			
DATA CAP LENS SHAPE	▲ LENS COLOR	ACCOMMODATES CARTRIDGES WITH BUILT-IN RESISTOR	ACCOMMODATES CARTRIDGES WITH NO RESISTOR
Long Cylindrical	Red	250-8745-1631-504	250-8738-1631-504
Short Cylindrical	Red	250-8745-3331-504	250-8738-3331-504

■ To obtain solder cup terminals change "87" in catalog number to "75". For amp "53" taper pin receptacles, change to "90".

Example: 250-9038-3331-504.

▲ See LENS COLOR data at left.

INCANDESCENT — For use on 6 - 120V Circuits

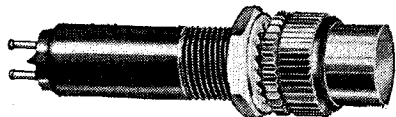

250-8758-1471-504

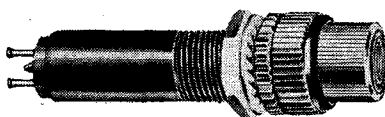

250-8758-3331-504

Mount in 3/8" Clearance Hole

This series accommodate longer cartridges that employ telephone type bulbs for higher voltages. Sufficient light is produced to be effective with either transparent or translucent Data Caps.

Datalamp cartridges are provided with 6 supply voltages. For levels between nominal ratings, cartridges of the next higher value should be chosen.

DATALAMP CARTRIDGES

CATALOG NUMBER	VOLTS	MA.	LIFE HOURS**	RELATIVE LUMINOSITY END-ON
507-5819-0747-600	6	140	5000 +	0.7
507-5820-0747-600	12	170	5000 +	2.1
507-5821-0747-600	28	40	5000 +	1.2
507-5822-0747-600	48	53	5000 +	1.5
507-5823-0747-600	60	50	5000 +	2.2
507-5824-0747-600	120	25	5000 +	1.5

**Based on the lamp manufacturer's statement: "Engineered to give a minimum of 5000 hours under static conditions." Lamps giving this performance are comparable with those rated at 25,000 hours "average" life. All Catalog Numbers above designate Datalamp Cartridges with clear (colorless) convex lens with matted back.

***INDICATOR LIGHTS WITH TURRET TERMINALS**

LENS COLOR	TRANSLUCENT LENS FOR USE WITH HOT-STAMPED LEGENDS	TRANSPARENT LENS WITH REFRACTIVE INNER SURFACES
Red	250-8758-1471-504	250-8758-3331-504
Green	250-8758-1472-504	250-8758-3332-504
Yellow (Amber)	250-8758-1473-504	250-8758-3333-504
Blue	250-8758-1474-504	250-8758-3334-504
White (Translucent)	250-8758-1475-504	250-8758-3335-504
Clear (Colorless)		250-8758-3337-504

*To specify Datalites with solder cup terminals, change so much of the catalog number that reads -8758- to -7558-. Example: 250-7558-1473-504.

DATA TWIN INDICATOR LIGHT

Accommodates 2 Neon or Incandescent DATALAMP Cartridges

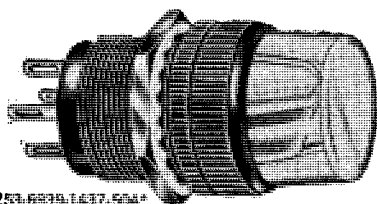

253-6939-1437-504

MOUNTS IN 3/4" CLEARANCE HOLE

The Data Twin Indicator Light houses 2 Datalamp Cartridges. Each cartridge may be operated independently thus indicating 4 possible conditions. The cartridge is removable from front of panel. The light barrier (between the 2 lamps) is an integral part of the lens cap.

*Examples: 253-6939-1437-504 — For use with all Incandescent or most Neon cartridges without built-in resistor. 253-6945-1437-504 — For use with Neon cartridges with built-in resistor only.

The Complete Line of

DIALCO

Indicator Lights

DIALIGHT CORPORATION

Foremost Manufacturer of Indicator Lights

(Illustrations are approx. actual size)

Sub-Miniature Indicator Lights for T-1³/₄ Bulbs

With Midget Flanged Base—INCANDESCENT



MOUNT IN 1/32" CLEARANCE HOLE FRONT OR BACK OF PANEL INSERTION WITH MOVABLE FLANGE

MOUNT IN 1/32" CLEARANCE HOLE FRONT OF PANEL INSERTION WITH FIXED FLANGE

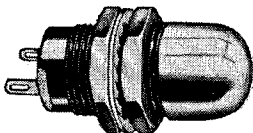

101-3830-0931-201

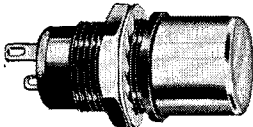

140-8430-1471-201

TYPE MOUNTING	LENS SURFACE	CATALOG NUMBER STOVEPIPE LENS SHAPE	CATALOG NUMBER CYLINDRICAL LENS SHAPE
Front or Back Mtg. in 15/32" Clearance Hole	Transparent	101-3830-0931-201	140-3830-1431-201
	Translucent	101-3830-0971-201	140-3830-1471-201
Front Mtg. in 17/32" Clearance Hole	Transparent	101-5030-0931-201	140-5030-1431-201
	Translucent	101-5030-0971-201	140-5030-1471-201
Front Mtg. in 15/32" Clearance Hole	Transparent	101-8430-0931-201	140-8430-1431-201
	Translucent	101-8430-0971-201	140-8430-1471-201

MOUNT IN 1/32" CLEARANCE HOLE • FRONT OF PANEL INSERTION WITH FIXED FLANGE • MS25256 2-12

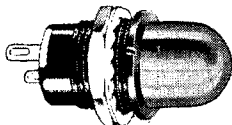

Note: The inclusion of lamp MS25237-327 in MS25256, formerly designated by the use of odd numbered suffixes, -1 through -11 inclusive, is now superseded by suffix -327 (28 volts .04 amp) or -328 (6 volts .20 amp) after the even numbered dash number. Examples: MS25256-2-327; MS25256-10-328.

162-8430-0931-502

CATALOG NUMBER	MS. NO. WITHOUT LAMP*	LENS CAP COLOR**
162-8430-0933-502	MS25256-2	Aviation Yellow
162-8430-0932-502	MS25256-4	Aviation Green
162-8430-0931-502	MS25256-6	Identification Red
162-8430-0937-502	MS25256-8	Aviation White
162-8430-0975-502	MS25256-10	Translucent White
162-8430-0934-502	MS25256-12	Aviation Blue

To specify translucent stovepipe or cylindrical; or transparent cylindrical lens cap (not covered by MS designations) write for Cat. L-178.

*Marking: Part number marked on the assembly is the part number for the complete assembly less lamp. — **All lens cap colors are transparent with the exception of white.



134-3830-0351-201

ROTATABLE LENS

Specially designed spring mounting facilitates rotation of lens and alignment of legend — after installation of the Indicator Light.

LENS SHAPE	LENS FINISH	CATALOG NO. (FRONT OR BACK MTD. 15/32" CLEARANCE HOLE)	CATALOG NO. (FRONT MTD. 17/32" CLEARANCE HOLE)	CATALOG NO. (FRONT MTD. 15/32" CLEARANCE HOLE)
FLAT	Transparent	134-3830-0331-201	134-5030-0331-201	134-8430-0331-201
	Translucent	134-3830-0351-201	134-5030-0351-201	134-8430-0351-201
CONVEX	Unfrosted	134-3830-0131-201	134-5030-0131-201	134-8430-0131-201
	Back Frosted	134-3830-0111-201	134-5030-0111-201	134-8430-0111-201
FACETED	Unfrosted	134-3830-2131-201	134-5030-2131-201	134-8430-2131-201

■ Specify translucent. colors: Red — 0351
Green — 0352 Yellow (Amber) — 0373 Blue — 0374
White — 0375 Light Yellow — 0376.

LENS COLOR: The figure before the last dash in the catalog number indicates that the lens is RED. When a color other than red is desired, change this digit to a figure from the listing below. Note that white lenses are translucent and are always furnished unfrosted.

RED—1 . . . Green—2 . . . Yellow (Amber)—3 . . . Blue—4 . . .
White Translucent—5 . . . Light Yellow—6 . . . Clear (Colorless)—7.
Example: 101-3830-0932-201 (Green)

Sub-Sub-Miniatures

Series 252-9951-0971



Conforms to Drawing MS25446 2-7 . . . Requires only .193" Panel Mounting Clearance Hole . . . For complete data, refer to Catalog L-168.

Two Terminals — Fully Insulated

Meet or exceed environmental and operational requirements of MIL-L-6723 and MIL-L-3661.

RUGGED CONSTRUCTION

Lamp, socket, and all connections are completely insulated from the bushing and panel to which it is attached. The use of phenolic material for military specification grade assures permanent isolation from ground. These assemblies are solidly made to withstand usual vibration and corrosion resistance tests.

Order Complete with Lamp. Specify Lamp Number.

DIMMERS — MECHANICAL or POLAROID

Choice of mechanical or polaroid dimming device. Polaroid produces some reduced intensity at all settings, but gives full diameter opening.

Mechanical varies opening size to complete blackout or has permanent small opening as in "semi-blackout" type.

MANUFACTURER'S RATINGS (Values given are approx.)

LAMP NO.	VOLTS	AMPERES	HOURS	CANDLE-POWER
▲331	1.35	.06	500	.006
▲338	2.7	.06	500	.04
▲375	3.0	.015	20,000	.004
*328	6.0	.20	1,000	.83
345	6.0	.04	1,000	.03
349	6.3	.20	3,000	.55
380	6.3	.04	50,000	.02
381	6.3	.20	50,000	.40
▲344	10.0	.014	50,000	.002
367x	10.0	.04	20,000	.08
330	14.0	.08	750	.50
382	14.0	.08	50,000	.30
370	18.0	.04	1,000	.15
**327	28.0	.04	1,000	.34
**387	28.0	.04	25,000	.30

▲ These lamps only are for use with transparent lens caps without legends. **MS18209 (BusShips) *Conforms to MS25237.

MOUNT IN 1/32" CLEARANCE HOLE FRONT OR BACK OF PANEL INSERTION WITH MOVABLE FLANGE



108-3830-0111-201

DIMMER TYPE	GLASS LENS TYPE	LENS SURFACE	CATALOG NO. (FRONT OR BACK MTD. 15/32" CLEARANCE HOLE)	CATALOG NO. (FRONT MTD. 17/32" CLEARANCE HOLE)	CATALOG NO. (FRONT MTD. 15/32" CLEARANCE HOLE)
Complete Blackout	Convex	Unfrosted	108-3830-0131-201	108-5030-0131-201	108-8430-0131-201
		Back Frosted	108-3830-0111-201	108-5030-0111-201	108-8430-0111-201
Semi-Blackout	Convex	Unfrosted	109-3830-0131-201	109-5030-0131-201	109-8430-0131-201
		Back Frosted	109-3830-0111-201	109-5030-0111-201	109-8430-0111-201
Polaroid	Convex	Unfrosted	112-3830-0131-201	112-5030-0131-201	112-8430-0131-201
		Back Frosted	112-3830-0111-201	112-5030-0111-201	112-8430-0111-201

NON-DIMMING TYPE	GLASS LENS TYPE	LENS SURFACE	COMPLETE ASSEMBLIES
Front or Back Mtg. in 15/32" Clearance Hole	Convex	Unfrosted	111-3830-0131-201
		Back Frosted	111-3830-0111-201
Front Mtg. in 17/32" Clearance Hole	Convex	Unfrosted	111-5030-0131-201
		Back Frosted	111-5030-0111-201
Front Mtg. in 15/32" Clearance Hole	Convex	Unfrosted	111-8430-0131-201
		Back Frosted	111-8430-0111-201

WATER-TIGHT ASSEMBLIES

Water-tight construction: These Sub-Miniature Lights are completely water-tight on the face of the panel. Water-tightness is achieved by means of retained O-ring seals. One O-ring is retained within the back of the lens cap, the other behind the flange on the mounting bushing.

MOUNT IN 1/32" CLEARANCE HOLE FRONT OF PANEL INSERTION WITH FIXED FLANGE

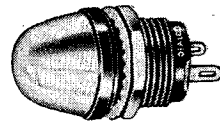

177-8430-0931-503

WATER-TIGHT DIMMERS

On the Dimmer type assembly, a third O-ring is mounted within the dimmer cap — so positioned as to assure absolutely no leakage through the dimmer slot. For data, request Catalog L-178.

LENS COLOR	COMPLETE ASSEMBLIES	
	TRANSPARENT COLORS	TRANSLUCENT COLORS
Red	177-8430-0931-503	177-8430-0971-503
Green	177-8430-0932-503	177-8430-0972-503
Yellow (Amber)	177-8430-0933-503	177-8430-0973-503
Blue	177-8430-0934-503	177-8430-0974-503
White (Translucent)	177-8430-0935-503	177-8430-0975-503
Light Yellow	177-8430-0936-503	177-8430-0976-503
Clear (Colorless)	177-8430-0937-503	—

Translucent Lens Cap Color	DIALCO Catalog No.	Military Number	Translucent Color Lens Cap	Catalog No. DIALCO	Number Military
Blue	252-9951-0974	MS25446-2	White	252-9951-0975	MS25446-5
Green	252-9951-0972	MS25446-3	Yellow (Amber)	252-9951-0973	MS25446-6
Red	252-9951-0971	MS25446-4	Clear (Transparent)	252-9951-0937	MS25446-7

The Complete Line of

DIALCO

Indicator Lights

DIALIGHT CORPORATION

Foremost Manufacturer of Indicator Lights

(Illustrations are approx. actual size)

When Connecting a Neon Light to a Circuit Having One Side Grounded, Always Connect the Hot Side of the Circuit to the Terminal Marked + (Center Contact).

ASSEMBLIES with BUILT-IN RESISTORS (U. S. Patent No. 2,421,321)

"Recognized under the component program of Underwriters' Labs Inc."  75W., 125V — 75W., 250V

For T-3/4 Bulb with Miniature Bayonet Base—NEON

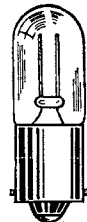

B1A (NE-51)
B2A (NE-51H)
(High Bright.)

For operation on 105-125V AC-DC ... 110-125V AC ... 210-250V AC-DC

Assemblies conform to MIL-L-3661.

BUILT-IN RESISTOR VALUES (in ohms) for NEON GLOW LAMPS

B2A (NE-51H)—High Brightness		B1A (NE-51)—Standard Brightness		
Circuit volts applied to terminals 110-125 AC		Circuit volts applied to terminals 105-125 AC-DC		
BRIGHT LIGHT	22,000	68,000	BRIGHT LIGHT	56,000
LONG LAMP LIFE	33,000	100,000	LONG LAMP LIFE	100,000

■ Standard values of patented built-in resistors.

PROPER CHOICE OF LAMP AND BUILT-IN RESISTOR VALUES: The NE-51 glow lamp types are shown with resistor table. Lamps are the standard brightness NE-51 and the high brightness NE-51H. The latter may be operated at about three times the level of current that may be applied to the standard lamp and it will produce more than 8 times as much brightness.

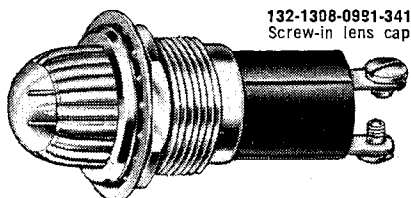

132-1308-0991-341
Screw-in lens cap

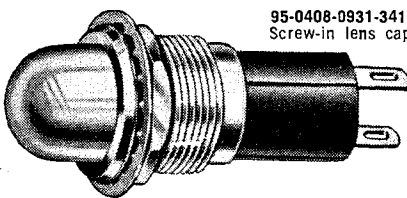

95-0408-0931-341
Screw-in lens cap

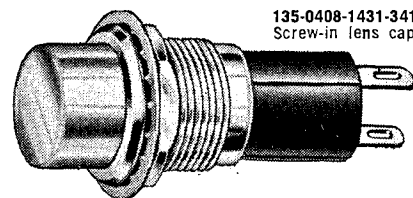

135-0408-1431-341
Screw-in lens cap

LENS HOLOER AND PLASTIC LENS STYLE	LENS FINISH	FOR B2A (NE-51H)—110-125V. AC		FOR B1A (NE-51)—105-125V. AC-DC	
		CATALOG NO. WITH SCREW TERMINALS	CATALOG NO. WITH SOLDER TERMINALS	CATALOG NO. WITH SCREW TERMINALS	CATALOG NO. WITH SOLDER TERMINALS
STOVEPIPE (Screw-in)	Internal Fluting	52-1363-0991-311	52-0463-0991-311	52-1308-0991-341	52-0408-0991-341
STOVEPIPE (Screw-in)	Special Internal Fluting	132-1363-0991-311	132-0463-0991-311	132-1308-0991-341	132-0408-0991-341
CYLINDRICAL (Screw-in)	Transparent	135-1363-1431-311	135-0463-1431-311	135-1308-1431-341	135-0408-1431-341
FLAT (Screw-in)	Transparent	81-1363-0331-311	81-0463-0331-311	81-1308-0331-341	81-0408-0331-341
STOVEPIPE (Screw-in)	Transparent	95-1363-0931-311	95-0463-0931-311	95-1308-0931-341	95-0408-0931-341
DOME (Screw-on)	Transparent + Matted Back	85-1363-1231-311	85-0463-1231-311	85-1308-1231-341	85-0408-1231-341
STOVEPIPE (Screw-on)	Internal Fluting +	169-1363-1191-311	169-0463-1191-311	169-1308-1191-341	169-0408-1191-341
	Transparent +	169-1363-1131-311	169-0463-1131-311	169-1308-1131-341	169-0408-1131-341

+ To specify white translucent color, change so much of the catalog number that reads -1231- to -0835-; from -1131- to -0935-; from -1191- to -0995-. Example: 169-1363-0935-311.

WATER-TIGHT CONSTRUCTION: The assemblies on this page may be made water-tight on the face of the panel. To specify, change the last digit in the catalog number suffix to 3. Example: 95-1308-0931-343.

HOW TO DESIGNATE THE THREE DIGIT CATALOG NUMBER SUFFIX (-XXX)

FINISH	RESISTOR	HARDWARE
-1 white nickel	1-22K	1-brass
-2 black nickel	3-33K	3-water-tight
-3 polished chrome	4-56K	on the face
-4 satin chrome	6-68K	of the panel.
	7-100K	

NOTE: The part numbers given in this catalog indicate standard indicator lights. The table at left provides the standard and optional designations for Finish, Resistor and Hardware where appropriate. Example: 85-1308-1231-273 (black nickel finish, 100K resistor, water-tight construction).

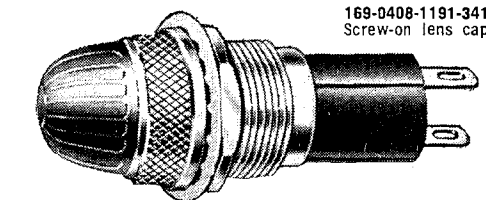

169-0408-1191-341
Screw-on lens cap

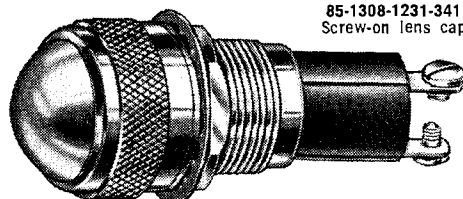

85-1308-1231-341
Screw-on lens cap

LENS COLOR—The last digit before the 3 digit catalog number suffix indicates that the lens is RED. When color other than red is desired, change this digit to a figure from the listing below.

Red — 1; Yellow (Amber) — 3; White Translucent — 5; Light Yellow — 6; Clear (Colorless) — 7.

9/16" Assemblies mount from BACK of panel only

17-1308-0931-245
Screw-on lens cap

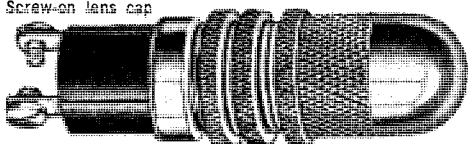

Optional Finishes: The catalog number suffix designates an assembly with standard black nickel finish. To specify optional finish, change the first digit of the catalog number suffix to -3 (polished chrome finish), or -4 (satin chrome finish).

Example: 17-1308-0931-345

SAMPLES ON REQUEST AT ONCE — NO CHARGE

WITH SCREW-ON LENS CAP

LENS STYLE	LENS FINISH	FOR B2A (NE-51H)—110-125V. AC		FOR B1A (NE-51)—105-125V. AC-DC	
		CATALOG NO. WITH SCREW TERMINALS	CATALOG NO. WITH SOLDER TERMINALS	CATALOG NO. WITH SCREW TERMINALS	CATALOG NO. WITH SOLDER TERMINALS
STOVEPIPE	Transparent	17-1363-0931-215	17-0463-0931-215	17-1308-0931-245	17-0408-0931-245
	Internal Fluting	17-1363-0991-215	17-0463-0991-215	17-1308-0991-245	17-0408-0991-245
STOVEPIPE	Transparent +	70-1363-1131-215	70-0463-1131-215	70-1308-1131-245	70-0408-1131-245
	Internal Fluting +	70-1363-1191-215	70-0463-1191-215	70-1308-1191-245	70-0408-1191-245
FLAT	Transparent	37-1363-0331-215	37-0463-0331-215	37-1308-0331-245	37-0408-0331-245

+ See footnote above.

Standard Hardware: 3 knurled rings... **Optional Hardware:** 1 ring, 1 lockwasher, 1 mounting nut. To designate an assembly with "optional hardware," change the last digit in the catalog number suffix to 6... Example: 37-0408-0331-246.

Also Available: Assemblies for T-3/4 Bulb with Miniature Bayonet Base — INCANDESCENT — 2 to 55V
For Mounting in 1/8" Clearance Hole... Refer to Catalog L-161.

The Complete Line of



Indicator Lights

DIALIGHT CORPORATION

Foremost Manufacturer of Indicator Lights

(Illustrations are approx. actual size)

“Recognized under the component program of Underwriters’ Labs Inc.”

ASSEMBLIES for INCANDESCENT LAMPS

For details, refer to Catalog L-161.

(with double contact bayonet base or candelabra screw base)

Mount in 1" Clearance Hole • Range of Voltage 6 to 145V • Refer to Cat. L-161



75W., 125V.

G-6 with Double Contact Bayonet Base — 6 to 32 volts max. S-6 (at 6 watts) with Double Contact Bayonet Base or Candelabra Screw Base — 6, 12, 24, 32, 48, 70-80, 125, 130, 135 and 145 volts.

Accommodate S-6 Bulb with Candelabra Screw Base

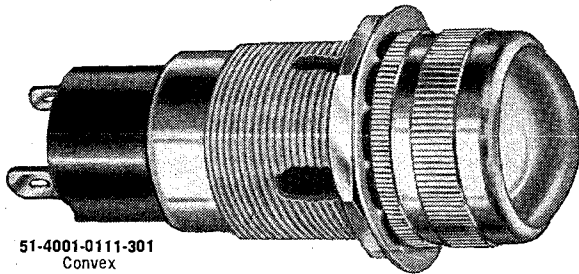

51-4001-0111-301
Convex

Standard Finish — Polished Chrome. To specify optional finish change the first digit of the catalog number suffix to -2 (black nickel finish) or -4 (satin chrome finish). Example: 51-0901-0231-201.

LENS COLORS: See listing below.

LENS STYLE	LENS FINISH	CATALOG NO. WITH SCREW TERMINALS (SIDE POSITION)	CATALOG NO. WITH SCREW TERMINALS (PROTRUDING)	CATALOG NO. WITH SOLDER TERMINALS	CATALOG NO. WITH QUICK CONNECT TERMINALS
CONVEX	Unfrosted	51-0901-0131-301	51-3101-0131-301	51-4001-0131-301	51-6701-0131-301
	Back Frosted	51-0901-0111-301	51-3101-0111-301	51-4001-0111-301	51-6701-0111-301
FLAT	Unfrosted	51-0901-0231-301	51-3101-0231-301	51-4001-0231-301	51-6701-0231-301
	Back Frosted	51-0901-0211-301	51-3101-0211-301	51-4001-0211-301	51-6701-0211-301
LARGE CONVEX	Unfrosted	61-0901-0231-301	61-3101-0231-301	61-4001-0231-301	61-6701-0231-301
	Back Frosted	61-0901-0211-301	61-3101-0211-301	61-4001-0211-301	61-6701-0211-301
TORPEDO	Unfrosted	80-0901-0531-301	80-3101-0531-301	80-4001-0531-301	80-6701-0531-301
	Back Frosted	80-0901-0511-301	80-3101-0511-301	80-4001-0511-301	80-6701-0511-301
DOME	Unfrosted	80-0901-1231-301	80-3101-1231-301	80-4001-1231-301	80-6701-1231-301
	Back Frosted	80-0901-1211-301	80-3101-1211-301	80-4001-1211-301	80-6701-1211-301
TORPEDO FACETED	Unfrosted	80-0901-1331-301	80-3101-1331-301	80-4001-1331-301	80-6701-1331-301
LARGE TORPEDO	Unfrosted	19-0901-0531-301	19-3101-0531-301	19-4001-0531-301	19-6701-0531-301
FACETED	Unfrosted	51-0901-0431-301	51-3101-0431-301	51-4001-0431-301	51-6701-0431-301

LENS STYLE	LENS FINISH	CATALOG NO. WITH FIXED SCREW TERMINALS	CATALOG NO. WITH FIXED SOLDER TERMINALS	CATALOG NO. WITH QUICK CONNECT TERMINALS
FLAT	Back Frosted	51-3202-0211-301	51-3402-0211-301	51-6602-0211-301
	Unfrosted	51-3202-0131-301	51-3402-0131-301	51-6602-0131-301
CONVEX	Back Frosted	51-3202-0111-301	51-3402-0111-301	51-6602-0111-301
	Unfrosted	61-3202-0231-301	61-3402-0231-301	61-6602-0231-301
LARGE CONVEX	Back Frosted	61-3202-0211-301	61-3402-0211-301	61-6602-0211-301
	Unfrosted	19-3202-0531-301	19-3402-0531-301	19-6602-0531-301
TORPEDO	Unfrosted	80-3202-1231-301	80-3402-1231-301	80-6602-1231-301
	Back Frosted	80-3202-1211-301	80-3402-1211-301	80-6602-1211-301
TORPEDO FACETED	Unfrosted	80-3202-1331-301	80-3402-1331-301	80-6602-1331-301

Accommodate S-6 Bulb with Double Contact Bayonet Base

To obtain assemblies with water-tight construction, change the last digit in Cat. No. to 3.

Example:
61-3202-0211-303

LENS COLOR:
See listing below

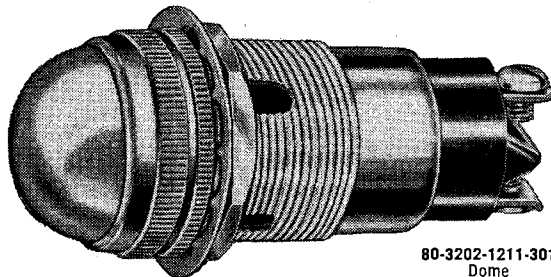

80-3202-1211-301
Dome

For T-3/4 Bulb with Min. Bay. Base—INCANDESCENT—2-55V.

For T-3 Bulb with Min. Bay. Base—INCANDESCENT—120V.

Mount in 1" Clearance Hole

51-1310-0211-301
Flat lens

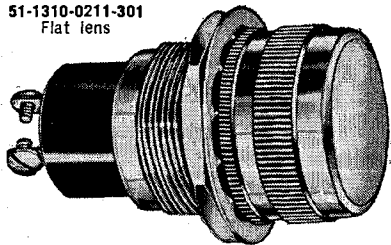

19-0410-0531-301
Large Torpedo lens

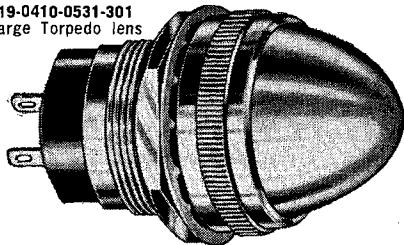

51-0410-0431-301
Faceted lens

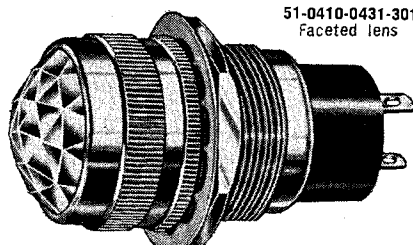

LENS STYLE	LENS FINISH	CATALOG NO. WITH SCREW TERMINALS	CATALOG NO. WITH SOLDER TERMINALS
FLAT	Unfrosted	51-1310-0231-301	51-0410-0231-301
	Back Frosted	51-1310-0211-301	51-0410-0211-301
TORPEDO	Unfrosted	80-1310-0531-301	80-0410-0531-301
	Back Frosted	80-1310-0511-301	80-0410-0511-301
LARGE CONVEX	Unfrosted	61-1310-0231-301	61-0410-0231-301
	Back Frosted	61-1310-0211-301	61-0410-0211-301
DOME	Unfrosted	80-1310-1231-301	80-0410-1231-301
	Back Frosted	80-1310-1211-301	80-0410-1211-301
CONVEX	Unfrosted	51-1310-0131-301	51-0410-0131-301
	Back Frosted	51-1310-0111-301	51-0410-0111-301
FACETED	Transparent	51-1310-0431-301	51-0410-0431-301
TORPEDO FACETED	Unfrosted	80-1310-1331-301	80-0410-1331-301
LARGE TORPEDO	Unfrosted	19-1310-0531-301	19-0410-0531-301

LENS COLOR: The last digit before the 3 digit catalog number suffix indicates that the lens is RED. When color other than red is desired, change this digit to a figure from the listing below. Note that white lenses are translucent and are always furnished unfrosted.

RED — 1; Green — 2; Yellow (Amber) — 3; Blue — 4; White Translucent — 5; Light Yellow — 6; Clear (Colorless) — 7.

The catalog numbers given indicate **Standard finish**. To obtain optional finishes, see description above.

51-0410-0111-301
Convex lens

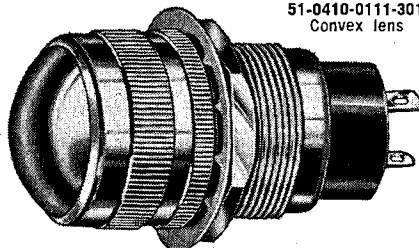

80-1310-1211-301
Dome lens

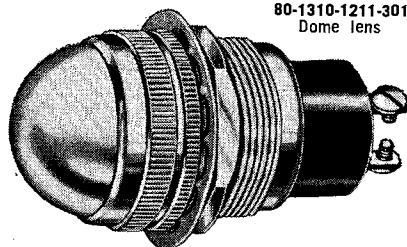

The catalog numbers listed indicate complete assemblies with screw-on lens cap. These assemblies may also be obtained with water-tight construction. To specify, change, the last digit in the catalog number to 3. Example: 80-1310-1331-303. These assemblies are also available with friction-fit or bayonet lock lens caps — but can not be furnished with water-tight construction.



DRAKE

**INDICATOR LIGHTS,
LAMP HOLDERS & LENSES**

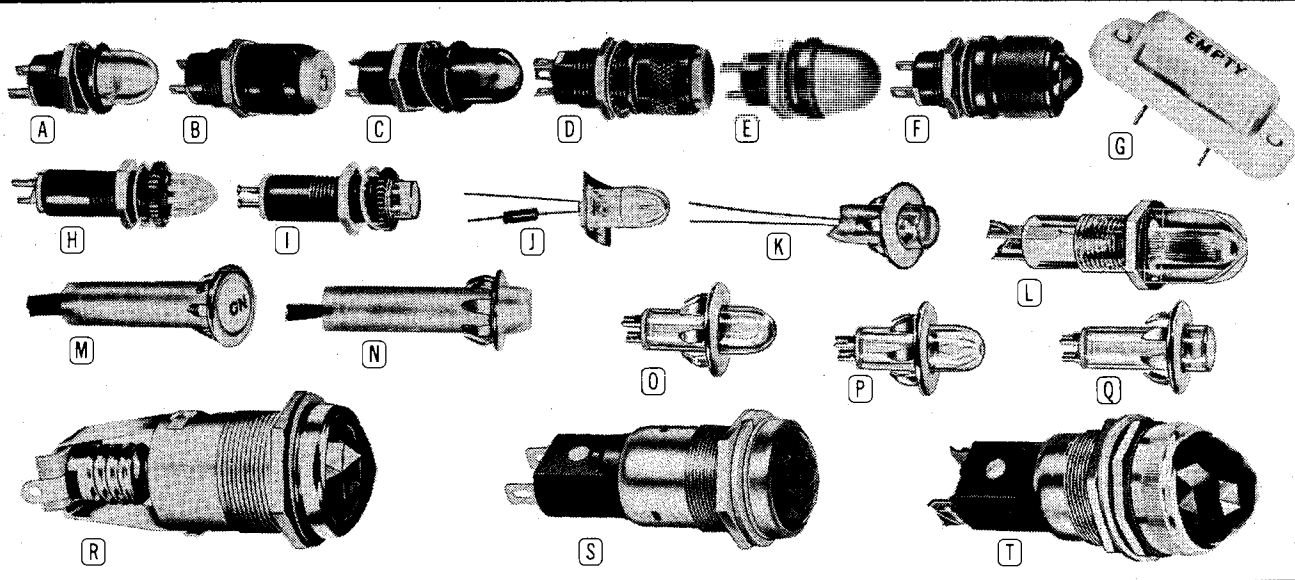

"MF" SERIES INDICATOR LIGHTS

MIDGET FLANGE BASE UNITS

Incandescent except for neon -703. Front mounted in 1/32" hole; aluminum body. Both lugs insulated from mounting. Threaded shank lens. Commercial units, clear finish; MIL units, black anodized: †LH-73-LC12, †LH73-LC11 and †LH74-LC13 respectively.

Drake Number	Fig.	Lens Dia.	Projection		Net Each, Lots of*		
			Front	Rear	1-9	10-24	25-99
5131-038-303†	A	3/16"	2 3/8"	3/4"	\$1.09	\$.98	\$.91
5131-038-544†	B	15/32"	3 3/8"	3/4"	1.48	1.33	1.23
5133-048-703*	C	3/16"	1 1/2"	6 3/8"	1.65	1.49	1.38

*Built-in 62K-ohm resistor. Max. panel th., 1/32"; others, 1/32".

"MF" PRESS-TO-TEST UNITS

Provides reliable, instantaneous check of lamp condition. Maximum panel thickness, 3/16".

Drake Number	Fig.	Lens Dia.	Projection Front	Projection Rear	Net Each	10-24	25-99
5131-638-503	D	15/32"	3 7/8"	1 3/8"	\$1.90	\$1.71	\$1.59

"MF" OIL-TITE/WATER-TITE UNITS

Recessed rubber "O" rings will withstand up to 25 p.s.i. pressure. Type 5150 has salt shaker dimmer in lens assembly. Maximum panel thickness, 3/16". Per MIL drawing: #D5-15-3217; *SM-B-450166; *SM-C-415155; *ONO20148.

Drake Number	Fig.	Lens Dia.	Projection Front	Projection Rear	Net Each	10-24	25-99
5139-038-304#	E	3/16"	1 1/2"	2 3/8"	\$1.33	\$1.19	\$1.11
5150-038-101*	F	15/32"	2 1/2"	2 3/8"	2.01	1.81	1.68

NEON INDICATOR LIGHTS — 115 VOLTS

"FLUSHLITE" — U/L AND CSA APPROVED

"One-of-a-kind". Built-in neon lamp and 25K ohm resistor. To be flush with face of panel, mount from rear in panel, up to 1/32" thick, on 3/16" or 1/8" centers; or, may be mounted on panel top.

Drake Number	Fig.	Lens Size	Projection		Net Each, Lots of*		
			Front	Rear	1-9	10-24	25-99
110-025	G	1 1/4" x 1 1/4"	1 1/2"	1 1/2"	\$.50	\$.45	\$.42

"MINEON"

Similar to "Econoglo"; mounted in black-anodized aluminum body with two turret or solder (*) lugs (specify on order). Mount from rear of panel, up to 3/8" thick, in 3/8" dia. hole on 5/8" centers. Hi-Brite, built-in neon lamp with 22K-ohm resistor; 115 v. AC.

Drake Number	Fig.	Lens Dia.	Projection Front	Projection Rear	Net Each	10-24	25-99
HR118-323*	H	1 1/2"	1 1/2"	1 3/4"	\$.84	\$.76	\$.70
HR118T-323	---	1 1/2"	1 1/2"	1 3/4"	.92	.83	.77
HR118T-603	I	1 1/2"	1 1/2"	1 3/4"	.92	.83	.77

"POSTLITE"

Extremely decorative. Built-in series resistor, 25K ohms, and neon lamp for 110-125 v. AC. Mount from front of panel, up to 3/8" thick, in 1/2" dia. hole on 3/8" centers. Hi-Brite lamp.

Drake Number	Fig.	Lens Dia.	Projection Front	Projection Rear	Net Each	10-24	25-99
105-025	L	5/8" sq.	3/4"	1 1/4"	\$.69	\$.62	\$.58

"GLO-LITES"

One-piece nylon body and lens with built-in Hi-Brite neon lamp. With two lead terminations, 22 ga. plastic-insulated wire. Mount from front of panel, up to .080" thick, in 1/2" dia. hole on 1/4" centers. Built-in resistor: 25K for 115 V; 100K for 250 V (*).

Drake Number	Fig.	Lens Dia.	Projection		Net Each, Lots of*		
			Front	Rear	1-9	10-24	25-99
6073-001-544	M	2 1/2"	1 1/2"	1 1/2"	\$.58	\$.52	\$.49
6073-001-634	N	2 1/2"	5/8"	1 1/2"	.49	.44	.41
6075-001-544	M	2 1/2"	1 1/2"	1 1/2"	.63	.57	.53
6075-001-634	N	2 1/2"	5/8"	1 1/2"	.53	.48	.45

*PRICES LESS LAMPS UNLESS BUILT-IN.

WRITE FOR O.E.M. DISCOUNTS ON LARGER QUANTITY ORDERS.

NEON INDICATOR LIGHTS (CONT'D)

"ECONOGLO" — WIRE LEADS

Mount from front of panel. For type 116, mount in 3/16" hole on panel up to 3/16" thick (fastened with tinnerman nut). For type 117, mount in 1/2" hole on panel up to 1/4" thick (chrome snap-in). Lens shapes (last 3 digits) interchangeable on types 116 and 117. Termination: two-wire leads. Built-in 22K-ohm resistor (*); others require external resistors, not supplied. Built-in neon lamp. Low cost 115 v. AC indicator lights.

Drake Number	Fig.	Lens Size	Projection		Net Each, Lots of*		
			Front	Rear	1-9	10-24	25-99
116-603	---	1 1/2"	3 3/8"	1 1/2"	\$.22	\$.19	\$.18
HR116-323*	J	1 1/2"	3 3/8"	1 1/2"	.28	.25	.23
117-603	K	1 1/2"	1 1/4"	5/8"	.29	.26	.24
HR117-323*	---	1 1/2"	3 3/8"	1 1/2"	.34	.31	.29

NEW "ECONOGLO" WITH LUGS

TINNERMAN NUT OR PLUG BUTTON MOUNTING

Mount from front of panel. For type 6140, mounts in 3/16" D hole on panel up to 3/16" thick (fasten with Tinnerman nut). For type 6150, mounts in 1/2" D hole on panel up to 1/4" thick (chrome snap-in plug button). Lens shapes (last three digits) interchangeable on type 6140 and 6150. Termination: Two lugs. Incandescent built-in lamp; Low-cost 28 v. AC—lamp rating .04A (6146 or 6156 types) Also 6.3 v. AC lamp rating .04A (6148 or 6158 types).

Drake Number	Fig.	Lens Size	Projection		Selling Prices Per Each		
			Front	Rear	1-9	10-24	25-99
6146-000-303	---	1 1/2"	3 3/8"	4 5/8"	\$1.01	\$.91	\$.85
6146-000-323	---	1 1/2"	3 3/8"	4 5/8"	1.01	.91	.85
6146-000-603	---	1 1/2"	3 3/8"	4 5/8"	1.01	.91	.85
6148-000-303	---	1 1/2"	3 3/8"	4 5/8"	.83	.75	.69
6148-000-323	---	1 1/2"	3 3/8"	4 5/8"	.83	.75	.69
6148-000-603	---	1 1/2"	3 3/8"	4 5/8"	.83	.75	.69
6156-000-303	O	1 1/2"	3 3/8"	4 1/2"	1.08	.97	.90
6156-000-323	P	1 1/2"	3 3/8"	4 1/2"	1.08	.97	.90
6156-000-603	Q	1 1/2"	3 3/8"	4 1/2"	1.08	.97	.90
6158-000-303	Q	1 1/2"	3 3/8"	4 1/2"	.89	.80	.75
6158-000-323	Q	1 1/2"	3 3/8"	4 1/2"	.89	.80	.75
6158-000-603	P	1 1/2"	3 3/8"	4 1/2"	.89	.80	.75

1" LENS INDICATOR LIGHTS

**CANDELABRA SCREW S-6 — 115 VOLTS
MONEY-SAVER — U/L AND CSA APPROVED**

Polished chrome lens holder. Lamps replaceable from front or rear. Mount from front of panel, up to 1/2" thick, in 1" dia. hole on 1 3/8" centers. Slip-fit bezel (*).

Drake Number	Fig.	Lens Dia.	Projection		Net Each, Lots of*		
			Front	Rear	1-9	10-24	25-99
75-110*	R	1"	3/8"	2 1/4"	\$1.11	\$1.00	\$.93

STANDARD — U/L AND CSA APPROVED

Easy front replacement of pop-forward lamps. Snap-in lens assembly.

Drake Number	Fig.	Lens Dia.	Projection Front	Projection Rear	Net Each	10-24	25-99
5756-522-110	S	1"	3/8"	2 3/8"	\$1.31	\$1.18	\$1.10

"TITELITE"

Neoprene gaskets seal out oil, water, dust and dirt.

Drake Number	Fig.	Lens Dia.	Projection Front	Projection Rear	Net Each	10-24	25-99
5796-522-410	T	1"	1 3/8"	1 7/8"	\$2.04	\$1.84	\$1.70

SPECIFY COLOR ON ORDER: Incandescent and Neon—Red, Yellow (Amber), White or Colorless. Incandescent Only—Green or Blue.

Lenses 503, 504, 603 and 604 may be imprinted; change 0 (2nd digit) to 4 (e.g., 543). Prices on Request.

ALL DRAKE PRICES subject to CHANGE WITHOUT NOTICE — check "United Pricing Reports" at your DISTRIBUTOR

ELDEMA INDICATOR LITES



GENISCO TECHNOLOGY CORPORATION

C-LITES

Eldema C-Lites are 2-pin cartridge lamps that are easily inserted from the front of the panel into the D-Holder assembly. C-Lites are in three basic series: CF—incandescent, CG—neon, and CR—neon with built-in resistor. Clear anodized aluminum case — stainless steel pins — plastic lens cap — high dielectric insulation — meets Mil-L-3661. Mate with all DH Series holders.

INCANDESCENT C-LITES

SERIES CF - Mates with all DH Holders

STYLE

CF03
Short Flat

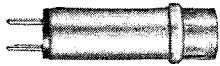

CF02
Flush

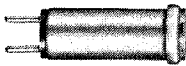

CF01
Dome

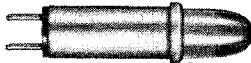

LENS COLORS

ACS	Amber Clear
BCS	Blue Clear
CCS	Cloudy Clear
GCS	Green Clear
RCS	Red Clear
WCS	Water Clear
YCS	Yellow Clear
ATS	Amber Translucent
BTS	Blue Translucent
GTS	Green Translucent
RTS	Red Translucent
WTS	White Translucent
YTS	Yellow Translucent

SPECIFY STYLE — LENS COLOR
AND LAMP NUMBER

Example: CF03-RTS-2187

LAMP NO.	VOLTS	M.A.	LIFE HRS
2158*	3	15	10,000
680	5	60	50,000
1730	6	40	1,000
2114	6	60	3,000
1784	6	200	1,000
2180	6.3	40	50,000
2181	6.3	200	50,000
1869*	10	15	50,000
2107*	10	40	5,000
2174	12	40	3,000
1705	14	80	750
2182	14	80	50,000
2102	18	40	1,000
1762	28	40	1,000
2187	28	40	25,000

*Use with clear colors only.

NEON C-LITES Mates with DH Holders

SERIES CG- SERIES CR

STYLE

CG03
or
CR03

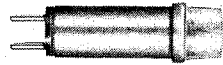

CG01
or
CR01

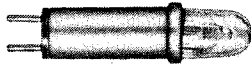

CG04
or
CR04

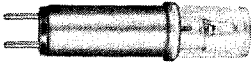

LENS COLORS

CLEAR ONLY

ACS	Amber Clear
CCS	Cloudy Clear
RCS	Red Clear
WCS	Water Clear
YCS	Yellow Clear

SPECIFY STYLE — LENS COLOR

LAMP OR LAMP/RESISTOR

Examples: CG03-RCS-N110
CR01-ACS-N123

NEON LAMP - CG SERIES

N110	- Standard brightness
N120	- High brightness

NEON LAMP/RESISTOR - CR SERIES

N114	- Standard brightness medium life - 56K
N117	- Standard brightness long life - 100K
N121	- High brightness medium life - 22K
N123	- high brightness long life - 33K

C-LITES

SERIES CN, CL AND CM

These are special purpose C-Lite types, each with mating single lamp D-Holders. The CL and CM have long life, higher voltage incandescent telephone type lamp bulbs. The CN is an older style neon C-Lite with resistor.

NEON C-LITES

SERIES CN - neon lamp built-in resistor

Mate with DN Holders

CN01-RCS-N117



CN04-WCS-N123

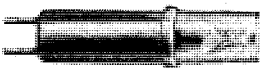

Slightly longer than new CR series. Otherwise the two types are identical. Specify in same manner except use CN instead of CR. CN03 style is available.

INCANDESCENT C-LITES

TYPE CL24

Mate with DL lampholders with D06, D09 or D25 lens caps. Bulb end exposed.



PART NO.	VOLTS	MA	LIFE HRS
CL24-6PS	6	140	5,000+
CL24-12PS	12	170	5,000+
CL24-24PS	24	73	5,000+
CL24-28PS	28	40	5,000+
CL24-48PS	48	53	5,000+
CL24-60PS	60	50	5,000+
CL24-120PS	120	25	5,000+

INCANDESCENT C-LITES

TYPE CM65

Mate with DM lampholders with D06, D09 or D25 lens caps. Light diffusing frosted lens.

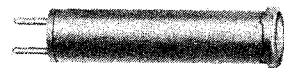

PART NO.	VOLTS	MA	LIFE HRS
CM65-6PS	6	140	5,000+
CM65-12PS	12	170	5,000+
CM65-28PS	28	40	5,000+
CM65-48PS	48	53	5,000+
CM65-60PS	60	50	5,000+
CM65-120PS	120	25	5,000+

ELDEMA INDICATOR LITES

R - LITES

R-Lites are Eldema's product family of relampable holders and lens caps for the midget flange based T-1 $\frac{3}{4}$ incandescent and T-2 neon bulbs. The lamps and lens caps are replaceable from the front of the panel. There are five R-Lite groups — each with its own features — the holder and lens cap part numbers in each group start with the same two letters to insure mating parts.

RM AND RN SERIES

The RM-RN groups meet MIL-L-3661. The RM is for incandescent lamps — the RN Series with a built in resistor is for neon lamps. Standard types RMA and RNA — waterproof types RMW and RNW — two tin plated lug terminals — black anodized aluminum cases — high impact plastic lenses. Mount from the front in $\frac{15}{32}$ " holes. Equivalent Military numbers are listed.

RMA-64BO-RM120RC

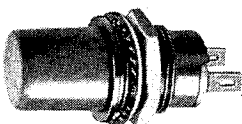
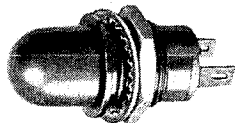

RMA-64BO-RM160RC

RMW-63BO-RM130RC

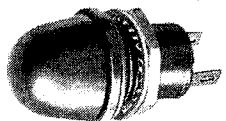

RMA-64BO-RM22BRC

RM SERIES

HOLDER P/N MIL. TYPE

RMA - 64BO Standard — black finish LH73/1

RMW - 63BO Waterproof — black finish LH89/1

LENS CAP STYLE MIL. TYPE

RM120 Dome LC12

RM160 Flat top LC29

RM22B Rotating type LC11

(Lens marking can be aligned)

RM130 Waterproof dome LC35

LENS COLORS

LENS COLORS	MIL. TYPE
AC Amber Clear	YN2
BC Blue Clear	BN2
CC Cloudy Clear	—
GC Green Clear	GN2
RC Red Clear	RN2
WC Water Clear	CN2
YC Yellow Clear	—
AT Amber Translucent	YT2
BT Blue Translucent	BT2
GT Green Translucent	GT2
RT Red Translucent	RT2
WT White Translucent	WT2
YT Yellow Translucent	—

SPECIFY HOLDER

LENS STYLE AND LENS COLOR

For example:

RMA-64BO-RM120RC is Eldema
LH73/1- LC12RN2 is Military

NOTE: RMA-64BO-RM120 meets
MS25256. Designate lens color.

RNA-64B5-RN120RC

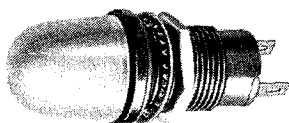
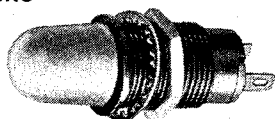

RNW-63B5-RN130RC

RN SERIES

HOLDER P/N MIL. TYPE

RNA - 64B5 Standard — black finish with 62K Ω for NE2D lamp LH74/1

RNA - 64B2 Standard — black finish with 27K Ω for NE2J lamp LH74/2

RNW - 64B5 Waterproof — black finish with 62K Ω for NE2D lamp LH88/1

RNW - 64B2 Waterproof — black finish with 27K Ω for NE2J lamp LH88/2

LENS CAP STYLE MIL. TYPE

RN120 Dome LC13

RN130 Waterproof dome LC33

LENS COLORS

LENS COLORS	MIL. TYPE
AC Amber Clear	YN2
CC Cloudy Clear	WT2
RC Red Clear	RN2
WC Water Clear	CN2
YC Yellow Clear	—

SPECIFY HOLDER

LENS STYLE AND LENS COLOR

For example:

RNA-64B5-RN120RC is Eldema
LH74/1- LC13RN2 is Military

NOTE: RNA-64B5-RN120 meets
MS25257. Designate lens color.

RA SERIES

The RA Series is for flange based T-1 $\frac{3}{4}$ incandescent bulbs. Three mounting styles are available and three metal finishes. Rugged two terminal lamp holders — brass housings — tin plated lug terminals — high impact strength plastic lens caps.

RAA-6020-RA220RT

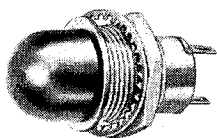
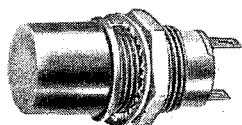

RAB-6010-RA210RT

RAC-6030-RA343RT

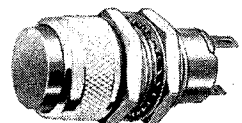

HOLDER STYLE

RAA - $\frac{15}{32}$ " Front mounting
RAB - $\frac{17}{32}$ " Front mounting
RAC - $\frac{15}{32}$ " Front or rear mounting

HOLDER FINISH

6010 Bright nickel
6020 Black nickel
6030 Polished chrome

ALL PLASTIC LENS CAP STYLE

RA210 Dome
RA220 Flat top

ROTATING LENS CAP STYLE

(Lens marking can be aligned)

RA341 Bright nickel ring
RA342 Black nickel ring
RA343 Polished chrome ring

LENS COLORS

AC Amber Clear
BC Blue Clear
CC Cloudy Clear
GC Green Clear
RC Red Clear
WC White Clear
YC Yellow Clear
AT Amber Translucent
BT Blue Translucent
GT Green Translucent
RT Red Translucent
WT White Translucent
YT Yellow Translucent

SPECIFY HOLDER STYLE

HOLDER FINISH

LENS STYLE AND LENS COLOR

ELDEMA INDICATOR LITES

T-SERIES

Eldema T-Series lampholders and lens caps are for the T-3 $\frac{1}{4}$ bayonet based incandescent and neon lamps. Four basic types — TAF and TCF for incandescents — TAG and TCG with built-in resistors for neons. Meets Mil-L-3661 — polished chrome, black nickel or bright nickel finish — front mounting in 11/16" holes water proof types — lug or screw terminals.

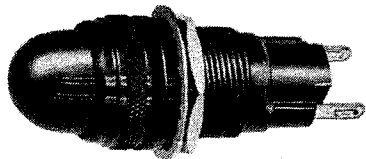

TCF-6220-TC222RC

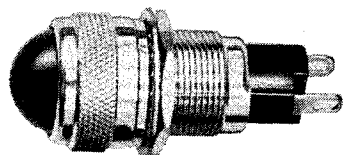

TCG-6032-TC263RC

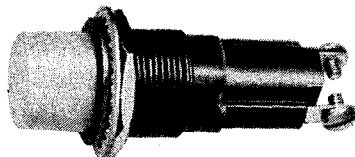

TAF-7020-TA160AT

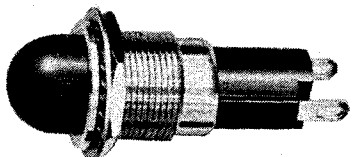

TAF-6030-TA120RT

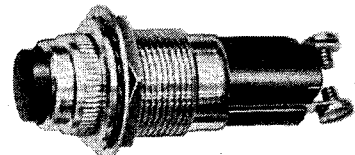

TAF-7030-TA243RT

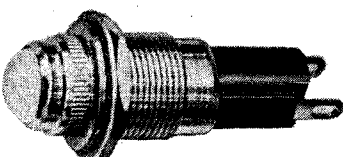

TAF-6030-TA223CD

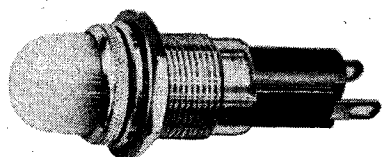

TAG-6032-TA263CD

HOLDER STYLE

TAF - Incandescent lampholder
Screw-in lens caps

TAG - Neon lampholder
Screw-in lens caps

TCF - Incandescent lampholder
Screw-on lens caps

TCG - Neon lampholder
Screw-on lens caps

NOTE: TAF and TAG holders mate with lens caps starting with letters TA. TCF and TCG holders mate with TC lens caps.

HOW TO SPECIFY HOLDER FEATURES:

Example — 6010

First digit: 6 = Solder lug (Terminals) 7 = Screw terminal

Second digit: 0 = Standard part (Mounting) 2 = Water proof

Third digit: 1 = Bright nickel (Finish) 2 = Black nickel 3 = Polished chrome

Fourth digit: 0 = None (TAF & TCF) (Resistor) 2 = 27K Ω for NE51H lamp 4 = 56K Ω for NE51 lamp 7 = 100K Ω for NE51 lamp 25,000 hour life rating

SCREW-IN LENS CAP STYLE

TA120 - Smooth dome — clear or translucent colors

TA130 - Fluted dome — clear colors only

TA140 - Semi-Fluted dome — clear colors only

TA160 - Flat top — clear or translucent colors

TA223† - Convex — clear or diffusing colors

TA243† - Flat top — clear, translucent or diffusing colors

TA263† - Fluted dome — clear colors only

SCREW-ON LENS CAP STYLE

TC223† - Smooth dome — clear or diffusing colors

TC243† - Fluted dome — clear colors only

TC263† - Large dome — clear or diffusing colors

† These lens caps have a metal ring with polished chrome finish specified by the digit 3. For bright nickel, change to 1, black nickel, change to 2. For example: TA221RC and TC242RC.

LENS COLORS

AC — Amber Clear*

BC — Blue Clear

GC — Green Clear

RC — Red Clear*

WC — Water Clear*

YC — Yellow Clear*

CC — Cloudy Clear*

AT — Amber Translucent

BT — Blue Translucent

GT — Green Translucent

RT — Red Translucent

WT — White Translucent

YT — Yellow Translucent

AD — Amber Diffusing

BD — Blue Diffusing

GD — Green Diffusing

RD — Red Diffusing

WD — White Translucent

YD — Yellow Diffusing

CD — Clear Diffusing

* These colors recommended for neon lamps

Diffusing colors have surface nearest lamp frosted — Note white is translucent only.

SPECIFY HOLDER STYLE — HOLDER FEATURES —
LENS STYLE AND LENS COLOR

SEE PART NUMBERS BY ILLUSTRATIONS FOR EXAMPLES

MILITARY VERSIONS

Certain configurations of the T-Series lampholders and lens caps carry MS numbers and specifications. Contact Eldema for complete cross-reference information. RFI/EMI shielded versions are also available in this series for all of the lampholder types.

WATERPROOF LENS CAP

To specify water proof lens caps in the TA styles change the first digit as follows: TA100 series to TA400, TA200 series to TA300. For example: TA120RC to TA420RC, TA223RC to TA323RC. Standard TC lens cap may be used. All necessary sealing gaskets are on the TC holder when it is specified water proof.

distributor catalog- stock items... off the shelf



neon pilot lights

- Enhance as well as beautify any product
- Complement and highlight design
- Invite attention
- Rugged and long lived — 10,000 hour life unaffected by vibration or shock
- Tamper proof housings
- Mount quickly, securely
- UL recognized, CSA approved

GLO — DOT Mounting hole—
5/16" diameter.

Series 2110A Series 2120A Series 2150A

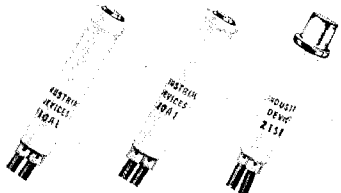

STOCK MODELS AVAILABLE

B2110A1 Red	B2120A1 Red	B2150A1 Red
B2110A2 Clear	---	---
B2110A3 Amber	B2120A3 Amber	B2150A3 Amber
B2110A4 White	B2120A4 White	B2150A4 White

LINE-O-LITE *Mounting hole—
19/32" x .395/.400".

Series 2330D

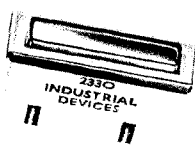

STOCK MODELS AVAILABLE

MODEL NO.	LENS COLOR
B2330D1	Red
B2330D3	Amber
B2330D4	White

*Will snap-fit into panels .055--.070" thick without speednut

OMNI — GLOW Mounting hole—
1/2" diameter.

Series 1050A Series 1050C Series 1050N

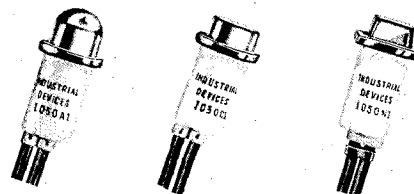

STOCK MODELS AVAILABLE

B1050A1 Red	B1050C1 Red	B1050N1 Red
B1050A2 Clear	---	---
B1050A3 Amber	B1050C3 Amber	B1050N3 Amber
B1050A4 White	B1050C4 White	B1050N4 White

OMNI-GLOW Series 2600 Mounting hole—
7/8" diameter.

STOCK MODELS AVAILABLE

MODEL NO.	LENS COLOR
B2620K1	Red
B2620K3	Amber
B2620K4	White

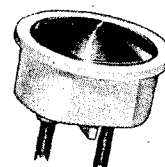

SPECIFICATIONS (COMMON TO ALL STOCK NEON PILOT LIGHTS)

Voltage: 105—125 A.C.
Leads: 4 1/2" 105°C plastic stripped 1/2" 22AWG for GLO-DOT, 18AWG for OMNI-GLOW & LINE-O-LITE.
Lamp: High brightness neon with built-in resistor.
Speednut: Hardened spring steel, rust-resistant finish.

MINI-SLIDE pilot light assemblies

- Bright, highly visible
- Long-lived — rated 5000 hours
- Available complete with lamps from 6 to 120 volts
- Variety of colors
- Utilize miniature slide base incandescent lamps
- Foolproof installation
- UL recognized, CSA approved

Model 2800 Series		Lens Color	Model 3060 Series	
Black Bezel	Stainless Bezel		Round Lens	Square Lens
B2800A1 Δ v	B2801A1 Δ v	Red	B3060C1 Δ v	B3060D1 Δ v
B2800A2 Δ v	B2801A2 Δ v	Clear	B3060C2 Δ v	B3060D2 Δ v
B2800A3 Δ v	B2801A3 Δ v	Amber	B3060C3 Δ v	B3060D3 Δ v
B2800A4 Δ v	B2801A4 Δ v	White	B3060C4 Δ v	B3060D4 Δ v
B2800A5 Δ v	B2801A5 Δ v	Green	B3060C5 Δ v	B3060D5 Δ v
B2800A6 Δ v	B2801A6 Δ v	Blue	B3060C6 Δ v	B3060D6 Δ v
B2800A7 Δ v	B2801A7 Δ v	Yellow	B3060C7 Δ v	B3060D7 Δ v

*Important — These units shipped complete with lamp, specify voltage when ordering. See lamps listing below.

SPECIFICATIONS

Model 2800 Series

Mounting nut: Nylon, self-locking, torque limiting (U.S. Patent 3352194)

Mtg. Hole: 11/16" Diameter

Lens: Molded polycarbonate, screw in (for easy relamping)

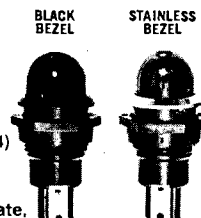

short slide base "pilot" lamps

FOR USE WITH MINI-SLIDE

Design Volts	Lamp Number	Design AMPS	Approx. Hrs. Life	Wattage at Design Volts	Rated End Foot Candles
6	6 PSB	.140	5,000	.8	800
12	12 PSB	.170	5,000	2.0	2400
24	24 PSB	.073	5,000	1.7	2200
28	28 PSB	.040	5,000	1.1	1900
48	48 PSB	.053	5,000	2.5	1500
60	60 PSB	.050	5,000	3.0	2400
120	120 PSB	.025	5,000	3.0	1600

- Complete line
- Rugged-long life
- Miniature up to 120 volts ratings to 3 watts

Model-3060 Series

Mounting nut: Speednut, hardened spring steel, rust resistant finish

Mtg. Hole: 1/2" Diameter

Lens: Molded polycarbonate snap-on for easy front panel relamping

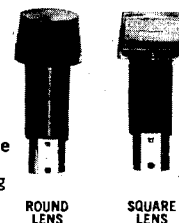

E. F. JOHNSON CO.

E. F. Johnson pilot lights have been classified as "PREFERRED TYPES", and are immediately available at parts distributors throughout the country. Specials, including types meeting military specifications, are available in production quantities.

Pilot lights

When ordering -1 indicates clear jewel (i.e. 147-1000-1); -2 transparent red; -3 transparent green; -4 transparent amber; -5 transparent blue; -6 opal. Green and blue not recommended for use with neon lamps. In pilot light sockets with built-in resistors for neon bulbs, higher resistance values give longer life; lower resistance values give greater brilliance.

For detailed specifications covering the entire Johnson pilot light line, write for complete catalog using your company letterhead.

RIB-LOC MINIATURE PRESS-IN INDICATOR LIGHT

New RIB-LOC light simply presses into place in a .312" diameter round hole. Typical push-in force in 1/16" thick aluminum panel is 15 lbs.; push-out force, 20 lbs.; torque to rotate, 32 oz. in. Ribs bite into sharp edges of hole to provide positive retention. Durable polycarbonate lens in six colors. Long-life incandescent bulb. Black polyamide housing. Terminations are 1/16" diameter terminals staked to body.

Cat. No.	Housing Color	Operating Voltage	Lens Color	Net Price
147-2203-100	Black	4-6 Volts	(See color table)	\$0.70
147-2203-300	Black	10-14 Volts		.80
147-2203-400	Black	22-28 Volts		.80

Lens color:

Add one of the following numbers to the last two digits of the catalog number to indicate lens color:

01 Clear	04 Amber
02 Red	05 Blue
03 Green	06 Opal (translucent)

For example: 6-Volt with amber lens is Cat. No. 147-2203-104.

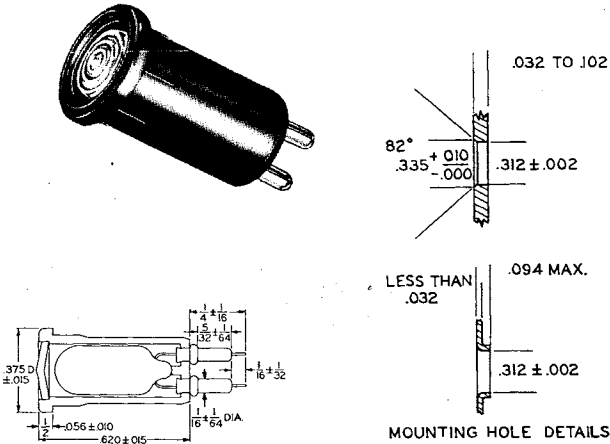

Polyamide spacers



These convenient polyamide spacer bushings make it possible to snap PC boards to a chassis and provide a choice of stand-off heights from .125" to .750". They provide mechanically secure, insulated mounting, yet PC boards can be quickly removed. Machined from nylon, the design provides permanent, snap-in insertion into pre-drilled or punched holes in any 1/16" chassis or panel. (Also available as specials for other panel and board thicknesses.) The other end of the spacer snaps in or out of the PC board so that the board can be removed for service or modification.

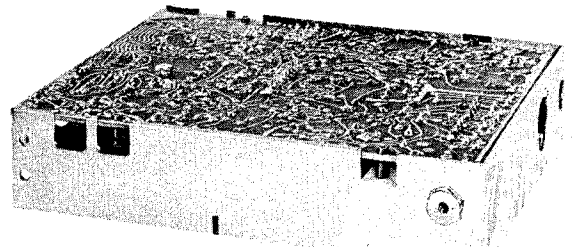
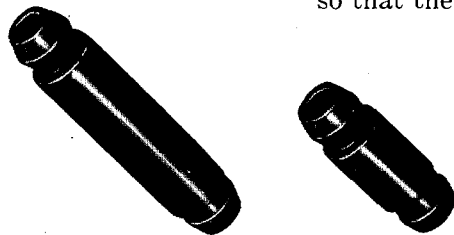

POLYAMIDE SPACER/BUSHINGS

Cat. No.	Dim. A	B	C	Net Price
115-260-1	.396	.065/.070	.125	\$0.04
115-260-3	.521	.065/.070	.250	.04
115-260-5	.646	.065/.070	.375	.05
115-260-7	.771	.065/.070	.500	.05
115-260-9	.896	.065/.070	.625	.06
115-260-11	1.021	.065/.070	.750	.06

Recommended mounting hole .152" ± .002".

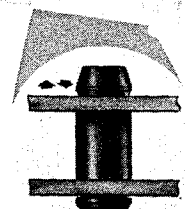
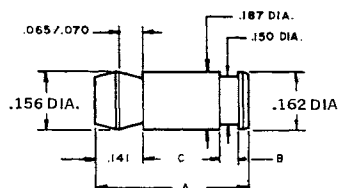

ATR Inverters, Vibrators, "A" Eliminators, etc.

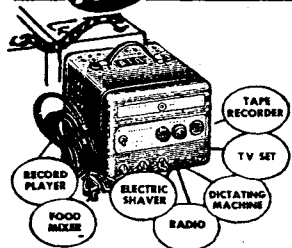

ATR DC TO AC UNIVERSAL INVERTERS

New, universal inverters for operating 110-v., 60 cycle A.C. equipment from DC voltages in autos, buses, trucks, boats, trains, planes and DC districts. Designed especially for standard 110-volt AC tape recorders, TV sets, radios, PA systems, electric razors, test equipment, etc. Units are carefully engineered and ruggedly constructed to provide long life operation. All feature complete RF interference suppression and exceptional frequency stability. Have operating efficiency in excess of 75%. Four-point voltage regulator corrects output voltage for minimum and maximum loads, and also helps compensate for input voltages lower or higher than normal. Inverters are recommended for use with loads having power factors in excess of 70%. Built-in toggle switch selects most efficient operation for use with TV sets or tape recorders. Inverters are not recommended for use with large motor driven appliances such as refrigerators, washing machines, etc. All have ON-OFF switches. Housed in attractive gray hammerloid metal cabinet with convenient leather carrying strap. Sizes: Standard Model RSF, 8 1/2" x 9 1/2" x 5 1/4"; Heavy-Duty Model RHG 6 1/2" x 11 1/2" x 8 1/2". With battery clips for instant connection to power source. Models with "F" suffix equipped with adapter cord for use in all cigarette lighter receptacles. *Recommended for 24 volt battery operation. Before ordering, check wattage of equipment with which inverter will be used.

Stock No.	Mfr's Type	Input D.C. Volts	A.C. Output 60 Cycles	Output Watt. Int. Cont.	Shipping Weight	List Price	Net Price	
6U-RSF	6	110	Volts	100	80	22 lbs.	\$ 82.50	\$ 55.00
6U-RSF-P	6	110		100	80	22	82.50	55.00
6U-RHG	6	110		150	125	27	109.50	73.00
6U-HSJ	6	110		175	150	37	137.25	91.50
12U-RSF	12	110		125	100	22	82.50	55.00
12U-RSF-P	12	110		125	100	22	82.50	55.00
12U-RHG	12	110		175	150	27	109.50	73.00
21U-HSJ	21	110		150	200	27	137.25	91.50
28U-RSF	28	110		125	100	22	82.50	55.00
28U-RHG	28	110		175	150	27	137.25	91.50
28U-HSJ	28	110		250	200	37	155.25	103.50
32U-RSF	32	110		150	100	22	82.50	55.00
32U-RHG	32	110		200	160	30	116.25	77.50
32U-HSJ	32	110		325	225	37	155.25	103.50
50U-RSF	50	110		150	100	22	82.50	55.00
50U-RHG	50	110		225	200	27	131.25	87.50
110U-RSF	110	110		250	150	22	82.50	55.00
110AU-RHG	110	110		325	250	27	98.00	68.00
110BU-RHG	110	110		450	350	30	116.25	77.50
110U-HSJ	110	110		600	400	37	155.25	103.50
220U-RSF	220	110		250	150	22	87.37	58.25
220U-RHG	220	110		325	250	27	109.50	73.00
220U-HSJ	220	110		500	300	37	155.25	103.50

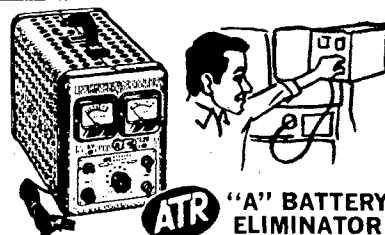

ATR "A" BATTERY ELIMINATOR

FOR DEMONSTRATING AND TESTING TRANSISTOR OR VIBRATOR-TYPE AUTO RADIOS. Designed for testing D.C. Electrical Apparatus on regular 110 volt A.C. lines... equipped with full-wave dry disc-type rectifier, assuring noiseless, interference-free operation. Fully Automatic and Fool-Proof; has voltmeter, ammeter, and 8-position voltage control. Fuse protected, and housed in heavy-duty beige grey hammerloid metal case. 6 ft. cord set included. Size: Model 610C-ELIF, 6 1/2" x 9 1/2" x 8 1/2" —shipping weight 22 lbs.; Model 620C-ELIT, 6 1/2" x 12 1/2" x 8 1/2" —shipping weight 33 lbs.

IDEAL AS A POWER SUPPLY FOR MODEL RAILROAD TRAINS, RADIO SETS, ELECTRO PLATING OUTFITS, AND OTHER 6 OR 12 VOLT D.C. EQUIPMENT. MAY ALSO BE USED AS A BATTERY CHARGER.

- Model 610C-ELIF (6 volt at 10 amps. or 12 volt at 6 amps.) Net \$55.00
- Model 620C-ELIT (6 volt at 20 amps. or 12 volt at 10 amps.) Net \$73.50



ATR AUTO PLUG-IN, HOME-TYPE PORTABLE BATTERY CHARGERS

No installation... just plug into cigarette lighter receptacle. Makes motor starting easy. Recharge car battery fully charged in your own garage. Operates directly from standard 110 volt A.C. Household Current. Available in three portable sizes for both 6 or 12 volt cars. Light in weight, rugged in construction, economical, and built to last. Each battery charger is housed in grey hammerloid-finish metal case. Complete with cord sets. Size of G1 is 5 1/4" x 4 1/2" x 2 1/4" —shipping weight is 6 lbs.; G2 is 8 1/2" x 5 1/2" x 3 1/4" —shipping weight is 8 lbs.; and G3 is 8 1/2" x 5 1/2" x 5 1/4" —shipping weight is 10 lbs.

- (G-1) 6 or 12 volt —Model 612CA4 (4 amp.) Net \$19.46
- (G-2) 6 or 12 volt —Model 612CA6 (6 amp.) Net \$22.46
- (G-3) 6 or 12 volt —Model 612CA10 (10 amp.) Net \$27.71



ATR PORTABLE PLUG-IN TYPE INVERTERS

SPECIALLY DESIGNED FOR OPERATING STANDARD A.C. DICTATING MACHINES, RECORD PLAYERS, INCANDESCENT LAMPS, ELECTRIC RAZORS, ELECTRONIC TEST EQUIPMENT, AND OTHER SMALL ELECTRICAL AND ELECTRONIC DEVICES FROM D.C. VOLTAGE IN AUTOMOBILES, BUSES, TRUCKS, BOATS, PLANES, TRAINS, AND D.C. DISTRICTS.

Lightweight inverters for operating 110 v. AC equipment from DC voltage sources. Feature excellent frequency stability and high efficiency. 6 and 12-volt units plug into cigarette lighter receptacle of any vehicle; others are equipped with standard 2-prong plugs. All are designed especially for use with dictating machines, record players, electric razors, test equipment, etc. Not recommended for tape recorders and large motor driven appliances such as refrigerators, washing machines, etc. Gray Hammerloid case with leather carrying strap. Sizes: DME, 5 1/4" x 4 1/2" x 2 1/4"; RME and RMF, 8 1/2" x 8 x 3 3/4". *Recommended for 24-volt operation. Check wattage rating of equipment before ordering. RMF/RME Model Inverters equipped with voltage regulator.

Stock No.	Mfr's Type	Input D.C. Volts	A.C. Output 60 Cycles	Output Watt. Int. Cont.	Shipping Weight	List Price	Net Price	
6-DME (1)	6	110	Volts	40	30	5 lbs.	\$27.75	\$18.50
6C-DME (1)	6/12	110		40	30	5	31.87	21.25
6-RMF (2)	6	110		80	60	12	54.75	36.50
6C-RMF (2)	6/12	110		80	60	12	60.37	40.25
12-DME (1)	12	110		50	40	10	27.75	18.50
12T-RME (2) (3)	12	110		125	90	12	54.75	36.50
28-RME (2)	28	110		100	80	12	69.75	46.50
32-RME (2)	32	110		100	80	12	69.75	46.50
110-RME (2)	110	110		150	100	12	65.25	43.50
220-RME	220	110		150	100	12	69.75	46.50

- These Inverters primarily recommended for Edison VP dictating machines. May also be used with Model 200 Sound-scriber (with engine of car not running).
- Primarily recommended for Dictaphone's Time Master, DeJus Stenorette, and Gray Audograph dictating machines or other similar types. Also recommended for use with Norelco tape recorder Model EL-3516 and Geosco Model G 285-S tape Recorder.
- This inverter specially designed and recommended also for use with RCA 8 1/2" portable TV set or G.E. 9" portable TV set in an automobile.

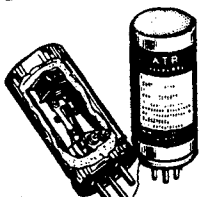

ATR VIBRATORS

FOR ALL AUTO RADIO SETS SINCE 1954 USE ONE OF THE ATR VIBRATORS LISTED BELOW ... ATR VIBRATORS FEATURE

Ceramic Stack Spacers with Two-Bolt Stack construction.
Instant Starting—as a result of highly efficient magnetic circuit with formed base for more uniform operation on both high and low voltages.
Large Oversize Tungsten Contacts having Full Wiping Action—for greater reliability and longer life.
Perforated Reed of Highest Quality Swedish Spring Steel.
Highest Precision Construction and Workmanship—Practically all parts used are held to within a tolerance of 0.0005 of inch.
Value Plus—as readily evidenced by the Larger Contacts, Ceramic Spacers and Precision Construction and Workmanship. Available in TEN-PAK.
ATR No. 1400 (Bulk), 4-Prong, 6-Volt For All 6-Volt Sets Since 1954
ATR No. 1843 (Bulk), 3-Prong, 12-Volt For All 12-Volt General Motors Since 1954
ATR No. 1843 also used in following automobiles: 1956 Ford (Philco), Lincoln (Bendix), and Mercury (Bendix); 1956 Chrysler (Philco); 1955-57 Packard; 1956-57 Plymouth (Philco); 1956 Studebaker (Philco) and 1957 Mercury (Philco)
ATR No. 1840 (Bulk), 4-Prong, 12-Volt For 12 Volt Cars other Than GM Since 1954
 Vibrator Prices subject to Excise Taxes, if applicable.



ATR ELECTRONIC TUBE PROTECTOR

A "MUST" FOR EVERY TV HOME! WILL DOUBLE OR TRIPLE THE LIFE OF ALL TYPES OF ELECTRONIC TUBES, INCLUDING TV PICTURE TUBE. Automatic in operation, for use with any electronic equipment having input wattage of 100 to 300 watts. Fuse protected; rugged construction, and enclosed in interior decorator's golden brown hammerloid-finish metal case. Available in two models. Our Floor Model 300 is 4" x 2 1/2" x 2 1/4" and weighs 2 lbs. Has 6 ft. cord set to plug into wall socket. Wall Model 250 is 1-15/16" OD x 3 1/4" in length and plugs directly into wall socket. Shipping weight is 1 lb.

- Wall Model 250 (115 volt A.C.) Net \$2.63
- Floor Model 300 (115 volts A.C.) Net \$3.30



ATR SHAV-PAKS

Every man should have this lightweight ATR Inverter in his car for that "Keep Clean-Shaved Look." Will operate standard A.C. Electric Shavers from your CAR or Boat*. Complete with 3 ft. cord set. Plugs into cigarette lighter receptacle. Fuse protected, rugged construction, and attractively housed in grey hammerloid-finish metal case. Size 4" x 2 1/2" x 2 1/4". Shipping weight 2 1/2 lbs.

- Model 6-SPB (6 volt) Net \$8.63
- Model 12-SPB (12 volt) Net 8.63

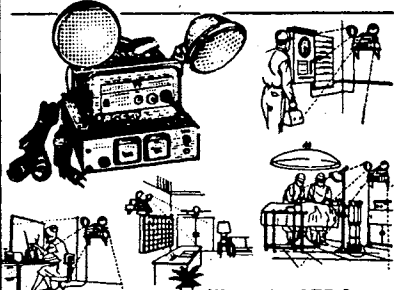

Illustrates ATR Emergency Lighting and Power Unit, Model ETS complete with lamps.

ATR EMERGENCY LIGHTING AND POWER UNIT

Completely Automatic Standby-Power Units Specially Designed to Permit the Instantaneous Continued Operation of Critical Lighting Equipment, PA Systems, Amplifiers, Intermcom Systems, Burglar Alarms, Fire Alarms, Synchronic Electric Clocks, Electric Time and Recording Clocks, Incubators, Gas Valves, Telephone and Test Equipment, and Similar Critical Devices in the Event of 115 Volt AC Commercial Power Line Failure. For Use: In Hospitals, Banks, Hotels, Theatres, Factories, Office Buildings, Schools, Homes, and Many Other Areas of Operation.

Type	*Storage Battery Input	A.C. Output 60 Cycles	Output Wattage Int. Cont.	Net Price
661-ETM	6-volts	110-volts	80	\$113.00
662-ETM	6	110	100	131.67
663-ETH	6	110	150	149.67
1232-ETH	12	110	125	131.67
1233-ETH	12	110	175	149.67
1234-ETJ	12	110	250	168.34

For Units Without Lamps Deduct \$14.66 Net

BURGESS BATTERIES

BURGESS Number	NEDA Number	Other	Volts	Terminal Type	Overall Dimensions			Unit Package Quantities	Weight of Unit Package in Pounds	Sugg. Dealer Each	Sugg. List Price Each
					L	W	H				
BURGESS ACTIVATORS FOR TRANSISTOR CIRCUITS											
130-Disp. 12	14	1035	1½	Flashlight	6 ³ / ₆₄ (diam.)	1 ¹ / ₁₆	12	1 ³ / ₈	\$.19	\$.30	
2MN6-Disp. 12	1604D	222	9	Snap Type	1	3 ³ / ₆₄ 1 ⁷ / ₈	12	1	.65	.98	
2N6	1602	246	9	Snap Type	1 ³ / ₈ 1 ³ / ₈	2 ³ / ₄	1	3 ¹ / ₁₀	1.30	1.85	
2U6-Disp. 12	1604	216	9	Snap Type	1	3 ³ / ₆₄ 1 ⁷ / ₈	12	1	.48	.69	
2Z3	1610	243	4½	Snap Type	1 ³ / ₈ 1 ³ / ₈	2 ³ / ₄	1	3 ¹ / ₁₀	4.18	6.25	
230-Disp. 12	13	1050	1½	Flashlight	1 ²¹ / ₆₄ (diam.)	2 ²⁵ / ₆₄	12	2 ³ / ₈	.19	.30	
4D4	1400	274	6	Snap	2 ¹ / ₃₂ 2	7 ¹ / ₁₆	1	2 ¹ / ₂	4.82	6.90	
930-Disp. 12	15	1015	1½	Flashlight	3 ⁵ / ₆₄ (diam.)	1 ³ / ₃₂	12	½	.155	.25	
A4	6	Flat Contacts	1 ¹ / ₃₂ 1 ¹ / ₃₂	2 ¹ / ₃₂	1	¼	2.48	3.50	
C6X	1612	2356N	9	Snap Type	2 ³ / ₁₆ 1 ¹ / ₃₂	6 ¹ / ₁₆	1	5 ⁸ / ₈	1.64	2.35	
D5	26	707	7½	Snap Type	2 ¹ / ₁₆ 2	2 ³ / ₃₂	1	7 ⁸ / ₈	2.00	2.90	
D6	1603	276	9	Snap Type	2 ¹ / ₁₆ 2	3 ³ / ₃₂	1	1	1.36	1.95	
D6P1	1601	2506	3, 6, 9	Socket	2 ¹ / ₃₂ 1 ¹ / ₁₆	7 ² / ₃₂	1	1 ³ / ₈	4.20	6.30	
D6S	1608	2761N	9	Socket	2 ¹ / ₄ 1 ¹ / ₄	7 ² / ₃₂	1	1 ¹ / ₈	4.80	7.20	
L6	1611	206	9	Flat Contacts	4 ⁷ / ₆₄ (diam.)	1 ³ / ₃₂	6	½	.62	.89	
M6	1605	266	9	Snap Type	1 ¹ / ₁₆ 1 ¹ / ₁₆	2 ¹ / ₁₆	1	2 ⁵ / ₈	1.36	1.95	
NE-Disp. 6	910	904	1½	Flashlight	7 ¹ / ₁₆ (diam.)	1 ¹ / ₆₄	6	¼	.08	.125	
P6-Disp. 6	1600	226	9	Snap Type	1 (diam.)	1 ¹ / ₁₆	6	3 ⁸ / ₈	.62	.89	
PM6-Disp. 6	1600D	9	Snap Type	1 (diam.)	1 ¹ / ₁₆	6	5 ⁸ / ₈	.80	1.19	
PM8	1810	228	12	Snap Type	1 (diam.)	2 ¹ / ₁₆	1	1 ¹ / ₈	1.05	1.50	
XX9	1900	239	9, 13½	Socket	3 ⁵ / ₈ 3 ⁵ / ₈	1 ⁹ / ₁₀	1	1 ¹ / ₈	1.77	2.55	
Y6	1606	9	Snap Type	1 ¹ / ₃₂ 2 ² / ₃₂	2 ¹ / ₃₂	12	½	.83	1.20	
BURGESS MERCURY ACTIVATORS											
Information on additional Mercury Batteries not listed below is available.											
Hg-1	1100	E1	1.4	Flat	5 ⁸ / ₈ (diam.)	2 ¹ / ₃₂	4	.13	.57	.85	
Hg-1R	E1N	1.35	Flat	5 ⁸ / ₈ (diam.)	2 ¹ / ₃₂	4	.13	.64	.95	
Hg-3R	E3	1.35	Flat	1 (diam.)	2 ¹ / ₃₂	4	.30	1.05	1.50	
Hg-4R	E4	1.35	Flat	1 ¹ / ₆₄ (diam.)	2 ¹ / ₃₂	4	.45	1.31	1.95	
Hg-9-4PK.	15M	E9	1.4	Flat	1 ¹ / ₃₂ (diam.)	1 ³ / ₃₂	4	.30	.64	.95	
Hg-12	1101	E12	1.4	Flat	5 ⁸ / ₈ (diam.)	2	2	.25	.92	1.35	
Hg-12R	E12N	1.35	Flat	5 ⁸ / ₈ (diam.)	2	2	.25	1.05	1.50	
Hg-42R	E42N	1.35	Flat	1 ¹ / ₆₄ (diam.)	2 ³ / ₈	1	.50	3.15	4.50	
H114R	E114	5.4	Flat	4 ³ / ₆₄ (diam.)	1 ¹ / ₃₂	2	.15	1.85	2.65	
H115R	E115N	6.75	Flat	4 ³ / ₆₄ (diam.)	1 ² / ₆₄	2	.15	2.06	2.75	
H126-Disp. 6	1611M	E126	8.4	Flat	4 ⁷ / ₆₄ (diam.)	2	6	.50	1.32	1.95	
H132R	E132N	2.7	Flat	4 ³ / ₆₄ (diam.)	1 ¹ / ₁₆	2	.15	1.17	1.65	
H133-Disp. 6	1306M	E133	4.2	Flat	2 ¹ / ₃₂ (diam.)	2	12	1.20	1.32	1.95	
H133R	E133N	4.05	Flat	2 ¹ / ₃₂ (diam.)	2	2	.20	1.35	1.95	
H134R	E134N	5.4	Flat	4 ³ / ₆₄ (diam.)	2 ⁵ / ₈	2	.25	1.72	2.50	
H135R	E135N	6.75	Flat	4 ³ / ₆₄ (diam.)	3 ³ / ₃₂	2	.30	2.00	2.95	
H136R	E136N	8.1	Flat	4 ³ / ₆₄ (diam.)	3 ¹ / ₁₆	2	.35	2.40	3.50	
H137R	E137N	9.45	Flat	4 ³ / ₆₄ (diam.)	4 ¹ / ₃₂	1	.20	2.76	3.95	
H146X-Disp. 6	1604M	E146X	8.4	Snap	1 ¹ / ₃₂ 2 ¹ / ₃₂	1 ³ / ₄	6	.75	1.32	1.95	
H152R	E152N	2.7	Flat	3 ¹ / ₃₂ (diam.)	1 ¹ / ₆₄	2	.075	1.05	1.50	
H162R	E162	2.7	Flat	4 ³ / ₆₄ (diam.)	5 ⁷ / ₆₄	2	.15	1.05	1.50	
H163	1305	E163	4.2	Flat	2 ¹ / ₃₂ (diam.)	1 ¹ / ₁₆	2	.15	1.32	1.95	
H163R	E163N	4.05	Flat	2 ¹ / ₃₂ (diam.)	1 ¹ / ₁₆	2	.15	1.57	2.25	
H164-Disp. 6	1404	E164	5.6	Flat	2 ¹ / ₃₂ (diam.)	1 ¹ / ₄	6	.40	1.32	1.95	
H164R	E164N	5.4	Flat	2 ¹ / ₃₂ (diam.)	1 ³ / ₄	2	.20	1.57	2.25	
H165	1500	E165	7.0	Flat	2 ¹ / ₃₂ (diam.)	2 ¹ / ₆₄	2	.20	1.70	2.50	
H165R	E165N	6.75	Flat	2 ¹ / ₃₂ (diam.)	2 ¹ / ₆₄	2	.20	1.90	2.75	
H177-Disp. 6	1606M	9.8	Snap	3 ⁵ / ₆₄ (diam.)	1 ² / ₃₂	6	.15	1.32	1.95	
H233	1300	E233	4.2	Flat	1 ¹ / ₆₄ (diam.)	1 ³ / ₃₂	1	.20	2.34	3.50	
Hg-312	E312	1.4	Flat	3 ¹ / ₁₆ (diam.)	9 ⁶ / ₆₄	6	.024	.24	.35	
Hg-400	1106	E400	1.4	Flat	2 ⁵ / ₆₄ (diam.)	9 ⁶ / ₆₄	6	.024	.24	.35	
Hg-400R	E400N	1.35	Flat	2 ⁵ / ₆₄ (diam.)	9 ⁶ / ₆₄	6	.024	.35	.50	
Hg-401	910M	E401	1.4	Flat	2 ⁵ / ₆₄ (diam.)	1 ¹ / ₈	3	.09	.51	.75	
Hg-401R	E401N	1.35	Flat	2 ⁵ / ₆₄ (diam.)	1 ¹ / ₈	2	.05	.60	.85	
Hg-450R	E450	1.35	Flat	2 ⁵ / ₆₄ (diam.)	9 ⁶ / ₁₆	4	.01	.53	.75	
Hg-502R	E502	1.35	Flat	1 ¹ / ₃₂ (diam.)	1 ³ / ₃₂	2	.16	.87	1.25	
Hg-520	E520	1.40	Flat	1 ¹ / ₂ (diam.)	9 ⁶ / ₃₂	6	.024	.20	.30	
Hg-575	1.4	Flat	2 ⁵ / ₆₄ (diam.)	1 ¹ / ₈	6	.05	.24	.35	
Hg-625	E625	1.4	Flat	5 ⁸ / ₈ (diam.)	¼	4	.05	.42	.60	
Hg-625R	E625N	1.35	Flat	5 ^{8 (diam.)}	¼	4	.05	.53	.75	
Hg-630	1104	E630	1.4	Flat	5 ^{8 (diam.)}	¼	4	.05	.42	.60	
Hg-630R	E630N	1.35	Flat	5 ^{8 (diam.)}	¼	4	.05	.53	.75	
Hg-640	1105	E640	1.4	Flat	5 ^{8 (diam.)}	7 ¹ / ₁₆	4	.15	.42	.60	
Hg-640R	E640N	1.35	Flat	5 ^{8 (diam.)}	7 ¹ / ₁₆	4	.15	.53	.75	
Hg-675	E675	1.4	Flat	2 ⁵ / ₆₄ (diam.)	1 ³ / ₆₄	6	.022	.32	.45	
HPX-13	EPX13	1.35	Flat	5 ^{8 (diam.)}	¼	4	.05	.50	.75	
HPX-14	EPX14	2.70	Flat	2 ¹ / ₃₂ (diam.)	5 ⁸	4	.34	1.05	1.50	
303314	16.8	Flat	2 ⁷ / ₈ 1 ¹ / ₁₆	1 ¹ / ₁₆	1	.80	11.20	16.00	



BURGESS BATTERIES



F6A60



F2BP



XX30PI



5308

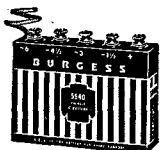

5540



5360

BURGESS Number	NEDA Number	Other	Volts	Terminal Type	Overall Dimensions			Unit Pkg. Quant.	Wgt. Unit Pkg. in Lbs.	Sugg. Dealer Each	Sugg. List Price Each
					L	W	H				
BURGESS INDUSTRIAL - ELECTRONIC - TRANSISTOR - RADIO "B" BATTERIES											
103085C	716	W363F	45	Spring Clip	8 ¹ / ₃₂	4 ¹ / ₃₂	7 ³ / ₁₆	1	12	\$7.66	\$10.95
10308PI	726	W363P	45	Socket	8 ¹ / ₃₂	4 ¹ / ₃₂	7 ³ / ₁₆	1	11 ¹ / ₂	7.66	10.95
213085C	715	W364F	45	Spring Clip	8 ¹ / ₈	4 ¹⁵ / ₃₂	7 ³ / ₃₂	1	12-4/5	8.25	11.70
21308PI	727	W364P	45	Socket	8 ¹ / ₈	4 ¹⁵ / ₃₂	7 ³ / ₃₂	1	12-4/5	8.14	12.15
23085C	723	W365F	45	Spring Clip	8 ³ / ₃₂	2 ¹ / ₃₂	7 ¹ / ₄	1	7 ¹ / ₂	7.66	10.95
2308PI	717	W365P	45	Socket	8 ³ / ₃₂	2 ¹ / ₃₂	7 ¹ / ₄	1	7-4/5	11.98	17.90
4156	710	763	22 ¹ / ₂	Binding Post	3 ¹⁷ / ₃₂	2 ¹ / ₈	2 ²⁹ / ₃₂	1	1	1.61	2.35
5156PI	721	...	22 ¹ / ₂	Socket	4 ⁷ / ₆₄	2 ⁹ / ₈	2 ²⁹ / ₆₄	1	1 ¹ / ₂	4.16	5.95
51565C	708	778	22 ¹ / ₂	Spring Clip	4 ¹ / ₈	2 ¹ / ₂	2 ³ / ₄	5	8	4.16	5.95
5308	709	762S	45	Binding Post	4 ¹ / ₁₆	2 ¹ / ₁₆	5 ¹ / ₈	1	2 ¹ / ₂	3.05	4.35
A30	206	W359	45	Socket	3 ¹ / ₁₆	2 ¹ / ₄	4 ⁵ / ₁₆	2	3 ¹ / ₂	3.46	4.95
A60	90	Socket	4 ⁷ / ₁₆	3 ³ / ₈	4 ¹ / ₈	1	3 ¹ / ₃	14.50	20.75
B30	207	484	45	Socket	4 ¹ / ₁₆	2 ¹ / ₃₂	5 ¹ / ₁₆	2	4 ¹ / ₂	5.40	7.75
D30	...	487	45	Socket	5 ¹ / ₁₆	2 ¹ / ₃₂	7 ³ / ₁₆	1	4 ¹ / ₂	7.70	11.25
K10	224	417	15	Flat Contact	1 ¹ / ₄	7 ⁸ / ₈	1 ¹⁷ / ₃₂	1	2 ozs.	1.28	1.75
K15	225	420	22 ¹ / ₂	Flat Contact	1 ¹ / ₄	7 ⁸ / ₈	2 ²⁹ / ₃₂	1	2 ozs.	1.44	1.95
K20	226	430	30	Flat Contact	1 ¹ / ₄	1 ⁹ / ₁₆	2 ²⁹ / ₃₂	1	3 ozs.	1.72	2.35
K45	203	457	67 ¹ / ₂	Snap Type	2 ¹¹ / ₁₆	1 ⁵ / ₁₆	2 ¹ / ₄	6	3	2.97	4.25
M30	202	482	45	Socket	3 ¹ / ₁₆	1 ¹ / ₄	5 ¹ / ₂	6	3	2.97	4.25
N60X	216	495	90	Snap Type	1 ¹ / ₈	1 ¹ / ₃₂	7 ¹ / ₈	1	1	6.50	9.70
P45	211	477	67 ¹ / ₂	Snap Type	1 ²⁹ / ₃₂	1	5 ⁵ / ₃₂	1	3 ⁴ / ₅	2.70	3.85
P60	214	479	90	Snap Type	1 ²⁹ / ₃₂	1	7 ¹⁷ / ₃₂	1	4 ¹ / ₅	2.97	4.25
U10	208	411	15	Flat Contact	1	3 ³ / ₆₄	1 ¹ / ₁₆	1	1 oz.	.81	1.15
U15	215	412	22 ¹ / ₂	Flat Contact	1	3 ³ / ₆₄	1 ¹ / ₃₂	1	1 oz.	1.05	1.50
U20	210	413	30	Flat Contact	1	3 ³ / ₆₄	2 ¹⁷ / ₃₂	1	2 ozs.	1.23	1.75
U200	722	493	300	Pin Jacks	2 ³ / ₄	2 ³ / ₃₂	3 ⁷ / ₈	1	1	8.37	11.95
U30	213	415	45	Snap Type	1 ¹ / ₃₂	1 ⁹ / ₃₂	3 ¹⁷ / ₃₂	1	1 ¹ / ₈	1.75	2.50
UX45	217	416	67 ¹ / ₂	Snap Type	1 ⁷ / ₃₂	3 ¹ / ₃₂	3 ³¹ / ₃₂	1	1 ¹ / ₄	2.07	2.95
V45	200C	468	67 ¹ / ₂	Snap Type	2 ³ / ₄	1 ¹¹ / ₃₂	3 ⁴³ / ₆₄	6	4 ¹ / ₂	2.77	3.95
V60	204	490	90	Snap Type	3 ²⁹ / ₃₂	1 ¹ / ₃₂	3 ¹⁷ / ₁₆	1	1-3/10	3.15	4.50
W20PI	30	Socket	1 ⁵ / ₁₆	1 ¹³ / ₁₆	3 ⁷ / ₃₁	1	1 ¹ / ₂	5.15	7.35
W30	45	Binding Post	3	1 ¹ / ₄	3 ²⁵ / ₃₂	1	3 ⁵ / ₈	4.78	7.15
W30BPX	...	W358	45	Binding Post	3	1 ¹ / ₄	3 ²⁵ / ₃₂	1	3 ⁵ / ₈	6.05	8.65
XX15	...	425P	22 ¹ / ₂	Socket	1 ¹¹ / ₃₂	1 ⁵ / ₁₆	3 ⁷ / ₈	1	1 ¹ / ₄	1.75	2.50
XX22	...	433P	33	Socket	2 ¹⁷ / ₃₂	3 ¹ / ₃₂	3 ¹ / ₈	1	1 ¹ / ₃	5.65	8.45
XX30	201	455	45	Snap Type	2 ¹⁷ / ₃₂	3 ¹ / ₃₂	3 ²¹ / ₃₂	1	1 ¹ / ₂	2.27	3.25
XX30PI	...	455P	45	Socket	2 ¹⁷ / ₃₂	3 ¹ / ₃₂	4 ¹ / ₃₂	1	1 ¹ / ₂	2.84	4.25
XX45	200	467	67 ¹ / ₂	Snap Type	2 ³ / ₄	1 ¹¹ / ₃₂	3 ⁴³ / ₆₄	1	3 ⁴ / ₅	2.70	3.85
XX50	212	437	75	Snap Type	1 ²⁷ / ₃₂	1 ⁵ / ₁₆	6 ⁵ / ₁₆	1	9 ¹ / ₁₀	5.50	8.20
XX69	227	W361	103 ¹ / ₂	Flashlight Brass	1 ¹¹ / ₃₂	1 ¹¹ / ₃₂	11 ²³ / ₃₂	1	1	4.86	6.95
Y10	220	504	15	Flat Contact	1 ⁹ / ₃₂	1 ⁹ / ₃₂	1 ²³ / ₆₄	1	1 oz.	.81	1.15
Y15	221	505	22 ¹ / ₂	Flat Contact	1 ⁹ / ₃₂	1 ⁹ / ₃₂	1 ³¹ / ₃₂	1	1 oz.	1.05	1.50
Y20	223	506	30	Flat Contact	1 ¹³ / ₁₆	1 ⁹ / ₃₂	1 ¹³ / ₃₂	1	1 oz.	1.30	1.85
Y20S	222	507	30	Flat Contact	1 ⁹ / ₃₂	1 ⁹ / ₃₂	2 ¹ / ₁₆	1	1 oz.	1.30	1.85
Z30	205	738	45	Socket	3	2 ⁵ / ₁₆	4 ¹ / ₁₆	1	1 ¹ / ₄	4.95	7.25
Z30NX	711	W350	45	Binding Post	3 ¹ / ₃₂	1 ⁷ / ₈	4 ¹⁹ / ₃₂	5	7 ³ / ₅	2.69	3.85
BURGESS INDUSTRIAL AND ELECTRONIC "C" BATTERIES											
2156	702	766	22 ¹ / ₂	Spring Clips	6 ²¹ / ₃₂	4 ¹ / ₁₆	2 ³¹ / ₃₂	1	3	9.20	13.25
2370	712	761T	4 ¹ / ₂	Binding Post	3 ¹⁵ / ₁₆	1 ¹ / ₈	2 ⁷ / ₈	5	3 ⁷ / ₁₀	2.10	3.00
2370PI	718	771	4 ¹ / ₂	Socket	4 ¹ / ₆₄	1 ²⁷ / ₆₄	2 ⁴³ / ₆₄	1	3 ⁴ / ₅	3.52	5.25
5360	714	781	4 ¹ / ₂	Binding Post	2 ¹³ / ₃₂	2 ⁷ / ₃₂	2 ²¹ / ₃₂	1	1 ¹ / ₄	1.23	1.75
5540	713	773	7 ¹ / ₂	Bndg Post Neg	4	7 ⁸ / ₈	2 ³ / ₄	5	1 ⁹ / ₁₀	1.80	2.50
A3BPX	-----	-----	4 ¹ / ₂	Binding Post	1 ³¹ / ₃₂	2 ³ / ₃₂	2 ¹ / ₄	1	1 ¹ / ₄	4.60	6.60
A8BP	-----	-----	12	Binding Post	2 ²⁹ / ₃₂	1 ²⁵ / ₆₄	2 ¹⁵ / ₃₂	1	1 ¹ / ₂	10.20	14.60
W5BP	-----	W362	7 ¹ / ₂	Binding Post	2 ³¹ / ₃₂	2 ²³ / ₃₂	1 ¹ / ₄	6	4 ¹ / ₅	5.80	8.65
BURGESS "A & B" PACKS FOR RADIO AND OTHER ELECTRONIC APPLICATIONS											
4TZ60	425	729	1 ¹ / ₂ A, 90B	Socket	7 ⁵ / ₈	2 ¹ / ₈	3 ³ / ₄	1	3 ⁴ / ₅	14.85	21.95
6TA60	410	W369	1 ¹ / ₂ A, 90B	Socket	9 ³¹ / ₃₂	2 ¹ / ₄	4 ¹ / ₁₆	1	4 ⁴ / ₅	11.40	16.95
G6B60	400	752	9A, 90B	Recessed Plug	13 ²⁹ / ₃₂	2 ¹³ / ₁₆	4 ²¹ / ₃₂	1	6 ⁷ / ₁₀	12.00	17.90
BURGESS POCKET TAPE RECORDER BATTERIES											
2VT8(3XX7)	1700	12	Flat Contact	1 ¹ / ₁₆	1 ¹ / ₁₆	3 ¹ / ₃₂	1	3 ⁸ / ₈	2.00	3.00
2X62X	1 ¹ / ₂ , 9	Snap Type	2 ¹ / ₂	1 ²⁹ / ₃₂	2 ¹ / ₃₂	1	1 ¹ / ₂	7.45	11.10
2X7	10 ¹ / ₂	Snap Type	2 ¹ / ₂	1 ²⁹ / ₃₂	2 ¹ / ₃₂	1	1 ¹ / ₂	4.00	5.90
BURGESS ALKALINE BATTERIES											
AL1-Disp. 6	14A	E93	1 ¹ / ₂	Flat Contact	6 ³ / ₆₄ (diam.)	1 ¹⁵ / ₁₆		6	1	.43	.65
AL133-Disp. 6	1306A	523	4 ¹ / ₂	Flat Contact	2 ¹ / ₃₂ (diam.)	2		6	1 ¹ / ₂	.84	1.25
AL2-Disp. 6	13A	E95	1 ¹ / ₂	Flat Contact	1 ¹² / ₆₄ (diam.)	2 ¹³ / ₃₂		6	2	.60	.90
AL7-Disp. 24	24A	E92	1 ¹ / ₂	Flat Contact	1 ¹³ / ₃₂ (diam.)	1 ¹ / ₄		24	1 ¹ / ₂	.325	.50
AL9-4PK.	15A	E91	1 ¹ / ₂	Flat Contact	1 ¹⁷ / ₃₂ (diam.)	1 ³¹ / ₃₂		24	2	.325	.50
ALN-2PK.	910A	E90	1 ¹ / ₂	Flat Contact	2 ²⁹ / ₃₂ (diam.)	1 ¹ / ₈		2	1 oz.	.27	.40
APX19-2PK.	1307	531	4 ¹ / ₂	Snap Type	2 ¹ / ₃₂ (diam.)	2 ¹³ / ₃₂		2	3 ⁸ / ₈	.84	1.25
APX21-2PK.	523	4 ¹ / ₂	Flat Contact	2 ¹ / ₃₂ (diam.)	2 ¹ / ₃₂		2	3 ⁸ / ₈	.84	1.25
APX24-2PK.	1308	532	3	Flat Contact	2 ¹ / ₃₂ (diam.)	2		2	3 ⁸ / ₈	.67	1.00
APX825-2PK.	1 ¹ / ₂	Flat Contact	2 ²⁹ / ₃₂ (diam.)	1 ⁵ / ₆₄		2	1 oz.	.33	.50
AL912	18	Flat Contact	2 ⁵⁵ / ₆₄	2 ⁴⁹ / ₆₄	1 ¹ / ₃₂	1	3 ⁴ / ₄	5.70	8.15

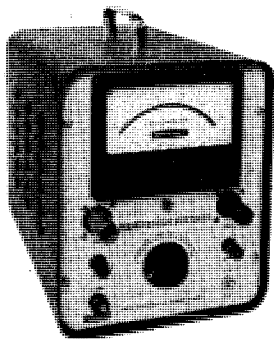

PORTABLE HIGH VOLTAGE DC POWER SUPPLIES

These general purpose supplies are particularly suited for laboratory or production line use to provide a convenient source of high voltage, low current dc power. Widely used for such applications as powering photo-multiplier tubes, image intensifiers, condenser charging, and routine insulation breakdown testing.

Voltage readings are indicated by a 6" precision mirror scale kilovoltmeter of 1% accuracy. Polarity is reversible from the front panel (patent applied for). An ac input protection fuse is included as well as a built-in limiting ballast lamp restricting maximum current output levels. These levels may be adjusted by changing ballast. A single control allows continuous adjustment of output voltage from zero to maximum rated voltage.

The output is unregulated (regulation is 20% for 10 to 100% loading). Current rating is 5 milliamperes. The ripple is 5% (rms) at full voltage and current load.

Model	Output Voltage	Output Current	Price
6000-1ma-ms	0 to 1kV	5ma	\$250.00
6000-5ma-ms	0 to 2.5kV	5ma	275.00
6005-5ma-ms	0 to 5kV	5ma	300.00
6010-5ma-ms	0 to 10kV	5ma	325.00
6015-5ma-ms	0 to 15kV	5ma	350.00
6025-5ma-ms	0 to 25kV	5ma	400.00

HEAVY DUTY DC POWER SUPPLIES

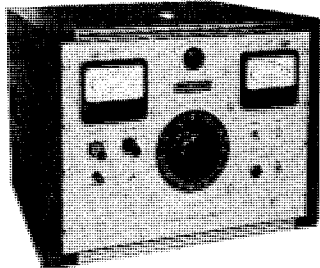

These industrial type power supplies are built for service and efficiency. All are of the transformer type and employ husky components that have been selected for their power handling capacity. Controls are arranged so that operation is simple and the units contain a number of safety features for protection of personnel and equipment. Output is continuously variable from zero to full rated values. These supplies are unregulated and standard ripple is 5% or less. Ripple of from 0.01% to 1%, and regulated supplies are available on special order. All power supplies have automatic overload cutout control circuits.

ously variable from zero to full rated values. These supplies are unregulated and standard ripple is 5% or less. Ripple of from 0.01% to 1%, and regulated supplies are available on special order. All power supplies have automatic overload cutout control circuits.

Model	Voltage	Current	Price
F-6001	0-1000	2 Amp.	\$ 950.00
F-6002	0-2000	1 Amp.	1050.00
F-6003-A1	0-3000	100 MA.	600.00
F-6003-AV	0-3000	500 MA.	700.00
F-6003-AK	0-3000	1 Amp.	1150.00
F-6005-A1-H	0-5000	100 MA.	650.00
F-6005-AV	0-5000	500 MA.	850.00
F-6005-A1K	0-5000	1 Amp.	1250.00
F-6010-AV	0-10,000	500 MA.	2100.00
F-6020-A05	0-20,000	50 MA.	1050.00
F-6030-A3	0-30,000	300 MA.	3500.00

HIGH VOLTAGE SWITCHES

For high voltage, low current circuits requiring complete isolation; nominal rating 5,000 volts (D.C. or A.C.) Model A or D may be used in lower duty circuits to 10,000 volts D.C. Steady state current rating 500 milliamperes—5Ma when switching. Isolated for 15,000 volts D.C. test to ground ... made of modified Diallyl Phthalate. May be ganged together for 2 gang operations.

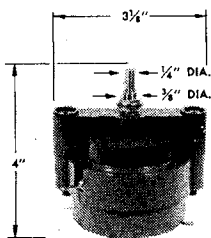

Model	Type	Price
A	2 Pole reversible (for polarity reversing of power supplied)	\$22.00
B	D.P.D.T.	24.00
D	4 Position (1 Gang)	22.00
E	6 Position (1 Gang)	24.00
F	8 Position (1 Gang)	28.00
G	10 Position (1 Gang)	30.00

PACKAGED POWER SUPPLIED AND ZENER REGULATORS

These new low-cost units make D.C. voltage problems easy. Just wire input and output connections and the unit is ready to operate. Building block construction provides a basic transformer, a rectifier unit, and where necessary a regulating device. These three elements bolt together quickly and maintenance is simplified should any of the components fail. Each of the three basic building blocks are mechanically constructed in a molded Diallyl Phthalate shell and encapsulated with epoxy resin.



ZENER REGULATOR

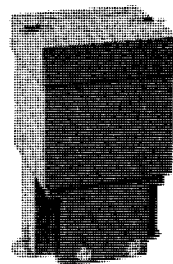

PACKAGED POWER SUPPLY

The output is completely isolated and either post may be grounded or the unit operated as a floating supply. The D.C. voltage is filtered and provides 5% or less ripple. Output may be varied from full rating down to zero by simply inserting a small adjustable transformer in the input. Most units are rated for 5 MA current. Power supplies 7.5 KV and higher have modified mechanical construction from that described above. Input 115 V. 60 Hz.

Use with High Voltage Zener Regulators to obtain 1% line and load regulation.

Simply connect in parallel* with any high voltage power supply and automatically obtain line and load voltage regulation as well as ripple reduction. Nominal current rating is 0.5 to 1 MA for better than 1% stabilization. Regulation over range of 0 to 5 MA is 3%. Can be wired in series for high voltage service (five 4,000 volt types to regulate a 20,000 volt power supply). Twenty built-in taps included, each provides a regulated voltage to an accuracy of 20%. Ideal for photomultiplier tubes. Use as a high voltage reference in conjunction with regulator amplifier circuitry.

*If necessary, insert a series resistor to limit zener current to under 5 MA.

	Model	Output Voltage	Total Voltage	Volts at Each Tap	Price
POWER SUPPLY	05-KV-5 MA	500 volts DC			\$ 50.00
	1-KV-5 MA	1-KV-DC			60.00
	2-KV-5 MA	2-KV-DC			65.00
	3-KV-5 MA	3-KV-DC			70.00
	5-KV-5 MA	5-KV-DC			75.00
	10-KV-5 MA	10-KV-DC			100.00
	15-KV-5 MA	15-KV-DC			110.00
	20-KV-5 MA	20-KV-DC			180.00
	30-KV-5 MA	30-KV-DC			210.00
	ZENER REGULATORS	ZA-1K		1,000 volts	50 volts
ZA-2K			2,000 volts	100 volts	70.00
ZA-3K			3,000 volts	100 & 200	80.00
ZA-4K			4,000 volts	200 volts	100.00
ZA-5K			5,000 volts	200 volts	110.00

HIGH VOLTAGE CONNECTORS

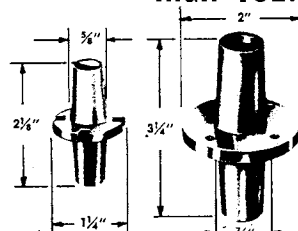

Price \$10.00 Ea.
Sample Kit of 10
(1 of each color) \$60.00

Price \$5.00 Ea.
Sample Kit of 10
(1 of each color) 30.00

Modified Diallyl Phthalate construction for superior arc resistance and low power factor; convenient miniature size with extra long air paths; sealed center conductor handles up to 20 amperes; neoprene gasket for mounting on oil filled tanks. For quick disconnect (easily mated with standard banana jack) or for permanent service with 10/32" machine bolt; neat styling—available in 10 colors—ideal for mounting on front panels.

Model C-1 rated for 25,000 volts D.C. max.
Model C-0 rated for 5,000 volts D.C. max.

Beckman INSTRUMENTS, INC.
CEDAR GROVE OPERATIONS



ELECTRO REGULATED AND INDUSTRIAL POWER SUPPLIES

Stocked at your franchised ELECTRO distributor.

PRECISION BUILT

The ELECTRO line provides a wide range of DC outputs up to 125 volts with adequate filtering for requirements ranging from critical transistor circuitry to applications permitting up to 5% ripple.

Every model is engineered to give unusual performance

REGULATED

Models PSR-12-25 and PSR-12-50 Regulated Supplies. (Fig. A) Solid state units with continuously variable outputs. Line regulation $\pm 0.01\%$ + 2mV over 105-125V input range. Load regulation 0.01%, no load to full load, max. ripple 100 microvolts. Ideal for transistor circuit development and testing. Front panel controls include: on-off switch; meter function switch, coarse and fine voltage controls for precise adjustment. Rack-mount accessory for up to 4 units available. PSR-12-25 output: 0-25v, 0-500mA; PSR-1250 output: 0-50v, 0-250mA. Input: 105-125 VAC, 60 Hz.

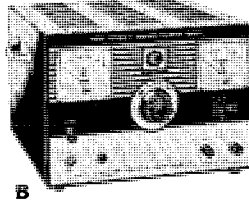
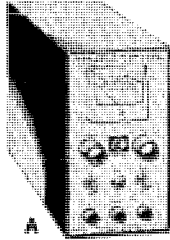

Model PSR-500 Series (Fig. B) delivers 500 watts of DC power with output voltage regulated to less than 1% for load and 0.1% for line changes. Maximum ripple less than 0.5%. All solid-state circuitry. Uses silicon rectifiers and SCR regulation. Fused input, circuit-breaker output protection.

Three models are available with output voltage ranges: 2-32v, 2-55v, and 2-125v. Input: 105-125 VAC, 60 Hz.

INDUSTRIAL

Model EF (Fig. C) provides variable voltage 0-28v or 0-14v at 5 amps continuous, 10 amps. intermittent load. Ripple less than 1%. Uses selenium rectifiers. Input: 117 VAC, 60 Hz.

Models EFB and EFBR (Figs. C, G) designed for very low ripple requirements of transistor work. Continuously variable voltage control. Selenium rectifiers. Employs chokes and capacitors in ripple filter. Model EFB Federal stock number 6130-957-1450. Model EFBR (Fig. G) same except with standard EIA rack panel. Input: 117 VAC, 50/60 Hz.

Models NFB and NFBR (Figs. D, G) for continuous heavy-duty. Continuously variable output, 0-32v for loads to 15 amps. Ripple: less than 0.75% at 15 amps. Ripple filter circuit uses chokes and capacitors. Variable autotransformer for smooth control. Bridge-type silicon rectifiers. Model NFBR same except with standard EIA rack panel. (Federal stock number 6130-853-3127.) Input: 117 VAC, 50/60Hz.

Models GFL and GFLR (Figs. D, G) low cost, semi-regulated, low ripple, higher voltage. Ideal for designing and testing DC appliances, telephone circuits, relays and solenoids; laboratory work. Continuously variable output 0-125v DC at 5 amps. Ripple: 0.5%. Silicon rectifiers. Overload protection. Model GFLR same except with standard EIA rack panel. Input: 117 VAC, 50/60 Hz.

Models PS-5 and PS-5R (Figs. D, G) designed for 48-volt applications. Delivers 550 watts well-filtered DC output continuously variable 0-55v DC. Ripple: 0.5% rms at 10 amps. Silicon rectifiers. Model PS-5R same except with standard EIA rack panel. Input: 117 VAC, 50/60 Hz.

PS-1000 Series (Fig. F) For continuous heavy duty. Continuously variable output. Low ripple. Filter circuit uses chokes and capacitors. Variable autotransformer for smooth control. Bridge-type silicon rectifiers. Three models are available with output voltage ranges 0-32v DC at 30 amps, 0-55v DC at 20 amps and 125v DC at 8 amps. Input: 117 VAC, 50/60 Hz.

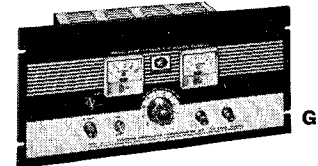
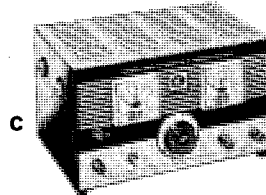
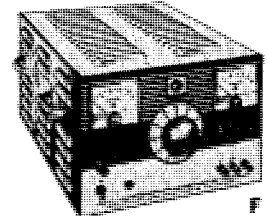
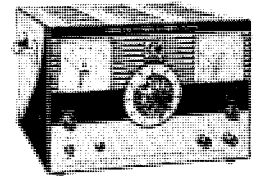

Selection Guide – Power Supplies for every need

REGULATED											
Model	Figure	Output		Line Reg.**	Load Reg.*	Max. Ripple, RMS	Meters††	DC Imp. Ohms*	Size (HxWxD)	Shpg. Wt. Lbs.	Price (net)
		Volts	Current								
PSR-12-25	A	0-25	0-500mA	0.01%+2mV	0.01%	100uV	0-30V/600mA	.005	5-1/4x3-1/8x10	7	\$110.00
PSR-12-50	A	0-50	0-250mA	0.01%+2mV	0.01%	100uV	0-60V/300mA	.02	5-1/4x3-1/8x10	7	110.00
PSR-500-32	B	2-32	0-15A	0.1%	1.0%	0.5%	0-50V, 0-25A	.02	9-3/4x14-1/4x14-1/4	89	395.00
PSR-500-55	B	2-55	0-10A	0.1%	1.0%	0.5%	0-75V, 0-15A	.06	9-3/4x14-1/4x14-1/4	88	395.00
PSR-500-125	B	2-125	0-5A	0.1%	1.0%	0.5%	0-150V, 0-5A	.25	9-3/4x14-1/4x14-1/4	93	425.00
INDUSTRIAL											
Model	Figure	Voltage Output	Amps Output	Load Regulation* (V/A)†	Max. Ripple %	Meters††	DC Impedance (ohms)*	Size (HxWxD) inches	Weight lbs. (net)	Price (net)	
EF	C	0-28 0-14	0-5 0-5	0.9 (1-5A) 0.6 (1-5A)	1.0 1.0	0-80V, 0-5A	0.9 (1-5A) 0.6 (1-5A)	7x12x8-1/2	25	\$125.00	
EFB	C	0-32 0-16	0-4 0-8	1.25 1.0	0.1 0.1	0-40/20V 0-10A	1.25 1.0	7x12x8-1/2	36	165.00	
EFBR	G	0-32 0-16	0-4 0-8	1.25 1.0	0.1 0.1	0-40, 20V 0-10A	1.25 1.0	8-3/4x19x8-1/2	47	185.00	
GFL	D	0-125	0-5	1.5	0.5	0-150V, 0-5A	1.5	9-3/4x14-1/4x14-1/4	88	325.00	
GFLR	G	0-125	0-5	1.5	0.5	0-150V, 0-5A	1.5	10-1/2x19x14-1/4	100	345.00	
NFB	D	0-32	0-15	0.4	0.75	0-50V, 0-25VA	0.4	9-3/4x14-1/4x14-1/4	84	300.00	
NFBR	G	0-32	0-15	0.4	0.75	0-50V, 0-25A	0.4	10-1/2x19x14-1/4	97	320.00	
PS-5	D	0-55	0-10	0.8	0.5	0-75V, 0-15A	0.8	9-3/4x14-1/4x14-1/4	70	325.00	
PS-5R	G	0-55	0-10	0.8	0.5	0-75V, 0-15A	0.8	10-1/2x19x14-1/4	89	345.00	
PS-1000-32	F	0-32	0-30	0.2	0.75	0-50V, 0-30A	0.2	9-3/4x14-1/4x19-1/4	103	398.00	
PS-1000-55	F	0-55	0-20	0.5	0.5	0-75V, 0-30A	0.5	9-3/4x14-1/4x19-1/4	113	398.00	
PS-1000-125	F	0-125	0-8A	1.0	Less than 1%	0-150V, 0-10A	1.0	9-3/4x14-1/4x19-1/4	120	425.00	

*No-load to full-load unless otherwise specified.

**From 105-125 VAC.

†Output voltage change for each ampere of output current change.

††All 2% accuracy except 5% for general purpose units.

Rectifiers: Selenium and Silicon ("avalanche" characteristics on industrial units).

ELECTRO PRODUCTS LABORATORIES, INC.

GATES POWER SUPPLIES

SILICON POWER RECTIFIER



For transistor circuits & electronic equipment
MODEL 692F

INPUT: 115 volts AC 60 cycles, 1 phase
OUTPUT: 0-32 Volts DC, 0-10 Amperes D.C. continuous duty
REGULATION: No load to full load 15%
RIPPLE: Less than 0.3% RMS
METERS: 2% Accuracy
DIMENSIONS: 17" x 9" x 9"
PRICE: \$169.50 NET
*Also available in 5 Amperes
PRICE: \$114.50 NET

INDUSTRIAL POWER UNITS

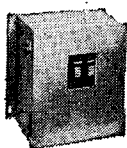

MODEL A10

INPUT 115 or 230 AC Volts, 60 cycles—Single Phase.
DC OUTPUT 115 Volts DC 125 Watts
APPLICATION: Power sources for operating DC Motors, Relays, Solenoids, Magnetic Chucks.
DIMENSIONS: 11" H x 9" W x 6 1/2" D
PRICE \$63.00 NET
250 Watts — \$72.50

SELENIUM POWER SUPPLY

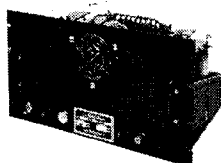

MODEL 648-6FM

INPUT: 115 Volts AC 60 Cycles—Single Phase
OUTPUT: 0-48 Volts DC, 0-6 Amperes
CONTROL: Continuously variable over entire range
RIPPLE: 1% RMS
DIMENSIONS: 19" W x 13" D x 10 1/2" H, Fits RETMA, Western Electric racks
PRICE: \$190.00 NET

SILICON POWER SUPPLY

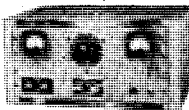

MODEL #GS 14-15F

INPUT: 115 Volts AC, 1 Phase, 60 cycles
OUTPUT: 0-14 Volts DC, 0-15 Amperes, continuous duty
RIPPLE: Less than 1% RMS
METER ACCURACY: 2%
DIMENSIONS: 9" H x 17 1/2" W x 9" D
Rack Model Same Price

SILICON RACK MOUNT SUPPLY



MODEL #GX30-10

INPUT: 115 Volts AC 60 Cycles, Single Phase
OUTPUT: 26, 28, 30 Volts DC 0-10 Amperes Continuous Duty
REGULATION: 10% No Load to Full Load
RIPPLE: 0.3% RMS
DIMENSIONS: 8 3/4" H x 19" W x 10" D
PRICE: \$137.50 NET

AIRCRAFT BATTERY ELIMINATOR

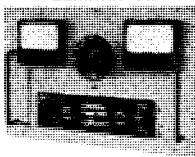

MODEL #G101F

INPUT: 115 Volts AC 60 cycles, single phase
OUTPUT: 0-32 Volts DC, 0-20 Amperes, continuous duty
RIPPLE: 0.5% RMS
Unique overload device prevents needle slam and shows overload condition
REGULATION: D.C.V. at full load: 30 D.C.V. at 1/10 load: 35
METERS: 2% Accuracy
DIMENSIONS: 19" x 14 1/4" x 12 1/4"
PRICE: \$275.00 NET
May be used for Rack or Bench

ECONOMY RANGE DC POWER SUPPLIES — Less Than 1% Ripple - Good Regulation - Rack Mount Type - Heavy Duty Construction - Powerstat - Fused 2% Meters - 115 Vac Input

MODEL GT 12-5:	Output 0-12V,	5A	\$	Inquire
MODEL GT 12-10:	Output 0-12V,	10A	\$	Inquire
MODEL GT 12-15:	Output 0-12V,	15A	\$	Inquire
MODEL GT 12-25:	Output 0-12V,	25A	\$	Inquire
MODEL GT 12-100:	Output 0-12V,	100A	\$	Inquire
MODEL GT 14-5:	Output 0-14V,	5A	\$	Inquire
MODEL GT 14-15:	Output 0-14V,	15A	\$	Inquire
MODEL GT 14-20:	Output 0-14V,	20A	\$	Inquire
MODEL GT 14-30:	Output 0-14V,	30A	\$	Inquire
MODEL GT 14-40:	Output 0-14V,	40A	\$	Inquire
MODEL GT 14-50:	Output 0-14V,	50A	\$	Inquire
MODEL GT 14-75:	Output 0-14V,	75A	\$	Inquire
MODEL GT 14-100:	Output 0-14V,	100A	\$	Inquire
MODEL GT 16-5:	Output 0-16V,	5A	\$	Inquire
MODEL GT 16-10:	Output 0-16V,	10A	\$	Inquire
MODEL GT 16-25:	Output 0-16V,	25A	\$	Inquire
MODEL GT 16-30:	Output 0-16V,	30A	\$	Inquire
MODEL GT 16-40:	Output 0-16V,	40A	\$	Inquire
MODEL GT 16-50:	Output 0-16V,	50A	\$	Inquire
MODEL GT 16-70:	Output 0-16V,	70A	\$	Inquire
MODEL GT 16-80:	Output 0-16V,	80A	\$	Inquire
MODEL GT 28-5:	Output 0-28V,	5A	\$	Inquire
MODEL GT 28-12:	Output 0-28V,	12A	\$	Inquire
MODEL GT 28-24:	Output 0-28V,	24A	\$	Inquire
MODEL GT 32-5:	Output 0-32V,	5A	\$	Inquire
MODEL GT 32-8:	Output 0-32V,	8A	\$	Inquire
MODEL GT 32-12:	Output 0-32V,	12A	\$	Inquire
MODEL GT 32-15:	Output 0-32V,	15A	\$	Inquire
MODEL GT 32-24:	Output 0-32V,	24A	\$	Inquire
MODEL GT 32-30:	Output 0-32V,	30A	\$	Inquire
MODEL GT 32-50:	Output 0-32V,	50A	\$	Inquire
MODEL GT 48-5:	Output 0-48V,	5A	\$	Inquire
MODEL GT 48-10:	Output 0-48V,	10A	\$	Inquire
MODEL GT 48-15:	Output 0-48V,	15A	\$	Inquire
MODEL GT 48-35:	Output 0-48V,	35A	\$	Inquire
MODEL GT 80-5:	Output 0-80V,	5A	\$	Inquire
MODEL GT 80-10:	Output 0-80V,	10A	\$	Inquire
MODEL GT 80-20:	Output 0-80V,	20A	\$	Inquire
MODEL GT 115-5:	Output 0-115V,	5A	\$	Inquire
MODEL GT 115-10:	Output 0-115V,	10A	\$	Inquire
MODEL GT 130-2:	Output 0-130V,	2A	\$	Inquire
MODEL GT 120-5:	Output 0-120V,	5A	\$	Inquire
MODEL GT 130-5:	Output 0-130V,	5A	\$	Inquire
MODEL GT 130-10:	Output 0-130V,	10A	\$	Inquire

PRICES SUBJECT TO CHANGE

GATES

ELECTRONIC COMPANY, INC.

3 PHASE MODEL POWERSTAT METERS

MODEL GP 125-40:	Output 40A, 0-125V	\$	Inquire
MODEL GP 125-80:	Output 80A, 0-125V	\$	Inquire
MODEL GP 125-125:	Output 125A, 0-125V	\$	Inquire
MODEL GP 250-15:	Output 15A, 0-250V	\$	Inquire
MODEL GP 250-25:	Output 25A, 0-250V	\$	Inquire
MODEL GP 250-40:	Output 40A, 0-250V	\$	Inquire
MODEL GP 250-75:	Output 75A, 0-250V	\$	Inquire
MODEL GP 500-5:	Output 5A, 0-500V	\$	Inquire
MODEL GP 500-10:	Output 10A, 0-500V	\$	Inquire
MODEL GP 500-25:	Output 25A, 0-500V	\$	Inquire
MODEL GP 500-35:	Output 35A, 0-500V	\$	Inquire
MODEL GT 32-60:	Output 0-32V, 60A	\$	Inquire
MODEL GT 48-25:	Output 0-48V, 25A	\$	Inquire
MODEL GT 48-50:	Output 0-48V, 50A	\$	Inquire
MODEL GT 48-60:	Output 0-48V, 60A	\$	Inquire
MODEL GT 48-80:	Output 0-48V, 80A	\$	Inquire
MODEL GT 48-100:	Output 0-48V, 100A	\$	Inquire
MODEL GT 115-15:	Output 0-115V, 15A	\$	Inquire
MODEL GT 115-20:	Output 0-115V, 20A	\$	Inquire
MODEL GT 115-25:	Output 0-115V, 25A	\$	Inquire
MODEL GT 115-30:	Output 0-115V, 30A	\$	Inquire
MODEL GT 115-40:	Output 0-115V, 40A	\$	Inquire
MODEL GT 115-50:	Output 0-115V, 50A	\$	Inquire
MODEL GT 115-60:	Output 0-115V, 60A	\$	Inquire
MODEL GT 115-70:	Output 0-115V, 70A	\$	Inquire
MODEL GT 200-10:	Output 0-220V, 10A	\$	Inquire
MODEL GT 80-50:	Output 0-80V, 50A	\$	Inquire
MODEL GT 80-100:	Output 0-80V, 100A	\$	Inquire

LOW-COST BASIC / OEM SUPPLIES

MODEL L6 3-30	6.3VDC @ 30A/1%	\$	Inquire
MODEL L12-12	12VDC @ 12A/Rip. 1Mv/.01%	\$	Inquire
MODEL L12-15	12VDC @ 15A/1%	\$	Inquire
MODEL L12-24	12VDC @ 24Amp	\$	Inquire
MODEL L12-24	12VDC @ 24A/1%	\$	Inquire
MODEL L12-50	12VDC @ 50Amp	\$	Inquire
MODEL L12-50	12VDC @ 50A/Rip. 1%	\$	Inquire
MODEL L24-30	24VDC @ 30A/Rip. 1%	\$	Inquire
MODEL L28-1	28VDC @ 1A/0.5%	\$	Inquire
MODEL L28-2	28VDC @ 1A/Rip. .05%	\$	Inquire
MODEL L28-5	28VDC @ 5Amp	\$	Inquire
MODEL L28-8	28VDC @ 8Amp	\$	Inquire
MODEL L28-12	28VDC @ 12Amp	\$	Inquire
MODEL L28-24	28VDC @ 24Amp (N.F.)	\$	Inquire
MODEL L28-24	28VDC @ 24Amp	\$	Inquire
MODEL L28-30	28VDC @ 30Amp	\$	Inquire
MODEL L28-50	28VDC @ 50Amp (N.F.)	\$	Inquire
MODEL L28-50	28VDC @ 50Amp	\$	Inquire
MODEL L28-50	28VDC @ 50Amp. -1% R.	\$	Inquire
MODEL L28-100	28VDC @ 100Amp	\$	Inquire
MODEL L115-2.5	115VDC @ 2.5A	\$	Inquire
MODEL L115-5	115VDC @ 5A	\$	Inquire
MODEL L115-10	115VDC @ 10A (N.F.)	\$	Inquire
MODEL L115-10	115VDC @ 10A	\$	Inquire
MODEL L220-5	220VDC @ 5A	\$	Inquire
MODEL L220-10	220VDC @ 10A	\$	Inquire
MODEL L440-5	440VDC @ 5A	\$	Inquire

(N.F.) means not filtered

12 VOLT POWER SUPPLIES — 1% Ripple

MODEL GS 12-1,	Output 1A, 12V	\$	Inquire
MODEL GS 12-3,	Output 3A, 12V	\$	Inquire
MODEL GS 12-5,	Output 5A, 12V	\$	Inquire
MODEL GS 12-10,	Output 10A, 12V	\$	Inquire
MODEL GS 12-15,	Output 15A, 12V	\$	Inquire
MODEL GS 12-20,	Output 20A, 12V	\$	Inquire
MODEL GS 12-25,	Output 25A, 12V	\$	Inquire
MODEL GS 12-30,	Output 30A, 12V	\$	Inquire

GATES POWER SUPPLIES

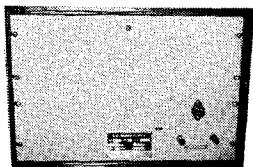
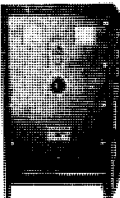
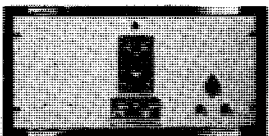
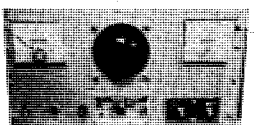
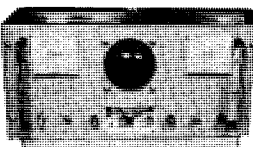
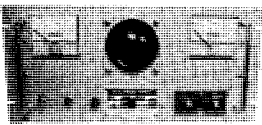
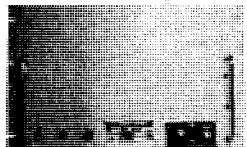
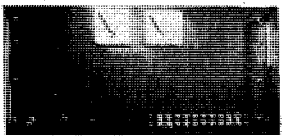
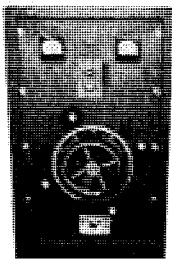
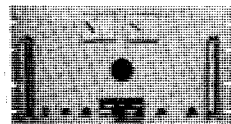
<p>MODEL G230-25</p>  <p>INPUT: 208/440, 3ph 60 cy OUTPUT: 230 @ 25A RIPPLE: 4.5% REGULATION: 1/10 Load 8% METERS: None DIMENSIONS: 21" W x 15" D x 14" H PRICE: \$575.00 METERS \$50.00 EXTRA</p>	<p>MODEL G12-250</p>  <p>INPUT: 208, 3ph 60 cy OUTPUT: 0-12V @ 250A RIPPLE: 4.5% REGULATION: 1/10 Load 8% METERS: YES DIMENSIONS: 20" W x 20" D x 35" H PRICE: \$575.00</p>	<p>MODEL G220-10</p>  <p>INPUT: 115VAC OUTPUT: 220VDC @ 10A RIPPLE: 48% METERS: NONE DIMENSIONS: 21" W x 15" D x 10" H PRICE: \$425.00 METERS \$50.00 EXTRA</p>	<p>SILICON INDUSTRIAL POWER UNIT MODEL G30-40F</p>  <p>INPUT: 115 Volts AC, 60 cycles, single phase. OUTPUT: 0-32 Volts DC, 0-40 Amperes DC, continuous duty RIPPLE: 1% RMS DIMENSIONS: 12 1/4" H x 19" W x 13" D REGULATION: D.C.V. at full load: 32 minimum D.C.V. at 1/10 load: 35 maximum PRICE: \$425.00</p>
<p>MODEL GT125-5F</p>  <p>INPUT: 115VAC OUTPUT: 0-125 @ 5A RIPPLE: 0.5% REGULATION: UNREGULATED METERS: YES DIMENSIONS: 21" W x 15" D x 10 1/2" H PRICE: \$325.00</p>	<p>MODEL GT14-40</p>  <p>INPUT: 115VAC OUTPUT: 0-14 @ 40A RIPPLE: 0.1% REGULATION: UNREGULATED METERS: YES DIMENSIONS: 19" W x 13 1/2" D x 8-3/6" H PRICE: \$275.00 — RACK MOUNTED</p>	<p>MODEL GX28-50</p>  <p>INPUT: 115VAC OUTPUT: 28 @ 50A RIPPLE: 0.5% REGULATION: UNREGULATED METERS: NONE DIMENSIONS: 19" W x 13 1/2" D x 12 1/4" H PRICE: \$325.00 — RACK MOUNTED</p>	<p>MODEL G45-30</p>  <p>INPUT: 115VAC OUTPUT: 45, 42, 40, 36, 32, 30, 29, 28, 26 @ 30A RIPPLE: 1% REGULATION: FAN COOLED METERS: 5% DIMENSIONS: 19" W x 10" D x 8-3/6" H PRICE: \$375.00</p>
<p>MODEL GT20-200</p>  <p>INPUT: 220 VAC 60 cy. 1 Phase OUTPUT: 0-22 VDC @ 200A RIPPLE: 1% CABINET: 35" x 20" x 20" METERS: VOLT & AMP. PRICE \$625.00</p>		<p>NEW SCR REGULATED POWER SUPPLIES</p>  <p>GCR32-30 115VAC 24-32 @ 30A 1% ±1% Meters 19"Wx17"Dx12 1/4"H PRICE: \$550.00 — Cabinet \$25.00 more GCR32-25 115VAC 24-32 @ 25A 1% ±1% Meters 19"Wx17"Dx12 1/4"H PRICE: \$505.00 — Cabinet \$25.00 more GCR32-20 115VAC 24-32 @ 20A 1% ±1% Meters 19"Wx17"Dx10 1/4"H PRICE: \$475.00 — Cabinet \$25.00 more</p>	

HIGH VOLTAGE DC POWER SUPPLIES

1% Ripple - Good Regulation - Cabinets - Meters - Heavy Duty Construction - Powerstat - Fused 2% Meters

MODEL GP 32-5	Input 115V, 60c, 1ph.	Output 0-32V @ 5A\$ Inquire
MODEL GP 32-10	Input 115V, 60c, 1ph.	Output 0-32V @ 10A\$ Inquire
MODEL GP 32-20	Input 115V, 60c, 1ph.	Output 0-32V @ 20A\$ Inquire
MODEL GP 32-40	Input 115V, 60c, 1ph.	Output 0-32V @ 40A\$ Inquire
MODEL GP 32-100	Input 220V, 60c, 3ph.	Output 0-32V @ 100A\$ Inquire
MODEL GP 32-150	Input 220V, 60c, 3ph.	Output 0-32V @ 150A\$ Inquire
MODEL GP 60-6	Input 115V, 60c, 1ph.	Output 0-60V @ 6A\$ Inquire
MODEL GP 60-10	Input 115V, 60c, 1ph.	Output 0-60V @ 10A\$ Inquire
MODEL GP 60-12	Input 115V, 60c, 1ph.	Output 0-60V @ 12V..\$ Inquire
MODEL CP 60-20	Input 115V, 60c, 1ph.	Output 0-60V @ 20A\$ Inquire
MODEL GP 60-50	Input 220V, 60c, 3ph.	Output 0-60V @ 50A\$ Inquire
MODEL GP 60-80	Input 220V, 60c, 3ph.	Output 0-60V @ 80A\$ Inquire
MODEL GP 60-250	Input 220V, 60c, 3ph.	Output 0-60V @ 250A\$ Inquire
MODEL GP 125-2.5	Input 117V, 60c, 1ph.	Output 0-125V @ 2.5A\$ Inquire
MODEL GP 125-3	Input 117V, 60c, 1ph.	Output 9-124V @ 3A\$ Inquire
MODEL GP 125-5	Input 117V, 60c, 1ph.	Output 0-125V @ 5A\$ Inquire
MODEL GP 125-10	Input 117V, 60c, 1ph.	Output 0-125V @ 10A\$ Inquire
MODEL GP 125-20	Input 117V, 60c, 1ph.	Output 0-124V @ 20A\$ Inquire

MODEL GP 125-24	Input 220V, 60c, 3ph.	Output 0-125V @ 24A\$ Inquire
MODEL GP 125-40	Input 220V, 60c, 3ph.	Output 0-125V @ 40A\$ Inquire
MODEL GP 125-80	Input 220V, 60c, 3ph.	Output 0-125V @ 80A\$ Inquire
MODEL GP 125-120	Input 220V, 60c, 3ph.	Output 0-125V @ 120A\$ Inquire
MODEL GP 250-5	Input 117V, 60c, 1ph.	Output 0-250V @ 5A\$ Inquire
MODEL GP 250-10	Input 117V, 60c, 1ph.	Output 0-250V @ 10A\$ Inquire
MODEL GP 250-12	Input 220V, 60c, 3ph.	Output 0-250V @ 12A\$ Inquire
MODEL GP 250-20	Input 220V, 60c, 3ph.	Output 0-250V @ 20A\$ Inquire
MODEL GP 250-40	Input 220V, 60c, 3ph.	Output 0-250V @ 40A\$ Inquire
MODEL GP 250-60	Input 220V, 60c, 3ph.	Output 0-250V @ 60A\$ Inquire
MODEL GP 300-1	Input 220V, 60c, 3ph.	Output 0-250V @ 1A\$ Inquire
MODEL GP 300-1.5	Input 220V, 60c, 3ph.	Output 0-250V @ 1.5A\$ Inquire
MODEL GP 300-2	Input 220V, 60c, 3ph.	Output 0-250V @ 2A\$ Inquire
MODEL GP 300-3	Input 220V, 60c, 3ph.	Output 0-250V @ 3A\$ Inquire
MODEL GP 300-5	Input 220V, 60c, 3ph.	Output 0-250V @ 5A\$ Inquire
MODEL GP 500-1	Input 220V, 60c, 3ph.	Output 0-500V @ 1A\$ Inquire
MODEL GP 500-1.5	Input 220V, 60c, 3ph.	Output 0-500V @ 1.5A\$ Inquire
MODEL GP 500-2	Input 220V, 60c, 3ph.	Output 0-500V @ 2A\$ Inquire
MODEL GP 500-3	Input 220V, 60c, 3ph.	Output 0-500V @ 3A\$ Inquire
MODEL GP 500-5	Input 220V, 60c, 3ph.	Output 0-500V @ 5A\$ Inquire
MODEL GP 500-5	Input 220V, 60c, 3ph.	Output 0-500V @ 5A\$ Inquire
MODEL GP 500-10	Input 220V, 60c, 3ph.	Output 0-500V @ 10A\$ Inquire
MODEL GP 500-20	Input 220V, 60c, 3ph.	Output 0-500V @ 20A\$ Inquire
MODEL GP 500-30	Input 220V, 60c, 3ph.	Output 0-500V @ 30A\$ Inquire

FIXED VOLTAGE, 1% LINE AND LOAD REGULATED POWER SUPPLIES

SPECIFICATIONS

AC INPUT: 105 - 125V, 57 - 63 Hz, 1 phase
 REGULATION: ±1% for ±10% line change
 ±1% for no load to full load
 RIPPLE: 0.1% +10MV rms maximum
 GROUNDING: Floating output; either positive or negative may be grounded.
 PROTECTION: Automatic short-circuit protection

GATES

ELECTRONIC COMPANY, INC.

ALL TYPES OF POWER SUPPLIES

BENCH MODEL PLATING SUPPLIES (continued)

MODEL GI 50-6F	6V	50A	\$	Inquire
MODEL GI 50-9	9V	50A	\$	Inquire
MODEL GI 50-9F	9V	50A	\$	Inquire
MODEL GI 50-12	12V	50A	\$	Inquire
MODEL GI 50-12F	12V	50A	\$	Inquire
MODEL GI 50-18	18V	50A	\$	Inquire
MODEL GI 50-18F	18V	50A	\$	Inquire
MODEL GI 75-6	6V	75A	\$	Inquire
MODEL GI 75-6F	6V	75A	\$	Inquire
MODEL GI 75-9	9V	75A	\$	Inquire
MODEL GI 75-9F	9V	75A	\$	Inquire
MODEL GI 75-12	12V	75A	\$	Inquire
MODEL GI 75-12F	12V	75A	\$	Inquire
MODEL GI 75-18	18V	75A	\$	Inquire
MODEL GI 75-18F	18V	75A	\$	Inquire
MODEL GI 100-6	6V	100A	\$	Inquire
MODEL GI 100-6F	6V	100A	\$	Inquire
MODEL GI 100-9	9V	100A	\$	Inquire
MODEL GI 100-9F	9V	100A	\$	Inquire
MODEL GI 100-12	12V	100A	\$	Inquire
MODEL GI 100-12F	12V	100A	\$	Inquire
MODEL GI 100-18	18V	100A	\$	Inquire
MODEL GI 100-18F	18V	100A	\$	Inquire

MODEL GI 150-6	6V	150A	\$	Inquire
MODEL GI 150-6F	6V	150A	\$	Inquire
MODEL GI 150-9	9V	150A	\$	Inquire
MODEL GI 150-9F	9V	150A	\$	Inquire
MODEL GI 150-12	12V	150A	\$	Inquire
MODEL GI 150-12F	12V	150A	\$	Inquire
MODEL GI 200-9	9V	200A	\$	Inquire
MODEL GI 200-9F	9V	200A	\$	Inquire
MODEL GI 200-12	12V	200A	\$	Inquire
MODEL GI 200-12F	12V	200A	\$	Inquire

* FILTERED (F)

PRICES SUBJECT TO CHANGE

TECHNICIAN SPECIALS					
MODEL G28-2	28V	2A	1% R	\$37.50
MODEL G48-3	48V	3A	1% R	\$39.50
MODEL GI15-1	115V	1A	1% R	\$49.50

MAGNETICALLY REGULATED D.C. POWER SUPPLIES

REGULATION: Line $\pm 1\%$ for $\pm 15\%$ line voltage change load $\pm 2\%$ for any load change between $\frac{1}{2}$ load and full load. Ripple 1% RMS Maximum. Rack or cabinet types.

VOLTS	D.C. OUTPUT AMPS	VA	CATALOG NUMBER	LOAD REGULATION		PRICE
				20% F.L.	50% F.L.	
6	10	60	6GDCV10	9	7	\$130.00
6	15	90	6GDCV15	9	7	140.00
12	5	60	12GDCV5	7	5	92.00
12	10	120	12GDCV10	7	5	120.00
12	15	180	12GDCV15	7	5	155.00
18	5	90	18GDCV5	5	4	96.00
18	10	180	18GDCV10	7	5	141.00
24	6	144	24GDCV6	5	4	116.00
24	10	240	24GDCV10	6	4	144.00
24	15	360	24GDCV15	5	4	200.00
24	25	600	24GDCV25	6	4	275.00
28	8	224	28GDCV8	6	4	144.00
28	15	420	28GDCV15	7	5	200.00
48	4	192	48GDCV4	3.5	2.5	109.00
48	4	480	48GDCV4	4	2	149.00
48	20	960	48GDCV20	3	2	223.00
125	2	250	125GDCV2	2.5	1.5	117.00
150	2	300	150GDCV2	2	1.5	117.00
150	1	200	200GDCV1	3	2	112.00
250	1	250	250GDCV1	3	2	120.00

A single source for all possible types of "brute" force" and regulated power supplies that can fill 90% of your design and application needs. Gates Power Supplies give you absolutely lowest cost and long life. The units are excellently constructed of high rated components for trouble free, years of service.

Silicon or Selenium. Single and three-phase units. 1 to

1000 volts, 1 to 1000 Amps. Metered and un-metered Static or variable outputs. Rack, cabinet or chassis mounts. Unit or hundred quantities 48 hour delivery. Two year guarantees. Power supplies for OEM Application, Testing Prototype, Lab type units, Plating, Motor Control, Cathode Protection, Transistor power, Anodizing, Battery Charging, Battery Conversions, Marine types, Aircraft Starting.

GATES

ELECTRONIC COMPANY, INC.



FLASHLIGHTS, LANTERNS and BATTERIES

the world's most trusted brand for over 50 years!

ALL PRICES WITHOUT BATTERIES.

"CORDAHIDE" polyethylene FLASHLIGHTS—

Insulated, Withstand Abuse,
Resists Oils, Greases,
Most Chemicals.



No. 330 Utility Lite. Uses 2 No. 950, D-99 or E95 Batteries, No. PR2 Lamp. Available individually boxed (No. 330).

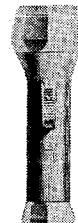

No. 349 Handy Lite. Uses 2 No. 935 or E-93 Batteries, No. PR4 Lamp. Available in assortment of 6 (No. 48) in colors.



No. 337 Magnet Utility Lite. Uses 2 No. 950, D-99 or E95 Batteries, No. PR2 Lamp. Available individually boxed (No. 337) or in display of 12 (No. 51) in Colors.

	No. 49	No. 51	No. 330	No. 337
List Each	\$5.94	\$16.68	\$0.99	\$1.39
Sugg. Dealer	4.14	11.16	0.70	0.94

INDUSTRIAL and SPECIAL PURPOSE LITES



Industrial Flashlights

No. 1251—2 Cell, No. PR6 Lamp. No. 1351—3 Cell, No. PR7 Lamp. Uses Nos. 950, 1050, D99 or E95 Batteries. Will not shatter crack or dent.

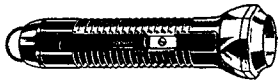

Safety Flashlights

No. 1259—2 Cell, No. PR6 Lamp. No. 1359—3 Cell, No. PR7 Lamp. Uses Nos. 950, 1050, D99 or E95 Batteries. Approved by U.S. Bureau of Mines, Listed by Underwriters' Laboratories, Inc.



No. 3452 Head-Lite. Uses 1 No. 510S Battery and No. PR13 Lamp. Rainproof pouch also available (No. 1348).



Torch Lite

No. 273—3" wand. No. 275—5" wand. Uses 2 No. 950, D99 or E95 Batteries and No. PR2 Lamp.

	No. 273	No. 275	No. 1251	No. 1259	No. 1348	No. 1351	No. 1359	No. 3452
List Each	\$1.49	\$1.59	\$2.89	\$4.15	\$0.79	\$3.29	\$4.35	\$3.29
Sugg. Dealer	.99	1.05	1.93	2.74	0.53	2.19	2.89	2.14

HEAVY-GAUGE, CHROME-PLATED METAL FLASHLIGHTS



America's Standard

No. 2251 All-Purpose Flashlight—2 Cell, No. PR2 Lamp. Use Nos. 950, D-99 or E95 Batteries. Available individually.



Magnet Lites

No. 5MF Magnet Lite—2 Cell, No. PR2 Lamp. No. 7MF—3 Cell, No. PR3 Lamp. Use Nos. 950, D-99 or E95 Batteries. Available individually boxed. No. 5MF available in display of 6 with Selling Tags (No. 6-5MF).



Leader Lites

No. 356 Leader Lite—Uses 2 No. 950, D-99 or E95 Batteries. No. PR2 Lamp. Available in Displayer No. 16A (containing 12 No. 356 Lites).

	No. 4MF	No. 5MF	No. 5	No. 6-5MF	No. 7MF	No. 16A	No. 44	No. 26	No. 131	No. 2251	No. 4251	No. 5251
List Each	\$2.29	\$1.99	\$11.88	\$11.94	\$2.49	\$11.88	\$13.74	\$11.94	\$14.28	\$1.95	\$1.99	\$.99
Sugg. Dealer	1.53	1.33	7.14	7.98	1.66	7.56	9.18	7.98	9.48	1.30	1.33	.595



No. 26 Offer 6 "Eveready" Wrangler No. 4251 flashlights in pre-packed, pre-loaded displayer.

No. 4251 Wrangler Flashlight Luxurious, inset, walnut grain vinyl, chrome-plated lens ring, 4-position switch, optically perfect reflector. Available individually boxed. Uses 2 No. 950, D-99 or E95 Batteries. No. PR-2 lamp.



No. 5251 "Commander" Flashlight Triple-plated chrome finish, sturdy, safety-glow lens ring. Positive action switch. Uses 2 No. 950, D-99 or E95 batteries. No. PR-2 Lamp.



No. 44 Assortment—Contains 6 No. 4MF "Eveready" Magnet Lites (2 red, 2 gold, 2 blue). No. 4MF "Pop-Out" Magnet Flashlight Hidden magnet bulb into sleek case pops out when placed near steel, retracts into case when removed.



COMPLETE LINE SPECIFICATIONS



MERCURY BATTERIES



No. E9
1.4 Volts



No. E146X
8.4 Volts



No. E133
4.2 Volts

SEALED NICKEL CADMIUM RECHARGEABLE BATTERIES



B50
1.25 Volts



C450
1.25 Volts



CH4
1.25 Volts



R2
1.25 Volts

LANTERN BATTERIES



No. 509 — Spring
No. 510S — Screws
No. 510F — Fahnestock
6 Volts

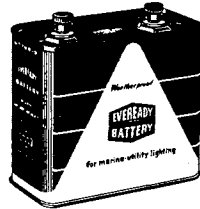

No. 731
6 Volts



No. 520
6 Volts
Alkaline

OTHER BATTERIES



No. 6 "Ignitor"
1½ Volts



"HOT SHOT"
No. 1461 6 Volts
No. 1462 6 Volts
No. 1463 12 Volts
No. 1562 7½ Volts
No. 1662 9 Volts



EMERGENCY LIGHTING
No. 715 7½ Volts
No. 706 6 Volts
No. 716 9 Volts

"Eveready" Battery Number	NEDA Number		Overall Dimensions in Inches			Terminals & Voltages	Battery Weight lbs.	Unit Pkg. Qun.	Sugg. Dealer Each	List Each	Major Use			
			L	W	H									
B1	—	Nickel Cad.	1.980	Diam.	x 0.394	Flat Contacts—	+1.25	—	2.0	1	2.66	3.80	Instr., Hobby, Trans. Appl., Misc.	
B1T	—	Nickel Cad.	1.980	Diam.	x 0.406	Solder Tabs—	+1.25	—	2.0	1	2.79	4.00		
BH1	—	Nickel Cad.	1.980	Diam.	x 0.394	Flat Contacts—	+1.25	—	2.0	1	2.79	4.00		
BH1T	—	Nickel Cad.	1.980	Diam.	x 0.406	Solder Tabs—	+1.25	—	2.0	1	2.92	4.20		
CH1.0	—	Nickel Cad.	1.034	Diam.	x 1.167	Flat Contacts—	+1.25	—	1.8	1	2.32	3.35		
CH1.0T	—	Nickel Cad.	1.034	Diam.	x 1.177	Solder Tabs—	+1.25	—	1.8	1	2.45	3.55		
E1	1100	Mercury	0.625	Diam.	x 0.650	Flat Contacts—	+1.35	—	0.43	4	0.57	0.85		Meters, Instr., Misc.
E1N	—	Mercury	0.625	Diam.	x 0.650	Flat Contacts—	+1.35	—	0.43	4	0.64	0.95		
EPX-1	—	Mercury	0.625	Diam.	x 0.650	Flat Contacts—	+1.35	—	0.43	4	0.66	0.95		
C1.2	—	Nickel Cad.	0.900	Diam.	x 1.684	Flat Contact—	Solder Tab +1.25	—	1.7	1	2.32	3.35		Instr., Trans. Appl., Misc.
C1.2T	—	Nickel Cad.	0.900	Diam.	x 1.689	Solder Tabs—	+1.25	—	1.7	1	2.45	3.55		
CH1.2	—	Nickel Cad.	0.900	Diam.	x 1.684	Flat Contact—	Solder Tab +1.25	—	1.7	1	2.58	3.70	Camera Light Meter	
CH1.2T	—	Nickel Cad.	0.900	Diam.	x 1.689	Solder Tabs—	+1.25	—	1.7	1	2.71	3.90		
CH1.5	—	Nickel Cad.	1.031	Diam.	x 1.969	Flat Contact—	Solder Tab +1.25	—	2.3	1	4.06	5.80	Instr., Hobby, Trans. Appl., Misc.	
CH1.5T	—	Nickel Cad.	1.031	Diam.	x 1.969	Solder Tabs—	+1.25	—	2.3	1	4.19	6.00		
RH1.6	—	Nickel Cad.	1½ x ¾ x 2½			Nut & Stud—	+1.25	—	4.1	1	3.53	5.00		
B2	—	Nickel Cad.	1.984	Diam.	x 0.689	Flat Contact—	+1.25	—	3.3	1	4.69	6.70		
B2T	—	Nickel Cad.	1.984	Diam.	x 0.701	Solder Tabs—	+1.25	—	3.3	1	4.82	6.90		
C2	—	Nickel Cad.	1.344	Diam.	x 2.406	Flat Contact—	Solder Tab +1.25	—	5.0	1	4.06	5.80		
C2T	—	Nickel Cad.	1.344	Diam.	x 2.416	Solder Tabs—	+1.25	—	5.0	1	4.19	6.00		
R2	—	Nickel Cad.	1¾ x 1¾ x 2½			Nut, Stud & Tab—	+1.25	—	6.0	1	5.97	8.50		
RH2.6	—	Nickel Cad.	1½ x ¾ x 4¼			Nut & Stud—	+1.25	—	6.8	1	5.51	7.95		
B3	—	Nickel Cad.	1.984	Diam.	x 0.984	Flat Contacts—	+1.25	—	5.0	1	5.70	8.15		Meters, Instr., Misc.
B3T	—	Nickel Cad.	1.984	Diam.	x 0.996	Solder Tabs—	+1.25	—	5.0	1	5.83	8.35		
E3	—	Mercury	0.985	Diam.	x 0.660	Flat Contacts—	+1.35	—	.93	4	1.05	1.50		
NP3.5-6T	—	Lead Acid	2¼ x 1¾ x 4¾			Solder Tabs—	+6	—	1	10.0	12.94	18.50	Appl., Instr., Misc.	
PD3.5-6W	—	Lead Acid	2¼ x 1¾ x 3¼			Wire Leads—	+6	—	1	5.0	8.62	12.50		
R3.5	—	Nickel Cad.	1¾ x 1¾ x 3¼			Nut, Stud & Tab—	+1.25	—	9.2	1	7.12	10.15	Instr., Hobby, Trans. Appl., Misc.	
CH4	—	Nickel Cad.	1.344	Diam.	x 2.406	Flat Contact—	Solder Tab +1.25	—	5.4	1	5.69	8.15		
CH4T	—	Nickel Cad.	1.344	Diam.	x 2.416	Solder Tabs—	+1.25	—	5.4	1	5.82	8.35		
E4	—	Mercury	1.195	Diam.	x 0.660	Flat Contacts—	+1.25	—	1.6	4	1.31	1.95		Meters, Instr., Misc.
EPX-4	—	Mercury	0.662	Diam.	x 1.965	Flat Contacts—	+5.4	—	1.16	1	1.57	2.25	Camera	
RH4	—	Nickel Cad.	1½ x ¾ x 4¼			Nut & Stud—	+1.25	—	9.5	1	8.40	12.00	Instr., Trans. Appl., Misc.	
R4.5	—	Nickel Cad.	1¾ x 1¾ x 3¾			Nut & Stud—	+1.25	—	13.4	1	9.35	13.35		
No. 6 "Ignitor" Gen. Purpose	905	Carb. Zinc	2½	Diam.	x 6¾	**Knurled Nut & Screw—	+1.5	—	2	1.0	0.91	1.35	Ign. Lighting	
No. 6 "Gray Label" Telephone	914	Carb. Zinc	2½	Diam.	x 6¾	***Fahnestock—	+1.5	—	2	2.0	0.91	1.35	Tele.	
No. 6 Railroad & Industrial	911	Carb. Zinc	2½	Diam.	x 6¾	**Knurled Nut & Screw—	+1.5	—	2	3.0	0.94	1.40	Ign., Tele.	
EPX-6	—	Mercury	0.662	Diam.	x 4.415	Flat Contacts—	+4.05, +8.1	—	1.6	1	2.75	3.95	Camera Appl., Instr., Misc.	
NP4-6T	—	Lead Acid	4½ x 2¼ x 3¾			Solder Tabs—	+6	—	2	3.0	18.83	26.95		

*NEDA number same as an "Eveready" battery number on a different battery. Omitted to prevent errors in shipping.
 **Equipped with screw terminals unless Fahnestock spring terminals are specified.
 ***Equipped with Fahnestock spring terminals unless screw terminals are specified.

•Items differ from corresponding sizes in that they have tabs enabling the user to solder leads to battery without damage.
 □Flashlight types.



SECTION 4000

COMPLETE LINE SPECIFICATIONS



"Eveready" Battery Number	NEDA Number	Chemical System	Overall Dimensions in Inches			Terminals & Voltages	Battery Weight		Unit Pkg. Quan.	Sugg. Dealer Each	List Each	Major Use
			L	W	H		lbs.	ozs.				
S312	—	Silver	0.312	Diam.	x 0.140	Flat Contacts—, +1.4	—	0.02	6	0.27	0.40	Electr. Dev.
333	1306	Carb. Zinc	0.662	Diam.	x 1.965	Flat Contacts—, -4.5	—	0.9	6	0.68	0.98	
W-350	*	Carb. Zinc	3 1/4	x 1 1/2	x 4 3/32	Knurled Nut & Screw—, +22.5+45	—	14.5	1	2.69	3.85	Electr. Dev. Instr.
W-352	701	Carb. Zinc	2 3/4	x 1 1/2	x 4 1/2	Knurled Nut & Screw—, +22.5+45	—	12.0	1	1.33	1.90	
W-353	11	Carb. Zinc	2 1/2	x 1 3/8	x 4 3/32	Socket—, +1.5	—	12.5	1	1.22	1.75	Port. Radio
W-356	*	Carb. Zinc	2 3/4	x 2 1/2	x 4 3/8	Knurled Nut & Screw—, +3	1	6.0	1	1.92	2.75	Radio & Electr. Dev.
W-357	901	Carb. Zinc	3 3/32	x 2 1/2	x 5 1/16	Fahnestock—, +3	2	12.0	1	1.92	2.75	Model Ign., Tele.
W-359	*	Carb. Zinc	3 1/2	x 2 1/2	x 4 1/2	Socket—, +45	1	11.8	1	3.46	4.95	Port. "B"
W-361	227	Carb. Zinc	1 3/8	x 1 3/8	x 1 13/32	Flat Contacts—, +103.5	1	4.0	1	4.86	6.95	Radio "C"
W-362	—	Carb. Zinc	2 1/2	x 1 3/8	x 1 13/32	Knurled Nut & Screw—, -4.5, -7.5	—	1.5	1	2.45	3.50	
W-363F	*	Carb. Zinc	8 1/2	x 4 1/2	x 7 5/8	Fahnestock—, +22.5, +45	10	5.0	1	7.66	10.95	Heavy Duty Radio "B"
W-364F	*	Carb. Zinc	8 1/8	x 4 3/8	x 7 1/16	Fahnestock—, +22.5, +45	11	14.0	1	8.37	11.95	
W-365F	723	Carb. Zinc	8 1/8	x 2 1/2	x 4 3/32	Fahnestock—, +22.5, +45	7	7.5	1	7.66	10.95	Ind. "B"
E400	1106	Mercury	0.455	Diam.	x 0.135	Flat Contacts—, +1.4	—	0.04	6	0.24	0.35	Trans. Appl.
E400N	—	Mercury	0.455	Diam.	x 0.135	Flat Contacts—, +1.35	—	0.04	6	0.35	0.50	
E401	910M	Mercury	0.470	Diam.	x 0.130	Flat Contacts—, +1.4	—	0.4	3	0.50	0.75	
E401N	—	Mercury	0.470	Diam.	x 0.130	Flat Contacts—, +1.35	—	0.4	2	0.60	0.85	Lanterns
409	908C	Carb. Zinc	2 3/8	x 2 3/8	x 4 13/32	Coil Springs—, +6	1	6.5	1	—	—	
411	208	Carb. Zinc	1 1/2	x 3/4	x 1 1/4	Flat Contacts—, +15	—	0.95	1	0.81	1.15	Port. Radio "B" Instr.
412	215	Carb. Zinc	1 1/2	x 3/8	x 2	Flat Contacts—, +22.5	—	1.3	1	1.05	1.50	
413	210	Carb. Zinc	1 1/2	x 3/8	x 2 1/8	Flat Contacts—, +30	—	1.6	1	1.23	1.75	Port. Radio "B" Instr.
415	213	Carb. Zinc	1 3/4	x 3/8	x 3 1/16	Min. Snap—, +45	—	2.5	1	1.75	2.50	
416	217	Carb. Zinc	1 3/4	x 3/8	x 3 1/2	Min. Snap—, +67.5	—	4.0	1	2.07	2.95	Instr.
417	224	Carb. Zinc	1 3/4	x 3/4	x 3 1/2	Flat Contacts—, +15	—	1.8	1	1.56	2.25	
420	225	Carb. Zinc	1 3/8	x 3/4	x 1 3/8	Flat Contacts—, +22.5	—	2.5	1	1.65	2.35	Instr.
425P	*	Carb. Zinc	1 3/4	x 1 1/2	x 3 1/8	Socket—, +22.5	—	4.1	1	2.10	3.00	
430	—	Carb. Zinc	1 3/4	x 1	x 2 1/16	Flat Contacts—, +30	—	3.2	1	1.92	2.75	Port. Radio "B"
437	212	Carb. Zinc	1 3/8	x 1 1/8	x 6 1/32	Snap Type—, +75	—	14.8	1	3.15	4.50	Port. Radio "B"
B450	—	Nickel Cad.	1.697	Diam.	x 0.315	Flat Contacts—, +1.25	—	1.17	1	1.47	2.10	Instr., Hobby, Trans. Appl., Misc.
B450T	—	Nickel Cad.	1.697	Diam.	x 0.327	Solder Tabs—, +1.25	—	1.17	1	1.60	2.30	
C450	—	Nickel Cad.	0.563	Diam.	x 1.969	Flat Contacts—, +1.25	—	0.8	1	1.93	2.75	Instr., Hobby, Trans. Appl., Misc.
C450T	—	Nickel Cad.	0.563	Diam.	x 1.969	Solder Tabs—, +1.25	—	0.8	1	2.10	3.00	
E450	—	Mercury	0.455	Diam.	x 0.570	Flat Contacts—, +1.35	—	0.18	4	0.53	0.75	Instr.
455	*	Carb. Zinc	2 3/32	x 1	x 3 1/16	Snap Type—, +45	—	7.8	1	2.27	3.25	
455P	—	Carb. Zinc	2 3/32	x 1 1/4	x 3 3/32	Socket—, +45	—	8.6	1	2.27	3.25	Instr.
457	203	Carb. Zinc	1 3/4	x 1 3/8	x 2 1/2	Snap Type—, +67.5	—	7.4	1	2.70	3.85	
460	—	Carb. Zinc	1 3/4	x 1 3/8	x 2 3/8	Flat Contacts—, +45	—	5.3	1	1.67	2.50	Photoflash
467	200	Carb. Zinc	2 3/4	x 1 3/8	x 3 3/4	Snap Type—, +67.5	—	12.0	1	2.70	3.85	Port. Radio "B"
468	200C	Carb. Zinc	2 3/4	x 1 3/8	x 3 3/4	Snap Type—, +67.5	—	12.0	1	2.77	3.95	Radio, Electr. Dev.
477	211	Carb. Zinc	1 3/2	x 3/4	x 5 1/16	Snap Type—, +67.5	—	8.6	1	2.97	3.85	Port. Radio "B"
479	214	Carb. Zinc	1 3/2	x 1 1/2	x 7 1/32	Snap Type—, +90	—	12.0	1	2.97	4.25	
482	202	Carb. Zinc	3 1/2	x 2 1/2	x 5 3/32	Socket—, +45	1	15.0	1	2.97	4.25	Fluor. Lantern
484	207	Carb. Zinc	3 1/2	x 2 1/2	x 5 3/32	Socket—, +45	3	2.0	1	3.47	4.95	
487	—	Carb. Zinc	5 1/8	x 2 1/8	x 7 1/4	Socket—, +22.5, +45	4	2.0	1	3.84	5.50	Farm Radio "B"
489	—	Carb. Zinc	4 1/2	x 2 1/8	x 4 3/16	Socket—, +225	2	12.0	1	6.96	9.95	Electr. Flash
490	204	Carb. Zinc	3 3/32	x 1 3/8	x 3 3/4	Snap Type—, +90	—	15.0	1	3.15	4.50	Port. Radio "B"
491	—	Carb. Zinc	2 1/2	x 1 3/8	x 4 1/2	Flat Recessed & Socket—, +240	—	13.0	1	5.56	7.95	Electr. Flash
492	—	Carb. Zinc	3 3/8	x 2 3/32	x 4 3/32	Socket—, +180, +225	2	8.0	1	7.65	10.95	
493	722	Carb. Zinc	2 1/4	x 2 3/32	x 3 3/32	Pinjacks—, +300	—	14.5	1	8.37	11.95	Geiger Counter
495	—	Carb. Zinc	1 1/4	x 1 1/2	x 7 1/8	Snap Type—, +90	1	—	1	3.47	4.95	Port. Radio "B"
497	—	Carb. Zinc	3	x 1 1/2	x 5 3/8	Flat Recessed—, +180, +510	1	10.0	1	11.16	15.95	Electr. Flash
BH500	—	Nickel Cad.	1.360	Diam.	x 0.394	Flat Contacts—, +1.25	—	1.0	1	1.75	2.50	Instr., Hobby, Trans. Appl., Misc.
BH500T	—	Nickel Cad.	1.360	Diam.	x 0.416	Solder Tabs—, +1.25	—	1.0	1	1.88	2.70	
CH500	—	Nickel Cad.	0.563	Diam.	x 1.969	Flat Contacts—, +1.25	—	0.8	1	1.93	2.75	Instr., Hobby, Misc.
CH500T	—	Nickel Cad.	0.563	Diam.	x 1.974	Solder Tabs—, +1.25	—	0.8	1	2.10	3.00	
E502	—	Mercury	0.550	Diam.	x 1.968	Flat Contacts—, +1.35	—	1.05	2	0.87	1.25	Trans. Appl.
504	220	Carb. Zinc	3/4	x 1 1/2	x 1 3/8	Flat Contacts—, +15	—	0.6	1	0.81	1.15	Instr.
505	221	Carb. Zinc	3/4	x 1 1/2	x 1 3/8	Flat Recessed—, +22.5	—	0.8	1	1.05	1.50	
506	223	Carb. Zinc	1 1/4	x 3/8	x 1 3/4	Flat Contacts—, +30	—	0.9	1	1.75	2.50	Instr.
507	*	Carb. Zinc	5/8	x 1 3/8	x 2.605	Flat Contacts—, +30	—	0.9	1	1.30	1.85	
509	908	Carb. Zinc	2 3/8	x 2 3/8	x 4 13/32	Coil Springs—, +6	1	5.5	1	0.92	1.39	Lantern
510F	917	Carb. Zinc	2 3/8	x 2 3/8	x 4 13/32	Fahnestock—, +6	1	4.0	1	0.92	1.39	Misc.
510S	*	Carb. Zinc	2 3/8	x 2 3/8	x 4 3/8	Knurled Nut & Screw—, +6	1	7.0	1	0.92	1.39	
520	930	Alkaline	5 1/2	x 4 3/32	x 2 3/16	Ins. Screw—, +6	2	8.0	1	3.31	4.95	Lanterns
E520	—	Mercury	0.455	Diam.	x 0.286	Flat Contacts—, +1.4	—	0.07	6	0.21	0.30	Trans. Appl.
523	1306A	Alkaline	0.662	Diam.	x 1.965	Flat Contacts—, +4.5	—	1.17	1	0.82	1.25	Photoflash, Trans. Radio
531	1307	Alkaline	0.664	Diam.	x 2.290	Min. Snap—, +4.5	—	1.25	1	0.82	1.25	Automatic Camera
532	1308	Alkaline	0.664	Diam.	x 1.670	Snap Type—, +3	—	0.8	1	0.70	1.00	
544	1460A	Silver Oxide	0.510	Diam.	x 0.990	Flat Contacts—, +6	—	0.5	1	1.75	2.50	Photo.
560	—	Alk. Sec.	2 3/32	x 1 1/2	x 7 5/32	Socket—, +7.5	1	9.0	1	4.62	6.95	Electr. Dev.
561	—	Alk. Sec.	8 1/8	x 2 1/8	x 5 7/8	Socket—, +15	6	—	1	10.62	15.95	
563	—	Alk. Sec.	1 3/4	Diam.	x 7 3/32	Flat Contacts—, +4.5	—	15.0	3	2.76	4.15	Micro Television
564	—	Alk. Sec.	8 1/8	x 2 1/8	x 5 7/8	Socket—, +13.5	5	8.0	1	9.94	14.95	
596	—	Alk. Sec.	1.375	Diam.	x 3713	Flat Contacts—, +1.5	—	7.5	1	1.20	1.75	Instr.
E601	—	Mercury	0.627	Diam.	x 1.140	Flat Contacts—, +1.35	—	1.22	2	0.83	1.30	
621	—	Carb. Zinc	2 1/8	Diam.	x 13	Knurled Nut & Screw—, +3	4	10.0	1	3.68	5.50	Fishing Buoy
E625	—	Mercury	0.615	Diam.	x 0.238	Flat Contacts—, +1.4	—	0.15	4	0.42	0.60	Trans. Appl.
E625N	—	Mercury	0.615	Diam.	x 0.238	Flat Contacts—, +1.35	—	0.15	4	0.53	0.75	
EPX-625	—	Mercury	0.615	Diam.	x 0.238	Flat Contacts—, +1.4	—	0.15	4	0.51	0.75	Camera Light Meter
E630	1104	Mercury	0.615	Diam.	x 0.238	Flat Contacts—, +1.4	—	0.17	4	0.42	0.60	Trans. Radio
E630N	—	Mercury	0.615	Diam.	x 0.238	Flat Contacts—, +1.35	—	0.17	4	0.53	0.75	Instr.
E640	1105	Mercury	0.625	Diam.	x 0.440	Flat Contacts—, +1.4	—	0.38	4	0.42	0.60	Trans. Radio
E640N	—	Mercury	0.625	Diam.	x 0.440	Flat Contacts—, +1.35	—	0.38	4	0.53	0.75	Instr.
EPX640	—	Mercury	0.625	Diam.	x 0.440	Flat Contacts—, +1.35	—	0.13	2	0.53	0.75	Photo.
E675	—	Mercury	0.455	Diam.	x 0.210	Flat Contacts—, +1.4	—	0.07	6	0.32	0.45	Instr.
EPX675	—	Mercury	0.445	Diam.	x 0.210	Flat Contacts—, +1.35	—	0.09	6	0.42	0.60	
703	*	Carb. Zinc	2 1/4	x 3/4	x 3 3/8	Spring—, +4.5	—	5.0	1	1.36	1.95	Instr.
706	902	Carb. Zinc	8 3/8	x 2 1/4	x 6 1/4	Ins. Screw—, +6	5	14.0	1	4.01	5.98	
707	26	Carb. Zinc	2 3/8	x 2 1/2	x 2 1/8	Snap Type—, +7.5	—	12.0	1	1.15	1.65	Port. Radio "A"
711	700	Carb. Zinc	2 3/8	x 1 3/8	x 4 1/2	Knurled Nut & Screw—, +1.5	—	12.0	1	0.79	1.15	Model Ign. "Glo-Plug"
713	8	Carb. Zinc	3 3/8	x 5/8	x 2 3/32							



AC VOLTAGE STABILIZERS

For Electronic and Electric Equipment



General Electric a-c voltage stabilizers are static-magnetic transformer-type products which provide voltage maintained within $\pm 1\%$ variation while input line voltage fluctuates $\pm 15\%$. They are offered in the following variations:

Unfiltered output: output voltage waveform is relatively flat-topped, with harmonic content from 15 to 20%.

Harmonic filtered output: output voltage is filtered to near sinusoidal waveshape, with a maximum of 3% harmonic content.

Enclosed construction: completely metal enclosed for safe external mounting.

Open construction: for installation within electronic or electric equipment.

Cord/Receptacle units: for convenient temporary connections.

SINGLE PHASE — Magnetic-capacitor circuitry is frequency sensitive. Stabilizers designed for one frequency are not suitable for use on another.

THREE PHASE — Standard single-phase a-c voltage stabilizers can be connected for 3-phase, 4-wire loads with input connected delta. However, single-phase models cannot be connected for 3-phase, 3-wire loads: select from 3-phase delta-delta models.

Single Phase

Volt-amp Output Capacity	Input Voltage Range	Stabilized Output Voltage	Unfiltered Output		Harmonic Filtered Output	
			Model Number	List Price	Model Number	List Price
ENCLOSED — FOR 60 CYCLES						
15	95-130	118	9T91Y4070	\$15.10
30	95-130	118	9T91Y4090	17.30
60	95-130	118	9T91Y4110	22.80
120	95-130	118	9T91Y4130	31.40
250	95-130	118	9T91Y4140	52.40	9T91Y7140	\$54.10
250	190-260	118	9T91Y4142	52.40
250	190-260X380-520	118/236	9T91Y4144	58.20
250	380-520	118	9T91Y4145	52.40
500	95-130	118	9T91Y4150	82.20	9T91Y7150	84.90
500	190-260	118	9T91Y4152	82.20
500	380-520	118	9T91Y4155	82.20
1000	95-130	118	9T91Y4170	126.00	9T91L7170	130.00
1000	95-130X175-235X190-260	118/236	9T91Y7173	146.00
1000	190-260	118	9T91Y4172	126.00	9T91Y7172	130.00
1000	190-260X380-520	118/236	9T91Y7174	144.00
1000	380-520	118	9T91Y4175	126.00
2000	95-130X175-235X190-260	118/236	9T91Y4183	253.00	9T91Y7183	265.00
2000	190-260X380-520	118/236	9T91Y4184	249.00	9T91Y7184	261.00
2000	380-520	236/472	9T91Y4186	242.00
3000	95-130X175-235X190-260	118/236	9T91Y4193	340.00	9T91Y7193	357.00
3000	190-260X380-520	118/236	9T91Y4194	333.00
3000	380-520	236/472	9T91Y4196	324.00
5000	190-260X380-520	118/236	9T91Y4204	513.00	9T91Y7204	541.00
5000	95-130X175-235X190-260	118/236	9T91Y4203	521.00	9T91Y7203	551.00
5000	380-520	236/472	9T91Y4206	497.00
7500	95-130X175-235X190-260	118/236	9T91Y4213	777.00
7500	190-260X380-520	118/236	9T91Y4214	762.00	9T91Y7214	840.00
10000	95-130X175-235X190-260	118/236	9T91Y7223	1114.00
10000	190-260X380-520	118/236	9T91Y4224	995.00	9T91Y7224	1093.00
15000	190-260X380-520	118/236	9T91Y4244	1461.00	9T91Y7244	1612.00
OPEN — FOR 60 CYCLES						
15	95-130	118	9T91Y5070	\$14.30
30	95-130	118	9T91Y5090	16.30
60	95-130	118	9T91Y5110	21.30
120	95-130	118	9T91Y5130	29.50
250	95-130	118	9T91Y5140	49.30	9T91Y8140	\$50.90
250	190-260	118	9T91Y5142	49.30
500	95-130	118	9T91Y5150	77.40	9T91Y8150	78.80
500	190-260	118	9T91Y5152	77.40
750	95-130	118	9T91Y5160	97.60	9T91Y8160	101.00
1000	95-130	118	9T91Y5170	118.00	9T91Y8170	122.00
1000	190-260	118	9T91Y5172	118.00	9T91Y8172	122.00
1500	95-130	118	9T91Y5010	164.00	9T91Y8010	172.00
2000	95-130X175-235X190-260	118/236	9T91Y5183	237.00	9T91Y8183	249.00
ENCLOSED — FOR 50 CYCLES						
250	95-130	118	9T91Y4147	\$60.40	9T91Y7147	\$62.20
250	95-130X175-235X190-260	118/236	9T91Y4148	68.30	9T91Y7148	70.30
500	95-130X175-235X190-260	118/236	9T91Y4158	107.00	9T91Y7158	110.00
500	190-260X380-520	118/236	9T91Y4159	105.00	9T91Y7159	108.00
1000	95-130X175-235X190-260	118/236	9T91Y4178	164.00	9T91Y7178	169.00
2000	95-130X175-235X190-260	118/236	9T91Y4188	291.00	9T91Y7188	305.00
3000	95-130X175-235X190-260	118/236	9T91Y4198	391.00	9T91Y7198	410.00
5000	95-130X175-235X190-260	118/236	9T91Y4208	600.00	9T91Y7208	630.00
7500	95-130X175-235X190-260	118/236	9T91Y4218	892.00	9T91Y7218	981.00
7500	190-260X380-520	118/236	9T91Y4219	877.00	9T91Y7219	965.00

OPEN — FOR 60 CYCLES

Volt-amp Output Capacity	Input Voltage Range	Output	Output		Model Number	List Price
			Volts	Amps		
ENCLOSED						
15	95-130	6	2.5	9T91Y366	\$15.10	
15	95-130	6.3	2.4	9T91Y368	15.10	
OPEN						
15	95-130	6	2.5	9T91Y365	\$14.30	
15	95-130	6.3	2.4	9T91Y367	14.30	
31.5	95-130/190-260	6.3	5.0	9T91Y369	16.30	
63	95-130/190-260	6.3	10.0	9T91Y370	21.30	
94.5	95-130/190-260	6.3	15.0	9T91Y371	24.40	
157.5	95-130/190-260	6.3	25.0	9T91Y372	35.70	

ENCLOSED — FOR 50 CYCLES

Freq.	VA	Input Voltage Range	Stabilized Output Voltage*	Model Number	List Price
ENCLOSED					
60	6000†	190 to 260/380 to 520 delta	230/236 delta	9T91Y3506	\$1098
60	10000†	190 to 260 delta	236 delta	9T91Y3501G2	1583
50	10000†	190 to 260 delta	236 delta	9T91Y3510	1730

† Can be used with adapter kit for quick conversion to a cord and receptacle unit.

3 Phase Delta Delta

Freq.	VA	Input Voltage Range	Stabilized Output Voltage*	Model Number	List Price
ENCLOSED					
60	6000†	190 to 260/380 to 520 delta	230/236 delta	9T91Y3506	\$1098
60	10000†	190 to 260 delta	236 delta	9T91Y3501G2	1583
50	10000†	190 to 260 delta	236 delta	9T91Y3510	1730

* Maximum harmonic content — 5%.

† Minimum recommended load — 20% of rated.

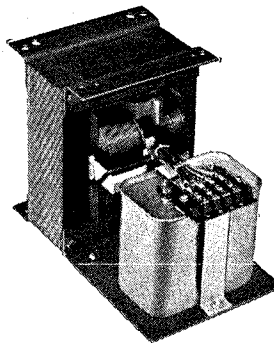

Open — small ratings

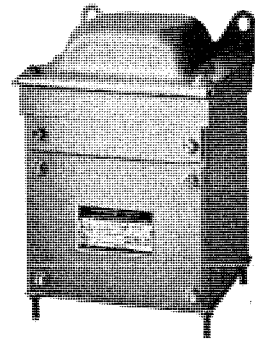

Enclosed — small ratings

Cord/Receptacle Units

Integral single-phase units with a 2-prong cord set and female receptacle in the case.

Volt-amp Output Capacity	Input Voltage Range	Stabilized Output Voltage	Model Number		List Price
			Model Number	List Price	
ENCLOSED — UNFILTERED OUTPUT — FOR 60 CYCLES					
15	95-130	118	9T91Y4070G19	\$17.30	
30	95-130	118	9T91Y4090G19	19.50	
60	95-130	118	9T91Y4110G19	24.90	
120	95-130	118	9T91Y4130G19	33.60	

Adapter kits are available for use with 250 and 500 volt-amp stabilizers to provide quick conversion to a cord and receptacle unit.

For Use With Stabilizer Model Number	Order Adapter Kit Model Number		List Price
	2-prong	3-prong	
9T91Y4140	9T91Y4140G55	9T91Y4140G75	2-prong Kits \$2.10
9T91Y4142	9T91Y4140G55	9T91Y4140G75	
9T91Y4144	9T91Y4140G55	9T91Y4140G75	
9T91Y4145	9T91Y4140G55	9T91Y4140G75	
9T91Y4147	9T91Y4140G55	9T91Y4140G75	
9T91Y4148	9T91Y4140G55	9T91Y4140G75	
9T91Y4150	9T91Y4140G55	9T91Y4140G75	
9T91Y4152	9T91Y4140G55	9T91Y4140G75	
9T91Y4155	9T91Y4140G55	9T91Y4140G75	
9T91Y7140	9T91Y7140G55	9T91Y7140G75	
9T91Y7150	9T91Y7150G55	9T91Y7150G75	
9T91Y7147	9T91Y7147G55	9T91Y7147G75	
9T91Y7148	9T91Y7147G55	9T91Y7147G75	

Filament Ratings—Single Phase—60 Cycles

For stabilized power for 6-volt nominal filaments, these stabilizers are suitable for operation with other 6-volt loads of rated or lower output current requirements. Current-limiting characteristic protects cold filaments from high current surges.

Volt-amp Output Capacity	Input Voltage Range	Output		Model Number	List Price
		Volts	Amps		
ENCLOSED					
15	95-130	6	2.5	9T91Y366	\$15.10
15	95-130	6.3	2.4	9T91Y368	15.10
OPEN					
15	95-130	6	2.5	9T91Y365	\$14.30
15	95-130	6.3	2.4	9T91Y367	14.30
31.5	95-130/190-260	6.3	5.0	9T91Y369	16.30
63	95-130/190-260	6.3	10.0	9T91Y370	21.30
94.5	95-130/190-260	6.3	15.0	9T91Y371	24.40
157.5	95-130/190-260	6.3	25.0	9T91Y372	35.70

Typical cord/receptacle unit

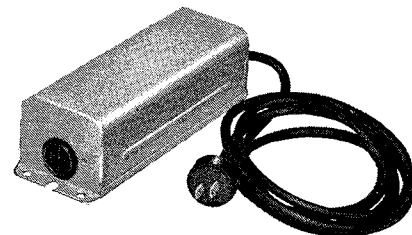

Prices subject to change without notice.



REGULATED DC POWER SUPPLIES



Improve Performance of Computers and Other Electronic Equipment

These component power supplies can be used in a wide variety of applications where relatively constant d-c voltage is required despite fluctuating line voltages. Computers, process control equipment, and electronic measuring devices are typical applications where demands for accuracy require constant regulation of voltage.

Performance-proved GE d-c power supplies can be designed to suit your needs for either 50- or 60-cycle power sources.

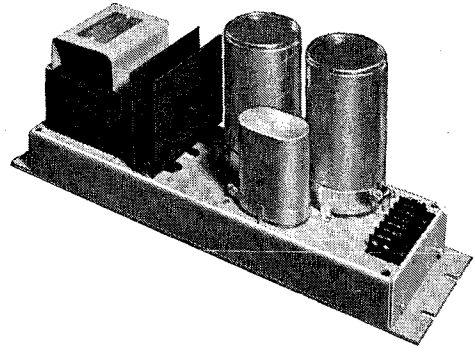

97- TO 130-VOLT INPUT RANGE, 40C AMBIENT

DC OUTPUT†		MODEL NO.	List Price	LOAD REGULATION‡		OVER-ALL			MOUNTING				NET WGT. LBS.	
Volts	Amps			100% to 50% load	100% to 20% load	A	B	C	Chassis		Rack			
									F	E	F'	E'		
60 CYCLES														
10.0	16.0	9T66Y8	\$165.00	5%	8%	19	7	6 5/8	6 1/4	16 1/4	4	18 3/8	25	
12.0	5.0	9T66Y51	140.00	5%	6%	19	3 1/2	7 7/8	2 3/4	16 1/4	3	18 3/8	16	
12.0	15.0	9T66Y53	170.00	5%	7%	19	5 1/4	8	4 1/2	16 1/4	2 1/4	18 3/8	25	
12.0	20.0	9T66Y978	185.00	5%	7%	19	7	8	6 1/4	16 1/4	4	18 3/8	35	
18.0	5.0	9T66Y61	128.00	4%	5%	19	3 1/2	7 7/8	2 3/4	16 1/4	3	18 3/8	19	
18.5	6.0	9T66Y966	133.00	4%	5%	19	5 1/4	7	4 1/2	16 1/4	2 1/4	18 3/8	20	
18.5	12.0	9T66Y967	158.00	5%	7%	19	5 1/4	7 3/4	4 1/2	16 1/4	2 1/4	18 3/8	20	
±18.5	24.0	9T66Y965	373.00	5%	8%	19	8 3/4	7	8	16 1/4	5 3/4	18 3/8	45	
24.0	2.5	9T66Y987	121.00	4%	6%	19	3 1/2	6 1/8	2 3/4	16 1/4	3	18 3/8	16	
24.0	6.0	9T66Y988	143.00	3%	5%	19	5 1/4	6 1/2	4 1/2	16 1/4	2 1/4	18 3/8	25	
24.0	10.0	9T66Y989	166.00	3%	5%	19	5 1/4	8	4 1/2	16 1/4	2 1/4	18 3/8	28	
24.0	20.0	9T66Y990	217.00	3%	5%	19	7	9 3/8	6 1/4	16 1/4	4	18 3/8	45	
24.0	50.0	9T66Y991	383.00	3%	5%	19	10 1/2	11 3/8	9 3/4	16 1/4	5	18 3/8	105	
28.0	8.0	9T66Y83	159.00	3%	5%	19	5 1/4	8	4 1/2	16 1/4	2 1/4	18 3/8	25	
28.0	20.0	9T66Y85	236.00	3%	5%	19	7	9 3/8	6 1/4	16 1/4	4	18 3/8	50	
28.0	50.0	9T66Y6	429.00	3%	5%	19	10 1/2	12 1/8	10 1/2	17 1/2	10 1/2	18 3/8	105	
48.0	4.0	9T66Y93	133.00	3%	5%	19	5 1/4	8	4 1/2	16 1/4	2 1/4	18 3/8	25	
48.0	10.0	9T66Y94	182.00	2%	4%	19	5 1/4	8	4 1/2	16 1/4	2 1/4	18 3/8	35	
90.0	1.0	9T66Y69	115.00	2%	3%	19	3 1/2	7 1/8	2 5/8	16 1/4	3	18 3/8	19	
90.0	10.0	9T66Y985	253.00	3%	4%	20 7/8	7 3/8	7	6 1/8	20	†	†	100	
125.0	2.0	9T66Y980	143.00	2%	3%	19	5 1/4	6 1/2	4 1/2	16 1/4	2 1/4	18 3/8	26	
125.0	4.0	9T66Y970	185.00	2%	3%	19	7	7 7/8	6 1/2	16 1/4	4	18 3/8	48	
150.0	2.0	9T66Y981	151.00	2%	3%	19	5 1/4	6 1/2	4 1/2	16 1/4	2 1/4	18 3/8	28	
200.0	1.0	9T66Y982	134.00	2%	3%	19	5 1/4	6 1/2	4 1/2	16 1/4	2 1/4	18 3/8	24	

50 CYCLES

12.0	15.0	9T66Y53G5	\$179.00	5%	7%	19	5 1/4	6 1/2	4 1/2	16 1/4	2 1/4	18 3/8	27
24.0	10.0	9T66Y989G5	174.00	3%	5%	19	5 1/4	8	4 1/2	16 1/4	2 1/4	18 3/8	30
24.0	20.0	9T66Y990G5	228.00	3%	5%	19	7	8 1/2	6 1/2	16 1/4	4	18 3/8	50
28.0	8.0	9T66Y83G5	167.00	2%	5%	19	5 1/4	8	4 1/2	16 1/4	2 1/4	18 3/8	25
48.0	4.0	9T66Y93G5	140.00	3%	5%	19	4 1/4	8	4 1/2	16 1/4	2 1/4	18 3/8	30
48.0	10.0	9T66Y94G5	191.00	2%	4%	19	5 1/2	9	4 1/2	16 1/4	2 1/4	18 3/8	38
125.0	2.0	9T66Y980G5	150.00	2%	3%	19	5 1/4	7 3/8	4 1/2	16 1/4	2 1/4	18 3/8	28

† May vary ±1%. All standard units come equipped with a plate for 19-inch rack mounting.

‡ Indicates approximate percent increase in output voltage due to decrease of load current from full load.

§ Rack mounting plate has four mounting slots on each end. Distance between centers of two outer slots is 7 1/2 in., between two inner slots 3 in.

¶ Not available for 19-inch rack mounting.

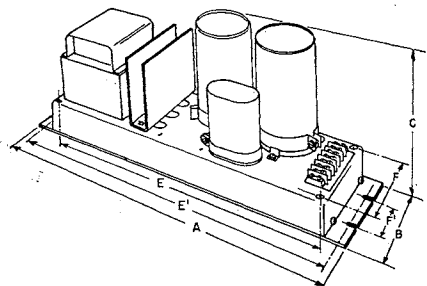

Mounting holes suitable for 1/4-20 screws. Length of screw may vary with chassis height.

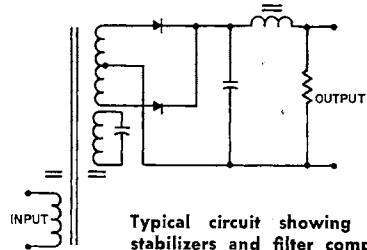

Typical circuit showing voltage stabilizers and filter components.

EFFECT OF INPUT VOLTAGE VARIATION

D-c power supplies can be designed for various input voltages and ranges. With all other variables constant, the output voltage will not vary more than ±1 percent for a change in input voltage over the rated range of 97 to 130 volts input.

EFFECT OF TEMPERATURE CHANGE

For every 40C change in the ambient temperature, the output voltage level will change approximately one percent.

EFFECT OF FREQUENCY

A change of one percent in frequency will change output voltage level approximately one and one-half percent.

ISOLATION

All d-c power supplies provide electrical isolation between the a-c power source and the d-c load.

POLARITY

GE d-c power supplies can be designed with the polarity you require. All standard units listed can be installed with either plus or minus grounded.

RIPPLE

Ripple levels of one percent RMS meet most requirements. However, other levels of ripple content can be designed into G-E power supplies.

EFFICIENCY

Efficiency ranges from 70 to 85 percent for normal output voltage levels. For unusually low output voltages or low power ratings, some decrease in efficiency may occur.

REGULATION

Load regulation characteristics depend on the rated output voltage and rated power level of the power supply.

Prices subject to change without notice.



HIPOTRONICS

HIGH VOLTAGE POWER PACKS

The Hipotronics wide range of compact miniaturized power packs with output voltages from 2 to 100 KV and current ratings of 2, 5 or 10 milliamperes are designed for long life and trouble free operation. Advanced high voltage techniques developed by Hipotronics permit greater size and weight reduction than previously possible.

All units are housed in a hermetically sealed MIL-T-27A can and vacuum filled with mineral type transformer oil or epoxy. The insulating medium insures corona-free operation and allows for running the supply at 3 or 4 times normal current rating for long periods of time. The corona free operation precludes component failure caused by long term corona degradation of insulation and guarantees a pure DC output free of any interfering high frequency signals which might possibly influence or affect the system which it is powering.

Every component in the supply is operated at well below its design rating and pre-assembly hipotted at one and one half times its operating voltage.

The output connections are high voltage ceramic type on models 30 KV and below and through plug in re-entrant receptacles for coaxial cables on greater than 30 KV units. Three foot cable assemblies are supplied with each re-entrant bushing type and longer ones are easily assembled if required.

Output Voltage Kilovolts	Current Milliamperes	Model	Height	Width	Depth	Price
2.5 KV	2 ma.	2.5A	3 1/2"	3 3/4"	2 3/4"	\$ 50
2.5 KV	5 ma.	2.5B	3 1/2"	3 3/4"	2 3/4"	60
2.5 KV	10 ma.	2.5C	4 3/8"	3 3/4"	2 3/4"	70
5 KV	2 ma.	5A	4 3/8"	3 3/4"	2 3/4"	65
5 KV	5 ma.	5B	4 3/8"	3 3/4"	2 3/4"	75
5 KV	10 ma.	5C	4 3/8"	4"	3 3/8"	90
7.5 KV	10 ma.	7.5C	5"	4 3/4"	4"	110
10 KV	2 ma.	10A	5 1/4"	4"	3 1/4"	75
10 KV	5 ma.	10B	8"	6"	5"	95
10 KV	10 ma.	10C	8"	6"	5"	125
15 KV	5 ma.	15B	8"	6"	5"	125
15 KV	10 ma.	15C	8"	6"	5"	150
20 KV	2 ma.	20A	8"	6"	5"	135
20 KV	5 ma.	20B	8"	6"	5"	180
25 KV	10 ma.	25C	10"	6"	5"	350
30 KV	2 ma.	30A	10"	6"	5"	190
30 KV	5 ma.	30B	10"	6"	5"	250
40 KV	2 ma.	40A	12"	6"	5"	270
50 KV	5 ma.	50B	10"	6"	8"	390
60 KV	2 ma.	60A	10"	6"	8"	325
100 KV	2 ma.	100A	15 1/2"	8 1/8"	9 1/4"	625

HV TERMINATIONS

SPHERES Nickel plated with threaded insert	Diameter	
	Diameter	Price
	1"	\$2.00
	2"	3.00
	3"	4.00
	4"	5.00
	6"	\$10.00
	8"	20.00
	10"	40.00
	12"	50.00

TOROIDS

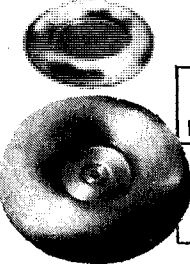
Cross Section Diameter	Outside Diameter	Inside Diameter	Price	
	2"	10"	6"	\$ 30.00
	5"	20"	10"	\$125.00

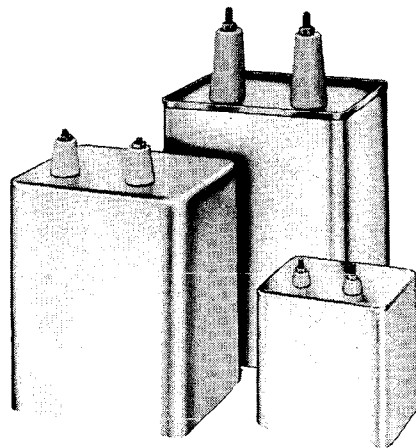

FEATURES

- Hermetically sealed, oil or epoxy filled
- Solid state rectifiers
- 10 year life
- Low ripple
- Good regulation
- Compact, highly miniaturized
- Reversible polarity

Inquiries are invited for units with outputs different than our standards, with built in line regulation, short circuit current limited units, lower output ripple, with 220V, 50/60 cycle inputs or with center tapped output etc.

SPECIFICATIONS FOR ALL MODELS

Input	0-125 volts, output voltages and currents stated for nominal 117 volt input.
Regulation	10 to 15% no load to full load
Ripple	1/2% rms per milliampere output
Life	10 years at 25°C ambient with rated output voltage and current
Terminations	Ceramic bushings on 30 KV and below models Re-entrant receptacles with 3 foot mating coaxial cables on 40 KV and up models

SEND FOR CATALOG
HIPOTRONICS, INC.



BATTERIES

RADIO • FLASHLIGHT • FARM • TRANSISTOR
HEARING AID • INDUSTRIAL • PHOTO FLASH

FEBRUARY 15, 1968

Type	Distr. Resale Price Ea.*	List Price Ea.*	Volts	Suggested Current Range mA	Max. Dimensions Inches			Standard Package		NEDA Type No.	Replaces		
					L. Dia.	W. Dia.	Overall Ht.	Units	Lbs. (Appr.)		Eveready	Burgess	Mallory
PORTABLE "A" TYPES													
VS004	1.15	1.65	1.5	0-1000	2 5/8	2 5/8	3 3/32	12	17	4	742	4F	M4
VS034A♦	.13	.20	1.5	0-25	—	1 1/8	1 1/8	144	5.3	15F	915	Z	M15F
VS035A♦	.1635	.25	1.5	0-80	—	1 1/32	1 1/8	240	22.5	14F	930	1	M14F
VS036♦	.1625	.25	1.5	0-150	—	1 1/32	2 1/32	192	39	13F	955	2R	M13F
VS065	1.23	1.75	7.5	0-70	2 5/8	1 1/8	3 3/32	12	7.3	9	717	C5	M9
VS067	1.23	1.75	4.5	0-250	3 1/8	1 1/8	4 3/32	6	6	3	736	F3	—
VS068♦	.87	1.25	6	0-250	1 1/2	1 1/32	2 1/32	6	1	2	724	Z4	—
VS069	1.15	1.65	1.5	0-300	2 5/8	1 1/32	3 3/32	6	3	18	720	2D	—
VS070	.87	1.25	1.5	0-250	—	1 1/32	4 1/8	6	4.5	23	960P	8R	—
VS072	1.23	1.75	4.5	0-150	4 3/8	1 1/8	2 1/8	3	2	19	726	D3	—
VS129	2.27	3.25	7.5	0-50	3 3/32	5/8	2 3/32	6	2.5	8	713	B5	—
VS141	1.22	1.75	1.5	0-500	2 1/32	1 3/8	4 3/32	6	4.5	11	W353	2F	—
VS236♦	.52	.75	1.5	0-300	—	1 1/32	4 3/8	12	4.5	20	964	21R	M20
VS315▲	1.15	1.65	7.5	0-80	2 1/8	2 5/8	2 1/8	6	4.7	26	707	D5	—
VS343♦	.19	.30	1.5	0-150	—	1 1/32	2 1/32	192	40	13D	D99	—	—
VS345	1.15	1.65	6	0-250	2 5/8	2 5/8	3 3/32	12	17	6	744	F4P1	—
VS734♦	.16	.25	1.5	0-25	—	1/8	1 1/32	144	5.4	15P	815	920	M15P
VS735♦	.19	.30	1.5	0-80	—	1 1/32	1 1/8	72	7	14P	835	120	M14P
VS736♦	.19	.30	1.5	0-150	—	1 1/32	2 1/32	72	13	13P	850	220	M13P



PORTABLE "B" TYPES

VS013	2.97	4.25	45	0-40	3 1/32	1 3/32	5 1/2	6	13.8	202	482	M30	—
VS014	3.46	4.95	45	0-40	3 3/8	2 1/4	4 1/2	5	9.5	206	W359	A30	—
VS015	2.76	3.95	22.5, 45	0-25	3	2 1/8	4 1/8	6	6.5	205	738	Z30	—
VS016▲	2.70	3.85	67.5	0-10	2 1/32	1 3/8	3 3/4	12	10.5	200	467	XX45	M200
VS055▲	2.27	3.25	45	0-10	2 3/32	1	3 1/8	12	6.7	201	455	XX30	—
VS082▲	2.70	3.85	67.5	0-6	2 1/32	1 3/8	2 1/2	12	6.3	203	457	K45	—
VS084	1.05	1.50	22.5	0-25	1 1/2	5/8	2	12	1	215	412	U15	M215
VS086▲	1.75	2.50	45	0-4	1 3/4	5/8	3 1/8	12	2	213	415	U30	—
VS090▲	3.15	4.50	90	0-10	3 3/32	1 3/8	3 3/4	6	6.5	204	490	V60	—
VS125▲	2.77	3.95	67.5	0-10	2 1/32	1 3/8	3 3/32	12	9.8	200C	468	V45	—
VS217▲	3.15	4.50	75	0-10	1 1/8	1 1/32	6 1/32	12	12.6	212	437	XX50	—
VS218▲	2.70	3.85	67.5	0-8	1 3/32	5/8	5 1/8	12	6.4	211	477	P45	M211P
VS219▲	2.97	4.25	90	0-8	1 3/32	1 3/32	7 1/32	12	9.1	214	479	P60	—
VS316▲	3.47	4.95	90	0-10	1 1/8	1 1/32	7 1/8	6	6.5	216	495	N60X	—
VS318▲	2.07	2.95	67.5	0-3	1 1/4	5/8	3 1/2	6	1.5	217	416	UX45	—
VS344	3.47	4.95	45	0-70	3 1/32	2 1/32	5 3/8	6	19.3	207	484	B30	—



PORTABLE "A-B" TYPES

Type	Distr. Resale Price Ea.*	List Price Ea.*	A		B		Suggested Current Range mA	Max. Dimensions Inches			Units	Lbs. (Appr.)	NEDA Type No.	Replaces	
			Volts	Current	Volts	Current		L. Dia.	W. Dia.	Overall Ht.					
VS019	6.22	8.95	7.5, 9	90	0-50	0-15	9 3/32	2 3/32	4 3/8	1	5.3	401	753	F6A60	—
VS047	6.35	9.25	9	90	0-50	0-15	14 1/8	2 1/8	4 1/8	1	6.5	400	752	G6B60	—
VS050	5.78	8.25	6, 7.5	75	0-50	0-12	8 3/8	2 1/8	3 3/4	1	2.4	403	755	T5250	—
VS057W	5.43	7.75	7.5, 9	90	0-50	0-12	8 7/8	2 1/8	3 5/32	1	2.9	405	756	T6260	—
VS058	6.35	9.25	9	90	0-50	0-15	9 3/32	2 3/32	4 3/8	1	5.5	406	757	F6A60P	—
VS064	5.33	7.65	1.5	90	0-300	0-14	3 3/32	2 3/32	7 1/8	1	2.3	425	729	4T260	—

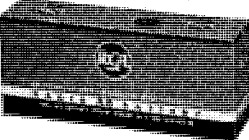

HEARING AID TYPES

VS312■	.24	.35	1.4	—	—	—	0.312	0.140	60	3	—	E312	HC312	RM312
VS400■	.24	.35	1.4	—	—	—	0.455	0.135	60	0.5	1106	E400	HC400	RM400
VS401■	.50	.75	1.4	0-7	—	—	0.470	0.130	24	1	910M	E401	HC401	RM401
VS575■	.24	.35	1.4	—	—	—	0.455	0.132	60	0.5	—	E575	HC575	—
VS625■	.42	.60	1.4	—	—	—	0.615	0.238	40	0.5	—	E625	HC625	RM625
VS630■	.42	.60	1.4	0-20	—	—	0.615	0.238	40	0.5	1104	E630	HC630	RM630
VS675■	.32	.45	1.4	0-10	—	—	0.455	0.210	60	0.5	—	E675	HC675	RM675
VS1713	.30	.45	1.5	—	—	—	0.310	0.206	60	0.5	—	S13	—	MS13
VS1741	.30	.45	1.5	—	—	—	0.455	0.160	60	0.5	—	S41	—	MS41
VS1776	.34	.50	1.5	—	—	—	0.455	0.210	60	0.5	—	S76	—	MS76

TYPES FOR TRANSISTOR APPLICATIONS

VS1■	.57	.85	1.4	0-75	—	—	0.627	0.650	40	2	1100	E1	HG1	RM1
VS9■	.64	.95	1.4	0-200	—	—	0.555	1.968	24	1 3/4	15M	E9	HG9	ZM9
VS12■	.92	1.35	1.4	0-250	—	—	0.640	1.968	10	1 1/4	1101	E12	HG12	RM12
VS126■	1.32	1.95	8.4	0-50	—	—	0.730	2.000	24	2	1611M	E126	H126	TR126
VS132■	1.05	1.50	4.2	0-75	—	—	0.662	1.315	10	3/4	1200	E132	H132	TR132
VS133■	1.32	1.95	4.2	0-75	—	—	0.662	1.965	24	2.3	1306M	E133	H133	TR133
VS146■	1.32	1.95	8.4	0-30	1.031	—	0.660	1.641	24	1 3/4	1604M	E146X	H146X	TR146X
VS163■	1.32	1.95	4.2	0-50	—	—	0.662	1.327	10	3/4	1305	E163	H163	TR163
VS164■	1.32	1.95	5.6	0-50	—	—	0.662	1.767	24	2 1/4	1404	E164	H164	TR164
VS165■	1.70	2.50	7	0-50	—	—	0.662	2.217	10	1	1500	E165	H165	TR165
VS177■	1.32	1.95	9.8	0-10	—	—	0.547	1.906	24	1	1606M	E177	H177	TR177
VS233■	2.34	3.50	4.2	0-60	—	—	1.016	1.969	10	2.5	1300	E233	H233	TR233
VS300A	.68	.98	9	0-9	—	—	1	1 1/8	36	4	1600	E26	P6	M1600
VS301	1.92	2.75	3, 6, 9	0-150	8	1 1/8	2 1/8	6	8	1601	E2506	D6P1	—	
VS304	1.30	1.85	13.5	0-10	1 1/32	1 1/32	2 1/8	12	2.3	1900	E239	XX9	—	
VS305	1.30	1.85	9	0-15	1 1/32	1 1/32	2 3/4	12	3.8	1602	E246	2N6	M1602	
VS306	1.36	1.95	9	0-30	2 1/8	2 1/8	3 3/32	6	5.6	1603	E276	D6	M1603	
VS322	1.36	1.95	9	0-20	1 1/8	1 1/8	2 1/8	12	5.3	1605	E266	M6	M1605	
VS323	.48	.69	9	0-8	1 1/32	2 3/32	1 2 3/32	72	6	1604	E216	2U6	M1604	
VS324	1.30	1.85	4.5	0-40	1 1/32	1 1/32	2 3/4	6	1.5	1610	E243	Z23	—	
VS327	.62	.89	9	0-7	—	—	3/4	2	12	1	1611	E206	L6	M1611
VS329	1.05	1.50	12	0-9	—	—	1	12	1.8	1810	E228	PM8	—	
VS330	1.64	2.35	9	0-80	2 1/8	1 3/8	6 1/4	6	6.5	1612	E2356N	C6X	—	
VS331	2.76	3.95	9	0-30	2 3/32	1 1/4	7 3/32	6	8 1/4	1608	E2761N	D6S	—	
VS332	.68	.98	4.5	0-12	—	—	0.662	1.965	12	0.9	1306	E333	—	—
VS334	.155	.25	1.5	0-25	—	—	1/8	1 1/32	144	5.5	15	1015	930	M15R
VS335	.19	.30	1.5	0-80	—	—	1 1/32	1 1/8	72	7	14	1035	130	M14R
VS336	.19	.30	1.5	0-150	—	—	1 1/32	2 1/32	192					



HIGH VOLTAGE POWER PACKS



COMPACT "M" SERIES 2 TO 75 KVDC

The "M" series Power Packs are a completely new design. Long life and a small package directed the use of the latest techniques and advanced materials. Many features have been incorporated with the highest quality materials, at the same time maintaining economy of cost.

Standard input voltage is 118 at frequencies from 50 to 500 cycles per second inclusive. Available also are input voltages of 220, 230 and 240 volts from 50 to 500 cycles per second inclusive. For 220 volts suffix the desired part number with "X", 230 volts "Y" and 240 Volts "Z". All units may be modified for other input voltages.

The output is filtered DC and standard potentials and current ratings are listed below. All units can be modified for any required potential and current below the values specified in the listing. The output potential can be varied from zero to the rated voltage and load by means of a variable auto transformer at the primary.

Ripple is 1% RMS or 2.75% peak to peak at rated current and voltage.

Design life is 40,000 hours at 35°C and 5,000 hours at 85°C.

Case finish is light blue gray lacquer per MIL-L-7178.

All units except the 75 KV, have two output terminals isolated from the container, permitting either terminal to be operated at ground or an intermediate point between them can be tied to ground. The 75 KV unit has a single high voltage terminal for the output. The Power Pack is normally furnished to deliver a positive output potential relative to ground. If a negative output is desired it can be shipped as such from the factory upon request. The polarity can be easily reversed as required by opening the top access port and reversing the selenium rectifier board. The remaining output terminal at low potential is left ungrounded so that the lead current be monitored if required.

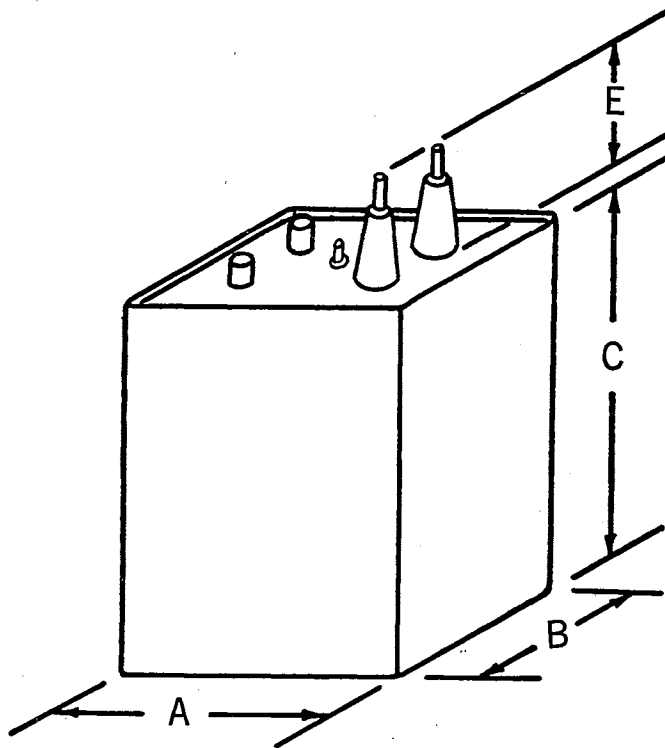

PART NUMBER	KV RANGE	MAX. MA.	DIMENSIONS				MOUNTING AREA		WEIGHT LBS.
			A	B	C	E	L	W	
HV20-152M	0-2	1.5	3 $\frac{3}{4}$	1 $\frac{3}{4}$	3 $\frac{3}{8}$	$\frac{3}{8}$	1 $\frac{3}{4}$	5 $\frac{1}{4}$	2 LBS.
HV50-152M	0-5	1.5	3 $\frac{3}{4}$	2 $\frac{1}{4}$	3 $\frac{3}{8}$	$\frac{5}{8}$	2 $\frac{1}{4}$	5 $\frac{1}{4}$	2 LBS.
HV100-152M	0-10	1.5	3 $\frac{3}{4}$	3 $\frac{3}{16}$	4 $\frac{1}{2}$	1 $\frac{1}{16}$	3 $\frac{3}{16}$	5 $\frac{1}{4}$	4 LBS.
HV150-152M	0-15	1.5	3 $\frac{3}{4}$	3 $\frac{3}{8}$	5 $\frac{1}{2}$	1 $\frac{1}{16}$	3 $\frac{3}{16}$	5 $\frac{1}{4}$	5 LBS.
HV200-152M	0-20	1.5	3 $\frac{3}{4}$	4 $\frac{1}{16}$	5 $\frac{7}{8}$	2 $\frac{1}{8}$	4 $\frac{1}{16}$	5 $\frac{1}{4}$	9 LBS.
HV300-152M	0-30	1.5	3 $\frac{3}{4}$	4 $\frac{1}{16}$	7 $\frac{1}{2}$	3 $\frac{3}{4}$	4 $\frac{9}{16}$	5 $\frac{1}{4}$	11 LBS.
HV500-152M	0-50	1.5	4 $\frac{1}{16}$	6	8 $\frac{1}{2}$	4 $\frac{5}{16}$	6	6 $\frac{1}{4}$	18 LBS.
HV750-152M	0-75	1.5	5 $\frac{7}{8}$	7 $\frac{5}{8}$	12 $\frac{3}{16}$	7 $\frac{1}{2}$	7 $\frac{3}{8}$	7 $\frac{1}{4}$	45 LBS.
HV20-502M	0-2	5	3 $\frac{3}{4}$	2 $\frac{1}{4}$	3 $\frac{3}{8}$	$\frac{3}{8}$	2 $\frac{1}{4}$	5 $\frac{1}{4}$	2 LBS.
HV50-502M	0-5	5	3 $\frac{3}{4}$	2 $\frac{1}{4}$	3 $\frac{3}{4}$	$\frac{5}{8}$	2 $\frac{1}{4}$	5 $\frac{1}{4}$	3 LBS.
HV100-502M	0-10	5	3 $\frac{3}{4}$	4 $\frac{1}{16}$	5 $\frac{7}{8}$	1 $\frac{1}{16}$	4 $\frac{1}{16}$	5 $\frac{1}{4}$	8 LBS.
HV150-502M	0-15	5	3 $\frac{3}{4}$	4 $\frac{1}{16}$	6 $\frac{1}{8}$	1 $\frac{1}{16}$	4 $\frac{1}{16}$	5 $\frac{1}{4}$	10 LBS.
HV200-502M	0-20	5	3 $\frac{3}{4}$	4 $\frac{1}{16}$	8	2 $\frac{1}{8}$	4 $\frac{1}{16}$	5 $\frac{1}{4}$	14 LBS.
HV300-502M	0-30	5	4 $\frac{1}{16}$	6	8 $\frac{1}{2}$	3 $\frac{1}{4}$	6	6 $\frac{1}{4}$	22 LBS.
HV500-502M	0-50	5	5 $\frac{7}{8}$	7 $\frac{3}{8}$	12 $\frac{3}{16}$	4 $\frac{5}{16}$	7 $\frac{3}{8}$	7 $\frac{1}{4}$	45 LBS.
HV750-502M	0-75	5	11 $\frac{1}{8}$	14 $\frac{1}{16}$	16 $\frac{1}{4}$	7 $\frac{1}{2}$	14 $\frac{1}{16}$	11 $\frac{1}{8}$	124 LBS.
HV10-103M	0-1	10	3 $\frac{3}{4}$	2 $\frac{1}{4}$	3 $\frac{3}{8}$	$\frac{3}{8}$	2 $\frac{1}{4}$	5 $\frac{1}{4}$	2 LBS.
HV25-103M	0-2.5	10	3 $\frac{3}{4}$	2 $\frac{1}{4}$	3 $\frac{3}{4}$	$\frac{5}{8}$	2 $\frac{1}{4}$	5 $\frac{1}{4}$	3 LBS.
HV50-103M	0-5	10	3 $\frac{3}{4}$	4 $\frac{1}{16}$	5 $\frac{7}{8}$	$\frac{5}{8}$	4 $\frac{1}{16}$	5 $\frac{1}{4}$	10 LBS.
HV100-103M	0-10	10	3 $\frac{3}{4}$	4 $\frac{1}{16}$	8	1 $\frac{1}{16}$	4 $\frac{1}{16}$	5 $\frac{1}{4}$	14 LBS.
HV150-103M	0-15	10	4 $\frac{1}{16}$	6	8 $\frac{1}{2}$	1 $\frac{1}{16}$	6	6 $\frac{1}{4}$	22 LBS.
HV250-103M	0-25	10	5 $\frac{7}{8}$	7 $\frac{5}{8}$	12 $\frac{3}{16}$	3 $\frac{3}{4}$	7 $\frac{5}{8}$	7 $\frac{1}{4}$	45 LBS.
HV375-103M	0-37.5	10	11 $\frac{1}{8}$	14 $\frac{1}{16}$	16 $\frac{1}{4}$	4 $\frac{5}{16}$	14 $\frac{1}{16}$	11 $\frac{1}{8}$	124 LBS.

SURFACE AREA REQUIRED FOR MOUNTING INCLUDING AREA REQUIRED FOR FOOTED BRACKETS

SEE SECTION 1500, PAGES 344, 345

HIGH & LOW VOLTAGE CAPACITORS

Plastic Capacitors, Inc.

SPELLMAN



HIGH VOLTAGE POWER SUPPLIES

FOR INDUSTRY,
SCIENCE,
INSTRUMENTATION,
EDUCATION,
AEROSPACE,
DEFENSE,
DISPLAYS

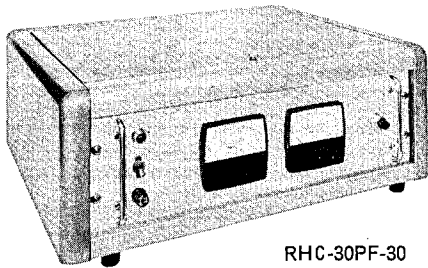

RHC-30PF-30

0-30 KV/Regulated Focus Tap.
Used in flying spot scanners and
photomultipliers.

*Cabinet models RHC & UHC also avail-
able with same ratings. Models with re-
versible polarity available at additional
cost.

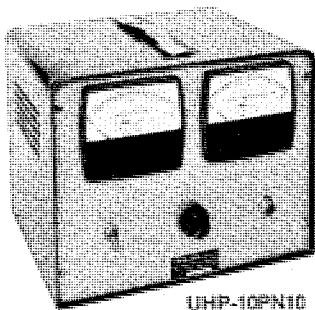

UHP-10PN10

Unregulated. Portable. Reversible
Polarity.

RACK AND CABINET STYLES

HIGH VOLTAGE POWER SUPPLIES

Series **RHR** and **UHR** – Rack Mounted Units

- All solid state • All silicon • Unique circuitry
- High performance • Low Price • 82 Models

	RHR/RHC	UHR/UHC
REGULATION	0.01% or 100mV, whichever is greater	Less than 20% of max rated voltage
RIPPLE (RMS-p-p/2.82)	0.02% RMS or 200mV RMS, whichever is greater	0.1% RMS of max rated output voltage
INPUT	105-125V; 50-60Hz; single phase	

Ask for Bulletins 6810 and 6820 for more detailed technical information.

PARTIAL LISTING

MAX RATINGS		REGULATED RACK MOUNTED *		UNREGULATED RACK MOUNTED		REGULATED PORTABLE		UNREGULATED PORTABLE	
KV	MA.								
5	2			RHR-5P30	\$425	UHR-5P30	\$300	RHP-5P10	\$300
5	6	RHR-5P60	\$475	UHR-5P60	\$350	RHP-5P20	\$425	UHP-5P30	\$300
5	10	RHR-5P60	\$475	UHR-5P60	\$350	RHP-5P60	\$475	UHP-5P60	\$350
10	1			RHR-10P30	\$495	UHR-10P30	\$320	RHP-10P10	\$325
10	3	RHR-10P30	\$495	UHR-10P30	\$320	RHP-10P30	\$495	UHP-10P30	\$320
10	6	RHR-10P60	\$535	UHR-10P60	\$350	RHP-10P60	\$535	UHP-10P60	\$350
10	10	RHR-10P120	\$575	UHR-10P120	\$380	RHP-10P60	\$535	UHP-10P60	\$350
15	0.67					RHP-5P10	\$480	UHP-5P10	\$200
15	2	RHR-15P30	\$620	UHR-15P30	\$340	RHP-15P30	\$620	UHP-15P30	\$340
15	4	RHR-15P60	\$670	UHR-15P60	\$380	RHP-15P60	\$670	UHP-15P60	\$380
15	8	RHR-15P120	\$720	UHR-15P120	\$420	RHP-15P60	\$670	UHP-15P60	\$380
20	0.50					RHP-20P10	\$550	UHP-20P10	\$250
20	1.5	RHR-20P30	\$685	UHR-20P30	\$360	RHP-20P30	\$685	UHP-20P30	\$360
20	3	RHR-20P60	\$735	UHR-20P60	\$400	RHP-20P60	\$735	UHP-20P60	\$400
20	6	RHR-20P120	\$785	UHR-20P120	\$440	RHP-20P60	\$735	UHP-20P60	\$400
30	0.33					RHP-30P10	\$600	UHP-30P10	\$300
30	1	RHR-30P30	\$750	UHR-30P30	\$380	RHP-30P30	\$750	UHP-30P30	\$380
30	2	RHR-30P60	\$800	UHR-30P60	\$420	RHP-30P60	\$800	UHP-30P60	\$420
30	4	RHR-30P120	\$850	UHR-30P120	\$460	RHP-30P60	\$800	UHP-30P60	\$420
40	0.25					RHP-40P10	\$700	UHP-40P10	\$400
40	0.75	RHR-40P30	\$800	UHR-40P30	\$480	RHP-40P30	\$800	UHP-40P30	\$480
40	1.5	RHR-40P60	\$850	UHR-40P60	\$520	RHP-40P60	\$850	UHP-40P60	\$520
40	3	RHR-40P120	\$925	UHR-40P120	\$560	RHP-40P60	\$850	UHP-40P60	\$520
60	0.17					RHP-60P10	\$1000	UHP-60P10	\$600
60	0.50	RHR-60P30	\$1150	UHR-60P30	\$690	RHP-60P30	\$1150	UHP-60P30	\$690
60	1	RHR-60P60	\$1250	UHR-60P60	\$750	RHP-60P60	\$1250	UHP-60P60	\$750
60	2	RHR-60P120	\$1350	UHR-60P120	\$810				
90	1	RHR-90P90	\$1600	UHR-90P90	\$1100				

PORTABLE STYLE

HIGH VOLTAGE POWER SUPPLIES

Series **RHP** Regulated

UHP Unregulated

- All Solid State • All Silicon • Compact and dependable designs • Lightweight • Built-in safety features
- Voltage and current meters • 38 standard models

	RHP	UHP
REGULATION	Less than 0.1% or ±1 Volt, whichever is greater, for either line or load regulation	Less than 20% of max rated voltage
RIPPLE	0.1% or 1VRMS, whichever is greater	0.1% RMS of maximum rated output voltage
INPUT	105-125, 50-400Hz, single phase	

Ask for Bulletin 6830 for more detailed technical information

SOLA® CVDC power supplies, available off-the-shelf.

Sola offers a wide range of CVDC type power supplies which are available from stock of your local electronic parts distributor or the factory. These standard designs are available in any quantity and are the result of Sola custom engineering efforts.

Inherently highly reliable, the CVDC supplies are ruggedly built and use simple circuitry. Fast and dependable regulation, current limiting, and high efficiency are provided by the heart of the supply: the famous Sola Constant Voltage Transformer.

CHARACTERISTICS

- Fast, dependable line-voltage regulation: within $\pm 1\%$ for fluctuations of $\pm 15\%$; voltage will return to regulation envelope in approximately 50 milliseconds.
- Load regulation: from 1/2% to 8%, one half to full load.
- Automatic current limiting; short circuit protection; withstands load faults; high overloads cannot damage power supply or equipment components.
- High efficiency: upwards of 75%; low input-power requirements.
- Simplified operation: no adjustments or maintenance; continuous duty.
- Convection cooling.
- Ripple: 1% rms maximum.
- Ambient operating temperature: 50° C maximum.

Constant-voltage Sola transformer provides $\pm 1\%$ regulation for line voltage variations as great as $\pm 15\%$, serves as the heart of CVDC power supplies for voltage-sensitive equipment.

STANDARD CVDC MODELS

(fixed output for pulse, variable, intermittent and fixed loads—Inputs 100-130 volts, 60Hz)

CATALOG NO.	OUTPUT RATINGS			PANEL HT.	WT. LBS.	PRICE 1-4
	VOLTS	AMPS	VA			
281513-2	6	10	60	3½	27	\$105.00
282123	6	15	90	5¼	38	115.00
281514-2	12	5	60	3½	18	105.00
282124	12	10	120	5¼	31	120.00
281515-2	18	5	90	3½	20	110.00
282125	18	10	180	5¼	45	145.00
281024-1	24	6	144	5¼	30	105.00
282126	24	10	240	5¼	48	125.00
281203-1	24	15	360	7	64	155.00
282127	24	25	600	8¾	72	202.00
28626 -1	28	8	224	5¼	42	120.00
282128	28	15	420	7	55	195.00
281048	48	4	192	5¼	32	110.00
281561	48	10	480	5½	48	155.00
282129	48	20	960	8¾	95	250.00
281125	125	2	250	5¼	44	125.00
281150	150	2	300	5¼	48	130.00
281200	200	1	200	5¼	39	110.00
281250	250	1	250	5¼	45	115.00

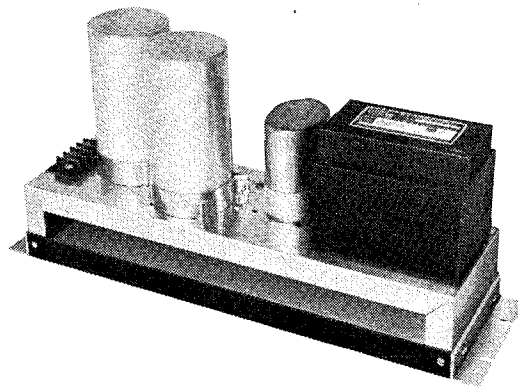
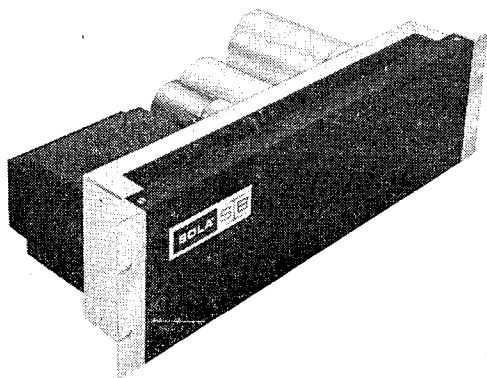

SOLA ELECTRIC **SE**
DIVISION OF SOLA BASIC INDUSTRIES

STABILINE[®] automatic VOLTAGE REGULATORS

- THE MOST EXTENSIVE LINE OF AUTOMATIC VOLTAGE REGULATORS
- RATED OUTPUTS FROM 0.25 TO 275 KVA

Deliver a constant output voltage regardless of variations in input voltage or changes in load current. Conservatively rated, ruggedly built, precision products. Submit specifications for ratings desired but not given in the charts. Input voltage ranges shown are at nominal output voltage; input voltage range shifts with output voltage setting. All are cabinet types; those with other construction also are indicated.

EMT series

Electro Mechanical Transistorized types in ratings from 2.3 to 118 kva. Control circuit is completely transistorized. POWERKOTE Coils in power section permit higher output ratings. Rated accuracy $\pm 0.75\%$ for all variations of line voltage or load current within stated range of unit.

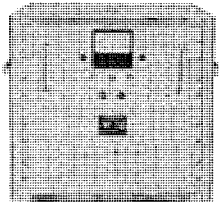

TYPE EMT4115B

EMS series

Electro Mechanical Transistorized types for single or three phase duty with ratings from 25 to 275 kva. Several types available with individual line control for greater application flexibility. Plug-in transistorized control circuit permits quick replacement in event of malfunction.

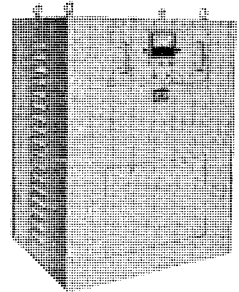

TYPE EMS42100

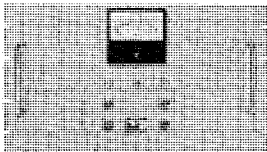

TYPE EMK4105R

EMK series

Electro Mechanical high speed, high accuracy assemblies in ratings of 2.5/5.0 KVA. Accuracy $\pm 1.0\%$ of nominal output voltage.



TYPE IES9101

IES series

Solid-state types with accuracy within 100 millivolts bandwidth, efficiency up to 95%, fast response, low distortion and wide operating frequency range. No vacuum tubes, motors, blowers or relays are used. All units have provision for remote sensing and have removable plug-in solid-state circuit boards.

All-boost Marine

Electro Mechanical Transistorized type EMT10228 is fully enclosed in a weatherproof cabinet. Well suited for marine or industrial applications where equipment must withstand effects of dust and moisture. Has 6 KVA rated output.

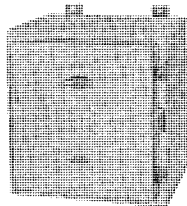

TYPE EMT10228

Militarized

Standard Electro Mechanical and Electro Mechanical Transistorized types that meet the requirements of applicable military specifications. Type EMTH41007MH is 3½ x 6 x 4½"; type EM4108MCR fits standard 19" relay rack. Accuracy $\pm 1.0\%$.

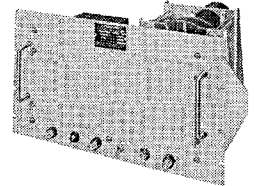

TYPE EM4108MCR

Overvoltage Detector OVK100

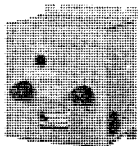

TYPE OVK100

Solid-state voltage level detector used with STABILINE Automatic Voltage Regulators. Actuates relay contacts when monitored voltage exceeds preset level. Relay contacts can be used to actuate protective equipment in a latching (relay remains closed) or nonlatching (relay automatically resets) connection. Trip level adjustable from 110 to 150 volts. Adaptable for higher voltage operation.

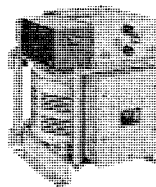

TYPE EMT4104BUT

Types EMT4104B, (U), (UT)

Have two primary windings for parallel or series (120 or 240 volt) duty. Type EMT4104B is cabinet enclosed; EMT4104BU is of open construction; EMT4104BUT has components screened or enclosed.



THE SUPERIOR ELECTRIC COMPANY

SEE OTHER SUPERIOR ELECTRIC PRODUCT PAGES

terado CHARGERS, INVERTERS AND VOLTAGE ADJUSTERS

CHANGES BATTERY CURRENT TO 110 VAC, 60 CYCLE, $\pm 1/2$ CYCLE, REGARDLESS OF LOAD*

INVERTER-BATTERY CHARGER TRAV-ELECTRIC*

Operates anything using 117 VAC, 60 cps from 25 amps rechargeable wet storage battery enclosed. Capacity: 175 watts; 125 watts continuous. Frequency stable within 1/2 cps with load change. Plugs into AC outlet or car cigarette lighter to recharge battery. Charger has automatic overcharge protection. Meter shows charge rate and hours of anticipated output. Size: 12" x 5 1/2" x 8". Wt.: Net, 30 lbs. including battery; shpg., 36 lbs.
Terado No. 50-160—**\$6340**
Net Each

INVERTERS

DUAL CONTINENTAL*

Transistorized, 600 watts
Converts 12 VDC to 110 V, 60 cycle, 550 to 600 watts. Filtered for tape recorders. Frequency stable within 1/2 cycle with changing input voltage load. Includes battery cables, remote control, variable AC output. Size: 10 3/4" w. x 13" d. x 6" h. Shpg. Wt., 60 lbs.
Terado No. 50-202—Net Each..... **\$32316**

CONTINENTAL*

Transistorized, 300 watts
Same as DUAL CONTINENTAL except: 275-300 watts capacity. Size: 10 3/4" w. x 6" d. x 6" h. Shpg. Wt., 30 lbs.
Terado No. 50-191—Net Each..... **\$15313**

ATLAS*

Transistorized, 200 watts
Same as DUAL CONTINENTAL except: 175-200 watts capacity. Size: 10 3/4" w. x 6" d. x 6" h. Shpg. Wt., 21 lbs.
Terado No. 50-200—Net Each..... **\$11453**

TITAN*

Transistorized, 175 watts
Same as DUAL CONTINENTAL except: less remote control; 150-175 watts capacity; on-off switch; AC receptacle. Size: 10 3/4" w. x 6" d. x 6" h. Shpg. Wt., 20 lbs.
Terado No. 50-201—Net Each..... **\$10051**

SUPREME*

Non-transistorized. Converts 12 VDC to AC. Power output, 175-200 W, filtered. Remote control has variable AC output switch and signal light. Size: 10 3/4" w. x 6" d. x 6" h. Shpg. Wt., 20 lbs.
Terado No. 50-153—Net Each..... **\$8407**

RECORDER*

150-175 watt version of SUPREME, less remote control. Plugs into cigarette lighter. Size: 10 3/4" w. x 6" d. x 6" h. Shpg. Wt., 21 lbs.
Terado No. 50-175—Net Each..... **\$7667**

AUTOMATIC*

Operates automatically from 6 or 12 VDC without vibrator charge or switching (6 V, 55-75 watts; 12 V, 85-110 watts). Easy installation into cigarette lighter. For dictation machines, radios, tape recorders, phonographs, heating pads, etc. Steel case. Seal brown baked enamel. Size: 3 1/2" w. x 6 1/2" d. x 4" h. Shpg. Wt., 8 lbs.
Terado No. 50-134—Net Each..... **\$4452**

SUPER*

Single input version of AUTOMATIC above. Size: 3 1/2" w. x 6 1/2" d. x 4" h. Shpg. Wt., 8 lbs.
Terado No. 50-126—Input, 6 V; AC power output, 60-75 watts. Net Each..... **\$3847**
Terado No. 50-127—Input, 12 V; AC Power output, 75-100 watts. Net Each..... **\$3847**

MASTER*

Voltage input, 12 V; AC power output, 60-75 watts. Size: 3 1/2" w. x 6 1/2" d. x 4" h. Shpg. Wt., 6 lbs.
Terado No. 50-122—Net Each..... **\$3196**

CHIEF*

Operates tape recorders, power tools, dictation machines, mixers, blenders, etc. Front AC receptacle connects direct to battery. Toggle switch output control. Ventilated steel case. Size: 3 1/2" w. x 6 1/2" d. x 4" h. Shpg. Wt., 8 lbs.
Terado No. 50-137—Input, 6 V; AC power output, 75-100 watts. Net Each..... **\$5390**
Terado No. 50-138—Input, 12 V; AC power output, 100-125 watts. Net Each..... **\$5390**

ELECTRAL*

Glove compartment size inverter, available in 12 volt input. Easy installation into cigarette lighter. Vinyl coated steel case with leatherette appearance. Size: 3" w. x 2 1/4" d. x 5 1/2" h. Shpg. Wt., 3 lbs.
Terado No. 50-167—Voltage input, 12 V; AC power output, 42-52 watts. Net Each..... **\$2077**

SENIOR*

Operates radios, lights, phonographs and small tape recorders. Available in 6 V or 12 V input. Simple to install into cigarette lighter. Aluminum case. Seal brown baked enamel. Size: 2 1/2" w. x 4 1/2" d. x 2 1/4" h. Shpg. Wt., 3 lbs.
Terado No. 50-115—Voltage input, 6 V; AC power output, 35-40 watts. Net Each..... **\$1847**
Terado No. 50-116—Voltage input, 12 V; AC power output, 40-50 watts. Net Each..... **\$1847**

DYNAMO*

Permits operating AC radios and electric shavers on 12 VDC battery. Power output, 25-30 watts. Size: 2" x 2" x 3 3/4". Shpg. Wt., 2 lbs.
Terado No. 50-197—Net Each..... **\$1295**

AUTO SHAVER*

Operates all electric shavers. Available in 6 V (10-15 W) or 12 V (15-20 W) input. Plugs into cigarette lighter. Polyethylene non-breakable case. Size: 3 3/8" w. x 2 1/4" d. x 4 1/4" h. Shpg. Wt., 2 lbs.
Terado No. 50-102—6 V. Net Each..... **\$931**
Terado No. 50-103—12 V. Net Each..... **\$931**

TRANSISTORIZED Frequency Not Stabilized

GEMINI

(Transistorized, 450 to 500 watts)
Transistorized 12 VDC to 110 VAC. Designed to operate equipment not sensitive to frequency change. Size: 12 1/2" x 6" x 6". Shpg. Wt., 20 lbs.
Terado No. 50-128—Net Each..... **\$97.17**
Remote Control No. 50-130—Net Each..... **\$11.50**

FALCON

(Transistorized, 275 to 300 watts)
Transistorized 12 VDC to 110 VAC. Designed to operate equipment not sensitive to frequency change. Size: 12 1/2" x 6" x 6". Shpg. Wt., 20 lbs.
Terado No. 50-129—Net Each..... **\$74.25**
Remote Control No. 50-130—Net Each..... **\$11.50**

GALAXY

Transistorized 12 VDC to 110 VAC, 140-175 watts filtered. Adjustable voltage and frequency. Ideal where frequency is not critical. Size: 10 3/4" w. x 6" d. x 6" h. Shpg. Wt., 9 1/2 lbs.
Terado No. 50-205—Net Each..... **\$3990**

TEMPEST

Transistorized 12 VDC to 110 VAC, 125-150 watts. Ideal where frequency is not important. Size: 10 3/4" w. x 6" d. x 6" h. Shpg. Wt., 9 1/2 lbs.
Terado No. 50-170—Net Each..... **\$3296**

BATTERY CHARGERS

DYN-A-MITE

Baked seal brown paint over aluminum case. Charge rate 1 amp, both 6 and 12 volts. Size: 1 3/4" x 1 3/4" x 3 1/4". Wt., 1 lb.
Terado No. 50-186—Net Each..... **\$590**

TAPERITE

Brown baked enamel case. Charges 6 amps, or in low position charge automatically tapers to 0. Will not overcharge battery; has charge rate meter. Size: 4" x 6" x 6". Wt., 7 1/2 lbs.
Terado No. 50-192—Net Each..... **\$2660**

CHALLENGER

Brown baked enamel, ventilated steel case. Charge rate 6 amps, both 6 and 12 volts. Charge rate meter. Brackets for colling wire provided. Size: 4" x 5" x 6". Wt., 5 lbs.
Terado No. 50-189—Net Each..... **\$2027**

SUPER CHARGER

Brown baked enamel, ventilated steel case. Charge rate 10 amps, both 6 and 12 volts. Color coded meter shows condition of battery and charge rate. Size: 4" x 5" x 6". Wt., 7 1/2 lbs.
Terado No. 50-181—Net Each..... **\$2597**

POWERHOUSE

Heavy duty, heavy copper clad, ventilated steel case with handle. Full fast 20 amp charge rate on either 6 or 12 volt batteries, plus trickle charge. Full wave type with 4 silicon rectifiers. Complete with charge rate meter and 6 ft. cable with battery clamps. Size: 11" x 6" x 6". Ship. Wt., 20 lbs.
Terado No. 50183—Net Each..... **\$4897**

VOLTAGE ADJUSTERS

For TV, hi-fi and AC motorized equipment. Change high or low voltage over range of 95-135 V to normal. Input: 110 VAC line. Size: 5 1/2".
Terado No. 50-204 Polaris—Cap., 300 W cont., 500 W int. Wt., 3 lbs. Net Each..... **\$9.90**
Terado No. 50-172 Saturn—Same as Polaris, but with accurate AC voltmeter. Net Each..... **\$15.97**

APOLLO

Cap. 1200 W. Cont. 150 W int. Wt., 8 lbs.
Terado No. 50-141—Net Each..... **\$22.75**

MARK I

INVERTER-CHARGER COMBINATION Transistorized—Solid State Frequency Not Controlled

Copper baked enameled case. Changes battery voltage to 117 volts. AC capacity 450 to 500 watts. Charges 12 volt storage battery at 20 amps, 10 amps or trickle. Has charge meter. Size: 12 1/2" x 6" x 6". Shpg. Wt., 21 lbs.
Terado No. 50-131—Net Each..... **\$10450**

MARK II

Same specifications as MARK I above except inverter capacity is 275-300 watts.
Terado No. 50-132—Net Each..... **\$8950**

SERIES 6000 MICRO-RELAYS 60 MILLIWATT OPERATING POWER

Hermetically sealed, single pole double throw (Form C) silver contacts, rated at 1 amp at 24 v. non-inductive load. Operating temperature range -55°C to +85°C. Insulation: 500 v. at any terminal to ground. Excellent vibration characteristics due to short armature. Base fits 7-pin miniature tube socket. Size: 3/4" x 1-11/16" long.

STOCK RELAYS

Terado No.	Coil Resistance	Operating Volts DC	Net Each*
B1330	24 ohms	1.5	\$8.42
B1331	300 ohms	6	8.55
B1332	2,000 ohms	12	8.94
B1333	5,000 ohms	24	9.71
B1249†	8,000 ohms	20	10.55
B1334	8,000 ohms	24-28	10.55
B1335	10,000 ohms	32	10.91

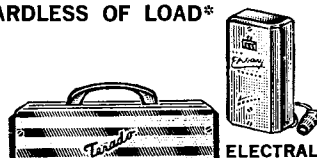

ELECTRAL



ATLAS TITAN

SUPREME, CONTINENTAL

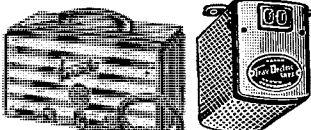

RECORDER CHIEF

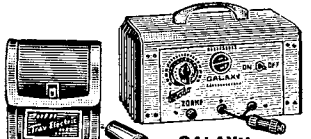

AUTOSHAPER

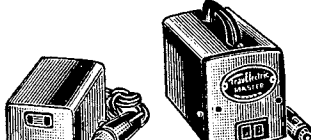

GALAXY TEMPEST

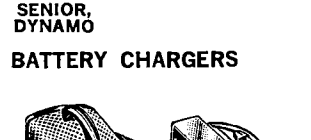

SENIOR DYNAMO

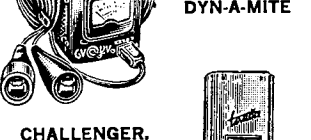

AUTOMATIC, SUPER AND MASTER



DYN-A-MITE

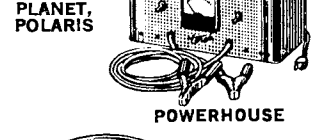

CHALLENGER, SUPER CHARGER



SATURN



POWERHOUSE

PLANET, POLARIS

MARK I MARK II

TERADO CORPORATION

HAYDEN/RIDER Technical Books

COMPUTERS

- COMPREHENSIVE FORTRAN PROGRAMMING, James N. Haag, #5646, paper...\$ 4.95
 IBM 1620 PROGRAMMING FOR SCIENCE AND MATHEMATICS,
 Irving Allen Dodes, #5511.....\$ 6.75
 BASICS OF DIGITAL COMPUTER PROGRAMMING, John S. Murphy, #0405...\$ 3.75
 UNDERSTANDING DIGITAL COMPUTERS, Ronald M. Benrey,
 #0473\$4.25 #0474, cloth.....\$ 5.45
 DESIGN OF TRANSISTORIZED CIRCUITS FOR DIGITAL COMPUTERS,
 by Abraham I. Pressman, M.S., #0215, cloth bound.....\$ 9.95
 COMPUTER ARITHMETIC by Henry Jacobowitz, #0297.....\$ 3.25
 BASICS OF ANALOG COMPUTERS, 'Pictured-Text' Courses
 by Thos. D. Truitt, Dir. of Advanced Study Group. Electronic Assoc.,
 Inc. & A. E. Rogers, Sr. Consultant, Electronic Assoc., Inc.,
 #0256, cloth\$12.50
 BASICS OF DIGITAL COMPUTERS, 'Pictured-Text' Course
 by John S. Murphy, #0069, 3 vol. set...\$9.75 #0073, cloth bound...\$ 9.50
 DATA TRANSMISSION & DATA PROCESSING DICTIONARY, J. Holmes,
 #0396\$ 2.50
 DIGITAL MAGNETIC TAPE RECORDING: Principles & Computer Applica-
 tions. B. Bycer, #5031, cloth.....\$11.00
 COMPUTER NUMBERING SYSTEMS & BINARY ARITHMETIC, Training
 Systems, Inc. & Stanley L. Levine, #0380.....\$ 4.95
 HOW TO BUILD A WORKING DIGITAL COMPUTER, by Alcosser, Phillips
 & Wolk, #0748\$ 3.75

TRANSISTORS

- SIMPLIFIED TRANSISTOR THEORY, Training Systems, Inc. & Stanley L.
 Levine, #0705\$ 4.35
 103 SIMPLE TRANSISTOR PROJECTS, Tom Kneitel, #0313.....\$ 2.95
 PRINCIPLES OF TRANSISTOR CIRCUITS (3rd ed.) by S. W. Ames, B.Sc.
 (Hons.), Birmingham, England, #5649.....\$ 7.95
 FUNDAMENTALS OF TRANSISTORS (2nd ed., Revised & Enlarged) by
 Leonard M. Krugman, P.R., #0160.....\$ 3.50
 BASIC TRANSISTORS, 'Pictured-Text' Course by Alexander Schure, Ph.D.,
 #0444, soft cover, 152 pp., 6"x9".....\$ 3.95 #0445, hard bound...\$ 5.50
 FUNDAMENTALS OF TRANSISTOR PHYSICS by Irving Gottlieb, B.S., #0267...\$ 3.90
 TRANSISTOR TELEVISION RECEIVERS, T. D. Towers, #0329, cloth.....\$ 6.95
 TRANSISTOR BASICS: a short course by George C. Stanley, Jr., #5819...\$ 2.75

SPACE TECHNOLOGY

- UNDERSTANDING ROCKETS & THEIR PROPULSION, C. Kuentz, #0362.....\$ 3.95
 SPACE COMMUNICATIONS, S. Leinwoll, #0384.....\$ 3.95
 FUNDAMENTALS OF ROCKETS, MISSILES & SPACECRAFT, Marvin Hobbs,
 #0393\$ 3.95
 SATELLITE TRACKING, cloth bound, Stanley Macko, #0289.....\$ 5.50
 GYRO FUNDAMENTALS, Training Systems Inc. & Stanley L. Levine,
 #0332\$ 2.65
 FUNDAMENTALS OF RADIO TELEMETRY, by M. Tepper, #0225.....\$ 3.25

ELECTRICAL ENGINEERING

- BENCH-TESTED COMMUNICATIONS PROJECTS, ELEMENTARY ELECTRONICS
 & RADIO TV EXPERIMENTER, #0788, paper.....\$ 3.25
 FUNDAMENTALS OF INTEGRATED CIRCUITS, L. Stern, #5695, cloth.....\$ 8.95
 MICROELECTRONIC DESIGN, Edited by Howard Bierman, #5762, cloth...\$11.50
 MATRIX ALGEBRA FOR ELECTRONIC ENGINEERS, Paul Hlawiczka,
 #5629, cloth\$ 8.75
 400 IDEAS FOR DESIGN (selected from Electronic Design), #5537, cloth...\$ 8.50
 PLANNING AND PREPARING DATA FLOW DIAGRAMS, J. DiCerto,
 #5027, cloth\$10.50
 PRINCIPLES OF FEEDBACK DESIGN, G. Edwin & Thomas Roddam,
 #5533, cloth\$ 8.75
 MICROPHONES, A. E. Robertson, #5528, cloth.....\$12.75
 CIRCUIT THEORY ANALYSIS, Joseph Mittleman, #5525, cloth.....\$ 9.50
 DESIGN OF LOW NOISE TRANSISTOR INPUT CIRCUITS,
 William A. Rheinfelder, #5014, cloth.....\$ 5.50
 MODERN NETWORK SYNTHESIS, Donald A. Callahan,
 #5007, 2 vols.....\$ 7.50 #5010, 1 vol., cloth.....\$ 8.50
 ELECTRICAL INTERFERENCE, Rocco Ficchi, #5512, cloth.....\$ 8.75
 DIODES AND TRANSISTORS, G. Fontaine, #5500, cloth.....\$ 7.95
 NUMERICAL ANALYSIS, Irving Allen Dodes & Dr. Samuel L. Greitzer,
 #5515, cloth\$ 7.50
 TRANSISTOR CIRCUITS IN ELECTRONICS, #5034, cloth.....\$ 9.50
 THEORY AND APPLICATIONS OF TOPOLOGICAL & MATRIX METHODS,
 Keats Pullen, #0300\$ 2.50
 SIMPLIFIED MODERN FILTER DESIGN by Philip R. Geffe, #0317, cloth...\$ 8.75
 DESIGN OF COMMUNICATIONS SYSTEMS, Keats Pullen, Jr.,
 #5011\$ 2.75 #5012, cloth.....\$ 4.25

ELECTRONIC TECHNOLOGY SERIES

Edited by Alexander Schure, Pr.D.

R-C/R-L TIME CONSTANT, #0601, \$.90; CRYSTAL OSCILLATORS, #0604, \$1.25;
 LIMITERS & CLIPPERS, #0606, \$1.25; AMPLITUDE MODULATION, #0612, \$1.25;
 BLOCKING OSCILLATORS, #0610, \$1.25; SUPERHETERODYNE CONVERTERS &
 I-F AMPLIFIERS, #0612, \$2.25; RESONANT CIRCUITS, #0616, \$1.25; ELECTRO-
 STATICS, #0617, \$1.35; D-C CIRCUIT ANALYSIS, #0618, \$1.35; A-C CIRCUIT
 ANALYSIS, #0619, \$1.80; MAGNETISM & ELECTROMAGNETISM, #0620, \$1.80;
 IMPEDANCE MATCHING, #0623, \$2.90; GAS TUBES, #0624, \$1.50; LDW-FRE-
 QUENCY AMPLIFIERS, #0630, \$1.80; PHOTOTUBES, #0633, \$1.80; TRANS-
 FORMERS, #0637, \$2.00.

INDUSTRIAL ELECTRONICS

- UNDERSTANDING LASERS & MASERS, S. Leinwoll, #0664.....\$ 2.49
 ELEMENTARY INDUSTRIAL ELECTRONICS, Leonard C. Lane,
 #0461, 2 volume set.....\$ 7.80 #0464, cloth.....\$ 9.00
 BASIC PRINCIPLES & APPLICATIONS OF RELAYS, H. Pollack, #0434.....\$ 2.90
 PHOTOELECTRIC CONTROL, Harvey Pollack, #0435.....\$ 3.50
 BASIC ULTRASONICS, 'Pictured-Text' Course by Cyrus Glickstein,
 #0442, soft cover\$ 3.50
 INDUSTRIAL CONTROL CIRCUITS by Sidney Platt, B.S., M.S., #0202.....\$ 3.90
 *BASICS OF INDUCTION HEATING, 'Pictured-Text' Course
 by Chester A. Tudbury, M.S., #0420, 2 vols., soft cover\$ 7.80
 BASIC INDUSTRIAL ELECTRICITY by Van Valkenburgh, Nooger & Neville
 (Picture Book Course) 2 vols., #0469, paper...\$ 7.00 #0472, cloth...\$ 8.50
 CIRCUIT PROBLEMS & SOLUTIONS, vol. 1, elementary methods
 by Gerard Lippin, #5754.....\$3.95

ELECTRONICS

- UNDERSTANDING SILICON CONTROLLED RECTIFIERS, S. Heller,
 #0782, paper\$ 3.50
 MEASURING METHODS AND DEVICES IN ELECTRONICS, A. C. J. Beerens,
 #5831, paper\$ 4.25 #5832, cloth.....\$ 6.25
 BASIC ELECTRONICS (vol. 6), 'Picture Book' Course by Van Valkenburgh,
 Nooger & Neville, Inc., #0046, soft cover.....\$ 2.75
 BASIC ELECTRONICS (Expanded Course), 'Picture Book' Course
 by Van Valkenburgh, Nooger & Neville, Inc.,
 #0048, set of six vols. in soft cover.....\$16.25
 #0049, set of six vols. in a single cloth binding.....\$14.85
 HOW TO BUILD ELECTRONIC EQUIPMENT, paper, J. Richard Johnson,
 #0699\$ 3.95
 USING THE SLIDE RULE IN ELECTRONIC TECHNOLOGY, Charles Alvarez
 #0253\$ 2.75
 BASIC SYNCHROS & SERVOMECHANISMS, 'Picture Book' Course by Van
 Valkenburgh, Nooger & Neville, Inc., individual vols., #0058 & #0059...\$ 3.50
 #0057, soft cover, 2 vols., 270 pp., 6" x 9".....\$ 7.00
 BASIC PULSES by Irving Gottlieb, P.E., 'Picture-Text' #0216.....\$3.50
 METALLIC RECTIFIERS & CRYSTAL DIODES by Theodore Conti, #0213.....\$ 3.50
 HOW TO READ SCHEMATIC DIAGRAMS by David Mark, #0208.....\$ 3.50
 RADIO-TELEVISION-ELECTRONICS DICTIONARY by the Staff of National
 Radio Institute, #0307, paper.....\$ 3.85
 HOW TO SOLVE PROBLEMS IN ELECTRICITY AND ELECTRONICS
 by Henry Jacobowitz, #0302, paper.....\$ 3.75
 SIMPLIFIED INDUSTRIAL TELEMETERING, J. Campbell, #5542.....\$ 3.95
 BASIC MICROWAVES, Bernard Berkowitz, #5740, paper.....\$ 3.95
 THE ELECTRON IN ELECTRONICS, M. G. Scroggie, #5707, cloth.....\$ 9.95
 THE PHYSICAL BASIS OF ELECTRONICS, J. G. R. Van Dijk, #5706, cloth \$11.95
 ELECTRONICS DRAFTING, by A. Wolk, #5815.....\$ 3.95
 ELECTRONICS ONE-SEVEN, edited by Harry Mileaf,
 #5552, 7 vols., soft cover...\$23.65 #5560, 1 vol., cloth...\$14.96

TELEVISION (THEORY AND PRACTICE)

- FUNDAMENTALS OF TELEVISION, W. Buchsbaum,
 #0391, paper\$ 4.95 #0366, cloth.....\$ 7.45
 VIDEO TAPE RECORDING by Julian Bernstein, #0254, cloth bound.....\$ 8.95
 BASIC TELEVISION, 'Pictured-Text' Course by Alex Schure, Ph.D., Ed.D.,
 #0082, soft cover, 5 vols.\$14.75
 CLOSED CIRCUIT TV SYSTEM PLANNING by M. A. Mayers &
 R. D. Chipp, P.E., #0203, cloth bound\$10.00
 PLANNING THE LOCAL UHF-TV STATION, P. Finnegan, #5701, cloth.....\$10.00
 HOW TO USE SIGNAL GENERATORS IN THE LABORATORY,
 by John D. Lenk, #0768.....\$ 3.25

HAYDEN BOOK COMPANY, INC.

AUTHORITATIVE HOWARD W. SAMS PUBLICATIONS
AMATEUR RADIO

AMATEUR RADIO MOBILE HANDBOOK, 20035.....	\$ 3.50
AMATEUR RADIO STATION MANUAL, 20049.....	\$ 3.95
BUILDING YOUR AMATEUR RADIO NOVICE STATION, 20050.....	\$ 3.75
ABC's OF HAM RADIO (3rd Edition), 20638.....	\$ 2.95
AMATEUR RADIO ANTENNAS (2nd Edition), 20611.....	\$ 3.95
AMATEUR RADIO CONSTRUCTION PROJECTS, 20045.....	\$ 3.25
GENERAL-CLASS AMATEUR LICENSE HANDBOOK, 20639.....	\$ 3.25
HAM ANTENNA CONSTRUCTION PROJECTS, 20207.....	\$ 3.95
INTERNATIONAL CODE TRAINING SYSTEM, 20138.....	\$ 7.50
PRACTICAL HAM RADIO PROJECTS, 20042.....	\$ 2.95
SO YOU WANT TO BE A HAM (4th Edition), 20607.....	\$ 4.50
TRANSISTORIZED AMATEUR RADIO PROJECTS, 20570.....	\$ 3.50
TRANSISTOR TRANSMITTERS FOR THE AMATEUR, 20450.....	\$ 3.25

APPLIANCES, MOTORS and POWER MECHANICS

ABC's OF ELECTRIC MOTORS AND GENERATORS, 20186.....	\$ 2.95
ABC's OF FLUID POWER, 20519.....	\$ 2.95
CONTROL INSTRUMENT MECHANISM, 20596.....	\$ 9.95
ELECTRICAL MOTOR CONTROLS AND CIRCUITS, 20163.....	\$ 5.75
ELECTRONIC MOTOR CONTROL, 20269.....	\$ 4.50
ELIMINATING ENGINE INTERFERENCE, 20184.....	\$ 2.75
*FLUID POWER, 20587.....	\$ 7.95
Student's Workbook, 20588.....	\$ 2.50
Calculator, 20590.....	\$.60
HOW TO REPAIR MAJOR APPLIANCES, 20650.....	\$ 4.95
HOW TO REPAIR SMALL APPLIANCES, Vol. 1, 20041.....	\$ 2.95
HOW TO REPAIR SMALL APPLIANCES, Vol. 2, 20524.....	\$ 2.95
INSTRUMENTATION TRAINING COURSE —	
Vol. 1—Pneumatic Instruments, 20621.....	\$ 8.95
Vol. 2—Electronic Instruments, 20622.....	\$ 6.95
Both volumes, 20623.....	\$14.50
OUTBOARD MOTOR SERVICE MANUAL (4th Edition) —	
Vol. 1—Motors under 30 Hp., 20598.....	\$ 4.95
Vol. 2—Motors 30 Hp. and above, 20599.....	\$ 4.95
Both volumes, 20603.....	\$ 9.50
ROCKET AND SPACE SCIENCE SERIES —	
Vol. 1—Propulsion, 20386.....	\$ 4.25
Vol. 2—Propellants, 20528.....	\$ 4.25
SMALL ENGINES SERVICE MANUAL (8th Edition), 20357.....	\$ 4.95
SMALL GASOLINE ENGINES TRAINING MANUAL, 20204.....	\$ 5.25

AUDIO and HI-FI

ABC's OF ELECTRONIC ORGANS (2nd Edition), 20551.....	\$ 2.95
ABC's OF HI-FI AND STEREO (2nd Edition), 20539.....	\$ 2.75
ABC's OF TAPE RECORDING (2nd Edition), 20395.....	\$ 2.50
AUDIO AMPLIFIER DESIGN, 20560.....	\$ 4.25
ELECTRIC GUITAR AMPLIFIER HANDBOOK, 20202.....	\$ 3.50
ELECTRONIC ORGANS, 20188.....	\$ 5.75
F-M MULTIPLEXING FOR STEREO (2nd Edition), 20199.....	\$ 3.95
HI-FI PROJECTS FOR THE HOBBYIST, 20222.....	\$ 2.95
HI-FI STEREO HANDBOOK (3rd Edition), 20565.....	\$ 5.50
HOW TO BUILD SPEAKER ENCLOSURES, 20520.....	\$ 3.50
INTERMODULATION AND HARMONIC DISTORTION HANDBOOK, 20242.....	\$ 4.25
MEASURING HI-FI AMPLIFIERS, 20561.....	\$ 3.95
PASSIVE AUDIO NETWORK DESIGN, 20031.....	\$ 5.50
TAPE RECORDERS — HOW THEY WORK (2nd Edition), 20445.....	\$ 4.50
TROUBLESHOOTING AUDIO EQUIPMENT, 20525.....	\$ 3.95

BASIC and HOBBYIST

ABC's OF ELECTRICAL SOLDERING, 20627.....	\$ 2.95
ABC's OF ELECTRICITY, 20263.....	\$ 2.50
ABC's OF ELECTRONICS, 20185.....	\$ 2.50
ABC's OF MODERN RADIO (2nd Edition), 20047.....	\$ 2.95
ABC's OF SHORT-WAVE LISTENING (2nd Edition), 20554.....	\$ 2.50
ABC's OF SILICON CONTROLLED RECTIFIERS, 20124.....	\$ 2.95
BASIC ELECTRICITY/ELECTRONICS —	
Vol. 1—Basic Principles and Applications, 20167.....	\$ 4.95
20175 (hardbound).....	\$ 5.50
Vol. 2—How A-C and D-C Circuits Work, 20168.....	\$ 4.95
20176 (hardbound).....	\$ 5.50
Vol. 3—Understanding Tube and Transistor Circuits, 20169.....	\$ 4.95
20177 (hardbound).....	\$ 5.50
Vol. 4—Understanding and Using Test Instruments, 20170.....	\$ 4.95
20178 (hardbound).....	\$ 5.50
Vol. 5—Motors and Generators—How They Work, 20171.....	\$ 4.95
20179 (hardbound).....	\$ 5.50
5-volume set, 20172.....	\$19.95
5-volume set (hardbound), 20180.....	\$24.95
Laboratory Workbook, 20173.....	\$ 4.95
BASIC ELECTRICITY AND AN INTRODUCTION TO ELECTRONICS (2nd Edition), 20540.....	\$ 4.25
BASIC PIEZOELECTRICITY, 20087.....	\$ 2.95
ELECTRONIC CIRCUIT ACTION SERIES —	
Amplifier Circuit Actions, 20059.....	\$ 3.50
Detector and Rectifier Circuit Actions, 20061.....	\$ 3.50
Oscillator Circuit Actions, 20070.....	\$ 3.50
Radio Circuit Actions, 20073.....	\$ 3.50
Transistor Circuit Actions, 20075.....	\$ 3.50
TV Sync and Deflection Circuit Actions, 20077.....	\$ 3.50
TV Video and Sound Circuit Actions, 20080.....	\$ 3.50
7-volume set, 20071.....	\$19.95

ELECTRONIC GADGETS FOR YOUR CAR, 20096.....	\$ 3.25
ELECTRONIC GAMES AND TOYS YOU CAN BUILD, 20183.....	\$ 2.95
ELECTRONICS EXPERIMENTS AND PROJECTS, 20194.....	\$ 2.95
ELECTRONIC SERVICING FOR THE BEGINNER, 20090.....	\$ 3.95
ELECTRONICS FOR THE BEGINNER, (2nd Ed.) 20664.....	\$ 3.95
*ELECTRONICS FOR THE BEGINNER, 20677.....	\$ 5.25
EXPERIMENTAL ASTRONAUTICS, 20509.....	\$ 3.95
EXPERIMENTAL EARTH SCIENCES, 20601.....	\$ 2.95
HAVING FUN IN ELECTRONICS, 20541.....	\$ 3.95
HAVING FUN WITH TRANSISTORS, 20433.....	\$ 2.95
HOW TO DETECT AND MEASURE RADIATION, 20024.....	\$ 3.95
HOW TO READ SCHEMATIC DIAGRAMS (2nd Edition), 20568.....	\$ 3.50
LEARNING ELECTRICITY FUNDAMENTALS (2nd Edition) 20522.....	\$ 6.50
NORTH AMERICAN RADIO-TV STATION GUIDE (5th Edition), 20635.....	\$ 2.95
PROJECTS IN BASIC MAGNETISM, 20556.....	\$ 2.50
SCIENCE PROJECTS IN ELECTRICITY, 20366.....	\$ 3.50
SCIENCE PROJECTS IN ELECTRONICS, 20367.....	\$ 3.50
SHORT-WAVE LISTENER'S GUIDE (2nd Edition), 20542.....	\$ 1.95
SOLAR CELL AND PHOTOCELL EXPERIMENTER'S GUIDE, 20312.....	\$ 3.25
TAPE RECORDING FOR THE HOBBYIST, 20583.....	\$ 3.95
TV TUBE SYMPTOMS AND TROUBLES (2nd Edition), 20476.....	\$ 2.50
49 EASY TRANSISTOR PROJECTS, 20617.....	\$ 1.75
101 EASY AUDIO PROJECTS, 20608.....	\$ 3.50

CB and COMMUNICATIONS

ABC's OF CITIZENS BAND RADIO (2nd Edition), 20019.....	\$ 2.50
ABC's OF LASERS AND MASERS (2nd Edition), 20262.....	\$ 2.95
ABC's OF MICROWAVES, 20040.....	\$ 2.50
ABC's OF RADAR (2nd Edition), 20014.....	\$ 2.95
ABC's OF RADIO AND TV BROADCASTING, 20575.....	\$ 2.95
ABC's OF TELEMETRY, 20051.....	\$ 2.50
AM-FM BROADCAST MAINTENANCE, 20068.....	\$ 5.95
AM-FM BROADCAST OPERATIONS, 20066.....	\$ 5.95
CB RADIO ANTENNAS (2nd Edition), 20567.....	\$ 3.50
CB RADIO CONSTRUCTION PROJECTS, 20099.....	\$ 2.95
CB RADIO SERVICING GUIDE, 20125.....	\$ 3.95
CITIZENS BAND RADIO HANDBOOK (3rd Edition), 20569.....	\$ 4.25
*CLOSED-CIRCUIT TELEVISION HANDBOOK, 20108.....	\$ 7.95
COMMUNICATIONS EQUIPMENT SCHEMATIC MANUAL, 20105.....	\$ 3.95
FIRST-CLASS RADIOTELEPHONE LICENSE HANDBOOK (2nd Edition), 20086.....	\$ 5.75
LASERS AND MASERS, 20559.....	\$ 4.95
MARINE ELECTRONICS HANDBOOK (2nd Edition), 20277.....	\$ 5.50
MICROWAVE PRIMER, 20282.....	\$ 4.25
*MICROWAVE TEST AND MEASUREMENT TECHNIQUES, 20280.....	\$ 6.95
MOBILE AND MARINE STATION LICENSE MANUAL, 20285.....	\$ 7.50
RADAR LICENSE ENDORSEMENT HANDBOOK, 20330.....	\$ 3.75
RADIO OPERATORS LICENSE HANDBOOK, 20332.....	\$ 3.50
SECOND-CLASS RADIOTELEPHONE LICENSE HANDBOOK (3rd Edition), 20316.....	\$ 5.75
TELEVISION SYSTEMS MAINTENANCE, 20069.....	\$ 5.95
TELEVISION TAPE FUNDAMENTALS, 20065.....	\$ 5.95
TWO-WAY MOBILE RADIO MAINTENANCE (2nd Edition), 20478.....	\$ 4.95
UHF BUSINESS RADIO HANDBOOK, 20088.....	\$ 3.95
UNDERSTANDING AMPLITUDE MODULATION, 20514.....	\$ 3.95
WALKIE-TALKIE HANDBOOK, 20572.....	\$ 3.95
99 WAYS TO IMPROVE YOUR CB RADIO, 20515.....	\$ 2.95
101 QUESTIONS AND ANSWERS ABOUT CB OPERATIONS, 20604.....	\$ 2.50
101 QUESTIONS AND ANSWERS ABOUT CATV AND MATV, 20655.....	\$ 2.50

CIRCUITS and COMPONENTS

ABC's OF CAPACITORS, 20097.....	\$ 2.50
ABC's OF THERMOCOUPLES, 20586.....	\$ 2.95
ABC's OF TRANSISTORS (2nd Edition), 20440.....	\$ 2.75
ABC's OF TRANSFORMERS AND COILS, 20612.....	\$ 2.50
ABC's OF VARACTORS, 20508.....	\$ 2.75
APPLICATIONS HANDBOOK FOR ELECTRICAL CONNECTORS, 20161.....	\$ 3.95
BRIDGES AND OTHER NULL DEVICES, 20564.....	\$ 3.50
DC INSTRUMENTATION AMPLIFIERS, 20231.....	\$ 3.25
DESIGN AND OPERATION OF REGULATED POWER SUPPLIES (2nd Edition), 20333.....	\$ 3.75
DIODE CIRCUITS (2nd Edition), 20588.....	\$ 3.50
ELECTRONIC CABLE HANDBOOK, 20160.....	\$ 4.50
ELECTRONIC CORROSION CONTROL FOR BOATS, 20098.....	\$ 2.25
FET CIRCUITS, 20585.....	\$ 3.95
FREQUENCY CHANGERS, 20196.....	\$ 4.95
HANDBOOK OF ELECTRONIC CIRCUITS, 20214.....	\$ 1.75
HANDBOOK OF TRANSISTOR CIRCUITS, 20399.....	\$ 5.50
INDUSTRIAL TRANSISTOR CIRCUITS, 20245.....	\$ 2.75
MICROMINIATURE ELECTRONICS, 20582.....	\$ 5.75
PRACTICAL POWER SUPPLY CIRCUITS, 20571.....	\$ 2.95
PULSE CIRCUIT TECHNOLOGY, 20307.....	\$ 4.25
SILICON CONTROLLED RECTIFIERS, 20526.....	\$ 2.95
SOLID-STATE POWER SUPPLIES AND CONVERTERS, 20310.....	\$ 2.95
TRANSISTOR AF AND RF CIRCUITS, 20393.....	\$ 3.25
TRANSISTOR ETCHED-CIRCUIT PROJECTS, 20398.....	\$ 3.50
UNDERSTANDING ELECTRONIC CIRCUITS, 20484.....	\$ 3.95
UNDERSTANDING ELECTRONIC COMPONENTS, 20483.....	\$ 3.95

* Indicates hard-cover binding.



EDITORS and ENGINEERS, Ltd. Outstanding Publications

books on equipment design and building, ham radio, world electronic tubes

17TH EDITION OF THE WORLD-FAMOUS RADIO HANDBOOK

- the most comprehensive how-to-build-it source
- top problem solver for builders of practical equipment

Completely revised and enlarged by William I. Orr, W6SAI. This is the comprehensive communications manual which is the industry standard for electronic engineers, technicians, and advanced radio amateurs. **New How-to-Build Data:** The 17th Edition RADIO HANDBOOK presents design data on the latest amplifiers, transmitters, receivers, and transceivers. Includes greatly enlarged sections on single-sideband equipment and design, and semiconductors. Gives extended coverage to r-f amplifiers, and special vacuum-tube circuits. All equipment described is of modern design, free of TVI-producing problems. **Thoroughly Revised & Updated:** Provides a complete understanding of the theory and construction of all modern circuitry, semiconductors, antennas, power supplies; full data on workshop practice, test equipment, radio math and calculations. Includes aspects of the industrial and military electronics fields of special interest to the engineer and advanced amateur. All data is clearly indexed. 848 pages, 6½" x 9¼"; hardbound. Invaluable for electronic engineers, designers, builders, amateurs, and technicians.

Famous bestseller —
greater than ever

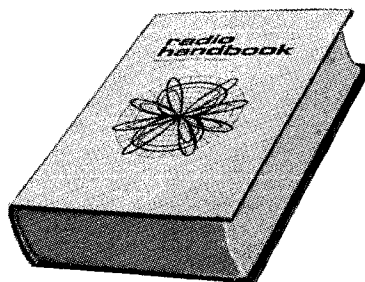

EE-167 \$12.95

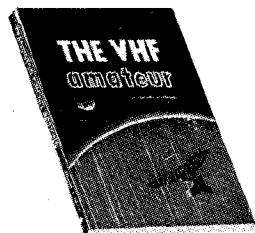

NEW! THE VHF AMATEUR by Robert M. Brown, K2ZSQ/W9HBF

A completely updated handbook packed with data on vital vhf subjects not available elsewhere. The author formerly published the famous **VHF Amateur** magazine, which had so important an impact in the ham world that many back issues are currently going for \$5 each. Not since **VHF Amateur** has there been available vhf-only data for the serious vhf student. This new handbook incorporates the finest material from the former publication of great interest to both old and new vhf men. 160 pages.

EE-65060 \$4.50

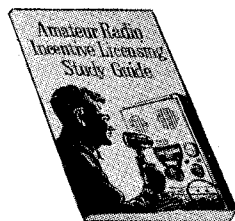

NEW! AMATEUR RADIO INCENTIVE LICENSING STUDY GUIDE

by Robert M. Brown, K2ZSQ/W9HBF, and Tom Kneitel, K2AES

Fully explains the new incentive licensing which affects both newcomers and old-timers. Covers all the new FCC Regulations and band allocations. Includes multiple-choice questions and answers (as close to actual FCC exams as possible) covering the new Advanced-Class, and the modified requirements for the Extra-Class exams. Also includes sample exams for Novice, Technician, Conditional, and General-Class licensing. 160 pages.

EE-050, only \$2.75

NEW! COMMERCIAL RADIOTELEPHONE LICENSE Q and A Study Guide

One convenient volume helps you prepare for all USA commercial radiotelephone license exams. Gives the basis for a sound understanding of every pertinent subject. Complete study-guide questions with clear, concise answers. Contains four sections: (1) Questions on Basic Laws; (2) Basic Operating Practice; (3) Basic Radiotelephone; (4) Advanced Radiotelephone. 272 pages.

EE-031 \$6.95



SINGLE SIDEBAND: Theory and Practice by Harry D. Hooton, W6TYH

The one-source guide to the entire timely subject of ssb. Covers the origin and principles of ssb, derivation of ssb signals, carrier suppression techniques, sideband selection, carrier generators, speech amplifiers and filters, ssb generators, balanced mixers and converters, low-power ssb transmitters, linear r-f amplifiers, ssb communications receivers, transceivers, tests and measurements. The definitive and best book available on single sideband theory and practice, comprehensively treated and easily understandable. 352 pages. Fully illustrated. Hardbound.

EE-350 \$6.95

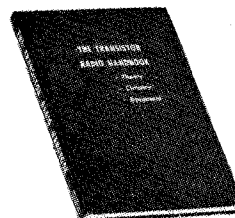

TRANSISTOR RADIO HANDBOOK — Transistor Communications Equipment

by Donald L. Stoner, W6TNS and Lester A. Earnshaw, ZL1AAX

Handbook covers a wide range of communication uses for both amateur radio and commercial applications. Simplified theory, plus practical construction projects including amplifiers, vhf equipment, single sideband exciters and a complete ssb transceiver. 180 pages. Hardbound.

EE-044 \$5.00

WORLD'S RADIO TUBES (Radio Tubes Vade Mecum)

Characteristics of all existing radio tubes made in all countries. The world's most comprehensive and authoritative tube book. All types classified numerically and alphabetically. To find a given tube is only a matter of seconds! Also complete section on base connections.

EE-504 \$11.00

WORLD'S EQUIVALENT TUBES (Equivalent Tubes Vade Mecum)

All replacement tubes for a given type, both exact and near-equivalents (with points of difference detailed). From normal tubes to the most advanced comparisons. Also military tubes of 7 nations, with commercial equivalents. Over 43,900 comparisons!

EE-493 \$9.00

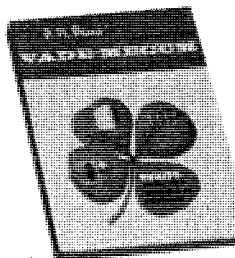

WORLD'S TELEVISION TUBES (Television Tubes Vade Mecum)

Characteristics of all TV picture, cathode ray, and many special purpose tubes. Invaluable to technicians and all specialists in the electronic field.

EE-482 \$9.00

THERMOSTATIC

AMPERITE

DELAY RELAYS

GLASS ENCLOSED • HERMETICALLY SEALED • A.C., D.C., OR PULSATING CURRENT



AMPERITE THERMOSTATIC DELAY RELAYS

Amperite Thermostatic Delay Relays are manufactured on automatic high production equipment — resulting in a low price — and top quality. Quality is not sacrificed at any point. For example, although contacts are rated at 3 amps, 10 amp contacts are actually used. Similarly with all other parts—only the best available are used.

Amperite Thermostatic Delay Relays are actuated by a heater . . . and therefore can be used on A.C., D.C., or pulsating current. Being hermetically sealed, Amperite Relays are not affected by altitude, moisture, or other atmospheric conditions. **REPLACED AS EASILY AS A RADIO TUBE.**

CIRCUITS SPST: Available only — normally open or normally closed.

HEATER VOLTAGES AVAILABLE: 2.5, 5.0, 6.3, 12.6, 26, 50, 115V.

For 220V use a 6500 ohm-5 watt resistor in series, with 115V heater.

HEATER WATTAGE: Standard and Miniature Relays—all voltages—2w prox. All heaters may be operated continuously. Heaters will not be damaged by a 50% voltage overload for duration of 1 hour or less.

Amperite Delay Relays are approved for all voltages up to and including 115V under the component regulations of Underwriters' Laboratories, Inc.

VARIATION OF DELAY WITH HEATER VOLTAGE

FIG. 1—Effect of change in heater voltage on delay in seconds. Only low voltage heaters (2.5 to 26 V.) incorporate heater voltage regulations as shown in diagram.

For 22 to 30 V. supply: We recommend Amperite Delay Relays with 26 V. heaters for airplanes and similar power supplies. These heaters are regulated for battery variation of 22 to 30 V. as shown in this diagram.

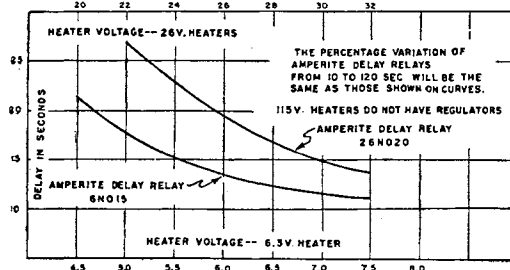

Figure 1

CONTACT RATING

	Delay	Contact Rating Non-Inductive	DC Voltage Contact-to-Contact	Breakdown Heater-to-Contact
STANDARD RELAYS	2 to 10 Sec.	115V - 3a AC	250V	500V
	15 to 180 Sec.	115V - 3a AC 220V - 1a AC	800V 800V	800V 800V
MINIATURE RELAYS	2 to 10 Sec.	115V - 2a AC	250V	500V
	15 to 180 Sec.	115V - 2a AC 220V - 1a AC	800V 800V	800V 800V
FLASHERS		- 1/2a AC		

CONTACT DROP: — 0.1V — Prox. at 1A.

DELAYS AVAILABLE:—From 2 to 180 seconds. Relays can be used in series to obtain longer delays. The delay of any individual relay up to 120 seconds can be increased up to 25% by using a resistor in series with the heater. Delays above 120 seconds cannot be increased. Relays with short delays such as 2 to 5 seconds can be increased 50%.

LIFE of any individual relay will depend on the service the contacts are subjected to. With a 115V — 2A A.C. non inductive load the contacts will withstand at least 250,000 operations. **SHELF LIFE** of Amperite Delay Relays is over 10 years.

INDUCTIVE A.C. LOADS: When breaking an inductive A.C. load, use a condenser of .01 to .1 mfd across contacts. In some cases, putting a 20,000 ohm, 5w. resistor across the contacts reduces the arcing considerably.

Relay Contacts should not be used on voltages above 220V.

FOR INSTANTANEOUS RECYCLE AND ELIMINATION OF CHATTER

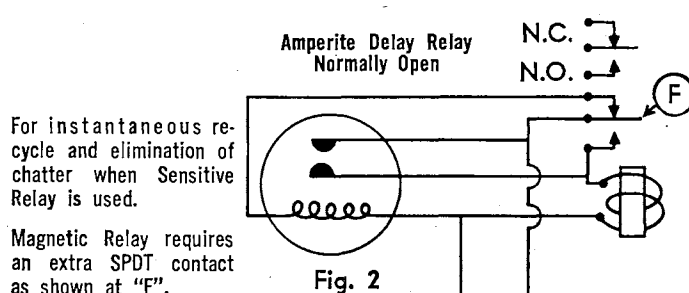
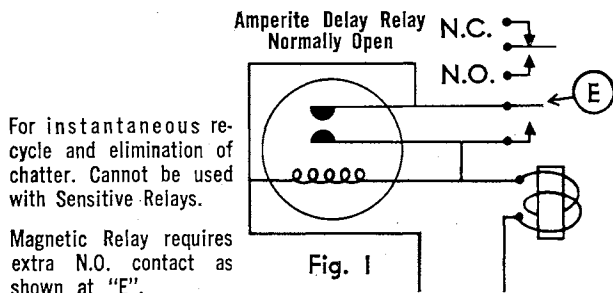

INSTANTANEOUS RECYCLE: This can be obtained by using a normally open Amperite Delay Relay in conjunction with a Magnetic Relay as shown above. If normally closed is required — use a normally open Amperite Delay Relay — and use the NC contacts on the magnetic relay. Choose the Amperite Delay Relay for the voltage required and the delay required (e.g. — 115N030 — would be used on 115 volt supply — for a 30 second delay).

LONG CYCLE RELAYS: are also available. For example, Amperite Delay Relay 115N07T has a delay in closing of 3 to 7 seconds. After heater is disconnected, contacts will remain closed for 30 seconds minimum. Write us about your requirements.

DOW-KEY COAXIAL RELAYS, SWITCHES AND CONNECTORS

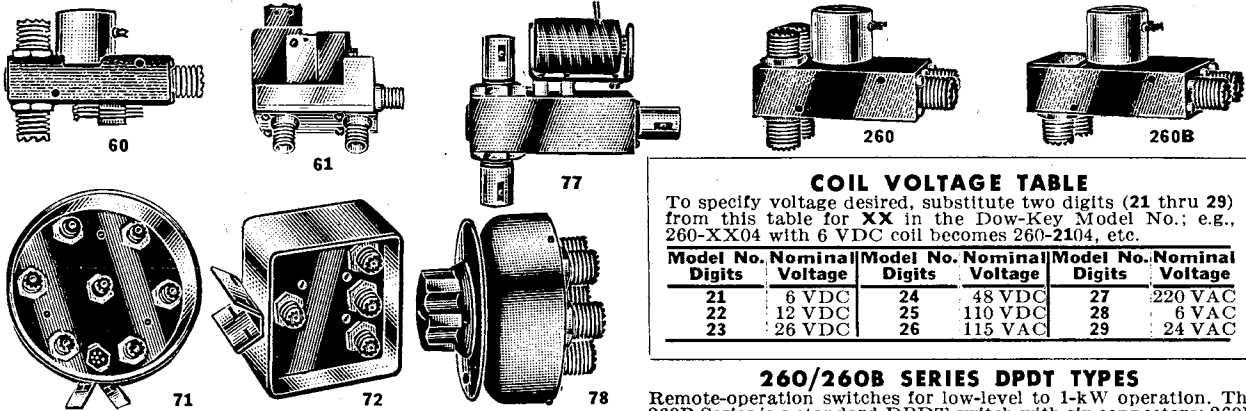

COIL VOLTAGE TABLE

To specify voltage desired, substitute two digits (21 thru 29) from this table for **XX** in the Dow-Key Model No.; e.g., 260-XX04 with 6 VDC coil becomes 260-2104, etc.

Model No.	Nominal Voltage	Model No.	Nominal Voltage	Model No.	Nominal Voltage
21	6 VDC	24	48 VDC	27	220 VAC
22	12 VDC	25	110 VDC	28	6 VAC
23	26 VDC	26	115 VDC	29	24 VAC

60 SERIES SPDT TYPES

Remote-operation SPDT coaxial relays for low-level to 1-kW operation. Available with 2 Form C auxiliary contacts, and with high isolation "G" connector at NC or receive position in transmit-receive applications. The "G" connector increases isolation to greater than -100 dB at up to 500 MHz, reduces the power rating to 20 W, and increases VSWR above 400 MHz. Range: 0 to 1000 MHz (UHF types not recommended for use above 400 MHz). RF power rating, 1 kW to 100 MHz; 750 W at 400 MHz; 500 W at 1000 MHz. VSWR, 1.05:1 0-50 MHz; 1.3:1 at 1000 MHz. Impedance, 50 ohms. Body size, 3.00" x 0.88" x 0.88". **Specify Coil Voltage:** 6, 12, 26, 48 or 110 VDC; or 115, 220, 6 or 24 VAC. See **Coil Voltage Table**.

Dow-Key Model	Conn. Type	With 2 Form C Aux Contacts	Net Each, Lots of			
			1-4	5-9	10-24	25-49
60-XX04*	UHF	No	\$14.85	\$13.50	\$12.15	\$10.80
60-XX0442*	UHF	Yes	16.50	15.00	13.50	12.00
60-XX28†	UHF	No	16.35	14.85	13.35	11.90
60-XX2842†	UHF	Yes	18.00	16.35	14.70	13.10
60-XX02*	BNC	No	16.60	15.05	13.55	12.05
60-XX0242*	BNC	Yes	18.25	16.55	14.90	13.25
60-XX26†	BNC	No	18.05	16.40	14.80	13.15
60-XX2642†	BNC	Yes	19.70	17.90	16.15	14.35
60-XX19	Solder	No	16.10	14.60	13.15	11.70
60-XX1942	Solder	Yes	17.75	16.10	14.50	12.90
60-XX35†	Solder	No	17.55	15.95	14.35	12.80
60-XX3542†	Solder	Yes	19.20	17.45	15.70	14.00

61 SERIES SPDT TYPES

Small switches for military and severe environmental requirements. Withstand applicable requirements of MIL-S-3928B specifications. Balanced armature actuator prevents contact chatter under high-frequency vibration and severe shock. Offered with many connector types and 1 or 2 Form C microswitch aux contacts. RF power rating, 150 W to 50 MHz; 75 W at 1000 MHz. VSWR, 1.03:1 0-50 MHz; 1.18:1 at 1000 MHz. Operating time, 15 msec max. Aux contact rating, 5 A at 115 VAC. Life expectancy, 1,000,000 cycles. Body size, 1.58" x 0.64" x 1.20" h, max. Wt., 3 1/2 to 4 oz. **Specify Coil Voltage:** 6, 12, 26, 48 or 110 VDC; or 115 VAC. See **Coil Voltage Table**.

Dow-Key Model	Conn. Type	With Aux Cont.		Net Each, Lots of			
		1 Form C	2 Form C	1-4	5-9	10-24	25-49
61-XX02*	BNC	No	No	\$28.95	\$26.30	\$23.70	\$21.05
61-XX0212*	BNC	Yes	No	29.80	27.05	24.35	21.65
61-XX0222*	BNC	No	Yes	30.60	27.80	25.05	22.25
61-XX03	TNC	No	No	28.95	26.30	23.70	21.05
61-XX0312	TNC	Yes	No	29.80	27.05	24.35	21.65
61-XX0322	TNC	No	Yes	30.60	27.80	25.05	22.25
61-XX19	Solder	No	No	27.20	24.75	22.25	19.80
61-XX1912	Solder	Yes	No	28.05	25.50	22.95	20.40
61-XX1922	Solder	No	Yes	28.85	26.25	23.60	21.00

77 SERIES SPDT TYPES

Medium-size, lightweight, low-priced coaxial switches for industrial and less critical military uses. T-shaped connector configuration has common connector at one end and NO and NC types 180° apart at other. Available with or without 1 Form C aux contact. RF power rating, 150 W to 50 MHz; 60 W at 1200 MHz. Impedance, 50 ohms. Size, 1.88" x 0.68" x 0.68". Weight, 3 oz. (Other specifications similar to 61 Series above.) **Specify Coil Voltage:** 6, 12, 26, 48 or 110 VDC (115 VAC available at additional cost). See **Coil Voltage Table**.

Dow-Key Model	Conn. Type	With 1 Form C Aux Cont.	Net Each, Lots of			
			1-4	5-9	10-24	25-49
77-XX0202*	BNC	No	\$11.50	\$10.50	\$ 9.45	\$ 8.40
77-XX0232*	BNC	Yes	12.75	11.60	10.45	9.30
77-XX0302	TNC	No	11.50	10.50	9.45	8.40
77-XX0332	TNC	Yes	12.75	11.60	10.45	9.30
77-XX0902	Phono	No	10.50	9.60	8.65	7.70
77-XX0932	Phono	Yes	11.75	10.70	9.65	8.60

*Available with mating plugs; prices on request. †With NC "G" connector as described.

Space does not permit listing various modifications or variations of the standard relays shown. The following types and variations of relays however, are also available.

1. Additional types of coaxial connectors on many relays.
2. 72-ohm type in some relays (50-ohm standard).
3. Gold plated contacts and others (silver contacts standard).

260/260B SERIES DPDT TYPES

Remote-operation switches for low-level to 1-kW operation. The 260B Series is a standard DPDT switch with six connectors; 260B Series similar but has internal connection between its NC contacts, leaving only four connectors; 260B is widely used for inserting a circuit element between two normally connected elements (e.g., inserting power amplifier between exciter and antenna). RF power rating, 1 kW to 100 MHz; 750 W at 400 MHz. VSWR, 1.05:1 0-50 MHz; 1.06:1 100 MHz; 1.12:1 at 400 MHz. Impedance, 50 ohms. Aux contacts rated 5 A, 115 VAC. Operating time 25 msec approx. Life, 1,000,000 cycles. With UHF connectors (others available). Body size, 3.00" x 1.75" x 0.88". Weight, 12 oz. approx. **Specify Coil Voltage:** 6, 12, 26, 48 or 100 VDC; or 115, 220, 6 or 24 VAC. See **Coil Voltage Table**.

Dow-Key Model	With 2 Form C Aux Contacts	Net Each, Lots of			
		1-4	5-9	10-24	25-49
260-XX04	No	\$24.75	\$22.50	\$20.25	\$18.00
260-XX0442	Yes	26.40	24.00	21.60	19.20
260B-XX04	No	23.90	21.75	19.55	17.40
260B-XX0442	Yes	25.55	23.25	20.90	18.60

71/72 SERIES MULTI-POSITION TYPES

Weatherproof, high power switches for switching antennas, transmitters or receivers up to 500 MHz. Separate actuating coil for each position. RF power rating, 1 kW to 200 MHz; 750 W at 500 MHz. VSWR, 1.06:1 0-50 MHz; 1.3:1 at 500 MHz. Impedance, 50 ohms. Operating time, 25 msec approx. Life, 500,000 cycles per position. With UHF connectors (BNC, C, N, TNC connectors available). Body size, 71 Series, 4" x 3.5" x 2.62"; 72 Series, 5.75" dia. x 2.75" d. Wt., 71 Series, 3 lbs. approx.; 72 Series, 1 1/2 lbs. approx. **Specify Coil Voltage:** 6, 12, 26, 48 or 110 VDC; or 115, 220, 6 or 24 VAC. See **Coil Voltage Table**.

Dow-Key Model	Description	Net Each, Lots of			
		1-4	5-9	10-24	25-49
71-XX0401	SP6T shorting	\$57.75	\$52.50	\$47.25	\$42.00
71-XX0402	SP6T non-shorting	61.85	56.25	50.60	45.00
72-XX0401	SP3T shorting	27.20	24.75	22.25	19.80
72-XX0402	SP3T non-shorting	31.35	28.50	25.65	22.80

78 SERIES MULTI-POSITION TYPES

Manually operated switches with true coaxial switching members (not wafer switches). Useful frequency range, 0 to 500 MHz. RF power rating, 1.5 kW at 50 MHz; 1 kW at 100 and 400 MHz. VSWR, 1.05:1 at 50 MHz; 1.15:1 at 400 MHz. Impedance, 50 ohms. Crosstalk, 60 dB at 50 MHz; 45 dB at 400 MHz. Insertion loss, .03 dB at 50 MHz; .05 dB at 400 MHz. Dial plate and knob included. With UHF connectors (also available with BNC, C, N, TNC connectors). Size, 3" dia. x 1" deep. Weight, 10 oz. approx.

Dow-Key Model	Function	Net Each, Lots of			
		1-4	5-9	10-24	25-49
78-0204	SPDT	\$14.00	\$12.75	\$11.45	\$10.20
78-0304	SP3T	14.45	13.10	11.80	10.50
78-0404	SP4T	15.05	13.80	12.40	11.05
78-0604	SP6T	15.65	14.25	12.80	11.40
78-0704	D&DT	17.65	16.10	14.50	12.90
78-0904	Transfer	16.65	15.20	13.70	12.20

UHF CONNECTORS AND ADAPTERS

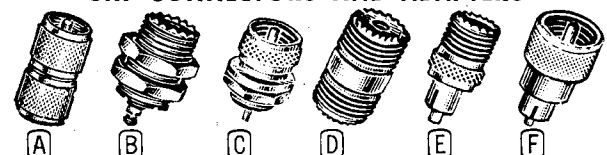

Types C-201, C-60P and C-60PT have UHF female or male connector to solder terminal, and mount through panels 1/8" thick max. C-201 mounts through 5/8" hole. C-60P mounts into 5/8-24 tapped hole or through 5/8" hole. C-60PT similar to C-60P except Tefton® insulation and better impedance match.

*Registered DuPont TM.

Dow-Key Model	Fig.	Description	Lg., In.	Net Each, Lots of			
				1-4	5-9	10-24	25-49
A-F2P	A	UHF double male	1.00	\$0.76	\$0.69	\$0.62	\$0.54
C-60P	B	UHF panel-mount female	1.19	.69	.63	.57	.50
C-60PT	B	UHF panel-mount female	1.19	.99	.90	.81	.72
C-201	C	UHF panel-mount male	1.40	1.07	.97	.87	.78
A-202	D	UHF double female	1.12	.82	.75	.67	.60
A-210	E	UHF fem. to male phono	1.30	1.24	1.12	1.01	.90
A-211	F	UHF male to male phono	1.34	1.32	1.20	1.08	.96



ALLIED CONTROL

ALLIED CONTROL COMPANY INC.

GENERAL PURPOSE RELAYS

RELAY TYPE ¹	COIL VOLTAGE OR CURRENT	CONTACTS FORMS	AMPS ²	COIL POWER AT 25°C	COIL RESIST. OHMS ³	NET PRICE	OUTLINE DRAWING	DESCRIPTION
TF154-2C								Features no internal wiring, contact arms extended to form combination solder and plug-in terminals Terminals: Elongated holes .080 x .040 Enclosure: Dust cover Weight: 0.80 ounces max. Socket: Allied type 30055-1
TF154-2C	6v d-c	DPDT	5	700 mw	52	\$3.37		
TF154-2C	12v d-c	DPDT	5	700 mw	185	3.37		
TF154-2C	24v d-c	DPDT	5	700 mw	700	3.37		
TF154-2C	48v d-c	DPDT	5	700 mw	2500	3.37		
TF154-2C	115v d-c	DPDT	5	700 mw	15000	5.07		
TF154-4C								Features no internal wiring, contact arms extended to form combination solder and plug-in terminals Terminals: Elongated holes .080 x .040 Enclosure: Dust cover Weight: 0.95 ounces max. Socket: Allied type 30055-2
TF154-4C	6v d-c	4PDT	5	700 mw	52	3.87		
TF154-4C	12v d-c	4PDT	5	700 mw	185	3.87		
TF154-4C	24v d-c	4PDT	5	700 mw	700	3.87		
TF154-4C	48v d-c	4PDT	5	700 mw	2500	3.87		
TF154-4C	115v d-c	4PDT	5	700 mw	15000	5.57		
TF154-6C								Features no internal wiring, contact arms extended to form combination solder and plug-in terminals Terminals: Elongated holes .080 x .040 Enclosure: Dust cover Weight: 1.0 ounces max. Socket: Allied type 30055-20
TF154-6C	6v d-c	6PDT	5	1.5 w	25	5.02		
TF154-6C	12v d-c	6PDT	5	1.5 w	90	5.02		
TF154-6C	24v d-c	6PDT	5	1.5 w	430	5.02		
TF154-6C	48v d-c	6PDT	5	1.5 w	1550	5.02		
TF154-6C	115v d-c	6PDT	5	1.5 w	9000	5.92		

CRADLE MAGNETIC LATCHING

T351—SINGLE COIL							Designed for pulse operation. In the single coil version a pulse of 10 milliseconds minimal duration is required to activate the armature. Weight: 2C-2 oz. 4C-4 oz. Socket: 2C-30055-1 4C-30055-2
RELAY TYPE ¹	COIL VOLTAGE OR CURRENT	CONTACTS FORMS	AMPS ²	COIL POWER AT 25°C	COIL RESIST. OHMS ³	NET PRICE	
T351-2C	6v d-c	DPDT	1	900 mw	40	\$5.00	The dual coil functions similarly to the single wound version except that while the armature is actuated by a pulse applied to one winding it is reset by pulsing the second winding. Weight: 2C-2 oz. 4C-4 oz. Socket: 2C-30055-1 4C-30055-2
T351-2C	12v d-c	DPDT	1	900 mw	166	5.00	
T351-2C	24v d-c	DPDT	1	900 mw	630	5.00	
T351-2C	48v d-c	DPDT	1	900 mw	2640	5.20	
T351-2C	110v d-c	DPDT	1	900 mw	13800	6.40	
TF351-2C	6v d-c	DPDT	5	900 mw	40	5.12	
TF351-2C	12v d-c	DPDT	5	900 mw	166	5.12	
TF351-2C	24v d-c	DPDT	5	900 mw	630	5.12	
TF351-2C	48v d-c	DPDT	5	900 mw	2640	5.32	
TF351-2C	110v d-c	DPDT	5	900 mw	13800	6.52	
T351-4C	6v d-c	4PDT	1	900 mw	40	5.50	
T351-4C	12v d-c	4PDT	1	900 mw	166	5.50	
T351-4C	24v d-c	4PDT	1	900 mw	630	5.50	
T351-4C	48v d-c	4PDT	1	900 mw	2640	5.70	
T351-4C	110v d-c	4PDT	1	900 mw	13800	6.90	
T351—DUAL COIL							
T351-2C	2/6v d-c	DPDT	1	1.2 w	31.5	6.00	
T351-2C	2/12v d-c	DPDT	1	1.2 w	134	6.00	
T351-2C	2/24v d-c	DPDT	1	1.2 w	485	6.00	
T351-2C	2/48v d-c	DPDT	1	1.2 w	1760	6.40	
T351-2C	2/110v d-c	DPDT	1	1.2 w	9600	8.80	
T351-4C	2/6v d-c	4PDT	1	1.2 w	31.5	6.74	
T351-4C	2/12v d-c	4PDT	1	1.2 w	134	6.74	
T351-4C	2/24v d-c	4PDT	1	1.2 w	485	6.74	
T351-4C	2/48v d-c	4PDT	1	1.2 w	1760	7.14	
T351-4C	2/110v d-c	4PDT	1	1.2 w	9600	9.54	
TF351-2C	2/6v d-c	DPDT	5	1.2 w	31.5	6.12	
TF351-2C	2/12v d-c	DPDT	5	1.2 w	134	6.12	
TF351-2C	2/24v d-c	DPDT	5	1.2 w	485	6.12	
TF351-2C	2/48v d-c	DPDT	5	1.2 w	1760	6.52	
TF351-2C	2/110v d-c	DPDT	5	1.2 w	9600	8.92	



ALLIED CONTROL ALLIED CONTROL COMPANY INC.

SENSITIVE and PLATE CIRCUIT RELAYS



	COIL RELAY TYPE ¹	VOLTAGE OR CURRENT	CONTACTS FORMS	AMPS ²	COIL POWER AT 25°C	COIL RESIST. OHMS ³	OUTLINE DRAWING	DESCRIPTION
	WJS-3D	3.2 ma d-c	SPDT	3	25 mw	2500	 MOUNTING - 125 DIA HOLES (2)	Vibration: 15g to 2000 cps Shock: 50g operational Operate: 15 milliseconds Release: 10 milliseconds Temp: -65°C to +125°C Weight: 1.0 ounces max. Welded Construction
	WJS-3D	2.2 ma d-c	SPDT	3	25 mw	5000		
	WJS-3D	1.6 ma d-c	SPDT	3	25 mw	10000		
	WJS-6D	4.0 ma d-c	DPDT	3	40 mw	2500		
	WJS-6D	2.8 ma d-c	DPDT	3	40 mw	5000		
	WJS-6D	2.0 ma d-c	DPDT	3	40 mw	10000		
	WJSO-6D	2.8 ma d-c	DPDT	3	40 mw	5000	 MOUNTING - 170 DIA HOLES (2)	Vibration: 15g to 2000 cps Shock: 50g operational Operate: 15 milliseconds Release: 10 milliseconds Temp: -65°C to +125°C Weight: 1.0 ounces max. Socket: Armel type HRC-1 or equiv. Welded Construction
	WJSO-6D	2.0 ma d-c	DPDT	3	40 mw	10000		
	TFMOO-2C	9.5 ma d-c	DPDT	5	220 mw	2500		Inclosed in a transparent polycarbonate cover and rigidly secured to base. Enclosure: Dust cover Weight: 2.5 ounces max. Socket: Any std. RETMA or EIA octal
	TFMOO-2C	7.0 ma d-c	DPDT	5	250 mw	5000		
	TFMOO-2C	5.5 ma d-c	DPDT	5	300 mw	10000		
	TFT-2C	9.5 ma d-c	DPDT	5	220 mw	2500		Subminiature with small size moving parts resulting in quick release and exceptional contact rating. Terminals: Elongated holes .080 x .040 Weight: 0.70 ounces max. Mounting: (4) 4-48NF 2B tapped holes
	TFT-2C	7.0 ma d-c	DPDT	5	250 mw	5000		
	TFT-2C	5.5 ma d-c	DPDT	5	300 mw	10000		
	TS154-2C	5.8 ma d-c	DPDT	1	85 mw	2500	 DUST COVER 3-48 NC-2A STUD Elongated Holes .080 x .040	Features no internal wiring. Contact arms extend to form combination solder and plug in terminals. Terminals: Printed circuit available as type TSP-154 Enclosure: Dust cover Weight: 0.80 ounces max. Socket: Allied type 30055-1
	TS154-2C	4.1 ma d-c	DPDT	1	85 mw	5000		
	TS154-2C	3.1 ma d-c	DPDT	1	85 mw	10000		
	TS154-4C	8.4 ma d-c	4PDT	1	175 mw	2500	 DUST COVER 3-48NC-2A STUD Elongated Holes .080 x .040	Features no internal wiring. Contact arms extend to form combination solder and plug in terminals. Terminals: Printed circuit available as type TSP-154 Enclosure: Dust cover Weight: 0.95 ounces max. Socket: Allied type 30055-2
	TS154-4C	6.2 ma d-c	4PDT	1	175 mw	5000		
	TS154-4C	4.5 ma d-c	4PDT	1	175 mw	10000		
	WKJ-6D	6v d-c	DPDT	3	1.5 w	40	 MOUNTING - 80 DIA HOLES (2)	Vibration: 20g to 2000 cps Shock: 100g operational Operate: 5 milliseconds Release: 3 milliseconds Temp: 65°C to +125°C Weight: 0.5 ounces max. Plug-in: Type WKJO (not shown) Socket: Armel type HRC-1 or equivalent
	WKJ-6D	12v d-c	DPDT	3	1.5 w	150		
	WKJ-6D	26.5v d-c	DPDT	3	1.5 w	600		
	WKJ-6D	48v d-c	DPDT	3	1.5 w	2320		
	WKJ-6D	115v d-c	DPDT	3	1.5 w	10000		
	WKJO-6D	26.5v d-c	DPDT	3	1.5 w	600		

SUBMINIATURE TYPE RELAYS

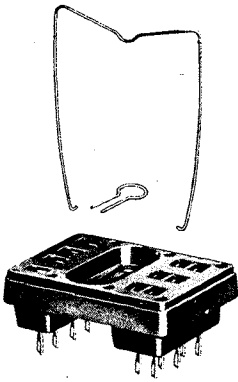
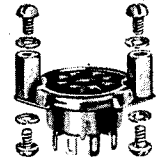
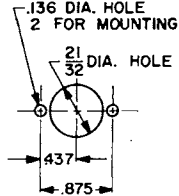
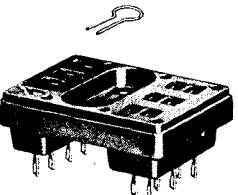

ALLIED CONTROL ALLIED CONTROL COMPANY INC.

SOCKETS - RETAINERS

SOCKET NUMBER	RELAY TYPE	PRICE	SOCKET NUMBER	RELAY TYPE	PANEL LAYOUT	
	30055-1	T154-2C		16479-1	MHO-6D (Above chassis mtg.)	
	30055-1	T163-2C		16185-1	MHLO-12D (Below chassis mtg.)	
	30055-1	T351-2C		30055-1	\$.55	
	30055-2	T154-4C		30055-2	\$.60	
	30055-2	T163-4C		30055-3	\$.72	
	30055-2	T351-4C		30055-4	\$.88	
	30055-20	T154-6C		30055-5	\$.55	
	30055-20	T163-6C		30055-6	\$.70	
	30055-20	T163-6C		30055-8	\$.70	
	30054-1	T154-2C	30055-20	\$.95		
	30054-1	T163-2C	30055-24	\$.95		
	30054-1	T255-2C	30054-1	\$.50		
	30054-2	T154-4C	30054-2	\$.55		
	30054-2	T163-4C	30054-20	\$.90		
	30054-2	T255-4C	30040-1	\$.05		
	30054-20	T154-6C	30040-2	\$.05		
	30054-20	T163-6C	30040-3	\$.05		
	30054-20	T163-6C	30040-4	\$.05		
30054-20	T163-6C	30040-5	\$.05			
	30040-1	T154-2C	16479-1	1.25		
	30040-1	T163-2C	16185-1	1.42		
	30040-2	T154-4C	16188-1	1.42		
	30040-2	T163-4C	16187-1	1.64		
	30040-3	T154-6C	16189-1	1.64		
	30040-3	T163-6C				
	30040-4	T255-2C				
	30040-5	T255-4C				
<p>NOTE: STANDARD PACKAGE FOR SOCKETS—20 STANDARD PACKAGE FOR RETAINERS—100</p>						
<p>DESCRIPTION Hardware: Ground wire Hardware Material: Stainless steel 18-8, Type 302 Contacts: Beryllium copper, gold plated Insulator: Black phenolic per Mil-P-14D CFG Chassis Thickness: .062 recommended</p>			<p>DESCRIPTION Hardware: Saddle, spacers, screws and washers Hardware Finish: Cadmium plated Contacts: Beryllium copper, silver plated, tin dipped Insulator: Mica-filled phenolic Chassis Thickness: .062 recommended</p>			

GENERAL INFORMATION

- 1—Relay type—the letter H designates a hermetically sealed unit.
- 2—Contact ratings are for a resistive load at 29 volts d-c. Low level contacts are available except on Power Relays and Types AS, BJ, CH, MHY and MHYO.
- 3—Ohms—d-c resistance, standard tolerance $\pm 10\%$
- 4—Contact ratings are for a resistive load at 29 volts d-c or 115 volts a-c.
- 5—Other mounting variations are available.

How to order: Specify Allied relay type and coil voltage or current Example: MHYO-12D 26.5v d-c TS154-4C 8.4 ma d-c

TELEPHONE RELAYS

TYPE 2 Dependable and versatile, the Type 2 is the "workhorse" of relays. It operates millions of times with reliability and requires little attention during its long life. An unusually large number of variations in contact assemblies, contact materials, coils, adjustments, and mounting arrangements are available.

On special order:

Operating Voltage: Up to 750 volts DC. Up to 440 volts AC, 60 cycles.

Resistance: Up to 50,000 ohms, single or double wound.

Standard Contacts: 18 ga. palladium, rated 3 amps, 150W. resistive. (Gold Flashed)

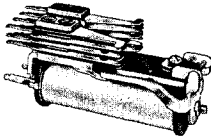

LONG FRAME

Type (DC)	Coil Voltage	Contact Arrange.	Coil Res. (Ohms)	Operate Curr. (Amps)	Operate Time (Sec.)	Resale
2DC-6-2C	6	DPDT	50	.048	.030	7.20
2DC-6-6C	6	6PDT	50	.090	.065	11.20
2DC-24-2C	24	DPDT	600	.015	.025	7.50
2DC-24-6C	24	6PDT	600	.024	.050	11.50
2DC-48-4C	48	4PDT	2,000	.011	.040	7.70
2DC-48-6C	48	6PDT	2,000	.013	.050	11.70
2DC-115-1C	115	SPDT	3,600	.0045	.010	7.00
2DC-115-3C	115	3PDT	3,600	.008	.015	9.25
2DC-230-2C	230	DPDT	10,000	.004	.010	8.80
2DC-230-4C	230	4PDT	10,000	.006	.050	10.80

Type (AC)	Coil Voltage	Contact Arrange.	Coil Res. (Ohms)	Curr. Drain (Amps)	Pick-up Volt. (AC)	Resale
2AC-6-1C	6	SPDT	0.2	1	4.5	7.10
2AC-6-4C	6	4PDT	0.2	1	4.5	8.60
2AC-24-2C	24	DPDT	4	.24	21	7.55
2AC-24-4C	24	4PDT	4	.24	21	8.60
2AC-115-1C	115	SPDT	100	.08	100	7.50
2AC-115-3C	115	3PDT	100	.08	100	9.70

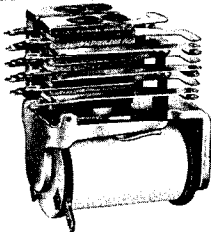

SHORT FRAME

TYPE 4C Relays constructed on the same general design of compact assembly and possess similar specifications. The heelpiece, armature and coil core are made of annealed magnetic iron, with the heelpiece acting as a return path for the magnetic circuit. The armature is pivoted on long-life bearings to insure constant pickup and drop-out adjustment. Standard relays are supplied with solder terminals for contact springs and coils.

Standard Contacts: 18 ga. palladium, rated 3 amps, 150W. resistive. (Gold Flashed)

TYPE (DC)	CONTACT ARRANGE.	COIL RES. OHMS	Resale
4CDC-6-2C	DPDT	30	5.30
4CDC-12-2C	DPDT	75	5.30
4CDC-24-2C	DPDT	425	5.30
4CDC-115-2C	DPDT	6500	5.80
4CDC-6-4C	4PDT	30	7.05
4CDC-12-4C	4PDT	75	7.05

TYPE (DC)	CONTACT ARRANGE.	COIL RES. OHMS	Resale
4CDC-24-4C	4PDT	425	7.05
4CDC-115-4C	4PDT	6500	7.65
4CDC-12-6C	6PDT	75	8.60
4CDC-24-6C	6PDT	425	8.65
4CDC-115-6C	6PDT	6500	9.20

TYPE 8PI Small versatile multi-contact telephone type relays. They have specific spring forms, mating flush-mounted sockets and clear plastic covers that snap over the socket; offer prewiring of sockets; fast installation or removal. Available with many variations in coils, contact assemblies, contact ratings, adjustments, terminal arrangements and mountings for a variety of applications. Standard contact blades are made of spring temper nickel silver, designed to give true independent twin contact operation. Available in: 1.) Plug in; 2.) Taper Tab; 3.) Solder Terminal. Supplied less socket and cover.

Operating Voltage: Up to 300 volts D.C., 115 volts A.C.

Resistance: Up to 21,000 ohms. Single or double wound.

Standard Contacts: Twin palladium, rated 4 amps, 175W. resistive (Gold Flashed.)

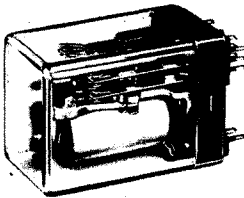

TYPE 8PI

TYPE (DC)	COIL RES. (OHMS)	CONTACT ARRANGE.	Resale
8DC-PI-12-4C	100	4PDT	8.25
8DC-PI-12-6C	100	6PDT	11.30
8DC-PI-12-8C	100	8PDT	13.75
8DC-PI-24-4C	300	4PDT	8.25
8DC-PI-24-6C	300	6PDT	11.30
8DC-PI-24-8C	300	8PDT	13.75
8DC-PI-115-4C	8000	4PDT	9.80
8DC-PI-115-6C	8000	6PDT	12.15
8DC-PI-115-8C	8000	8PDT	14.60

TYPE (AC)	COIL RES. (OHMS)	CONTACT ARRANGE.	Resale
8AC-PI-115-4C	1300	4PDT	10.60
8AC-PI-115-6C	1300	6PDT	13.65
8AC-PI-115-8C	1300	8PDT	16.10

SOCKETS

PART NUMBER	TOTAL CONTACTS	PLATING
218-14-1	16 (12 SPRINGS, 4 COILS) †	CADMIUM
218-14-2	16 (12 SPRINGS, 4 COILS) †	GOLD
218-15-1	28 (24 SPRINGS, 4 COILS) ‡	CADMIUM
218-15-2	28 (24 SPRINGS, 4 COILS) ‡	GOLD

† WILL ACCOMMODATE 4 C'S

‡ WILL ACCOMMODATE 8 C'S

DIMENSIONAL DETAILS AVAILABLE FROM HART-ADVANCE.

PLASTIC COVERS

PART NUMBER	DIMENSIONS
65-85-1	1 25/64 X 1 45/64 X 2 5/8
67-85-2	1 25/64 X 2 7/64 X 2 5/8



BRKT. 29-331 USED WITH COVER LESS SOCKET

POWER RELAYS

TYPE PC Compact and positive-acting relays for either AC or DC. Used in air conditioning and lighting systems, small motor starting, transformers, garage door openers—wherever dependable circuit switching is necessary. Contacts rated at 15 Amps resistive, 5 Amps inductive at 115VAC or 26.5 VDC.

Dimensions: H. 1 1/8", W. 1 1/8", L. 2 1/8"—1 & 2 pole.
H. 1 1/8", W. 2 3/4", L. 3 1/4"—3 & 4 pole.

Mounting Data: 2 tapped holes 6-32 NC-2; 2" centers.

Weight: 8 oz.

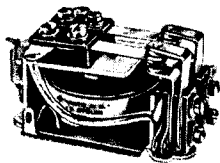

TYPE	COIL RESISTANCE (OHMS)	CONTACTS FORM	RATING (AMPS)	Resale
PC/1C/6VA	1.6	SPDT	15	4.55
PC/1C/12VA	4	SPDT	15	4.55
PC/1C/24VA	16	SPDT	15	4.55
PC/1C/115VA	450	SPDT	15	4.55
PC/1C/220VA	1600	SPDT	15	5.70
PC/1C/6VD	16	SPDT	15	4.55
PC/1C/12VD	63	SPDT	15	4.55
PC/1C/24VD	250	SPDT	15	4.55
PC/1C/110VD	4000	SPDT	15	5.15
PC/2C/6VA	1.6	DPDT	15	6.85
PC/2C/12VA	4	DPDT	15	6.85
PC/2C/24VA	16	DPDT	15	6.85

TYPE	COIL RESISTANCE (OHMS)	CONTACTS FORM	RATING (AMPS)	Resale
PC/2C/115VA	450	DPDT	15	6.85
PC/2C/220VA	1600	DPDT	15	8.00
PC/2C/6VD	16	DPDT	15	6.85
PC/2C/12VD	63	DPDT	15	6.85
PC/2C/24VD	250	DPDT	15	6.85
PC/2C/110VD	4000	DPDT	15	7.55
PC/3C/6VA	1.6	3PDT	15	9.75
PC/3C/24VA	16	3PDT	15	9.75
PC/3C/115VA	450	3PDT	15	9.75
PC/3C/220VA	1600	3PDT	15	11.05
PC/3C/6VD	16	3PDT	15	9.75
PC/3C/12VD	63	3PDT	15	9.75
PC/3C/24VD	250	3PDT	15	9.75
PC/3C/110VD	4000	3PDT	15	10.30
PC/4C/6VA	1.6	4PDT	15	12.60
PC/4C/24VA	16	4PDT	15	12.60
PC/4C/115VA	450	4PDT	15	12.60
PC/4C/220VA	1600	4PDT	15	14.35
PC/4C/6VD	16	4PDT	15	12.60
PC/4C/12VD	63	4PDT	15	12.60
PC/4C/24VD	250	4PDT	15	12.60
PC/4C/110VD	4000	4PDT	15	13.20

Note: PC/3C and PC/4C not available in 12 volts AC.

TYPES—GHA—GHP Low-cost continuous-duty general purpose relay. Contacts rated at 5 amps resistive load. Available as an open relay (GHA) or with a dustite plastic enclosure (GHP). Enclosed types with SPDT and DPDT contacts have 8 pin octal plug-in bases while the 3PDT types use 11 pin plug-in bases. Open relays supplied with axial type solder lugs. UL (Underwriters Laboratories) approval granted on types GHA1C and GHA2C.

Dimensions: Open Style—1 7/8" x 1 1/4" x 1 1/2"
Enclosed Style—1 1/2" x 1 1/4" x 2 1/8".



TYPE	COIL RESISTANCE (OHMS)	FORM	CONTACTS RATING (AMPS)	Resole
GHA/1C/6VA	4	SPDT	5	3.20
GHA/1C/12VA	16	SPDT	5	3.20
GHA/1C/24VA	63	SPDT	5	3.20
GHA/1C/115VA	1600	SPDT	5	3.20
GHA/1C/220VA	5000	SPDT	5	3.75
GHA/1C/6VD	25	SPDT	5	3.20
GHA/1C/12VD	100	SPDT	5	3.20
GHA/1C/24VD	400	SPDT	5	3.20
GHA/1C/110VD	8000	SPDT	5	3.75
GHA/2C/6VA	4	DPDT	5	3.75
GHA/2C/12VA	16	DPDT	5	3.75
GHA/2C/24VA	63	DPDT	5	3.75
GHA/2C/115VA	1600	DPDT	5	3.75
GHA/2C/220VA	5000	DPDT	5	4.25
GHA/2C/6VD	25	DPDT	5	3.50
GHA/2C/12VD	100	DPDT	5	3.50
GHA/2C/24VD	400	DPDT	5	3.50
GHA/2C/110VD	8000	DPDT	5	4.05
GHA/3C/6VA	4	3PDT	5	4.25
GHA/3C/12VA	16	3PDT	5	4.25
GHA/3C/24VA	63	3PDT	5	4.25
GHA/3C/115VA	1600	3PDT	5	4.25

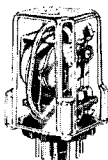

TYPE	COIL RESISTANCE (OHMS)	FORM	CONTACTS RATING (AMPS)	Resole
GHA/3C/220VA	5000	3PDT	5	4.80
GHA/3C/6VD	25	3PDT	5	4.05
GHA/3C/12VD	100	3PDT	5	4.05
GHA/3C/24VD	400	3PDT	5	4.05
GHA/3C/110VD	8000	3PDT	5	4.45
GHP/1C/6VA	4	SPDT	5	5.35
GHP/1C/12VA	16	SPDT	5	5.35
GHP/1C/24VA	63	SPDT	5	5.35
GHP/1C/115VA	1600	SPDT	5	5.35
GHP/1C/6VD	25	SPDT	5	5.40
GHP/1C/12VD	100	SPDT	5	5.40
GHP/1C/24VD	400	SPDT	5	5.40
GHP/1C/110VD	8000	SPDT	5	5.95
GHP/2C/6VA	4	DPDT	5	6.05
GHP/2C/12VA	16	DPDT	5	6.05
GHP/2C/24VA	63	DPDT	5	6.05
GHP/2C/115VA	1600	DPDT	5	6.05
GHP/2C/220VA	5000	DPDT	5	6.55
GHP/2C/6VD	25	DPDT	5	5.95
GHP/2C/12VD	100	DPDT	5	5.95
GHP/2C/24VD	400	DPDT	5	5.95
GHP/2C/110VD	8000	DPDT	5	6.45
GHP/3C/6VA	4	3PDT	5	7.40
GHP/3C/24VA	63	3PDT	5	7.40
GHP/3C/115VA	1600	3PDT	5	7.40
GHP/3C/220VA	5000	3PDT	5	7.95
GHP/3C/6VD	25	3PDT	5	7.30
GHP/3C/12VD	100	3PDT	5	7.30
GHP/3C/24VD	400	3PDT	5	7.30
GHP/3C/110VD	8000	3PDT	5	7.85

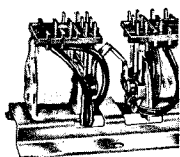

LATCHING

TYPE LGA Used in industrial and power control applications where it is desirable to eliminate continuous use of current consumption by the duty coil. Latching mechanism is positive and assures consistent performance. Both operate and reset coils are electrically operated.

Dimensions: 1 3/4" x 1 1/2" x 3 1/2".
Two 6-32 mounting holes on 1 3/8" centers.

TYPE	COIL RESISTANCE (BOTH COILS) (OHMS)	FORM	CONTACTS RATING (AMPS)	Resole
LGA/4C/24VA	40	4PDT	5	11.00
LGA/4C/115VA	1000	4PDT	5	11.00
LGA/4C/6VD	16	4PDT	5	9.85
LGA/4C/12VD	63	4PDT	5	9.85
LGA/4C/24VD	250	4PDT	5	9.85
LGA/4C/110VD	5000	4PDT	5	11.05
LGA/6C/24VA	40	6PDT	5	13.15
LGA/6C/115VA	1000	6PDT	5	13.15
LGA/6C/6VD	16	6PDT	5	11.95
LGA/6C/12VD	63	6PDT	5	11.95
LGA/6C/24VD	250	6PDT	5	11.95
LGA/6C/110VD	5000	6PDT	5	13.20

TYPES GHB—GHH Similar in size and mounting to the GHA and GHP types shown above with contacts rated at 10 amps resistive. GHB is open style with axial leads and GHH utilizes plastic enclosure and plug-in base. UL Listing granted on types GHB/1C and GHB/2C.

Dimensions: Open Style—1 7/8" x 1 1/4" x 1 1/2"
Enclosed Style—1 1/2" x 1 1/4" x 2 1/8".

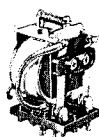

TYPE	COIL RESISTANCE (OHMS)	FORM	CONTACTS RATING (AMPS)	Resole
GHB/1C/6VA	4	SPDT	10	3.70
GHB/1C/12VA	16	SPDT	10	3.70
GHB/1C/24VA	63	SPDT	10	3.70
GHB/1C/115VA	1600	SPDT	10	3.70
GHB/1C/6VD	25	SPDT	10	3.70
GHB/1C/12VD	100	SPDT	10	3.70
GHB/1C/24VD	400	SPDT	10	3.70
GHB/2C/6VA	4	DPDT	10	4.25
GHB/2C/12VA	16	DPDT	10	4.25
GHB/2C/24VA	63	DPDT	10	4.25
GHB/2C/115VA	1600	DPDT	10	4.25
GHB/2C/6VD	25	DPDT	10	4.00
GHB/2C/12VD	100	DPDT	10	4.00
GHB/2C/24VD	400	DPDT	10	4.00
GHB/3C/6VA	4	3PDT	10	4.85

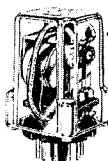

TYPE	COIL RESISTANCE (OHMS)	FORM	CONTACTS RATING (AMPS)	Resole
GHB/3C/24VA	63	3PDT	10	4.85
GHB/3C/115VA	1600	3PDT	10	4.85
GHB/3C/6VD	25	3PDT	10	4.65
GHB/3C/12VD	100	3PDT	10	4.65
GHB/3C/24VD	400	3PDT	10	4.65
GHH/2C/6VA	4	DPDT	10	6.35
GHH/2C/12VA	16	DPDT	10	6.35
GHH/2C/24VA	63	DPDT	10	6.35
GHH/2C/115VA	1600	DPDT	10	6.35
GHH/2C/6VD	25	DPDT	10	6.10
GHH/2C/12VD	100	DPDT	10	6.10
GHH/2C/24VD	400	DPDT	10	6.10
GHH/3C/6VA	4	3PDT	10	7.60
GHH/3C/12VA	16	3PDT	10	7.60
GHH/3C/24VA	63	3PDT	10	7.60
GHH/3C/115VA	1600	3PDT	10	7.60
GHH/3C/6VD	25	3PDT	10	7.60
GHH/3C/12VD	100	3PDT	10	7.60
GHH/3C/24VD	400	3PDT	10	7.60

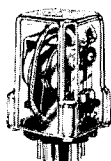

TYPE GHE A plate circuit current operated unit having extremely good sensitivity. Standard GHE enclosed in dustite plastic enclosure and mounts with either an 8 pin or 11 pin plug-in base. Nominal power of 130 milliwatts per 1C (single pole) is required.

Dimensions: 1 1/2" x 1 1/2" x 2 1/8".

TYPE	COIL RESISTANCE (OHMS)	COIL CURRENT	FORM	CONTACTS RATING (AMPS)	Resole
GHE/1C/2500D	2500	7.2 MA	SPDT	5	4.65
GHE/1C/5000D	5000	5.0 MA	SPDT	5	5.10
GHE/1C/10000D	10000	3.6 MA	SPDT	5	5.50
GHE/2C/2500D	2500	10.0 MA	DPDT	5	5.45
GHE/2C/5000D	5000	7.2 MA	DPDT	5	5.50
GHE/2C/10000D	10000	5.0 MA	DPDT	5	5.95
GHE/3C/2500D	2500	11.8 MA	3PDT	5	6.95
GHE/3C/5000D	5000	8.3 MA	3PDT	5	7.05
GHE/3C/10000D	10000	5.8 MA	3PDT	5	7.45

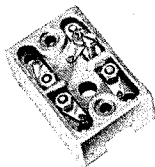

TIME DELAY

TYPE DT Efficient, low-cost units used in conjunction with various relays for delayed making or breaking of controlled circuits. Applicable wherever a time delay of 5 to 60 seconds is needed. Units are adjustable with a range of 8 to 20 cycles per minute. Operating on the bi-metal thermal principle, these types are housed in unglazed porcelain, and are obtainable with either normally-open or normally-closed contacts.

Dimensions: H. 1 1/4", W. 1 1/4", L. 1 3/4".

Mounting Data: 2 holes .154 dia. for 6-32 NC-2 screws; 1 3/8" centers.

Weight: 1.4 oz.

TYPE	COIL VOLT	CONTACTS FORM	RATING (AMPS)	Resale
DT/1A/115VA	115VAC	SPST	2	3.15
DT/1B/115VA	115VAC	SPST-NC	2	3.15

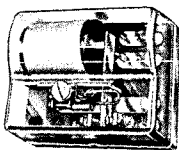

SENSITIVE

TYPE SV For use in any DC circuit restricted to a few thousandths of a watt power consumption.

Transparent, molded plastic cover guards against dust or dirt reaching the contacts or other working parts.

Adjustments are quickly made with the vernier screws which vary relay sensitivity from the 5-milliwatt factory setting. Both the two stationary contacts and the spring tension can be accurately and permanently set—yet easily changed.

Dimensions: H. 1 1/2", W. 2", L. 2 3/4".

Mounting Data: 2 holes .52 dia.

Weight: 6.5 oz.

Sensitivity: 5 Milliwatts.

TYPE	COIL RESISTANCE (OHMS)	COIL CURRENT (MA)	CONTACTS FORM	RATING (AMPS)	Resale
SV/1C/005D	.005	1000	SPDT	1	9.15
SV/1C/1000D	1000	2.25	SPDT	1	9.60
SV/1C/1600D	1600	1.80	SPDT	1	9.60
SV/1C/2200D	2200	1.50	SPDT	1	9.60
SV/1C/3500D	3500	1.20	SPDT	1	9.70
SV/1C/5500D	5500	0.95	SPDT	1	10.10
SV/1C/8700D	8700	0.75	SPDT	1	11.30
SV/1C/10000D	10000	0.70	SPDT	1	11.30
SV/1C/14000D	14000	0.60	SPDT	1	11.60
SV/1C/20000D	20000	0.50	SPDT	1	12.75
SV/1C/30000D	30000	0.40	SPDT	1	13.62
SV/1C/40000D	40000	0.35	SPDT	1	15.30

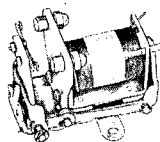

HIGH VOLTAGE

TYPE HV Applicable where "standard" design high voltage units occupy too much space. Contact assembly mounted on Steatite to insure high insulation and low energy loss. Will break up to 5000 volts RMS at 200 milliamperes current. Available in SPDT (double break-double make DM-DB) contact arrangement.

Dimensions: 1 3/4" x 2 1/2" x 3 1/4".

Mounting data: 2 holes 3/8" diameter on 1 3/4" centers.

TYPE	COIL RESISTANCE	CONTACTS	Resale
HV/1Z/24VD	120 Ohms	SPDT DB-DM	20.30
HV/1Z/110VD	3000 Ohms	SPDT DB-DM	21.00

MICRO-MINIATURE RELAYS

TYPE MV Hermetically sealed rotary action DPDT (2 Form C) DC relay for severe military and industrial applications. All units are designed to meet requirements of MIL-R-5757 D. Occupies 1/4 cubic inch. Contains new spring leaf contact blades which insure longer life with rapid heat dissipation. This Series, is available from stock with wide variety of terminal and mounting arrangements.

Type	Mounting	Coil Res. (Ohms)	Nominal Volts	Resale
MV/2C/30D-13	Sol. Head. w/Side Brkt. (2 Hole)	30	6	\$13.50
MV/2C/30D-15	Sol. Head. w/Side Brkt. (4 Hole)	30	6	13.50
MV/2C/30D-24	Plug In—Plain Can	30	6	13.50
MV/2C/30D-34	3" Leads—Plain Can	30	6	13.80
MV/2C/120D-11	Solder Header w/2 Side Studs	120	12	13.50
MV/2C/120D-12	Solder Header w/2 Top Studs	120	12	13.50
MV/2C/120D-13	Sol. Head. w/Side Brkt. (2 Hole)	120	12	13.50
MV/2C/120D-16	Solder Header w/2 Mtg. Brkts.	120	12	13.50
MV/2C/120D-24	Plug In—Plain Can	120	12	13.50
MV/2C/120D-26	Plug In w/2 Mtg. Brackets	120	12	13.50
MV/2C/120D-31	3" Leads w/2 Side Studs	120	12	13.80
MV/2C/120D-33	3" Leads w/Side Brkt (2 Hole)	120	12	13.80
MV/2C/120D-34	3" Leads—Plain Can	120	12	13.80
MV/2C/600D-11	Solder Header w/2 Side Studs	600	26	13.50
MV/2C/600D-12	Solder Header w/2 Top Studs	600	26	13.50
MV/2C/600D-13	Sol. Head. w/Side Brkt. (2 Hole)	600	26	13.50
MV/2C/600D-14	Solder Header—Plain Can	600	26	13.50
MV/2C/600D-15	Sol. Head. w/Side Brkt. (4 Hole)	600	26	13.50

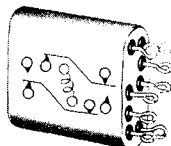

CRYSTAL CAN

Type	Mounting	Coil Res. (Ohms)	Nominal Volts	Resale
MV/2C/600D-16	Solder Header w/2 Mtg. Brkts.	600	26	13.50
MV/2C/600D-17	Solder Header w/Flange Bracket	600	26	13.50
MV/2C/600D-21	Plug In w/2 Side Studs	600	26	13.50
MV/2C/600D-22	Plug In w/2 Top Studs	600	26	13.50
MV/2C/600D-24	Plug In—Plain Can	600	26	13.50
MV/2C/600D-31	3" Leads w/2 Side Studs	600	26	13.80
MV/2C/600D-33	3" Leads w/Side Bracket (2 Hole)	600	26	13.80
MV/2C/600D-34	3" Leads—Plain Can	600	26	13.80
MV/2C/1000D-11	Solder Header w/2 Side Studs	1000	35	13.50
MV/2C/1000D-12	Solder Header w/2 Top Studs	1000	35	13.50
MV/2C/1000D-13	Solder Header w/Side Brkt. (2 Hole)	1000	35	13.50
MV/2C/1000D-15	Solder Header w/Side Brkt. (4 Hole)	1000	35	13.50
MV/2C/1000D-17	Solder Header w/Flange Bracket	1000	35	13.50
MV/2C/1000D-24	Plug In—Plain Can	1000	35	13.50
MV/2C/2500D-12	Solder Header w/2 Top Studs	2500	55	13.60
MV/2C/2500D-13	Solder Header w/Side Brkt. (2 Hole)	2500	55	13.60
MV/2C/2500D-24	Plug In—Plain Can	2500	55	13.60
MV/2C/5000D-16	Solder Header w/2 Mtg. Brkts.	5000	78	13.95
MV/2C/5000D-21	Plug In w/2 Side Studs	5000	78	13.95
MV/2C/5000D-24	Plug In—Plain Can	5000	78	13.95
MV/2C/10,000D-13	Solder Header w/Side Brkt. (2 Hole)	10,000	110	18.50
MV7033	Conforms to RY4NA3B3L02 of MIL-R-5757D	600	26.5	13.50

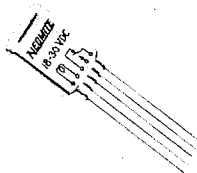

NEOMITE

TYPE NM Hermetically sealed SPDT (form C) DC relay for missiles, aircraft, control equipment and printed circuits. Occupying only 0.04 of a cubic inch, it is ideal where space is at a minimum and long life is important. Contact resistance is extraordinarily low, making it invaluable in dry circuit switching. Available from stock with a screw down mounting bracket or a bend-over-tab mounting bracket for printed circuit board use.

TYPE	RESISTANCE (OHMS)	PULL-IN CURRENT MAX. (MA)	COIL NOMINAL VOLTAGE (VDC)	Resale
NM/1C/50	50	44	4	24.15
NM/1C/200	200	22	8	24.15
NM/1C/500	500	14	12	24.15
NM/1C/1K	1000	10	16	24.15
NM/1C/2K	2000	7	24	24.15
6B 346000	Two hole Bracket			.50
6B 347000	Tab Bracket			.50

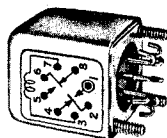

TYPE VGS Miniature sealed rotary action DPDT (2 form C) relay for missile and aircraft use. A more sensitive version of its forerunner, the VG. VGS occupies less than a cubic inch of space and withstands 15 G's to 2000 cycles vibration, utilizing only 125 milliwatts of power at 25 degrees C. Contacts rated at 5 amps resistive at 115 VAC or 26.5 VDC. Contact material is silver magnesium nickel alloy, gold flashed.

TYPE	COIL RESISTANCE (OHMS)	Resale
VGS/2C/2000D	2000	25.90

STANDARD PLUNGER
STYLES AVAILABLE

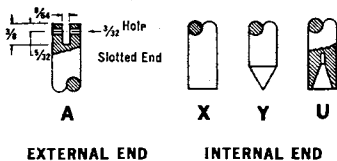

TYPES 38, 39, 40, 41, 42, 51 Solid frame solenoids using high-grade steel in all parts of the magnetic circuit. Carefully controlled annealing, after all machining operations are completed, assures maximum efficiency. The frame is dovetailed and staked to the end plate, adding mechanical strength and increasing the performance of the magnetic circuit. Plungers and plunger stops, which are made of annealed and specially processed steel, are available in three standard types for specific operating requirements. Type 51 is a laminated frame solenoid and has been designed and engineered to meet all of the requirements of the highest quality A. C. solenoid. Special production techniques and rigid quality control combine to provide a highly efficient unit. The frame is composed of silicon steel laminations securely riveted to a steel frame. Pole faces are precision ground and equipped with copper shading rings. Silicon steel laminations are also used for the plunger.

Type	41		42		38		39		40		51	
size	1 x 1 1/2 x 1 1/4		1 x 1 1/2 x 2		1 1/4 x 1 1/2 x 1 1/2		1 1/4 x 1 1/2 x 2 1/2		1 1/4 x 1 1/2 x 2 1/2		2 1/4 x 1 1/4 x 3 1/2	
weight (oz.)	6		8		12		16		20		16	
coil watts max. at 25°C.	3		6		10		12		15		60 VA	
std. plunger	AC	DC	AC	DC	AC	DC	AC	DC	AC	DC	AC	DC
	AX	AX	AX	AU	AX	AY	AX	AY	AX	AY	AX	AY
max. stroke inches	3/8"		1/2"		1/2"		3/8"		3/8"		1"	
plunger dia.	3/8"		3/8"		1/2"		1/2"		1/2"		1/2"	

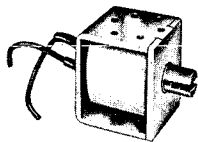

DC SOLENOIDS

CONTINUOUS DUTY				25% INTERMITTENT DUTY*			
Type	Volt.	Coil Res.	Resale	Type	Volt.	Coil Res.	Resale
38C06DC-AY	6	6	4.50	—	—	—	—
38C12DC-AY	12	21	4.50	382512DC-AY	12	6	4.50
38C24DC-AY	24	66	4.50	382524DC-AY	24	21	4.50
38C48DC-AY	48	300	4.50	382548DC-AY	48	66	4.50
38C115DC-AY	115	1500	4.50	3825115DC-AY	115	400	4.50

AC SOLENOIDS

CONTINUOUS DUTY				25% INTERMITTENT DUTY*			
Type	Volt.	Coil Res.	Resale	Type	Volt.	Coil Res.	Resale
38C0660-AX	6	0.75	4.50	—	—	—	—
38C1260-AX	12	2.5	4.50	38251260-AX	12	0.75	4.50
38C2460-AX	24	10	4.50	38252460-AX	24	2.5	4.50
38C11560-AX	115	135	4.50	382511560-AX	115	50	4.50
38C23060-AX	230	470	4.50	382523060-AX	230	135	4.50

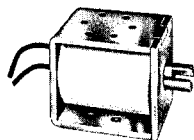

DC SOLENOIDS

CONTINUOUS DUTY				25% INTERMITTENT DUTY*			
Type	Volt.	Coil Res.	Resale	Type	Volt.	Coil Res.	Resale
39C06DC-AY	6	4	5.10	—	—	—	—
39C12DC-AY	12	10	5.10	392512DC-AY	12	4	5.10
39C24DC-AY	24	60	5.10	392524DC-AY	24	10	5.10
39C48DC-AY	48	250	5.10	392548DC-AY	48	60	5.10
39C115DC-AY	115	1600	5.10	3925115DC-AY	115	300	5.10

AC SOLENOIDS

CONTINUOUS DUTY				25% INTERMITTENT DUTY*			
Type	Volt.	Coil Res.	Resale	Type	Volt.	Coil Res.	Resale
39C0660-AX	6	.4	5.10	—	—	—	—
39C1260-AX	12	1.5	5.10	39251260-AX	12	.4	5.10
39C2460-AX	24	7	5.10	39252460-AX	24	1.5	5.10
39C11560-AX	115	105	5.10	392511560-AX	115	30	5.10
39C23060-AX	230	400	5.10	392523060-AX	230	105	5.10

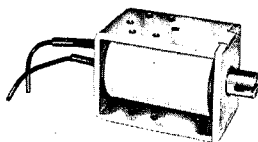

DC SOLENOIDS

CONTINUOUS DUTY				25% INTERMITTENT DUTY*			
Type	Volt.	Coil Res.	Resale	Type	Volt.	Coil Res.	Resale
40C06DC-AY	6	3.6	6.00	—	—	—	—
40C12DC-AY	12	12	6.00	402512DC-AY	12	3.6	6.00
40C24DC-AY	24	47.5	6.00	402524DC-AY	24	12	6.00
40C48DC-AY	48	225	6.00	402548DC-AY	48	47.5	6.00
40C115DC-AY	115	1570	6.00	4025115DC-AY	115	417	6.00

AC SOLENOIDS

CONTINUOUS DUTY				25% INTERMITTENT DUTY*			
Type	Volt.	Coil Res.	Resale	Type	Volt.	Coil Res.	Resale
40C0660-AX	6	0.8	6.00	—	—	—	—
40C1260-AX	12	1.5	6.00	40251260-AX	12	0.8	6.00
40C2460-AX	24	8.8	6.00	40252460-AX	24	1.5	6.00
40C11560-AX	115	84	6.00	402511560-AX	115	25	6.00
40C23060-AX	230	417	6.00	402523060-AX	230	84	6.00

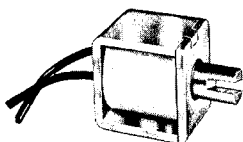

DC SOLENOIDS

CONTINUOUS DUTY				25% INTERMITTENT DUTY*			
Type	Volt.	Coil Res.	Resale	Type	Volt.	Coil Res.	Resale
41C06DC-AU	6	12	4.10	—	—	—	—
41C12DC-AU	12	60	4.10	412512DC-AU	12	12	4.10
41C24DC-AU	24	200	4.10	412524DC-AU	24	60	4.10
41C48DC-AU	48	830	4.10	412548DC-AU	48	200	4.10
41C115DC-AU	115	4500	4.10	4125115DC-AU	115	1400	4.10

AC SOLENOIDS

CONTINUOUS DUTY				25% INTERMITTENT DUTY*			
Type	Volt.	Coil Res.	Resale	Type	Volt.	Coil Res.	Resale
41C0660-AX	6	1	4.10	—	—	—	—
41C1260-AX	12	10	4.10	41251260-AX	12	1	4.10
41C2460-AX	24	45	4.10	41252460-AX	24	10	4.10
41C11560-AX	115	740	4.10	412511560-AX	115	230	4.10
41C23060-AX	230	2700	4.10	412523060-AX	230	740	4.10

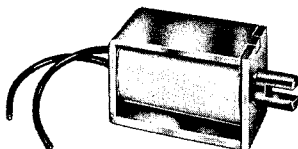

DC SOLENOIDS

CONTINUOUS DUTY				25% INTERMITTENT DUTY*			
Type	Volt.	Coil Res.	Resale	Type	Volt.	Coil Res.	Resale
42C06DC-AU	6	8	4.50	—	—	—	—
42C12DC-AU	12	30	4.50	422512DC-AU	12	8	4.50
42C24DC-AU	24	115	4.50	422524DC-AU	24	30	4.50
42C48DC-AU	48	420	4.50	422548DC-AU	48	115	4.50
42C115DC-AU	115	2300	4.50	4225115DC-AU	115	675	4.50

AC SOLENOIDS

CONTINUOUS DUTY				25% INTERMITTENT DUTY*			
Type	Volt.	Coil Res.	Resale	Type	Volt.	Coil Res.	Resale
42C0660-AX	6	1	4.50	—	—	—	—
42C1260-AX	12	3.5	4.50	42251260-AX	12	1	4.50
42C2460-AX	24	30	4.50	42252460-AX	24	3.5	4.50
42C11560-AX	115	370	4.50	422511560-AX	115	125	4.50
42C23060-AX	230	1100	4.50	422523060-AX	230	370	4.50

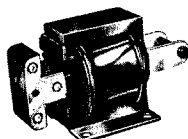

TYPE 51 AC SOLENOIDS

CONTINUOUS DUTY				25% INTERMITTENT DUTY*			
Type	Volt.	Coil Res.	Resale	Type	Volt.	Coil Res.	Resale
51C11560	115	30	7.20	512511560	115	15	7.20
51C23060	230	150	7.20	512523060	230	65	7.20
51C46060	460	650	7.20	512546060	460	285	7.20

*DUTY BASED ON 4 MINUTE CYCLE

GENERAL DESCRIPTION The series W is a double-pole, double-throw relay, available with socket for plug-in application or for use without socket with standard quick-connect terminals for simplicity and ease in wiring. Rated to 1 and 2 HP motor loads, it offers high quality, dependable performance and long life.

These relays are ideal for use in appliances, automation equipment, motor starting, heater circuits, clock controlled systems, laundry equipment, vending machines, machine tools, furnace controls, panel boards and air conditioners.

Type	Coil Voltage	Contacts Form	Rating (Amps)	Resale
WHU12D3	12VOLTS D.C.	DPDT	25	8.00
WUQ24D2	24VOLTS D.C.	DPDT	25	8.00
WUQ24D3	24VOLTS D.C.	DPDT	25	8.00
WUO115A2	115VOLTS A.C.	DPDT	25	8.00
WUO115A3	115VOLTS A.C.	DPDT	25	8.00
WUP220A3	220VOLTS A.C.	DPDT	25	8.30
WHU115A4	115VOLTS A.C.	NOTE 1	25	8.95

NOTE 1 SERIES WHU RELAYS ARE PROVIDED WITH A HOLDING CIRCUIT CONTACT.

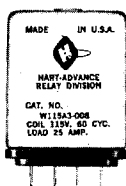

GUARDIAN® ELECTRIC

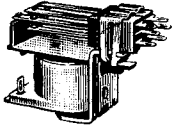

SERIES 900 & 910 10 AMP RELAY

- *U/L Recognized Component
- Designed with reduced number of parts for long, trouble-free service
- Has keyed and locked lifters



Series 910 is exactly the same as the 900 relay, both electrically and mechanically, but with $\frac{3}{16}$ quick disconnects instead of soldered termination.

Dependable, low cost, DPDT relay featuring new, trouble-free design that incorporates a minimum of parts. Contacts all rated 10 amps, 115V., AC resistive load. Has molded switches, one-piece mounting clip and return spring; molded bobbin and coil cover. Average shpg. wt., 6 oz.

SIZE: 2 $\frac{1}{8}$ " x 1 $\frac{1}{8}$ " x 1 $\frac{3}{32}$ "

Guardian No.	Coil Res.	Coil Voltage	QUANTITIES		
			1-9	10-24	25-49
900-2C-24A	24	24 AC	\$1.75	\$1.66	\$1.49
900-2C-115A	550	115 AC	1.75	1.66	1.49
900-2C-230A	2950	230 AC	1.75	1.66	1.49
905-2C-6D	8	6 DC	1.75	1.66	1.49
905-2C-12D	32	12 DC	1.75	1.66	1.49
905-2C-24D	130	24 DC	1.75	1.66	1.49

*U/L Recognition File #E-23524B

Guardian No.	Coil Res.	Coil Voltage	QUANTITIES		
			1-9	10-24	25-49
910-2C-24A	24	24 AC	\$1.75	\$1.66	\$1.49
910-2C-115A	550	115 AC	1.75	1.66	1.49
910-2C-230A	2950	230 AC	1.75	1.66	1.49
915-2C-6D	8	6 DC	1.75	1.66	1.49
915-2C-12D	32	12 DC	1.75	1.66	1.49
915-2C-24D	130	24 DC	1.75	1.66	1.49

*U/L Recognized Component File #E-23524B

Further savings are available when Series 900 relays are purchased in bulk packs of 50 units. Relays are supplied nested in new, convenient "form fitted" assembly line trays... one package of 50—\$70.00; 2 and up—\$61.50 ea.

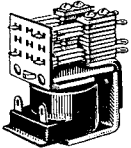

ALL PURPOSE ECONOMY RELAY

IR-640U AC—IR-645U DC—10 AMPERE

A compact, lightweight relay capable of unusually heavy power control for its size. Long life, high quality relay available in a variety of AC and DC voltages with a selection of contact combinations.

All contact ratings are 10 amps. Contact ratings at 60 cycles, 115V. non-inductive load. 8-32 single screw, center pole mounting. Shpg. wt., 3.5 oz.

*U/L Recognized Component File #E-17260

SIZE: 1 $\frac{1}{8}$ " x 1 $\frac{1}{2}$ " x 1"

Guardian No.	Coil Res.	Coil Voltage	Cont. Comb.	QUANTITIES				
				1-24	25-49	50-99	100-249	250-up
IR-640U-A-6A	1.7	6AC	SPST*	\$2.90	\$2.61	\$2.47	\$2.32	\$2.03
IR-640U-C-6A	1.7	6AC	SPDT	3.15	2.84	2.68	2.52	2.21
IR-640U-2C-6A	1.7	6AC	DPDT	3.40	3.06	2.89	2.72	2.38
IR-640U-4C-6A	1.7	6AC	4PDT	5.00	4.50	4.25	4.00	3.50
IR-640U-A-24A	24	24AC	SPST*	2.90	2.61	2.47	2.32	2.03
IR-640U-C-24A	24	24AC	SPDT	3.15	2.84	2.68	2.52	2.21
IR-640U-2C-24A	24	24AC	DPDT	3.40	3.06	2.89	2.72	2.38
IR-640U-4C-24A	24	24AC	4PDT	5.00	4.50	4.25	4.00	3.50
IR-640U-A-120A	550	120AC	SPST*	2.90	2.61	2.47	2.32	2.03
IR-640U-C-120A	550	120AC	SPDT	3.15	2.84	2.68	2.52	2.27
IR-640U-2C-120A	550	120AC	DPDT	3.40	3.06	2.89	2.72	2.38
IR-640U-4C-120A	550	120AC	4PDT	5.00	4.50	4.25	4.00	3.50
IR-640U-2C-240A	2950	240AC	DPDT	4.20	3.78	3.57	3.36	2.94
IR-645U-A-6D	12	6DC	SPST*	2.90	2.61	2.47	2.32	2.03
IR-645U-C-6D	12	6DC	SPDT	3.15	2.84	2.68	2.52	2.21
IR-645U-2C-6D	12	6DC	DPDT	3.40	3.06	2.89	2.72	2.38
IR-645U-4C-6D	12	6DC	4PDT	5.00	4.50	4.25	4.00	3.50
IR-645U-A-12D	50	12DC	SPST*	2.90	2.61	2.47	2.32	2.03
IR-645U-C-12D	50	12DC	SPDT	3.15	2.84	2.68	2.52	2.21
IR-645U-2C-12D	50	12DC	DPDT	3.40	3.06	2.89	2.72	2.38
IR-645U-4C-12D	50	12DC	4PDT	5.00	4.50	4.25	4.00	3.50
IR-645U-A-24D	200	24DC	SPST*	2.90	2.61	2.47	2.32	2.03
IR-645U-C-24D	200	24DC	SPDT	3.15	2.84	2.68	2.52	2.21
IR-645U-2C-24D	200	24DC	DPDT	3.40	3.06	2.89	2.72	2.38
IR-645U-4C-24D	200	24DC	4PDT	5.00	4.50	4.25	4.00	3.50
IR-645U-A-110D	4000	110DC	SPST*	3.40	3.06	2.89	2.72	2.38
IR-645U-C-110D	4000	110DC	SPDT	3.70	3.33	3.15	2.96	2.59
IR-645U-2C-110D	4000	110DC	DPDT	3.95	3.56	3.36	3.16	2.77
IR-645U-4C-110D	4000	110DC	4PDT	5.25	4.73	4.46	4.20	3.68

*Normally Open.

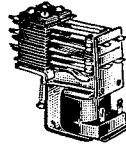

SERIES 240U AC—245U DC

Designed for contact ratings up to 15 amps, Guardian series 240 AC and 245 DC relays are compact, reliable, inexpensive. Factory pretested and adjusted to be ready for assembly into your product. Contact rating is 15 amp, 115V., 60 cycles non-inductive load. Easy assembly with 8-32 single-screw, center-hole mounting. Shpg. wt., 4.5 oz.

*U/L Recognized Component File #E-23524A

SIZE: (4PDT) 2 $\frac{3}{32}$ " x 1 $\frac{3}{32}$ " x 2 $\frac{1}{16}$ "

Guardian No.	Coil Res.	Coil Voltage	Cont. Comb.	QUANTITIES				
				1-24	25-49	50-99	100-249	250-up
240U-A-6A	1.7	6AC	SPST*	\$3.15	\$2.84	\$2.68	\$2.52	\$2.21
240U-2C-6A	1.7	6AC	DPDT	3.95	3.56	3.36	3.16	2.77
240U-4C-6A	1.7	6AC	4PDT	5.80	5.22	4.93	4.64	4.06
240U-A-24A	24	24AC	SPST*	3.15	2.84	2.68	2.52	2.21
240U-2C-24A	24	24AC	DPDT	3.95	3.56	3.36	3.16	2.77
240U-4C-24A	24	24AC	4PDT	5.80	5.22	4.93	4.64	4.06
240U-A-120A	550	120AC	SPST*	3.15	2.84	2.68	2.52	2.21
240U-2C-120A	550	120AC	DPDT	3.95	3.56	3.36	3.16	2.77
240U-4C-120A	550	120AC	4PDT	5.80	5.22	4.93	4.64	4.06
245U-A-6D	12	6DC	SPST*	3.15	2.84	2.68	2.52	2.21
245U-2C-6D	12	6DC	DPDT	3.95	3.56	3.36	3.16	2.77
245U-4C-6D	12	6DC	4PDT	5.80	5.22	4.93	4.64	4.06
245U-A-12D	50	12DC	SPST*	3.15	2.84	2.68	2.52	2.21
245U-2C-12D	50	12DC	DPDT	3.95	3.56	3.36	3.16	2.77
245U-4C-12D	50	12DC	4PDT	5.80	5.22	4.93	4.64	4.06
245U-A-24D	200	24DC	SPST*	3.15	2.84	2.68	2.52	2.21
245U-2C-24D	200	24DC	DPDT	3.95	3.56	3.36	3.16	2.77
245U-4C-24D	200	24DC	4PDT	5.80	5.22	4.93	4.64	4.06

*Normally Open.

PLATE CIRCUIT DC RELAY IR-625—10 AMPERE

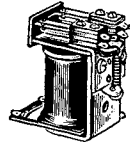

Has extra long coil for greater sensitivity. Adaptable to voltage operation as well as sensitive plate circuit control installations. Coil impregnated for reliability and longer life. Average power requirement, 0.2 watt. Contacts, fine silver. Contact ratings, 10 amps. Mounting: One 8-32 (NC-2) center hole. Shpg. wt., 5.5 oz.

SIZE: 2 $\frac{1}{8}$ " x 2" x 1 $\frac{1}{2}$ "

Guardian No.	Oper. Mils.	Coil Res.	Cont. Comb.	QUANTITIES				
				1-24	25-49	50-99	100-249	250-up
IR-625-2.5	9 M.A.	2,500	DPDT	\$4.45	\$4.01	\$3.78	\$3.56	\$3.12
IR-625-5	6.3 M.A.	5,000	DPDT	4.75	4.28	4.04	3.80	3.33
IR-625-10	4.5 M.A.	10,000	DPDT	5.80	5.22	4.93	4.64	4.06

LONG LIFE 4PDT, 3 AMP-MINIATURE RELAY 1310 AC, 1315 DC

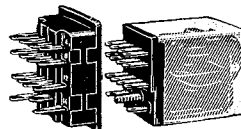

4PDT...3 AMP Plug-in Relay available AC or DC. Contacts rated 3 amps at 30VDC or 115VAC resistive. Heat resistant; Lexan cover; Life in excess of 100 million operations. A/C size: 1 $\frac{1}{4}$ " x $\frac{5}{16}$ " x 1 $\frac{1}{16}$ ". Weight: 1 $\frac{1}{8}$ oz.

Guardian No.	Coil Voltage	1-24	25-49	Net Each, Lots of		
				50-99	100-249	250-499
1310-4C	6AC	\$5.50	\$4.95	\$4.67	\$4.40	\$3.85
1310-4C	12AC	5.50	4.95	4.67	4.40	3.85
1310-4C	24AC	5.50	4.95	4.67	4.40	3.85
1310-4C	120AC	5.85	5.26	4.97	4.68	4.09
1315-4C	6DC	\$4.50	\$4.05	\$3.82	\$3.60	\$3.15
1315-4C	12DC	4.50	4.05	3.82	3.60	3.15
1315-4C	24DC	4.50	4.05	3.82	3.60	3.15
1315-4C	110AC	5.25	4.72	4.46	4.20	3.67

1310-1 Series Relay Socket (PRINTED CIRCUIT)..... .60¢ ea.
1310-2 Series Relay Socket (SOLDER TERMINAL)..... .60¢ ea.

INTERLOCKING RELAY—AC IR-1200/1200—10 AMPERE



Two interlocking AC relays in sturdy metal frame bracket. Used to maintain circuits continuously without coil power consumption. Unit is electrically pulse operated with mechanical hold and electrical release. Contacts rated for 10 amps, at 60 cycles, 115V., AC, non-inductive load. Coil resistance is 1,100 ohms. Shpg. wt., 5.5 oz.

SIZE: 1 $\frac{1}{4}$ " x 1 $\frac{3}{8}$ " x 3 $\frac{1}{8}$ "

Guardian No.	Cont. Comb.	Coil Voltage	QUANTITIES			
			1-24	25-49	50-99	100-249
IR-1200/1200-4C-120A	4PDT	120AC	\$10.40	\$9.36	\$8.84	\$8.32

GUARDIAN® ELECTRIC

GUARDIAN AC SOLENOIDS and SOLENOID SWITCHES

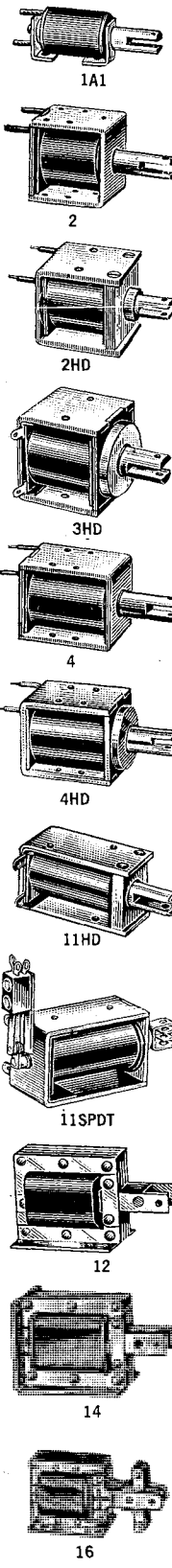

Solenoids available in both intermittent and continuous duty types. Intermittent types should not be energized for more than 5 consecutive minutes, or be permitted to rise more than 85°C. above 24°C. ambient, without giving sufficient time to cool between operation cycles. Continuous duty types are designed so they will not rise more than 85°C. above the 24°C. ambient temperature when operated at rated load. Plunger has slotted end with 1/8" diameter hole for coupling.

When Ordering give the following information: (1) Solenoid Number; (2) Operating voltages and AC or DC current; (3) Continuous or intermittent duty (if intermittent, give the cycle of operation, length of time current will be passed through the coil, and any other pertinent information); (4) Maximum stroke and maximum pull required.

Pull Data listed in this bulletin obtained during "cold" operation.

"S" indicates single pole double throw switch, rated at 10 amps 115 vac.

MFG. NO.	VOLTS DC	DUTY	OHMS	MINIMUM — MAXIMUM		SIZE, INCHES	SHIPPING		NET EACH, LOTS OF				
				STROKES	LIFT		L. x W. x H.	WT. OZS.	1-24	25-49	50-99	100-249	250-499
1A1	115A	Inter.	300	8 oz. at 1/8"	2 oz. at 1/2"	1 3/4 x 1 3/8 x 1 1/2	4.5	\$3.15	\$2.84	\$2.68	\$2.52	\$2.21	\$2.05
1A1	115A	Cont.	675	3 oz. at 1/8"	.5 oz. at 3/8"	1 3/4 x 1 3/8 x 1 1/2	4.5	3.15	2.84	2.68	2.52	2.21	2.05
2	115A	Inter.	60	33 oz. at 1/8"	4.5 oz. at 7/8"	1 1/2 x 1 1/2 x 1 5/8	10	3.68	3.31	3.13	2.95	2.58	2.39
2	115A	Cont.	166	10.5 oz. at 1/8"	3 oz. at 7/8"	1 1/2 x 1 1/2 x 1 5/8	10	3.68	3.31	3.13	2.95	2.58	2.39
2HD	115A	Inter.	39	38 oz. at 1/8"	16 oz. at 3/4"	1 3/2 x 1 1/2 x 1 5/8	13	8.66	7.79	7.36	6.93	6.06	5.63
2HD	115A	Cont.	113	17 oz. at 1/8"	4 oz. at 3/4"	1 3/2 x 1 1/2 x 1 5/8	13	8.66	7.79	7.36	6.93	6.06	5.63
3HD	115AC	Inter.	25	96 oz. at 1/8"	13 oz. at 7/8"	2 1/2 x 1 1/2 x 1 5/8	14	6.00	5.40	5.10	4.80	4.50	3.90
3HD	115AC	Cont.	100	24 oz. at 1/8"	2 oz. at 7/8"	2 1/2 x 1 1/2 x 1 5/8	14	6.00	5.40	5.10	4.80	4.50	3.90
4	115A	Inter.	37	24 oz. at 1/8"	22 oz. at 1"	2 x 1 1/2 x 1 5/8	14.5	4.20	3.78	3.57	3.36	2.94	2.73
4	115A	Cont.	133	8 oz. at 1/8"	6 oz. at 1"	2 x 1 1/2 x 1 5/8	14.5	4.20	3.78	3.57	3.36	2.94	2.73
4HD	115AC	Inter.	15	107 oz. at 1/8"	30 oz. at 1 1/4"	2 3/4 x 1 1/2 x 1 5/8	15	6.41	5.77	5.45	5.13	4.81	4.17
4HD	115AC	Cont.	53	26 oz. at 1/8"	8 oz. at 1 1/4"	2 3/4 x 1 1/2 x 1 5/8	15	6.41	5.77	5.45	5.13	4.81	4.17
11	24A	Inter.	5.1	10 oz. at 1/8"	3 oz. at 1"	1 3/4 x 1 1/2 x 1 1/2	7.5	3.15	2.84	2.68	2.52	2.21	2.05
11	24A	Cont.	12	26 oz. at 1/8"	3 oz. at 1"	1 3/4 x 1 1/2 x 1 1/2	7.5	3.15	2.84	2.68	2.52	2.21	2.05
11	115A	Inter.	125	10 oz. at 1/8"	3 oz. at 1"	1 3/4 x 1 1/2 x 1 1/2	7.5	3.15	2.84	2.68	2.52	2.21	2.05
11	115A	Cont.	300	26 oz. at 1/8"	3 oz. at 1"	1 3/4 x 1 1/2 x 1 1/2	7.5	3.15	2.84	2.68	2.52	2.21	2.05
11S-SPDT	115A	Inter.	125	26 oz. at 1/8"	3 oz. at 1"	1 3/4 x 1 1/2 x 2 1/4	7.5	4.15	3.73	3.53	3.32	2.90	2.69
11S-SPDT	115A	Cont.	300	10 oz. at 1/8"	3 oz. at 1"	1 3/4 x 1 1/2 x 2 1/4	7.5	4.15	3.73	3.53	3.32	2.90	2.69
12	115A	Inter.	100	32 oz. at 1/8"	4 oz. at 1"	1 5/8 x 1 1/2 x 1 1/2	6	4.46	4.01	3.79	3.57	3.12	2.90
12	115A	Cont.	150	22 oz. at 1/8"	3 oz. at 7/8"	1 5/8 x 1 1/2 x 1 1/2	6	4.46	4.01	3.79	3.57	3.12	2.90
14	115A	Inter.	11	110 oz. at 1/8"	52 oz. at 1 1/2"	2 3/4 x 1 1/2 x 2 1/4	19	6.04	5.44	5.13	4.83	4.23	3.93
14	115A	Cont.	18	65 oz. at 1/8"	37 oz. at 1 1/2"	2 3/4 x 1 1/2 x 2 1/4	19	6.04	5.44	5.13	4.83	4.23	3.93
16	115A	Inter.	41	96 oz. at 1/8"	35 oz. at 3/4"	1 5/8 x 1 1/2 x 1 1/2	7.5	3.68	3.31	3.13	2.94	2.58	2.39
16	115A	Cont.	85	50 oz. at 1/8"	10 oz. at 3/4"	1 5/8 x 1 1/2 x 1 1/2	7.5	3.68	3.31	3.13	2.94	2.58	2.39
16	230A	Inter.	200	96 oz. at 1/8"	35 oz. at 3/4"	1 5/8 x 1 1/2 x 1 1/2	7.5	3.94	3.55	3.35	3.15	2.76	2.56
16	230A	Cont.	350	50 oz. at 1/8"	10 oz. at 3/4"	1 5/8 x 1 1/2 x 1 1/2	7.5	3.94	3.55	3.35	3.15	2.76	2.56
18	115A	Inter.	8.8	280 oz. at 1/8"	80 oz. at 1"	2 1/2 x 1 1/2 x 2 1/4	16.5	4.99	4.49	4.24	3.99	3.49	3.24
18	115A	Cont.	19.7	145 oz. at 1/8"	40 oz. at 1"	2 1/2 x 1 1/2 x 2 1/4	16.5	4.99	4.49	4.24	3.99	3.49	3.24
18	230A	Inter.	45	280 oz. at 1/8"	80 oz. at 1"	2 1/2 x 1 1/2 x 2 1/4	16.5	5.25	4.73	4.46	4.20	3.68	3.41
18	230A	Cont.	78	145 oz. at 1/8"	40 oz. at 1"	2 1/2 x 1 1/2 x 2 1/4	16.5	5.25	4.73	4.46	4.20	3.68	3.41
24	115A	Inter.	310	16 oz. at 1/8"	3 oz. at 5/8"	1 1/4 x 2 3/2 x 5 3/4	3	3.41	3.07	2.90	2.73	2.39	2.22
24	115A	Cont.	500	10.5 oz. at 1/8"	2 oz. at 5/8"	1 1/4 x 2 3/2 x 5 3/4	3	3.41	3.07	2.90	2.73	2.39	2.22
24S-SPDT	115A	Inter.	310	16 oz. at 1/8"	3 oz. at 5/8"	1 1/4 x 2 3/2 x 2 3/4	3	4.41	3.97	3.75	3.52	3.09	2.87
24S-SPDT	115A	Cont.	500	10.5 oz. at 1/8"	2 oz. at 5/8"	1 1/4 x 2 3/2 x 2 3/4	3	4.41	3.97	3.75	3.52	3.09	2.87
26	115AC	Inter.	140	28 oz. at 1/8"	3 oz. at 7/8"	2 3/2 x 7/8 x 1 3/8	4	3.60	3.24	3.06	2.88	2.70	2.34
26	115AC	Cont.	250	13 oz. at 1/8"	4 oz. at 3/4"	2 3/2 x 7/8 x 1 3/8	4	3.60	3.24	3.06	2.88	2.70	2.34
28	24A	Inter.	7.5	35 oz. at 1/8"	5 oz. at 1/2"	1 1/8 x 1 1/2 x 1 1/2	3.5	3.15	2.84	2.68	2.52	2.21	2.05
28	24A	Cont.	17.4	20 oz. at 1/8"	2.5 oz. at 1/2"	1 1/8 x 1 1/2 x 1 1/2	3.5	3.15	2.84	2.68	2.52	2.21	2.05
28	115A	Inter.	220	35 oz. at 1/8"	5 oz. at 1/2"	1 1/8 x 1 1/2 x 1 1/2	3.5	3.41	3.07	2.90	2.73	2.39	2.22
28	115A	Cont.	400	20 oz. at 1/8"	2.5 oz. at 1/2"	1 1/8 x 1 1/2 x 1 1/2	3.5	3.41	3.07	2.90	2.73	2.39	2.22
28S-SPDT	115A	Inter.	220	35 oz. at 1/8"	5 oz. at 1/2"	1 1/8 x 1 1/2 x 2 1/4	3.5	3.94	3.54	3.30	3.15	2.75	2.56
28S-SPDT	115A	Cont.	400	20 oz. at 1/8"	2.5 oz. at 1/2"	1 1/8 x 1 1/2 x 2 1/4	3.5	3.94	3.54	3.30	3.15	2.75	2.56
34	115A	Inter.	400	15 oz. at 1/8"	1 oz. at 1/2"	1 1/8 x 3/4 x 1 3/4	2.5	2.31	2.08	1.96	1.85	1.62	1.50
34	115A	Cont.	865	7 oz. at 1/8"	.5 oz. at 1/2"	1 1/8 x 3/4 x 1 3/4	2.5	2.31	2.08	1.96	1.85	1.62	1.50
34S-SPDT	115A	Inter.	400	15 oz. at 1/8"	1 oz. at 1/2"	1 1/8 x 3/4 x 2 3/4	2.5	3.31	2.98	2.81	2.65	2.32	2.15
34S-SPDT	115A	Cont.	865	7 oz. at 1/8"	.5 oz. at 1/2"	1 1/8 x 3/4 x 2 3/4	2.5	3.31	2.98	2.81	2.65	2.32	2.15

GUARDIAN POWER RELAYS

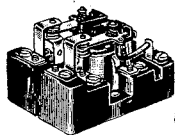

2100U DPDT — Contacts: double pole, double throw. Size: 3 3/8" L. x 2 1/2" W. x 3/8" H. Shipping Weight: 11 ounces. Series 2100 and 2110 power relays are rated at 25 amperes, continuous duty at 230 Volts AC, with 75% power factor. Operating power requirement for AC is 9.5 volt amperes, 60 cycles. Coil drain approx. .080 amperes at 115 volts, 60 cycles. Approximate weight of replacement coil assemblies is 6 ounces.

MOUNTING: 2 holes .196" dia. on 1 7/8" centers.

*UL/Recognized Component File #E23524

Guardian	Volts	QUANTITIES				
		1-24	25-49	50-99	100-249	250 UP
2100U-DPDT-6	6AC	\$6.75	\$6.08	\$5.74	\$5.40	\$4.73
2100U-DPDT-24	24AC	6.75	6.08	5.74	5.40	4.73
2100U-DPDT-120	120AC	6.75	6.08	5.74	5.40	4.73
2100U-DPDT-240	240AC	7.25	6.53	6.16	5.80	5.08

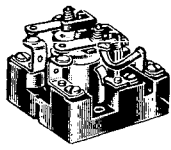

2110U DPSTNO
Contacts: Double pole, single throw, normally open. Size: 2 1/4" L. x 2 1/2" W. x 3/8" H. Shipping Weight: 10 ounces.

*UL/Recognized Component File #E23524

Guardian	Volts	QUANTITIES				
		1-24	25-49	50-99	100-249	250 UP
2110U-DPST-N.O.-6	6AC	\$5.75	\$5.18	\$4.89	\$4.60	\$4.03
2110U-DPST-N.O.-24	24AC	5.75	5.18	4.89	4.60	4.03
2110U-DPST-N.O.-120	120AC	5.75	5.18	4.89	4.60	4.03
2110U-DPST-N.O.-240	240AC	6.10	5.49	5.19	4.98	4.37

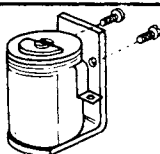

Interchangeable Coil Assemblies (No Solder Connections)... By removing two easy accessible screws, coil assembly can be replaced by coil of another value. Complete instructions for this operation are included with each unit. Solder connections are not required when changing coils.

REPLACEMENT COILS FOR EITHER RELAY

Guardian	Volts	QUANTITIES				
		1-24	25-49	50-99	100-249	250 UP
2100-6A	6AC	\$2.35	\$2.12	\$2.00	\$1.88	\$1.65
2100-24A	24AC	2.35	2.12	2.00	1.88	1.65
2100-120A	120AC	2.35	2.12	2.00	1.88	1.65
2100-240A	240AC	2.65	2.39	2.25	2.12	1.86

Power Relay Replacement Contact Switch Parts — Available for Series 2100, only — Replacement Contact Switch Parts for easy right or left SPDT assembly. No solder needed. Package contains one normally open and one normally closed contact bracket, complete moving blade and terminal. Left or Right Switch Assemblies determined by viewing relay from armature hinge end with contacts up.

Guardian	QUANTITIES				
	1-24	25-49	50-99	100-249	250 UP
CS-2100 — LEFT	\$1.95	\$1.76	\$1.66	\$1.56	\$1.37
CS-2100 — RIGHT	1.95	1.76	1.66	1.56	1.37

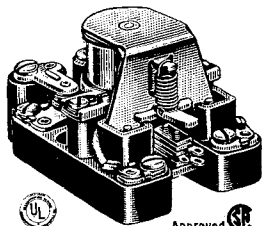

GUARDIAN SERIES 2300U AC SERIES 2305 DC POWER RELAY

15 Amperes

Size: 3 3/8" x 2 1/2" x 2 1/8". Shipping Weight: 8 ounces. Mounting: Two .196" Diam. holes on 1 7/8" centers.

In power applications that require up to 15 ampere contacts the Guardian Series 2300 AC, or Series 2305 DC Power Relays are specified. Both have standard DPDT contacts rated for 15 amperes non-inductive, or 1 HP at 115/230 volts, 60 cycles. Series 2300 standard coil voltages are 6, 12, 24 and 120 VAC. Series 2305 standard coil voltages are 6, 12, 24 and 110 VDC. Inverted coil construction protects armature and contacts. Armature extension permits manual circuit testing. Screw type terminals easily accessible for top or bottom connections. Easy to mount, recessed auxiliary switch, up to SPDT for 10 ampere operation, available for both AC and DC versions.

*U/L Recognized Component File #E-23524

Guardian No.	Volts	Rating Amps.	QUANTITIES				
			1-24	25-49	50-99	100-249	250 UP
2300U-DPDT-6	6AC	15	\$6.25	\$5.63	\$5.31	\$5.00	\$4.38
2300U-DPDT-24	24AC	15	6.25	5.63	5.31	5.00	4.38
2300U-DPDT-120	120AC	15	6.25	5.63	5.31	5.00	4.38
2300U-DPDT-240	240AC	15	6.50	5.85	5.53	5.20	4.55
2305-DPDT-6	6DC	15	6.25	5.63	5.31	5.00	4.38
2305-DPDT-12	12DC	15	6.25	5.63	5.31	5.00	4.38
2305-DPDT-24	24DC	15	6.25	5.63	5.31	5.00	4.38
2305-DPDT-110	110DC	15	6.75	6.08	5.74	5.40	4.73
2300-SPDT-AUX Auxiliary Switch		10	1.35	1.22	1.15	1.08	.95

GUARDIAN TIME DELAY RELAYS

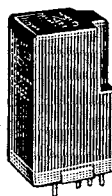

SERIES TD — This is the most accurate and compact solid-state time-delay available commercially from stock. 3DPT contacts handle up to 10 amp resistive load. Six standard model relays for 24V., DC and 115V., AC 50/60 cycles provide delays from 1 to 180 seconds. All units utilize silicon semi-conductors and precision tantalum capacitors for reliability. 15-turn screw-type potentiometer furnishes high resolution and accuracy. Accurate to 5% of a nominal setting over its complete temperature and voltage range. Repeatability is 2% after a line interruption of 50 milliseconds. Termination can be quick disconnects, socket or solder connections. Size: 3" x 1 5/8" x 1 1/8". Shpg. wt., 5 oz.

Guardian No.	Coil Voltage	Adjustment Range	Net Each, Lots of		
			1-49	50-99	100 Up
TD33C15-24D	24VDC±10%	1 to 15 sec.	\$24.20	\$21.88	\$19.69
TD33C60-24D	24VDC±10%	10 to 60 sec.	25.19	22.67	20.40
TD33C180-24D	24VDC±10%	50 to 180 sec.	32.09	29.88	26.90
TD63C15-115A	115VAC±10%	1 to 15 sec.	29.70	26.73	24.06
TD63C60-115A	115VAC±10%	10 to 60 sec.	30.06	27.54	24.79
TD63C180-115A	115VAC±10%	50 to 180 sec.	36.85	33.16	29.84

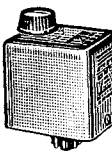

SERIES TDO — Incorporates many features of more expensive units, but is the most economical 5 amp DPDT 115V., AC solid-state adjustable time-delay relay ever offered. Delay is adjustable from 0.5 to 30 seconds on attract and is controlled by a 10-turn potentiometer for high resolution, easy reset and accuracy. Unit terminates in octal plug. Accurate within 10% of a nominal setting over its entire temperature and voltage range. Repeatability is within 2% after a line interruption of 100 milliseconds. Size: 3" x 2 5/8" x 2 1/4". Shpg. wt., 8 oz.

Guardian No.	Coil Voltage	Adjustment Range	Net Each, Lots of		
			1-49	50-99	100 Up
TD0-62C30-115A	115V ±%	50/60 cycle 0.5 to 30 sec.	\$16.32	\$15.69	\$14.12

SERIES 200 RELAY WITH COMPLETELY INTERCHANGEABLE COIL AND CONTACT ASSEMBLIES

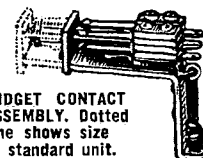
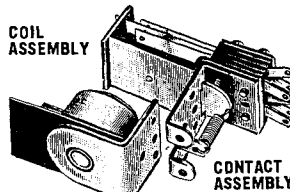

MIDGET CONTACT ASSEMBLY. Dotted line shows size of standard unit.

The coil consists of the coil and field piece; the contact assembly consists of switch blades, armature, return spring and mounting bracket. The Guardian Midget Assembly is interchangeable with the standard Series 200 coil assembly. Available with SPDT, DPDT or 4PDT contact switch assemblies, each interchangeable with all AC or DC coils.

SERIES 200 RELAY

Guardian No.	Volts	Coil	Net Each, Lots of				
			1-24	25-49	50-99	100-249	250 Up
200-6A	6	AC	\$1.85	\$1.67	\$1.57	\$1.48	\$1.30
200-12A	12	AC	1.85	1.67	1.57	1.48	1.30
200-24A	24	AC	1.85	1.67	1.57	1.48	1.30
200-115A	115	AC	2.15	1.94	1.83	1.72	1.51
200-230A	230	AC	2.85	2.57	2.42	2.28	2.00
200-6D	6	DC	2.00	1.80	1.70	1.60	1.40
200-12D	12	DC	2.00	1.80	1.70	1.60	1.40
200-24D	24	DC	2.00	1.80	1.70	1.60	1.40
200-32D	32	DC	2.00	1.80	1.70	1.60	1.40
200-110D	110	DC	2.65	2.39	2.25	2.12	1.86
200-5,000D	†	DC	2.30	2.07	1.96	1.84	1.61
200-10,000D	†	DC	2.65	2.39	2.25	2.12	1.86

† Plate.

CONTACT SWITCH ASSEMBLIES

Guardian No.	Type	Cont. Amps	Cont. Comb.	Net Each, Lots of				
				1-24	15-49	50-99	100-249	250 Up
200-1	Standard	8	SPDT	\$1.60	\$1.44	\$1.36	\$1.28	\$1.12
200-2	Standard	8	DPDT	2.10	1.89	1.79	1.68	1.47
200-4	Standard	12.5	DPDT	2.35	2.12	2.00	1.88	1.65
200-5	Standard	8	4PDT	3.70	3.33	3.15	2.96	2.59
200-M1	Midget	10	SPDT	1.50	1.35	1.28	1.20	1.05
200-M2	Midget	10	DPDT	1.85	1.67	1.57	1.48	1.30
200-M5	Midget	8	4PDT	3.00	2.70	2.55	2.40	2.10

CONTACT SWITCH PARTS

Guardian No.	Type	Net Each, Lots of				
		1-24	25-49	50-99	100-249	250 Up
200-3	Standard	\$1.60	\$1.99	\$1.36	\$1.28	\$1.12
200-M3	Midget	1.60	1.99	1.36	1.28	1.12

Use contact switch parts 200-3 for adding poles to contact switch assemblies 200-1 and 200-2. Use midget contact switch parts 200-M3 for adding poles to midget contact switch assemblies 200-M1 and 200-M2.

GUARDIAN PROTECTIVE SENSOR DEVICES



Fast-acting voltage, frequency and phase rotation sensors provide accurate repeat cycle characteristic of solid state input sensors, plus dependable 3PDT relay output. For use in visual or audible indicating devices or transfer switches. Sensors are non-latching; electrical latch and unlatch can be obtained by interwiring Guardian 24 VDC or 115 VAC enclosed relays. Versatile mounting; accepts printed-circuit

socket, chassis mount, clip or chassis-mounted socket. 3PDT contacts rated 10 amps resistive at 115 VAC. Temperature range, 0°C to 50°C. Life expectancy, 100,000 operations min. Protected for transient voltages: 600 volts on 3-phase models, 2500 volts on all other types. With plastic dust cover.

3-PHASE, 4-WIRE VOLTAGE SENSING DEVICE

Detects from 3-phase source of 95 VAC when sufficient voltage available and loss of any line or drop-in average to 50 VAC. For use as warning or lockout device to protect 3-phase motors and systems. Designed for pull-in and drop-out; will repeat close values, allowing for unevenly loaded lines which can cause drastic rise and fall in other lines.

Guardian No. IR-AV2-611 — For 115 VAC, 60 Hz.Net \$34.20
Guardian No. IR-AV2-621 — For 115 VAC, 400 Hz.Net 34.20

CLOSE DIFFERENTIAL VOLTAGE SENSING DEVICE

Output relay energizes as input voltage rises to adjusted sense-point, de-energizes as input drops to adjusted differential release point. Non-latching output; energizes when voltage is returned to normal. Both sense-point and differential are adjusted through top of cover.

Guardian Number	Nominal Input	Adjustable Voltage Ranges		Net Each
		Sense-Point	Differential	
IR-VS3-610	115 VAC, 60 Hz	105 - 130 VAC	2.5 - 15 VAC	\$54.80
IR-VS3-620	115 VAC, 400 Hz	105 - 130 VAC	2.5 - 15 VAC	54.80
IR-VS3-300	24 VDC	23 - 32 VDC	1 - 5 VDC	53.40
IR-VS3-410	24 VAC, 60 Hz	23 - 32 VAC	1 - 5 VAC	54.15
IR-VS3-420	24 VAC, 400 Hz	23 - 32 VAC	1 - 5 VAC	54.15

OVER-VOLTAGE SENSING DEVICE

Output relay energizes as input voltage rises to adjusted sense-point. De-energizes as input voltage drops approx. 2.5% below sense-point. Permits sensor to function as under or over-voltage detector. Adjustment through cover.

Guardian Number	Nominal Input	Adjustable Voltage Range	Net Each
IR-VS1-610	115 VAC, 60 Hz	90 - 130 VAC	\$42.90
IR-VS1-620	115 VAC, 400 Hz	90 - 130 VAC	42.90
IR-VS1-300	24 VDC	18 - 32 VDC	41.70
IR-VS1-410	24 VAC, 60 Hz	18 - 32 VAC	42.15
IR-VS1-420	24 VAC, 400 Hz	18 - 32 VAC	42.15

UNDER-VOLTAGE SENSING DEVICE

Output relay energizes at low voltage pull-in point, independent of control circuit; remains energized until voltages rise to adjusted sense-point.

Guardian Number	Nominal Input	Adjustable Voltage Range	Net Each
IR-VS2-610	115 VAC, 60 Hz	90 - 130 VAC	\$42.90
IR-VS2-620	115 VAC, 400 Hz	90 - 130 VAC	42.90
IR-VS2-300	24 VDC	18 - 32 VDC	41.70
IR-VS2-410	24 VAC, 60 Hz	18 - 32 VAC	42.15
IR-VS2-420	24 VAC, 400 Hz	18 - 32 VAC	42.15

4-WIRE PHASE ROTATION SENSOR DEVICE

With ABC phase rotation, output relay is energized by 75 VAC balanced phase inputs. Non-latching. Designed to monitor power input to 3-phase motors or systems.

Guardian No. IR-PR1-610 — For 115 VAC, 60 Hz.Net \$39.95
Guardian No. IR-PR1-620 — For 115 VAC, 400 Hz.Net 39.95

ADJUSTABLE FREQUENCY SENSOR DEVICE

Use as under or over-frequency detector; ideal as AC generator speed detector, destructive frequency trip-out or AC power loss detector. Output relay of types IR-FS1 energizes as frequency rises to the adjusted sense-point and de-energizes when frequency drops to approx. 1.5% of sense-point; output relay of types IR-FS2 energizes at its low-voltage pull-in point, independent of control circuit and remains energized until frequency rises to the adjusted sense-point. Adjustable through cover.

Guardian Number	Nominal Input	Adjustable Frequency Range	Net Each
IR-FS1-610	115 VAC, 60 Hz	45 - 66 Hz	\$55.20
IR-FS1-620	115 VAC, 400 Hz	360 - 440 Hz	55.20
IR-FS2-610	115 VAC, 60 Hz	45 - 66 Hz	55.20
IR-FS2-620	115 VAC, 400 Hz	360 - 440 Hz	55.20

GUARDIAN RELAYS & SOLENOIDS

**GENERAL PURPOSE
POWER
STEPPING
TIME DELAY
SOLENOIDS
SENSORS**



*Available at Factory Prices from
Your Authorized Guardian Distributor*



LINE ELECTRIC COMPANY

RELAYS • BUZZERS • FOOT SWITCHES

GENERAL PURPOSE RELAYS

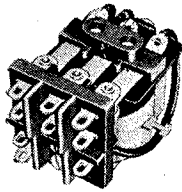

MINIATURE OPEN TYPE (SERIES MK)

Open type relay in standard contact arrangements up to 3PDT. 5 or 10 amp contact rating. Voltages up to 230 volts, A.C. or D.C. Factory adjusted to pull in at 75% max. of nominal voltage D.C. and 80% max. of nominal voltage A.C. Designed to pass 1,000 volt A.C. Hipot test between all elements. UL File #36213

AC	5 amp contact rating	6, 12, 24, 115V	220V
	MK1A SPDT	\$3.10	\$3.55
	MK2A DPDT	3.75	4.15
	MK3A 3PDT	4.15	4.55



PLATE CIRCUIT RELAYS 5 amp. open type

	2500Ω	5000Ω	10,000Ω	20,000Ω
MKC-1 SPDT	\$3.15	\$3.25	\$3.80	\$4.05
MKC-2 DPDT	3.65	3.80	4.30	4.55
MKC-3 3PDT	4.10	4.20	4.75	5.00

10 amp models ask for series MKCO

DC	5 amp contact rating	6, 12, 24V	110V
	MK1D SPDT	\$3.05	\$3.45
	MK2D DPDT	3.40	3.85
	MK3D 3PDT	3.85	4.25

All models available in 10 amps. DIMENSIONS: 1-11/16 × 1-3/16 × 29/32
All models available in 10 amps. Ask for series MKO.

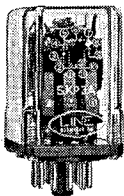

MINIATURE PLUG-IN (SERIES MKP)

Plug-in type relay, same factory tested, quality features as above. Will operate continuously in ambient temperature ranges of 45° to 75°C. for D.C. coils and -45° to 55°C. for A.C. coils. Metal or clear C-11 Styrene dust cover. UL File #36213

AC	5 amp contact rating	6, 12, 24, 115V	220V
	MKP1A SPDT	\$5.45	\$5.90
	MKP2A DPDT	6.05	6.45
	MKP3A 3PDT	7.50	7.95



PLATE CIRCUIT RELAYS 5 amp. enclosed type

	2500Ω	5000Ω	10,000Ω	20,000Ω
MKF-1 SPDT	\$5.90	\$6.00	\$6.40	\$6.65
MKF-2 DPDT	6.30	6.40	6.80	7.10
MKF-3 3PDT	7.75	7.90	8.40	8.65

10 amp models ask for series MKFO

DC	5 amp contact rating	6, 12, 24V	110V
	MKP1D SPDT	\$5.40	\$5.85
	MKP2D DPDT	6.00	6.40
	MKP3D 3PDT	7.45	7.90

All models available in 10 amps. Ask for series MKH. DIMENSIONS: 2-1/4 × 1-5/8 × 1-3/8

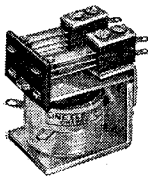

MINIATURE MULTIPLE LEAF (SERIES MW)

A small, versatile relay available in a variety of contact configurations consisting of forms A, B, C or D. (make before break), up to a maximum of 12 springs. Coils can be supplied for operation on D.C. or A.C. 60 cps. Operation on 400 cps. source is available with self-contained rectifiers on relays with covers.

	10 amp contact rating	6, 12, 24, 115V	220V
AC	MW1A SPDT	\$2.70	\$3.10
	MW2A DPDT	3.30	3.75
	MW3A 3PDT	3.80	4.20
	MW14A 4PDT	6.35	6.75
		6, 12, 24V	110V
DC	MW1D SPDT	\$2.60	\$3.10
	MW2D DPDT	3.25	3.65
	MW3D 3PDT	3.75	4.15
	MW14D 4PDT	6.35	6.80

DIMENSIONS: 1-17/32 × 1-21/32 × 1-0



SPOTLIGHT RELAYS (SERIES A)

High quality, general purpose plug-in relay with built-in circuit indicator lamp. Available in C-11 Styrene colored cases for circuit identification or in metal can. Saves panel space, reduces costly labor. UL File #36213.

	5 amp contact rating	6, 12, 24, 115V	220V
AC	A-1A SPDT	\$6.40	\$6.85
	A-2A DPDT	7.00	7.40
	A-3A 3PDT	8.45	8.85
		6, 12, 24V	110V
DC	A-1D SPDT	\$6.35	\$6.75
	A-2D DPDT	6.95	7.35
	A-3D 3PDT	8.40	8.80

All models available in 10 amps. AH series.
DIMENSIONS: 2-1/4 × 1-3/8 × 1-3/8

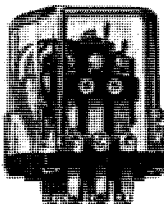

SPOTLIGHT RELAYS. LOW COST. (SERIES ATR)

A plug-in relay which is identical in construction to our miniaturized low profile SERIES MKTR (see page 3) but with built-in circuit indicator lamp. It can be used in conjunction with our 92-67 or 92-82 sockets and 91-49 spring clip. UL File #36213.

	5 amp contact rating	6, 12, 24, 115V	220V
AC	ATR1A SPDT	\$5.25	\$5.60
	ATR2A DPDT	5.90	6.30
	ATR3A 3PDT	6.35	6.80
		6, 12, 24V	110V
DC	ATR1D SPDT	\$5.15	\$5.55
	ATR2D DPDT	5.55	6.00
	ATR3D 3PDT	6.05	6.45

All models available in 10 amps AHTR Series.
DIMENSIONS: 1-3/16 × 1-3/8 × 1-3/8

LINE ELECTRIC COMPANY

RELAYS • BUZZERS • FOOT SWITCHES

GENERAL PURPOSE RELAYS

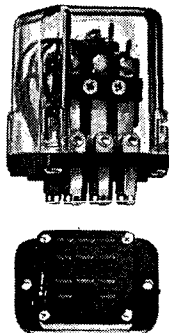

MINIATURE PLUG-IN LOW PROFILE LOW COST (SERIES MKTR)

Despite its compact size this new totally enclosed, low cost, low profile miniature relay has not compromised the high quality of its progenitor the Series MK open relay. The low mounting profile (dust cover included) has been made possible by incorporating the frame of the relay with the connector-header. Thus a certain basic hardware has been eliminated resulting in important size reduction. Versatility is also assured since the standard terminals can be used with Amp snap-on connectors, printed circuits, or plug-in receptacles. Also available with studs for chassis mounting. Termination can be used for soldered connections. The plug-in-receptacle is true 10 ampere construction. Lugs can be used for either solder or snap-on connections. UL File #36213 10 Amps series MKTRO

5 amp contact rating		6, 12, 24, 115V	220V
AC	MKTR1A SPDT	\$4.25	\$4.65
	MKTR2A DPDT	4.95	5.35
	MKTR3A 3PDT	5.40	5.85
		6, 12, 24V	110V
DC	MKTR1D SPDT	\$4.20	\$4.60
	MKTR2D DPDT	4.60	5.05
	MKTR3D 3PDT	5.10	5.50

AVAILABLE 3 WAYS: Plate circuit relay. Spotlight relay (with or without colored dust cover). Hermetic seal or any combination. DIMENSIONS: 1-27/32 X 1-3/8 X 1-3/8

- 92-67 RECEPTACLE .30 net.
- 92-82 Clip-on Receptacle .50
- 91-49 Hold down Spring .12

NEW MINIATURE SENSITIVE RELAYS (SERIES SK) 60 MILLIWATTS PER POLE

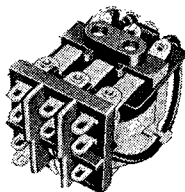

This entire series of SK type relays is identical in construction to our MK series miniature relays, with one essential difference—the special alloy used in pole and frame increases the magnetic

flux many times thus making the relays very sensitive to very low power levels—only 60 milliwatts per pole.

UL File #39077

SERIES SK OPEN TYPE 5 AMPS

	up to 2500Ω	5000Ω	10,000Ω	15,000Ω	20,000Ω
SK-1 SPDT	\$4.15	\$4.25	\$4.80	\$4.80	\$5.05
SK-2 DPDT	4.65	4.80	5.30	5.30	5.55
SK-3 3PDT	5.10	5.20	5.75	5.75	6.00
SK-4 SPST-NO	4.10	4.20	4.75	4.75	5.00
SK-5 DPST-NO	4.55	4.70	5.20	5.20	5.45
SK-6 3PST-NO	4.95	5.05	5.60	5.60	5.85
SK-7 SPST-NC	4.10	4.20	4.75	4.75	5.00
SK-8 DPST-NC	4.55	4.70	5.20	5.20	5.45
SK-9 3PST-NC	4.95	5.05	5.60	5.60	5.85

SERIES SKT PRINTED CIRCUIT TYPE 5 AMPS

	up to 2500Ω	5000Ω	10,000Ω	15,000Ω	20,000Ω
SKT-1 SPDT	\$4.30	\$4.45	\$5.10	\$5.10	\$5.30
SKT-2 DPDT	4.85	5.00	5.55	5.55	5.85
SKT-3 3PDT	5.25	5.40	6.00	6.00	6.25
SKT-4 SPST-NO	4.25	4.40	5.05	5.05	5.25
SKT-5 DPST-NO	4.75	4.90	5.45	5.45	5.75
SKT-6 3PST-NO	5.10	5.25	5.85	5.85	6.10
SKT-7 SPST-NC	4.25	4.40	5.05	5.05	5.25
SKT-8 DPST-NC	4.75	4.90	5.45	5.45	5.75
SKT-9 3PST-NC	5.10	5.25	5.85	5.85	6.10

Type SK

Type SKA

Type SKD

Type SKT



Type SKP

SERIES SKA OPEN TYPE 5 AMPS .110 QUICK CONNECT LUGS

	up to 2500Ω	5000Ω	10,000Ω	15,000Ω	20,000Ω
SKA-1 SPDT	\$4.30	\$4.45	\$5.05	\$5.05	\$5.30
SKA-2 DPDT	4.85	5.00	5.55	5.55	5.85
SKA-3 3PDT	5.25	5.60	6.00	6.00	6.25
SKA-4 SPST-NO	4.25	4.40	5.00	5.00	5.25
SKA-5 DPST-NO	4.75	4.90	5.45	5.45	5.75
SKA-6 3PST-NO	5.10	5.45	5.85	5.85	6.10
SKA-7 SPST-NC	4.25	4.40	5.05	5.05	5.25
SKA-8 DPST-NC	4.75	4.90	5.45	5.45	5.75
SKA-9 3PST-NC	5.10	5.45	5.85	5.85	6.10

SERIES SKD OPEN TYPE 5 AMPS .187 QUICK CONNECT LUGS

	up to 2500Ω	5000Ω	10,000Ω	15,000Ω	20,000Ω
SKD-1 SPDT	\$4.30	\$4.45	\$5.05	\$5.05	\$5.30
SKD-2 DPDT	4.85	5.00	5.55	5.55	5.85
SKD-3 3PDT	5.25	5.60	6.00	6.00	6.25
SKD-4 SPST-NO	4.25	4.40	5.00	5.00	5.25
SKD-5 DPST-NO	4.75	4.90	5.45	5.45	5.75
SKD-6 3PST-NO	5.10	5.45	5.85	5.85	6.10
SKD-7 SPST-NC	4.25	4.40	5.00	5.00	5.25
SKD-8 DPST-NC	4.75	4.90	5.45	5.45	5.75
SKD-9 3PST-NC	5.10	5.45	5.85	5.85	6.10

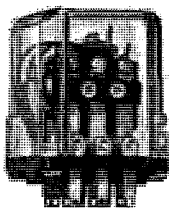

Type SKTR

SERIES SKP PLUG-IN PLASTIC HOUSING 5 AMPS

	up to 2500Ω	5000Ω	10,000Ω	15,000Ω	20,000Ω
SKP-1 SPDT	\$6.90	\$7.00	\$7.40	\$7.40	\$7.65
SKP-2 DPDT	7.30	7.40	7.80	7.80	8.10
SKP-3 3PDT	8.75	8.90	9.40	9.40	9.65
SKP-4 SPST-NO	6.85	6.95	7.35	7.35	7.60
SKP-5 DPST-NO	7.20	7.30	7.70	7.70	8.00
SKP-6 3PST-NO	8.60	8.75	9.25	9.25	9.50
SKP-7 SPDT-NC	6.85	6.95	7.35	7.35	7.60
SKP-8 DPST-NC	7.20	7.30	7.70	7.70	8.00
SKP-9 3PST-NC	8.60	8.75	9.25	9.25	9.50

SERIES SKTR LOW COST PLATE CIRCUIT RELAYS

PLUG-IN TYPE

5 AMP. DC	Up to 2500Ω	5,000Ω	10,000Ω	20,000Ω
SKTR1 SPDT	\$5.30	\$5.45	\$6.05	\$6.30
SKTR2 DPDT	5.85	6.00	6.55	6.85
SKTR3 3PDT	6.25	6.60	7.00	7.25

PRINTED CIRCUIT TYPE ENCLOSED

SKTE1 SPDT	\$5.30	\$5.45	\$6.05	\$6.30
SKTE2 DPDT	5.85	6.00	6.55	6.85
SKTE3 3PDT	6.25	6.60	7.00	7.25



LINE ELECTRIC COMPANY

RELAYS • BUZZERS • FOOT SWITCHES

GENERAL PURPOSE RELAYS



HEAVY DUTY RELAY PLUG-IN TYPE (SERIES LGP)

Plug-in type relay, with same quality features as above. Also available in either metal or clear bC-11 Styrene

enclosure. Ambient temperature operating range, continuous duty; A.C., —45° to 55°C.; D.C., —45° to 75°C.

AC	10 amp contact rating	6, 12, 24, 115V	220V
LGP1A SPDT		\$7.30	\$7.50
LGP2A DPDT		7.85	8.05
LGP3A 3PDT		8.40	8.60

DC	10 amp contact rating	6, 12, 24V	110V
LGP1D SPDT		\$7.20	\$7.40
LGP2D DPDT		7.75	8.05
LGP3D 3PDT		8.40	8.60



HEAVY DUTY POWER RELAYS* (SERIES STA)

A 25 amp. power relay ideally suited for starting motors up to 1 hp, elevator controls, and many other applications which require high current or high voltage switching with maximum dependability. One piece molded base, sturdy two-hole mounting. Top removable coil.

AC	25 amp contact rating	6, 12, 24, 115V	220V
STA2A DPDT		\$6.55	\$6.85
STA3A (1. aux. con.)		8.55	8.85
STA14A (2. aux. con.)		10.05	10.35

DC	25 amp contact rating	6, 12, 24VDC	110VDC
STA2D DPDT		\$6.55	\$6.85
STA3D (1. aux. con.)		8.55	8.85
STA14D (2. aux. con.)		10.05	10.35

Available with one or two auxiliary 5 ampere contacts.

* See new miniature power relay (series PF) on Pg. 7 of this listing.

DIMENSIONS: 2-1/2 × 2-15/16 × 3-3/8

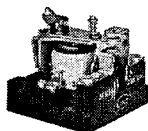

HEAVY DUTY POWER RELAYS (SERIES STM)

Same quality features as Series ST, but assembled on a compact base. Available with one or two auxiliary 5 amp contacts.

AC	25 amp contact rating	6, 12, 24, 115V	220V
STM1A SPDT		\$4.25	\$4.75
STM4A SPST NO		3.90	4.40
STM5A DPST NO		4.65	5.15
STM7A SPST NC		3.90	4.40
STM10A SPST NO DB		4.15	4.65
STMCC AVAILABLE WITH 1 AUX. CON.			
STMCC AVAILABLE WITH 2 AUX. CON.			

DC	25 amp contact rating	6, 12, 24V	110V
STM1D SPDT		\$4.25	\$4.95
STM4D SPST NO		3.90	4.50
STM5D DPST NO		4.65	5.50
STM7D SPST NC		3.90	4.50
STM10D SPST NO DB		4.15	4.75

DIMENSIONS: 2-1/8 × 2-1/2 × 2-5/16

MECHANICAL LATCH RELAYS

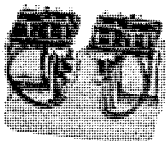

OPEN TYPE (SERIES RL)

Open type for use where a sustained relay closure is required, and current drain of a relay coil is to be eliminated. Incorporates two coils, one to close load con-

tacts, the other to reset them. Requires only momentary electrical contact to operate or release. Provides positive mechanical latch, eliminating chatter during sustained relay closure.

AC	5 amp contact rating	6, 12, 24, 115V	220V
RL1A SPDT		\$7.15	\$8.00
RL2A DPDT		8.25	9.00
RL3A 3PDT		9.15	9.95
RL14A 4PDT		10.45	11.30
RL15A 5PDT		11.45	12.30
RL16A 6PDT		12.55	13.35

DC	5 amp contact rating	6, 12, 24V	110V
RL1D SPDT		\$6.50	\$7.75
RL2D DPDT		7.50	8.75
RL3D 3PDT		8.50	9.75
RL14D 4PDT		9.50	10.75
RL15D 5PDT		10.50	11.75
RL16D 6PDT		11.50	12.75

Available in 10 amp contact rating. ASK FOR SERIES RLO DIMENSIONS: 2-11/16 × 1-3/4 × 1-3/4



PLUG-IN TYPE (SERIES RLP)

Plug-in type, same factory-tested quality features as above. Available in clear C-11 Styrene enclosure up to 5PDT.

AC	5 amp contact rating	6, 12, 24, 115V	220V
RLP1A SPDT		\$9.40	\$10.25
RLP2A DPDT		10.50	11.30
RLP3A 3PDT		14.75	15.60
RLP14A 4PDT		16.15	17.00
RLP15A 5PDT		17.25	18.00

DC	5 amp contact rating	6, 12, 24V	110V
RLP1D SPDT		\$8.75	\$10.05
RLP2D DPDT		9.85	11.15
RLP3D 3PDT		14.10	15.40
RLP14D 4PDT		15.55	16.80
RLP15D 5PDT		16.65	17.90

All models available 3PDT, 4PDT, 5PDT, and in 10 amp contact rating.

ASK FOR SERIES RLH



LINE ELECTRIC COMPANY

RELAYS • BUZZERS • FOOT SWITCHES

TIME DELAY RELAYS

PLUG-IN TYPE (SERIES TRP)

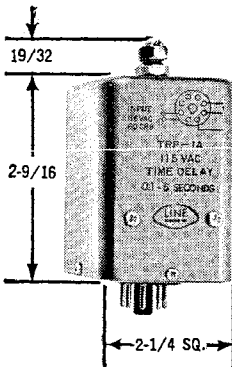

The series TRP Time Delay Relay provides a pre-set delay between the closing of one set of contacts and the subsequent operation of a set of SPDT load contacts.

The series TRP initiates from a sustained switch closure to L1 and L2. The unit resets instantaneously when this circuit is opened; ready for another timing operation.

The series TRP is available in two operational options:

Type "A"—If sustained closure is interrupted during time cycle, unit will not reset. When closure is again made, timing will continue to give originally selected time delay.

Type "B"—If sustained closure is interrupted during time cycle, unit will instantaneously reset.

Information Required When Ordering \$18.50
Time Cycle selected from chart. List

SPECIFICATIONS

Plug in only using standard 8 pin octal receptacle.

TIME CYCLES		
Model	Minimum Setting	Maximum Setting
TRP-5	0.1 sec.	5 seconds
TRP-10	0.1 sec.	10 seconds
TRP-15	0.1 sec.	15 seconds
TRP-30	0.1 sec.	30 seconds
TRP-60	0.1 sec.	60 seconds

Note: Time Cycles exceeding 60 seconds available, contact factory for details.

Voltagcs 115/60 only.

Load Contacts SPDT rated at 5 amps., non-inductive — Note: 10 amps available, contact factory.

REED RELAYS — 3 STANDARD TYPES

In computer, data processing and guidance system development, design engineers are enthusiastically applying dry reed relays in place of switching diodes. The reasons: miniature profile—life expectancy exceeding 100,000,000 operations—less heat generated compared with switching diodes—3 millisecond operating time and very high resistance in the open contact stage.

To efficiently serve the growing demand for dry reed relays in these and other applications, Line Electric now stocks these 3 standard types for immediate delivery in prototype quantities.

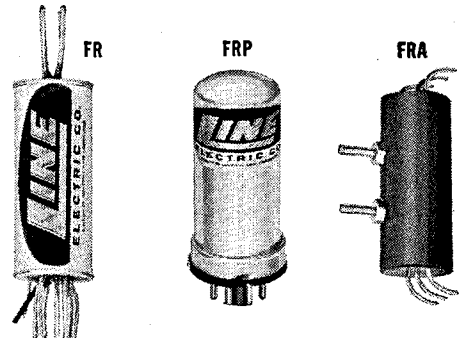

Open Coil Type—Series FR

6 VDC & 12 VDC & 24 VDC. 6 Contact Arrangements

FR1-SPDT, \$ 5.50 ea. FR4-SPST NO, \$3.30 ea.
FR2-2PDT, \$ 9.00 ea. FR5-2PST NO, \$4.50 ea.
FR3-3PDT, \$12.75 ea. FR6-3PST NO, \$5.50 ea.

Plug-In Type—Series FRP

6 VDC & 12 VDC & 24 VDC. 6 Contact Arrangements

FRP1-SPDT, \$ 8.50 ea. FRP4-SPST NO, \$6.00 ea.
FRP2-2PDT, \$12.00 ea. FRP5-2PST NO, \$7.50 ea.
FRP3-3PDT, \$16.00 ea. FRP6-3PST NO, \$8.50 ea.

Lug Mount Type—Series FRA

6 VDC & 12 VDC & 24 VDC. 2 Contact Arrangements

FRA1-SPDT, \$7.50 ea. FRA4-SPST NO, \$4.50 ea.

SPECIFICATIONS

CONTACT RATING 10 volt-amperes resistive 3 watts D.C. resistive	OPERATE TIME 3 milliseconds maximum, including bounce
MAXIMUM CURRENT 0.5 amperes	CONTACT RESISTANCE 50 milliohms
DIELECTRIC STRENGTH 250 volts 60 cps R.M.S.	INSULATION RESISTANCE 1000 megohms minimum
MAXIMUM VOLTAGE 110 volts	RELEASE TIME 5 milliseconds maximum, including bounce
LIFE EXPECTANCY Rated load - - - 1 x 10 ⁶ operations Dry circuit - - - 100 x 10 ⁶ operations	

NEW MINIATURE POWER RELAY (SERIES PF)

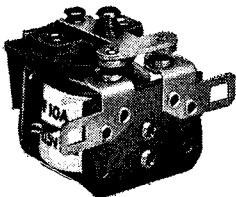

The PF Series Relays are especially designed for applications where limited space is a factor. This relay, although small in size, is ideally suited for heavy duty industrial control applications where long life and fast action are a requirement. The PF Relay is supplied with 1/4" quick connect terminals on the contacts for ease of installation. Other type terminals are available upon request. Consult factory for details.

CONTACTS

Material 1/4" dia. silver cadmium oxide gold flashed.
Contact Terminals 1/4" quick connect. Pierced for soldering.

COILS

Dielectric Strength 750 V.R.M.S.
Nominal Power D.C. relays - 1.1 watts avg.
A.C. relays - 2.5 volt amp avg.
Over-Voltage D.C. - 140% of nominal. A.C. - 125% of nominal.
Operate Time 15 milliseconds or less.
Weight 3 ounces
Temperature Range -40° C. to +50° C.
Coil Terminals Solder type.

	25 amp. contact rating	6-12-24-115V	220V
AC PF10A SPST-NO-DB		\$3.90	\$4.30
DC PF10D SPST-NO-DB		3.70	4.30

MAGNECRAFT RELAYS

The relays you can rely on

444 different Relay Models

Immediate Delivery from STOCKING DISTRIBUTORS

MAGNECRAFT ELECTRIC CO.

All prices and specifications effective January 6, 1968 and subject to change without notice.

All prices are NET for 1 to 9 Relays except Mercury-Wetted Contact and Dry Reed Relay prices are NET for 1 to 24.

All contact ratings based on 115 VAC or 28 VDC, non-inductive load.

ORDER BY CATALOG NUMBER. Labels on MAGNECRAFT STOCK RELAY CARTONS carry Catalog Number, contact combination and rating; coil voltage or current.

All enclosed relays are identified by catalog number and wiring diagram.

NOTE. Order MAGNECRAFT STOCK RELAYS from STOCKING DISTRIBUTORS. Their stocks are supplemented by complete stocks maintained at the MAGNECRAFT plant in Chicago.

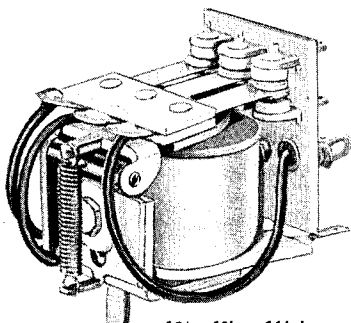

Class 88
AC and DC
Small, 10-amp.
General Purpose
Relay

Open Type Relay. Has 10 ampere silver alloy contacts. Tinned solder terminals, spaced for easy wiring. One #6-32 tapped mounting hole with locating boss. Weight 2 ounces.

1 3/4 x 1 1/8 x 1 3/4 h.

The General Purpose Relay with Telephone Type Reliability

The MAGNECRAFT 88 Relay is an abrupt departure in clapper type relay design. Dimensionally interchangeable with relays made by others the 88 has been developed to provide Telephone Type Reliability at general purpose relay prices.

Unique in relays of this type MAGNECRAFT 88 Relays have rugged, precision-built hinge-pin armature bearings with over-size bearing surfaces—the same construction used in the finest telephone type relays for lowest friction and maximum contact effectiveness with stabilized adjustment over long life.

Glass insulation provides great di-electric strength unaffected by humidity and temperature changes.

Molded Nylon bobbins with ruggedized coil terminal inserts eliminate possibility of shorts.

Built-in contact wipe with riveted contacts further advance reliability through long life.

The many refinements, plus MAGNECRAFT Quality Control and Inspection Standards, give you hidden values beyond price—unseen values that keep making friends through years of dependable service.

When you inspect and compare you will soon see that many MAGNECRAFT 88 extra values are not hidden.

Wiring diagrams for Class 88 Plug-in Mounted Relay

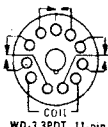
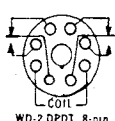
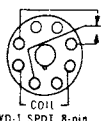

h* is overall dimension above socket WD is abbreviation for Wiring Diagram †Voltage operated relays pull in at 85% of nominal voltage.

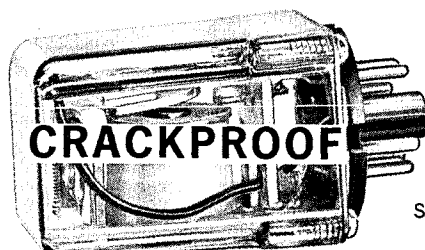

Class 88CP
AC and DC
Small, Plug-in
in Crackproof
plastic cover

See wiring diagrams at lower left

1 1/2 x 1 1/8 x 2 1/8 h*

Enc. 40-279 CRACKPROOF, clear as glass, tough as steel dust cover of polycarbonate resin housing Class 88 relay with 8- or 11-pin standard octal plug. Silver alloy contacts, 10 amp. rating. Weight, 3 ounces.

contact arrangement	COIL			10 ampere silver alloy contacts					
	†VOLT. or current	res. ohms	nominal power	OPEN RELAY		with Enclosure 40-279			
				Stock Part No.	Price 1 to 9	Stock Part No.	Price 1 to 9		
alternating current voltage actuated									
SPDT WD-1	6VAC		3 VA	W88AX1	3.45	W88ACPX1	5.56		
	12VAC			W88AX2	3.45	W88ACPX2	5.56		
	24VAC			W88AX3	3.50	W88ACPX3	5.61		
	115VAC			W88AX4	3.66	W88ACPX4	5.79		
	230VAC			W88AX34	4.12	W88ACPX76	6.31		
DPDT WD-2	6VAC		3 VA	W88AX5	4.07	W88ACPX5	6.24		
	12VAC			W88AX6	4.07	W88ACPX6	6.24		
	24VAC			W88AX7	4.12	W88ACPX7	6.29		
	115VAC			W88AX8	4.27	W88ACPX8	6.44		
	230VAC			W88AX32	4.74	W88ACPX32	6.99		
3PDT WD-3	6VAC		3 VA	W88AX9	4.56	W88ACPX9	7.66		
	12VAC			W88AX10	4.56	W88ACPX10	7.66		
	24VAC			W88AX11	4.62	W88ACPX11	7.81		
	115VAC			W88AX12	4.77	W88ACPX12	7.97		
	230VAC			W88AX36	5.26	W88ACPX39	8.51		
direct current voltage actuated									
SPDT WD-1	6VDC	25	1.5W	W88X2	3.20	W88CPX1	5.35		
	12VDC	100		W88X3	3.20	W88CPX2	5.35		
	24VDC	400		W88X4	3.28	W88CPX3	5.40		
	110VDC	8000		W88X5	3.85	W88CPX4	5.95		
	DPDT WD-2	6VDC		25	1.5W	W88X6	3.73	W88CPX5	5.85
12VDC		100	W88X7	3.73		W88CPX6	5.85		
24VDC		400	W88X8	3.79		W88CPX7	5.95		
110VDC		8000	W88X9	4.36		W88CPX8	6.51		
3PDT WD-3		6VDC	25	1.5W		W88X10	4.17	W88CPX9	7.23
	12VDC	100	W88X11		4.17	W88CPX10	7.28		
	24VDC	400	W88X12		4.21	W88CPX11	7.38		
	110VDC	8000	W88X13		4.77	W88CPX12	7.95		
	SPDT WD-1	7.2 MA	2500		125MW	W88X14	3.75	W88CPX13	5.90
5.0 MA		5000	W88X15	3.85		W88CPX14	6.00		
3.6 MA		10000	W88X16	4.25		W88CPX15	6.40		
DPDT WD-2		10 MA	2500	250MW		W88X17	4.01	W88CPX16	6.30
		7.2 MA	5000			W88X18	4.11	W88CPX17	6.40
	5 MA	10000	W88X19		4.51	W88CPX18	6.80		
3PDT WD-3	12.3 MA	2500	375MW	W88X20	4.44	W88CPX19	7.70		
	8.7 MA	5000		W88X21	4.54	W88CPX20	7.80		
	6.1 MA	10000		W88X22	4.94	W88CPX21	8.20		

Class 88HP—Hermetically Sealed Enclosure Plug-in Mounted—10 amps.—AC and DC

40-180 enclosure, hermetically sealed, housing Class 88 high reliability relay (see above) with standard 8-pin octal plug. Silver alloy contacts, 10-ampere rating. Weight 5 ounces.



Stock Part No.	contacts 10 amps.	COIL		nom. power	Price 1 to 9
		†Volts	Ohms		
W88AHPX-21	DPDT WD-2	6VAC	—	3VA	8.59
W88AHPX-22		12VAC	—		8.59
W88AHPX-23		24VAC	—		8.64
W88AHPX-24		115VAC	—		8.79
W88HPX-32	DPDT WD-2	6VDC	25	1.5W	8.19
W88HPX-33		12VDC	100		8.19
W88HPX-34		24VDC	400		8.24
W88HPX-35		110VDC	8000		9.29
		W88AHPX-36	3PDT WD-3		115VAC
W88AHPX-37		24VDC	400	1.5W	10.63

1-11/16 diameter x 2-1/2 3/4 h.

Telephone Type Relays

MAGNECRAFT RELAYS

Miniature—5 Amp—4pdt
Dust Cover and Sockets

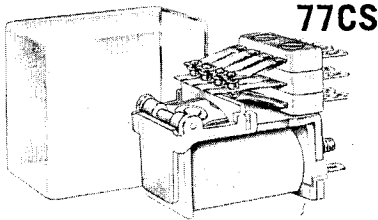

1-7/64 x 1-19/32 x 55/64

Switches up to 5 amps—has greater contact pressure without increasing coil operating power. No internal wiring, solder connections or pigtailed. Hinge-pin armature bearings with oversize bearing surfaces guarantee longer life. Insulation of contact terminals provides higher dielectric strength. Comes in molded insulated snap-on dust cover.

Stock Part No.	contacts 5 Amps	COIL		nominal power	Price 1 to 9
		†volts	*ohms		
W77CSX-1	4PDT	6VDC	40	1.0W	5.30
W77CSX-2		12VDC	160		5.30
W77CSX-3		24VDC	600		5.40
W77CSX-4		48VDC	2500		5.55
W77CSX-5		110VDC	10000		5.97
W77ACSX-1		115VAC	—	3VA	5.60

Sockets



Solder Terminal

PC Terminal

- 70-161-1 Solder Terminal Socket with Retainer 58
- 70-161-3 Printed Circuit Terminal Socket 58

Small—AC and DC—Plug-in with removable dust cover

22CP

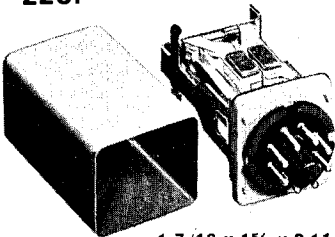

1-7/16 x 1 1/8 x 2-11/16 h*

40-284 enclosure with removable dust cover housing Class 22 relay with 8- or 11-pin standard octal plug. Internal bracket supports cover and protects relay. One screw holds cover in place. Silver alloy contacts, 5 ampere rating. Weight, 6 ounces.

Stock Part No.	contacts 5 amps.	COIL		nominal power	Price 1 to 9
		†volts	ohms		
alternating current voltage actuated					
W22ACPX60	DPDT WD-5	115VAC	—	5VA	10.23
direct current voltage actuated					
W22CPX49	DPDT WD-5	12VDC	80	2.0W	9.85
W22CPX50		24VDC	375	1.5W	9.90
W22CPX51		110VDC	8000	1.5W	11.14
W22CPX54	3DPT WD-6	24VDC	375	1.5W	11.92
W22CPX56	DPDT WD-5	4.5 MA	10000	200MW	11.14

h is overall dimension above socket

Sub-miniature—DC—3 amps.

33

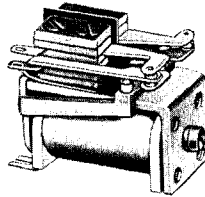

1-11/32 x 11/16 x 1 1/4 h. max.

Class 33 midjet sub-miniature; the smallest telephone type MAGNECRAFT Relay and one of the smallest telephone type relays on the market. Class 33 is also the fastest operating and inherently more shock resistant and vibration resistant. Long life, reliability and accuracy fit Class 33 relays for a wide range of small space requirements. They are extensively used for aircraft, computer and mobile applications where small size, light weight and resistance to shock and vibration are essential. Palladium contacts; 3 ampere rating. Four 4-40 tapped mounting holes on 3/8 x 3/8 centers. Weight 1 ounce.

Stock Part No.	contacts 3 amps.	COIL—DC		nominal power	Price 1 to 9
		†Volts	ohms		
W33X237	DPDT	6VDC	17	2.0W	4.87
W33X238		12VDC	75		4.87
W33X239		24VDC	280		4.92
W33X240		110VDC	6500	5.50	
W33X241	4DPT	6VDC	17	2.0W	6.58
W33X242		12VDC	75		6.58
W33X243		24VDC	280		6.63
W33X244		110VDC	6500		7.23

Small—DC—Plug-in with removable dust cover

22CP

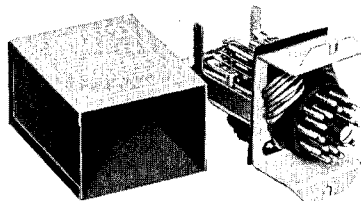

1-9/16 x 2-11/16 x 3-13/32 h*

45-176 removable dust cover with Class 22 relay and 20-pin octal plug. Hold-down bracket permits mounting in any position. Internal bracket supports cover. One screw holds cover. Rubber gasket seals out dust. Silver alloy contacts, 5 ampere rating. Hold down bracket has two mounting holes for 6-32 screws on 2 1/2 centers. Weight, 8 ounces.

Stock Part No.	contacts 5 amps.	COIL		nominal power	Price 1 to 9
		†volts	ohms		
W22CPX61	6PDT WD-7	6VDC	12	3.0W	16.72
W22CPX62		12VDC	50		16.72
W22CPX63		24VDC	225		16.77
W22CPX64		110VDC	5000		17.35

Small—AC and DC—Twin Contacts

22T

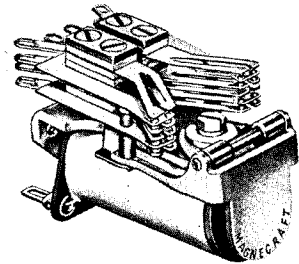

2-1/16 x 1-3/32 x 1 1/4 h. max.

Class 22T—miniature long form relay with accuracy reliability and long life equal and sometimes superior to larger relays. A unique, pin type armature hinge of heavy duty design and precision construction assures stabilized adjustment through millions of operations. Twin Palladium contacts with long, flexible bifurcated contact springs assure the ultimate in switching reliability.

Twin Palladium contacts, 4 ampere rating. All mounting and wiring at heel end. Tinned solder terminals with easy-to-wire spacing. Two #6-32 tapped mounting holes on 3/4 centers. Weight, 5 ounces.

Stock Part No.	contacts 4 amps.	COIL		nominal power	Price 1 to 9
		+V or C	ohms		
direct current voltage actuated					
W22TX267	4PDT	6VDC	20	2.0W	8.44
W22TX268		12VDC	80	2.0W	8.44
W22TX269		24VDC	375	1.5W	8.48
W22TX270		110VDC	8000	1.5W	9.97
W22TX271	6PDT	6VDC	12	3.0W	11.87
W22TX272		12VDC	50		11.87
W22TX273		24VDC	250		11.92
W22TX274		110VDC	5000		12.91
DC current actuated for plate circuit operation					
W22TX275	DPDT	4.5 MA	10000	200MW	6.93

Miniature Power—DC
50 amps.—SPST-NO-DB

11D

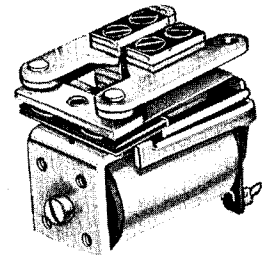

1 5/8 x 15/16 x 1-7/16 h.

Class 11D miniature telephone type relay with heavy brass contact arms and large 50-ampere silver alloy, single pole, single throw, normally open, double break contacts. The Class 11 is a small size relay with big relay reliability accuracy and long life. Solder terminals, spaced for easy wiring. Four 4-40 tapped mounting holes on 3/8 x 7/8 centers. Weight, 3 ounces.

Stock Part No.	contacts 50 amps.	COIL		nominal power	Price 1 to 9
		†volts	ohms		
W11DX39	SPST- NO double break	12VDC	100	1.5W	5.45
W11DX40		24VDC	400		5.45

*Resistance values ± 10%, measured at 25° C.
†Voltage operated relays pull in at 80% of nominal or less for DC relays and 85% of nominal or less for AC relays, at 25° C.

Heavy Duty Relays

MAGNECRAFT RELAYS

Class 99—Heavy Duty Industrial Control Power Relays

Class 99 with 25 Ampere SPDT Contacts

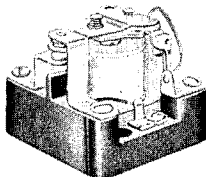

2 1/2 x 2 1/2 x 2 1/2 high

Dimensionally interchangeable with relays made by others. Superior quality hinge-pin design, molded nylon bobbin and adjustment stability features give it longer life. 5/16" contacts of silver cadmium oxide, gold flash. Standard dielectric strength: 1500 VAC, RMS. Screw type terminals and molded phenolic base. Weight, 8 ounces.

Stock Part No.	Contacts Amps	COIL		Nominal Power	Price 1 to 9
		†Volts	*Ohms		
W99AX-1	SPDT 25 Amps	24VAC	—	3VA	5.66
W99AX-2		115VAC	—		5.68
W99AX-3		230VAC	—		5.86
W99X-1	SPDT 25 Amps	6VDC	18	2.0W	5.42
W99X-2		12VDC	70		5.42
W99X-3		24VDC	290		5.44
W99X-4		110VDC	6000		5.83

Class 99 with 25 Ampere DPDT Contacts

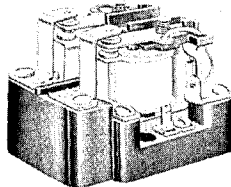

3-3/16 x 2 1/2 x 2-5/16 high

Dimensionally interchangeable with relays made by others. Superior quality hinge-pin design, molded nylon bobbin and adjustment stability features give it longer life. 5/16" contacts of silver cadmium oxide, gold flash. Standard dielectric strength: 1500 VAC, RMS. Screw type terminals and molded phenolic base. Weight, 11 ounces.

Stock Part No.	Contacts Amps	COIL		Nominal Power	Price 1 to 9
		†Volts	*Ohms		
W99AX-4	DPDT 25 Amps	24VAC	—	3VA	8.43
W99AX-5		115VAC	—		8.43
W99AX-6		230VAC	—		8.63
W99AX-7		440VAC	—		8.68
W99X-5	DPDT 25 Amps	6VDC	18	2.0W	8.12
W99X-6		12VDC	70		8.12
W99X-7		24VDC	290		8.14
W99X-8		110VDC	6000		8.53

Class 99 with 25 Ampere DPST-NO Contacts

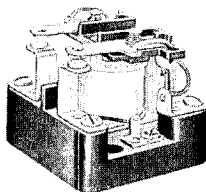

2 1/2 x 2 1/2 x 2-5/16 high

Dimensionally interchangeable with relays made by others. Superior quality hinge-pin design, molded nylon bobbin and adjustment stability features give it longer life. 5/16" contacts of silver cadmium oxide, gold flash. Standard dielectric strength: 1500 VAC, RMS. Screw type terminals and molded phenolic base. Weight, 9 ounces.

Stock Part No.	Contacts Amps	COIL		Nominal Power	Price 1 to 9
		†Volts	*Ohms		
W99AX-8	DPST 25 Amps	24VAC	—	3VA	6.65
W99AX-9		115VAC	—		6.67
W99AX-10		230VAC	—		6.85
W99X-9	DPST 25 Amps	6VDC	18	2.0W	6.36
W99X-10		12VDC	70		6.36
W99X-11		24VDC	290		6.38
W99X-12		110VDC	6000		6.77

Class 99 with 50 Ampere SPST-NO-DB Contacts

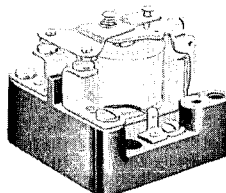

2 1/2 x 2 1/2 x 2-3/32 high

Dimensionally interchangeable with relays made by others. Superior quality hinge-pin design, molded nylon bobbin and adjustment stability features give it longer life. 5/16" contacts of silver cadmium oxide, gold flash. Standard dielectric strength: 1500 VAC, RMS. Screw type terminals and molded phenolic base. Weight, 8 ounces.

Stock Part No.	Contacts Amps	COIL		Nominal Power	Price 1 to 9
		†Volts	*Ohms		
W99ADX-1	SPST-NO-DB 50 Amps	24VAC	—	3VA	5.64
W99ADX-2		115VAC	—		5.64
W99ADX-3		230VAC	—		5.85
W99DX-1	SPST-NO-DB 50 Amps	6VDC	18	2.0W	5.35
W99DX-2		12VDC	70		5.35
W99DX-3		24VDC	290		5.37
W99DX-4		110VDC	6000		5.74

Class 99 Power Relay with Auxiliary Contacts

99 DPDT Relay with SPDT Aux. Contacts

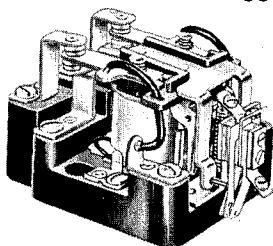

2 1/2 x 4-3/32 x 2-5/16 high

Basic Class 99 DPDT alternating current relay with same specifications shown above. Auxiliary contacts rated 5 amperes with screw type terminals. (DPDT relay with SPDT auxiliary contacts are available on special order.) Weight 1 1/2 ounces.

Stock Part No.	Contacts	COIL		Nom. Power	Price 1 to 9
		†Volts	*Ohms		
W99AX-15	DPDT (Relay)	115VAC	—	3VA	10.43
W99AX-16		230VAC	—		10.63

Class 99 Space-Saver Power Relays

99SD 50 Amperes

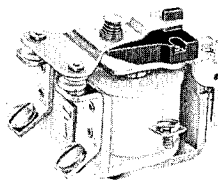

2 x 2 1/2 x 1 7/8 high

Space-Saver in every sense of the word. Specification-wise it is same as Class 99 D power relay featured above. Tapped with one 6-32 mounting hole and locating boss. Weight, 6 ounces.

Stock Part No.	Contacts	COIL		Nom. Power	Price 1 to 9
		†Volts	*Ohms		
W99SADX-1	SPST-NO-DB 50 Amps	24VAC	—	3VA	6.26
W99SADX-2		115VAC	—		6.34
W99SADX-3		230VAC	—		6.56
W99SDX-1	SPST-NO-DB 50 Amps	6VDC	18	2.0W	6.10
W99SDX-2		12VDC	70		6.10
W99SDX-3		24VDC	290		6.14
W99SDX-4		110VDC	6000		6.44

99S 25 Amperes

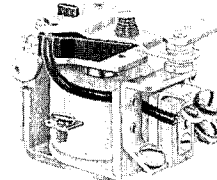

2 x 2 7/8 x 1 7/8 high

Space-Saver without phenolic base. Specification-wise it is same as Class 99 power relay featured above. Tapped with one 6-32 mounting hole and locating boss. Weight, 6 ounces.

Stock Part No.	Contacts	COIL		Nom. Power	Price 1 to 9
		†Volts	*Ohms		
W99SAX-1	SPDT 25 Amps	24VAC	—	3VA	7.35
W99SAX-2		115VAC	—		7.40
W99SAX-3		230VAC	—		7.60
W99SX-1	SPDT 25 Amps	6VDC	18	2.0W	7.11
W99SX-2		12VDC	70		7.13
W99SX-3		24VDC	290		7.13
W99SX-4		110VDC	6000		7.46

*Resistance values ± 10%, measured at 25° C.
†Voltage operated relays pull in at 80% of nominal or less for DC relays and 85% of nominal or less for AC relays, at 25° C.

Miniature Form A Reed Relays

MAGNECRAFT RELAYS

101 SPST-NO, Miniature

Open type miniature dry reed relay with solder terminals.

Nom. Power, 600MW
Weight, 1 oz.

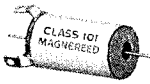

Operate, 1 ms. aver. Release, 1/2 ms. aver.
Contact Bounce, less than 1/2 ms. aver.
Contact Load Rating, 12VA at .25 amp. max. or 100VAC max., non-inductive.
Contact Resistance, 150 milliohms aver.
Life Expectancy, 5 million cycles at full load; 20 million at 1/2 load.
Capacitance across contacts, 0.7 pf. aver.
Operates in any position.

Stock Part No.	Contacts	COIL-DC			Price 1 to 24
		MA	Volts	Ohms	
W101X-1	SPST-NO	—	6V	100	3.29
W101X-2		—	12V	250	3.29
W101X-3		—	24V	500	3.85
W101X-4		9MA	—	2500	4.25

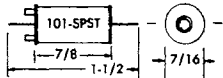

101EP SPST-NO, Miniature

Encapsulated dry reed relay with axial leads.

Nominal Power, 600MW
Weight, 1 oz.



Operate, 1 ms. aver. Release, 1/2 ms. aver.
Contact Bounce, less than 1/2 ms. aver.
Contact Load Rating, 12VA at .25 amp. max. or 100VAC max., non-inductive.
Contact Resistance, 150 milliohms aver.
Life Expectancy, 5 million cycles at full load; 20 million at 1/2 load.
Capacitance across contacts, 0.5 pf. aver.
Operates in any position.

Stock Part No.	Contacts	COIL-DC			Price 1 to 24
		MA	Volts	Ohms	
W101EPX-5	SPST-NO	—	6V	65	3.62
W101EPX-6		—	12V	225	3.62
W101EPX-7		—	24V	1000	4.24
W101EPX-8		8MA	—	5000	4.68

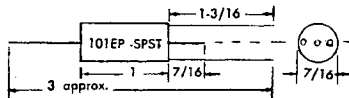

101MPC SPST-NO, Miniature

MPC high reliability Printed Circuit Construction

Nom. Power, 500MW
Weight, 1 oz.

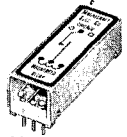

Operate, 1 ms. aver. Release, 1/2 ms. aver.
Contact Bounce, less than 1/2 ms. aver.
Contact Load Rating, 12VA at .25 amp. max. or 100VAC max., non-inductive.
Contact Resistance, 150 milliohms aver.
Life Expectancy, 5 million cycles at full load; 20 million at 1/2 load.
Capacitance across contacts, 0.8 pf. aver.
Operates in any position.

Stock Part No.	Contacts	COIL-DC			Price 1 to 24
		Volts	Ohms		
W101MPCX-1	SPST-NO	6	70	3.60	
W101MPCX-2		12	300	3.60	
W101MPCX-3		24	1100	3.63	
W101MPCX-4		48	4300	3.77	

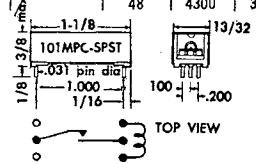

Ultra-Reliable Encapsulated Printed Circuit Reed Relays

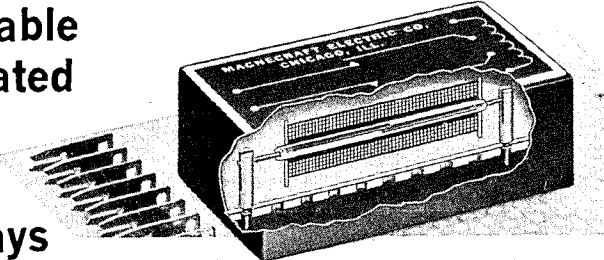

1. Reed contact leads are soldered stress-free to rugged terminal posts.
2. Terminal posts extend through the terminal board as printed circuit pins.
3. The complete assembly is encapsulated, which provides:

- a. Mechanical protection for the glass capsule, contact leads and coil.
- b. Full protection against tampering and contaminating atmosphere.
- c. Rigid positioning of terminal supports and printed circuit pins; stresses on circuit pins cannot transmit to the reed contact leads and affect relay adjustment.

The package illustrated is a Class 102PC, DPST-NO Standard Size Relay (page 7) cut away to show typical assembly of one reed.

Construction of miniature encapsulated printed circuit reed relays (pages 5 and 6) is similar to the standard size.

101PC SPST-NO, Miniature

Ultra-reliable encapsulated printed circuit construction described above.

Nom. Power 600MW
Weight, 1 oz.

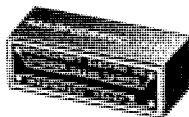

Operate, 1 ms. aver. Release, 1/2 ms. aver.
Contact Bounce, less than 1/2 ms. aver.
Contact Load Rating, 12VA at .25 amp. max. or 100VAC max., non-inductive.
Contact Resistance, 150 milliohms aver.
Life Expectancy, 5 million cycles at full load; 20 million at 1/2 load.
Capacitance across contacts, 0.8 pf. aver.
Operates in any position.

Stock Part No.	Contacts	COIL-DC			Price 1 to 24
		MA	Volts	Ohms	
W101PCX-5	SPST-NO	—	6V	65	5.11
W101PCX-6		—	12V	250	5.16
W101PCX-7		—	24V	1000	5.26
W101PCX-8		8MA	—	5000	5.68

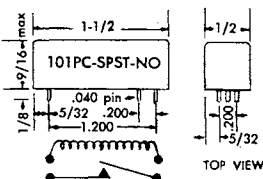

101PC DPST-NO, Miniature

Ultra-reliable encapsulated printed circuit construction described above.

Nom. Power, 900MW
Weight, 2 oz.



Operate, 1 ms. aver. Release, 1/2 ms. aver.
Contact Bounce, less than 1/2 ms. aver.
Contact Load Rating, 12VA at .25 amp. max. or 100VAC max., non-inductive.
Contact Resistance, 150 milliohms aver.
Life Expectancy, 5 million cycles at full load; 20 million at 1/2 load.
Capacitance across contacts, 1.0 pf. aver.
Operates in any position.

Stock Part No.	Contacts	COIL-DC			Price 1 to 24
		MA	Volts	Ohms	
W101PCX-9	DPST-NO	—	6V	40	7.15
W101PCX-10		—	12V	150	7.18
W101PCX-11		—	24V	650	7.24
W101PCX-12		8MA	—	5000	7.69

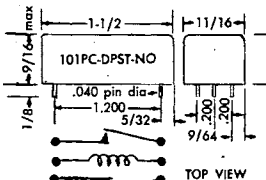

101MPC 3PST-NO, Miniature

MPC high reliability Printed Circuit Construction

Nom. Power, 700MW
Weight, 1 oz.

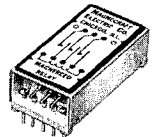

Operate, 1 ms. aver. Release, 1/2 ms. aver.
Contact Bounce, less than 1/2 ms. aver.
Contact Load Rating, 12VA at .25 amp. max. or 100VAC max., non-inductive.
Contact Resistance, 150 milliohms aver.
Life Expectancy, 5 million cycles at full load; 20 million at 1/2 load.
Capacitance across contacts, 1.0 pf. aver.
Operates in any position.

Stock Part No.	Contacts	COIL-DC			Price 1 to 24
		Volts	Ohms		
W101MPCX-5	3PST-NO	6	50	6.75	
W101MPCX-6		12	220	6.75	
W101MPCX-7		24	850	6.77	
W101MPCX-8		48	3300	6.85	

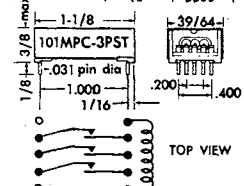

*Resistance values ± 10%, measured at 25° C.
†Voltage operated relays pull in at 80% of nominal or less for DC relays and 85% of nominal or less for AC relays, at 25° C.
‡Current operated relays pull in at specified value or less.

Standard Size Form A Reed Relays

MAGNECRAFT RELAYS

102PC SPST-NO, Standard Size

Ultra-Reliable encapsulated printed circuit construction



Nom. Power, 400MW Weight, 1 oz.

Operate, 3 ms. aver. Release, 1/2 ms. aver.
Contact Bounce, less than 1 ms. aver.
Contact Load Rating, 15VA at 1 amp. max. or 250VAC max., non-inductive.
Contact Resistance, 100 milliohms, aver.
Life Expectancy, 20 million cycles at full load; 100 million at 1/2 load.
Capacitance across contacts, 1.0 pf. aver.
Operating position, any.

Stock Part No.	Contacts	COIL-DC			Price 1 to 24
		MA	Volts	Ohms	
W102PCX-1	SPST-NO	—	6V	100	4.77
W102PCX-2		—	12V	400	4.83
W102PCX-3		—	24V	1500	4.87
W102PCX-4		6.5MA	—	5000	5.32

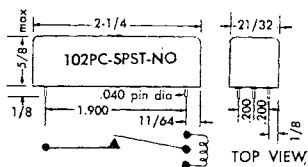

102PC DPST-NO, Standard Size

Ultra-Reliable encapsulated printed circuit construction

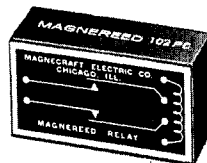

Nom. Power, 700MW Weight, 2 oz.

Operate, 3 ms. aver. Release, 1/2 ms. aver.
Contact Bounce, less than 1 ms. aver.
Contact Load Rating, 15VA at 1 amp. max. or 250VAC max., non-inductive.
Contact Resistance, 100 milliohms, aver.
Life Expectancy, 20 million cycles at full load; 100 million at 1/2 load.
Capacitance across contacts, 1.2 pf. aver.
Operating position, any.

Stock Part No.	Contacts	COIL-DC			Price 1 to 24
		MA	Volts	Ohms	
W102PCX-5	DPST-NO	—	6V	50	6.22
W102PCX-6		—	12V	200	6.28
W102PCX-7		—	24V	800	6.33
W102PCX-8		9MA	—	5000	6.78

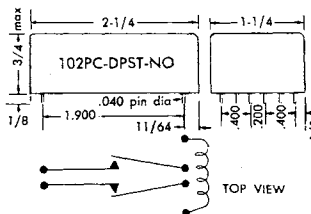

102 SPST-NO, Standard Size

Open type, standard size, dry reed relay with solder terminals.

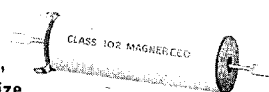

Nom. Power, 300MW Weight, 1 oz.

Operate, 3 ms. aver. Release, 1/2 ms. aver.
Contact Bounce, less than 1 ms. aver.
Contact Load Rating, 15VA at 1 amp. max. or 250VAC max., non-inductive.
Contact Resistance, 100 milliohms, aver.
Life Expectancy, 20 million cycles at full load; 100 million at 1/2 load.
Capacitance across contacts, 0.9 pf. aver.
Operating position, any.

Stock Part No.	Contacts	COIL-DC			Price 1 to 24
		MA	Volts	Ohms	
W102X-1	SPST-NO	32MA	—	100	2.57
W102X-2		—	6V	200	2.57
W102X-3		—	12V	500	2.57
W102X-4		—	24V	2000	2.70
W102X-5		4.6MA	—	5000	3.25

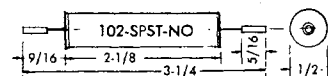

102MPC SPST-NO, Standard Size

MPC, high reliability printed circuit construction

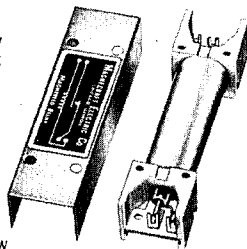

Nom. Power, 500MW Weight, 1 oz.

Operate, 3 ms. aver. Release, 1/2 ms. aver.
Contact Bounce, less than 1 ms. aver.
Contact Load Rating, 15VA at 1 amp. max. or 250VAC max., non-inductive.
Contact Resistance, 100 milliohms, aver.
Life Expectancy, 20 million cycles at full load; 100 million at 1/2 load.
Capacitance across contacts, 1.0 pf. aver.
Operating position, any.

Stock Part No.	Contacts	COIL-DC			Price 1 to 24
		MA	Volts	Ohms	
W102MPCX-5	SPST-NO	140	—	30	3.29
W102MPCX-6		—	6VDC	70	
W102MPCX-7		—	12VDC	250	
W102MPCX-8		—	24VDC	1000	
W102MPCX-9		—	48VDC	4000	
W102MPCX-10	9	—	7000	4.14	

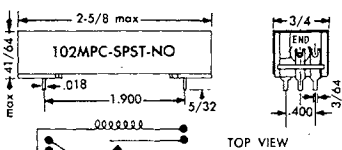

102MPC 3PST-NO, Standard Size

MPC high reliability printed circuit construction

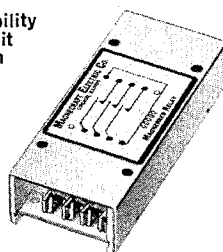

Nom. Power, 750MW Weight, 2 oz.

Operate, 3 ms. aver. Release, 1/2 ms. aver.
Contact Bounce, less than 1 ms. aver.
Contact Load Rating, 15VA at 1 amp. max. or 250VAC max., non-inductive.
Contact Resistance, 100 milliohms, aver.
Life Expectancy, 20 million cycles at full load; 100 million at 1/2 load.
Capacitance across contacts, 1.2 pf. aver.
Operating position, any.

Stock Part No.	Contacts	COIL-DC			Price 1 to 24
		MA	Volts	Ohms	
W102MPCX-48	3PST-NO	—	6	50	5.62
W102MPCX-49		—	12	175	5.63
W102MPCX-50		—	24	750	5.77
W102MPCX-51		—	48	3000	5.97

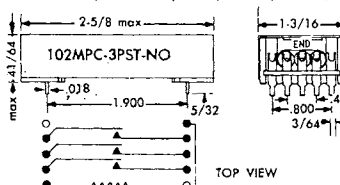

102MPC 6PST-NO, Standard Size

MPC, high reliability printed circuit construction

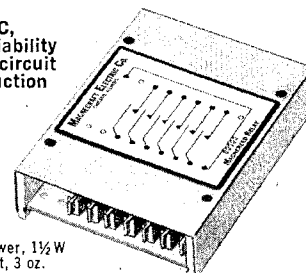

Nom. Power, 1 1/2W Weight, 3 oz.

Operate, 3 ms. aver. Release, 1/2 ms. aver.
Contact Bounce, less than 1 ms. aver.
Contact Load Rating, 15VA at 1 amp. max. or 250VAC max., non-inductive.
Contact Resistance, 100 milliohms, aver.
Life Expectancy, 20 million cycles at full load; 100 million at 1/2 load.
Capacitance across contacts, 1.2 pf. aver.
Operating position, any.

Stock Part No.	Contacts	COIL-DC			Price 1 to 24
		MA	Volts	Ohms	
W102MPCX-52	6PST-NO	—	6	25	9.18
W102MPCX-53		—	12	100	9.30
W102MPCX-54		—	24	375	9.35
W102MPCX-55		—	48	1500	9.43

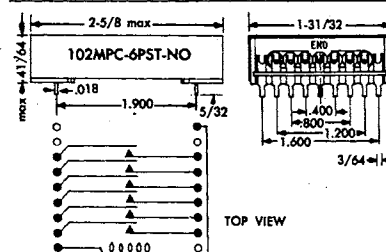

*Resistance values ± 10%, measured at 25° C.
†Voltage operated relays pull in at 80% of nominal or less for DC relays and 85% of nominal or less for AC relays, at 25° C.
‡Current operated relays pull in at specified value or less.

Mercury Wetted and Dry Reed Relays

MAGNECRAFT RELAYS

Mercury Wetted Reed Relays for Printed Circuit Applications

132MPC SPST-NO Standard Size Mercury-Wetted

Nom. Power 500MW weight 2 oz.

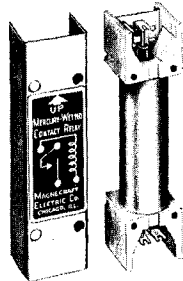

Operate, 2 ms. aver. Release, 2 ms. aver. Contact bounce, none. Contact Load Rating, 50VA at 3.0 amps. max. or 400V max., non-inductive. Contact Resistance, 50 milliohms aver. Capacitance across contacts, 1.0 pf. aver. Life Expectancy, 25 million cycles at full load; 1 billion at low load. Operating Position, Upright, not more than 30° from vertical.

Stock Part No.	Contacts	COIL—DC			Price 1 to 24
		±MA	+Volts	*Ohms	
W132MPCX-1	SPST-NO	140	30	70	5.83
W132MPCX-2		6VDC	70	250	
W132MPCX-3		12VDC	250	1000	
W132MPCX-4		24VDC	1000	4000	
W132MPCX-5		48VDC	4000	7000	
W132MPCX-6		9	7000	6.00	

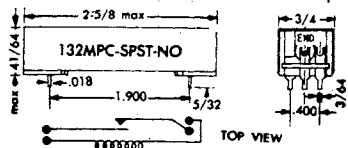

133MPC SPDT Standard Size Mercury-Wetted

Nom. Power 500MW weight 2 oz.

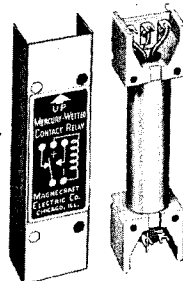

Operate, 2 ms. aver. Release, 2 ms. aver. Contact bounce, none. Contact Load Rating, 50VA at 2.0 amps. max. or 400V max., non-inductive. Contact Resistance, 50 milliohms aver. Capacitance across contacts, 3.0 pf. aver. Life Expectancy, 25 million cycles at full load; 1 billion at low load. Operating Position, Upright, not more than 30° from vertical. Magnetically biased, observe coil polarity.

Stock Part No.	Contacts	COIL—DC			Price 1 to 24
		±MA	+Volts	*Ohms	
W133MPCX-1	SPDT	140	30	70	8.42
W133MPCX-2		6VDC	70	250	
W133MPCX-3		12VDC	250	1000	
W133MPCX-4		24VDC	1000	4000	
W133MPCX-5		48VDC	4000	7000	
W133MPCX-6		9	7000	8.60	

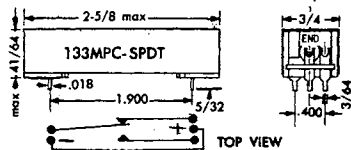

133LMPC SPDT Standard Size Magnetic Latching Relay

Mercury-Wetted

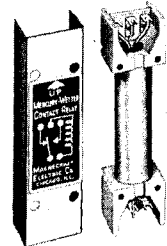

Ideal for memory applications. Bi-stable SPDT Contacts—biased permanent magnet holds either contact position without coil power until coil polarity is reversed. Operate, 2ms aver. Contact bounce, none. Contact Load Rating, 50VA at 2.0 amps. max. or 400V max., resistive. Contact Resistance, 50 milliohms aver. Capacitance across contacts, 3.0 pf. aver. Life Expectancy, 25 million cycles at full load; 1 billion at low load. Operating Position, Upright, not more than 30° from vertical.

Stock Part No.	Contacts	COIL—DC			Price 1 to 24
		±MA	+Volts	*Ohms	
Single Wound Coils					
W133LMPCX-17	SPDT	40	70	9.87	
W133LMPCX-18		6	250	9.88	
W133LMPCX-19		12	1000	9.92	
W133LMPCX-20		24	4000	10.07	
W133LMPCX-21		4	7000	10.17	

Stock Part No.	Contacts	COIL—DC			Price 1 to 24
		±MA	+Volts	*Ohms	
Double Wound Coils					
W133LMPCX-22	SPDT	80	30/30	11.23	
W133LMPCX-23		6	120/120	11.25	
W133LMPCX-24		12	460/460	11.32	
W133LMPCX-25		24	1800/1800	11.42	
W133LMPCX-26		8	3000/3000	11.50	

Miniature Encapsulated Mercury Wetted Reed Relays

131PC SPST-NO Miniature

Nom. Power 500MW weight 1 oz.



131PC DPST-NO Miniature

Nom. Power 900MW weight 2 oz.



Operate, 1 ms. aver. Release, 1 ms. aver. Contact Bounce, none. Contact Load Rating, 28VA, 1 amp. max. or 100V max., non-inductive. Contact Resistance, 50 milliohms aver. Capacitance across contacts, 1.0 pf. aver. Life Expectancy, 100 million cycles at rated load. Operating Position, Upright, not more than 30° from vertical.

Stock Part No.	Contacts	COIL—DC			Price 1 to 24
		±MA	+Volts	Ohms	
W131PCX-8	SPST-NO	6	65	8.38	
W131PCX-9		12	250	8.44	
W131PCX-10		24	1000	8.55	
W131PCX-11		8	5000	9.01	
W131PCX-12	DPST-NO	6	40	10.62	
W131PCX-13		12	150	10.66	
W131PCX-14		24	650	10.71	
W131PCX-15		8	5000	11.21	

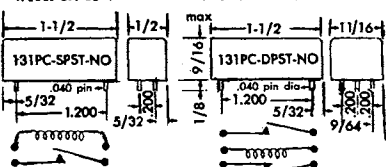

Miniature Modular Packaged Mercury Wetted Reed Relays

131MPC SPST-NO Miniature

Nom. Power 500MW weight 1 oz.



131MPC DPST-NO Miniature

Nom. Power 700MW weight 2 oz.



Operate, 1 ms. aver. Release, 1 ms. aver. Contact bounce, none. Contact Load Rating, 28VA at 1.0 amps. max. or 100V max., non-inductive. Contact Resistance, 50 milliohms aver. Capacitance across contacts, 1.2 pf. aver. Dielectric Strength, 500 VAC, RMS. Life Expectancy, 25 million cycles at full load, longer at reduced load. Operating Position, Upright, no more than 30° from vertical.

Stock Part No.	Contacts	COIL		Price 1 to 24
		+Volts	*Ohms	
W131MPCX-2	SPST-NO	6VDC	70	6.40
W131MPCX-3		12VDC	300	6.48
W131MPCX-4		24VDC	1100	6.53
W131MPCX-5		48VDC	4300	6.98
W131MPCX-6	DPST-NO	6VDC	50	11.53
W131MPCX-7		12VDC	220	11.58
W131MPCX-8		24VDC	850	11.65
W131MPCX-9		48VDC	3300	11.93

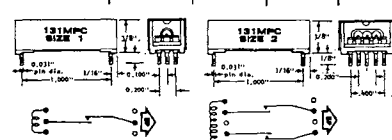

Bi-Stable Latching Relay

Dry Reed

103LMPC Magnetic Latching Relay

Nom. Power 150MW Weight, 1 oz.

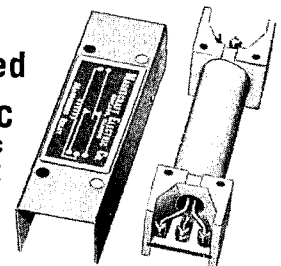

Ideal for memory applications. Bi-stable SPDT Contacts—biased permanent magnet holds either contact position without coil power until coil polarity is reversed. Dimensions and wiring same as 103MPC, page 13. Operate, 2 ms. aver. Bounce, 3 ms. max. Contact Resistance, 150 milliohms aver. Contact Load Rating, 10VA, 0.2 amp. max. or 200V max., non-inductive. Life Expectancy, 25 million cycles at rated load. Operating Position, any.

Stock Part No.	con-tacts	COIL—DC			Price 1 to 24
		MA	+Volts	Ohms	
Single Wound Coils					
W103LMPCX-3	SPDT	40	70	7.07	
W103LMPCX-4		6	250	7.07	
W103LMPCX-5		12	1000	7.07	
W103LMPCX-6		24	4000	7.26	
W103LMPCX-7		4	7000	8.01	

Stock Part No.	con-tacts	COIL—DC			Price 1 to 24
		MA	+Volts	Ohms	
Double Wound Coils					
W103LMPCX-8	SPDT	80	30/30	8.22	
W103LMPCX-9		6	120/120	8.33	
W103LMPCX-10		12	460/460	8.33	
W103LMPCX-11		24	1800/1800	9.00	
W103LMPCX-12		8	3000/3000	10.04	

*Resistance values ± 10%, measured at 25° C. †Voltage operated relays pull in at 80% of nominal or less for DC relays and 85% of nominal or less for AC relays, at 25° C. ‡Current operated relays pull in at specified value or less.

OHMITE general purpose relays

MODEL GPR — INDICATOR, PLATE, THYRATRON AND LATCHING VERSIONS IN UNENCLOSED AND ENCLOSED TYPES

Simple, rugged, low cost relays handling substantial power for small size. Uncomplicated design provides unusual flexibility for making and changing connections and mounting. Stock includes

relays in versatile enclosures, some with indicator light, also plate, thyatron and latching versions. Wide commercial and industrial use where economy and versatility are important.

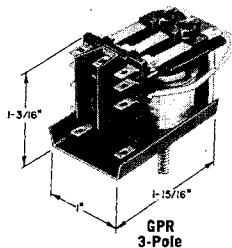

GPR 3-Pole

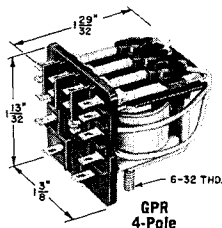

GPR 4-Pole

UNENCLOSED RELAYS

Basic (Unenclosed) Relay: All connections terminate on barrier-type terminal panel on combination solder — quick-connect (push-on) lugs which accept AMP 110 female connectors. The terminal panel is conveniently incorporated into printed circuit boards. Fixed contacts are integral inlay on terminal itself. Normally furnished with a 6-32 x 1/2" mounting stud and non-turn boss (or lug for 4-pole relays). A 6-32 threaded hole is optional. Unenclosed relays can also be mounted by

plugging their panels into Ohmite SOGPR sockets. See "Socket" following.

Contact Ratings: Two ratings — fine silver contacts, 5 amps at 115 VAC or 32 VDC resistive; silver-cadmium contacts, 10 amps.

Insulation: Tested at 1500 VAC.

Coil Wattage: 1.4 watts DC operation; 1.6 watts (2.0 volt-amps) AC except 2.4 watts (3.70 volt-amps) for 4-pole AC and AC latching relays.

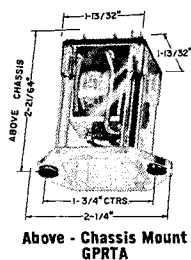

Above-Chassis Mount GPRTA

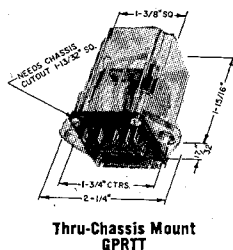

Thru-Chassis Mount GPRTT

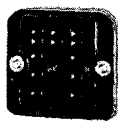

SOGPR Sockets

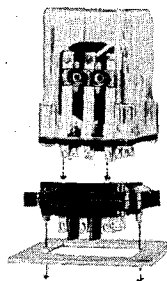

For Socket Mount GPRTS

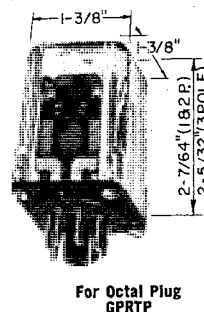

For Octal Plug GPRTP

ENCLOSED RELAYS

(GPRTA, GPRTT, GPRTS, GPRTP)

Four types of clear plastic enclosures as follows:

Chassis Mounting Types: "GPRTA" — ("Terminals-Above-Chassis" type) has terminal panel opposite to mounting flange; "GPRTT" — ("Terminals-Through-Chassis" type) has terminal panel on same end as mounting flange, requires chassis cutout; "GPRTS" type (Terminals for Socket Use) is similar to GPRTT but has no mounting flanges. It is intended strictly for plug-in mounting in Ohmite socket "SOGPR" (see "Socket" below).

Plug Base Type: "GPRTP" — employs octal plug for 1 and 2 pole relays; 11-pin plug for 3-pole. The octal plug base is integral with relay for rigidity — is designed with recessed pins which meet UL spacing requirements (150V).

Socket (SOGPR): Unique socket fits the terminal panels of all GPR relays and provides over-the-surface spacing to meet UL

requirements for 150 volts. Requires chassis cut-out to mount. Hold down springs (see illustration) for unenclosed and enclosed relays, are provided with each socket but are not required except under conditions of vibration or shock. Socket solder terminals will also accept AMP 11 quick-connectors. See socket listings.

SOCKETS FOR GPR, GPRTS RELAYS

For up to 3PDT: 1 3/4" square, requires 1 3/4" x 1 1/2" cutout.* 2 holes (for No. 6 screws) on 1 3/8" centers. **Stock No. SOGPR-9 Net 1-24 \$1.10**

For 4-pole models, 1 3/4" x 2", requires 1 1/2" x 1 1/2" cutout.* 2 holes (for No. 6 screws) on 1 3/8" centers. **Stock No. SOGPR-12 Net 1-24 \$1.25**

*Std. punches and dies from Ward Machinery Co., Chicago. No. 28, Style 22N, 1 3/4 x 1 1/2, for SOGPR-9; No. 28, Style 14R, 1 1/2 x 1 1/2, for SOGPR-12.

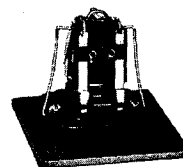
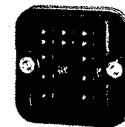

Indicator Relay: Incorporates light bulb to indicate energized condition of coil. Stocked only in GPRTP enclosures described in preceding. Neon bulb furnished with coil ratings 70 volts and above; incandescent bulbs for coil ratings below 70 volts.

UL & CSA Approval: Column heads in the stock tables carry the

UL (Underwriters' Laboratories) or CSA symbol (Canadian Standards Association) where applicable. The grey tint in the column indicates the relays are recognized under the "UL components program." The acceptability of such relays by UL depends upon their combination with other equipment such as sockets etc.

OHMITE general purpose relays

Thyratron Plate Relay: Designed specifically for plate circuit of thyratron tubes 2050 and 2D21 with 115 VAC supply (see diagram). Also suitable for operation in series with silicon

controlled rectifiers from a 115 VAC supply. Ready to work, no capacitors or adjustments required, no chatter. Available unenclosed and in most GPR enclosures.

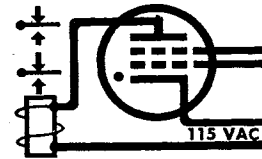

Relay in circuit Showing Thyratron

STOCK GPR THYRATRON RELAYS

5 AMP CONTACTS

10 AMP CONTACTS

Contacts	Unen- closed GPR	Net \$ 1-24	Enclosed Above- Chassis GPRTA	Net \$ 1-24	Enclosed Thru- Chassis GPRTT	Net \$ 1-24	Enclosed for SOGPR Socket GPRTS	Net \$ 1-24	Enclosed Plug- Base GPRTP	Net \$ 1-24	Unen- closed GPR	Net \$ 1-24	Enclosed for SOGPR Socket GPRTS	Net \$ 1-24	Enclosed Plug- Base GPRTP	Net \$ 1-24
SPDT																
DPDT	GPRX	-191T 3.50	GPRTAX	-191T 5.60	GPRTTX	-191T 5.60	GPRTSX		GPRTPX	-191T 5.85	GPRX	-391T 3.55	GPRTSX		GPRTPX	-391T 5.95
3PDT		-192T 4.20		-192T 6.30		-192T 6.30				-192T 6.50		-392T 4.30			-392T 6.70	
4PDT		-193T 4.60		-193T 7.25		-193T 7.25				-193T 8.00		-393T 4.75			-393T 8.35	
		-473T 5.40										-483T 5.55				

MODEL DO RELAYS AC or DC

Particularly adaptable to aircraft and mobile equipment applications where severe shock and vibration are encountered. Design of molded parts around contact arms protects against mechanical injury. Stocked in 3-pole or 4-pole type, and also in hermetic enclosures and in latching types.

Coil Wattage: 3.00 watts, DC operation; 6.00 watts, 60 cycle AC. Maximum temperature rise 45°C, DC operation; 75°C, AC.

Coil Operating Voltage: Any voltage up to 230 VDC or 440 VAC, 60 cycle. Stock voltages in table.

Contacts: 10 amps nominal. Ratings are for 115 VAC or 32 VDC, resistive load.

Weight: Unenclosed 3-pole, 5 oz.; 4-pole, 6 oz.

DO RELAYS IN HERMETIC ENCLOSURES

Stock DO relays with 115 volt coil in hermetically sealed metal enclosures, filled with dry nitrogen. Enclosures provide protection for relay under most adverse ambient conditions. Both 3 and 4-pole DO relays are supplied in these enclosures with plug (DOHPX-) or solder terminal (DOHX-) connectors as illustrated. See listings in stock table above.

Weights: 3-pole hermetic relay approx. 14 oz.; 4-pole approx. 15 oz.

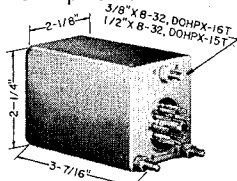

DOHPX-16T, 3PDT, 11 Prongs
DOHPX-15T, 4PDT, 20 Prongs

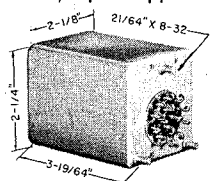

DOHX-22T, 3PDT, 14 Terminals
DOHX-23T, 4PDT, 14 Terminals

WIRING FOR PLUG-BASE STOCK DO RELAYS

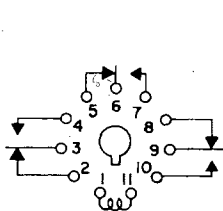

DOHPX-16T

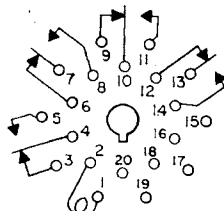

DOHPX-15T

Mates with Amphenol 77 MIP 11 Socket Mates with Amphenol 77 MIP 20 Socket

ITEMS APPEARING IN BOLD PRINT ARE POPULAR MODELS AND ARE USUALLY STOCKED BY AUTHORIZED OHMITE DISTRIBUTORS

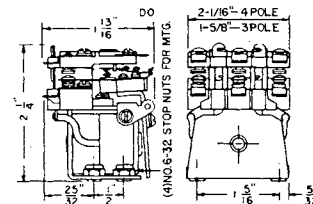

STOCK DO RELAYS — 10 AMP CONTACTS*

Stock No.	Type†	Volts	Coil Data Amps	DC Ohms	Net \$ 1-24
UNENCLOSED					
DOX-50T	3PDT	6VAC	2.33	0.36	9.10
DOX-183T	4PDT	6VAC	2.33	0.36	10.35
DOX-49T	3PDT	12VAC	1.28	1.40	9.10
DOX-184T	4PDT	12VAC	1.28	1.40	10.35
DOX-181T	3PDT	24VAC	.57	5.50	9.10
DOX-185T	4PDT	24VAC	.57	5.50	10.35
DOX-226T	DPST*	115VAC	.110	145.0	9.05
DOUX-34§	DPST*	115VAC	.110	145.0	10.25
DOX-227T	3PST	115VAC	.110	145.0	8.25
DOX-228§	3PST	115VAC	.110	145.0	9.45
DOX-46T	3PDT	115VAC	.110	145.0	9.10
DOUX-30§	3PDT	115VAC	.110	145.0	10.30
DOX-228T	4PST	115VAC	.110	145.0	9.25
DOUX-31§	4PST	115VAC	.110	145.0	10.50
DOX-53T	4PDT	115VAC	.110	145.0	10.35
DOX-226§	4PDT	115VAC	.110	145.0	11.60
DOX-61T	3PDT	230VAC	.070	550.0	9.50
DOX-130T	4PDT	230VAC	.070	550.0	10.75
DOX-145T	3PDT	6VDC	.487	12.3	7.85
DOX-186T	4PDT	6VDC	.487	12.3	9.10
DOX-51T	3PDT	12VDC	.231	51.8	7.85
DOX-102T	4PDT	12VDC	.231	51.8	9.10
DOX-141T	3PDT	24VDC	.105	230.0	7.85
DOX-137T	4PDT	24VDC	.105	230.0	9.10
DOX-93T	3PDT	110VDC	.022	5,000	8.45
DOX-187T	4PDT	110VDC	.022	5,000	9.70
DOX-182T	3PDT	220VDC	.014	16,100	9.20
DOX-188T	4PDT	220VDC	.014	16,100	10.45
IN HERMETIC ENCLOSURE					
DOHPX-16T	3PDT	115VAC	.110	145.0	23.05
DOHPX-15T	4PDT	115VAC	.110	145.0	28.80
DOHX-22T	3PDT	115VAC	.110	145.0	22.40
DOHX-23T	4PDT	115VAC	.110	145.0	24.05

*Except DOX-226T, DOUX-34 20 amps, double break contacts.

†All single-throw (— ST) relays are normally open.

§Listed by UL.

OHMITE latching relays

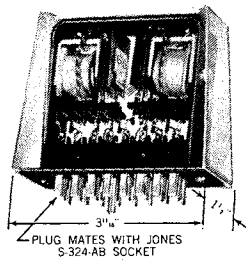

Enclosed Latching Relay (GPRLETP)

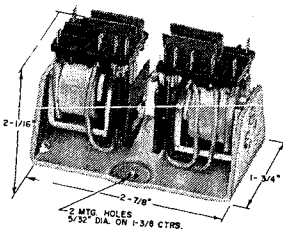

6PDT Latching Relay (GPRLE)

Latching Relay: Consists of two GPR relays with armatures linked so that the n.o. contacts of one are mechanically latched in closed position when, and after, this relay is energized. When 2nd relay is energized, first relay restores and latches 2nd. Permits switching of twice the number of circuits and holding without coil current. Unenclosed type "GPRLE." Enclosed type "GPRLETP" in clear plastic case with Jones plug P-324-SB fitting S-324-AP socket.

STOCK GPR LATCHING RELAYS — 5 AMP CONTACTS

Total Con- tacts	COIL DATA — (Each Coil)			UL Unen- closed GPRLE†	Net \$ 1-24	UL Enclosed Plug-Base GPRLETP†	Net \$ 1-24
	Volts	Amps	Ohms				
4PDT	6VAC	.650	2.5	GPRLEX-1T	11.00	GPRLETPX-1T	17.30
6PDT	6VAC	.650	2.5	GPRLEX-2T	13.20	GPRLETPX-2T	20.55
4PDT	12VAC	.309	10.0	GPRLEX-3T	11.00	GPRLETPX-3T	17.30
6PDT	12VAC	.309	10.0	GPRLEX-4T	13.20	GPRLETPX-4T	20.55
4PDT	24VAC	.155	40.0	GPRLEX-5T	11.00	GPRLETPX-5T	17.30
6PDT	24VAC	.155	40.0	GPRLEX-6T	13.20	GPRLETPX-6T	20.55
4PDT	115VAC	.0325	1000	GPRLEX-7T	11.00	GPRLETPX-7T	17.30
4PDT	115VAC	.0325	1000	GPRLEX-8T	13.20	GPRLETPX-8T	20.55
4PDT	230VAC	.0147	4000	GPRLEX-9T	11.80	GPRLETPX-9T	18.10
6PDT	230VAC	.0147	4000	GPRLEX-10T	14.00	GPRLETPX-10T	21.35
4PDT	6VDC	.23	26	GPRLEX-11T	9.90	GPRLETPX-11T	16.20
6PDT	6VDC	.23	26	GPRLEX-12T	12.00	GPRLETPX-12T	19.35
4PDT	12VDC	.114	105	GPRLEX-13T	9.90	GPRLETPX-13T	16.20
6PDT	12VDC	.114	105	GPRLEX-14T	12.00	GPRLETPX-14T	19.35
4PDT	24VDC	.060	400	GPRLEX-15T	9.90	GPRLETPX-15T	16.20
6PDT	24VDC	.060	400	GPRLEX-16T	12.00	GPRLETPX-16T	19.35
4PDT	110VDC	.0110	10,000	GPRLEX-17T	11.15	GPRLETPX-17T	17.45
6PDT	110VDC	.0110	10,000	GPRLEX-18T	13.25	GPRLETPX-18T	20.60
Approx. weight					7.0 oz.	11.3 oz.	

*Column heads carry symbols to indicate UL or CSA (Canadian Standards Assn.) approval. The grey tint indicates that relay is recognized under UL "components program" (File No. E33069, Guide No. 380W1.14C, Assignment No. 62C3559A). CSA File No. is 21309. See explanation in "UL and CSA Approval."

MODEL DO LATCHING RELAY (DOLEX-)

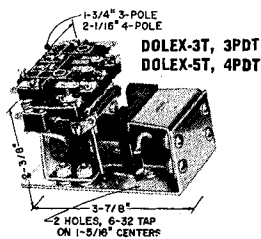

Consists of Model DO relay and a "reset magnet" with both armatures mechanically latched so that the normally open contacts of the relay remain closed when the relay energizing voltage is removed. The relay releases to

normal position when the reset coil is pulsed. Permits "holding" of circuits without continuous coil current. Coils of stock units (both relays and reset coils) are 115 VAC. Available with 3 or 4-pole DO relays

Weights: 3-pole — 16.5 oz.; 4-pole — 17 oz.

LATCHING TYPE†

DOLEX-3T, 3PDT	DOLEX-5T, 4PDT	115VAC	.110	145.0	\$15.95
		115VAC	.110	145.0	17.20

†Coil data applies to relay part of latching assembly. Reset magnet operates on 115VAC, 60 cycle also.

MODEL DOS LATCHING RELAY (DOSLEX-)

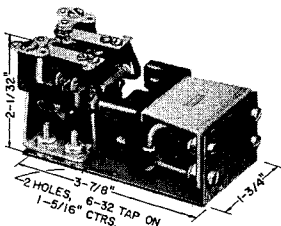

Consists of Model DOS relay and a "reset magnet" with both armatures mechanically latched so that the normally open contacts of the relay remain closed when the relay energizing voltage is removed. The relay releases to normal position when the reset coil is pulsed. Permits "holding" of circuits without continuous coil current. Coils of stock units (both relay and reset magnet) are 115VAC — see DOSLEX-1T in DOS stock table.

Weight: 14.2 oz.

LATCHING TYPE†

Stock No.	Type	Volts	Coil Data Amps	DC Ohms	Net \$ 1-24
DOSLEX-1T	DPDT	115VAC	.043	450	12.60

†Coil data applies to relay part of latching assembly. Reset magnet operates on 115 VAC, 60 cycle also.

MODEL DOSY RELAY FOR PLATE CIRCUITS

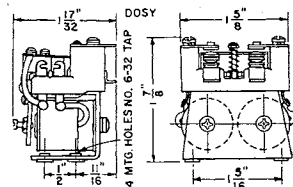
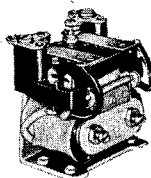

Similar in construction to Model DOS relay but equipped with twin coils for increased sensitivity. The DOSY relay is adaptable to a wide range of electronic control applications such as plate circuit controls, or as overload or underload controls in D.C. circuits to signal attainment of predetermined current levels.

Coil Wattage: 1.00 watt, with maximum temperature rise of 45°C. Lower wattages available.

Contacts: Stock combinations as listed. Ratings are for 115 VAC or 32 VDC, resistive load.

Weight: Approximately 4½ ounces.

Stock No.	Type	Coil Data		Con- tact Amps	Net 1-24
		DC Ohms	Max. Pull-in Current		
DOSYX-67T	DPDT	10,000	8 MA	15	\$6.40
DOSYX-68T	DPDT	5,000	11 MA	15	6.40
DOSYX-69T	SPDT	10,000	5 MA	15	5.90
DOSYX-70T	SPDT	5,000	7 MA	15	5.90

Potter & Brumfield Relays

KA AND KAP SERIES Small, low cost, highly efficient general purpose relays for handling light power loads such as small motors, solenoids and other relays, and general automation work. All KA and KAP relays with "Y" suffix bear CSA* listing and carry U/L component recognition (File No. E22575). Mechanical life expectancy: 10 million operations. Duty: Continuous. Contacts: Movable, $\frac{1}{8}$ " dia. gold-flashed silver; stationary, $\frac{3}{16}$ " dia. wide silver overlay.

The KA is the open version of this series. Mounting: One No. 6-32 threaded stud and locating tab on $\frac{1}{8}$ " centers. Weight: 2 ozs. The KAP is the enclosed model and is protected by a clear, high impact plastic dust cover. Terminals: 8 or 11-pin plug. Weight: 3 ozs.

"C" suffix indicates silver-cadmium-oxide contacts on movables rated 10 amps.

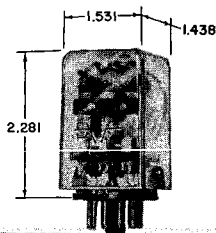
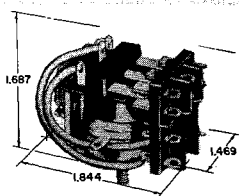

HOLD DOWN SPRINGS

Designed to insure secure mounting of relays in any position. Will accommodate machine screws or rivets.

For KAP relays: (shown above)
9KA1 50 per box NET \$5.80

For KCP and KRP relays (pages 6 and 3)
9KR15 50 per box NET \$5.80

For KUP plain case relays (page 3)
9KU3 50 per box NET \$5.25

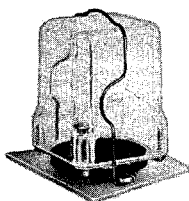

KHU/KHP/KHS SERIES Small, rugged, 4PDT, available for AC or DC operation. Only KHU relays carry Underwriters' Laboratories component recognition. KHU has Lexan and KHP has nylon dust cover; KHS is hermetically sealed in metal enclosure. These relays are designed to meet the exacting requirements of data processing, computer and process control applications. Contacts are $\frac{1}{8}$ " gold-flashed silver and are rated 3 amps @ 30V DC or 120V AC resistive for 100,000 operations. "12" suffix indicates silver-cadmium-oxide contacts. Mounting: Solder terminals with a No. 3-48 $\frac{1}{16}$ " long. Adaptable to sockets (below) with printed circuit or solder lug terminals. Weights without sockets; KHU or KHP 1 $\frac{1}{2}$ ozs.; KHS 1 $\frac{1}{2}$ ozs.

KHU/KHP hold down spring (similar to KCP-KRP, above.)

9KH3 50 per box, weight 3 ozs. Net \$5.80

9KH1 Solder terminal sockets and retainers.
Box of 10 Net \$6.95

9KH2 Printed circuit terminal sockets,
Box of 10 Net \$6.95

Weight per box: 4 ozs.

Dimensions same as KHP

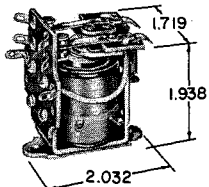
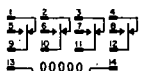
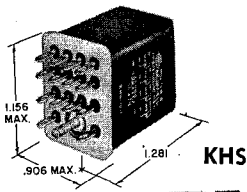
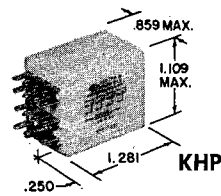
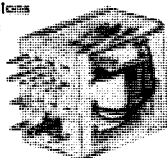

KL SERIES Multiple contact relay. Varied contact combinations and high dielectric phenolic insulation affords extreme versatility and utility. Widely used in such applications as industrial controls, elevator controls, communications equipment and electronic measuring devices. Mounting: All models—Two No. 6-32 tapped holes on $1\frac{1}{8}$ " centers. Contacts: $\frac{1}{8}$ " dia. gold-flashed silver. Weight: 5 ozs.

GENERAL PURPOSE RELAYS

TYPE	COILS			CONTACTS		SUGG. RESALE PRICE
	Voltage or Current	Resistance in Ohms	Nominal Power	Arrangement	Rate in Amps	
KA5AY	6V	6	2VA	SPDT	5	\$3.50
KA5AY	12V	21	2VA	SPDT	5	3.50
KA5AY	24V	75	2VA	SPDT	5	3.50
KA5AY	120V	2,250	2VA	SPDT	5	3.50
KA5AY	240V	9,110	2VA	SPDT	5	4.00
KA5AG	6V	6	2VA	SPDT	10	3.55
KA5AG	12V	21	2VA	SPDT	10	3.55
KA5AG	24V	75	2VA	SPDT	10	3.55
KA5AG	120V	2,250	2VA	SPDT	10	3.55
KA5AG	240V	9,110	2VA	SPDT	10	4.05
KA5DY	6V	32.1	1.2W	SPDT	5	3.35
KA5DY	12V	120	1.2W	SPDT	5	3.35
KA5DY	24V	472	1.2W	SPDT	5	3.35
KA5DY	110V	10,000	1.2W	SPDT	5	4.05
KA5DG	6V	32.1	1.2W	SPDT	10	3.40
KA5DG	12V	120	1.2W	SPDT	10	3.40
KA5DG	24V	472	1.2W	SPDT	10	3.40
KA5DG	110V	10,000	1.2W	SPDT	10	4.10
KA11AY	6V	6	2VA	DPDT	5	4.25
KA11AY	12V	21	2VA	DPDT	5	4.25
KA11AY	24V	75	2VA	DPDT	5	4.25
KA11AY	120V	2,250	2VA	DPDT	5	4.25
KA11AY	240V	9,110	2VA	DPDT	5	4.65
KA11AG	6V	6	2VA	DPDT	10	4.35
KA11AG	12V	21	2VA	DPDT	10	4.35
KA11AG	24V	75	2VA	DPDT	10	4.35
KA11AG	120V	2,250	2VA	DPDT	10	4.35
KA11AG	240V	9,110	2VA	DPDT	10	4.75
KA11DY	6V	32.1	1.2W	DPDT	5	3.75
KA11DY	12V	120	1.2W	DPDT	5	3.75
KA11DY	24V	472	1.2W	DPDT	5	3.75
KA11DY	110V	10,000	1.2W	DPDT	5	4.40
KA11DG	6V	32.1	1.2W	DPDT	10	3.90
KA11DG	12V	120	1.2W	DPDT	10	3.90
KA11DG	24V	472	1.2W	DPDT	10	3.90
KA11DG	110V	10,000	1.2W	DPDT	10	4.50
KA14AY	6V	6	2VA	3PDT	5	4.65
KA14AY	12V	21	2VA	3PDT	5	4.65
KA14AY	24V	75	2VA	3PDT	5	4.65
KA14AY	120V	2,250	2VA	3PDT	5	5.15
KA14AY	240V	9,110	2VA	3PDT	5	5.65
KA14AG	6V	6	2VA	3PDT	10	4.85
KA14AG	12V	21	2VA	3PDT	10	4.85
KA14AG	24V	75	2VA	3PDT	10	4.85
KA14AG	120V	2,250	2VA	3PDT	10	4.85
KA14AG	240V	9,110	2VA	3PDT	10	5.30
KA14DY	6V	32.1	1.2W	3PDT	5	4.25
KA14DY	12V	120	1.2W	3PDT	5	4.25
KA14DY	24V	472	1.2W	3PDT	5	4.25
KA14DY	110V	10,000	1.2W	3PDT	5	4.90
KA14DG	6V	32.1	1.2W	3PDT	10	4.40
KA14DG	12V	120	1.2W	3PDT	10	4.40
KA14DG	24V	472	1.2W	3PDT	10	4.40
KA14DG	110V	10,000	1.2W	3PDT	10	5.10
KAP5AGS	24V	75	2VA	SPDT	10	6.10
KAP5AGS	120V	2,250	2VA	SPDT	10	6.10
KAP5DG5	24V	472	1.2W	SPDT	10	6.00
KAP5DG5	110V	10,000	1.2W	SPDT	10	6.65
KAP11AY5	24V	75	2VA	DPDT	5	6.65
KAP11AY5	120V	2,250	2VA	DPDT	5	6.65
KAP11AY5	240V	9,110	2VA	DPDT	5	7.10
KAP11AG5	24V	75	2VA	DPDT	10	6.75
KAP11AG5	120V	2,250	2VA	DPDT	10	6.75
KAP11DG5	24V	472	1.2W	DPDT	10	6.70
KAP11DG5	110V	10,000	1.2W	DPDT	10	7.40
KAP11DY5	12V	120	1.2W	DPDT	5	6.60
KAP11DY5	24V	472	1.2W	DPDT	5	6.60
KAP11DY5	110V	10,000	1.2W	DPDT	5	7.30
KAP14AY5	24V	75	2VA	3PDT	5	8.30
KAP14AY5	120V	2,250	2VA	3PDT	5	8.30
KAP14AY5	240V	9,110	2VA	3PDT	5	8.70
KAP14AG5	24V	75	2VA	3PDT	10	8.45
KAP14AG5	120V	2,250	2VA	3PDT	10	8.45
KAP14DG5	24V	472	1.2W	3PDT	10	8.40
KAP14DG5	110V	10,000	1.2W	3PDT	10	9.05
KAP14DY5	24V	472	1.2W	3PDT	5	8.20
KAP14DY5	110V	10,000	1.2W	3PDT	5	8.85
KHU17A115	6V	10.5	1.2VA	4PDT	3	5.55
KHU17A115	12V	43	1.2VA	4PDT	3	5.55
KHU17A115	24V	160	1.2VA	4PDT	3	5.55
KHU17A115	120V	3,900	1.2VA	4PDT	3	6.05
KHU17D115	6V	40	900MW	4PDT	3	5.05
KHU17D115	12V	160	900MW	4PDT	3	5.05
KHU17D115	24V	650	900MW	4PDT	3	5.20
KHU17D115	48V	2,600	900MW	4PDT	3	5.25
KHU17D115	90V	9,000	900MW	4PDT	3	5.90
KHU17D115	110V	11,000	900MW	4PDT	3	5.90
KHU17D115	110V	11,000	900MW	4PDT	3	6.05
KHP17A115	6V	10.5	1.2VA	4PDT	3	5.55
KHP17A115	12V	43	1.2VA	4PDT	3	5.55
KHP17A115	24V	160	1.2VA	4PDT	3	5.55
KHP17A115	120V	3,900	1.2VA	4PDT	3	6.05
KHP17D115	6V	40	900MW	4PDT	3	5.05
KHP17D115	12V	160	900MW	4PDT	3	5.05
KHP17D115	24V	650	900MW	4PDT	3	5.05
KHP17D115	48V	2,600	900MW	4PDT	3	5.25
KHP17D115	90V	9,000	900MW	4PDT	3	5.90
KHP17D115	110V	11,000	900MW	4PDT	3	5.90
KHP17D115	110V	11,000	900MW	4PDT	3	6.05
KHS17A111	6V	10.5	1.2VA	4PDT	3	9.55
KHS17A111	12V	43	1.2VA	4PDT	3	9.55
KHS17A111	24V	160	1.2VA	4PDT	3	9.55
KHS17A111	120V	3,900	1.2VA	4PDT	3	9.90
KHS17D111	6V	40	900MW	4PDT	3	8.55
KHS17D111	12V	160	900MW	4PDT	3	8.55
KHS17D111	24V	650	900MW	4PDT	3	8.55
KHS17D111	110V	11,000	900MW	4PDT	3	9.40
KL5A	120V	760	2.9VA	SPDT	5	4.25
KL5D	24V	600	1.1W	SPDT	5	2.00
KL11A	12V	7.8	2.9VA	DPDT	5	5.30
KL11A	24V	33	2.9VA	DPDT	5	5.30
KL11A	120V	760	2.9VA	DPDT	5	5.30
KL14A	24V	33	2.9VA	3PDT	5	5.90
KL14A	120V	760	2.9VA	3PDT	5	5.90
KL14D	24V	600	1.1W	3PDT	5	5.65
KL14D	110V	10,000	1.1W	3PDT	5	6.35
KL17A	6V	2.25	2.9VA	4PDT	5	7.00
KL17A	24V	33	2.9VA	4PDT	5	7.00
KL17A	120V	760	2.9VA	4PDT	5	7.00
KL17D	12V	140	1.1W	4PDT	5	6.60
KL17D	24V	600	1.1W	4PDT	5	6.60
KL17D	110V	10,000	1.1W	4PDT	5	7.30

*Canadian Standards Association File No. LR-15734

Potter & Brumfield Relays

AB SERIES For appliance and general purpose applications where rugged construction, long life and quiet operation are required. All equipped with terminals to fit snap-on connectors and may also be applied to printed circuits using dip soldering. Snap-on screw adaptors packed with each relay. All AC models carry U/L component recognition (File No. E29244) and CSA* listing. Mounting: Two No. 8-32 tapped holes, on 1 1/4" centers. Silver contacts. Weight: Approx. 5 ozs.

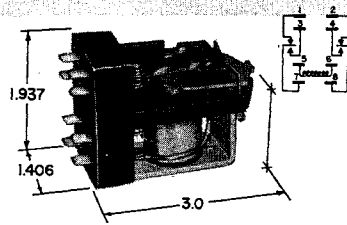

ABC SERIES Medium duty power relay with dust cover. For small motors, industrial control and similar applications. All equipped with terminals to fit snap-on connectors and may also be applied to printed circuits using dip soldering. Snap-on screw adaptors packed with each relay. All AC models carry U/L component recognition (File No. E29244) and CSA* listing. Mounting: One No. 8-32 threaded stud 3/8" long and locating tab on 1/8" centers. Contacts: 1/4" dia. silver. Weight: Approx. 7 ozs.

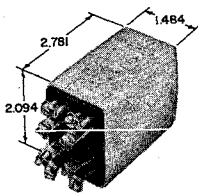

GF SERIES Medium duty power relay for industrial control applications. Long contact arms have 1/4" dia. silver contacts rated at 10 amps at 120V AC or 28V DC resistive. Contacts have excellent wipe or self-cleaning action. Tinned, pierced solder terminals. Mounting: 8-32 tapped core with locating boss. Weight: 4.75 ozs. (See GA series, page 1, for similar voltage actuated relays.)

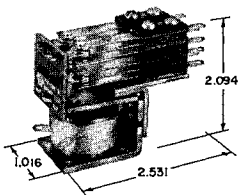

MR SERIES A medium duty power relay that can handle small motors, transmitters, and general purpose applications. Mounting: Two 5/16" dia. holes on 2 1/4" centers for MR3 and 11, 2 1/2" centers for MR2, 5 and 14. Contacts: 1/2" dia. silver. Weight: 4 ozs.

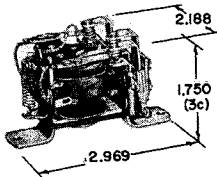

MS/MR Metal dust cover similar to PM/PR shown below. 3 1/2" x 2 1/2" x 2 1/2". Weight: 7.5 ozs.

35D130 fits MS/MR NET \$2.20

PM SERIES A compact heavy duty 4PDT power relay for polyphase and heavy duty switching applications. Screw terminals. Has 1/4" silver-cadmium-oxide contacts rated at 25 amps at 120V., 25 amps at 240V. 50/60 Hz resistive AC, 1HP per movable arm at 120V. or 240V. AC single phase, U/L (File No. E22575) and CSA* listed, except 480V. Mounts by one front key-hole and two rear channel slots for 8-32 screws on 2" x 2 1/2" triangular centers. Weight: 14 ozs.

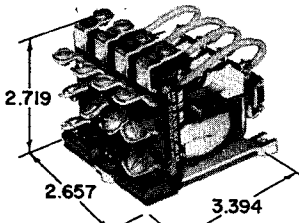

9PM1 Adaptor plates for mounting PM on PR mounting holes. Box of 10 NET \$1.75 Enclosures for PM relay — see below.

PR SERIES Heavy duty relay for industrial control applications requiring long life and fast action. Heavy duty screw type terminals. All AC and DC models except PR-11AL5 carry U/L (File No. E22575) and CSA* listing. Mounting: Two 5/16" dia. holes on 1 1/2" centers. Weight: 11 ozs. max. Contacts: 1/2" dia. silver. Enclosure: See "PR" cover. The PR11AL5 relay is equipped with 1/2" dia. silver SPDT auxiliary contacts rated at 5 amps.

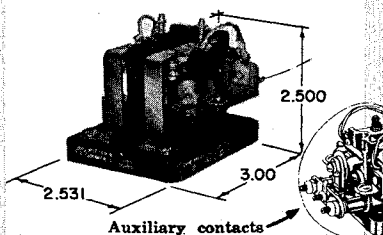

PM and PR DUST COVERS These dust covers have a sheet metal base with knock-outs for 3/8" dia. conduit and an aluminum cover fitted with two screws. Finished in gray hammertone. Mounting: Three No. 10 holes on 1 1/2" x 4 1/2" centers. Approx. weight: 1 lb.

PM:
L 5.313
W 3.812
H 3.812

PR:
L 5.312
W 3.375
H 3.125

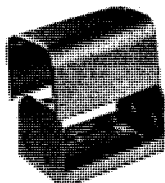

35D227 Metal cover for PM only NET \$3.45

9PM2 Plastic dust cover for PM only. Box of 4 NET \$1.90

35D013 Metal cover for PR only NET \$3.45

POWER RELAYS

TYPE	COILS			CONTACTS		SUGG. RESALE PRICE
	Voltage or Current	Resistance in Ohms	Nominal Power	Arrangement	Rate in Amps	
AB11AY	6V	1.3	6.4VA	DPDT	10	\$ 5.85
AB11AY	24V	23	6.4VA	DPDT	10	5.85
AB11AY	120V	310	6.4VA	DPDT	10	5.85
AB11AY	240V	2,050	6.4VA	DPDT	10	6.30
AB11D	12V	72	2.0W	DPDT	10	5.70
AB11D	24V	288	2.0W	DPDT	10	5.70
AB11D	110V	6,050	2.0W	DPDT	10	6.30
ABC11AY§	6V	1.3	6.4VA	DPDT	10	7.05
ABC11AY§	24V	23	6.4VA	DPDT	10	7.05
ABC11AY§	120V	310	6.4VA	DPDT	10	7.05
ABC11AY§	240V	2,050	6.4VA	DPDT	10	7.50
ABC11D§	6V	18	2.0W	DPDT	10	6.95
ABC11D§	12V	72	2.0W	DPDT	10	6.95
ABC11D§	24V	288	2.0W	DPDT	10	6.95
ABC11D§	110V	6,050	2.0W	DPDT	10	7.50
GF17A	6V	1.7	6VA	4PDT	10	7.35
GF17A	12V	6.8	6VA	4PDT	10	7.35
GF17A	24V	24	6VA	4PDT	10	7.35
GF17A	120V	660	6VA	4PDT	10	7.35
GF17A	240V	2,950	6VA	4PDT	10	7.75
GF17D	6V	18	2.0W	4PDT	10	7.35
GF17D	12V	72	2.0W	4PDT	10	7.35
GF17D	24V	288	2.0W	4PDT	10	7.35
GF17D	110V	6,050	2.0W	4PDT	10	7.75
MR3A	6V	2.75	3.25VA	SPST-NO-DB	10	4.30
MR3A	24V	50	3.25VA	SPST-NO-DB	10	4.30
MR3A	120V	1,250	3.25VA	SPST-NO-DB	10	4.30
MR3D	6V	24	1.6W	SPST-NO-DB	10	3.90
MR3D	12V	96	1.6W	SPST-NO-DB	10	3.90
MR3D	24V	360	1.6W	SPST-NO-DB	10	3.90
MR5A	6V	2.75	3.25VA	SPDT	8	3.85
MR5A	12V	13.25	3.25VA	SPDT	8	3.85
MR5A	24V	50	3.25VA	SPDT	8	3.85
MR5A	120V	1,250	3.25VA	SPDT	8	3.85
MR5A	240V	4,600	3.25VA	SPDT	8	4.30
MR5D	6V	24	1.6W	SPDT	8	3.55
MR5D	12V	96	1.6W	SPDT	8	3.55
MR5D	24V	360	1.6W	SPDT	8	3.55
MR5D	110V	8,000	1.6W	SPDT	8	4.10
MR11A	6V	2.75	3.25VA	DPDT	8	5.40
MR11A	12V	13.25	3.25VA	DPDT	8	5.40
MR11A	24V	50	3.25VA	DPDT	8	5.40
MR11A	120V	1,250	3.25VA	DPDT	8	5.40
MR11A	240V	4,600	3.25VA	DPDT	8	5.85
MR11D	6V	24	1.6W	DPDT	8	5.15
MR11D	12V	96	1.6W	DPDT	8	5.15
MR11D	24V	360	1.6W	DPDT	8	5.15
MR11D	110V	8,000	1.6W	DPDT	8	5.65
MR14A	6V	2.75	3.25VA	3PDT	8	6.45
MR14A	12V	13.25	3.25VA	3PDT	8	6.45
MR14A	24V	50	3.25VA	3PDT	8	6.45
MR14A	120V	1,250	3.25VA	3PDT	8	6.45
MR14A	240V	4,600	3.25VA	3PDT	8	6.85
MR14D	6V	24	1.6W	3PDT	8	6.10
MR14D	12V	96	1.6W	3PDT	8	6.10
MR14D	24V	360	1.6W	3PDT	8	6.10
MR14D	110V	8,000	1.6W	3PDT	8	6.60
PM17AY	6V	.37	14VA	4PDT	25	13.60
PM17AY	12V	1.4	14VA	4PDT	25	13.60
PM17AY	24V	5.0	14VA	4PDT	25	13.60
PM17AY	120V	120	14VA	4PDT	25	13.60
PM17AY	240V	587	14VA	4PDT	25	14.10
PM17A	480V	1,790	14VA	4PDT	25	15.00
PM17DY	6V	8.2	4.4W	4PDT	25	13.00
PM17DY	12V	33	4.4W	4PDT	25	13.00
PM17DY	24V	132	4.4W	4PDT	25	13.00
PM17DY	110V	2,760	4.4W	4PDT	25	13.65
PR1AY	24V	12	9.8VA	SPST-NO	25	4.45
PR3AY	6V	.86	9.8VA	SPST-NO-DB	25	4.55
PR3AY	12V	3.2	9.8VA	SPST-NO-DB	25	4.55
PR3AY	24V	12	9.8VA	SPST-NO-DB	25	4.55
PR3AY	120V	290	9.8VA	SPST-NO-DB	25	4.55
PR3AY	240V	1,200	9.8VA	SPST-NO-DB	25	5.00
PR3DY	6V	18	2.0W	SPST-NO-DB	25	4.55
PR3DY	12V	71	2.0W	SPST-NO-DB	25	4.55
PR3DY	24V	288	2.0W	SPST-NO-DB	25	4.55
PR3DY	110V	6,050	2.0W	SPST-NO-DB	25	5.25
PR5AY	6V	.86	9.8VA	SPDT	25	4.80
PR5AY	12V	3.2	9.8VA	SPDT	25	4.80
PR5AY	24V	12	9.8VA	SPDT	25	4.80
PR5AY	120V	290	9.8VA	SPDT	25	4.80
PR5AY	240V	1,200	9.8VA	SPDT	25	5.25
PR5DY	6V	18	2.0W	SPDT	25	4.80
PR5DY	12V	71	2.0W	SPDT	25	4.80
PR5DY	24V	288	2.0W	SPDT	25	4.80
PR5DY	110V	6,050	2.0W	SPDT	25	5.45
PR7AY	6V	.86	9.8VA	DPST	25	5.40
PR7AY	12V	3.2	9.8VA	DPST	25	5.40
PR7AY	24V	12	9.8VA	DPST	25	5.40
PR7AY	120V	290	9.8VA	DPST	25	5.40
PR7AY	240V	1,200	9.8VA	DPST	25	5.90
PR7DY	6V	18	2.0W	DPST	25	5.40
PR7DY	12V	71	2.0W	DPST	25	5.40
PR7DY	24V	288	2.0W	DPST	25	5.40
PR7DY	110V	6,050	2.0W	DPST	25	6.10
PR11AY	6V	.86	9.8VA	DPDT	25	7.10
PR11AY	12V	3.2	9.8VA	DPDT	25	7.10
PR11AY	24V	12	9.8VA	DPDT	25	7.10
PR11AY	120V	290	9.8VA	DPDT	25	7.10
PR11AY	240V	1,200	9.8VA	DPDT	25	7.65
PR11AY	480V	4,500	9.8VA	DPDT	25	8.60
PR11AL5	6V	.86	9.8VA	DPDT	20	9.00
PR11AL5	12V	3.2	9.8VA	DPDT	20	9.00
PR11AL5	24V	12	9.8VA	DPDT	20	9.00
PR11AL5	120V	290	9.8VA	DPDT	20	9.00
PR11AL5	240V	1,200	9.8VA	DPDT	20	9.45
PR11DY	6V	18	2.0W	DPDT	25	7.10
PR11DY	12V	71	2.0W	DPDT	25	7.10
PR11DY	24V	288	2.0W	DPDT	25	7.10
PR11DY	110V	6,050	2.0W	DPDT	25	7.75

*Canadian Standards Association File No. LR-15734

Potter & Brumfield Relays

KM SERIES Subminiature relay for applications requiring unusually small relays with up to 3-poles $\frac{3}{8}$ " dia. silver contacts. Withstands 30g mechanical shock and .06" excursion 10 to 55 Hz mechanical vibration. Used extensively in small business machines, alarm systems, automatic toys and communications systems. Mounting: One 2-56 tapped core and locating .062" dia. half-punch on .187" centers. Solder terminals. Weight: .58 ozs.

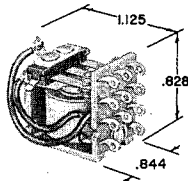

SPECIAL PURPOSE RELAYS

TYPE	COILS			CONTACTS		SUGG. RESALE PRICE
	Voltage or Current	Resistance in Ohms	Nominal Power	Arrangement	Rate in Amps	
KM5D	6V	36	1.1W	SPDT	2	\$3.80
KM5D	12V	144	1.1W	SPDT	2	3.80
KM5D	24V	500	1.1W	SPDT	2	3.80
KM11D	6V	36	1.1W	DPDT	2	4.15
KM11D	12V	144	1.1W	DPDT	2	4.15
KM11D	24V	500	1.1W	DPDT	2	4.15
KM14D	6V	36	1.1W	3PDT	2	4.80
KM14D	12V	144	1.1W	3PDT	2	4.80
KM14D	24V	500	1.1W	3PDT	2	4.80

KT SERIES ANTENNA SWITCHING RELAY Glass base insulation for minimum RF loss to switch 300 ohm line. Mounting: One No. 6-32 threaded stud and locating tab on $\frac{1}{8}$ " centers. Contacts: $\frac{3}{8}$ " dia. gold-flashed silver. Weight: 1 $\frac{1}{2}$ ozs.

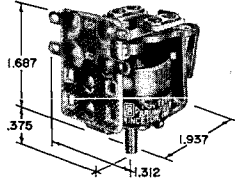

KT11A	6V	6	2VA	DPDT	5	4.10
KT11A	120V	2,250	2VA	DPDT	5	4.10
KT11D	6V	32.1	1.2W	DPDT	5	4.10
KT11D	12V	120	1.2W	DPDT	5	4.10

MS SERIES MOTOR STARTING RELAYS For starting capacitor start, induction-run motors. Operates on back EMF of start winding. Armature gap can be altered to change pull-in. Carries U/L component recognition (File No. 29245). Mounting: Two $\frac{3}{8}$ " dia. holes on 1 $\frac{1}{8}$ " centers. Contacts: $\frac{1}{2}$ HP, $\frac{3}{8}$ " dia. fine silver; 3 HP, $\frac{3}{8}$ " dia. silver cadmium. Weight: 5 ozs. max. MS/MR Metal dust cover similar to PM/PR shown on page 4. 3 $\frac{5}{8}$ " x 2 $\frac{3}{8}$ " x 2 $\frac{1}{2}$ ". Weight: 7.5 ozs. 35D130 fits MS/MR NET \$2.20

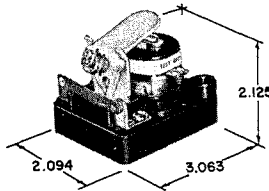

MS2AY	120V	530	5.9VA	SPST-NC	$\frac{3}{4}$ HP	4.00
MS2AY	240V	2,100	5.9VA	SPST-NC	$\frac{3}{4}$ HP	4.45
MS4AY	120V	530	5.9VA	SPST-NC-DB	3HP	4.65
MS4AY	240V	2,100	5.9VA	SPST-NC-DB	3HP	5.10

PC SERIES Single coil impulse latching relay for on-off and current reversal switching on alternate pulses. Operates on 30 millisecond pulses to the coil. Mounting: Two $\frac{3}{8}$ " dia. holes on 2 $\frac{3}{8}$ " centers. Weight: 5 ozs. Contacts: $\frac{3}{8}$ " dia. gold-flashed silver-cadmium-oxide. Coils for intermittent duty only.

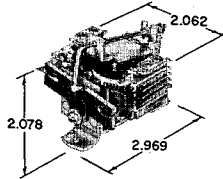

PC11A	6V	.6	18.5VA	DPDT	7.5	6.20
PC11A	12V	2.28	18.5VA	DPDT	7.5	6.20
PC11A	24V	8.8	18.5VA	DPDT	7.5	6.20
PC11A	120V	240	18.5VA	DPDT	7.5	6.20
PC11D	6V	4	9.0W	DPDT	7.5	6.00
PC11D	12V	15.5	9.0W	DPDT	7.5	6.00
PC11D	24V	65	9.0W	DPDT	7.5	6.00
PC17A	24V	8.8	18.5VA	4PDT	7.5	8.55
PC17A	120V	240	18.5VA	4PDT	7.5	8.55
PC17D	24V	65	9.0W	4PDT	7.5	8.35

SA SERIES STEPPING SWITCH A twelve position stepping relay with printed circuit strips to switch currents up to 250 milliamps. Armature-driven pawl operates a ratchet wheel to drive the movable contact in steps of 30 degrees over 12 positions. Used widely for audio-level switching in TV remote control units, scoreboards and process controls. Mounting: Two 6-32 holes on 1 $\frac{1}{8}$ " centers. Weight: 4 ozs. AC coil for intermittent duty only.

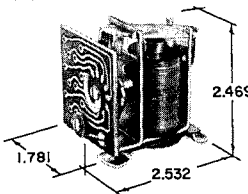

SA-1N-12A	120V	140	20VA	12-steps	.25	7.35
-----------	------	-----	------	----------	-----	------

PLATE CIRCUIT AND SENSITIVE RELAYS

GB SERIES (See GA series page 1 for similar voltage actuated relays.) Sensitivity 115 milliwatts for single pole and 275 milliwatts for 4 pole. Medium cost, high quality relay. Pick-up is not adjustable. Mounting: No. 8-32 tapped core and locating boss. Contacts: $\frac{3}{8}$ " dia. silver. Weight: Approximately 5 ozs.

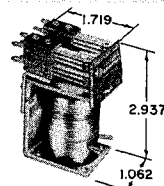

TYPE	COILS			CONTACTS		SUGG. RESALE PRICE
	Voltage or Current	Resistance in Ohms	Nominal Power	Arrangement	Rate in Amps	
GB5D	6.8MA	2,500	115MW	SPDT	5	\$3.80
GB5D	4.6MA	5,000	115MW	SPDT	5	4.00
GB5D	3.4MA	10,000	115MW	SPDT	5	4.50
GB11D	7MA	2,500	125MW	DPDT	5	5.35
GB11D	5MA	5,000	125MW	DPDT	5	5.45
GB11D	3.53MA	10,000	125MW	DPDT	5	6.10
GB17D	10.5MA	2,500	275MW	4PDT	5	6.40
GB17D	7.4MA	5,000	275MW	4PDT	5	6.55
GB17D	5.25MA	10,000	275MW	4PDT	5	7.05

KCP SERIES Low cost plate circuit relay enclosed in clear high impact plastic cover. Sensitivity 125 mw single pole; 250 mw double pole; 375 mw three pole. Mounting: Standard octal plug-in type. Eight pin for KCP5 and KCP11. Eleven pin for KCP14. Contacts: $\frac{3}{8}$ " dia. gold-flashed silver. Weight: Approximately 3 ozs. Use KCP-KRP hold down spring when vibration is a factor or when using inverted or horizontal mounting. (see page 2).

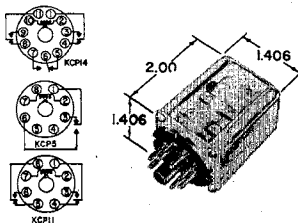

KCP5§	7.2MA	2,500	125MW	SPDT	2	6.50
KCP5§	5MA	5,000	125MW	SPDT	2	6.60
KCP5§	3.6MA	10,000	125MW	SPDT	2	7.05
KCP11§	10MA	2,500	250MW	DPDT	2	6.95
KCP11§	7.2MA	5,000	250MW	DPDT	2	7.05
KCP11§	5MA	10,000	250MW	DPDT	2	7.50
KCP14§	12.3MA	2,500	375MW	3PDT	2	8.55
KCP14§	8.7MA	5,000	375MW	3PDT	2	8.65
KCP14§	6.1MA	10,000	375MW	3PDT	2	9.10

Potter & Brumfield Relays

LS SERIES Short springs and light weight armature provide fast action without sacrificing reliability and long life. Stainless steel hinge bearing designed to give 100 million operations. Tinned, pierced solder terminals. Mounting: Two No. 6-32 tapped holes on $\frac{3}{8}$ " centers. Bifurcated contact arms with $\frac{1}{8}$ " dia. twin palladium contacts. Weight: Approximately 4 ozs.

The LSP version has identical specifications as the LS, except that it is enclosed in a high impact, clear plastic cover and is provided with a rectangular socket with combination taper tab or solder terminations. Enables plug-in like any other plug-in component. Two sizes of sockets and covers are available: 16-pin for 4 Form C (4PDT) or 28-pin for 6 Form C (6PDT). Dimensions: LSP17D: 1.71" x 1.39" x 2.52" seated; weight: 4 ozs. LSP23D: 2.11" x 1.39" x 2.52" seated; weight: 4½ ozs.

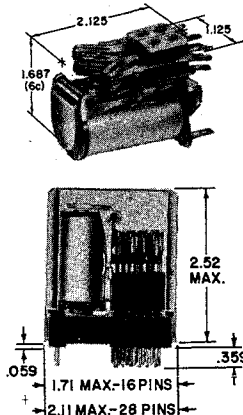

TELEPHONE TYPE RELAYS

TYPE	COILS			CONTACTS		SUGG. RESALE PRICE
	Voltage or Current	Resistance in Ohms	Nominal Power	Arrangement	Rate in Amps	
LS17D	24V	300	1.9W	4PDT	4	\$ 6.25
LS17D	48V	1,300	1.8W	4PDT	4	6.40
LS17D	110V	8,000	1.5W	4PDT	4	6.65
LS23D	24V	300	1.9W	6PDT	4	7.55
LS23D	48V	1,300	1.8W	6PDT	4	7.70
LS23D	110V	8,000	1.5W	6PDT	4	8.05
LSP17D‡	24V	300	1.9W	4PDT	4	8.20
LSP17D‡	48V	1,300	1.8W	4PDT	4	8.30
LSP17D‡	110V	8,000	1.5W	4PDT	4	8.60
LSP23D‡	24V	300	1.9W	6PDT	4	10.15
LSP23D‡	48V	1,300	1.8W	6PDT	4	10.25
LSP23D‡	110V	8,000	1.5W	6PDT	4	10.55
MB3D	6V	13.3	2.7W	SPST-NO-DB	60	5.95
MB3D	12V	62.3	2.7W	SPST-NO-DB	60	6.10
MB3D	24V	245	2.7W	SPST-NO-DB	60	6.10
MB3D	110V	5,000	2.7W	SPST-NO-DB	60	6.50
MC5A	6V	2.5	4.6VA	SPDT	1	5.80
MC5D	12V	96	1.6W	SPDT	1	5.10
MC5D	24V	365	1.6W	SPDT	1	5.10
MC11A	120V	680	4.6VA	DPDT	1	8.00
MC11D	24V	365	1.6W	DPDT	1	7.35
MC11D	110V	6,200	1.6W	DPDT	1	7.95
MG11D	6V	23	1.6W	DPDT	2	5.70
MG11D	12V	90	1.6W	DPDT	2	5.70
MG11D	24V	365	1.6W	DPDT	2	5.70
MG11D	110V	7,560	1.6W	DPDT	2	6.25
MG17D	12V	90	1.6W	4PDT	2	7.65
MG17D	24V	365	1.6W	4PDT	2	7.65
MG17D	110V	7,560	1.6W	4PDT	2	8.05
MG17DP‡	12V	90	1.6W	4PDT	2	12.75
MG17DP‡	24V	365	1.6W	4PDT	2	12.75
MG17DP‡	110V	7,560	1.6W	4PDT	2	13.40
MG17DT†	24V	365	1.6W	4PDT	2	13.90
MG17DT†	110V	7,560	1.6W	4PDT	2	14.55
MH11L	4.5MA	10,000	200MW	DPDT	3	6.55
MH11L‡	4.5MA	10,000	200MW	DPDT	3	11.15
MH17D	6V	23	1.6W	4PDT	5	6.55
MH17D	12V	96	1.6W	4PDT	5	6.55
MH17D	24V	365	1.6W	4PDT	5	6.55
MH17DM†	12V	96	1.6W	4PDT	5	13.30
MH17DM†	24V	365	1.6W	4PDT	5	13.30
MH17AMR†	120V	6,200	2VA	4PDT	5	21.70
MH23D	6V	13.3	2.5W	6PDT	5	8.30
MH23D	12V	62.3	2.5W	6PDT	5	8.30
MH23D	24V	245	2.5W	6PDT	5	8.30
MH23D	110V	5,000	2.5W	6PDT	5	8.80
MH23DD†	12V	62.3	2.5W	6PDT	5	17.65
MH23DD†	24V	245	2.5W	6PDT	5	17.65
MH23DD†	110V	5,000	2.5W	6PDT	5	18.25
ML11D	4.0MA	2,500	40MW	DPDT	3	\$ 7.00
ML11D	2.83MA	5,000	40MW	DPDT	3	7.15
ML11D	2.0MA	10,000	40MW	DPDT	3	7.50
ML17D	4.0MA	2,500	80MW	4PDT	3	8.30
ML17D	4.0MA	5,000	80MW	4PDT	3	8.50
ML17D	2.83MA	10,000	80MW	4PDT	3	8.80
ML23D	6.93MA	2,500	120MW	6PDT	3	9.40
ML23D	4.9MA	5,000	120MW	6PDT	3	9.60
ML23D	3.4MA	10,000	120MW	6PDT	3	9.90

MB SERIES Miniature DC contactor. Designed for very high current applications. Extra rugged construction insures long life. Handles 150 ampere surges for 0.3 sec. Contact arms: Stationary, heavy brass, $\frac{1}{4}$ " dia. silver contacts pierced solder terminals. Movable, $\frac{1}{4}$ " x $\frac{1}{8}$ " silver bar contact. Mounting: Four No. 3-48 tapped holes on $\frac{3}{8}$ " x $\frac{3}{8}$ " centers. Weight: 2 ozs.

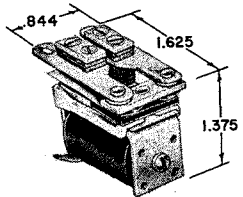

MC SERIES Built with ceramic contact spaces for RF switching to minimize losses at high frequencies. Intercontact capacitance 1.5 mmfd. max. Tinned, pierced solder type terminals. Mounting: Four No. 3-48 tapped holes on $\frac{3}{8}$ " x $\frac{3}{8}$ " centers. Contacts: $\frac{1}{8}$ " dia. palladium. Weight: 2 ozs.

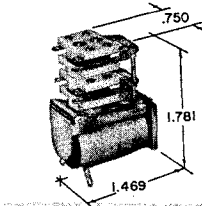

MG SERIES Sub-miniature telephone type relay can be furnished open, sealed or in nylon dust cover. Mounting: Open model has four No. 3-48 tapped holes on $\frac{3}{8}$ " x $\frac{3}{8}$ " centers. Sealed model has three No. 4-40 threaded studs on 1" x $\frac{1}{2}$ " centers. Dust cover model has plug-in header that fits Amphenol receptacle No. 57-20140 or similar. Contacts: $\frac{1}{8}$ " dia. silver. Weight: Open 1.2 ozs.; Dust cover 2.0 ozs.; Sealed 2.75 ozs.

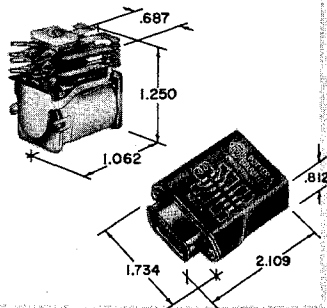

MH SERIES MINIATURE TYPE Ideal for applications where space and weight are factors. Mounting: Open model, MH11L, one No. 6-32 threaded stud $\frac{1}{2}$ " long plus locating boss. All other open models have four No. 3-48 holes on $\frac{3}{8}$ " x $\frac{3}{8}$ " centers. Sealed models, M enclosures, three 6-32 NC 2 threaded studs on 1½" x $\frac{1}{2}$ " centers. D enclosures, three 6-32 threaded studs on 1½" x $\frac{1}{2}$ " centers. All sealed models have hook end solder terminals. All models have $\frac{1}{8}$ " dia. gold-flashed silver contacts. Weight: Open models 2½ oz. max. Sealed models 5 ozs. max.

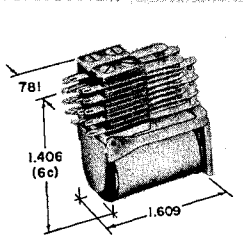

ML SERIES A small telephone type relay having excellent sensitivity and outstanding switching capabilities. Ideal for transistorized computer networks, telephone systems and battery powered communications equipment. Single contact arms have $\frac{1}{8}$ " dia. gold-flashed silver contacts rated at 3 amps for 100,000 operations. Pierced solder terminals. Mounting: Four 3-48 holes on $\frac{3}{8}$ " centers. Weight: 2.5 ozs.

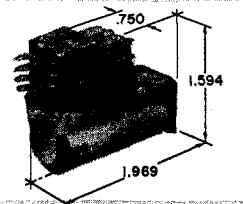

DRY REED RELAYS

TYPE JR STANDARD TYPE JRM MINIATURE

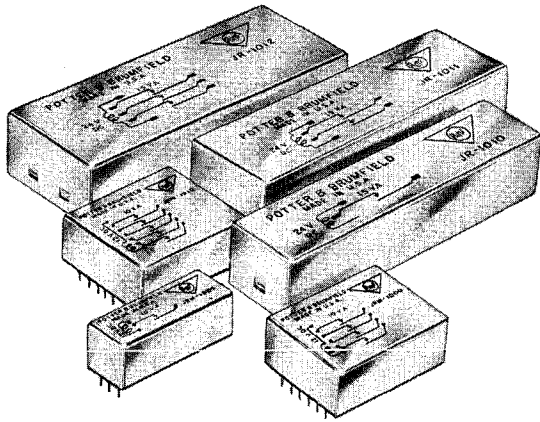

Fast response, reliable performance, high sensitivity, and long life make JR standard and JRM miniature series relays especially suited for data processing applications, computer equipment, logic circuitry and various other sophisticated control circuits.

TWO TYPES OF BASIC CAPSULES

Both JR and JRM relays employ dry reed glass capsules with two basic types of contact arrangements, Form A (SPST-NO) or Form C (SPDT). Biasing with a permanent magnet changes Form A to a Form B (SPST-NC). This arrangement

TYPE	Contact Arrangement	Number of Cavities	COILS		Reed Rating Watts	SUGG. RESALE PRICE
			Sugg. Nominal Voltage	Resistance in Ohms		
JR1000	1A	1	6	150	15	\$ 3.05
JR1001	2A	2	6	100	15	4.10
JR1003	4A	4	6	37.5	15	5.70
JR1020	1A	1	6	150	50	4.30
JR1021	2A	2	6	100	50	6.60
JR1040	1C*	1	6	150	10	7.65
JR1041	2C*	2	6	100	10	8.40
JR1060	1B	2	6	100	15	4.10
JR1061	2B	3	6	50	15	5.35
JR1084	1A+1B	3	6	50	15	5.05
JR1085	2A+2B	5	6	24	15	8.25
JR1005	1A	1	12	600	15	3.05
JR1006	2A	2	12	400	15	4.10
JR1008	4A	4	12	150	15	5.70
JR1025	1A	1	12	600	50	4.30
JR1026	2A	2	12	400	50	6.60
JR1045	1C*	1	12	600	10	7.65
JR1046	2C*	2	12	400	10	8.40
JR1063	1B	2	12	400	15	4.10
JR1064	2B	3	12	200	15	5.35
JR1086	1A+1B	3	12	200	15	5.05
JR1087	2A+2B	5	12	96	15	8.25
JR1010	1A	1	24	2,400	15	3.55
JR1011	2A	2	24	1,600	15	4.35
JR1013	4A	4	24	600	15	6.00
JR1030	1A	1	24	2,400	50	4.60
JR1031	2A	2	24	1,600	50	6.90
JR1050	1C*	1	24	2,400	10	8.00
JR1051	2C*	2	24	1,600	10	8.50
JR1066	1B	2	24	1,600	15	4.15
JR1067	2B	3	24	800	15	5.50
JR1088	1A+1B	3	24	800	15	5.35
JR1089	2A+2B	5	24	384	15	8.35

*True Form C

JRM MINIATURE SERIES

JRM1000	1A	1	6	200	10	3.30
JRM1001	2A	2	6	130	10	4.80
JRM1003	4A	4	6	67	10	7.65
JRM1018	1C*	1	6	200	4	7.05
JRM1019	2C*	2	6	130	4	12.10
JRM1036	1B	2	6	130	10	4.20
JRM1037	2B	3	6	86	10	5.60
JRM1048	1A+1B	3	6	86	10	5.60
JRM1049	2A+2B	5	6	50	10	8.60
JRM1006	1A	1	12	800	10	3.30
JRM1007	2A	2	12	520	10	4.80
JRM1009	4A	4	12	268	10	7.65
JRM1024	1C*	1	12	800	4	7.05
JRM1025	2C*	2	12	520	4	12.10
JRM1040	1B	2	12	520	10	4.20
JRM1041	2B	3	12	344	10	5.60
JRM1050	1A+1B	3	12	344	10	5.60
JRM1051	2A+2B	5	12	200	10	8.60
JRM1012	1A	1	24	3,200	10	3.60
JRM1013	2A	2	24	2,080	10	4.95
JRM1015	4A	4	24	1,072	10	7.75
JRM1030	1C*	1	24	3,200	4	7.20
JRM1031	2C*	2	24	2,080	4	12.25
JRM1044	1B	2	24	2,080	10	4.30
JRM1045	2B	3	24	1,376	10	5.75
JRM1052	1A+1B	3	24	1,376	10	5.75
JRM1053	2A+2B	5	24	800	10	8.75

*True Form C

requires that coil polarity be observed. It uses a two-cavity bobbin. Combining one Form A with one Form B results in a single Form C (SPDT) break-before-make; this uses a three-cavity bobbin. A "true" Form C (SPDT) uses a reed switch with two stationary and one movable contact. The movable contact is normally closed until the coil is energized, causing a "true" Form C (SPDT) break-before-make; it uses a single-cavity bobbin.

SPECIFICATIONS

Pick-up: 75% of nominal @ 25°C.

Operate Time: At nom. voltage @ 25°C.: JR: 3ms. JRM: 1ms.

Release Time: At 25°C.: JR: .5ms. JRM: .05ms.

Coil Power: Based upon nom. voltage and resistance. JR: 1 capsule — 240 mw; 2 capsules — 360 mw; 3 capsules — 720 mw; 4 capsules — 960 mw; 5 capsules 1.5 w.

JRM: 1 capsule — 180 mw; 2 capsules — 275 mw; 3 capsules — 420 mw; 4 capsules — 540 mw; 5 capsules — 720 mw.

For additional specifications see columnar listings and drawings.

OUTLINE DIMENSIONS

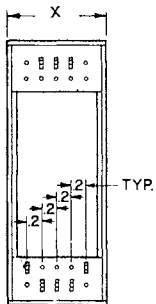

JR Standard Relays

Weights

- X = 1 Cavity = .687" max.—1.50 ozs.
- X = 2 Cavities = .890" max.—2.00 ozs.
- X = 3 Cavities = 1.094" max.—2.50 ozs.
- X = 4 Cavities = 1.297" max.—3.00 ozs.
- X = 5 Cavities = 1.516" max.—3.50 ozs.

JRM Miniature Relays

- X = 1 Cavity = .437" max.—.366 oz.
- X = 2 Cavities = .562" max.—.395 oz.
- X = 3 Cavities = .703" max.—.530 oz.
- X = 4 Cavities = .813" max.—.620 oz.
- X = 5 Cavities = .968" max.—.781 oz.

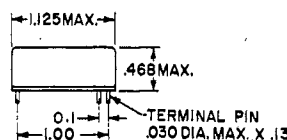
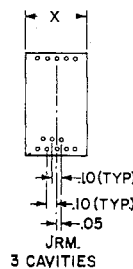
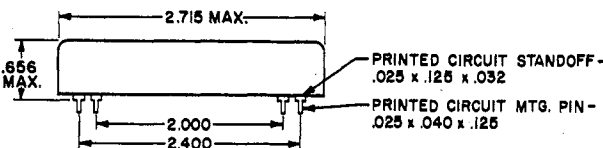

TYPICAL WIRING DIAGRAMS

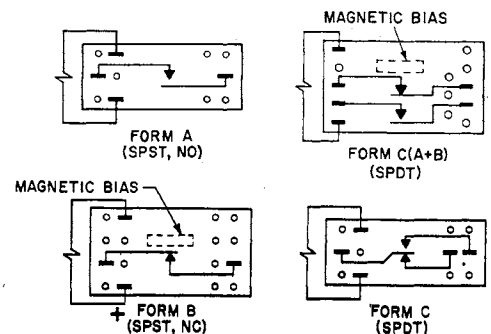

TIME DELAY RELAYS

AS LOW AS \$12.50

- ON DELAY ● OFF DELAY ● KNOB ADJUSTABLE ● RESISTOR ADJUSTABLE ● FIXED TIME DELAY

A wide selection of solid state time delay controls are represented by Potter & Brumfield. The differences are in their degree of accuracy, the variety available in each series, and their cost.

BASIC TIMING CIRCUIT

The basic timing circuit of all three series consists of a resistor in series with a capacitor. When the input voltage is applied to the resistor-capacitor circuit, the voltage across the capacitor slowly increases. When the firing level is reached a solid state trigger circuit acts to turn on a solid state output switch that energizes a switching relay or external electrical load.

CD SERIES

Remarkably dependable, accurate and flexible, the CD series offers an unusually wide selection of operational configurations, all with accurate time delay values, fast reset time and excellent repeatability. It is available in two types: Knob-adjustable in two versions, one with the relay in the same enclosure as the solid state unit, the other with an auxiliary relay. A second type is adjustable with an external resistor. The CD series is available for time delay on operate or on release.

CH SERIES

The CH series is intended for a wide range of industrial applications where economy is of greater interest than highly critical performance. It is available in two types:

Knob-adjustable with the relay in the same enclosure as the solid state unit. The second type has a fixed time delay period that is set at the factory and cannot be modified; its case has no knob. The CH series is available for time delay on operate and on release.

CU SERIES

An outstanding value in a solid state time delay relay at low cost, the CU series is designed for delay on operate applications in machine tool controls, copiers, office equipment, coin-operated machines, process controls and many others. It is available in two types: Fixed time delay that is set at the factory and cannot be modified. Second, adjustable with an external resistor. For minimum time two terminals, 2 and 5, must be shorted; for maximum time the listed external resistor between terminals 2 and 5 must be added. For intermediate times select a lesser value resistor, or a potentiometer. Either model can be furnished in two types of enclosure: with the relay in the same enclosure as the solid state unit. The CU series is offered with delay on operate only.

CJ SERIES

CJ Series time delay dry reed relays combine the basic timing characteristics of time delay relays with the long life and performance of miniature dry reed relays. Two series are available, the CJC fixed time delay on operate and the CJH external resistor adjustable time delay on operate.

COMPARISON OF SPECIFICATIONS OF CD WITH CH AND CU SERIES

TYPE	DIAL SETTING	TEMP. RANGE	ACCURACY AND TOLERANCE	TRANSIENT PROTECTION	INHERENT FALSE OPERATION	RESET TIME	REPEATABILITY	POLARITY PROTECTION
CD	Time, calibrated $\pm 5\%$ of full scale	-40° to +55°C	$\pm 5\%$ of nominal	Tested to 1000V, 1/2 cycle surges (on all 120V AC models)	None	60 Milli-seconds	$\pm 1\%$	Yes
CH	Reference scale	-10° to +55°C	$\pm 10\%$ of nominal	Twice rated input voltage for 8 milli-seconds	Contacts may transfer momentarily interval is if timing interrupted	100 Milli-seconds	$\pm 2\%$	Yes
CU	Not applicable	Norm. room temp.	Tolerance: Fixed $\pm 5\%$ of nominal; resist. adj. $\pm 10\%$ of nominal	Twice rated input voltage for 8 milli-seconds	Contacts may transfer momentarily if timing interval is interrupted	150 Milli-seconds	$\pm 3\%$	Yes
CJ	Not applicable	Norm. room temp.	Tolerance: Fixed $\pm 5\%$ of nominal; resist. adj. $\pm 10\%$ of nominal	Twice rated input voltage for 8 milli-seconds	None	60 Milli-seconds	$\pm 2\%$	No

SOCKETS FOR CU-41 PLAIN CASE RELAYS

All CU series time delays have an internal DPDT 10 amp relay of the KUP series featured on page 3. The cases for the CU and KUP are dimensionally the same. The plain cases fit the same sockets, and the same hold down spring (9KU3) can be used. Please use the KUP type designations (9KU1, 9KU2 and 9KU4) and prices (page 3) for these accessories when ordering.

APPROX. WEIGHTS:

- | | |
|------------------------|-------------------------|
| SERIES CD-31 2.00 ozs. | SERIES CD-45 6.00 ozs. |
| SERIES CD-21 4.25 ozs. | SERIES CD-38 8.25 ozs. |
| SERIES CH-38 4.00 ozs. | ALL CU SERIES 3.25 ozs. |
| SERIES CJC01 1.25 ozs. | SERIES CJH01 1.25 ozs. |
| SERIES CJC02 1.38 ozs. | SERIES CJH02 1.38 ozs. |
| SERIES CJC03 1.63 ozs. | SERIES CJH03 1.63 ozs. |

CS SERIES SOLID STATE VOLTAGE SENSORS

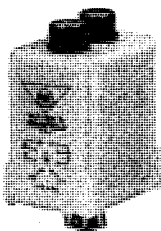

Adjustable pick-up and drop-out. Two knobs for setting desired values.

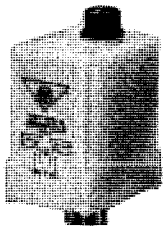

Fixed pick-up and adjustable drop-out. One knob for setting drop-out value.

Two types of accurate, low cost solid state voltage sensors are available. First, an adjustable pick-up and drop-out series for 24V DC and 120V AC voltage sources. Second, a series with factory-fixed pick-up and adjustable drop-out, also for 24V DC and 120V AC voltage sources. All are provided with standard octal plugs for socket mounting and are enclosed in a nylon dust cover. Please see the tables for ranges of voltage adjustments.

ADJUSTABLE PICK-UP AND DROP-OUT

Type	Pick-up Range (Volts)	Drop-out Range (Volts)	Type of Voltage	Sugg. Resale Price
CSJ38-30010	20-30	18-28	AC(50/60Hz)	\$29.75
CSJ38-70010	92-140	90-138	AC(50/60Hz)	32.50
CSL38-30010	20-30	18-28	DC	25.75

FIXED PICK-UP AND ADJUSTABLE DROP-OUT

Type	Pick-up Range (Volts)	Drop-out Range (Volts)	Type of Voltage	Sugg. Resale Price
CSJ38-71010	105	90-103	AC(50/60Hz)	\$28.75
CSL38-31010	22	16-20	DC	22.70

Tolerances: All limits indicated above are $\pm 5\%$ on high and low ranges.

Specifications

- Sensing Current Drain: Maximum of 3 ma.
- Maximum Current Drain: After sensing: 30 ma.
- Accuracy of Set Point: 1% after initial setting.
- Reverse Polarity Protection: Yes, on DC types.
- Operating Temperature: -40°C to $+55^{\circ}\text{C}$.
- Load Switching Relay Contacts: 2 Form C (DPDT). Rating: 3 amps 28V DC resistive; 120V AC resistive.
- Expected Life: Mechanical: 10 million operations. Electrical: 100,000 operations minimum @ rated load.

OUTLINE DIMENSIONS

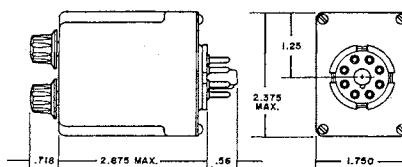

SCHEMATICS

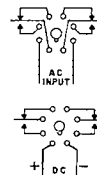

MDP SERIES SMALL POLARIZED RELAYS

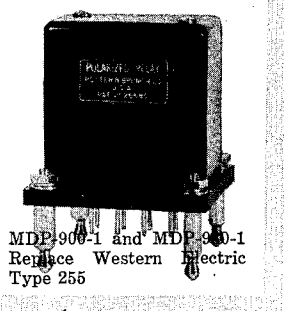
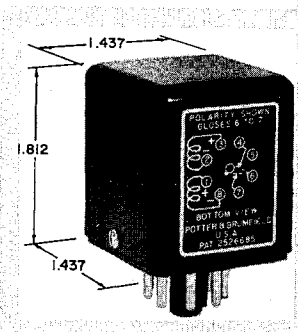

MDP-900-1 and MDP-930-1 Replace Western Electric Type 255

- Sensitive
- High Speed
- Bounce-free

For Bi-Stable or Center-Stable Operation

Small size, ultra-sensitivity and high speed switching together with efficient, bounce-free contact action characterize MDP polarized relays. Their operation depends on both the magnitude and direction of the coil current. Two types of contact arrangements provide the following action when the coils are de-energized: *Bi-stable* — armature remains in its last energized position; *Center-stable* — armature remains in center-off position with contacts open. Contact materials as listed. Temperatures: -60°C to $+85^{\circ}\text{C}$. Measuring only $1\frac{1}{8}$ " sq. by $1\frac{1}{8}$ " high (seated), MDP relays are equipped with a plastic dust cover and 8 or 12-pin plugs. Weight: 4 $\frac{1}{2}$ ozs.

Types MDP-900-1 and MDP-930-1 (with extra long life contacts) will directly replace Western Electric Type 255 relays. 2 $\frac{1}{8}$ " square x 3 $\frac{3}{8}$ " overall height. Weight: 10 ozs.

TYPE	COILS			CONTACTS			SUGG. RESALE PRICE
	Pull-In Current In MA	Resistance In Ohms Each Coil*	Pull-In Power In Micro Watts	Arrangement	Rate In Amps Resistive		
Bi-stable:							
MDP-300-1	1.5	150 (2)	338	1 Form C②	.01-1A† 25-150V	23.45	
MDP-900-1	2.0	150 (2)	600	1 Form C③	.01-1A† 25-150V	30.45	
MDP-930-1	2.4	150 (2)	863	1 Form C③	.01-1A† 25-150V	31.05	
MDP-1300-1	1.4	150 (2)	294	1 Form C②	.01-1A† 25-150V	23.45	
Center-stable:							
MDP-1004	0.49	130 (1)	31.2	1 Form K①	3 @ 28 VDC	26.85	
MDP-1006	0.32	330 (1)	33.8	1 Form K①	3 @ 28 VDC	26.85	
MDP-1007	0.27	480 (1)	35.0	1 Form K①	3 @ 28 VDC	26.85	
MDP-1009	0.18	1460 (1)	47.3	1 Form K①	3 @ 28 VDC	26.85	
MDP-1011	0.10	3500 (1)	35.0	1 Form K①	3 @ 28 VDC	26.85	
MDP-1013	0.067	7200 (1)	32.3	1 Form K①	3 @ 28 VDC	26.85	
MDP-2001	3.50	6 (2)	73.5	1 Form K①	3 @ 28 VDC	26.85	
MDP-2009	0.32	1000 (2)	102.0	1 Form K①	3 @ 28 VDC	26.85	
MDP-2011	0.17	2300 (2)	66.5	1 Form K①	3 @ 28 VDC	26.85	
MDP-2107	0.80	240 (2)	154	1 Form K①	3 @ 28 VDC	26.85	
MDP-2112	0.22	3300 (2)	160	1 Form K①	3 @ 28 VDC	26.85	

*Number of coils shown in () parenthesis. † With suitable arc suppression

Contact materials shown in O circles:

- ① Silver.
- ② Tungsten and Paliney.
- ③ Silver-tungsten-corbide.



STANDARD CONTROLS

**When you use RBM STANDARD
Controls you are assured of...**

IMMEDIATE AVAILABILITY

Sold by Industrial Electronic Distributors in major marketing areas —
AT FACTORY PRICES IN ANY QUANTITY.

HIGHEST QUALITY

Millions of standard relays, time-tested and field proven by major
OEM accounts.

COMPETITIVE PRICES

Mass production facilities — to supply its extensive OEM markets —
enable RBM to manufacture at lowest costs.

LOWEST TOTAL COST

Enclosed contacts — multiple mountings — solderless terminals —
cross-bar contacts for low level circuits.

SERVICE REPLACEMENT

Available from over 1000 industrial and Service Parts Electronic Dis-
tributors located in over 500 cities.

SOLD NATIONALLY THROUGH ELECTRONIC DISTRIBUTORS BY

ESSEX WIRE CORPORATION

CONTROLS DIVISION — DISTRIBUTOR MARKETING

PRODUCTION PART NUMBER IS RBM MANUFACTURING NUMBER WHICH IS STAMPED ON EACH UNIT

Catalog Number	Production Number	Page	Suggested Price			
			1/24	25/49	50/99	100/249
92-901	92-321111-11607	7	5.87	5.29	4.70	4.11
92-902	92-311111-11607		6.07	5.47	4.86	4.25
92-903	92-331111-11607		6.24	5.62	5.00	4.37
92-904	92-321177-11607		5.79	5.21	4.63	4.05
92-905	92-311177-11607		5.99	5.39	4.79	4.19
92-906	92-331177-11607		6.14	5.53	4.92	4.30
92-907	92-327711-77607		5.70	5.13	4.56	3.99
92-908	92-317711-77607		5.90	5.31	4.72	4.13
92-909	92-337711-77607		6.05	5.45	4.84	4.24
92-910	92-327777-77607		5.64	5.08	4.51	3.95
92-911	92-317777-77607		5.84	5.26	4.67	4.09
92-912	92-337777-77607		5.99	5.39	4.80	4.20
92D-911	92-383333-33507	6.04	5.44	4.84	4.23	
92D-912	92-373333-33507	6.04	5.44	4.84	4.23	
92D-913	92-323333-33507	6.04	5.44	4.84	4.23	
93-153-1	None	6	.60	.54	.48	.42
93-901	93-208030-13000B		3.25	2.93	2.60	2.28
93-902	93-208303-13000B		3.95	3.56	3.16	2.74
93-903	93-208333-13000B		4.40	3.96	3.52	3.08
93-904	93-202030-13300B		3.25	2.93	2.60	2.28
93-905	93-202303-13300B		3.95	3.56	3.16	2.74
93-906	93-202333-13300B		4.40	3.96	3.52	3.08
93-907	93-201030-13000B		3.25	2.93	2.60	2.28
93-908	93-201303-13000B		3.95	3.56	3.16	2.74
93-909	93-201333-13000B		4.40	3.96	3.52	3.08
93-910	93-203030-13000B		3.65	3.29	2.92	2.56
93-911	93-203303-13000B		4.35	3.92	3.48	3.05
93-912	93-203333-13000B	4.80	4.32	3.84	3.36	
93-913	93-508030-13300B	3.10	2.79	2.48	2.17	
93-914	93-508303-13300B	3.50	3.15	2.80	2.45	
93-915	93-508333-13300B	4.00	3.60	3.20	2.80	
93-916	93-507030-13300B	3.10	2.79	2.48	2.17	
93-917	93-507303-13300B	3.50	3.15	2.80	2.45	
93-918	93-507333-13300B	4.00	3.60	3.20	2.80	
93-919	93-502030-13300B	3.10	2.79	2.48	2.17	
93-920	93-502303-13300B	3.50	3.15	2.80	2.45	
93-921	93-502333-13300B	4.00	3.60	3.20	2.80	
93-922	93-501030-13300B	3.70	3.33	2.96	2.59	
93-923	93-501303-13300B	4.10	3.69	3.28	2.87	
93-924	93-501333-13300B	4.60	4.14	3.68	3.22	
93-931	93-208090-13000A	3.20	2.88	2.56	2.24	
93-932	93-208909-13000A	3.85	3.47	3.08	2.70	
93-933	93-208999-13000A	4.25	3.83	3.40	2.98	
93-934	93-202090-13300A	3.20	2.88	2.56	2.24	
93-935	93-202909-13300A	3.85	3.47	3.08	2.70	
93-936	93-202999-13300A	4.25	3.83	3.40	2.98	
93-937	93-201090-13000A	3.20	2.88	2.56	2.24	
93-938	93-201909-13000A	3.85	3.47	3.08	2.70	
93-939	93-201999-13000A	4.25	3.83	3.40	2.98	
93-940	93-203090-13000A	3.60	3.24	2.88	2.52	
93-941	93-203909-13000A	4.25	3.83	3.40	2.98	
93-942	93-203999-13000A	4.65	4.19	3.72	3.26	
93-943	93-508090-13300A	3.05	2.75	2.44	2.14	
93-944	93-508909-13300A	3.40	3.06	2.72	2.38	
93-945	93-508999-13300A	3.85	3.47	3.08	2.70	
93-946	93-507090-13300A	3.05	2.75	2.44	2.14	
93-947	93-507909-13300A	3.40	3.06	2.72	2.38	
93-948	93-507999-13300A	3.85	3.47	3.08	2.70	
93-949	93-502090-13300A	3.05	2.75	2.44	2.14	
93-950	93-502909-13300A	3.40	3.06	2.72	2.38	
93-951	93-502999-13300A	3.85	3.47	3.08	2.70	
93-952	93-501090-13300A	3.65	3.29	2.92	2.56	
93-953	93-501909-13300A	4.00	3.60	3.20	2.80	
93-954	93-501999-13300A	4.45	4.01	3.56	3.12	
93-954	93-202090-30300A	3.20	2.88	2.56	2.24	
93-955	93-202909-30300A	3.85	3.47	3.08	2.70	
93-956	93-202999-30300A	4.25	3.83	3.40	2.98	
93-957	93-201090-30000A	3.20	2.88	2.56	2.24	
93-958	93-201909-30000A	3.85	3.47	3.08	2.70	
93-959	93-201999-30000A	4.25	3.83	3.40	2.98	
93-976	93-507090-30300A	3.05	2.75	2.44	2.14	
93-977	93-507909-30300A	3.40	3.06	2.72	2.38	
93-978	93-507999-30300A	3.85	3.47	3.08	2.70	
93-979	93-502090-30300A	3.05	2.75	2.44	2.14	
93-980	93-502909-30300A	3.40	3.06	2.72	2.38	
93-981	93-502999-30300A	3.85	3.47	3.08	2.70	
93-985	93-207030-13000B	3.25	2.93	2.60	2.28	
93-986	93-207303-13000B	3.95	3.56	3.16	2.74	
93-987	93-207333-13000B	4.40	3.96	3.52	3.08	
93-988	93-207090-13000A	3.20	2.88	2.56	2.24	
93-989	93-207909-13000A	3.85	3.47	3.08	2.70	
93-990	93-207999-13000A	4.25	3.83	3.40	2.98	
93-991	93-207090-30000A	3.20	2.88	2.56	2.24	
93-992	93-207909-30000A	3.85	3.47	3.08	2.70	
93-993	93-207999-30000A	4.25	3.83	3.40	2.98	
93P-901	93-208030-70000B	6	5.50	4.95	4.40	3.85
93P-902	93-208303-60000B		6.15	5.54	4.92	4.31
93P-903	93-208333-90000B		7.65	6.89	6.12	5.36
93P-904	93-202030-70300B		5.50	4.95	4.40	3.85
93P-905	93-202303-60300B		6.15	5.54	4.92	4.31
93P-906	93-202333-90300B		7.65	6.89	6.12	5.36
93P-907	93-201030-70000B		5.50	4.95	4.40	3.85
93P-908	93-201303-60000B		6.15	5.54	4.92	4.31
93P-909	93-201333-90000B		7.65	6.89	6.12	5.36
93P-910	93-203030-70000B		5.90	5.31	4.72	4.13
93P-911	93-203303-60000B		6.55	5.90	5.24	4.59
93P-912	93-203333-90000B		8.05	7.25	6.44	5.64
93P-913	93-508030-70300B	5.45	4.91	4.36	3.82	
93P-914	93-508303-60300B	6.10	5.49	4.88	4.27	
93P-915	93-508333-90300B	7.60	6.84	6.08	5.32	
93P-916	93-507030-70300B	5.45	4.91	4.36	3.82	
93P-917	93-507303-60300B	6.10	5.49	4.88	4.27	
93P-918	93-507333-90300B	7.60	6.84	6.08	5.32	
93P-919	93-502030-70300B	5.45	4.91	4.36	3.82	
93P-920	93-502303-60300B	6.10	5.49	4.88	4.27	
93P-921	93-502333-90300B	7.60	6.84	6.08	5.32	
93P-922	93-501030-70300B	6.05	5.45	4.84	4.24	
93P-923	93-501303-60300B	6.70	6.03	5.36	4.69	
93P-924	93-501333-90300B	8.20	7.38	6.56	5.74	
93P-925	93-208090-70000A	5.45	4.91	4.36	3.82	
93P-926	93-208909-60000A	6.05	5.45	4.84	4.24	
93P-927	93-208999-90000A	7.50	6.75	6.00	5.25	
93P-928	93-202090-70300A	5.45	4.91	4.36	3.82	
93P-929	93-202909-60300A	6.05	5.45	4.84	4.24	
93P-930	93-202999-90300A	7.50	6.75	6.00	5.25	
93P-931	93-201090-70000A	5.45	4.91	4.36	3.82	
93P-932	93-201909-60000A	6.05	5.45	4.84	4.24	
93P-933	93-201999-90000A	7.50	6.75	6.00	5.25	
93P-934	93-203090-70000A	5.85	5.27	4.68	4.10	
93P-935	93-203909-60000A	6.45	5.81	5.16	4.42	
93P-936	93-203999-90000A	7.90	7.11	6.32	5.53	
93P-937	93-508090-70300A	5.40	4.86	4.32	3.78	
93P-938	93-508909-60300A	6.00	5.40	4.80	4.20	
93P-939	93-508999-90300A	7.45	6.71	5.96	5.22	
93P-940	93-507090-70300A	5.40	4.86	4.32	3.78	
93P-941	93-507909-60300A	6.00	5.40	4.80	4.20	
93P-942	93-507999-90300A	7.45	6.71	5.96	5.22	
93P-943	93-502090-70300A	5.40	4.86	4.32	3.78	
93P-944	93-502909-60300A	6.00	5.40	4.80	4.20	
93P-945	93-502999-90300A	7.45	6.71	5.96	5.22	
93P-946	93-501090-70300A	6.00	5.40	4.80	4.20	
93P-947	93-501909-60300A	6.60	5.94	5.28	4.62	
93P-948	93-501999-90300A	8.05	7.25	6.44	5.64	
93P-949	93-207030-70000B	5.50	4.95	4.40	3.85	
93P-950	93-207303-60000B	6.15	5.54	4.92	4.31	
93P-951	93-207333-90000B	7.65	6.89	6.12	5.36	
93P-952	93-207090-70000A	5.45	4.91	4.36	3.82	
93P-953	93-207909-60000A	6.05	5.45	4.84	4.24	
93P-954	93-207999-90000A	7.50	6.75	6.00	5.25	
93Q-901	93-208030-25000B	6	3.75	3.38	3.00	2.63
93Q-902	93-208303-25000B		4.50	4.05	3.60	3.15
93Q-903	93-208333-25000B		5.00	4.50	4.00	3.50
93Q-904	93-202030-25300B		3.75	3.38	3.00	2.63
93Q-905	93-202303-25300B		4.50	4.05	3.60	3.15
93Q-906	93-202333-25300B		5.00	4.50	4.00	3.50
93Q-907	93-201030-25000B		3.75	3.38	3.00	2.63
93Q-908	93-201303-25000B		4.50	4.05	3.60	3.15
93Q-909	93-201333-25000B		5.00	4.50	4.00	3.50

GENERAL PURPOSE RELAYS — GENERAL REPLACEMENT RELAYS
TIME DELAY RELAYS — POWER & INDUSTRIAL CONTACTORS

Maximum Continuous Load In Amperes (Inductive)	Number of Poles								
	Single Pole			Two Pole			Three Pole		
	Classification	Type	Page	Classification	Type	Page	Classification	Type	Page
LOW LEVEL Thermo-couple, pilot lights, etc.	General Purpose	93	6	General Purpose	91	7	General Purpose	92	7
	Time Delays	84T	12	General Purpose	93	6	General Purpose	93	6
	General Purpose	84	7						
3	Time Delays	84T	12	General Purpose	91	7	General Purpose	987	8
	Time Delays	59	12	General Purpose	987	8	General Purpose	92	7
5	General Purpose	93	6	General Purpose	93	6	General Purpose	93	6
8	General Purpose	84	7						
10	General Purpose	93	6	General Purpose	93	6	General Purpose	93	6
12				General Purpose	91	7	General Purpose	92	7
15	General Purpose	987	8	General Purpose	987	8	General Purpose	987	8
18	General Purpose	129	8	Power Contactors	143	8			
	Time Delays	129T	12	Power Contactors	75	9			
25				Power Contactors	80	9			
				Power Contactors	143	8	Power Contactors	85	9
30							Power Contactors	S30	9
							Industrial Contactors	C30	10
							Industrial Contactors	CR30	11
40							Power Contactors	S40	9
10-15 30-50	Type C 4 Pole Industrial Contactors Pages 10 and 11.								

REPLACEMENT CONTACTS, CONTACT BLOCK AND CARRIER, MAGNET COILS, MAGNET AND ARMATURE KITS FOR TYPE C CONTACTORSPAGE 11
All relays rated below 5 amps have special alloy contacts designed for low level current.

A.C. ENGINEERING DESIGN DATA

Type	Magnet Coil Rating (Volt Amperes)			Operation in % of Nom. Coil Rating		Breakdown Voltage All Terminals - 60 cy. RMS			Contact Material		Electrical Life		**Mechanical Life		Practical Maximum Operating Ambient Degrees Fahrenheit
	Inrush	Sealed		Pick-up	Safe *Max. Operate	Opposite Polarity	Open Contacts Same Polarity	To Ground	Power Rating	Pilot Rating	Oper. At Rated Load	Oper. Per Min.	Oper. At No Load	Oper. Per Min.	
		Nom.	Max.												
59	No Magnet Coil			85%	110%	1500	1000	1500	—	Fine Silver	100,000	1	1,000,000	1	140
75	16	10	12	85%	110%	1500	1000	1500	Silver Alloy	—	†100,000	6	1,000,000	60	140
80	27	15.6	17	85%	110%	1500	1500	1500	Silver Alloy	—	†100,000	3	1,000,000	60	130
84	4	2.8	3	85%	110%	1500	1000	1500	Silver Alloy	Fine Silver	100,000	6	1,000,000	140	140
84T	9	2.8	3	85%	110%	1500	1000	1500	—	Gold Alloy	100,000	6	1,000,000	140	140
85	90	19	23	85%	110%	2200	2200	2200	Silver Alloy	—	†100,000	6	500,000	130	130
91	22	8	10	85%	110%	1500	1000	1500	Fine Silver	• Gold Alloy	†100,000	6	750,000	60	130
92	24	8.9	12	85%	110%	1500	1000	1500	Fine Silver	• Gold Alloy	†100,000	6	750,000	60	130
93	4.5	3.0	4	85%	110%	1500	1000	1500	Fine Silver	• Gold Alloy	100,000	6	10,000,000	60	160
129	10	4.5	5	85%	110%	1500	1000	1500	Silver Alloy	—	†100,000	3	500,000	60	130
129AR	10	4.5	5	85%	110%	1500	1000	1500	Silver Alloy	—	†100,000	3	500,000	60	130
129T	10	4.5	5	85%	110%	1500	1000	1500	Silver Alloy	—	†100,000	3	500,000	1	130
143	24	8.9	12	85%	110%	1500	1000	1500	Silver Alloy	—	†100,000	6	500,000	30	130
987	9	5.5	6.5	85%	110%	1500	1000	1500	Fine Silver	• Gold Alloy	100,000	6	1,000,000	60	140
C	90	18	21	85%	110%	2200	2200	2200	Silver Alloy	—	†100,000	6	1,000,000	10	130
CR	90	18	21	85%	110%	2200	2200	2200	Silver Alloy	—	†100,000	6	1,000,000	10	130
S	50	14.5	17	85%	110%	2200	2200	2200	Silver Alloy	—	†100,000	6	500,000	10	130

* Magnet coils designed for continuous duty. Do not operate at rate higher than indicated under Mechanical Life.
** Based on steady state test under laboratory environmental conditions. Consult factory if application involves unusual load, speed of operation, off-on ratio, environmental or operating conditions. Electric life substantially greater when operated below rated load.
† Load tests — making inrush ratings (0.4 to 0.5 P.F.) — breaking 125% continuous rating (0.65 to 0.8 P.F.).
• Cross-bar contacts.

TYPE 93

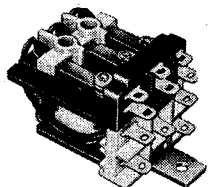

Solder Terminals (Fig. 1a)

OPEN TYPE

Solder Terminal Relay designed for front single hole screw or stud rear mounting. Stud and screw included.

SIZE Fig. 1a 1 1/8" x 1 3/8" x 1 3/8"
 SIZE Fig. 1b 1 1/8" x 1 3/8" x 1 3/8"

TYPE 93

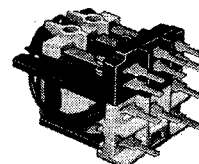

Printed Circuit (Fig. 1b)

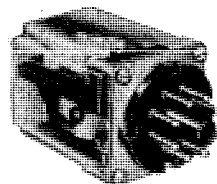

8 Pin Plug-in (Fig. 2)

PLUG-IN

8 pin octal base for single & two pole—11 pin base for three pole. High impact case.

SIZE 2 1/8" x 1 1/8" x 1 1/8"

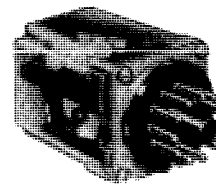

11 Pin Plug-in (Fig. 2)

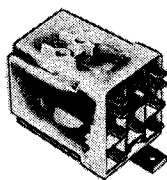

Quick Connect (Fig. 3)

QUICK CONNECT

Enclosed relay designed for front mounting. Panel board polarized sockets are available. Terminal .020 x .187. Hardware included.

SIZE 2 1/8" x 1 1/8" x 1 1/8"

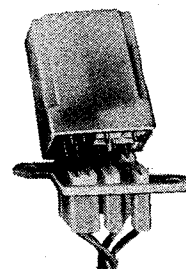

Relay Receptacle** (Fig. 4)
 93-153-1 Socket Kit (Hardware Included)

* May be controlled by SCR providing firing angle no more than 10 degrees.

** Remove relay bracket when 93-153-1 receptacle is used.

Voltage	CONTACT RATING			
	Fine Silver Button		Gold-Alloy Cross Bar	
	Inductive	Resistive	Inductive	Resistive
28VDC or 120VAC	1/6 H.P.	10 AMP.	1/10 H.P.	5 AMP.
28VDC or 240VAC	1/3 H.P.	5 AMP.	1/6 H.P.	3 AMP.

Coil Voltage	D.C. Resistance in Ohms @ 25°C	Contact Form	Open Type				Enclosed Type			
			Solder Terminals (Fig. 1a)		Printed Circuit (Fig. 1b)		Plug-In (Fig. 2)		Quick Connect Terminals (Fig. 3)	
			10 Amp. Button Contacts	5 Amp. Cross-Bar Contacts	5 Amp. Cross-Bar Contacts	10 Amp. Button Contacts	5 Amp. Cross-Bar Contacts	10 Amp. Button Contacts	5 Amp. Cross-Bar Contacts	
			Catalog Number	Catalog Number	Catalog Number	Catalog Number	Catalog Number	Catalog Number	Catalog Number	
6 (50/60 CY.)	3.5	1PDT	93-901	93-931	—	93P-901	93P-931	93Q-901	93Q-931	
		2PDT	93-902	93-932	—	93P-902	93P-932	93Q-902	93Q-932	
		3PDT	93-903	93-933	—	93P-903	93P-933	93Q-903	93Q-933	
12 (50/60 CY.)	14	1PDT	93-985	93-988	*93-991	93P-955	93P-958	93Q-955	93Q-958	
		2PDT	93-986	93-989	*93-992	93P-956	93P-959	93Q-956	93Q-959	
		3PDT	93-987	93-990	*93-993	93P-957	93P-960	93Q-957	93Q-960	
24 (50/60 CY.)	55	1PDT	93-904	93-934	*93-964	93P-904	93P-934	93Q-904	93Q-934	
		2PDT	93-905	93-935	*93-965	93P-905	93P-935	93Q-905	93Q-935	
		3PDT	93-906	93-936	*93-966	93P-906	93P-936	93Q-906	93Q-936	
120 (50/60 CY.)	1400	1PDT	93-907	93-937	*93-967	93P-907	93P-937	93Q-907	93Q-937	
		2PDT	93-908	93-938	*93-968	93P-908	93P-938	93Q-908	93Q-938	
		3PDT	93-909	93-939	*93-969	93P-909	93P-939	93Q-909	93Q-939	
208/240 (50/60 CY.)	4850	1PDT	93-910	93-940	—	93P-910	93P-940	93Q-910	93Q-940	
		2PDT	93-911	93-941	—	93P-911	93P-941	93Q-911	93Q-941	
		3PDT	93-912	93-942	—	93P-912	93P-942	93Q-912	93Q-942	
6 D.C.	24	1PDT	93-913	93-943	—	93P-913	93P-943	93Q-913	93Q-943	
		2PDT	93-914	93-944	—	93P-914	93P-944	93Q-914	93Q-944	
		3PDT	93-915	93-945	—	93P-915	93P-945	93Q-915	93Q-945	
12 D.C.	96	1PDT	93-916	93-946	*93-976	93P-916	93P-946	93Q-916	93Q-946	
		2PDT	93-917	93-947	*93-977	93P-917	93P-947	93Q-917	93Q-947	
		3PDT	93-918	93-948	*93-978	93P-918	93P-948	93Q-918	93Q-948	
24 D.C.	384	1PDT	93-919	93-949	*93-979	93P-919	93P-949	93Q-919	93Q-949	
		2PDT	93-920	93-950	*93-980	93P-920	93P-950	93Q-920	93Q-950	
		3PDT	93-921	93-951	*93-981	93P-921	93P-951	93Q-921	93Q-951	
110 D.C.	8000	1PDT	93-922	93-952	—	93P-922	93P-952	93Q-922	93Q-952	
		2PDT	93-923	93-953	—	93P-923	93P-953	93Q-923	93Q-953	
		3PDT	93-924	93-954	—	93P-924	93P-954	93Q-924	93Q-954	

8 RBM CONTROLS

A.C. GENERAL PURPOSE RELAYS

TYPE 987

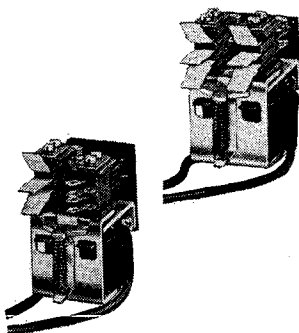

SIZE 2 1/8" x 1" x 2"

- 9" Leadwire Coil
-
- Front or Rear Mounting
-
- Hardware Included
-
- Quick Connect Terminals on 15 Amp Poles
-
- Solder Terminals on 3 Amp Poles

TWO POLE and THREE POLE DOUBLE THROW

Coil Voltage 60 cy.	Contact Form	Catalog Number	Contact Rating — Non-Inductive 125/250 V.A.C.	
			Left Stack	Right Stack
24	2PDT	987-902	SPDT - 15 AMP.	SPDT - 3 AMP.
120	2PDT	987-903		
240	2PDT	987-904		
24	2PDT	987-906	SPDT - 15 AMP.	SPDT - 15 AMP.
120	2PDT	987-907		
240	2PDT	987-908		
24	3PDT	987-910	SPDT - 15 AMP.	2PDT - 3 AMP.
120	3PDT	987-911		
240	3PDT	987-912		

A.C. POWER RELAYS

TYPE 129

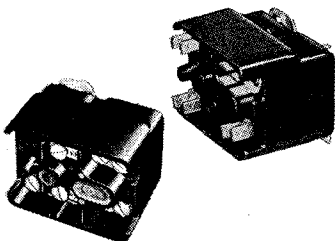

FIGURE 1 FIGURE 2

SIZE 2 3/8" x 1 7/8" x 1 7/8"

- Double-Break Contacts
-
- Totally Enclosed
-
- Screw or 1/4" Quick Connect Termination
-
- Hardware Included
-
- Non-Positional

SINGLE POLE NORMALLY OPEN and SINGLE POLE DOUBLE THROW

Coil Voltage (50/60 cy.)	Catalog Number				Contact Rating 250 V.A.C. Max.	
	Figure 1		Figure 2		Inductive	Resistive
	1PNO	†1PDT	1PNO	†1PDT		
6	129-901	129-905	—	—	18 Amp. Continuous 1 H.P.-125 V. 2 H.P.-250 V.	18 Amp. Continuous
24	129-902	129-906	129-911	129-914		
120	129-903	129-907	129-912	129-915		
208/230	129-904	129-908	129-913	129-916		

† All contact terminals must be wired same polarity.

TYPE 129AR

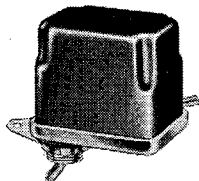

SIZE 2 3/4" x 2 5/8" x 3 1/2"

- Totally Enclosed
-
- Double-Break Contacts
-
- Easy to Mount
-
- Pre-Wired
-
- No Enclosure Required
-
- Low Cost

SINGLE POLE NORMALLY OPEN and SINGLE POLE DOUBLE THROW

Coil Voltage (50/60 cy.)	Catalog Number		Contact Rating — 250 V.A.C. Max.	
	1PNO	†1PDT	Inductive	Resistive
24	129AR-901	129AR-904	18 Amp. Continuous 1 H.P.-120 V. 2 H.P.-250 V.	18 Amp. Continuous
120	129AR-902	129AR-905		
208/230	129AR-903	129AR-906		

FITS ANY 1/2" KNOCK-OUT. MEETS STANDARD CODE REQUIREMENTS. Underwriters Lab. white card listed. File E12139D 184N13.13 7/17/63. Aluminum die-cast base and bushing. High impact phenolic enclosure. Locknuts and position locking washer included. Color coded 8" lead wires.

† All contact terminals must be wired same polarity.

A.C. POWER CONTACTORS

TYPE 143

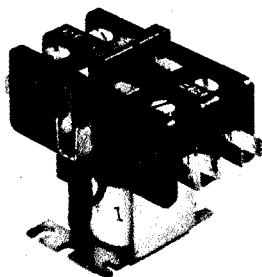

SIZE 3 1/4" x 2 3/8" x 2 1/2"

- Straight-Through Wiring
-
- Auxiliary Quick-Connect Terminals
-
- Hardware Included
-
- Screw Power Terminals For #10 Solid Wire Max.
-
- Double Break Contacts

TWO POLE NORMALLY OPEN

Coil Voltage (50/60 cy.)	Catalog Number	Contact Rating	
		Inductive	Resistive
24	143-901	18 Amp. Continuous 90 Amp Inrush @ 250 V.A.C. Inductive Only	
120	143-902		
208/240	143-903		
24	143-911		25 Amp. @ 277 V.A.C. Resistive Only
120	143-912		
208/240	143-913		

10 RBM CONTROLS

A.C. INDUSTRIAL CONTACTORS

UNIQUE DESIGN PERMITS COMMON BASE, COIL & MAGNET FOR CONTACTOR RATINGS FROM 10 TO 50 AMPERES • DOUBLE BREAK "NO-KISS" CONTACT ACTION • REPLACEABLE CONTACTS & COIL • EPOXY SEALED MOLDED MAGNET COIL HOUSING • LAMINATED CORROSION RESISTANT E-TYPE MAGNET & SELF-ALIGNING ARMATURE • HI-DIELECTRIC ARC RESISTANT MOLDED CONTACT BLOCK & CARRIER • 50/60 CYCLE MAGNET COIL • RESILIENT MOUNTING

TYPE C10



SIZE 3 5/8" x 2 3/4" x 3 3/8"

10 Amp.
600 Volts

•
Pressure Type
Power Terminals
#10 Solid Wire Max.

•
All Contacts
Convert to N.C.
See Page 11

•
Double Break
Contacts

FOUR POLE NORMALLY OPEN

Coil Voltage (50/60 cy.)	Catalog Number	Contact Rating (A.C.)		
		Horsepower		
		Voltage	Single Phase	Three Phase
24	C10-901	120	1/2	3/4
		208/240	3/4	1
110	C10-902	600	1	1
220	C10-903	Resistive		
		10 Amp. 600 V. Max. (Per Pole)		

TYPE C15



SIZE 3 5/8" x 2 3/4" x 3 3/8"

15 Amp.
600 Volts

•
Pressure Type
Power Terminals
#10 Solid Wire Max.

•
All Contacts
Convert to N.C.
See Page 11

•
Double Break
Contacts

FOUR POLE NORMALLY OPEN

Coil Voltage (50/60 cy.)	Catalog Number	Contact Rating (A.C.)		
		Horsepower		
		Voltage	Single Phase	Three Phase
24	C15-901	120	1	1 1/2
		208/240	1 1/2	2
110	C15-902	600	1 1/2	2
220	C15-903	Resistive		
		15 Amp. 600 V. Max. (Per Pole)		

TYPE C30



SIZE 3 5/8" x 2 3/4" x 3 3/8"

30 Amp.
600 Volts

•
Pressure Type
Power Terminals
#8 Solid Wire Max.

•
SPNO Auxiliary
Converts to N.C.
See Page 11

•
Double Break
Contacts

THREE POLE NORMALLY OPEN

Coil Voltage (50/60 cy.)	Catalog Number	Contact Rating (A.C.)		
		Horsepower		
		Voltage	Single Phase	Three Phase
24	C30-901	120	2	3
		208/240	3	7 1/2
110	C30-902	600	5	10
220	C30-903	Resistive		
		30 Amp. — 600 V. (Per Pole)		

TYPE C50R



SIZE 3 5/8" x 2 3/4" x 3 3/8"

50 Amp.
480 Volts

•
Pressure Type
Power Terminals
#6 Stranded Wire
Max.

•
Double Break
Contacts

FOUR POLE NORMALLY OPEN

Coil Voltage (50/60 cy.)	Catalog Number	Contact Rating (A.C.)
24	C50R-901	Resistive Only For Electric Heating 50 Amp. — 480 Volt Max.
110	C50R-902	
220	C50R-903	

TYPE 59

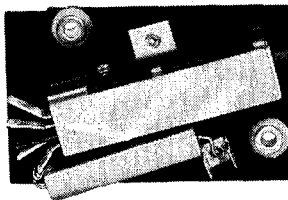

SIZE 3 3/8" x 2 1/8" x 7/8"

- Thermal Type
-
- Fixed Timing
-
- Ambient Compensated
-
- 1/4" Quick-Connect Termination
-
- Wiring Terminals Included
-
- Resilient Mounting
-
- Non-Positional Reset Time Approx. 60 Sec.

SINGLE POLE NORMALLY OPEN

TIME DELAY TO CLOSE — AFTER ENERGIZATION — 15 TO 45 SECS.

Operating		Catalog Number	Contact Rating
Voltage (50/60 cy.)	Watts		
24	3.0	59-901	3 Amp. 125/250 V.A.C. Pilot Duty
115/120	7.0	59-902	
230/240	10.0	59-903	

SINGLE POLE NORMALLY CLOSED

TIME DELAY TO OPEN — AFTER ENERGIZATION — APPROX. 30 SECS.

24	3.0	59-904	3 Amp. 125/250 V.A.C. Pilot Duty
115/120	7.0	59-905	
230/240	10/0	59-906	

TYPE 84T

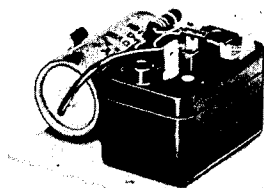

SIZE 2 5/8" x 2 1/4" x 1 1/2"

- Rectifier/ Capacitor Type
-
- Fixed Timing
-
- 1/4" Quick-Connect Termination
-
- Wiring Terminals Included
-
- Totally Enclosed
-
- Approx. Reset Time 4 Seconds

SINGLE POLE DOUBLE THROW

Coil (50/60 cy.)	Contact Action		Catalog Number	Time Delay in Seconds ±25%	Contact Rating (A.C.) Inductive
	Delay After Coil Energized	Delay After Coil De-Energized			
115/120	X	—	84TE-902	2	3 Amp. 125 V. 1.5 Amp. 250 V. Continuous
230/240	X	—	84TE-903	2	
115/120	—	X	84TD-902	2	
230/240	—	X	84TD-903	2	

TYPE 129T

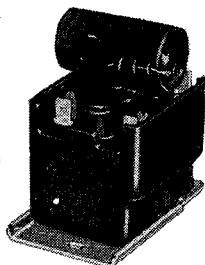

SIZE 3 1/8" x 2" x 3"

- Rectifier/ Capacitor Type
-
- Fixed Timing
-
- 1/4" Quick-Connect Termination
-
- Wiring Terminals Included
-
- Totally Enclosed
-
- Double Break Contacts

SINGLE POLE NORMALLY OPEN

TIME DELAY TO OPEN — AFTER DE-ENERGIZATION — 2 seconds ±25%.

Coil Voltage (50/60 cy.)	Catalog Number	Contact Rating — 250 V.A.C. Max.	
		Inductive	Resistive
115/120	129TD-901	18 Amp. Continuous 1 H.P. — 125 V. 2 H.P. — 250 V.	18 Amp. Continuous
230/240	129TD-902		

TYPE 60

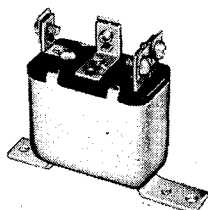

SIZE 2 7/8" x 1 1/8" x 2 5/8"

- Metal Case
-
- Totally Enclosed
-
- Isolated Coil
-
- Screw Terminals
-
- Screws Included
-
- Low Cost

SINGLE POLE NORMALLY OPEN

Coil Voltage (D.C.)	Resistance In Ohms @ 25°C	Catalog Number	Contact Rating D.C.	
			Inductive	
			Voltage	Current
6	11	60-901	6	15 Amp.
12	35	60-902	12	15 Amp.
24	160	60-903	24	7.5 Amp.

SINGLE POLE DOUBLE THROW — TWO POLE DOUBLE THROW — THREE POLE DOUBLE THROW

Electrical Life			Mechanical Life	Operate Time (Incl. Bounce)	Vibration	Shock	Operating Ambient	
NON-INDUCTIVE LOAD	0.5 Amp.	1.0 Amp.	2.0 Amp.	100,000,000 At 180 Operations Per Minute (No Load)	20 Milliseconds	2G 10-55 Cycles	2G Operate 10G Non-Operate	-55°C to +85°C
NUMBER OPERATIONS	1,000,000	300,000	100,000					

TYPE MS40

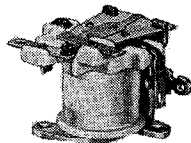

SIZE 1 1/8" x 1 1/8" x 1 3/8"

- Solder Terminals
-
- 4-40 Mounting
-
- Armature Common to Frame
-
- Long Life
-
- Low Cost

SINGLE POLE DOUBLE THROW — OPEN TYPE

Contact Rating		Coil Power	
2 Amp. Non-Inductive 28 V.D.C. — 115 V.A.C.		Minimum Required	0.050 Watts
		Maximum Capacity	1.0 Watts
D.C. Magnet Coil At 25°C			
Nominal Voltage or Current	*Max. Pick-up Voltage or Current	†Resistance in Ohms	Catalog Number
18.7 MA.	14 MA.	250	MS40-901
13.5 MA.	10 MA.	500	MS40-902
11.0 MA.	8.2 MA.	750	MS40-903
9.3 MA.	7 MA.	1000	MS40-904
7.7 MA.	5.8 MA.	1500	MS40-905
6.0 MA.	4.5 MA.	2500	MS40-906
4.3 MA.	3.2 MA.	5000	MS40-907
3.5 MA.	2.6 MA.	7500	MS40-908
2.9 MA.	2.2 MA.	10000	MS40-909

*D.O. Approx. 35% of P.U. †Nominal ±10%.

TYPE MS64

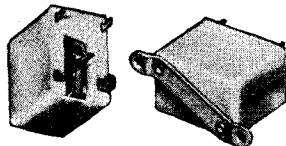

FIG. 1 FIG. 2
SIZE 1 3/8" x 3/4" x 1 1/8"

- Printed Circuit Terminals or Bracket Mounting
-
- Isolated Contacts
-
- Snap-on Cover
-
- Molded Construction

SINGLE POLE DOUBLE THROW — ENCLOSED TYPE

Contact Rating		Coil Power	
2 Amp. Non-Inductive 28 V.D.C. — 115 V.A.C.		Minimum Required	0.050 Watts
		Maximum Capacity	1.0 Watts
D.C. Magnet At 25°C			
Nominal Voltage or Current	*Max. Pick-up Voltage or Current	†Resistance in Ohms	Catalog Number Fig. 1
6 V.	4.5 V.	400	MS64-901
12 V.	9.0 V.	1600	MS64-902
24 V.	18.0 V.	6500	MS64-903
3. MA.	2.3 MA.	10000	MS64-904

*D.O. Approx. 35% of P.U. †Nominal ±10%.

TYPE MS25

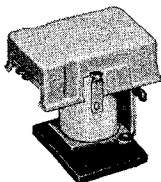

SIZE 1 3/8" x 1 1/2" x 1 3/8"

- Solder Terminals
-
- Isolated Contacts
-
- Protective Contact Cover
-
- Insulating Fiber Base

SINGLE POLE DOUBLE THROW — OPEN TYPE

Contact Rating		Coil Power	
2 Amp. Non-Inductive 28 V.D.C. — 115 V.A.C.		Minimum Required	0.040 Watts
		Maximum Capacity	1.5 Watts
D.C. Magnet Coil At 25°C			
Nominal Voltage or Current	*Max. Pick-up Voltage or Current	†Resistance in Ohms	Catalog Number
6 V.	4.5 V.	510	MS25-901
12 V.	9.0 V.	2025	MS25-902
24 V.	18.0 V.	8100	MS25-903
3.7 MA.	2.8 MA.	5000	MS25-904
2.7 MA.	2.0 MA.	10000	MS25-905
2.1 MA.	1.6 MA.	15000	MS25-906

*D.O. Approx. 35% of P.U. †Nominal ±10%.

TYPE MS25P

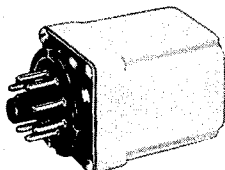

SIZE 2" x 1 3/8" x 1 3/8"

- 8 Pin Plug-In
-
- Isolated Contacts
-
- High Impact Case

SINGLE POLE DOUBLE THROW — PLUG-IN

D.C. Magnet Coil At 25°C			
Nominal Voltage or Current	*Max. Pick-up Voltage or Current	†Resistance in Ohms	Catalog Number
6 V.	4.5 V.	510	MS25P-901
12 V.	9.0 V.	2025	MS25P-902
24 V.	18.0 V.	8100	MS25P-903
3.7 MA.	2.8 MA.	5000	MS25P-904
2.7 MA.	2.0 MA.	10000	MS25P-905
2.1 MA.	1.6 MA.	15000	MS25P-906

*D.O. Approx. 35% of P.U. †Nominal ±10%.

BRM-902
MINIATURE



BRS-901
STANDARD



TRM-901
MINIATURE



Contact Form		Single Pole Normally Open						Single Pole Double Throw			
Miniature or Standard		Miniature BRM-902			Standard BRS-901			Miniature TRM-901			
Catalog Number											
Non-Inductive Contact Rating	Make and Break	15 VA. A.C. — 5 Watts D.C. ¼ Amp. Maximum up to 250 Volts			15 VA. A.C. — 15 Watts D.C. 1.0 Amp. Maximum up to 250 Volts			15 VA. A.C. — 5 Watts D.C. ¼ Amp. Maximum up to 125 V. A.C. or 32 V. D.C.			
	No Make or Break	1.0 Amp. 250 V.			5 Amp. 250 V.			1 Amp. 125 V. A.C. or 32 V. D.C.			
Contact Life Based on 10 Ohm Miss Test	Resistive Load (D.C.)	10 Micro-Amp. @ 10 Milli-Volts	½ Amp. @ 32 Volts	10 Micro-Amp. @ 10 Milli-Volts	½ Amp. @ 32 Volts	10 Micro-Amp. @ 10 Milli-Volts	½ Amp. @ 32 Volts	10 Micro-Amp. @ 10 Milli-Volts	½ Amp. @ 32 Volts		
	Number Operations	100,000,000	10,000,000	200,000,000	125,000,000	100,000,000	10,000,000	100,000,000	10,000,000		
Approximate Overall Dimensions		Over Leads	Glass Length	Glass Diameter	Over Leads	Glass Length	Glass Diameter	Over Leads	Glass Length	Glass Diameter	
Weight		1.5"	0.75"	0.100"	3.2"	2.1"	0.200"	1.5"	0.60"	0.125"	
Minimum Breakdown Voltage (60 cy. R.M.S.)		250 V.			500 V.			250 V.			
Minimum Insulation Resistance (Megohms)		500 K.			500 K.			100 K.			
Initial Contact Resistance (Milliohms Max.)		150			50			150			
Maximum Operate Time (Milliseconds)		Pull-In (Including Bounce)		Release	Pull-In (Including Bounce)		Release	Pull-In (Including Bounce)		Release	
Ampere-Turns To Operate		1.0		0.5	2.0		0.5	1.0		0.5	
Nominal Coil Power		0.335 Watts		0.360 Watts		0.335 Watts		0.335 Watts		0.335 Watts	
Vibration		15G — 2000 C.P.S.		20G — 750 C.P.S.		15G — 2000 C.P.S.		15G — 2000 C.P.S.		15G — 2000 C.P.S.	
Shock (JAN S-44)		50G (Min.)		40G (Min.)		50G (Min.)		50G (Min.)		50G (Min.)	
Ambient Temperature Range		-55° to +85°C		-55° to +85°C		-55° to +85°C		-55° to +85°C		-55° to +85°C	
Standard Test Coil Specifications Available	Wire Size	#44		#36		#44		#44		#44	
	Number Turns	10,000		10,000		10,000		10,000		10,000	
	Tube I.D.	0.150"		0.210"		0.150"		0.200"		0.150"	
	Tube O.D.	0.200"		0.375"		0.200"		0.200"		0.200"	
	Tube Length	0.75"		1.75"		0.75"		0.75"		0.75"	

MINIATURE D.C. GLASS REED RELAYS

TYPE BRMR
MINIATURE

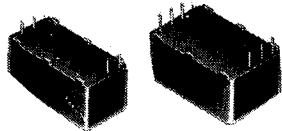

FIGURE 1
FIGURE 2
SIZE Fig. 1 - 1 1/4" x 3/16" x 3/64"
SIZE Fig. 2 - 1 1/4" x 3/16" x 3/64"
PLUS LEADS

See BRM-902 For Contact Rating

Operate Time 1 M.S. Including Bounce

Release Time 0.5 M.S. Max.

Magnetically Shielded

Coil Power	Nominal Voltage	Max. Pick-up Voltage	Minimum Drop-out Voltage	Max. Pick-up Current	Resistance in Ohms ±10%	Catalog Number
SINGLE POLE NORMALLY OPEN — Figure 1						
1.0 Watts Max. @ 25°C	6 V.	3.25 V.	0.8 V.	27.0 MA.	105	BRMR1-901
	12 V.	6.5 V.	1.0 V.	15.5 MA.	420	BRMR1-902
	28 V.	15.2 V.	2.5 V.	6.5 MA.	2350	BRMR1-903
TWO POLE NORMALLY OPEN — Figure 2						
1.5 Watts Max. @ 25°C	6 V.	3.25 V.	0.8 V.	46.5 MA.	70	BRMR2-901
	12 V.	6.5 V.	1.0 V.	25.2 MA.	280	BRMR2-902
	28 V.	15.2 V.	2.5 V.	9.8 MA.	1540	BRMR2-903

TYPE TRMR
MINIATURE

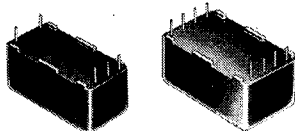

FIGURE 1
FIGURE 2
SIZE Fig. 1 - 1 1/4" x 3/16" x 3/64"
SIZE Fig. 2 - 1 1/4" x 3/16" x 3/64"
PLUS LEADS

See TRM-901 For Contact Rating

Operate Time 1 M.S. Including Bounce

Release Time 0.5 M.S. Max.

Shielded

Coil Power	Nominal Voltage	Max. Pick-up Voltage	Minimum Drop-out Voltage	Max. Pick-up Current	Resistance in Ohms ±10%	Catalog Number
TRUE FORM — SINGLE POLE DOUBLE THROW — Figure 1						
1.0 Watts Max. @ 25°C	6 V.	4 V.	1.5 V.	42 MA.	105	TRMR1-901
	12 V.	8 V.	3 V.	21 MA.	420	TRMR1-902
	28 V.	19 V.	6 V.	8 MA.	2350	TRMR1-903
TRUE FORM — TWO POLE DOUBLE THROW — Figure 2						
1.5 Watts Max. @ 25°C	6 V.	4 V.	1.5 V.	64 MA.	70	TRMR2-901
	12 V.	8 V.	3 V.	32 MA.	280	TRMR2-902
	28 V.	19 V.	6 V.	12 MA.	1540	TRMR2-903

TYPE BRSR
STANDARD

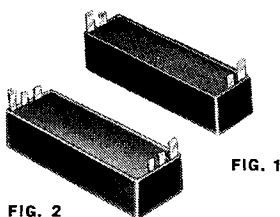

FIG. 1
FIG. 2
SIZE Fig. 1 - 2.55" x .675" x .625"
SIZE Fig. 2 - 2.55" x .925" x .625"

See BRS-901 For Contact Rating

Operate Time 2 M.S. Including Bounce

Release Time 0.5 M.S. Max.

Shielded

Coil Power	Nominal Voltage	Max. Pick-up Voltage	Minimum Drop-out Voltage	Max. Pick-up Current	Resistance in Ohms ±10%	Catalog Number
SINGLE POLE NORMALLY OPEN						
3.0 Watts Max. @ 25°C	6 V.	4.5 V.	0.55 V.	43.0 MA.	115	BRSR1-901
	12 V.	9.0 V.	1.10 V.	22.5 MA.	445	BRSR1-902
	28 V.	18.0 V.	2.50 V.	7.8 MA.	2550	BRSR1-903
TWO POLE NORMALLY OPEN						
3.2 Watts Max. @ 25°C	6 V.	4.5 V.	0.51 V.	86.5 MA.	58	BRSR2-901
	12 V.	9.0 V.	1.00 V.	45.0 MA.	220	BRSR2-902
	28 V.	18.0 V.	2.10 V.	13.3 MA.	1500	BRSR2-903

DIMENSIONS ARE APPROX. CONSULT FACTORY FOR EXACT DIMENSIONS.

*ASTERISK DENOTES BOTTOM VIEW—ALL OTHERS TOP VIEW

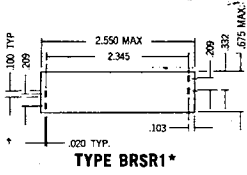

TYPE BRSR1*

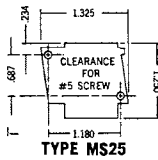

TYPE MS25

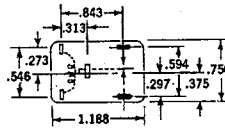

TYPE MS84
P.C. MTG.

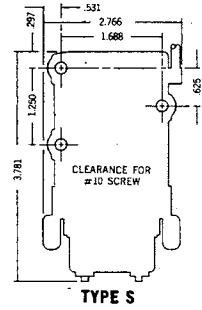

TYPE S

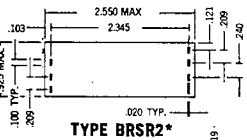

TYPE BRSR2*

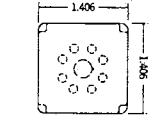

TYPE MS25P
TYPE MS50P (2 Pole)

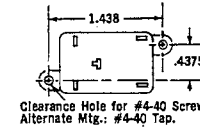

TYPE MS84
BRACKET MTG.

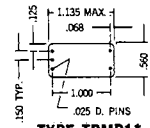

TYPE TRMR1*

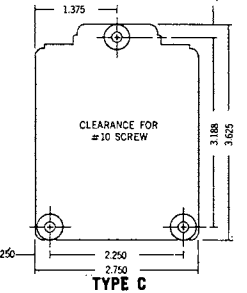

TYPE C

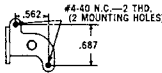

TYPE MS40



TYPE TRMR2*

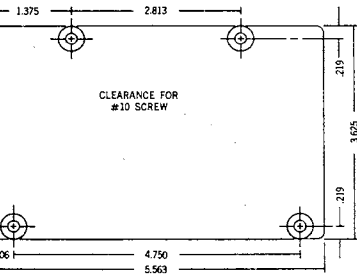

TYPE CR

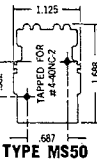

TYPE MS50

WIRING DIAGRAMS

TYPE 91 CONTACT TERMINAL ARRANGEMENT

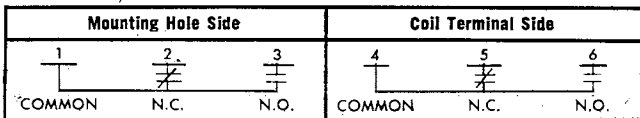

TYPE 92 CONTACT TERMINAL ARRANGEMENT

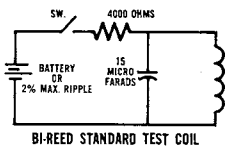
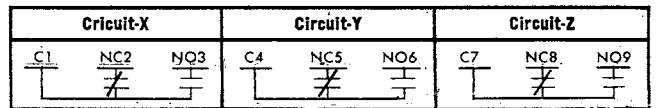

BI-REED STANDARD TEST COIL

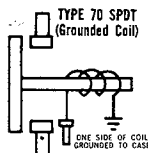

TYPE 70 SPDT
(Grounded Coil)

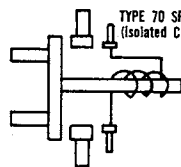

TYPE 70 SPDT
(Isolated Coil)

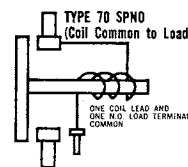

TYPE 70 SPNO
(Coil Common to Load)

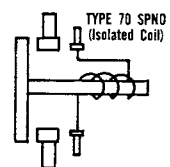

TYPE 70 SPNO
(Isolated Coil)

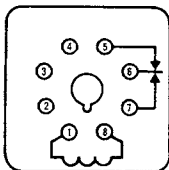

MS25P ONE POLE

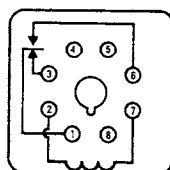

93P ONE POLE

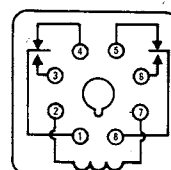

93P 2 POLE

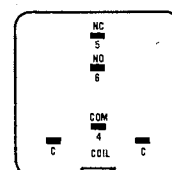

93Q ONE POLE

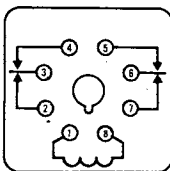

MSSOP 2 POLE

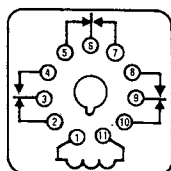

MSSOP 3 POLE

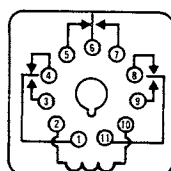

93P 3 POLE

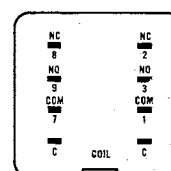

93Q 2 POLE

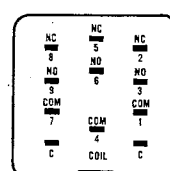

93Q 3 POLE



SCHRACK RELAYS

CAD SERIES

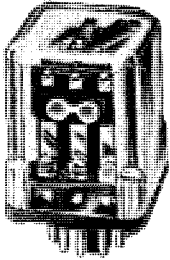

Contacts	10 Amp. Rating		
	SPDT	DPDT	3PDT
Relay Type	CAD5A10	CAD11A10	CAD14A10
6 volts a.c. 12 volts a.c. 24 volts a.c. 115 volts a.c.	\$4.95	\$5.55	\$6.75
230 volts a.c.	\$5.50	\$5.95	\$7.15
Relay Type	CAD5D10	CAD11D10	CAD14D10
6 volts d.c. 12 volts d.c. 24 volts d.c.	\$4.95	\$5.55	\$6.75
110 volts d.c.	\$5.50	\$5.95	\$7.15

5 AMP ALSO AVAILABLE

Same basic design as CA series; however, with clear plastic dust cover and octal-type plug-in base. Case is secured firmly to base by 4 "upset" plastic studs. Contact carrier plate is self-centering. Contact carrier is made of "KERIPOLE," a polyester material with glass fibre filling.

CSD SERIES

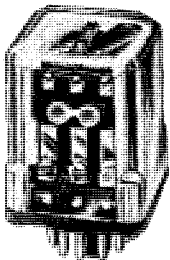

A plate circuit relay, similar to the CAD Type; however with increased sensitivity (125 MW per movable arm).

Contacts	SPDT	2 Amp. Rating	
		DPDT	3PDT
Relay Type	CSD5	CSD11	CSD14
2500 ohms	\$5.20	\$5.60	\$6.80
5000 ohms	\$5.30	\$5.70	\$6.90
10,000 ohms	\$5.70	\$6.10	\$7.30

SENSITIVE RELAY — CMD SERIES

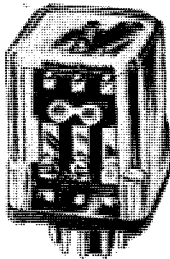

In this series there are eleven types in three classifications.

No.	Coil	List Price
CMD-5D	600Ω	\$4.95
CMD-5D	2400Ω	4.95
CMD-5D	9600Ω	5.20
CMD-11D	450Ω	6.10
CMD-11D	1890Ω	6.10
CMD-11D	7300Ω	6.10
CMD-5A	540Ω	5.00
CMD-5A	234Ω	4.75
CMD-5A	1000Ω	4.75
CMD-5A	3850Ω	4.75
CMD-5A	6900Ω	5.30

1. D.C. Relays with one form C contact Type CMD 5D—Pull-in sensitivity 40 mw; Coil Windings — 600 ohm, 2400 ohm, 9600 ohm
2. D.C. Relays with two form C contacts Type CMD 11D — Pull-in sensitivity 60 mw; Coil Windings — 450 ohm, 1890 ohm, 7300 ohm
3. A.C. Relays with one form C contact Type CMD 5A — Pull-in sensitivity 80 MVA; Coil Windings — 540 ohm, 234 ohm, 1000 ohm, 3850 ohm, and 6900 ohm

Contact ratings are 2 amps at 115 VAC.
Contact points are gold-flashed silver.

NEW MINIATURE UNIVERSAL TYPE RA

A precision piece of equipment at a commercial price —



1.515" high, 0.847" wide with dust cover

designed for use in computers, data processing equipment, communications equipment, process control applications, and other equally important systems.

Type RA is a four pole universal type relay for 4 PDT or double-make, double-break (DPDT-DB) action. $\frac{3}{32}$ " contacts rated at 3A — normally supplied in gold-flashed silver. Also available in silver, cadmium oxide, gold nickel, silver palladium, etc.

STANDARD COIL DATA

Sockets Available

DC Voltage	Resistance in Ohms $\pm 10\%$ at 25° C	List Prices	AC Voltage	Average AC current in MA (relay closed)	List Prices
6	40	\$3.50	6	200	\$4.10
12	160	3.50	12	100	4.10
24	650	3.50	24	52	4.10
48	2.600	4.20	48	25	4.80
90	9.000	4.20	115	10.5	4.80
110	11.000	4.20			

Printed Circuit Terminals at Same Prices

TYPE RR REMANENCE RELAYS

Magnetic Latching for miniaturized circuitry. Same physical characteristics as RA. Voltages from 24-220 AC and 12-110 DC. Same electrical characteristics as CRD and CRF on opposite page. Prices range from \$4.50-\$5.30 list.

ROTARY STEPPING SWITCH TYPE RT

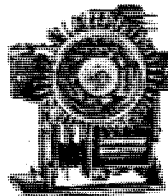

The SCHRACK Rotary Stepping Switch is a combination of three reliable components:

1. Standard Relay with 1 Form C heavy-duty contact.
2. Ratchet driven Rotary Switch consisting of four banks of twelve or ten points each with sliding bifurcated wipers.

3. Ratchet driven Stepping Relay with two cams which actuate one Form C contact each.

Schrack Rotary Stepping Switches have a highly efficient magnetic circuit and a driving mechanism designed for maximum operating safety. All components are mounted on a rigid die-cast light metal frame and contacts are permanently molded in a sturdy melamine plastic.

ROTARY SWITCH terminals are arranged in a circular pattern with four groups of twelve points each. A conversion can make it operate with 3 groups of 16 each. An alternate version with 4 x 10 points is available for applications requiring decimal counting. Each group occupies a quadrant of the circle and contains a common bus which is connected to the twelve or ten insulated points in sequence by means of a sliding wiper as the switch is operated.

TYPE RT 304 — 4 x 12 Contact Points \$19.00 ea.

TYPE RT 404 — 4 x 10 Contact Points \$19.00 ea.

SEND FOR DISCOUNT SCHEDULES

FOR FURTHER INFORMATION ASK FOR CATALOG

SCHRACK ELECTRICAL SALES CORPORATION

RELAYS

SIGMA RELAYS - GENERAL PURPOSE - SERIES 11 AC AND DC - SPDT

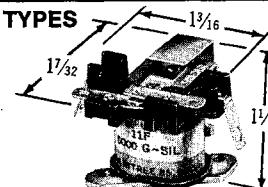
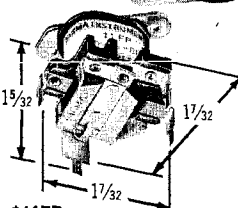
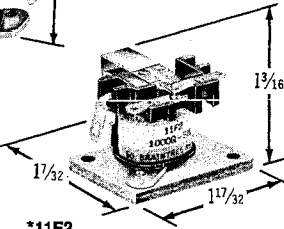
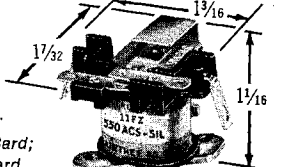

Exceptional among small, low-cost relays rated for 1-ampere switching. DC operation from sliding-current as well as on-off 50 milliwatt signals, plus an AC shaded-pole design operating from 0.3 volt-ampere on-off signals. Good environmental capability. Temperature range: -40 F to +122 F. UL- and CSA-listed.

DC TYPES	CATALOG NUMBER	COIL DATA			CONTACTS		PRICE	
		Nominal VDC	Resistance (ohms)	Pickup, Max (ma DC)	Pickup Power (mw)	Arrangement		Rating (amperes)
 <p>*11F Screw mounting (2 #4-40 spaced .898), 5 solder terminals, armature common to mounting bracket. Weight: 1 ounce.</p>  <p>*11FP Shoulder lug mounting, printed-circuit terminals. Weight: 1.1 ounces.</p>  <p>*11F2 Insulated base with clearance holes for screw mounting, 5 solder terminals. Weight: 1.2 ounces.</p>	11F - 100 G - SIL	—	100	22	50	SPDT	1	\$2.05
	11F - 250 G - SIL	6	250	14.0	↓	↓	↓	1.95
	11F - 550 G - SIL	—	550	9.5	↓	↓	↓	1.95
	11F - 1000 G - SIL	12	1000	7.0	↓	↓	↓	1.95
	11F - 1500 G - SIL	—	1500	5.8	↓	↓	↓	1.95
	11F - 2300 G - SIL	—	2300	4.6	↓	↓	↓	1.95
	11F - 6000 G - SIL	24	6000	2.9	↓	↓	↓	2.15
	11F - 9000 G - SIL	—	9000	2.4	↓	↓	↓	2.35
	11F2 - 1000 G - SIL	12	1000	7.0	50	SPDT	1	2.15
	11F2 - 2300 G - SIL	—	2300	4.6	↓	↓	↓	2.15
	11F2 - 6000 G - SIL	24	6000	2.9	↓	↓	↓	2.35
	11F2 - 9000 G - SIL	—	9000	2.4	↓	↓	↓	2.60
11FP - 1000 G - SIL	12	1000	7.0	50	SPDT	1	2.05	
11FP - 1500 G - SIL	—	1500	5.8	↓	↓	↓	2.15	
11FP - 2300 G - SIL	—	2300	4.6	↓	↓	↓	2.05	
11FP - 6000 G - SIL	24	6000	2.9	↓	↓	↓	2.35	
AC TYPES	CATALOG NUMBER	COIL DATA			CONTACTS		PRICE	
		Nominal VAC	Resistance (ohms)	Nominal Power (va)	Arrangement	Rating (amperes)		
 <p>*11FZ Screw mounting (2 #4-40 spaced .898), 5 solder terminals, armature common to mounting bracket. Weight: 1 ounce.</p> <p><i>*U.L. File No. E28610, Yellow Card; C.S.A. File No. 20954, White Card.</i></p>	11FZ - 25 ACS - SIL	6	25	.6	SPDT	1	\$3.05	
	11FZ - 550 ACS - SIL	24	550	↓	↓	↓	3.15	
	11FZ - 9000 ACS - SIL	115	9000	↓	↓	↓	3.60	

GENERAL PURPOSE - SERIES 50 AC AND DC - SPDT, DPDT, 3PDT

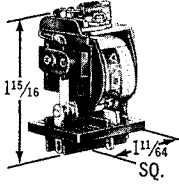
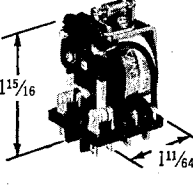
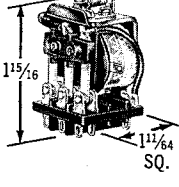

Highly efficient, compact, low-cost multipole relay for switching of industrial loads of 5 or 10 amperes to actuate small motors, solenoids, or other relays. 50ROL plug-in types incorporate an indicating lamp which lights when the coil is energized. 10-million-operation mechanical life. Temperature range: 50F: +14 F to +158 F; 50R0, 50ROL: To +131 F. UL- and CSA-listed.

DC TYPES	CATALOG NUMBER	COIL DATA			CONTACTS		PRICE
		Nominal VDC	Resistance (ohms)	Nominal Power (w)	Arrangement	Rating (amperes)	
 <p>*50F1 Screw mounting (1 #6-32 hole), 5 solder terminals. Weight: 2 ounces.</p>  <p>*50F2 Screw mounting (1 #6-32 hole), 8 solder terminals. Weight: 2 ounces.</p>  <p>*50F3 Screw mounting (1 #6-32 hole), 11 solder terminals. Weight: 2 ounces.</p> <p><i>*U.L. File No. E28610, Yellow Card; C.S.A. File No. 23903, White Card.</i></p>	50F1 - 6 DC	6	23.5	1.5	SPDT	5	\$3.05
	50F1 - 12 DC	12	95	↓	↓	↓	3.05
	50F1 - 24 DC	24	430	↓	↓	↓	3.05
	50F1 - 48 DC	48	1630	↓	↓	↓	3.05
	50F1 - 110 DC	110	10,000	↓	↓	↓	3.55
	50F1 - 6 DC - SCO	6	23.5	↓	↓	10	3.15
	50F1 - 12 DC - SCO	12	95	↓	↓	↓	3.15
	50F1 - 24 DC - SCO	24	430	↓	↓	↓	3.15
	50F1 - 48 DC - SCO	48	1630	↓	↓	↓	3.15
	50F1 - 110 DC - SCO	110	10,000	↓	↓	↓	3.65
	50F2 - 6 DC	6	23.5	1.5	DPDT	5	3.45
	50F2 - 12 DC	12	95	↓	↓	↓	3.45
	50F2 - 24 DC	24	430	↓	↓	↓	3.45
	50F2 - 48 DC	48	1630	↓	↓	↓	3.45
	50F2 - 110 DC	110	10,000	↓	↓	↓	3.90
50F2 - 6 DC - SCO	6	23.5	↓	↓	10	3.60	
50F2 - 12 DC - SCO	12	95	↓	↓	↓	3.60	
50F2 - 24 DC - SCO	24	430	↓	↓	↓	3.60	
50F2 - 48 DC - SCO	48	1630	↓	↓	↓	3.60	
50F2 - 110 DC - SCO	110	10,000	↓	↓	↓	4.05	
50F3 - 6 DC	6	23.5	1.5	3PDT	5	3.85	
50F3 - 12 DC	12	95	↓	↓	↓	3.85	
50F3 - 24 DC	24	430	↓	↓	↓	3.85	
50F3 - 48 DC	48	1630	↓	↓	↓	3.85	
50F3 - 110 DC	110	10,000	↓	↓	↓	4.35	
50F3 - 6 DC - SCO	6	23.5	↓	↓	10	4.05	
50F3 - 12 DC - SCO	12	95	↓	↓	↓	4.05	

SIGMA SIGMA INSTRUMENTS, INC.

SIGMA RELAYS - SERIES 50 - SPDT, DPDT, 3PDT



AC TYPES (continued)

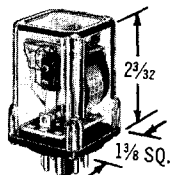

***50RO1, *50RO2, *50ROL2**
Polycarbonate dust cover,
8-pin plug; 50ROL2, with
indicating lamp.

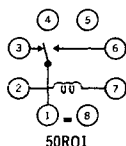

50RO1

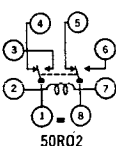

50RO2

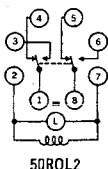

50ROL2

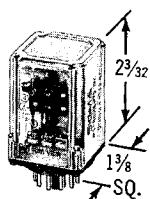

***50RO3, *50ROL3**
Polycarbonate dust cover,
11-pin plug; 50ROL3, with
indicating lamp.

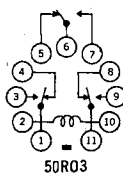

50RO3

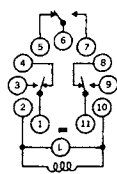

50ROL3

*U.L. File No. E28610, Yellow Card; C.S.A. File No. 23903, White Card.

CATALOG NUMBER	COIL DATA			CONTACTS		PRICE								
	Nomi-nal VAC	Resist-ance (ohms)	Nomi-nal Power (va)	Arrange-ment	Rating (amperes)									
50RO1 - 6 AC	6	5.8	2.2	SPDT	5	\$4.80								
50RO1 - 12 AC	12	23.5	↓			↓	4.80							
50RO1 - 24 AC	24	95					↓	↓	4.80					
50RO1 - 115 AC	115	2300							↓	↓	5.15			
50RO1 - 230 AC	230	7500									↓	↓	4.90	
50RO1 - 6 AC - SCO	6	5.8											↓	10
50RO1 - 12 AC - SCO	12	23.5			↓									
50RO1 - 24 AC - SCO	24	95	↓			↓								
50RO1 - 115 AC - SCO	115	2300					↓	↓						
50RO1 - 230 AC - SCO	230	7500							↓	↓				
50RO2 - 6 AC	6	5.8									DPDT	5		
50RO2 - 12 AC	12	23.5											↓	↓
50RO2 - 24 AC	24	95		↓	↓									
50RO2 - 115 AC	115	2300	↓			↓								
50RO2 - 230 AC	230	7500					↓	↓						
50RO2 - 6 AC - SCO	6	5.8							↓	10				
50RO2 - 12 AC - SCO	12	23.5										↓		
50RO2 - 24 AC - SCO	24	95											↓	↓
50RO2 - 115 AC - SCO	115	2300		↓	↓									
50RO2 - 230 AC - SCO	115	2300	↓			↓								
50RO2 - 230 AC - SCO	230	7500					↓	↓						
50RO3 - 6 AC	6	5.8							3PDT	5				
50RO3 - 12 AC	12	23.5									↓	↓		
50RO3 - 24 AC	24	95											↓	↓
50RO3 - 115 AC	115	2300		↓	↓									
50RO3 - 230 AC	230	7500	↓			↓								
50RO3 - 6 AC - SCO	6	5.8					↓	10						
50RO3 - 12 AC - SCO	12	23.5								↓				
50RO3 - 24 AC - SCO	24	95									↓	↓		
50RO3 - 115 AC - SCO	115	2300											↓	↓
50RO3 - 230 AC - SCO	115	2300		↓	↓									
50RO3 - 230 AC - SCO	230	7500	↓			↓								

GENERAL PURPOSE - SERIES 59^{DC} - SPDT



Dependable, low-cost, snap-action relay for commercial applications where economy and size determine choice. The snap switch that serves as the contact assembly provides positive operation whether input signal changes slowly or abruptly. Pin-hinge armature construction for one-million-operation mechanical life. Temperature range: +14 to +158 F. UL- and CSA-listed.

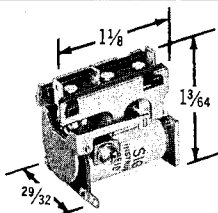

***59F1D** Screw mounting (2 #3-48 holes spaced .394), 5 solder terminals. Weight: 0.8 ounce.

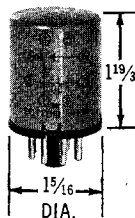

***59AO1D** Painted metal dust cover, 8-pin plug. Weight: 1.5 ounces.

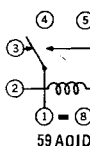

59AO1D

*U.L. File No. E28610, Yellow Card; C.S.A. File No. 23903, White Card.

CATALOG NUMBER	COIL DATA			CONTACTS		PRICE		
	Nomi-nal VDC	Resist-ance (ohms)	Nomi-nal Power (mw)	Arrange-ment	Rating (amperes)			
59F1D - 6 DC	6	120	300	SPDT	2	\$2.05		
59F1D - 12 DC	12	465	↓			↓	2.05	
59F1D - 24 DC	24	1800					↓	↓
59AO1D - 6 DC	6	120		300	SPDT			
59AO1D - 12 DC	12	465	↓	↓		3.55		
59AO1D - 24 DC	24	1800				↓	↓	3.55

GENERAL PURPOSE - SERIES 62^{DC} - DPDT, 4PDT, 6PDT



Miniature industrial relay for economical low-level to 5-ampere multiple-circuit switching. Choice of voltage adjustment and either bifurcated or standard contacts, or sensitive current adjustment. Voltage-adjusted types with bifurcated contacts rated for ten million operations switching dry-circuit to maximum loads from low-power transistor drive and with minimum coil heating. Standard gold-plated silver contacts rated for one million operations and gold-plated silver-cadmium-oxide contacts 100,000 operations, both at maximum load. Sensitive types rated for one million operations at maximum load. Mechanical life all types, 100 million operations. Choice of solder- or printed-circuit terminal sockets designed for fast, easy connection. Ideal for communications and data-processing equipment, measuring instruments, process controls, recording devices, alarm systems. Interchangeable with similar commercial relays. Temperature range: +14 F to +158 F. UL- and CSA-listed.

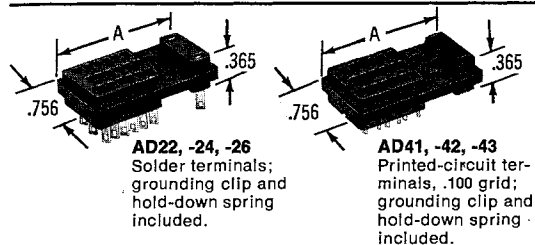

Socket	Dim. A.
AD22, AD41	.944
AD24, AD42	1.172
AD26, AD43	1.378

SOCKETS		
CATALOG NUMBER		PRICE
Socket Assembly AD22	2-pole	.55
Socket Assembly AD24	4-pole	.65
Socket Assembly AD26	6-pole	.95
Socket Assembly AD41	2-pole	.55
Socket Assembly AD42	4-pole	.65
Socket Assembly AD43	6-pole	.95

GENERAL PURPOSE - SERIES 63 DC - DPDT, 4PDT

Compact, telephone-type relay for reliable, minimum-distortion switching of low-level audio signals and for use in logic circuitry. Good sensitivity, low and stable contact resistance, 10-million-operation mechanical life. Temperature range: +14 F to +158 F.

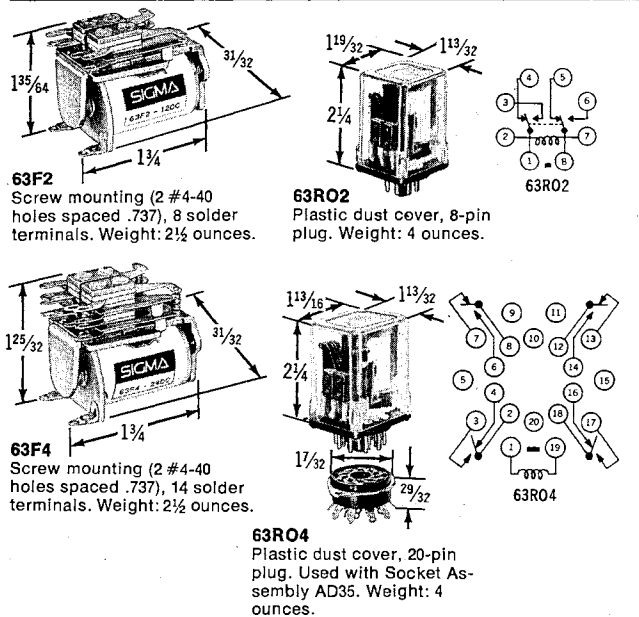

CATALOG NUMBER	COIL DATA			CONTACTS		PRICE
	Nominal VDC	Resistance (ohms)	Nominal Power (mw)	Arrangement	Rating (amperes)	
63F2 - 6 DC	6	50	720	DPDT	2	\$5.10
63F2 - 12 DC	12	200	↓			5.10
63F2 - 24 DC	24	800	↓			5.10
63F2 - 48 DC	48	3200	↓			5.10
63R02 - 6 DC	6	50	720	DPDT	2	8.20
63R02 - 12 DC	12	200	↓			8.20
63R02 - 24 DC	24	800	↓			8.20
63R02 - 48 DC	48	3200	↓			8.20
63F4 - 6 DC	6	50	720	4PDT	2	7.10
63F4 - 12 DC	12	200	↓			7.10
63F4 - 24 DC	24	800	↓			7.10
63F4 - 48 DC	48	3200	↓			7.10
63R04 - 6 DC	6	50	720	4PDT	2	10.60
63R04 - 12 DC	12	200	↓			10.60
63R04 - 24 DC	24	800	↓			10.60
63R04 - 48 DC	48	3200	↓			10.60
Socket AD35	For use with Type 63R04 relays					.50

GENERAL PURPOSE - SERIES 65 DC - SPDT

For commercial applications requiring a small, low-cost relay capable of positive response to low-power signals. Excellent adjustment stability, sturdy construction, 5-million-operation mechanical life. An economical choice for such applications as remote TV channel selectors, vending machines, semiautomatic home slide projectors, automatic toys and games. Temperature range: +14 F to +158 F.

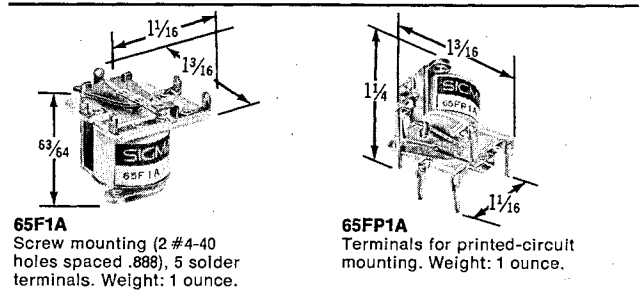

CATALOG NUMBER	COIL DATA			CONTACTS		PRICE
	Nominal VDC	Resistance (ohms)	Nominal Power (mw)	Arrangement	Rating (amperes)	
65F1A - 6 DC	6	410	90	SPDT	1	\$1.50
65F1A - 12 DC	12	1640	↓			1.50
65F1A - 24 DC	24	6560	↓			1.50
65FP1A - 6 DC	6	410	90	SPDT	1	1.60
65FP1A - 12 DC	12	1640	↓			1.60
65FP1A - 24 DC	24	6560	↓			1.60

GENERAL PURPOSE - SERIES 67 AC AND DC - 4PDT

Miniature, rugged relay. Switches low-level to 3-ampere loads from 1.2 volt-ampere or 900-milliwatt signals. 100,000 operations minimum at rated load. 100 million mechanical operations DC types; 50 million AC types. Solder- or printed-circuit-terminal sockets for fast chassis top mounting and easy wiring. Relay and sockets interchangeable with comparable types. For computers, data-handling equipment, process control, other demanding applications. Temperature range: -4 F to +140 F. UL- and CSA-listed.



SIGMA RELAYS-SERIES 68 - SPDT, DPDT, 3PDT (continued)



CATALOG NUMBER	COIL DATA				CONTACTS		PRICE
	Nominal VAC	Resistance (ohms)	Pickup, Max (VAC)	Nominal Power (va)	Arrangement	Rating (amperes)	
AC TYPES							
68R34 - 24 AC - SCO	24	74	20.4	2.5	3PDT	10	4.40
68R34 - 115 AC - SCO	115	2000	98	↓	↓	↓	4.40
68R34 - 230 AC - SCO	230	7500	196	↓	↓	↓	4.80
Socket AD40	Fits all except flange-mounted 68R34 types.						.70
Socket AD51	Fits all except flange-mounted 68R34 types.						.80

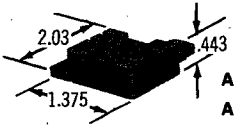

SENSITIVE - SERIES 4 DC - SPDT



A precise, versatile relay for applications requiring low power, stable trip values, and high dropout. Excellent repeatability over 100,000-operation rated life. Mechanical life eight million operations minimum. Responds to gradually changing or on-off signals. Useful where coil remains partially energized when relay is in deenergized condition, as in transistor circuits with high idle current. Ideal for vacuum-tube plate circuits, smoke detection controls and alarm systems in which the relay must trip under alarm conditions but not under supervisory conditions. Temperature range: +32 F to +122 F. UL-listed for use in burglary protection equipment.

CATALOG NUMBER	COIL DATA				CONTACTS		PRICE
	Resistance (ohms)	Pickup, Max (ma DC)	Dropout, Min (ma DC)	Pickup Power (mw)	Arrangement	Rating (amperes)	
4F - 1000 S - SIL	1000	4.5	2.0	20	SPDT	2	\$6.50
4F - 2500 S - SIL	2500	3.0	1.3	↓	↓	↓	6.50
4F - 5000 S - SIL	5000	2.0	.90	↓	↓	↓	6.85
4F - 8000 S - SIL	8000	1.6	.75	↓	↓	↓	7.10
4F - 10,000 S - SIL	10,000	1.4	.65	↓	↓	↓	7.10
4R - 1000 S - SIL	1000	4.5	2.0	20	SPDT	2	8.90
4R - 2500 S - SIL	2500	3.0	1.3	↓	↓	↓	9.75
4R - 5000 S - SIL	5000	2.0	.90	↓	↓	↓	9.20
4R - 8000 S - SIL	8000	1.6	.75	↓	↓	↓	9.45
4R - 10,000 S - SIL	10,000	1.4	.65	↓	↓	↓	9.45

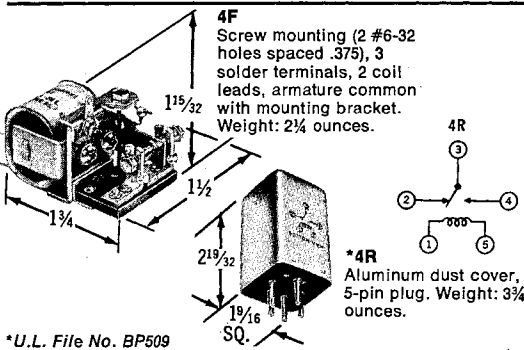

*U.L. File No. BP509

SENSITIVE - SERIES 5 DC - SPDT



Extremely sensitive, precise, and rugged — one of the most versatile relays available. Applications range from air navigation systems to burglar alarms and meter protection equipment. Unusually high contact forces at inputs as low as 1 milliwatt, gradually changing or on-off. Useful for overload-underload detection — reacts without amplification to minute variations from normal. Exceptional trip-point stability ($\pm 2\%$) over five-million-operation life. Withstands heavy voltage-or-current 30-to-1 coil overloads, 100 g shock. Temperature range: S: -4 F to +158 F; SS: +50 F to +140 F. All types UL-listed for use in burglary protection equipment.

CATALOG NUMBER	COIL DATA				CONTACTS		PRICE
	Resistance (ohms)	Pickup, Max (ma DC)	Dropout, Min (ma DC)	Pickup Power (mw)	Arrangement	Rating (amperes)	
5F - 1000 S - SIL	1000	2.3	.80	5	SPDT	1	\$9.25
5F - 2500 S - SIL	2500	1.4	.50	↓	↓	↓	9.25
5F - 5000 S - SIL	5000	1.0	.40	↓	↓	↓	9.90
5F - 10,000 S - SIL	10,000	.70	.25	↓	↓	↓	10.85
5F - 16,000 S - SIL	16,000	.55	.20	↓	↓	↓	11.70
5F - 1000 SS - PAL	1000	1.0	.40	1	↓	.25	10.50
5F - 10,000 SS - PAL	10,000	.30	.13	1	↓	.25	12.10
5JO - 1000 S - SIL	1000	2.3	.80	5	SPDT	1	17.00
5JO - 2500 S - SIL	2500	1.4	.50	↓	↓	↓	17.00
5JO - 5000 S - SIL	5000	1.0	.40	↓	↓	↓	17.65
5JO - 10,000 S - SIL	10,000	.70	.25	↓	↓	↓	18.55
5JO - 16,000 S - SIL	16,000	.55	.20	↓	↓	↓	19.80
5R - 1000 S - SIL	1000	2.3	.80	5	SPDT	1	11.70
5R - 2500 S - SIL	2500	1.4	.50	↓	↓	↓	11.70
5R - 5000 S - SIL	5000	1.0	.40	↓	↓	↓	12.35
5R - 10,000 S - SIL	10,000	.70	.25	↓	↓	↓	13.25
5R - 16,000 S - SIL	16,000	.55	.20	↓	↓	↓	14.25
5R - 1000 SS - PAL	1000	1.0	.40	1	↓	.25	13.90
5R - 10,000 SS - PAL	10,000	.30	.13	1	↓	.25	15.65
5RO - 1000 S - SIL	1000	2.3	.80	5	SPDT	1	12.60
5RO - 2500 S - SIL	2500	1.4	.50	↓	↓	↓	12.60
5RO - 5000 S - SIL	5000	1.0	.40	↓	↓	↓	13.30
5RO - 10,000 S - SIL	10,000	.70	.25	↓	↓	↓	14.25
5RO - 16,000 S - SIL	16,000	.55	.20	↓	↓	↓	15.30

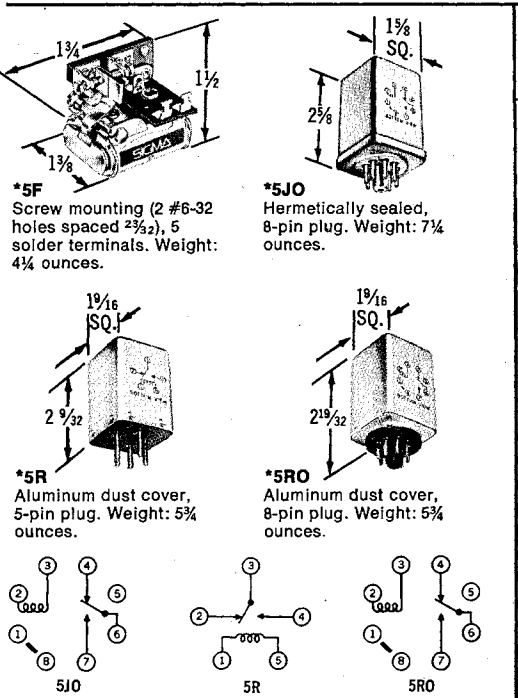

*U.L. File No. BP509



A sensitive and rugged multipurpose relay. Responds to signals as small as 100 milliwatts DC or 0.30 volt-ampere AC, thereby minimizing coil load in circuits with limited load-handling ability. Excellent stability, high circuit insulation, coil overload capacity four to six times rated input. High release for use in circuits with high idle current. Mechanical-life-rated for one billion operations. Electrical life from 100,000 to one million operations depending on load. For general-purpose applications ranging from alarm and control systems to demand meters and timing circuits. Temperature range: -67 F to +185 F, except plastic covers to +158 F. UL- and CSA-listed.

DC TYPES	CATALOG NUMBER	COIL DATA				CONTACTS		PRICE
		Nominal VDC	Resistance (ohms)	Pickup, Max ¹ (ma DC)	Pickup Power (mw)	Arrangement	Rating (amperes)	
<p>*42F Stud mounting (2 #6-32 holes spaced .375), 6 solder terminals, 2 coil leads, non-insulated base. Weight: 2½ ounces.</p>	42F - 150 G - SIL	—	150	38	200	DPDT	5	\$5.10
	42F - 500 G - SIL	—	500	20	↓			5.10
	42F - 1000 G - SIL	24	1000	14	↓			5.10
	42F - 2500 G - SIL	48	2500	9.0	↓			5.10
	42RO - 50 G - SIL	6	50	65	200			DPDT
42RO - 100 G - SIL	—	100	45	↓	6.90			
42RO - 200 G - SIL	12	200	32	↓	6.55			
42RO - 500 G - SIL	—	500	20	↓	6.55			
42RO - 1000 G - SIL	24	1000	14	↓	6.55			
42RO - 2500 G - SIL	48	2500	9.0	↓	6.55			
42RO - 5000 G - SIL	—	5000	6.5	↓	6.80			
42RO - 10,000 G - SIL	—	10,000	4.5	↓	7.00			
42RO - 12,000 G - SIL	—	12,000	4.0	↓	7.30			
42RO - 100 S - SIL	—	100	32	100	2	7.55		
42RO - 150 S - SIL	6	150	26	↓		7.20		
42RO - 200 S - SIL	—	200	22	↓		7.55		
42RO - 500 S - SIL	12	500	14	↓		7.20		
42RO - 1000 S - SIL	—	1000	10	↓		7.20		
42RO - 2500 S - SIL	24	2500	6.2	↓		7.20		
42RO - 5000 S - SIL	—	5000	4.5	↓		7.45		
42RO - 10,000 S - SIL	—	10,000	3.1	↓		7.70		
42RO6 - 50 G - SIL	6	50	65	200		DPDT	5	6.90
42RO6 - 500 G - SIL	—	500	20	↓				6.55
42RO6 - 1000 G - SIL	24	1000	14	↓	6.55			
42RO6 - 2500 G - SIL	48	2500	9.0	↓	6.55			
42RO6 - 5000 G - SIL	—	5000	6.5	↓	6.80			
42RO6 - 10,000 G - SIL	—	10,000	4.5	↓	7.00			
42RO6 - 500 S - SIL	12	500	14	100	2			7.55
42RO6 - 1000 S - SIL	—	1000	10	↓				7.20
42RO6 - 2500 S - SIL	24	2500	6.2	↓				7.20
42RO6 - 5000 S - SIL	—	5000	4.5	↓				7.45

¹Dropout will always be higher than 20% of maximum pickup.

AC TYPES	CATALOG NUMBER	COIL DATA				CONTACTS		PRICE				
		Nominal VAC	Resistance (ohms)	Pickup, Max ¹ (VAC)	Pickup Power (va)	Arrangement	Rating (amperes)					
<p>42JOZ Hermetically sealed, 8-pin plug. Weight: 5¼ ounces.</p> <p>*42ROZ Plastic dust cover, 8-pin plug. Weight: 3¼ ounces.</p> <p>*42RO6Z Plastic dust cover, 8-pin plug. Weight: 3¼ ounces.</p>	42JOZ - 4000 ACG - SIL	115	4000	90	.5	DPDT	5	\$11.25				
	42ROZ - 8 ACG - SIL	6	8	4	.5			DPDT	5	6.55		
	42ROZ - 50 ACG - SIL	12	50	9	↓					6.55		
	42ROZ - 200 ACG - SIL	24	200	18	↓					6.55		
	42ROZ - 4000 ACG - SIL	115	4000	90	↓					6.55		
	42ROZ - 7000 ACS - SIL	115	7000	90	.3					↓	2	7.80
	42RO6Z - 8 ACG - SIL	6	8	4	.5					DPDT	5	6.80
	42RO6Z - 4000 ACG - SIL	115	4000	90	.5							DPDT

¹U.L. File No. E28610, Yellow Card; C.S.A. File No. 20954, White Card.

¹Dropout will always be higher than 20% of maximum pickup.



RESISTORS



±1% PRECISION® CARBOFILM RESISTORS

Precision deposited carbon resistors designed for circuits calling for the accuracy and stability of wire-wound resistors with the marked economy of carbon resistors. The exclusive Aeroglaze conformal coating offers mechanical protection superior to any other coating eliminating the need for special tubes, sleeves and jackets. Aeroglaze coating will meet all moisture requirements of MIL-R-10509B. Carbofilm resistors offer outstanding stability, low voltage coefficient, low capacitance and inductance in high frequency applications.

CARBOFILM CHARACTERISTICS

TESTING: All Tests conducted in accordance with MIL-R-10509B requirements.

TEMPERATURE COEFFICIENT: Approximately 200 ppm per degree C in the lower resistance ranges and not exceeding 500 ppm per degree C in the highest values specified by MIL-R-10509B.

MOISTURE RESISTANCE: Will meet or surpass the requirements of MIL-R-10509B.

LOAD LIFE: When tested for more than 1,000 hours at full load operation in 40°C ambient temperature, maximum changes are less than 1% with an average change of less than 0.5%.

TEMPERATURE CYCLING: After 5 complete temperature cycles there is an average change of 0.21% with a maximum change of less than 0.5%.

SHORT TIME OVERLOAD: When subjected to 2.5 times the rated working voltage, but not exceeding 2 times the maximum rated voltage for 5 seconds, changes are less than 0.25% with an average change of 0.13%.

LOW TEMPERATURE OPERATION: Maximum changes are less than 1%.

ACCURACY: Guaranteed tolerance of plus/minus 1% at 25°C. (77°F.)

AGING: Due to manufacturing process and control, changes attributed to aging are negligible. The average change in resistance for self-aging is approximately 0.2% per year.

VOLTAGE COEFFICIENT: Does not exceed .002% per volt.

For full technical information request Bulletin NPJ-115-16 Rev. 2

CARBOFILM

TYPE	SIZES	STD. MIN. OHMS	STD. MAX. MEGOHMS	Availability		MIL-R-10509B Max DC Voltage	Equiv. to MIL-R-10509B			MARKING
				Comm. Value	MIL-BELL Value		Type	Char.	Tol.	
CPSX½	.203 x 1/32	10	2.2	✓	✓	350	RN20	X	1%	RN20 Number
CPX½	.260 x 3/32	2,210,000	5.0	✓		350	----	--	---	Type, Value, Tolerance
CPLX½	.260 x 1	5,100,000	7.5	✓		500	----	--	---	Type, Value, Tolerance
*CPX 1	.328 x 1/16	10	15	✓	✓	500	RN25	X	1%	Type, Value, Tolerance and RN25 Number
**CPX 2	.328 x 2/16	50	100†	✓		750	RN30	X	1%	Type, Value, Tolerance and RN30 Number

† Only stock value above 50 megohms is 100 megohms furnished in ±2% tolerance.

* Values from 10.1 meg to 15 meg will be furnished at ±2% only.

** Values from 30.1 meg to 100 meg will be furnished at ±2% only.

Amperex Resistors LINEAR NON-LINEAR

CARBON FILM

These resistors offer high stability, low noise and long life. For applications requiring steady low power drop. Accuracy and consistency are relatively unaffected by adverse climatic conditions. Range from 1Ω to 10M. Pure carbon or nickel film deposited on a high grade ceramic body.

	1/10W	1/4W	1/2W
P_{nom} $T_A < 70^\circ C$	0.1W	0.25W	0.5W
Max. voltage AC or DC	150V	250V	350V
Permissible RMS applied for 1 sec. across insulation	300V	500V	700V
Insulation resistance	10 ⁴ MΩ	10 ⁴ MΩ	10 ⁴ MΩ
Amb. temp. (all types)	-55 to +155°C		

Style	Range	Tolerance (±)
CR16 (1/10W)	10Ω to 220k	5%
	270k to 1M	10%
CR25 (1/4W)	1Ω to 3.9Ω	10%
	4.3Ω to 1M	5%
	10Ω to 1M	2%
CR37 (1/2W)	1.2M to 10M	10%
	1Ω to 10M	10%
	4.3Ω to 1M	5%
	10Ω to 1M	2%

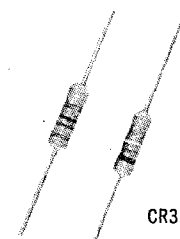

CR37

CARBON POTENTIOMETER

Reliable trimmers, despite small size and low cost, for tube or transistorized PCs. Consist of annular carbon track riveted to base plate of resin bonded paper. Screw driver slot or plastic knob for readjustment. Available in seven mechanical types.

Dimensions

Type	Length	Width	Depth
E097	0.787	0.709	0.177
E086	0.394	0.394	0.150
	Diameter	Depth	
440	0.488 ± .002	0.205 ± .008	

Type E086: Linear Resistance Range: 100Ω to 1M ±20%: 13 ranges
Effective angle of rotation240 ±5°
Maximum permissible power dissipation (of total resistance) at an ambient temperature of 40°C0.1W
Permissible ambient temperature range-30° to +70°C
Type E097: Linear Resistance Range: 100Ω to 4.7M ±20%: 15 ranges
Effective angle of rotation220 ±5°
Maximum permissible power dissipation (of total resistance) at ambient temperature of 40°C0.25W
Permissible ambient temperature range-30° to +70°C
Type 440: Linear Resistance Range: 4700Ω, 10KΩ, 22KΩ, ±20%
Nominal resistance values4.7K, 10K, 22K
Resistance lawlinear and logarithmic
Working temperature range-10° to +70°C
Life expectancyin excess of 15,000 cycles
(Available with ON-OFF switch as Type 441)



E086

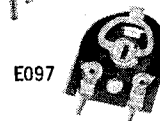

E097



441

LIGHT DEPENDENT

LDRs, made from cadmium sulfide, are semiconductors whose conductivity increases when irradiated by wave lengths within a certain range of the spectrum. Made in specific versions with relevant electrical characteristics for control, counting, measuring, alarm and switching applications.

Type	Description	Diameter (")	Thickness (")
LDR-03	Makrolon case and epoxy resin	0.55 ± 0.196	0.35 ± 0.06
LDR-05	Plastic case and epoxy resin	0.43 ± 0.006	0.14 ± 0.004
LDR-07	Lacquered protective coating	0.34 ± 0.16	0.071 ± 0.002

Applications: Auto Parking & Headlight Dimmers, TV Brightness Control, Exposure Meters, Flame Control in Oil Burners, Magnetic Tape Controls, etc.



LDR-03



LDR-05



LDR-07

VOLTAGE DEPENDENT

Most important property is the non-linearity between their resistance and the applied voltage. Voltage dependency is due to contact resistance between the silicon carbide crystals. Crystal contacts form a network of series and parallel resistors which determine the electrical characteristics.

Available Types
Disc types available: 0.8W to 3W
Rod types available: 0.7W

Applications
VDRs can be used in spark suppression and contact-protection applications, as well as in series with a resistor for voltage stabilization. Although the stabilizing circuit with a VDR cannot compete with more elaborate circuits, it has vital advantages of simplicity and small space adaptability.



Disc



Rod

POSITIVE TEMPERATURE COEFFICIENT THERMISTORS

PTC Thermistors increase in resistance as the temperature increases. PTCs are disc shaped with connecting leads and are lacquer coated for protection against atmospheric influences.

Available Types
Standard Discs 1W 40 to 50V series
Standard Discs 0.5W 25V series

Applications
Resistance changes of 10%/°C or better permit the use of PTCs wherever any of the following factors are decisive: ambient temperature; dissipated power; inertia of PTC and positive temperature coefficient.



Discs

NEGATIVE TEMPERATURE COEFFICIENT THERMISTORS

NTC thermistors are resistors which exhibit a high negative temperature coefficient of resistivity. They are made of semiconducting oxidic materials. The resistance of the oxides decreases rapidly when the temperature rises.

Available Types
Rod Type
Disc Type
Miniature Bead Type
Special Types for Automobiles
Special Types for Radio and TV

Applications
Resistance changes of 3% to 6% per °C permit the use of NTCs in applications such as: ambient temperature measurement and control; resistance determined by dissipation and time delays.



Disc



Rod

SPEER FIXED COMPOSITION RESISTORS

Airco Speer resistors are made on modern high speed equipment which molds component material into one integral, dense unit. Heavy pure tin-coated copper lead wires, thermosetting bonding resins, finely divided inorganic fillers, and specially produced and treated high conductivity materials such as carbon blacks are the materials used.

During the molding process, preformed insulating shells of bonded inorganic fillers are filled with carefully adjusted conducting compounds. The binders and fillers of both shell and core are completely compatible and, under high pressure, allow the formation of an inseparable bond between core and shell. The thermal characteristics of shell and core are essentially equal.

After high pressure molding, the "green" resistors are cured in precisely adjusted, indirectly heated continuous tube furnaces. The resin cure is complete and the final resistance of the unit is thereby fixed. A vacuum and pressure impreg-

nation of a special high temperature material develops maximum protection against moisture penetration.

The special impregnant used is completely stable under all operating conditions.

Airco Speer resistors are color coded with special paints developed to provide a high degree of solvent resistance.

All Airco Speer resistors have lead wires of high conductivity copper with a solderable coating of heavy pure tin. The wires are completely precoated before assembly, so that the solderable surface is unbroken over the entire area. The tin coat is controlled to a thickness of .0003"-.0008", several times as heavy as that on ordinary tinned wire. The use of pure tin affords superior storage life and offers the ultimate in low temperature solderability.

The impregnated resistors are measured on high speed automatic resistance sorters and classified into appropriate resistance nominals and tolerances. The color bands are applied after sorting.

SPECIFICATIONS

Speer Type	Mil Type	Rating In Watts	Resistance Range Ohms	Diameter D	Length L	Wire Size A.W.G.	Nom. Dia. LD	Length LL
SR ¼	RC 07	¼	10 Ohm to 1.0 Meg.	.090 ± .008	.250 ± .031	No. 22	.025	1½ ± ¼
SR ½	RC 20	½	2.7 Ohm to 22 Meg.	.138 ± .007	.390 ± .025	No. 20	.032	1½ ± ¼
SR 1	RC 32	1	2.7 Ohm to 22 Meg.	.225 ± .010	.562 ± .030	No. 18	.040	1½ ± ¼
SR 2	RC 42	2	10 Ohm to 22 Meg.	.312 ± .010	.688 ± .030	No. 17	.045	1½ ± ¼

STANDARD RESISTANCE VALUES AND TOLERANCES

As shown in the table below, Speer resistors are available in all standard values specified by MIL-R-11, RS 172 and MIL-R-39008.

Ohms	Ohms	Ohms	Ohms	Ohms	Ohms	Ohms	Ohms	Ohms	Meg.	Meg.
2.7	12	56	270	1200	5600	27K	120K	560K	2.7	12.0
3.0	13	62	300	1300	6200	30K	130K	620K	3.0	13.0
3.3	15	68	330	1500	6800	33K	150K	680K	3.3	15.0
3.6	16	75	360	1600	7500	36K	160K	750K	3.6	16.0
3.9	18	82	390	1800	8200	39K	180K	820K	3.9	18.0
4.3	20	91	430	2000	9100	43K	200K	910K	4.3	20.0
4.7	22	100	470	2200	10K	47K	220K	1.0M	4.7	22.0
5.1	24	110	510	2400	11K	51K	240K	1.1	5.1	
5.6	27	120	560	2700	12K	56K	270K	1.2	5.6	
6.2	30	130	620	3000	13K	62K	300K	1.3	6.2	
6.8	33	150	680	3300	15K	68K	330K	1.5	6.8	
7.5	36	160	750	3600	16K	75K	360K	1.6	7.5	
8.2	39	180	820	3900	18K	82K	390K	1.8	8.2	
9.1	43	200	910	4300	20K	91K	430K	2.0	9.1	
10	47	220	1000	4700	22K	100K	470K	2.2	10.0	
11	51	240	1100	5100	24K	110K	510K	2.4	11.0	

Items in bold face type available in 5% tolerance only.

AIRCO Speer Electronic Components

Formerly Speer Resistor Division Speer Carbon Co.



"GREENOHM V"™ VITREOUS-ENAMEL RESISTORS

Based on years of research and engineering development, these vitreous-enamel wire-wound power resistors offer superlative performance and life as proved by countless tests. "Greenohm V" resistors provide all the outstanding quality which made Clarostat "Greenohm" cement-coated units famous, plus a glass-smooth vitreous-enamel coating in a handsome bluish-green for maximum eye appeal. Made to MIL-R-26C specifications.

- Fixed and adjustable
- 5-watt to 200 watt sizes
- ± 5% tolerance, 1 ohm and over. ± 10% tolerance, 0.9 ohms and under. ± 10% for adjustable.

"GREENOHM V"™ FIXED RESISTORS (VITREOUS ENAMEL)

5-WATT SERIES VPR-5-F

Core: 1" x 5/16"

Terminals, wire lead and lug

	Resistance Ohms			
1	30	350	1250	7000
1.5	35	400	1500	7500
2	40	450	1750	8000
3	50	500	2000	9000
4	75	600	2250	10K
5	100	700	2500	12.5K
7.5	125	750	3000	15K
10	150	800	3500	17.5K
12	200	900	4000	20K
15	225	1000	4500	22.5K
20	250	1100	5000	25K
25	300	1200	6000	

NET PRICES:

1 to 1K	\$0.51
1100 to 5K	.54
6K to 10K	.57
12.5K to 15K	.60
17.5K to 20K	.63
22.5K to 25K	.66

10-WATT SERIES VPR-10-F

Core: 1 3/4" x 5/16"

Terminals, wire lead and lug

	Resistance Ohms			
0.4	30	500	3000	13.5K
1	35	600	3500	14.3K
1.2	40	700	4000	15K
1.3	50	750	4500	16K
1.5	75	800	5000	17.5K
2	100	900	6000	18K
3	125	1000	7000	20K
4	150	1100	7500	22.5K
5	200	1200	8000	25K
7.5	225	1250	8500	30K
10	250	1300	9000	35K
12	300	1750	10K	40K
15	350	2000	11K	45K
20	400	2250	12K	50K
25	450	2500	12.5K	

NET PRICES:

0.4 to 1K	\$0.57
1100 to 5K	.60
6K to 10K	.69
11K to 20K	.78
22.5K to 25K	.81
30K to 50K	.90

100-WATT SERIES VK-100-N

Core: 6 1/2" x 3/4"

Lug terminals — Mtg. bracket furnished

	Resistance Ohms			
1	50	800	8000	25K
2	75	500	4000	30K
3	100	750	5000	40K
4	125	1000	7500	50K
5	150	1500	10K	60K
10	200	2000	15K	75K
25	250	2500	20K	100K
				200K

NET PRICES:

1 to 3	\$2.22
4 to 1K	1.59
1500 to 5K	1.68
7500 to 10K	1.80
15K to 20K	1.98
25K to 40K	2.13
50K to 60K	2.22
75K	2.43
100K	2.73

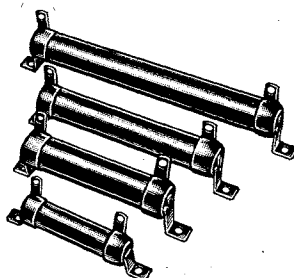

20-WATT SERIES VPR-20-H

Core: 2" x 7/16"

Terminals, wire lead and lug

	Resistance Ohms			
0.4	350	1850	7500	55K
0.6	400	2000	8000	60K
0.8	500	2250	9000	65K
5	850	2400	10K	70K
10	700	2500	12.5K	75K
25	750	2750	15K	80K
50	800	3000	20K	85K
75	850	3500	25K	90K
100	1000	4000	30K	95K
150	1200	4500	35K	100K
200	1250	5000	40K	
250	1500	6000	45K	
300	1750	7000	50K	

NET PRICES:

0.4 to 1K	\$0.66
1200 to 5K	.69
6K to 10K	.81
12.5K to 20K	.84
25K to 40K	.99
45K to 60K	1.14
65K to 80K	1.35
85K to 100K	1.56

160-WATT SERIES VK-160-W

Core: 8 1/2" x 1 1/8"

Lug terminals — Mtg. bracket furnished

	Resistance Ohms			
1	50	750	7500	60K
2	75	1000	10K	80K
3	100	1500	15K	75K
4	125	2000	20K	100K
5	150	2500	25K	
10	250	3000	30K	
25	500	5000	40K	

NET PRICES:

1 to 5	\$3.18
10 to 1K	2.28
1500 to 5K	2.31
7500 to 10K	2.52
15K to 20K	2.70
25K to 40K	2.79
50K to 60K	2.88
75K	3.06
100K	3.24

25-WATT SERIES VP-25-K

Core: 2" x 9/16"

Lug terminals — Mtg. bracket furnished

	Resistance Ohms			
1	50	800	5000	30K
2	75	1000	6000	35K
3	100	1500	7500	40K
4	150	2000	10K	50K
5	200	2500	12K	60K
10	250	3000	15K	70K
15	500	3500	20K	80K
25	750	4000	25K	100K

NET PRICES:

1 to 1K	\$0.72
1500 to 10K	.75
6K to 10K	.84
12K to 20K	.90
25K to 40K	1.02
50K to 60K	1.20
70K to 80K	1.41
100K	1.62

50-WATT SERIES VP-50-K

Core: 4" x 9/16"

Lug terminals — Mtg. bracket furnished

	Resistance Ohms			
1	100	1000	7500	50K
2	150	1250	8000	75K
3	200	1500	10K	100K
4	250	2000	12K	125K
5	300	2500	15K	150K
10	400	3000	20K	175K
25	500	4000	25K	200K
50	750	5000	30K	225K
75	800	6000	35K	250K

NET PRICES:

1	\$1.53
2 to 1K	1.11
1500 to 5K	1.14
7500 to 10K	1.26
12K to 20K	1.38
25K to 35K	1.53
50K	1.71
75K	1.95
100K	2.13
125K	2.55
150K	2.70
175K	2.79
200K	2.88
225K	3.24
250K	3.24

200-WATT SERIES VK-200-W

Core: 10 1/2" x 1 1/8"

Lug terminals — Mtg. bracket furnished

	Resistance Ohms			
1	50	750	7500	40K
2	75	1000	10K	50K
3	100	1500	12K	60K
4	150	2000	15K	75K
5	200	2500	20K	100K
10	250	3000	25K	
25	500	5000	30K	

NET PRICES:

1 to 5	\$3.42
10 to 1K	2.46
1500 to 5K	2.52
7500 to 10K	2.70
15K to 20K	2.88
25K to 40K	2.87
50K to 60K	3.06
75K	3.24
100K	3.45



AXIAL LEAD VITREOUS RESISTORS

Available in three sizes 3, 5 and 10 watts, Series VC3D, VC5E and VC10F. Axial lead resistors are particularly adapted to printed circuit, terminal board, and point-to-point wiring applications. These resistors save considerable space because of the elimination of mounting brackets and terminal lugs. Standard resistance tolerance is $\pm 5\%$ for 1 ohm and higher and tolerance below 1 ohm is $\pm 10\%$. Attractively packaged in a newly designed carton particularly adapted to this new axial lead resistor, beautifully finished with Clarostat's new vitreous shade of teal green.

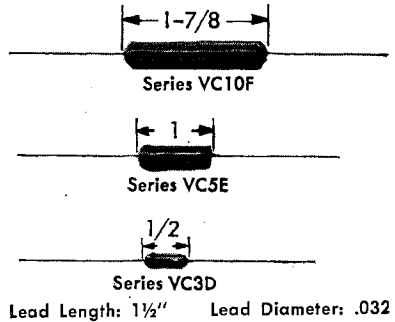

SERIES VC3D STOCK VALUES					
1	20	68	250	600	1.75K
1.5	22	75	270	680	1.8K
2	25	82	300	700	2K
3	27	100	330	750	2.2K
4	30	120	350	800	2.25K
5	33	125	390	820	2.5K
7.5	35	150	400	900	2.7K
10	39	180	450	1K	3K
12	40	200	470	1.1K	3.3K
15	47	220	500	1.2K	3.5K
18	50	225	560	1.25K	3.9K
56			1.5K	4K	10K

Net Prices	
1	to 1K\$.51
1.1K	to 5K54
6K	to 10K57

SERIES VC5E STOCK VALUES					
1	22	82	330	820	2.7K
1.5	25	100	350	900	3K
2	27	120	390	1K	3.3K
3	30	125	400	1.1K	3.5K
4	33	150	450	1.2K	3.9K
5	35	180	470	1.25K	4K
7.5	39	200	500	1.5K	4.5K
10	40	220	560	1.75K	4.7K
12	47	225	600	1.8K	5K
15	50	250	680	2K	5.6K
18	56	270	700	2.2K	6K
20	68	300	750	2.25K	6.8K
75			800	2.5K	7K

Net Prices	
1	to 1K\$.54
1.1K	to 5K57
6K	to 10K60
12.5K	to 20K72
22.5K	to 25K75

SERIES VC10F STOCK VALUES							
1	25	120	400	1.2K	3.5K	8.5K	22.5K
1.5	27	125	450	1.25K	3.9K	9K	25K
2	30	150	470	1.3K	4K	10K	27K
3	33	180	500	1.5K	4.5K	11K	30K
4	35	200	560	1.75K	4.7K	12K	33K
5	39	220	600	1.8K	5K	12.5K	35K
7.5	40	225	680	2K	5.6K	13.5K	39K
10	47	250	700	2.2K	6K	15K	40K
12	50	270	750	2.25K	6.8K	16K	45K
15	56	300	800	2.5K	7K	17.5K	47K
18	68	330	820	2.7K	7.5K	18K	50K
20	75	350	900	3K	8K	20K	
22	82	390	1K	3.3K	8.2K	22K	
100			1.1K				

Net Prices	
1	to 1K\$.60
1.1K	to 5K63
6K	to 10K72
11K	to 20K81
22.5K	to 40K84
45K	to 50K96

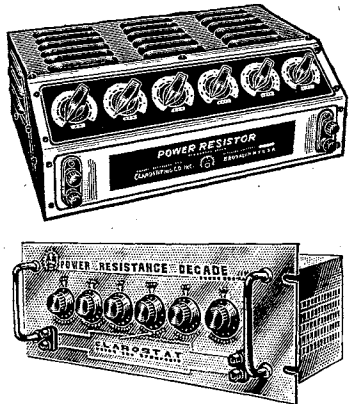

POWER RESISTOR DECADE BOX

The Resistance Decade Box, Model 240-C for bench use—Model 250 for rack mounting, provides any resistance from 1 to 999,999 ohms for working circuits at the flip of a switch. Six front-panel dials enable selection in 1 ohm increments, the total value being read directly from the dial. Each decade has a power rating of 225 watts maximum, 1,000 VDC or 660 VAC maximum.

Resistance changing switches are of the type that prevent a resistance breakdown between steps, thus protecting delicate meters and measuring instruments in the circuit. Knobs indicate the resistance

value being used at a glance.

Clarostat GREENOHM Power Resistors are used throughout. These components are wire-wound power resistors on ceramic tubes and coated with an exclusive Clarostat inorganic cold-setting cement, providing the most rugged, long-lasting, trouble-free power resistor available. The resistors are mounted in rigid metal supports.

Overall length: 240C: 13" long x 8 1/2" deep x 5 3/4" high, weight 1 1/2 lbs. 250: 19" long x 13 3/4" deep x 7" high (fits in standard 19" relay rack), weight 1 1/2 lbs.

SUGGESTED USES: Resistance determination, Load Resistance, Meter Multiplier, Calibrating Meters, Providing any desired ohmage as a universal power resistor.

Decade No.	1	2	3	4	5	6
Max. Current Rating (amps)	5	1.5	.5	.15	0.5	.005
Resistance Tolerance	5%	2%	2%	2%	2%	2%

NET PRICE: Model 240C \$110.00, Model 250 \$150.00

SERIES U39
UNIVERSAL "HUMDINGER" CONTROL
2W. WIRE WOUND

Series U39 is a shaftless potentiometer with the contact arm grounded to the housing. The design of terminals and mounting tabs, meets the following requirements: Above chassis mounting, as a potentiometer or rheostat; printed circuit mounting, as a potentiometer or rheostat. The terminal layout meets the popular industry standards. A fiber adapter plate is furnished with each control. Series U39 is ideally suited for radio and television requirements, as well as many industrial applications. Resistance tolerance $\pm 20\%$. Linear only.

Cat. No.	Total Res. Ohms	Min. Res. Ohms	Cat. No.	Total Res. Ohms	Min. Res. Ohms
U39-1.5	1.5	—	U39-700	700	—
U39-5	5	—	U39-700-200	700	200
U39-8	8	—	U39-800	800	—
U39-15	15	—	U39-800-50	800	50
U39-50	50	—	U39-1000	1000	—
U39-75	75	—	U39-1000-100	1000	100
U39-100	100	—	U39-1500	1500	—
U39-125	125	—	U39-2000	2000	—
U39-150	150	—	U39-2000-100	2000	100
U39-175	175	—	U39-3000	3000	—
U39-200	200	—	U39-3000-700	3000	700
U39-300	300	—	U39-4000	4000	—
U39-500	500	—	U39-4000-350	4000	350
U39-500-100	500	100	U39-4000-1000	4000	1000
U39-800	800	—	U39-5000	5000	—
U39-850	850	—			

NET PRICE \$60

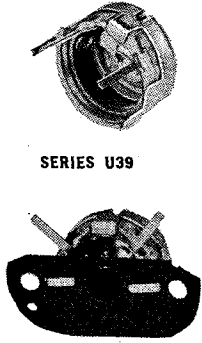

CORNING® GLASS TIN OXIDE FILM RESISTORS

New glass tin oxide film resistors—with tighter, ½ to 5% purchase and load-life tolerances, precision temperature coefficients—make CORNING Resistors more than ever your best buy for stability and reliability. Add these new and

improved characteristics to the established physical and electrical integrity of glass tin oxide film resistors and you will see how CORNING Precision, General-purpose, and Power Resistors can add real value to your equipment.

	TYPE AND MIL SPEC	MODEL/MIL	RESISTANCE (ohms)		WATTAGE			TOLERANCE
			±1%	±½%	70°C	125°C	125°C	
NEW NC	New low ±50 ppm TC with ½ and 1% tolerances for predictable performance. Meets MIL-R-10509F, Char. C. 	NC4/RN55C NC5/RN60C NC6/RN65C	49.9 to 301K 49.9 to 1 meg. 49.9 to 2 meg.	49.9 to 150K 49.9 to 499K 49.9 to 1 meg.	125°C 1/10 1/8 1/4		±1/2, 1% ±1/2, 1% ±1/2, 1%	
IMPROVED NA	Stable ½% and 1% performance at 70°C and 125°C ratings. Meets MIL-R-10509F, Char. D. 100 ppm TC. 	NA55/RN55D NA60/RN60D NA65/RN65D NA70/RN70D	10 to 301K 10 to 1 meg. 10 to 2 meg. 51.1 to 1 meg.	49.9 to 150K 49.9 to 499K 49.9 to 1 meg. 51.1 to 1 meg.	70°C 125°C 1/8 1/10 1/4 1/8 1/2 1/4 3/4 —		±1/2, 1% ±1/2, 1% ±1/2, 1% ±1/2, 1%	
NEW C	Precision stability in a unique multi-use part for both MIL-R-22684B and MIL-R-10509F, Char. D. New C3 style provides ½ watt performance in RN50/RCO5 size. 	C3 C4/RL07S C5/RL20S	100 ppm 100Ω-150K 10Ω-301K 10Ω-1MEG	200 ppm 10Ω-150K	70°C 70°C 125°C 1/8 1/8 1/10 1/4 1/4 1/8		±1, 2, 5, 10% ±1, 2, 5% ±1, 2, 5%	
C	General-purpose, low-cost film type. Film resistor performance characteristics at prices comparable to carbon composition types. 	C32/RL32S C42S/RL42S	10 to 1 meg. 10 to 1.5 meg.		1 @ 70°C 2 @ 70°C		±2%, 5% ±2%, 5%	
FP	Low-power resistors that won't burn, even under 100 times-rated overload. FP Style Resistors open up, fuse, but will not flame. Highly stable and non-inductive performance. 	FP-2 FP-3 FP-4 FP-5 FP-7 FP-10	9 to 90K 9 to 40K 16 to 90K 19 to 90K 24 to 90K 24 to 90K		40°C 70°C 3 2 4 3 5 4 7 5 — 7 10 —		2, 5, 10% 2, 5, 10% 2, 5, 10% 2, 5, 10% 2, 5, 10% 2, 5, 10%	
S	Fixed-film type for high-temperature operation. Silicone baked lacquer. MIL-R-11804D. Char. P. 	S20/RD60P S25/RD65P S30/RD70P	10 to 500K 10 to 1.54 meg. 30.1 to 4.22 meg.		130°C 25°C ½ 1 1 2 2 4		±1, 2, 5, 10% ±1, 2, 5, 10% ±1, 2, 5, 10%	
R	Power type, essentially non-inductive in high-frequency operations. MIL-R-11804D. 	R31/RD31P R33/RD33P R35/RD35P R37/RD37P R39/RD39P	10 to 70K 19.6 to 150K 19.6 to 301K 19.6 to 500K 30.1 to 1 meg.		7 @ 25°C 13 @ 25°C 25 @ 25°C 55 @ 25°C 115 @ 25°C		±2, 5, 10% ±2, 5, 10% ±2, 5, 10% ±2, 5, 10% ±2, 5, 10%	

STANDARD DECADES* Precision (Mil-R-10509)

Semi-precision (Mil-R-22684)

Purchase tolerance in %*																Purchase tolerance in %	
D (0.5)	F (1.0)	D (0.5)	F (1.0)	D (0.5)	F (1.0)	D (0.5)	F (1.0)	D (0.5)	F (1.0)	D (0.5)	F (1.0)	D (0.5)	F (1.0)	D (0.5)	F (1.0)	G & J 2.0 & 5.0	
10.0	10.0	13.3	13.3	17.8	17.8	23.7	23.7	31.6	31.6	42.2	42.2	56.2	56.2	75.0	75.0	10	33
10.1	...	13.5	...	18.0	...	24.0	...	32.0	...	42.7	...	56.9	...	75.9	...	11	36
10.2	10.2	13.7	13.7	18.2	18.2	24.3	24.3	32.4	32.4	43.2	43.2	57.6	57.6	76.8	76.8	12	39
10.4	...	13.8	...	18.4	...	24.6	...	32.8	...	43.7	...	58.3	...	77.7	...	13	43
10.5	10.5	14.0	14.0	18.7	18.7	24.9	24.9	33.2	33.2	44.2	44.2	59.0	59.0	78.7	78.7	15	47
10.6	...	14.2	...	18.9	...	25.2	...	33.6	...	44.8	...	59.7	...	79.6	...	16	51
10.7	10.7	14.3	14.3	19.1	19.1	25.5	25.5	34.0	34.0	45.3	45.3	60.4	60.4	80.6	80.6	18	56
10.9	...	14.5	...	19.3	...	25.8	...	34.4	...	45.9	...	61.2	...	81.6	...	20	62
11.0	11.0	14.7	14.7	19.6	19.6	26.1	26.1	34.8	34.8	46.4	46.4	61.9	61.9	82.5	82.5	22	68
11.1	...	14.9	...	19.8	...	26.4	...	35.2	...	47.0	...	62.6	...	83.5	...	24	75
11.3	11.3	15.0	15.0	20.0	20.0	26.7	26.7	35.7	35.7	47.5	47.5	63.4	63.4	84.5	84.5	27	82
11.4	...	15.2	...	20.3	...	27.1	...	36.1	...	48.1	...	64.2	...	85.6	...	30	91
11.5	11.5	15.4	15.4	20.5	20.5	27.4	27.4	36.5	36.5	48.7	48.7	64.9	64.9	86.6	86.6		
11.7	...	15.6	...	20.8	...	27.7	...	37.0	...	49.3	...	65.7	...	87.6	...		
11.8	11.8	15.8	15.8	21.0	21.0	28.0	28.0	37.4	37.4	49.9	49.9	66.5	66.5	88.7	88.7		
12.0	...	16.0	...	21.3	...	28.4	...	37.9	...	50.5	...	67.3	...	89.8	...		
12.1	12.1	16.2	16.2	21.5	21.5	28.7	28.7	38.3	38.3	51.1	51.1	68.1	68.1	90.9	90.9		
12.3	...	16.4	...	21.8	...	29.1	...	38.8	...	51.7	...	69.0	...	92.0	...		
12.4	12.4	16.5	16.5	22.1	22.1	29.4	29.4	39.2	39.2	52.3	52.3	69.8	69.8	93.1	93.1		
12.6	...	16.7	...	22.3	...	29.8	...	39.7	...	53.0	...	70.6	...	94.2	...		
12.7	12.7	16.9	16.9	22.6	22.6	30.1	30.1	40.2	40.2	53.6	53.6	71.5	71.5	95.3	95.3		
12.9	...	17.2	...	22.9	...	30.5	...	40.7	...	54.2	...	72.3	...	96.5	...		
13.0	13.0	17.4	17.4	23.2	23.2	30.9	30.9	41.2	41.2	54.9	54.9	73.2	73.2	97.6	97.6		
13.2	...	17.6	...	23.4	...	31.2	...	41.7	...	55.6	...	74.1	...	98.8	...		

*Standard resistance values are obtained from the decade table by multiplying by multiples of 10. As an example, 1.33 can represent 13.3 ohms, 133 ohms, 1.33k, 13.3k, 133k, 1.33 megohms. 2 and 5% decade values for Mil-R-11804 are standard on CORNING® R, S and H Styles.

CORNING
ELECTRONICS

CORNING GLASS WORKS
ELECTRONIC PRODUCTS DIVISION

DALE

for Optimum Value in Wirewound Resistors

WIREWOUND PRECISION RESISTORS, SILICONE COATED & MOLDED

TYPE RS

Coated and molded models meet applicable requirements of MIL-R-26E, MIL-R-26C and MIL-R-23379. Non-inductive styles available.



(Available with Weldable Leads)

STANDARD ELECTRICAL SPECIFICATIONS

DALE TYPE	MIL-R-26E TYPE*	DALE RATING		RESISTANCE RANGES (OHMS)		MAX. WORKING VOLTAGE		MAX. WT. GRAMS	STANDARD TEMPERATURE COEFFICIENT VALUE RANGES (OHMS)†			
		U	V	.05% thru 5%	.1%, .25% 5%, 1% 3%, 5%	U	V		± 90 PPM	± 50 PPM	± 30 PPM	± 20 PPM
		.05% thru 5%	3% & 5%									
RS-¼	—	.4 W	—	10 to 950	1 to 3.4K	20	—	.21	Below 1 Ω	1 to 6.9	—	7 to 3.4K
RS-½	—	.75 W	—	10 to 1.3K	1 to 4.9K	29	—	.23	Below 1 Ω	1 to 9.9	—	10 to 4.9K
RS-1A	RW-70	1.0 W	—	1 to 2.7K	.1 to 10.4K	52	—	.34	Below 1 Ω	1 to 9.9	10 to 19	20 to 10.4K
RS-1B	—	1.1 W	—	1 to 4.0K	.1 to 15K	62	—	.40	Below 1 Ω	1 to 9.9	10 to 29	30 to 15K
RS-2	—	4.0 W	5.5 W	1 to 12.7K	.1 to 47.1K	210	250	2.1	Below 1 Ω	1 to 9.9	10 to 79	80 to 47.1K
RS-2A	—	3.25 W	4.75 W	1 to 11.4K	.1 to 42.1K	185	220	.90	Below 1 Ω	1 to 9.9	10 to 79	80 to 42.1K
RS-2B	RW-79	3.0 W	3.75 W	1 to 6.5K	.1 to 24.5K	135	148	.70	Below 1 Ω	1 to 9.9	10 to 49	50 to 24.5K
RS-2C	—	2.5 W	3.25 W	1 to 8.6K	.1 to 32.3K	138	157	1.6	Below 1 Ω	1 to 9.9	10 to 59	60 to 32.3K
RS-2C-23	RW-69	2.5 W	3.25 W	1 to 8.6K	.1 to 32.3K	138	157	1.6	Below 1 Ω	1 to 9.9	10 to 59	60 to 32.3K
RS-5	—	5.0 W	6.5 W	.5 to 25.7K	.1 to 95.2K	330	376	4.2	Below 1 Ω	1 to 9.9	10 to 169	170 to 95.2K
RS-5-69	RW-74	5.0 W	6.5 W	.5 to 24.5K	.1 to 91.0K	323	368	4.2	Below 1 Ω	1 to 9.9	10 to 169	170 to 91.0K
RS-5-70	RW-67	5.0 W	6.5 W	.5 to 25.7K	.1 to 95.2K	330	376	4.2	Below 1 Ω	1 to 9.9	10 to 169	170 to 95.2K
RS-7	—	7.0 W	9.0 W	.5 to 41.4K	.1 to 154K	504	576	4.7	Below 1 Ω	1 to 9.9	10 to 269	270 to 154K
RS-10	—	10 W	13 W	.5 to 73.4K	.1 to 273K	799	911	9.0	Below 1 Ω	1 to 9.9	10 to 469	470 to 273K
RS-10-38	RW-78	10 W	13 W	.5 to 71.3K	.1 to 265K	788	898	9.0	Below 1 Ω	1 to 9.9	10 to 469	470 to 265K
RS-10-39	RW-68	10 W	13 W	.5 to 73.4K	.1 to 273K	799	911	9.0	Below 1 Ω	1 to 9.9	10 to 469	470 to 273K

*NOTE: The following Dale RS series resistors meet requirements of MIL-R-26C (Char. G & V) and MIL-R-23379:

**Max. working voltage determined at .0008 dia. wire resistance values.

†Consult factory for special T.C. requirements.

MIL-R-26C

DALE TYPE	RS-2C	RS-5	RS-10
MIL. TYPE	RW-69	RW-67	RW-68

MIL-R-23379

DALE TYPE	RS-1A	RS-2C-23	RS-5	RS-10
MIL. TYPE	RWP-18	RWP-20	RWP-21	RWP-23

WIREWOUND PRECISION RESISTORS, BOBBIN TYPE (Available with Weldable Leads)

Contact Distributor for Prices

STANDARD ELECTRICAL SPECIFICATIONS

Non-inductive precision resistors. Epoxy molded for high dielectric strength and complete environmental protection. Meet applicable requirements of MIL-R-39005 and MIL-R-93.



TYPE WWA

Patented design insures high stability. Special tolerances and matching available.



TYPE MWA

Sub-miniature size retains Dale's unique bobbin-type design and high protection molded coating.

DALE TYPE	MIL-R-93 TYPE	POWER RATING (WATTS)	MINIMUM RESISTANCE RANGE (OHMS)*					MAXIMUM RESISTANCE (OHMS) ALL TOLERANCES	MAXIMUM WORKING VOLTAGE	MAXIMUM WEIGHT (GRAMS)
			.05%	.1%	.25%	.5%	1%			
MWA-8	—	.1	50	10	5	2	1	100K	27	.21
MWA-10	—	.125	50	10	5	2	1	160K	37	.23
WWA-13	—	.125	50	10	5	2	1	311K	50	.35
WWA-22	—	.15	130	20	5	.2	.1	600K	100	.9
WWA-23	RB-56	.15	105	12	5	.2	.1	650K	150	1.0
WWA-24	RB-55	.20	40	12	6	.2	.1	900K	200	1.2
WWA-26	RB-54	.25	20	10	5	.2	.1	1.72 Meg.	300	1.5
WWA-36	RB-53	.33	15	4	1	.2	.1	4 Meg.	300	3.1
WWA-38	RB-52	.50	10	3	1	.2	.1	5.4 Meg.	600	3.8
WWA-44	†	.5	15	4	1	.2	.1	5.75 Meg.	500	3.4
WWA-45	†	.5	10	3	1	.2	.1	7.5 Meg.	550	5.4
WWA-48	RB-57	.75	10	3	1	.2	.1	11.5 Meg.	850	6.5
WWA-412	RB-58	.875	10	3	1	.2	.1	17.5 Meg.	1050	8.4
WWA-416	RB-59	1	10	3	1	.2	.1	23 Meg.	1400	15.5

*Consult factory for tolerances below .05%

†Although there is no direct mil. model of the same physical size, the Dale type will meet the electrical and environmental requirements of MIL-R-93.

DALE

for Optimum Value in Metal Film Resistors
and Trimmer Potentiometers

PRECISION METAL FILM RESISTORS

(Available with Weldable Leads)

TYPE MF

Epoxy molded. Meets MIL-R-10509 (Char. D, C or E, depending on T.C.). Includes subminiature MF50 (1/20 watt).

TYPE MFF

Epoxy conformal coated. Meets electrical and environmental characteristics of MIL-R-10509F, but is dimensionally smaller. Characteristics D, C or E apply, depending on T.C. required.

*Characteristic F **Characteristic B

Tolerance: $\pm 1\%$, $\pm .5\%$, $\pm 0.25\%$, $\pm 0.10\%$ standard
Special tolerances and matching on request.

STANDARD ELECTRICAL SPECIFICATIONS

DALE TYPE	MIL. TYPE	125° C RATING (Char. C&E)	70° C RATING (Char. D)	MAX. WT. (Grams)	MAX. WORKING VOLTAGE
MF50	RN-50	1/20 w	1/10 w	.11	200
MF-1/10	RN-55	1/10 w	1/8 w	.35	200
MF-1/8	RN-60	1/8 w	1/4 w	.45	300
MF-1/4	RN-65	1/4 w	1/2 w	.84	350
MFS-1/2	RN-70	1/2 w	3/4 w	1.6	500
MF-3/4	RN-70F	3/4 w*	—	1.9	500
MF-1	RN-75	—	1 w**	4.4	500
MF-2	RN-80	—	2 w**	7.9	750
MFF-1/8	—	1/8 w	—	.40	300
MFF-1/4	—	1/4 w	—	.65	350
MFF-1/2	—	1/2 w	—	.95	500
MFF-1	—	—	1 w	2.7	500
MFF-2	—	—	2 w	4.7	750





RESISTANCE RANGE (OHMS) 1%, .5%, .25%, .1%

	T-0* (Char. D)	T-1* (Char. D)	T-2 (Char. C)	T-9 (Char. E)
MF50	24.9 Ω -100K Ω	49.9 Ω -100K Ω	100 Ω -100K Ω	100 Ω -100K Ω
MF-1/10	10 Ω -301K Ω	30.1 Ω -301K Ω	30.1 Ω -301K Ω	30.1 Ω -301K Ω
MF-1/8, MFF-1/8	10 Ω -1 Meg.	24.9 Ω -1 Meg.	30.1 Ω -499K Ω	30.1 Ω -499K Ω
MF-1/4, MFF-1/4	10 Ω -2 Meg.	24.9 Ω -2 Meg.	30.1 Ω -1 Meg.	30.1 Ω -1 Meg.
MFS-1/2, MFF-1/2	10 Ω -2.49 Meg.	24.9 Ω -2.49 Meg.	24.9 Ω -1 Meg.	24.9 Ω -1 Meg.
MF-3/4	10 Ω -2.49 Meg.	24.9 Ω -2.49 Meg.	100 Ω -1 Meg.	100 Ω -1 Meg.
MF-1, MFF-1	10 Ω -5.11 Meg.	24.9 Ω -4.02 Meg.	49.9 Ω -2.61 Meg.	49.9 Ω -2.61 Meg.
MF-2, MFF-2	30.1 Ω -10 Meg.	100 Ω -8 Meg.	100 Ω -6 Meg.	200 Ω -5.11 Meg.

*T-0 and T-1 are available in tolerance of $\pm .25\%$ and greater only.

TRIMMER POTENTIOMETERS

MILITARY GRADE WIREWOUND TRIMMERS (High Temperature, Precision) Humidity Proof (Mil. Spec.)

SERIES	ILLUSTRATION	MODEL	CONFIGURATION	STANDARD RESISTANCE & TOLERANCE	POWER RATING	OPERATING TEMPERATURE RANGE	ADJUSTMENT TURNS	HEIGHT	WIDTH	LENGTH
600	 Mil. Equiv. RT-10 PANEL MOUNT STYLES AVAILABLE	680 690 697 692	• Printed Circuit Pins 22 AWG • Hook Type Wire Solder Terminal • 28 AWG Stranded Teflon Leads • 26 AWG Solid Leads	10 ohms to 50K ohms $\pm 5\%$	1 watt at 70° C, derated to 0 at 175° C	-65° C to 175° C	15 \pm 2	.18	.32	1.00
1200	 Mil. Equiv. RT-11 PANEL MOUNT STYLES AVAILABLE	1287 1288 1299	• Printed Circuit Pins 21 AWG • Stranded Teflon Leads 28 AWG • Solder Lug	10 ohms to 100 K ohms $\pm 5\%$	1 watt at 70° C, derated to 0 at 175° C	-65° C to 175° C	25 \pm 2	.28	.31	1.25
1600	 Mil. Equiv. RT-12 PANEL MOUNT STYLES AVAILABLE	1680 1697 1690	• Printed Circuit Pins 21 AWG • Stranded Teflon Leads 28 AWG • Solder Lug	10 ohms to 100K ohms $\pm 5\%$	1 watt at 70° C, derated to 0 at 175° C	-65° C to 175° C	22 \pm 3	.19	.32	1.25
5000	 Mil. Equiv. RT-22	5050 5080 5091	• Stranded Teflon Leads 30 AWG insulated leads • Printed Circuit Pins 21 AWG, Edge Mount • Printed Circuit Pins 21 AWG	10 ohms to 50K ohms $\pm 5\%$	1 watt at 70° C, derated to 0 at 175° C	-65° C to 175° C	23 \pm 2	.22†	.50	.50
5800	 Mil. Equiv. RT-24	5850 5891 5880 5887	• 30 AWG Stranded Teflon insulated leads • Printed Circuit Pins, base mount, 22 AWG gold plated • Printed Circuit Pins, edge mount, 22 AWG gold plated • Printed Circuit Pins, edge mount, side adjust, 22 AWG gold plated	10 ohms to 50K ohms $\pm 5\%$	1 watt at 70° C, derated to 0 at 175° C	-65° C to 175° C	25 \pm 3	.145	.375	.375



RESISTIVE DEVICES

GLO-BAR THERMISTORS

Complete Selection individually skin carded on master display cards

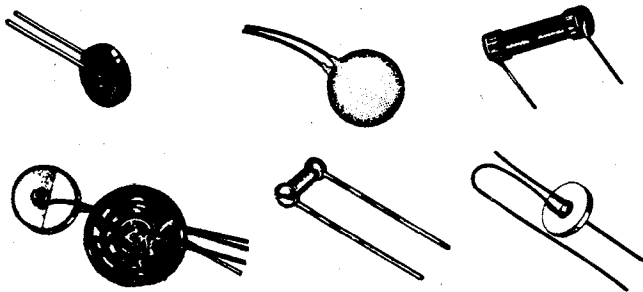

Engineered to the original manufacturer's rigid specifications, GC Chemical Fuses are exact replacements for RCA, Emerson, Zenith, etc. All GC Chemical Fuses are visual packed for quick identification. U.L. approved.

RESISTORS

1/4, 1/2, 1 & 2 watt resistors (10% Tol.) in **MOISTURE-PROOF** packages EIA approved MIL-R-11E.

BULK RESISTOR PRICES →

WATTAGE	EA. 1-9	10-49	50-99	100-UP
1/4 WATT	.13	.09	.06	\$4.32/C
1/2 WATT	.12	.085	.05	\$4.15/C
1 WATT	.17	.10	.07	\$6.47/C
2 WATT	.22	.19	.14	\$12.28/C

WRITE FOR CATALOG #FR-69 FOR COMPLETE LISTINGS

BEL[®]



CHEMICAL FUSES

GC PART NO.	WALSCO	COLOR	ORIG. MFRS. PART NO.	MFRS. STOCK NO.	BEL FUSE NO.	SP	NET
25-929-S	40-929-S	Yellow	Emerson 808238		1700-1	10	.45
25-935-S	40-935-S	Pink	RCA 945392-4		450-1	10	.45
25-937-S	40-937-S	Green	Emerson 808238		1200-1	10	.45
25-954-S	40-954-S	Black	RCA 945392-1	RCA 109079	500-1	10	.45
25-956-S	40-956-S	Blue	RCA 945392-2	RCA 109588	400-1	10	.45
25-958-S	40-958-S	Red	RCA 945392-3	RCA 109860	3-1	10	.45
25-995-S	40-995-S	Maroon	Zenith 136-66		2000-1	10	.45
25-997-S	40-997-S	Gray	Emerson 808241		1400-1	10	.45
25-976-S	40-976-S	White	Zenith 136-71		1000-1	10	.45

AUTO SUPPRESSORS

ILLUSTRATION	PART NO.	DESCRIPTION	STD. PKG.	NET
	A-833	SPARK PLUG CARBON SUPPRESSOR Fits screw-on type terminals	1	.33
	A-835	SLIP-ON TYPE SUPPRESSOR Super wire wound	1	.65
	A-836	DISTRIBUTOR MODEL SUPPRESSOR Super wire wound	1	.65
	A-831 A-834	KNURLED NUT AND BRACKET SUPPRESSORS Carbon type	1	.33
	A-829	DISTRIBUTOR TYPE SUPPRESSOR Cable type for splicing cables	24	.33
	A-830	SLIP ON CARBON TYPE SUPPRESSOR Fits all cars	1	.33
	A-832	DISTRIBUTOR MODEL SUPPRESSOR Carbon type	1	.33

**whatever electronic products
you require...**



**...you'll find it
faster in
this catalog...**

**...the world's largest catalog
of electronic
products
sold through
distributors**

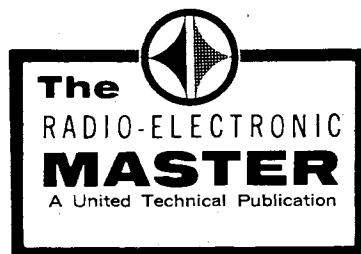



CARBON COMPOSITION RESISTORS

DIVISION OF TRW INC.

TYPE RC CARBON COMPOSITION RESISTORS

PERFORMANCE CHARACTERISTICS

These are in relation to MIL-R-11 and/or MIL-R-39008 specification limits. A performance span or range is given for each important characteristic. You know in advance the typical limits within which IRC carbon composition resistors can be expected to perform. Ask for Catalog "D".

The performance data are based on many thousands of individual tests made on random samples taken from production. The resistors are tested to MIL-R-11 and/or MIL-R-39008 and to other tests of greater severity.

APPEARANCE

IRC carbon composition resistors have a glossy brown, smooth body. The molded jacket has close dimensional tolerances for trouble-free use in high speed lead forming and inserting machines. There is no wax coating to clog equipment.

IDENTIFICATION

Resistance values are clearly indicated by standard EIA/MIL Color Code bands. Solvent-resistant paints are baked on to provide distinct, permanent color bands.

STANDARD RESISTANCE VALUES

Type RC resistors are supplied in all EIA/MIL standard values, subject to the minimum and maximum values for each type. (See table.) Other values are available on special order.



EIA/MIL COLOR CODE

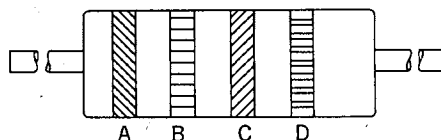

- Band A—1st significant figure
- Band B—2nd significant figure
- Band C—Number of zeros or decimal multiplier
- Band D—Tolerance
- Band E—(not shown) — Solderability

Color	Significant Figure	Multiplying Value
Black	0	1
Brown	1	10
Red	2	100
Orange	3	1,000
Yellow	4	10,000
Green	5	100,000
Blue	6	1,000,000
Violet	7	10,000,000
Gray	8	100,000,000
White	9	1,000,000,000
Gold	±5% tolerance	0.1
Silver	±10% tolerance	0.01
No color	±20% tolerance	

PACKAGING

Type RC resistors are packaged on the exclusive GRIP STRIP®, in multiples of 50.

Also, see page 1159 for RC resistors in IRC's new SNAP PAK.



SNAP PAK

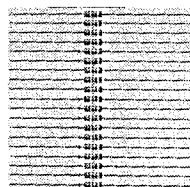

GRIP STRIP®



50 PAK

IRC TYPE	RC07	RC20	RC32	RC42
MIL Style	RC07 — RCR07	RC20 — RCR20	RC32	RC42
Rating	¼w @ 70° amb.	½w @ 70° amb.	1w @ 70° amb.	2w @ 70° amb.
Minimum Resistance	2.7 ohms *	2.7 ohms	2.7 ohms	10 ohms
Maximum Resistance	22 meg *	22 meg	22 meg	22 meg
Rated Voltage	250V	350V	500V	500V
Dimensions— Body size	.250" x .090" dia.	.390" x .140" dia.	.562" x .225" dia.	⅞" x .312" dia.
Lead size	1½" x .025" dia.	1½" x .031" dia.	1½" x .040" dia.	1½" x .045" dia.

* RC07 values below 10 ohms and above 1 meg are available on special order.

STANDARD STOCK VALUES*

10% and 5% tolerance. 10% in bold type. All values available in 5%. Values are indicated on each resistor by EIA color code.

2.7	10	39	150	560	2,200	8,200	33K	120K	470K	1.8 meg.	6.8 meg.
3.0	11	43	160	620	2,400	9,100	36K	130K	510K	2.0 meg.	7.5 meg.
3.3	12	47	180	680	2,700	10K	39K	150K	560K	2.2 meg.	8.2 meg.
3.6	13	51	200	750	3,000	11K	43K	160K	620K	2.4 meg.	9.1 meg.
3.9	15	56	220	820	3,300	12K	47K	180K	680K	2.7 meg.	10.0 meg.
4.3	16	62	240	910	3,600	13K	51K	200K	750K	3.0 meg.	11.0 meg.
4.7	18	68	270	1,000	3,900	15K	56K	220K	820K	3.3 meg.	12.0 meg.
5.1	20	75	300	1,100	4,300	16K	62K	240K	910K	3.6 meg.	13.0 meg.
5.6	22	82	330	1,200	4,700	18K	68K	270K	1.0 meg.	3.9 meg.	15.0 meg.
6.2	24	91	360	1,300	5,100	20K	75K	300K	1.1 meg.	4.3 meg.	16.0 meg.
6.8	27	100	390	1,500	5,600	22K	82K	330K	1.2 meg.	4.7 meg.	18.0 meg.
7.5	30	110	430	1,600	6,200	24K	91K	360K	1.3 meg.	5.1 meg.	20.0 meg.
8.2	33	120	470	1,800	6,800	27K	100K	390K	1.5 meg.	5.6 meg.	22.0 meg.
9.1	36	130	510	2,000	7,500	30K	110K	430K	1.6 meg.	6.2 meg.	

* Lower and higher values than standard available on special order.



RESISTOR ENGINEERING LABORATORY STOCKS

DIVISION OF TRW INC.

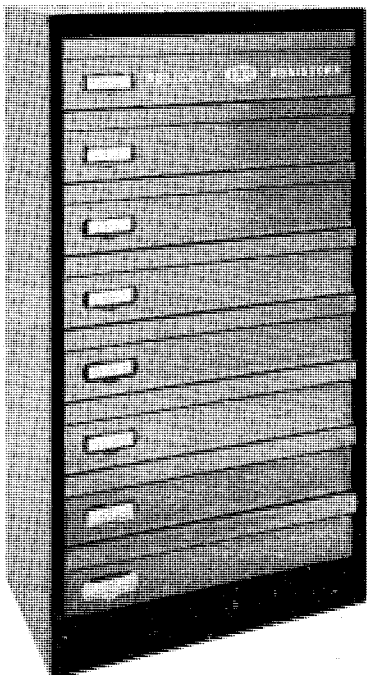

These new Engineering Laboratory Stocks were developed to give your Engineering, Model or Service Shop a complete selection of values in the popular ¼ watt (RC07), ½ watt (RC20), 1 watt (RC32) MIL-R-11, carbon composition resistors and the 2 watt (RC32 size) BWH wirewound resistors.

SNAP PAK

— an IRC exclusive, patented resistor package, that's revolutionizing the resistor market. Snap Pak permits immediate content identification and testing without product removal. Finding the desired resistor is quick and easy. Printed directly on each package is the resistor type, value and tolerance — makes sorting a cinch. No need to read color codes. Take one resistor out and the others stay in the package for fast locating the next time. Snap Pak offers protection for resistors . . . no bent or twisted leads.

¼ and ½ watt, 5% resistors are packaged ten per Snap Pak and the 1 and 2 watt, 5% types are packaged five per Snap Pak. Both are in strips of five individual Snap Paks.

Matching Snap Pak packaging with the attractive free "Inventory Control" cabinet, measuring 54" high x 27" wide x 15" deep pictured left, offers "fingertip inventory" for small resistor quantities saving you both time and money. The inventory cabinet is supplied with a complete set of indexing cards and resistance value labels — ultimate convenience for fast and easy shop use.

All-metal, sturdy "Fingertip Inventory" cabinet finished in red and black baked-on enamel, measures 54" high, 27" wide, and 15" deep.

SELECT THE WATTAGE THAT BEST SUITS YOUR REQUIREMENTS

RC07 ¼ WATT ELS22

6050 resistors total

Engineering Lab Stock of IRC RC07 ¼ watt carbon composition resistors. 121 standard 5% values from 10 ohms to 1.0 megohm. 50 resistors per value. See page 1156 for Standard Stock Values.

RC20 ½ WATT ELS23

8350 resistors total

Engineering Lab Stock of IRC RC20 ½ watt carbon composition resistors. 167 standard 5% values from 2.7 ohms to 22 megohms. 50 resistors per value. See page 1156 for Standard Stock Values.

RC32 1 WATT ELS24

4175 resistors total

Engineering Lab Stock of IRC RC32 1 watt carbon composition resistors. 167 standard 5% values from 2.7 ohms to 22.0 megohms. 25 resistors per value. See page 1156 for Standard Stock Values.

BWH 2 WATT ELS25

2575 resistors total

Engineering Lab Stock of Type BWH, 2 watts, 5% tolerance molded wirewound resistors. Type BWH is same physical size of RC32 carbon resistor — *small enough for ½ watt and 1 watt needs although rated at full 2 watts at 70°C ambient temperature.* 103 standard 5% values from 0.1 ohm to 1800 ohms. 25 resistors per value. See page 1157 for Standard Stock Values.



FILE-O-PAK DEALER STOCKS

DIVISION OF TRW INC.

NEW STOCKING CABINET FOR COMPONENTS IN SNAP PAK

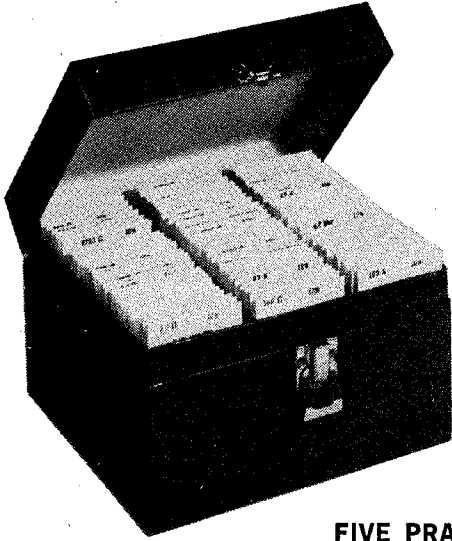

Sturdy new dealer stocking cabinets are available with a variety of practical FILE-O-PAK resistor assortments. Constructed of heavy cardboard, cabinet is covered in rich simulated red leather-like covering. Metal hinges and fastener. Heavy dividers provide nine bins for practical self-indexing of SNAP PAK. Dimensions are 8" wide, 7½" deep, 5½" high (lid closed).

SNAP PAK CONDENSES RESISTOR STOCKS

Resistors in SNAP PAK permit practical stocking in handy, compact arrangement. Package provides complete identification, cross reference, resistance value and tolerance. Resistors stay put—do not fall out when one or more are removed.

FIVE PRACTICAL RESISTOR STOCKS FOR DEALERS

IRC ASST. NO. 8 — 20 VALUES OF ½ WATT RESISTORS. Most often used resistor values cover nearly one-half of the usage of resistors. Parallel and series connections will provide coverage of most standard 10% values. Ten each RC20 ½ watt resistors, 10% tolerance, in following values: 10, 22, 47, 100, 220, 470, 1000, 2200, 4700, 10K, 22K, 47K, 100K, 220K, 470K, 1.0M, 2.2M, 4.7M, 10M, 22M. With good-looking stocking cabinet.

IRC ASST. NO. 9 — 20 VALUES OF 1 WATT RESISTORS. Best selling resistor values cover nearly 50% of resistor values used. By parallel or series connections, 80 values of 10% resistors can be covered. Five each RC32 1 watt resistors, 10% tolerance, in these values: 10, 22, 47, 100, 220, 470, 1000, 2200, 4700, 10K, 22K, 47K, 100K, 220K, 470K, 1.0M, 2.2M, 4.7M, 10M, 22M. With sturdy stocking cabinet.

IRC ASST. NO. 10 — 61 VALUES OF ¼ WATT RESISTORS. Stock includes 61 10% values of RC07 ¼ watt resistors from 10 ohms to 1.0 megohms. Because of the small size of these resistors, they are ideal for replacement in transistor radio and similar compact equipment. Suitable for single-ended replacement by bending one lead over resistor body and retaining by spaghetti tubing over lead and resistor body.

IRC ASST. NO. 11 — 84 VALUES OF ½ WATT RESISTORS. All RC20 ½ watt 10% resistors from 2.7 ohms to 22 megohms. Small enough for many transistor radio replacements and large enough for most radio and TV needs. Resistors provide more than usual insulation giving better protection from humidity. Special heat-sink action of leads assures better high temperature operation and stability. Stocking cabinet included.

IRC ASST. NO. 12 — 84 VALUES OF 1 WATT RESISTORS. Stock includes all 10% values of RC32 1 watt resistors, 10% tolerance, from 2.7 ohms to 22 megohms. This is a comprehensive stock of units frequently used by service technicians to replace lower wattage resistors which have failed. Provided increased insulation and heat-sink leads for stable operation in hot, humid conditions. Practical stocking cabinet is included.



RESISTOR KITS & ASSORTMENTS

DIVISION OF TRW INC.

RESIST-O-CABINET. A practical way to give any shop a professional appearance. Sturdy metal Resist-O-Cabinets are FREE with any of five balanced assortments. Designed for stacking, and for tidy stocks of many small parts. Resist-O-Cabinets have four non-spill drawers and 28 compartments. Overall size is 5 3/8" x 5 15/16" x 10 7/8". Blue and silver finish.

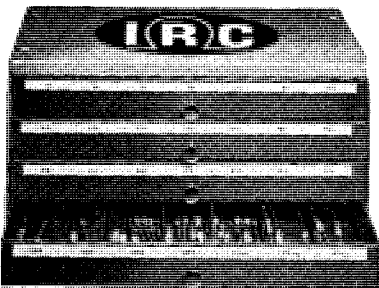

1/4 WATT ASSORTMENT #7A 150 RC07 1/4-Watt Resistors		1/2 WATT ASSORTMENT #4A 150 RC20 1/2-Watt Resistors		1 WATT ASSORTMENT #5A 125 RC32 1-Watt Resistors		2 WATT ASSORTMENT #3A 120 BWH and RC42 2-Watt Resistors		COMB. ASSORTMENT #6A 139 Insulated Resistors and Type DCF Precision Film Resistors				
Quantity	Range	Quantity	Range	Quantity	Range	Quantity	Range	Range	1/2 Watt	1 Watt	2 Watt	DCF
3	47 ohms	3	47 ohms	3	47 ohms	2	4.7 ohms	47 ohms	2	1	1	—
6	100 ohms	4	100 ohms	3	100 ohms	2	10 ohms	100 ohms	2	1	1	—
4	150 ohms	3	220 ohms	3	150 ohms	1	15 ohms	150 ohms	2	1	—	—
4	220 ohms	3	270 ohms	3	220 ohms	2	22 ohms	220 ohms	2	1	—	—
3	270 ohms	4	470 ohms	3	270 ohms	1	27 ohms	270 ohms	2	1	—	—
6	470 ohms	8	1,000 ohms	3	470 ohms	1	33 ohms	470 ohms	2	1	1	—
3	680 ohms	4	1,500 ohms	7	1,000 ohms	1	39 ohms	1,000 ohms	4	4	—	1
10	1,000 ohms	4	2,200 ohms	3	1,500 ohms	3	47 ohms	1,500 ohms	2	1	—	—
6	1,500 ohms	4	2,700 ohms	5	2,200 ohms	2	68 ohms	2,200 ohms	2	1	—	—
8	2,200 ohms	5	3,300 ohms	3	2,700 ohms	3	82 ohms	2,700 ohms	2	1	—	—
4	2,700 ohms	7	4,700 ohms	3	3,300 ohms	4	100 ohms	3,300 ohms	2	2	—	—
5	3,300 ohms	7	10K ohms	5	4,700 ohms	3	150 ohms	4,700 ohms	3	1	1	—
4	3,900 ohms	5	22K ohms	7	10K ohms	3	220 ohms	10K ohms	3	4	1	1
10	4,700 ohms	5	27K ohms	3	15K ohms	3	270 ohms	15K ohms	2	2	—	—
6	6,800 ohms	5	33K ohms	5	22K ohms	4	330 ohms	22K ohms	2	2	1	—
10	10K ohms	8	47K ohms	7	27K ohms	4	470 ohms	27K ohms	2	4	—	—
6	15K ohms	4	56K ohms	4	33K ohms	5	1,000 ohms	33K ohms	2	1	—	—
4	18K ohms	4	68K ohms	4	39K ohms	4	1,500 ohms	39K ohms	2	1	—	—
8	22K ohms	8	100K ohms	7	47K ohms	4	2,200 ohms	47K ohms	4	4	—	—
3	27K ohms	7	220K ohms	4	68K ohms	4	3,300 ohms	68K ohms	2	3	1	—
6	33K ohms	8	270K ohms	7	100K ohms	3	3,900 ohms	100K ohms	2	2	—	1
3	39K ohms	5	330K ohms	3	150K ohms	4	4,700 ohms	150K ohms	2	2	—	—
3	47K ohms	8	470K ohms	3	220K ohms	5	6,800 ohms	220K ohms	3	1	—	—
3	68K ohms	8	1.0 meg.	7	270K ohms	7	8,200 ohms	270K ohms	4	2	—	—
8	100K ohms	7	2.2 meg.	7	470K ohms	7	19K ohms	470K ohms	4	3	—	—
3	220K ohms	4	3.3 meg.	7	1.0 meg.	5	15K ohms	1.0 meg.	4	4	—	1
3	470K ohms	5	4.7 meg.	3	2.2 meg.	5	22K ohms	2.2 meg.	3	3	—	—
5	1.0 meg.	3	10.0 meg.	3	4.7 meg.	4	27K ohms	4.7 meg.	2	1	—	—
						7	47K ohms	5.0 meg.	—	—	—	1
						5	100K ohms					
						3	220K ohms					
						3	470K ohms					
						4	1.0 meg.					

BWH ASSORTMENT NO. 77

SERVICE CONVENIENCE FROM IRC

38 LOW RANGE RESISTORS

This BWH resistor assortment is a real time and work saver. Resistors are neatly mounted in a sturdy 6" x 12" molded plastic dispenser. They are removed easily, but do not fall out.

Balanced assortment of miniature wirewounds. Two each of the following values:

.27	.56	1.2	2.7	5.6
.33	.68	1.5	3.3	6.8
.39	.82	1.8	3.9	8.2
.47	1.0	2.2	4.7	

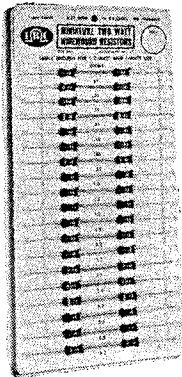

- Quick Identification—resistor value is printed on dispenser
- Instant Use—dispenser can be hung over workbench
- Fits easily in tube caddy or tool case
- Keeps leads straight for easier handling

RESIST-O-GUIDES

S-008D Resistor Color Code Chart. New color, serrated edge wheels, updated information on IRC types, MIL styles and minimum and maximum values.



HANDY-PAKS

The neatest, most compact resistor package available, and it's exclusive from IRC. Slimline plastic sleeve keeps leads straight and in place.

- Easier to identify—Type, resistance value and power rating on every Handy-Pak. Resistor color code is easily seen through the plastic.
- Handier to use—Opens at either end. Simply slide package out of plastic sleeve... withdraw the required number of resistors and slide the package into the sleeve.
- Quicker to find—Handy-Paks can be indexed by power rating and resistance. Resistors are always visible for inventory.

3 TYPES AVAILABLE — 10% tolerance.

... 1/2 watt contains 6 RC20 carbon composition resistors; 1 watt package contains 4 RC32 resistors and the 2 watt Handy-Pak contains 3 RC42 resistors.

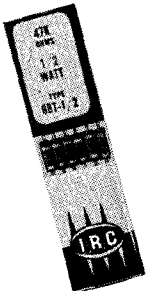



TUBULAR POWER WIREWOUND RESISTORS

DIVISION OF TRW INC.

RESISTEG COATED POWER RESISTORS need no derating. They operate at full rated power even at high resistance values. Other features include heat resistant terminals for easy soldering, ceramic cores that withstand shock and are impervious to moisture, heavy windings that handle overloads without burnout, and standard size spring loaded push-in brackets for easy mounting on sizes of 25 watts and over.

IRC Tubular Power Wirewound Resistors are standard tubular construction with lugs and/or leads for use in general applications. They are used in DC and low frequency AC circuits where appreciable power must be dissipated:

- High voltage bleeder resistors in power supplies
- Voltage dropping resistors
- Voltage divider networks
- Bias supply resistor
- RC decoupling resistor
- Filament dropping resistor
- Load resistor
- Shunt resistor

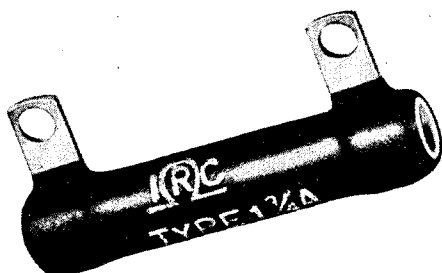

FIXED RESISTANCE TYPES

TYPE 1A—5-8 watts. Resisteg coating. Core Size: 1" long by 3/8" dia. Terminals: 13A. Tolerance: $\pm 5\%$. No mounting hardware included. Standard package: 5.

Ohms					
1	20	200	750	2250	8000
1.5	25	225	800	2500	9000
2	30	250	900	3000	10K
3	35	300	1000	3500	12.5K
4	40	350	1100	4000	15K
5	50	400	1200	4500	17.5K*
7.5	75	450	1250	5000	20K*
10	100	500	1500	6000	22.5K*
12	125	600	1750	7000	25K*
15	150	700	2000	7500	

* No. 1 Terminal

TYPE 1 3/4A—10-12 watts. Resisteg coating. Core Size: 1 3/4" long x 3/8" dia. Terminals: 13A. Tolerance: $\pm 5\%$. No mounting hardware included. Standard package: 5.

Ohms					
1	30	350	1250	7000	17.5K
1.5	35	400	1500	7500	18K
2	40	450	1750	8000	20K
3	50	500	2000	8500	22.5K
4	75	600	2250	9000	25K
5	100	700	2500	10K	30K
7.5	125	750	3000	11K	35K
10	150	800	3500	12K	40K
12	200	900	4000	12.5K	45K
15	225	1000	4500	13.5K	50K
20	250	1100	5000	15K	
25	300	1200	6000	16K	

TYPE 2C—20 watts. Resisteg coating. Core size: 2" long x 3/8" dia. Terminals: 13A. Tolerance: $\pm 5\%$. No mounting hardware included. Standard package: 5.

Ohms					
1	150	800	2750	10K	55K
2	200	900	3000	12.5K	60K
3	250	1000	3500	15K	65K
4	300	1200	4000	20K	70K
5	350	1250	4500	25K	75K
10	400	1500	5000	30K	80K
25	500	1750	6000	35K	85K*
50	650	2000	7000	40K	90K*
75	700	2250	7500	45K	95K*
100.	750	2500	8000	50K	100K*
			9000		

* No. 1 Terminal.

TYPE 2D—25 watts. Resisteg coating. Core size: 2" long x 3/8" dia. Terminals: 12A Tolerance: $\pm 5\%$. Mounting hardware included: Z-1 brackets. Standard package 1.

Ohms					
1	25	500	3000	12K	50K
2	50	750	3500	15K	60K
3	75	800	4000	20K	70K
4	100	1000	5000	25K	80K
5	150	1500	6000	30K	100K
10	200	2000	7500	35K	
15	250	2500	10K	40K	

TYPE 4D—50 watts. Resisteg coating. Core size: 4" long x 3/8" dia. Terminals: 12A. Tolerance: $\pm 5\%$. Mounting hardware included: Z-1 bracket. Standard package: 1.

Ohms					
1	50	750	4000	20K	150K
2	75	800	5000	25K	175K
3	100	1000	7500	35K	200K
4	150	1500	8000	50K	250K
5	200	2000	10K	75K	
10	250	2500	12K	100K	
25	500	3000	15K	125K	

TYPE 6 1/2E—100 watts. Resisteg coating. Core size: 6 1/2" long x 3/4" dia. Terminals: 12A. Tolerance: $\pm 5\%$. Mounting hardware included: Z-2 bracket. Standard package: 1.

Ohms					
1	25	250	2500	20K	75K
2	50	500	3000	25K	100K
3	75	750	5000	30K	
4	100	1000	7500	40K	
5	125	1500	10K	50K	
10	150	2000	15K	60K	

TYPE 8 1/2H—160-175 watts. Resisteg coating. Core size: 8 1/2" long x 1 1/8" dia. Terminals: 4A. Tolerance: $\pm 5\%$. Mounting hardware included: Z-3 brackets. Standard package: 1.

Ohms					
1	25	250	2500	20K	75K
2	50	500	3000	25K	100K
3	75	750	5000	30K	
4	100	1000	7500	40K	
5	125	1500	10K	50K	
10	150	2000	15K	60K	

TYPE 10 1/2H—200-225 watts. Resisteg coating. Core size: 10 1/2" long x 1 1/8" dia. Terminals: 4A. Tolerance: $\pm 5\%$. Mounting hardware included: Z-3 brackets. Standard package: 1.

Ohms					
1	25	250	2500	20K	75K
2	50	500	3000	25K	100K
3	75	750	5000	30K	
4	100	1000	7500	40K	
5	125	1500	10K	50K	
10	150	2000	15K	60K	



POWER & FUSE RESISTORS

DIVISION OF TRW INC.

FUSE RESISTORS

These special resistors function as a resistor under normal conditions, and as a fuse under overload conditions.



Attractive new SNAP PAK style package. Back of card contains complete replacement information.

Exact Duplicate Original Equipment Part as used in auto Radios. .33Ω and .68Ω in insulated fiberglass sleeve, 47Ω in rectangular ceramic case. Precisely wound element and superior lead solderability.

- FR.33 — .33 ohm
- FR.47 — .47 ohm
- FR.68 — .68 ohm

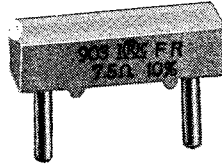

- FR5.0* — 5 ohms
- FR5.6 — 5.6 ohms
- FR7.5 — 7.5 ohms

* Suitable for 4.7Ω fuse for resistor applications.

Fuse resistors are used extensively as a surge-limiting resistor in voltage doubler circuits of TV receivers. Installation of an IRC Type FR fuse resistor in a TV set will prevent over-loading of more valuable components and possible fire due to a short circuit. The compact, modern design of the IRC fuse resistor measures only 1²⁵/₆₄" x 1¹/₃₂" x 3¹/₈". This unit is completely insulated in a rectangular ceramic case, and equipped with plug-in terminals.

AXIAL LEAD POWER WIRE WOUND RESISTORS

TYPES PW5, PW10 & PW18

STANDARD STOCK VALUES

(Available in BULK on Snap Pak)

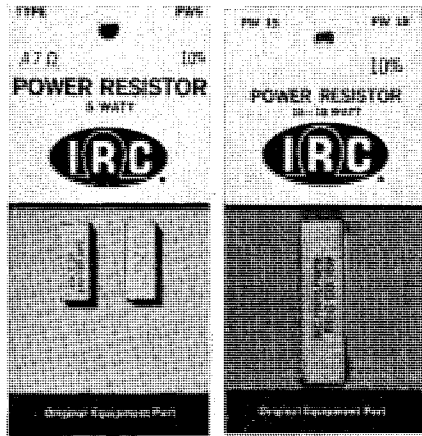

Attractive new SNAP PAK style package holds 2 each PW5 or PW10, one of PW18.

These popular axial lead power resistors are the industry favorites for 5 and 10 watt applications. The compact shape fits among other components more easily. The axial lead design speeds installation. And, the superior solderability of the terminals assures sound connections every time. A precisely wound element is sealed in a ceramic case — fully protected and insulated. Conservative rating permits

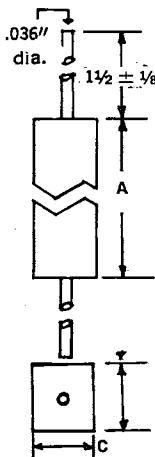

PW5				PW10				
Ohms:				Ohms:				
.15	7.5	300	2000	1	120	1000	6000	
.22	10	350	2250	2	125	1200	7000	
.27	15	400	2500	3	150	1250	7500	
.33	20	500	3000	4	200	1500	8000	
.47	25	600	3300	5	250	1750	8200	
.51	30	700	3500	7.5	300	2000	8500	
.56	40	750	3900	10	350	2250	9000	
.68	50	800	4000	15	400	2500	10,000	
.82	75	820	4500	20	500	3000	12,000	
1	100	900	5000	25	600	3300	12,500	
2	120	1000	6000	30	700	3500	15,000	
3	125	1200		40	750	3900	20,000	
4	150	1250		50	800	4000	25,000	
5	200	1500		75	820	4500		
5.6	250	1750		100	900	5000		
PW18 (Snap Pak only)								
60	810	1000	1250	6000				
600	910	1100	1400					

TYPE	DIMENSIONS		
	A	B	C
PW5	7/8 ± 1/32	3/8 ± 1/32	1 1/32 ± 1/32
PW10	1 7/8 ± 1/32	3/8 ± 1/32	1 1/32 ± 1/32
PW18	1 7/8 ± 1/32	1/2 ± 1/32	1/2 ± 1/32

continuous operation at full power. Resistance, wattage and tolerance are permanently marked on resistor body. Standard tolerance is 10%.

MULTI-RANGE POWER RESISTORS

Up to 47 values from a single resistor. 5 multi-range resistors give complete 10 watt coverage . . . 200 values from 1/2 to 50,000 ohms. No delays for a particular value, and you don't tie up inventory with odd values. Ideal for in-home servicing and weekend shop work.

Four-wire wound elements are sealed in a statite housing. It's simple to solder a basic interconnection for the required value, and cut off unused terminals. Connection diagrams included.

5 TYPES COVER 200 VALUES

- TYPE MR1. 0.5 through 15 ohms. 1, 2, 4, 8 ohm elements. 10 watts. 47 values.
- TYPE MR2. 5 through 150 ohms. 10, 20, 40, 80 ohm elements. 10 watts. 47 values.
- TYPE MR3. 50 through 1,500 ohms. 100, 200, 400, 800 ohm elements. 10 watts. 47 values.
- TYPE MR4. 500 through 15K ohms. 1K, 2K, 4K, 8K ohm elements. 10 watts. 47 values.
- TYPE MR5. 3K through 50K ohms. 10K, 10K, 15K, 15K ohm elements. 10 watts. 12 values.

MULTI-RANGE KIT #55

Complete 10 watt power resistor coverage that fits in the palm of your hand. Rigid clear plastic case holds 5 Handy-Paks, 2 of each type MR resistor. With these 10 versatile resistors you have finger-tip coverage of 200 values from 1/2 to 50,000 ohms. Fits easily in tool case or tube caddy.

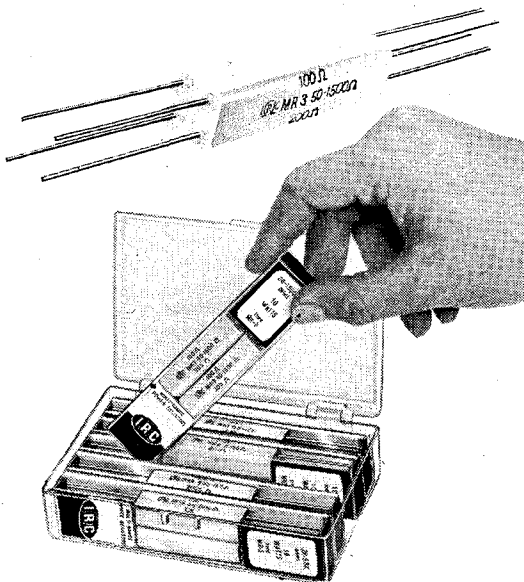

MEMCOR COMPONENTS

**POWER WIREWOUND VITREOUS ENAMELED
RESISTORS... RHEOSTATS**

... another product of

LTV

ELECTROSYSTEMS, INC.

COMPONENTS OPERATION

**MEMCOR
DIVISION**

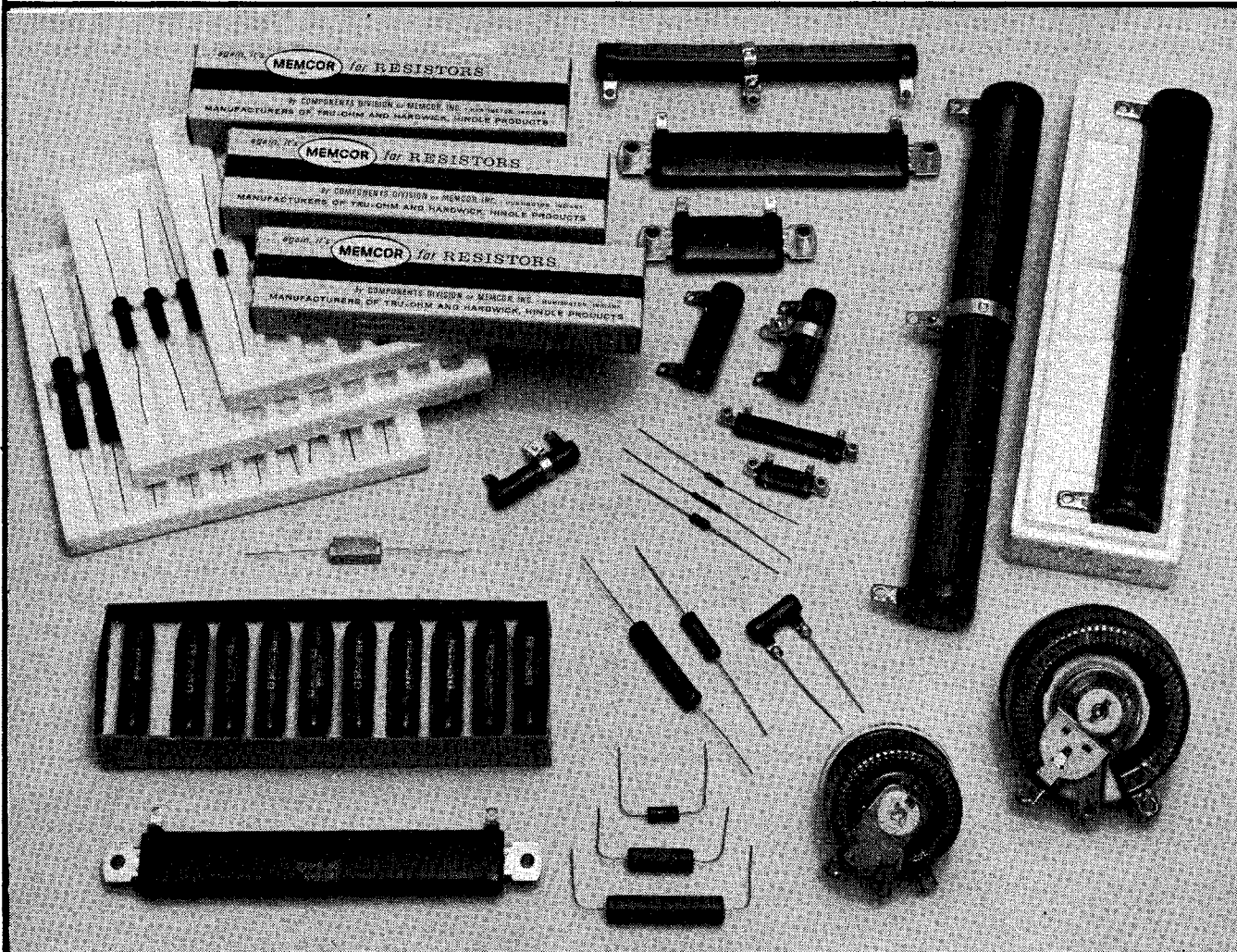

**SEE FOLLOWING PAGES
FOR COMPLETE CATALOG
OF ALL TYPES OF
RESISTORS AND RHEOSTATS
AVAILABLE**

A DIVISION OF LTV ELECTROSYSTEMS, INC.

MEMCOR COMPONENTS

... VAL 10
... FRL 5 ... FRL 10

Originators of TRU-OHM & HARDWICK, HINDLE Products

RESISTORS
POWER
WIRE WOUND
VITREOUS ENAMELED

VITREOUS AXIAL LEADS VAL 10 (10 WATTS)		Ohms	Stock No.	Ohms	Stock No.	Ohms	Stock No.	Ohms	Stock No.	Ohms	Stock No.
CORE: 5/16" x 1 1/8" WEIGHT: .014 LBS.		4.7	2905B	40	2919	360	2935B	1800	2951	9100	2969A
Ohms		5	2906	43	2919A	390	2936	2000	2952	10K	2970
Stock No.		5.1	2906A	47	2920	400	2937	2200	2953	11K	2970A
1	2901A	5.6	2906B	50	2921	430	2937A	2400	2953A	12K	2971
1.1	2901B	6.2	2906C	51	2921A	450	2937B	2500	2954	13K	2971A
1.2	2901C	6.8	2906D	56	2922	470	2938	2700	2955	14K	2971B
1.3	2901D	7.5	2907	62	2922A	500	2939	3000	2956	15K	2972
1.5	2902	8.2	2907A	68	2923	510	2939A	3300	2957	16K	2972A
1.6	2902A	9.1	2907B	75	2924	560	2940	3500	2957A	17K	2972B
1.8	2902B	10	2908	82	2925	600	2941	3600	2957B	18K	2973
2	2903	11	2908A	91	2925A	620	2941A	3900	2958	20K	2974
2.2	2903A	12	2909	100	2926	670	2942	4000	2959	22K	2975
2.4	2903B	13	2909A	110	2926A	680	2942A	4300	2959A	24K	2975A
2.7	2903C	15	2910	120	2927	700	2943	4500	2959B	25K	2976
3	2904	16	2910A	130	2927A	750	2944	4700	2960	27K	2977
3.3	2904A	18	2911	150	2928	800	2945	5000	2961	30K	2978
3.6	2904B	20	2912	160	2928A	820	2946	5100	2961A	33K	2979
3.9	2904C	22	2912A	180	2929	900	2947	5600	2962	35K	2979A
4	2905	24	2912B	200	2930	910	2947A	6000	2963	36K	2979B
4.3	2905A	25	2913	220	2931	1000	2948	6200	2963A	39K	2980
		27	2915	240	2931A	1100	2948A	6800	2964	40K	2981
		30	2916	250	2932	1200	2949	7000	2965	43K	2981A
		33	2917	270	2933	1300	2949A	7500	2966	45K	2981B
		35	2917A	300	2934	1400	2949B	8000	2967	47K	2982
		36	2917B	330	2935	1500	2950	8200	2968	50K	2983
		39	2918	350	2935A	1600	2950A	9000	2969	51K	2983B

These widely-used fixed wire wound vitreous enameled resistors have solidly anchored welded tabs (lugs) and shock-absorbing mounting brackets to withstand vibration. Multi-layer vitreous enamel coating locks the uniformly-wound resistance wire in position and also seals out moisture. MEMCOR resistors have a high-temperature stability and a com-

patible coefficient of expansion which prevents crazing and cracking.

MEMCOR resistors have a standard tolerance of $\pm 5\%$ on all values above one OHM and a $\pm 10\%$ tolerance on resistance values lower than one OHM (available in closer tolerances).

All MEMCOR resistors listed in this section manufactured to the

rigid requirements of MIL-R-26 Specifications . . . MEMCOR resistors meet and exceed all requirements of this specification.

FR and FRL TYPES

MEMCOR fixed wire wound vitreous enameled types in 5, 10 and 20 watt sizes (FRL) are light enough to be mounted by attached leads and are also available without (FR) tuned leads.

VITREOUS FIXED LEADS FRL 5 (5 WATTS)		Ohms	Stock No.	Ohms	Stock No.	Ohms	Stock No.	Ohms	Stock No.
CORE: 5/16" x 3/8" x 1" WEIGHT: .012 LBS. MOUNTING BY LEADS		3	1005	100	1019	800	1033	4500	1047
Ohms		4	1006	125	1020	900	1034	5000	1048
Stock No.		5	1007	150	1021	1000	1035	6000	1049
.5	1001	7.5	1008	200	1022	1100	1036	7000	1050
1	1002	10	1009	225	1023	1200	1037	7500	1051
1.5	1003	12	1010	250	1024	1250	1038	8000	1052
2	1004	15	1011	300	1025	1500	1039	9000	1053
		20	1012	350	1026	1750	1040	10K	1054
		25	1013	400	1027	2000	1041	12.5K	1055
		30	1014	450	1028	2250	1042	15K	1056
		35	1015	500	1029	2500	1043	17.5K	1057
		40	1016	600	1030	3000	1044	20K	1058
		50	1017	700	1031	3500	1045	22.5K	1059
		75	1018	750	1032	4000	1046	25K	1060

VITREOUS FIXED LEADS FRL 10 (10 WATTS)		Ohms	Stock No.	Ohms	Stock No.	Ohms	Stock No.	Ohms	Stock No.
CORE: 5/16" x 3/8" x 1 1/4" WEIGHT: .019 LBS. MOUNTING BY LEADS		3	1105	100	1119	800	1133	4500	1147
Ohms		4	1106	125	1120	900	1134	5000	1148
Stock No.		5	1107	150	1121	1000	1135	6000	1149
.5	1101	7.5	1108	200	1122	1100	1136	7000	1150
1	1102	10	1109	225	1123	1200	1137	7500	1151
1.5	1103	12	1110	250	1124	1250	1138	8000	1152
2	1104	15	1111	300	1125	1500	1139	8500	1153
		20	1112	350	1126	1750	1140	9000	1154
		25	1113	400	1127	2000	1141	10K	1155
		30	1114	450	1128	2250	1142	11K	1156
		35	1115	500	1129	2500	1143	12K	1157
		40	1116	600	1130	3000	1144	12.5K	1158
		50	1117	700	1131	3500	1145	13.5K	1159
		75	1118	750	1132	4000	1146	15K	1161

MEMCOR COMPONENTS

A DIVISION OF LTV ELECTROSYSTEMS, INC.

... FR 25 ... FR 50
... FR 100 ... FR 160 ... FR 200

Originators of TRU-OHM & HARDWICK, HINDLE Products

RESISTORS
POWER
WIRE WOUND
VITREOUS ENAMELED

VITREOUS FIXED FR 25 (25 WATTS) CORE: $\frac{3}{16}$ " x $\frac{3}{16}$ " x 2" WEIGHT: .051 LBS. MTG. BRKT.: P3747	Ohms	Stock No.	Ohms	Stock No.	Ohms	Stock No.	Ohms	Stock No.	Ohms	Stock No.
	1	1301	75	1310	1000	1321	6000	1330	35K	1338
2	1302	100	1311	1500	1323	7500	1331	40K	1339	
3	1303	150	1312	2000	1324	10K	1332	50K	1340	
4	1304	200	1313	2500	1325	12K	1333	60K	1341	
5	1305	250	1314	3000	1326	15K	1334	70K	1342	
10	1306	500	1317	3500	1327	20K	1335	75K	1343	
25	1308	750	1318	4000	1328	25K	1336	80K	1344	
50	1309	800	1319	5000	1329	30K	1337	100K	1345	

VITREOUS FIXED FR 50 (50 WATTS) CORE: $\frac{3}{8}$ " x $\frac{3}{8}$ " x 4" WEIGHT: .082 LBS. MTG. BRKT.: P3747	Ohms	Stock No.	Ohms	Stock No.	Ohms	Stock No.	Ohms	Stock No.	Ohms	Stock No.
	1	1401	100	1410	2000	1421	12K	1430	75K	1439
2	1402	150	1411	2500	1422	12.5K	1431	100K	1440	
3	1403	200	1412	3000	1423	15K	1432	125K	1441	
4	1404	250	1413	4000	1424	20K	1433	150K	1442	
5	1405	500	1416	5000	1425	25K	1434	175K	1443	
10	1406	750	1417	6000	1426	30K	1435	200K	1444	
25	1407	800	1418	7500	1427	35K	1436	225K	1445	
50	1408	1000	1419	8000	1428	40K	1437	250K	1446	
75	1409	1500	1420	10K	1429	50K	1438			

VITREOUS FIXED FR 100 (100 WATTS) CORE: $\frac{3}{8}$ " x $\frac{1}{2}$ " x $6\frac{1}{2}$ " WEIGHT: .200 LBS. MTG. BRKT.: P3689	Ohms	Stock No.	Ohms	Stock No.	Ohms	Stock No.	Ohms	Stock No.	Ohms	Stock No.
	1	1501	75	1509	1500	1518	20K	1529	75K	1537
2	1502	100	1510	2000	1519	25K	1530	100K	1538	
3	1503	125	1511	2500	1520	30K	1531			
4	1504	150	1512	3000	1521	35K	1532			
5	1505	250	1513	5000	1525	40K	1533			
10	1506	500	1514	7500	1526	50K	1534			
25	1507	750	1515	10K	1527	60K	1535			
50	1508	1000	1516	15K	1528	70K	1536			

VITREOUS FIXED FR 160 (160 WATTS) CORE: $1\frac{1}{8}$ " x $\frac{3}{4}$ " x $8\frac{1}{2}$ " WEIGHT: .445 LBS. MTG. BRKT.: P4898	Ohms	Stock No.	Ohms	Stock No.	Ohms	Stock No.	Ohms	Stock No.	Ohms	Stock No.
	1	1601	75	1610	1500	1618	20K	1629	80K	1637
2	1602	100	1611	2000	1619	25K	1630	100K	1638	
3	1603	125	1611A	2500	1620	30K	1631			
4	1604	150	1612	3000	1621	35K	1632			
5	1605	250	1614	5000	1625	40K	1633			
10	1606	500	1615	7500	1626	50K	1634			
25	1608	750	1616	10K	1627	60K	1635			
50	1609	1000	1617	15K	1628	75K	1636			

VITREOUS FIXED FR 200 (200 WATTS) CORE: $1\frac{1}{8}$ " x $\frac{3}{4}$ " x $10\frac{1}{2}$ " WEIGHT: .740 LBS. MTG. BRKT.: P4898	Ohms	Stock No.	Ohms	Stock No.	Ohms	Stock No.	Ohms	Stock No.	Ohms	Stock No.
	1	1701	75	1709	2000	1717	25K	1728		
2	1702	100	1710	2500	1718	30K	1729			
3	1703	150	1711	3000	1719	35K	1730			
4	1704	250	1712	5000	1723	40K	1731			
5	1705	500	1713	7500	1724	50K	1732			
10	1706	750	1714	10K	1725	60K	1733			
25	1707	1000	1715	15K	1726	75K	1734			
50	1708	1500	1716	20K	1727	100K	1735			

ADJUSTABLE VALUE RESISTORS

MEMCOR adjustable resistors are used in applications where it is necessary to make adjustment in resistance periodically... where intermediate values of resistance are needed... or when multi-tabs are required. The AR types are especially useful in laboratories for experimental work, circuit design, etc.

A section of the winding is exposed on one side to enable the adjustment band to make contact at any desired point. This adjustable band **should not** be moved unless the screw holding it in position is completely loosened to prevent abrading or possible damage to the resistance wire.

Adjustable lugs are formed to the exact contour of the body of the resistor to assure positive contact with the exposed section of winding. Standard adjustable bands are screw-driven style and have an embossed area on the lug.

Special adjustable lugs are available with a silver contact... also, bakelite thumb screw type bands are available.

The AR wattage ratings (and the $\pm 10\%$ tolerance) given in this section are for **the entire** resistor. Never exceed the maximum rating through any portion of the resistor.

MEMCOR COMPONENTS

A DIVISION OF LTV ELECTROSYSTEMS, INC.

... MOR 10 ... MOR 20
... OR 30 ... OR 40 ... OR 55

Originators of TRU-OHM & HARDWICK, HINDLE Products

RESISTORS
POWER
WIRE WOUND
VITREOUS ENAMELED

 <p>VITREOUS MIDGET OVAL MOR 10 (10 WATTS) CORE: 3/8" x 3/4" LENGTH: 1 1/8" MTG. CENTERS: 1"</p>	Ohms	Stock No.	Ohms	Stock No.	Ohms	Stock No.	Ohms	Stock No.
	1	3001	30	3009	250	3017	1500	3025
	2	3002	40	3010	300	3018	1750	3026
	5	3003	50	3011	400	3019	2000	3027
	7.5	3004	75	3012	500	3020	2500	3028
	10	3005	100	3013	600	3021	3000	3029
	15	3006	125	3014	750	3022	4000	3030
	20	3007	150	3015	1000	3023	5000	3031
	25	3008	200	3016	1250	3024		
<p>VITREOUS MIDGET OVAL MOR 20 (20 WATTS) CORE: 3/8" x 2" LENGTH: 2 5/8" MTG. CENTERS: 2 1/8"</p>	Ohms	Stock No.	Ohms	Stock No.	Ohms	Stock No.	Ohms	Stock No.
	1	3201	75	3209	800	3217	4000	3225
	2	3202	100	3210	1000	3218	5000	3226
	5	3203	150	3211	1250	3219	6000	3227
	10	3204	200	3212	1500	3220	7500	3228
	15	3205	250	3213	2000	3221	10K	3229
	25	3206	300	3214	2500	3222	12.5K	3230
	40	3207	400	3215	3000	3223	15K	3231
	50	3208	500	3216	3500	3224	20K	3232

OVAL (FLAT CORE) RESISTORS

MEMCOR wire wound flat core resistors are applicable for individual and/or stack mounting. Their high watt rating per unit of space and the bracket construction which facilitates stacking (integral mounting brackets are supplied as standard)... make the MOR and OR types space savers par excellence.

The line of ovals (OR) was designed particularly for applications where available space is limited... and the supplementary line of midget ovals (MOR) are

very desirable for applications where the size of the components must be kept to an absolute minimum. The through bracket helps dissipate heat and reduces hot spots. This permits higher wattage dissipation without requiring additional space.

When stack mounted, the OR and MOR resistors should be derated. For an ambient temperature not higher than 40°C, the maximum rise of these resistors will not exceed 300°C. when mounted on a steel panel.

Tapped or adjustable ovals are available.

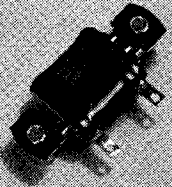
 <p>VITREOUS OVAL OR 30 (30 WATTS) CORE: 3/8" x 1" x 1 1/4" WEIGHT: .055 LBS.</p>	Ohms	Stock No.	Ohms	Stock No.	Ohms	Stock No.	Ohms	Stock No.
	1	3301	40	3306A	500	3313	5000	3323
	1.5	3301A	50	3307	750	3314	7500	3324
	2	3302B	75	3307A	1000	3315	10K	3325
	3	3302	100	3308	1500	3317		
	5	3303	150	3309	2000	3318		
	10	3304	200	3310	2500	3319		
	15	3305	250	3311	3000	3320		
	25	3306	400	3312	4000	3322		
<p>VITREOUS OVAL OR 40 (40 WATTS) CORE: 3/8" x 1" x 2" WEIGHT: .075 LBS.</p>	Ohms	Stock No.	Ohms	Stock No.	Ohms	Stock No.	Ohms	Stock No.
	1	3401	25	3406	400	3412	3500	3421
	1.5	3401A	40	3406A	500	3413	5000	3423
	2	3402A	50	3407	750	3414	7500	3424
	3	3402	75	3407A	1000	3415	10K	3425
	4	3403A	100	3408	1500	3417	15K	3426
	5	3403	150	3409	2000	3418	20K	3427
	7.5	3404A	200	3410	2500	3419	25K	3428
	10	3404	250	3411	3000	3420		
<p>VITREOUS OVAL OR 55 (55 WATTS) CORE: 3/8" x 1" x 3 1/2" WEIGHT: .130 LBS.</p>	Ohms	Stock No.	Ohms	Stock No.	Ohms	Stock No.	Ohms	Stock No.
	1	3501	25	3506	400	3512	4000	3522
	1.5	3501A	40	3506A	500	3513	5000	3523
	2	3502A	50	3507	750	3514	7500	3524
	3	3502	75	3507A	1000	3515	10K	3525
	4	3503A	100	3508	1500	3517	15K	3526
	5	3503	150	3509	2000	3518	20K	3527
	7.5	3504A	200	3510	2500	3519	25K	3528
	10	3504	250	3511	3000	3520	30K	3529

MOULDED SILICONE RESISTORS

These resistors will operate at 350°C. (660°F.) and will withstand thermal shocks to minus 55°C. Because of the moulded construction the resistors are effectively hermetically sealed and will withstand severe moisture conditions without deterioration.

The construction of the resistors are uniform in all dimensions within a few thousandths of an inch, which facilitates their use in automatic-insertion machinery... for which use they may be obtained specially packaged. They will improve the appearance of any assembly in which they are used.

Temperature co-efficients of plus or minus 20 parts per million per C. degree are standard.

The moulding compound used in these resistors was developed through research and development extending over several years, and represents a marked advance in the "state-of-the-art" for such compounds.



NYTRONICS, INC.® Resistors

Precision Wire-Wound Resistors

Miniaturized
High Reliability
Highly Stable
Meets MIL-R-39005 and MIL-R-93

Tolerance 1% to .001%

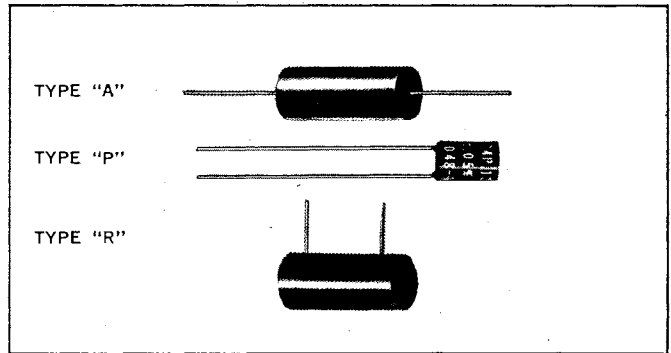

Nytronics specializes in the design and manufacture of ultra-stable, high reliability, precision wire wound resistors that meet the circuit applications of complex systems.

TYPE #	D (IN.)	L (IN.)	LEADS (AWG)	MAX R (OHMS)	MAX P (WATTS)	MAX V (VOLTS)	MIL TYPE #	TYPE #	D (IN.)	L (IN.)	S (IN.)	LEADS (AWG)	MAX R (OHMS)	MAX P (WATTS)	MAX V (VOLTS)	MIL TYPE #
*A 1003	.100	3/16	24	50K	.050	50		P 2504	1 4	1 4	.150	22	350K	.100	150	
A 1206	1/8	3/8	22 or 24	130K	.063	150		P 2505	1/4	5 16	.150	22	450K	.125	300	
A 1208	1/8	1/2	22 or 24	170K	.100	150		P 2506	1 4	3/8	.150	22	550K	.188	150	
A 1506	.150	3/8	22 or 24	130K	.100	150		P 2508	1 4	1/2	.150	22	700K	.250	300	
A 1508	.150	1/2	22 or 24	170K	.125	150		P 2510	1 4	5 8	.150	22	900K	.333	300	
A 1806	3/16	3/8	22 or 24	200K	.125	150		P 2805	.280	5.16	.200	22	450K	.125	300	RBR 71
A 1808	3/16	1/2	22 or 24	260K	.188	150		P 3108	5 16	1 2	.200	22	1.25M	.375	300	
A 2504	1/4	1/4	24	250K	.125	150		P 3706	3/8	3 8	.200	22	1.00M	.250	300	
A 2505	1/4	5/16	22 or 24	300K	.125	150		P 3708	3/8	1 2	.200	22	1.50M	.375	300	RBR 70
A 2506	1/4	3/8	22 or 24	350K	.188	150	RBR 56	P 3712	3/8	3/4	.200	22	2.00M	.625	600	
A 2508	1/4	1/2	22 or 24	500K	.250	300	RBR 55	P 5008	1/2	1 2	.300	22	1.75M	.500	300	
A 2510	1/4	5/8	22 or 24	800K	.333	300		P 5016	1 2	1	.300	22	3.50M	1.000	600	
A 2512	1/4	3/4	20 or 22	1.00M	.500	600	RBR 54	SPECIFY TYPE "P" FOR PRINTED CIRCUIT LEADS.								
A 2516	1/4	1	20 or 22	1.25M	.500	600		MIL STYLE CROSS REFERENCE CHART								
A 3106	5/16	3/8	22 or 24	1.00M	.250	300		OLD MIL-R-9444 PART NUMBER	NYTRONICS' PART NUMBER		NEW USAGE MIL-R-93 PART NUMBER					
A 3112	5/16	3/4	20 or 22	1.20M	.500	300		AFRT 10	A 2508		RB 55					
A 3114	5/16	7/8	20	2.50M	.500	600		AFRT 11	A 2512		RB 54					
A 3116	5/16	1	20	2.50M	.625	600		AFRT 12	A 3712		RB 53					
A 3708	3/8	1/2	20	1.75M	.375	300		AFRT 13	A 3716		RB 52					
A 3709	3/8	9/16	20	2.50M	.438	300		AFRT 14	A 5016		RB 57					
A 3710	3/8	5/8	20	3.00M	.500	300		AFRT 15	A 5024		RB 58					
A 3712	3/8	3/4	20	4.00M	.625	600	RBR 53	AFRT 16	A 5032		RB 59					
A 3716	3/8	1	20	5.00M	.750	600	RBR 52	AFRT 17	L 5008		RB 08					
A 3720	3/8	1-3/16	20	5.00M	1.000	600		AFRT 18	L 5010		RB 16					
A 5008	1/2	1/2	20	3.50M	.500	300		AFRT 19	L 5016		RB 17					
A 5010	1/2	5/8	20	4.50M	.625	300		AFRT 20	L 5024		No equivalent					
A 5014	1/2	7/8	20	8.00M	.875	600		AFRT 21	L 5032		No equivalent					
A 5016	1/2	1	20	10.00M	1.000	600	RBR 57	No equivalent	A 2506		RB 56					
A 5020	1/2	1-1/4	20	12.00M	1.250	600		No equivalent	L 6220		RB 18					
A 5024	1/2	1-1/2	20	15.00M	1.500	900	RBR 58	No equivalent	L 8734		RB 19					
A 5028	1/2	1-3/4	20	18.00M	1.750	900		No equivalent	P 2805		RB 71					
A 5032	1/2	2	20	20.00M	2.000	1200	RBR 59	No equivalent	P 3708		RB 70					
A 6209	5/8	9/16	20	4.50M	.750	300		No equivalent								
A 6220	5/8	1-1/4	20	15.00M	1.500	600		No equivalent								
A 7520	3/4	1-1/4	20	20.00M	2.000	600		No equivalent								

*Specify Type "R" for Radial Leads, and Type "A" for Axial Leads.

In addition to precision resistors, Nytronics offers a line of complete networks utilizing our extreme engineering knowhow. The components comprising these networks are carefully selected and matched for accuracy and T.C., pre-wired and tested ready for installation as a complete assembly.



NYTRONICS, INC.® / PRECISION RESISTOR DIVISION

PRICES

All prices listed in The MASTER are subject to change without notice — they should not be considered final.

Get quick-on-the-spot quotations from your distributor who subscribes to the up-to-the-minute

UNITED *Pricing Reports*

The Perpetual Pricing System for Electronic Parts and Equipment



- Over 750 manufacturers
- Over 400,000 catalog numbers tabulated with current prices
- Revised pages mailed semi-weekly: insert new pages—discard old pages
- Compression type loose-leaf binder for rapid replacement of revised pages
- Weekly summary sheet—Ups, Downs, Additions, Deletions

For complete details and subscription rates write to:



UNITED PRICING REPORTS

A UNITED TECHNICAL PUBLICATION

645 STEWART AVENUE, GARDEN CITY, N. Y. 11530

DELIVERY

Delivery is often dependent on availability of raw materials. Check with your distributor for delivery information at the time you place your order.

series 99 MOLDED axial lead vitreous enameled resistors

- **FIRST MOLDED WIREWOUND, VITREOUS ENAMEL RESISTOR**
- **INSULATED! Meets 1000 VAC Test**
- **WITHSTANDS 1500°F Temperatures without Distortion**
- **RESISTS Chipping, Breaking**
- **VITRIFIED MARKINGS, Resist Abrasion and Active Solvents**
- **UNIFORM SIZE Permits Clip-Mounting with Significant Heat Sink Benefits**
- **HIGH OVERLOAD CAPABILITY**

vitreous enamel coating by **molding** instead of the conventional "dip" process. The dimensionally consistent and thicker coating that results, guarantees a 1000 VAC insulation rating plus unparalleled capability for withstanding very high temperatures, high humidity and immersion in salt solution.

These resistors are normally mounted by their axial leads. However, their consistent form also permits mounting in clips with heat sink benefits up to 100% (see "Clips" lower left). Resistor markings are also vitreous and will not burn off even under extreme overloads. Resistance tolerance is $\pm 5\%$. Series 99 resistors meet the requirements of MIL-R-26 for "insulated" resistors. See Catalog 101 or Catalog 50 for specific MIL types.

An exclusive technique (U.S. Patent No. 3,229,237) permits application of the

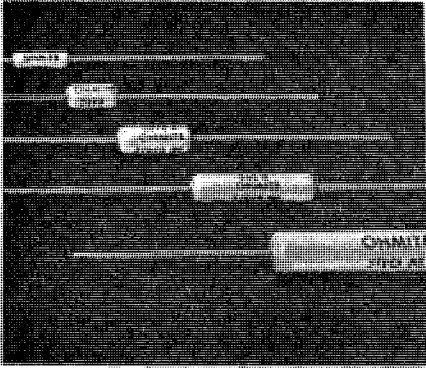

SERIES 99 STOCK PRICES 1-9 QTY.

Ohms Range*	1½	2¼	Watts 3¼	5	11
1.0 - 1K	\$.62	\$.60	\$.59	\$.62	\$.68
1100 - 5K	.66	.64	.62	.66	.73
5100 - 10K			.66	.70	.84
11K - 20K				.78	.95
22K - 40K				.82	1.00
43K - 51K					1.12

*Actual stock values and resistance limits are indicated in stock tables.

MOUNTING CLIPS

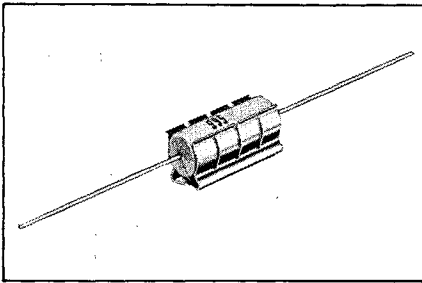

Uniform shape and consistent dimensions of Series 99 and 88 (pages 6-7) resistors, permits them to be conveniently mounted in clips. If the clip is on a metal surface, the wattage capability of the resistor can increase by as much as 100%. Holes in clip base permit fastening to chassis by means of machine screws, eyelets or rivets.

CLIPS for SERIES 99 and 88* RESISTORS

Watts	Resistor Series	Clip Stock No.	Net \$ 1-99
1½	99	5900	.20
2¼	99	5902	.20
3	88	5904	.20
3¼	99	5904	.20
5	88	5905	.20
5	99	5906	.20
10	88	5909	.20
11	99	5908	.20

* See pages 6 and 7 for Series 88 resistors.

1½ WATT

.422"x.125" Dia. Style 995-1A Avg. Wt., .0009 lb.

Ohms	Stock No.	Max. Amps	Ohms	Stock No.	Max. Amps
1.0	4030	1.24	75	4087	.141
1.1	4031	1.17	82	4089	.135
1.2	4032	1.12	91	4091	.128
1.3	4033	1.08	100	4092	.123
1.5	4034	1.00	110	4093	.117
1.6	4035	.97	120	4094	.112
1.8	4036	.91	130	4095	.108
2.0	4037	.87	150	4096	.100
2.2	4038	.83	160	4097	.097
2.4	4039	.79	180	4098	.091
2.7	4041	.75	200	4099	.087
3.0	4042	.71	220	4100	.083
3.3	4043	.67	240	4101	.079
3.6	4044	.65	250	4102	.077
3.9	4045	.62	270	4103	.075
4.0	4046	.61	300	4104	.071
4.3	4047	.59	330	4105	.067
4.7	4048	.56	350	4105A	.065
5.0	4049	.55	360	4106	.064
5.1	4050	.54	390	4107	.062
5.6	4051	.52	400	4108	.061
6.2	4053	.49	430	4109	.059
6.8	4054	.47	450	4109A	.058
7.5	4056	.45	470	4110	.056
8.2	4058	.43	500	4111	.055
9.1	4060	.41	510	4112	.054
10	4061	.39	560	4113	.052
11	4062	.37	600	4114	.050
12	4063	.35	620	4115	.049
13	4064	.34	680	4116	.047
15	4065	.32	700	4117	.046
16	4066	.31	750	4118	.045
18	4067	.29	800	4119	.043
20	4068	.27	820	4120	.043
22	4069	.26	900	4121	.041
24	4070	.25	910	4122	.041
25	4071	.25	1000	4123	.039
27	4072	.24	1100	4124	.037
30	4073	.22	1200	4125	.035
33	4074	.21	1300	4126	.034
35	4074A	.207	1400	4126A	.033
36	4075	.200	1500	4127	.032
39	4076	.196	1600	4128	.031
40	4077	.193	1800	4129	.029
43	4078	.187	2000	4130	.027
47	4079	.179	2200	4131	.026
50	4080	.173	2400	4132	.025
51	4081	.171	2500	4133	.025
56	4082	.164	2700	4134	.024
62	4084	.156	3000	4135	.022
68	4085	.149			

2¼ WATT

.375"x.188" Dia. Style 995-2A Avg. Wt., .0018 lb.

Ohms	Stock No.	Max. Amps	Ohms	Stock No.	Max. Amps
1.0	3860	1.50	68	3916	.18
1.1	3861	1.43	75	3918	.17
1.2	3862	1.37	82	3920	.16
1.3	3863	1.31	91	3922	.16
1.5	3864	1.22	100	3923	.15
1.6	3865	1.18	110	3924	.14
1.8	3866	1.11	120	3925	.14
2.0	3867	1.05	130	3926	.13
2.2	3868	1.01	150	3927	.12
2.4	3869	.97	160	3928	.12
2.7	3871	.91	180	3929	.11
3.0	3872	.86	200	3930	.10
3.3	3873	.82	220	3931	.10
3.6	3874	.79	240	3932	.097
3.9	3875	.76	250	3933	.094
4.0	3876	.73	270	3934	.091
4.3	3877	.72	300	3935	.086
4.7	3878	.69	330	3936	.082
5.0	3879	.67	350	3937	.080
5.1	3880	.66	360	3938	.079
5.6	3881	.63	390	3939	.076
6.2	3883	.60	400	3940	.075
6.8	3884	.57	430	3941	.072
7.5	3886	.55	450	3942	.071
8.2	3888	.52	470	3943	.069
9.1	3890	.50	500	3944	.067
10	3891	.47	510	3945	.066
11	3892	.45	560	3946	.063
12	3893	.43	600	3947	.061
13	3894	.41	620	3948	.060
15	3895	.39	680	3949	.057
16	3896	.37	700	3950	.056
18	3897	.35	750	3951	.055
20	3898	.33	800	3952	.053
22	3899	.32	820	3953	.052
24	3900	.31	900	3954	.050
25	3901	.30	910	3955	.050
27	3902	.29	1000	3956	.047
30	3903	.27	1100	3957	.045
33	3904	.26	1200	3958	.043
35	3905	.25	1300	3959	.041
36	3906	.25	1400	3960	.040
39	3907	.24	1500	3961	.039
40	3908	.24	1600	3962	.037
43	3909	.23	1800	3963	.035
47	3910	.22	2000	3964	.033
50	3911	.21	2200	3965	.032
51	3912	.21	2400	3966	.031
56	3913	.20	2500	3967	.030
62	3915	.19	2700	3968	.028
			3000	3969	.027

*ITEMS APPEARING IN BOLD PRINT ARE POPULAR VALUES AND ARE USUALLY STOCKED BY AUTHORIZED OHMITE DISTRIBUTORS

OHMITE**type 884 Riteohm® Resistors—1% tolerance**

**molded
for uniform
shape and size**

miniature precision resistors—1% tolerance

OHMICONE® molded • wirewound • aged for stability
• insulated for 1000 volts • low T.C.

Type 884 Riteohm® Resistors are stocked in power ratings of 3, 5 and 10 watts depending upon resistance. Single layer wound on ceramic cores, Riteohm resistors feature a pressure-molded coating of tough, resilient Ohmicone® silicone-ceramic material which meets the MIL-R-26, 1000 VAC insulation test. Riteohms are aged for long term stability and exhibit negligible inductance at audio frequencies. Temperature coefficient of resistance is $\pm 10 \text{ppm}/^\circ\text{C}$ for most values. Values shown are based on the MIL-Bell system of standard values. For non-standard values, closer tolerances, etc. contact your local Ohmite office.

3 WATTS			3 WATTS			3 WATTS			3 WATTS		
Rating in Free Air for Resistance Values to 13.3K Ohms			Rating in Free Air for Resistance Values to 13.3K Ohms			Rating in Free Air for Resistance Values to 13.3K Ohms			Rating in Free Air for Resistance Values to 13.3K Ohms		
Ohms	Stock No. ²	Max. Volts	Ohms	Stock No. ²	Max. Volts	Ohms	Stock No. ²	Max. Volts	Ohms	Stock No. ²	Max. Volts
0.100	80013	.547	3.83	80733	3.39	21.5	81453	8.03	121	82173	19.1
0.121	80023	.602	3.92	80743	3.43	22.1	81463	8.14	124	82183	19.3
0.150	80033	.670	4.02	80753	3.47	22.6	81473	8.23	127	82193	19.5
0.182	80043	.739	4.12	80763	3.51	23.2	81483	8.34	130	82203	19.7
0.200	80053	.774	4.22	80773	3.56	23.7	81493	8.43	133	82213	20.0
0.221	80063	.814	4.32	80783	3.60	24.3	81503	8.54	137	82223	20.3
0.249	80073	.864	4.42	80793	3.64	24.9	81513	8.64	140	82233	20.5
0.274	80083	.906	4.53	80803	3.69	25.5	81523	8.74	143	82243	20.7
0.332	80093	.998	4.64	80813	3.73	26.1	81533	8.84	147	82253	21.0
0.392	80103	1.08	4.75	80823	3.77	26.7	81543	8.95	150	82263	21.2
0.475	80113	1.19	4.87	80833	3.82	27.4	81553	9.06	154	82273	21.5
0.499	80123	1.22	4.99	80843	3.87	28.0	81563	9.16	158	82283	21.8
0.562	80133	1.30	5.11	80853	3.91	28.7	81573	9.28	162	82293	22.0
0.681	80143	1.43	5.23	80863	3.96	29.4	81583	9.39	165	82303	22.2
0.750	80153	1.50	5.36	80873	4.01	30.1	81593	9.50	169	82313	22.5
0.825	80163	1.57	5.49	80883	4.06	30.9	81603	9.62	174	82323	22.8
1.00	80173	1.73	5.62	80893	4.10	31.6	81613	9.74	178	82333	23.1
1.02	80183	1.75	5.76	80903	4.16	32.4	81623	9.86	182	82343	23.4
1.05	80193	1.77	5.90	80913	4.20	33.2	81633	9.98	187	82353	23.7
1.07	80203	1.79	6.04	80923	4.25	34.0	81643	10.1	191	82363	23.9
1.10	80213	1.82	6.19	80933	4.31	34.8	81653	10.2	196	82373	24.2
1.13	80223	1.84	6.34	80943	4.36	35.7	81663	10.3	200	82383	24.5
1.15	80233	1.86	6.49	80953	4.41	36.5	81673	10.5	205	82393	24.8
1.18	80243	1.88	6.65	80963	4.46	37.4	81683	10.6	210	82403	25.1
1.21	80253	1.91	6.81	80973	4.52	38.3	81693	10.7	215	82413	25.4
1.24	80263	1.93	6.98	80983	4.57	39.2	81703	10.8	221	82423	25.7
1.27	80273	1.95	7.15	80993	4.63	40.2	81713	11.0	226	82433	26.0
1.30	80283	1.97	7.32	81003	4.68	41.2	81723	11.1	232	82443	26.4
1.33	80293	2.00	7.50	81013	4.74	42.2	81733	11.2	237	82453	26.7
1.37	80303	2.03	7.68	81023	4.80	43.2	81743	11.4	243	82463	27.0
1.40	80313	2.05	7.87	81033	4.86	44.2	81753	11.5	249	82473	27.3
1.43	80323	2.07	8.06	81043	4.92	45.3	81763	11.7	255	82483	27.7
1.47	80333	2.10	8.25	81053	4.97	46.4	81773	11.8	261	82493	28.0
1.50	80343	2.12	8.45	81063	5.04	47.5	81783	11.9	267	82503	28.3
1.54	80353	2.15	8.66	81073	5.10	48.7	81793	12.1	274	82513	28.7
1.58	80363	2.18	8.87	81083	5.16	49.9	81803	12.2	280	82523	29.0
1.62	80373	2.20	9.09	81093	5.22	51.1	81813	12.4	287	82533	29.3
1.65	80383	2.22	9.31	81103	5.28	52.3	81823	12.5	294	82543	29.7
1.69	80393	2.25	9.53	81113	5.34	53.6	81833	12.7	301	82553	30.0
1.74	80403	2.28	9.76	81123	5.41	54.9	81843	12.8	309	82563	30.4
1.78	80413	2.31	10.0	81133	5.47	56.2	81853	13.0	316	82573	30.8
1.82	80423	2.34	10.2	81143	5.53	57.6	81863	13.1	324	82583	31.2
1.87	80433	2.37	10.5	81153	5.61	59.0	81873	13.3	332	82593	31.6
1.91	80443	2.39	10.7	81163	5.66	60.4	81883	13.4	340	82603	31.9
1.96	80453	2.42	11.0	81173	5.74	61.9	81893	13.6	348	82613	32.3
2.00	80463	2.45	11.3	81183	5.82	63.4	81903	13.8	357	82623	32.7
2.05	80473	2.48	11.5	81193	5.87	64.9	81913	13.9	365	82633	33.1
2.10	80483	2.51	11.8	81203	5.95	66.5	81923	14.1	374	82643	33.5
2.15	80493	2.54	12.1	81213	6.02	68.1	81933	14.3	383	82653	33.9
2.21	80503	2.57	12.4	81223	6.10	69.8	81943	14.5	392	82663	34.3
2.26	80513	2.60	12.7	81233	6.17	71.5	81953	14.6	402	82673	34.7
2.32	80523	2.64	13.0	81243	6.24	73.2	81963	14.8	412	82683	35.1
2.37	80533	2.67	13.3	81253	6.32	75.0	81973	15.0	422	82693	35.6
2.43	80543	2.70	13.7	81263	6.41	76.8	81983	15.2	432	82703	36.1
2.49	80553	2.73	14.0	81273	6.48	78.7	81993	15.4	442	82713	36.4
2.55	80563	2.77	14.3	81283	6.55	80.6	82003	15.5	453	82723	36.9
2.61	80573	2.80	14.7	81293	6.64	82.5	82013	15.7	464	82733	37.3
2.67	80583	2.83	15.0	81303	6.70	84.5	82023	15.9	475	82743	37.7
2.74	80593	2.87	15.4	81313	6.80	86.6	82033	16.1	487	82753	38.2
2.80	80603	2.90	15.8	81323	6.88	88.7	82043	16.3	499	82763	38.7
2.87	80613	2.93	16.2	81333	6.97	90.9	82053	16.5	511	82773	39.1
2.94	80623	2.97	16.5	81343	7.03	93.1	82063	16.7	523	82783	39.6
3.01	80633	3.00	16.9	81353	7.12	95.3	82073	16.9	536	82793	40.1
3.09	80643	3.04	17.4	81363	7.22	97.6	82083	17.1	549	82803	40.6
3.16	80653	3.08	17.8	81373	7.30	100	82093	17.3	562	82813	41.0
3.24	80663	3.12	18.2	81383	7.39	102	82103	17.5	576	82823	41.6
3.32	80673	3.16	18.7	81393	7.49	105	82113	17.7	590	82833	42.0
3.40	80683	3.19	19.1	81403	7.57	107	82123	17.9	604	82843	42.5
3.48	80693	3.23	19.6	81413	7.66	110	82133	18.2	619	82853	43.1
3.57	80703	3.27	20.0	81423	7.74	113	82143	18.4	634	82863	43.6
3.65	80713	3.31	20.5	81433	7.84	115	82153	18.6	649	82873	44.1
3.74	80723	3.35	21.0	81443	7.94	118	82163	18.8	665	82883	44.6

* ITEMS APPEARING IN BOLD PRINT ARE POPULAR VALUES AND ARE USUALLY STOCKED BY AUTHORIZED OHMITE DISTRIBUTORS

6

OHMITE PAGE 6

OHMITE type 270 vitreous enameled fixed resistors

These lug type resistors are wire-wound on high quality ceramic cores, protected and insulated by Ohmite vitreous enamel—the time-proved standard covering that is the best conductor of heat for a material which must also be a good electrical insulator.

Resistance tolerance is $\pm 5\%$ for values 1 ohm or higher; $\pm 10\%$ below 1 ohm.

Wattage ratings are for use in free air. When resistors are mounted in

closed spaces or where the circulation of air is restricted, they should not be used at more than one-half rating. Currents and voltages for reduced ratings can be obtained by multiplying full rating by the following factors: 75% load = .86, 66% = .81, 50% = .71, 33% = .57, 25% = .50.

See Catalog 50 for MIL-R-26 styles. Mounting brackets are automatically supplied in individual unit packs; supplied only when specified in bulk packs.

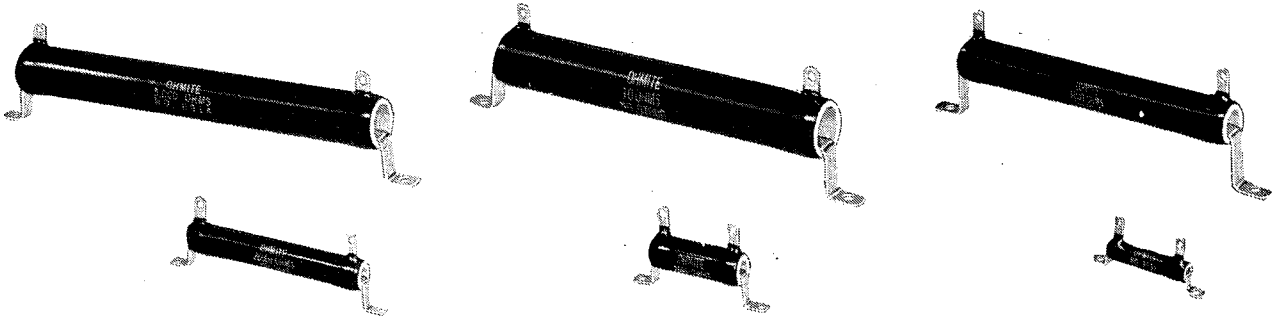

12 WATT				25 WATT				50 WATT				100 WATT				175 WATT				225 WATT			
Free air rating to 5600 Ohms Core: 1 3/4" x 3/4" Mtg. Ctr: 2 3/4" — Av. Wt. .02 lb.				Free air rating to 12,000 Ohms. Core: 2" x 3/4" Mtg. Ctr: 2 3/4" — Av. Wt. .05 lb.				Free air rating to 25,000 Ohms. Core: 4" x 3/4" Mtg. Ctr: 2 3/4" — Av. Wt. .09 lb.				Free air rating to 60,000 Ohms. Core: 6 1/2" x 3/4" Mtg. Ctr: 7 3/8" — Av. Wt. .20 lb.				Free air rating for All Values Core: 8 1/2" x 1 1/8" Mtg. Ctr: 9 3/8" — Av. Wt. .50 lb.				Free air rating for All Values Core: 10 1/2" x 1 1/8" Mtg. Ctr: 11 3/8" — Av. Wt. .62 lb.			
Resist. Ohms.	Stock No.	Max. Amps.	Net 1-9	Ohms. Res.	Stock No.	Max. Amps.	Net 1-9	Stock No.	Max. Amps.	Net 1-9	Stock No.	Max. Amps.	Net 1-9	Stock No.	Max. Amps.	Net 1-9	Stock No.	Max. Amps.	Net 1-9	Stock No.	Max. Amps.	Net 1-9	
.51	3723	4.86	.60	1	0200J	5.00	.76	0400J	7.07	\$1.63	0600C	10.00	\$2.27	0700C	13.20	\$3.35	0900C	15.00	\$3.61				
1.0	3730	3.46	.60	2	0200K	3.54	.76	0400K	5.00	1.17	0600D	7.07	2.27	0700D	9.35	3.35	0900D	10.60	3.61				
1.5	3734	2.83	.60	3	0200L	2.88	.76	0400L	4.07	1.17	0600E	5.77	2.27	0700E	7.63	3.35	0900E	8.67	3.61				
2.2	3738	2.34	.60	4	0200M	2.50	.76	0400M	3.53	1.17	0600F	5.00	1.62	0700F	6.60	3.35	0900F	7.50	3.61				
3.3	3742	1.91	.60	5	0200A	2.24	.76	0400A	3.16	1.17	0600A	4.47	1.62	0700A	5.92	3.35	0900A	6.72	3.61				
4.7	3746	1.60	.60	10	0200B	1.58	.76	0400B	2.23	1.17	0600B	3.16	1.62	0700B	4.18	2.39	0900B	4.74	2.58				
6.8	3750	1.33	.60	15	0200R	1.29	.76																
10	3754	1.10	.60	25	0200C	1.00	.76	0400C	1.41	1.17	0601	2.00	1.62	0701	2.64	2.39	0901	3.00	2.58				
12	3756	1.00	.60	50	0200D	.71	.76	0400D	1.00	1.17	0602	1.41	1.62	0702	1.87	2.39	0902	2.12	2.58				
15	3758	.89	.60	75	0200E	.58	.76	0400E	.82	1.17	0603	1.15	1.62	0703	1.52	2.39	0903	1.73	2.58				
18	3760	.82	.60	100	0200F	.50	.76	0400F	.71	1.17	0604	1.00	1.62	0704	1.32	2.39	0904	1.50	2.58				
22	3762	.74	.60	125							0604B	.90	1.62	0704B	1.18	2.39							
27	3764	.67	.60	150	0200G	.41	.76	0400G	.58	1.17	0605	.82	1.62	0705	1.08	2.39	0905	1.25	2.58				
33	3766	.60	.60	200	0200H	.35	.76	0400H	.50	1.17													
39	3768	.55	.60	250	0201	.32	.76	0401	.45	1.17	0606	.63	1.62	0706	.84	2.39	0906	.95	2.58				
47	3770	.53	.60	500	0202	.22	.76	0402	.32	1.17	0607	.45	1.62	0707	.59	2.39	0907	.67	2.58				
56	3772	.46	.60	750	0203	.18	.76	0403	.26	1.17	0608	.37	1.62	0708	.48	2.39	0908	.55	2.58				
68	3774	.42	.60	800	0204	.17	.76	0404	.25	1.17													
82	3776	.38	.60	1,000	0205	.16	.76	0405	.22	1.17	0609	.32	1.62	0709	.42	2.39	0909	.47	2.58				
100	3778	.35	.60	1,500	0206	.13	.79	0406	.18	1.20	0610	.26	1.68	0710	.34	2.44	0910	.39	2.66				
120	3780	.32	.60	2,000	0207	.12	.79	0407	.16	1.20	0611	.22	1.68	0711	.30	2.44	0911	.34	2.66				
150	3782	.28	.60	2,500	0208	.10	.79	0408	.14	1.20	0612	.20	1.68	0712	.26	2.44	0912	.30	2.66				
180	3784	.26	.60	3,000	0209	.091	.79	0409	.13	1.20	0613	.18	1.68	0713	.24	2.44	0913	.27	2.66				
220	3786	.23	.60	3,500	0210	.084	.79																
270	3788	.21	.60	4,000	0211	.079	.79	0410	.11	1.20				0714	.19	2.44	0914	.21	2.66				
330	3790	.19	.60	5,000	0212	.070	.79	0411	.10	1.20	0614	.14	1.68										
390	3792	.18	.60	6,000	0213	.064	.89				0615	.12	1.82	0715	.15	2.66	0915	.17	2.85				
470	3794	.16	.60	7,500	0214	.057	.89	0412	.081	1.29													
560	3796	.15	.60	8,000				0413	.079	1.29	0616	.10	1.82	0716	.13	2.66	0916	.15	2.85				
680	3798	.13	.60	10,000	0215	.050	.89	0414	.071	1.29													
820	3800	.12	.60	12,000	0216	.045	.95	0415	.064	1.42	0617	.081	1.96	0717	.11	2.85	0917	.13	3.03				
1,000	3802	.11	.60	15,000	0217	.036	.95	0416	.057	1.42	0618	.071	1.96	0718	.094	2.85	0918	.11	3.03				
1,200	3804	.10	.64	20,000	0218	.031	.95	0417	.050	1.42	0619	.063	2.24	0719	.083	2.94	0919	.095	3.13				
1,500	3806	.089	.64	25,000	0219	.028	1.09	0418	.045	1.62	0620	.058	2.24	0720	.076	2.94	0920	.087	3.13				
1,800	3808	.082	.64	30,000	0220	.026	1.09																
2,200	3810	.074	.64	35,000	0221	.024	1.09	0419	.032	1.62	0621	.050	2.24	0721	.066	2.94	0921	.075	3.13				
2,700	3812	.067	.64	40,000	0222	.022	1.09				0622	.045	2.32	0722	.059	3.03	0922	.067	3.23				
3,300	3814	.060	.64	50,000	0224	.019	1.27	0420	.026	1.81	0623	.041	2.32	0723	.054	3.03	0923	.061	3.23				
3,900	3816	.055	.64	60,000	0225	.016	1.27																
4,700	3818	.051	.64	70,000	0226	.013	1.49																
5,600	3820	.046	.74	75,000				0421	.021	2.07	0624	.032	2.57	0724	.048	3.23	0924	.055	3.42				
6,800	3822	.038	.74	80,000	0227	.012	1.49				0625	.028	2.89	0725	.042	3.42	0925	.047	3.63				
8,200	3824	.035	.74	100,000	0229	.0094	1.72	0422	.018	2.24													
10,000	3826	.032	.74	125,000				0423	.017	2.70													
12,000	3828	.029	.83	150,000				0424	.015	2.84													
15,000	3830	.026	.83	175,000				0425	.014	2.93													
18,000	3832	.024	.83	200,000				0426	.012	3.03													
22,000	3834	.021	.87	250,000				0428	.010	3.40													
27,000	3836	.019	.87																				
33,000	3838	.017	.87																				
39,000	3840	.016	.87																				
47,000	3842	.015	.98																				
51,000	3843	.014	.98																				

ITEMS APPEARING IN BOLD PRINT ARE POPULAR VALUES AND ARE USUALLY STOCKED BY AUTHORIZED OHMITE DISTRIBUTORS



dividohm® type 210 adjustable vitreous enameled resistors

"Dividohm" resistors make ideal voltage dividers for original equipment and replacement in transmitters, rectifiers and other apparatus. Such tapped "bleeders" are made by using one or more adjustable lugs, as required. "Dividohms" are also handy for obtaining odd resistance values, for adjusting circuits, and for use on equipment which must be set to meet various line voltages.

"Dividohm" resistors are vitreous enameled resistors on which a narrow strip has been left uncovered to expose a portion of each turn. Contact to any wire in this strip is made by an embossed contact on the adjustable lug (supplied).

WATT RATING: The stated wattage rating applies only when the entire resistance is in the circuit. When the adjustable lug is set at an intermediate point, the wattage rating is reduced in approximately the same portion, i.e., if the lug is set at half the resistance, the wattage is reduced by one-half. A safe rule to follow is to make sure that the maximum rated current is not exceeded. This should be carefully checked particularly if the resistor will be used as a voltage divider with several adjustable lugs. Resistance tolerance is $\pm 10\%$ for the total resistance value. See Catalog 50 for MIL-R-26 styles.

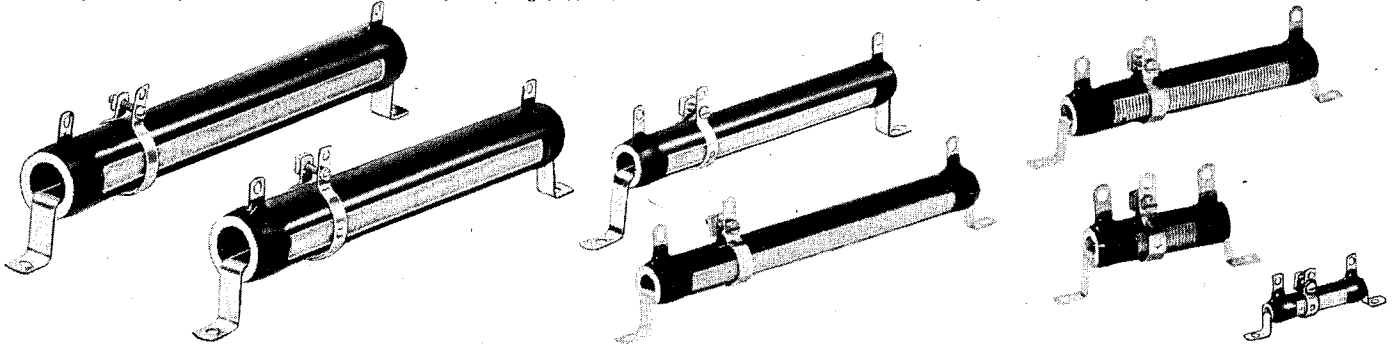

Resist. Ohms	12 WATT Core: 1 1/2" x 3/16" D. Mtg. Ctr: 2 3/8" — Av. Wt. .02 lb.			25 WATT Core: 2" x 1/8" D. Mtg. Ctr: 2 3/8" — Av. Wt. .05 lb.			50 WATT Core: 4" x 3/16" D. Mtg. Ctr: 4 3/4" — Av. Wt. .09 lb.			75 WATT Core: 6" x 1/8" D. Mtg. Ctr: 6 3/4" — Av. Wt. .15 lb.			100 WATT Core: 6 1/2" x 3/16" D. Mtg. Ctr: 7 3/8" — Av. Wt. .20 lb.			175 WATT Core: 8 1/2" x 1/8" D. Mtg. Ctr: 9 3/8" — Av. Wt. .50 lb.			225 WATT Core: 10 1/2" x 1/8" D. Mtg. Ctr: 11 3/8" — Av. Wt. .62 lb.		
	Stock No. 1	Max. Amps.	Net 1-9	Stock No. 1	Max. Amps.	Net 1-9	Stock No. 1	Max. Amps.	Net 1-9	Stock No. 1	Max. Amps.	Net 1-9	Stock No. 1	Max. Amps.	Net 1-9	Stock No. 1	Max. Amps.	Net 1-9	Stock No. 1	Max. Amps.	Net 1-9
1	1001	3.46	\$1.20	0360	5.00	\$1.35	0560A	7.07	\$2.23	0789A	8.66	\$2.51	0956A	10.0	\$2.87	1156A	13.2	\$4.27	1356A	15.00	\$4.54
2	1002	2.45	1.20	0360B	3.54	1.35	0560B	5.00	1.76	0789B	6.12	2.51	0956B	7.07	2.87	1156B	9.35	4.27	1356B	10.60	4.54
3	1003	2.00	1.20	0361	2.88	1.35	0560C	4.07	1.76	0789C	5.00	1.96	0956C	5.77	2.87	1156C	7.63	4.27	1356C	8.67	4.54
4							0560D	3.53	1.76	0789D	4.33	1.96	0956D	5.00	2.22	1156D	6.60	4.27	1356D	7.50	4.54
5							0560	3.16	1.76	0789	3.87	1.96	0956	4.47	2.22	1156	5.92	4.27	1356	6.72	4.54
7.5	1005	1.54	1.20	0362	2.24	1.35	0562	1.41	1.76	0772	1.73	1.96	0958	2.00	2.22	1158	2.64	3.32	1358	3.00	3.51
10	1006	1.28	1.20	0362B	1.82	1.35	0563	1.00	1.76	0773	1.22	1.96	0959	1.41	2.22	1159	1.87	3.32	1359	2.12	3.51
15	1007	1.09	1.20	0363	1.58	1.35	0564	.82	1.76												
20	1008	.89	1.20	0363B	1.29	1.35	0565	.71	1.76	0774	.86	1.96	0960	1.00	2.22	1160	1.32	3.32	1360	1.50	3.51
25	1009	.77	1.20	0364	.89	1.35	0566	.58	1.76	0774B	.61	1.96									
50	1010	.69	1.20	0364B	1.12	1.35	0567	.50	1.76	0775	.55	1.96	0960B	.63	2.22	1160B	.84	3.32	1360B	.95	3.51
75	1011	.49	1.20	0365	1.00	1.35	0568	.45	1.76	0775B	.50	1.96									
100	1012	.49	1.20	0366	.71	1.35	0568B	.41	1.76												
150	1013	.40	1.20	0367	.58	1.35	0569	.35	1.76	0775C	.43	1.96	0961	.45	2.22	1161	.59	3.32	1361	.67	3.51
200	1014	.34	1.20	0367B	.58	1.35	0570	.26	1.76	0776	.39	1.96									
250	1015	.24	1.20	0368	.50	1.35	0571	.25	1.76	0777	.32	1.96	0962	.32	2.22	1162	.42	3.32	1362	.47	3.51
300	1016	.22	1.20	0368B	.41	1.35	0572	.22	1.76	0777B	.30	1.96									
350	1017	.20	1.20	0369	.41	1.35	0572B	.20	1.80	0778	.27	1.96	0962B	.26	2.28	1162B	.34	3.36	1362B	.39	3.58
400	1018	.17	1.20	0370	.35	1.35	0573	.18	1.80	0778B	.24	2.02									
500	1019	.15	1.20	0371	.32	1.35	0573B	.18	1.80	0779	.22	2.02	0963	.20	2.28	1163	.26	3.36	1363	.30	3.58
600	1020	.14	1.20	0371B	.29	1.35	0574	.16	1.80	0780	.19	2.02									
750	1021	.13	1.20	0371C	.25	1.35	0574B	.15	1.80	0780B	.18	2.02	0963	.20	2.28	1163	.26	3.36	1363	.30	3.58
800	1022	.12	1.20	0372	.22	1.35	0575	.14	1.80	0781	.17	2.02									
1000	1023	.11	1.20	0372B	.22	1.35	0575B	.13	1.80	0781B	.16	2.02	0964	.14	2.28	1164	.19	3.36	1364	.21	3.58
1250	1024	.098	1.24	0373	.18	1.35	0576	.13	1.80	0782	.15	2.02									
1500	1025	.089	1.24	0373B	.14	1.39	0576B	.12	1.80	0782B	.14	2.02	0964	.14	2.28	1164	.19	3.36	1364	.21	3.58
2000	1026	.077	1.24	0374	.13	1.39	0577	.11	1.80	0782C	.13	2.02									
2250	1027	.073	1.24	0375	.16	1.35	0577B	.10	1.80	0783	.12	2.02	0964	.14	2.28	1164	.19	3.36	1364	.21	3.58
2500	1028	.069	1.24	0375B	.14	1.39	0578	.10	1.80	0783B	.11	2.11									
3000	1029	.063	1.24	0377	.12	1.39	0578B	.091	1.89	0783C	.10	2.11	0965	.10	2.42	1165	.13	3.58	1365	.15	3.77
3500	1030	.058	1.24	0377B	.11	1.39	0579	.084	1.89	0784	.096	2.11									
4000	1031	.055	1.24	0378	.10	1.39	0579B	.079	1.89	0784B	.096	2.11	0965	.10	2.42	1165	.13	3.58	1365	.15	3.77
4500	1032	.052	1.24	0379	.091	1.39	0580	.074	1.89	0785	.086	2.11	0966	.081	2.56	1166	.11	3.77	1366	.13	3.96
5000	1033	.049	1.24	0380	.084	1.39	0580B	.074	1.89	0785B	.079	2.24	0967	.071	2.56	1167	.094	3.77	1367	.11	3.96
6000	1034	.045	1.33	0381	.079	1.39	0582	.064	2.02	0786	.070	2.24	0968	.063	2.84	1168	.083	3.86	1368	.095	4.05
7000	1035	.042	1.33	0381B	.074	1.39	0582B	.064	2.02	0787	.061	2.24	0969	.058	2.84	1169	.076	3.86	1369	.087	4.05
7500	1036	.040	1.33	0382	.070	1.39	0583	.057	2.02	0788	.054	2.44	0970	.046	2.44	1170	.066	3.86	1370	.075	4.05
8000	1037	.039	1.33	0383	.064	1.49	0583B	.050	2.02	0789	.050	2.44	0971	.045	2.92	1171	.059	3.96	1371	.067	4.16
8500	1038	.037	1.33	0383B	.060	1.49	0584	.045	2.22	0790	.046	2.44	0972	.042	3.17	1172	.048	4.16	1372	.055	4.35
9000	1039	.036	1.33	0384	.057	1.49	0584B	.045	2.22	0791	.043	2.44	0973	.045	2.92	1173	.042	4.35	1373	.047	4.56
10000	1040	.035	1.33	0384B	.055	1.49	0586	.036	2.22	0792	.035	2.65	0974	.032	3.17						
12000				0384C	.052	1.49	0587	.029	2.22	0793	.033	2.65	0975	.028	3.49						
15000				0385	.050	1.49	0588	.026	2.40	0794	.030	2.65									
20000				0385B	.042	1.54	0589	.024	2.40												
25000				0387	.036	1.54															
30000				0388	.031	1.54															
35000				0389	.028	1.69															
40000																					
45000																					
50000																					
60000																					
75000																					
80000																					
80000																					
100000																					

ITEMS APPEARING IN BOLD PRINT ARE POPULAR VALUES AND ARE USUALLY STOCKED BY AUTHORIZED OHMITE DISTRIBUTORS

adjustable lugs

One "Screw Driver Type Adjustable Lug" is supplied with each unit. Lugs with a silver contact button can be ordered from the table shown below.

MOVING THE LUGS: Lugs always should be loosened completely before moving



STANDARD

Core Diam. Inches	Screw Driver Type		Bakelite Knob Type	
	Stock No.	Net 1-9	Stock No.	Net 1-9
3/16	1058	\$0.15	—	—
3/16	0358	.15	0359	\$0.33
3/16	1958	.15	1959	.33
1/8	2158	.24	2159	.42

With SILVER CONTACT BUTTONS

Core Diam. Inches	Screw Driver Type		Bakelite Knob Type	
	Stock No.	Net 1-9	Stock No.	Net 1-9
3/16	2161	\$0.38	—	—
3/16	2164	.38	2165	\$0.56
3/16	2166	.38	2167	.56
1/8	2170	.47	2171	.65

DOUBLE THUMB SCREW ADJUSTABLE LUG

This adjustable lug, which is illustrated above, features two advantages — ease of adjustment and less chance of damaging the resistance wire while moving lugs. Available for 1/8" cores. Stock No. 2160.....Net 1-9 \$0.89

OHMITE *Little Devil*® molded composition resistors on "Tally Tape"™

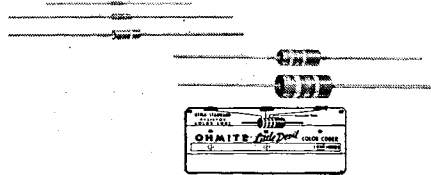

Color Coder 104*

"Tally Tape," Ohmite's wonderfully convenient packaging presently provides for 1/4, 1/2, 1 and 2-watt resistors. Each perforated segment holds 5 resistors — prevents spilling or tangling — simplifies counting — is printed for quick identification — guarantees original, factory-fresh stock.

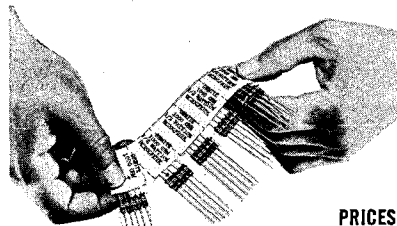

Now Includes MIL-R-II Types

Little Devils, Ohmite's famous molded composition resistors, find broad use in commercial and military applications. The 1/8, 1/4, 1/2, 1 and 2-watt sizes, which conform respectively to Styles RC05, RC07, RC20, RC32 and RC42 of MIL-R-11, meet all the stringent requirements of this military specification. The five sizes available satisfy a wide range of design and service needs.

Little Devils have molded insulation for high dielectric strength. Noted advantages of these units are great stability, low noise level, low voltage coefficient, high insulation breakdown voltage and rapid heat dissipation. They may be used at full rated wattage at 70°C (158°F) ambient temperature.

Little Devils are available from stock in standard EIA resistance values in the tolerances and resistance ranges shown in the price table. Ratings for maximum continuous RMS voltage drop are high: 150 volts for 1/8 watt units, 250 volts for 1/4 watt, 350 volts for 1/2 watt, 500 volts for 1 watt, and 750 volts for 2 watt units. See "Little Devil" Resistor Assortments, page 14.

PRICES

WATTS	RESISTANCE RANGE		±5%		±10%	
	From	Thru	1-4	5-49	1-4	5-49
			Net	Net	Net	Net
1/8	2.7 ohms	9.1 ohms	37c	31c	27c	22c
	10 ohms	22 megs	34c	28c	24c	20c
1/4	2.7 ohms	9.1 ohms	29c	24c	14c	12c
	10 ohms	22 megs	26c	22c	13c	11c
1/2	1 ohm	2.4 ohms	26c	22c	13c	11c
	2.7 ohms	22 megs	24c	20c	12c	10c
1	2.7 ohms	22 megs	36c	30c	18c	15c
2	10 ohms	22 megs	48c	40c	24c	20c

*Little Devil Color Coder, Stk. No. 5190, \$0.10 ea.

available only from ohmite distributors

1/8 WATT MIL Type: RC 05* Size: .145" L x .062" D. Leads: .062" D. x 1" L.			1/8 WATT MIL Type: RC 05* Size: .145" L x .062" D. Leads: .062" D. x 1" L.			1/8 WATT MIL Type: RC 05* Size: .145" L x .062" D. Leads: .062" D. x 1" L.			1/8 WATT MIL Type: RC 05* Size: .145" L x .062" D. Leads: .062" D. x 1" L.			1/8 WATT MIL Type: RC 05* Size: .145" L x .062" D. Leads: .062" D. x 1" L.		
Resistance	Catalog Number	±5% ±10%	Resistance	Catalog Number	±5% ±10%	Resistance	Catalog Number	±5% ±10%	Resistance	Catalog Number	±5% ±10%	Resistance	Catalog Number	±5% ±10%
2.7 ohms	OB2765	OB27G1	62. ohms	OB6205		1,500. ohms	OB1525	OB1521	36,000. ohms	OB3635		0.82 megs	OB8245	OB8241
3.0 ohms	OB3065		68. ohms	OB6805	OB6801	1,600. ohms	OB1625		39,000. ohms	OB3935	OB3931	0.91 megs	OB9145	
3.3 ohms	OB3365	OB33G1	75. ohms	OB7505		1,800. ohms	OB1825	OB1821	43,000. ohms	OB4335		1. meg	OB1055	OB1051
3.6 ohms	OB3665		82. ohms	OB8205	OB8201	2,000. ohms	OB2025		47,000. ohms	OB4735	OB4731	1.1 megs	OB1155	
3.9 ohms	OB3965	OB39G1	91. ohms	OB9105		2,200. ohms	OB2225	OB2221	51,000. ohms	OB5135		1.2 megs	OB1255	OB1251
4.3 ohms	OB4365		100. ohms	OB1015	OB1011	2,400. ohms	OB2425		56,000. ohms	OB5635	OB5631	1.3 megs	OB1355	
4.7 ohms	OB4765	OB47G1	110. ohms	OB1115		2,700. ohms	OB2725	OB2721	62,000. ohms	OB6235		1.5 megs	OB1555	OB1551
5.1 ohms	OB5165		120. ohms	OB1215	OB1211	3,000. ohms	OB3025		68,000. ohms	OB6835	OB6831	1.6 megs	OB1655	
5.6 ohms	OB5665	OB56G1	130. ohms	OB1315		3,300. ohms	OB3325	OB3321	75,000. ohms	OB7535		1.8 megs	OB1855	OB1851
6.2 ohms	OB6265		150. ohms	OB1515	OB1511	3,600. ohms	OB3625		82,000. ohms	OB8235	OB8231	2.0 megs	OB2055	
6.8 ohms	OB6865	OB68G1	160. ohms	OB1615		3,900. ohms	OB3925	OB3921	91,000. ohms	OB9135		2.2 megs	OB2255	OB2251
7.5 ohms	OB7565		180. ohms	OB1815	OB1811	4,300. ohms	OB4325		0.1 megs	OB1045	OB1041	2.4 megs	OB2455	
8.2 ohms	OB8265	OB82G1	200. ohms	OB2015		4,700. ohms	OB4725	OB4721	0.11 megs	OB1145		2.7 megs	OB2755	OB2751
9.1 ohms	OB9165		220. ohms	OB2215	OB2211	5,100. ohms	OB5125		0.12 megs	OB1245	OB1241	3.0 megs	OB3055	
10. ohms	OB1005	OB1001	240. ohms	OB2415		5,600. ohms	OB5625	OB5621	0.13 megs	OB1345		3.3 megs	OB3355	OB3351
11. ohms	OB1105		270. ohms	OB2715	OB2711	6,200. ohms	OB6225		0.15 megs	OB1545	OB1541	3.6 megs	OB3655	
12. ohms	OB1205	OB1201	300. ohms	OB3015		6,800. ohms	OB6825	OB6821	0.16 megs	OB1645		3.9 megs	OB3955	OB3951
13. ohms	OB1305		330. ohms	OB3315	OB3311	7,500. ohms	OB7525		0.18 megs	OB1845	OB1841	4.3 megs	OB4355	
15. ohms	OB1505	OB1501	360. ohms	OB3615		8,200. ohms	OB8225	OB8221	0.20 megs	OB2045		4.7 megs	OB4755	OB4751
16. ohms	OB1605		390. ohms	OB3915	OB3911	9,100. ohms	OB9125		0.22 megs	OB2245	OB2241	5.1 megs	OB5155	
18. ohms	OB1805	OB1801	430. ohms	OB4315		10,000. ohms	OB1035	OB1031	0.24 megs	OB2445		5.6 megs	OB5655	OB5651
20. ohms	OB2005		470. ohms	OB4715	OB4711	11,000. ohms	OB1135		0.27 megs	OB2745	OB2741	6.2 megs	OB6255	
22. ohms	OB2205	OB2201	510. ohms	OB5115		12,000. ohms	OB1235	OB1231	0.30 megs	OB3045		6.8 megs	OB6855	OB6851
24. ohms	OB2405		560. ohms	OB5615	OB5611	13,000. ohms	OB1335		0.33 megs	OB3345	OB3341	7.5 megs	OB7555	
27. ohms	OB2705	OB2701	620. ohms	OB6215		15,000. ohms	OB1535	OB1531	0.36 megs	OB3645		8.2 megs	OB8255	OB8251
30. ohms	OB3005		680. ohms	OB6815	OB6811	16,000. ohms	OB1635		0.39 megs	OB3945	OB3941	9.1 megs	OB9155	
33. ohms	OB3305	OB3301	750. ohms	OB7515		18,000. ohms	OB1835	OB1831	0.43 megs	OB4345		10. megs	OB1065	OB1061
36. ohms	OB3605		820. ohms	OB8215	OB8211	20,000. ohms	OB2035		0.47 megs	OB4745	OB4741	11. megs	OB1165	
39. ohms	OB3905	OB3901	910. ohms	OB9115		22,000. ohms	OB2235	OB2231	0.51 megs	OB5145		12. megs	OB1265	OB1261
43. ohms	OB4305		1,000. ohms	OB1025	OB1021	24,000. ohms	OB2435		0.56 megs	OB5645	OB5641	13. megs	OB1365	
47. ohms	OB4705	OB4701	1,100. ohms	OB1125		27,000. ohms	OB2735	OB2731	0.62 megs	OB6245		15. megs	OB1565	OB1561
51. ohms	OB5105		1,200. ohms	OB1225	OB1221	30,000. ohms	OB3035		0.68 megs	OB6845	OB6841	16. megs	OB1665	
56. ohms	OB5605	OB5601	1,300. ohms	OB1325		33,000. ohms	OB3335	OB3331	0.75 megs	OB7545		18. megs	OB1865	OB1861
			1,500. ohms	OB1525	OB1521							20. megs	OB2065	
			1,600. ohms	OB1625								22. megs	OB2265	OB2261

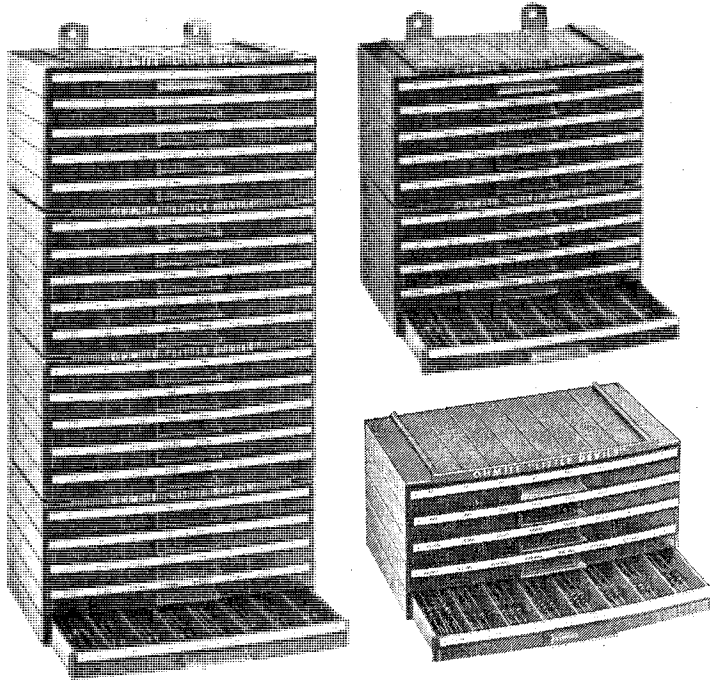

RESISTORS AND HANDY CABINET FOR THE PRICE OF THE RESISTORS ALONE

Select the composition resistor you need, right on the job from time-saving Little Devil® Assortments. Ohmite now offers seven industrial assortments in addition to the four service assortments that have been so popular for many years. In this complete line, there is an assortment to fill every industrial and service need. An attractive plastic cabinet or cabinet assembly is furnished at no extra cost with each assortment. Each drawer of a single 5-drawer cabinet has eight compartments, all individually labeled. Dimensions of the single cabinet are 9" long, 4 3/4" high, 5 1/4" deep. Dovetail tops and bottoms facilitate stacking. Cabinet assemblies for industrial assortments are riveted to metal strips which afford rigidity and permit hanging of the unit on the wall.

Of the seven industrial assortments, there are three ±10% tolerance assortments of 1/4, 1/2 or 1 watt sizes each containing 80 values. A two-cabinet assembly is furnished for these assortments. Four 5% tolerance assortments provide 160 values each of resistors in the 1/8, 1/4, 1/2, or 1 watt sizes. A four-cabinet assembly is furnished for each of these assortments.

The four popular service assortments provide ±10% tolerance resistors in a single cabinet in 1/4, 1/2, 1 or 2 watt sizes.

Cabinets are factory packed in accordance with the tables shown below.

11 ASSORTMENTS

Assortment	Stock No.	Quantity of Resistors	Wattage Size	Net Price
INDUSTRIAL ±10% Tolerance 80 Resistance Values 2 Cabinets	CAB-25 CAB-26 CAB-27	1000 1000 600	1/4 1/2 1	\$ 70.00 60.00 54.00
INDUSTRIAL ±5% Tolerance 160 Resistance Values 4 Cabinets	CAB-45 CAB-46 CAB-47 CAB-48	1000 1500 1500 900	1/8 1/4 1/2 1	225.00 210.00 180.00 160.00
RADIO & TV SERVICE KITS ±10% Tolerance 37 Values—CAB-4 40 Values—Others 1 Cabinet	CAB-4 CAB-10 CAB-2 CAB-3	150 150 125 125	1/4 1/2 1 2	19.50 18.00 22.50 30.00

Prices Subject to Change Without Notice

10% TOLERANCE ASSORTMENTS

5% TOLERANCE ASSORTMENTS

10% Resistance Values	Quantities In Each Assortment			10% Resistance Values	Quantities In Each Assortment			5% Resistance Values	Quantities In Each Assortment			5% Resistance Values	Quantities In Each Assortment			5% Resistance Values	Quantities In Each Assortment			5% Resistance Values	Quantities In Each Assortment												
	Service Assortments				Industrial Assortments				Service Assortments				Industrial Assortments				Service Assortments				Industrial Assortments			Service Assortments			Industrial Assortments						
	Cab-4	1/2 W	1 W		Cab-25	1/4 W	1/2 W		Cab-4	1/4 W	1/2 W		Cab-25	1/4 W	1/2 W		Cab-45	1/8 W	1/4 W		Cab-45	1/8 W	1/4 W	Cab-45	1/8 W	1/4 W	Cab-45	1/8 W	1/4 W				
2.7			5	5	10	6,800	5	1	1	1	30	15	10	2.7	5	5	5	5	160	5	5	5	5	7,500	5	5	5	5	0.36 meg.	5	5	5	5
3.3			5	5	5	8,200					20	5	5	3.0	5	5	5	5	180	20	5	5	5	8,200	5	5	5	5	0.39 meg.	5	5	5	5
3.9			5	5	5	10,000	10	10	10	10	30	30	10	3.3	5	5	5	5	200	5	5	5	15	9,100	5	5	5	5	0.43 meg.	5	5	5	5
4.7			5	5	10	12,000					20	15	5	3.6	5	5	5	5	220	10	25	15	10	10,000	20	30	30	10	0.47 meg.	5	10	20	5
5.6			5	5	5	15,000	5	3	3	3	30	5	10	3.9	5	5	5	5	240	5	5	5	5	11,000	5	5	5	5	0.51 meg.	5	5	5	5
6.8			5	5	10	18,000					20	5	5	4.7	5	5	5	5	270	5	10	15	10	12,000	10	25	20	5	0.56 meg.	5	5	5	5
10	1	1	1	20	20	22,000	5	5	5	5	30	30	10	5.1	5	5	5	5	300	5	5	5	5	13,000	5	5	5	5	0.62 meg.	5	5	5	5
12			5	5	5	27,000	5	10	10	10	20	20	10	5.6	5	5	5	5	330	5	25	15	10	15,000	5	30	30	5	0.68 meg.	5	5	5	5
15	1	1	1	5	5	33,000	3	3	1	1	20	20	10	6.8	5	5	5	5	360	5	5	5	5	16,000	5	5	5	5	0.75 meg.	5	5	5	5
18			5	5	5	39,000	3	5	5	5	5	15	10	7.5	5	5	5	5	390	5	10	15	5	18,000	5	10	15	5	0.82 meg.	5	5	5	5
22			5	5	10	47,000	5	10	10	10	30	30	10	8.2	5	5	5	5	430	5	5	5	5	20,000	5	25	15	5	0.91 meg.	5	5	5	5
27	1	1	1	5	5	56,000					20	15	5	9.1	5	5	5	5	470	10	25	20	10	22,000	5	25	30	10	1.0 meg.	5	25	20	5
33			5	5	10	68,000	3	3	1	1	20	20	5	10	20	25	30	10	510	5	10	15	10	24,000	5	5	15	5	1.1 meg.	5	5	5	5
39			5	5	5	82,000	2	1	1	1	5	15	5	11	5	5	5	5	560	5	10	15	5	27,000	5	10	15	5	1.2 meg.	5	5	5	5
47	5	1	1	20	20	0.10 meg.	10	10	10	10	30	30	10	12	5	5	5	5	620	5	5	15	5	30,000	5	10	5	5	1.3 meg.	5	5	5	5
56			5	5	5	0.12 meg.					5	5	5	15	5	5	5	5	680	5	10	5	10	33,000	5	25	20	5	1.5 meg.	5	10	5	5
68			5	5	5	0.15 meg.	3	5	5	5	5	15	10	16	5	5	5	5	750	5	5	5	5	36,000	5	5	5	5	1.6 meg.	5	5	5	5
82			5	5	5	0.18 meg.					5	5	5	18	5	5	5	5	820	5	10	5	5	39,000	5	10	15	5	1.8 meg.	5	5	5	5
100	5	5	1	30	30	0.22 meg.	3	3	1	1	20	20	10	20	5	5	5	5	910	5	5	5	5	43,000	5	5	5	5	2.0 meg.	5	5	5	5
120			5	5	5	0.27 meg.	3	10	10	10	5	20	10	22	5	5	5	5	1,000	20	30	30	10	47,000	10	25	20	10	2.2 meg.	5	5	5	5
150	1	1	1	20	15	0.33 meg.	3	3	1	1	20	15	5	24	5	5	5	5	1,100	5	5	5	5	51,000	5	10	15	5	2.4 meg.	5	5	5	5
180			5	5	5	0.39 meg.					5	5	5	27	5	5	15	5	1,200	10	25	15	10	56,000	5	5	15	5	2.7 meg.	5	5	5	5
220			20	20	10	0.47 meg.	5	10	10	10	20	30	10	30	5	5	5	5	1,300	5	5	5	5	62,000	5	5	5	5	3.0 meg.	5	5	5	5
270	3	3	1	30	15	0.56 meg.					5	5	5	33	5	5	5	5	1,500	20	10	20	5	68,000	5	10	15	5	3.3 meg.	5	5	5	5
330	1	1	1	20	15	0.68 meg.	1	1	1	1	5	5	5	36	5	5	5	5	1,600	5	5	5	5	75,000	5	5	5	5	3.6 meg.	5	5	5	5
390			5	5	10	0.82 meg.					5	5	5	39	5	5	5	5	1,800	5	25	15	5	82,000	5	10	5	5	3.9 meg.	5	5	5	5
470	3	3	1	20	30	1.0 meg.	10	10	10	10	30	30	10	43	5	5	5	5	2,000	20	25	30	10	91,000	5	5	5	5	4.3 meg.	5	5	5	5
560			5	15	10	1.2 meg.					5	5	5	47	10	10	5	5	2,200	20	30	30	10	0.10 meg.	20	30	30	10	4.7 meg.	5	5	5	5
680	1	1	1	20	15	1.5 meg.	1	1	1	1	5	5	5	51	10	10	15	10	2,400	5	10	5	5	0.11 meg.	5	5	5	5	5.1 meg.	5	5	5	5
820			5	5	5	1.8 meg.					5	5	5	56	5	5	5	5	2,700	10	25	15	5	0.12 meg.	5	5	5	5	5.6 meg.	5	5	5	5
1,000	10	5	3	5	30	2.2 meg.	1	1	1	1	5	15	5	62	5	5	5	5	3,000	5	10	15	5	0.13 meg.	5	5	5	5	6.2 meg.	5	5	5	5
1,200			5	5	10	2.7 meg.	1	3	1	1	5	5	5	68	5	5	5	5	3,300	5	25	30	5	0.15 meg.	5	10	15	5	6.8 meg.	5	5	5	5
1,500	5	1	1	20	20	3.3 meg.					5	15	5	75	5	5	20	5	3,600	5	5	5	5	0.16 meg.	5	5	5	5	7.5 meg.	5	5	5	5
1,800			5	15	5	3.9 meg.	1	1	1	1	5	5	5	82	5	5	5	5	3,900	10	25	15	5	0.18 meg.	5	5	5	5	8.2 meg.	5	5	5	5
2,200	10	1	1	30	30	4.7 meg.	1	1	1	1	5	5	5	91	5	5	5	5	4,300	5	5	5	5	0.20 meg.	5	10	5	5	10.0 meg.	5	5	5	5
2,700	5	3	3	20	15	5.6 meg.					5	5	5	100	20	30	30	10	4,700	20	30	30	10	0.22 meg.	5	5	15	5	12.0 meg.	5	5	5	5
3,300			30	20	10	6.8 meg.	1	1	1	1	5	5	5	110	5	5	5	5	5,100	10	25	15	5	0.24 meg.	5	5	5	5	15.0 meg.	5	5	5	5
3,900			20	5	10	10.0 meg.	1	1	1	1	5	5	5	120	5	5	5	5	5,600	5	25	15	5	0.27 meg.	5	5	5	5	18.0 meg.	5	5	5	5
4,700	10	10	5	30	30	15.0 meg.					5	5	5	130	5	5	5	5	6,200	5	10	5	5	0.30 meg.	5	5	5	5	20.0 meg.	5	5	5	5
5,600			5	20	5	22.0 meg.					5	5	5	150	5	10	15	10	6,800	5	30	20	5	0.33 meg.	5	5	5	5	22.0 meg.	5	5	5	5

OHMITE

corrib® HIGH CURRENT LOW OHMS resistors

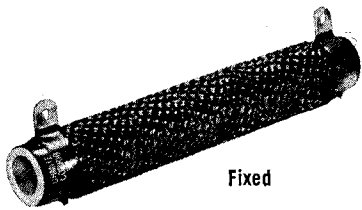

Fixed



"Dividohm"

STOCK CORRIBS — 300 WATT SIZE
Type 280 Fixed; 230 Dividohm

Core: 8½"x1¼" Fixed or Adjustable (DIVIDOHM)
Avg. Weight (Fixed) .61 lb.; (Dividohm) .64 lb.

Ohms	Amps.	Fixed		Dividohm*	
		Stock No. 1	Net 1-9	Stock No.	Net 1-9
.10	54.7	2501	\$5.05	2601	\$5.95
.12	50.0	2502	5.05	2602	5.95
.16	43.3	2503	5.05	2603	5.95
.20	38.7	2504	5.05	2604	5.95
.25	34.6	2505	4.35	2605	5.25
.31	31.1	2506	4.35	2606	5.25
.40	27.4	2507	4.35	2607	5.25
.50	24.5	2508	4.35	2608	5.25
.63	21.8	2509	4.35	2609	5.25
.80	19.3	2510	4.35	2610	5.25
1.0	17.3	2511	3.55	2611	4.55
1.2	15.8	2512	3.55	2612	4.55
1.6	13.7	2513	3.55	2613	4.55
2.0	12.2	2514	3.55	2614	4.55
2.5	10.9	2515	3.55	2615	4.55
3.1	9.8	2516	3.55	2616	4.55
4.0	8.6	2517	3.55	2617	4.55
5.0	7.7	2518	3.55	2618	4.55
6.3	6.9	2519	3.55	2619	4.55
8.0	6.1	2520	3.55	2620	4.55
10.0	5.5	2521	3.55	2621	4.55
12.0	5.0	2522	3.55	2622	4.55
16.0	4.3	2523	3.55	2623	4.55
20.0	3.8	2524	3.55	2624	4.55

*Adjustable Lug Stk. No. 1974 supplied with Dividohm.

THRU-BOLT MOUNTING BRACKETS FOR CORRIBS

Includes 2 brackets; bolt; centering, mica, and lock washers; nuts. Diagram below.

No. of Resistors	Stock No.	Net 1-9
1	6126PB½	\$.55
2	6127PB½	1.08
3	6128PB½	1.49
4	6129PB½	1.76

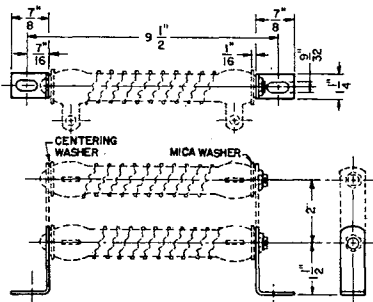

High current, low resistance, heavy duty units used in motor starting, dynamic braking, etc. "Corrib" type units employ a corrugated ribbon of resistance alloy. This is space-wound edge-wise around a ceramic tube. Vitreous enamel is fused around the alloy ribbon to lock the turns securely in place. Heavy lug terminals. Resistance tolerance is ±10%.

Available in fixed or "Dividohm" adjustable types. "Dividohm" type is similar to fixed and includes one adjustable lug. Rating of Fixed or Dividohm stock units—300 watts—reduce unit load for stack-mounted resistors; core size (bare) 8½" long x 1¼" diameter. Other sizes made to order.

EXTRA ADJUSTABLE LUGS FOR CORRIBS

For Dividohm	Lug Stock No.	Net \$ 1-9
2601 to 2618	1974-B	\$.24
2619 to 2624	1974-A	.24

powr-rib® HIGH CURRENT LOW OHMS resistors

Even higher power handling capability—approximately 700 to 1000 watts—is available in stock, "Powr-Rib" resistors. These are UNCOATED types and are wound either edgewise with ribbon ("Edgewound" type) or with round wire (Round-Wire type).

The core of these units consists of ceramic segments on a metal bar which is slotted on both ends for rapid installation. Standard resistance tolerance is ±10%. Terminals clamp onto the resistor wire and may be moved in from the ends for intermediate resistance values. Extra terminals available for use as taps. See diagrams for terminals. Terminal Stk. No. 2172G (not shown) has screw connections.

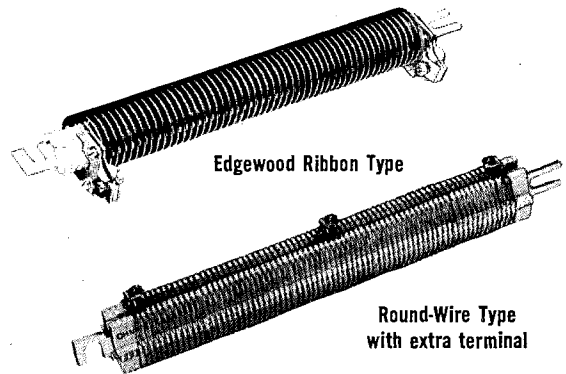

Edgewound Ribbon Type

Round-Wire Type with extra terminal

STYLE O80-5 EDGEWOUND POWR-RIBS

Ohms*	H D	
	±½	+¾ —0
.10-.22	3¾	2½
.25-1.00	3¾	1¾
1.30-1.60	2½	1¾
2.2, 2.8, 4.5, 5.4	2½	1¾
3.5, 6.8, 8.5	2¾	1¾

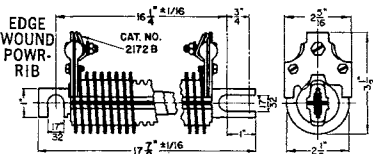

*.10 to 1.00 Ω with terminal No. 2172B
1.3 to 8.5 Ω with terminal No. 2172G

Avg. Weight .18Ω or less, 4 lbs.; .22Ω and up, 2 lbs.

Stock No.	Ohms	Max. Amps.	Net 1 Qty.	Stock No.	Ohms	Max. Amps.	Net 1 Qty.
2301	.10	100	\$27.00	2318	.67	41	\$16.80
2302	.12	91	23.75	2311	.75	39	16.05
2303A	.14	89	19.75	2312	1.00	33	13.55
2304A	.16	78	18.60	2319	1.30	29	11.85
2305A	.18	75	17.65	2313	1.60	26	10.90
2306A	.22	68	15.10	2331A	2.20	18.4	8.70
2306	.25	63	14.50	2332A	2.80	16.3	8.00
2308A	.30	57	13.25	2333A	3.50	14.6	7.15
2308	.33	54	12.40	2334A	4.50	12.7	12.70
2309A	.37	50	11.65	2335A	5.40	11.8	11.85
2310	.50	47	19.75	2336A	6.80	10.3	11.25
2317	.60	43	17.85	2337A	8.50	9.4	10.40

STYLE O82-5 ROUND-WIRE POWR-RIBS

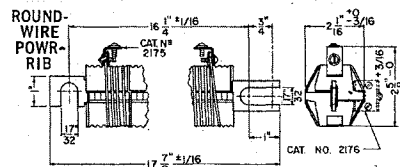

Avg. Weight ¾ lbs.

Stock No.	Ohms	Max. Amps.	Net 1 Qty.
2338	11.0	8.3	\$14.05
2339	13.0	7.6	13.75
2340	17.0	6.6	13.45
2341	20.0	5.9	13.25
2342	25.0	5.1	13.15

EXTRA TERMINALS

For Round Wire Powr-Rib			For Edgewound Powr-Rib		
Descrip.	Stock No.	Net 1 Qty.	Descrip.	Stock No.	Net 1 Qty.
In-Line Mtg.	2175	\$.64	30 Amps & more	2172B	\$1.17
90° Mtg.	2176	1.12	29 Amps & less	2172G	.44

ITEMS APPEARING IN BOLD PRINT ARE POPULAR VALUES AND ARE USUALLY STOCKED BY AUTHORIZED OHMITE DISTRIBUTORS

PRECISION CARBON FILM RESISTORS

proven quality resistors



Carbon Film Resistors are composed of a basic substrate of strong non-hygroscopic steatite to which is applied a coating of high stability carbon film. Units are processed at high temperature to insure stability and minimize aging and humidity effects. A protective coating of high temperature electrical varnish covers the resistance element. Special applications include resistive coating of custom forms, anti-corona provisions and numerous others. Military items presently include the several styles of Mil-R-14293.

HIGH VOLTAGE RESISTORS

Resistance— to 100 Gigaohms
(100X10⁹)
Voltage— to 125000 Volts
Wattage— to 100 Watts

HIGH FREQUENCY RESISTORS

Resistance— 20 ohms to
100 Megohms
Voltage— to 12500 Volts
Wattage— to 100 Watts

**ENCAPSULATED
HIGH VOLTAGE RESISTORS**

Above types encapsulated into filled epoxy resin in values to 1 Gigaohm (1X10⁹)

HIGH MEGOHM RESISTORS

Resistance— 1 Megohm to
100 Teraohms (1X10¹⁴)
Voltage— to 40000 Volts
Wattage— to 10 Watts

TYPE	Watts MAX.	Volts MAX.	OHMS		DIMENSIONS INCHES	
			MIN.	MAX.	L	D
Radial Lugs						
BBF	1	3500	10K	10G	1	5/16
BBM	2	7500	10K	25G	1 3/4	5/16
BBR	3	15000	20K	25G	3	5/16
BBV	5	30000	40K	25G	5 1/2	5/16
BFQ	4	15000	20K	25G	2 1/2	5/16
BFT	6	25000	40K	25G	4	5/16
BFW	10	40000	70K	25G	6 1/2	5/16
Axial Wire Leads						
BAEW	5	2500	10K	1G	3/4	1/4
BAKW	1	5000	20K	2G	1 1/2	1/4
BBFW	1	3500	10K	10G	1	5/16
BBMW	2	7500	10K	25G	1 3/4	5/16
BBRW	3	15000	20K	25G	3	5/16
Radial Bands						
DJU	10	25KV	50K	100G	4 1/2	3/4
DPW	20	35KV	100K	100G	6 1/2	1 1/8
DPX	30	65KV	200K	100G	10 1/2	1 1/8
DVY	60	90KV	400K	100G	14 1/2	1 1/2
DZW	35	40KV	300K	100G	6 1/2	2
DZZ	100	125KV	700K	100G	18 1/2	2
Ferrule Ends						
DPW-1	20	35KV	100K	100G	7 1/16	1 1/8
DPX-1	30	65KV	200K	100G	11 1/16	1 1/8
DVY-1	60	90KV	400K	100G	15 1/16	1 1/2
DZW-1	35	40KV	300K	100G	7 1/16	2
DZZ-1	100	125KV	700K	100G	19 1/16	2
Axial Wire Leads						
MILITARY OR COMMERCIAL HERMETICALLY SEALED RESISTORS						
HSD	5	2500	1M	1T	7/8	.345
HSK	1	5000	1M	5T	1 5/8	.345

TYPE	Watts MAX.	Volts MAX.	OHMS		DIMENSIONS INCHES	
			MIN.	MAX.	L	D
Radial Lugs						
BP-2	2	10KV	100G	10G	2	5/16
BP-4	4	15KV	100G	10G	3 1/2	5/16
BP-6	6	30KV	100G	10G	6	5/16
BP-8	8	30KV	100G	10G	5	5/16
BP-10	10	60KV	100G	10G	11	5/16
BP-12	12	50KV	100G	10G	8	5/16
BP-20	20	80KV	100G	10G	13	5/16
Axial Wire Leads						
BP-1W	1	5KV	100G	10G	1 1/2	1/4
BP-2W	2	10KV	100G	10G	2	5/16
BP-4W	4	15KV	100G	10G	3 1/2	5/16
BP-6W	6	30KV	100G	10G	6	5/16

POWER RATING

Power ratings shown are maximum ratings for free air operation at an ambient temperature of 25°C. They are based on an average operating temperature of approx. 110°C. The hot spot temperature may not exceed 120°C.

VOLTAGE RATINGS

Voltage ratings shown are maximum ratings based on safe gradient for element length operated in free air.

RESISTANCE TOLERANCE

Type B, D and E Standard Tolerance is ±15%. Tolerances of ±10%, ±5% and ±3% can be furnished at additional cost.

RESISTANCE VALUE NOMENCLATURE

1,000 Ohms = 1 x 10³ = 1 Kilohm = 1 K
1,000,000 Ohms = 1 x 10⁶ = 1 Megohm = 1 M
1,000,000,000 Ohms = 1 x 10⁹ = 1 Gigaohm = 1 G
1,000,000,000,000 Ohms = 1 x 10¹² = 1 Teraohm = 1 T

RESISTOR NETWORKS—RPC manufactures numerous networks of precision and high voltage resistors. Most are designed to specific customer requirements; send your specifications or sketches for our review.

Ask for 18-page catalog with descriptions and parameters of our full line of products.

Our Business is Engineering, Designing and Manufacturing Resistors and Resistor Networks adaptable to Customer Needs and Specifications.

Resistance Products Co.

SPRAGUE RESISTORS

KOOLOHM® AXIAL-LEAD WIREWOUND RESISTORS FOR INDUSTRIAL APPLICATIONS

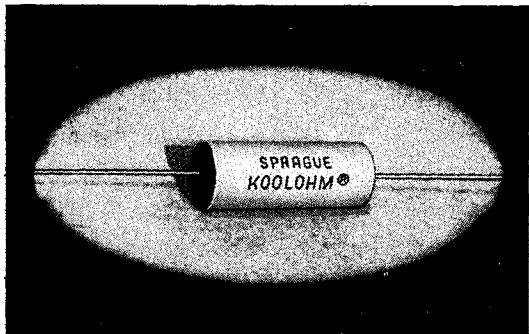

- Insulated-Shell Design for Easy Mounting
 - Feature Improved Internal Construction in Which Windings and Leads are Welded to End-Cap for Superior Mechanical Strength
 - Ceramic-Insulated Wire is Space Wound and Cemented, to Prevent Turn-to-Turn Shorting. Permits Higher Resistance Values in a Given Size Than in Conventional Resistors
 - Non-Porous Tubular Ceramic Shells Sealed With High Temperature Silicone Cement
 - Unexcelled Insulation and Mechanical Protection. Can be Mounted in Direct Contact With Chassis
 - Call Your Sprague Industrial Distributor for Quantity Prices.
 - For Complete Technical Details, Refer to Latest Issue of Sprague Engineering Bulletin 7300
- Types 450E, 452E, 454E, 456E and 458E are Standard Resistors. Types 451E, 453E, 455E, 457E and 459E are Non-Inductive Resistors

Ohms	Type 450E 3 WATTS 1/4" x 1/16"		Type 452E 5 WATTS 1/4" x 1"		Type 454E 7 WATTS 1 1/2" x 1 1/16"		Type 456E 10 WATTS 1 1/2" x 1 2/32"		Type 458E 14 WATTS 1 1/2" x 1 2/32"	
	Cat. No.		Cat. No.		Cat. No.		Cat. No.		Cat. No.	
1	450E1R05	Call Your Sprague Industrial Distributor for Current Quantity Prices	452E1R05	Call Your Sprague Industrial Distributor for Current Quantity Prices	454E1R05	Call Your Sprague Industrial Distributor for Current Quantity Prices	456E1R05	Call Your Sprague Industrial Distributor for Current Quantity Prices	458E1R05	Call Your Sprague Industrial Distributor for Current Quantity Prices
1.5	450E1R55		452E1R55		454E1R55		456E1R55		458E1R55	
2	450E2R05		452E2R05		454E2R05		456E2R05		458E2R05	
3	450E3R05		452E3R05		454E3R05		456E3R05		458E3R05	
4	450E4R05		452E4R05		454E4R05		456E4R05		458E4R05	
5	450E5R05		452E5R05		454E5R05		456E5R05		458E5R05	
7.5	450E7R55		452E7R55		454E7R55		456E7R55		458E7R55	
10	450E1005		452E1005		454E1005		456E1005		458E1005	
12	450E1205		452E1205		454E1205		456E1205		458E1205	
15	450E1505		452E1505		454E1505		456E1505		458E1505	
18	450E1805		----		----		----		----	
20	450E2005		452E2005		454E2005		456E2005		458E2005	
22	450E2205		----		----		----		----	
25	450E2505		452E2505		454E2505		456E2505		458E2505	
27	450E2705		----		----		----		----	
30	450E3005		452E3005		454E3005		456E3005		458E3005	
33	450E3305		----		----		----		----	
35	----		452E3505		454E3505		456E3505		458E3505	
39	450E3905	----	----	----	----					
40	450E4005	452E4005	454E4005	456E4005	458E4005					
47	450E4705	----	----	----	----					
50	450E5005	452E5005	454E5005	456E5005	458E5005					
56	450E5605	----	----	----	----					
68	450E6805	----	----	----	----					
75	450E7505	452E7505	454E7505	456E7505	458E7505					
82	450E8205	----	----	----	----					
100	450E1015	452E1015	454E1015	456E1015	458E1015					
120	450E1215	452E1215	454E1215	456E1215	458E1215					
150	450E1515	452E1515	454E1515	456E1515	458E1515					
180	450E1815	----	----	----	----					

SPRAGUE RESISTORS

NON-INDUCTIVE KOOLOHM AXIAL-LEAD WIREWOUND RESISTORS

Ohms	Type 451E 3 WATTS $\frac{1}{4}$ " x $\frac{3}{16}$ "		Type 453E 5 WATTS $\frac{1}{4}$ " x 1"		Type 455E 7 WATTS $1\frac{1}{2}$ " x $1\frac{1}{16}$ "		Type 457E 10 WATTS $1\frac{1}{2}$ " x $1\frac{29}{32}$ "		Type 459E 14 WATTS $1\frac{5}{16}$ " x $1\frac{29}{32}$ "	
	Cat. No.		Cat. No.		Cat. No.		Cat. No.		Cat. No.	
1	451E1R05	CALL YOUR SPRAGUE INDUSTRIAL DISTRIBUTOR FOR CURRENT QUANTITY PRICES	453E1R05	CALL YOUR SPRAGUE INDUSTRIAL DISTRIBUTOR FOR CURRENT QUANTITY PRICES	455E1R05	CALL YOUR SPRAGUE INDUSTRIAL DISTRIBUTOR FOR CURRENT QUANTITY PRICES	457E1R05	CALL YOUR SPRAGUE INDUSTRIAL DISTRIBUTOR FOR CURRENT QUANTITY PRICES	459E1R05	CALL YOUR SPRAGUE INDUSTRIAL DISTRIBUTOR FOR CURRENT QUANTITY PRICES
1.5	451E1R55		453E1R55		455E1R55		457E1R55		459E1R55	
2	451E2R05		453E2R05		455E2R05		457E2R05		459E2R05	
3	451E3R05		453E3R05		455E3R05		457E3R05		459E3R05	
4	451E4R05		453E4R05		455E4R05		457E4R05		459E4R05	
5	451E5R05		453E5R05		455E5R05		457E5R05		459E5R05	
7.5	451E7R55		453E7R55		455E7R55		457E7R55		459E7R55	
10	451E1005		453E1005		455E1005		457E1005		459E1005	
12	451E1205		453E1205		455E1205		457E1205		459E1205	
15	451E1505		453E1505		455E1505		457E1505		459E1505	
18	451E1805		453E1805		455E1805		457E1805		459E1805	
20	451E2005		453E2005		455E2005		457E2005		459E2005	
22	451E2205		453E2205		455E2205		457E2205		459E2205	
25	451E2505		453E2505		455E2505		457E2505		459E2505	
27	451E2705		453E2705		455E2705		457E2705		459E2705	
30	451E3005		453E3005		455E3005		457E3005		459E3005	
33	451E3305		453E3305		455E3305		457E3305		459E3305	
35	451E3505		453E3505		455E3505		457E3505		459E3505	
39	451E3905		453E3905		455E3905		457E3905		459E3905	
40	451E4005		453E4005		455E4005		457E4005		459E4005	
47	451E4705	453E4705	455E4705	457E4705	459E4705					
50	451E5005	453E5005	455E5005	457E5005	459E5005					
56	451E5605	453E5605	455E5605	457E5605	459E5605					
68	451E6805	453E6805	455E6805	457E6805	459E6805					
75	451E7505	453E7505	455E7505	457E7505	459E7505					
82	451E8205	453E8205	455E8205	457E8205	459E8205					
100	451E1015	453E1015	455E1015	457E1015	459E1015					
120	451E1215	453E1215	455E1215	457E1215	459E1215					
150	451E1515	453E1515	455E1515	457E1515	459E1515					
180	451E1815	453E1815	455E1815	457E1815	459E1815					
200	451E2015	453E2015	455E2015	457E2015	459E2015					
220	451E2215	453E2215	455E2215	457E2215	459E2215					
250	451E2515	453E2515	455E2515	457E2515	459E2515					
270	451E2715	453E2715	455E2715	457E2715	459E2715					
300	451E3015	453E3015	455E3015	457E3015	459E3015					
330	451E3315	453E3315	455E3315	457E3315	459E3315					
350	451E3515	453E3515	455E3515	457E3515	459E3515					
390	451E3915	453E3915	455E3915	457E3915	459E3915					
400	451E4015	453E4015	455E4015	457E4015	459E4015					
450	451E4515	453E4515	455E4515	457E4515	459E4515					
470	451E4715	453E4715	455E4715	457E4715	459E4715					
500	451E5015	453E5015	455E5015	457E5015	459E5015					
560	451E5615	453E5615	455E5615	457E5615	459E5615					
600	451E6015	453E6015	455E6015	457E6015	459E6015					
680	451E6815	453E6815	455E6815	457E6815	459E6815					
700	451E7015	453E7015	455E7015	457E7015	459E7015					
750	451E7515	453E7515	455E7515	457E7515	459E7515					
800	451E8015	453E8015	455E8015	457E8015	459E8015					

SPRAGUE RESISTORS

BLUE JACKET® INDUSTRIAL WIREWOUND RESISTORS

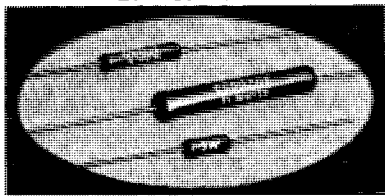

- Improved Minified Resistors Designed for Thorough Reliability and Stability Under Extreme Operating Conditions
- Matched Coefficient of Expansion Allows Uniform Expansion of Vitreous Enamel Coating, Ceramic Base, and End Caps, Eliminating Cracking, Cracks, and Protects From Fumes and Humidity
- Windings and Leads Welded to End-Caps for Superior Mechanical Strength
- For 2BJ, 3BJ, 5BJ and 10BJ Commercial or Service Equivalents to These Resistors, Refer to the Latest issue of Sprague Catalog C-617
- See Your Sprague Industrial Distributor for Quantity Prices

Ohms	Type 239E, 1 WATT 1/8" x 3/8"		Type 240E, 2 WATTS 3/16" x 3/8"		Type 242E, 3 WATTS 1 3/4" x 1 1/32"		Type 243E, 5 WATTS 1 3/4" x 1 1/16"		Type 244E, 7 WATTS 5/16" x 1"		Type 247E, 10 WATTS 5/16" x 1 3/4"	
	Cat. No.		Cat. No.		Cat. No.		Cat. No.		Cat. No.		Cat. No.	
1	239E1R05		240E1R05		242E1R05		243E1R05		244E1R05		247E1R05	
1.2	239E1R25		240E1R25		242E1R25		243E1R25		244E1R25		247E1R25	
1.5	239E1R55		240E1R55		242E1R55		243E1R55		244E1R55		247E1R55	
1.8	239E1R85		240E1R85		242E1R85		243E1R85		244E1R85		247E1R85	
2	239E2R05		240E2R05		242E2R05		243E2R05		244E2R05		247E2R05	
2.2	239E2R25		240E2R25		242E2R25		243E2R25		244E2R25		247E2R25	
2.7	239E2R27		240E2R27		242E2R27		243E2R27		244E2R27		247E2R27	
3	239E3R05		240E3R05		242E3R05		243E3R05		244E3R05		247E3R05	
3.3	239E3R35		240E3R35		242E3R35		243E3R35		244E3R35		247E3R35	
3.9	239E3R95		240E3R95		242E3R95		243E3R95		244E3R95		247E3R95	
4	239E4R05		240E4R05		242E4R05		243E4R05		244E4R05		247E4R05	
4.7	239E4R75		240E4R75		242E4R75		243E4R75		244E4R75		247E4R75	
5	239E5R05		240E5R05		242E5R05		243E5R05		244E5R05		247E5R05	
5.6	239E5R65		240E5R65		242E5R65		243E5R65		244E5R65		247E5R65	
6.8	239E6R85		240E6R85		242E6R85		243E6R85		244E6R85		247E6R85	
7.5	239E7R55		240E7R55		242E7R55		243E7R55		244E7R55		247E7R55	
8.2	239E8R25		240E8R25		242E8R25		243E8R25		244E8R25		247E8R25	
10	239E1005		240E1005		242E1005		243E1005		244E1005		247E1005	
12	239E1205		240E1205		242E1205		243E1205		244E1205		247E1205	
15	239E1505		240E1505		242E1505		243E1505		244E1505		247E1505	
18	239E1805		240E1805		242E1805		243E1805		244E1805		247E1805	
20	239E2005		240E2005		242E2005		243E2005		244E2005		247E2005	
22	239E2205		240E2205		242E2205		243E2205		244E2205		247E2205	
25	239E2505		240E2505		242E2505		243E2505		244E2505		247E2505	
27	239E2705		240E2705		242E2705		243E2705		244E2705		247E2705	
30	239E3005		240E3005		242E3005		243E3005		244E3005		247E3005	
33	239E3305		240E3305		242E3305		243E3305		244E3305		247E3305	
35	239E3505		240E3505		242E3505		243E3505		244E3505		247E3505	
39	239E3905		240E3905		242E3905		243E3905		244E3905		247E3905	
40	239E4005		240E4005		242E4005		243E4005		244E4005		247E4005	
47	239E4705		240E4705		242E4705		243E4705		244E4705		247E4705	
50	239E5005		240E5005		242E5005		243E5005		244E5005		247E5005	
56	239E5605		240E5605		242E5605		243E5605		244E5605		247E5605	
68	239E6805		240E6805		242E6805		243E6805		244E6805		247E6805	
75	239E7505		240E7505		242E7505		243E7505		244E7505		247E7505	
82	239E8205		240E8205		242E8205		243E8205		244E8205		247E8205	
100	239E1015		240E1015		242E1015		243E1015		244E1015		247E1015	
120	239E1215		240E1215		242E1215		243E1215		244E1215		247E1215	
150	239E1515		240E1515		242E1515		243E1515		244E1515		247E1515	
180	239E1815		240E1815		242E1815		243E1815		244E1815		247E1815	
200	239E2015		240E2015		242E2015		243E2015		244E2015		247E2015	
220	239E2215		240E2215		242E2215		243E2215		244E2215		247E2215	
250	239E2515		240E2515		242E2515		243E2515		244E2515		247E2515	
270	239E2715		240E2715		242E2715		243E2715		244E2715		247E2715	
300	239E3015		240E3015		242E3015		243E3015		244E3015		247E3015	
330	239E3315		240E3315		242E3315		243E3315		244E3315		247E3315	
350	239E3515		240E3515		242E3515		243E3515		244E3515		247E3515	
390	239E3915		240E3915		242E3915		243E3915		244E3915		247E3915	
400	239E4015		240E4015		242E4015		243E4015		244E4015		247E4015	
450	239E4515		240E4515		242E4515		243E4515		244E4515		247E4515	
470	239E4715		240E4715		242E4715		243E4715		244E4715		247E4715	
500	239E5015		240E5015		242E5015		243E5015		244E5015		247E5015	
560	239E5615		240E5615		242E5615		243E5615		244E5615		247E5615	
600	239E6015		240E6015		242E6015		243E6015		244E6015		247E6015	
680	239E6815		240E6815		242E6815		243E6815		244E6815		247E6815	
700	239E7015		240E7015		242E7015		243E7015		244E7015		247E7015	
750	239E7515		240E7515		242E7515		243E7515		244E7515		247E7515	
800	239E8015		240E8015		242E8015		243E8015		244E8015		247E8015	
820	239E8215		240E8215		242E8215		243E8215		244E8215		247E8215	
900	239E9015		240E9015		242E9015		243E9015		244E9015		247E9015	
1000	239E1025		240E1025		242E1025		243E1025		244E1025		247E1025	
1100	239E1125		240E1125		242E1125		243E1125		244E1125		247E1125	
1200	239E1225		240E1225		242E1225		243E1225		244E1225		247E1225	
1400	239E1425		240E1425		242E1425		243E1425		244E1425		247E1425	
1500	239E1525		240E1525		242E1525		243E1525		244E1525		247E1525	
1800	239E1825		240E1825		242E1825		243E1825		244E1825		247E1825	
2000	239E2025		240E2025		242E2025		243E2025		244E2025		247E2025	
2200	239E2225		240E2225		242E2225		243E2225		244E2225		247E2225	
2500	239E2525		240E2525		242E2525		243E2525		244E2525		247E2525	
2700			240E2725		242E2725		243E2725		244E2725		247E2725	
3000			240E3025		242E3025		243E3025		244E3025		247E3025	
3300			240E3325		242E3325		243E3325		244E3325		247E3325	
3500			240E3525		242E3525		243E3525		244E3525		247E3525	
3900					242E3925		243E3925		244E3925		247E3925	
4000					242E4025		243E4025		244E4025		247E4025	
4500					242E4525		243E4525		244E4525		247E4525	
4700					242E4725		243E4725		244E4725		247E4725	
5000					242E5025		243E5025		244E5025		247E5025	
5600					242E5625		243E5625		244E5625		247E5625	
6000					242E6025		243E6025		244E6025		247E6025	
6800					242E6825		243E6825		244E6825		247E6825	
7000							243E7025		244E7025		247E7025	
7500					242E7525		243E7525		244E7525		247E7525	
8000					242E8025		243E8025		244E8025		247E8025	
8200					242E8225		243E8225		244E8225		247E8225	

SPRAGUE RESISTORS

FILMISTOR® METAL-FILM RESISTORS

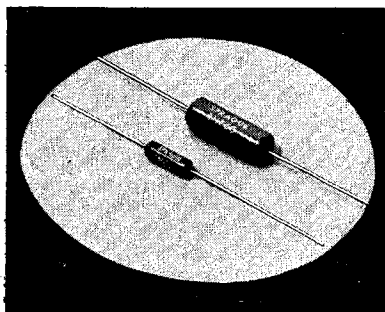

- Filmistor® C Series Resistors are Ideal for Circuits Requiring High Accuracy, Reliability, and Stability with Low Temperature Coefficients.
- Physical Size of Types RN55 and RN60 is Compatible With Those of Other Resistors, Capacitors, and Diodes for "Cordwood" Packaging.
- Designed to Meet the Stringent Performance Requirements of Spec. MIL-R-10509D.
- Low Self-inductance, Low Distributed Capacitance. Equal or Surpass the Characteristics of Precision Wirewound Resistors, Yet Are Smaller in Size.
- Metallic Resistive Film is Firmly Bonded to Special Ceramic Core, Automatically Spiralled to Desired Resistance Value.
- Tough Molded Shell Provides Protection Against Mechanical Damage as Well as Catastrophic Failures From Electrolysis Caused by Moisture Penetration.
- Standard Resistance Tolerance, $\pm 1\%$
- For Complete Technical Data, Refer to Latest Issue of Engineering Bulletin 7025
- Call Your Sprague Industrial Distributor For Quantity Prices.

STANDARD RESISTANCE VALUES (Ohms)

20.0	57.6	165	475	1.37 K	3.92 K	11.3 K	32.4 K	93.1 K	267 K	750 K
20.5	59.0	169	487	1.40 K	4.02 K	11.5 K	33.2 K	95.3 K	274 K	768 K
21.0	60.4	174	499	1.43 K	4.12 K	11.8 K	34.0 K	97.6 K	280 K	787 K
21.5	61.9	178	511	1.47 K	4.22 K	12.1 K	34.8 K	100 K	287 K	806 K
22.1	63.4	182	523	1.50 K	4.32 K	12.4 K	35.7 K	102 K	294 K	825 K
22.6	64.9	187	536	1.54 K	4.42 K	12.7 K	36.5 K	105 K	301 K	845 K
23.2	66.5	191	549	1.58 K	4.53 K	13.0 K	37.4 K	107 K	309 K	866 K
23.7	68.1	196	562	1.62 K	4.64 K	13.3 K	38.3 K	110 K	316 K	887 K
24.3	69.8	200	576	1.65 K	4.75 K	13.7 K	39.2 K	113 K	324 K	909 K
24.9	71.5	205	590	1.69 K	4.87 K	14.0 K	40.2 K	115 K	332 K	931 K
25.5	73.2	210	604	1.74 K	4.99 K	14.3 K	41.2 K	118 K	340 K	953 K
26.1	75.0	215	619	1.78 K	5.11 K	14.7 K	42.2 K	121 K	348 K	976 K
26.7	76.8	221	634	1.82 K	5.23 K	15.0 K	43.2 K	124 K	357 K	1.00 meg.
27.4	78.7	226	649	1.87 K	5.36 K	15.4 K	44.2 K	127 K	365 K	1.02 meg.
28.0	80.6	232	665	1.91 K	5.49 K	15.8 K	45.3 K	130 K	374 K	1.05 meg.
28.7	82.5	237	681	1.96 K	5.62 K	16.2 K	46.4 K	133 K	383 K	1.07 meg.
29.4	84.5	243	698	2.00 K	5.76 K	16.5 K	47.5 K	137 K	392 K	1.10 meg.
30.1	86.6	249	715	2.05 K	5.90 K	16.9 K	48.7 K	140 K	402 K	1.13 meg.
30.9	88.7	255	732	2.10 K	6.04 K	17.4 K	49.9 K	143 K	412 K	1.15 meg.
31.6	90.9	261	750	2.15 K	6.19 K	17.8 K	51.1 K	147 K	422 K	1.18 meg.
32.4	93.1	267	768	2.21 K	6.34 K	18.2 K	52.3 K	150 K	432 K	1.21 meg.
33.2	95.3	274	787	2.26 K	6.49 K	18.7 K	53.6 K	154 K	442 K	1.24 meg.
34.0	97.6	280	806	2.32 K	6.65 K	19.1 K	54.9 K	158 K	453 K	1.27 meg.
34.8	100	287	825	2.37 K	6.81 K	19.6 K	56.2 K	162 K	464 K	1.30 meg.
35.7	102	294	845	2.43 K	6.98 K	20.0 K	57.6 K	165 K	475 K	1.33 meg.
36.5	105	301	866	2.49 K	7.15 K	20.5 K	59.0 K	169 K	487 K	1.37 meg.
37.4	107	309	887	2.55 K	7.32 K	21.0 K	60.4 K	174 K	499 K	1.40 meg.
38.3	110	316	909	2.61 K	7.50 K	21.5 K	61.9 K	178 K	511 K	1.43 meg.
39.2	113	324	931	2.67 K	7.68 K	22.1 K	63.4 K	182 K	523 K	1.47 meg.
40.2	115	332	953	2.74 K	7.87 K	22.6 K	64.9 K	187 K	536 K	1.50 meg.
41.2	118	340	976	2.80 K	8.06 K	23.2 K	66.5 K	191 K	549 K	1.54 meg.
42.2	121	348	1.0 K	2.87 K	8.25 K	23.7 K	68.1 K	196 K	562 K	1.58 meg.
43.2	124	357	1.02 K	2.94 K	8.45 K	24.3 K	69.8 K	200 K	576 K	1.62 meg.
44.2	127	365	1.05 K	3.01 K	8.66 K	24.9 K	71.5 K	205 K	590 K	1.65 meg.
45.3	130	374	1.07 K	3.09 K	8.87 K	25.5 K	73.2 K	210 K	604 K	1.69 meg.
46.4	133	383	1.10 K	3.16 K	9.09 K	26.1 K	75.0 K	215 K	619 K	1.74 meg.
47.5	137	392	1.13 K	3.24 K	9.31 K	26.7 K	76.8 K	221 K	634 K	1.78 meg.
48.7	140	402	1.15 K	3.32 K	9.53 K	27.4 K	78.7 K	226 K	649 K	1.82 meg.
49.9	143	412	1.18 K	3.40 K	9.76 K	28.0 K	80.6 K	232 K	665 K	1.87 meg.
51.1	147	422	1.21 K	3.48 K	10.0 K	28.7 K	82.5 K	237 K	681 K	1.91 meg.
52.3	150	432	1.24 K	3.57 K	10.2 K	29.4 K	84.5 K	243 K	698 K	1.96 meg.
53.6	154	442	1.27 K	3.65 K	10.5 K	30.1 K	86.6 K	249 K	715 K	2.00 meg.
54.9	158	453	1.30 K	3.74 K	10.7 K	30.9 K	88.7 K	255 K	732 K	
56.2	162	464	1.33 K	3.83 K	11.0 K	31.6 K	90.9 K	261 K		

1/20 WATT METAL FILM TYPE 415E/RN50C

.065" Dia. x .140" Long
20 ohms thru 100K

1/4 WATT METAL FILM TYPE 419E/RN65C

.200" Dia. x .600" Long
49.9 ohms thru 1 meg.

1/10 WATT METAL FILM TYPE 416E/RN55C

.095" Dia. x .250" Long
49.9 ohms thru 100K

1/2 WATT METAL FILM TYPE 420E/RN70C

.250" x Dia. .750" Long
49.9 ohms thru 1 meg.

1/8 WATT METAL FILM TYPE 418E/RN60C

.135" Dia. x .400" Long
49.9 ohms thru 499 K

1 WATT METAL FILM TYPE 421E/RN75C

.375" Dia. x 1.062" Long
49.9 ohms thru 2 meg.



WARD LEONARD

Metohm[®] RESISTORS Metal Film Precision Type

THE STANDARD OF QUALITY FOR MILITARY AND INDUSTRIAL PURPOSES

FEATURES

- High stability and reliability
- Designed to exceed MIL-R-10509F
- Close resistance tolerance
- Wide range of resistance values
- Stock or made-to-order types
- 1/20, 1/10, 1/8, 1/4 and 1/2 watt sizes

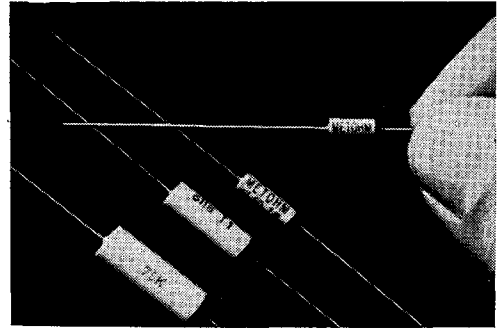

In critical space-age electronic circuitry, METOHM metal film precision resistors guarantee high reliability, high stability, close accuracy, low TC and miniature size. Metohms are precision made under "white-room" conditions in the industry's most modern plant.

MIL SPECS. — All Metohm precision resistors are designed to exceed MIL-R-10509F char. C, D and E.

POWER RATING — is based on full rated load in an ambient of 125°C.

WELDABLE LEADS — gold plated Dumet leads and nickel "270" leads are available for weldable applications.

STOCK METOHMS — RN50, 55, 60, 65 and 70 Metohm resistors, char .C, TC Code T2 (±50PPM) are stocked in MIL standard values listed below. Standard tolerance is ±1%.

MADE-TO-ORDER TYPES — see data in accompanying tables for non-stock resistors available in production order quantities.

CONFORMAL COATED TYPES — also available in 1/20, 1/10, 1/8, 1/4 and 1/2 w. sizes. Durable solvent resistant coating allows smaller size. Ideal for micro module circuitry where space is at a premium.

RATINGS AND SIZES — METOHM Metal Film Precision Resistors

Designations		Watt Rating		Resistance Range Ohms		Max. Voltage Rating (Continuous)	Standard Resistance Tolerance	Temperature Coefficient	A Length	B Diameter	C Axial Lead	
MIL	Industrial	@ 125°C	@ 70°C	Min.	Max.						Length	Diameter
RN 55†	1/20	1/10	30.1	100K	200v	1%*	**	.150±0.10	.065±.005	1 ±1/8	.016±.002 (#26 AWG)
.....	WLC 50†	1/20	1/10	30	100K							
RN 55	1/10	1/5	49.9	100K	200v	1%*	**	.260±.010	.120 +.005 - .015	1 1/2 ±1/8	.025±.002 (#22 AWG)
.....	††WLC 55	1/10	1/5	10	301K							
RN 60	1/8	1/4	49.9	499K	250v	1%*	**	.406±.015	.130±.015	1 1/2 ±1/8	.025±.002 (#22 AWG)
.....	††WLC 60	1/8	1/4	10	500K							
RN 65	1/4	1/2	49.9	1 meg.	300v	1%*	**	.594±.015	.203 +.015	1 1/2 ±1/8	.025±.002 (#22 AWG)
.....	WLC 65	1/4	1/2	10	1 meg.							
RN 70	1/2	1	24.9	1.5 meg.	350v	1%*	**	.719±.020	.261±.020	1 1/2 ±1/8	.025±.002 (#22 AWG)
.....	WLC 70	1/2	1	10	1.5 meg.							

* Closer tolerances to order. See MIL Resistance Tolerance table below.
 ** See Temperature Coefficient Code Table below.
 † Conformal coated. †† Also available conformal coated.

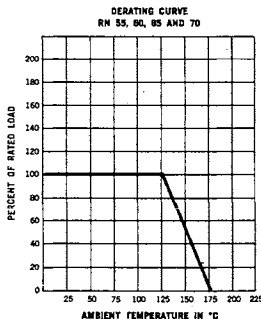
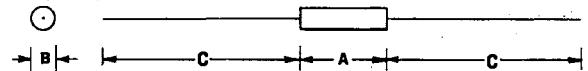

RESISTANCE TOLERANCE

MIL Designation	Tolerance
F	± 1%
D	± 0.5%
C	± 0.25%
B	± 0.1%
—	± 0.05%

TEMPERATURE COEFFICIENT CODE

T.C. Code**	MIL Char.	Temperature Coefficient Range***	Temperature Range
T-0	D	±100 PPM/°C	-55°C to +175°C
T-2	C	± 50 PPM/°C	-55°C to +175°C
T-3	—	0 to + 100 PPM/°C	-55°C to +175°C
T-4	—	0 to - 100 PPM/°C	-55°C to +175°C
T-5	—	± 25 PPM/°C	+25°C to +145°C
T-6	—	0 to + 50 PPM/°C	-55°C to +175°C
T-7	—	0 to - 50 PPM/°C	-55°C to +175°C
T-8	—	{ ± 35 PPM/°C	-55°C to + 25°C
		{ ± 25 PPM/°C	+25°C to +175°C
T-9	E	± 25 PPM/°C	-55°C to +175°C

** For other temperature coefficients consult Home Office for price.
 *** Parts per Million Per Degree Centigrade (100 PPM equals 0.01%)

MIL STANDARD RESISTANCE VALUES FOR STOCK METOHM RESISTORS

24.9	36.5	53.6	78.7	115	169	249	365	536	768	1100	1580	2260	3240	4640	6810	9760	14.0K	20.0K	28.7K	41.2K	59.0K	84.5K	121K	174K	249K	357K	511K	732K
25.5	37.4	54.9	80.6	118	174	255	374	549	787	1130	1620	2320	3320	4750	6980	10.0K	14.3K	20.5K	29.4K	42.2K	60.4K	86.6K	124K	178K	255K	365K	523K	750K
26.1	38.3	56.2	82.5	121	178	261	383	562	806	1150	1650	2370	3400	4870	7150	10.2K	14.7K	21.0K	30.1K	43.2K	61.9K	88.7K	127K	182K	261K	374K	536K	768K
26.7	39.2	57.6	84.5	124	182	267	392	576	825	1180	1690	2430	3480	4990	7320	10.5K	15.0K	21.5K	30.9K	44.2K	63.4K	90.9K	130K	187K	267K	383K	549K	787K
27.4	40.2	59.0	86.6	127	187	274	402	590	845	1210	1740	2490	3570	5110	7500	10.7K	15.4K	22.1K	31.6K	45.3K	64.9K	93.1K	133K	191K	274K	392K	562K	806K
28.0	41.2	60.4	88.7	130	191	280	412	604	866	1240	1780	2550	3650	5230	7680	11.0K	15.8K	22.6K	32.4K	46.4K	66.5K	95.3K	137K	196K	280K	402K	576K	825K
28.7	42.2	61.9	90.9	133	196	287	422	619	887	1270	1820	2610	3740	5360	7870	11.3K	16.2K	23.2K	33.2K	47.5K	68.1K	97.6K	140K	200K	287K	412K	590K	845K
29.4	43.2	63.4	93.1	137	200	294	432	634	909	1300	1870	2670	3830	5490	8060	11.5K	16.5K	23.7K	34.0K	48.7K	69.8K	100K	143K	205K	294K	422K	604K	866K
30.1	44.2	64.9	95.5	140	205	301	442	649	931	1330	1910	2740	3920	5620	8250	11.8K	16.9K	24.3K	34.8K	49.9K	71.5K	102K	147K	210K	301K	432K	619K	887K
30.9	45.3	66.5	97.6	143	210	309	453	665	953	1370	1960	2800	4020	5760	8450	12.1K	17.4K	24.9K	35.7K	51.1K	73.2K	105K	150K	215K	309K	442K	634K	909K
31.6	46.4	68.1	100	147	215	316	464	681	976	1400	2000	2870	4120	5900	8660	12.4K	17.8K	25.5K	36.5K	52.3K	75.0K	107K	154K	221K	316K	453K	649K	931K
32.4	47.5	69.8	102	150	221	324	475	698	1000	1430	2050	2940	4220	6040	8870	12.7K	18.2K	26.1K	37.4K	53.6K	76.8K	110K	158K	226K	324K	464K	665K	953K
33.2	48.7	71.5	105	154	226	332	487	716	1020	1470	2100	3010	4320	6190	9090	13.0K	18.7K	26.7K	38.3K	54.9K	78.7K	113K	162K	232K	332K	475K	681K	976K
34.0	49.9	73.2	107	158	232	340	499	732	1050	1500	2150	3090	4420	6340	9310	13.3K	19.1K	27.4K	39.2K	56.2K	80.6K	115K	165K	237K	340K	487K	698K	1 Meg.
34.8	51.1	75.0	110	162	237	348	511	750	1070	1540	2210	3160	4530	6490	9530	13.7K	19.6K	28.0K	40.2K	57.6K	82.5K	118K	169K	243K	348K	499K	715K	1.5 Meg.
35.7	52.3	76.8	113	165	243	357	523							6650														



WARD LEONARD

Vitrohm[®] RESISTORS Vitreous Enamel Wire-Wound Power Type



Types 5F, 10F, and 20F. Furnished with wire terminal leads. Brackets supplied on request.

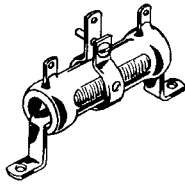

Types 10A, 25A, 50A, 80A, 100A, 160A, 200A. Furnished with mounting brackets and one adjustable band.

Vitrohm fixed and adjustable power type resistors from 5 to 200 watts are designed and produced for high reliability. All cores, terminals and vitreous enamels are manufactured by W/L to guarantee top quality.

5 WATT • TYPE 5F

Size—1" x 5/8"

Ohms	m.a.	Ohms	m.a.	Ohms	m.a.
1	2230	100	223	1200	64
1.5	1820	125	200	1250	63
2	1580	150	182	1500	57
3	1290	200	158	1750	53
4	1117	225	148	2000	50
5	1000	250	141	2250	47
7.5	811	300	129	2500	45
10	707	350	119	3000	40
12	644	400	112	3500	37
15	577	450	105	4000	35
20	500	500	100	4500	33
25	450	600	91	5000	31
30	408	700	84	6000	28
35	378	750	81	7000	26
40	353	800	79	7500	25
50	316	900	74	8000	25
75	257	1000	70	9000	23
		1100	67	10000	22

10 WATT

Size—1 3/4" x 5/8" Mtg. Centers—2 1/8"

Type 10F—Fixed			Type 10A—Adj.		
Fixed Ohms	Adj. Ohms	m.a.	Fixed Ohms	Adj. Ohms	m.a.
1	1	3160	1200		91
1.5		2580	1250	1250	89
2	2	2235	1500	1500	81
3	3	1825	1750		75
4		1580	2000	2000	70
5	5	1415	2250		66
7.5	7.5	1155	2500	2500	63
10	10	1000	3000	3000	58
12		913	3500	3500	53
15	15	815	4000	4000	50
20	20	707	4500	4500	47
25	25	630	5000	5000	45
30		577	6000	6000	41
35		534	7000	7000	38
40		500	7500	7500	36
50	50	450	8000	8000	35
75	75	365	8500	8500	34
100	100	316	9000	9000	33
125		283	10000	10000	32
150	150	258	11000		30
200	200	224	12000		29
225		211	12500		28
250	250	200	13500		27
300	300	182	15000		25.5
350	350	169	16000		25
400	400	158	17500		24
450		149	18000		23
500	500	142	20000		22
600	600	129	22500		21
700		120	25000		20
750	750	115	30000		18
800	800	112	35000		17
900		105	40000		16
1000	1000	100	45000		15
1100		95	50000		14

20 WATT • TYPE 20F

Size—2" x 5/8" Mtg. Centers—2 5/8"

Ohms	m.a.	Ohms	m.a.	Ohms	m.a.
1	4480	850	153	10000	45
3	2580	1000	141	12500	40
5	2000	1200	130	15000	36
10	1410	1250	125	20000	32
15	1150	1500	115	25000	28
25	900	1750	107	30000	26
50	630	1850	104	35000	24
75	517	2000	100	40000	22
100	450	2250	94	45000	21
150	365	2400	91	50000	20
175	340	2500	90	55000	18
200	320	2750	85	60000	16
250	285	3000	81	65000	15
300	258	3500	76	70000	14
350	240	4000	70	75000	13
400	224	4500	67	80000	12
500	200	5000	63	85000	11.5
650	175	6000	57	90000	11
700	169	7000	53	95000	10.5
750	163	7500	51	100000	10
800	155	8000	50		

25 WATT

Size—2" x 5/8" Mtg. Centers—2 5/8"

Type 25F—Fixed			Type 25A—Adj.		
Fixed Ohms	Adj. Ohms	m.a.	Fixed Ohms	Adj. Ohms	m.a.
1	1	5000	2500	2500	100
2	2	3535	3000	3000	90
3	3	2890	3500	3500	85
4		2500	4000	4000	80
5	5	2230	4500	4500	74
	7.5	1825	5000	5000	70
10	10	1580	6000	6000	65
15	15	1290	7000	7000	60
	20	1115	7500	7500	58
25	25	1000	8000	8000	56
50	50	710	8500	8500	54
75	75	580	9000	9000	52
100	100	500	10000	10000	50
150	150	410	12000	12000	46
200	200	354	15000	15000	41
250	250	315	20000	20000	34
300	300	289	25000	25000	32
400	400	250	30000		29
500	500	224	35000		27
750	750	182	40000		25
800	800	177	50000		20
850	850	170	60000		17
1000	1000	158	70000		14
1250	1250	140	75000		13
1500	1500	129	80000		12
2000	2000	112	100000		10
		2250	105		

50 WATT

Size—4 1/2" x 3/4" Mtg. Centers—5 1/4"

Type 50F—Fixed			Type 50A—Adj.		
Fixed Ohms	Adj. Ohms	m.a.	Fixed Ohms	Adj. Ohms	m.a.
1	1	7070	5000	5000	100
2	2	5000	6000	6000	91
3	3	4080	7000	7000	85
4	4	3535	7500	7500	82
5	5	3160	8000	8000	79
10	10	2235	9000	9000	75
25	25	1415	10000	10000	71
50	50	1000	12000	12000	65
75	75	815	12500		63
100	100	707	15000	15000	58
150	150	577	20000	20000	50
200	200	500	25000	25000	45
250	250	445	30000	30000	41
300	300	408	35000		38
400	400	353	40000	40000	35
500	500	316	45000		33
750	750	258	50000	50000	32
800	800	250	60000		29
1000	1000	224	75000	75000	23
	1250	200	80000		21
1500	1500	180	100000	100000	17
2000	2000	160	125000		14
	2250	150	150000		12
2500	2500	141	175000		10
3000	3000	130	200000		9
	3500	120	225000		8
4000	4000	110	250000		7
	4500	105			

80 WATTS • TYPE 80A

Size—6 1/2" x 3/4" Mtg. Centers—7 1/4"

Ohms	m.a.	Ohms	m.a.	Ohms	m.a.
1	8940	750	325	7500	103
2	6320	800	316	8000	100
3	5160	1000	282	9000	94
4	4470	1250	253	10000	89
5	4000	1500	231	15000	73
10	2830	2000	200	20000	63
15	2310	2250	188	25000	57
25	1790	2500	178	30000	51
50	1260	3000	161	35000	48
75	1030	3500	151	40000	45
100	894	4000	141	45000	41
200	632	4500	133	50000	40
250	565	5000	126	60000	36
300	515	6000	115	70000	33
400	447	7000	107	80000	31
500	400	8000	100	100000	28

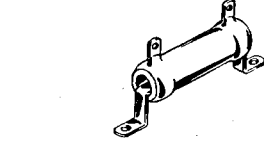

100 WATT

Size—6 1/2" x 1 1/8" Mtg. Centers—7 1/4"

Type 100F—Fixed			Type 100A—Adj.		
Fixed Ohms	Adj. Ohms	m.a.	Fixed Ohms	Adj. Ohms	m.a.
1	1	10000	2000	2000	225
2	2	7070	2500	2500	200
3	3	5770	3000	3000	180
4	4	5000	3500		170
5	5	4470	4000	4000	158
10	10	3160	4500	4500	150
25	25	2000	5000	5000	141
50	50	1410	7500	7500	130
75	75	1150	10000	10000	115
100	100	1000	15000	15000	100
	125	895	20000	20000	80
	150	815	25000	25000	70
	200	707	30000	30000	63
250	250	630	35000		58
	500	500	40000		54
	500	447	50000		50
	750	365	60000		45
	1000	316	70000		41
	1250	285	75000		38
	1500	260	100000		36
			100000	100000	32

160 WATT

Size—8 1/2" x 1 1/8" Mtg. Centers—9 1/4"

Type 160F—Fixed			Type 160A—Adj.		
Fixed Ohms	Adj. Ohms	m.a.	Fixed Ohms	Adj. Ohms	m.a.
1	1	12650	2500	2500	252
2	2	8940	3000	3000	230
3	3	7300	3500	3500	215
4	4	6320	4000	4000	200
5	5	5650	4500	4500	185
10	10	4000	5000	5000	178
15	15	3265	7500	7500	146
25	25	2525	10000	10000	126
50	50	1785	15000	15000	105
75	75	1460	20000	20000	90
100	100	1265	25000	25000	80
150	150	1035	30000	30000	73
200	200	894	35000		68
250	250	800	40000	40000	64
500	500	565	50000	50000	57
750	750	460	60000	60000	52
1000	1000	400	75000	75000	46
1500	1500	326	80000	80000	45
2000	2000	280	100000	100000	40

200 WATT

Size—10 1/2" x 1 1/8" Mtg. Centers—11 1/4"

Type 200F—Fixed			Type 200A—Adj.		
Fixed Ohms	Adj. Ohms	m.a.	Fixed Ohms	Adj. Ohms	m.a.
1	1	14140	3500	3500	240
2	2	10000	4000	4000	225
3	3	8162	4500	4500	210
4	4	7070	5000	5000	200
5	5	6320	7500	7500	163
10	10	4470</			

**It's so easy to order
from this catalog . . .**

When ordering products shown in this book
or writing for additional information, please
be sure to specify:

- 1. Manufacturer's Catalog Numbers
and Page Numbers.**
- 2. The Year and Edition of This
MASTER.**

This will avoid confusion and expedite delivery.

Thank you!



CENTRALAB POTENTIOMETERS



CENTRALAB
Electronics Division
GLOBE-UNION INC.

Ranging from transistor circuit, highly miniaturized units to heavy-duty types, Centralab controls are outstanding for adaptability and quality of construction.

Included in this product line are carbon film, hot molded carbon and wirewound types. Physical descriptions include the hearing aid-transistor radio types as well as the typical 1/8" and 1/4" diameter shaft units.

All of the controls shown here are available for immediate delivery at factory prices; your Centralab Industrial Distributor serves you as your field source for controls identical in performance, price and quality to those obtained from the factory.

Centralab controls are quality units that have been satisfactorily applied in the most demanding commercial, industrial and military applications.

**Model B16
MINIATURE
Composition
Potentiometers**

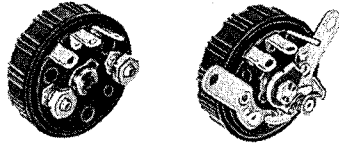

B16 controls fulfill needs for a 1/10 watt, 0.625" dia. unit. Applications include hearing aids, miniature radios, laboratory instruments, communication equipment, business machines, computers and military equipment. Plain and switch types are available.

Produced under Patent No. 2,499,711.

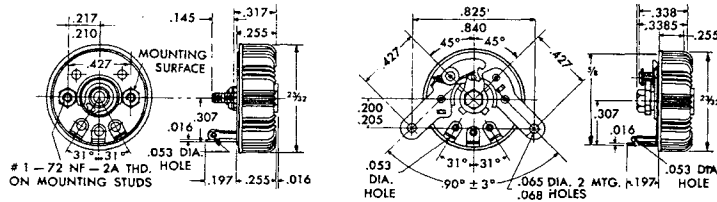

ELECTRICAL SPECIFICATIONS

- RESISTANCE RANGE:** 500 ohms to 5 megohms
- TOLERANCE:** ±20%, except * ±30%
- TAPER:** Linear (C1) log modified clockwise 1/5 watt C1 taper, 1/10 watt C2 taper.
- WATTAGE RATING:** 1/10 watt
- RESISTANCE ELEMENT:** Composition
- DIELECTRIC STRENGTH:** 900 VAC-RMS to ground
- EFFECTIVE ROTATION:** Plain type, 260°; Switch type, 225°
- ROTATIONAL LIFE:** Tested to a minimum of 25,000 cycles
- SWITCH:** SPST, factory assembled, 6.5 amperes @ 1.5 VDC; 0.2 amperes at 45 VDC

MECHANICAL SPECIFICATIONS

- SIZE:** 3/32" diameter with knob. Can be reduced to 5/8" diameter without knob.
- MECHANICAL ROTATION:** 260°
- MOUNTING:** Plain Type: Stud mounted. Two No. 1-72-NF-2 thd. x .140" long studs on .427" centers.
- SWITCH TYPE:** Bracket mounted
- CONTACTS:** Double wiping phosphor-bronze contact arm to resistor element, combined with special spiral spring electrical contact between arm and center terminal, assures positive smooth variation and extremely low noise level.
- ROTATIONAL TORQUE:** 0.3 inch-ounces
- KNOB:** Covers control completely. Removing the knob does not disassemble the control.
- PACKAGED:** One per individual display carton with mounting nuts, and/or screws and instruction sheet.

Ohms	Taper	Catalog No. Plain	Catalog No. Switch
500	C1	B16-107
1000	C1	B16-109
2500	C1	B16-111
2500	C2	B16-112	B16-212
5000	C1	B16-113
5000	C2	B16-114	B16-214
10K	C1	B16-115
10K	C2	B16-116	B16-216
25K	C1	B16-125
25K	C2	B16-117
50K	C1	B16-119
100K	C1	B16-121
250K	C1	B16-123
500K	C2	B16-118	B16-218
1 Meg.	C2	B16-120	B16-220
2 Meg.	C2	B16-122	B16-222
3 Meg.	C2	*B16-124	*B16-224
5 Meg.	C1	*B16-127
5 Meg.	C2	*B16-128	*B16-228

* ±30%

**Model SM
ULTRA MINIATURE
Composition Potentiometers**

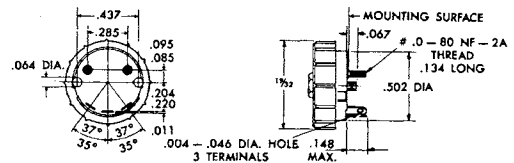
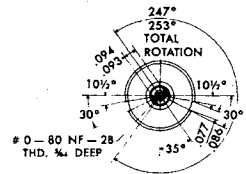
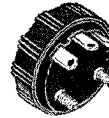

SM controls (1/10 watt, 0.502" diameter) were designed for hearing aids, telephone equipment, military communications equipment and other miniature applications. Furnished complete with on-off switch.

Produced under Patent No. 2,887,553.

ELECTRICAL SPECIFICATIONS

- RESISTANCE RANGE:** 2500 ohms to 25K ohms
- TOLERANCE:** ±20%
- TAPER:** Log modified clockwise (C2)
- WATTAGE RATING:** 1/10 watt
- RESISTANCE ELEMENT:** Composition
- DIELECTRIC STRENGTH:** 500 VAC-RMS to ground
- EFFECTIVE ELECTRICAL ROTATION:** 205°
- ROTATIONAL LIFE:** Less than 10% resistance change after 25,000 cycles
- SWITCH:** SPST, rated 2.5 amperes at 2 VDC; 0.1 amperes at 45 VDC

MECHANICAL SPECIFICATIONS

- SIZE:** 1/32" diameter with knob. Can be reduced to .502" diameter without knob
- MECHANICAL ROTATION:** 250°
- MOUNTING:** Two No. 0-80NF-2A—thread x .134" long studs on .285" centers
- CONTACTS:** Double wiping phosphor-bronze contacts assure smooth, noise-free rotation
- ROTATIONAL TORQUE:** 0.4-1.0 inch-ounces
- KNOB:** Covers control completely. Removing the knob does not disassemble the control.
- PACKAGED:** One per individual display carton with mounting nuts and instruction sheet.

Switch Type Only

Ohms	Taper	Catalog No.
2500	C2	SM2-252-S
5000	C2	SM2-502-S
10K	C2	SM2-103-S
25K	C2	SM2-253-S



CENTRALAB
Electronics Division
GLOBE-UNION INC.

JWP-JWL Models 2 WATT MINIATURE WIREWOUND POTENTIOMETERS

These are high quality miniaturized units; external appearance is similar to JMP and JML controls.

The resistance elements of the JWP and JWL controls are completely enclosed permitting sealing and potting without damage.

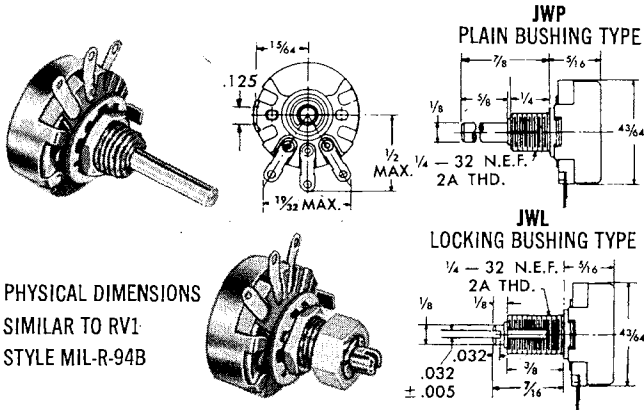

PHYSICAL DIMENSIONS
SIMILAR TO RV1
STYLE MIL-R-94B

ELECTRICAL SPECIFICATIONS

RESISTANCE RANGE: 50 ohms to 30K ohms
TOLERANCE: $\pm 5\%$
TAPER: Linear
WATTAGE RATING: 2 watts at 70°C. derated to 0 watts at 125°C. when tested to MIL-R-19A.
RESISTANCE ELEMENT: Wirewound
DIELECTRIC STRENGTH: 900 VAC-RMS at atmospheric pressure. 450 VAC at reduced barometric pressure per MIL-R-19A.
ROTATIONAL LIFE: Resistance change less than 10% for units below 10K when tested to MIL-R-19A. For values of 10K and above, less than 10% change for 20,000 cycles rotation.

MECHANICAL SPECIFICATIONS

SIZE: $3/16$ " $\pm 1/64$ " diameter, $3/16$ " deep
SHAFTS: Model JWP: Stainless steel screwdriver slotted shaft $1/8$ " diameter, $3/8$ " long from mounting surface.
Model JWL: Screwdriver slotted stainless steel shaft $1/8$ " diameter, $3/8$ " long from mounting surface.
TERMINALS: Nickel-silver, gold plated
LOCATING LUG: Left only
MECHANICAL ROTATION: $250^\circ \pm 3^\circ$
MOUNTING: Bushing Type; mounting nut and lockwasher furnished.
BUSHING: Model JWP: $1/4$ "-32 NEF-2A thd., $1/4$ " long from mounting surface.
Model JWL: Locking Type, $1/4$ "-32 NEF-2A thd., $3/8$ " long from mounting surface. Shaft locking nut furnished.
ROTATIONAL TORQUE: 0.4-6.0 inch-ounces.

ENVIRONMENTAL SPECIFICATIONS

VIBRATION: Meets the requirements of MIL-R-19A.
MOISTURE RESISTANCE: Meets the requirements of MIL-R-19A.
INSULATION RESISTANCE: Meets the requirements of MIL-R-19A.

JWP (Plain Bushing)

Ohms	Cat. No.
50	JWP-500
100	JWP-101
200	JWP-201
300	JWP-301
500	JWP-501
750	JWP-751
1000	JWP-102
1500	JWP-152
2000	JWP-202
2500	JWP-252
3000	JWP-302
4000	JWP-402
5000	JWP-502
7500	JWP-752
10K	JWP-103
15K	JWP-153
20K	JWP-203
25K	JWP-253
30K	JWP-303

JWL (Locking Bushing)

Ohms	Cat. No.
50	JWL-500
100	JWL-101
200	JWL-201
300	JWL-301
500	JWL-501
750	JWL-751
1000	JWL-102
1500	JWL-152
2000	JWL-202
2500	JWL-252
3000	JWL-302
4000	JWL-402
5000	JWL-502
7500	JWL-752
10K	JWL-103
15K	JWL-153
20K	JWL-203
25K	JWL-253
30K	JWL-303

Model B 1/2 WATT COMPOSITION POTENTIOMETERS 15/16" Diameter

Available in plain or switch types to meet prevalent radio, television and industrial needs, these controls are engineered to provide maximum adaptability. The universal terminals of the Model B may be easily applied to wirewrap, printed circuit or standard solder use.

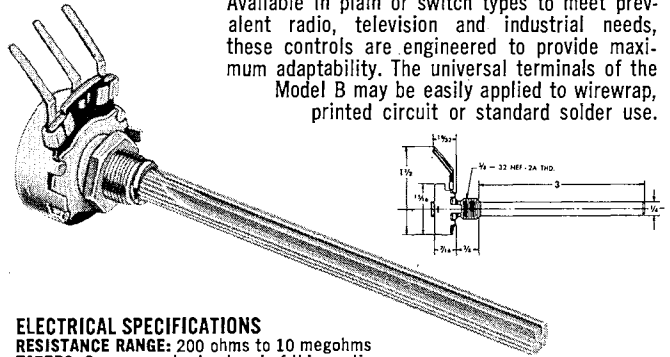

ELECTRICAL SPECIFICATIONS

RESISTANCE RANGE: 200 ohms to 10 megohms
TAPERS: See curve charts at end of this section
WATTAGE RATING: $1/2$ watt
LOAD LIFE: Less than 10% change after 1000 hours at 40°C.
RESISTANCE ELEMENT: Composition
DIELECTRIC STRENGTH: 900 VAC-RMS to ground
ROTATIONAL LIFE: Tested to a minimum of 25,000 cycles at 600 cycles per hour. Less than 15% resistance change after 25,000 cycles at no load.
SWITCH: 3 amp, 125VAC. Factory assembled on Model BPL, B-60-S and B-70-S. Model B accommodates type KR (snap-on) switches.

MECHANICAL SPECIFICATIONS

SIZE: Model B $15/16$ " diameter, $3/16$ " deep. Model BPL, $15/16$ " diameter, $1/4$ " deep.
SHAFTS: Universal fluted knurl type. Model B, Model B Switch type, BPL: $1/4$ " diameter, $3/8$ " long from mounting surface.
TERMINALS: Universal type for wirewrap, printed circuit and standard applications on Model B and B Switch types.
LOCATING LUG: Both right and left
MECHANICAL ROTATION: $330^\circ \pm 3^\circ$
MOUNTING: Bushing mounted. Suitably plated steel hex nut included.
BUSHING: $3/8$ " long, $3/8$ "-32 NEF-2A thread
CONTACTS: Spring tempered brass, double wiping
STOP STRENGTH: 12 inch-pounds
ROTATIONAL TORQUE: 1.0-6.0 inch-ounces

ENVIRONMENTAL SPECIFICATIONS

TEMPERATURE COEFFICIENT: At $+105^\circ\text{C}$. $-0.04\%/^\circ\text{C}$. resistance change; at 55°C . $+0.09\%/^\circ\text{C}$. resistance change (reference temperature, $+25^\circ\text{C}$.)
HUMIDITY CHARACTERISTICS: Less than 25% change after 96 hours in 95% relative humidity.
PACKAGED: One per individual display carton with instruction sheet.

MODEL B UNIVERSAL SHAFT TYPE CONTROLS (Plain Type)

Ohms	Taper	Catalog Number	Ohms	Taper	Catalog Number
200	C-1	B-2	500K	C-1	B-59
500	C-1	B-4	500K	C-2	B-60
1000	C-1	B-5	1 Meg.	C-1	B-69
2000	C-1	B-6	1 Meg.	C-2	B-70
2500	C-1	B-7	1.5 Meg.	C-1	B-742
5000	C-1	B-10	2 Meg.	C-1	B-75
5000	C-2	B-11	2 Meg.	C-2	B-76
10K	C-1	B-14	2.5 Meg.	C-1	B-83
10K	C-2	B-15	3 Meg.	C-1	B-84
20K	C-1	B-22	5 Meg.	C-1	B-87
25K	C-1	B-26	7.5 Meg.	C-1	B-90
50K	C-1	B-31	10 Meg.	C-1	B-98
50K	C-2	B-32	MODEL BPL SWITCH TYPE (Push-Pull Switch)		
100K	C-1	B-40			
100K	C-2	B-41			
200K	C-1	B-46	Ohms	Taper	Cat. No.
250K	C-1	B-50	500K	C-2	BPL-60
250K	C-2	B-51	1 Meg.	C-2	BPL-70

MODEL B SWITCH TYPE

Factory assembled switch type units are universal D.P.S.T., for S.P.S.T., D.P.S.T., or 3 wire usage. Switch rated 3 amp-125VAC.

Ohms	Taper	Catalog Number
500K	C-2	B-60-S
1 Meg.	C-2	B-70-S

TYPE KR FASTACH® SWITCHES

Underwriters approved. Remove label and snap on control. (Patent No. 2,776,356)

Switching	Rating	Cat. No.
SPST	5 amp., 125 v.a.c.	KR-1
DPST	3 amp., 125 v.a.c.	KR-2
DP ... { 1 pole on } { 1 pole off }	3 amp., 125 v.a.c.	KR-3*
SPST	15 amp., 10 v.d.c.	KR-4
SPST	15 amp., 10 v.d.c.	KR-6**
DPST	15 amp., 10 v.d.c.	KR-7
(Switch Shield)		KR-5)

* Can be used as SPDT by adding a jumper wire between terminals 1 and 3
** With dummy lug

REPLACEMENT AC LINE SWITCHES

Used primarily as replacement switches for factory assembled switch type controls in original equipment.

Switching	Rating	Cat. No.
DPST	3 amp., 125 VAC	SP-2
SPST	3 amp., 125 VAC	SP-3



CENTRALAB
Electronics Division
GLOBE-UNION INC.

Model N 3/4 WATT HOT MOLDED POTENTIOMETERS

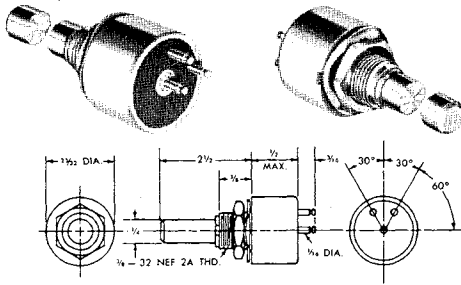

Model "N" is a Hot Molded Potentiometer only $\frac{3}{32}$ " diameter and rated at $\frac{3}{4}$ Watt. Minimal physical and electrical noise; all exposed metal parts are corrosion-resistant. One piece aluminum case is spun over the insulating base to provide a seal and to promote rapid heat dissipation. Pin-type terminals project to the rear for easy wire attachment.

ELECTRICAL SPECIFICATIONS

RESISTANCE RANGE: 500 ohms to 2.5 megohms
TOLERANCES: $\pm 10\%$ or $\pm 20\%$ as listed
TAPERS: Linear (C1); Log, modified clockwise (C2); Log, modified counterclockwise (C3)
WATTAGE RATING: $\frac{3}{4}$ watt at 70° C., 350 volts
RESISTANCE ELEMENT: Hot molded carbon composition
DIELECTRIC STRENGTH: 900 VAC-RMS to ground

MECHANICAL SPECIFICATIONS

SIZE: $\frac{3}{32}$ " diameter, $\frac{1}{2}$ " deep FMS

SHAFT: $\frac{1}{8}$ " diameter, full round steel, zinc chromate finish. $2\frac{1}{2}$ " long from mounting surface
TERMINALS: Silver-plated brass $\frac{1}{16}$ " diameter, $\frac{3}{16}$ " long pin type. Terminals are grooved so wires can be crimped into place.
CASE: Cold-formed aluminum alloy, securely swaged to the insulating base. Suitable for encapsulation without affecting operation.
MECHANICAL ROTATION: $300^\circ \pm 3^\circ$
MOUNTING: Single hole, bushing type. Nickel-plated brass nut and internal tooth lock washer furnished.
BUSHING: $\frac{3}{16}$ "-32NEF-2A thd., aluminum alloy, $\frac{3}{8}$ " long
ROTATIONAL TORQUE: 5.0 ounce-inches average

Ohms	Taper	Tol.	Catalog No.
500	C1	$\pm 10\%$	NCP9-501-U
1000	C1	$\pm 10\%$	NCP9-102-U
2500	C1	$\pm 10\%$	NCP9-252-U
5000	C1	$\pm 10\%$	NCP9-502-U
10K	C1	$\pm 10\%$	NCP9-103-U
10K	C3	$\pm 10\%$	NCP9-103-B
25K	C1	$\pm 10\%$	NCP9-253-U
25K	C3	$\pm 10\%$	NCP9-253-B
50K	C1	$\pm 10\%$	NCP9-503-U
50K	C3	$\pm 10\%$	NCP9-503-B
100K	C1	$\pm 10\%$	NCP9-104-U
100K	C2	$\pm 10\%$	NCP9-104-A
250K	C1	$\pm 10\%$	NCP9-254-U
250K	C2	$\pm 10\%$	NCP9-254-A
500K	C1	$\pm 10\%$	NCP9-504-U
500K	C2	$\pm 10\%$	NCP9-504-A
1 Meg.	C1	$\pm 20\%$	NCP9-105-M
1 Meg.	C2	$\pm 20\%$	NCP9-105-R
2.5 Meg.	C1	$\pm 20\%$	NCP9-255-M

Model P 1/2 WATT HOT MOLDED POTENTIOMETERS

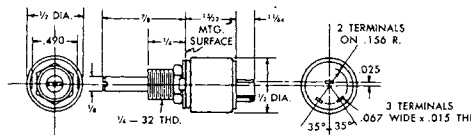
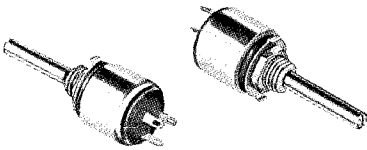

Model "P" (RV 6 style) Hot Molded Potentiometers is only $\frac{1}{2}$ " diameter, rated $\frac{1}{2}$ watt at 70° C. Minimal mechanical and electrical noise. A stainless steel shaft and anodized aluminum case provide corrosion resistance equivalent to MIL-R-94-B Style RV6.

ELECTRICAL SPECIFICATIONS

RESISTANCE RANGE: 500 ohms to 2.5 megohms
TOLERANCES: $\pm 10\%$ or $\pm 20\%$ as listed
TAPERS: Linear (C1)
WATTAGE RATING: $\frac{1}{2}$ watt at 70° C., 350 volts
RESISTANCE ELEMENT: Hot molded carbon composition
DIELECTRIC STRENGTH: 900 VAC-RMS to ground

MECHANICAL SPECIFICATIONS

SIZE: $\frac{1}{2}$ " diameter, $\frac{1}{32}$ " deep
SHAFTS: $\frac{1}{8}$ " diameter, full round stainless steel, screw-driver slotted, $\frac{3}{8}$ " long from mounting surface (seal type)

TERMINALS: Nickel silver; .015" thick, .067" wide, $\frac{1}{32}$ " long
CASE: Cold-formed anodized aluminum alloy, securely swaged to the insulating base. Suitable for encapsulation without affecting operation.
LOCATING LUGS: Two, .091" wide on .490" diameter (.245" radius)
MECHANICAL ROTATION: $295^\circ \pm 3^\circ$
MOUNTING: Single hole, bushing type (panel and shaft seal style) nut and lockwasher furnished.
BUSHING: $\frac{1}{4}$ "-32NEF-2A thd., double flattened, $\frac{1}{4}$ " long. Formed as part of the aluminum alloy case. Has separate "O" ring panel seal.
ROTATIONAL TORQUE: 1.5 ounce-inches

Ohms	Taper	Tol.	Catalog No.
500	C1	$\pm 10\%$	PNS7-501-U
1000	C1	$\pm 10\%$	PNS7-102-U
2500	C1	$\pm 10\%$	PNS7-252-U
5000	C1	$\pm 10\%$	PNS7-502-U
10K	C1	$\pm 10\%$	PNS7-103-U
25K	C1	$\pm 10\%$	PNS7-253-U
50K	C1	$\pm 10\%$	PNS7-503-U
100K	C1	$\pm 10\%$	PNS7-104-U
250K	C1	$\pm 10\%$	PNS7-254-U
500K	C1	$\pm 10\%$	PNS7-504-U
1 Meg.	C1	$\pm 20\%$	PNS7-105-M
2.5 Meg.	C1	$\pm 20\%$	PNS7-255-M

Model T 1/3 WATT HOT MOLDED POTENTIOMETERS

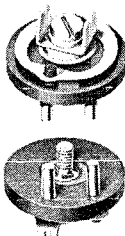
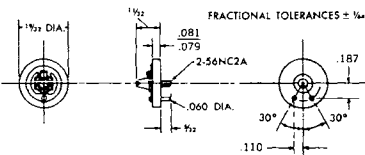

The Model T extends Hot Molded construction to the trimmer resistor or trimmer potentiometer. All critical parts non-magnetic and silver plated for superior performance and long life. Especially designed for printed circuit use. May be encapsulated.

ELECTRICAL SPECIFICATIONS

RESISTANCE RANGE: 500 ohms to 2.5 megohms
TOLERANCE: $\pm 20\%$
TAPER: Linear (C1)
WATTAGE RATING: $\frac{1}{3}$ watt at 70° C.
RESISTANCE ELEMENT: Hot molded carbon composition
DIELECTRIC STRENGTH: 900 VAC-RMS to ground

MECHANICAL SPECIFICATIONS

SIZE: $\frac{1}{32}$ " diameter, $\frac{1}{32}$ " deep
SHAFT: Screwdriver adjust with concentric screwdriver lock
TERMINALS: Silver-plated, pin type $\frac{1}{32}$ " long
MECHANICAL ROTATION: $300^\circ \pm 3^\circ$
MOUNTING: Two stub terminals and a threaded centerpiece serve as both electrical terminals and mounting means. All these terminals may be used in dip soldering on printed wiring board applications; or a nut on the center terminal may be used to mount the Model T to an insulated chassis, with the other two terminals serving as conventional solder lugs.
ROTATIONAL TORQUE: Locking type

Single Turn, Locking Type

Ohms	Taper	Tol.	Catalog No.
500	C1	$\pm 20\%$	TMX0-501-M
1000	C1	$\pm 20\%$	TMX0-102-M
2500	C1	$\pm 20\%$	TMX0-252-M
5000	C1	$\pm 20\%$	TMX0-502-M
10K	C1	$\pm 20\%$	TMX0-103-M
25K	C1	$\pm 20\%$	TMX0-253-M
50K	C1	$\pm 20\%$	TMX0-503-M
100K	C1	$\pm 20\%$	TMX0-104-M
250K	C1	$\pm 20\%$	TMX0-254-M
500K	C1	$\pm 20\%$	TMX0-504-M
1 Meg.	C1	$\pm 20\%$	TMX0-105-M
2.5 Meg.	C1	$\pm 20\%$	TMX0-225-M

ENVIRONMENTAL SPECIFICATIONS

Can be encapsulated in either flexible or rigid encapsulating compounds for endurance to atmospheric attack. All metal parts silver-plated. Temperature stable plastic is used in the insulating base molding.

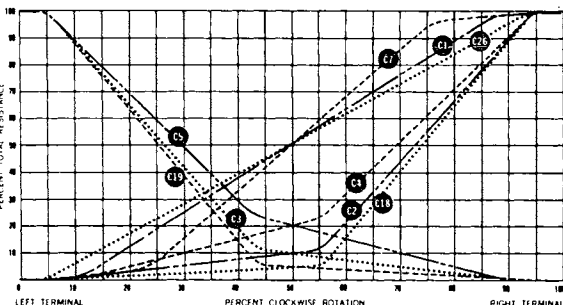

- C-1 Linear, has uniform resistance change from either end. Used for Hor. & Vert. Centering; Hor. & Vert. Hold; Hor. Drive; Vert. Linearity; Focus; Brightness; Height; Contrast, Volume or Tone.
- C-2 Semi-log (audio) 10% center. Used for Volume or Tone.
- C-3 Right-hand semi-log. Reverse of C-2. Decreases with clockwise rotation.

PRODUCTS OF
THE HOUSE OF RESISTORS



RESISTORS • CONTROLS
RESISTANCE DEVICES

COMPOSITION-ELEMENT CONTROLS

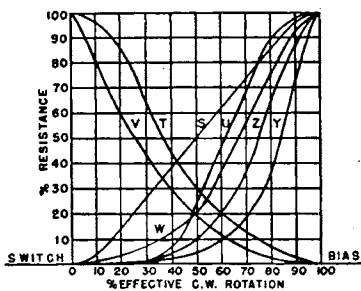

Graph Explanation:
Taper S—Straight or uniform resistance change with rotation.
Taper T — Right-hand 30% resistance at 50% of C.C.W. rotation.
Taper U — Left-hand 1% resistance at 33 1/3% of C.W. rotation.
Taper V — Right-hand 20% resistance at 50% of C.C.W. rotation.
Taper W—Left-hand 20% resistance at 50% of C.W. rotation.
Taper Z—Left-hand (Log. audio) 10% resistance at 50% of C.W. rotation.
Taper Y — Left-hand 5% resistance at 50% of C.W. rotation.

SERIES "A47" 1/2-WATT CONTROLS

Composition-element controls in the popular 1 5/16" dia. size. Series "A47" controls are field-assembled with the selected "Pick-A-Shaft" and "Ad-A-Switch". These controls are also available with factory-assembled shafts at no extra charge, by omitting prefix "A" from catalog number and designating the type shaft desired when ordering. Example: 47-100K-S with FKS-1/4 shaft.

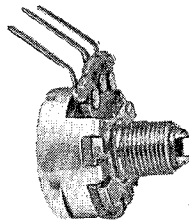

CAT No.	OHMS	TAPER	CAT No.	OHMS	TAPER
A47-500-S	500	S	A47-75K-V	75K	V
A47-750-S	750	S	A47-100K-S	100K	S
A47-1000-S	1000	S	A47-100K-Z	100K	Z
A47-1500-S	1500	S	A47-150K-S	150K	S
A47-2000-S	2000	S	A47-200K-S	200K	S
A47-2500-S	2500	S	A47-250K-S	250K	S
A47-3000-S	3000	S	A47-250K-Z	250K	Z
A47-4000-S	4000	S	A47-300K-S	300K	S
A47-5000-S	5000	S	A47-500K-S	500K	S
A47-7500-S	7500	S	A47-500K-Z	500K	Z
A47-10K-S	10K	S	A47-750K-S	750K	S
A47-10K-V	10K	V	A47-750K-Z	750K	Z
A47-10K-W	10K	W	A47-1 Meg-S	1 Meg.	S
A47-10K-Z	10K	Z	A47-1.5 Meg-S	1.5 Meg.	S
A47-15K-S	15K	S	A47-2 Meg-Z	2 Meg.	Z
A47-15K-V	15K	V	A47-2.5 Meg-S	2.5 Meg.	S
A47-15K-W	15K	W	A47-3 Meg-S	3 Meg.	S
A47-20K-S	20K	S	A47-3 Meg-Z	3 Meg.	Z
A47-25K-S	25K	S	A47-4 Meg-S	4 Meg.	S
A47-25K-W	25K	W	A47-4 Meg-Z	4 Meg.	Z
A47-25K-V	25K	V	A47-5 Meg-Z	5 Meg.	Z
A47-30K-S	30K	S	A47-5 Meg-S	5 Meg.	S
A47-40K-S	40K	S	A47-7.5 Meg-S	7.5 Meg.	S
A47-50K-S	50K	S	A47-10 Meg-S	10 Meg.	S
A47-50K-W	50K	W			
A47-50K-Z	50K	Z			
A47-75K-S	75K	S			

NET PRICE \$1.08

SERIES "AD47" 1/2-WATT DUAL CONTROLS

These are the same as "A47" except that they are dual controls.

Cat. No.	Panel	Taper	Rear	Taper
AD47-50K-S	50K	S	50K	S
AD47-100K-S	100K	S	100K	S
AD47-250K-S	250K	S	250K	S
AD47-250K-Z	250K	Z	250K	Z
AD47-500K-S	500K	S	500K	S
AD47-500K-Z	500K	Z	500K	Z
AD47-1 Meg.-S	1 Meg.	S	1 Meg.	S
AD47-1 Meg.-Z	1 Meg.	Z	1 Meg.	Z
AD47-2 Meg.-S	2 Meg.	S	2 Meg.	S
AD47-2 Meg.-V	2 Meg.	V	2 Meg.	V
AD47-5 Meg.-S	5 Meg.	S	5 Meg.	S

NET PRICE \$2.25

SERIES "C47S" 1/2-WATT CONTROLS WITH PUSH-PULL SWITCH

Cat. No.	Cat. No.
C47S-1000-V	C47S-750K-Z
C47S-2500-V	C47S-1MEG-S
C47S-250K-S	C47S-1MEG-Z
C47S-250K-Z	C47S-2MEG-S
C47S-500K-S	C47S-2MEG-Z
C47S-500K-Z	C47S-3MEG-Z
C47S-750K-S	

NET PRICE \$1.68

SERIES "C47SF" (TAPPED)

Cat. No.	Tap
C47SF-500K	Tap 250K
C47SF1-500K	Tap 150K
C47SF-1MEG	Tap 500K
C47SF1-1MEG	Tap 250K
C47SF-2MEG	Tap 1MEG
C47SF-3MEG	Tap 1.5MEG

NET PRICE \$2.15

SERIES "A47F"

Series "A47F" controls are field-assembled with the selected "Pick-A-Shaft" and "Ad-A-Switch". "A47F" controls have taps 1, 2, 3 located at 40%, 50% and 60% of rotation, double taps at 35 and 65% of electrical position. These controls are also available with factory-assembled shafts at no extra charge, by omitting prefix "A" from catalog number and designating the type of shaft desired when ordering. Example: 47F-200K with FS-3 shaft.

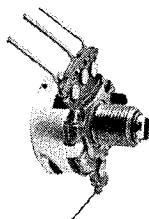

Cat. No.	Res. Ohms.	Tap		Tap No. 3
		No. 1 30%	No. 2 50%	
A47F-15K	15K	5K		10K
A47F-30K	30K	10K		
A47F-50K	50K		25K	
A47F-200K	200K			100K
A47F-250K	250K			50K
A47F1-250K	250K		125K	
A47F2-250K	250K	60K		125K
A47F-350K	350K	75K		
A47F1-350K	350K		75K	
A47F-500K	500K			100K
A47F1-500K	500K	25K		200K
A47F2-500K	500K			100K
A47F3-500K	500K		100K	50K
A47F4-500K	500K		250K	300K
A47F5-500K	500K	100K		200K
A47F6-500K	500K	250K		
A47F-1 Meg.	1 Meg.			
A47F1-1 Meg.	1 Meg.			200K
A47F2-1 Meg.	1 Meg.		50K	
A47F3-1 Meg.	1 Meg.		100K	
A47F4-1 Meg.	1 Meg.		225K	
A47F5-1 Meg.	1 Meg.		500K	
A47F-1.5 Meg.	1.5 Meg.	250K		500K
A47F-2 Meg.	2 Meg.	20K		
A47F1-2 Meg.	2 Meg.	5000		
A47F2-2 Meg.	2 Meg.	15K		
A47F3-2 Meg.	2 Meg.		1 Meg.	
A47F4-2 Meg.	2 Meg.		200K	
A47F5-2 Meg.	2 Meg.		400K	
A47F6-2 Meg.	2 Meg.		500K	
A47F7-2 Meg.	2 Meg.	250K		1 Meg.
A47F-2.5 Meg.	2.5 Meg.	250K		500K
A47F-3 Meg.	3 Meg.		250K	

NET PRICE \$1.49

*Reg. U.S. Pat. Off.

SERIES 44 — 0.02 WATT CONTROLS

Composition Element Controls rated at 0.2 watt, designed specifically for miniaturized applications such as transistorized circuits, pocket radios, hearing aids, etc. Stocked controls have Clarostat "W" taper (20% log audio). Other tapers available on special order. Series 44 is without switch, while Series 44S has factory-attached 0.5 am. 25 v.d.c. DPST switch. Other ohmages available on special order. 200 ohms to 5 meg. linear; 1500 to 2.5 meg. tapered. Also available on special order, controls with 0.5 a. 25 v.d.c. SPST switch. Items not listed are special. Prices and information on request.

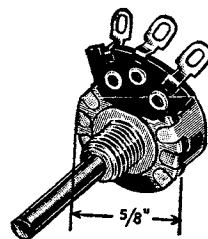

Without Switch Cat. No.	With SPST Switch Cat. No.
44-500-W	44S-500-W
44-50K-W	44S-1K-W
44-1K-W	44S-5K-W
44-5K-W	44S-10K-W
44-10K-W	44S-250K-W
44-15K-W	44S-500K-W
44-25K-W	44S-15K-W
	44S-25K-W

NET PRICE \$1.08

NET PRICE \$1.68

SERIES B47 1/2-WATT TAB-MOUNT

Composition element controls designed for radio and TV applications, where bushingless controls are required. Phenolic shaft insures insulation if control is used on a "hot" chassis. Items not listed are special, for which information and prices will be supplied on request.

Cat. No.	Cat. No.	Cat. No.	Cat. No.
B47-500-S	B47-10K-S	B47-250K-S	B47-1.5 Meg-S
B47-750-S	B47-25K-S	B47-330K-Z	B47-2 Meg-S
B47-1500-S	B47-50K-S	B47-500K-S	B47-2.5 Meg-S
B47-2500-S	B47-100K-S	B47-500K-Z	B47-3 Meg-S
B47-3000-S	B47-150K-S	B47-1 Meg-S	B47-5 Meg-S
B47-5000-S	B47-200K-S	B47-1 Meg-Z	B47-5 Meg-Z
			B47-7.5 Meg-S

NET PRICE \$7.75

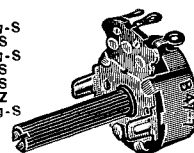

SERIES B47S 1/2-WATT TAB MOUNT WITH SWITCH

Cat. No.	Cat. No.
B47S-250K-S	B47S-1 Meg-S
B47S-250K-Z	B47S-1 Meg-Z
B47S-500K-S	B47S-2 Meg-S
B47S-500K-Z	B47S-2 Meg-Z

NET PRICE \$1.35



WIRE-WOUND CONTROLS

These are "Pick-A-Shaft" controls which take any one of 12 shafts listed on page R-24 including High Voltage Coupler and insulated shaft. Your choice of any one of the 12 shafts listed (this does not include insulated shaft) with each control. Tolerances of these controls are in accordance with EIA standards. Overall resistance

tolerance of plus/minus 10% for all values. All controls are linear. Available with factory-assembled shafts at no extra charge, by omitting the prefix "A" from the catalog number and designating the type of shaft desired when ordering. Example: 43-500 with FKS-1/4 shaft, or 43S-10K with FS-3 shaft and SPST switch.

SERIES "A43" and "A43S" 2-WATT CONTROLS

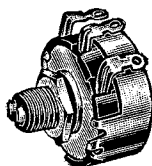

SERIES A43
(INDUSTRIAL)
SERIES 43

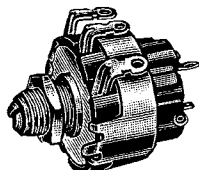

SERIES A43S
(INDUSTRIAL)
SERIES 43S

"A43" is without switch, while "A43S" has factory-attached SPST switch. When ordering "A43S" controls, specify type of switch. Controls with other than SPST switch are special. Prices and information on request.

Without Switch Cat. No.	With SPST Switch Cat. No.	Res. Ohms	Without Switch Cat. No.	With SPST Switch Cat. No.	Res. Ohms
A43-5	A43S-5	5	A43-1,000	A43S-1,000	1,000
A43-10	A43S-10	10	A43-1,500	A43S-1,500	1,500
A43-20	A43S-20	20	A43-2,000	A43S-2,000	2,000
A43-25	A43S-25	25	A43-2,500	A43S-2,500	2,500
A43-30	A43S-30	30	A43-3,000	A43S-3,000	3,000
A43-40	A43S-40	40	A43-4,000	A43S-4,000	4,000
A43-50	A43S-50	50	A43-5,000	A43S-5,000	5,000
A43-75	A43S-75	75	A43-7,500	A43S-7,500	7,500
A43-100	A43S-100	100	A43-10K	A43S-10K	10K
A43-150	A43S-150	150	A43-15K		
A43-200	A43S-200	200	A43-20K		
A43-250	A43S-250	250	A43-25K		
A43-300	A43S-300	300	A43-30K		
A43-400	A43S-400	400	A43-40K		
A43-500	A43S-500	500	A43-50K		
A43-750	A43S-750	750			

NET PRICES: (Without Switch)

5 to 10KΩ	\$1.25
15K to 25KΩ	1.52
30K to 50KΩ	1.95

(With Switch)

5 to 10KΩ	\$1.80
-----------	--------

SERIES "A58" and "A58S" 3-WATT CONTROLS

"A58" is without switch, while "A58S" has factory-attached SPST switch. Available with factory-assembled shafts, at no extra charge, by omitting prefix "A" from catalog number, and designating type of shaft desired when ordering. Example: 58-50K with KSS-3 shaft, or 58S-25K with RS-8 shaft and SPST switch. Controls with other than SPST switch are special. Prices and information on request.

Without Switch Cat. No.	Res. Ohms	Without Switch Cat. No.	Res. Ohms
A58-1	1	A58-5,000	5,000
A58-2	2	A58-7,500	7,500
A58-4	4	A58-10K	10K
A58-6	6	A58-15K	15K
A58-10	10	A58-20K	20K
A58-15	15	A58-25K	25K
A58-20	20	A58-30K	30K
A58-25	25	A58-40K	40K
A58-30	30	A58-50K	50K
A58-40	40		
A58-50	50		
A58-60	60		
A58-75	75		
A58-100	100		
A58-200	200		
A58-250	250		
A58-300	300		
A58-400	400		
A58-500	500		
A58-750	750		
A58-1,000	1,000		
A58-1,500	1,500		
A58-2,000	2,000		
A58-2,250	2,250		
A58-2,500	2,500		
A58-3,000	3,000		
A58-4,000	4,000		

NET PRICES:

1 to 10KΩ	\$1.25
15K to 25KΩ	1.52
30K to 50KΩ	1.95

With SPST Switch Res.

Cat. No.	Ohms
A58S-1	1
A58S-2	2
A58S-4	4
A58S-6	6
A58S-10	10
A58S-15	15
A58S-20	20
A58S-25	25
A58S-30	30
A58S-40	40

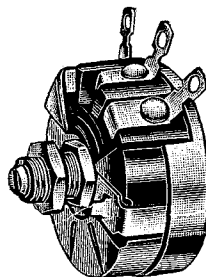

SERIES A58
(INDUSTRIAL)
SERIES 58

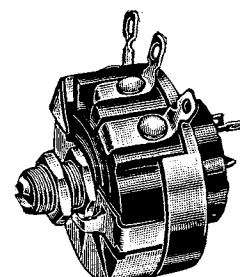

SERIES A58S
(INDUSTRIAL)
SERIES 58S

With SPST Switch Cat. No.	Res. Ohms	A58S-4,000	4,000
A58S-50	50	A58S-5,000	5,000
A58S-60	60	A58S-7,500	7,000
A58S-75	75	A58S-10K	10K
A58S-100	100	A58S-15K	15K
A58S-200	200	A58S-20K	20K
A58S-300	300	A58S-25K	25K
A58S-400	400	A58S-30K	30K
A58S-500	500	A58S-40K	40K
A58S-750	750	A58S-50K	50K
A58S-1,000	1,000		
A58S-1,500	1,500		
A58S-2,000	2,000		
A58S-2,500	2,500		
A58S-3,000	3,000		

NET PRICES:

1 to 10KΩ	\$1.80
15K to 25KΩ	1.91
30K to 50KΩ	2.35

SERIES A10 — 4 WATTS

Cat. No.	Ohms	Net
A10-75K	75K	\$2.46
A10-100K	100K	2.97

SERIES BHM ROTARY SWITCHES

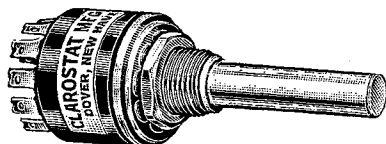

Series BHM switches are rated at 50 ma. at 300 V. a.c. or d.c., and 500 ma. at 30 V. a.c. or d.c. All moving parts and contact mechanism are totally enclosed, and the switch assembly is sealed for protection from dust and atmospheric conditions. They are particularly adapted to portable radios, receivers and transmitters, X-ray and medical instruments, calculating machines and computers.

Current: 50 Millamps. at 300 volts a.c. or d.c.
Rating: 500 Millamps. at 30 volts a.c. or d.c.
Protection: All moving parts and contact mechanisms are totally enclosed and switch is sealed, which protects it from dust and atmospheric conditions.
Shaft: 1/4" diameter round 1" beyond bushing.
Finish: Nickel Plating.
Bushing: 3/8" x 32 NEF-2 Thread. 3/8" Long.
Torque: 30 to 50 oz. in.

BHM-SP12P-S	Single Pole 12 Positions — Shorting
BHM-SP12P-NS	Single Pole 12 Positions — Non Shorting
BHM-2P6P-S	2 Pole 6 Positions — Shorting
BHM-2P6P-NS	2 Pole 6 Positions — Non-Shorting
BHM-3P4P-S	3 Pole 4 Positions — Shorting
BHM-3P4P-NS	3 Pole 4 Positions — Non-Shorting
BHM-4P3P-S	4 Pole 3 Positions — Shorting
BHM-4P3P-NS	4 Pole 3 Positions — Non-Shorting

Meets or exceeds test paragraph 4.5.3 thru 4.5.13 of MIL-S-3786.

PRODUCTS OF
THE HOUSE OF RESISTORS



RESISTORS • CONTROLS
RESISTANCE DEVICES

SOUND-SYSTEM CONTROLS

For proper control of volume and tone alike, Clarostat offers a choice of several controls, such as L- and T-pads, output attenuators, and individual-speaker volume controls as used for drive-in theatre instal-

lations. These are not ordinary radio controls but rather sound-system controls designed and built for critical requirements.

CONSTANT-IMPEDANCE CONTROLS

Self-compensating volume controls known as L-pads and T-pads for use in sound systems. Rated at 2½ watts DC, but will handle up to 10 watts audio. Continuous range from 0.5 to 30 decibels attenuation in 90% rotation. Last 10% affords infinite attenuation. With Clarostat constant-impedance L-pads and T-pads the input and output impedances of associated circuits can be kept within the limits of a constant required value. Knob and dial plate furnished with each control.

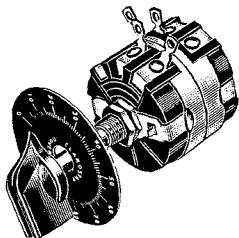

CIT Cat. No.	CIL Cat. No.	Res. Ohms
CIT-4	CIL-4	4
CIT-6	CIL-6	6
CIT-8	CIL-8	8
CIT-15	CIL-15	15
CIT-50	CIL-50	50
CIT-100	CIL-100	100
CIT-200	CIL-200	200
CIT-250	CIL-250	250

CIT — NET PRICE \$3.15

CIL — NET PRICE \$2.79

CIT Cat. No.	CIL Cat. No.	Res. Ohms
CIT-500	CIL-500	500
CIT-600	CIL-600	600
CIT-1,000	CIL-1,000	1,000
CIT-2,000	CIL-2,000	2,000
CIT-3,000	CIL-3,000	3,000
	CIL-4,000	4,000
	CIL-5,000	5,000

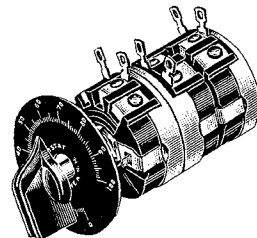

U. S. Pat. 2,434,248

CONSTANT IMPEDANCE OUTPUT ATTENUATORS

Series "CIB" rated at 10 watts, but will handle up to 30 watts in audio circuit. Linear attenuation provided in 3 decibel steps up to 24db, then 30db followed by infinity. Equipped with dial plate and bar knob. One-hole mounting, ⅜" bushing diameter. 1" shaft. This control has been developed to meet the need for a constant-impedance attenuator capable of handling considerable power without measurable insertion loss. Recommended as an output level control for power amplifiers, or as an input attenuator for individual or for a group of speakers in a public address system.

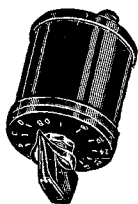

Cat. No.	Res. Ohms	Cat. No.	Res. Ohms
CIB-6	6	CIB-200	200
CIB-8	8	CIB-250	250
CIB-15	15	CIB-500	500
CIB-50	50	CIB-600	600

NET PRICE \$7.70

SPECIAL DRIVE-IN THEATRE L-PAD

To meet the needs of theater sound systems, more especially those of drive-in theaters, a special 8 ohm L-Pad is now available, containing two separate windings of 5 ohms and 40 ohms. Also 50 ohm linear rheostat and 35 ohm tapered rheostat, as listed. Units have ⅜"-32 bushing ⅜" long, and 1½" round shaft. (Knob furnished with each control).

Cat. No. CM8727-1 8 ohm L-Pad
Net Price \$1.80

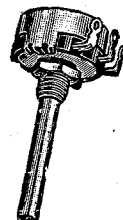

SPACE-SAVER CONSTANT-IMPEDANCE ATTENUATORS

Characterized by reduced depth and diameter, these attenuators are ideal for use in remote control of speakers since they are small enough to be installed in standard electrical boxes in the home, office, stockroom, etc.

These controls are rated 2 watts D.C., but will handle up to 4 watts of audio, depending upon the type signal being handled. (As the frequency becomes constant, wattage reduces to 2 watts or the same as the D.C. rating).

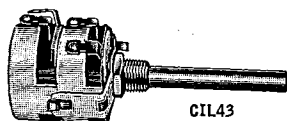

CIL43

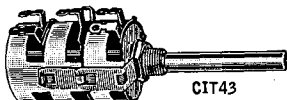

CIT43

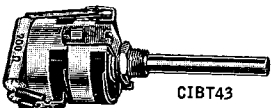

CIBT43

Cat. No. CIL43 (L-Pad)	Cat. No. CIT43 (T-Pad)	Cat. No. CIBT43 (Bridged T-Pad)	Impedance
CIL43-4	CIT43-4	CIBT43-4	4 ohms
CIL43-6	CIT43-6	CIBT43-6	6 ohms
CIL43-8	CIT43-8	CIBT43-8	8 ohms
CIL43-15	CIT43-15	CIBT43-15	15 ohms
CIL43-50	CIT43-50	CIBT43-50	50 ohms
CIL43-100	CIT43-100	CIBT43-100	100 ohms
CIL43-200	CIT43-200	CIBT43-200	200 ohms
CIL43-250	CIT43-250	CIBT43-250	250 ohms
CIL43-500	CIT43-500	CIBT43-500	500 ohms
		CIBT43-600	600 ohms

NET PRICE CIL43 \$2.79

NET PRICE CIT43 \$3.15

NET PRICE CIBT43 \$3.63

- Attenuation range of 0 to 30 db over 90% of rotation, 60 db in remaining 10% of rotation. Attenuation will increase approximately linearly to 30 db with counter-clockwise rotation.

- Insertion loss less than 0.5 db.

- Input impedance within plus/ minus 20%.

- The CIT43 and CIBT43 (Bridged T Pad) have constant input and output impedances, while the CIL43 has constant impedance in the input only.

- Shafts and bushings are insulated from the circuit elements.

- Pads have ⅜"-32 x ⅜" long bushing.

- ¼" dia. round shafts 1½" long beyond bushing.

- All pads supplied with bar knob and dial plates, as shown above.

- Dia. 1¼". Depth of body from mounting surface: CIL43 — 1⅜"; CIT43 — 1½"; CIBT43 — 1½".

PRODUCTS OF
THE HOUSE OF RESISTORS®



RESISTORS - CONTROLS
RESISTANCE DEVICES

SERIES 76JA

Multi-turn Trimming Potentiometer

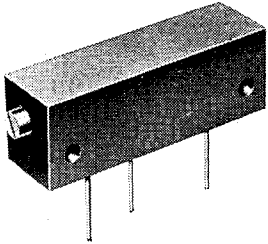

A miniature, 10-turn trimming potentiometer that offers up to 15 times the winding length available in comparable units. This feature results in setability and resolution exceeding that of trimming potentiometers several times the size. Brief specifications include a power rating of $\frac{3}{4}$ watt at 85°C derated to zero power at 150°C , resistances from 100 ohms to 20K ohms standard with other values offered on special order, standard resistance tolerance of $\pm 5\%$, printed circuit or solder lug mounting, overall dimensions of only $1.250'' \times 0.437'' \times 0.328''$.

Stock Values	Resolution %
100	0.1
200	0.09
500	0.08
1,000	0.075
2,000	0.06
5,000	0.05
10,000	0.04
20,000	0.036

SERIES 62JA

Commercial Multi-turn Potentiometer

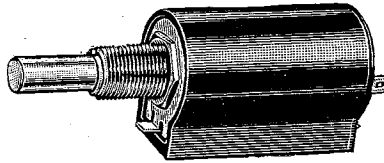

A 10-turn potentiometer offering electrical operating characteristics comparable to units costing far more. Designed specifically for the industrial instrumentation market, the Series 62JA has the inherent advantages of far greater resolution in trimming, better instrument control and settings for all types of electronic equipment. Brief specifications include: $\frac{7}{8}''$ diameter, $1\frac{1}{8}''$ deep behind panel, bushing and shaft or split-locking bushing with screwdriver slot, 2 watts @ 25°C , derated to zero @ 85°C , 1000 to 100K ohms standard—others available, absolute linearity of $\pm 0.25\%$ standard, closer on order.

Stock Values	Resolution %	Stock Values	Resolution %
100,000	.012	2,500	.022
50,000	.013	2,000	.029
30,000	.016	1,000	.030
25,000	.017	500	.036
20,000	.019	250	.038
10,000	.024	200	.048
5,000	.026	100	.062

CLARODIALS

Ten-Turn Concentric Scale Dials

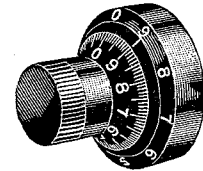

Calibrated dials designed for multi-turn potentiometers up to 10 turns or other rotary devices. CLARODIALS require only one inch of panel space. The knob attaches directly to the shaft, and the body of the dial is mounted rigidly to the panel. As a result, accurate readings with a ratio 1000:1 for ten turns are provided with zero backlash and no reading error. CLARODIALS are made of anodized aluminum for years of attractive use. Mounting requirements are $\frac{1}{4}''$ shaft and $\frac{3}{8}''$ -32 NEF-2A bushing. Adapters for $\frac{1}{8}''$ dia. shafts are available.

Cat. No.	Description
411	Commercial 10 turn, black anodize $\frac{1}{4}''$ shaft, no lock
412	Commercial 10 turn, black anodize $\frac{1}{4}''$ shaft, with lock
461	Commercial 10 turn, clear anodize $\frac{1}{4}''$ shaft, no lock
462	Commercial 10 turn, clear anodize $\frac{1}{4}''$ shaft, with lock

SERIES 54-48JA

3" Dia. Vari/Phase Single Turn Potentiometer

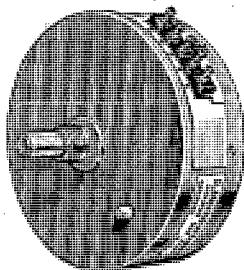

Permits external phasing of electrical rotation to mechanical rotation. Ultra precise unit for professional use. Exclusive Clarostat design eliminates bulky, hard-to-adjust clamping rings. Anodized aluminum housings for minimum weight. Widely used in aircraft instrumentation.

Stock Values	Resolution 100/Total Turns
250,000	.023%
100,000	.031%
50,000	.040%
10,000	.061%
1,000	.083%

SERIES SC42-970 SINE-COSINE

Single-Turn Potentiometer

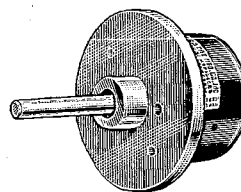

Used in radar, computer and servomechanisms, or any application requiring two output voltages accurately proportioned to the sine and cosine rotation angle. Due to functional use, units are designed and built for exceptionally long rotational life.

SPECIFICATIONS

FUNCTION: Sine-Cosine.

TOTAL RESISTANCE: $16,000 \Omega \pm 10\%$.

POWER RATING: 2.46 watts @ 40°C .
(198 volts R.M.S.)

ROTATION: (Eff., Elec., Mech) 360° (Cont.)

MAXIMUM SPEED

RECOMMENDED: 30 RPM (20 gm. contact pressure)

EXPECTED LIFE: 500,000 Cycles.

RESOLUTION: 0.14% maximum of peak to peak voltage.

CONFORMITY: Standard, $\pm 1\%$ peak to peak voltage (Available, $\pm \frac{1}{2}\%$ peak to peak voltage. Not stocked—must be ordered special price and information on request.)

SHAFT TORQUE: 1 oz. in.

WEIGHT: 6 oz.

PRODUCTS OF
THE HOUSE OF RESISTORS



RESISTORS - CONTROLS
RESISTANCE DEVICES

MILITARY POTENTIOMETERS

ITEMS IN STOCK FOR IMMEDIATE DELIVERY

RA10 per MIL-R-19 1 WATT WIRE-WOUND POTENTIOMETERS — Commercial Equivalent — Series 49M

RA10NASD150A	RA10NASD152A	RA10NASL501A	RA10LASD201A	RA10LASM750A
RA10NASD250A	RA10NASD202A	RA10NASL751A	RA10LASD251A	RA10LASM101A
RA10NASD500A	RA10NASD252A	RA10NASL102A	RA10LASD351A	RA10LASM151A
RA10NASD750A	RA10NASL150A	RA10NASL152A	RA10LASD501A	RA10LASM201A
RA10NASD101A	RA10NASL250A	RA10NASL202A	RA10LASD751A	RA10LASM251A
RA10NASD151A	RA10NASL500A	RA10NASL252A	RA10LASD102A	RA10LASM351A
RA10NASD201A	RA10NASL750A	RA10LASD150A	RA10LASD152A	RA10LASM501A
RA10NASD251A	RA10NASL101A	RA10LASD250A	RA10LASD202A	RA10LASM751A
RA10NASD351A	RA10NASL151A	RA10LASD500A	RA10LASD252A	RA10LASM102A
RA10NASD501A	RA10NASL201A	RA10LASD750A	RA10LASM150A	RA10LASM152A
RA10NASD751A	RA10NASL251A	RA10LASD101A	RA10LASM250A	RA10LASM202A
RA10NASD102A	RA10NASL351A	RA10LASD151A	RA10LASM500A	RA10LASM252A

RA20 per MIL-R-19 2 WATT WIRE-WOUND POTENTIOMETERS — Commercial Equivalent — Series 43M

RA20NASA3R0A	RA20NASA352A	RA20NASD751A	RA20LASB151A	RA20LASD250A
RA20NASA6R0A	RA20NASA502A	RA20NASD102A	RA20LASB201A	RA20LASD350A
RA20NASA8R0A	RA20NASA752A	RA20NASD152A	RA20LASB251A	RA20LASD500A
RA20NASA100A	RA20NASA103A	RA20NASD202A	RA20LASB351A	RA20LASD750A
RA20NASA150A	RA20NASA153A	RA20NASD252A	RA20LASB501A	RA20LASD101A
RA20NASA200A	RA20NASD3R0A	RA20NASD352A	RA20LASB751A	RA20LASD151A
RA20NASA250A	RA20NASD6R0A	RA20NASD502A	RA20LASB102A	RA20LASD201A
RA20NASA350A	RA20NASD8R0A	RA20NASD752A	RA20LASB152A	RA20LASD251A
RA20NASA500A	RA20NASD100A	RA20NASD103A	RA20LASB202A	RA20LASD351A
RA20NASA750A	RA20NASD150A	RA20NASD153A	RA20LASB252A	RA20LASD501A
RA20NASA101A	RA20NASD200A	RA20LASB3R0A	RA20LASB352A	RA20LASD751A
RA20NASA151A	RA20NASD250A	RA20LASB6R0A	RA20LASB502A	RA20LASD102A
RA20NASA201A	RA20NASD350A	RA20LASB8R0A	RA20LASB752A	RA20LASD152A
RA20NASA251A	RA20NASD500A	RA20LASB100A	RA20LASB103A	RA20LASD202A
RA20NASA351A	RA20NASD750A	RA20LASB150A	RA20LASB153A	RA20LASD352A
RA20NASA501A	RA20NASD101A	RA20LASB200A	RA20LASD3R0A	RA20LASD502A
RA20NASA751A	RA20NASD151A	RA20LASB250A	RA20LASD6R0A	RA20LASD752A
RA20NASA102A	RA20NASD201A	RA20LASB350A	RA20LASD8R0A	RA20LASD103A
RA20NASA152A	RA20NASD251A	RA20LASB500A	RA20LASD100A	RA20LASD153A
RA20NASA202A	RA20NASD351A	RA20LASB750A	RA20LASD150A	
RA20NASA252A	RA20NASD501A	RA20LASB101A	RA20LASD200A	

RA30 per MIL-R-19 4 WATT WIRE-WOUND POTENTIOMETERS — Commercial Equivalent — Series 58M

RA30NASA3R0A	RA30NASA102A	RA30NASD250A	RA30NASD752A	RA30LASB201A
RA30NASA6R0A	RA30NASA152A	RA30NASD350A	RA30NASD103A	RA30LASB251A
RA30NASA8R0A	RA30NASA202A	RA30NASD500A	RA30NASD153A	RA30LASB351A
RA30NASA100A	RA30NASA252A	RA30NASD750A	RA30NASD203A	RA30LASB501A
RA30NASA150A	RA30NASA352A	RA30NASD101A	RA30NASD253A	RA30LASB751A
RA30NASA200A	RA30NASA502A	RA30NASD151A	RA30LASB3R0A	RA30LASB102A
RA30NASA250A	RA30NASA752A	RA30NASD201A	RA30LASB6R0A	RA30LASB152A
RA30NASA350A	RA30NASA103A	RA30NASD251A	RA30LASB8R0A	RA30LASB202A
RA30NASA500A	RA30NASA153A	RA30NASD351A	RA30LASB100A	RA30LASB252A
RA30NASA750A	RA30NASA203A	RA30NASD501A	RA30LASB150A	RA30LASB352A
RA30NASA101A	RA30NASA253A	RA30NASD751A	RA30LASB200A	RA30LASB502A
RA30NASA151A	RA30NASD3R0A	RA30NASD102A	RA30LASB250A	RA30LASB752A
RA30NASA201A	RA30NASD6R0A	RA30NASD152A	RA30LASB350A	RA30LASB103A
RA30NASA251A	RA30NASD8R0A	RA30NASD202A	RA30LASB500A	RA30LASB153A
RA30NASA351A	RA30NASD100A	RA30NASD252A	RA30LASB750A	RA30LASB203A
RA30NASA501A	RA30NASD150A	RA30NASD352A	RA30LASB101A	RA30LASB253A
RA30NASA751A	RA30NASD200A	RA30NASD502A	RA30LASB151A	

RV4 per MIL-R-94 2 WATT CARBON POTENTIOMETERS — Commercial Equivalent — Series 53M — Series 53C

RV4NAYS101A	RV4NAYS102A	RV4NAYS0355B	RV4LAYS501A	RV4LAYS205B
RV4NAYS251A	RV4NAYS152A	RV4NAYS0505B	RV4LAYS751A	RV4LAYS255B
RV4NAYS501A	RV4NAYS252A	RV4NAYS101A	RV4LAYS102A	RV4LAYS355B
RV4NAYS102A	RV4NAYS352A	RV4NAYS102A	RV4LAYS152A	RV4LAYS505B
RV4NAYS252A	RV4NAYS502A	RV4NAYS1051A	RV4LAYS252A	
RV4NAYS502A	RV4NAYS752A	RV4NAYS1052A	RV4LAYS352A	RV4LAYS101A
RV4NAYS103A	RV4NAYS103A	RV4NAYS1052A	RV4LAYS502A	RV4LAYS051A
RV4NAYS253A	RV4NAYS153A	RV4NAYS103A	RV4LAYS752A	RV4LAYS251A
RV4NAYS503A	RV4NAYS253A	RV4NAYS1053A	RV4LAYS103A	RV4LAYS102A
RV4NAYS104A	RV4NAYS353A	RV4NAYS1053A	RV4LAYS153A	RV4LAYS252A
RV4NAYS254A	RV4NAYS503A	RV4NAYS104A	RV4LAYS253A	RV4LAYS502A
RV4NAYS504A	RV4NAYS753A	RV4NAYS1054A	RV4LAYS353A	RV4LAYS103A
RV4NAYS105A	RV4NAYS104A	RV4NAYS1054A	RV4LAYS503A	RV4LAYS253A
RV4NAYS255B	RV4NAYS154A	RV4NAYS1055A	RV4LAYS753A	RV4LAYS503A
RV4NAYS505B	RV4NAYS254A	RV4NAYS1055A	RV4LAYS104A	RV4LAYS104A
RV4NAYS0500A	RV4NAYS354A	RV4NAYS1055B	RV4LAYS154A	RV4LAYS254A
RV4NAYS0101A	RV4NAYS504A	RV4NAYS1055B	RV4LAYS254A	RV4LAYS504A
RV4NAYS0151A	RV4NAYS754A	RV4LAYS500A	RV4LAYS354A	RV4LAYS105A
RV4NAYS0251A	RV4NAYS105A	RV4LAYS101A	RV4LAYS504A	RV4LAYS255B
RV4NAYS0351A	RV4NAYS155B	RV4LAYS151A	RV4LAYS754A	RV4LAYS505B
RV4NAYS0501A	RV4NAYS205B	RV4LAYS104A	RV4LAYS105A	
RV4NAYS0751A	RV4NAYS255B	RV4LAYS151A	RV4LAYS155B	

RV6 per MIL-R-94 0.5 WATT CARBON POTENTIOMETERS — Commercial Equivalent — Series 63C

RV6NAYS101A	RV6NAYS0254A	RV6NAYS1503A	RV6LAYS103A	RV6LAYS102A
RV6NAYS0251A	RV6NAYS0504A	RV6NAYS1104A	RV6LAYS153A	RV6LAYS252A
RV6NAYS0501A	RV6NAYS105A	RV6NAYS154A	RV6LAYS253A	RV6LAYS0502A
RV6NAYS102A	RV6NAYS101A	RV6NAYS1254A	RV6LAYS503A	RV6LAYS103A
RV6NAYS0252A	RV6NAYS1251A	RV6NAYS1504A	RV6LAYS104A	RV6LAYS153A
RV6NAYS0502A	RV6NAYS1501A	RV6NAYS1054A	RV6LAYS154A	RV6LAYS253A
RV6NAYS103A	RV6NAYS102A	RV6LAYS101A	RV6LAYS254A	RV6LAYS0503A
RV6NAYS0253A	RV6NAYS1252A	RV6LAYS251A	RV6LAYS504A	RV6LAYS104A
RV6NAYS0503A	RV6NAYS1502A	RV6LAYS501A	RV6LAYS105A	RV6LAYS254A
RV6NAYS104A	RV6NAYS103A	RV6LAYS102A	RV6LAYS105A	RV6LAYS154A
RV6NAYS0154A	RV6NAYS153A	RV6LAYS252A	RV6LAYS101A	RV6LAYS254A
	RV6NAYS1253A	RV6LAYS502A	RV6LAYS251A	RV6LAYS0504A
	RV6NAYS1253A	RV6LAYS502A	RV6LAYS501A	RV6LAYS105A

SECTION 4750

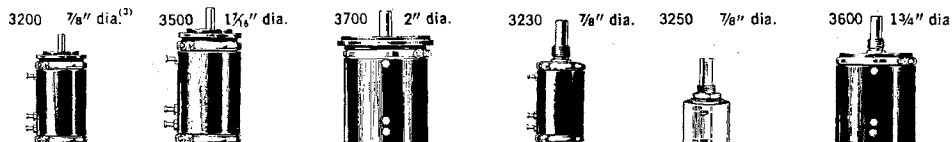

**WIREWOUND
MULTI-TURN POTENTIOMETERS**

MILITARY | COMMERCIAL

ELECTRICAL	3200	3500	3700	3230	3250	3600
Electrical Rotation	3600° ^{+4°} / _{-0°}	3600° ^{+1°} / _{-0°}	3600° ^{+1°} / _{-0°}	3600° ^{+10°} / _{-0°}	3600° ^{+10°} / _{-0°}	3600° ^{+4°} / _{-0°}
Normal Resistance Range (Ohms)	100-100K	100-200K	100-300K	100-100K	100-100K	100-300K
Extended Resistance Range (Ohms)	10-250K	50-500K	10-830K	10-200K	25-150K	10-600K
Resistance Tolerance: Std.	±3%	±3%	±3%	±3%	±5%	±3%
Best Practical	±1%	±1%	±1%	±1%	±2%	±1%
Power Rating (Watts)	2.5	5	7	2.5	2	7
Linearity: Std.	±0.25%	±0.15%	±0.1%	±0.25%	±.25%	±0.25%
Best Practical	±0.05%	±0.03%	±0.02%	±0.1%	±.10%	±0.05%
Noise, ENR Max. (Ohms)	100	100	100	100	100	100
End Resistance	Within linearity tolerance or 0.1Ω whichever is greater				0.5%	
Insulation Resistance (Megs)	1,000	1,000	1,000	1,000	1,000	1,000
Dielectric, Volts RMS	1,000	1,000	1,000	750	1,000	1,000
Voltage Across Terminals, DC	1,000	1,000	1,000	1,000	550	1,000
Tempco of Pot, Maximum	.007%/°C	.007%/°C	.007%/°C	.007%/°C	.007%/°C	.007%/°C
MECHANICAL						
Mechanical Rotation, Turns	10 ⁽¹⁾	10 ⁽¹⁾	10 ⁽¹⁾	10	10	10 ⁽²⁾
Angle	Same as Electrical Rotation					
Mechanical Life, Revolutions	2,000,000	2,000,000	2,000,000	2,000,000	500,000	2,000,000
Ganged Cups, Maximum	2	2	2	N/A	N/A	2
Taps, Maximum Number	46	110	135	46	N/A	135
Moment of Inertia (gm-cm ²)	0.4	11	12	0.4	0.3	12
Weight (oz): Single Cup	1.3	4.0	4.5	1.3	0.5	3.7
Each Additional Cup	1.0	2.5	2.7	N/A	N/A	2.5
Stop Strength (oz-in)	128	750	1,000	100	50	750
Torque: (oz-in) Starting, Bushing	0.5	N/A	1.5	0.6	1.0	1.5
Running, Bushing	0.5	N/A	1.2	0.5	1.0	1.2
Starting, Servo	0.5	1.0	1.2	N/A	N/A	N/A
Running, Servo	0.4	0.8	0.8	N/A	N/A	N/A
ENVIRONMENTAL						
Temperature Range (°C), Std.	-65 to +125	-65 to +125	-65 to +125	-55 to +105	-25 to +85	-55 to +105
Meets MIL-R-12934 For:						
Humidity	Yes	Yes	Yes	N/A ⁽⁴⁾	N/A	N/A ⁽⁴⁾
Vibration	Yes	Yes	Yes	N/A ⁽⁴⁾	N/A	N/A ⁽⁴⁾
Shock	Yes	Yes	Yes	N/A ⁽⁴⁾	N/A	N/A ⁽⁴⁾
PRICE						
Std. Item, 1-9 pcs., Bushing	\$13.00	N/A	\$20.00	\$9.50	\$5.95	\$10.00
Servo	\$19.00	\$40.00	\$22.00	N/A	N/A	N/A

⁽¹⁾ Also available in 3- & 5-turn rotation.

⁽²⁾ Also available in 3-turn rotation.

⁽³⁾ Also available in ¾" diameter.

⁽⁴⁾ Environmental specs for commercial pots: enclosed construction, 10G at 2,000 cycles vibration, 50G shock.

N/A means not available or not applicable.

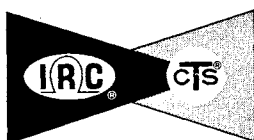

NEW! IRC-CTS STRIPTROL CONTROL REPLACEMENT SYSTEM

IRC, DIVISION OF TRW INC.

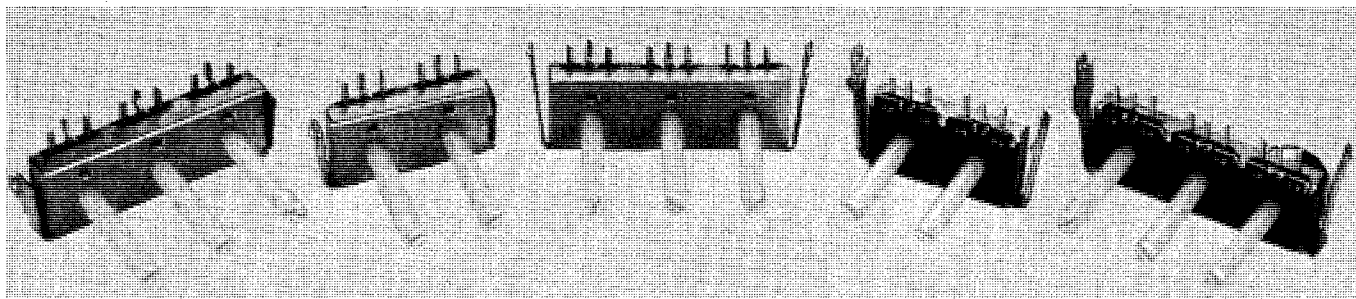

Here is a brand new replacement system which saves time and money on frequently hard-to-get TV controls.

Striptrol is a unique and modern method of providing exact replacement coverage of many often used side-by-side controls found in the majority of today's black-and-white and color TV receivers. Striptrol features simplicity of assembly and low inventory cost.

This entire replacement system stems from 3 basic

components: elements, housings and adjustors. Striptrol is assembled using a combination of one or more of the three basic parts.

The total Striptrol line consists of a variety of elements with different values and tapers. Also included are eight housings, including both vertical and horizontal mounting styles, with and without power switches, and three adjustors covering both out-the-front, out-the-rear, and switch operating styles.

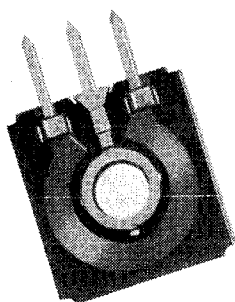

ELEMENT

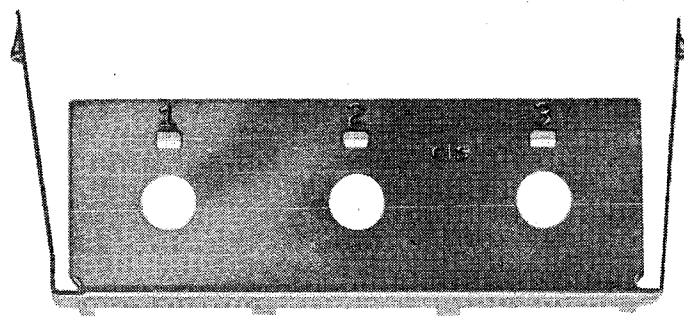

HOUSING

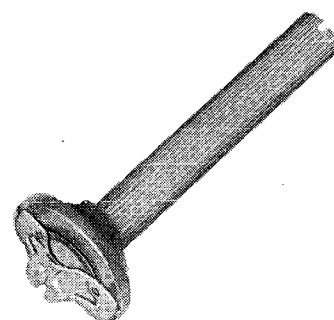

ADJUSTMENT

ELEMENTS

BY RESISTANCE VALUE

Ohms	Stock No.	Ohms	Stock No.	Ohms	Stock No.
0*	E0	15K	E8	350K	E16
150	E1	25K	E9	500K	E17
250	E2	25K	E25L	500K	E27L
500	E3	50K	E10	750K	E18
500	E24R	60K	E11	1.0M	E19
3000	E5	100K	E12	1.5M	E20
1000	E4	100K	E26L	1.5M	E28L
6000	E6	150K	E13	2.0M	E21
10K	E7	200K	E14	3.0M	E22
		250K	E15	5.0M	E23

BY IRC STOCK NUMBER

Stock No.	Ohms	Stock No.	Ohms	Stock No.	Ohms
E0	*	E9	25K	E19	1.0M
E1	150	E10	50K	E20	1.5M
E2	250	E11	60K	E21	2.0M
E3	500	E12	100K	E22	3.0M
E4	1000	E13	150K	E23	5.0M
E5	3000	E14	200K	E24R	500
E6	6000	E15	250K	E25L	25K
E7	10K	E16	350K	E26L	100K
E8	15K	E17	500K	E27L	500K
		E18	750K	E28L	1.5M

IRC NO. SECTIONS MOUNTING

IRC NO.	SECTIONS	MOUNTING
H1	2	Horizontal
H2	3	Horizontal
H3	2	Vertical
H4	3	Vertical
H5	3	Vertical - Long Leg - GC Switch
H6	3	Vertical - Long Leg - WF Switch
H7	3	Vertical - GC Switch
H8	3	Vertical - WF Switch

IRC NO. STYLE

IRC NO.	STYLE
A1	Out-the-front Adjustor
A2	Out-the-front Adjustor For Switch Operation
A3	Out-the-rear Adjustor

* No Resistive Element, No Terminals.
Elements have linear taper except where suffix letter is added to Stock No.: L—lefthand taper; R—righthand taper.

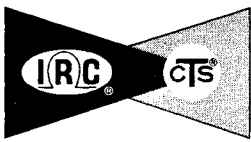

IRC-CTS SNAPTROL

IRC, DIVISION OF TRW INC.

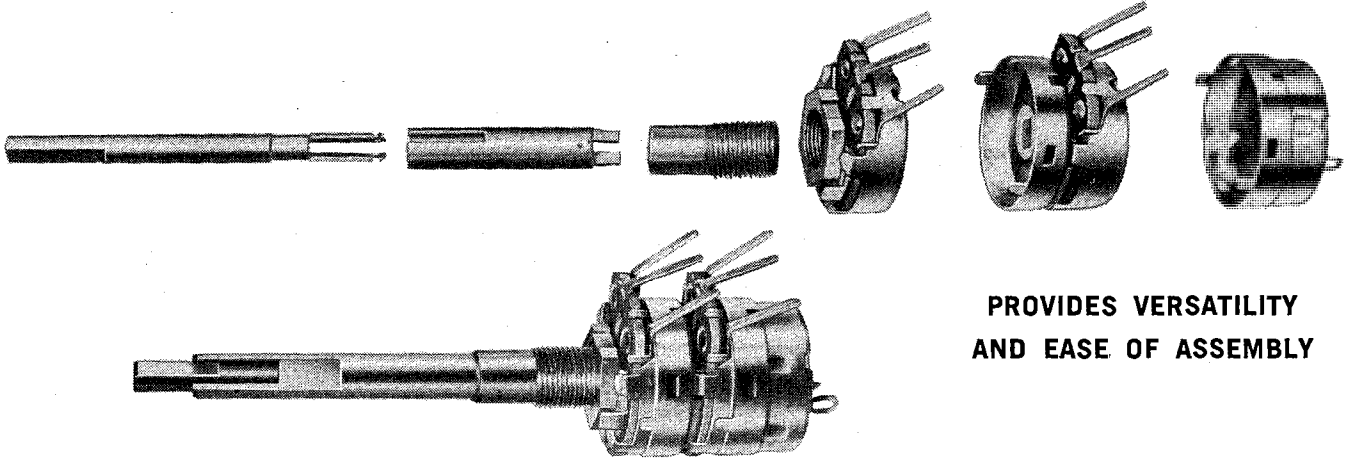

**PROVIDES VERSATILITY
AND EASE OF ASSEMBLY**

SNAPTROL Newest of three IRC replacement systems designed to provide servicing technicians with satisfactory replacements for comprehensive coverage of single controls, tandem dual controls, stereo controls and concentric dual controls for television, radio, auto sets and high fidelity equipment.

SNAPTROL provides a broad variety of basic, factory assembled control sections, shafts and switches which snap together to provide a wide selection of replacement controls. Literally, it is a "snap" to assemble nearly any standard or special control.

SERIES 45 INDUSTRIAL CONTROLS. With a variety of five basic control components, the Series 45 line permits quick assembly of 12,631,500 different control specifications. These include single, double, triple and quadruple section controls, with or without power switches, in all popular styles and ranges needed for industrial electronic equipment.

Series 45 components are completely compatible and interchangeable with SNAPTROL. Together, these two snap-together systems provide an almost unlimited means to furnish unusual and special controls for industrial applications.

EASY TO USE. Parts assemble into exact duplicate control in 15 to 30 seconds. Sections completely factory assembled. No shaft cutting or modification needed.

GREATER VERSATILITY. SNAPTROL provides new and unique designs which provide for better utility and adaptability of component parts:

1—Interchangeable Control Mountings. $\frac{3}{8}$ ", $\frac{7}{16}$ " and $\frac{1}{2}$ " diameter bushings of varying lengths and bores, quickly thread into front control sections. Accommodates thick panel requirements *without* extra bushing or adjuster. Specially designed tab mounting plates or printed circuit brackets easily attached in place of bushings. This exclusive new design feature reduces the number of front sections needed and extends their use in a greater variety of replacement needs.

2—Printed Circuit Terminals. All carbon control sections are equipped with terminals that will handle both conventional and printed circuit wiring. This original IRC-CTS terminal design doubles the adaptability of control sections.

3—Rotary or Pull-Push Power Switches. Either type of power switch snaps onto either carbon Front or Rear Sections. Another exclusive IRC-CTS design feature which very considerably increases the utility of control components.

4—Uniform Diameter Rear Section Shafts. New design of rear section (inner) shafts provide uniform diameter — permits use of heavy-walled front section (outer) shaft contributing better concentric shaft operation and superior knob retention. Simple compression type adapter fits rear section shaft to knobs normally requiring larger diameter. No drilling or modification of knobs needed. Shafts are flatted or slotted as required — no shaft insert or tine needed! This new design reduces the number of exact length shafts required for broad replacement coverage.

5—Front Sections Serve for Single Controls. Without modification or adapters, all SNAPTROL front sections may be used for single control replacements. Provides practical use of single front section for special bushings, tab mountings, printed circuits, special shaft needs and a variety of power switches. No other section-type control system provides such broad versatility.

FEWER COMPONENT PARTS. Because of the realistic design features provided, SNAPTROL requires far fewer items of components than any other section-type exact duplicate control system which offers so broad a replacement coverage. (Over 2300 exact duplicate concentric dual controls and many thousands of single controls.)

BEST SELLING CONTROLS. SNAPTROL is a special replacement design of the world's most frequently specified and most widely sold CTS Series 45 control. Over 300,000,000 in current use — a strong testimony to the quality and performance of these outstanding controls.

(See Page 1235 for Dealer Stocks of this Product)

IRC DISTRIBUTOR PRODUCTS



IRC-CTS SNAPTROL

IRC, DIVISION OF TRW INC.

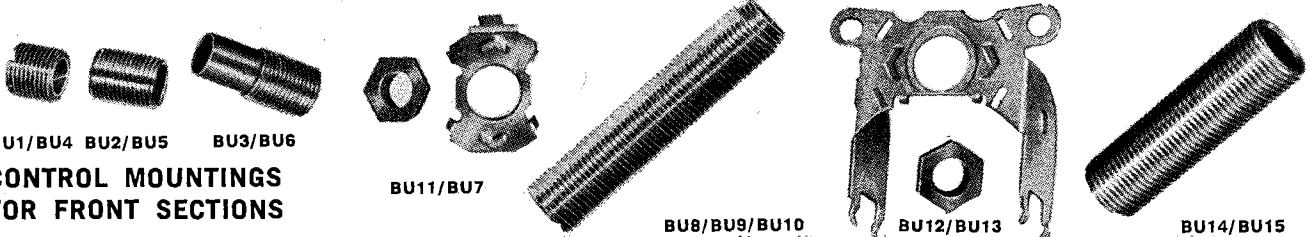

CONTROL MOUNTINGS FOR FRONT SECTIONS

A variety of control mountings permit the use of SNAPTROL Front Sections for many different replacement controls. Bushings of varying diameters and inside bores thread into front sections. Tab mounting plates and printed circuit brackets attach to front section with special male nut supplied with each.

This exclusive design feature of selectable control mountings actually reduces inventory investment for distributors and servicing technicians. For a specific resistance value and taper, only one SNAPTROL Front Section is needed—in contrast to other systems where an additional front section is needed for *each* different control mounting.

Stock No.	Description	Stock No.	Description
BU1	Bushing 3/8"—32 x 1/4" FMS— for single controls	BU9	Bushing 1/4"—28 x 2 1/4" FMS—for concentric controls. Double flat.
BU2	Bushing 3/8"—32 x 3/8" FMS— for single controls	BU10	Bushing 1/2"—28 x 2 1/4" FMS—for concentric controls. Single flat.
BU3	Bushing 3/8"—32 x 3/4" FMS— for single controls	BU11	Tab mounting with nut— for single controls
BU4	Bushing 3/8"—32 x 1/4" FMS— for concentric controls	BU12	Printed circuit bracket with nut— for single controls
BU5	Bushing 3/8"—32 x 3/8" FMS— for concentric controls	BU13	Printed circuit bracket with nut— for concentric controls
BU6	Bushing 3/8"—32 x 3/4" FMS— for concentric controls	BU14	Bushing 3/8"—32 x 1 3/4" FMS— for single controls
BU7	Tab mounting with nut— for concentric controls	BU15	Bushing 3/8"—32 x 2" FMS— for concentric dual controls.
BU8	Bushing 1/4"—28 x 1 7/8" FMS— for concentric controls		

CARBON & WIREWOUND REAR SECTIONS

Type CR Carbon Rear Sections and Type WR Wirewound Rear Sections snap onto SNAPTROL Front Sections for use as either concentric dual or tandem dual controls. Rotary or pull-push power switches snap onto CR sections. (WR sections do not accept switches.) Rear or inner concentric shafts snap into either type of rear sections for concentric dual operation. SS7A Intersection Insert provides tandem dual operation. Additional tandem sections may be snapped on by use of SS13 Multisection Couplers.

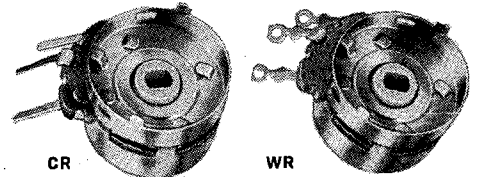

Stock No.	Ohms	Taps	Taper*
CR1	100	—	1
CR2	1000	—	1
CR3	2000	—	2
CR4	5000	—	2
CR5	10 K	—	2
CR6	25 K	—	2
CR7	50 K	—	2
CR8	100 K	—	2
CR9	200 K	—	2
CR10	250 K	—	2
CR11	500 K	—	2
CR12	1.0 Meg	—	2
CR13	1.5 Meg	—	2
CR14	2.0 Meg	—	2
CR15	2.5 Meg	—	2
CR16	3.0 Meg	—	2
CR17	5.0 Meg	—	2
CR18	250 K	—	3
CR19	350 K	—	3
CR20	500 K	—	3
CR21	1.0 Meg	—	3
CR22	2.0 Meg	—	3
CR23	3.0 Meg	—	3
CR24	5.0 Meg	—	3
CR25	2000	—	4
CR26	10 K	—	4
CR27	750	—	5
CR28	1000	—	5
CR29T	250 K	60 K	11
CR30T	350 K	75 K	11
CR31T	500 K	125 K	11
CR32T	1.0 Meg	250 K	11
CR33T	2.0 Meg	500 K	11
CR34T	250 K	125 K	12
CR35T	500 K	250 K	12
CR36T	1.0 Meg	500 K	12
CR37T	2.0 Meg	1.0 Meg	12
CR38T	3.0 Meg	1.5 Meg	12
CR39T	500 K	50 K	13
CR40T	1.0 Meg	100 K	13
CR41	500	—	1
CR42	125 K	—	2
CR43	500 K	—	4
CR44	1.0 Meg	—	4
CR45	2.0 Meg	—	4
CR46	3.0 Meg	—	4
CR47	5.0 Meg	—	4
CR48T	7.5 K	3750	12
CR49T	10 K	5000	12
CR50T	20 K	6000	11
CR51	5000	—	3
CR52	10 K	—	3
CR53	100 K	—	4
CR54TT	3.0 Meg	1.0 & 2.0 Meg	1
WR1	10 K	—	U
WR2	15 K	—	U

Ohms	Taps	Taper *	Stock No.
100	—	1	CR1
500	—	1	CR41
750	—	5	CR27
1000	—	1	CR2
1000	—	5	CR28
2000	—	2	CR3
2000	—	4	CR25
5000	—	2	CR4
5000	—	3	CR51
7500	3750	12	CR48T
10 K	—	2	CR5
10 K	—	4	CR26
10 K	5000	12	CR49T
10 K	—	3	CR52
20 K	6000	11	CR50T
25 K	—	2	CR6
50 K	—	2	CR7
100 K	—	2	CR8
100 K	—	4	CR53
125 K	—	2	CR42
200 K	—	2	CR9
250 K	—	2	CR10
250 K	—	3	CR18
250 K	60 K	11	CR29T
250 K	125 K	12	CR34T
350 K	—	3	CR19
350 K	75 K	11	CR30T
500 K	—	2	CR11
500 K	—	3	CR20
500 K	—	4	CR43
500 K	125 K	11	CR31T
500 K	250 K	12	CR35T
500 K	50 K	13	CR39T
1.0 Meg	—	2	CR12
1.0 Meg	—	3	CR21
1.0 Meg	—	4	CR44
1.0 Meg	250 K	11	CR32T
1.0 Meg	500 K	12	CR36T
1.0 Meg	100 K	13	CR40T
1.5 Meg	—	2	CR13
2.0 Meg	—	2	CR14
2.0 Meg	—	3	CR22
2.0 Meg	—	4	CR45
2.0 Meg	500 K	11	CR33T
2.0 Meg	1.0 Meg	12	CR37T
2.5 Meg	—	2	CR15
3.0 Meg	—	2	CR16
3.0 Meg	—	3	CR23
3.0 Meg	—	4	CR46
3.0 Meg	1.5 Meg	12	CR38T
3.0 Meg	1.0 & 2.0 Meg	1	CR54TT
5.0 Meg	—	3	CR17
5.0 Meg	—	3	CR24
5.0 Meg	—	4	CR47
10 K	—	U	WR1
15 K	—	U	WR2

* See Taper explanation chart, page 1246.

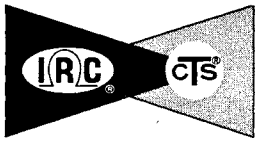

IRC-CTS SNAPTROL

IRC, DIVISION OF TRW INC.

POWER SWITCHES

SNAPTROL rotary and pull-push power switches snap on to carbon front or rear sections.

Stock No.	Description
GC	Rotary Power Switch, S.P.S.T.
K	Pull-push Power Switch, S.P.S.T., 5 Amp
VF	Rotary Power Switch, S.P.D.T.
WF	Rotary Power Switch, D.P.S.T.

DUST COVER

Stock No.	Description
DC1	Dust Cover. For use on either front or rear section when switch is not used.
DC2	Reverse Tab mount dust cover.

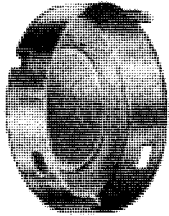

Type DC1

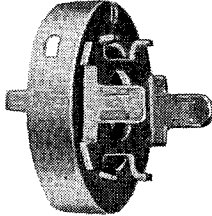

Type DC2

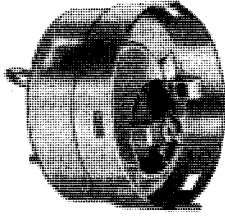

Type GC

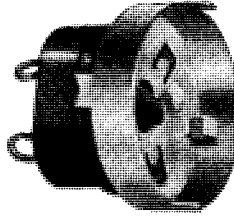

Type K

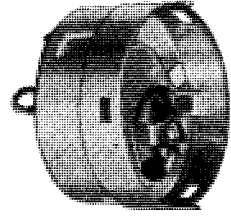

Types VF/WF

EXACT DUPLICATE SHAFTS

SNAPTROL Exact Duplicate Shafts are supplied to close tolerances against original control specifications. Easily snap into molded nylon rotors of front or rear sections. Uniform diameter of rear section (inner) shafts permit use of heavier wall on front section (outer) shafts providing better concentric rotation and superior knob fit. Knob Adapter (Stock No. KA1) fits rear (inner) shaft to knobs normally requiring larger diameter shafts. No drilling or modification of knobs is required. No cutting of shafts is needed with SNAPTROL Exact Duplicate Shafts! Easy to install!

Knob Adapter. Fits rear section shaft to knob requirements of over-size shaft. Converts .187" diameter shaft to .202" diameter shaft.

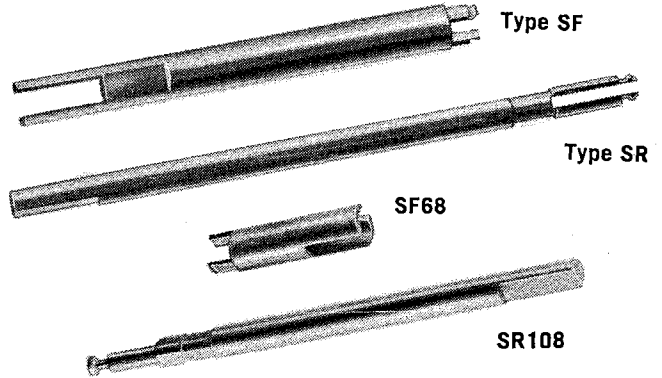

Type SF

Type SR

SF68

SR108

FRONT SECTION (OUTER) SHAFTS

STOCK NO.	SHAFT LENGTH FMS*	SHAFT END*	STOCK NO.	SHAFT LENGTH FMS*	SHAFT END*
SFA	3"	U	SF35	3 1/2"	FS
SF1	3 1/4"	S	SF36	3 3/4"	FS
SF2	3 1/2"	S	SF37	4"	FS
SF3	3 3/4"	S	SF38	4 1/4"	FS
SF4	2 1/2"	FS	SF39	4 1/2"	FS
SF5	1 5/8"	FS	SF40	1 5/8"	FS
SF6	1"	FS	SF41	1 1/8"	S
SF7	1 1/4"	FS	SF42	1 1/4"	S
SF8	1 3/8"	FS	SF43	1 3/8"	S
SF9	1 1/2"	FS	SF44	1 1/2"	S
SF10	1 3/8"	FS	SF45	2"	S
SF11	1 1/2"	FS	SF46	2 1/4"	S
SF12	1 5/8"	FS	SF47	2 1/2"	S
SF13	1 3/4"	FS	SF48	2 3/8"	S
SF14	1 3/4"	FS	SF49	2 1/2"	S
SF15	1 7/8"	FS	SF50	2 3/4"	S
SF16	1 3/4"	FS	SF51	1 5/8"	K
SF17	1 3/8"	FS	SF52	2 1/2"	K
SF18	2 1/4"	FS	SF53	1"	K
SF19	2 3/8"	FS	SF54	1 3/8"	K
SF20	2 1/2"	FS	SF55	1 3/8"	K
SF21	2 3/8"	FS	SF56	1 3/8"	K
SF22	2 1/2"	FS	SF57	3 1/2"	SD
SF23	2 1/4"	FS	SF58	3 1/2"	SD
SF24	2 1/4"	FS	SF59	3/4"	SD
SF25	2 3/4"	FS	SF60	1 1/8"	S
SF26	2 1/2"	FS	SF61	1 5/8"	S
SF27	2 1/4"	FS	SF62	1 1/8"	S
SF28	3"	FS	SF63	1 1/2"	SP
SF29	3 1/2"	FS	SF64	1 3/8"	S
SF30	3 1/8"	FS	SF65	1 3/2"	S
SF31	3 3/8"	FS	SF66	1 1/2"	SP
SF32	3 3/8"	FS	SF67	1 3/2"	SP
SF33	3 1/2"	FS	SF68	2 1/2"	FS
SF34	3 1/8"	FS			

REAR SECTION (INNER) SHAFTS

STOCK NO.	SHAFT LENGTH FMS*	SHAFT END*	STOCK NO.	SHAFT LENGTH FMS*	SHAFT END*	STOCK NO.	SHAFT LENGTH FMS*	SHAFT END*
SRA	3 1/2"	U	SR37	4 1/4"	F	SR74	3 1/4"	SD
SRB**	4 1/2"	U	SR38	4 3/4"	F	SR75	2 3/4"	SD
SR1	1 5/8"	F	SR39	1 3/4"	S	SR76	2 3/8"	SD
SR2	1 3/8"	F	SR40	1 3/8"	S	SR77	2"	SP
SR3	1 3/4"	F	SR41	1 1/2"	S	SR78	3 3/4"	SP
SR4	1 3/4"	F	SR42	1 3/4"	S	SR79	3 1/2"	SP
SR5	1 3/8"	F	SR43	1 3/4"	S	SR80	4"	SP
SR6	1 1/2"	F	SR44	1 3/4"	S	SR81**	1 1/2"	F
SR7	1 7/8"	F	SR45	1 7/8"	S	SR82**	1 1/8"	F
SR8	1 1/2"	F	SR46	1 1/2"	S	SR83**	1 1/2"	F
SR9	1 3/4"	F	SR47	2"	S	SR84**	1 3/4"	F
SR10	1 3/4"	F	SR48	2 3/4"	S	SR85**	1 3/4"	F
SR11	1 1/2"	F	SR49	2 3/4"	S	SR86**	1 1/2"	F
SR12	2"	F	SR50	2 3/4"	S	SR87**	2"	F
SR13	2 3/4"	F	SR51	2 3/8"	S	SR88**	2 3/4"	F
SR14	2 3/4"	F	SR52	2 1/2"	S	SR89**	2 3/8"	F
SR15	2 3/4"	F	SR53	2 1/2"	S	SR90**	2 3/8"	F
SR16	2 3/8"	F	SR54	2 1/2"	S	SR91**	2 3/8"	F
SR17	2 1/2"	F	SR55	2 3/4"	S	SR92**	2 3/4"	F
SR18	2 1/2"	F	SR56	2 3/4"	S	SR93**	2 3/4"	F
SR19	2 1/2"	F	SR57	2 1/4"	S	SR94**	2 1/4"	F
SR20	2 3/4"	F	SR58	3"	S	SR95	1 3/4"	S
SR21	2 1/2"	F	SR59	3 3/4"	S	SR96	1 3/4"	S
SR22	2 1/2"	F	SR60	3 1/2"	S	SR97	1 3/4"	S
SR23	3"	F	SR61	3 3/4"	S	SR98	3 1/8"	S
SR24	3 3/4"	F	SR62	3 1/2"	S	SR99	1 1/8"	S
SR25	3 3/4"	F	SR63	3 1/2"	S	SR100	3/2"	SD
SR26	3 3/4"	F	SR64	3/4"	K	SR101	1 1/2"	S
SR27	3 3/8"	F	SR65	1 1/8"	K	SR102**	2 1/2"	S
SR28	3 1/2"	F	SR66	1"	K	SR103**	2 3/2"	S
SR29	3 1/2"	F	SR67	1 3/8"	K	SR104**	2 1/8"	S
SR30	3 1/2"	F	SR68	1 3/8"	K	SR105**	2 3/4"	S
SR31	3 3/4"	F	SR69	1 1/2"	K	SR106**	3 3/2"	S
SR32	3 7/8"	F	SR70	1 1/2"	K	SR107	1 3/2"	S
SR33	3 1/2"	F	SR71	3/8"	SD	SR108**	2"	F
SR34	4 1/2"	F	SR72	1 5/8"	SD	SR109	2 1/2"	F
SR35	4 1/2"	F	SR73	2 1/2"	SD	SR110**	3 3/8"	F
SR36	4 1/2"	F						

* FMS—Measured from mounting surface. F—Flat. FS—Flat & Slot. K—Knurled. S—Slot.

** Used with pull-push switch only. SD—Screw-driver Slot. SP—Special. U—Universal Shaft

IRC-CTS SNAPTRONL/SERIES 45 INDUSTRIAL CONTROLS



IRC, DIVISION OF TRW INC.

IRC-CTS SERIES 45 CONTROLS

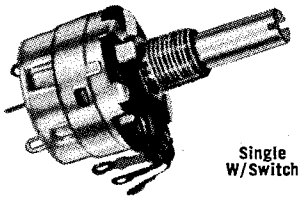

Single W/Switch

Designed to provide a wide variety of 1/2 watt controls for industrial applications, the Series 45 is a snap-together system in which selected values and sizes of five basic components will quickly assemble any of 12,631,500 specifications. Included are 25 values and tapers of single control or panel sections, 20 popular values of multi-sections or rear control sections, 20 most used shafts in length increments of 1/8" from 1/2" to 2" plus a 3" length, 2 rotary power switches and a control dust cover. Completely compatible and interchangeable with SNAPTRONL, the Series 45 affords an extremely broad selection of mechanical and electrical specifications for industrial applications. **See Page 1256 for Model Shop Stock of this Product**

SERIES 45 SNAP-IN SHAFTS

20 most often needed shafts for industrial applications. Provide screwdriver slot, flat, knurl or full round types in 1/8" increments from 1/2" to 2" in length. 3" length included. Broad shaft selection generally eliminates need for cutting or modification. All shafts 1/4" diameter.

	STOCK NO.	LENGTH FMS	KNOB TRIM
	01	1/2"	Screwdriver Slot
	02	5/8"	Screwdriver Slot
	03	3/4"	Screwdriver Slot
	04	7/8"	Screwdriver Slot
	05	1"	Screwdriver Slot
	06	7/8"	.156 x 3/16" Flat
	07	1"	.156 x 1/8" Flat
	08	1 1/8"	.156 x 5/8" Flat
	09	1 1/4"	.156 x 5/8" Flat
	10	1 3/8"	.156 x 5/8" Flat
	11	1 1/2"	.156 x 5/8" Flat
	12	1 5/8"	.156 x 5/8" Flat
	13	1 3/4"	.156 x 5/8" Flat
	14	1 7/8"	.156 x 5/8" Flat
	15	2"	.156 x 5/8" Flat
	16	2"	Full Round
	17	3"	Full Round
	18	1"	Split Knurl
	19	1 1/4"	Split Knurl
	20	1 1/2"	Split Knurl

SINGLE CONTROL OR FRONT SECTIONS. 25 most used resistance values in two resistance tapers: 45A logarithmic taper and 45D linear taper. Rated at 1/2 watt (linear taper). Equipped with 3/8"-32x3/8" long bushing for 1/4" diameter shafts. Mounting nut included. Resistance tolerance +20%.

LISTING BY STOCK NUMBER			
Stock No.	Ohms	CTS Taper	Similar To Snaptronl No.
45A103	10 K	A	CF61
45A104	100 K	A	CF52
45A105	1.0 Meg	A	CF26
45A205	2.0 Meg	A	CF27
45A254	250 K	A	CF23
45A305	3.0 Meg	A	CF28
45A503	50 K	A	CF63
45A504	500 K	A	CF25
45D102	1000	D	CF6
45D103	10 K	D	CF9
45D104	100 K	D	CF13
45D105	1.0 Meg	D	CF17
45D106	10.0 Meg	D	CF70
45D202	2000	D	—
45D203	20 K	D	CF62
45D204	200 K	D	CF14
45D205	2.0 Meg	D	CF19
45D253	25 K	D	CF11
45D254	250 K	D	CF15
45D302	3000	D	CF59
45D501	500	D	CF4
45D502	5000	D	CF8
45D503	50 K	D	CF12
45D504	500 K	D	CF16
45D505	5.0 Meg	D	CF22

LISTING BY RESISTANCE VALUE			
Stock No.	Ohms	CTS Taper	Similar To Snaptronl No.
45D501	500	D	CF4
45D102	1000	D	CF6
45D202	2000	D	—
45D302	3000	D	CF59
45D502	5000	D	CF8
45A103	10 K	A	CF61
45D103	10 K	D	CF9
45D203	20 K	D	CF62
45D253	25 K	D	CF11
45A503	50 K	A	CF63
45D503	50 K	D	CF12
45A104	100 K	A	CF52
45D104	100 K	D	CF13
45D204	200 K	D	CF14
45A254	250 K	A	CF23
45D254	250 K	D	CF15
45A504	500 K	A	CF25
45D504	500 K	D	CF16
45A105	1.0 Meg	A	CF26
45D105	1.0 Meg	D	CF17
45A205	2.0 Meg	A	CF27
45D205	2.0 Meg	D	CF19
45A305	3.0 Meg	A	CF28
45D505	5.0 Meg	D	CF22
45D106	10.0 Meg	D	CF70

POWER SWITCHES AND DUST COVER

Snap on to either panel or rear sections. Dust cover used where switch is not required.

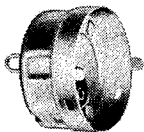

Type D/S

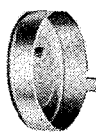

Type 45C

STOCK NO.	DESCRIPTION
D	DPST Power Switch (Snaptronl-WF)
S	SPST Power Switch (Snaptronl GC)
45C	Dust Cover (Snaptronl DC1)

* See Taper Explanation Chart, page 1246.



IRC-CTS CONCENTRIKIT® TYPE Q

IRC, DIVISION OF TRW INC.

IRC-CTS TYPE Q CONTROLS AND BASE ELEMENTS

Type Q Replacement Controls and the versatile Type Q Base-Element provide the broadest selection of resistance values and tapers. Type Q is equipped with 3" long Knobmaster Shaft—flatted, grooved and knurled for universal knob fit. Bushing $\frac{3}{8}$ —32 by $\frac{1}{4}$ " long FMS. Stock numbers in parentheses () may be assembled with Base-Element indicated and SK1 Kit. PPO items may be assembled with Base-Element listed and either SK7 or SK8 as required.

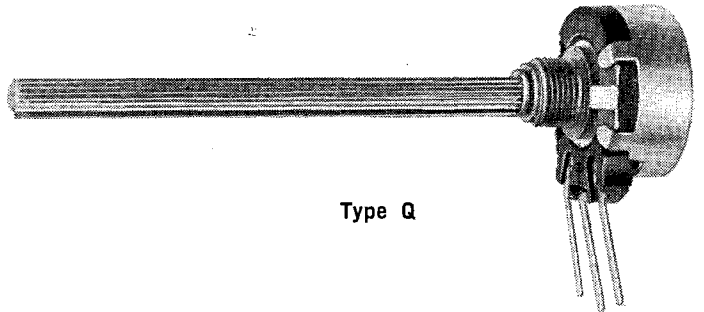

Type Q

LISTING BY RESISTANCE VALUE

OHMS	TAP	TAPER*	Q CONTROL STOCK NO.**	Q BASE-ELEMENT STOCK NO.
100	—	1 (A)	(Q11-084)	B11-084
250	—	2 (A)	Q11-201	B11-201
300	—	1 (A)	(Q11-102)	B11-102
500	—	1 (A)	Q11-103	B11-103
500	—	5 (P)	(Q17-103)	B17-103
500	60	14 (S)	(Q17-103X)	B17-103X
750	—	1 (A)	Q11-105	B11-105
750	—	5 (P)	(Q17-105)	B17-105
750	250	8 (S)	Q17-105X	B17-105X
1000	—	2 (A)	Q11-108	B11-108
1000	—	5 (P)	(Q17-108)	B17-108
1000	150	20 (S)	(Q17-108X)	B17-108X
1200	—	4 (Q)	(Q17-208)	B17-208
1500	—	2 (A)	Q11-109	B11-109
1500	—	4 (Q)	(Q17-109)	B17-109
1500	180	27 (S)	(Q15-109X)	B15-109X
1500	185 & 375	34 (S)	(Q17-109XX)	B17-109XX
2000	—	2 (A)	Q11-110	B11-110
2000	—	4 (Q)	(Q17-110)	B17-110
2000	550	38 (S)	(Q17-110X)	B17-110X
2000	250 & 500	34 (S)	Q17-110XX	B17-110XX
2500	—	2 (A)	(Q11-111)	B11-111
2500	—	3 (C)	Q13-111	B13-111
2500	—	4 (Q)	Q17-111	B17-111
2500	250	13 (S)	(Q15-111X)	B15-111X
2500	500	21 (S)	(Q17-111X)	B17-111X
2500	625	28 (S)	(Q27-111X)	B27-111X
3000	—	2 (A)	Q11-112	B11-112
3000	—	4 (Q)	(Q17-112)	B17-112
3000	150	9 (S)	(Q17-112X)	B17-112X
5000	—	2 (A)	Q11-114	B11-114
5000	—	3 (C)	Q13-114	B13-114
5000	—	4 (Q)	Q17-114	B17-114
5000	500	13 (S)	(Q15-114X)	B15-114X
5000	1000	21 (S)	(Q17-114X)	B17-114X
7500	—	2 (A)	Q11-115	B11-115
7500	3750	12	(Q21-115X)	B21-115X
10 K	—	2 (A)	Q11-116***	B11-116
10 K	—	3 (C)	Q13-116	B13-116
10 K	—	23 (D)	Q14-116***	B14-116
10 K	—	4 (Q)	(Q17-116)	B17-116
10 K	300	22 (S)	(Q15-116X)	B15-116X
10 K	5000	12	(Q19-116X)	B19-116X

LISTING BY RESISTANCE VALUE

OHMS	TAP	TAPER*	Q CONTROL STOCK NO.**	Q BASE-ELEMENT STOCK NO.
11.5 K	—	5 (Q)	(Q17-117)	B17-117
15 K	—	2 (A)	(Q11-118)	B11-118
15 K	5000	29 (S)	Q17-118X	B17-118X
15 K	10 K	8 (S)	(Q13-118X)	B13-118X
15 K	5000 & 10 K	33 (S)	(Q13-118XX)	B13-118XX
15 K	5000 & 10 K	48 (S)	Q17-118XX	B17-118XX
20 K	—	2 (A)	Q11-119	B11-119
20 K	—	4 (Q)	(Q17-119)	B17-119
20 K	—	45 (S)	Q16-119***	B16-119
20 K	6000	11	(Q19-119X)	B19-119X
25 K	—	2 (A)	Q11-120	B11-120
25 K	—	3 (C)	Q13-120	B13-120
25 K	—	23 (D)	Q14-120	B14-120
25 K	—	4 (Q)	(Q17-120)	B17-120
30 K	—	2 (A)	(Q11-121)	B11-121
30 K	10 K	8 (S)	(Q20-121X)	B20-121X
35 K	—	2 (A)	(Q11-122)	B11-122
50 K	—	2 (A)	Q11-123	B11-123
50 K	—	3 (C)	Q13-123	B13-123
50 K	—	23 (D)	Q14-123***	B14-123
50 K	—	4 (Q)	(Q17-123)	B17-123
75 K	—	2 (A)	Q11-125	B11-125
100 K	—	2 (A)	Q11-128	B11-128
100 K	—	3 (C)	Q13-128	B13-128
100 K	—	4 (Q)	(Q17-128)	B17-128
125 K	—	2 (A)	Q11-228	B11-228
150 K	—	2 (A)	Q11-328	B11-328
150 K	—	3 (C)	(Q13-328)	B13-328
150 K	19 K & 38 K	34 (S)	Q17-328XX	B17-328XX
200 K	—	2 (A)	Q11-129	B11-129
200 K	—	4 (Q)	(Q17-129)	B17-129
250 K	—	2 (A)	Q11-130	B11-130
250 K	—	3 (C)	Q13-130	B13-130
250 K	60 K	44 (H)	Q18-130X	B18-130X
250 K	125 K	12 (S)	(Q13-130X)	B13-130X
250 K	60 K & 120 K	46 (S)	Q18-130XX	B18-130XX
300 K	—	2 (A)	(Q11-131)	B11-131
350 K	—	2 (A)	(Q11-132)	B11-132
350 K	—	3 (C)	Q13-132	B13-132
350 K	35 K	13 (S)	Q17-132X	B17-132X
350 K	75 K	30 (H)	Q18-132X	B18-132X
400 K	—	2 (A)	(Q11-232)	B11-232

* Taper listing shows both new (numerical) Taper and old (alphabetical) Taper. See Taper explanation chart, page 12-46.

** Stock numbers listed in parentheses () are not available as factory-assembled controls. Use Q Base-Element shown with SK1 Kit for field assembly of such items.

*** Supplied with 270Ω bias resistor.

LISTING CONTINUED ON NEXT PAGE



IRC-CTS TYPE 4W CONTROLS AND BASE ELEMENTS

IRC, DIVISION OF TRW INC.

Types WPK and WPS are compact, 1¼" diameter wire wound controls available for replacement use in two popular shaft styles and an extensive variety of resistance values and tapers. Many stock numbers can be supplied as factory-assembled units. All stock numbers may be assembled in field using Base-Element with SK4 or SK5 Kit as desired.

Resistance elements are uniformly wound with highest grade alloy resistance wire on special form that withstands high temperature without shrinking. Pressure molded plastic housing is designed for maximum heat dissipation and accurate location of terminals. Contactor and collector are of long-wearing alloy that makes direct contact.

Resistance tolerance is $\pm 10\%$.

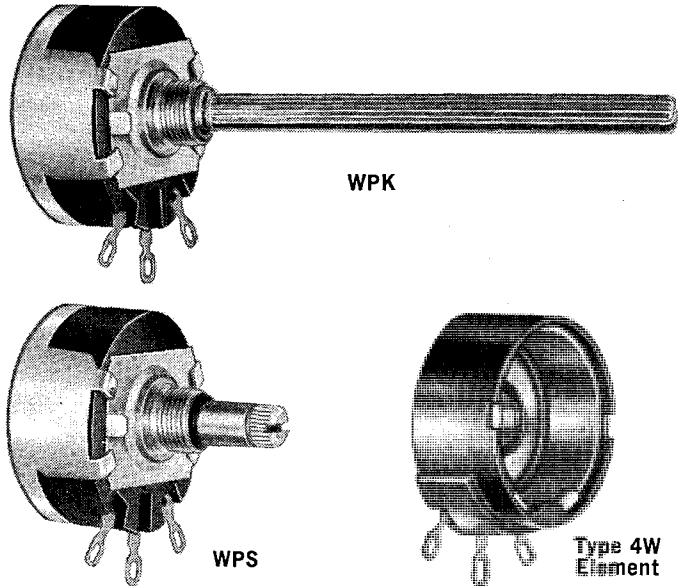

LISTING BY RESISTANCE VALUE					
OHMS	TAP	TAPER	TYPE WPK STOCK NO.*	TYPE WPS STOCK NO.*	4W BASE-ELEMENT STOCK NO.
10	—	U	WPK10	(WPS10)	W11-010
10	5	U	(WPK10X5)	WPS10X5	W11-010X
15	7.5	U	(WPK15X7.5)	WPS15X7.5	W11-015X
20	—	U	WPK20	(WPS20)	W11-020
20	10	U	(WPK20X10)	WPS20X10	W11-020X
25	—	U	(WPK25)	WPS25	W11-025
25	12.5	U	(WPK25X12.5)	WPS25X12.5	W11-025X
30	—	U	WPK30	(WPS30)	W11-030
30	15	U	(WPK30X15)	(WPS30X15)	W11-030X
40	—	U	(WPK40)	(WPS40)	W11-040
40	20	U	(WPK40X20)	WPS40X20	W11-040X
50	—	U	WPK50	(WPS50)	W11-050
50	25	U	(WPK50X25)	(WPS50X25)	W11-050X
60	—	U	(WPK60)	WPS60	W11-060
80	40	U	(WPK80X40)	WPS80X40	W11-080X
100	—	U	WPK100	(WPS100)	W11-084
100	50	U	(WPK100X50)	WPS100X50	W11-084X
140	70	U	(WPK140X70)	(WPS140X70)	W11-092X
150	75	U	(WPK150X75)	WPS150X75	W11-094X
200	—	U	WPK200	(WPS200)	W11-100
200	100	U	(WPK200X100)	WPS200X100	W11-100X
250	—	U	WPK250	WPS250	W11-201
300	—	U	WPK300	(WPS300)	W11-102
400	—	U	WPK400	(WPS400)	W11-202
500	—	U	WPK500	WPS500	W11-103
500	—	L	(WPK500L)	(WPS500L)	W13-103
600	—	U	WPK600	(WPS600)	W11-104
650	—	U	WPK650	(WPS650)	W11-204
750	—	U	WPK750	(WPS750)	W11-105
750	—	L	(WPK750L)	(WPS750L)	W13-105
750	—	R	(WPK750R)	(WPS750R)	W17-105
750	250	S	(WPK750X250)	(WPS750X250)	W17-105X

LISTING BY RESISTANCE VALUE					
OHMS	TAP	TAPER	TYPE WPK STOCK NO.*	TYPE WPS STOCK NO.	4W BASE-ELEMENT STOCK NO.
1000	—	U	WPK1000	WPS1000	W11-108
1350	—	U	(WPK1350)	(WPS1350)	W11-308
1350	—	R	WPK1350R	(WPS1350R)	W17-308
1500	—	U	WPK1500	(WPS1500)	W11-109
1500	—	L	(WPK1500L)	(WPS1500L)	W13-109
1500	500	S	(WPK1500X500)	(WPS1500X500)	W17-109X
2000	—	U	WPK2000	WPS2000	W11-110
2000	—	L	WPK2000L	(WPS2000L)	W13-110
2250	—	U	(WPK2250)	WPS2250	W11-210
2250	—	L	WPK2250L	(WPS2250L)	W13-210
2500	—	U	WPK2500	WPS2500	W11-111
2500	—	R	WPK2500R	(WPS2500R)	W17-111
3000	—	U	WPK3000	WPS3000	W11-112
3000	—	R	(WPK3000R)	(WPS3000R)	W17-112
3300	—	L	(WPK3300L)	(WPS3300L)	W13-212
4000	—	U	(WPK4000)	WPS4000	W11-113
4000	—	L	(WPK4000L)	WPS4000L	W13-113
5000	—	U	WPK5000	WPS5000	W11-114
5000	—	L	WPK5000L	(WPS5000L)	W13-114
5000	—	R	(WPK5000R)	(WPS5000R)	W17-114
6000	—	U	(WPK6000)	(WPS6000)	W11-214
6000	—	L	WPK6000L	(WPS6000L)	W13-214
7500	—	U	(WPK7500)	(WPS7500)	W11-115
7500	—	L	WPK7500L	(WPS7500L)	W13-115
10 K	—	U	WPK10000	WPS10000	W11-116
12.5 K	—	U	(WPK12500)	(WPS12500)	W11-217
15 K	—	U	(WPK15000)	(WPS15000)	W11-118
20 K	—	U	(WPK20000)	(WPS20000)	W11-119
25 K	—	U	WPK25000	(WPS25000)	W11-120
30 K	—	U	WPK30000	(WPS30000)	W11-121
40 K	—	U	(WPK40000)	(WPS40000)	W11-222
50 K	—	U	WPK50000	(WPS50000)	W11-123

* Stock numbers listed in parentheses () are not available as factory-assembled controls. Use 4W Base-Element shown with SK4 Kit (for WPK) or SK5 Kit (for WPS). See Taper explanation chart, page 1246.



IRC-CTS CONCENTRIKIT[®] TYPE Q & 4W PARTS

IRC, DIVISION OF TRW INC.

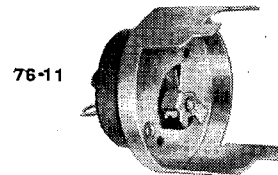
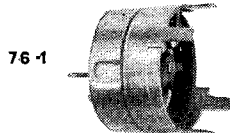

HARDWARE FOR CONCENTRIKIT[®]

Stock No.	Description
KA1	Knob Adapter. Fits rear section shaft to knob requirements of over-size shaft. Converts .187" diameter shaft to .202" diameter.
N1	Mounting Nut for 7/16" Bushings (5/8" across flats).
N2	Mounting Nut for 1/2" Bushings (5/8" across flats).
N3	Mounting Nut for 1/2" Bushings (3/4" across flats).
N4	Mounting Nut for 7/16" Bushings (1/2" across flats).
R2	Concentrikit.
R3	Q Concentric Duals.
R4	WP Concentric Duals.
R5	Ground Plate Tab Concentric Dual.
R6	Retainers as supplied in K16, K17 and K18 Kits.
R7	Shaft retainer for 1/4" diameter shafts. Replaces R1.

POWER SWITCHES

Easily attached to Type Q or Type 4W controls. Stock No. 76-5 supplied for replacement only. For attachment of this pull-push switch to controls, use SK7 or SK8 Kit below with desired Base-Element.

Stock No.	Description
76-1	S.P.S.T.—Rotary type for Type Q.
76-2	D.P.S.T.—Rotary type for Type Q
76-4	S.P.D.T.—Rotary type for Type Q. Used also as "make-one, break-one" for spot-killer switch in TV.
76-5	S.P.S.T.—Pull-push type for Type Q.
76-11	S.P.S.T.—Rotary type for Types WP, WPK, WPRL, WPS.
76-12	D.P.S.T.—Rotary type for Types WP, WPK, WPRL, WPS.

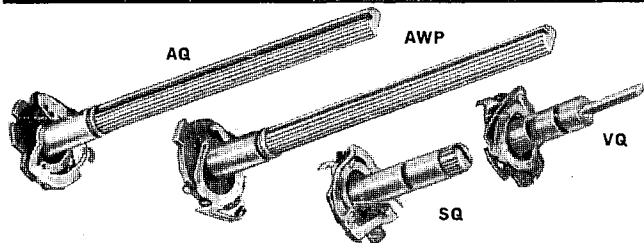

SINGLE CONTROL SHAFTS

Using control parts listed on the previous page, these shafts will assemble many variations of Types Q and 4W controls. Individually boxed with R7 retainer (except TQ).

Stock No.	Description
AQ	Knobmaster shaft, 1/4" diameter, 3" long FMS. Flatted, grooved and knurled full length. Fits knobs requiring flatted or knurled shaft. Uses QCB Bushing. For Type Q.
AQ-5	Same as AQ but 5" long FMS. For Type Q. (Bushing included.)
AWP	Same as AQ but for Type WPK control.
AWP-5	Same as AWP but 5" long FMS.
JQ	1/8" diameter shaft, 4 1/8" long FMS. Flatted .105" full length. Uses QCB Bushing. For Type Q.
NQ	3/16" diameter shaft, 4" long FMS. Flatted and grooved full length. Uses QCB Bushing. For Type Q.
PQ	1/4" diameter shaft, 3" long FMS. Full round. May be used with 1/4" or 3/8" long bushings. (3/8" long bushing included.) For Type Q.
PWP	Same as PQ but for Type WP control.
RQ	1/4" diameter shaft, 1/2" long FMS. Screwdriver slotted. Used with 3/8" long bushing only (included). For Type RQ.
SQ	1/4" diameter shaft, 3/4" long FMS. Screwdriver slotted with short knurl. Uses QCB Bushing. For Type Q.
SWP	Same as SQ but for Type WPS. Uses WPB Bushing.
TQ	1/4" diameter shaft, 3" long FMS. Insulated, full round. Cannot be used with switch. Uses QCB, QCB-1, QCB-2. For Type Q.
VQ	1/4" diameter shaft, 3/4" long FMS. Tongued end 3/16" wide by 1/2" long by .050" thick. Uses QCB Bushing. For Type Q.
WQ	1/4" diameter shaft, 1" long FMS. Tongued end 1/4" wide by 1/2" long by .062" thick. Uses QCB Bushing. For Type Q.

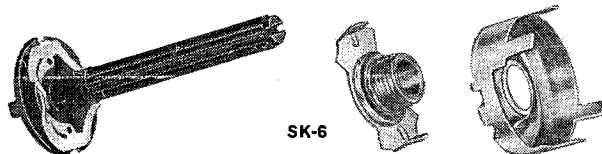

SHAFT KITS FOR BUSHING MOUNTED CONTROLS

Package of parts for assembly of specific standard or special control type. Includes shaft, bushing and cover. Add desired Base-Element.

Stock No.	Description
SK1	Assembles Q Control with Knobmaster Shaft.
SK2	Assembles Q Control with RQ Shaft.
SK3	Assembles Q Control with SQ Shaft.
SK4	Assembles WPK Control.
SK5	Assembles WPS Control.
SK6	Assembles Q Control with Insulated Shaft.
SK7	Assembles Q Control with Knobmaster Shaft and 76-5 Pull-push Switch (Switch included). Shaft is 3" FMS.
SK8	Assembles Q Control with 3/16" diameter universal shaft and 76-5 Pull-push Switch (Switch included). Shaft is 3 1/2" FMS.
SK9	Assembles Q Control with 3/16" diameter universal shaft. 3 1/2" FMS.

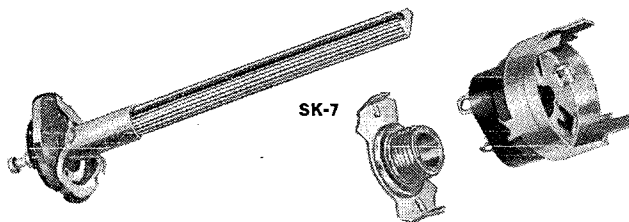

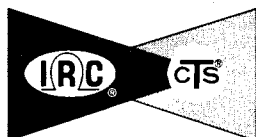

IRC-CTS CONCENTRIKIT® EXACT DUPLICATE SHAFT SPECIFICATIONS

IRC, DIVISION OF TRW INC.

EXACT DUPLICATE SHAFTS

Stock numbers and corresponding lengths are listed on these pages. In general, the last three numbers of the stock number indicates shaft length from control mounting face (not end of bushing) to end of shaft. Of the last three numbers, the first indicates number of inches and the second and third number indicates the number of 32nds. For Stock No. P1-210, length is 2¹⁰/₃₂" or 2⁵/₁₆". For inner shafts employed with K3 CONCENTRIKIT, subtract ³/₃₂" from dimension indicated by stock number.

There is an IRC-CTS Exact Duplicate Shaft available for nearly every concentric dual control. These Outer and Inner Shafts require no modification. Shaft lengths are held within close limits to original shaft lengths. Careful attention is given to end trims for fit to original knobs. The specifications on this page provide dimensions and use.

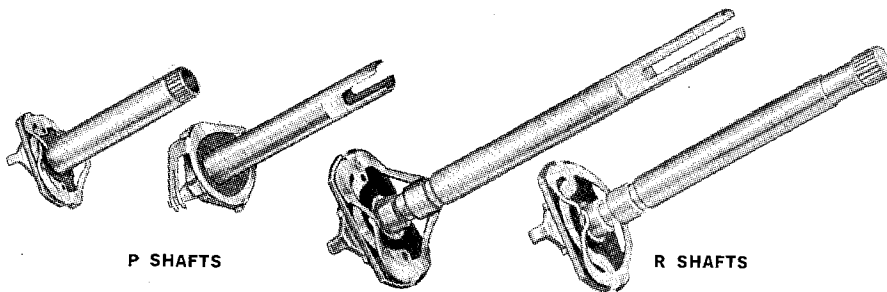

OUTER SHAFTS

Stock No.	Shft. Lgth.	Stock No.	Shft. Lgth.	Stock No.	Shft. Lgth.	Stock No.	Shft. Lgth.	Stock No.	Shft. Lgth.	Stock No.	Shft. Lgth.	Stock No.	Shft. Lgth.
P1-017	1/32"	P1-306	3/16"	P3-129	1 1/32"	P7-222	2 1/16"	P13-122	1 1/16"	P15-114	1 7/8"	P18-015	1 5/32"
P1-020	5/8"	P1-308	3/4"	P3-131	1 3/32"	P8-016	1/2"	P13-128	1 7/8"	P15-120	1 5/8"	P18-018	1 1/16"
P1-024	3/4"	P1-310	3 5/16"	P3-203	2 3/32"	P8-020	5/8"	P13-200	2"	P15-122	1 1/16"	P19-012	3/8"
P1-028	7/8"	P1-314	3 7/16"	P3-208	2 1/4"	P8-100	1"	P13-210	2 5/16"	P15-130	1 5/16"	P19-016	1/2"
P1-030	1 1/16"	P1-317	3 1/2"	P3-210	2 5/16"	P8-106	1 3/16"	P13-214	2 1/2"	P15-200	2"	P20-101	1 1/2"
P1-102	1 1/16"	P1-320	3 5/8"	P3-212	2 3/8"	P8-424	4 3/4"	P13-217	2 1/2"	P15-204	2 1/8"	P20-104	1 1/8"
P1-106	1 3/16"	P1-325	3 7/32"	P3-214	2 7/16"	P9-018	3/16"	P14-014	2 1/2"	P15-206	2 1/8"	P20-212	2 3/8"
P1-109	1 3/32"	P1-400	4"	P3-217	2 1/2"	P9-021	1 1/2"	P14-016	1 1/2"	P15-218	2 1/8"	P21-029	2 3/32"
P1-112	3/8"	P1-405	4 3/8"	P3-223	2 25/32"	P9-101	1 1/2"	P14-019	1 3/8"	P16-023	2 3/32"	P22-015	1 5/32"
P1-114	1 1/16"	P2-031	3 3/32"	P3-226	2 19/32"	P9-104	1 1/8"	P14-024	3/4"	P16-027	2 3/32"	P22-021	2 1/32"
P1-116	1 1/2"	P2-116	1 1/2"	P3-400	4"	P9-112	1 3/8"	P14-026	1 3/8"	P17-024	3/4"	P22-027	2 7/32"
P1-118	1 1/16"	P2-118	1 1/16"	P3-405	4 3/32"	P9-116	1 1/2"	P14-029	2 3/8"	P17-028	7/8"	P22-100	1"
P1-121	1 1/32"	P2-128	1 7/8"	P4-115	1 19/32"	P9-124	1 3/4"	P14-102	1 1/16"	P17-031	3 1/32"	P22-103	1 3/32"
P1-123	1 1/32"	P2-200	2"	P4-121	1 1/2"	P9-128	1 7/8"	P14-112	1 3/8"	P17-102	1 1/16"	P22-109	1 3/32"
P1-126	1 1/32"	P2-209	2 23/32"	P4-124	1 3/4"	P9-209	2 3/8"	P14-118	1 3/8"	P17-105	1 3/8"	P22-115	1 15/32"
P1-128	1 7/8"	P2-214	2 1/16"	P5-206	2 3/4"	P9-212	2 3/8"	P14-121	1 3/16"	P17-108	1 1/4"	P22-121	1 21/32"
P1-200	2"	P2-218	2 1/16"	P6-028	7/8"	P10-110	1 1/8"	P14-125	1 25/32"	P17-112	1 3/8"	P22-203	2 3/32"
P1-204	2 1/8"	P2-222	2 1/16"	P6-102	1 1/4"	P10-225	2 25/32"	P14-130	1 1/16"	P17-115	1 1/2"	P22-312	3 3/8"
P1-206	2 1/8"	P2-226	2 1/16"	P6-112	1 3/8"	P10-227	2 27/32"	P14-202	2 1/16"	P17-118	1 1/2"	P22-315	3 1/32"
P1-210	2 3/16"	P3-028	7/8"	P6-122	1 11/16"	P10-308	3 1/4"	P14-204	2 1/8"	P17-120	1 5/8"	P23-100	1"
P1-212	2 3/8"	P3-100	1"	P6-125	1 1/2"	P11-018	3/8"	P14-206	2 3/8"	P17-123	1 3/4"	P23-103	1 3/8"
P1-216	2 1/2"	P3-104	1 1/8"	P6-130	1 15/16"	P11-024	3/4"	P14-208	2 1/4"	P17-126	1 1/2"	P23-112	1 3/8"
P1-220	2 5/8"	P3-106	1 3/8"	P6-200	2"	P11-102	1 1/4"	P14-211	2 1/8"	P17-129	1 3/4"	P23-130	1 15/32"
P1-222	2 1/2"	P3-111	1 1/4"	P6-202	2 1/8"	P12-122	1 1/2"	P14-214	2 1/4"	P17-204	2 1/8"	P24-030	1 5/8"
P1-224	2 3/4"	P3-114	1 1/8"	P6-211	2 1/4"	P12-204	2 1/8"	P14-303	3 3/8"	P17-208	2 1/4"	P24-103	1 3/8"
P1-226	2 3/8"	P3-116	1 1/2"	P6-218	2 3/8"	P13-022	1 1/16"	P15-019	1 1/2"	P17-214	2 1/4"	P25-121	1 17/32"
P1-229	2 3/32"	P3-118	1 1/8"	P6-224	2 3/4"	P13-104	1 1/8"	P15-026	1 3/8"	P17-224	2 3/4"		
P1-300	3"	P3-121	1 1/2"	P6-302	3 1/8"	P13-113	1 1/32"	P15-102	1 1/8"	P17-300	3"		
P1-302	3 1/16"	P3-123	1 1/2"	P7-109	1 1/2"	P13-116	1 1/2"	P15-106	1 3/8"	P17-310	3 1/2"		
P1-304	3 1/8"	P3-127	1 1/32"	P7-206	2 3/8"	P13-118	1 1/8"	P15-112	1 3/8"	P17-316	3 1/2"		

INNER SHAFTS

Stock No.	Shft. Lgth.	Stock No.	Shft. Lgth.	Stock No.	Shft. Lgth.	Stock No.	Shft. Lgth.	Stock No.	Shft. Lgth.	Stock No.	Shft. Lgth.	No. No.	Lgth. Lgth.
R1-024	3/4"	R1-304	3 1/8"	R2-230	2 1/16"	R7-212	2 3/8"	R12-119	1 1/32"	R16-313	3 1/2"	R23-312	3 3/8"
R1-028	7/8"	R1-308	3 1/4"	R2-300	3"	R7-229	2 29/32"	R12-122	1 1/16"	R17-203	2 3/8"	R24-109	1 1/2"
R1-100	1"	R1-312	3 3/8"	R2-306	3 1/4"	R8-213	2 1/32"	R12-129	1 29/32"	R17-206	2 3/8"	R24-115	1 15/32"
R1-103	1 3/32"	R1-316	3 1/2"	R2-308	3 3/4"	R9-110	1 1/8"	R12-131	1 31/32"	R17-216	2 1/2"	R24-124	1 3/4"
R1-105	1 1/32"	R1-323	3 3/32"	R2-310	3 5/8"	R9-112	1 3/8"	R12-206	2 3/8"	R18-200	2"	R24-127	1 7/8"
R1-108	1 1/4"	R1-326	3 1/2"	R2-312	3 3/8"	R9-115	1 15/32"	R13-316	3 1/2"	R19-011	1 1/2"	R24-204	2 1/8"
R1-111	1 1/8"	R1-417	4 1/8"	R2-314	3 7/8"	R9-202	2 1/4"	R13-331	3 31/32"	R19-014	1 1/2"	R24-208	2 1/4"
R1-113	1 1/32"	R1-420	4 5/8"	R2-318	3 3/4"	R9-205	2 1/4"	R14-116	1 1/2"	R20-208	2 1/4"	R24-216	2 1/2"
R1-115	1 1/32"	R2-028	7/8"	R2-322	3 11/16"	R9-208	2 1/4"	R14-128	1 7/8"	R20-213	2 1/2"	R24-224	2 3/4"
R1-118	1 1/8"	R2-103	1 1/2"	R2-329	3 3/32"	R9-211	2 1/4"	R14-204	2 1/8"	R21-201	2 1/2"	R24-306	3 3/8"
R1-122	1 1/4"	R2-105	1 1/2"	R2-401	4 1/8"	R9-214	2 1/4"	R14-211	2 1/8"	R21-202	2 5/8"	R24-328	3 7/8"
R1-126	1 1/8"	R2-110	1 1/2"	R2-420	4 5/8"	R9-222	2 1/2"	R14-214	2 1/4"	R22-200	2"	R25-118	1 1/8"
R1-130	1 1/16"	R2-115	1 1/2"	R2-426	4 3/8"	R9-314	3 7/8"	R14-229	2 29/32"	R23-107	1 1/2"	R25-200	2"
R1-200	2"	R2-117	1 1/2"	R2-429	4 29/32"	R9-324	3 3/4"	R14-302	3 1/8"	R23-114	1 3/4"	R26-112	1 3/8"
R1-202	2 1/16"	R2-119	1 1/2"	R3-204	2 1/8"	R10-028	7/8"	R14-308	3 1/4"	R23-119	1 1/2"	R26-121	1 21/32"
R1-205	2 1/8"	R2-124	1 3/4"	R3-223	2 3/8"	R10-431	4 31/32"	R14-409	4 3/8"	R23-122	1 11/16"	R26-124	1 3/4"
R1-207	2 3/32"	R2-127	1 3/32"	R3-331	3 3/32"	R11-028	7/8"	R14-414	4 1/2"	R23-125	1 25/32"	R26-206	2 3/8"
R1-209	2 3/32"	R2-131	1 31/32"	R4-106	1 1/8"	R11-031	1 1/8"	R14-426	4 13/16"	R23-128	1 7/8"	R26-215	2 15/32"
R1-210	2 3/32"	R2-200	2"	R4-210	2 5/8"	R11-108	1 1/4"	R15-005	5/8"	R23-200	2"	R26-230	2 15/32"
R1-212	2 3/8"	R2-204	2 1/8"	R4-212	2 5/8"	R11-112	1 3/8"	R15-009	9/16"	R23-202	2 1/8"	R26-303	3 3/8"
R1-214	2 3/8"	R2-206	2 3/8"	R4-221	2 3/4"	R11-118	1 1/2"	R15-014	7/16"	R23-205	2 5/8"	R26-309	3 7/8"
R1-216	2 5/8"	R2-209	2 3/8"	R4-226	2 3/4"	R11-124	1 3/4"	R15-017	7/16"	R23-208	2 3/4"	R26-312	3 3/8"
R1-218	2 5/8"	R2-212	2 3/8"	R4-228	2 7/8"	R11-200	2"	R15-028	7/32"	R23-211	2 1/32"	R26-315	3 15/32"
R1-220	2 5/8"	R2-216	2 3/2"	R4-306	3 1/8"	R11-216	2 1/2"	R16-106	1 3/8"	R23-216	2 1/2"		
R1-223	2 3/32"	R2-218	2 5/8"	R4-322	3 1/16"	R11-219	2 1/32"	R16-112	1 3/8"	R23-218	2 3/8"		
R1-226	2 1/16"	R2-220	2 5/8"	R5-215	2 1/32"	R12-026	1 1/2"	R16-118	1 1/8"	R23-223	2 23/32"		
R1-228	2 1/8"	R2-222	2 1/16"	R6-208	2 1/4"	R12-029	1 3/8"	R16-127	1 7/32"	R23-226	2 13/32"		
R1-300	3"	R2-226	2 1/16"	R7-208	2 1/4"	R12-108	1 1/4"	R16-205	2 5/32"	R23-229	2 29/32"		



IRC-CTS AUTO RADIO BUSHINGS & TAPER CHART

IRC, DIVISION OF TRW INC.

EXACT DUPLICATE BUSHINGS FOR AUTO RADIOS

Stock No.	Dimensions	Type
S6	$\frac{1}{16}'' \times 1\frac{1}{16}''$	Double-flat
S7	$\frac{1}{16}'' \times 1\frac{1}{32}''$	Double-flat
S8	$\frac{1}{16}'' \times 1\frac{1}{8}''$	Double-flat
S9	$\frac{1}{16}'' \times 1\frac{1}{8}''$	Double-flat
S10	$\frac{1}{2}'' \times 0.2''$	Single-flat
S11	$\frac{1}{2}'' \times \frac{3}{16}''$	Single-flat
S12	$\frac{1}{2}'' \times 1\frac{1}{16}''$	Single-flat
S13	$\frac{1}{2}'' \times 1''$	Single-flat
S14	$\frac{1}{2}'' \times 1\frac{1}{4}''$	Single-flat
S15	$\frac{1}{2}'' \times 1\frac{1}{2}''$	Single-flat
S16	$\frac{1}{2}'' \times 1\frac{1}{8}''$	Single-flat
S17	$\frac{1}{2}'' \times 1\frac{1}{8}''$	Single-flat
S18	$\frac{1}{2}'' \times 2''$	Single-flat
S19	$\frac{1}{2}'' \times 2\frac{1}{8}''$	Single-flat
S20	$\frac{1}{2}'' \times 2\frac{1}{4}''$	Single-flat
S21	$\frac{1}{2}'' \times 1\frac{1}{8}''$	Notched
S22	$\frac{1}{2}'' \times 1\frac{1}{16}''$	Notched
S23	$\frac{1}{2}'' \times 1\frac{1}{32}''$	Notched
S24	$\frac{1}{2}'' \times 1\frac{3}{8}''$	Notched
S25	$\frac{1}{2}'' \times 1\frac{1}{16}''$	Notched
S26	$\frac{1}{2}'' \times 1\frac{1}{32}''$	Notched
S27	$\frac{1}{2}'' \times 1\frac{1}{32}''$	Notched
S28	$\frac{1}{2}'' \times 1\frac{3}{4}''$	Notched
S29	$\frac{1}{2}'' \times 1\frac{1}{16}''$	Notched
S30	$\frac{1}{2}'' \times 1\frac{1}{8}''$	Notched
S31	$\frac{1}{2}'' \times 2''$	Notched
S32	$\frac{1}{2}'' \times 2\frac{1}{8}''$	Notched
S33	$\frac{3}{8}'' \times \frac{1}{4}''$	—
S34	$\frac{3}{8}'' \times \frac{3}{8}''$	—
S35	$\frac{1}{2}'' \times 1\frac{1}{32}''$	Single-flat
S36	$\frac{1}{2}'' \times \frac{5}{8}''$	Single-flat
S37	$\frac{1}{2}'' \times \frac{1}{2}''$	Single-flat
S38	$\frac{1}{2}'' \times 2\frac{1}{32}''$	Single-flat
S39	$\frac{1}{2}'' \times \frac{3}{4}''$	Single-flat
S40	$\frac{1}{2}'' \times 1\frac{1}{16}''$	Single-flat
S41	$\frac{1}{2}'' \times 1\frac{1}{16}''$	Notched
S42	$\frac{1}{2}'' \times 1\frac{1}{16}''$	Single-flat
S43	$\frac{1}{2}'' \times 1\frac{1}{8}''$	Single-flat
S44	$\frac{3}{8}'' \times .590''$	—
S45	$\frac{3}{8}'' \times 1\frac{1}{16}''$	—
S46	$\frac{1}{16}'' \times \frac{5}{8}''$	Double-flat
S47	$\frac{1}{16}'' \times 1\frac{1}{32}''$	Double-flat
S48	$\frac{1}{2}'' \times \frac{3}{16}''$	Single-flat
S49	$\frac{1}{2}'' \times 1''$	Notched
S50	$\frac{1}{2}'' \times 1\frac{1}{16}''$	Single-flat
S51	$\frac{1}{16}'' \times 1\frac{1}{4}''$	Double-flat
S52	$\frac{3}{8}'' \times \frac{7}{8}''$	—

TAPERS

New numerical taper system assigns specific identification for each Control. Listing below shows new taper number and old taper designation.

NEW TAPER DESIGNATION	OLD TAPER DESIGNATION	USE
1, 2	A	For potentiometer or rheostat where uniform resistance change is required.
3, 23, 45	B, C	Left-hand logarithmic taper for audio circuit control.
4, 5,	D, Q, P	Right-hand semi-logarithmic taper for use in audio circuit controls, contrast, and picture control circuits in television. Taper 4 is also used for stereo tone and balance control.
6	S	Bass and treble tone control. Open circuited at mid-point.
7, 39, 41	S	Bass and treble tone control. Open circuited at mid-point.
8, 9, 20, 38	S	Tapped right-hand taper for contrast and picture control circuits in television.
10, 25, 27, 29	S	Tapped left-hand taper for contrast and picture control circuits in television. Also used for audio compensation.
11, 22, 24, 26, 30, 31, 37, 40, 44, 47	H, S	Tapped left-hand logarithmic taper for audio level control for treble, bass, or audio compensation.
12	S	Left-hand taper tapped at 50% of total resistance for audio compensation.
13	S	Left-hand taper tapped at 10% of total resistance for audio compensation, for transistor circuits.
14, 21, 28	S	Right-hand logarithmic taper tapped for contrast and picture control circuits in television.
15, 16, 17, 18, 19, 35, 36, 43, 46, 49, 50	S	Left-hand logarithmic taper with double taps for tone and loudness compensation.
32	S	Fader and balance controls.
33	S	Left-hand taper with two taps for contrast and picture control circuits in television.
34, 48	S	Right-hand taper with two taps for contrast and picture control circuits in television.
—	L	Left-hand taper for use in focus circuits in television.
—	R	Right-hand logarithmic taper for use in contrast and picture control circuits in television.
—	S	Tapped right-hand taper for contrast and picture control circuits in television.
—	U	For potentiometer or rheostat where uniform resistance change is required.



IRC-CTS INDUSTRIAL 4W CONTROLS

IRC, DIVISION OF TRW INC.

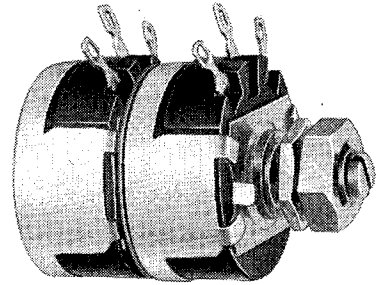
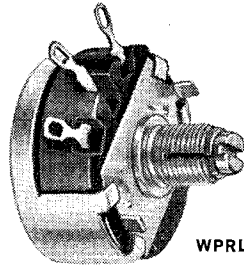
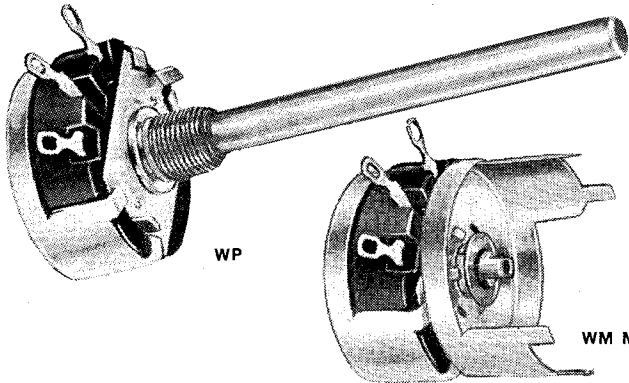

TYPE 4/W INDUSTRIAL CONTROLS

IRC-CTS Type 4W Controls for industry provide 4 watt (linear) rating in conventional 2 watt size. Available in wide assortment of resistance values. Types WP and WPRL may be combined with Type WM Multisections to provide broad selection of tandem dual controls.

Special platings of metal parts provide outstanding appearance. Resistance tolerance of all units is $\pm 10\%$.

TYPE WP

A wirewound industrial control with $\frac{3}{8}$ -32 x $\frac{3}{8}$ " bushing and a full round shaft of $\frac{1}{4}$ " diameter, approximately 3" long from mounting face. For 2, 3 and 4 watt requirements — 10% tolerance; linear taper; in 36 stock values as listed on the preceding page.

TYPE WM MULTISECTIONS

These 4 watt Multisections are rear control sections which add to Types WP and WPRL to supply a wide selection of tandem dual controls. Available in 13 factory-assembled stock numbers. WM Multisections do not operate power switches.

TYPE WPRL

A wirewound industrial control with a short, screwdriver slot shaft of $\frac{1}{4}$ " diameter and approximately $\frac{1}{2}$ " long from mounting face, with $\frac{3}{8}$ " locking type bushing, and locking nut. For 2, 3 and 4 watt requirements — 10% tolerance; linear taper; 36 stock values.

IRC-CTS TYPE 4/W INDUSTRIAL CONTROLS STOCK LIST

STOCK VALUES OF TYPE WP AND WPRL CONTROLS AND MULTISECTIONS 10% TOLERANCE				
Ohms	Taper*	Type WP	Type WPRL	Multisections
2	U (Lin.)	WP2	WPRL2	—
3	U	WP3	—	—
5	U	WP5	WPRL5	—
6	U	WP6	WPRL6	—
8	U	WP8	WPRL8	—
10	U	WP10	WPRL10	—
15	U	WP15	WPRL15	—
20	U	WP20	WPRL20	—
25	U	WP25	WPRL25	—
30	U	WP30	WPRL30	—
40	U	—	WPRL40	—
50	U	WP50	WPRL50	WM50
60	U	WP60	WPRL60	—
75	U	WP75	WPRL75	—
100	U	WP100	WPRL100	WM100
200	U	WP200	WPRL200	WM200
250	U	WP250	WPRL250	WM250
300	U	WP300	WPRL300	—
400	U	WP400	WPRL400	—
500	U	WP500	WPRL500	WM500
750	U	WP750	WPRL750	—
1,000	U	WP1000	WPRL1000	WM1000
1,500	U	WP1500	WPRL1500	WM1500
2,000	U	WP2000	WPRL2000	WM2000
2,500	U	WP2500	WPRL2500	WM2500
3,000	U	WP3000	WPRL3000	WM3000
4,000	U	WP4000	WPRL4000	—
5,000	U	WP5000	WPRL5000	WM5000
7,500	U	WP7500	WPRL7500	—
7,500	L	—	—	WM7500L
10,000	(L.H. Log.)	WP10000	WPRL10000	WM10000
15,000	U	WP15000	WPRL15000	—
20,000	U	WP20000	WPRL20000	—
25,000	U	WP25000	WPRL25000	—
30,000	U	WP30000	WPRL30000	—
40,000	U	WP40000	—	—
50,000	U	WP50000	WPRL50000	—

* See Taper Explanation Chart, page 1246.

DIMENSIONS OF TYPE 4/W INDUSTRIAL CONTROLS

Dimension	WP	WPRL
A	$\frac{23}{32}$	$\frac{23}{32}$
B	$1\frac{1}{4}$	$1\frac{1}{4}$
C	$1\frac{1}{32}$	$1\frac{1}{32}$

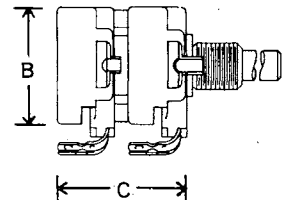
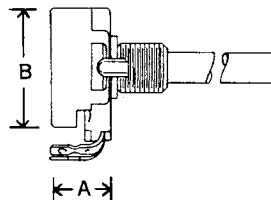

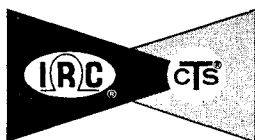

IRC-CTS CARBON & WIREWOUND TRIMMERS

IRC, DIVISION OF TRW INC.

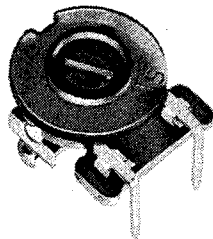

TYPE U-201

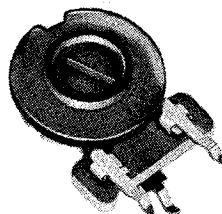

TYPE X-201

- Miniature Size — Knob 19/32" Diameter
- Knob Slotted for Front or Rear Screwdriver Adjustment
- Snap-in Self-supporting Bracket Mounted
- Low Cost

Electrical Specifications

Tolerance: $\pm 20\%$
 Power Rating: 1/4 Watt
 Taper: Linear Only
 Voltage Rating: 500 VDC Operating Maximum
 Switches: Not Available
 Taps: Not Available

Mechanical Specifications

Mounting: U-201 Mounts with Knob Parallel to Printed Circuit Board
 X-201 Mounts with Knob Perpendicular to Printed Circuit Board
 Angle of Rotation: $260^\circ \pm 5^\circ$
 Terminals: Printed Circuit Type
 Adjustment: Blue Nylon Knob 19/32" Diameter. Slotted for Front and Rear Adjustment.

U-201 AND X-201 CARBON TRIMMERS

STANDARD RESISTANCE RANGES

STOCK NO.		RESISTANCE VALUE
TYPE U-201	TYPE X-201	
U201R101B	X201R101B	100 Ω
U201R251B	X201R251B	250 Ω
U201R501B	X201R501B	500 Ω
U201R102B	X201R102B	1000 Ω
U201R252B	X201R252B	2500 Ω
U202R502B	X201R502B	5000 Ω
U201R103B	X201R103B	10K Ω
U201R253B	X201R253B	25K Ω
U201R503B	X201R503B	50K Ω
U201R104B	X201R104B	100K Ω
U201R254B	X201R254B	250K Ω
U201R504B	X201R504B	500K Ω
U201R105B	X201R105B	1.0M Ω

See Page 1257 for Engineering Laboratory Stocks of this Product

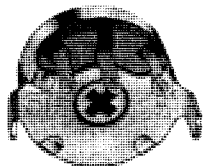

TYPE P-115

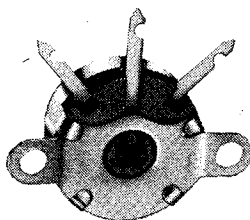

TYPE 117

- Fully Enclosed Construction
- Long Rotational Life
- Insulated Rotor
- Wide Resistance Range

Electrical Specifications

Tolerance: $\pm 10\%$
 Power Rating: 2 Watts
 Taper: Linear Only
 Voltage Rating: 500 VDC Operating Maximum
 Shafts: 1/16" Delrin Plastic Shaft available, Stock #P115-117-1
 Switches: Not Available
 Taps: Not Available

Mechanical Specifications

Mounting: P-115 Twist Tab Mounted
 117 Rivet Ear Mounted
 Angle of Rotation: $270^\circ \pm 5^\circ$
 Terminals: Printed Circuit Type
 Adjustment: Cross Slot in Nylon Rotor

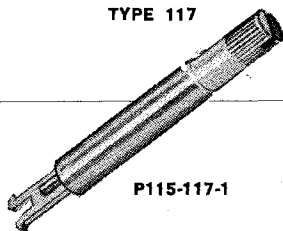

P115-117-1

TYPE P115 AND 117 WIREWOUND TRIMMERS

STANDARD RESISTANCE RANGES

STOCK NO.		RESISTANCE
P115R5R0A	117R5R0A	
P115R100A	117R100A	10 Ω
P115R250A	117R250A	25 Ω
P115R500A	117R500A	50 Ω
P115R101A	117R101A	100 Ω
P115R251A	117R251A	250 Ω
P115R501A	117R501A	500 Ω
P115R102A	117R102A	1000 Ω
P115R252A	117R252A	2500 Ω
P115R502A	117R502A	5000 Ω
P115R103A	117R103A	10K Ω

See Page 1257 for Engineering Laboratory Stocks of this Product

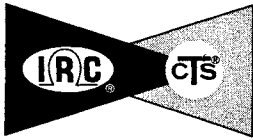

IRC-CTS MILITARY CONTROLS

IRC, DIVISION OF TRW INC.

IRC-CTS MILITARY VARIABLE RESISTORS TO MIL-R-19B AND MIL-R-94C GENERAL SPECIFICATIONS

	MIL-R-19B		Char.	MIL-R-94C			
	RA20	RA30		RV2	RV4	RV5	RV6
Resistance Range (ohms)	3-15K	10-25K	X & Y	100-2.5 megs	100-1.0 megs	250-2.5 megs	100-2.5 megs
Rotational Life	5% max, 25,000 cycles		X Y	10% max, 15,000 cycles 10% max, 25,000 cycles			
Load Life	3% max, 1,000 hours, rated load, 40°C		X Y	12% max, 1,000 hours, rated load, 70°C 10% max, 1,000 hours, rated load, 70°C			
Moisture Resistance	10% max, Method 106, MIL-STD-202, 3.5 megs min insulation resistance		X Y	10% average, 14% max, Method 106, MIL-STD-202, 50 megs min insulation resistance 6% average, 10% max, Method 106, MIL-STD-202, 100 megs min insulation resistance			
Low Temp. Storage	4% max		X Y	4% max 2% max			
Low Temp. Operation	4% max		X Y	4% max 3% max			
Thermal Cycling	4% max		X Y	10% max 6% max			
Acceleration	3% max		X & Y	3% max			
Shock	2% max		X & Y	2% max			
High Freq. Vibration	2% max		X & Y	2% max			
Temp. Range	-63°C to +105°C		X & Y	-63°C to 150°C			

Fast, local delivery from Distributors' stock is now available for IRC-CTS military controls. A total of 255 variable resistors is included in this new, local service. The 6 styles illustrated cover the latest MIL-R-94C composition and MIL-R-19B wire wound specifications.

IRC-CTS WIRE WOUND VARIABLE RESISTORS TO MIL-R-19B

STYLE RA20 2 WATT WIRE WOUND

Type 252, style RA20, 1 $\frac{17}{64}$ " diameter wirewound variable resistor.

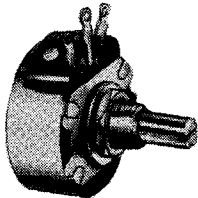

STYLE RA20

- 2 watt rating
- Compact size
- Meets MIL-R-19
- 15 resistance values
- Insulated housing

Choice of 2 shaft styles, plain or locking bushings.

Resistance

3 ± 10%
10 ± 10%
25 ± 10%
50 ± 10%
75 ± 10%
100 ± 10%
200 ± 10%
250 ± 10%
500 ± 10%
1,000 ± 10%
2,500 ± 10%
5,000 ± 10%
7,500 ± 10%
10,000 ± 10%
15,000 ± 10%

IRC-CTS TYPE 252

$\frac{7}{8}$ " Slotted Shaft
 $\frac{3}{8}$ " Long Bushing
Linear Resistance Taper

RA20NASD3R0A
RA20NASD100A
RA20NASD250A
RA20NASD500A
RA20NASD750A
RA20NASD101A
RA20NASD201A
RA20NASD251A
RA20NASD501A
RA20NASD102A
RA20NASD252A
RA20NASD502A
RA20NASD752A
RA20NASD103A
RA20NASD153A

CTS TYPE 252LT

$\frac{5}{8}$ " Slotted Shaft $\frac{7}{8}$ " Slotted Shaft
 $\frac{1}{2}$ " Long $\frac{1}{2}$ " Long
Locking Bushing Locking Bushing
Linear Resistance Linear Resistance
Taper Taper

RA20LASB3R0A	RA20LASD3R0A
RA20LASB100A	—
RA20LASB250A	RA20LASD250A
RA20LASB500A	RA20LASD500A
RA20LASB750A	—
RA20LASB101A	RA20LASD101A
RA20LASB201A	—
RA20LASB251A	RA20LASD251A
RA20LASB501A	RA20LASD501A
RA20LASB102A	RA20LASD102A
RA20LASB252A	RA20LASD252A
RA20LASB502A	RA20LASD502A
RA20LASB752A	RA20LASD752A
RA20LASB103A	RA20LASD103A
RA20LASB153A	RA20LASD153A

STYLE RA30 4 WATT WIRE WOUND

Type 25, style RA30, 1 $\frac{17}{32}$ " diameter wirewound variable resistor.

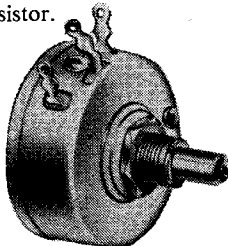

STYLE RA30

- 4 watt rating
- Reliable CTS wirewound element
- Meets all MIL-R-19 requirements
- 15 resistance values

Choice of 2 shaft styles, plain or locking bushings.

Resistance

10 ± 10%
25 ± 10%
50 ± 10%
100 ± 10%
200 ± 10%
250 ± 10%
500 ± 10%
750 ± 10%
1,000 ± 10%
2,500 ± 10%
5,000 ± 10%
7,500 ± 10%
10,000 ± 10%
15,000 ± 10%
25,000 ± 10%

IRC-CTS TYPE 25

$\frac{7}{8}$ " Slotted Shaft
 $\frac{3}{8}$ " Long Bushing
Linear Resistance Taper

RA30NASD100A
RA30NASD250A
RA30NASD500A
RA30NASD101A
RA30NASD201A
RA30NASD251A
RA30NASD501A
RA30NASD751A
RA30NASD102A
RA30NASD252A
RA30NASD502A
RA30NASD752A
RA30NASD103A
RA30NASD153A
RA30NASD253A

CTS TYPE 25LT

$\frac{5}{8}$ " Slotted Shaft
 $\frac{1}{2}$ " Long Locking Bushing
Linear Resistance Taper

RA30LASB100A
RA30LASB250A
RA30LASB500A
RA30LASB101A
RA30LASB201A
RA30LASB251A
RA30LASB501A
RA30LASB751A
RA30LASB102A
RA30LASB252A
RA30LASB502A
RA30LASB752A
RA30LASB103A
RA30LASB153A
RA30LASB253A

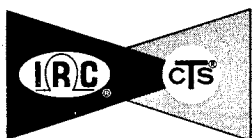

IRC-CTS SPECIAL PURPOSE CONTROLS

IRC, DIVISION OF TRW INC.

TV HEIGHT CONTROLS AVOID CALL-BACK INCONVENIENCES

USES:

This control is supplied for reliable replacement of TV Height Controls and other controls in B+C CIRCUITS — such as AGC, NOISE GATE, FOCUS, FRINGE LOCK and SYNC controls — which have become unsatisfactory because of element etching due to voltages present in the particular circuitry.

TYPE HLC TV HEIGHT CONTROLS

IRC Stock No.	Resistance Value	IRC Stock No.	Resistance Value
HLC-1	2.0 Meg. ±30%	HLC-4	4.0 Meg. ±30%
HLC-2	2.5 Meg. ±30%	HLC-5	5.0 Meg. ±30%
HLC-3	3.0 Meg. ±30%	HLC-6	7.5 Meg. ±30%

FEATURES:

- Premium quality control (originally designed for rugged service in military gear)
- 1 watt rating, 750 V. max. between outer terminals
- Small size $\frac{15}{16}$ " diameter — same as most original controls
- Nylon shaft — slotted and knurled — easily shortened where required.

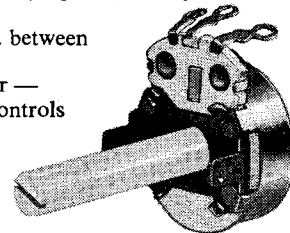

2 WATT, $\frac{3}{4}$ " DIAMETER WIREWOUND CONTROLS

TYPE 110—TAB-MOUNT UNIT

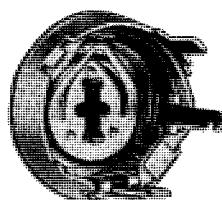

TYPES 110 & 110D

IRC STOCK NO.	RESISTANCE
110-1.5	1.5 Ω
110-5	5 Ω
110-15	15 Ω
110-60	60 Ω
110-100	100 Ω
110-300	300 Ω
110-600	600 Ω
110-1000	1000 Ω
110-3000	3000 Ω
110-3000-350	3000 Stops at 350 Ω

IRC-CTS buzz-bias controls are 2 watt preset type wirewound resistors. They are designed for hum-balancing, sensitivity, bias-adjust. AGC, holding, locking, and other radio and TV applications. All units are ±20% tolerance, linear taper, and have contact arm grounded to housing.

TYPE 110D—TAB-MOUNT SPECIAL TEMPERATURE COMPENSATED UNITS

IRC STOCK NO.	RESISTANCE
110D175-60	175 Ω Stops at 60 Ω Replaces Delco #7275554
110D260-90	260 Ω Stops at 90 Ω Replaces Delco #7275474

TYPE 112—FLANGE MOUNT UNITS

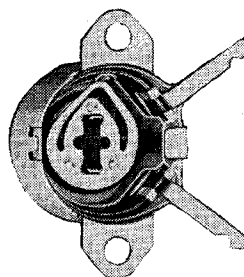

TYPE 112

IRC STOCK NO.	RESISTANCE
112-50	50Ω
112-100	100Ω
112-150	150Ω
112-200	200Ω
112-300	300Ω
112-500	500Ω
112-500-100	500Ω Stops at 100Ω
112-600	600Ω
112-650	650Ω
112-800	800Ω
112-800-50	850Ω Stops at 50Ω
112-1000	1000Ω
112-1000-100	1000Ω Stops at 100Ω
112-1500	1500Ω
112-2000	2000Ω
112-2000-100	2000Ω Stops at 100Ω
112-2500-700	2500Ω Stops at 700Ω
112-3000	3000Ω
112-4000	4000Ω
112-4000-350	4000Ω Stops at 350Ω
112-4000-1000	4000Ω Stops at 1000Ω
112-5000	5000Ω
112-10K	10KΩ

TYPE 110C—TAB-MOUNT TV COLOR CONVERGENCE CONTROLS WITH INTEGRAL NYLON KNOBS

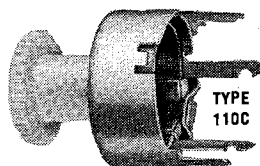

IRC STOCK NO.	RESISTANCE
110C-10	10 Ω
110C-30	30 Ω
110C-60	60 Ω
110C-120	120 Ω
110C-150	150 Ω

L & T ATTENUATOR PADS

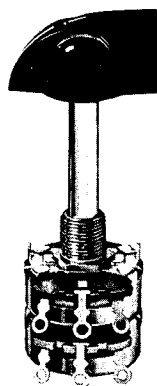

IRC-CTS L and T pads provide constant impedance for use in sound systems and for speaker controls. Both types handle up to 15 watts audio power (5 watts DC). L pads provide a constant input impedance and T pads provide constant input and output impedances.

ELECTRICAL SPECIFICATIONS:

- Continuous D.C. Rating: 5 watts
- Peak Audio Rating: 15 watts
- Dielectric Strength: 1000 V.A.C. RMS to Ground
- Attenuation Range: 4, 8 and 16Ω IMPEDANCES: 0 to 30 db
- 500Ω IMPEDANCE: 0 to 40 db
- Insertion Loss: Negligible (less than .5 db)
- Input Impedance: Constant within +30% -20%

MECHANICAL SPECIFICATIONS:

- Size: $\frac{15}{16}$ " diameter
- Shaft Dimensions: Diameter: .250"
- Length: 2" from mounting surface
- Bushing: $\frac{3}{8}$ " .32 x $\frac{3}{8}$ " long bushing
- Angle of Rotation: 300° ± 5°

IRC Stock No.	IMPEDANCE
L PADS	
LP4A	4Ω
LP8A	8Ω
LP15A	15Ω
LP500A	500Ω
T PADS	
TP4A	4Ω
TP8A	8Ω
TP15A	15Ω
TP500A	500Ω

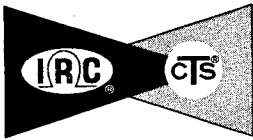

IRC-CTS ENGINEERING LABORATORY STOCKS

IRC, DIVISION OF TRW INC.

See Pages 1236 and 1237 for details of components

15/16" diameter Variable Resistors CTS SERIES 45

The most often used variable resistor, "ELS-1" gives you the 15 most frequently used values for single composition controls. Each panel section has a factory installed bushing $\frac{3}{8}$ " — $32 \times \frac{3}{8}$ ". 19 shafts styles and lengths included. Installed Shafts are permanent. Power switches may be snapped on easily. Assembly is fast, easy, and permanent. "ELS-2" is an expanded stock of Series 45 control components. Permits fast assembly not only of single section controls but also dual, triple and quadruple section tandem operated controls.

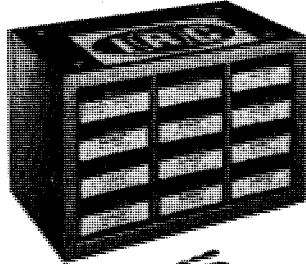

ELS-1

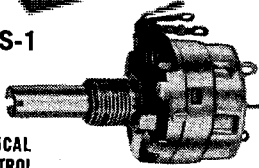

TYPICAL CONTROL

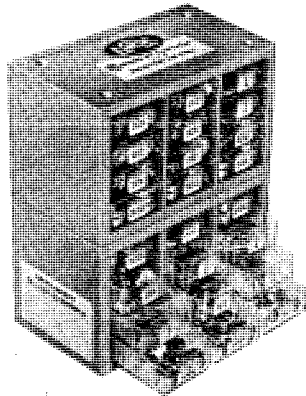

ELS-2

SHAFTS

Quantity	ELS-1	ELS-2	Item	Length	End Trim
2	5	01	1/2"	SD Slot	
2	2	02	5/8"	SD Slot	
2	3	03	3/4"	SD Slot	
2	5	04	7/8"	SD Slot	
3	5	05	1"	SD Slot	
2	5	06	7/8"	Flat	
2	2	07	1"	Flat	
2	2	08	1 1/8"	Flat	
3	5	09	1 1/4"	Flat	
2	2	10	1 3/8"	Flat	
2	2	11	1 1/2"	Flat	
2	2	12	1 5/8"	Flat	
2	2	13	1 3/4"	Flat	
2	2	14	1 7/8"	Flat	
2	2	15	2"	Flat	
2	5	16	2"	Round	
3	5	17	3"	Round	
2	2	18	1"	Knurl	
2	2	19	1 1/4"	Knurl	
1	2	20	1 1/2"	Knurl	

ENGINEERING LAB STOCKS ELS-1 AND ELS-2

CONTROL SECTIONS

Quantity	ELS-1	ELS-2	Item	Ohms	Type Taper	Description
2	4	4	45A103	10K	Log Taper	Front Section
2	4	4	45A104	100K	Log Taper	Front Section
2	4	4	45A105	1 Meg	Log Taper	Front Section
2	4	4	45A254	250K	Log Taper	Front Section
2	4	4	45A503	50K	Log Taper	Front Section
2	4	4	45A504	500K	Log Taper	Front Section
3	4	4	45D102	1000	Linear Taper	Front Section
3	4	4	45D103	10K	Linear Taper	Front Section
3	4	4	45D104	100K	Linear Taper	Front Section
3	4	4	45D105	1 Meg	Linear Taper	Front Section
3	4	4	45D253	25K	Linear Taper	Front Section
3	4	4	45D254	250K	Linear Taper	Front Section
—	4	4	45D502	5000	Linear Taper	Front Section
3	4	4	45D503	50K	Linear Taper	Front Section
3	4	4	45D504	500K	Linear Taper	Front Section
3	4	4	45D505	5 Meg	Linear Taper	Front Section
—	2	2	M45A104	100K	Log Taper	Rear Section
—	2	2	M45A105	1 Meg	Log Taper	Rear Section
—	2	2	M45A254	250K	Log Taper	Rear Section
—	2	2	M45A504	500K	Log Taper	Rear Section
—	2	2	M45D102	1000	Linear Taper	Rear Section
—	4	4	M45D103	10K	Linear Taper	Rear Section
—	4	4	M45D104	100K	Linear Taper	Rear Section
—	4	4	M45D105	1 Meg	Linear Taper	Rear Section
—	2	2	M45D253	25K	Linear Taper	Rear Section
—	2	2	M45D254	250K	Linear Taper	Rear Section
—	2	2	M45D502	5000	Linear Taper	Rear Section
—	4	4	M45D503	50K	Linear Taper	Rear Section
—	4	4	M45D504	500K	Linear Taper	Rear Section
—	2	2	M45D505	5 Meg	Linear Taper	Rear Section

SWITCHES AND COVERS

ELS-1	ELS-2	Item	Description
3	5	DPST	Rotary type, 3 amps at 125 volts, 1 amp at 250 volts, 5 amps at 20 volts, AC. UL approved.
9	15	SPST	Rotary type, 3 amps at 125 volts, 1 amp at 250 volts, AC. UL approved.
42	44	45C	Snap-on cover.

See Pages 1332 thru 1335 for details of components

Rotary Selector Switches CTS TYPE 212

A handy engineering stock of standard switch sections and shaft/detent assemblies to provide means of putting together standard and special rotary switches. Includes unique dust-proof kits, section shields and AC power switches.

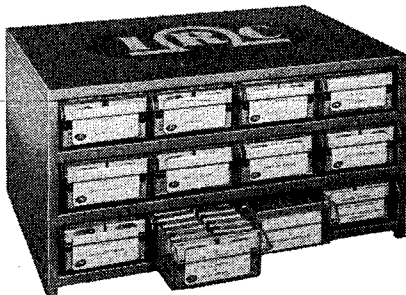

ELS-8

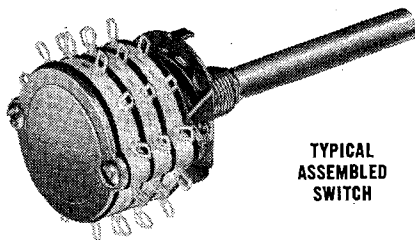

TYPICAL ASSEMBLED SWITCH

ENGINEERING LAB STOCK ELS-8

The ELS-8 Rotary Selector Switch Lab Stock affords you the versatility of a combination for every application.

Contents:

10 T1 Wafers	5 T81 Shaft/Detent
10 T2 Wafers	5 T82 Shaft/Detent
10 T3 Wafers	1 SSK-1 Sealing Kit
5 T4 Wafers	1 DSWK-1 Sealing Kit
10 T5 Wafers	5 SSS-1 Shields
10 T6 Wafers	5 SSS-2 Shields
10 T7 Wafers	5 SSS-3 Shield/Bracket
5 T8 Wafers	1 GC-21 Switch
5 T9 Wafers	1 VF-21 Switch
10 T99 Shaft/Detent	1 WF-21 Switch

Packed in sturdy, steel cabinet with 12 labeled drawers.

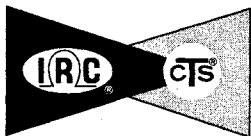

IRC-CTS ENGINEERING LABORATORY STOCKS

IRC, DIVISION OF TRW INC.

Military Miniature $\frac{3}{4}$ watt Variable Resistors RV6LAYS A — CTS SERIES 300 — LOCKING BUSHING

ELS-17 See Page 1253 for details of components

Reliable CTS carbon ceramic resistance element. Contents: 3 each of following values

Ohms	Ohms
$\frac{1}{4}$ " — 32 x $\frac{1}{2}$ " long locking bushing. Slotted shaft	100 50K
$\frac{1}{8}$ " diameter x $\frac{5}{8}$ " long F.M.S. High resolution.	250 100K
Tolerance: $\pm 10\%$ thru 1000	500 250K
500K ohms; $\pm 20\%$ above 2500	1000 500K
500K ohms. Packed in sturdy, steel cabinet with 12 labeled plastic drawers.	2500 1.0 meg.
	5000 2.0 meg.
	10K 2.5 meg.
	25K

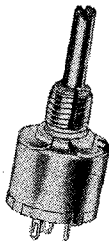

TYPICAL CONTROL

Military 3 watt Variable Resistors RV4NAYS D — CTS SERIES 320

ELS-18 See Page 1253 for details of components

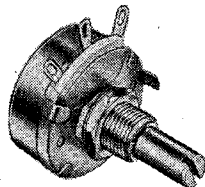

TYPICAL CONTROL

Carbon ceramic element. Completely enclosed construction. 1-1/16" diameter. Contents: 3 each of following values

Ohms	Ohms
$\frac{3}{8}$ " — 32 x $\frac{3}{8}$ " long bushing. Slotted shaft $\frac{1}{4}$ " diameter x $\frac{7}{8}$ " long F.M.S. Resistance tolerance: $\pm 10\%$ thru 500K ohms; $\pm 20\%$ 1 megohm and over. Packed in sturdy, steel cabinet with 12 labeled plastic drawers.	100 50K
	250 100K
	500 250K
	1000 500K
	2500 1.0 meg.
	5000 2.5 meg.
	10K 5.0 meg.
	25K

Military 3 watt Variable Resistors RV4LAYS A — CTS SERIES 320

ELS-19 See Page 1253 for details of components

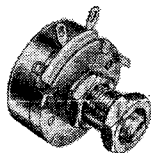

TYPICAL CONTROL

Carbon ceramic element. Completely enclosed construction. 1-1/16" diameter. Contents: 3 each of following values

Ohms	Ohms
$\frac{3}{8}$ " — 32 x $\frac{1}{2}$ " long locking bushing. Slotted shaft $\frac{1}{4}$ " diameter x $\frac{5}{8}$ " long F.M.S. Resistance tolerance: $\pm 10\%$ thru 500K ohms; $\pm 20\%$ 1.0 megohm and above. Packed in sturdy, steel cabinet with 12 labeled plastic drawers.	100 25K
	250 50K
	500 100K
	1000 250K
	2500 500K
	5000 1.0 meg.
	10K 5.0 meg.

1-1/16" diameter 3 watt Variable Resistors RV4NAY — CTS SERIES 320 — $2\frac{1}{2}$ " SHAFT

ELS-20 See Page 1253 for details of components

Reliable carbon ceramic element. Enclosed construction. Military grade control. $\frac{3}{8}$ " — 32 x $\frac{3}{8}$ " long bushing. Contents: 3 each of following values

Ohms	Ohms
$\frac{1}{4}$ " diameter full round shaft	250 25K
$2\frac{1}{2}$ " long F.M.S. Resistance tolerance: $\pm 10\%$ thru 500K ohms; $\pm 20\%$ 1.0 megohm and above. Packed in sturdy, steel cabinet with 12 labeled plastic drawers.	500 50K
	1000 100K
	2500 250K
	5000 500K
	10K 1.0 meg.

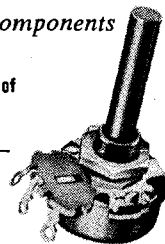

TYPICAL CONTROL

ELS-21 Series 45 Model Shop Stock See Page 1236 and 1237 for component details

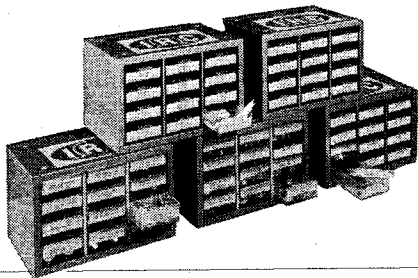

This ELS-21 Model Shop Stock provides you with a carefully selected assortment of control components which snap-together to provide an especially wide variety of types, mountings and resistance values of controls or variable resistors. These components are arranged in module-type cabinets in alpha-numerical order.

The components included are those which will generally be needed for engineering, laboratory and prototype use. Many additional components are available.

SNAP-TOGETHER COMPONENTS. Here is a quick, easy way to fill your engineering and prototype needs for reliable controls, variable resistors and potentiometers. CTS basic Series 45 SNAP-TROL system, pioneered for practical, dependable replacements for TV, radio and automobile controls, provides snap-together components for literally millions of variations. This ELS-21 Model Shop Stock will assist you in expediting important development projects, giving you a carefully selected assortment of control components which snap-together to provide an especially wide variety of types, mountings and resistance values. Ask for Booklet S-607 for complete details.

TYPICAL CONTROL

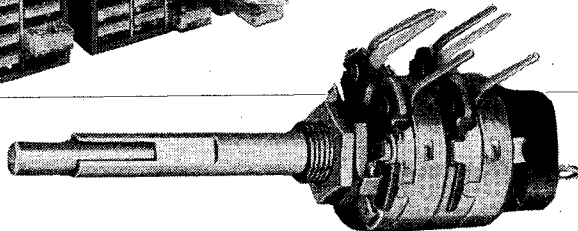

Nearly Endless Combinations of:

- Single section controls
- Tandem dual section controls
- Concentric dual controls
- Combinations of concentric and tandem controls
- Tandem triple controls
- Tandem quadruple controls
- Custom and special controls

FROM THESE BASIC PARTS

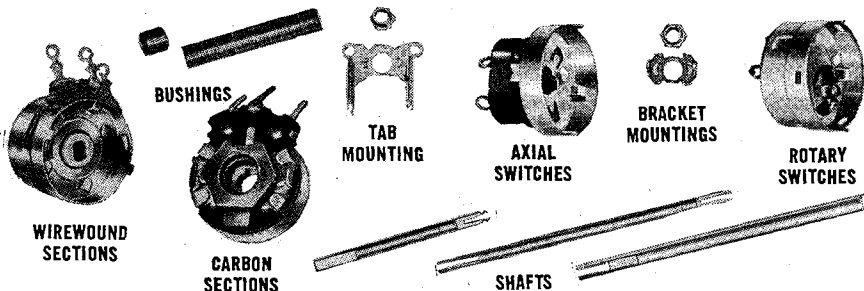

OHMITE vitreous enameled rheostats (potentiometers)

Now, Ohmite offers TWELVE sizes in its line of famous rheostats ranging from 7.5 to 1000 watts. Nothing to shrink or burn, all models are metal and ceramic construction and coated with Ohmite's exclusive vitreous enamel. The revolutionary Model C, 7½ watt miniature unit, the **smallest rheostat of its rating available**, employs this same construction! All Model C stock units and the enclosed Model E unit, are normally supplied in a corrosion-resistant dust-proof case. Model C units are stocked in both standard and locking type bushings.

In all Ohmite rheostats, the resistance wire is wound on a solid ceramic core. The turns are locked in place with tough, protective vitreous enamel. Pivoted, universal action mounting of the brush, assures perfect contact. Copper-graphite brushes (and on heavier current units, silver-graphite) prevent wear of the resistance track. Terminals at each end of the winding permit connection of the unit as a potentiometer.

Models H, J, G, K, L, P, and N, marked "Series A," are listed under the Underwriters' Laboratories Reexamination Service. RHEOSTAT KNOBS are listed on page 20. (Request Catalog 50 for rheostats to meet military specification, MIL-R-22).

RATINGS: Current ratings shown, assume use in free air. If units are enclosed, currents should be reduced to as much as 50% depending upon ventilation. The rated current causes the rheostat to dissipate its rated wattage when its full resistance is in the circuit.

SPECIAL RHEOSTAT FEATURES: Hundreds of features to meet your special rheostat requirements can be furnished. Submit your specifications.

Model C
7½ Watts

**NOW, FOR ITS RATING
INDUSTRY'S SMALLEST
RHEOSTAT!**



Unenclosed
Model E
12½ Watts

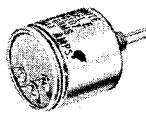

Enclosed
Model E
12½ Watts

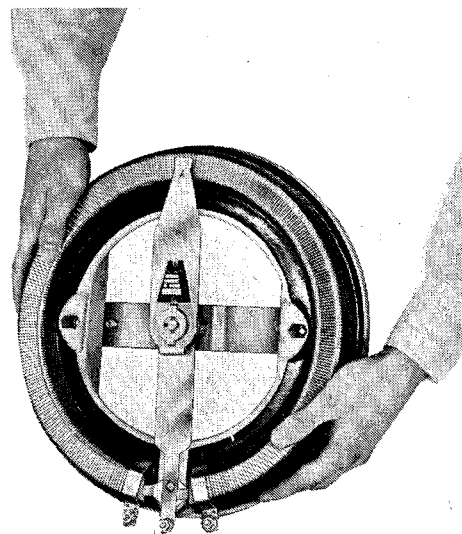

MODEL "C" — 7½ WATT* — STANDARD & LOCKING BUSHINGS

Diameter .515" max. — Depth behind panel 7/8" — Shaft 1/8" diameter, slotted for both types; Std. shaft accommodates knob — Rotation 300° — Mounting for panels up to 1/8" by means of 1/4"-32 bushing and hex. nut — Non-turn lug requires 1/4" hole 1/4" below center of shaft — No. 5151 knob recommended — Solder terminals also fit EIA type TS-E3R100 transistor socket — Wt. 0.27 oz.

Ohms	Amps.	Standard Shaft		Locking Shaft		Ohms	Amps.	Standard Shaft		Locking Shaft	
		No. 1	Net \$ 1-4	No. 1	Net \$ 1-4			No. 1	Net \$ 1-4	No. 1	Net \$ 1-4
10	.86	4908	8.59	4948	10.48	250	.17	4917	8.59	4957	10.48
15	.71	4909	8.59	4949	10.48	350	.15	4918	8.59	4958	10.48
25	.55	4910	8.59	4950	10.48	500	.12	4919	8.59	4959	10.48
35	.46	4911	8.59	4951	10.48	750	.10	4920	8.59	4960	10.48
50	.39	4912	8.59	4952	10.48	1000	.086	4921	9.72	4961	11.61
75	.32	4913	8.59	4953	10.48	1500	.071	4922	9.72	4962	11.61
100	.27	4914	8.59	4954	10.48	2500	.055	4923	9.72	4963	11.61
150	.22	4915	8.59	4955	10.48	3500	.046	4924	10.15	4964	12.04
200	.19	4916	8.59	4956	10.48	5000	.039	4925	10.15	4965	12.04

*Rating on metal panel — unit is silicone-ceramic coated.

Locking-type Model C mounted in socket on panel. Solder terminals fit transistor socket.

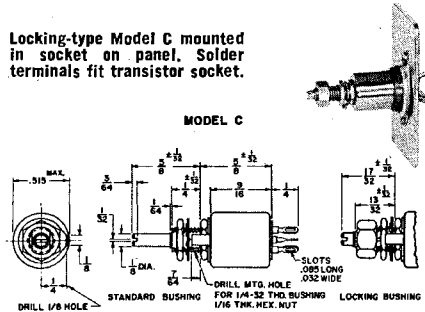

MODEL "E" — 12½ WATT* — UNENCLOSED & ENCLOSED

Diameter 7/8"; Diameter with dust-tight aluminum enclosure 1 1/4" — Depth behind panel 1 1/4"; for enclosed, 1 1/2" — Rotation 300° — Mounts on panels up to 1/8" by means of 1/4"-32 bushing and hex nut — Non-turn lug requires 1/8" hole 1/4" below center of shaft. No. 5151 knob recommended — Wt. 0.6 oz.; enclosed 0.85 oz.

Total Ohms	Max. Amps	Steps Appr.	Unenclosed Stock		Enclosed Stock		Total Ohms	Max. Amps	Steps Appr.	Unenclosed Stock		Enclosed Stock	
			No. 1	Net \$ 1-4	No. 1	Net \$ 1-4				No. 1	Net \$ 1-4	No. 1	Net \$ 1-4
1	3.53	28	0101	5.05	W0101	6.95	175	.27	155	0114	4.55	W0114	6.35
2	2.50	29	0102	5.05	W0102	6.95	200	.25	135	0114A	4.55	W0114A	6.35
2.5	2.24	29	0102A	5.05	W0102A	6.95	250	.22	170	0115	4.55	W0115	6.35
3	2.04	38	0103	5.05	W0103	6.95	350	.19	190	0116	4.55	W0116	6.35
5	1.58	51	0103A	5.05	W0103A	6.95	500	.16	210	0117	4.55	W0117	6.35
6	1.44	35	0104	5.05	W0104	6.95	750	.13	200	0118	4.55	W0118	6.35
8	1.25	53	0105	5.05	W0105	6.95	1,000	.11	260	0119	5.05	W0119	6.95
10	1.12	50	0106	5.05	W0106	6.95	1,500	.091	209	0120	5.05	W0120	6.95
15	.91	70	0107	4.55	W0107	6.35	2,500	.071	323	0121	5.05	W0121	6.95
25	.71	72	0108	4.55	W0108	6.35	3,500	.060	400	0122†	5.35	W0122†	7.25
35	.60	82	0109	4.55	W0109	6.35	5,000	.050	340	0123†	5.35	W0123†	7.25
50	.50	92	0110	4.55	W0110	6.35	7,500	.041	420	4190†	5.55	W4190†	7.45
75	.41	105	0111	4.55	W0111	6.35	10,000	.035	560	4191†	5.55	W4191†	7.45
100	.35	102	0112	4.55	W0112	6.35	12,500	.031	480	4192†	6.05	W4192†	7.95
125	.32	110	0113	4.55	W0113	6.35	15,000	.029	490	4193†	6.05	W4193†	7.95
150	.29	130	0113A	4.55	W0113A	6.35							

*Rating on metal panel. †Silicone-ceramic coating — 350V maximum; 7500 ohms = 305V

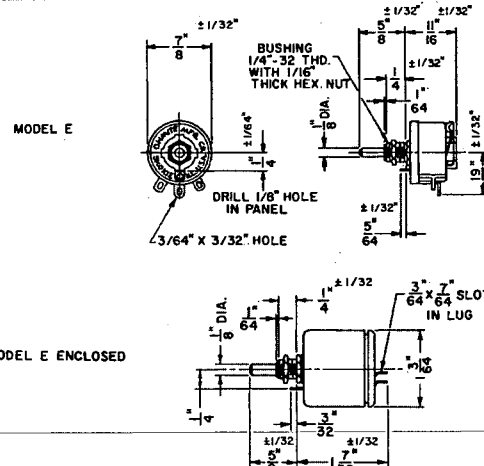

dimensions: MODELS H, J, G, K, L*

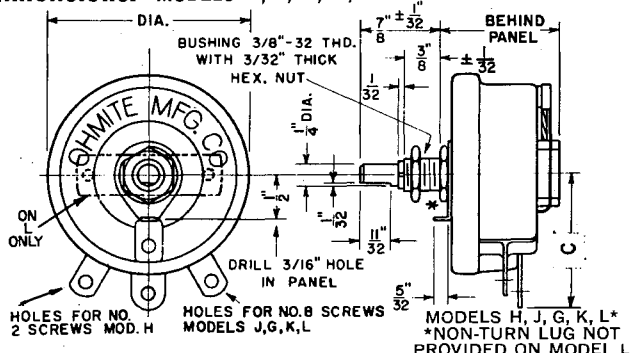

MODELS P, N, R, T, U

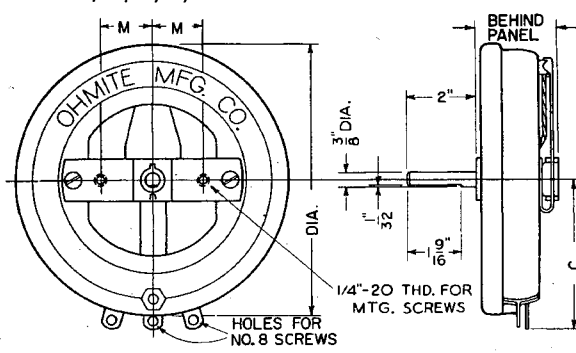

*ITEMS APPEARING IN BOLD PRINT ARE POPULAR MODELS AND ARE USUALLY STOCKED BY AUTHORIZED OHMITE DISTRIBUTORS

OHMITE

rheostat tandem coupling kits

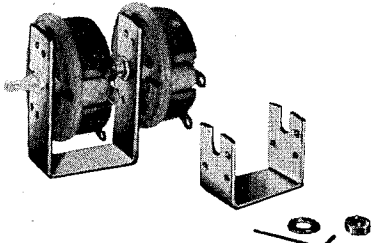

Tandem rheostat assemblies can be ordered from the factory or assembled by the user with these kits which permit assembly of two units. Each kit consists of a steel "U" frame, a coupling with set screw, mica washer, Allen wrench and instructions.

Rheostat shafts are joined by the coupling which is fastened to the shaft of the rear unit. Projections on the coupling fit a recess on the rear of the hub of the front unit.

Three kits are available as follows:

Cat. No. 6532—Mounts Models H or J, also accommodates Models H, J, G, K or L in rear position.

Cat. No. 6533—Mounts G, K or L units, also accommodates Models H, J, G, K or L in rear position.

Cat. No. 6591—Mounts Model E units only.

Stock No.	Max. Panel	Weight	Net 1-4
6532	3/2"*	.17 lb.	\$2.20
6533	3/8"*	.41	2.75
6591	1/8"	.044	2.20

*Using No. 5150 Knob.

black bakelite knobs

Stock No.	Description	Knob Dia.	Hole Dia.	Net 1-2
5102	Bar Knob, 2 1/4" long		1/4"	\$.53
5103	Bar Knob, 1 1/4" long		1/4"	.22
5104	Handwheel with Pointer	3 1/4"	3/8"	1.45
5105	Handwheel without Pointer	3 1/4"	3/8"	1.22
5106	Handwheel with Pointer	3 1/4"	1/4"	1.45
5107	Handwheel without Pointer	3 1/4"	1/4"	1.22
5109	Finger-Grip with Pointer	1 5/8"	1/4"	.93
5110	Finger-Grip without Pointer	1 5/8"	1/4"	.86
5111	Finger-Grip with Pointer	2 3/8"	1/4"	1.39
5112	Finger-Grip without Pointer	2 3/8"	1/4"	1.27
*5115	Bar Knob, 4 3/4" long		3/8"	3.15
5116	Bar Knob, 1 1/2" long.		1/4"	.53
5150	Finger-Grip	1 1/2"	3/4"	.30
5151	Finger-Grip	3/4"	1/8"	.30
5152A	Like 5104 but shorter pointer	3 1/4"	1/4"	1.68

*Requires pin and tapped hole in shaft.

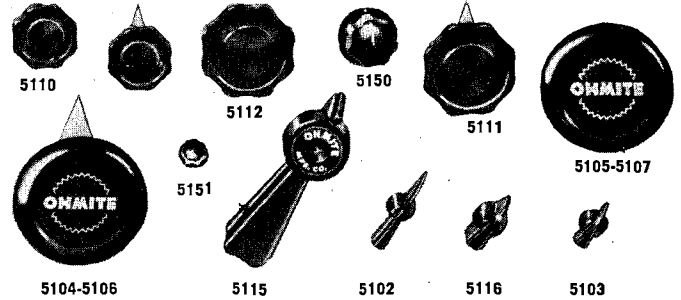

rheostat dials

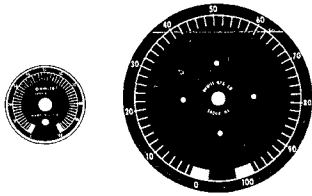

Handsomely finished dials for Ohmite rheostats and other apparatus, feature bright figures and lines on etched black background. Divisions marked from 0 to 100 indicate approximate percentage of rheostat resistance in circuit.

Stock No.	For Rheostat	Dial Dia.	Recom'd. Knobs*	Net 1-2
5007	C, E	1 1/4"	5151	\$.30
5000	H, J, G, K, L	2 3/8"	5150, 5116, 5103	.30
5001	P, N, R, T, U	5 1/2"	5104, 5106	.74

*See Bakelite Knobs above

heat control rheostats

A convenient control for regulating the temperature of soldering irons, melting pots (such as those used for solder, wax, potting material) or other heater loads. With soldering irons, it permits quick adjustment of operating heat for the type of job and grade of solder.

Consists of vitreous enameled rheostat housed in a perforated metal cage, with knob and dial. Supplied with series plug and six feet of heater type cord. The cord from the heater load is plugged into the series plug which is then plugged into a receptacle. Order in accordance with expected maximum wattage load.

Wattage of Device To Be Controlled		Rheostat Control Stock No.	Cage Dimensions		Net Weight lbs.	Net Price 1 Qty.
Watts	Volts		Dia.	Height		
40-65	115	SRC65	3 1/8"	2"	.58	\$14.45
85-100	115	SRC100	3 1/8"	2"	.58	14.45
120-150	115	SRC150	3 3/4"	2 3/8"	.93	16.40
175-220	115	SRC220	3 3/4"	2 3/8"	1.05	20.00
300-350	115	SRC350	4 1/2"	2 3/8"	1.63	22.25
430-500	115	SRC500	7 1/2"	3 1/4"	2.25	27.50

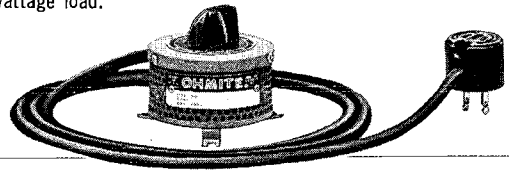

high wattage T-pad and L-pad attenuators

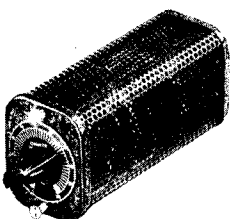

Stepless control of speaker volume with essentially constant impedance is provided by Ohmite attenuators. In use, these units are interposed between high power amplifiers and speaker or speakers.

Housed in grey, perforated metal cage 3 1/8" high, 2 5/8" wide and extending 4 1/4" behind panel for L-pads; 6 1/4" for T-pads. Shaft 1/4" and bushing 3/8" diameter; bushing length is for 1/4" maximum panel (specify greater thicknesses). Mounted with two 10/32 screws (supplied) on 2 5/8" vertical centers.

T-PAD ATTENUATORS				L-PAD ATTENUATORS		
25 WATT Avg. Wt. 1.44 lbs.				25 WATT Avg. Wt. 1 lb.		
Stock No.	Line Impedance in Ohms	Net Price 1 Qty.		Stock No.	Line Impedance in Ohms	Net Price 1 Qty.
3001	15	\$28.10		3201	15	\$25.75
3002	50	28.10		3202	50	25.75
3003	200	28.10		3203	200	25.75
3004	500	28.10		3204	500	25.75
50 WATT Avg. Wt. 1.88 lbs.				50 WATT Avg. Wt. 1.25 lbs.		
3101	15	\$28.65		3301	15	\$26.90
3102	50	28.65		3302	50	26.90
3103	200	28.65		3303	200	26.90
3104	500	28.65		3304	500	26.90

MALLORY Wire-Wound Controls

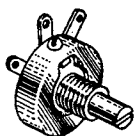

C

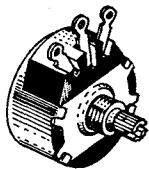

R

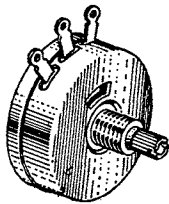

M

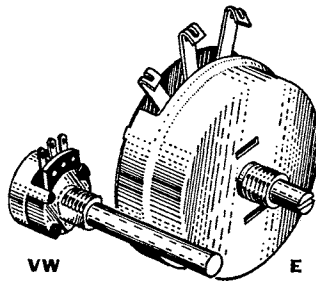

VW

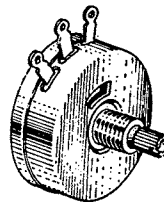

MG

2 WATT TYPE C

Rated 2 watts at 40° C. 1 1/4" diameter. Mech. Rotation: 280°. Elec. Rotation: 255°. Resis. Tolerance: ±10%. Contact arm grounded. Bushing: 3/8"-32 x 3/8". Shaft: 1/4" dia. x 3/4" FMS with screwdriver slot. Furn. with nut.

POTENTIOMETERS

Mallory No.	Ohms Resis.	Carrying Capacity In Amps	Net Each
C6P	6	.58	\$1.08
C10P	10	.45	1.08
C15P	15	.37	1.08
C20P	20	.32	1.08
C30P	30	.26	1.08
C40P	40	.22	1.08
C50P	50	.2	1.08
C100P	100	.14	1.08
C200P	200	.1	1.08
C400P	400	.07	1.08
C1MP	1K	.045	1.20
C3MP	3K	.025	1.20
C5MP	5K	.02	1.47
C6MP	6K	.018	1.47
C10MP	10K	.014	1.47
C15MP	15K	.011	1.47

RHEOSTATS*

Mallory No.	Ohms Resis.	Carrying Capacity In Amps	Net Each
C6R	6	.58	93c
C10R	10	.45	93c
C15R	15	.37	93c
C20R	20	.32	93c
C30R	30	.26	93c
C40R	40	.22	93c
C50R	50	.2	93c
C100R	100	.14	93c

*"Open" or "off" position counter-clockwise.

3 WATT TYPE R

Standard TV wire-wound control rated 3 watts at 40° C. 1 1/4" diameter. Mech. Rotation: 297°. Elec. Rotation: 290°. Voltage Breakdown: 900 VAC rms. Bushing: 3/8"-32 x 1/4". Shaft: 1/4" dia. x 1 1/2" FMS, knurled with screwdriver slot. Furn. with nut. See listing below for switches for R controls.

Mallory No.	Ohms Resis.	Net Each	Mallory No.	Ohms Resis.	Net Each
R2L	2	\$0.33	R50CT†	50	\$1.32
R3L	3	.33	R100L	100	.33
R5L	5	.33	R250L	250	.33
R6L	6	.33	R500L	500	.33
R8L	8	.33	R750L	750	.33
R10L	10	.33	R1000L	1000	.33
R10CT†	10	1.32	R1500L	1500	.33
R15L	15	.33	R2500L	2500	.33
R20L	20	.33	R3000L	3000	.33
R20CT†	20	1.32	R5000L	5000	.33
R25L	25	.33	R7500L	7500	1.08
R30L	30	.33	R10ML	10000	1.08
R30CT†	30	1.32	R15ML	15000	1.08
R50L	50	.33	R20ML	20000	1.08

†Center-tapped controls.

SWITCHES FOR TYPE R POTS

Mail. No.	Description	Net
US30	Single Pole, Single Throw	42c
US32	Double Pole, Single Throw	54c

TV FOCUS CONTROLS

Mallory No.	Resis., Ohms	Shaft	Net Each
TVF140	1500	1/4" dia. x 2 1/2" lg.	\$1.35
TVF143	2500	1/4" dia. x 2 lg.	1.35

4 WATT TYPE M

Rated 4 watts at 40° C. 1 1/2" diameter. Mech. Rotation: 294°. Elec. Rotation: 275°. Resis. Tolerance: ±10%. Voltage Breakdown: 900 VAC rms. Bushing: 3/8"-32 x 3/8" FMS. Shaft: 1/4" dia. x 3/4" FMS, knurled with screwdriver slot. Furn. with nut.

POTENTIOMETERS

Mallory Number	Ohms Resis.	Capacity In Amps	Net Each
M1PK	1	2.00	\$1.35
M3PK	3	1.15	1.35
M6PK	6	.82	1.35
M10PK	10	.63	1.35
M15PK	15	.52	1.35
M20PK	20	.45	1.35
M25PK	25	.40	1.35
M30PK	30	.37	1.35
M40PK	40	.32	1.35
M50PK	50	.28	1.35
M60PK	60	.26	1.35
M75PK	75	.23	1.35
M100PK	100	.20	1.35
M200PK	200	.14	1.47
M300PK	300	.116	1.47
M400PK	400	.10	1.47
M500PK	500	.09	1.47
M600PK	600	.082	1.47
M1MPK	1K	.063	1.35
M1.5MPK	1.5K	.052	1.35
M2MPK	2K	.045	1.35
M2.5MPK	2.5K	.04	1.35
M3MPK	3K	.037	1.35
M4MPK	4K	.032	1.35
M5MPK	5K	.028	1.35
M10MPK	10K	.02	1.35
M15MPK	15K	.016	1.47
M20MPK	20K	.014	1.47
M25MPK	25K	.013	1.47
M50MPK	50K	.009	1.74
M70MPK	70K	.0075	1.74
M75MPK	75K	.0073	2.46
M100MPK	100K	.0063	2.46

CENTER-TAPPED POTENTIOMETERS

Mallory Number	Ohms Resis.	Capacity In Amps	Net Each
MT10PK	10	.63	\$1.32
MT20PK	20	.45	1.32
MT30PK	30	.37	1.32

RHEOSTATS*

Mallory Number	Ohms Resis.	Capacity In Amps	Net Each
M05RK	0.5	2.80	93c
M1RK	1	2.00	93c
M2RK	2	1.40	93c
M3RK	3	1.15	93c
M4RK	4	1.00	93c
M6RK	6	.82	93c
M10RK	10	.63	93c
M15RK	15	.52	93c
M20RK	20	.45	93c
M25RK	25	.40	93c
M30RK	30	.37	93c
M40RK	40	.32	93c
M50RK	50	.28	93c
M60RK	60	.26	93c
M75RK	75	.23	93c
M100RK	100	.20	93c

*"Open" or "off" position counter-clockwise.

5 WATT TYPE VW SUBMINIATURE

Rated 5 watts at 35° C. 3/4" diameter. Mech. Rotation: 305°. Elec. Rotation: 275°. Resis. Tolerance: ±10%. Voltage Breakdown: 900 VAC rms. Bushing: 3/8"-32 x 3/8" Shaft: 1/4" dia. x 2 1/2" FMS. Furn. with nut and lug.

Mallory No.	Ohms Resis.	Net Each	Mallory No.	Ohms Resis.	Net Each
VW1	1	\$1.38	VW300	300	\$1.38
VW2	2	1.38	VW400	400	1.38
VW3	3	1.38	VW500	500	1.38
VW5	5	1.38	VW600	600	1.38
VW6	6	1.38	VW750	750	1.38
VW8	8	1.38	VW1K	1000	1.38
VW10	10	1.38	VW1P5K	1500	1.44
VW15	15	1.38	VW2K	2000	1.44
VW20	20	1.38	VW2P5K	2500	1.44
VW25	25	1.38	VW3K	3000	1.44
VW30	30	1.38	VW4K	4000	1.44
VW40	40	1.38	VW5K	5000	1.44
VW50	50	1.38	VW7P5K	7500	1.50
VW60	60	1.38	VW10K	10000	1.50
VW75	75	1.38	VW15K	15000	1.56
VW100	100	1.38	VW20K	20000	1.56
VW200	200	1.38	VW25K	25000	1.65
VW250	250	1.38			

7 WATT TYPE E

Rated 7 watts at 40° C. 2 5/16" diameter. Mech. Rotation: 307°. Elec. Rotation: 295°. Resis. Tolerance: ±10%. Contact arm grounded. Bushing: 3/8"-32 x 3/8". Shaft: 1/4" dia. x 3/4" FMS with screwdriver slot. Furnished with nut.

Mallory Number	Ohms Resis.	Capacity In Amps	Net Each
E5MP	5K	.042	\$2.76
E10MP	10K	.03	2.94
E20MP	20K	.021	3.00
E25MP	25K	.019	3.09
E50MP	50K	.0135	3.15
E75MP	75K	.011	3.24
E100MP	100K	.0095	3.30
E125MP	125K	.0085	3.30
E150MP	150K	.0078	3.36

12 1/2 WATT TYPE MG

Rated 12 1/2 watts at 35° C. 1 5/8" diameter. Mech. Rotation: 294°. Elec. Rotation: 275°. Resis. Tolerance: ±10%. Voltage Breakdown: 900 VAC rms. Bushing: 3/8"-32 x 3/8" FMS. Shaft: 1/4" dia. x 3/4" FMS, knurled with screwdriver slot. Furn. with nut.

Mallory No.	Ohms Resis.	Net Each	Mallory No.	Ohms Resis.	Net Each
MG1	1	\$2.18	MG600	600	\$2.18
MG3	3	2.18	MG1000	1000	2.22
MG6	6	2.18	MG1500	1500	2.22
MG10	10	2.18	MG2000	2000	2.22
MG15	15	2.18	MG2500	2500	2.22
MG20	20	2.18	MG3000	3000	2.22
MG25	25	2.18	MG4000	4000	2.22
MG30	30	2.18	MG5000	5000	2.22
MG50	50	2.18	MG10K	10K	2.32
MG100	100	2.18	MG15K	15K	2.32
MG200	200	2.18	MG20K	20K	2.32
MG300	300	2.18	MG25K	25K	2.32
MG400	400	2.18	MG50K	50K	2.50
MG500	500	2.18	MG100K	100K	2.72

STANDARD TAPER FOR MALLORY WIRE-WOUND CONTROLS IS NORMAL LINEAR TAPER. OTHER TAPERS MAY BE SPECIFIED ON SPECIAL ORDER.

A DIVISION OF LTV ELECTROSYSTEMS, INC.

MEMCOR COMPONENTS

12½ thru 225 WATT

Originators of TRU-OHM & HARDWICK, HINDLE Products

RHEOSTATS

POWER

VITREOUS ENAMELED

MEMCOR power vitreous enameled rheostats are exceptionally rugged and are "made better than they need be." They exhibit characteristics that meet the most exacting specifications. Special design features assure long life and protection under extremes of humidity and abnormal atmospheric conditions.

In the 225, 500, 750 and 1000 watt sizes the "buss bar" contact arm automatically adjusts for complete, continuous contact, and smooth, flexible control. MEMCOR high temperature enamel gives increased service life with an extreme factor of safety.

MEMCOR rheostats are stocked in eleven sizes; 12½ through 1000 watts resistance from 0.5 to 10,000 ohms with diameters from 7/8" through 12". All standard stock units are identified by stock number.

TYPE	Ohms				Ohms				Ohms				
	Max. Amps.	Approx. Steps	Stock No.		Max. Amps.	Approx. Steps	Stock No.		Max. Amps.	Approx. Steps	Stock No.		
TYPE R-12½ (12½ WATTS) DIAM.: 7/8" WEIGHT: .035 LBS.	1.	3.53	27	600	25	.71	65	607	250	.22	124	614	
	2.	2.5	38	601	35	.6	78	608	350	.19	150	615	
	2.5	2.23	40	601A	50	.5	81	609	500	.16	164	616	
	3.	2.04	36	602	75	.41	98	610	750	.13	188	617	
	5.	1.58	55	602A	100	.35	102	611	1000	.11	196	618	
	6.	1.44	45	603	125	.32	102	612	1500	.091	235	619	
	8.	1.25	49	604	150	.29	96	612A	2500	.071	260	620	
	10	1.18	42	605	175	.27	112	613	3500	.06	285	621	
	15	.91	49	606	200	.25	128	613A	5000	.05	315	622	
	TYPE R-25 (25 WATTS) DIAM.: 1 1/8" WEIGHT: .23 LBS.	1.	5.0	26	100	35	.845	100	108	500	.222	215	116
		2.	3.54	28	101	50	.707	105	109	750	.182	230	117
		3.	2.88	44	102	75	.575	120	110	1000	.155	270	118
		6.	2.04	50	103	100	.5	140	111	1500	.129	325	119
		8.	1.77	54	104	125	.445	145	112	2500	.1	410	120
		10	1.58	60	105	175	.375	153	113	3500	.084	440	121
15		1.29	78	106	250	.316	170	114	5000	.07	480	122	
25		1.0	80	107	350	.267	180	115					
TYPE R-50 (50 WATTS) DIAM.: 2 1/8" WEIGHT: .45 LBS.		.5	10.0	22	200	35	1.19	120	209	1000	.223	375	218
		1.	7.07	36	201	50	1.0	120	210	1600	.176	465	219
		2.	5.0	38	202	80	.79	135	211	2500	.141	560	220
		4.	3.54	38	203	125	.63	185	212	3500	.119	585	221
		6.	2.88	75	204	150	.574	175	213	5000	.1	600	222
		8.	2.5	70	205	225	.47	215	214	8000	.079	710	223
		12	2.04	80	206	300	.408	225	215	10K	.07	720	224
	16	1.76	90	207	500	.316	295	216					
	22	1.5	95	208	800	.25	360	217					
	TYPE R-75 (75 WATTS) DIAM.: 2 3/8" WEIGHT: .60 LBS.	.5	12.3	27	300	25	1.73	92	308	750	.316	260	316
		1.	8.66	18	301	50	1.23	118	309	1000	.274	290	317
		2.	6.12	30	302	75	1.0	135	310	1500	.224	350	318
		3.	5.0	30	303	100	.866	147	311	2000	.194	380	319
		5.	3.8	45	304	200	.612	180	312	2500	.173	425	320
		7.5	3.16	47	305	300	.5	227	313	5000	.123	630	321
10		2.74	50	306	400	.433	232	314	7500	.1	715	322	
16		2.17	87	307	500	.388	250	315	10K	.087	820	323	
TYPE R-100 (100 WATTS) DIAM.: 3 1/8" WEIGHT: .72 LBS.		.5	14.1	30	400	25	2.0	105	408	750	.365	280	416
		1.	10.0	20	401	50	1.41	140	409	1000	.316	316	417
		2.	7.07	32	402	75	1.15	155	410	1500	.258	370	418
		3.	5.75	32	403	100	1.0	168	411	2000	.224	420	419
		5.	4.47	50	404	200	.707	190	412	500	.2	460	420
		7.5	3.65	52	405	300	.575	260	413	5000	.141	650	421
		10	3.16	58	406	400	.500	262	414	7500	.115	740	422
	16	2.5	97	407	500	.447	270	415	10K	.1	850	423	
	TYPE R-150 (150 WATTS) DIAM.: 4" WEIGHT: 1.50 LBS.	.5	17.3	28	500	35	2.07	133	509	750	.447	370	518
		1.	12.3	37	501	50	1.735	160	510	1250	.346	460	519
		2.	8.65	38	502	75	1.415	185	511	1800	.288	550	520
		3.	7.07	67	503	100	1.225	190	512	2250	.259	570	521
		5.	5.48	68	504	150	1.0	230	513	3000	.224	600	522
		7.5	4.47	71	505	200	.865	242	514	4500	.182	680	523
		10	3.88	70	506	250	.775	250	515	7500	.141	980	524
15		3.163	138	507	350	.655	280	516	10K	.122	990	525	
25		2.45	140	508	500	.548	330	517					
TYPE R-225 (225 WATTS) DIAM.: 5" WEIGHT: 2.18 LBS.		1.	15.0	55	4001	25	3.0	117	4009	700	.567	495	4017
		2.	10.61	54	4002	50	2.12	250	4010	900	.5	498	4018
		3.	8.66	56	4003	75	1.73	306	4011	1200	.43	523	4019
		4.	7.5	52	4004	100	1.5	322	4012	1500	.39	630	4020
		5.	6.71	52	4005	150	1.22	385	4013	1750	.358	605	4021
		7.5	5.48	113	4006	200	1.06	355	4014	2000	.33	710	4022
	10	4.74	107	4007	300	.866	336	4015	2500	.3	700	4023	
	15	3.87	111	4008	400	.75	352	4016					

**whatever electronic products
you require...**



**...you'll find it
faster in
this catalog...**

**...the world's largest catalog
of electronic
products
sold through
distributors**

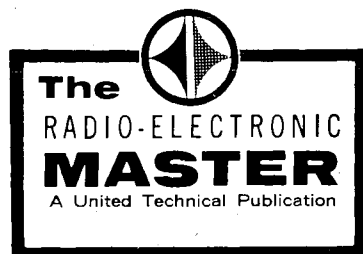

Amperex Semiconductors

GERMANIUM TRANSISTORS

(METAL CANS)

Audio, Low Level

TYPE	CONSTRUCTION
2N2428	TO-1
2N2429	TO-1
2N2430	TO-1
2N2706	TO-1

Audio, Power

TYPE	CONSTRUCTION
2N2431	TO-1
2N2431 (MP)	TO-1
2N2707 (CP)	TO-1
2N4077	Small TO-3
2N4078	Small TO-3
2N4078 (MP)	Small TO-3
2N4079 (CP)	Small TO-3
2N4106	TO-1
2N4107 (CP)	TO-1
2N4136 (CP)	TO-1
2N4241	TO-3
2N4241 (MP)	TO-3

R. F. Amplifiers

TYPE	CONSTRUCTION
2N987	TO-18
USA 2N987	TO-18
2N990	TO-18
2N993	TO-18
2N1224	TO-5
USA 2N1224	TO-5
2N1225	TO-5
USA 2N1225	TO-5
2N1226	TO-5
2N1395	TO-5
2N1396	TO-5
2N2084	TO-5
USA 2N2084	TO-5
2N2089	TO-5
2N2092	TO-5
2N2495	TO-5
2N2496	TO-18
2N2654	TO-5
2N2671	TO-5
2N2672	TO-5
2N3399	TO-18
2N3588	TO-18

Switches

TYPE	CONSTRUCTION
1302 (PNP)	TO-5
1303 (PNP)	TO-5
1304 (NPN)	TO-5
1305 (PNP)	TO-5
1306 (NPN)	TO-5
1307 (PNP)	TO-5
1308 (NPN)	TO-5
1309 (PNP)	TO-5

CP = Complementary Pair
MP = Matched Pair

N-CHANNEL, JUNCTION FETS

(Metal TO-18's)

TYPE	APPLICATION
2N4221	A. F. Amplifier
2N4221A	A. F. Amplifier
2N4222	A. F. Amplifier
2N4222A	A. F. Amplifier
2N4391	High speed switch
2N4392	High speed switch
2N4393	High speed switch
2N5103	Low Level, Low Noise
2N5104	Low Level, Low Noise
2N5105	Low Level, Low Noise
A190	Low Level, Low Noise
A191	Low Level, Low Noise
A192	R. F. Amplifier
A193	R. F. Amplifier
2N3823	R. F. Amplifier

FETS, ZENERS, DUAL ISOLATED DIODES, RF & IF AMPLIFIERS & SWITCHES available in



LIDS, (Leadless Inverted Devices) introduced by Amperex are the microelectronic packages for semiconductors which brought mechanized production to hybrid circuit manufacture.

TYPE	DESCRIPTION
LDA 400/401	Low level amplifier (NPN) similar to 2N929/2N930
LDA 402/403	Medium current switch and amplifier (NPN)
LDA 404/405	Medium current switch and amplifier (NPN) similar to 2N2218/2N2219
LDA 406/407	Very high frequency amplifier (NPN) similar to 2N918/2N2857
LDA 410	High gain, low capacity IF amplifier (NPN)
LDA 450/451	Low current amplifier and switch (PNP) similar to 2N2604
LDA 452/453	Medium current amplifier and switch (PNP) similar to 2N2904/2N2905
LDD 5	Single fast diode similar to IN914
LDD 10	Dual diode common cathode similar to IN914
LDD 50	Dual diode common anode (IN914)
LDD 15	Dual diode fully isolated (IN914)
LDF 603/604/605	Junction field effect transistor DC-100 MHz
LDS 200/201	High speed switch (NPN) similar to 2N2368/2N2369
LDS 205	Very high speed switch similar to 2N709 (NPN)
LDS 206/208	D/A switch (NPN)
LDZ 70 Series	5% zener diode 4 to 10 Volts

DIODES

Germanium

Silicon

TYPE	DESCRIPTION	TYPE	DESCRIPTION
A20	Bias diode	A13	Switching
IN34A	General Purpose	A23	Switching
IN67A	General Purpose	A33	H. F. Varicap
IN68A	General Purpose	A34	H. F. Varicap
IN87	Small Signal Detector	A35	H. F. Varicap
IN87A	Small Signal Detector	A45	Clamping
IN90	General Purpose	A48	Clamping
IN116	General Purpose	A74	High Voltage Rectifier
IN117	General Purpose	A82	R. F. Switch
IN126	General Purpose	A93	H. F. Varicap Triplet
IN128	General Purpose	A94	H. F. Varicap Triplet
IN191	Switching	A95	H. F. Varicap Triplet
IN270	High Conductance	BA114	Stabistor
IN541	Small Signal Detector	BY100	Power Rectifier
IN542	Small Signal Detector	BY122	Bridge Rectifier
IN616	General Purpose	BY123	Bridge Rectifier
IN617	General Purpose	BY126	Power Rectifier
IN618	General Purpose	BY127	Power Rectifier
IN698	Switching	IN914	Switching
AA119MP	Small Signal Detector	IN914A	Switching
AA119	Small Signal Detector	IN3182	Varicap

INTEGRATED CIRCUITS

Hybrid Linear Thin Film

TYPE	DESCRIPTION
ATF 401	Operational amplifier
ATF 402	High gain operational amplifier

Monolithic, Linear, Silicon

TYPE	DESCRIPTION
TAB 101	Ring modulator/demodulator
TAA 103	3-stage, low-level amplifier
OM 200	Hearing-aid amplifier
TAA 263	3-stage, DC coupled, low-level amplifier
TAA 293	3-stage preamplifier
TAA 310	AF high-gain preamplifier
TAA 320	MOS/Bipolar amplifier
TAA 350	IF strip, FM and TV sound
TAA 370	1 mw hearing-aid amplifier

SILICON POWER DEVICES

RF Power Transistors (NPN)

TYPE	PACKAGE
A201	TO-60
A210	TO-39
A211	TO-39
2N3924	TO-5
2N3926	TO-60
2N3927	TO-60
2N3375	TO-60
2N3553	TO-5
2N3632	TO-60
2N3866	TO-39
2N4427	TO-39

Varactors (DO-4's)

TYPE	DESCRIPTION
1N4885	UHF, VHF HiFrequency Multiplier 24W output
1N4886	UHF, VHF HiFrequency Multiplier 16W output

Hi-Voltage Switch (TO-3)

A705	1400V, 25 Amps Switch
------	-----------------------

from

TO-18 to PRESSURE-PACK TYPES

and

NATURAL CONVECTION UNITS to HIGH-HEAT
DISSIPATING FORCED AIR ASSEMBLIES

has a complete line of standard heat sinks and extrusions available from stock. Custom-engineered units are also supplied to meet virtually any heat dissipation requirements.

PRESS-FIT/CIRCUIT BOARD TYPES

2201

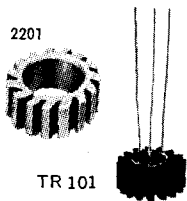

TR 101

2201/TR-101 Series—for optimum natural convection cooling of all standard TO-size transistors used in printed circuit boards, computer cards, etc. Four sizes in TR series provide from 1 to 4 square inches surface area.

2700 (Convection)/2800 Conduction Series—provide greater surface contact plus secure mounting. Eight units provide thermal resistance ranging from 2°C/watt (2801) to 28°C/watt (2701).



2703



2300

2300 Series—free circulation, low-profile units for circuit-board use. Four heat sinks (1/2", 3/4", 1", 1 1/4" x 1.81"² base) of high conductivity aluminum alloy, supplied with black anodize or gold iridite.

FORCED CONVECTION

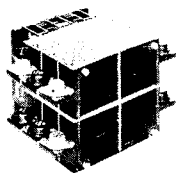

2401-12B

Modular Design permits custom assembly of compact electronic/heat sink units which may incorporate associated electronics and/or terminals. Model 2601 permits mounting more than 40 units to single fan.

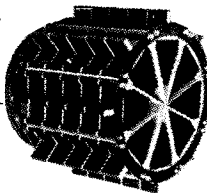

2601-40B

NATURAL CONVECTION UNITS

with 20% Greater Cooling Surface*

Catalog NC-2500 plus actual size outline drawing chart on request.



2501



2502



2513



2517

*Provided by Astrodyne patented T-FIN Construction.

HIGH POWER — CRITICAL COOLING

Model 2450 in four standard sizes (2 x 2", 3 x 3", 4 x 4" and 4 x 6") provides exceptionally low thermal resistance for effective use with "pressure-pack" rectifiers. 4 x 4" unit dissipating 650 watts with 1500 LFM forced air has thermal resistance of 0.105°C/watt with 23 fins and 0.089°C/watt with 33 fins.

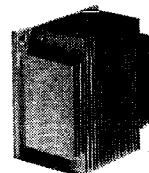

2450



2529/2530

Model 2507 handles heavy duty SCR devices on easily accessible, wide shelf.

Models 2529/2530 "Little Giant" heat sinks (5 and 6" lengths) provide .35°C/watt thermal resistance at 100 watts with natural convection for high power rectifier assemblies.

THERMAL/CONDUCTIVE/BONDING COMPOUNDS



THERMAL BOND 312—general purpose conductive adhesive available in 5 oz. kits (12/carton — \$46.60, individual boxes — \$4.65 each), 2 qt. cans, 2 gal. cans.

CONDUCTIVE COMPOUND 829—supplied in ready-to-use 1, 2, 4 and 8 ounce jars (\$1.25, \$2.00, \$2.35 and \$5.75 each — 12 jars/carton). Providing optimum, long-term thermal/electrical contact plus protection against oxidation.



POTTING COMPOUND

166—for potting heat generating devices such as transformers, resistors, etc. Available in mix-and-use packages (jar of compound, vial of hardener). 12 boxes to case \$42.00. Individual boxes \$4.25 each.



Complete line catalog information sent on request.

CALL COLLECT FOR COMPLETE INFORMATION AND QUOTATIONS ON ANY ASTRODYNE HEAT SINKS



astrodyne, inc.

SUBSIDIARY OF ROANWELL CORP.

The Kokomoans'

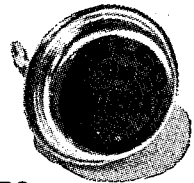
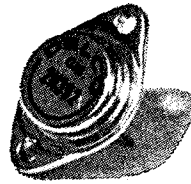
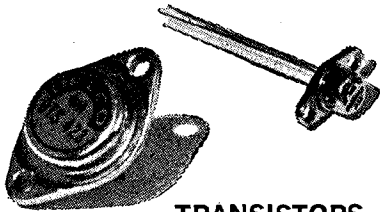

TRANSISTORS

Type	Ic	Vcbo	Vceo	hFE @ Ic Amps	Vce(sat) @ Ic Volts @ Amps
------	----	------	------	------------------	-------------------------------

NPN SILICON TO-36, HIGH VOLTAGE

2N2580	5	400	400	10/40 4 min	5	0.7	5.0
2N2580M†	5	400	400	10/40	5	0.7	5.0
2N2581	10	400	400	25/65 10 min	5	1.0	10.0
2N2582	5	500	500	10/40 4 min	5	0.7	5.0
2N2583	10	500	500	25/65 10 min	5	1.0	10.0
2N3079	10	200	200	10/50	5	.14Ω*	5.0
2N3080	10	300	300	10/50	5	.14Ω*	5.0

NPN SILICON TO-3, HIGH VOLTAGE

DTS-401	3.5	400	400	30/90	1.0	0.8	1.0
DTS-402	3.5	400	400	30/90	1.0	0.8	1.0
DTS-410	3.5	200	200	30/90	1.0	0.8	1.0
DTS-411	3.5	300	300	30/90	1.0	0.8	1.0
DTS-413	2.0	400	400	20/80	0.5	0.8	0.5
DTS-423	3.5	400	400	30/90	1.0	0.8	1.0
DTS-423M†	3.5	400	400	30/90	1.0	0.8	1.0
DTS-424	3.5	500	500	30/90	1.0	0.8	1.0
DTS-425	3.5	500	500	30/90	1.0	0.8	1.0
DTS-430	5	400	400	15/45	2.5	0.9	2.5
DTS-431	5	400	400	15/35	2.5	0.7	2.5
DTS-431M†	5	400	400	15/35	2.5	0.7	2.5
2N3902	3.5	700⑥	400	30/90	1.0	0.8	1.0
JAN 2N3902	3.5	700⑥	400	30/90	1.0	0.8	1.0
2N5157	3.5	700⑥	500	30/90	1.0	0.8	1.0
2N5241	5	400	400	15/35	2.5	0.7	2.5

PNP GERMANIUM TO-36 ALLOY BASE

2N173	15	60	45	35/70	5.0	1.0	12.0
2N174	15	80	55	25/50	5.0	0.9	12.0
JAN 2N174A	15	80	40	40/80	1.2	0.7	12.0
2N277	15	40	25	35/70	5.0	0.3②	12.0
2N278	15	50	30	35/70	5.0	1.0	12.0
2N441	15	40	25	20/40	5.0	0.3②	12.0
2N442	15	50	30	20/40	5.0	0.3②	12.0
2N443	15	60	45	20/40	5.0	1.0	12.0
2N1099	15	80	55	35/70	5.0	0.7	12.0
2N1100	15	100	65	25/50	5.0	0.7	12.0
2N1358	15	80	40	40/80	1.2	0.7	12.0
2N1358A	15	100	60	25/50	5.0	0.7	12.0
JAN 2N1358	15	80	40	25/50	5.0	0.7	12.0
2N1412	15	100	65	25/50	5.0	0.7	12.0
JAN 2N1412A	15	100	70	25/50	5.0	0.6	12.0
2N1518	25	50	40	15/60	15	0.7	25
2N1519	25	80	60	15/60	15	0.7	25
2N1520	35	50	40	17/68	15	0.6	35
2N1521	35	80	60	17/68	15	0.6	35
2N1522	50	50	40	25/100	15	0.5	50
2N1523	50	80	60	25/100	15	0.5	50
2N1970	15	100	50	17/40	5.0	1.0	12.0
2N2075	15	80	65	20/40	5.0	0.7	12.0
2N2076	15	70	55	20/40	5.0	0.7	12.0
2N2077	15	50	45	20/40	5.0	0.9	12.0
2N2078	15	40	25	20/40	5.0	0.9	12.0
2N2079	15	80	65	35/70	5.0	0.7	12.0
2N2080	15	70	55	35/70	5.0	0.7	12.0
2N2081	15	50	45	35/70	5.0	0.9	12.0
2N2082	15	40	25	35/70	5.0	0.9	12.0
JAN 2N2210				use JAN 2N1412A			
2N2490	15	70	50	20/40	5.0	0.7	12.0
2N2491	15	60	40	35/70	5.0	0.7	12.0
2N2492	15	80	65	25/60	5.0	0.5	12.0
2N2493	15	100	75	25/50	5.0	0.5	12.0

PNP GERMANIUM TO-37 NU-BASE

2N3212	5	100⑥	80	30/90	3.0	0.5	5.0
2N3213	5	80⑥	60	30/90	3.0	0.5	5.0
2N3214	5	60⑥	40	30/90	3.0	0.5	5.0
2N3215	5	40⑥	30	25/100	3.0	0.5	5.0

TRANSISTORS

Type	Ic	Vcbo	Vceo	hFE @ Ic Amps	Vce(sat) @ Ic Volts @ Amps
------	----	------	------	------------------	-------------------------------

PNP GERMANIUM TO-41 NU-BASE

2N1073	10	40②	40②	20/60	5.0	0.6	5.0
2N1073A	10	80②	80②	20/60	5.0	0.6	5.0
2N1073B	10	120②	120②	20/60	5.0	0.6	5.0

PNP GERMANIUM TO-3 NU-BASE

2N5155	25	140⑥	120⑦	25/100	8.0	0.9	25.0
DTG-110A	25	110⑥	70	50/300	1.0		
DTG-110B	25	90⑥	40⑦	65/300	1.0	0.5	5.0
DTG-600	25	90⑥	50⑦	50/115⑤	5.0	0.75	25
DTG-601	25	90⑥	60⑦	50/115⑤	5.0	0.75	25
DTG-602	25	100⑥	70⑦	50/115⑤	5.0	0.75	25
DTG-603	25	90⑥	80⑦	50/	5.0	0.75	25.0
DTG-603M†	25	90⑥	80⑦	50/	5.0	0.75	25.0
DTG-1200	15	120⑥	120⑦	20	8.0	0.5	12
DTG-1010	15	325⑥	110⑦	100⑤	8.0	0.5	12
DTG-1110	15	200⑥	80⑦		0.5		10
DTG-2000	25	60⑥	30⑦	25	8.0	0.9	25
DTG-2100	25	80⑥	60⑦	25	8.0	0.9	25
DTG-2200	25	100⑥	80⑦	25	8.0	0.9	25
DTG-2300	25	120⑥	100⑦	25	8.0	0.9	25
DTG-2400	25	140⑥	120⑦	25	8.0	0.9	25
DTG-2400M†	25	140⑥	120	25/125	10.0	0.9	25

PNP GERMANIUM TO-3 ALLOY BASE

2N255A	5	15	15②	25③	.450		
2N301	3	40	32	62.5	.700		
2N301A	3	60	32	62.5	.700		
2N379	7	80③	40	20/90	2.0	1.0	2.0
2N380	7	60③	30	20/90	2.0	1.0	2.0
2N392	5	60	45	60/150	3.0	0.5	3.0
2N456A	7	40	20	30/90	5.0	0.5	5.0
2N456B	7	40	30	30/90	5.0	0.5	5.0
2N457A	7	60	30	30/90	5.0	0.5	5.0
2N457B	7	60	40	30/90	5.0	0.5	5.0
2N458A	7	80	40	30/90	5.0	0.5	5.0
2N458B	7	80	45	30/90	5.0	0.5	5.0
2N554	5	15	30	30	1.0		
2N669	3	30④	30①	250④	.500	0.4⑥	3.0
2N1011	5	80	40	30/75	3.0	1.5	3.0
2N1021	7	100	50	30/90	5.0	0.5	5.0
2N1021A	7	100	50	30/90	5.0	0.5	5.0
2N1022	7	120	50	30/90	5.0	0.5	5.0
2N1022A	7	120	55	30/90	5.0	0.5	5.0
2N1159	5	80	60	30/75	3.0	1.0	3.0
2N1160	7	80	60	20/50	5.0	1.0	5.0
2N1168	5	50	30	60⑤	3.0	.25⑤	3.0
2N1534	5	40	20	35/70	3.0	1.2	3.0
2N1535	5	60	30	35/70	3.0	1.2	3.0
2N1536	5	80	40	35/75	3.0	1.2	3.0
2N1539	5	25	20	50/100	3.0	0.3	.300
2N1540	5	40	30	50/100	3.0	0.3	.300
2N1541	5	55	40	50/100	3.0	0.3	.300
2N1542	5	65	50	50/100	3.0	0.3	.300
2N1543	5	80	60	50/100	3.0	0.3	.300
2N1544	5	25	20	75/150	3.0	0.2	.300
2N1545	5	40	30	75/150	3.0	0.2	.300
2N1546	5	55	40	75/150	3.0	0.2	.300
2N1547	5	65	50	75/150	3.0	0.2	.300
2N5156	10	100	60⑦	25/60	5.0	1.0	10
DTG-110	7	40	40②	74/250	1.0	5.0	2.0

① Vces ② VceR *Rsat † Military Type Spec.
 ③ VceR *Rsat † Military Type Spec.
 ④ Max. ⑤ Typical
 ⑥ VceR *Rsat † Military Type Spec.
 ⑦ VceR *Rsat † Military Type Spec.



SERVICE-DESIGNED ENTERTAINMENT SEMICONDUCTORS



UNIVERSAL REPLACEMENT TRANSISTORS

Highly dependable low-cost germanium and silicon transistors especially designed as general replacements for most types of

transistors used in Radio and TV Sets and other home entertainment devices.

Cat. No.	Unit Type	Dwg. No.	Application(s)	Configuration	Use	Max. Current	Max. Wattage	Max. Coll./Emit. Volts	Sugg. List Price
GE-1	Germanium	B	Mixer/Oscillator Converter, RF & IF Amplifiers (AM Radio)	TO-5	PNP	100MA	150MW	12V	\$2.00
GE-2	Germanium	B	AF Amplifier	TO-5	PNP	200MA	200MW	20V	1.70
GE-3	Germanium	C	AF Power Amplifier	TO-3	PNP	3A	25W	50V	2.95
GE-4	Germanium	D	AF High Power Amplifier	TO-36	PNP	12A	50W	50V	4.90
GE-5	Germanium	B	Mixer/Oscillator Converter, RF & IF Amplifiers (AM Radio)	TO-5	NPN	100MA	150MW	12V	2.80
GE-6	Germanium	A	Mixer/Oscillator Converter, RF Amplifier (AM Radio)	OV-5	NPN	20MA	65MW	15V	3.05
GE-7	Germanium	A	IF Amplifier (AM Radio)	OV-5	NPN	20MA	65MW	15V	2.95
GE-8	Germanium	B	AF Amplifier	TO-5	NPN	200MA	150MW	20V	2.15
GE-9	Germanium	F	Mixer/Oscillator Converter, RF & IF Amplifiers (AM Radio), FM-IF Amplifier	RO-73	PNP	6MA	80MW	12V	2.10
GE-9A	Germanium	G	Mixer/Oscillator Converter, RF & IF Amplifiers (AM-FM Radio)	TO-72	PNP	10MA	70MW	30V	2.10
GE-10	Silicon	E	Mixer/Oscillator Converter, RF & IF Amplifiers (AM Radio), AF Amplifier	RO-67	NPN	100MA	200MW	25V	2.00
GE-11	Silicon	E	Mixer/Oscillator Converter, RF & IF Amplifiers (FM Radio), VHF Tuner, UHF Oscillator	RO-67	NPN	25MA	200MW	30V	2.55
GE-12	Silicon	C	AF Power Amplifier (Line Operated Units)	TO-66	NPN	300MA	10W	300V	3.90
GE-13MP	Germanium	C	AF Power Amplifier, Matched Pairs of GE-3	TO-3	PNP	3A	25W	50V	5.90
GE-14	Silicon	C	AF Power Amplifier	TO-3	NPN	15A	115W	100V	5.85
GE-15MP	Silicon	C	AF Power Amplifier. Match Pairs of GE-14	TO-3	NPN	15A	115W	100V	11.70
GE-16	Germanium	C	AF High Power Amplifier	TO-3	PNP	10A	90W	60V	5.25
GE-17	Silicon	B	FM, RF, & Oscillator, TV and Other Low-Noise Circuits 50-100 mHz	RO-97A	NPN	100MA	500MW	30V	2.40
GE-18	Silicon	H	AF Amplifier, Output, or Oscillator	TO-5	NPN	500MA	800MW	80V	2.40
GE-19	Silicon	C	AF Amplifier, Output Oscillator — High Current	TO-3	NPN	4A	90W	50V	5.10
GE-20	Silicon	H	RF & IF Amplifiers, Oscillator, Audio, and Applications to 50 mHz	TO-18	NPN	500MA	500MW	25V	1.85
GE-21	Silicon	H	RF & IF Amplifiers, Oscillator, Audio, and Applications to 50 mHz	TO-5	PNP	500MA	500MW	25V	1.90
GE-22	Silicon	B	RF & IF Amplifier, Oscillator (AM-FM) to 100 mHz	RO-110	PNP	500MA	500MW	25V	1.70
GE-23	Silicon	C	Class A & B AF Power Amplifiers, Communications, Hi-Fi	TO-66	NPN	2A	15W	40V	4.20
GE-24MP	Silicon	C	Class A & B AF Power Amplifiers, etc. Matched Pairs of GE-23	TO-66	NPN	2A	15W	40V	8.40
GE-25	Germanium	C	Horizontal & Vertical TV Sweep Circuits and Other High Voltage, High Current Use	TO-3	PNP	10A	50W	325V	12.50
GE-FET-1	Silicon	J	N Channel Field Effect Transistor for Small Signal Use	TO-92	(10MA Gate Current, 200MW)			25V	3.75

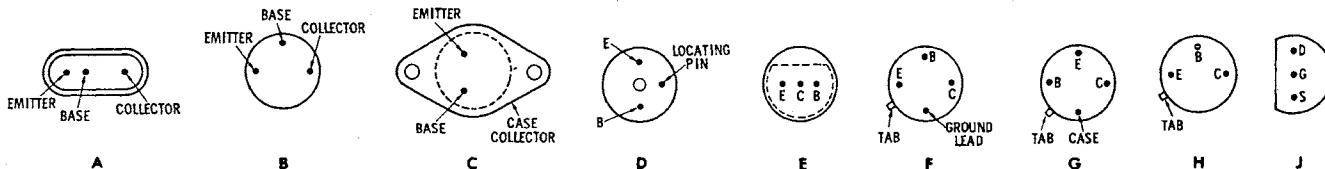

REGISTERED JEDEC TRANSISTORS

These supplement the Universal Line above. Characteristics conform to JEDEC specifications.

Type or JEDEC No.	Use	Appli- cation	Sugg. List Price	Type or JEDEC No.	Use	Appli- cation	Sugg. List Price
2N107	PNP	AF	\$1.25	2N404	PNP	SW	\$0.90
2N170	NPN	IF	1.70	2N508	PNP	AF OUT	1.30
2N188A	PNP	AF OUT	3.05	2N1415	PNP	AF SW	1.70
2N190	PNP	AF	1.40	2N2160	*	OSC	2.75
2N324	PNP	AF	1.20				

* Silicon Unijunction

NEW GE GE-504A UNIVERSAL RECTIFIER

A silicon rectifier with a 60-amp surge rating. Recommended as a replacement for all selenium, germanium and silicon rectifiers used in TV receivers. The 60-amp surge rating eliminates the need for the surge limiting resistors normally required when silicon rectifiers are used.

Type	PIV	I _{DC}	Sugg. List Price	Type	PIV	I _{DC}	Sugg. List Price
GE-504A	600V	1A	\$1.10	GE-509	1000V	1A	\$1.25

GE TYPE IN91 GERMANIUM RECTIFIER

This top hat, hermetically sealed rectifier is designed for general-purpose applications. PRV is 100 volts; maximum I_{DC} is 150 mA. Suggested List Price \$1.55.

GE VAC-U-SEL® DOUBLE/DIODES

Miniature double diodes for TV horizontal phase detector, replacement and other applications. 7/16 x 9/16 x 3/16"

Type No.	I _{fwd}	I _{mr}	Description	Max Case Temp.	Sugg. List Price
6GC1	1.1 @ 2.5V	4 @ 20V	Common cathode	85°C	\$0.99
6GD1	1.1 @ 2.5V	4 @ 20V	Series connected	85°C	.99
6GX1	1.1 @ 2.5V	4 @ 20V	Common anode	85°C	.99

GE CRYSTAL DIODES

Type	Description	Average Forward Current (ma)	Peak Reverse Voltage (volts)	Sugg. List price
1N34AS	General Purpose	50	75	\$0.55
1N60	Video Detector	50	30	.55
1N82A	Silicon UHF Mixer	—	5	1.45
1N295	50 MC Detector	30	50	.55

RECTIFIERS AND CRYSTALS FOR COLOR TV

GE Selenium Rectifiers			GE Quartz Crystals†		
Cat. No.	Type	Sugg. List Price	Cat. No.	Type	Sugg. List Price
GECR-1	Focus Rect.	\$6.20	GE-41	Color burst filter	\$5.60
GECR-2	Boosted Boost	2.45	GE-42	Color subcarrier oscillators	3.80
GECR-3	Convergence	1.43			

† Resonant frequency 3579.545 kc

GE EXPERIMENTER/HOBBYIST COMPONENTS

Blister-packaged components with circuit diagrams for educational and practical uses. Contact your GE Distributor for details.

ELECTRONIC EXPERIMENTER

Hobbyist Manual, ETR-3960

Every engineer, experimenter, hobbyist, student, and technician can learn new applications for electronic components with the simple but interesting and useful circuits in this manual. Price \$1.50.

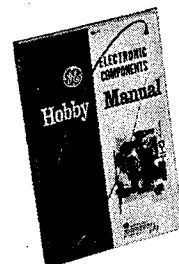

GE ENTERTAINMENT SEMICONDUCTOR ALMANAC

A handy reference of over 9000 semiconductor replacements is available at no charge from your GE Distributor.

GENERAL ELECTRIC

LTE has your number

LINEAR INTEGRATED CIRCUITS/TRANSISTORS

Every LTE Component 100% Tested to each Parameter

For military/industrial types, for consumer/entertainment types, for linear integrated circuits in ANY quantity, call us for low factory-direct prices; Government Source Inspection and Certificate of Conformance available where required.

LINEAR INTEGRATED CIRCUITS

MIL 702 709 710 711 COMMERCIAL 702C 709C 710C 711C

MILITARY - INDUSTRIAL TYPES

2N109	2N501A	2N722	2N935	2N1132B	2N1608	2N1986	2N2217	2N2540	2N3020
2N128	2N502	2N722A	2N936	2N1135	2N1613	2N1987	2N2217A	2N2586	2N3072
2N207	2N502A	2N743	2N937	2N1135A	2N1623	2N1988	2N2218	2N2616	2N3073
2N207A	2N502B	2N744	2N938	2N1158	2N1639	2N1989	2N2218A	2N2645	2N3107
2N207B	2N503	2N753	2N939	2N1158A	2N1643	2N1990	2N2219	2N2651	2N3108
2N217	2N504	2N768	2N940	2N1177	2N1654	2N1991	2N2219A	2N2696	2N3109
2N223	2N534	2N770	2N941	2N1178	2N1655	2N2008	2N2220A	2N2697	2N3110
2N224	2N535	2N771	2N942	2N1179	2N1656	2N2048	2N2221	2N2710	2N3114
2N225	2N535A	2N772	2N943	2N1180	2N1663	2N2049	2N2221A	2N2784	2N3117
2N226	2N535B	2N773	2N944	2N1199	2N1676	2N2083	2N2222	2N2795	2N3120
2N227	2N536	2N774	2N945	2N1199A	2N1677	2N2086	2N2222A	2N2796	2N3121
2N231	2N581	2N775	2N946	2N1200	2N1708	2N2087	2N2274	2N2787	2N3133
2N232	2N582	2N776	2N947	2N1201	2N1711	2N2088	2N2275	2N2788	2N3134
2N240	2N583	2N777	2N956	2N1204	2N1726	2N2147	2N2276	2N2789	2N3135
2N269	2N584	2N778	2N960	2N1219	2N1727	2N2148	2N2277	2N2790	2N3136
2N300	2N588	2N779	2N961	2N1221	2N1728	2N2162	2N2280	2N2791	2N3137
2N301	2N589	2N783	2N962	2N1222	2N1742	2N2163	2N2281	2N2792	2N3209
2N301A	2N597	2N785	2N963	2N1223	2N1743	2N2164	2N2282	2N2801	2N3244
2N317A	2N598	2N794	2N964	2N1228	2N1744	2N2165	2N2297	2N2837	2N3245
2N327A	2N599	2N795	2N965	2N1229	2N1745	2N2166	2N2303	2N2838	2N3250
2N327B	2N600	2N796	2N966	2N1230	2N1746	2N2167	2N2360	2N2845	2N3251
2N328A	2N601	2N828	2N977	2N1231	2N1747	2N2168	2N2361	2N2846	2N3252
2N328B	2N647	2N834	2N978	2N1232	2N1748	2N2169	2N2362	2N2847	2N3253
2N329A	2N649	2N835	2N995	2N1233	2N1749	2N2170	2N2368	2N2848	2N3254
2N329B	2N656	2N846	2N1010	2N1252	2N1750	2N2175	2N2369	2N2868	2N3299
2N344	2N657	2N846A	2N1024	2N1253	2N1752	2N2176	2N2369A	2N2869	2N3301
2N345	2N670	2N858	2N1025	2N1267	2N1753	2N2177	2N2374	2N2870	2N3302
2N346	2N671	2N859	2N1026	2N1268	2N1754	2N2178	2N2375	2N2883	2N3304
2N352	2N672	2N860	2N1027	2N1269	2N1785	2N2180	2N2376	2N2884	2N3337
2N353	2N673	2N861	2N1028	2N1270	2N1786	2N2181	2N2380	2N2894	2N3338
2N386	2N696	2N862	2N1034	2N1271	2N1787	2N2182	2N2380A	2N2904	2N3339
2N387	2N697	2N863	2N1035	2N1272	2N1788	2N2183	2N2398	2N2904A	2N3342
2N393	2N698	2N864	2N1036	2N1275	2N1790	2N2184	2N2399	2N2905	2N3343
2N395	2N699	2N865	2N1037	2N1411	2N1864	2N2185	2N2410	2N2905A	2N3344
2N396	2N699A	2N869	2N1118	2N1416	2N1865	2N2186	2N2443	2N2906	2N3345
2N396A	2N699B	2N869A	2N1118A	2N1420	2N1866	2N2187	2N2475	2N2906A	2N3346
2N404	2N703	2N870	2N1119	2N1427	2N1867	2N2192	2N2476	2N2907	2N3730
2N406	2N706	2N871	2N1122	2N1428	2N1868	2N2192A	2N2477	2N2907A	2N3731
2N408	2N706A	2N910	2N1122A	2N1429	2N1889	2N2192B	2N2478	2N2930	2N3732
2N410	2N706B	2N911	2N1123	2N1436	2N1890	2N2193	2N2479	2N2954	
2N412	2N708	2N912	2N1124	2N1467	2N1893	2N2193A	2N2480	2N2966	
2N414	2N709	2N914	2N1125	2N1472	2N1905	2N2193B	2N2481	2N2967	
2N428	2N717	2N915	2N1128	2N1478	2N1917	2N2194	2N2483	2N3009	
2N495	2N718	2N916	2N1129	2N1494	2N1918	2N2194A	2N2484	2N3010	
2N496	2N719	2N918	2N1130	2N1494A	2N1973	2N2194B	2N2509	2N3011	
2N497	2N719A	2N926	2N1131	2N1499	2N1974	2N2195	2N2510	2N3012	
2N498	2N720	2N927	2N1131A	2N1499A	2N1975	2N2195A	2N2511	2N3013	
2N499	2N720A	2N928	2N1131B	2N1500	2N1983	2N2195B	2N2537	2N3014	
2N499A	2N721	2N929	2N1132	2N1606	2N1984	2N2199	2N2538	2N3015	
2N501	2N721A	2N930	2N1132A	2N1607	2N1985	2N2205	2N2539	2N3019	

CONSUMER - ENTERTAINMENT TYPES

2N109	2N301A	2N408	2N1177	2N1179	2N1638	2N1906	2N2147	2N2870	2N3731
2N217	2N406	2N647	2N1178	2N1180	2N1639	2N2083	2N2148	2N3730	2N3732

WRITE FOR COMPLETE CATALOG — AND LINEAR INTEGRATED CIRCUITS DATA SHEETS

CUSTOM SPECIFICATIONS ARE OUR SPECIALTY

Guaranteed 24-Hour Quote Service on Custom Requirements

LTE LANSDALE TRANSISTOR & ELECTRONICS, INC.

PA & PB SERIES	1-24	25-49	50-99	100-249	250-499	500-999	1000-4999	5000-9999	10,000 & up
PA1-U**	.150	.128	.113	.098	.083	.072	.064	.057	.050
PA2-U	.145	.123	.108	.093	.078	.069	.062	.055	.048
PA1-1U	.150	.128	.113	.098	.083	.072	.064	.057	.050
PA2-1U	.145	.123	.108	.093	.078	.069	.062	.055	.048
PB1-U	.189	.160	.142	.124	.106	.090	.081	.072	.063
PB2-U	.180	.153	.135	.117	.099	.087	.078	.069	.060
PB1-2U	.189	.160	.142	.124	.106	.090	.081	.072	.063
PB2-2U	.180	.153	.135	.117	.099	.087	.078	.069	.060
PB1-3U	.180	.160	.142	.124	.106	.090	.081	.072	.063
PB2-3U	.180	.153	.135	.117	.099	.087	.078	.069	.060

*Available in aluminum only. **Letter "U" denotes unplated.

LP SERIES — FOR TO-5, TO-18 TYPE TRANSISTORS

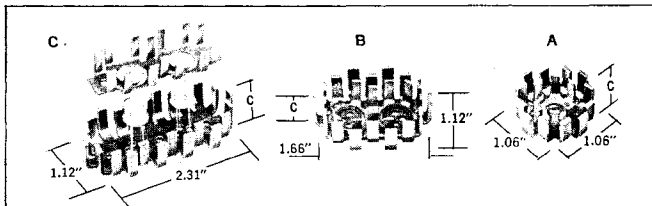

Versatile transistor cooling devices provide excellent heat dissipation in applications of low to high power transistors of TO-5 and TO-18 configurations. IERC's efficient staggered-finger configuration optimizes convection currents and radiating surface area. Available for single and multiple transistor mounting. Send for Bulletin 135.

IERC PART NO.	DIMENSION "C"	NUMBER OF TRANSISTORS	JEDEC OUTLINE NO.	PRICES				
				1-24	25-49	50-99	100-249	250-499
LP 5A 1B	1/2"	1	TO-5, TO-9	\$.80	\$.68	\$.64	\$.60	\$.56
LP 5A 2B	5/16"	1	TO-5, TO-9	.80	.68	.64	.60	.56
LP 18A 1B	1/2"	1	TO-18	.80	.68	.64	.60	.56
LP 18A 2B	5/16"	1	TO-18	.80	.68	.64	.60	.56
LP 18A 3B	1/2"	2	TO-18	.80	.68	.64	.60	.56
LP 18A 4B	5/16"	2	TO-18	.80	.68	.64	.60	.56
LP 5B 1B	1/2"	1	TO-5, TO-9	.90	.77	.72	.68	.63
LP 5B 2B	5/16"	1	TO-5, TO-9	.90	.77	.72	.68	.63
LP 5B 3B	1/2"	2	TO-5, TO-9	.90	.77	.72	.68	.63
LP 5B 4B	5/16"	2	TO-5, TO-9	.90	.77	.72	.68	.63
LP 5C 1B	1/2"	1	TO-5, TO-9	1.00	.85	.80	.75	.70
LP 5C 2B	5/16"	1	TO-5, TO-9	1.00	.85	.80	.75	.70
LP 5C 3B	1/2"	2	TO-5, TO-9	1.00	.85	.80	.75	.70
LP 5C 4B	5/16"	2	TO-5, TO-9	1.00	.85	.80	.75	.70

Note: Clamp sections may be used separately as retaining devices; change first two letters of the part number to "LC". Base section LB5A1B or LB5A2B may be used separately for TO-37 transistors such as 2N1172 and 2N1609. Delete letter "B" from part number for Insulube 448 finish. Consult your IERC representative or factory for special orders.

LB SERIES — FOR TO-66 TYPE TRANSISTORS

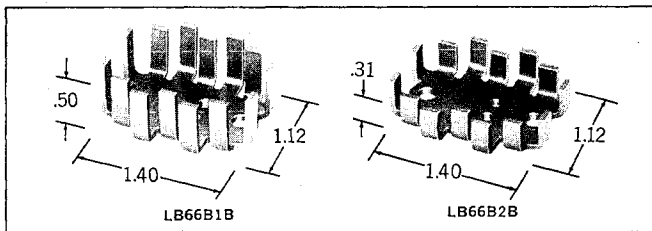

Efficient staggered-finger design requires only 1.7 sq.in. of mounting area. In natural convection, dissipates 9 watts with case temperature maintained at less than 150°C. At 1,000 RPM, dissipates 15 watts with case temperature maintained at 90°C. Send for Bulletin 146.

IERC PART NO.	JEDEC OUTLINE NO.	QUANTITY PRICES				
		1-24	25-49	50-99	100-249	250-499
LB66B1B	TO-66	.328	.283	.265	.222	.194
LB66B2B	TO-66	.286	.250	.226	.197	.173

Fabricated of aluminum. Letter "B" at end of part number denotes black anodize finish. For Insulube 448 (positive insulation up to 500 watts) delete letter "B". "U" denotes unplated part.

UP SERIES — FOR POWER TYPE TRANSISTORS AND DIODES

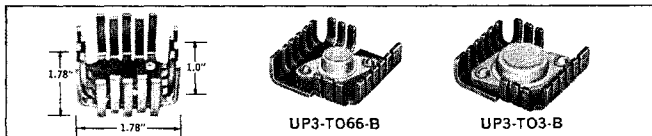

Design gives maximum dissipation in medium power applications at lower cost than comparable finned extrusions. Staggered finger configuration allows maximum efficiency in both natural convection and forced

air at less weight and volume. Increased dissipation achieved by mounting dissipators back-to-back on a bracket. Standard finish black anodize. Send for Bulletin 134.

IERC PART NO.	JEDEC OUTLINE NO.	QUANTITY PRICES				
		1-24	25-49	50-99	100-249	250-499
UP-T03-B	TO-3	\$.66	\$.56	\$.53	\$.50	\$.47
UP-T06-B	TO-6 or TO-36	.66	.56	.53	.50	.47
UP-T066-B	TO-66	.66	.56	.53	.50	.47
UP-T015-B	TO-15 or TO-13 (1/4" stud)	.66	.56	.53	.50	.47
UP-T0V7B	Universal*	.66	.56	.53	.50	.47
UP-IE2-B	IE-2	.66	.56	.53	.50	.47
UP3-T066-B	TO-66	.40	.34	.32	.30	.28
UP3-T03-B	TO-3	.40	.34	.32	.30	.28

Delete letter "B" from part number for Insulube 448 finish. Above parts are 1" high; for 3/4", add numeral "2" after first two letters of part number; for 1/2", add numeral "1" after first two letters; example: UP2-T03-B describes a dissipator 3/4" high, with TO-3 hole pattern and black anodize finish. For other hole patterns, see your IERC representative or consult the factory.

HP SERIES — FOR POWER TYPE TRANSISTORS AND DIODES

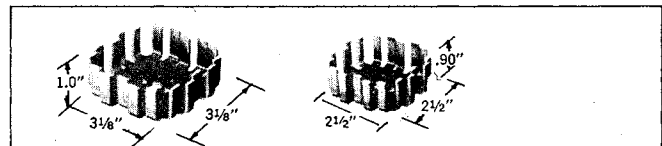

Heat dissipating performance of IERC's staggered-finger design is comparable to conventional extrusions up to 3 times as heavy and 30% larger. Two sizes: may be used separately or with the smaller unit nested in the larger unit. Standard finish black anodize. Send for Bulletin 139.

IERC PART NO.	JEDEC OUTLINE NO.	QUANTITY PRICES				
		1-24	25-49	50-99	100-249	250-499
HP1-T03-B	TO-3	\$1.30	\$1.11	\$1.04	\$.98	\$.91
HP1-T06-B	TO-6	1.30	1.11	1.04	.98	.91
HP1-T015-B	TO-15, 1/2" STUD	1.30	1.11	1.04	.98	.91
HP1-T0V2-B	UNIVERSAL*	1.30	1.11	1.04	.98	.91
HP1-IE6-B	TO-18, TO-31 8-32 or 10-32 STUD	1.30	1.11	1.04	.98	.91
HP3-T03-B	TO-3	1.40	1.19	1.12	1.05	.98
HP3-T06-B	TO-6	1.40	1.19	1.12	1.05	.98
HP3-T015-B	TO-15, 1/2" STUD	1.40	1.19	1.12	1.05	.98
HP3-T0V2-B	UNIVERSAL*	1.40	1.19	1.12	1.05	.98

Note: Delete letter "B" from part number for Insulube 448 finish. For other hole patterns, insert JEDEC Outline Number after the "dash" in the part number; or, contact your IERC representative or the factory for assistance with special orders.

*Combination hole pattern for TO-3, TO-6, TO-36 or studs up to 1/4" dia.

EXTRUSIONS — E1, E2 AND E3 SERIES

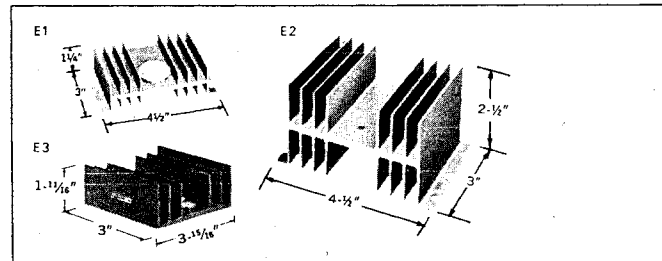

Optimized fin design gives the most power dissipation for volume and weight. Standard finish black anodize. Standard units supplied with mounting notches and choice of six popular semiconductor mounting hole patterns. Send for Bulletins 142 (E1 and E2) and 145 (E3).

EXTRUSION TYPE	IERC PART NO.	TRANSISTOR MOUNTING HOLE PATTERN	QUANTITY PRICES				
			1-24	25-49	50-99	100-249	250-499
E1 and E3**	E1000-0600B	BLANK	\$1.38	\$1.18	\$1.11	\$.95	\$.82
	E1003-0600B	TO-3	1.62	1.38	1.30	1.12	.97
	E1006-0600B	TO-6	1.62	1.38	1.30	1.12	.97
	E1015-0600B	TO-15	1.62	1.38	1.30	1.12	.97
	E10E2-0600B	LIKE 2N1015	1.62	1.38	1.30	1.12	.97
	E100V-0600B	UNIVERSAL*	1.62	1.38	1.30	1.12	.97
E2	E1096-0600B	TO-66	2.04	1.74	1.67	1.40	1.20
	E2003-0600B	BLANK	2.28	1.94	1.86	1.57	1.35
	E2006-0600B	TO-3	2.28	1.94	1.86	1.57	1.35
	E2015-0600B	TO-6	2.28	1.94	1.86	1.57	1.35
	E2015-0600B	TO-15	2.28	1.94	1.86	1.57	1.35
	E20E2-0600B	LIKE 2N1015	2.28	1.94	1.86	1.57	1.35
E3	E200V-0600B	UNIVERSAL*	2.28	1.94	1.86	1.57	1.35
	E2066-0600B	TO-66	2.28	1.94	1.86	1.57	1.35

**For E3 configuration change first numeral of part no. to 3. For example E3000-0600B.

*Combination hole pattern for TO-3, TO-6, TO-36 or studs up to 1/4" dia. Note: Other lengths, in 1/2" increments are available. Specify non-standard hole patterns by JEDEC Outline Number, or by transistor type. For unplated, or Insulube 448 finishes, consult your nearest IERC representative or the factory.

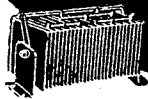
DIRECTRON

Industrial Selenium Rectifiers, Transformers, Chokes and Power Supplies

FULL WAVE BRIDGE RECTIFIERS, SINGLE PHASE, RESISTIVE-INDUCTIVE LOADS

ALL PRICES SHOWN ARE USER NET PRICES

Max. Amps.	18v. in— 14v. out		36v. in— 28v. out		54v. in— 42v. out		130v. in— 100v. out	
	No.	Price	No.	Price	No.	Price	No.	Price
1/2	A 18	\$ 1.05	A 36	\$ 1.50	A 54	\$ 2.50	A 130	\$ 5.00
1	B 18	1.20	B 36	2.20	B 54	3.20	B 130	8.00
2	C 18	2.10	C 36	3.00	C 54	4.50	C 130	10.00
3	D 18	2.70	D 36	4.00	D 54	6.00	D 130	14.00
4	E 18	3.60	E 36	7.50	E 54	10.00	E 130	24.00
6	F 18	4.50	F 36	9.00	F 54	12.00	F 130	32.00
10	G 18	6.60	G 36	12.00	G 54	18.00	G 130	39.00
12	H 18	8.20	H 36	16.00	H 54	22.00	H 130	44.00
15	J 18	10.50	J 36	20.00	J 54	27.00	J 130	54.00
20	K 18	12.50	K 36	25.00	K 54	36.00	K 130	77.00
24	L 18	15.00	L 36	30.00	L 54	42.00	L 130	82.00
30	M 18	19.10	M 36	37.00	M 54	55.00		
36	P 18	24.00	P 36	48.00				
50	R 18	30.00	R 36	60.00				



C36

220 v. Single Phase available . . . up to 1000 amps.

HALF-WAVE, CENTER-TAP, DOUBLER,

TRIPLER or 3-PHASE

Quotations on request

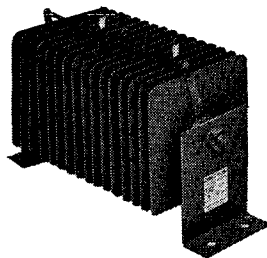

E130

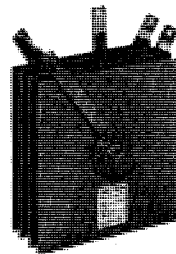

F18

24 HOUR SERVICE

on Custom Built Stacks

SEE OUR AD UNDER "TRANSFORMERS" IN SECTION 5600 FOR RECTIFIER TRANSFORMERS AND HIGH CURRENT CHOKES

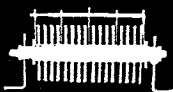

Mfd. by SANFORD MILLER CORP.



SEMICONDUCTOR PRODUCTS

MAY, 1968

TRANSISTORS, THYRISTORS, GERMANIUM DIODES & TUNNEL DIODES

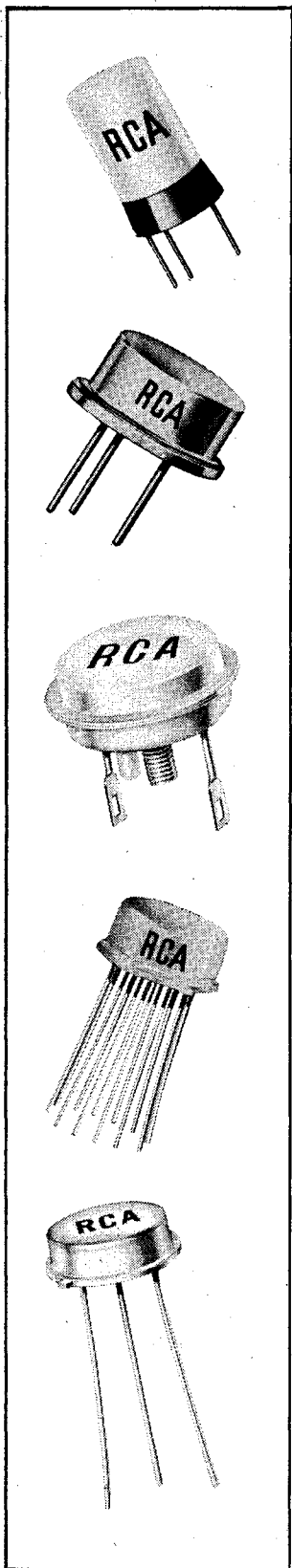

Type	RCA Equipment Manufacturers Price (Bulk)		
	1-99 SCH. D	100-999 SCH. B	1,000 & up SCH. C
1N2326	\$.55	\$.40	\$.33
2N104	1.65	1.20	1.00
2N109	.66	.48	.40
2N140	1.24	.90	.75
2N175	1.63	1.19	.99
2N176	1.31	.95	.79
2N215	1.73	1.26	1.05
2N217	.57	.41	.34
2N220	1.52	1.10	.92
2N270	.76	.55	.46
2N274	1.24	.90	.75
2N351	1.73	1.26	1.05
2N370	1.08	.78	.65
2N372	1.06	.77	.64
2N376	1.88	1.37	1.14
2N384	1.65	1.20	1.00
JAN2N384	3.30	2.40	2.00
2N388	.47	.34	.28
JAN2N388	.48	.35	.29
2N388A	.88	.64	.53
2N398	.83	.60	.50
JAN2N398A	.99	.72	.60
JAN2N398	.91	.66	.55
2N398A	.91	.66	.55
2N398B	1.16	.84	.70
2N404	.42	.30	.25
JAN2N404	.43	.32	.26
2N404A	.55	.40	.33
JAN2N404A	.62	.45	.37
2N405	.48	.35	.285
2N406	.41	.30	.245
2N407	.54	.39	.325
2N408	.48	.35	.285
2N409	.55	.40	.33
2N410	.48	.35	.29
2N411	.60	.44	.36
2N412	.53	.39	.32
2N414	.42	.30	.25
2N581	.50	.36	.30
2N582	.66	.48	.40
2N585	.99	.72	.60
2N586	1.73	1.26	1.05
2N591	.58	.42	.35
2N647	1.08	.78	.65
2N649	.86	.63	.52
2N697	.63	.46	.38
2N699	1.16	.84	.70
2N706	.55	.40	.33
2N706A	.73	.53	.44
2N709	1.32	.96	.80
2N718A	1.08	.78	.65
2N720A	1.32	.96	.80
2N834	1.98	1.44	1.20
2N917	1.27	.92	.77
2N918	1.41	1.02	.85
JAN2N918	2.15	1.56	1.30
JANTX2N918	5.80	4.20	3.50
2N1010	2.89	2.10	1.75
2N1023	2.72	1.98	1.65
2N1066	1.98	1.44	1.20
2N1177	1.01	.74	.61
2N1178	.99	.72	.60
2N1179	.99	.72	.60
2N1180	.80	.58	.48
2N1183	1.82	1.32	1.10
JAN2N1183	2.64	1.92	1.60
2N1183A	2.31	1.68	1.40
JAN2N1183A	3.30	2.40	2.00
2N1183B	2.89	2.10	1.75
JAN2N1183B	3.88	2.82	2.35

Type	RCA Equipment Manufacturers Price (Bulk)		
	1-99 SCH. D	100-999 SCH. B	1,000 & up SCH. C
2N1184	2.48	1.80	1.50
JAN2N1184	3.71	2.70	2.25
2N1184A	2.81	2.04	1.70
JAN2N1184A	4.04	2.94	2.45
2N1184B	4.13	3.00	2.50
JAN2N1184B	5.36	3.90	3.25
2N1224	1.24	.90	.75
JAN2N1224	1.41	1.02	.85
2N1225	1.41	1.02	.85
JAN2N1225	1.57	1.14	.95
2N1226	1.49	1.08	.90
2N1285	1.72	1.25	1.04
2N1302	.42	.30	.25
JAN2N1302	.43	.32	.26
2N1303	.42	.30	.25
JAN2N1303	.43	.32	.26
2N1304	.50	.36	.30
JAN2N1304	.53	.39	.32
2N1305	.48	.35	.29
JAN2N1305	.52	.38	.31
2N1306	.62	.45	.37
JAN2N1306	.66	.48	.40
2N1307	.58	.42	.35
JAN2N1307	.63	.46	.38
2N1308	.91	.66	.55
JAN2N1308	.96	.70	.58
2N1309	.91	.66	.55
JAN2N1309	.96	.70	.58
2N1384	3.30	2.40	2.00
2N1395	1.49	1.08	.90
2N1396	1.65	1.20	1.00
2N1397	2.15	1.56	1.30
2N1479	2.15	1.56	1.30
JAN2N1479	2.56	1.86	1.55
2N1480	2.31	1.68	1.40
JAN2N1480	2.72	1.98	1.65
2N1481	2.48	1.80	1.50
JAN2N1481	2.89	2.10	1.75
2N1482	3.30	2.40	2.00
JAN2N1482	3.71	2.70	2.25
2N1483	2.89	2.10	1.75
JAN2N1483	3.71	2.70	2.25
2N1484	3.63	2.64	2.20
JAN2N1484	4.46	3.24	2.70
2N1485	4.46	3.24	2.70
JAN2N1485	5.28	3.84	3.20
2N1486	6.77	4.92	4.10
JAN2N1486	7.59	5.52	4.60
2N1487	4.54	3.30	2.75
JAN2N1487	5.36	3.90	3.25
2N1488	4.96	3.60	3.00
JAN2N1488	5.78	4.20	3.50
2N1489	7.43	5.40	4.50
JAN2N1489	8.25	6.00	5.00
2N1490	8.25	6.00	5.00
JAN2N1490	9.10	6.60	5.50
2N1491	1.82	1.32	1.10
2N1492	4.29	3.12	2.60
2N1493	7.01	5.10	4.25
JAN2N1493	7.43	5.40	4.50
2N1524	.47	.34	.28
2N1525	.53	.39	.32
2N1526	.48	.35	.29
2N1527	.55	.40	.33
2N1605	.62	.45	.37
2N1605A	1.09	.80	.66
2N1613	.75	.54	.45
2N1631	.65	.47	.39
2N1632	.58	.42	.35
2N1637	.57	.41	.34

Type	RCA Equipment Manufacturers Price (Bulk)		
	1-99 SCH. D	100-999 SCH. B	1,000 & up SCH. C
2N1638	.50	.36	.30
2N1639	.53	.39	.32
2N1683	1.90	1.38	1.15
2N1700	1.90	1.38	1.15
2N1701	2.31	1.68	1.40
2N1702	4.54	3.30	2.75
2N1711	.94	.69	.57
2N1893	1.08	.78	.65
2N1905	4.13	3.00	2.50
2N1906	6.60	4.80	4.00
2N2015	9.08	6.60	5.50
JAN2N2015	9.90	7.20	6.00
2N2016	9.90	7.20	6.00
JAN2N2016	10.75	7.80	6.50
2N2102	1.13	.82	.68
*S262102	14.50	12.00	10.00
2N2147	1.57	1.14	.95
2N2148	1.08	.78	.65
2N2208	1.54	1.12	.93
2N2270	.91	.66	.55
2N2304	4.29	3.12	2.60
2N2305	6.44	4.68	3.90
2N2338	6.60	4.80	4.00
2N2369	1.40	1.02	.85
2N2369A	1.65	1.20	1.00
2N2405	1.57	1.14	.95
2N2475	1.62	1.18	.98
2N2476	1.16	.84	.70
2N2477	1.32	.96	.80
2N2594	1.62	1.18	.98
2N2613	.55	.40	.33
2N2614	.50	.36	.30
2N2631	3.47	2.52	2.10
2N2708	2.31	1.68	1.40
JAN2N2708	2.72	1.98	1.65
2N2857	4.46	3.24	2.70
JAN2N2857	4.95	3.60	3.00
JANTX2N2857	10.20	8.45	7.05
2N2869/ 2N301	1.52	1.11	.92
2N2870/ 2N301A	3.15	2.29	1.91
2N2876	12.75	10.55	8.80
2N2895	1.41	1.02	.85
2N2896	2.06	1.50	1.25
2N2897	1.16	.84	.70
2N2953	.50	.36	.30
2N3011	.99	.72	.60
2N3053/ 40053	.75	.54	.45
2N3054	1.16	.84	.70
2N3055	1.82	1.32	1.10
2N3118	4.95	3.60	3.00
2N3119	5.36	3.90	3.25
2N3229	17.10	14.15	11.80
2N3241A	.73	.53	.44
2N3242A	.83	.60	.50
2N3261	1.32	.96	.80
2N3262	7.43	5.40	4.50
2N3263	79.75	66.00	55.00
2N3264	50.75	42.00	35.00
2N3265	76.85	63.50	53.00
2N3266	50.75	42.00	35.00
2N3375	10.80	8.95	7.45
JAN2N3375	18.50	15.30	12.75
2N3435	7.43	5.40	4.50
2N3439	3.71	2.70	2.25
JAN2N3439	4.70	3.42	2.85
2N3440	1.82	1.32	1.10
JAN2N3440	2.31	1.68	1.40
2N3441	2.48	1.80	1.50
JAN2N3441	3.05	2.22	1.85
2N3442	4.54	3.30	2.75

Prices shown do not include any state or local taxes. All prices are subject to change or withdrawal without notice.

RCA**SEMICONDUCTOR PRODUCTS****RCA Equipment
Manufacturers Price (Bulk)**

Type	RCA Equipment Manufacturers Price (Bulk)		
	1-99 SCH. D	100-999 SCH. B	1,000 & up SCH. C
40514	1.26	.92	.76
40517	15.10	12.50	10.40
40518	20.30	16.80	14.00
40519	1.41	1.02	.85
40537	1.24	.90	.75
40538	1.36	.99	.82
40539	.66	.48	.40
40542	1.31	.95	.79
40543	1.37	1.00	.83
40544	.75	.54	.45
40559;A	.70	.51	.42
*40560	9.80	7.15	5.95
40561	4.54	3.30	2.75
40562	4.54	3.30	2.75
40563	4.54	3.30	2.75
40564	4.54	3.30	2.75
40565	4.54	3.30	2.75
40566	7.43	5.40	4.50
40567	6.52	4.74	3.95
40568	7.01	5.10	4.25
40569	7.43	5.40	4.50
40570	10.75	7.80	6.50
40571	8.60	6.24	5.20
40572	7.01	5.10	4.25
40573	8.15	5.94	4.95
40574	10.75	7.80	6.50
*40577	58.00	48.00	40.00
*40578	58.00	48.00	40.00
40581	4.87	3.54	2.95
40582	5.12	3.72	3.10
40583	Order	1N5411	
40594	2.23	1.62	1.35
40595	2.23	1.62	1.35
40598	Price on request		
40600	1.24	.90	.75
40601	1.16	.84	.70
40602	.83	.60	.50
40603	1.04	.76	.63
40604	.98	.71	.59
40605	45.00	37.25	31.05
40608	2.53	1.85	1.55
40609	3.32	2.43	2.03
40611	.71	.52	.43
40612	.71	.52	.43
40613	.73	.53	.44
40616	.73	.53	.44
40617	.73	.53	.44
40618	.74	.54	.45
40621	.86	.62	.52
40622	.88	.64	.53
40623	.86	.62	.52
40624	1.14	.83	.69
40625	.89	.65	.54
40626	.89	.65	.54
40627	1.20	.83	.73
40628	.94	.68	.57
40629	.74	.54	.45
40630	.86	.62	.52
40631	.97	.71	.59
40632	1.24	.90	.75
40633	1.27	.92	.77
40634	1.29	.94	.78
40635	.74	.54	.45
40636	2.31	1.68	1.40
40653	2.61	1.90	1.58

*NOTED — Group 1 products can only be shipped direct to the end user due to technical specifications of the unit.

SILICON RECTIFIER ASSEMBLIES**RCA Equipment
Manufacturers Price (Bulk)**

Type	RCA Equipment Manufacturers Price (Bulk)	
	1 - 29	30 & up
CR101	\$ 5.75	\$ 5.47
CR102	7.20	6.85
CR103	8.15	7.75
CR104	9.60	9.10
CR105	10.55	10.05
CR106	12.00	11.40
CR107	12.95	12.30
CR108	13.90	13.20
CR109	15.35	14.60
CR110	16.30	15.50
CR201	3.10	2.96
CR203	4.80	4.56
CR204	5.75	5.47
CR206	6.95	6.60
CR208	8.40	8.00
CR210	10.10	9.60
CR212	12.00	11.40
CR301	28.00	26.55
CR302	40.00	37.95
CR303	51.00	48.45
CR304	57.60	54.72
CR305	73.00	69.35
CR306	83.00	78.85
CR307	93.00	88.35
CR311	30.00	28.50
CR312	42.00	39.90
CR313	53.00	50.35
CR314	64.00	60.75
CR315	75.00	71.25
CR316	85.00	80.75
CR317	95.00	90.25
CR321	35.00	33.25
CR322	49.00	46.55
CR323	62.00	58.90
CR324	76.00	72.20
CR325	90.00	85.50
CR331	37.00	35.15
CR332	52.00	49.40
CR333	65.00	61.75
CR334	79.00	75.05
CR335	93.00	88.35
CR341	44.00	41.80
CR342	61.00	57.95
CR343	78.00	74.10
CR344	94.00	89.30
CR351	46.00	43.70
CR352	64.00	60.80
CR353	82.00	72.90
CR354	98.00	93.10
CR401	28.00	26.60
CR402	32.00	30.40
CR403	44.00	41.80
CR404	30.00	28.50
CR405	36.00	34.20
CR406	54.00	51.30
CR407	40.00	38.00
CR408	48.00	45.60
CR409	64.00	60.80
CR501	40.00	38.00
CR502	48.00	45.60
CR503	50.00	47.50
CR504	62.00	58.90
CR505	64.00	60.80
CR506	84.00	79.80

PHOTOCELLS**RCA Equipment
Manufacturers Price (Bulk)**

Type	RCA Equipment Manufacturers Price (Bulk)		
	1-99 SCH. D	100-999 SCH. B	1,000 & up SCH. C
SQ2502	1.90	1.38	1.15
SQ2503	1.32	.96	.80

**RCA Equipment
Manufacturers Price (Bulk)**

Type	RCA Equipment Manufacturers Price (Bulk)		
	1-99 SCH. D	100-999 SCH. B	1,000 & up SCH. C
SQ2508	1.90	1.38	1.15
SQ2519	1.08	.78	.65
SQ2520	1.49	1.08	.90
SQ2521	1.54	1.12	.93
SQ2526	1.54	1.12	.93
SQ2527	1.54	1.12	.93
SQ2529	1.65	1.20	1.00
SQ2530	1.32	.96	.80
SQ2534	1.65	1.20	1.00
SQ2535	1.13	.82	.68
SQ2536	1.13	.82	.68
SQ2543	2.06	1.50	1.25
SQ2544	1.90	1.38	1.15
SQ2544V1	1.90	1.38	1.15
SQ2545	1.90	1.38	1.15
SQ2545V1	1.90	1.38	1.15
SQ2546	1.90	1.38	1.15
SQ2554	1.13	.82	.68
SQ2555	1.17	.85	.71
SQ2556	1.44	1.05	.87
SQ2557	1.40	1.02	.85
SQ2558	1.57	1.14	.95
4403	1.21	.88	.73
4404	1.32	.96	.80
4448	1.32	.96	.80
4451	1.37	1.00	.83
4453	1.28	.93	.77
7163	1.21	.88	.73

SILICON RECTIFIERS



1N248C;RC	1.65	1.20	1.00
JAN1N249B;RB	3.33	2.42	2.02
1N249C;RC	2.06	1.50	1.25
JAN1N250B;RB	4.08	2.96	2.47
1N250C;RC	2.72	1.98	1.65
1N440B	.66	.48	.40
1N441B	.70	.51	.42
1N442B	.80	.58	.48
1N443B	.98	.71	.59
1N444B	1.06	.77	.64
1N445B	1.42	1.04	.86
1N536	.45	.33	.27
1N537	.50	.36	.30
1N538	.53	.39	.32
1N539	.60	.44	.36
1N540	.68	.49	.41
1N547	.96	.70	.58
1N1095	.88	.64	.53
1N1183A;RA	2.15	1.56	1.30
JAN1N1184;R	4.31	3.13	2.61
1N1184A;RA	2.48	1.80	1.50
JAN1N1186;R	5.99	4.36	3.63
1N1186A;RA	3.55	2.58	2.15
1N1187A;RA	4.95	3.60	3.00
JAN1N1188	9.02	6.56	5.47
1N1188A;RA	6.19	4.50	3.75
1N1189A;RA	7.43	5.40	4.50
JAN1N1190;R	11.16	9.24	7.70
1N1190A;RA	8.65	6.30	5.25
1N1195A;RA	3.88	2.82	2.35
1N1196A;RA	4.95	3.60	3.00
1N1197A;RA	5.94	4.32	3.60
1N1198A;RA	7.01	5.10	4.25
JAN1N1198A;RA	9.02	6.56	5.47
1N1199A; RA	1.24	.90	.75
1N1200;RA	1.41	1.02	.85
1N1202A;RA	2.48	1.80	1.50
1N1203A;RA	3.47	2.52	2.10
1N1204A;RA	4.46	3.24	2.70
1N1205A;RA	5.36	3.90	3.25

NATIONAL[®] SILICON CONTROLLED RECTIFIERS

National Electronics, Inc. manufactures silicon controlled rectifiers with characteristics aimed at special and difficult applications.

NATIONAL[®] Regenerative Gate SCRs with:

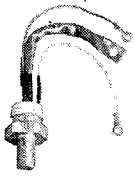
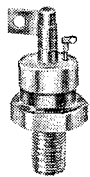
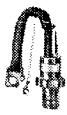
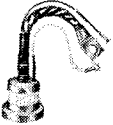
- High di/dt (typical 600 Amp/ μ sec).
- Half the switching losses of standard devices.
- No sacrifice in gate drive, turn-on time, turn-off time, or any other characteristic.

	Type Number	I_{rms} (Amperes)	V_{FOM} (Volts)	Special Characteristics
 JEDEC TO-48 1/4" Stud. Flag Terminals	NL-C36 Series (2N1842-1850) NL-511 Series NL-C37 Series NL-C35 Series (2N681-692) NL-C38 Series NL-C40 Series	16 16 25 35 35 35	25 to 800 800 to 1200 50 to 800 25 to 1000 25 to 500 25 to 500	$T_c = 105^\circ\text{C}$ $T_c = 150^\circ\text{C}$ $t_{off} = 12 \mu\text{sec}$
 JEDEC TO-49 1/2" Stud. Flexible Leads	NL-C46 Series NL-F46 Series NL-555 Series NL-C50 Series (2N1909-1916) NL-C55 Series NL-C60 Series (2N2023-2030) NL-C150 Series NL-F150 Series NL-C151 Series NL-C154 Series NL-C155 Series	55 55 55 110 110 110 110 110 110 110 110	25 to 1000 200 to 900 50 to 1300 25 to 1000 25 to 600 25 to 500 200 to 1000 500 to 1300 500 to 1000 100 to 500 100 to 500	$di/dt = 400\text{A}/\mu\text{sec}$ $t_{off} = 20 \mu\text{sec}$ $T_c = 150^\circ\text{C}$ $di/dt = 600\text{A}/\mu\text{sec}$ $t_{off} = 50 \mu\text{sec}$ $t_{off} = 10 \mu\text{sec}$ $t_{off} = 20 \mu\text{sec}$
 JEDEC TO-83 1/2" Stud. Flag Terminals	NL-C45 Series NL-F45 Series NL-556 Series NL-C52 Series (2N1792-1803) NL-C56 Series NL-C62 Series NL-C152 Series NL-F152 Series NL-C153 Series NL-C156 Series NL-C157 Series	55 55 55 110 110 110 110 110 110 110 110	25 to 1000 200 to 900 50 to 1300 25 to 1000 25 to 600 25 to 500 200 to 1000 500 to 1300 500 to 1000 100 to 500 100 to 500	$di/dt = 400\text{A}/\mu\text{sec}$ $t_{off} = 20 \mu\text{sec}$ $T_c = 150^\circ\text{C}$ $di/dt = 600\text{A}/\mu\text{sec}$ $t_{off} = 50 \mu\text{sec}$ $t_{off} = 10 \mu\text{sec}$ $t_{off} = 20 \mu\text{sec}$
 JEDEC TO-93 3/4" Stud. Flexible Leads	NL-C178 Series NL-C180 Series NL-C181 Series NL-C185 Series	200 235 235 235	100 to 1200 100 to 1300 100 to 1200 50 to 600	$t_{off} = 80 \mu\text{sec}$ $t_{off} = 20 \mu\text{sec}$
 Clamp Mounted	NL-C291 Series	470	50 to 1200	
	NL-C29120 Series	470	50 to 1200	Heat sink included

For Complete Data Request Bulletin SB-57

READOUT TUBES, DRIVERS, & BEZELS
NATIONAL'S complete line of numeric readout tubes, drivers, and bezels are available for prompt shipment. Write for individual data sheets and prices.

IGNITRONS, RECTIFIER TUBES, & THYRATRONS
NATIONAL'S complete line of industrial control ignitrons, rectifier tubes, and thyratrons are available for prompt shipment. Write for individual data sheets and prices.











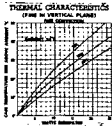

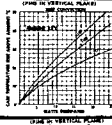

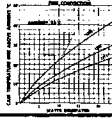

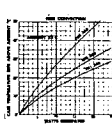
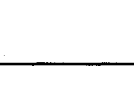

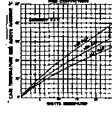

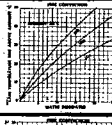
NATIONAL ELECTRONICS, Inc.

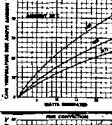
a varian subsidiary

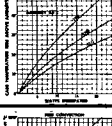

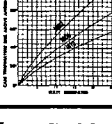
SEMICONDUCTOR COOLERS

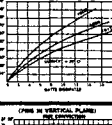
NATURAL CONVECTION COOLERS

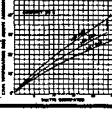
		Inches			Each					
		Model No.	H	W	D	1-49	50-99	100-249	250-499	
	Model 10		100310	1½"	2.94	1.31	1.02	.82	.69	.59
			100610	3"	2.94	1.31	1.20	.97	.82	.69
			101110	5½"	2.94	1.31	1.49	1.19	1.00	.86
	Model 11		110310	1½"	4.81	1.31	1.23	.98	.83	.71
			110610	3"	4.81	1.31	1.58	1.26	1.06	.91
			111110	5½"	4.81	1.31	2.07	1.65	1.40	1.19
	Model 12		120310	1½"	6.09	1.06	1.36	1.08	.92	.78
			120610	3"	6.09	1.06	1.83	1.47	1.24	1.05
			121110	5½"	6.09	1.06	2.44	1.95	1.65	1.40
	Model 13		13A0310	1½"	4.50	1.25	1.27	1.03	.86	.71
			13A0610	3"	4.50	1.25	1.49	1.20	1.00	.84
			13A1110	5½"	4.50	1.25	2.40	1.97	1.64	1.40
			13B0310	1½"	4.75	1.25	1.27	1.03	.86	.71
			13B0610	3"	4.75	1.25	1.49	1.20	1.00	.84
	Model 13		13B1110	5½"	4.75	1.25	2.40	1.97	1.64	1.40
			14A0310	1½"	4.50	2.50	1.65	1.25	1.10	.95
			14A0610	3"	4.50	2.50	2.21	1.80	1.49	1.26
			14A1110	5½"	4.50	2.50	3.35	2.71	2.26	1.90
			14B0310	1½"	4.75	2.50	1.65	1.25	1.10	.95
	Model 14		14B0610	3"	4.75	2.50	2.21	1.80	1.49	1.26
			14B1110	5½"	4.75	2.50	3.35	2.71	2.26	1.90
			150310	1½"	4.62	1.31	1.27	1.03	.86	.71
			150610	3"	4.62	1.31	1.49	1.20	1.00	.84
			151110	5½"	4.62	1.31	2.40	1.97	1.64	1.40
	Model 15		160310	1½"	5.12	1.25	1.65	1.25	1.10	.95
			160610	3"	5.12	1.25	2.21	1.80	1.49	1.26
			161110	5½"	5.12	1.25	3.35	2.71	2.26	1.90
	Model 16		170310	1½"	4.51	1.03	1.27	1.03	.86	.71
			170610	3"	4.51	1.03	1.49	1.20	1.00	.84
			171110	5½"	4.51	1.03	2.40	1.97	1.64	1.40
	Model 17		180310	¾"	2.00	2.00	1.23	1.02	.82	.66
			180610	1½"	2.00	2.00	1.33	1.12	.91	.76
			181210	3"	2.00	2.00	1.58	1.32	1.06	.91
	Model 18		190310	1½"	4.82	.460	1.30	1.05	.86	.71
			190610	3"	4.82	.460	1.45	1.22	.96	.81
			191110	5½"	4.82	.460	2.07	1.72	1.31	1.16
	Model 19		410310	1½"	4.75	1.88	1.65	1.25	1.10	.95
			410610	3"	4.75	1.88	2.21	1.80	1.49	1.26
			411110	5½"	4.75	1.88	3.35	2.71	2.26	1.90
	Model 41		410310	1½"	4.75	1.88	1.65	1.25	1.10	.95
			410610	3"	4.75	1.88	2.21	1.80	1.49	1.26
			411110	5½"	4.75	1.88	3.35	2.71	2.26	1.90

NOTES: Material: Aluminum Alloy 6063-T6 per QQ-A-8625
Finish: Standard Black Anodized to MIL-A-8625 Type II



**SARKES
TARZIAN**

SECTION 4800

JEDEC Silicon Avalanche Rectifiers

All the silicon rectifiers listed below are supplied with avalanche characteristics as standard. They are direct replacements, electrically and physically, for ordinary silicon rectifiers, yet they provide important benefits to you and your products, at no extra cost.

Overtoltage protection is built into the rectifier. Transient voltage induced failures are virtually eliminated because these units avalanche at voltages well below the destruction point. The overvoltage spike is dissipated through the junction at a point below the critical voltage stress across the edge of the junction.

Lower circuit costs are readily achieved. When avalanche rectifiers are

used suppressor and balancing devices, such as resistors, capacitors, R-C networks, etc., are no longer needed. In addition, their elimination improves circuit reliability, due to a reduction in number of components and interconnections.

Dependable performance is assured. Over 20,000,000 of these devices already have been delivered and are in actual use in the field. They are now routinely available from high volume production lines.

All Tarzian Silicon Rectifiers are supplied with avalanche protection at no extra cost. For additional types, not necessarily covered by JEDEC numbers, see the following pages.

Net Each, Lots of				Net Each, Lots of				Net Each, Lots of				Net Each, Lots of				Net Each, Lots of			
JeDEC No.	1-24	25-99	100 up	JeDEC No.	1-24	25-99	100 up	JeDEC No.	1-24	25-99	100 up	JeDEC No.	1-24	25-99	100 up	JeDEC No.	1-24	25-99	100 up
1N248	1.55	1.33	1.24	1N610	1.20	1.03	.96	1N1191A	1.75	1.50	1.39	1N1692	.35	.30	.28	1N2634	5.95	5.31	4.68
1N248A	1.75	1.50	1.39	1N610A	1.20	1.03	.96	1N1192	1.55	1.33	1.24	1N1693	.37	.32	.29	1N2635	7.07	6.31	5.56
1N248B	1.75	1.50	1.39	1N611	1.29	1.10	1.02	1N1192A	1.75	1.50	1.39	1N1694	.42	.36	.33	1N2637	9.65	8.65	7.78
1N248C	1.75	1.50	1.39	1N611A	1.29	1.10	1.02	1N1193	2.14	1.83	1.70	1N1695	.43	.37	.35	1N2858	.35	.30	.28
1N249	1.55	1.33	1.24	1N612	1.50	1.29	1.20	1N1193A	2.44	2.09	1.94	1N1696	.45	.39	.36	1N2859	.35	.30	.28
1N249A	1.75	1.50	1.39	1N612A	1.50	1.29	1.20	1N1194	2.14	1.83	1.70	1N1697	.47	.40	.37	1N2860	.37	.32	.29
1N249B	1.75	1.50	1.39	1N613	1.67	1.43	1.33	1N1194A	2.44	2.09	1.94	1N1701	.35	.30	.28	1N2861	.42	.36	.33
1N249C	2.44	2.09	1.94	1N613A	1.67	1.43	1.33	1N1195	2.84	2.43	2.26	1N1702	.35	.30	.28	1N2862	.43	.37	.35
1N250	2.14	1.83	1.70	1N614	2.12	1.82	1.69	1N1195A	3.72	3.19	2.97	1N1703	.37	.32	.29	1N2863	.45	.39	.36
1N250A	2.44	2.09	1.94	1N614A	2.12	1.82	1.69	1N1196	3.16	2.70	2.52	1N1704	.37	.32	.29	1N2864	.47	.40	.37
1N250B	2.44	2.09	1.94	1N1081	.60	.55	.51	1N1196A	4.14	3.55	3.30	1N1705	.43	.37	.35	1N3161	14.20	12.19	11.36
1N250C	2.44	2.09	1.94	1N1082	.65	.57	.53	1N1197	3.44	2.95	2.74	1N1706	.45	.39	.36	1N3162	14.20	12.19	11.36
1N253	1.19	.96	.89	1N1083	.70	.61	.57	1N1197A	4.41	3.78	3.51	1N1707	.35	.30	.28	1N3163	15.80	13.50	12.60
1N254	1.20	1.03	.96	1N1084	.75	.63	.59	1N1198	3.80	3.28	3.06	1N1708	.35	.30	.28	1N3164	15.80	13.50	12.60
1N255	1.50	1.29	1.20	1N1085A	3.34	2.86	2.66	1N1198A	4.89	4.19	3.90	1N1709	.37	.32	.29	1N3165	17.10	15.00	14.00
1N256	2.12	1.82	1.69	1N1086A	4.00	3.43	3.20	1N1199	1.19	1.02	.94	1N1710	.42	.36	.33	1N3166	17.10	15.00	14.00
1N322	1.50	1.29	1.20	1N1087A	4.67	4.00	3.75	1N1199A	1.19	1.02	.94	1N1711	.43	.37	.35	1N3167	24.40	20.95	19.52
1N333	1.50	1.29	1.20	1N1088A	5.35	4.67	4.27	1N1200	1.19	1.02	.94	1N1712	.45	.39	.36	1N3168	24.40	20.95	19.52
1N334	1.29	1.10	1.02	1N1095	.45	.39	.36	1N1200A	1.19	1.02	.94	1N1730	2.10	1.79	1.67	1N3169	32.60	27.95	26.10
1N335	1.29	1.10	1.02	1N1096	.47	.40	.37	1N1201	1.19	1.02	.94	1N1731	2.10	1.79	1.67	1N3170	42.40	36.20	33.80
1N336	1.20	1.03	.96	1N1100	.35	.30	.28	1N1201A	1.25	1.07	1.00	1N1732	2.90	2.50	2.33	1N3189	.37	.32	.29
1N337	1.20	1.03	.96	1N1101	.37	.32	.29	1N1202	1.25	1.07	1.00	1N1733	4.15	3.57	3.34	1N3190	.43	.37	.35
1N338	1.19	.96	.89	1N1102	.42	.36	.33	1N1202A	1.25	1.07	1.00	1N1734	5.00	4.29	4.00	1N3191	.47	.40	.37
1N339	1.19	.96	.89	1N1103	.43	.37	.35	1N1203	1.34	1.14	1.06	1N1763	.43	.37	.35	1N3208	1.19	1.02	.94
1N340	1.19	.96	.89	1N1104	.45	.39	.36	1N1203A	1.34	1.14	1.06	1N1764	.45	.39	.36	1N3209	1.19	1.02	.94
1N341	1.50	1.29	1.20	1N1105	.47	.40	.37	1N1204	1.67	1.43	1.33	1N2054	14.20	12.19	11.36	1N3210	1.25	1.07	1.00
1N342	1.50	1.29	1.20	1N1108	1.15	2.71	2.54	1N1204A	1.67	1.43	1.33	1N2055	14.20	12.19	11.36	1N3211	1.34	1.14	1.06
1N343	1.29	1.10	1.02	1N1109	4.00	3.43	3.20	1N1205	1.87	1.60	1.49	1N2056	15.80	13.50	12.60	1N3212	1.67	1.43	1.33
1N344	1.29	1.10	1.02	1N1110	4.75	4.15	3.86	1N1205A	1.87	1.60	1.49	1N2057	15.80	13.50	12.60	1N3213	1.87	1.60	1.49
1N345	1.20	1.03	.96	1N1111	5.65	4.86	4.53	1N1206	2.34	2.00	1.86	1N2058	15.80	13.50	12.60	1N3214	2.34	2.00	1.86
1N346	1.20	1.03	.96	1N1112	6.50	5.57	5.20	1N1206A	2.34	2.00	1.86	1N2059	17.10	15.00	14.00	1N3233	.33	.29	.27
1N347	1.19	.96	.89	1N1113	7.35	6.30	5.87	1N1237	5.25	4.69	4.13	1N2060	24.40	20.95	19.52	1N3260	12.90	11.09	10.32
1N348	1.19	.96	.89	1N1115	1.19	.96	.89	1N1238	5.25	4.69	4.13	1N2061	24.40	20.95	19.52	1N3261	12.90	11.09	10.32
1N349	1.19	.96	.89	1N1116	1.20	1.03	.96	1N1239	7.77	6.94	6.11	1N2062	32.60	27.95	26.10	1N3262	14.50	12.40	11.58
1N440	.35	.30	.28	1N1117	1.29	1.10	1.02	1N1262	6.44	5.75	5.06	1N2063	42.40	36.20	33.80	1N3263	14.50	12.40	11.58
1N440B	.35	.30	.28	1N1118	1.50	1.29	1.20	1N1341	1.19	.96	.89	1N2069	.33	.29	.27	1N3264	15.80	13.50	12.60
1N441	.37	.32	.29	1N1119	1.67	1.43	1.33	1N1341A	1.19	.96	.89	1N2070	.35	.30	.28	1N3265	15.80	13.50	12.60
1N441B	.37	.32	.29	1N1120	2.12	1.82	1.69	1N1342	1.19	.96	.89	1N2071	.37	.32	.29	1N3266	20.80	17.80	16.60
1N442	.42	.36	.33	1N1124	1.20	1.03	.96	1N1342A	1.19	.96	.89	1N2103	.35	.30	.28	1N3267	20.80	17.80	16.60
1N442B	.42	.36	.33	1N1124A	1.20	1.03	.96	1N1343	1.20	1.03	.96	1N2104	.35	.30	.28	1N3268	28.45	24.38	22.75
1N443	.43	.37	.35	1N1125	1.29	1.10	1.02	1N1344	1.20	1.03	.96	1N2105	.37	.32	.29	1N3269	34.60	29.60	27.65
1N443B	.43	.37	.35	1N1125A	1.29	1.10	1.02	1N1344A	1.20	1.03	.96	1N2106	.42	.36	.33	1N3289	12.20	10.45	9.79
1N444	.45	.39	.36	1N1126	1.50	1.29	1.20	1N1345	1.29	1.10	1.02	1N2107	.43	.37	.35	1N3290	13.40	11.76	10.95
1N444B	.45	.39	.36	1N1126A	1.50	1.29	1.20	1N1345A	1.29	1.10	1.02	1N2108	.45	.39	.36	1N3291	18.80	16.07	15.00
1N445	.47	.40	.31	1N1127	1.67	1.43	1.33	1N1346	1.50	1.29	1.20	1N2154	1.55	1.33	1.24	1N3292	24.25	20.78	19.40
1N445B	.47	.40	.31	1N1127A	1.67	1.43	1.33	1N1346A	1.50	1.29	1.20	1N2155	1.55	1.33	1.24	1N3293	28.50	24.40	22.80
1N532	.42	.36	.33	1N1128	2.12	1.82	1.69	1N1347	1.67	1.43	1.33	1N2156	2.14	1.83	1.70	1N3569	1.19	.96	.89
1N533	.43	.37	.35	1N1128A	2.12	1.82	1.69	1N1347A	1.67	1.43	1.33	1N2157	2.84	2.43	2.26	1N3570	1.20	1.03	.96
1N534	.45	.39	.36	1N1133	3.35	2.86	2.67	1N1348	2.12	1.82	1.69	1N2158	3.16	2.70	2.52	1N3571	1.29	1.10	1.02
1N535	.47	.40	.37	1N1134	3.35	2.86	2.67	1N1348A	2.12	1.82	1.69	1N2159	3.44	2.95	2.74	1N3572	1.50	1.29	1.20
1N536	.35	.30	.28	1N1135	3.75	3.22	3.00	1N1487	.35	.30	.28	1N2160	3.80	3.28	3.06	1N3573	1.67	1.43	1.33
1N537	.35	.30	.28	1N1136	3.75	3.22	3.00	1N1488	.37	.32	.29	1N2373	1.25	1.07	1.00	1N3574	2.12	1.82	1.69
1N538	.37	.32	.29	1N1137	4.15	3.58	3.34	1N1489	.42	.36	.33	1N2374	2.10	1.79	1.67	1N3615	1.19	1.02	.94
1N539	.42	.36	.33	1N1138	4.15	3.58	3.34	1N1490	.43	.37	.35	1N2376	2.10	1.79	1.67	1N3616	1.19	1.02	.94
1N540	.43	.37	.35	1N1139	5.40	4.64	4.33	1N1491	.45	.39	.36	1N2377	3.35	2.86	2.66	1N3617	1.25	1.07	1.00
1N547	.47	.40	.37	1N1140	5.40	4.64	4.33	1N1492	.47	.40	.37	1N2378	4.20	3.58	3.34	1N3618	1.34	1.14	1.06
1N550	1.20	1.03	.96	1N1141	7.50	6.43	6.00	1N1537	1.19	.96	.89	1N2379	5.00	4.30	4.00	1N3619	1.67	1.43	1.33
1N551	1.25	1.07	1.00	1N1142	7.50	6.43	6.00	1N1538	1.19	.96	.89	1N2380	7.10	6.08	5.66	1N3620	1.34	1.14	1.06
1N552	1.55	1.33	1.24	1N1143	8.75	7.50	7.00	1N1539	1.20	1.03	.96	1N2381	11.40	9.65	9.00	1N3621	1.87	1.60	1.49
1N553	1.95	1.67	1.56	1N1143A	8.75	7.50	7.00	1N1540	1.20	1.03	.96	1N2382	5.00	4.29	4.00	1N3622	2.34	2.00	1.86
1N554	2.35	2.10	1.88	1N1144	10.00	8.58	8.00	1N1541	1.29	1.10	1.02	1N2383	7.10	6.08	5.66	1N3639	.37	.32	.29
1N555	2.70																		



**SARKES
TARZIAN**

Silicon Avalanche Rectifiers

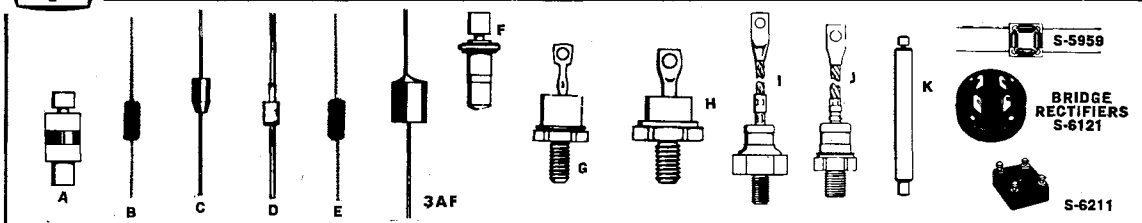

LOW CURRENT AVALANCHE RECTIFIERS

M SERIES 1.0 AMP (FIG. A)

S-T No.	JEDEC No.	Max. PIV	Max. RMS Volts	Max. Cur. Amps at 100° C*		Net Each, Lots of		
				DC Load	4MS Surge	1-24	25-99	100 Up
10M	1N1081	100	70	1.0	60 Amps	\$0.60	\$0.57	\$0.51
20M	1N1082	200	140	1.0	60 Amps	.65	.57	.53
30M	1N1083	300	210	1.0	60 Amps	.70	.61	.57
40M	1N1084	400	280	1.0	60 Amps	.75	.63	.59
M-500	1N1084	400	280	1.0	60 Amps	.75	.63	.59
50M	500	350	1.0	60 Amps	.80	.69	.64
60M	600	420	1.0	60 Amps	.85	.70	.66

HIGH VOLTAGE SM SERIES (FIG. K)

S-T No.	JEDEC No.	Max. PIV	Max. RMS Volts	DC Load Amps	Recur. Peak Amps	Net Each, Lots of		
						1-24	25-99	100 Up
80SM	1N1108	800	560	.45	4.5	\$3.15	\$2.71	\$2.54
120SM	1N1109	1200	840	.425	4.25	4.00	3.43	3.20
160SM	1N1110	1600	1120	.4	4.0	4.75	4.15	3.86
200SM	1N1111	2000	1400	.375	3.75	5.65	4.86	4.53
240SM	1N1112	2400	1680	.35	3.5	6.50	5.57	5.20
280SM	1N1113	2800	1960	.325	3.25	7.35	6.30	5.87

HIGH CURRENT, HERMETICALLY SEALED AVALANCHE RECTIFIERS

Stud base, rectifiers. Add suffix N for neg. base (anode), P for pos. base (cathode).

E SERIES 1.0 AMP (FIG. B, .125" DIA.)

E1	1N4001	100	70	1.0	70	\$0.33	\$0.29	\$0.27
E1	1N4002	100	70	1.0	70	.33	.29	.27
E2	1N4003	200	140	1.0	70	.33	.29	.27
E4	1N4004	400	280	1.0	70	.35	.30	.28
E6	1N4005	600	420	1.0	70	.37	.32	.29
E8	1N4006	800	560	1.0	70	.42	.44	.41
E10	1N4008	1000	700	1.0	70	.79	.67	.63

F SERIES 1.0 AMP (FIG. C, .195" DIA.)

F2	1N2482	200	140	1.0	60	\$0.33	\$0.29	\$0.27
F2	1N2069	200	140	1.0 <td>60</td> <td>.33</td> <td>.29</td> <td>.27</td>	60	.33	.29	.27
F4	1N2483	400	280	1.0 <td>60</td> <td>.35</td> <td>.30</td> <td>.28</td>	60	.35	.30	.28
F6	1N2070	400	280	1.0 <td>60</td> <td>.35</td> <td>.30</td> <td>.28</td>	60	.35	.30	.28
F8	1N2484	600	420	1.0 <td>60</td> <td>.37</td> <td>.32</td> <td>.29</td>	60	.37	.32	.29
F10	1N2071	600	420	1.0 <td>60</td> <td>.37</td> <td>.32</td> <td>.29</td>	60	.37	.32	.29
	800	560	1.0 <td>60</td> <td>.52</td> <td>.44</td> <td>.41</td>	60	.52	.44	.41
	1000	700	1.0 <td>60</td> <td>.79</td> <td>.67</td> <td>.63</td>	60	.79	.67	.63

G SERIES 1.0 AMP (FIG. E, .125" DIA. GLASS)

G1	100	70	1.0	50	\$0.35	\$0.30	\$0.28
G2	200	140	1.0	50	.37	.32	.29
G4	400	280	1.0	50	.43	.37	.35
G6	600	420	1.0	50	.47	.40	.37
G8	800	560	1.0	50	.52	.53	.49
G10	1000	700	1.0	50	.95	.82	.76

C SERIES 1.0 AMP (FIG. D)

18C	1N2610	100	70	1.0	60	\$0.35	\$0.30	\$0.28
18C	1N2611	200	140	1.0	60	.37	.32	.29
30C	1N2612	300	210	1.0	60	.42	.36	.33
40C	1N2613	400	280	1.0	60	.43	.37	.35
50C	1N2614	500	350	1.0	60	.45	.39	.36
60C	1N2615	600	420	1.0	60	.47	.40	.37
80C	1N2616	800	560	1.0	60	.62	.53	.49
100C	1N2617	1000	700	1.0	60	.95	.82	.76

MEDIUM CURRENT AVALANCHE RECTIFIERS LA SERIES 2 AMPS (FIG. F)

S-T No.	JEDEC No.	Max. PIV	Max. RMS Volts	DC Load Amps	4MS Surge	Net Each, Lots of		
						1-24	25-99	100 Up
10LA	1N1085A	100	70	2.0	100	\$3.34	\$2.86	\$2.66
20LA	1N1086A	200	140	2.0	100	4.00	3.43	3.20
30LA	1N1087A	300	210	2.0	100	4.67	4.00	3.73
40LA	1N1088A	400	280	2.0	100	5.35	4.67	4.27
50LA	500	350	2.0	100	5.87	5.03	4.70
60LA	600	420	2.0	100	6.45	5.52	5.15

3AF SERIES 3 AMPS

3AF2	200	140	3.0	150	\$.52	\$.44	\$.40
3AF6	400	280	3.0	150	.74	.63	.58
3AF8	600	420	3.0	150	1.09	.83	.85
3AF8	800	560	3.0	150	1.37	1.17	1.07

H3 SERIES 6 AMPS (FIG. G)

Add suffix N for negative or P for positive base. Add R to JEDEC type for negative base.

10H3	1N1342	100	70	6	150	\$1.19	\$0.96	\$0.89
20H3	1N1344	200	140	6	150	1.20	1.03	.96
30H3	1N1345	300	210	6	150	1.29	1.10	1.02
40H3	1N1346	400	280	6	150	1.67	1.29	1.20
50H3	1N1347	500	350	6	150	1.67	1.43	1.33
60H3	1N1348	600	420	6	150	2.12	1.82	1.69
80H3	800	560	6	150	2.54	2.17	2.02

ST2 SERIES 12 AMP (FIG. G)

Add suffix N for negative base or P for positive base.

ST210	1N1200	100	70	12	260	\$1.19	\$1.02	\$0.94
ST220	1N1202	200	140	12	260	1.25	1.07	1.00
ST230	1N1203	300	210	12	260	1.34	1.14	1.06
ST240	1N1204	400	280	12	260	1.87	1.43	1.33
ST250	1N1205	500	350	12	260	1.87	1.60	1.49
ST260	1N1206	600	420	12	260	2.34	2.00	1.86
ST280	800	560	12	260	2.82	2.42	2.25
ST2100	8000	700	12	3.38	2.80	2.70

ST3A SERIES 25 AMP (FIG. H)

ST3A10	1N1191	100	70	25	400	\$1.55	\$1.33	\$1.24
	1N1192					1.25	1.07	1.00
ST3A20	1N1193	200	140	25	400	2.14	1.83	1.70
	1N1194					2.14	1.83	1.70
ST3A30	1N1195	300	210	25	400	2.84	2.43	2.26
ST3A40	1N1196	400	280	25	400	3.16	2.70	2.52
ST3A50	1N1197	500	350	25	400	3.44	2.95	2.74
ST3A60	1N1198	600	420	25	400	3.80	3.28	3.06
ST3A80	800	560	25	4.60	3.94	3.66
ST3A100	1000	700	25	5.53	4.73	4.38

ST4 SERIES 35 AMP (FIG. H)

ST410	1N1183	100	70	35	500	\$1.75	\$1.50	\$1.39
	1N1184					1.70	1.46	1.36
ST420	1N1185	200	140	35	500	2.44	2.09	1.94
	1N1186					2.44	2.09	1.94
ST430	1N1187	300	210	35	500	3.72	3.19	2.97
ST440	1N1188	400	280	35	500	4.14	3.55	3.36
ST450	1N1189	500	350	35	500	4.41	3.78	3.51
ST460	1N1190	600	420	35	500	4.89	4.19	3.90
ST480	800	560	35	5.89	5.03	4.69
ST4100	1000	700	35	7.05	6.03	5.61

ST5A SERIES 50 AMP (FIG. I)

ST5A10	100	70	50	1000	\$3.25	\$2.78	\$2.60
ST5A20	200	140	50	1000	3.78	3.23	3.00
ST5A30	300	210	50	1000	4.53	3.88	3.60
ST5A40	400	280	50	1000	5.28	4.52	4.20
ST5A50	500	350	50	1000	6.27	5.38	5.00
ST5A60	600	420	50	1000	7.80	6.68	6.20
ST5A80	800	560	50	9.35	8.00	7.45
ST5A100	1000	700	50	11.22	9.15	8.95

ST11 SERIES 70 AMPS (FIG. H)

ST1110	100	70	70	1120	\$3.59	\$3.08	\$2.86
ST1120	200	140	70	1120	4.16	3.56	3.31
ST1130	300	210	70	1120	4.89	4.26	3.96
ST1140	400	280	70	1120	5.81	4.98	4.63
ST1150	500	350	70	1120	6.91	5.92	5.51
ST1160	600	420	70	1120	8.60	7.37	6.85

ST6 SERIES 100 AMP (FIG. I)

ST610	100	70	100	1600	\$11.20	\$ 9.60	\$ 8.96
ST620	200	140	100	1600	12.20	10.45	9.79
ST630	300	210	100	1600	13.40	11.76	10.95
ST640	400	280	100	1600	16.80	16.07	15.00
ST650	500	350	100	1600	24.25	20.78	19.40
ST660	600	420	100	1600	28.50	24.40	22.80
ST680	800	560	100	42.85	36.18	33.18
ST6100								

SARKES
TARZIAN

Silicon Regulators, Suppressors

SILICON ZENER VOLTAGE REGULATORS

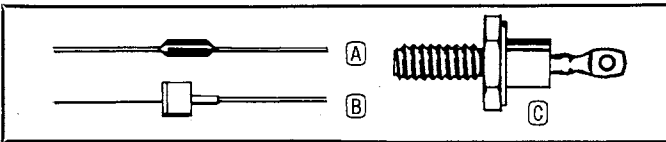

One series covers many JEDEC types. Meet or exceed all JEDEC requirements. Tolerance $\pm 5\%$; available in $\pm 10\%$ and $\pm 20\%$. To order, add voltage and tolerance letter to S-T No. (i.e.: .25T5.6A).

S-T Series	Fig.	Tol. $\pm 5\%$	Watts	Net Each, Lots of		
				1-24	25-99	100 Up
.25T	A	A	.25	\$2.25	\$1.93	\$1.80
.4T	A	A, B	.4	2.50	2.15	2.00
1TA	B	A, B	1	1.67	1.43	1.33
10T	C	A, B	10	3.76	3.22	2.99

JEDEC NUMBERS AND VOLTAGES AVAILABLE

.25T (250 Mw)		.4T (400 Mw)		1TA Series (1 Watt)				10T Series (10 Watt)					
JEDEC No.	Zener Volts	JEDEC No.	Zener Volts	JEDEC No.	Zener Volts	JEDEC No.	Zener Volts	JEDEC No.	Zener Volts	JEDEC No.	Zener Volts	JEDEC No.	Zener Volts
1N708A	5.6	1N769A	23.5	1N3016B	6.8	1N1774A	13	1N1351A	10	1N1823A	27	1N2993B	43
1N709A	6.2	1N752A	5.6	1N3D17B	7.5	1N1775A	15	1N1352A	11	1N1824A	30	1N2994B	45
1N710A	6.8	1N753A	6.2	1N3018B	8.2	1N1776A	16	1N1353A	12	1N1825A	33	1N2995B	47
1N711A	7.5	1N754A	6.8	1N3019B	9.1	1N1777A	20	1N1354A	13	1N1826A	36	1N2996B	50
1N712A	8.2	1N755A	7.5	1N3020B	10	1N1779A	22	1N1355A	15	1N1827A	39	1N2997B	51
1N713A	9.1	1N756A	8.2	1N3021B	11	1N1780A	24	1N1356A	16	1N1828A	43	1N2998B	52
1N714A	10	1N757A	9.1	1N3022B	12	1N1781A	27	1N1357A	18	1N1829A	47	1N2999B	56
1N715A	11	1N758A	10	1N3023B	13	1N1782A	30	1N1358A	20	1N1830A	51	1N3000B	62
1N716A	12	1N759A	12	1N3024B	15	1N1783A	33	1N1359A	22	1N1831A	56	1N3001B	68
1N717A	13	1N957B	6.8	1N3025B	16	1N1784A	36	1N1360A	24	1N1832A	62	1N3002B	75
1N718A	15	1N958B	7.5	1N3026B	18	1N1785A	39	1N1361A	27	1N1833A	68	1N3003B	82
1N719A	16	1N959B	8.2	1N3027B	20	1N1786A	43	1N1362A	30	1N1834A	75	1N3004B	91
1N720A	18	1N960B	9.1	1N3028B	22	1N1787A	47	1N1363A	33	1N1835A	82	1N3005B	100
1N721A	20	1N961B	10	1N3029B	24	1N1788A	51	1N1364A	36	1N1836A	91	1N3006B	105
1N722A	22	1N962B	11	1N3030B	27	1N1789A	56	1N1365A	39	1N2008A	100	1N3007B	110
1N723A	24	1N963B	12	1N3031B	30	1N1790A	62	1N1366A	43	1N2009A	110	1N3008B	120
1N724A	27	1N964B	13	1N3032B	33	1N1791A	68	1N1367A	47	1N2010A	120	1N3009B	130
1N725A	30	1N965B	15	1N3033B	36	1N1792A	75	1N1368A	51	1N2011A	130	1N3010B	140
1N726A	33	1N966B	16	1N3034B	39	1N1793A	82	1N1369A	56	1N2012A	150	1N3011B	150
1N727A	36	1N967B	18	1N3035B	43	1N1794A	91	1N1370A	62	1N2498A	10	1N3012B	160
1N728A	39	1N968B	20	1N3036B	47	1N1795A	100	1N1371A	68	1N2499A	11	1N3013B	175
1N729A	43	1N969B	22	1N3037B	51	1N1796A	110	1N1372A	75	1N2500A	12	1N3014B	180
1N730A	47	1N970B	24	1N3038B	56	1N1797A	120	1N1373A	82	1N2970B	6.8	1N3015B	200
1N731A	51	1N971B	27	1N3039B	62	1N1798A	130	1N1374A	91	1N2971B	7.5		
1N732A	56	1N972B	30	1N3040B	68	1N1799A	150	1N1375A	91	1N2972B	8.2		
1N733A	62	1N973B	33	1N3041B	75	1N1800A	160	1N1803A	5.6	1N2973B	9.1		
1N734A	68	1N974B	36	1N3042B	82	1N1801A	180	1N1804A	6.2	1N2974B	10		
1N735A	75	1N975B	39	1N3043B	91	1N1802A	200	1N1805A	6.8	1N2975B	11		
1N736A	82	1N976B	43	1N3044B	100			1N1806A	7.5	1N2976B	12		
1N737A	91	1N977B	47	1N3045B	110			1N1807A	8.2	1N2977B	13		
1N738A	100	1N978B	51	1N3046B	120			1N1808A	9.1	1N2978B	14		
1N739A	110	1N979B	56	1N3047B	130			1N1809A	110	1N2979B	15		
1N740A	120	1N980B	62	1N3048B	150			1N1810A	120	1N2980B	16		
1N741A	130	1N981B	68	1N3049B	160			1N1811A	130	1N2981B	17		
1N742A	150	1N982B	75	1N3050B	180			1N1812A	150	1N2982B	18		
1N743A	160	1N983B	82	1N3051B	200			1N1813A	160	1N2983B	19		
1N744A	180	1N984B	91	1N1765A	5.6			1N1814A	180	1N2984B	20		
1N745A	200	1N985B	100	1N1766A	6.2			1N1815A	200	1N2985B	22		
1N762A	5.8	1N986B	110	1N1767A	6.8			1N1816A	13	1N2986B	24		
1N763A	7.1	1N987B	120	1N1768A	7.5			1N1817A	15	1N2987B	25		
1N764A	8.8	1N988B	130	1N1769A	8.2			1N1818A	16	1N2988B	27		
1N765A	10.5	1N989B	150	1N1770A	9.1			1N1819A	18	1N2989B	30		
1N766A	12.8	1N990B	160	1N1771A	10			1N1820A	20	1N2990B	33		
1N767A	15.8	1N991B	180	1N1772A	11			1N1821A	22	1N2991B	36		
1N768A	19	1N992B	200	1N1773A	12			1N1822A	24	1N2992B	39		

VR SERIES ECONOMY ZENER REGULATORS

One watt zener regulators in rugged plastic case, recommended for use in all 1/4, 0.4, 1/2 and 1 watt applications. Add suffix A for $\pm 5\%$ tolerance, B for $\pm 20\%$ ($\pm 10\%$ standard).

S-T No.	Zener Volts*	S-T No.	Zener Volts*	S-T No.	Zener Volts*	S-T No.	Zener Volts*	S-T No.	Zener Volts*
VR6	6	VR14	14	VR33	33	VR80	80	VR130	130
VR7	7	VR18	18	VR39	39	VR90	90	VR150	150
VR8.5	8.5	VR20	20	VR47	47	VR105	105	VR160	160
VR10	10	VR24	24	VR56	56	VR110	110	VR180	180
VR12	12	VR28	28	VR67	67	VR120	120	VR200	200

*Avalanche volts.

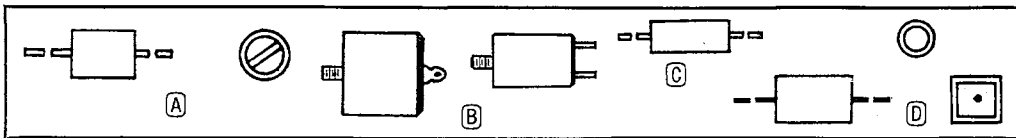

KLIPVOLT TRANSIENT VOLTAGE SUPPRESSORS

Can handle transient peak voltages at least double steady state rating. Non-polarized, AC or DC; polarized, DC only. Higher voltage and 3-ph. models available. Figs. C and D are sealed types.

POLARIZED TYPE

A—Max. DC Blocking Volts, B—Max. Discharge Current (Amps), C—Min. DC Volts, D—Figure.

A	B	C	S-T No.	D	Net Each, Lots of			S-T No.	D	Net Each, Lots of		
					1-9	10-99	100 Up			1-9	10-99	100 Up
22	.250	15	S-235	A	\$0.45	\$0.33	\$0.29	S-235C	C	\$1.01	\$0.73	\$0.65
22	.850	15	S-236	B	.56	.40	.36	S-236C	D	1.87	1.35	1.20
44	.250	23	S-237	A	.49	.36	.31	S-237C	C	1.05	.76	.67
44	.850	23	S-238	B	.62	.45	.40	S-238C	D	1.94	1.40	1.24
66	.250	45	S-239	A	.56	.40	.36	S-239C	C	1.12	.81	.72
66	.850	45	S-240	B	.75	.54	.48	S-240C	D	2.06	1.48	1.32
88	.250	67	S-241	A	.60	.43	.38	S-241C	C	1.16	.82	.74
88	.850	67	S-242	B	.81	.58	.52	S-242C	D	2.12	1.53	1.36
110	.250	89	S-243	A	.64	.46	.41	S-243C	C	1.40	.89	.77
110	.850	89	S-244	B	.88	.63	.56	S-244C	D	2.19	1.57	1.40
132	.250	111	S-245	A	.67	.49	.43	S-245C	C	1.24	.90	.79
132	.850	111	S-246	B	.94	.68	.60	S-246C	D	2.25	1.62	1.44
154	.250	133	S-247	A	.71	.51	.46	S-247C	C	1.27	.92	.80
154	.850	133	S-248	B	1.00	.72	.64	S-248C	D	2.21	1.66	1.48

NON-POLARIZED TYPE

A—Max. rms Volts, B—Max. Discharge Current (Amps), C—Min. rms Volts, D—Figure.

S-T No.	A	B	C	D	Net Each, Lots of		
					1-9	10-99	100 Up
S-249	52	.200	27	A	\$0.52	\$0.38	\$0.34
S-249C	52	.200	27	C	1.09	.78	.70
S-250	52	.700	27	B	.69	.50	.44
S-250C	52	.700	27	D	2.12	1.53	1.36
S-251	78	.200	53	A	.60	.43	.38
S-251C	78	.200	53	C	1.16	.82	.74
S-252	78	.700	53	B	.81	.58	.52
S-252C	78	.700	53	D	2.12	1.53	1.36
S-253	104	.200	79	A	.67	.49	.43
S-253C	104	.200	79	C	1.24	.89	.79

SPRAGUE SEMICONDUCTORS

SEMICONDUCTORS, continued

Type Number	Case Code	Description	Type Number	Case Code	Description	Type Number	Case Code	Description
2N2002	TO-5	PNP Planar Alloy Replacement	2N2334	TO-18	PNP Planar Alloy Replacement	2N2958	TO-5	NPN Si Switch SEPT
2N2003	TO-5	PNP Planar Alloy Replacement	2N2335	TO-18	PNP Planar Alloy Replacement	2N2959	TO-5	NPN Si Switch SEPT
2N2004	TO-5	PNP Planar Alloy Replacement	2N2336	TO-18	PNP Planar Alloy Replacement	2N2968	TO-5	Si Symmetrical SPAT
2N2005	TO-5	PNP Planar Alloy Replacement	2N2337	TO-18	PNP Planar Alloy Replacement	2N2969	TO-18	Si Symmetrical SPAT
2N2006	TO-5	PNP Planar Alloy Replacement	2N2360	TO-12	Ge Amplifier MADT	2N2970	TO-5	Si Symmetrical SPAT
2N2007	TO-5	PNP Planar Alloy Replacement	2N2361	TO-12	Ge Amplifier MADT	2N2971	TO-18	Si Symmetrical SPAT
2N2048	TO-9	ECDC Switch	2N2362	TO-12	Ge Amplifier MADT	2N3058	TO-46	PNP Si Amplifier SEPT
2N2162	TO-5	Si Chopper SPAT	2N2370	TO-5	PNP Planar Alloy Replacement	2N3059	TO-46	PNP Si Amplifier SEPT
2N2163	TO-5	Si Chopper SPAT	2N2371	TO-5	PNP Planar Alloy Replacement	2N3060	TO-46	PNP Si Amplifier SEPT
2N2164	TO-5	Si Chopper SPAT	2N2372	TO-18	PNP Planar Alloy Replacement	2N3061	TO-46	PNP Si Amplifier SEPT
2N2165	TO-5	Si Chopper SPAT	2N2373	TO-18	PNP Planar Alloy Replacement	2N3115	TO-18	NPN Si Switch SEPT
2N2166	TO-5	Si Chopper SPAT	2N2377	TO-18	Si Amplifier SPAT	2N3116	TO-18	NPN Si Switch SEPT
2N2167	TO-5	Si Chopper SPAT	JAN-2N2377	TO-18	Si Amplifier SPAT	2N3133	TO-5	PNP Si Switch SEPT
2N2168	TO-9	Ge Switch MADT	2N2378	TO-18	Si Switch SPAT	2N3134	TO-5	PNP Si Switch SEPT
2N2169	TO-9	Ge Switch MADT	JAN-2N2378	TO-18	Si Switch SPAT	2N3135	TO-18	PNP Si Switch SEPT
2N2170	TO-9	Ge Switch MADT	2N2398	TO-12	Ge Amplifier MADT	2N3136	TO-18	PNP Si Switch SEPT
2N2175	TO-5	PNP Planar Alloy Replacement	2N2399	TO-12	Ge Amplifier MADT	2N3217	TO-46	PNP Si Switch, Amplifier, Chopper SEPT
2N2176	TO-18	PNP Planar Alloy Replacement	2N2400	TO-18	Ge Switch ECDC	2N3218	TO-46	PNP Si Switch, Amplifier, Chopper SEPT
2N2177	TO-5	PNP Planar Alloy Replacement	2N2401	TO-18	Ge Switch ECDC	2N3219	TO-46	PNP Si Switch, Amplifier, Chopper, SEPT
2N2178	TO-18	PNP Planar Alloy Replacement	2N2402	TO-18	Ge Switch ECDC	2N3317	TO-18	Si Chopper SPAT
2N2185	TO-18	Si Chopper SPAT	2N2451	TO-24	Ge Switch MAT	2N3318	TO-18	Si Chopper SPAT
2N2186	TO-18	Si Matched Pair SPAT	2N2453	TO-5	NPN Si Diff. Amp.	2N3319	TO-18	Si Chopper SPAT
2N2187	TO-18	Si Matched Pair SPAT	2N2476	TO-5	NPN Si Switch SEPT	2N3320	TO-18	Ge Switch MADT
2N2217	TO-5	NPN Si Switch SEPT	2N2477	TO-18	NPN Si Switch SEPT	2N3321	TO-18	Ge Switch MADT
2N2218	TO-5	NPN Si Switch SEPT	2N2480	TO-5	NPN Si Diff. Amp.	2N3322	TO-18	Ge Switch MADT
2N2218A	TO-5	NPN Si Switch SEPT	2N2487	TO-18	Ge Switch MADT	2N3342	TO-5	PNP Planar Alloy Replacement
2N2219	TO-5	NPN Si Switch SEPT	2N2488	TO-18	Ge Switch MADT	2N3343	TO-5	PNP Planar Alloy Replacement
2N2219A	TO-5	NPN Si Switch SEPT	2N2489	TO-18	Ge Switch MADT	2N3344	TO-5	PNP Planar Alloy Replacement
2N2220	TO-18	NPN Si Switch SEPT	2N2537	TO-5	NPN Si Switch SEPT	2N3345	TO-5	PNP Planar Alloy Replacement
2N2221	TO-18	NPN Si Switch SEPT	2N2538	TO-5	NPN Si Switch SEPT	2N3346	TO-5	PNP Planar Alloy Replacement
JAN-2N2221	TO-18	MIL-S-19500/225D	2N2539	TO-18	NPN Si Switch SEPT	2N3840	TO-46	PNP Si Switch, Amp., Chopper
JAN-TX2N2221	TO-18	MIL-S-19500/255	2N2540	TO-18	NPN Si Switch SEPT	2N3977	TO-46	PNP Si Switch, Amp., Chopper
2N2221A	TO-18	NPN Si Switch SEPT	2N2795	TO-18	Ge Switch ECDC	2N3978	TO-46	PNP Si Switch, Amp., Chopper
JAN-2N2221A	TO-18	MIL-S-19500/255D	2N2796	TO-18	Ge Switch ECDC	2N3979	TO-46	PNP Si Switch, Amp., Chopper
JAN-TX2N2221A	TO-18	MIL-S-19500/255	2N2845	TO-5	NPN Si Switch SEPT	2N4383	TO-5	NPN Si SEPT Low-Level Amplifier
2N2222	TO-18	NPN Si Switch SEPT	2N2846	TO-18	NPN Si Switch SEPT	2N4384	TO-18	NPN Si SEPT Low-Level Amplifier
JAN-2N2222	TO-18	MIL-S-19500/225D	2N2847	TO-5	NPN Si Switch SEPT	2N4385	TO-5	NPN Si SEPT Low-Level Amplifier
JAN-TX2N2222	TO-18	MIL-S-19500/255	2N2848	TO-18	NPN Si Switch SEPT	2N4386	TO-18	NPN Si SEPT Low-Level Amplifier
2N2222A	TO-18	NPN Si Switch SEPT	2N2904	TO-5	PNP Si Switch SEPT	2N4412	TO-5	PNP Si SEPT Low-Level Amplifier
JAN-2N2222A	TO-18	MIL-S-19500/255D	2N2904A	TO-5	PNP Si Switch SEPT	2N4412A	TO-5	PNP Si SEPT Low-Level Amplifier
JAN-TX2N2222A	TO-18	MIL-S-19500/255	2N2905	TO-5	PNP Si Switch SEPT	2N4413	TO-18	PNP Si SEPT Low-Level Amplifier
2N2274	TO-18	Si Chopper SPAT	2N2905A	TO-5	PNP Si Switch SEPT	2N4413A	TO-18	PNP Si SEPT Low-Level Amplifier
2N2275	TO-18	Si Matched Pair SPAT	2N2906	TO-18	PNP Si Switch SEPT	2N4414	TO-5	PNP Si SEPT Low-Level Amplifier
2N2276	TO-18	Si Chopper SPAT	2N2906A	TO-18	PNP Si Switch SEPT	2N4414A	TO-5	PNP Si SEPT Low-Level Amplifier
2N2277	TO-18	Si Matched Pair SPAT	2N2907	TO-18	PNP Si Switch SEPT	2N4415	TO-18	PNP Si SEPT Low-Level Amplifier
2N2278	TO-18	Si Chopper SPAT	2N2907A	TO-18	PNP Si Switch SEPT	2N4415A	TO-18	PNP Si SEPT Low-Level Amplifier
2N2279	TO-18	Si Matched Pair SPAT	2N2944	TO-46	PNP SEPT Switch, Amp., Chopper			
2N2280	TO-18	Si Chopper SPAT	2N2945	TO-46	PNP SEPT Switch, Amp., Chopper			
2N2281	TO-18	Si Matched Pair SPAT	2N2946	TO-46	PNP SEPT Switch, Amp., Chopper			
2N2330	TO-5	NPN Si Chopper SEPT	2N2951	TO-5	NPN Si Amplifier SEPT			
2N2331	TO-18	NPN Si Chopper SEPT	2N2952	TO-18	NPN Si Amplifier SEPT			
2N2332	TO-18	PNP Planar Alloy Replacement						
2N2333	TO-18	PNP Planar Alloy Replacement						

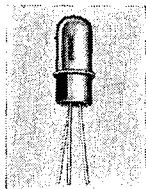

TO-24

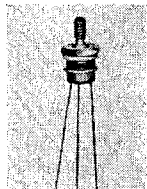

TO-31



TO-46

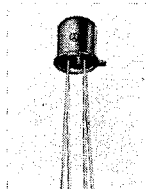

TO-72



S-31



RECTIFIERS

are grouped by half wave average current ratings. Ratings shown apply at case temperatures indicated. All surge ratings are peak one-half cycle currents at 60 cps. Surge ratings apply from full load. Voltage ratings

shown are repetitive peak reverse maximum values. Most units have somewhat higher transient ratings. Reverse polarity JEDEC types are designated "R". On non-JEDEC types, the second listing designates reverse polarity where available.

LOW POWER

AA A B C FF

	AA 1.5 AMPS	A 1.5 AMPS	B .75 AMPS	B 1.6 AMPS	C 1.0 AMPS	FF 3.0 AMPS
	@ 40°C Amb. 50A surge	@ 40°C Amb. 50A surge	@ 50°C Amb. *35°C, †30°C •.6A @ 30°C 15A surge	@ 140°C case 25A surge	50°C Amb. 35A surge T _{rr} = 100ns	@ 50°C Amb. 200A surge
Ⓢ Type	359		380	380	388	
VOLTS						
50	1N5390	1N4816	1N536	1N1217B	388A	1N5400
100	1N5391	1N4817	1N537	1N1218B	388B	1N5401
150	1N5392	1N1219B	388C	1N5402
200	1N5393	1N4818	1N538	1N1220B	388D	1N5403
300	1N5394	1N4819	1N539	1N1221B	388F	1N5404
400	1N5395	1N4820	1N540	1N1222B	388H	1N5405
500	1N5396	1N4821	*1N1095	1N1223B	388K	1N5406
600	1N5397	1N4822	†1N1096	1N1224B	388M	1N5407
600	1N547
700	1N5398	1N5052	1N1225B	1N5408
800	1N5399	1N5053	•1N560	1N1226B	1N5409
1000	1N5400	1N5054	•1N561	1N1443B	1N5410
DATA SHEET REFERENCE	T.D. 54-171 pg. 1-2	T.D. 54-161 pg. 3-4	T.D. 54-161 pg. 5-6	T.D. 54-161 pg. 1-2	T.D. 54-161 pg. 9-10	T.D. 54-171 pg. 3-4

MEDIUM POWER

D E

	D 5 AMPS	D 6 AMPS	D 12 AMPS	D 15 AMPS	E 15 AMPS
@ T _{case} I _{surge}	150°C 25A	150°C 150A	150°C 240A	125°C 200A	150°C 250A
Ⓢ Type	441, 446	404, 437	368	703
VOLTS					
50	1N1612	1N1341A, AR	1N1199A, B, AR, BR	368A	703A, AR
100	1N1613	1N1342A, AR	1N1200A, B, AR, BR	368B	703B, BR
150	1N1343A, AR	1N1201A, B, AR, BR	368C	703C, CR
200	1N1614	1N1344A, AR	1N1202A, B, AR, BR	368D	703D, DR
300	1N1345A, AR	1N1203A, B, AR, BR	368F	703F, FR
400	1N1615	1N1346A, AR	1N1204A, B, AR, BR	368H
500	1N1347A, AR	1N1205A, B, AR, BR	368K
600	1N1616	1N1348A, AR	1N1206A, B, AR, BR	368M
700	1N3987, R, AR	1N3670, R, AR
800	1N3988, R, AR	1N3671, R, AR
900	1N3989, R, AR	1N3762, R, AR
1000	1N3990, R, AR	1N3673, R, AR
DATA SHEET REFERENCE	T.D. 54-162 pg. 9-10	T.D. 54-162 pg. 11-12	T.D. 54-172 pg. 5-6	T.D. 54-163 pg. 5-6

MEDIUM POWER

G

	G 18 AMPS	G 20 AMPS	G 25 AMPS	G 35 AMPS	G 40 AMPS	G 70 AMPS
@ T _{case} I _{surge}	145°C 220A	150°C 250A	150°C 400A	140°C 500A	150°C 1000A	100°C 1000A
Ⓢ Type	303,336	302, 335	402, 435	416
VOLTS						
50	1N1191, R	1N248, A, B	1N2154, R	1N1183, R	1N1183A, AR	416A, AR
100	1N1192, R	1N249, A, B	1N2155, R	1N1184, R	1N1184A, AR	416B, BR
150	1N1193, R	1N1185, R	1N1185A, AR	416C, CR
200	1N1194, R	1N250, A, B	1N2156, R	1N1186, R	1N1186A, AR	1N4136, R
300	1N1195, R	1N2157, R	1N1187, R	1N1187A, AR	416F, FR
400	1N1196, R	1N2135A	1N2158, R	1N1188, R	1N1188A, AR	1N4137, R
500	1N1197, R	1N2159, R	1N1189, R	1N1189A, AR	416K, KR
600	1N1198, R	1N2160, R	1N1190, R	1N1190A, AR	1N4138, R
700	1N3765	416P, PR
800	1N3766	416S, SR
900	1N3767	416V, VR
1000	1N3768	416Z, ZR
DATA SHEET REFERENCE	T.D. 54-163 pg. 1-2	T.D. 54-164 pg. 1-2	T.D. 54-164 pg. 3-4

BOLD FACE LISTINGS MILITARY TYPES AVAILABLE.



HIGH VOLTAGE SILICON RECTIFIER ASSEMBLIES

Voltage Ratings to 208 KV in a single channel. Three Phase Current Ratings to 510 Amperes. Westinghouse Silicon Rectifier Stacks have proven their outstanding reliability in over 50 million stack hours of failure free operation. Each cell is shunted with a capacitor and resistor which provide the optimum in steady state and transient voltage division. The design of the stack provides for cooling by oil, free or

forced air convection and vapor atmospheres. Where required, assemblies can be supplied with mil-type capacitors and resistors which combined with the high temperature characteristics of the hermetically sealed silicon rectifier cells, allows operation in ambients up to 110°C. Use of these stacks in place of vacuum tubes will increase equipment efficiency by as much as 25%.

Listed are maximum voltage and currents for single assemblies. Stacks can be combined in series or parallel.

PRV	1 ϕ FW I_{DC}	3 ϕ FW I_{DC}
208K	3.0	4.5
83.2K	12.0	18.0
83.2K	19.0	28.5
41.6K	31.0	46.5
14K	112.0	168.0
21K	210.0	315.0

Ratings are based on forced air cooling of 1000 fpm at 25°C ambient.

Oil cooling will increase ratings.

Assemblies are designed to meet most standard military environmental conditions.

For very high voltage applications, corona shielding is available. Where voltage will allow, entire rectifier assemblies can be packaged in one channel.

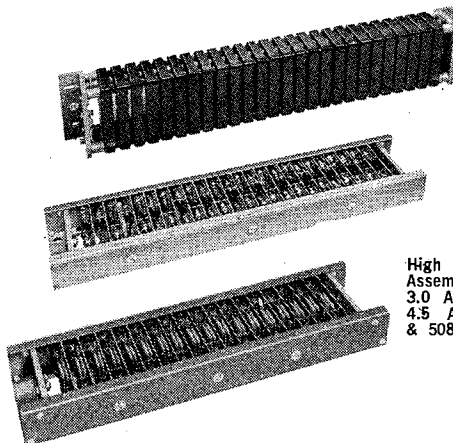

Encapsulated Silicon Rectifier Assembly. Single phase up to 3.0 Amps, three phase up to 4.5 Amps, 208 KV. 5090915 Series.

High Voltage Rectifier Assembly. Single phase up to 22 Amps, three phase up to 33 Amps, 83.2 KV. 508C686 Series.

High Voltage Silicon Rectifier Assembly. Single phase up to 3.0 Amps, three phase up to 4.5 Amps, 208 KV. 508C686 & 508C695 Series.

TRANSISTORS

ALLOY "OEM" TRANSISTORS

The Westinghouse "OEM Line" of economically priced transistors are designed expressly to meet the needs of original equipment manufacturers of commercial, electronic and control ap-

paratus. Their low saturation resistance, high collector voltage and high temperature characteristics make them ideally suited for use in regulators, power supplies, inverters and ignition systems.

	6 AMPS "OEM"		7.5 AMPS "OEM"		20 AMPS "OEM"	
Ⓢ Type	151	152	153	154	163	164
@ $I_C =$	1.5A	1.5A	1.5A	1.5A	5A	5A
$h_{FE} \text{ min}$	11	18	15	25	15	25
$R_{SAT} \text{ max}$	0.86 Ω	0.83 Ω	0.86 Ω	0.83 Ω	0.22 Ω	0.20 Ω
$f_{Tkc} \text{ (typ)}$	250	250	250	250	200	200
V_{CE}						
40	151-04	152-04	153-04	154-04	163-04	164-04
60	151-06	152-06	153-06	154-06	163-06	164-06
80	151-08	152-08	153-08	154-08	163-08	164-08
100	151-10	152-10	153-10	154-10	163-10	164-10
120	151-12	152-12	153-12	154-12	163-12	164-12
140	151-14	152-14	153-14	154-14	163-14	164-14
160	151-16	152-16	153-16	154-16	163-16	164-16
180	151-18	152-18	153-18	154-18	163-18	164-18
200	151-20	152-20	153-20	154-20	163-20	164-20
220	151-22	152-22	153-22	154-22	163-22	164-22
240	151-24	152-24	153-24	154-24	163-24	164-24
260	151-26	152-26	153-26	154-26	163-26	164-26
280	151-28	152-28	153-28	154-28	163-28	164-28
300	151-30	152-30	153-30	154-30	163-30	164-30
MAXIMUM RATINGS	$V_{EB} = 25V, I_B = 3A$ $T_j = -65^\circ \text{ to } +150^\circ$ $PD = 100W @ 80^\circ \text{ case}$ $R_{THERMAL} = 0.7^\circ C/Watt$		$V_{EB} = 15V, I_B = 3A$ $T_j = -65^\circ \text{ to } +175^\circ$ $PD = 200W @ 25^\circ \text{ case}$ $R_{THERMAL} = 0.75^\circ C/Watt$		$V_{EB} = 15V, I_B = 7.5A$ $T_j = -65^\circ \text{ to } +175^\circ$ $PD = 200W @ 75^\circ \text{ case}$ $R_{THERMAL} = 0.5^\circ C/Watt$	
DATA SHEET REFERENCE	T.D. 54-672 pg. 1-2		T.D. 54-672 pg. 3-4		T.D. 54-672 pg. 5-6	

SILICON DIFFUSED "OEM" TRANSISTORS

Ⓢ Type 156						
JEDEC	I_{Cmax}	V_{CE}	$P_C @ T_C = 25^\circ C$	$h_{FE} @ I_C$	$R_{CE} @ I_C$	
2N3055	15A	60V	115W	20 @ 4A	.275 Ω @ 4A	
2N3232	7.5A	60V	117W	18 @ 3A	.83 Ω @ 3A	
2N3233	7.5A	100V	117W	18 @ 3A	.83 Ω @ 3A	
2N3234	7.5A	160V	117W	18 @ 3A	.83 Ω @ 3A	
2N3235	15A	55V	117W	20 @ 4A	.275 Ω @ 4A	
2N3442	10A	140V	117W	20 @ 3A	.33 Ω @ 3A	
Ⓢ Type 158						
2N3236	15A	90V	150W	17 @ 5A	.22 Ω @ 5A	
2N3237	20A	75V	200W	12 @ 10A	.20 Ω @ 10A	
2N3238	15A	80V	150W	8.5 @ 10A	.33 Ω @ 10A	
2N3239	15A	80V	150W	8.5 @ 10A	.1 Ω @ 10A	
2N3240	15A	160V	150W	8.5 @ 10A	.1 Ω @ 10A	
2N3771	30A	40V	150W	15 @ 15A	.13 Ω @ 15A	
2N3772	30A	60V	150W	15 @ 10A	.14 Ω @ 10A	
2N3773	30A	140V	150W	15 @ 8A	.175 Ω @ 8A	

ALCOSWITCH

DIV. OF ALCO ELECTRONIC PRODUCTS, INC.

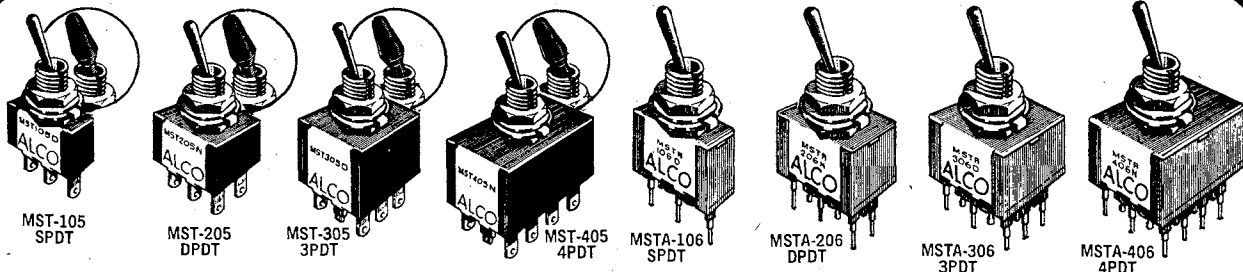

The original Alcoswitch Series of high quality ultra-miniature toggle switches combines high current capacity and long life in a 1/2" case. Slim, bat handle or optional plastic caps(*) are provided. Terminals and contacts are solid silver. Case material is black phenolic resin; 1/4-40 threaded bushing. Rated 5 amps at 115 VAC. SPDT and DPDT types have life cycle of over 80,000 on-off operations. High voltage barriers between terminals and contacts. Rated 5 amps @ 115 VAC.

Model	Contacts	Description	One-24	25-99	100-499	500-999
MST-115D*	SPDT	On-None-On	1.70	1.16	1.02	.85
MST-105D	SPDT	On-None-On	1.65	1.12	.99	.83
MST-105E	SPDT	On-Off-On	1.95	1.33	1.17	.975
MST-105G	SPDT	None-On-(On)	1.95	1.33	1.17	.975
MST-105H	SPDT	(On)-Off-(On)	1.95	1.33	1.17	.975
MST-105H	SPDT	On-Off-On	1.95	1.33	1.17	.975
MST-215N*	DPDT	On-None-On	2.20	1.47	1.32	1.10
MST-205N	DPDT	On-None-On	2.15	1.43	1.29	1.08
MST-205P	DPDT	On-Off-On	2.55	1.72	1.53	1.28
MST-205R	DPDT	None-On-(On)	2.55	1.72	1.53	1.28
MST-205S	DPDT	(On)-Off-(On)	2.55	1.72	1.53	1.28
MST-205T	DPDT	On-Off-On	2.55	1.72	1.53	1.28
MST-205PA	DP3T	On-On-On	2.85	1.90	1.71	1.42
MST-205TA	DP3T	On-On-(On)	3.15	2.14	1.89	1.58
MST-205SA	DP3T	(On)-On-(On)	3.15	2.14	1.89	1.58
MST-315D*	3PDT	On-None-On	3.90	2.61	2.34	1.95
MST-305D	3PDT	On-None-On	3.85	2.57	2.31	1.925
MST-305E	3PDT	On-Off-On	4.15	2.82	2.49	2.075
MST-305F	3PDT	None-On-On	4.15	2.82	2.49	2.075
MST-305H	3PDT	On-Off-(On)	4.15	2.82	2.49	2.075
MST-415N*	4PDT	On-None-On	4.90	3.33	2.94	2.45
MST-405N	4PDT	On-None-On	4.85	3.29	2.91	2.43
MST-405P	4PDT	On-Off-On	5.35	3.64	3.21	2.68

Hardware supplied mounted. (On) Indicates momentary positions.

This new Alcoswitch Series fills a need for those who want the best product possible at an optimum price. Similar in appearance and specs to the Alco "E" Series but without the waterproof feature. Has the important features wanted in a good miniature: turret terminals, extra-wide contacts, heavier current capabilities, low-loss, high heat and high impact case construction. "No Tear" shoulder on bushing. Overall dimension allows use in tight quarters. Rated 6 amps @ 125 VAC.

Model	Contacts	Description	One-24	25-99	100-499	500-999
MSTA-106D	SPDT	On-None-On	1.80	1.23	1.08	.90
MSTA-106E	SPDT	On-Off-On	2.25	1.53	1.35	1.125
MSTA-206N	DPDT	On-None-On	2.35	1.60	1.41	1.18
MSTA-206P	DPDT	On-Off-On	2.85	1.90	1.71	1.42
MSTA-206PA	DP3P	On-On-On	3.15	2.14	1.89	1.58
MSTA-306D	3PDT	On-None-On	4.05	2.75	2.43	2.03
MSTA-306E	3PDT	On-Off-On	4.45	3.03	2.67	2.23
MSTA-406N	4PDT	On-None-On	5.10	3.47	3.06	2.55
MSTA-406P	4PDT	On-Off-On	5.65	3.84	3.39	2.83
MSTA-406PA	4P3T	On-On-On	6.15	4.18	3.69	3.08

C-10* Plastic cap for MST, A, E Series — .028 .025 .022
 C-17* Flat top cap for MST, A, E Series — .028 .025 .022
 N-1A* 1/4-40 "Perfect Fit" Nut — .04 .036 .033

*Packaged in multiples of 25; when ordering caps specify red, white, black, blue, gray, green, yellow or pink.

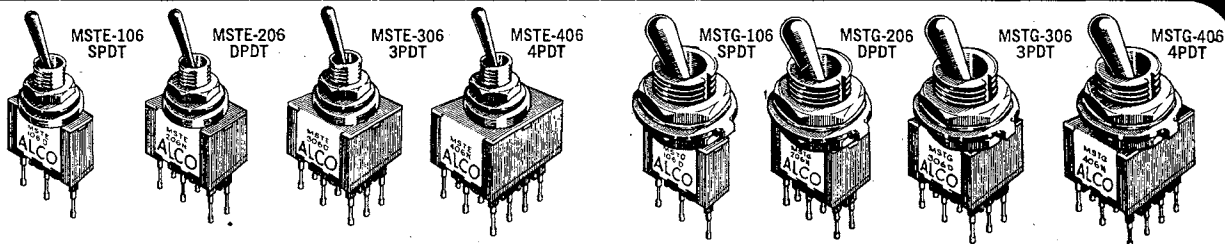

The new "E" Series has the most-wanted features in miniature switches. Waterproof "O" rings are located inside the toggle and on the shoulder. A mechanical shoulder on the bottom of the bushing prevents "tear-offs" when a single mounting nut is employed. High voltage barriers between terminals inside as well as outside. Case has a new, superior plastic material capable of withstanding a higher impact; guards against accidental damage. Low-loss case has extremely high resistance between terminals and case ground, and its high temperature coefficient is ideally suited for prolonged soldering and printed circuits. Turret type terminals are used for simplified wiring or for P.C. Extra-wide, solid silver contacts are bonded, not riveted, on copper-silver plated terminals. Long-life cycle over 100,000 On-Off operations at operating conditions (SPDT). Rated 6 amps @ 125 VAC.

Model	Contacts	Description	One-24	25-99	100-499	500-999
MSTE-106D	SPDT	On-None-On	1.95	1.33	1.17	.975
MSTE-106E	SPDT	On-Off-On	2.55	1.72	1.53	1.28
MSTE-206N	DPDT	On-None-On	2.55	1.72	1.53	1.28
MSTE-206P	DPDT	On-Off-On	3.15	2.14	1.89	1.58
MSTE-206PA	DP3T	On-On-On	3.45	2.35	2.07	1.73
MSTE-306D	3PDT	On-None-On	4.25	2.89	2.55	2.13
MSTE-306E	3PDT	On-Off-On	4.75	3.23	2.85	2.38
MSTE-406N	4PDT	On-None-On	5.35	3.64	3.21	2.68
MSTE-406P	4PDT	On-Off-On	5.95	4.05	3.57	2.98

Hardware supplied mounted.
 Color-coded caps: see "A" Series story above.



The Mustang Series is for designers who prefer the feel of a larger toggle switch but have space limitations behind today's compact panel. The familiar ultra-miniature Alcoswitch 1/2" case is utilized, however the Mustang mounting requirements are the same as the larger switches with 1/32" bushings. This new Alcoswitch concept is a behind-the-panel space-saver in all Mustang models and it is especially true in the 3 Pole and 4 Pole Series where non-miniature switches are bulky in size. The Mustang switches have the most-wanted features as itemized in the "E" Series story (at left) with the exception of the waterproof "O" rings. The case construction is of low-loss, high impact and high temperature materials with turret terminals and bonded silver contacts. Rated 6 amps @ 125 VAC.

Model	Contacts	Description	One-24	25-99	100-499	500-999
MSTG-106D	SPDT	On-None-On	2.15	1.43	1.29	1.08
MSTG-106E	SPDT	On-Off-On	2.75	1.87	1.65	1.38
MSTG-206N	DPDT	On-None-On	2.75	1.87	1.65	1.38
MSTG-206P	DPDT	On-Off-On	3.35	2.28	2.01	1.68
MSTG-206PA	DP3T	On-On-On	3.65	2.48	2.19	1.83
MSTG-306D	3PDT	On-None-On	4.45	3.03	2.67	2.23
MSTG-306E	3PDT	On-Off-On	4.95	3.37	2.97	2.48
MSTG-406N	4PDT	On-None-On	5.55	3.77	3.33	2.78
MSTG-406P	4PDT	On-Off-On	6.15	4.18	3.69	3.08

C-15* Plastic cap for Mustang Series — .04 .036 .033
 N-1B* 15/32" "Perfect Fit" Nut — .056 .05 .044
 *Packaged in multiples of 25; when ordering caps specify red, white, black, blue or gray.

ALCO ELECTRONIC PRODUCTS, INC.

AMPHENOL RF SWITCHES



AMPHENOL

Series 360 DYNAFORM FUNCTIONS AND PART NUMBERS

Conn.	Term.	Schematic	Coil Volts	SPDT Outline Dwg. A	SPDT Outline Dwg. B	DPDT Outline Dwg. C	DPDT Outline Dwg. D	Transfer Outline Dwg. E
BNC	SH	1	26 DC	360-11891-12	360-11891-13	360-11896-12	360-11896-13	
			110 DC	360-11891-34	360-11891-35	360-11896-34	360-11896-35	
			115 AC	360-11891-45	360-11891-46	360-11896-45	360-11896-46	
	NS	2	26 DC	360-11891-14	360-11891-15	360-11896-14	360-11896-15	
			110 DC	360-11891-36	360-11891-37	360-11896-36	360-11896-37	
			115 AC	360-11891-47	360-11891-48	360-11896-47	360-11896-48	
	50 Ω RT	3	26 DC	360-11891-16	360-11891-17	360-11896-16	360-11896-17	
			110 DC	360-11891-38	360-11891-39	360-11896-38	360-11896-39	
			115 AC	360-11891-49	360-11891-50	360-11896-49	360-11896-50	
	75 Ω RT	3	26 DC	360-11891-18	360-11891-19	360-11896-18	360-11896-19	
			110 DC	360-11891-40	360-11891-41	360-11896-40	360-11896-41	
			115 AC	360-11891-51	360-11891-52	360-11896-51	360-11896-52	
95 Ω RT	3	26 DC	360-11891-20	360-11891-21	360-11896-20	360-11896-21		
		110 DC	360-11891-42	360-11891-43	360-11896-42	360-11896-43		
		115 AC	360-11891-53	360-11891-54	360-11896-53	360-11896-54		
TRANS	4	26 DC					360-11891-22	
		110 DC					360-11891-44	
		115 AC					360-11891-55	
TNC	SH	1	26 DC	360-11892-12	360-11892-13	360-11897-12	360-11897-13	
			110 DC	360-11892-34	360-11892-35	360-11897-34	360-11897-35	
			115 AC	360-11892-45	360-11892-46	360-11897-45	360-11897-46	
	NS	2	26 DC	360-11892-14	360-11892-15	360-11897-14	360-11897-15	
			110 DC	360-11892-36	360-11892-37	360-11897-36	360-11897-37	
			115 AC	360-11892-47	360-11892-48	360-11897-47	360-11897-48	
	50 Ω RT	3	26 DC	360-11892-16	360-11892-17	360-11897-16	360-11897-17	
			110 DC	360-11892-38	360-11892-39	360-11897-38	360-11897-39	
			115 AC	360-11892-49	360-11892-50	360-11897-49	360-11897-50	
	75 Ω RT	3	26 DC	360-11892-18	360-11892-19	360-11897-18	360-11897-19	
			110 DC	360-11892-40	360-11892-41	360-11897-40	360-11897-41	
			115 AC	360-11892-51	360-11892-52	360-11897-51	360-11897-52	
95 Ω RT	3	26 DC	360-11892-20	360-11892-21	360-11897-20	360-11897-21		
		110 DC	360-11892-42	360-11892-43	360-11897-42	360-11897-43		
		115 AC	360-11892-53	360-11892-54	360-11897-53	360-11897-54		
TRANS	4	26 DC					360-11892-22	
		110 DC					360-11892-44	
		115 AC					360-11892-55	
N	SH	1	26 DC	360-11890-12	360-11890-13	360-11895-12	360-11895-13	
			110 DC	360-11890-34	360-11890-35	360-11895-34	360-11895-35	
			115 AC	360-11890-45	360-11890-46	360-11895-45	360-11895-46	
	NS	2	26 DC	360-11890-14	360-11890-15	360-11895-14	360-11895-15	
			110 DC	360-11890-36	360-11890-37	360-11895-36	360-11895-37	
			115 AC	360-11890-47	360-11890-48	360-11895-47	360-11895-48	
	50 Ω RT	3	26 DC	360-11890-16	360-11890-17	360-11895-16	360-11895-17	
			110 DC	360-11890-38	360-11890-39	360-11895-38	360-11895-39	
			115 AC	360-11890-49	360-11890-50	360-11895-49	360-11895-50	
	75 Ω RT	3	26 DC	360-11890-18	360-11890-19	360-11895-18	360-11895-19	
			110 DC	360-11890-40	360-11890-41	360-11895-40	360-11895-41	
			115 AC	360-11890-51	360-11890-52	360-11895-51	360-11895-52	
95 Ω RT	3	26 DC	360-11890-20	360-11890-21	360-11895-20	360-11895-21		
		110 DC	360-11890-42	360-11890-43	360-11895-42	360-11895-43		
		115 AC	360-11890-53	360-11890-54	360-11895-53	360-11895-54		
TRANS	4	26 DC					360-11890-22	
		110 DC					360-11890-44	
		115 AC					360-11890-55	

COIL CHARACTERISTICS	Nominal Voltage		Operating Range		Resistance, ohms ±10%	
	26 DC		20 - 32		260 ohms	
	110 DC		85 - 130		5100 ohms	
	115 AC (50 - 400 Hz)		90 - 130		1500 ohms thru diodes	

ELECTRICAL CHARACTERISTICS

Conn.	Term.	Typical VSWR (Frequency Gc)								Typical Crosstalk - db (Frequency Gc)							
		.03	0.2	0.4	1.0	2.0	4.0	6.0	8.0	.03	0.2	0.4	1.0	2.0	4.0	6.0	8.0
BNC	SH	1.03	1.06	1.08	1.10	1.20	1.25	1.30	1.35	70	66	60	53	42	35	25	15
	NS	1.03	1.06	1.08	1.10	1.21	1.27	1.31	1.35	68	64	58	51	40	33	22	15
	50 Ω RT	1.03	1.06	1.08	1.14	1.25	1.50	—	—	40	35	31	24	17	14	—	—
	75 Ω RT	1.03	1.06	1.08	1.14	1.25	1.50	—	—	40	35	31	24	17	14	—	—
	95 Ω RT	1.03	1.06	1.08	1.14	1.25	1.50	—	—	40	35	31	24	17	14	—	—
TRANS	1.05	1.08	1.10	1.20	1.50	—	—	—	45	38	32	24	17	—	—	—	
TNC	SH	1.03	1.06	1.08	1.10	1.20	1.25	1.30	1.35	70	66	60	53	42	35	25	15
	NS	1.03	1.06	1.08	1.10	1.21	1.27	1.31	1.35	68	64	58	51	40	33	22	15
	50 Ω RT	1.03	1.06	1.08	1.14	1.25	1.50	—	—	40	35	31	24	17	14	—	—
	75 Ω RT	1.03	1.06	1.08	1.14	1.25	1.50	—	—	40	35	31	24	17	14	—	—
	95 Ω RT	1.03	1.06	1.08	1.14	1.25	1.50	—	—	40	35	31	24	17	14	—	—
TRANS	1.05	1.08	1.10	1.20	1.50	—	—	—	45	38	32	24	17	—	—	—	
N	SH	1.03	1.04	1.07	1.10	1.15	1.18	1.20	1.25	70	66	60	53	42	35	25	15
	NS	1.03	1.04	1.07	1.10	1.17	1.20	1.22	1.25	68	64	58	51	40	33	22	15
	50 Ω RT	1.03	1.05	1.08	1.12	1.18	1.50	—	—	41	35	31	24	17	14	—	—
	75 Ω RT	1.03	1.05	1.08	1.12	1.18	1.50	—	—	39	32	30	23	16	14	—	—
	95 Ω RT	1.03	1.05	1.08	1.12	1.18	1.50	—	—	37	31	29	22	15	14	—	—
TRANS	1.05	1.10	1.15	1.20	1.50	—	—	—	45	38	32	24	17	—	—	—	

SCHEMATICS

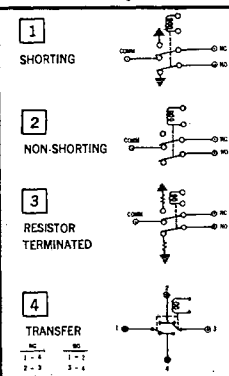

A SPDT

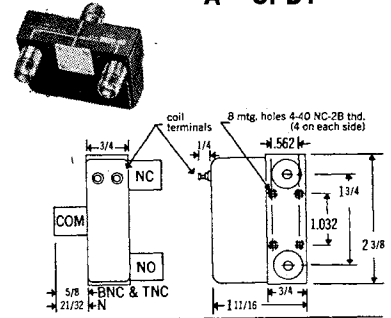

B SPDT

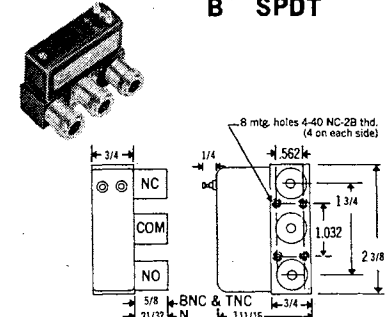

C DPDT

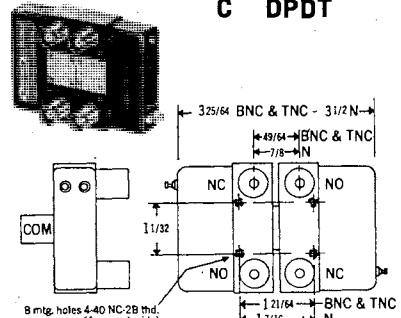

D DPDT

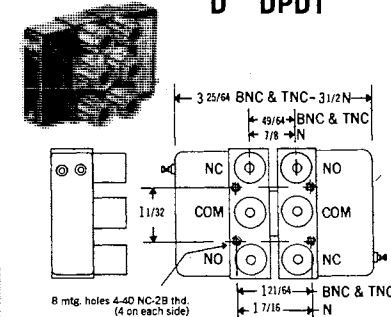

E TRANSFER

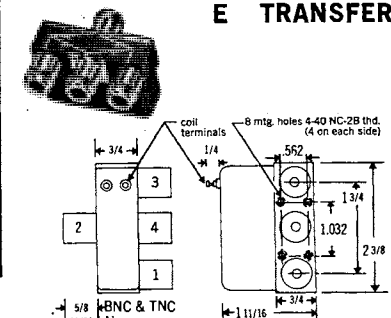

NOTE: High frequency electrical characteristics are typical values (not maximum) as measured in a 50 ohm circuit and may be used for most design analyses. For more exacting applications, maximum values in the frequency range may be obtained upon request. SWR measured to common with a matched 50 ohm termination. For additional specifications request Amphenol RF Switches Catalog SS-1.

PRICES

All prices listed in The MASTER are subject to change without notice — they should not be considered final.

Get quick-on-the-spot quotations from your distributor who subscribes to the up-to-the-minute

UNITED *Pricing Reports*

The Perpetual Pricing System for Electronic Parts and Equipment



- Over 750 manufacturers
- Over 400,000 catalog numbers tabulated with current prices
- Revised pages mailed semi-weekly: insert new pages—discard old pages
- Compression type loose-leaf binder for rapid replacement of revised pages
- Weekly summary sheet—Ups, Downs, Additions, Deletions

For complete details and subscription rates write to:



UNITED PRICING REPORTS

A UNITED TECHNICAL PUBLICATION

645 STEWART AVENUE, GARDEN CITY, N. Y. 11530

DELIVERY

Delivery is often dependent on availability of raw materials. Check with your distributor for delivery information at the time you place your order.

Buss® and Fusetron® Fuses, Holders

SERIES HLD PANEL-MOUNTING VISUAL INDICATING FUSEHOLDER



For 1/4" x 1 1/4" GBA fuse. Transparent knob permits bright red dot to be seen readily if fuse is open. Knob grips fuse tightly; when removed, pulls fuse from holder. Knob also interchangeable with that of HKP fuseholder for easy conversion. Supplied with washer and nut. Locking keys available without charge: 1/16" lg. for panels up to 1/8" thick; 3/16" lg. for thicker panels. Specify length desired.

Buss No.	Description	Net Price For	
		Ten	100
HLD	Complete holder	\$4.30	\$36.00
HLD	Knob only No. 5487	2.00	17.00

VISUAL INDICATING FUSE



For use with HLD fuseholder. Bright red dot on indicating pin extends from end of fuse when fuse is open even after power is off. Rated 125 V or less, carries 110%, opens at 135% in 1 hour or less. Only 1/4" x 1 1/4".

Buss No.	Amperes	Net Price For	
		Five	100
GBA	3/4	\$2.45	\$41.00
GBA	1, 1 1/2, 2, 3, 4, 5	1.90	32.00

PANEL MOUNTED FUSEHOLDERS BAYONET KNOB TYPE



Side terminal held with solder and mechanically. Knob grips fuse tightly; pulls it from holder when knob is removed. Terminals designed to withstand severe service. Molded black phenolic body with flat spot for lock against rotation when used in punched hole; permits use of locking key in drilled holes. May be used in panels up to 3/16" thick. Locking keys available; specify 1/16" or 3/32" length. U/L Approved.

Buss No.	For Fuse Size, In.	Amps	Volts	Net Price For	
				Ten	100
HJM	1/4 x 1	5	125	\$4.00	\$33.00
HKP	3/4 x 1 1/4	15	250	4.00	33.00

SHIELDED FUSEHOLDERS

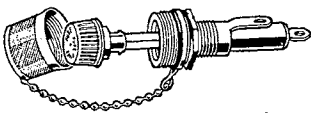

Prevents RFI from reaching fuse and nearby circuits. Metal cap covers bayonet type knob. To shield and ground holder, a threaded metal collar fits over holder body; metal cap threads on collar. Collar grounds on metal panel when mounting nut is tight. Carrying capacity 30 amps, 250 volts or less. Meets MIL-1-6181D and MIL-F-19207B specifications.

Buss No.	For Fuse Size, In.	Net Price Each	
		One	10 Up
HMR	1/4 x 1 1/4	\$4.50	\$3.75
HMS	3/4 x 1	4.50	3.75

HIGH VOLTAGE FUSES

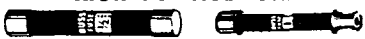

Designed for protection of circuits up to 20 kW on DC and 30 kVA on AC.

Buss No.	Amperes	V	Net Price For	
			Ten	100
HVA	3/8, 1/2, 3/4, 1, 1 1/2, 2	1000	\$ 2.50	\$21.00
HVB	1/2, 3/4, 1, 1 1/2, 2	2500	3.50	29.00
HVJ	1/2, 3/4, 1, 1 1/2, 2	5000	6.30	53.00
HVL	1/8, 1/4, 1/2, 3/4, 1, 1 1/2, 2	10K	12.70	106.00

HIGH INTERRUPTING CAPACITY FUSES



Type KTK—For use on circuits as high as 100,000 amps at 600 volts or less, AC only. Glass fiber melamine tubes and sand filler surrounding a silver fuse element. Amperes: 1/10, 1/8, 2/10, 1/4, 3/10, 1/2, 3/4, 1, 1 1/2, 2, 3, 4, 5, 6, 8, 10, 15, 20, 25 or 30. Lot of 10, Net \$10.20 Lot 100, Net \$85.00

INDICATING FUSETRON FUSES



Similar to FNM types. Indicating pin extends from fuse when fuse blows. Use in signal fuse block or HPC-C fuseholder (larger than 10 amps units cannot be used in HPC-C). U/L Approved in 0-15 amp sizes.

Buss No.	Amperes	Net Price For	
		Ten	100
FNA	1/10, 15/100, 2/10, 3/10, 4/10, 1/2, 6/10, 8/10, 1, 1 1/2, 1 3/4, 1-4/10, 1-6/10, 1-8/10, 2, 2 1/2, 2 3/4, 2-8/10, 3, 3-2/10, 3 1/2, 4, 4 1/2, 5, 5-6/10, 6, 6 1/2, 7, 8, 10	\$5.80	\$49.00
	12, 15, 20, 25, 30	6.60	55.00

INDICATING, LAMINATED TUBE FUSES



Red button on indicating pin extends from end of fuse when fuse is blown. Units are built in accordance with Navy Specifications. These units may be used in Buss HPC-C fuseholders. Voltage, (1-15 amps), 250, others, 125 V.

Buss No.	Amperes	Net Price For	
		Ten	100
MIN	1, 2, 3, 5, 10, 15, 20, 25, 30	\$3.80	\$32.00

SIGNAL OR VISUAL INDICATING FUSES

MIC fuses have silver-plated indicating pin. Pin may be used as visual indicator or may be used to actuate a signal. MIJ fuses are similar to MIC types except they have been specially designed for complex circuitry as in computers. Voltage, 250 except 20 amps and over which are 32 V.

Buss No.	Amperes	Net Price For	
		Ten	100
MIC	1, 2, 3, 5, 10, 15, 20, 25, 30	\$4.40	\$37.00
MIJ	1, 2, 3, 5, 10, 15, 20, 25, 30	4.90	41.00

SCREW-IN KNOB TYPE FUSEHOLDERS

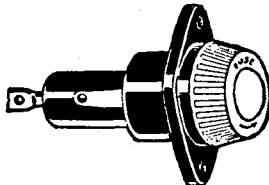

Attaches to panel with screws or rivets; mounts with flange on front side of panel of any thickness; with flange on rear side, panel up to 1/8" thick. Molded black phenolic body with soldered and mechanically held side terminal. Type HPC U/L Approved for 30 amps 600 volts. Type HPC-L U/L Approved for 5 A, 600 V.

Buss No.	For Fuses	Fuse Size, In.	Net Price For	
			Ten	100
HPC	AGU, ABU, BAF, BAN, FNM, MDR, KLM	1 3/8 x 1 1/2	\$6.00	\$50.00
HPC-L	BBS	1 3/8 x 1 3/8	6.00	50.00
HPC-C	MIN, MIC, FNA	*	7.50	63.00

*Same as HPC but with transparent knob.

"QUICK-BLOWING" 600 V FUSES



Designed to protect control circuits, fluorescent lighting circuits or similar uses where quick-blowing characteristics are desired. Use HPC-L fuseholder or 3845 fuse block. U/L Approved. Fiber tube 1 3/8" x 1 3/8".

Buss No.	Amperes	Net Price For	
		Ten	100
BBS	4/10, 3/4, 8/10	\$2.10	\$17.00
	1, 2, 3, 4, 5	1.90	16.00

TRON® SUBMINIATURE PIGTAIL FUSES

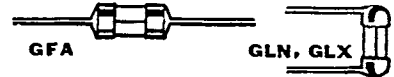

Glass-tube construction with 1 1/2" leads of #24 tinned copper for 1/100-5 amp ratings, #18 tinned copper for 7-15 amp ratings. Hermetically sealed. Color coded to indicate amp ratings. For circuits with fault current of 50 amps or less (1/100-5 amps for 125 V or less, 7-15 amps for 32 V or less). GLN, GLX body size, .140" x .3"; GFA body size, .145" x .3".

Buss No.	Amperes	Net Price For	
		Ten	100
GLN	1/100	\$11.80	\$99.00
GLN	1/32, 1/20, 1/16, 1/10, 1/8, 3/10, 4/10, 7, 8, 15	10.00	83.00
GLX	15/100, 2/10, 1/4, 1/2, 6/10, 3/4, 1, 1 1/2, 2, 3, 4, 5	13.00	108.00
GFA	1/100, 1/32, 1/20, 1/16, 1/10, 1/8, 15/100, 2/10, 1/4, 3/10, 4/10, 1/2, 6/10	4.30	36.00
GFA	3/4, 1, 1 1/2, 2, 3, 4, 5, 7, 8, 15	3.70	31.00

SPACE SAVER PANEL MOUNTED FUSEHOLDERS

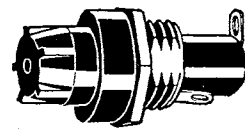

Length 1 1/2"; extends 3/4" behind front of panel. Takes 1/4" x 1 1/4" fuses. Easily converts to take 3/8" x 1 1/4" fuses by changing screw type knob. Flat part of molded phenolic body locks fuseholder against rotation when used on punched hole. Requires 3/8" mounting hole.

Buss No.	For Fuse Size Dia. x L.	Net Each
HCL	3/8" x 1 1/4"	.40
HMB*	1/4" x 1 1/4"	.40
HMM*	3/8" x 1 1/4"	.40

*Requires 3/8" mounting hole; HMM has screwdriver slot knob.

SUBMINIATURE PRONG TYPE UNIT

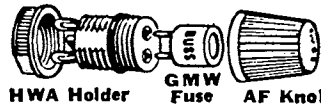

Rated 125 V or less, faulty current not over 300 amps; open at 200% within 10 sec. or less. Use AF knob for waterproof. Size, .27" dia., 1/4" lg. (body).

Buss No.	Amperes	Net Price For	
		Ten	100
GMW	1/200, 1/100, 1/4, 1/2, 3/4, 1, 1 1/2, 2, 3, 4, 5, 6, 8, 10, 15, 20, 25, 30, 40, 50, 60, 70, 80, 100, 150, 200, 250, 300	\$7.10	\$60.00
GMW	1/10, 2/10, 3/10, 4/10, 1/2, 6/10, 3/4, 1, 1 1/2, 2, 3, 4, 5	5.50	46.00
HWA*	Holder, fits all GMW	6.80	57.00
HWA†	Holder, fits all GMW	6.00	50.00
AF	Knob only, fits HWA	.84	7.00

*With AF knob. †Without AF knob.

SIGNAL-INDICATING ALARM ACTIVATING TYPE UNIT



Takes only 1/4" x 1 1/4" space. Color indicator. Rated 300 V or less; 100% for 10 min.; open at 150% within 5 min.

Buss No.	Amperes and Color of Indicator	Net Price For	
		Ten	100
GMT	18/100*, 1/4, 1/2, 3/4, 1, 1 1/2, 2, 3, 4, 5, 7 1/2, 10**	\$4.20	\$35.00
HLT	Holder, fits all GMT	4.30	36.00

Color of Indicator: *Yellow; †violet; ‡red; §black; ¶brown; **gray; ††white; †††orange; ††††blue; †††††green; ††††††black-white; **red-white.

©Electronic Publishing Co., Inc., 1968
ALL RIGHTS RESERVED

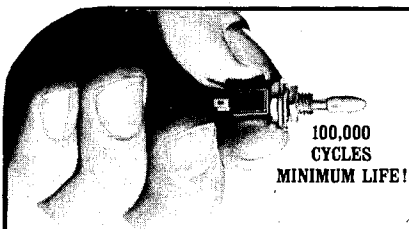

SUBMINIATURE TOGGLE SWITCHES

Designed to meet the highest standards of quality and reliability, C&K's subminiature toggle switches successfully combine maximum performance with minimum weight and small size. All of the switches shown below feature rugged construction, simple mounting, excellent appearance, and long, trouble-free operation! These new subminiature toggle switches adapt to virtually any manual switching requirement in a very wide range of aerospace/ground/undersea applications where space is at a premium!

SERIES 7100
SPDT

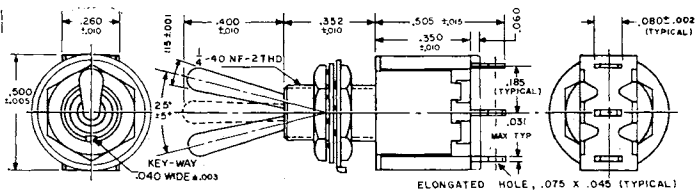

SERIES 7200
DPDT

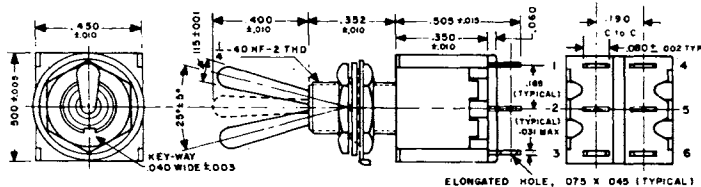

SERIES 7200/TYPICAL OUTLINE DRAWING

SERIES 7300
3PDT

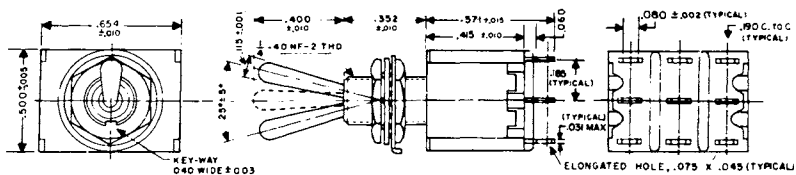

SERIES 7300/TYPICAL OUTLINE DRAWING

SERIES 7400
4PDT

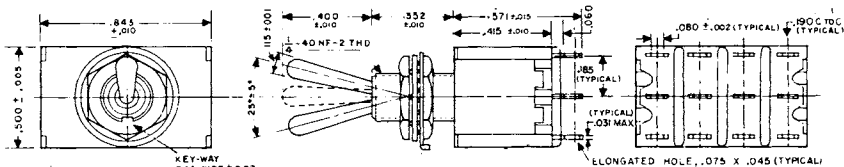

SERIES 7400/TYPICAL OUTLINE DRAWING



quality electro-mechanical products



ONE HOLE MOUNTING
SLOW MAKE, SLOW BREAK A-C SWITCHES
3-6, 10-15 AMP. — ONE AND TWO POLE

Features include: heavy duty independent springs for positive contact pressure, solid silver to silver contacts and strong substantial terminal construction.

Bushing dia. $1\frac{1}{32}$ " , bushing length $1\frac{1}{32}$ " . Also available with $1\frac{1}{32}$ " bushing length.

Screw terminals except 7516 and 7517 which have plug-in type terminals. All switches listed except 7516 and 7517 also available with solder lug or spade type terminals.



Cat. Nos. 7503, 7505

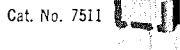

Cat. No. 7511

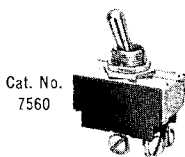

Cat. No. 7560



Cat. No. 7516, 7517
Plastic Superstructure

Circuit Arrangement			Throws	Catalog Number	
A	B	C		Screw Terminals Δ and $1\frac{1}{32}$ " Bushing Length	2 Pole
Keyway on "C" Side of Switch				1 Pole	2 Pole
3 AMP. — 250 V. A-C, 6 AMP. — 125 V. A-C					
ON	OFF	ON	DT	7581K4	7591K4
ON	OFF	ON*	DT	7586K4	7596K4
ON*	OFF	ON*	DT	7587K4	7597K4
ON	NONE	ON	DT	7582K4	7592K4
ON	NONE	ON*	DT	7585K4	7595K4
ON	NONE	OFF	ST	7516K5 Δ
ON	NONE	OFF	ST	7580K4	7590K4
ON	NONE	OFF*	ST	7584K4	7594K4
OFF	NONE	ON*	ST	7583K4	7593K4
10 AMP. — 250 V. A-C, $\frac{1}{2}$ MAX. H.P. — 250 V. A-C					
ON	OFF	ON*	DT	7508K6	7568K2
ON*	OFF	ON*	DT	7509K5	7569K2
ON	NONE	ON*	DT	7510K7	7570K5
ON	NONE	OFF	ST	7517K5 Δ
ON	NONE	OFF*	ST	7507K4	7567K5
OFF	NONE	ON*	ST	7506K4	7566K5
10 AMP. — 250 V. A-C, 15 AMP. — 125 V. A-C, $\frac{3}{4}$ MAX. H.P. — 250 V. A-C					
ON	OFF	ON	DT	7502K13	7562K4
ON	NONE	ON	DT	7504K4	7564K6
ON	NONE	OFF	ST	7500K14	7560K5

*Momentary contact Δ 7516 and 7517 supplied with plug-in terminals only.

10-15 AMP. LINE — THREE AND FOUR POLE

Bushing dia. $1\frac{1}{32}$ " . Bushing length — $1\frac{1}{32}$ " (7610 and 7615 also available with $1\frac{1}{32}$ " bushing).

Ratings — Three pole switches — 10 amp. — 250 V. A-c, 15 Amp. — 125 V. A-c, 1 hp poly-phase — 115-575 V. A-c. Four pole switches — 10 Amp. — 250 V. A-c, $\frac{1}{2}$ hp — 230 V. A-c.

Cat. Nos. 7690, 7697



Cat. Nos. 7610, 7618

Circuit Arrangement			Throws	Catalog Number— $1\frac{1}{32}$ " Bushing Length			
A	B	C		3 Pole		4 Pole	
Keyway on "C" Side of Switch				Screw Terminals	Solder Lug Terminals	Screw Terminals	Solder Lug Terminals
ON	OFF	ON	DT	7612K2	7613K2	7692K13	7693K2
ON*	OFF	ON	DT	7613K2
ON*	NONE	ON	DT	7614K2	7615K2	7694K4	7695K5
ON*	NONE	ON	DT	7618K2
ON	NONE	OFF	ST	7610K2	7611K2	7690K8	7691K14
ON*	NONE	OFF	ST	7616K2
ON*	NONE	OFF	ST	7696K6	7697K6

*Momentary contact.

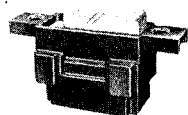

Cat. Nos. 8476 and 8477

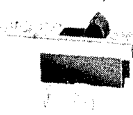

Cat. Nos. 8486, 8487, 8488

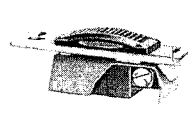

Cat. No. 8303

CUTLER-HAMMER, Inc.,

Most C-H switches are available with optional features for special applications. See your local Sales Office or Distributor for complete switch listings, accessories and optional features.

QUICK MAKE, QUICK BREAK A-C, D-C SWITCHES
UTILITY TYPE

They have a quick make and quick break over center arrangement on the movable contact which permits exceptionally fast contact action minimizing pitting and erosion of the contact surfaces.

Available with screw terminals, solder lug terminals or with 6" lead wires stripped $\frac{3}{4}$ ". Bushing dia. $1\frac{1}{32}$ " , bushing length $1\frac{1}{32}$ ". Also available with bushing lengths of $\frac{1}{4}$ " , $1\frac{1}{32}$ " , $\frac{3}{4}$ " and 1" — $\frac{3}{4}$ " and 1" bushings furnished with ball type lever only.

Cat. No. 8383

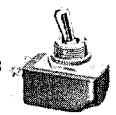

Cat. No. 8396

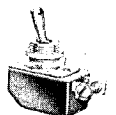

Cat. Nos. 8363, 8373
With Nylon Paddle Operator



Cat. Nos. 8365, 8375



Cat. Nos. 8364, 8374

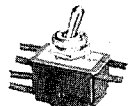

Nominal Ratings (Amps.)		Poles and Throws	Catalog No.— $1\frac{1}{32}$ " Bushing Length		
250 V. A-c, D-c	125 V. A-c, D-c		Screw Terminals	Solder Lug Terminals	Wire Lead Terminals
1	3	SPDT (3 Way)	8297K8	8282K14	8292K14
3	SPST	8295K8	8280K16	8290K16
3	DPST	8362K7	8360K7	8361K7
3	DPDT	8365K7	8363K7	8364K7
3	6	SPST	8396K8	8381K8	8391K8
3	6	DPST	8372K7	8370K7	8371K7
3	6	DPDT	8375K7	8373K7	8374K7

HEAVY DUTY TYPE

Screw terminals or plug-in terminals (connection made by plugging wire into switch body) are available. Plug-in type switches have $\frac{3}{32}$ " square hole to accept #14, 16 or 18 ga., stranded, tin dipped wire leads skinned $\frac{1}{32}$ ".

Bushing dia. $1\frac{1}{32}$ " , bushing length $1\frac{1}{32}$ ". Also available with $1\frac{1}{32}$ " bushing length.

Cat. Nos. 7320, 7321, 7322

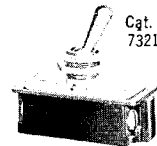

Rear view of 7343 showing holes for plug-in wire leads.

Cat. No. 7402



Nominal Ratings (Amperes)		Max Hp Ratings (250 V.)		Poles and Throws	Catalog Number $1\frac{1}{32}$ " Bushing Length	
250 V. A-c, D-c	125 V. A-c, D-c	A-c	D-c		Screw Terminals	Plug-In Terminals
5	DPDT w/o Center Off	8680K2
5	10	$\frac{1}{2}$	$\frac{1}{2}$	SPST	7347K3
5	10	$\frac{1}{2}$	$\frac{1}{2}$	DPST	7343K2
8	16	1	1	SPST	7321K3
8	16	1	1	DPST	7320K3	7443K3
10	15	1	$\frac{1}{2}$	DPST	7354K3
10	15	1	$1\frac{1}{2}$	SPST	7361K5
10	15	1	$1\frac{1}{2}$	DPST	7360K8
10	15	DPDT w/o Center Off	8690K2
20	..	2	2	SPST	7403K2
20	2	2	DPST	7402K4

SLIDE BUTTON SWITCHES
FLUSH MOUNTING

SPST and SPDT, flush mounting slide switches.

Mounting centers — $2\frac{1}{16}$ " — 8303, $1\frac{1}{2}$ " — 8746 and 8477, $1\frac{1}{8}$ " on all others.

Operating buttons are red plastic on 8476-77, black phenolic on all others.

Ampere Rating	Maximum Hp Ratings A-c Only		Circuit Arrangement	Catalog Numbers						
	A-c	D-c		Screw Term.	Solder Spade Term.	Plug-In Term.				
125 V.	250 V.	125 V.	250 V.	Poles and Throw	A	B	C
6	3	SPST	On	None	Off	8476K1
6*	3*	SPST	On	None	Off	8303K1
7	3	$\frac{1}{4}$	SPST	On	None	Off	8486K1	8486K2
7	3	$\frac{1}{4}$	SPDT	On	Off	On	8487K1	8487K2
7	3	$\frac{1}{4}$	SPDT	On	None	On	8488K1	8488K2
10	5	$\frac{1}{2}$	$\frac{1}{2}$	SPST	On	None	Off	8477K1

*A-c and d-c rating.

See your local C-H representative for prices and accessory information.

SECTION 5100

CUTLER-HAMMER SWITCHES



"Military Application"

MIL-S-3950B

MIL-S-3950C

MIL-S-8834B

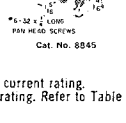
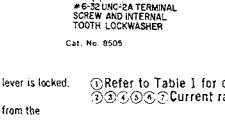
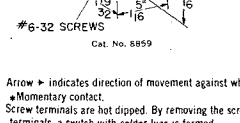
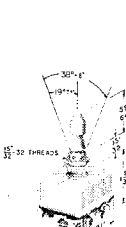
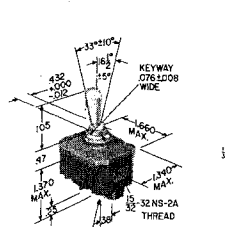
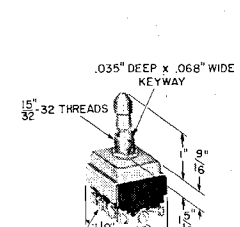
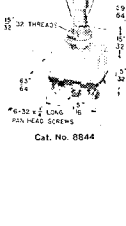
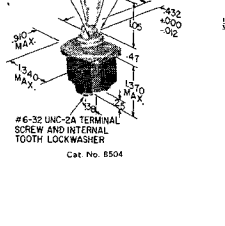
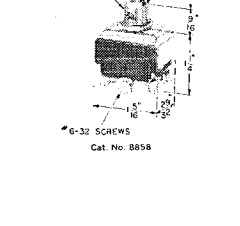
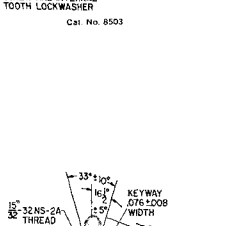
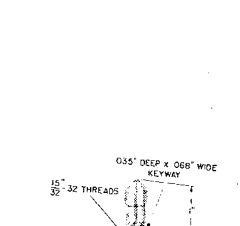
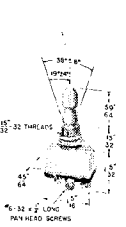
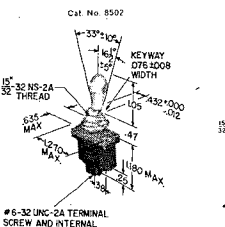
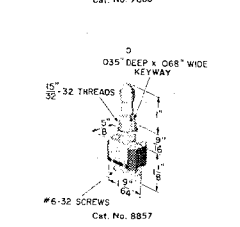
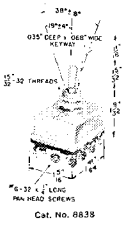
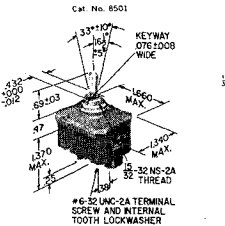
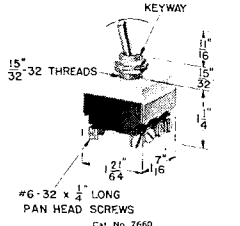
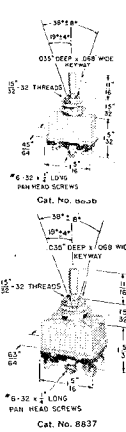
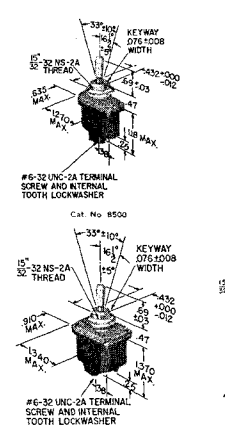
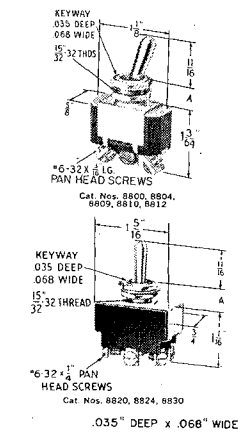

Arrow indicates direction of movement against which lever is locked. Refer to Table 1 for current rating. Momentary contact. Current rating. Refer to Table 2. Screw terminals are hot dipped. By removing the screws from the terminals, a switch with solder lugs is formed.

Circuit with lever in . . .	MIL-S-3950B		MIL-S-3950C		MIL-S-8834B				
	UP Position	CENTER Position	DOWN Position (Keyway)	C-H Part Number	MIL-S-Part Number	C-H Part Number	MIL-S-Part Number		
1 POLE	ON	OFF	ON	8800K16	MS35058-21	8500K1②	MS24523-21	8836K1	MS25306-212
	ON	NONE	OFF	8801K22	MS35058-22	8500K9②	MS24523-22	8836K9	MS25306-222
	ON	OFF	NONE	8801K23	MS35058-23	8500K4②	MS24523-23	8836K4	MS25306-223
	ON	OFF*	NONE	8813K8	MS35058-25	8500K8②	MS24523-25	8836K5	MS25306-262
	ON	NONE	OFF	8804K13	MS35058-26	8500K5②	MS24523-26	8836K5	MS25306-272
	ON	OFF	ON*	8812K14	MS35058-27	8500K2②	MS24523-27	8836K2	MS25306-282
	ON	OFF	ON*	8811K18	MS35058-28	8500K7②	MS24523-28	8836K7	MS25306-282
	ON	OFF	NONE	8826K12	MS35058-29	8500K10②	MS24523-29	8836K10	MS25306-292
	ON	OFF	NONE	8811K17	MS35058-30	8500K11②	MS24523-30	8836K11	MS25306-302
	ON	ON*	ON	8809K16	MS35058-31	8500K3②	MS24523-31	8836K3	MS25306-312
	ON	ON*	NONE	—	—	8500K12②	MS24523-32	—	—
	ON	ON	NONE	—	—	8500K13②	MS24523-33	—	—
2 POLE	ON	OFF	ON	8820K16	MS35059-21	8501K1②	MS24524-21	8837K1	MS25307-212
	ON	OFF	OFF	8822K20	MS35059-22	8501K9②	MS24524-22	8837K9	MS25307-222
	ON	OFF	NONE	8824K14	MS35059-23	8501K4②	MS24524-23	8837K4	MS25307-232
	ON	OFF*	NONE	8822K21	MS35059-24	8501K6②	MS24524-24	8837K6	MS25307-242
	ON	OFF	ON*	8830K13	MS35059-26	8501K5②	MS24524-26	8837K5	MS25307-262
	ON	NONE	OFF	8834K5	MS35059-27	8501K2②	MS24524-27	8837K2	MS25307-272
	ON	NONE	OFF	8826K14	MS35059-28	8501K7②	MS24524-28	8837K7	MS25307-282
	ON	OFF	OFF*	8828K13	MS35059-29	8501K10②	MS24524-29	8837K10	MS25307-292
	ON	OFF	NONE	8826K15	MS35059-30	8501K11②	MS24524-30	8837K11	MS25307-302
	ON	ON*	ON	8812K12	MS35059-31	8501K3②	MS24524-31	8837K3	MS25307-312
	ON	ON	NONE	—	—	8501K13②	MS24524-32	—	—
	ON	ON	NONE	—	—	8501K13②	MS24524-33	—	—
4 POLE	ON	OFF	ON	7662K7	MS25068-21	8502K1②	MS24525-21	8838K1	MS25308-212
	ON	NONE	OFF	7664K5	MS25068-23	8502K9②	MS24525-22	8838K9	MS25308-222
	ON	NONE	ON	7660K13	MS25068-24	8502K4②	MS24525-23	8838K4	MS25308-232
	ON	OFF	NONE	7668K7	MS25068-25	8502K6②	MS24525-24	8838K6	MS25308-242
	ON	OFF*	NONE	7674K5	MS25068-26	8502K5②	MS24525-25	8838K5	MS25308-262
	ON	NONE	ON*	7672K3	MS25068-27	8502K7②	MS24525-26	8838K7	MS25308-272
	ON	OFF	ON*	7666K9	MS25068-28	8502K7②	MS24525-27	8838K7	MS25308-282
	ON	NONE	OFF*	—	—	8502K10②	MS24525-29	8838K10	MS25308-292
	ON	NONE	OFF*	—	—	8502K11②	MS24525-30	8838K11	MS25308-302
	ON	OFF	ON*	7670K6	MS25068-31	8502K3②	MS24525-31	8838K3	MS25308-312
	ON	OFF	NONE	—	—	8502K12②	MS24525-32	—	—
	ON	ON	NONE	—	—	8502K13②	MS24525-33	—	—

Circuit with lever in . . .	MIL-S-3950B		MIL-S-3950C		MIL-S-8834B					
	UP Position	CENTER Position	DOWN Position (Keyway)	C-H Part Number	MIL-S-Part Number	C-H Part Number	MIL-S-Part Number			
1 POLE	ON	<OFF>	<ON	8857K39	MS25125-A1	8503K1②	MS24658-21A	8843K1	MS24612-A212	
	ON	<OFF>	ON	8857K40	MS25125-B1	8503K2②	MS24658-21B	8843K2	MS24612-B212	
	ON	OFF	<ON	8857K41	MS25125-C1	8503K3②	MS24658-21C	8843K3	MS24612-C212	
	ON	<OFF>	NONE	8857K54	MS25125-B2	8503K16②	MS24658-21G	8843K16	MS24612-B242	
	ON	OFF	<ON	8857K43	MS25125-D1	8503K4②	MS24658-21D	8843K4	MS24612-D212	
	ON	NONE	<OFF	8857K45	MS25125-E1	8503K5②	MS24658-21E	8843K5	MS24612-E212	
	ON	NONE	<OFF	8857K47	MS25125-E2	8503K9②	MS24658-21F	8843K9	MS24612-F212	
	ON	NONE	<OFF	8857K48	MS25125-E2	8503K10②	MS24658-21G	8843K10	MS24612-G212	
	ON	NONE	<ON	8857K45	MS25125-C3	8503K7②	MS24658-21H	8843K7	MS24612-H212	
	ON	NONE	<ON	8857K44	MS25125-C3	8503K8②	MS24658-21I	8843K8	MS24612-I212	
	ON	<OFF>	NONE	8857K49	MS25125-F1	8503K12②	MS24658-21J	8843K12	MS24612-J212	
	ON	NONE	ON*	8857K79	MS25125-L6	8503K20②	MS24658-21K	8843K20	MS24612-K212	
	ON	<OFF>	ON*	8857K50	MS25125-F7	8503K12②	MS24658-21L	8843K12	MS24612-L212	
	ON	OFF	ON*	8857K52	MS25125-H7	8503K14②	MS24658-21M	8843K14	MS24612-M212	
	ON	NONE	ON*	8857K53	MS25125-K8	8503K15②	MS24658-21N	8843K15	MS24612-N212	
	ON	NONE	ON*	8857K48	MS25125-L9	8503K21②	MS24658-21P	8843K21	MS24612-P212	
	ON	OFF	ON*	8857K81	MS25125-L10	8503K19②	MS24658-21Q	8843K19	MS24612-Q212	
	ON	OFF	ON*	8857K51	MS25125-G1	8503K13②	MS24658-21R	8843K13	MS24612-R212	
	ON	<OFF>	ON*	8857K56	MS25125-K11	8503K18②	MS24658-21S	8843K18	MS24612-S212	
	ON	<OFF>	ON*	8857K46	MS25125-M11	8503K8②	MS24658-21T	8843K8	MS24612-T212	
	ON	<OFF>	ON*	8857K55	MS25125-N11	8503K17②	MS24658-21U	8843K17	MS24612-U212	
	ON	NONE	NONE	8857K78	MS25125-L5	8503K22②	MS24658-21V	8843K22	MS24612-V212	
	ON	<ON	NONE	—	—	8503K23②	MS24658-21W	—	—	
	ON	<ON	NONE	—	—	8503K24②	MS24658-21X	—	—	
	ON	<ON	NONE	—	—	8503K25②	MS24658-21Y	—	—	
	ON	<ON	NONE	—	—	8503K26②	MS24658-21Z	—	—	
	2 POLE	ON	<OFF>	<ON	8858K39	MS25126-A1	8504K1②	MS24659-21A	8844K1	MS24613-A212
		ON	<OFF>	ON	8858K40	MS25126-B1	8504K2②	MS24659-21B	8844K2	MS24613-B212
		ON	OFF	<ON	8858K41	MS25126-C1	8504K3②	MS24659-21C	8844K3	MS24613-C212
		ON	<OFF>	NONE	8858K42	MS25126-D1	8504K4②	MS24659-21D	8844K4	MS24613-D212
		ON	OFF	<ON	8858K47	MS25126-E1	8504K5②	MS24659-21E	8844K5	MS24613-E212
		ON	NONE	<OFF	8858K48	MS25126-E2	8504K9②	MS24659-21F	8844K9	MS24613-F212
		ON	NONE	<OFF	8858K48	MS25126-E2	8504K10②	MS24659-21G	8844K10	MS24613-G212
		ON	NONE	<ON	8858K45	MS25126-E3	8504K7②	MS24659-21H	8844K7	MS24613-H212
		ON	NONE	<ON	8858K44	MS25126-E3	8504K6②	MS24659-21I	8844K6	MS24613-I212
		ON	<OFF>	NONE	8858K49	MS25126-B4	8504K16②	MS24659-21J	8844K16	MS24613-J212
ON		OFF	ON*	8858K52	MS25126-L1	8504K11②	MS24659-21K	8844K11	MS24613-K212	
ON		NONE	ON*	8858K79	MS25126-L6	8504K20②	MS24659-21L	8844K20	MS24613-L212	
ON		<OFF>	ON*	8858K50	MS25126-F7	8504K12②	MS24659-21M	8844K12	MS24613-M212	
ON		OFF	ON*	8858K52	MS25126-H7	8504K14②	MS24659-21N	8844K14	MS24613-N212	
ON		NONE	OFF*	8858K53	MS25126-K8	8504K15②	MS24659-21O	8844K15	MS24613-O212	
ON		NONE	OFF*	8858K80	MS25126-L9	8504K21②	MS24659-21P	8844K21	MS24613-P212	
ON		OFF	ON*	8858K81	MS25126-L10	8504K19②	MS24659-21Q	8844K19	MS24613-Q212	
ON		<OFF>	ON*	8858K51	MS25126-G1	8504K13②	MS24659-21R	8844K13	MS24613-R212	
ON		<OFF>	ON*	8858K56	MS25126-K11	8504K18②	MS24659-21S	8844K18	MS24613-S212	
ON		<OFF>	ON*	8858K46	MS25126-M11	8504K8②	MS24659-21T	8844K8	MS24613-T212	
ON		<OFF>	ON*	8858K55	MS25126-N11	8504K17②	MS24659-21U	8844K17	MS24613-U212	
ON		NONE	NONE	8858K78	MS25126-L5	8504K22②	MS24659-21V	—	—	
ON		<ON	NONE	—	—	8504K23②	MS24659-21W	—	—	
ON		<ON	NONE	—	—	8504K24②	MS24659-21X	—	—	
ON		<ON	NONE	—	—	8504K25②	MS24659-21Y	—	—	
ON		<ON	NONE	—	—	8504K26②	MS24659-21Z	—	—	
4 POLE		ON	<OFF>	<ON	8859K39	MS25127-A1	8505K1②	MS24660-21A	8845K1	MS24614-A212
		ON	<OFF>	ON	8859K40	MS25127-B1	8505K2②	MS24660-21B	8845K2	MS24614-B212
		ON	OFF	<ON	8859K41	MS25127-C1	8505K3②	MS24660-21C	8845K3	MS24614-C212
		ON	<OFF>	NONE	8859K42	MS25127-D1	8505K4②	MS24660-21D	8845K4	MS24614-D212
		ON	OFF	<ON	8859K43	MS25127				

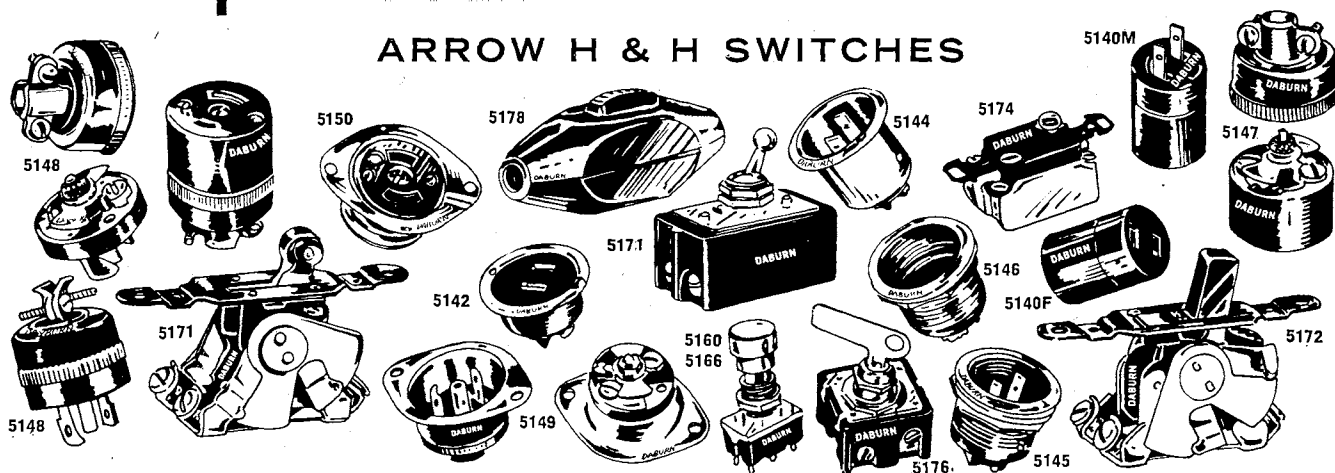
DABURN**DABURN ELECTRONICS & CABLE CORP.**
WIRE • CABLE • TUBING • MIL/COMM • SWITCHES • ELECTRONIC HARDWARE**ARROW H & H SWITCHES****DOUBLE ACTION COMPACT
PUSH-PUSH SHALLOW
QUICK MAKE AND BREAK**

$\frac{1}{32}$ " sleeve diameter, 3 amp., UL approved. Molded phenolic base. Complete with hex and knurled nut; nickel plated. All accept snap button; supplied less insulating button (#5132). (Order separately, red or black.) 1 amp., 250V 3 amp. 125V AC-DC. Solder lug terminals with double wiping blades.

Daburn No.	De-scrip.	Sleeve	Width	Lgth.	Hgt.
5160	SPST	9/16"	41/64"	1-1/32"	13/16"
5161	SPDT	9/16"	41/64"	1-1/32"	13/16"
5162	DPST	9/16"	41/64"	1-1/32"	13/16"
5163	DPDT	9/16"	41/64"	1-1/32"	13/16"

Std. Pkg. 25

**MOMENTARY ACTION COMPACT
PUSH SWITCH****QUICK MAKE AND BREAK** $\frac{1}{32}$ " Sleeve Diameter — 3 Amp.

UL approved. Molded base. Complete with hex and knurled nut; nickel plated. All accept snap button; supplied less insulating button (#5132). (Order separately, red or black.) Solder lug terminals with double wiping blades.

Daburn No.	De-scrip.	Sleeve	Width	Lgth.	Hgt.
*5166	SPST	9/16"	41/64"	1-1/32"	13/16"
5167	SPDT	9/16"	41/64"	1-1/32"	13/16"
*5168	DPST	9/16"	41/64"	1-1/32"	13/16"
5169	DPDT	9/16"	41/64"	1-1/32"	13/16"

*SPST and DPST — normally off.
Std. Pkg. 25

**HEAVY DUTY SWITCHES
TOGGLE TYPE 30 AMP**

UL approved. 30 Amp, 250 Volts, AC-DC, 2HP, 115V-230V AC; 1 HP, 460V AC. Used on machine tools, pumps, food machines, sanders, grinders, etc.

DABURN No.	Description	Std. Pkg.
5171	DPST	5
5172	DPST	5

**METAL PUSH BUTTON TYPE
NORMALLY OPEN — 20 AMP**

UL approved. 20 Amp.-250V, 2 HP 230V AC, 2 HP 250V DC. Used on floor sander, foot switch etc.

DABURN No.	Description	Std. Pkg.
5174	DPST	5

**ROTO-LOCK SWITCH
20 AMP.**

UL approved. 20 Amp., 120V, 240V AC.
1 $\frac{1}{2}$ HP — 120V AC
2 HP — 120V AC

Key removable in off position only.

DABURN No.	Description	Sleeve	Std. Pkg.
5176	DPST	9/16"	5
5176K0	Key only for above		5

**FEED-THRU CORD SWITCH
10 AMP.**

UL approved, sliding lever, black case. 10 Amp.-125V, 5 Amp.-250V. Cord hole— $\frac{3}{16}$ ".

DABURN No.	Description	Std. Pkg.
5178	SP	6

**FEED-THRU CORD SWITCH
15 AMP.**

UL approved for appliance use only. 10 Amp-250V, 15 Amp.-125V.

DABURN No.	Description	Std. Pkg.
5179	DP (3rd Wire Gd.)	5

**CORD CONNECTORS
10 AMP.**

Complete brown bakelite cord connector. 10 Amp.-250 Volts, end opening for wire size up to $\frac{3}{8}$ " O.D.

DABURN No.	Description	Std. Pkg.
5140	Complete	10
5140F	Female Part Only	10
5140M	Male Part Only	10

**DABURN H & H RECEPTACLES
10 AMP.****SHORT, FEMALE FLUSH RECEPTACLE**
UL approved. 10 Amp.-250 Volts AC.

DABURN No.	Description	Std. Pkg.
5143	Lock Nut Mounting	5
5142	2 Screw Mounting	5

Complete warehouse inventories on all AH&H numbers.

**RECESSED MALE RECEPTACLE
10 AMP.**

DABURN No.	Description	Std. Pkg.
5144	2 Screw Mounting	5
5145	Lock Nut Mounting	5

**RECESSED FEMALE RECEPTACLE
10 AMP.**

DABURN No.	Description	Std. Pkg.
5146	Lock Nut Mounting	5

**COMPACT RECEPTACLES —
TURN TO LOCK****3 WIRE GROUNDING TYPE****FEMALE CONNECTOR — 15 AMP.-125 VOLT**

Brass metal casings, corrosion resistant finish. Black bakelite.

DABURN No.	Description	Std. Pkg.
5147	Female Connector	5

**MALE CONNECTOR
15 AMP.-125 VOLT**

DABURN No.	Description	Std. Pkg.
5148	Male Connector	5

MALE RECEPTACLES**MALE RECEPTACLES
15 AMP.-125 VOLT**

DABURN No.	Description	Std. Pkg.
5149	Male Receptacle	5

**FEMALE RECEPTACLE
15 AMP.-125 VOLT**

DABURN No.	Description	Std. Pkg.
5150	Female Receptacle	5

CENTRALAB ROTARY SWITCHES



Consistent with all products within Centralab's overall product line, Centralab rotary switches range from highly miniaturized units to heavy-duty types. Centralab rotary switches are well-engineered and manufactured, precision components that may be depended upon to serve reliably. The detailed specifications given in this catalog will help you accurately specify these switches for your applications. The switches available through your Centralab Distributor are available with machine-assembled "staked" or bolted construction, ceramic or phenolic insulation. Comprehensive coverage of switching arrangements and number of sections per switch add to the total adaptability of this product line. Count on your Centralab Distributor as your source for immediate delivery of the exact switch for your application.

In addition to the thousands of switches available in your Centralab Distributor's stock, parts and kits are available for convenient, quick repair work and prototype assembly applications.

New PSA Sub-Miniature Rotary Switches with Adjustable Stops

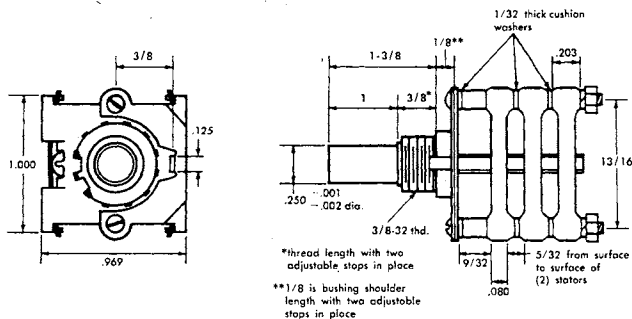
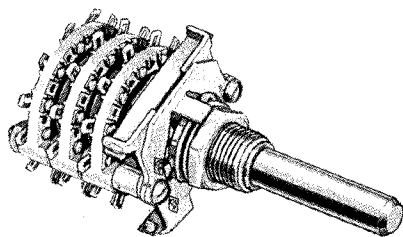

These deluxe, sub-miniature switches feature an all-new index mechanism with adjustable stops for extra switching arrangement versatility.

Construction is rugged 2-ball starwheel lateral thrust for exceptionally good torque control and feel. Plus extra application versatility for: band switching, ultra-small electronic equipment, transistor circuits, aircraft instruments, industrial and broadcasting equipment.

Each switch weighs less than one ounce, yet has the same electrical rating as switches much heavier and larger in diameter. Furnished with blue colored diallyl phthalate sections. Separate diallyl phthalate, phenolic and ceramic sections also available.

SPECIFICATIONS

MOUNTING: Bushing mounted

BUSHING: $\frac{3}{8}$ "—32 NEF Thread by $\frac{3}{8}$ " long

LOCATING LUG: On $\frac{3}{8}$ " radius

SHAFT: $\frac{1}{4}$ " diam., full round, $1\frac{1}{8}$ " L.F.M.S.

INDEX ANGLE: Positive 30°, w/adjustable stops

INDEX STOP STRENGTH: 10 inch-pounds

SECTION SPACING: $\frac{1}{32}$ " between front plate and clip surface of first section and $\frac{1}{32}$ " spacing between sections (surface-to-surface).

INSULATION: Diallyl Phthalate—(Stator and Rotor). Average surface resistivity: 900,000 megohms. High quality molded thermosetting plastic type SDG per MIL-M-14F. Voltage breakdown between critical parts 750 VAC-RMS.*

SECTION: Diallyl Phthalate .203" \pm .005" thick across strut holes and .080" thick across clip surface-to-surface.

CLIPS AND ROTOR CONTACTS: Brass, silver-plated

HARDWARE: Front plate, index plate, bushing, mtg. hdwe., strut nuts and shaft-steel, plated to resist corrosion; index springs, strut screws and lockwashers—stainless steel.

CURRENT AND VOLTAGE RATING: Make and break, resistive load; 0.550 amperes at 28 volts VDC; 170 milliamperes at 115 VAC. (Based on 10,000 cycles load life test.)

CURRENT CARRYING CAPACITY: 7 amperes

CONTACT RESISTANCE: Average initial resistance 5 milliohms

ROTATIONAL LIFE: (Index) 25,000 cycles minimum

PACKAGED: Singly, in sulphur-free cartons and Nox-Tarnish protective wrap insuring long shelf life. Includes mounting nut and lock washer.

*See Catalog 33-1 for INSULATION data for Ceramic and Phenolic Sections.

PSA SERIES SUB-MINIATURE ROTARY SWITCHES

Total Poles	No. of Positions	Poles per Section	No. of Sections	Catalog No. Shorting	Catalog No. Non-Shorting
1	2-12	1	1	PSA-200	PSA-201
2	2-6	2	1	PSA-202	PSA-203
2	2-12	1	2	PSA-204	PSA-205
3	2-5	3	1	PSA-206	PSA-207
3	2-12	1	3	PSA-208	PSA-209
4	2-6	2	2	PSA-210	PSA-211
5	2-3	5	1	PSA-214	PSA-215
6	2-5	3	2	PSA-220	PSA-221
6	2-6	2	3	PSA-222	PSA-223
9	2-5	3	3	PSA-228	PSA-229
10	2-3	5	3	PSA-230	PSA-231
15	2-3	5	3	PSA-238	PSA-239

FOR PROTOTYPES OR FIELD REPAIR

Separate index assemblies and sections are available for "on the spot" assembly of special switching or for repair requirements. Switches with 1-5 sections in Diallyl Phthalate, ceramic or phenolic can be assembled with parts listed below. Same specifications as factory assembled units.

INDEX ASSEMBLIES

For use with sections shown below. Index assemblies furnished with adjustable stops and appropriate hardware.

Catalog No.	No. Sections	No. Pos.	Indexing
PSA-512	1-2	2-12	30°
PSA-513	3-5	2-12	30°

Contains: (1) PSA-512 adjustable stop index, (2) $\frac{1}{16}$ ", $\frac{3}{32}$ ", $\frac{3}{16}$ " ceramic spacers, (12) $\frac{1}{4}$ " plastic spacer washers, (4) $\frac{1}{32}$ " glass cushion washers, (2) $1\frac{1}{8}$ " tie bolts, nuts, lockwashers, and assembly instructions.

Contains: (1) PSA-513 adjustable stop index, (2) $\frac{1}{16}$ ", $\frac{3}{16}$ " ceramic spacers, (8) $\frac{3}{32}$ " ceramic spacers, (24) $\frac{1}{4}$ " plastic spacer washers, (10) $\frac{1}{32}$ " glass cushion washers, (2) $1\frac{1}{8}$ " tie bolts, nuts, lockwashers and assembly instructions.

SECTIONS: For use with index assemblies shown above.

SEPARATE DIALLYL PHTHALATE SECTIONS

SEPARATE CERAMIC & PHENOLIC SECTIONS

No. Poles	No. Pos.	Catalog No. Shorting	Catalog No. Non-Shorting	Ceramic— $\frac{1}{8}$ " Thick		Phenolic— $\frac{1}{8}$ " Thick	
				Shorting	Non-Shorting	Shorting	Non-Shorting
1	2-11	PS-50	PS-51	PS-20	PS-21	PS-40	PS-41
1	2-12						
2	2-5	PS-52	PS-53	PS-22	PS-23	PS-42	PS-43
2	2-6						
3	2-3	PS-54	PS-55	PS-24	PS-25	PS-44	PS-45
3	2-5						
4	2	PS-56	PS-57	PS-26	PS-27	PS-46	PS-47
5	2-3						

The Centralab JV-9000 Series Heavy-Duty Rotary Power Switch was designed to meet today's requirements for high accuracy and long life. This series meets all engineering requirements for use in transmitters, industrial controls, laboratory test equipment and many other special applications for commercial products.

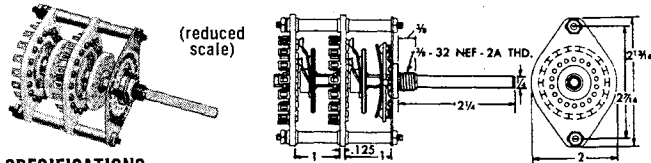

SPECIFICATIONS

CONSTRUCTION: Bolted
MOUNTING: Single hole, bushing mounted
BUSHING: 3/8" - 32NEF-2A thread, brass*, 3/8" long
LOCATING LUG: Adjustment of tie rod lengths will provide either one or two locating lugs
SHAFT: 1/2" diameter, double flat, steel*, 2 1/4" long from mounting surface
INDEX ANGLE: Positive 20°, two adjustable stops. Removal of stops provides continuous rotation
SECTION SPACING: 1" spacing between front plate and first section and between all sections
INSULATION: Centralab steatite, grade L-422 or better per MIL-I-10A, Dow-Corning 200 silicone treated to prevent accumulation of surface moisture. Voltage breakdown between critical parts 3000 VAC-RMS (static) except JV-18 and JVN-18 sections which are 2550 VAC-RMS (static). Extremely low frequency loss.
SECTIONS: Ceramic - 3/8" thick
COLLECTOR RINGS AND CONTACT BUTTONS: Contacting surface is silver alloy
HARDWARE: Contact springs silver-plated spring brass; terminals - brass silver-plate; tie-rods; tie-rod nuts, flat washers and adjustable stop nuts - brass, nickel-plated; front plate, shaft ball holder, adjustable stops, mounting nut and lockwasher - steel cadmium-plated; index spring - steel; index ball and front plate - stainless steel; tie-rod lockwashers - phosphor bronze*; rotor retaining ring - beryllium copper; spacer washers - nylon.
CURRENT AND VOLTAGE RATING: Make and break resistive load; 9 amp. @ 110 VAC-RMS; 15 MA (0.015 amp.) @ 2500 VAC-RMS; 30 amp. @ 5 VDC; 20 amp. @ 12 VDC; 11 amp. @ 28 VDC except JV-18 and JVN-18 sections which are rated 4 amp. @ 110 VAC-RMS.
CONTACT RESISTANCE: Average initial resistance - 7 milliohms
ROTATIONAL LIFE: 25,000 cycles minimum
PACKAGING: Singly, in extra heavy duty carton and Nox-Tarnish protective wrap. Includes 2" double set-screw pointer knob, Cat. No. P-168, dial plate, adjustable stop pin and nut and instruction sheet.
 *Suitably plated to resist corrosion.

1400 & 2500 Series SWITCHES

The 1400 Series Phenolic and 2500 Series Ceramic rotary switches provide a complete line of rotary switches used primarily for band change and general tap switch application where miniaturization is not a necessity. Three types of index assemblies combined with an extensive choice of phenolic or ceramic sections, provide exceptional application versatility.

SPECIFICATIONS

CONSTRUCTION: Bolted
MOUNTING: Single hole, bushing mounted
BUSHING: 3/8" - 32NEF-2A thread, 3/8" long, steel*
LOCATING LUG: None
SHAFT: 1/2" diameter, full round, 2 1/4" long from mounting surface, steel*
INDEX ANGLE: Positive 30°, adjustable stop. Maximum 11 positions without adjustable stop.
SECTION SPACING: 1/2" spacing between front plate and first section. 1/2" spacing between sections on two section switches; 1" spacing between sections on all 3 and 4 section switches.
INSULATION: 1400 Series: High quality laminated phenolic, type PBE, per MIL-P-3115B. Voltage breakdown between critical parts 1000 VAC-RMS.
 2500 Series: Centralab steatite, grade L-422 or better per MIL-I-10A, Dow-Corning 200 silicone treated to prevent accumulation of surface moisture. Voltage breakdown between critical parts 1500 VAC-RMS. Extremely low frequency loss.
SECTIONS: Phenolic - 3/8" thick; Ceramic - 3/8" thick
CLIPS AND ROTOR CONTACTS: Brass, silver-plated
HARDWARE: All other metal parts, except index ball, steel*
CURRENT AND VOLTAGE RATING: Make and break resistive load; 5.5 amp. @ 6 VDC; 2.75 amp. @ 15 VDC; 2.25 amp. @ 28 VDC; 350 MA @ 115 VAC. Based on 10,000 cycle life test.
CONTACT RESISTANCE: Average initial resistance - 3 milliohms
ROTATIONAL LIFE: 10,000 cycles minimum
PACKAGING: Singly. Includes mounting nut, lockwasher, and 1 1/4" black pointer knob, Cat. No. P-120. Sulphur-free cartons and Nox-Tarnish protective wrap insure long shelf life.
 *Suitably plated to resist corrosion.

1400 SERIES ROTARY PHENOLIC SWITCHES
2500 SERIES ROTARY CERAMIC SWITCHES

Total No. Poles	No. Positions	Poles per Section	No. Sections	CERAMIC		PHENOLIC	
				Catalog No. Shorting	Catalog No. Non-Shorting	Catalog No. Shorting	Catalog No. Non-Shorting
1	2-6	1	1	2500	2501	1400	1401
1	2-11	1	1	2502	2503	1402	1403
2	2-5	2	1	2504	2505	1404	1405
2	2-6	1	2	2510	2511	1410	1411
2	2-11	1	2	2512	2513	1412	1413
3	2-3	3	1	2506	2507	1406	1407
3	2-6	1	3	2520	2521	1420	1421
3	2-11	1	3	2522	2523	1422	1423
4	2	4	1	1408	1409
4	2-5	2	2	2514	2515	1414	1415
4	2-6	1	4	1426	1427
4	2-11	1	4	1428	1429
6	2-3	3	2	2516	2517	1416	1417
6	2-5	2	3	2524	2525	1424	1425
8	2	4	2	1418	1419
8	2-5	2	4	1430	1431

JV POWER SWITCHES

Total Poles	No. Positions	Poles per Section	No. Sections	Catalog No. Shorting	Catalog No. Non-Shorting
1	2-17	1	1	JV-9000	JV-9001
2	2-8	2	1	JV-9032	JV-9033
2	2-17	1	2	JV-9004	JV-9005
3	2-5	3	1	JV-9002	JV-9003
3	2-17	1	3	JV-9008	JV-9009
4	2-8	2	2	JV-9034	JV-9035
4	2-17	1	4	JV-9012	JV-9013
5	2-17	1	5	JV-9016	JV-9017
6	2-5	3	2	JV-9006	JV-9007
6	2-8	2	3	JV-9036	JV-9037
6	2-17	1	6	JV-9020	JV-9021
8	2-8	2	4	JV-9038	JV-9039
9	2-5	3	3	JV-9010	JV-9011
12	2-5	3	4	JV-9014	JV-9015
15	2-5	3	5	JV-9018	JV-9019

SEPARATE SECTIONS

For use with JV-7 index assembly. Sections 2 1/8" high, 2" wide, 2 1/4" strut centers, 3/8" thick.

Poles	Positions	Catalog No. Shorting	Catalog No. Non-Shorting
1	2-17	JV-8	JVN-8
2	2-8	JV-10	JVN-10
3	2-5	JV-9	JVN-9

SEPARATE MULTIPLE FINGER SECTION

Poles	Positions	Catalog No. Shorting	Catalog No. Non-Shorting
1	2-18	JV-18	JVN-18

(Rotor has 17 silver-plated phosphor bronze fingers, making contact with 17 contacts on stator leaving one contact open.) By cutting off unwanted fingers, this section can be adapted for many special circuits. For example, can be adapted to one off, nine progressively shorting positions, pick up and hold each progressive position.

SEPARATE INDEX ASSEMBLY

Indexing	Shaft Length	Sections No.	Catalog No.
20°	7"	2-6	JV-7

Contains: (1) JV-7W index with 7" rotor shaft, (2) P-5637 7 3/4" tie-rods, (6) P-5363 tie-rod nuts, (6) P-4665 tie-rod lockwashers, (12) P-9410 1/4" spacers, (1) P-168 2" black pointer knob, (24) P-7963 spacer washers, (1) P-21675 adjustable stop pin, (1) P-4088-1 stop pin nut, mounting nut and lockwasher; instruction sheet.

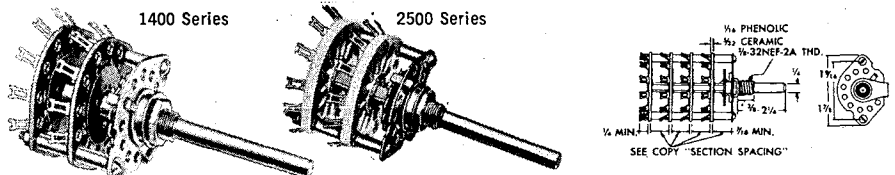

SEPARATE INDEX ASSEMBLIES

One piece construction with .187" rotor shaft, for use with 1400 Series phenolic or 2500 Series ceramic sections - AD through ZD. 30° positive index with adjustable stop. Packaged singly, including index, mounting nut and lockwasher, 1 1/4" black pointer knob Cat. No. P-120 and sufficient spacers, washers, tie-bolts, etc. to assemble complete switch. Assembly instructions furnished.

Suggested No. Sections	Catalog No.	Rear Shaft
1 to 3	P-270	2"
3 to 5	P-271	4"
5 to 10	P-272	8"

SEPARATE PHENOLIC SECTIONS

For use with P-270, P-271 and P-272 index assemblies. Sections 1 1/8" x 1 1/2" with 1 1/4" strut centers and 3/8" thick. Rotor slot .187". Clips and contacts, brass silver-plated. Breakdown voltage between critical parts 1000 VAC-RMS.

No. Poles	No. Positions	Shorting	Non-Shorting
1	2-6	AD	HD
1	2-11	BD	JD
2	2-5	CD	KD
3	2-3	DD	LD
4	2	ED	MD
4	2-3	EED	BBD
1	2-5	FD	AAD
(Unused contacts one side of common connected and shorted out.)			
1	2-11	GD	CCD
(All unused contacts connected and shorted out.)			
1	2-10	PID
(Nine active contacts, all open in full CW position, and progressively picked up and shorted to common contact with CCW rotation.)			
Combine for resistance decade		{ ND
		{ PD
Capacitance decade		QD

SEPARATE CERAMIC SECTIONS

For use with P-270, P-271 and P-272 index assemblies. Sections 1 1/8" x 1 1/2" with 1 1/4" strut centers and 3/8" thick. Rotor slot .187". Clips and contacts, brass silver-plated. Breakdown voltage between critical parts 1500 VAC-RMS.

No. Poles	No. Positions	Shorting	Non-Shorting
1	2-6	TD	XD
1	2-11	UD	YD
2	2-5	RD	RRD
3	2-3	SD	SSD
4	2	VD	ZD
1	2-11	GGD	FFD
(All unused contacts connected and shorted out.)			
1	2-10	PISD
(Nine active contacts, all open in full CW position, and progressively picked up and shorted to common contact with CCW rotation.)			
Combine for resistance decade		{ NSD
		{ PSD
Capacitance decade		QSD

PA-3000 Series SWITCHES

PA-4000 Series SWITCHES



CENTRAL LAB
Electronics Division
GLOBE-UNION INC.

The PA-3000 Series provides accurate crisp indexing in both single and multiple-section versions through the use of a new hill-and-dale index. Two removable adjustable stops provide a choice of 2 to 17 active positions or removal of the stops for continuous rotation.

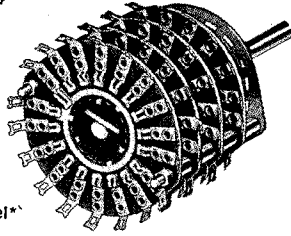
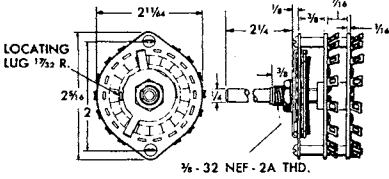

SPECIFICATIONS

- CONSTRUCTION:** Bolted
- MOUNTING:** Single hole, bushing mounted
- BUSHING:** 3/8" - 32NEF-2A thd., 3/8" long, steel*
- LOCATING LUG:** On 1/32" radius
- SHAFT:** 1/4" diameter, full round, 2 1/4" long from mounting surface, steel*
- INDEX ANGLE:** Positive 20°, adjustable stops or continuous rotation by removing both stops
- SECTION SPACING:** 3/8" spacing between front plate and first section; 1/8" spacing between sections
- INSULATION:** High quality laminated phenolic, type PBE per MIL-P-3115B. Voltage breakdown between critical parts 1000 VAC-RMS.
- SECTIONS:** Phenolic, 1/8" thick
- CLIPS AND CONTACTS:** Brass, silver-plated. Double eyelet construction clips.
- HARDWARE:** Index spring and front plate—stainless steel; index ball, black oxide steel; rotor wings—steel nickel-plate; all other parts, steel*
- CURRENT AND VOLTAGE RATING:** Make and break resistive load: 0.350 amp. @ 115 VAC; 2.25 amp. @ 28 VDC. Based on 10,000 cycle life test.
- CONTACT RESISTANCE:** Average initial resistance—5 milliohms.
- ROTATIONAL LIFE:** 25,000 cycles minimum
- PACKAGING:** Singly. Includes mounting nut and lockwasher. Sulphur-free cartons and Nox-Tarnish protective wrap insure long shelf life.

*Suitably plated to resist corrosion.

Total No. Poles	No. of Positions	Poles per Section	No. of Sections	Catalog No. Shorting	Catalog No. Non-Shorting
1	2-17	1	1	PA-3000	PA-3001
2	2-17	1	2	PA-3002	PA-3003
3	2-17	1	3	PA-3004	PA-3005
4	2-17	1	4	PA-3006	PA-3007

SEPARATE INDEX ASSEMBLY

One piece construction with wing drive rotor shaft for use with PA-393 Phenolic Section. 20° positive index with two adj. stops. Packaged singly including mtg. nut and L.W. and ceramic spacers, washers, tie-bolts and instruction sheet to assemble complete switch.

Catalog No.	Shaft Length	Number of Sections	Indexing
PA-330	4"	1-8	20°

Contains: (1) PA-330 index with 4" rotor shaft, (2) P-149 4 1/4" tie-rods, (3) P-148 tie-rod lockwasher, (3) P-147 tie-rod nut, (3) P-177 spacer washer, (14) P-7611 1/4" spacer, (2) P-7609 3/8" spacer.

SEPARATE PHENOLIC SECTION

No. Poles	No. Positions	Catalog No. Shorting	Catalog No. Non-Shorting
1	2-17	PA-393

Note: Above section will also replace sections on PA-3003, PA-3005 and PA-3007 Switches.

The PA-4000 Series of phenolic switches is designed to provide accurate, crisp indexing through the use of all new "hill-and-dale" index. All multiple section switches have new "wing type" rotor drive which minimizes rotation lag. Two removable adjustable stops simplify the choice of 2 to 23 active positions. Removal of both stops provide continuous rotation.

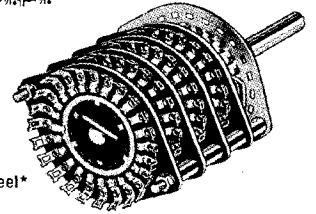
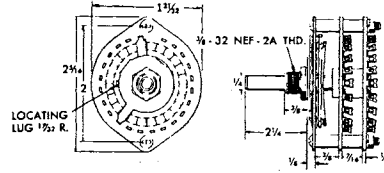

SPECIFICATIONS

- CONSTRUCTION:** Bolted
- MOUNTING:** Single hole, bushing mounted
- BUSHING:** 3/8" - 32NEF-2A thd., 3/8" long, steel*
- LOCATING LUG:** On 1/32" radius
- SHAFT:** 1/4" diameter, full round, 2 1/4" long from mounting surface, steel*
- INDEX ANGLE:** Positive 15°, adjustable stops or continuous rotation by removing both stops.
- SECTION SPACING:** 3/8" spacing between front plate and first section; 1/8" spacing between sections.
- INSULATION:** High quality laminated phenolic, type PBE per MIL P-3115B Voltage breakdown between critical parts 1000 VAC-RMS.
- SECTIONS:** Phenolic, 1/8" thick
- CLIPS AND CONTACTS:** Brass, silver-plated
- HARDWARE:** Index spring and front plate stainless steel; index ball, black oxide steel; rotor wings, steel nickel-plate; all other parts, steel*
- CURRENT AND VOLTAGE RATING:** Make and break resistive load: 5.5 amp. @ 6 VDC; 2.75 amp. @ 15 VDC; 1.5 amp. @ 28 VDC; 230 MA (0.230 amp.) @ 115 VAC; based on 10,000 cycles life test.
- CONTACT RESISTANCE:** Average initial resistance—5 milliohms.
- ROTATIONAL LIFE:** 25,000 cycles minimum
- PACKAGING:** Singly. Includes mounting nut and lock-washer. Sulphur-free cartons and Nox-Tarnish protective wrap insure long shelf life.

*Suitably plated to resist corrosion.

Total No Poles	No. of Positions	Poles per Section	No. of Sections	Catalog No. Shorting	Catalog No. Non-Shorting
1	2-23	1	1	PA-4000	PA-4001
2	2-23	1	2	PA-4002	PA-4003
3	2-23	1	3	PA-4004	PA-4005
4	2-23	1	4	PA-4006	PA-4007

SEPARATE INDEX ASSEMBLY

One piece construction with wing drive rotor shaft for use with PA-493 Phenolic Section. 15° positive index with two adj. stops. Packaged singly including mtg. nut and L.W. and ceramic spacers, washers, tie-bolts and instruction sheet to assemble complete switch.

Catalog No.	Rear Shaft	No. of Sections
PA-440	4"	1 to 8

SEPARATE PHENOLIC SECTION

No. Poles	No. Positions	Catalog No. Shorting	Catalog No. Non-Shorting
1	2-23	PA-493

Note: Above section will also replace sections on PA-4003, PA-4005 and PA-4007 Switches.



CENTRAL LAB

Electronics Division
GLOBE-UNION INC.

Lever Action SWITCHES

These units mounted singly or in groups on special plates, are adaptable to intercoms, public address systems, test instruments, broadcast, antenna interchange, speaker selection, record compensation, channel selection, galvanometers and many industrial applications.

SPECIFICATIONS

CONSTRUCTION: Staked
MOUNTING: Bracket mounted. Two 6-32 thd. mounting holes on 1 3/8" centers. Two 6-32 screws furnished.

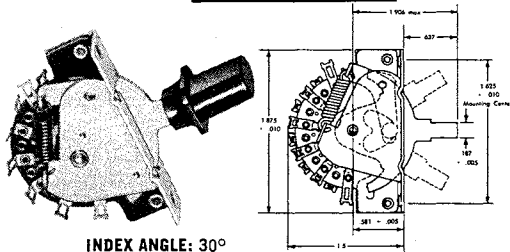

INDEX ANGLE: 30°
INSULATION: High grade laminated phenolic, type PBE, per MIL-P-3115B. Voltage breakdown between critical parts 1000 VAC-RMS.
CLIPS AND ROTOR CONTACTS: Brass, silverplated.
HARDWARE: All metal parts, except index spring—steel*.
CURRENT AND VOLTAGE RATING: Make and break resistive load: 1.5 amp. @ 28 VDC; 230 MA @ 115 VAC-RMS. Based on 10,000 cycle life test.
CONTACT RESISTANCE: Average initial resistance 3.5 milliohms.
ROTATIONAL LIFE: 25,000 cycles minimum.
PACKAGES: Singly, in sulphur-free carton and Nox-Tarnish protective wrap to insure long shelf life. Includes black push-on knob Cat. P-193 and two mounting screws.
*Suitably plated to resist corrosion.

1450, 1451, 1488, and 1489 Rotary Action SWITCHES

These 1 7/8" diameter switches feature various combinations of positive and spring return indexes which are ideally suited for long hard use in test equipment or in P.A. and intercom equipment.

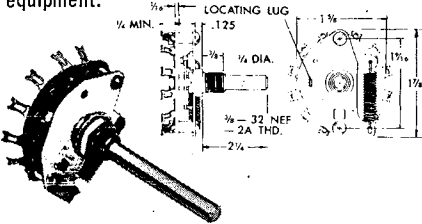

SPECIFICATIONS

CONSTRUCTION: Bolted, except Cat. No. 1450 — staked
MOUNTING: Single hole, bushing mounted
LOCATING LUG: 1488, 1489—one lug on 1/2" radius
SHAFTS: 1/2" diameter full round, steel*, 2 1/4" long from mounting surface.
INDEX ANGLE: 1450, 1451, 1488, 1489—30°
INSULATION: High quality laminated phenolic, type PBE per MIL-P-3115B. Voltage breakdown between critical parts 1000 VAC-RMS.
SECTIONS: Phenolic—3/8" thick
CLIPS AND ROTOR CONTACTS: Brass, silver-plated
HARDWARE: All other metal parts, except index springs, are steel*
CURRENT AND VOLTAGE RATING: Make and break resistive load: 5.5 amp. @ 6 VDC; 2.75 amp. @ 15 VDC; 1.75 amp. @ 28 VDC; 350 MA @ 115 VAC. Based on 10,000 cycle life test.
CONTACT RESISTANCE: Average initial resistance 3 milliohms
ROTATIONAL LIFE: 10,000 cycles minimum

SWITCH HARDWARE

FOR 1400 AND 2500 SERIES ROTARY SWITCHES

Catalog No.	Description
P-124	1/4" Metal Spacer
P-125	3/8" Metal Spacer
P-126	1/2" Metal Spacer
P-127	3/4" Metal Spacer
P-128	1" Metal Spacer
P-136	1" Screw
P-137	1 1/4" Screw
P-138	2" Screw
P-139	2 1/2" Screw
P-149	4 1/2" Screw
P-143	5" Screw
P-145	7" Screw
P-146	9" Screw
P-147	Nut
P-148	Lockwasher
P-177	Phenolic Spacer Washer
P-181	1/8" Steatite Spacer
P-187	1/4" Steatite Spacer
P-188	3/8" Steatite Spacer
P-189	1/2" Steatite Spacer
P-190	5/8" Steatite Spacer
P-192	1" Steatite Spacer

FOR PA-1000 AND PA-2000 SERIES MINIATURE ROTARY SWITCHES

P-319	Miniature Stop Plate
P-325	1/8" Min. Steatite Spacer
P-326	3/16" Min. Steatite Spacer
P-328	1/4" Min. Steatite Spacer
P-329	3/8" Min. Steatite Spacer
P-330	1/2" Min. Steatite Spacer
P-332	3/8" Min. Steatite Spacer
P-334	1/2" Min. Steatite Spacer
P-336	3/4" Min. Steatite Spacer
P-340	5/8" Min. Steatite Spacer
P-342	3/4" Min. Steatite Spacer
P-344	7/8" Min. Steatite Spacer
P-348	1" Min. Steatite Spacer
P-350	1 1/8" Min. Steatite Spacer
P-352	1 1/4" Min. Steatite Spacer

Catalog No.	Description
P-362	1" Miniature Screw
P-370	2" Miniature Screw
P-374	2 1/2" Miniature Screw
P-382	4" Miniature Screw
P-384	5" Miniature Screw
P-388	7" Miniature Screw
P-390	Miniature Nut
P-392	Miniature Lockwasher
P-394	Miniature Phenolic Spacer Washer

FOR PS-100 SERIES SUBMINIATURE ROTARY SWITCHES

Catalog No.	Description
P-515	1 1/8" Sub-Min. Screw
P-516	Sub-Miniature Nut
P-527	Sub-Miniature Lockwasher
P-519	Sub-Miniature Spacer Washer
P-520	1/8" Sub-Miniature Steatite Spacer
P-521	3/16" Sub-Miniature Steatite Spacer
P-522	1/4" Sub-Miniature Steatite Spacer
P-523	3/8" Sub-Miniature Steatite Spacer
P-524	1/2" Sub-Miniature Steatite Spacer

FOR PA-6000 SERIES MINIATURE MILITARY SWITCHES

Catalog No.	Description
P-395	Miniature MIL Screw
P-396	Miniature MIL Nut
P-397	Miniature MIL Lockwasher
P-398	Miniature MIL Glass Epoxy Spacer Washer

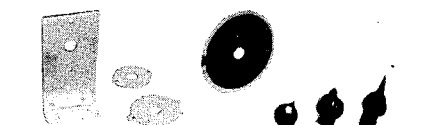

KNOB

Description	Cat. No.
1 1/4" Round Pointer Knob, Black, set screw, 1/4" Dia. Hole	P-106
1 1/2" Black Pointer Knob (set screw)	P-120
2" Black Pointer Knob Brass insert, 2 set screws (power)	P-168

WALL OUTLET TYPE PLATES

For installations where conduit and outlet boxes are used, permits mounting 1 or 2 units in outlet boxes—chrome satin finish.

No. of Switches	Catalog No.	Length	Width
1	P-222	2 3/4"	4 1/2"
2	P-221	2 3/4"	4 1/2"

1452 SERIES—LEVER ACTION SWITCHES

No. Poles	No. Positions	Type Indexing	Cat. No. Shorting	Cat. No. Non-Shorting
2	3	Positive	1452	1454
2	3	Spring Return	1453	1455
2	3	Positive & Sp. Ret.	1466	1467
4	2	Spring Return	1456	1457
4	2	Positive	1459	1458
1	3	Positive	1475*

* (Primarily a replacement part for the ganged switches found in tube testers and other testing equipment.)

2	3	Positive	2815
---	---	----------	------	-------

(Special model railroad reversing switch.)

PACKAGED: Singly, including mounting nut and lockwasher Nos. 1451, 1488, 1489 include (1) P-198 paddle knob. No. 1450 includes (1) P-120 pointer knob. Sulphur-free cartons and Nox-Tarnish protective wrap insure long shelf life.
*Suitably plated to resist corrosion.

ROTARY ACTION SWITCHES

Total No. Poles	No. Sections	No. Indexing	Cat. No. Non-Shorting
4	2	1 Positive	1450
(Can be used as SPST and up to 4 pole, 2 position.)			
4	2	1 Spring Return	1451
(Designed especially for "Press to talk" intercom systems.)			
6	3	2 Spring Return	1488
(Spring return both sides to center. Will replace any switch from 2 pole-2 position to 6 pole-3 position.)			
6	3	2 Positive & Spring Return	1489
(Spring return index one side to center, positive index opposite side to center.)			

Description	Cat. No.
Lever Switch—Black	P-193
Lever Switch—Red	P-194
1 1/2" Paddle—Walnut (PA and intercom)	P-198
1 3/8" Round, Split Knurl (Push on), Black with Chrome Center	P-401

INTERSECTION SHIELDS

MINIATURE—.035" thick, steel. Use with PA-1000 or PA-2000 Series Switches to reduce coupling effects.
Miniature ShieldCat. No. P-320
STANDARD—.035" thick. Use with 1400 or 2500 Series Switches between sections to reduce coupling effects.
Standard ShieldCat. No. P-200

DIAL PLATES

Etched aluminum, black background. 1 7/8" dia.
1-2-3 30° P-178 1-2-3-4 90° P-162
1 to 5 30° P-115 10-20-40- 90° P-163
1 to 6 30° P-116 80 60° P-402
1 to 10 30° P-117 1 to 5 60° P-402
1 to 11 30° P-118 10-15-20- 60° P-404
1 to 12 30° P-112 40-80 60° P-404
1 to 23 15° P-173

2 3/4" diameter, etched aluminum, 20° marking for power switches.
1 to 5 20° P-230 1 to 17 20° P-231
1 to 8 20° P-232

MOUNTING BRACKETS

For 1400 and 2500 series. .065" cadmium-plated steel. Use to mount between sections for rigidity, or at rear of long switch assemblies for more accurate indexing. Footed, with slotted mounting holes (1" centers) to chassis.
All 1 3/8" wide.

Bracket 1 1/4" from Base to Shaft Center	Cat. No. P-210
Bracket 2 1/4" from Base to Shaft Center	Cat. No. P-212
Bracket 3 1/4" from Base to Shaft Center	Cat. No. P-214

Bracket-Dial Plate—dual speaker	Etched aluminum—(1483-1484 switches)
Bracket-Dial Plate—4 channel dual lines	Etched aluminum (PA-2050 switch) Cat. No. P-216
Bracket-Dial Plate—4 channel dual lines	Etched aluminum (PA-2050 switch) Cat. No. P-218

ROTARY SWITCH KITS

These Centralab Switch kits afford a convenient, readily available source of stock sections, indexes and hardware for assembling 1 1/4" or 1 1/8" diameter phenolic or ceramic switches. All five SWK-810-860 kits are packed in rugged heavy gauge steel, shelf size cabinets, 23 1/4" wide, 9 1/2" high and 12" deep. All five SWK-400-480 kits are 10" x 11 1/2" x 10".

SWK-400 KIT

PS-100 SERIES SUB-MINIATURE CERAMIC SWITCH PARTS

Ceramic Sections—30° Indexing

Qty.	Cat. No. Shorting	Qty.	Cat. No. Non-Shorting	Poles per Section	No. Positions
3	PS-20	5	PS-21	1	2-11
3	PS-22	5	PS-23	2	2-5
3	PS-24	4	PS-25	3	2-3
3	PS-26	4	PS-27	4	2

Index Assemblies—30° Indexing

Qty.	Catalog No.	No. Positions	Qty.	Catalog No.	No. Positions
2	P-501	2	1	P-506	7
2	P-502	3	1	P-507	8
1	P-503	4	1	P-508	9
2	P-504	5	1	P-509	10
1	P-505	6	2	P-510	11
			2	P-511	Continuous Rotation

One switch cross reference included. Includes all necessary hardware to build 16 switches up to 3 sections per switch.

SWK-410

PA-1000 SERIES MINIATURE PHENOLIC SWITCH KIT

Contains 48—1 1/8" diameter phenolic sections, 13 complete index assemblies, plus hardware for constructing 13 phenolic standard or special switches.

Sections—30° Indexing

Qty.	Cat. No. Shorting	Qty.	Cat. No. Non-Shorting	Poles per Section	No. Positions
4	PA-30	8	PA-31	1	2-11
4	PA-32	8	PA-33	2	2-5
2	PA-34	4	PA-35	3	2-3
2	PA-36	4	PA-37	4	2
2	PA-38	2	PA-39	1	2-5
2	PA-40	2	PA-41	1	2-11
2	PA-49	1	2-10

Sections—60° Indexing

Qty.	Cat. No. Shorting	Qty.	Cat. No. Non-Shorting	Poles per Section	No. Positions
.....	2	PA-45	1	2-6

13 Index Assemblies and 5 Dial Plates

One switch cross-reference included. Kit packed in 4 drawer metal cabinet 10" x 11 1/2" x 10".

SWK-420

PA-2000 SERIES MINIATURE CERAMIC SWITCH KIT

Contains 52—1 1/2" diameter ceramic switch sections, 13 complete index assemblies, plus hardware for assembling 13 regular or special ceramic switches.

Sections—30° Indexing

Qty.	Cat. No. Shorting	Qty.	Cat. No. Non-Shorting	Poles per Section	No. Positions
4	PA-0	8	PA-1	1	2-12
4	PA-2	6	PA-3	2	2-6
2	PA-4	4	PA-5	3	2-5
2	PA-6	4	PA-7	5	2-3
2	PA-8	4	PA-9	6	2
2	PA-10	2	PA-19	1	2-5
2	PA-11	2	PA-18	1	2-11
2	PA-12	1	2-10

Sections—60° Indexing

Qty.	Cat. No. Shorting	Qty.	Cat. No. Non-Shorting	Poles per Section	No. Positions
.....	2	PA-17	1	2-6

13 Index Assemblies and 5 Dial Plates

One switch cross-reference included. Kit packed in 4 drawer metal cabinet 10" x 11 1/2" x 10".

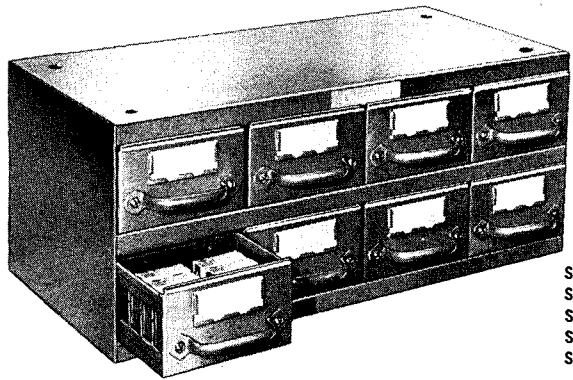

SWK-810
SWK-814
SWK-820
SWK-825
SWK-860

SWK-460 KIT

CONTAINS PA-6000 SERIES STYLE SR03 MINIATURE MILITARY PHENOLIC SWITCH PARTS BUILT TO MEET MIL-S-3786A

Phenolic Sections—30° Indexing

Qty.	Cat. No. Shorting	Qty.	Cat. No. Non-Shorting	Poles per Section	No. Positions
6	PA-60	8	PA-61	1	2-11
5	PA-62	8	PA-63	2	2-5
4	PA-64	6	PA-65	3	2-3
4	PA-66	4	PA-67	4	2

Index Assembly 30° Indexing

Qty.	Catalog No.	Shaft	Qty.	Catalog No.	Positions
15	PA-600	2"	1	P-115	1-5
			1	P-116	1-6
			1	P-117	1-10
			1	P-118	1-11
			1	P-178	1-2-3

Includes all necessary hardware to build 15 MIL switches up to 4 sections per switch.

SWK-480 KIT

CONTAINS PA-6000 SERIES STYLE SR03 MINIATURE MILITARY CERAMIC AND MYCALEX SWITCH PARTS BUILT TO MEET MIL-S-3786A

Ceramic Sections—30° Indexing

Qty.	Cat. No. Shorting	Qty.	Cat. No. Non-Shorting	Poles per Section	No. Positions
2	PA-80	4	PA-81	1	2-11
2	PA-82	4	PA-83	2	2-5
2	PA-84	4	PA-85	3	2-3
2	PA-86	4	PA-87	4	2

Mycalex Sections—30° Indexing

Qty.	Cat. No. Shorting	Qty.	Cat. No. Non-Shorting	Poles per Section	No. Positions
2	PA-70	2	PA-71	1	2-11
2	PA-72	2	PA-73	2	2-5
2	PA-74	2	PA-75	3	2-3
2	PA-76	2	PA-77	4	2

Index Assembly 30° Indexing

Qty.	Catalog No.	Shaft	Qty.	Catalog No.	Positions
15	PA-600	2"	1	P-115	1-5
			1	P-116	1-6
			1	P-117	1-10
			1	P-118	1-11
			1	P-178	1-2-3

Includes all necessary hardware to build 15 MIL switches up to 4 sections per switch.

SWK-810

PA-1000 SERIES MINIATURE PHENOLIC SWITCH PARTS

Phenolic Sections—30° Indexing

Qty.	Cat. No. Shorting	Qty.	Cat. No. Non-Shorting	Poles per Section	No. Positions
10	PA-30	16	PA-31	1	2-11
8	PA-32	14	PA-33	2	2-5
6	PA-34	10	PA-35	3	2-3
4	PA-36	8	PA-37	4	2
4	PA-38	6	PA-39	1	2-5
4	PA-40	4	PA-41	1	2-11
2	PA-43	1	2-10
2	PA-49	1	2-10

Phenolic Sections—60° Indexing

Qty.	Cat. No. Shorting	Qty.	Cat. No. Non-Shorting	Poles per Section	No. Positions
.....	8	PA-45	1	2-6

32 Index Assemblies and 35 Dial Plates

Plus sufficient spacers, screws, washers, nuts, knobs and shields for 32 regular or special switches. One switch cross-reference included.

DISTRIBUTOR PRODUCTS



CENTRALAB

Electronics Division
GLOBE-UNION INC.

SWK-814

1400 SERIES PHENOLIC SWITCH PARTS

Phenolic Sections—30° Indexing

Qty.	Cat. No. Shorting	Qty.	Cat. No. Non-Shorting	Poles per Section	No. Positions
4	AD	8	HD	1	2-6
6	BD	12	JD	1	2-11
8	CD	16	KD	2	2-5
4	DD	8	LD	3	2-3
2	ED	6	MD	4	2
2	EED	4	BBD	4	2-3
2	FD	4	AAD	1	2-5
2	GD	4	CCD	1	2-10
2	PID	1	2-10
2	ND	} Combine for resistance decade switch — for capacitance decade switch			
2	PD				
2	QD				

30 Index Assemblies and 30 Dial Plates

Plus sufficient spacers, screws, washers, nuts, knobs, shields and brackets for 30 regular or special switches. One switch cross-reference included.

SWK-820

PA-2000 SERIES MINIATURE CERAMIC SWITCH PARTS

Ceramic Sections—30° Indexing

Qty.	Shorting Cat. No.	Qty.	Cat. No. Non-Shorting	Poles per Section	No. Positions
8	PA-0	16	PA-1	1	2-12
6	PA-2	12	PA-3	2	2-6
6	PA-4	10	PA-5	3	2-5
4	PA-6	8	PA-7	5	2-3
4	PA-8	6	PA-9	6	2
2	PA-10	2	PA-19	1	2-5
2	PA-11	2	PA-18	1	2-11
2	PA-12	1	2-10
2	PA-13	1	2-10

Ceramic Sections—60° Indexing

2	PA-20	8	PA-17	1	2-6
---	-------	---	-------	---	-----

32 Index Assemblies and 35 Dial Plates

Plus sufficient spacers, screws, washers, nuts, knobs and shields for 32 regular or special switches. One switch cross-reference included.

SWK-825

2500 SERIES CERAMIC SWITCH PARTS

Ceramic Sections—30° Indexing

Qty.	Cat. No. Shorting	Qty.	Cat. No. Non-Shorting	Poles per Section	No. Positions
4	TD	8	XD	1	2-6
6	UD	12	YD	1	2-11
8	RD	14	RRD	2	2-5
6	SD	10	SSD	3	2-3
2	VD	6	ZD	4	2
2	GGD	4	FFD	1	2-10
2	PISD	1	2-10
2	NSD	} Combine for resistance decade switch — for capacitance decade switch			
2	PSD				
2	QSD				

Sections—60° Indexing

....	10	ZZD	1	2-6
------	-------	----	-----	---	-----

29 Index Assemblies and 30 Dial Plates

Plus sufficient spacers, screws, washers, nuts, knobs, shields and brackets for 29 regular or special switches. One switch cross-reference included.

SWK-860 KIT

CONTAINS PA-6000 SERIES STYLE SR03 MINIATURE MILITARY SWITCH PARTS BUILT TO MEET MIL-S-3786A

Ceramic Sections—30° Indexing

Qty.	Cat. No. Shorting	Qty.	Cat. No. Non-Shorting	Poles per Section	No. Positions
4	PA-80	5	PA-81	1	2-11
4	PA-82	5	PA-83	2	2-5
4	PA-84	4	PA-85	3	2-3
3	PA-86	3	PA-87	4	2

Phenolic Sections—30° Indexing

3	PA-60	4	PA-61	1	2-11
3	PA-62	4	PA-63	2	2-5
3	PA-64	3	PA-65	3	2-3
2	PA-66	2	PA-67	4	2

Mycalex Sections—30° Indexing

3	PA-70	3	PA-71	1	2-11
3	PA-72	3	PA-73	2	2-5
2	PA-74	2	PA-75	3	2-3
2	PA-76	2	PA-77	4	2

35 Index Assemblies and 25 Dial Plates

Includes all necessary hardware to build 35 MIL switches with up to 4 sections per switch.

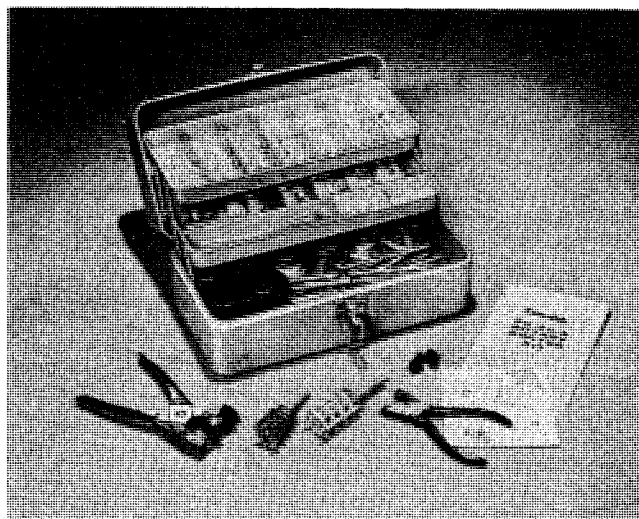

PARTS LIST FOR PK-20-S ROTARY SWITCH KIT

Cat. No.	Description
P8884-11	Clip 60° Short bent
P888-11	Clip 60° Long bent
P18407-11	Clip Reverse Short bent
P18408-11	Clip Reverse Long bent
P17894-11	Clip Insulated Long bent
P17896-11	Clip Insulated Short bent
P32312-11	Plug-in Clip Short bent
P32313-11	Plug-in Clip Long bent
P9251-11	Clip Dummy 60° bent
P30807	Insulator Block glass epoxy
P2708-11	Rivet for insulating to ceramic
Y37987-11	Eyelet for insulating to phenolic
P25611-11	Eyelet for phenolic stator
P16076-11	Eyelet for ceramic stator
P9093	Stator .062 thick phenolic
P31161	Stator .062 thick epoxy glass
P9097	Stator .100 thick ceramic
P9098	Stator .100 thick ceramic
P20483	Stator .031 thick 10 side
P20484	Stator .031 thick 12 side
P9101	Rotor phenolic .036 thick (use 2)
P9107	Rotor ceramic .115 thick
P29716	Rotor ceramic (must use with glass stator)
P10377-11	Contact for phenolic stator
P10225-11	Contact for phenolic stator
P10404-11	Contact for phenolic stator
P10823-11	Contact for phenolic stator
P9979-11	Contact for phenolic stator
P10205-11	Contact for phenolic stator
P10320-11	Contact for phenolic stator
P31990-11	Contact for phenolic stator
P31991-11	Contact for phenolic stator
P10648-11	Contact for ceramic stator
P10375-11	Contact for ceramic stator
P10207-11	Contact for ceramic stator
P10080-11	Contact for ceramic stator
P10218-11	Contact for ceramic stator
P10378-11	Contact for ceramic stator
P10405	Contact for ceramic stator
P18147	Spacers 3/16" long
P18149	Spacers 3/8" long
P18145	Spacers 1/4" long
P31063	Spacers 3/16" long
P18148	Spacers 1/32" long
P9416	Screw 3" long
P10667	Screw 6" long
P9408	Nut for struts
P30201	Lockwasher for struts
P9226	Cushion spacer washer
P10815	Adjustable stop
P9113	Rotor retainer
P10816	Intersection shield
P45121	3 amp 125 volt AC line switch assembly
P37462	Shaft extension to activate line switch
AK-16	Coupler for connecting shafts
P11039-00	C Ring
PS028-008	Index assemblies
PS028-202	60° index front plate assembly
42-927	Contact leg twisting tool
42-212R	Eyeletting pliers
	Nibbling pliers with acorn nut
	Punches (Splitting, non-shorting, shorting)
	Series 20 specification sheets
	Switch visualizer

A complete line of LEVER SWITCHES by GENERAL CONTROL COMPANY

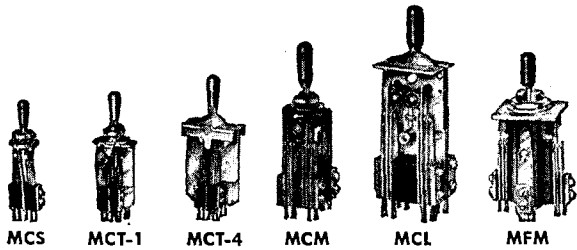

Type	Amps.*	High	Wide	Long**
MCS	1 or 3	7/8"	7/8"	2-1/16"
MCT-1	1 or 3	1 1/2"	3/4"	2-5/16"
MCT-4	1 or 3	1 1/2"	3/4"	2-17/32"
MCM	5	1 1/2"	1 1/4"	2-25/32"
MCL	10	1 3/4"	1 3/8"	3-15/16"
MFM	5	1 3/4"	1 3/4"	3"

*125 volts, 60 cycles, non-inductive.
**From back panel to end of terminals.

Write for data Sheet CLR M

LEVER OPERATION

Symbol	Three Position	Two-Position	Half Three	Two-Position	Full Three
Lock (Stays put)					
Non-lock (Spring return)					
Designation	MCS S1	*S2 S3	*S4 *S5	T1 T2 T3	*T4 *T5
	MCA M1	*M2 M3	*M4 *M5	M6	*M7
	MCL L1	*L2 L3	*L4 *L5		

*Lock and non-lock positions may be reversed. To reverse designate as R32, R34, R35, etc.



SPECIAL MCM LEVER
(A) waterproof lever
\$4.45 EACH, LST

MFM

DESCRIPTION	LOCK	NON-LOCK	FOUR-POSITION
SYMBOL			
OPERATION			
OPERATION No.	M8	M9	M10 M11 M12

CONTACTS

FRAME TYPES AND PRICES

Frame Type	Price
MS	\$ 1.80
MCT-4	\$ 2.15
MCT-1	\$ 2.70
MCM	\$ 4.00
MFM	\$18.50
MCL	\$ 5.40

Contact Forms

CIRCUIT	A	B	C	D	E	F	G	H	O
									No Contacts

To obtain list price—
add
contact prices
to frame price.

MCS 1 amp.	0.55	0.55	0.65	*	—	0.65	—	0.65	—
MCS 3 amp.	.65	.65	.80	*	—	.80	—	.80	—
MCT-4 1 amp.	.55	.55	.65	.85	.95	.65	—	.65	—
MCT-4 3 amp.	.65	.65	.80	1.00	1.12	.80	—	.80	—
MCT-1 1 amp.	.55	.55	.65	.85	.95	.65	—	.65	—
MCT-1 3 amp.	.65	.65	.80	1.00	1.12	.80	—	.80	—
MCM 5 amp.	.85	.85	1.00	1.25	1.60	1.00	1.00	1.00	—
MFM 5 amp.	.85	.85	1.00	1.25	1.60	1.00	1.00	1.00	—
MCL 10 amp.	1.25	1.25	1.45	1.75	2.70	1.45	1.45	1.45	—

PUSH-BUTTON SWITCHES by GENERAL CONTROL COMPANY

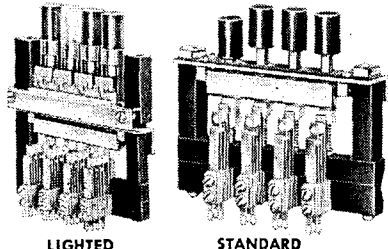

SP5-LPS FRAME PRICES 5/8" or 3/4" Button Centers

Buttons	2	3	4	5	6	7	8	9	10	11	12	13	14	15	16
B12 SPS	\$12.00	\$14.15	\$16.50	\$19.40	\$22.35	\$25.25	\$28.15	\$31.10	\$34.25	\$37.45	\$40.65	\$43.85	\$47.00	\$50.20	\$53.40
B12 LPS	21.30	26.50	31.90	38.00	44.20	50.45	56.65	62.85	70.45	77.20	85.55	90.75	97.50	104.30	111.05
B13 SPS	10.95	13.10	15.25	18.15	21.05	24.00	26.90	29.80	32.75	35.90	39.10	42.30	45.50	48.70	51.85
B13 LPS	20.25	25.45	30.50	36.75	42.95	49.15	55.40	61.60	69.20	75.95	84.25	89.50	96.25	103.00	109.80
B14 SPS	10.35	11.65	13.20	15.30	17.40	19.50	21.55	23.65	26.00	28.40	30.75	33.10	35.50	37.85	40.20
B14 LPS	19.65	24.05	28.50	33.90	39.25	44.65	50.05	55.45	62.50	68.40	74.35	80.30	86.25	92.20	98.10
B15 SPS	9.30	10.60	11.95	14.00	16.10	18.20	20.30	22.40	24.50	26.85	29.20	31.60	33.95	36.30	38.65
B15 LPS	18.60	23.00	27.25	32.60	38.00	43.40	48.80	54.20	60.95	66.90	72.80	78.75	84.70	90.65	96.60
B16 SPS	8.20	9.25	10.30	12.30	14.35	16.40	18.45	20.45	22.50	24.75	27.05	29.40	31.70	34.00	36.30
B16 LPS	17.50	21.60	25.60	30.90	36.25	41.60	46.90	52.25	58.95	64.80	70.70	76.55	82.45	88.35	94.20
B17 SPS	9.25	10.30	11.55	13.60	15.60	17.65	19.70	21.75	24.05	26.30	28.60	30.90	33.20	35.53	37.85
B17 LPS	18.55	22.65	26.85	32.20	37.50	42.85	48.20	53.50	60.50	66.35	72.20	78.10	84.00	89.90	95.75
B18 SPS	11.60	14.35	17.10	20.85	24.60	28.35	32.05	35.80	34.55	43.50	51.55	55.55	59.55	63.60	
B18 LPS	20.90	26.75	32.40	39.45	46.50	53.50	60.55	67.60	76.00	83.55	91.15	98.75	106.30	113.90	121.50
B19 SPS	12.65	15.40	18.40	22.10	25.85	29.60	33.35	37.10	41.10	45.05	49.05	53.10	57.10	61.10	65.10
B19 LPS	21.95	27.80	33.65	40.70	47.75	54.80	61.80	68.85	77.55	85.10	92.70	100.25	107.85	115.45	123.00

Note: Additional frame operations available. Contact General Control.

OPERATIONS

B12 POSITIVE LOCK-IN LOCK-OUT
Only one button can be depressed at a time. The Momentary Release button must be actuated to release any previously depressed button before any other button can be actuated.

B13 ACCUMULATIVE LOCK
Buttons pushed in remain locked in position until released by pushing reset button.

B14 NO-TWO-INTERLOCK
Only one button can be pushed in at one time, and releases any other button.

B15 LOCK-RELEASE
Any button pushed in releases any previously pushed in button.

B16 NON-LOCK
Has no locking action; returns to normal position on release of finger pressure.

B17 NON-LOCK, NO-TWO-OPERATIVE
The same as B16 except that no two buttons can be operated simultaneously.

B18 PUSH-LOCK, PUSH-RELEASE
Any button depressed remains locked in until that button is depressed again.

B19 PUSH-LOCK, PUSH-RELEASE, (WITH LOCK-OUT)
This is the same as B18 except that only one button can be depressed at a time.

CONTACTS

CONTACT FORMS	A	B	C	D	H
1 amp silver	\$0.55	\$0.55	\$0.65	\$0.90	\$0.65
3 amps paladium alloy	.65	.65	.80	1.05	.80
Direction of Throw					

Ratings of 125 volts, A. C. n.i. * In place of a "D" contact we can offer a "C" contact adjusted to provide make before break operation.

WRITE FOR DATA SHEET SLRM

ORDERING INFORMATION

1. Frame Type SP54	2. Operation B14	3. Contacts A-C-2A-2C	4. Contact Location TOP Mounted	5. Rating 3 amps.	6. Button Centers 5/8"
\$13.20		.65+ .80+1.30+1.60			= \$17.55

"Footrol" FOOT SWITCHES



MA - \$8.00 MI - \$14.00 MC - \$14.00

WRITE FOR BULLETIN FSRM

LIMIT SWITCHES

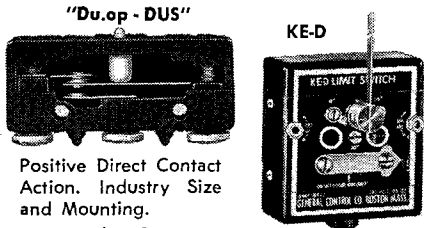

Positive Direct Contact Action. Industry Size and Mounting.
\$1.80

Adjustable contacts open and close in 360°. 73° pre or overtravel clock or counter wise. Quick conversion to rotary switch. Adjustable sensitivity.

Standard Model \$18.00

Write for Bulletin KDRM

THE WORLD'S FINEST SELECTION OF MAGNETIC REED SWITCHES BY **HAMLIN** INC.



HAMLIN, INC. has been the world leader in the design and manufacture of Magnetic Reed Switches since they first introduced them to industry in 1957. **HAMLIN** switches have met every conceivable test in the broad range of environmental and electrical applications. As the pioneer in the development of dry reed switches, **HAMLIN, INC.** offers the finest selection of magnetic reed switches in the world.

HAMLIN switches will operate in any position. May be actuated by either permanent or electro-magnets. Hermetically sealed for safe, reliable use in any atmosphere, wet or dry, even under explosive conditions. Unaffected by extremely high or low temperatures or pressures. Small size, high sensitivity, rapid cycling rate and long life make these units ideal for use in position indicators, counting instruments, limit switches, liquid level switches, flow meters and commutating instruments.

ILLUSTRATIONS
ACTUAL SIZE

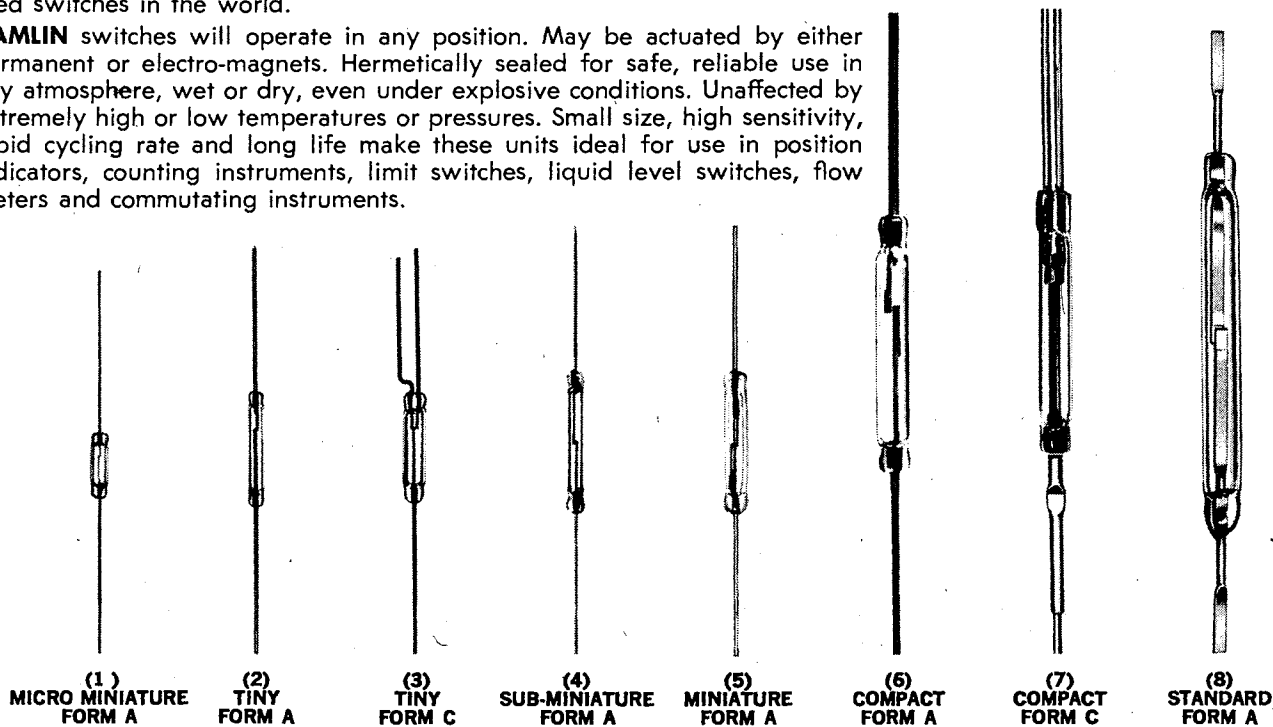

Switch Part No.	Size	Form	Actuating Magnet	D.C. Contact Rating	Maximum Amps	D.C. Maximum Voltage	Maximum Contact Resistance	D.C. Minimum Breakdown Voltage	Quantity Price Break			Special Features
									1-24	25-99	100-999	
MMRR-2-185	1	A	H-31	.3W	.010	28	.200	250	1.84	1.31	1.05	World's Smallest Reed Switch
MTRR-2-185	2	A	H-33	10W	.250	100	.150	250	1.32	.95	.75	Universal Rhodium Contacts
MRG-DT-175	3	C	H-33	3W	.250	28	.150	250	4.20	3.00	2.40	Smallest Form C
MSRG-2-185	4	A	H-33	10W	.500	50	.150	300	1.05	.75	.60	Low Cost Standard
MSRR-2-185	4	A	H-33	10W	.500	200	.100	300	1.15	.83	.66	Universal Rhodium Contacts
MRG-2-185	5	A	H-33	10W	.500	50	.150	300	1.05	.75	.60	Low Cost Standard
MRR-2-185	5	A	H-33	10W	.500	200	.100	300	1.15	.83	.66	Universal Rhodium Contacts
MRO-2-235	5	A	H-34	1W	.001	1000	.100	2000	6.30	4.50	3.60	High Breakdown Voltage
MRC-3-387	5	A	H-33	28W	1.0	100	.050	1000	4.20	3.00	2.90	Mercury Wetted Contacts
SRR-2-425	6	A	H-32	15W	1.0	400	.060	500	.89	.64	.51	Universal Rhodium Contacts
DRG-DTH-445	7	C	H-32	10W	.500	250	.075	1000	2.63	1.88	1.50	High Breakdown Form C
DRG-2-425	8	A	H-34	15W	1.0	250	.075	500	.79	.56	.45	Low Cost Standard
DRR-1-425	8	A	H-34	15W	1.0	400	.060	500	.89	.64	.51	Universal Rhodium Contacts
DRT-5-425	8	A	H-34	50W	3.0	1000	.100	1500	2.10	1.50	1.20	Inductive Load Type Contacts
DRVT-10-658	8	A	H-34	50W	3.0	5000	.080	10,000	4.20	3.00	2.40	10,000 Volt Breakdown
HRC-1-535	8	A	H-34	50W	3.0	400	.050	1000	2.10	1.50	1.20	Mercury Wetted Contacts

MAGNETS BY **HAMLIN**:

ALNICO V BAR MAGNETS

H-31 - 604	$\frac{1}{16} \times \frac{1}{16} \times \frac{1}{2}$ "30
H-32 - 605	$\frac{3}{16} \times \frac{3}{16} \times 1$ "35
H-33 - 606	$\frac{1}{8} \times \frac{1}{8} \times \frac{3}{4}$ "30
H-34 - 607	$\frac{1}{4} \times \frac{1}{4} \times 1$ "40

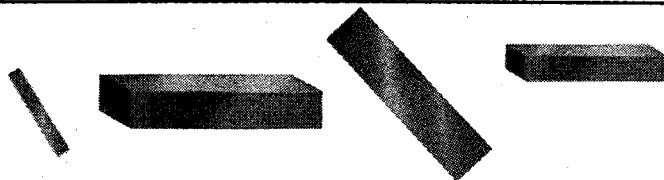

IRC-CTS EXACT DUPLICATE POWER SWITCHES



IRC, DIVISION OF TRW INC.

Exact duplicate replacements for pull-on, push-off power switches used on CTS 45 series controls. The quickest, most reliable switch replacements. Easy to install — eliminates double work of removing switch from cover and reinstalling. Prevent costly call-backs on universal adaptations.

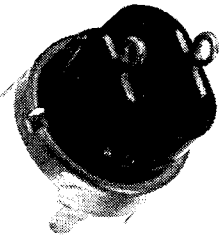

TK-1. Latest development of original CTS TK switch. Uses new molded actuator for greater fatigue strength. Mounted on two-tap switch cover for use on CTS 45 series controls ($1\frac{5}{16}$ " diameter) without element tap or with either one or two element taps. Replaces TK switch only — not used for replacement of original K switches.

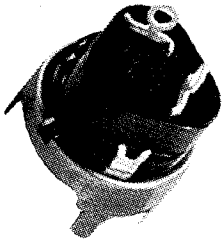

AK-1. Up-rated and improved replacement for CTS K switch. Rated at 5 amperes instead of 3 amperes to withstand heavy surges found in some applications. Mounted on two-tap cover for use on CTS 45 series controls ($1\frac{5}{16}$ " diameter) without element tap or with one or two element taps. Replaces K switch only — not used for replacement of original TK switches.

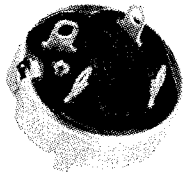

WFR. A reverse-action double pole, single throw switch for bracket-mounting on CTS 45 series controls to provide pull-on, push-off switch action. Switch element only — mounts on original bracket by bending over three lugs.

HIGH VOLTAGE RESISTORS FOR COLOR TV

SPECIFICATIONS

Type MV47 — 6000 Volts, 47 Meg. $\pm 20\%$
Type MV66 — 6000 Volts, 66 Meg. $\pm 20\%$

EXACT DUPLICATE ORIGINAL EQUIPMENT PART is available in two ranges for complete coverage, 47 and 66 megohms.

Film type axial lead resistors. Resistive coating applied in helical path on ceramic tube, providing long, effective resistance length with exceptional stability. Precise mechanical spacing of helical turns gives a uniform pitch, and allows uniform voltage gradient throughout the length of the resistor. All resistors are pre-cured and the resistance coating is stabilized at high temperature to eliminate appreciable aging. Temperature coefficient of approximately $-1\%/^{\circ}\text{C}$ over temperature range of -55°C to $+105^{\circ}\text{C}$.

HIGH VOLTAGE RESISTOR ASSORTMENTS

ASSORTMENT #100 — 25 MV47 resistors, packaged one to a display card, 5 cards to a strip. Contains 5 strips.

ASSORTMENT #101 — 25 MV66 resistors, packaged one to a display card, 5 cards to a strip. Contains 5 strips.



Attractive new SNAP PAK style package. Back of card contains complete replacement information.



IRC-CTS ROTARY SELECTOR SWITCHES

IRC, DIVISION OF TRW INC.

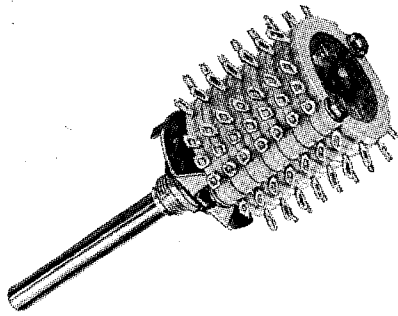

Switch Wafers Assembled
Without Spacers

1 Piece Molded
Construction —
Not Riveted

Soldering Heat Or
Handling Cannot
Loosen Terminals

Delicate Parts Are
Not Exposed To
Handling

Molded Glass Alkyd
Insulation Won't Break,
Even If Dropped

Terminals Molded Into
Exact Permanent Position

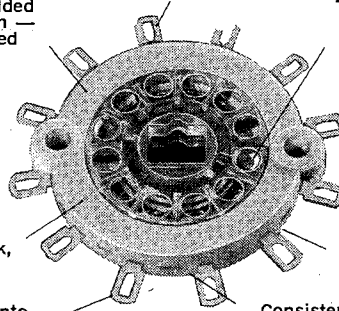

Natural Barrier Prevents
Solder From Flowing
Into Circuit

Consistent Insulation Barrier
Due To Exact Terminal Spacing
and Molded Glass Alkyd Material

SELECTOR SWITCH UNIQUE 1-PIECE MOLDED WAFER PROVIDES HIGH RELIABILITY

The new IRC-CTS design goes right to the heart of selector switch reliability . . . the wafer. Automated manufacture provides unprecedented uniformity. One-piece *molded* construction of the wafer virtually eliminates drift. In each production run, all switches are identical, terminal placement is exact and permanent. Machine exactness replaces human error and variation, eliminating wide tolerances and assuring high reliability.

- Compact 1 1/8" size design allows more circuitry per unit of depth behind panel.
- Rivet-free construction permits closer stacking.
- Superior insulation due to repetitive exactness in terminal spacing, and molded glass alkyd material.
- Rotor contacts are double-wiping and self-cleaning.
- Stator contacts are integral with terminals.
- Molded stator will not break or crush during ordinary handling, or if it is dropped.

GENERAL SPECIFICATIONS

	COMMERCIAL TYPE 212 SERIES	INDUSTRIAL-MILITARY TYPE M-212 SERIES
INSULATION:	Stator—Glass Alkyd Resin Rotor—IL Grade Glass-Filled Nylon	Stator—Type MAI-30 per MIL-M-21699 Rotor—IL grade glass-filled nylon
STATOR CONTACTS AND TERMINAL LUG MATERIAL	Brass Silver Plated movable contacts. Terminals and stator are brass, silver plated.	Military grade brass, silver plated movable contacts. Terminals and stator are brass, silver plated.
OPERATING TEMPERATURE:	85° C.	125° C.
DETENTS:	Index plate 30° between positions with one fixed and one adjustable stop.	Index plate 30° between positions with one fixed and one adjustable stop.
FINISH:	50-hour salt spray.	50-hour salt spray.
MOUNTING DETAILS:	Bushing—3/8"-32 thread, 3/8" long. Shaft—1/4" diameter round shaft, 1 7/8" beyond end of bushing. Hardware furnished.	Bushing—3/8"-32 thread, 3/8" long. Shaft—1/4" diameter round shaft, 1 7/8" beyond end of bushing. Hardware furnished.
MILITARY APPLICATIONS	Both types 212 and M-212 meet requirements of MIL-S-3786A, type SRO-3.	

EXCLUSIVE MILITARY GRADE CTS-IRC STARWHEEL SHAFT AND 30° DETENT ASSEMBLY

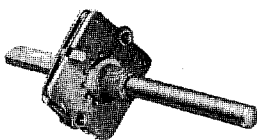

T-180 T-181 T-182

See Page 1256 for Engineering Laboratory Stocks of this Product

A balanced lever arm and star wheel detent assembly free from end and side thrust is available for precision military and instrumentation applications. Star wheel detent provides extremely long life and minimum turning torque variation. Double lever arm construction controls torque in both directions of rotation with practically no change in torque during 100,000 cycles of operation through 12 switch positions.

IRC DISTRIBUTOR PRODUCTS

IRC-CTS ROTARY SELECTOR SWITCHES



IRC, DIVISION OF TRW INC.

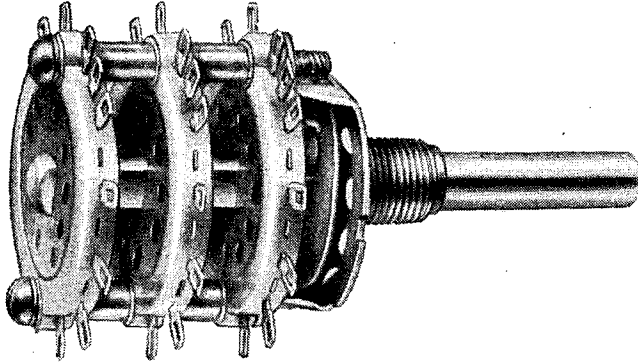

ELECTRICAL RATING

Voltage and Current Ratings:

1 amp at 28 volts DC

1½ amps at 115 volts AC

High Pot Test:

Between adjacent 30° terminals or terminals to ground: 1,750 volts AC RMS for one minute, Between adjacent 15° terminals: 750 volts AC RMS for one minute.

212 Wafer Assembly

The wafer assembly of the IRC-CTS selector switch can be separated into three basic elements, the rotor insulator, the rotor contacts and the stator. The stator consists of the stator insulator, terminal lugs, contacts, contact ring, which is made as a single unit.

Stator Insulator

The stator insulator is a circular molding which encloses the mid portion of each contact and serves as a container for the rotor. The stator insulator also serves as a natural solder and flux barrier, thus protecting the contact areas.

Contact Resistance

Circuit resistance ranges from .007 to .008 ohms on standard switches when measured from one terminal to an adjacent terminal. When measured terminals are not adjacent, up to 180° apart, the resistance will measure higher due to the extra metal in the stator circuits. It is to be noted

Contact Life:

Standard brass silver plated rotor contacts and brass silver plated stator provide reliable life for a minimum of

Detent Rotational Life:

The standard 212 detent assembly (T79, T80, T81 & T82) has a rated life of 25,000 cycles through 12 positions and return.

The Stator

The Stator is the heart of the IRC-CTS selector switch and determines the circuitry of the switch in conjunction with the location of the selected rotor contacts. The stator is actually a circuit pattern cut out of metal which forms the terminal lugs, center contact ring and the stator contact.

Rotor

The rotor of the IRC-CTS selector switch holds the rotor contacts in place and carries the contacts from one position to another, providing controlled float which prevents open circuiting during severe shock or vibration.

that the circuit resistance check measures all the metal in the circuit. Thus actual resistance at the point of contact is considerably less than the measured resistance. In IRC-CTS assemblies, contact resistance is unusually stable throughout the switch life.

25,000 cycles through 12 positions and return without appreciable increase in contact resistance. (See detent life.)

The star wheel detent mechanism (T180, T181, & T182) has a rated life of 100,000 cycles through 12 positions and return.

See Page 1256 for Engineering Laboratory Stocks of this Product

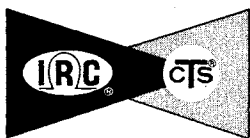

IRC-CTS ROTARY SELECTOR SWITCHES

IRC, DIVISION OF TRW INC.

IRC-CTS COMMERCIAL TYPE 212

Total Poles	Number of Positions		Poles per Section	Number of Sections	Stock Number	
	Shorting	Non-Shorting			Shorting	Non-Shorting
1	2-11	2-12	1	1	T201	T205
2	2-5	2-6	2	1	T202	T206
3	2-3	2-4	3	1	T203	T207
4	2	2-3	4	1	T204	T208
6		2	6	1		T209
2	2-11	2-12	1	2	T211	T215
4	2-5	2-6	2	2	T212	T216
6	2-3	2-4	3	2	T213	T217
8	2	2-3	4	2	T214	T218
12		2	6	2		T219
3	2-11	2-12	1	3	T221	T225
6	2-5	2-6	2	3	T222	T226
9	2-3	2-4	3	3	T223	T227
12	2	2-3	4	3	T224	T228
18		2	6	3		T229
4	2-11	2-12	1	4	T231	T235
8	2-5	2-6	2	4	T232	T236
12	2-3	2-4	3	4	T233	T237
16	2	2-3	4	4	T234	T238
24		2	6	4		T239

TERMINAL SPECIFICATIONS

1 Pole
11 Position
Shorting Type
T1 and T101

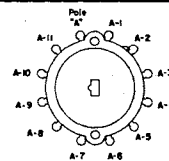

2 Pole
5 Position
Shorting Type
T2 and T102

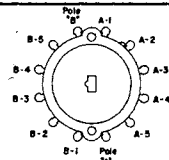

3 Pole
3 Position
Shorting Type
T3 and T103

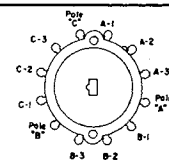

4 Pole
2 Position
Shorting Type
T4 and T104

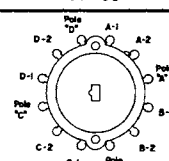

1 Pole
12 Position
Non-Shorting Type
T5 and T105

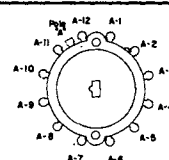

2 Pole
6 Position
Non-Shorting Type
T6 and T106

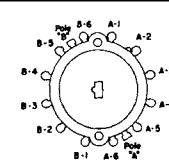

3 Pole
4 Position
Non-Shorting Type
T7 and T107

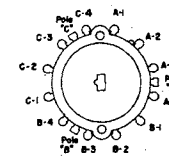

4 Pole
3 Position
Non-Shorting Type
T8 and T108

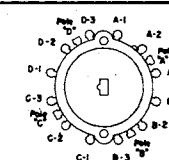

6 Pole
2 Position
Non-Shorting Type
T9 and T109

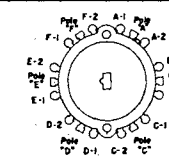

IRC-CTS INDUSTRIAL-MILITARY TYPE M-212

Total Poles	Number of Positions		Poles per Section	Number of Sections	Stock Number	
	Shorting	Non-Shorting			Shorting	Non-Shorting
1	2-11	2-12	1	1	T301	T305
2	2-5	2-6	2	1	T302	T306
3	2-3	2-4	3	1	T303	T307
4	2	2-3	4	1	T304	T308
6		2	6	1		T309
2	2-11	2-12	1	2	T311	T315
4	2-5	2-6	2	2	T312	T316
6	2-3	2-4	3	2	T313	T317
8	2	2-3	4	2	T314	T318
12		2	6	2		T319
3	2-11	2-12	1	3	T321	T325
6	2-5	2-6	2	3	T322	T326
9	2-3	2-4	3	3	T323	T327
12	2	2-3	4	3	T324	T328
18		2	6	3		T329
4	2-11	2-12	1	4	T331	T335
8	2-5	2-6	2	4	T332	T336
12	2-3	2-4	3	4	T333	T337
16	2	2-3	4	4	T334	T338
24		2	6	4		T339

WAFER SECTIONS	Total Poles	Number of Positions		Stock Number	
		Shorting	Non-Shorting	Shorting	Non-Shorting
COMMERCIAL WAFER SECTIONS	1	2-11	2-12	T1	T5
	2	2-5	2-6	T2	T6
	3	2-3	2-4	T3	T7
	4	2	2-3	T4	T8
INDUSTRIAL MILITARY WAFER SECTIONS DETENT ASSEMBLIES	1	2-11	2-12	T101	T105
	2	2-5	2-6	T102	T106
	3	2-3	2-4	T103	T107
	4	2	2-3	T104	T108
DETENT ASSEMBLIES	Total Positions	Rear Shaft Length	Suggested Number of Sections	Stock Number	
	2-12	7/32"	1	T79	
STANDARD SHAFT & 30° DETENT ASSEMBLIES	2-12	1- 9/32"	1-3	T80	
	2-12	2-15/16"	4-6	T81	
	2-12	5- 9/64"	7-10	T82	
	2-12	1- 9/32"	1-3	T180	
STARWHEEL SHAFT & 30° DETENT ASSEMBLIES	2-12	2-15/16"	4-6	T181	
	2-12	5- 9/64"	7-10	T182	

IRC-CTS ROTARY SELECTOR SWITCH ACCESSORIES

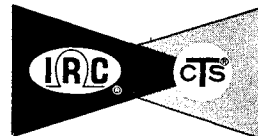

IRC, DIVISION OF TRW INC.

IRC-CTS ATTACHABLE POWER SWITCHES

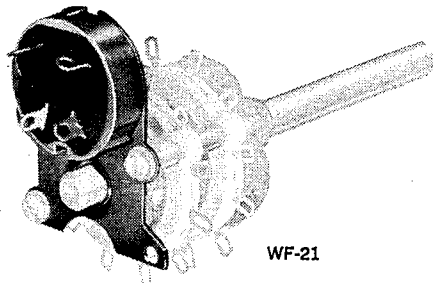

WF-21

A selection of reliable AC power switches is available for use with selector switches, giving an original source for both the selector switch and attached switches. These power switches can be mounted on the rear frame of the selector switch or between wafers by means of a specially designed bracket.

STOCK NO.	DESCRIPTION	VOLTAGE	CURRENT
GC-21	SPST	125	3 Amps
VF-21	SPDT	125	3 Amps
WF-21	DPST	125	3 Amps

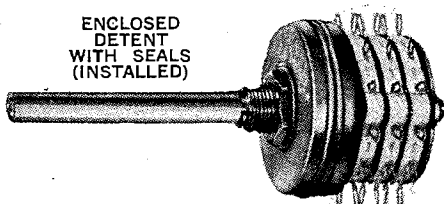
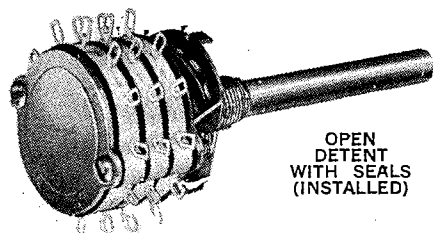
ENCLOSED
DETENT
WITH SEALS
(INSTALLED)OPEN
DETENT
WITH SEALS
(INSTALLED)

SEALED SWITCH KITS

STOCK NO.	DESCRIPTION
SSK-1	Enclosed detent construction seals both the wafer sections and the detent mechanism of the switch against dust, dirt, and moisture.
DSWK-1	Open detent construction protects and seals the wafer sections of the selector switch against dust and dirt.

SHIELDS AND MOUNTING BRACKETS

Shielding of switch sections from each other may be accomplished with these Switch Shields.

STOCK NO.	DESCRIPTION
SSS-1	Standard Shields
SSS-2	Brass, Silver Plated Shields
SSS-3	Combination Shields and Mounting Brackets

HARDWARE

STOCK NO.	DESCRIPTION
SSS-4	50 1/4" Spacers
SSS-5	50 3/8" Spacers
SSS-6	50 1/2" Spacers
SSS-7	50 3/4" Spacers
SSS-8	50 1" Spacers

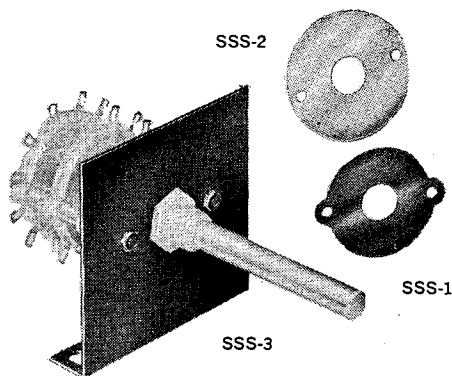

SSS-2

SSS-1

SSS-3

See Page 1256 for Engineering Laboratory Stocks of this Product



TOGGLE SWITCHES - HEAVY DUTY

J-B-T INSTRUMENTS, INC.

30th Year

WHY IT PAYS TO SPECIFY J-B-T TOGGLE SWITCHES

• **J-B-T** concentrates on trouble-free switches. Among the four groups of toggle switches J-B-T produces more than 170 models made to Government Specifications. Market studies indicate that while these switches are a must in military applications, almost half are produced for non-military use where the principal requirement is dependability. J-B-T apparently is specified because:

1. **Materials are good.** For instance, in MIL and AN heavy duty models, J-B-T uses generous proportions of selected silver alloys in integral construction for contact surface areas — to add overload protection, dissipate heat, and keep contact resistance under .005 ohms.
2. **The design is good.** All MS models have silicone rubber bushing seal for sand, dust and 15-foot head of water submersion tests. Medium-duty types MS25098 and MS25100 also feature case-to-terminal sealing and a new design which provides fast break and wider gap to surpass the 125 VDC endurance tests of MIL-S-3950C.
3. **The value is good.** The many features required to meet Government standards, and J-B-T's rigid in-plant testing pay off in long, useful life. Nevertheless, because J-B-T makes **only** quality switches, quantity production permits a surprisingly small price differential over run-of-the-mill brands.
4. **Deliveries are comparatively good.** See your distributor. Production is scheduled to back up his stocks with factory inventory of finished switches and work in process to meet predictable demand.

Cut-away view showing heavy duty MIL construction

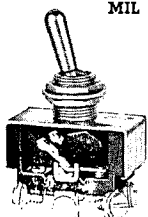

Group 1

HEAVY DUTY SINGLE- AND DOUBLE-POLE - MIL, AN, AND JAN TYPES Series MS35058, and MS35059 to MIL-S-3950C; Series ST40A-H, ST42A-H, ST50K-T, ST52K-T to JAN-S-23, MIL-S-21195A (Ships), or DDAX Drawings

• **MIL-S-3950C SERIES** - Single-pole MS35058 with suffix -21 and above, and double-pole MS35059 types with suffix -21 and above are recommended when maximum reliability is required. Temperature, endurance, and altitude requirements exceed earlier MS types (suffix -1 to -19), AN3021 and AN3027 switches to MIL-S-6745, and ST styles to JAN-S-23 and MIL-S-21195A (Ships). All MS switches contain a silicone rubber bushing seal to meet sand and dust and 15-foot head of water submersion tests.

NOMINAL RATINGS: 20 Amp. at 125 VAC, 10 Amp. at 250 VAC.

For MIL Requirements on Electrical Ratings, ask for Condensed Catalog TS-966A.

SIZE: Single-hole; bushing 15/32"-32NS-2A by 15/32" high; toggle lever, 11/16" long. Bodies including terminals: **SP:** 1 1/8" x 5/8" x 1-1/16" deep; **DP:** 1-21/64" x 3/4" x 1-1/32" or 1-13/64" deep.

TERMINALS: MIL-S-3950C switches have solderable 6-32 screw terminals; ST42's and ST52's, solder lugs. Screw type terminals and terminal screws are tin plated.

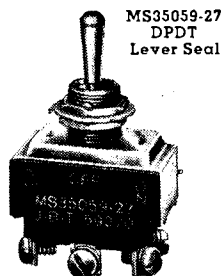

SINGLE AND DOUBLE POLE HEAVY DUTY WITH LEVER SEAL

MIL-S-3950C	Model No.	2-9☆	10-29	30-99	100-249
SPST - 2 term.					
On-X-Off	MS35058-22	\$1.76	\$1.32	\$1.08	\$.88
On-Off-X	MS35058-24	1.83	1.37	1.12	.92
On-Off-X*	MS35058-25	2.09	1.57	1.28	1.04
X-Off-On*	MS35058-28	2.10	1.57	1.28	1.05
On-X-Off*	MS35058-29	2.01	1.51	1.23	1.00
Off-X-On*	MS35058-30	2.01	1.51	1.23	1.00
SPDT - 3 term.					
On-Off-On	MS35058-21	2.09	1.57	1.28	1.04
On-X-On	MS35058-23	2.09	1.57	1.28	1.04
On-X-On*	MS35058-26	2.25	1.69	1.38	1.12
On*-Off-On*	MS35058-27	2.25	1.69	1.38	1.12
On-Off-On*	MS35058-31	2.30	1.72	1.41	1.15
DPST - 4 term.					
On-X-Off	MS35059-22	1.98	1.81	1.44	1.16
On-Off-X	MS35059-24	1.98	1.81	1.44	1.16
On-Off-X*	MS35059-25	2.62	2.39	1.90	1.53
X-Off-On*	MS35059-28	2.45	2.24	1.78	1.44
On-X-Off*	MS35059-29	2.45	2.24	1.78	1.44
Off-X-On*	MS35059-30	2.30	2.10	1.67	1.35
DPDT - 6 term.					
On-Off-On	MS35059-21	2.30	2.10	1.67	1.35
On-X-On	MS35059-23	2.30	2.10	1.67	1.35
On-X-On*	MS35059-26	2.62	2.39	1.90	1.53
On*-Off-On*	MS35059-27	2.62	2.39	1.90	1.53
On-Off-On*	MS35059-31	2.62	2.39	1.90	1.53

		TYPE TERMINALS					
		SINGLE AND DOUBLE POLE HEAVY DUTY'S					
		JAN-S-23	Model No. 2-9☆	10-29	30-99 100-249		
SCREW TYPE	SPST - 2 term.	On-X-Off	ST40A	\$1.44	\$1.08	\$.93	\$.75
		On-X-Off*	ST40B	1.61	1.21	1.04	.83
		Off-X-On*	ST40C	1.61	1.21	1.04	.83
	SPDT - 3 term.	On-X-On	ST40D	1.73	1.30	1.11	.90
		On-Off-On	ST40E	1.73	1.30	1.11	.90
		On-X-On*	ST40F	1.90	1.43	1.23	.99
		On*-Off-On*	ST40G	1.90	1.43	1.23	.99
		On-Off-On*	ST40H	1.90	1.43	1.23	.99
		SOLDER TYPE	SPST - 2 term.	On-X-Off	ST42A	1.35	1.01
On-X-Off*	ST42B			1.50	1.13	.90	.73
Off-X-On*	ST42C			1.50	1.13	.90	.73
SPDT - 3 term.	On-X-On		ST42D	1.60	1.20	.96	.78
	On-Off-On		ST42E	1.60	1.20	.96	.78
	On-X-On*		ST42F	1.79	1.34	1.08	.87
	On*-Off-On*		ST42G	1.79	1.34	1.08	.87
	On-Off-On*		ST42H	1.79	1.34	1.08	.87
	SCREW TYPE		DPST - 4 term.	On-X-Off	ST50K	1.82	1.36
On-X-Off*		ST50L		2.13	1.60	1.33	1.06
Off-X-On*		ST50M		2.13	1.60	1.33	1.06
DPDT - 6 term.		On-X-On	ST50N	2.13	1.60	1.33	1.06
		On-Off-On	ST50P	2.13	1.60	1.33	1.06
		On-X-On*	ST50R	2.42	1.82	1.52	1.21
		On*-Off-On*	ST50S	2.42	1.82	1.52	1.21
		On-Off-On*	ST50T	2.42	1.82	1.52	1.21
		SOLDER TYPE	DPST - 4 term.	On-X-Off	ST52K	1.66	1.24
On-X-Off*	ST52L			1.85	1.39	1.16	.92
Off-X-On*	ST52M			1.85	1.39	1.16	.92
DPDT - 6 term.	On-X-On		ST52N	1.85	1.39	1.16	.92
	On-Off-On		ST52P	1.85	1.39	1.16	.92
	On-X-On*		ST52R	2.15	1.61	1.35	1.08
	On*-Off-On*		ST52S	2.15	1.61	1.35	1.08
	On-Off-On*		ST52T	2.15	1.61	1.35	1.08

☆ For UL Identification and ratings on Models ST40A through ST52T, see Table on second following page.

☆ On orders for single switches, add 50c.

Prices shown are NET, F.O.B. New Haven, Conn. Domestic Packing, Effective April 1, 1968, subject to change.

TOGGLE SWITCHES — MEDIUM DUTY & CROSS-REFERENCE



30th Year

J-B-T INSTRUMENTS, INC.

Group II

SINGLE & DOUBLE POLE — GOVERNMENT QUALITY

Series MS25098 and MS25100 to MIL-S-3950C; Series ST12-27 to JAN-S-23, MIL-S-21195A (Ships), or DDAX Drawings

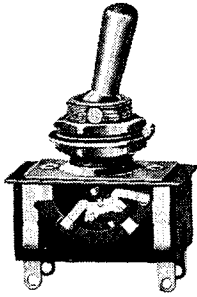

Cut-away view showing self-wiping double-grip contacts



MS25100-23 DPDT Rear Connected; Lever Seal

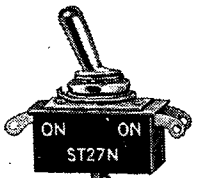

ST27N, DPDT Side and Rear Connected 1/4" Bushing

• **MEDIUM DUTY** describes the current-carrying capacity — nominally 6 amp. at 125 VAC, 3 amp. at 250 VAC — rather than the life characteristics. Self-wiping heavily silver plated double grip contacts provide exceptional reliability. Typical uses: instruments, data processing, and communications circuits.

NEW DESIGN FOR MS25098 & MS25100

— Significant internal changes now provide fast break, wide gap, and increased insulation values, to surpass the severe endurance tests of MIL-S-3950C. For example, after 20,000 cycles of operation at 65,000' altitude with resistive load of 5 amps. at 125 VDC, contact resistance was well within the permissible limits. This development is especially important for the double-throw models MS25098-23 and MS25100-23. All MS medium-duty models contain: (a) silicone rubber bushing seal for sand, dust, and 15-foot head of water submersion tests, and (b) case-to-terminal sealing.

SINGLE AND DOUBLE POLE MEDIUM DUTY WITH LEVER SEAL					
MIL-S-3950C	Model No.	2-9x	10-29	30-99	100-249
SPST — 2 term.					
On-X-Off	MS25098-22	\$1.48	\$1.18	\$1.11	\$1.03
On-X-Off*	MS25098-29	1.90	1.52	1.43	1.33
Off-X-On*	MS25098-30	1.90	1.52	1.43	1.33
SPDT — 3 term.					
On-X-On	MS25098-23	1.69	1.35	1.27	1.18
DPST — 4 term.					
On-X-Off	MS25100-22	2.12	1.69	1.59	1.48
On-X-Off*	MS25100-29	2.47	1.97	1.85	1.73
Off-X-On*	MS25100-30	2.47	1.97	1.85	1.73
DPDT — 6 term.					
On-X-On	MS25100-23	2.30	1.84	1.72	1.61

SIZE AND TERMINALS — Whether MS series to latest MIL-S-3950C or ST series to Specification JAN-S-23 and MIL-S-21195A (Ships), all have solder terminals. Medium-duty types use 11/16" long, toggle lever, bushing 15/32"-32NS-2A by 15/32" (or 1/4"). Bodies including terminals are: 1 1/4" long, 11/16" wide, 29/32" deep, except ST16A, -16B, -16C, -17A, and -27K are 1 3/4" long by 21/32" deep, while ST16D, -17D, -26N are 1 3/4" long by 29/32" deep.

SINGLE AND DOUBLE POLE MEDIUM DUTY§					
JAN-S-23	Model No.	2-9x	10-29	30-99	100-249
SPST — 2 term.					
On-X-Off	ST12A	\$.98	\$.78	\$.73	\$.68
On-X-Off*	ST12B	1.11	.89	.83	.78
Off-X-On*	ST12C	1.11	.89	.83	.78
On-X-Off	ST13A †	.98	.78	.73	.68
On-X-Off	ST16A †	.98	.78	.73	.68
On-X-Off*	ST16B †	1.11	.89	.83	.78
Off-X-On*	ST16C †	1.11	.89	.83	.78
On-X-Off	ST17A † ‡	.98	.78	.73	.68
SPDT — 3 term.					
On-X-On	ST12D	1.11	.89	.83	.78
On-X-On	ST13D †	1.11	.89	.83	.78
On-X-On	ST16D †	1.11	.89	.83	.78
On-X-On	ST17D † ‡	1.11	.89	.83	.78
DPST — 4 term.					
On-X-Off	ST22K	1.34	1.08	1.01	.95
On-X-Off*	ST22L	1.48	1.19	1.11	1.04
Off-X-On*	ST22M	1.48	1.19	1.11	1.04
On-X-Off	ST23K †	1.34	1.08	1.01	.95
On-X-Off	ST26K †	1.34	1.08	1.01	.95
On-X-Off*	ST26L †	1.48	1.19	1.11	1.04
Off-X-On*	ST26M †	1.48	1.19	1.11	1.04
On-X-Off	ST27K † ‡	1.34	1.08	1.01	.95
DPDT — 6 term.					
On-X-On	ST22N	1.48	1.19	1.11	1.04
On-X-On	ST23N †	1.48	1.19	1.11	1.04
On-X-On	ST26N †	1.48	1.19	1.11	1.04
On-X-On	ST27N † ‡	1.48	1.19	1.11	1.04

NOTES TO TABLES: * On orders for single switches, add 50c; X No position; * Momentary position; † Bushing 1/4" high; ‡ Side connected terminals only, except ST16D, -17D, -26N have both side and rear connected terminals; § For UL identification and ratings on Models ST12A through ST27N, see table on following page.

CROSS REFERENCE: AN, MS, AND ST MODEL NUMBERS WITH SIMILAR CIRCUITRY

SCREW TERMINAL				SOLDER LUG		SCREW TERMINAL				SOLDER LUG	
MIL-S-3950C See Notes A & B	JAN-S-23 & MIL-S-21195A	MIL-S-6745 See Note A	MIL-S-3950 See Notes A & B	JAN-S-23 & MIL-S-21195A (Ships)	MIL-S-3950 See Note A	MIL-S-3950C See Notes A & B	JAN-S-23 & MIL-S-21195A	MIL-S-6745 See Note A	MIL-S-3950 See Notes A & B	JAN-S-23 & MIL-S-21195A (Ships)	MIL-S-3950 See Note A
SPST						DPST					
MS35058-22	ST40A	AN3021-2	#	ST42A	MS35058-9	MS35059-22	ST50K	AN3027-2	#	ST52K	MS35059-9
MS35058-29	ST40B	AN3021-9	#	ST42B	MS35058-10	MS35059-29§	ST50L	AN3027-4§	#	ST52L	MS35059-10§
MS35058-30	ST40C	AN3021-8	#	ST42C	MS35058-11	MS35059-30§	ST50M	AN3027-5§	#	ST52M	MS35059-11§
MS35058-24	#	AN3021-10	MS35058-1	#	MS35058-12	MS35059-24	#	AN3027-9	MS35059-1	#	MS35059-12
MS35058-28	#	AN3021-11	MS35058-2	#	MS35058-13	MS35059-28	#	AN3027-11	MS35059-2	#	MS35059-13
MS35058-25	#	AN3021-12	MS35058-3	#	MS35058-14	MS35059-25§	#	AN3027-10§	MS35059-3§	#	MS35059-14§
SPDT						DPDT					
MS35058-23	ST40D	AN3021-3	MS35058-4	ST42D	MS35058-15	MS35059-23	ST50N	AN3027-3	MS35059-4	ST52N	MS35059-15
MS35058-21	ST40E	AN3021-1	MS35058-5	ST42E	MS35058-16	MS35059-21	ST50P	AN3027-1	MS35059-5	ST52P	MS35059-16
MS35058-26	ST40F	#	MS35058-6	ST42F	MS35058-17	MS35059-26§	ST50R	AN3027-6§	MS35059-6§	ST52R	MS35059-17§
MS35058-27	ST40G	AN3021-7	MS35058-7	ST42G	MS35058-18	MS35059-27	ST50S§	AN3027-7§	MS35059-7§	ST52S§	MS35059-18§
MS35058-31	ST40H	AN3021-5	MS35058-8	ST42H	MS35058-19	MS35059-31§	ST50T§	AN3027-8§	MS35059-8§	ST52T§	MS35059-19§
#	#	AN3021-6**	#	#	#	#	#	#	#	#	#

Not included in this specification.

**AN3021-6 same as AN3021-5 with jumper.

§ Same dimensions as MS35059-27.

NOTE A: MS and AN types use internal sand and dust toggle seal and other high performance features involving extra cost over ST types. MS types to MIL-S-3950C have internal toggle seal to meet 15 ft. water submersion test. MIL-S-3950 models are superseded by MIL-S-3950C models. NOTE B: For heavy duty switches in the MS25068, MS35058, and MS35059 Series, MIL-S-3950C calls for SCREW TERMINALS ONLY. These terminals have SOLDERABLE FINISH and may be soldered after removal of screw.

Prices Net, F.O.B. Factory; Individually Boxed, Domestic Packed, Effective April 1, 1968, subject to change.



TOGGLE SWITCHES—4-POLE, SP, DP & UL TABLES

J-B-T INSTRUMENTS, INC.

30th Year

Group III

OUTSTANDING 4-POLE SWITCHES TO MS25068 REQUIREMENTS

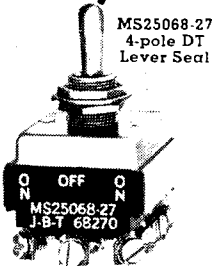

There is no mistaking the light brown color and silver printing of these distinctive J-B-T 4-pole heavy-duty switches. The superior molded body, chosen after extensive tests, features high arc resistance and low shrinkage. As a result the switches exceed the rigorous electrical endurance requirements of MS25068.

Equally important, J-B-T uses generous proportions of selected silver alloys in integral construction for contact surface areas — to add overload protection, dissipate heat, and keep contact resistance under .005 ohms. The 8 models listed here have silicone rubber bushing seals and solderable 6-32 screw terminals, the same as other heavy-duty J-B-T MS switches. Dimensions same as MS35059 except bodies including terminals: 1-11/32" long, 1-9/16" wide, 1-9/32" deep.

Underwriters' Laboratories, Inc. lists under "Switches, Special Use" (File E26557) models marked with the J-B-T part number shown below. In some instances, there are minor construction differences from ST

switches, but the ratings and external dimensions are the same. UL-marked types are not regularly stocked but only are manufactured in substantial production runs.

4-POLE HEAVY DUTY WITH LEVER SEAL					
MIL-S-3950C	Model No.	2-9*	10-29	30-99	100-249
4PST — 8 term.					
On-Off-X	MS25068-24	\$4.50	\$3.54	\$2.98	\$2.47
On-Off*-X	MS25068-25	5.30	4.18	3.51	2.92
X-Off-On*	MS25068-28	5.30	4.18	3.51	2.92
4PDT — 12 term.					
On-Off-On	MS25068-21	5.22	4.11	3.46	2.87
On-X-On	MS25068-23	5.30	4.18	3.51	2.92
On-X-On*	MS25068-26	5.63	4.44	3.73	3.10
On*-Off-On*	MS25068-27	5.63	4.44	3.73	3.10
On-Off-On*	MS25068-31	5.63	4.44	3.73	3.10

* On orders for single switches, add \$1.00
 X No position * Momentary position
Other MS25068 Numbers: Models with suffix -1 through -13 as set forth in MIL-S-3950 are superseded by MIL-S-3950 Revision C Types. The latter are interchangeable electrically and mechanically but meet additional performance standards above the former types. Specifically, MS25068-1 has become MS25068-21; -9 now -23; -5 now -31; -7 now -27; -10 now -26; -11 now -24; -12 now -28; 13 now -25.

UL IDENTIFICATION AND RATINGS: SINGLE AND DOUBLE-POLE; HEAVY DUTY AND MEDIUM DUTY

Underwriters' Laboratories, Inc. lists under "Switches, Special Use" (File E26557) models marked with the J-B-T part number shown below. In some instances, there are minor construction differences from ST

Heavy Duty — Single Pole			Heavy Duty — Double Pole			Medium Duty — Single Pole			Medium Duty — Double Pole			*Ratings	
JBT/UL Part No.**	ST Circuit Equivalent	Rating*	JBT/UL Part No.**	ST Circuit Equivalent	Rating*	JBT/UL Part No.**	ST Circuit Equivalent	Rating*	JBT/UL Part No.**	ST Circuit Equivalent	Rating*		
401	ST40A	A	501	ST50K	A	121	ST12A	B	221	ST22K	B	Rating A	
402	ST40B	A	502	ST50L	A	122	ST12B	B	222	ST22L	B		
403	ST40C	A	503	ST50M	A	123	ST12C	B	223	ST22M	B		10 amps, 250 VAC
404	ST40D	A	504	ST50N	A	124	ST12D	B	224	ST22N	B		20 amps, 125 VAC
405	ST40E	A	505	ST50P	A	131	ST13A	B	231	ST23K	B	9/4 H.P., 250 VAC	
406	ST40F	A	506	ST50R	A	134	ST13D	C	234	ST23N	B	1/2 H.P., 125 VAC	
407	ST40G	A	507	ST50S	A	161	ST16A	B	261	ST26K	B	Rating B	
408	ST40H	A	508	ST50T	A	162	ST16B	B	262	ST26L	B		
421	ST42A	A	521	ST52K	A	163	ST16C	B	263	ST26M	B	3 amps, 250 VAC-DC	
422	ST42B	A	522	ST52L	A	164	ST16D	C	264	ST26N	B		
423	ST42C	A	523	ST52M	A	171	ST17A	B	271	ST27K	B	6 amps, 125 VAC-DC	
424	ST42D	A	524	ST52N	A	174	ST17D	C	274	ST27N	B		
425	ST42E	A	525	ST52P	A	**NOTE: Above model numbers are basic ones for any given type and circuit. Variations, such as length of lever, have a suffix letter "J" and added suffix numbers.						Rating C	
426	ST42F	A	526	ST52R	A								
427	ST42G	A	527	ST52S	A								
428	ST42H	A	528	ST52T	A								

DRAWINGS FOR SUB-MINIATURE TOGGLE SWITCHES ON NEXT PAGE

JMT SERIES dimensions and details are shown below. MPC SERIES is identical with JMT series except that solid terminals are provided for direct insertion in a printed circuit board. For details on MPC terminals, see drawing at right. To obtain MPC model number, substitute MPC for JMT; example: JMT-121 becomes MPC-121. Complete dimensions and model numbers are available on drawings SK-166 through SK-169.

PCI SERIES can be provided where it is necessary to mount the switch at right angles to the circuit board. A two-prong bracket and attached terminals necessarily add to the cast.

NOTE A — Dimensions shown apply to standard terminals with holes. MPC series solid-terminals are, slightly larger as shown by configuration drawing at right.

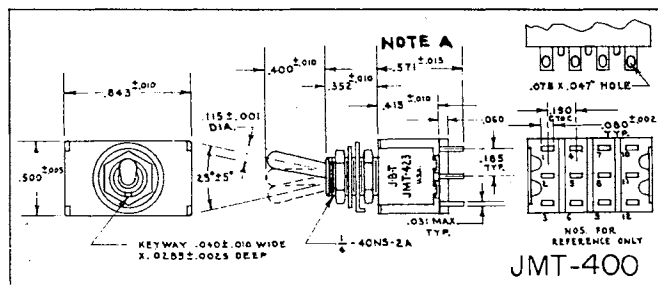
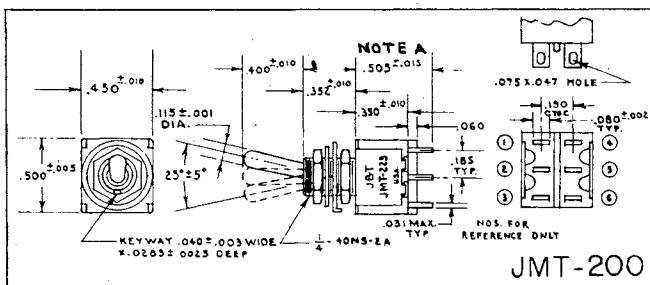
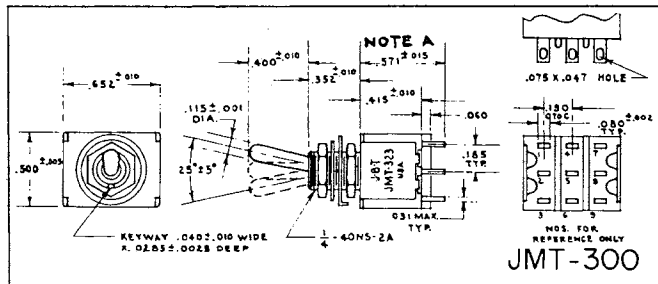
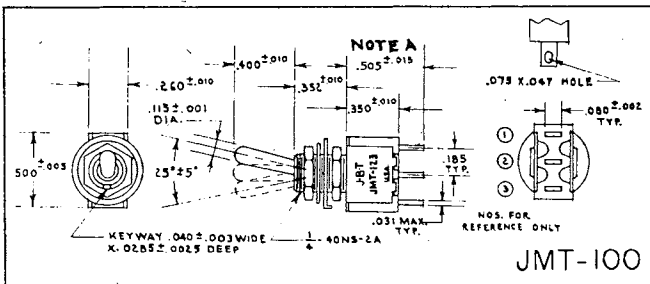
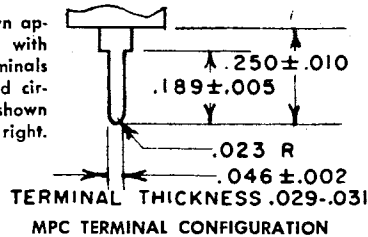

Prices shown are NET, F.O.B. New Haven, Conn. Domestic Packing, Effective April 1, 1968, subject to change.

SUB-MINIATURE TOGGLE SWITCHES



30th Year

J-B-T INSTRUMENTS, INC.

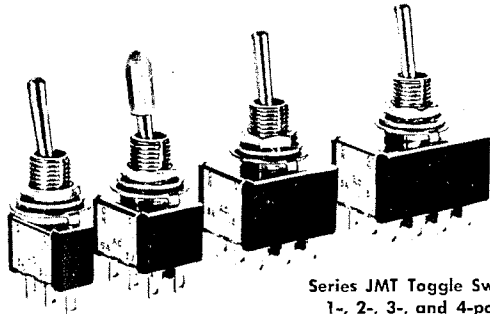
Series JMT Toggle Switches
1-, 2-, 3-, and 4-pole DT.* **NEW**Series MPC
For printed circuits
(drawings on preceding page)**Group IV****SERIES JMT, MPC, AND PC1;
A BROAD LINE OF SUB-MINIATURE TOGGLE SWITCHES
MANUFACTURED IN CONNECTICUT BY J-B-T**

MANUFACTURED IN J-B-T's spanking new plant, the sub-miniature types illustrated on this page make up the firm's fourth and newest group of toggle switches. Series JMT combines drastic reduction in size and weight with the trouble-free construction built into standard-size J-B-T switches. Widely used in manually controlled, low-current, solid-state devices and miniaturized circuitry of computers, instruments, space, geophysical, and test apparatus, these tiny switches also have application in aircraft, communications, and electronic equipment, and portable products.

Made with a distinctive GREEN BODY (bright color on some models, forest green on others) single-pole types are 1/4" thin, double-pole types less than 1/2" square, 3-pole and 4-pole types correspondingly small. All use single-hole mounting with 1/4" threaded bushing which will not turn or work loose in the J-B-T surface plate. Stringent in-plant controls assure terminals that are firmly staked and will withstand repeated soldering. Terminal holes on JMT Series accept up to three #22 wires. Terminal configuration for MPC Series (printed circuit type) is shown on opposite page.

SPECIFICATIONS

Nominal Rating: 5 Amp. resistive load, 125 VAC and 24 VDC. **Initial Contact Resistance:** 5 Milliohms max. 3 VDC, 100 Milliamps. **Insulation Resistance:** 10,000 Megohms, min. **Dielectric Strength:** 1,000 volts rms at sea level. **Life Under Load:** 100,000 make-and-break cycles minimum for all suffix-23 models; 60,000 for others. **Weight, Including Hardware:** SP, 0.19 oz.; DP, 0.23 oz.; 3-pole, 0.28 oz.; 4-pole, 0.32 oz.

MATERIALS: Switching contacts and rockers are coin silver; center terminal silver-plated. Bat handle is bright chrome-plated brass. Case and cradle are molded of colored phenolic; models with forest green bodies use glass-filled phenolic selected for extra mechanical strength and arc resistance. Bushing, locking ring, and hex nuts are brass nickel-plated. Clamp and lockwasher are made of (cadmium plated) steel, with chromate treatment, or of stainless steel.

HARDWARE AND MOUNTING

Mounting hardware supplied consists of one locking ring W-RI-12, two hex nuts, W-NU-11, one internal tooth lockwasher, W-WA-16, Knurled nut, W-NU-12 and tapered panel dress nut, W-NU-14 are also available.

DIRECTION OF MOVEMENT — All JMT switches make continuity to terminal OPPOSITE throw of lever.

MOUNTING INFORMATION — When mounting switch with locking ring, use drill procedure illustrated.

COLOR CAPS — Switches are normally supplied with bat handles. For color coding, tight-grip insulator caps are available for easy attachment before or after switches are mounted. Price, \$10.00 per thousand in bulk; 2c per switch if attached. Specify color and part number:

White — W-CAP-10A	Black — W-CAP-10D	Green — W-CAP-10H
Blue — W-CAP-10B	Brown — W-CAP-10E	Violet — W-CAP-10I
Red — W-CAP-10C	Orange — W-CAP-10F	Gray — W-CAP-10J
	Yellow — W-CAP-10G	

*NEW MPC Series has terminals for mounting directly in printed circuits, and PC1 Series has printed circuit board for right angle mounting.

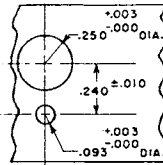
**J-B-T PUSH-BUTTON SUB-MINIATURE TOGGLES**

In the life of this catalog, it is expected that the JMT Series will be expanded to include models actuated by a push-button in place of the standard bat handles. Your inquiries are invited.

Circuitry†	Keyway	Model Number**	Quantity net prices**		
			2-9‡	10-29	30-99
†SPDT — Series JMT-100					
ON-OFF-ON		JMT-121	\$1.95	\$1.43	\$1.30
ON-NONE-ON		JMT-123	1.65	1.21	1.10
ON-NONE-ON*		JMT-126	1.95	1.43	1.30
ON*-OFF-ON*		JMT-127	2.10	1.54	1.40
ON-OFF-ON*		JMT-131	2.10	1.54	1.40
NONE-ON-ON*		JMT-134	1.95	1.43	1.30
†DPDT — Series JMT-200					
ON-OFF-ON		JMT-221	2.55	1.87	1.70
ON-NONE-ON		JMT-223	2.15	1.58	1.43
ON-NONE-ON*		JMT-226	2.55	1.87	1.70
ON*-OFF-ON*		JMT-227	2.70	1.98	1.80
ON-OFF-ON*		JMT-231	2.70	1.98	1.80
ON-ON-ON		JMT-232	2.85	2.09	1.90
ON-ON-ON*		JMT-233	3.15	2.31	2.10
NONE-ON-ON*		JMT-234	2.55	1.87	1.70
ON*-ON-ON*		JMT-235	3.10	2.26	2.05
†3-POLE DT — Series JMT-300					
ON-OFF-ON		JMT-321	4.25	3.12	2.84
ON-NONE-ON		JMT-323	3.85	2.82	2.57
ON*-OFF-ON*		JMT-327	4.40	3.23	2.93
ON-OFF-ON*		JMT-331	4.40	3.23	2.93
NONE-ON-ON*		JMT-334	4.50	3.30	3.00
†4-POLE DT — Series JMT-400					
ON-OFF-ON		JMT-421	5.45	4.00	3.64
ON-NONE-ON		JMT-423	4.85	3.56	3.24
ON*-OFF-ON*		JMT-427	5.60	4.10	3.74
ON-OFF-ON*		JMT-431	5.60	4.10	3.74
ON-ON-ON		JMT-432	6.00	4.40	4.00
ON-ON-ON*		JMT-433	6.25	4.57	4.15
NONE-ON-ON*		JMT-434	5.90	4.32	3.93
ON*-ON-ON*		JMT-435	6.40	4.70	4.28

NOTES

†These DT switches may also be used as ST by wiring only to applicable terminals. Example: JMT-123 can be connected as an "on and off" switch by using center terminals and terminals on one end only.

‡On orders for single switches, add 50c.

*Momentary position.

**For prices on MPC Series, add \$0.10 per pole to the price of the corresponding JMT Model Number in the 2-9 quantity bracket. Example: JMT-121, \$1.95; MPC-121, \$2.05; JMT-221, \$2.55, MPC-221, \$2.75.

Prices Net, F.O.B. Factory; Domestic Packed, Effective April 1, 1968, subject to change.

MULTI-POLE AND LEVER TYPE SWITCHES

J-B-T INSTRUMENTS, INC.

30th Year

IMPROVED MULTI-POLE MOLDED ROTARY SWITCHES, SERIES 20M.

- Superior Molded Material
- All Models Bonded & Ruggedized
- Panel Seal Available

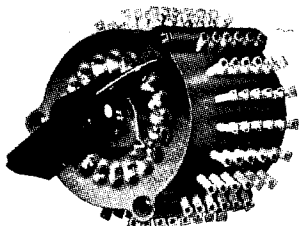

Front View Showing Panel Locator which is Normally at 3 o'clock Position.

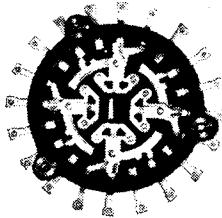

Rear View with Back Cover Cut Away to Show 4-Pole Construction with 4 Live Switching Contacts.

Although the new 20M-Series is 1/4" longer behind the panel than the 20-position molded switches described on the preceding page, the two styles are otherwise interchangeable in dimensions. Providing 19 live positions and off, the 20M-offers these additional features:

1. **Increased Versatility of Circuitry** — up to and including four poles per deck;
2. **Upgraded Insulation Resistance and Dielectric Qualities** — by use of melamine stators and rotors (or other MIL-M-14 molded materials when specially ordered);
3. **Built-in Panel Locator or Non-Turn Device;**
4. **Extended Switch Life** — new contact design with rotor brushes of phosphor bronze heavily silver-plated;
5. **All 20M-Models are Bonded and Ruggedized Construction;**
6. **Radial Alignment of Multi-Pole Contact Surfaces** — by means of newly-designed double-ball detent with diaphragm-type springs.

VARIATIONS OF 20M- Please request SK-142, Revision of March, 1967, or later for full dimensions and circuit diagrams. Besides the condensed listing in the accompanying table, various combinations of shorting and non-shortng contacts for each deck may be made. Fixed stops are built-in but may be altered for single-pole switches when specially ordered. **Over six decks** can be supplied for a reasonable number of poles; extra decks add 5/16" per deck and 5/16" per switch for rear support SU-3. **Ring-contact** (suffix R) may be specially ordered.

PANEL SEAL PS20M-SERIES — Sealed shaft and bushing meet the requirements of MIL-S-3786B for sealing. For details ask for SK-143, Revision of March, 1967, or later. The seal (prefix PS) adds \$1.75 per switch to catalog price.

SPECIFICATIONS AND TEST DATA — Available on request.

No. of Decks	Depth Behind Panel	Poles per Deck	Model Number	Circuitry Per Pole	Rotation Positions*	Boxed Incl. Knob
1	1-3/16"	1	20M-1201N	19 live, 1 off	Continuous	\$3.75
		1	20M-1191NF	19 live, no off	1 thru 19	4.10
		1	20M-1161N	15 live, 1 off	20 thru 15	3.75
		2	20M-2101N	9 live, 1 off	20 thru 9	4.15
2	1-1/2"	3	20M-3051N	4 live, 1 off	20 thru 4	4.50
		4	20M-4051N	4 live, 1 off	20 thru 4	4.85
		1	20M-1202N	19 live, 1 off	Continuous	5.00
		2	20M-2102N	9 live, 1 off	20 thru 9	5.80
3	1-13/16"	3	20M-3052N	4 live, 1 off	20 thru 4	6.50
		4	20M-4052N	4 live, 1 off	20 thru 4	7.20
		1	20M-1203N	19 live, 1 off	Continuous	6.25
		2	20M-2103N	9 live, 1 off	20 thru 9	7.45
4	2-3/16"	3	20M-3053N	4 live, 1 off	20 thru 4	8.50
		4	20M-4053N	4 live, 1 off	20 thru 4	9.55
		1	20M-1204N	19 live, 1 off	Continuous	7.70
		2	20M-2104N	9 live, 1 off	20 thru 9	9.30
6	2-13/16"	3	20M-3054N	4 live, 1 off	20 thru 4	10.70
		4	20M-4054N	4 live, 1 off	20 thru 4	12.10
		4	20M-4044N	3 live, 1 off	20 thru 3	12.10
		1	20M-1206N	19 live, 1 off	Continuous	10.80
6	2-13/16"	1	20M-1166N	15 live, 1 off	20 thru 15	10.80
		2	20M-2106N	9 live, 1 off	20 thru 9	13.20

* See MS-20 drawing on following page for location of positions.

- Notes: (1) For standard switches, knob pointer (active position) is 180° opposite flat on shaft, and off is at position 20.
 (2) **NON-shortng (N) type** — (break-before-make) — is shown. For shorting type (S), add \$.05 per pole per deck to catalog price. Example: 3 pole, 3 deck 20M-3053S is \$8.95.
 (3) All models have 18° angular indexing.
 (4) Maximum **LIVE** positions per single pole, 19; per 2-pole, 9; per 3- and 4-pole, 4.
 (5) Switches (such as 15 or 18 position) with all live or less than maximum live positions can be provided by fixed stops.
 (6) Maximum of 9 decks for 1 pole per deck
 6 decks for 2 poles per deck
 4 decks for 4 poles per deck.
 (7) †Suffix-F denotes all rotation positions shown are live with no off.

LEVER ACTION SWITCHES — 6, 5, 4, 3, and 2-Position — LAMINATED, MOLDED, & SUB-MINIATURE

LAMINATED 3- AND 4-POSITION, POSITIVE INDEXING. These lever switches are derived from the J-B-T SS-14 instrument-type rotaries.

Specified for tube checkers, inspection equipment, communications systems, control consoles, and other uses where quality is important. 4-position types are interchangeable with 3-position except in length of throw (1" slot for 3-position, 1 3/8" for 4-position) — mounting holes for boxed switches come with mounting hardware and KN-17 knob as illustrated; bulk shipments, without knobs. **SINGLE DECK** spacing between centers: recommended, 3/4"; minimum, 9/16". **TWO DECK** spacing: recommended, 15/16"; minimum, 13/16". 3/8" between decks matches TV twinlead wires. **SPRING RETURN TYPE** single deck, 3-position switches may be ordered with spring return. Lever returns to position 11°, giving momentary action at positions 9° and 10°. For dimensions on all SS-14-IL series switches, ask for drawing SK-138.

Two-Deck Lever-Action Switch

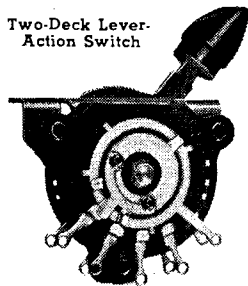

SS-14-1L4F-2

Molded 5 or 6 Position Lever Switch

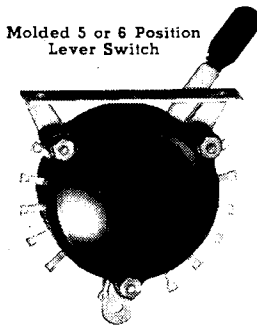

MOLDED 5- and 6-POSITION, POSITIVE-INDEXING. 5 or 6 live positions, two circuits per deck, in enclosed lustrous black molded construction; adapted from the MS-20 series with electrical characteristics as shown on the next page. These models can simplify circuitry for sound systems, control, inspection, test, experimental, and hobby purposes. Individually-boxed switches come with KN-20 threaded black molded knob; bulk shipments, without knobs. For mounting data see SK-64, Rev. H on 5-position and SK-119, Rev. B on 6-position.

MS-20-1L5A-1, 5-position, 2-circuit (1 deck)	\$3.25
MS-20-1L6A-1, 6-position, 2-circuits (1 deck)	3.50

2 AND 3 POSITION, 1 TO 4 DECKS, 2 TO 8 POLES PER DECK.

SUB-MINIATURE LEVER SWITCHES — Derived from the high-performance sub-miniature switches described on another page, the VL-7000 and the VL-5000 positive indexing series and the VSRL-7000 and VSRL-5000 spring return types provide excellence in lever switches. MIL materials throughout; crisp 30° indexing. Max. depth behind panel 1.250"; panel slot .962" x .082"; other details to SK-139, Rev. A and Catalog SM-32E. Typical switches are:

VL-71031N, single-pole, 3-position, one-deck, non-shortng	\$4.80
VSRL-71031N, same as above, with spring return to center position from either side	5.80
VL-71032N, single-pole, 3-position, two-deck, non-shortng	7.05

LEVER KNOBS

KN-17, black pointed with metal insert	\$0.19
KN-18, walnut, same as KN-19	0.08
KN-19, black, round, flat-type, push-on	0.08
KN-20, black, threaded, for MS-20-IL	0.20

Positions Per Circuit	Circ. (Poles) Per Deck	Decks or Gangs	Short. Non-Short	Stand.* Contact Pos.	Model	Boxed Incl. Knob
3, no "off"	1	1	N-S	A	SS-14-1L3	\$1.00
3, no "off"	2	1	N-S	B	SS-14-1L3A	1.15
3, no "off"	1	1	S	A	SS-14-1L3S	1.05
3, no "off"	1	1	N-S	A	SS-14-1L3R**	1.15
3, no "off"	1	1	S	A	SS-14-1L3S-R**	1.20
3, no "off"	1	2	N-S	A	SS-14-1L3-2	1.70
3, & "off"	1	1	N-S	C	SS-14-1L4	1.10
4, no "off"	1	1	N-S	D	SS-14-1L4F	1.10
4, no "off"	1	2	N-S	D	SS-14-1L4F-2	1.90

* Numbers correspond to contact positions in MS-14-2 drawing on next page. A—common at 12, contacts at 9, 10, 11; B—common at 9, 10, contacts at 6, 7, 8, 12, 13, 14; C—common and off at 12, contacts at 9, 10, 11; D—common at 12, contacts at 8, 9, 10, 11. **—Spring Return.

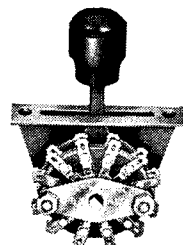

Sub-Miniature 1 Dual Duty Deck



Prices shown are NET, F.O.B. New Haven, Conn. Domestic Packing, Effective April 1, 1968, subject to change.

ROTARY SWITCHES — LAMINATED AND MOLDED



30th Year

J-B-T INSTRUMENTS, INC.

- INSTRUMENT AND TESTER TYPE • 14- AND 20-POSITION
- SINGLE AND MULTI-DECK • MILITARY OR COMMERCIAL

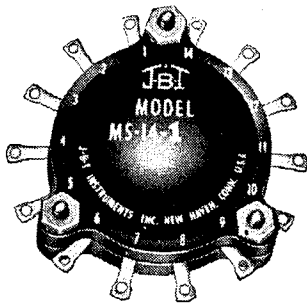

MS-14-1 Molded

USES — J-B-T Rotary Selector Switches are extensively used in quality test equipment, portable instruments, inspection setups, and other military aerospace and commercial applications where trouble-free, dependable performance is of major importance.

FEATURES — **Extra Contacts** — 14- and 20-position designs provide extra switching capability. **Dependability** — Sturdy rotors and decks with rigid 3-post deck suspension; current-carrying parts heavily silverplated to meet 100 hour salt spray test; sharp detent mechanism to assure positive indexing; insulation resistance above 50,000 megohms. **Low Contact Loss** — Double-grip collector arms, and large area contacts, silver to silver; average contact resistance, .007 ohms or less. **Ample Dielectric** — Conservatively rated at 1 amp., 125 VAC, inductive load; maximum momentary capacity (not make-and-break), 5 amp. AC or DC; maximum voltage between contacts, 1500 VAC, R.M.S.; between decks and ground, 2000 VAC, R.M.S.

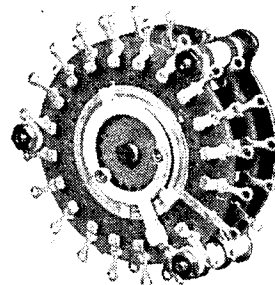

SS-20-2 Laminated

Enclosed — Molded models have all moving contacts enclosed to minimize dirt and corrosion.

Basic 14-Position: 13 circuits and "off" per deck in 2" circle (SS-14) or 2-3/32" circle (MS-14) with 25° 43' angular indexing. Supplied individually boxed with 1-1/4" Bar Knob, (KN-14), not on bulk orders unless specified. For details, SS-14, 1 to 6 decks, see Print SK-42 Rev. B. MS-14 1 to 6 decks, Print SK-111 Rev. D, 7 decks and over, Print SK-112 Rev. C.

Basic 20-Position: 19 circuits and "off" per deck in 2-23/32" circle (SS-20) or 2 5/8" circle (MS-20) with 18° angular indexing. Supplied individually boxed with 2" Bar Knob (KN-16), not on bulk orders unless specified. For details, SS-20 1 to 6 decks, see Print SK-116 Rev. A. MS-20, 1 to 6 decks, Print SK-113 Rev. D, 7 decks and over, Print SK-114 Rev. C.

Military or Commercial Variations: Special switches too numerous to list now are being made. Typical are: laminated models with 14 or 20 live positions, no off, designated by suffix F as in SS-14-2F or SS-20-1F. Inquiries are invited.

*****BONDED RUGGEDIZED TYPES** As indicated in the table, all molded rotary switches may be ordered with bonded construction as MS-14B or MS-20B types using cured laminations for ruggedization, shockproofing and further enclosure. This additional dependability factor adds only approx. 1/64" and 35c catalog price per deck.

6-POLE DOUBLE-THROW PER DECK —

1 or 2 DECKS (DT Series). Widely used for simultaneous double-throw switching of 6 circuits per deck (18° throw). Fully enclosed — illustration shows protective cover cut-away. Circuit arrangement printed on switch front. If DTS Shorting Type, 1500 VAC R.M.S. between contacts and ground, 1000 VAC R.M.S. between contacts. See MS-20-1-6DT, MS-20-1-6DTS, and MS-20-2-6DT in table.

ETCHED DIAL PLATES

For switches below, also 20M Series. Dull black finish, raised bright numerals, 2 3/4" dia.

EP-13 off thru 13	\$2.23
EP-14 1 thru 14	.23
EP-19 off thru 19	.23
EP-20 1 thru 20	.23

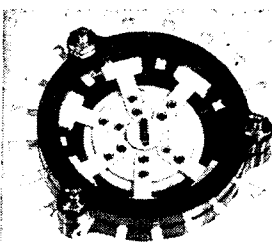

MS-20-1-6DT Double-throw Switching of 6 circuits per deck

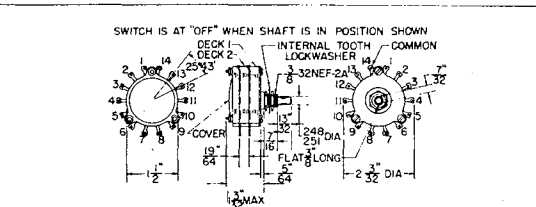

MS-14-2

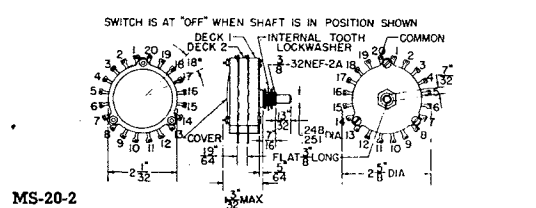

MS-20-2

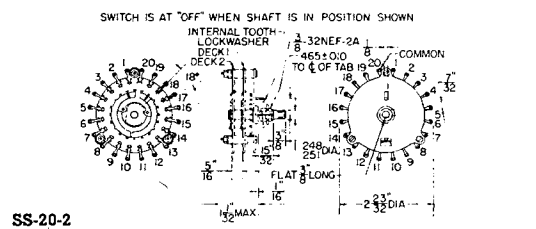

SS-20-2

14-POSITION ROTARY SWITCHES — 25° 43' INDEXING SERIES SS-14, MS-14, MS-14B, MAS-14, and MAS-14B

Cir. Pos. (Poles) Per Deck	Decks or Gangs	Short'g or Non-Sh.	LAMINATED (SS)			MOLDED (MS)												
			Standard Model	Max(d) Depth Behind Panel	Boxed Inc. Knob	Standard Model	Max. Depth Behind Panel	Boxed Inc. Knob	Bonded Model	Max. Depth Behind Panel	Boxed Inc. Knob	Adjustable Stop Model	Max. Depth Behind Panel	Boxed Inc. Knob	Bonded Adjustable Stop Model	Max. Depth Behind Panel	Boxed Inc. Knob	
14	1	1	N-S	SS-14-1	2 3/32"	\$2.30	MS-14-1	2 3/32"	\$2.45	MS-14B-1	7/8"	\$2.80	MAS-14-1	3 1/32"	\$3.10	MAS-14B-1*	1"	\$3.45
5(a)	2	1	N-S	SS-14-1A*	2 3/32"	2.45	—	—	—	—	—	—	—	—	—	—	—	—
14	1	1	S	SS-14-1S*	2 3/32"	2.35	MS-14-1S*	2 3/32"	2.50	MS-14B-1S*	7/8"	2.85	MAS-14-1S	3 1/32"	3.20	MAS-14B-1S*	1"	3.55
14	1	1	C-S(c)	SS-14-1CS*	2 3/32"	2.80	—	—	—	—	—	—	—	—	—	—	—	—
14	1	2	N-S	SS-14-2	1 3/32"	2.90	MS-14-2	1 3/32"	3.10	MS-14B-2	1 1/8"	3.80	MAS-14-2	1 1/32"	3.80	MAS-14B-2	1 1/4"	4.50
5(a)	2	2	N-S	SS-14-2A*	1 3/32"	3.20	—	—	—	—	—	—	—	—	—	—	—	—
14	1	2	S	SS-14-2S*	1 3/32"	3.00	MS-14-2S*	1 3/32"	3.20	MS-14B-2S*	1 1/8"	3.90	MAS-14-2S*	1 1/32"	3.95	MAS-14B-2S*	1 1/4"	4.65
14	1	3	N-S	SS-14-3	1 1/32"	3.50	MS-14-3	1 1/32"	3.75	MS-14B-3	1 1/32"	4.80	MAS-14-3	1 1/32"	4.60	MAS-14B-3*	1 1/32"	5.65
14	1	4	N-S	SS-14-4	1 3/32"	4.40	MS-14-4	1 3/32"	4.85	MS-14B-4	1 2 3/32"	6.25	MAS-14-4	1 2 3/32"	5.70	MAS-14B-4	1 1 3/16"	7.10
14	1	6	N-S	SS-14-6	2 1 3/32"	6.30	MS-14-6	2 1 3/32"	7.05	MS-14B-6	2 1/2"	9.15	MAS-14-6	2 1 3/32"	8.00	MAS-14B-6*	2 1 3/32"	10.10

20-POSITION ROTARY SWITCHES — 18° INDEXING SERIES SS-20, MS-20, and MS-20B

Cir. Pos. (Poles) Per Deck	Decks or Gangs	Short'g or Non-Sh.	LAMINATED (SS)			MOLDED (MS)			MOLDED (MS)									
			Standard Model	Max(d) Depth Behind Panel	Boxed Inc. Knob	Standard Model	Max. Depth Behind Panel	Boxed Inc. Knob	Bonded Model	Max. Depth Behind Panel	Boxed Inc. Knob	Adjustable Stop Model	Max. Depth Behind Panel	Boxed Inc. Knob	Bonded Adjustable Stop Model	Max. Depth Behind Panel	Boxed Inc. Knob	
20	1	1	N-S	SS-20-1	2 3/32"	4.00	MS-20-1	2 3/32"	3.10	MS-20B-1	7/8"	3.45	—	—	—	—	—	—
2(b)	2	1	N-S	SS-20-1A*	2 3/32"	4.15	—	—	—	—	—	—	—	—	—	—	—	—
2	6	1	N-S	—	—	—	MS-20-1-6DT	2 3/32"	3.90	MS-20B-1-6DT*	7/8"	4.25	—	—	—	—	—	—
2	6	1	S	—	—	—	MS-20-1-6DTS	2 3/32"	4.00	MS-20B-1-6DTS*	7/8"	4.35	—	—	—	—	—	—
20	1	1	S	SS-20-1S*	2 3/32"	4.05	MS-20-1S	2 3/32"	3.15	MS-20B-1S*	7/8"	3.50	—	—	—	—	—	—
20	1	2	N-S	SS-20-2	1 3/32"	4.75	MS-20-2	1 3/32"	3.90	MS-20B-2	1 1/8"	4.60	—	—	—	—	—	—
2	6	2	N-S	—	—	—	MS-20-2-6DT	1 3/32"	5.50	MS-20B-2-6DT*	1 1/8"	6.20	—	—	—	—	—	—
20	1	2	S	SS-20-2S*	1 3/32"	4.85	MS-20-2S	1 3/32"	4.00	MS-20B-2S*	1 1/8"	4.70	—	—	—	—	—	—
20	1	3	N-S	SS-20-3	1 1 3/32"	5.85	MS-20-3	1 1 3/32"	5.00	MS-20B-3*	1 1 3/32"	6.05	—	—	—	—	—	—
20	1	4	N-S	SS-20-4	1 2 3/32"	7.10	MS-20-4	1 2 3/32"	6.20	MS-20B-4	1 2 3/32"	7.60	—	—	—	—	—	—
20	1	6	N-S	SS-20-6	2 1 3/32"	9.40	MS-20-6	2 1 3/32"	8.60	MS-20B-6	2 1/2"	10.70	—	—	—	—	—	—

NOTES TO TABLES

- * Standard Items, but not regularly stocked; check with your electronic parts distributor.
- (a) 5 positions include 4 "live" and 1 "off."
- (b) 6 positions include 5 "live" and 1 "off."
- (c) Complete shorting—all contacts shorted except one in use.
- (d) Dimensions given are for continuous rotation switches. On Standard SS-14 Models only, adjustable stops are also furnished, and when used, increase depth behind panel 3/32" and decrease effective bushing length 3/32".

Non-Shorting — Break before make Shorting — Make before break

Prices Net, F.O.B. Factory; Individually Boxed, Domestic Packed, Effective April 1, 1968, subject to change.



SUB-MINIATURE ROTARY AND LEVER SWITCHES

J-B-T INSTRUMENTS, INC.

30th Year

SUB-MINIATURE SWITCHES MADE TO MANY PERFORMANCE LEVELS OF MIL-S-3786B, TYPE SR05; ALSO NON-MILITARY X AND V VERSIONS.

SERIES 7000, FULL 12 LIVE SWITCHING CONTACTS PER DECK; SERIES 5000, UP TO 8 POLES PER DUAL-DUTY DECK.

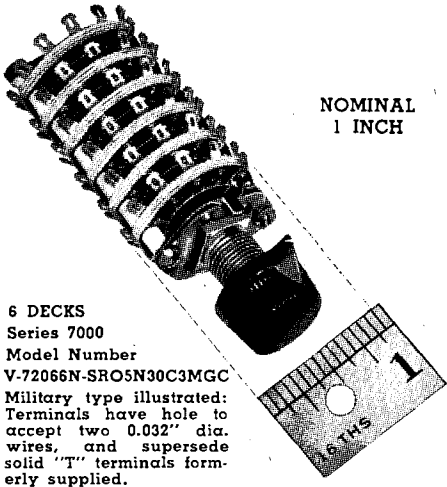

NOMINAL 1 INCH

6 DECKS
Series 7000
Model Number
V-7206N-SRO5N30C3MGC
Military type illustrated: Terminals have hole to accept two 0.032" dia. wires, and supersede solid "T" terminals formerly supplied.

- Precision built for Low-Current Usage where Size, Weight, Reliability are Important
- Unusual Versatility — More Contacts per Deck
- Accelerated Snap-Action Detent
- MIL Materials Throughout for Military & Non-Military Applications

CAUTION—MIL-S-3786B, a sophisticated specification, spells out more than one performance level in each of several categories such as Temperature-Life, Vibration, Shock, and Altitude. Each level is designated by its own symbol. J-B-T SR05 models meet an exceptional number of levels.

• USES — For test equipment, airborne and transistorized equipment, geophysical apparatus, and other miniaturized electrical and electronic devices.

TWO BASIC SERIES — Full 12 live switching contacts per deck are available in Series 7000 using a patented water design feature where rotor contacts are on the front, and switching contacts are on the rear of the same deck. 1 to 4 poles per deck 1 to 6 decks, standard.

Up to 8 poles per dual-duty deck are available in Series 5000 which has up to 12 contacts including common on the front, and up to 12 contacts including common on the rear of the same deck. 1 to 4 poles on each side of dual-duty decks; 1 to 4 decks, standard.

THREE ROTARY TYPES — Both Basic Series are made in 3 types: **MILITARY STYLE SR05**, numbered for specific performance levels of MIL-S-3786B; **V TYPE**, of similar construction to SR05, but not ordinarily subjected to full military test procedures; and **X TYPE**, using the same materials as V type switches, but intended as replacements for previous models or as original components for non-military devices where requirements are similarly exacting.

LEVER SERIES (L Types) — Outstanding design known as VL-7000 or VL-5000 Series, 1 to 4 decks. Illustrated on a preceding page.

KNOBS — Supplied with individually boxed switches on V and X types; not supplied on SR05 because separate military specification applies.

ITEM	MIL-S-3786B		MIL-S-3786B	
	X-7000	V-7000	V-7000 SR05	V-5000 SR05
Terminals	Hole-type not bent	Hole-type not bent	Hole-type; normally not bent	Hole-type; normally not bent
Shaft	1/8" dia.	1/8" dia.	1/8" dia. only	1/8" dia. only
Bushing	3/8" x 1/4" long	3/8" x 1/4" long	3/8" x 1/4" long	3/8" x 1/4" long
Rear Bridge	Black Identification	Red Identification	Stainless steel, full number	Supplied - Spec. requires
Non-Turn Device	Normally supplied	Normally supplied	Supplied - Spec. requires	Supplied - Spec. requires

FOR ADDITIONAL MODELS AND FULL SPECIFICATIONS, ASK FOR BULLETINS SM-32E AND LAYOUT SHEETS WITH CONTACT ARRANGEMENTS.

MOST FREQUENTLY ORDERED MODELS

DECKS	Circ. (Poles) per Deck	Pos. per Pole	Shorting, Non-Shorting	SHAFT DIA.	V-TYPE OR X-TYPE		SR05-TYPE	
					Model	Price	Model	Price
ONE DECK	1	12	N-S	1/4"	V-71121N	\$4.90	V-71121N-SR05*	\$5.25
	1	12	S	1/4"	V-71121S	4.90	V-71121S-SR05*	5.25
	1	12	N-S	1/8"	X-71121N	4.70	—	—
	1	12	S	1/8"	X-71121S	4.70	—	—
	2	6	N-S	1/4"	V-72061N	5.00	V-72061N-SR05*	5.35
	4	3	N-S	1/4"	V-74031N	5.20	V-74031N-SR05*	5.50
ONE DUAL DUTY DECK	2	11	N-S	1/4"	V-52111N	5.25	V-52111N-SR05*	5.60
	2	11	S	1/4"	V-52111S	5.25	V-52111S-SR05*	5.60
	4	5	N-S	1/4"	V-54051N	5.35	V-54051N-SR05*	5.70
	4	5	S	1/4"	V-54051S	5.35	V-54051S-SR05*	5.70
	8	2	N-S	1/4"	V-58021N	5.55	V-58021N-SR05*	5.90
TWO DECKS	1	12	N-S	1/4"	V-71122N	6.75	V-71122N-SR05*	7.20
	1	12	S	1/4"	V-71122S	6.75	V-71122S-SR05*	7.20
	1	12	N-S	1/8"	X-71122N	6.45	—	—
	2	6	N-S	1/4"	V-72062N	6.95	V-72062N-SR05*	7.40
	4	3	N-S	1/4"	V-74032N	7.40	V-74032N-SR05*	7.90
TWO DUAL DUTY DECKS	2	11	N-S	1/4"	V-52112N	8.10	V-52112N-SR05*	8.65
	2	11	N-S	1/8"	X-52112N	7.75	—	—
	4	5	N-S	1/4"	V-54052N	8.30	V-54052N-SR05*	8.85
THREE DECKS	1	12	N-S	1/4"	V-71123N	8.85	V-71123N-SR05*	9.45
	2	6	N-S	1/4"	V-72063N	9.15	V-72063N-SR05*	9.70
	4	3	N-S	1/4"	V-74033N	9.85	V-74033N-SR05*	10.45
FOUR DECKS	1	12	N-S	1/4"	V-71124N	11.95	V-71124N-SR05*	12.70
	1	12	N-S	1/8"	X-71124N	11.40	—	—
SIX DECKS	1	12	N-S	1/4"	V-71126N	16.05	V-71126N-SR05*	17.10
ONE DECK	4	3	N-S	—	VL-74031N	\$5.15	Levers not in Specs.	
	2	3	N-S	—	VL-72031N	5.05	" " " "	
	8	2	N-S	—	VL-58021N	5.35	" " " "	

* Typical MIL-S-3786B complete number is V-71121N-SRO5N30C3MGC. Unless otherwise ordered, switches will be furnished according to suffix N30C3MGC. Temperature-Life Characteristic C also qualifies for Characteristics A and B; Vibration Grade Symbol 3 also qualifies for Symbols 1 and 2; Shock Type M, medium impact, normally supplied. Shock Type H available at extra cost on some models when so ordered. Altitude C covers up to 70,000 ft., also meets Characteristic O (up to 10,000 ft.)

SPECIFICATIONS & TEST DATA ON SR05 MILITARY STYLE

NOTE: Most of the values shown here are given in the Specification and do not indicate the extent to which the test results of J-B-T switches were more favorable.

Current-carrying capacity: 5 amps at standard ambient conditions.

Current-breaking capacity: 750 MA at 30 VDC; 300 MA at 120 VDC; 1 AMP at 115 VAC Non-Inductive.

Initial Contact Resistance: .005 ohms max.

Contact Resistance: To MIL-STD-202C, Method 307, which requires Initial — 10 milliohms; After Moisture Resistance Test — 15 milliohms; After Life Test — 20 milliohms.

Materials: Terminals (double-wiping): gold-plated 90% silver alloy. **Rotor Contact:** J-B-T #1800 Silver Alloy. **Shaft & Frame:** Stainless steel, passivated.

Insulation: Wafer, glass epoxy laminate to MIL-P-18177C Type GEB, NEMA G-11; Rotor, ceramic to MIL-I-10A, Grade L-623.

Life Rotational; Temperature-Life Characteristic C, 25,000 rotational cycles at 10 cpm, Temperature —65°C to +125°C; 25,000 cycles at 70,000', room ambient temperature.

Vibration: Grade 3 of Table III MIL-S-3786B, 10 to 2000 cps. Tested in accordance with MIL-STD-202C, Method 204, Test Condition B.

SHOCK: Shock Type M, Medium Impact per Table IV, MIL-S-3786B. Tested in accordance with MIL-STD-202C, Method 205. Mating contacts did not open for more than 10 microseconds. Shock Type H, High Impact, Method 207, specifies not more than 5 milliseconds and does not automatically cover Type M Impact.

MAXIMUM DEPTH (L) BEHIND PANEL, INCHES

Series	1-Deck	2-Decks	3-Decks	4-Decks	5-Decks	6-Decks
Series V-7000-SR05 or X-7000	0.640	0.918	1.196	1.474	1.752	2.030
Series V-5000-SR05 or X-5000	0.640	0.918	1.196	1.474	—	—

THIS SKETCH APPLIES ONLY TO SR05 AND V-TYPE SWITCHES

FOR SR05, WHEN SPECIFIED, TERMINAL MARKING PLATE PROVIDED AT REAR OF SWITCH

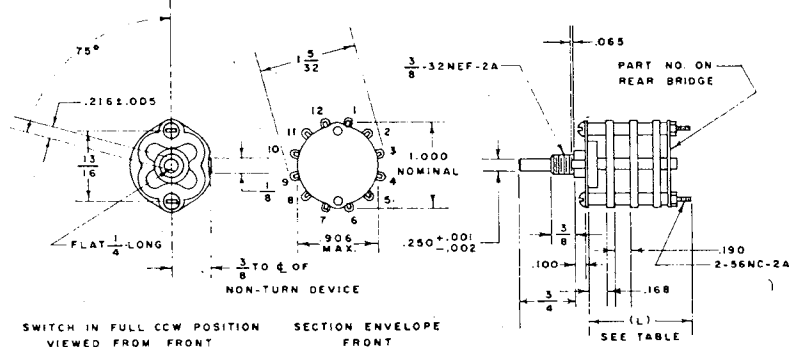

STYLE SR05, V-7000 AND V-5000

Prices Net, F.O.B. Factory; Individually Boxed, Domestic Packed, Effective April 1, 1968, subject to change.

REMARKABLE NEW 12 POSITION ROTARY SWITCHES



30th Year

J-B-T INSTRUMENTS, INC.

V/M SERIES 12-POSITION ROTARY SWITCHES
ULTRA-HIGH QUALITY WITH ADJUSTABLE TORQUE DETENT

This unusually fine family of fully enclosed rotary switches is being produced in J-B-T's thoroughly modern new plant. Used in precise laboratory test apparatus, test set-ups, telemetering, meter switching, calibration operations and similar applications where circuit stability is essential to accuracy and repeatability. The V/M Series virtually eliminates the influence of extraneous factors to the circuitry, and the initial electrical and mechanical characteristics remain substantially unchanged throughout the long useful life of the switch.

SPECIFICATIONS (Apply only to VMCS7 Models with coin silver contacts and rotor blades.): **Initial Contact Resistance**, .002 ohms; **Maximum Inductance**, less than .03 microhenry; **Capacitance between Segments**, less than 2 PFD; **Thermal EMF**, less than -1 microvolt; **Current Carrying Capacity**, 5 amp.; **Dielectric Strength**, 1000 volts, rms, 60 cy. — terminals to ground and terminals to terminals; **Insulation Resistance**, greater than 500,000 megohms; **Life Cycling** (make and break), 100,000 cycles at 1 amp., 120 VAC, res. and ind., and 28 VDC res. and ind.

DIMENSIONS: diameter over terminals 1 3/16"; bushing 3/8-32 x 3/8" long; non-turn device 1/8" diam., 1 7/32" from shaft centerline.

NOTES:

* Model Number shown is for VMCS7, with coin silver contacts and rotor blades. For nickel silver, model number would be VMNS7; for silver plated brass, VMSB7.

** Unlike other J-B-T rotary switches, VM series is normally shorting type; for non-shorting construction add 50c per deck per switch, Net.

† Includes knob and mounting hardware. Quantity prices on request.

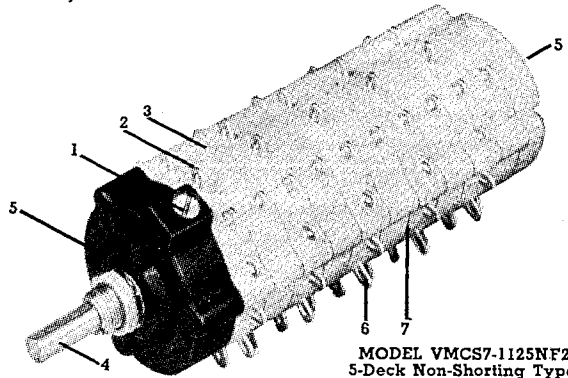

MODEL VMCS7-1125NF2
5-Deck Non-Shorting Type
Illustrated. (Shorting Type Has
Common Deck Adjacent to
Front of Switch)

FEATURES:

- (1) Adjustable detent action for variable torque (or factory set for 4 inch lbs. max.)
- (2) Unusually sturdy molded-in terminals .032" thick; accommodate two #18 wires.
- (3) Distinctive color-coded glass alkylid decks — gray for coin silver alloy contacts and rotor blades; blue for nickel silver; and green for silverplated brass.
- (4) Husky 1/4" stainless steel shaft.
- (5) Permanent identification of positions 0 through 11, cast-in detent housing and molded-in rear deck.
- (6) Integral connections between contacts and terminals — no mechanical joints.
- (7) Enclosed connections between contacts may be stacked for explosion-proof switch, per methods 3 and 4 of MIL-E-5272.

REPRESENTATIVE MODELS AND BASE PRICES
VMCS7, VMNS7, AND VMSB7 ROTARY SWITCHES

Model Number* (Shorting Type)	Poles Per Deck	Positions Per Deck	No. of Pole Decks	Shorting**	NET EACH—Quantity 1-9†			"L" Length Behind Panel
					VMCS7 Coin Silver	VMNS7 Nickel Silver	VMSB7 S.P. Brass	
VMCS7-1121SF1	1	12	1	S	\$16.00	\$10.50	\$ 9.25	1 5/8" max.
VMCS7-2061SF2	2	6	1	S	19.50	12.50	11.25	1 5/8" max.
VMCS7-1122SF1	1	12	2	S	24.10	15.00	13.75	2 1/8" max.
VMCS7-2062SF2	2	6	2	S	27.60	17.00	15.75	2 1/8" max.
VMCS7-1124SF1	1	12	4	S	40.30	24.00	22.75	3 1/8" max.
VMCS7-2064SF2	2	6	4	S	43.80	26.00	24.75	3 1/8" max.

RESONANT REED RELAYS AND OSCILLATOR CONTROLS

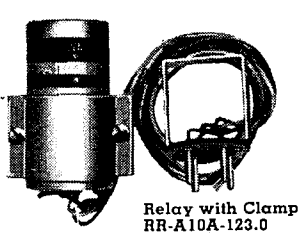

Relay with Clamp
RR-A10A-123.0

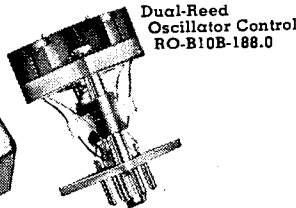
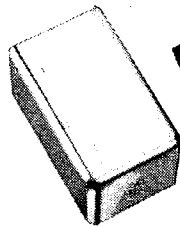

Dual-Reed
Oscillator Control
RO-B10B-188.0

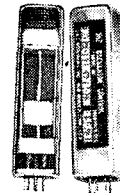

Single-Reed
Oscillator Control
RO-D62E-250.3
(Vibration-Isolated
in All Planes)

Relay
RR-DO2E-250.3
(Vibration-Isolated
in All Planes)

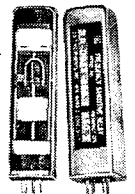

Applications: selective-calling mobile communication equipment, remote data transmission, and simultaneous or sequential coding and decoding.

For further data, ask for Bulletins 162-R and D664A. Inquiries are invited on newly-developed miniature combination relay-oscillator types.

J-B-T frequency-sensitive electro-mechanical relays (decoders) are highly stable control devices. They intermittently make and break contacts when a signal of the same frequency as the tuned reed is received. Although the reed has a high Q, the bandwidth at which the relay responds will be proportional to the input signal level.

RR-A11- and RR-A10 types are round, 4-pin plug-in relays, used primarily on existing mobile equipment.

RO-B Oscillator Controls (sometimes known as tone generators or encoders) are dual-reed units internally shock mounted and of sealed construction. These units control the frequency of oscillation in vacuum tube or transistor oscillator circuits. The RO-B type oscillator control is recommended where accurate and stable AC signals are required.

RR-D types are internally shock-mounted resonant reed relays, which are square, sealed units with 7-pin miniature plug. They now are the most widely used J-B-T relays.

RO-D types are single-reed, internally shock mounted oscillator controls for applications where space saving is of importance. Dimensionally they are identical to RR-D relays.

TYPICAL REED RELAY AND OSCILLATOR CONTROL SPECIFICATIONS

Model	Enclosure	Mounting & Connections	Frequency Range CPS	DC Coil Resistance (Standard)	Accuracy to	Change per °C —40° to +100°C	Individually Boxed
RR-A-10A-Reed Relay	1" round x 2" long	Clamp & Harness* 4 Pin Fits Cinch Socket #9804	67 to 600	200 ohms	±0.3%	±0.005 %	\$15.00**
RR-A11A-Reed Relay	1" round x 2" long	Plug In 4 Pin Fits Cinch Socket # 9804	67 to 600	200 ohms	±0.3%	±0.005 %	14.50**
RR-DO2E-Reed Relay	2 1/2" sq. x 3 1/2" lg sealed	7 Pin Miniature Plug In	67 to 1600	600 ohms	±0.1%	±0.0025%	19.00**
RO-B10B-Oscillator Control†	1 3/4" sq x 2 1/4" long sealed	Octal Plug In	67 to 600	2200 ohms/coil	±0.1%	±0.003 %	26.00**
RO-D62E-Oscillator Control	2 1/2" sq. x 3 1/2" lg sealed	7 Pin Miniature Plug In	67 to 1600	600 ohms	±0.1%	±0.0025%	18.00**

* Supplied with 2-piece clamp and 4-wire cable terminated in a 4-pin base.

** For frequencies 400 cps and up, add \$1.00 to catalog price.

† Dual reed construction.

Prices shown are NET, F.O.B., New Haven, Conn., domestic packing, May 1, 1968, subject to change.

J-B-T INSTRUMENTS, INC.

Electrical Instruments, Testers,
Switches and Other Components

For other J-B-T Products,
see Sec. 2900

BASIC SWITCHES FROM

LICON

FASTEST GROWING FULL-LINE SWITCH SUPPLIER

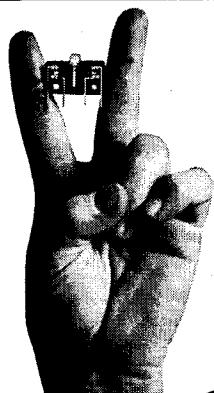

BUTTERFLY® DOUBLE-BREAK SWITCHES

The unique Licon® Butterfly double-break switch design is built around two blades that flex simultaneously, then actuate with a positive snap. A full-line of 2, 4 and 6-circuit miniature, sub-miniature and heavy-duty Butterfly switches meet every basic switch need.

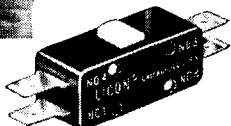

TYPE II

High electrical rating and long mechanical life in one compact package. Ideal for a wide range of applications.

ELECTRICAL RATING

125/250 v AC: 10 Amps

125 v AC: ½ HP

250 v AC: ¼ HP

30 v DC:

Form X or Y—15 Amps Res.

Form X or Y—10 Amps Ind.

Form Z— 10 Amps Res.

Form Z— 7 Amps Ind.

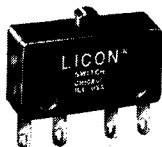

TYPE 16

Features two circuit control, direct cam operation with double bearing guided button plus high shock and vibration resistance.

ELECTRICAL RATING

125/250 v AC: 10 Amps

28 v DC:

Form X or Y—10 Amps Res.

Form X or Y—7.5 Amps Ind.

Form Z— 10 Amps Res.

Form Z— 5 Amps Ind.

TYPE 18

Big switch rating in the smallest double-break switch—.200" x .500" x .350".

ELECTRICAL RATING

125/250 v AC: 8 Amps

28 v DC:

Form X or Y—8 Amps Res.

Form X or Y—5 Amps Ind.

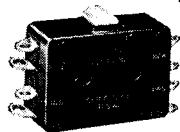

TYPE 22

Insures exacting double-break switch performance for 3-phase motors, permits simplified controls for multiple circuits.

ELECTRICAL RATING

125/250 v AC: 10 Amps

125 v AC: ½ HP

250 v AC: ¼ HP

30 v DC:

Form XX or YY—15 Amps Res.

Form XX or YY—10 Amps Ind.

Form ZZ— 10 Amps Res.

Form ZZ— 7 Amps Ind.

TYPE 26

Provides simultaneous operation of two Licon Butterfly double-break mechanisms in one case. Eliminates the need for dual components and complicated actuators.

ELECTRICAL RATING

125/250 v AC: 8 Amps

28 v DC:

Form XX or YY—10 Amps Res.

Form XX or YY—7.5 Amps Ind.

Form ZZ— 10 Amps Res.

Form ZZ— 5 Amps Ind.

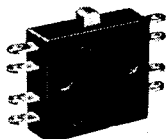

TYPE 36

Simultaneous operation of three poles through a special linkage between mechanisms. Eliminates the need for three components and complementing actuators.

ELECTRICAL RATING

125/250 v AC: 8 Amps Res.

28 v DC: Form XXX or YYY—10 Amps Res.

Form XXX or YYY—7.5 Amps Ind.

Form ZZZ— 10 Amps Res.

Form ZZZ— 5 Amps Ind.



TYPE 25 THIN SWITCH

The thin switch is designed for commercial applications which require utmost reliability at low price. Typical applications include coin and vending machines, timers and counters.

ELECTRICAL RATING

On-Center **Off-Center**

12 Amps Res. 6 Amps Res.

7 Amps Ind. 3 Amps Ind.



LICON® LIGHTED SWITCHES

Widely used on computers, machine tools, office machines, guidance control and a wide variety of applications. Heart of Licon lighted switches are the ultra-reliable Butterfly® Double-breaks for long life and dependable performance. Wide selection of colors, sizes, mounts and actuators.

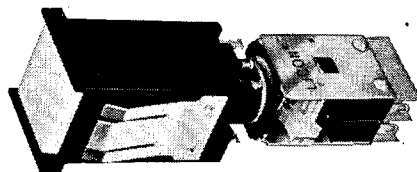

TYPE 04-590

Dressy panel appearance with four bulb illumination. Simple snap-on switch module, front-of-panel bulb service. Standard in black or clear anodizing.



TYPE 04 BARRIER MOUNT

Remove one or more switches without disturbing other units. Serves as safety separator between ganged switches. Also aluminum matrix barriers.

TYPE 01-700

Low cost momentary 1-lite stationary bulb in one-piece molded housing. Cylindrical, square or round lens caps. Front-of-panel bulb servicing.

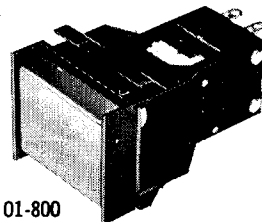

TYPE 01-800

Styled for maximum in function/appearance criteria. Has integral plastic housing that snaps in from front panel. Available in one and two pole, momentary and alternate action.

LICON® INDUSTRIAL SWITCHES

The most dependable machine tool and industrial switches on the market. Meet all OEM and replacement needs, and provide compatibility and interchangeability at the lowest possible cost. Wide selection of models, mountings, actuators.

TYPE 30-100 OVERTRAVEL PLUNGER SWITCH

General purpose limit or push button switch for circuit controls of heavy duty applications. The overtravel plunger provides added switch protection and also permits greater flexibility of application. Other models feature roller arm, roller plunger, sealed plunger, sealed roller arm, sealed palm button for a wide variety of applications.

Operating force.....10 oz.±4 oz.

Release force.....3 oz. min.

Pretravel......030 max.

Overtravel......7/32 min.

Movement differential......002 max.



LICON TYPE 10 BASIC SWITCHES

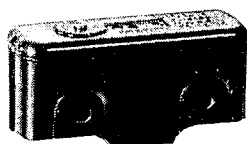

Type 10-122
Basic Switch

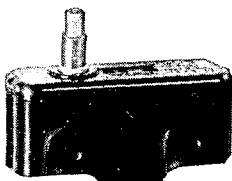

Type 10-222
Overtravel Plunger

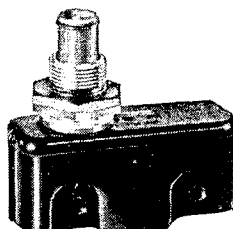

Type 10-322
Panel Mounting

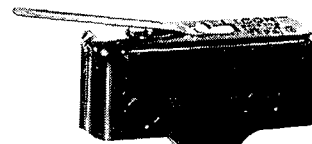

Type 10-422
Leaf Spring Actuator

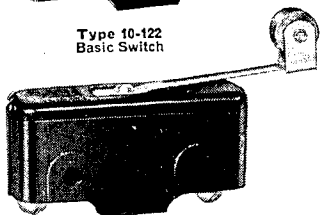

Type 10-522
Roller Leaf Actuator

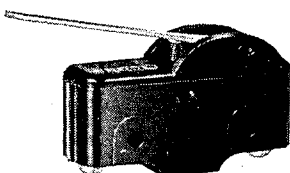

Type 10-622
Hinge-Type Lever

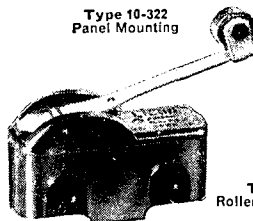

Type 10-722
Roller Lever Actuator

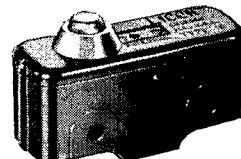

Type 10-822
Cam Actuator

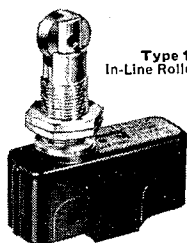

Type 10-922
In-Line Roller Actuator

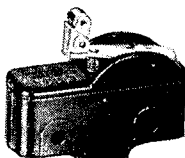

Type 10-72237
One Way Actuator

CHARACTERISTICS

Electrical Rating 15A, 125/250 V a-c, 460 V a-c
15A Res 5A Ind. 5A motor, 30 V d-c
UL APPROVED CSA APPROVED

Splash-proof sealing against moisture, dirt, dust and other harmful elements can be provided for most models. Preloaded reverse action actuator available.

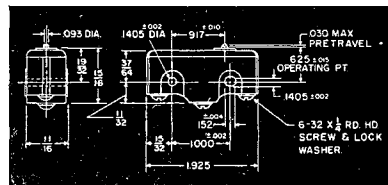

Type 10-122

LICON TYPE 14 HEAVY DUTY BASIC SWITCHES

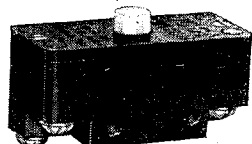

Type 14-124
Basic Switch

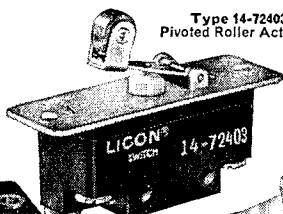

Type 14-72403
Pivoted Roller Actuator

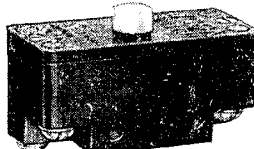

Type 14-1241
Maintained Contact, Reset



Type 14-128040
Interchangeable and economical

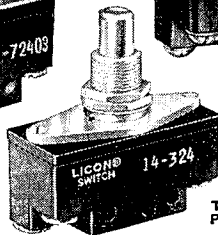

Type 14-324
Panel Mount

Movement differential available from .101" to over .040". 100 gram to 2 lb. operation force available. Terminals available with a No. 6 screw and cup washer, No. 8 screw with these same fastener choices. Custom terminal designs available. Auxiliary mounting plate available for panel mount.

ELECTRICAL RATING

Volts	A.C.			D.C.
	Steady	In-Rush	D.T.	
30	20	80	10	25
110	20	80	.5	2.0
220	20	80	.2	.5
440	15	50		
600	5	10		

UL APPROVED

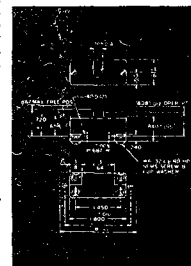

Type 14-124

Get the full story behind the switches you need from the fastest growing full-line switch supplier...LICON

NEW!

70-700 PROXIMITY SWITCH

be victorious with **LICON...the fastest growing line of DOUBLE BREAK SWITCHES**

BUTTERFLY® DOUBLE-BREAK SWITCHES

The theory behind the unique Licon Butterfly® Double-Break switch design, switch characteristics and ratings, and a catalog of the complete line.

join forces with **LICON...the fastest growing line of LIGHTED PUSH BUTTON SWITCHES**

LICON® LIGHTED SWITCHES

A complete description of the Licon Lighted switch line, physical and electrical properties, design considerations and a catalog of the 1-lite, 2-lite, and 4-lite series.

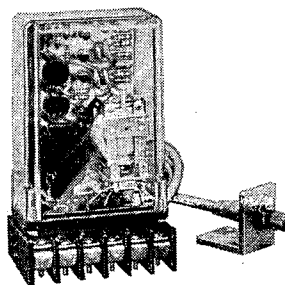

The 70-700 consists of two basic modules, a control module and a remote potted sensor. The control module contains a 10 amp relay and a transistor oscillator, both housing in a plastic plug-in case which mates with a 12 terminal heavy duty JIC style socket (supplied). A NEMA Class 1 metal enclosure is also available for housing both the control module and heavy duty socket.

SPECIFICATIONS











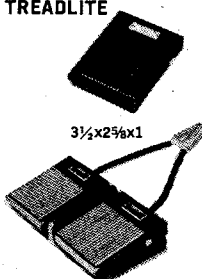



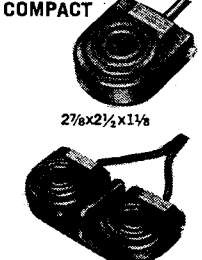



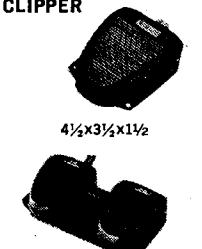

Accuracy — The circuit will actuate, at a given sensor to conductor spacing, within 0.0005".
Sensing Range — For the .750" diameter sensor .110" Min. — .261" Max., and for the .440" diameter sensor .048" Min. — .148" Max.
Speed — Up to 1000 operations per minute possible.
Ambient Temperature Ranges — 30° to + 250° F for the remote sensor, 0° to + 150° F for the control module.

For complete information about the full line of Licon switches, write for G105 catalog.

LICON
DIVISION ILLINOIS TOOL WORKS INC.

LINEMASTER

America's Footswitch Leader

<p>TREADLITE</p>  <p>3½x2½x1</p>	<p>T-51-S T-51-D T-52-S T-51-SC *T-51-SC3 **T-51-SC36 T-51-S TWIN</p>	<p>SINGLE STAGE MOMENTARY SINGLE STAGE MAINTAINED TWO STAGE MOMENTARY T-51-S COMPLETE WITH 6' CORD SET & SERIES PLUG TWO MOMENTARY SWITCHES ON ONE BASE</p>	<p>SPDT  SPDT  BOTH STAGES SPDT  BOTH SPDT </p>	<p>7 AMP 125-250 VAC 1/6 H.P. 125 VAC</p>	<p>Lowest Cost Foot Switch Formed Steel Housing. Wt.—7 ozs. *Similar to T-51-SC Except Grounded 3 Conductor Cord and 3 Prong Series Plug. **With Grounded 3 Conductor Cord, No Plug.</p>
<p>COMPACT</p>  <p>27/8x2½x1½</p>	<p>491-S 491-D 492-S 494-S 491-SC *491-SC3 **491-SC36 491-S TWIN 3B-20A2-S</p>	<p>MOMENTARY MAINTAINED MOMENTARY MOMENTARY 491-S COMPLETE WITH 6' CORD SET & SERIES PLUG TWO MOMENTARY SWITCHES ON ONE BASE MOMENTARY FOOT OPERATED AIR VALVE</p>	<p>SPDT  SPST  SPDT  DPDT  BOTH SPDT </p>	<p>10A 125 VAC 10A 125 VAC 20A 125-250 VAC 10A 125 VAC 5A 250 VAC 3-WAY AIR VALVE</p>	<p>Completely Enclosed Interior Switch. Formed Steel Housing. Wt.—7 oz. *Similar to 491-SC Except Grounded 8 Ft. 3 Conductor Cord and 3 Prong Series Plug. **With 6 Ft. Grounded 3 Conductor Cord, No Plug. 20 CFM @ 100 PSI.</p>
<p>CLIPPER</p>  <p>4½x3½x1½</p>	<p>632-S 632-D 635-S 634-D 636-S 632-S TWIN 3C-20A2-S</p>	<p>MOMENTARY MAINTAINED MOMENTARY MAINTAINED TWO STAGE MOMENTARY TWO MOMENTARY SWITCHES ON ONE BASE MOMENTARY FOOT OPERATED AIR VALVE</p>	<p>SPDT  SPDT  DPDT  DPDT  BOTH STAGES SPDT  BOTH SPDT </p>	<p>20A 125-250 VAC 20A 125-250 VAC 15A 125-250 VAC 10A 125 VAC 5A 250 VAC 15A 125-250 VAC 20A 125-250 VAC 3-WAY AIR VALVE</p>	<p>Cast Iron Housing. Also Available with Safety Guard or 7" Wide Treadle. Wt.—2¼ lbs. Twin Has Connecting Interwiring Tube So That Only One Cable Is Used. 20 CFM @ 100 PSI.</p>
<p>JUNIOR</p>  <p>5½x3¼x1¼</p>	<p>121-S 122-S</p>	<p>MOMENTARY MOMENTARY</p>	<p>SPDT  SPDT </p>	<p>15A 125-250 VAC 20A 125-250 VAC</p>	<p>Cast Aluminum Housing. Low Tapered Treadle Permits Easy Operation. Wt.—1 lb.</p>
<p>CADET</p>  <p>37/8x17/8</p>	<p>HB-2 *HB-3</p>	<p>MOMENTARY</p>	<p>SPDT </p>	<p>7A 125 VAC 1/6 H.P. 125 VAC</p>	<p>Round Switch Operates From Any Position. Switch Comes Complete With Cord set. Wt.—11 ozs. *Similar To HB-2 Except Grounded 6 Ft. 3 Conductor Cord and 3 Prong Series Plug.</p>

MANY OTHER STANDARD MODELS ARE AVAILABLE—WRITE FOR CATALOG

"When awkward jobs hold you up—a LINEMASTER FOOT SWITCH is your third hand!"

Write To Us For Complete Catalog.







LINEMASTER SWITCH CORPORATION

FOOTSWITCH

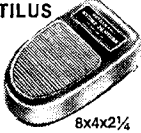
A Modern

for Every Use

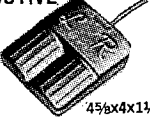
PRECISION-BUILT • DEPENDABLE • RUGGED • ECONOMICAL • OVER 1000 APPLICATIONS

NAUTILUS  8x4x2½	WP-541-S	MOMENTARY		SPDT	↗	20A 125-250 VAC	Completely Waterproof. Can Be submerged.
	WP-541-D	MAINTAINED		SPDT	↗	12A 125 VAC 6A 250 VAC	
SENIOR  7x4x3¼	MOMENTARY	MAINTAINED					Cast Iron Housing. Also Available With Complete Safety Guard. Wt.—5¼ lbs.
	4141-S	4141-D		DPST	⏏	20A 125-250 VAC&DC	
	4142-S	4142-D		DPDT	⏏	10A 125 VAC&DC 5A 250 VAC&DC	
	4143-S	4143-D		SPDT	↗	15A 125 VAC&DC 10A 250 VAC&DC	
	4351-S	4351-D		TPST	⏏	15A 125-230 VAC 5A 575 VAC	
HERCULES  8¾x4¾x4½	531-SW*	571-DW*	SINGLE STAGE	SPDT	↗	20 AMPS 125-480 VAC 1 H.P. 115-230 VAC	Cast Iron Housing. Wt.—7¼ lbs. Also Available With No Guard or Complete Hood. All Models Available in Explosion Proof Version. *Add Letter "N" For Model Without Guard; Add Letter "H", For Model With Full Side Shields.
	532-SW*	572-DW*	SINGLE STAGE	DPDT	⏏		
	533-SW*	573-DW*	SINGLE STAGE	TPDT	⏏		
	534-SW*	574-DW*	TWO STAGE	SPDT	↗		
	535-SW*	575-DW*	THREE STAGE	SPDT	↗		
POTENTIOMETER  8¾x4¾x4½	2 WATT	5 WATT	SPECIFY MAXIMUM RESISTANCE REQUIRED				Standard Model Wt. Approx. 7¼ lbs. Details on request
	500 thru 500-AH	505 thru 505-AH	2 WATT		5 WATT		
			Ohms	Megohms	Ohms		
			50 thru 1500	2500 thru 75000	.1 thru 5.0	2 thru 40	
LEKTRO-LOK  5x2½x1⅞	L-2-S	TWO MOMENTARY SWITCHES SIDE BY SIDE		BOTH SIDES SPDT	↗ ↗	15A 125-250 VAC	Stamped Metal Housing. Wt.—10 oz.
	L-4-S			BOTH SIDES DPDT	⏏ ⏏	10A 125 VAC 5A 250 VAC	
EXECUTIVE  4½x4x1⅞	B-2-S	TWO MOMENTARY SWITCHES SIDE BY SIDE		BOTH SIDES SPDT	↗ ↗	15A 125-250 VAC	Stamped Metal Housing. Wt.—14 oz.
	B-4-S			BOTH SIDES DPDT	⏏ ⏏	10A 125 VAC 5A 250 VAC	
DUPLEX  8½x3½x2	475-S	MOMENTARY HEAVY SPRING		BOTH SIDES SPDT	↗ ↗	15A 125-250 VAC	Cast Aluminum Housing. Wt.—1¼ lbs.
	476-S	MOMENTARY LIGHT SPRING					

Linemaster also manufactures many other types of foot controls with electronic impulse circuits, gear driven potentiometers, air valves, special cordsets, finishes, etc.

Write To Us For Complete Catalog.

LINEMASTER SWITCH CORPORATION

Printed in U.S.A.

LITTELFUSE Quality Fuses

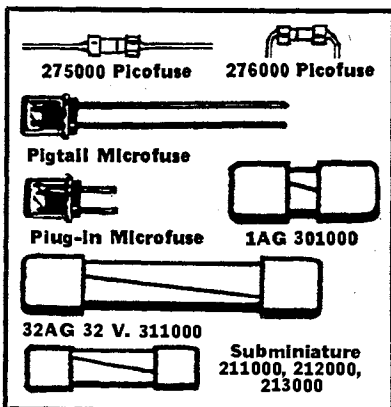

SUBMINIATURE FUSES

A must for servicing European electronic equipment. Size: 20 mm x 5 mm (.8" x .2").

FAST ACTING (250 V) TYPE F

L.F. No.	Amp Rating	Net per 5	Net per 100	
			100	500
212.100	1/10	1.59	26.50	21.20
212.125	1/8	1.59	26.50	21.20
212.200	2/10	1.23	20.50	16.40
212.250	1/4	1.23	20.50	16.40
212.300	3/10	1.23	20.50	16.40
212.400	4/10	1.23	20.50	16.40
212.500	1/2	1.23	20.50	16.40
212.600	6/10	1.23	20.50	16.40
212.700	7/10	1.23	20.50	16.40
212.800	8/10	1.23	20.50	16.40
212001	1	.99	16.50	13.20
2121.25	1-1/4	.99	16.50	13.20
21201.6	1-6/10	.99	16.50	13.20
212002	2	.99	16.50	13.20
21202.5	2-1/2	.99	16.50	13.20
212003	3	.99	16.50	13.20
212004	4	.99	16.50	13.20
212005	5	.99	16.50	13.20
212006	6	.99	16.50	13.20

MEDIUM ACTING (250 V) TYPE M

Net per 5: \$ 1.23
Net per 100: 100...\$20.50; 500... 16.40

L.F. No.	Amp Rtg.	L.F. No.	Amp Rtg.	L.F. No.	Amp Rtg.
211.100	1/10	211.500	1/2	211002	2
211.200	2/10	211.600	6/10	211003	3
211.250	1/4	211.800	8/10	211005	5
211.300	3/10	211001	1		
211.400	4/10	21101.6	1-6/10		

SLO BLO FUSES (250 V) TYPE T

Net per 5: \$ 1.23
Net per 100: 100...\$20.50; 500... 16.40

L.F. No.	Amp Rtg.	L.F. No.	Amp Rtg.	L.F. No.	Amp Rtg.
213.100	1/10	213.600	6/10	21302.5	2-1/2
213.125	1/8	213.700	7/10	213003	3
213.200	2/10	213.800	8/10	213004	4
213.250	1/4	213001	1	213005	5
213.300	3/10	2131.25	1-1/4	213006	6
213.400	4/10	21301.6	1-6/10		
213.500	1/2	213002	2		

SUBMINIATURE (125 V MAX.)

L.F. No.	Amp Rating	Net per 5	Net per 100	
			100	500
271.500	1/2	\$1.23	\$20.50	\$16.40
27101.5	1-1/2	.99	16.50	13.20

SUBMINIATURE PICOFUSES

For computer, micro-electronic and aerospace circuits of 125 V or less where short-circuit currents as high as 300 amps occur. High accuracy in blowing time at 300% of rating and higher is ideal for sequential switching or in circuits requiring redundancy. Blow time 4 hours min. at 100% of rating; 5 secs. max. at 200%. Amperage printed on body; can be color-coded at additional cost. Ceramic body only 1/2" lg. x 3/16" dia.; tin-coated copper leads .025" dia. Order 275 (prefix) for axial leads 1/4" long for diode clip or in-circuit mounting; 276 for radial leads 1 3/4" long for use in printed circuits or receptacles. *Avg., cold.

L.F. No.	Amp Rtg.	Res., Ohms*	Net	Net per 100	
				100	500
275.125	1/8	2.0	\$2.13	\$35.50	\$28.40
275.250	1/4	.71	2.13	35.50	28.40
275.375	3/8	.43	2.13	35.50	28.40
275.500	1/2	.26	2.13	35.50	28.40
275.750	3/4	.157	1.86	31.00	24.80
275001	1	.125	1.86	31.00	24.80
27501.5	1-1/2	.074	1.86	31.00	24.80
275002	2	.055	1.86	31.00	24.80
275003	3	.035	1.86	31.00	24.80
275004	4	.022	1.86	31.00	24.80
275005	5	.014	1.86	31.00	24.80

MICROFUSE SUBMINIATURE FUSES

For printed circuits and other minimum space uses. Ultra-fast blowing. Plug-in types use holder (listed on another page); pigtail types for soldering. Short circuit interrupting capacity 125 V, 10,000 amps DC. Blow Specs: 100%, 4-hour min.; 200%, 5-sec. max. Size: 1/4" dia. x 1/2" (fuse body). Plug-in, transparent cap type listed. Use prefix 272 for plug-in, metal cap; prefix 279 for pigtail, transparent cap; prefix 278 for pigtail, metal cap.

Plug-In L.F. No.	Amp Rating	Net per 5	Net per 100	
			100	500
273.002	1/500	\$5.13	\$85.50	\$68.40
273.005	1/200	5.13	85.50	68.40
273.010	1/100	5.13	85.50	68.40
273.015	1/64	5.13	85.50	68.40
273.031	1/32	5.13	85.50	68.40
273.050	1/20	4.29	71.50	57.20
273.062	1/16	4.29	71.50	57.20
273.100	1/10	4.29	71.50	57.20
273.125	1/8	4.29	71.50	57.20
273.200	2/10	4.29	71.50	57.20
273.250	1/4	4.29	71.50	57.20
273.300	3/10	4.29	71.50	57.20
273.400	4/10	4.29	71.50	57.20
273.500	1/2	4.29	71.50	57.20
273.600	6/10	4.29	71.50	57.20
273.700	7/10	4.29	71.50	57.20
273.750	3/4	4.29	71.50	57.20
273.800	8/10	4.29	71.50	57.20
273001	1	4.29	71.50	57.20
27301.5	1-1/2	4.29	71.50	57.20
273002	2	4.29	71.50	57.20
273003	3	4.29	71.50	57.20
273004	4	4.29	71.50	57.20
273005	5	4.29	71.50	57.20

HIGH RELIABILITY MICROFUSES

For zero defect programs. Hermetically sealed; gold-plated terminals for soldered or plug-in connections. Fuse rating identified on each fuse. Test data and traceability records are supplied and maintained. Proven performance in the Gemini "critical parts" manned space program. Voltage rating 125 V, blow time same as 273 series; time/current characteristics certified to 1% AQL per MIL-Std-105, Inspection Level II. Short circuit interrupting capacity at 125 V, 10,000 amps DC. Size: Fuse cap and body, .290" lg., leads for 262 "plug-in" series .170". Pigtail on 268 series 1.0". Use prefix 268 for pigtail type (e.g., 268.002).

Plug-In L.F. No.	Amp Rating	Net per 5	Net per 100	
			100	500
262.002	1/500	\$15.00	\$250.00	\$200.00
262.005	1/200	15.00	250.00	200.00
262.010	1/100	15.00	250.00	200.00
262.015	1/64	15.00	250.00	200.00
262.031	1/32	15.00	250.00	200.00
262.050	1/20	15.00	250.00	200.00
262.062	1/16	15.00	250.00	200.00
262.100	1/10	15.00	250.00	200.00
262.125	1/8	15.00	250.00	200.00
262.200	2/10	15.00	250.00	200.00
262.250	1/4	15.00	250.00	200.00
262.300	3/10	15.00	250.00	200.00

HIGH RELIABILITY PICO FUSES

For soldering into circuits or insertion into diode type clips and mtgs. Fuses rated at 125 V or less and will interrupt short circuit currents to 300 amps at 125 VDC. Non-hydroscopic ceramic bodies. Withstands 5-lb. axial pull test. Blow time 4 hours min., 100% rating; 5 secs. max., 200% rating. Insulation resistance is 1 meg min. measured with 100 V supply. Size: Body 1/2" lg., .078" dia. Leads are .025" dia., 1 1/4" lg., gold-plated copper.

Net per 5: \$15.00
Net per 100: 100...\$250.00; 500... \$200.00

L.F. No.	Amp Rtg.	L.F. No.	Amp Rtg.
265.125	1/8	26501.5	1 1/2
265.250	1/4	265002	2
265.375	3/8	265003	3
265.500	1/2	265004	4
265.750	3/4	265005	5
265001.	1		

7AG FUSES (32 V OR LESS)

Blow Time: 110%, 4-hr. min.; 135%, 1 hr. max.; 200%, 20-sec. max. Ig. 7/8", dia. 1/4".

L.F. No.	Amp Rating	Net per 5	Net per 100	
			100	500
303001	1	\$0.33	\$5.50	\$4.40
30302.5	2-1/2	.22	3.60	2.90
303004	4	.22	3.60	2.90
303006	6	.22	3.60	2.90
303015	15	.25	4.10	3.20
303020	20	.25	4.10	3.20
303030	30	.25	4.10	3.20

1AG FUSES (32 V OR LESS)

Blow Time: 110%, 4-hr. min.; 135%, 1 hr. max.; 200%, 20-sec. max. Ig. 7/8", dia. 1/4".

L.F. No.	Amp Rating	Net per 5	Net per 100	
			100	500
301001	1	\$0.33	\$5.50	\$4.40
301002	2	.33	5.50	4.40
30102.5	2-1/2	.33	5.50	4.40
301003	3	.30	5.00	4.00
301005	5	.25	4.10	3.20
301006	6	.25	4.10	3.20
30107.5	7-1/2	.25	4.10	3.20
301010	10	.25	4.10	3.20
301015	15	.25	4.10	3.20
301020	20	.25	4.10	3.20
301025	25	.25	4.10	3.20
301030	30	.25	4.10	3.20

3AG FUSES (32 V OR LESS)

Blow Time: 110%, 4-hour min.; 135%, 1 hour max.; 200%, 20-sec. max. Length 1 1/4", dia. 1/4".

L.F. No.	Amp Rating	Net per 5	Net per 100	
			100	500
311004	4	\$0.30	\$5.00	\$4.00
311005	5	.22	3.60	2.90
311006	6	.22	3.60	2.90
31107.5	7-1/2	.22	3.60	2.90
311008	8	.22	3.60	2.90
311010	10	.22	3.60	2.90
311015	15	.22	3.60	2.90
311025	25	.25	4.10	3.20
311030	30	.25	4.10	3.20
311035	35	.30	5.00	4.00

3AG FUSES (250 V OR LESS)

Blow Time: 110%, 4-hour min.; 135%, 1 hour max.; 200%, 10-sec. max. Length 1 1/4", dia. 1/4". U/L Approved.

L.F. No.	Amp Rating	Net per 5	Net per 100	
			100	500
312.010	1/100	\$2.07	\$34.50	\$27.60
312.031	1/32	1.77	29.50	23.60
312.062	1/16	.81	13.50	10.80
312.100	1/10	.81	13.50	10.80
312.125	1/8	.81	13.50	10.80
312.150	15/100	.81	13.50	10.80
312.175	.175	.81	13.50	10.80
312.187	3/16	.81	13.50	10.80
312.200	2/10	.81	13.50	10.80
312.250	1/4	.54	9.00	7.20
312.300	3/10	.54	9.00	7.20
312.375	3/8	.54	9.00	7.20
312.500	1/2	.54	9.00	7.20
312.600	6/10	.54	9.00	7.20
312.750	3/4	.54	9.00	7.20
312001	1	.33	5.50	4.40
3121.25	1-1/4	.33	5.50	4.40
31201.6	1-6/10	.33	5.50	4.40
312002	2	.33	5.50	4.40
31202.5	2-1/2	.30	5.00	4.00
312003	3	.30	5.00	4.00
312004	4	.42	7.00	5.60
312005	5	.42	7.00	5.60
312006	6	.42	7.00	5.60
312007	7	.42	7.00	5.60
312008	8	.63	10.50	8.40

3AG SLO BLO FUSES

Blow Time: 110%, 4-hour min.; 135%, 1 hour max.; 200%, 5-sec. min. Length 1 1/4", dia. 1/4". U/L Approved thru 5 amps.

L.F. No.	Amp Rating	Net per 5	Net per 100	
			100	500
313.010	1/100	\$1.53	\$25.50	\$20.40
313.031	1/32	1.53	25.50	20.40
313.062	1/16	1.11	18.50	14.80
313.100	1/10	1.11	18.50	14.80
313.125	1/8	1.11	18.50	14.80
313.150	15/100	1.11	18.50	14.80
313.175	.175	1.11	18.50	14.80
313.187	3/16	1.11	18.50	14.80
313.200	2/10	1.11	18.50	14.80
313.250	1/4	1.11	18.50	14.80
313.300	3/10	1.11	18.50	14.80
313.375	3/8	1.11	18.50	14.80
313.400	4/10	1.11	18.50	14.80
313.500	1/2	1.11	18.50	14.80
313.600	6/10	1.11		

LITTELFUSE Quality Fuses

3AG SLO BLO PIGTAIL FUSES (125 V)
 Blow Time: 110%, 4-hr. min.; 135%, 1 hr. max.; 200%, 5-sec. min. Lg. 1 1/4", dia. 1/4", 1 1/2" pigtails. U/L App. thru 3.2 amps.

L.F. No.	Amp Rating	Net per 5	Net per 100	
			100	500
315.010	1/100	\$1.89	\$31.50	\$25.20
315.031	1/32	1.89	31.50	25.20
315.062	1/16	1.38	23.00	18.40
315.100	1/10	1.38	23.00	18.40
315.125	1/8	1.38	23.00	18.40
315.150	.15	1.38	23.00	18.40
315.175	.175	1.38	23.00	18.40
315.187	3/16	1.38	23.00	18.40
315.200	2/10	1.38	23.00	18.40
315.250	1/4	1.38	23.00	18.40
315.300	3/10	1.38	23.00	18.40
315.375	3/8	1.38	23.00	18.40
315.400	4/10	1.38	23.00	18.40
315.500	1/2	1.38	23.00	18.40
315.600	6/10	1.38	23.00	18.40
315.700	7/10	1.38	23.00	18.40
315.750	3/4	1.38	23.00	18.40
315.800	8/10	1.38	23.00	18.40
315001	1	1.38	23.00	18.40
31501.2	1-2/10	1.29	21.50	17.20
3151.25	1-1/4	1.29	21.50	17.20
31501.5	1-1/2	1.29	21.50	17.20
31501.6	1-6/10	1.29	21.50	17.20
315002	2	1.29	21.50	17.20
31502.5	2-1/2	1.11	18.50	14.80
31502.8	2-8/10	1.11	18.50	14.80
315003	3	1.11	18.50	14.80
31503.2	3-2/10	1.11	18.50	14.80
315004	4	1.11	18.50	14.80
315005	5	1.11	18.50	14.80

3AG PIGTAIL FUSES (250 V)
 Blow Time: 110%, 4-hour min.; 135%, 1 hour max.; 200%, 10-sec. max. Length 1 1/4", dia. 1/4", 1 1/2" pigtails.

L.F. No.	Amp Rating	Net per 5	Net per 100	
			100	500
318.010	1/100	\$2.37	\$39.50	\$31.60
318.031	1/32	2.07	34.50	27.60
318.062	1/16	1.41	23.50	18.80
318.100	1/10	1.02	17.00	13.60
318.125	1/8	1.02	17.00	13.60
318.150	15/100	1.02	17.00	13.60
318.175	.175	1.02	17.00	13.60
318.187	3/16	1.02	17.00	13.60
318.200	2/10	1.02	17.00	13.60
318.250	1/4	.81	13.50	10.80
318.375	3/8	.81	13.50	10.80
318.500	1/2	.81	13.50	10.80
318.750	3/4	.81	13.50	10.80
318001	1	.63	10.50	8.40
3181.25	1-1/4	.63	10.50	8.40
31801.5	1-1/2	.63	10.50	8.40
31801.6	1-6/10	.63	10.50	8.40
318002	2	.63	10.50	8.40
31802.5	2-1/2	.63	10.50	8.40
318003	3	.63	10.50	8.40
318004	4	.66	11.00	8.80
318005	5	.66	11.00	8.80
318006	6	.66	11.00	8.80
318007	7	.66	11.00	8.80
318008	8	.81	13.50	10.80

3AG INDICATING FUSES (125 V)
 Blow Time: 110%, 4-hour min.; 135%, 1 hour max. Length 1 1/4", dia. 1/4".

L.F. No.	Amp Rating	Net per 5	Net per 100	
			100	500
334.750	3/4	\$2.25	\$37.50	\$30.00
334001	1	1.77	29.50	23.60
33401.5	1-1/2	1.77	29.50	23.60
334002	2	1.77	29.50	23.60
334003	3	1.77	29.50	23.60
334004	4	1.77	29.50	23.60
334005	5	1.77	29.50	23.60
334006	6*	2.43	40.50	32.40
334008	8*	2.43	40.50	32.40
334010	10*	2.43	40.50	32.40
334012	12*	2.43	40.50	32.40
334015	15*	2.43	40.50	32.40
334020	20*	2.43	40.50	32.40

*32 volt.
3AB TINY MIGHTY (250 V OR LESS)
 Blow Time: 110%, 4-hour min.; 135%, 1 hour max.; 200%, 30-sec. max. Length 1 1/4", dia. 1/4", U/L Approved thru 15amps.

L.F. No.	Amp Rating	Net per 5	Net per 100	
			100	500
314.125	1/8	\$0.72	\$12.00	\$ 9.60
314.250	1/4	.72	12.00	9.60
314.375	3/8	.72	12.00	9.60
314.500	1/2	.72	12.00	9.60
314.750	3/4	.72	12.00	9.60
314001	1	.69	11.50	9.20
314002	2	.69	11.50	9.20
314003	3	.69	11.50	9.20
314004	4	.69	11.50	9.20
314005	5	.66	11.00	8.80
314006	6	.66	11.00	8.80
314007	7	.66	11.00	8.80
314008	8	.66	11.00	8.80
314010	10	.66	11.00	8.80
314012	12	.69	11.50	9.20
314015	15	.69	11.50	9.20
314020	20	.69	11.50	9.20
314025	25	.84	14.00	11.20
314030	30	.84	14.00	11.20

LIMITED CURRENT (250 V) TYPE C
 Blow Time: 110%, 4-hour min.; 135%, 1 hour max.; 200%, 10-sec. max. Prices for applicable fuse holders available upon request.

L.F. No.	Amp Rating	Net per 5	Net per 100	
			100	500
332.031	1/32	\$1.71	\$28.50	\$22.80
332.062	1/16	1.14	19.00	15.20
332.125	1/8	.84	14.00	11.20
332.187	3/16	.84	14.00	11.20
332.250	1/4	.66	11.00	8.80
332.300	3/10	.66	11.00	8.80
332.375	3/8	.66	11.00	8.80
332.400	4/10	.66	11.00	8.80
332.500	1/2	.66	11.00	8.80
332.700	7/10	.66	11.00	8.80
332.750	3/4	.66	11.00	8.80
332001	1	.39	6.50	5.20
3321.25	1-1/4	.39	6.50	5.20
33201.5	1-1/2	.39	6.50	5.20
3321.75	1-3/4	.39	6.50	5.20
332002	2	.39	6.50	5.20
33202.5	2-1/2	.39	6.50	5.20
332003	3	.39	6.50	5.20
33203.5	3-1/2	.48	8.00	6.40
332004	4	.48	8.00	6.40
332005	5	.48	8.00	6.40
332006	6	.48	8.00	6.40
332007	7*	.48	8.00	6.40
332008	8*	.69	11.50	9.20
332010	10*	.72	12.00	9.60

*125 volt.
LC SLO BLO (125 V) TYPE N
 Blow Time: 110%, 4-hour min.; 135%, 1 hour max.; 200%, 5-sec. max. Prices for applicable fuse holders upon request.

L.F. No.	Amp Rating	Net per 5	Net per 100	
			100	500
333.010	1/100	\$1.62	\$27.00	\$21.60
333.031	1/32	1.62	27.00	21.60
333.062	1/16	1.17	19.50	15.60
333.100	1/10	1.17	19.50	15.60
333.150	15/100	1.17	19.50	15.60
333.200	2/10	1.17	19.50	15.60
333.250	1/4	1.17	19.50	15.60
333.300	3/10	1.17	19.50	15.60
333.400	4/10	1.17	19.50	15.60
333.500	1/2	1.17	19.50	15.60
333.600	6/10	1.17	19.50	15.60
333.700	7/10	1.17	19.50	15.60
333.750	3/4	1.17	19.50	15.60
333.800	8/10	1.17	19.50	15.60
333001	1	1.17	19.50	15.60
3331.25	1-1/4	1.05	17.50	14.00
33301.6	1-6/10	1.05	17.50	14.00
3331.75	1-3/4	1.05	17.50	14.00
333002	2	1.05	17.50	14.00
33302.5	2-1/2	.99	16.50	13.20
33302.8	2-8/10	.99	16.50	13.20
333003	3	.99	16.50	13.20
33303.2	3-2/10	.99	16.50	13.20
33303.5	3-1/2	.99	16.50	13.20
333004	4	.99	16.50	13.20
333005	5	.99	16.50	13.20
3336.25	6-1/4*	.99	16.50	13.20
333007	7*	.99	16.50	13.20

*32 volt.
SFE AUTO FUSES (32 V OR LESS)
 Blow Time: 110%, 4-hour min.; 135%, 0-1 hour; 150%, 20 amps or less 0-15 sec., 30 amps or less 0-30 sec. Dia. 1/4".

L.F. No.	Amp Rating	Lgth. In.	Net per 5	Net per 100	
				100	500
307004	4	5/8	\$0.25	\$4.10	\$3.20
307006	6	3/4	.25	4.10	3.20
30707.5	7-1/2	7/8	.22	3.60	2.90
307009	9	7/8	.22	3.60	2.90
307014	14	1 1/16	.20	3.30	2.60
307020	20	1 1/4	.20	3.30	2.60
307030	30	1 7/16	.25	4.10	3.20

SAG FUSES
 Blow Time: 110%, 4-hour min.; 135%, 1 hour max.; 200%, 10-sec. max. Length 1", dia. 1/4". U/L Approved.

L.F. No.	Amp Rating	Net per 5	Net per 100	
			100	500
362.125	1/8	\$0.81	\$13.50	\$10.80
362.250	1/4	.54	9.00	7.20
362.375	3/8	.54	9.00	7.20
362.500	1/2	.54	9.00	7.20
362.750	3/4	.54	9.00	7.20
362001	1	.33	5.50	4.40
36201.5	1-1/2	.33	5.50	4.40
362002	2	.33	5.50	4.40
36202.5	2-1/2	.33	5.50	4.40
362003	3	.33	5.50	4.40
362005	5	.22	3.60	2.90
362006	6	.22	3.60	2.90
362008	8	.22	3.60	2.90
362010	10	.22	3.60	2.90
362012	12	.22	3.60	2.90
362015	15	.22	3.60	2.90
362020	20	.22	3.60	2.90
362025	25	.24	4.10	3.20
362030	30	.24	4.10	3.20

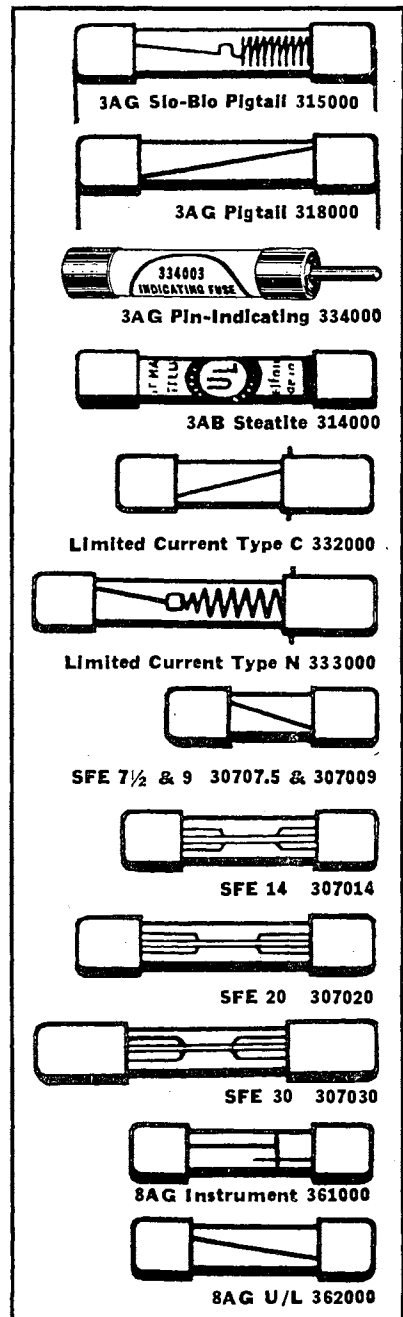

3AG INSTRUMENT FUSES
 Blow Time: 100%, 4-hour min.; 200%, 5-sec. max. Length 1", dia. 1/4".

L.F. No.	Amp Rating	Net per 5	Net per 100	
			100	500
361.002	1/500	\$5.43	\$90.50	\$72.40
361.005	1/200	2.25	37.50	30.00
361.010	1/100	2.07	34.50	27.60
361.031	1/32	1.77	29.50	23.60
361.062	1/16	1.14	19.00	15.20
361.100	1/10	.81	13.50	10.80
361.125	1/8	.81	13.50	10.80
361.187	3/16	.81	13.50	10.80
361.200	2/10	.81	13.50	10.80
361.250	1/4	.54	9.00	7.20
361.375	3/8	.54	9.00	7.20
361.400	4/10	.54	9.00	7.20
361.500	1/2	.54	9.00	7.20
361.750	3/4	.54	9.00	7.20
361001	1	.33	5.50	4.40
36101.5	1-1/2	.33	5.50	4.40
361002	2	.33	5.50	4.40
361003	3	.33	5.50	4.40
361004	4	.33	5.50	4.40
361005	5	.33	5.50	4.40

9AG FUSES (32 V OR LESS)
 Blow Time: 100%, 4-hour min.; 125%, 0-1 hour; 200%, 0-25 seconds. Lg. 1 1/16", dia. 1/4".

L.F. No.	Amp Rating	Net per 5	Net per 100
306050	50	\$0.45	\$7.50 \$6.00

LITTELFUSE Fuses, Fuse Puller

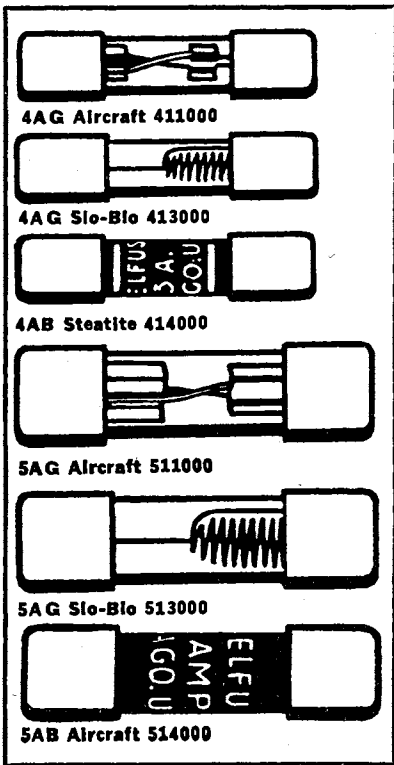

4AG QUICK-ACTING FUSES (250 V OR LESS)
 Blow Time: 110%, 4-hour min.; 135%, 1 hour max.; 200%, 10-sec. max. Length 1 1/4", dia. 3/32".

L.F. No.	Amp Rating	Net per 5	Net per 100	
			100	500
412.062	1/16	\$1.71	\$28.50	\$22.80
412.125	1/8	1.20	20.00	16.00
412.150	15/100	1.20	20.00	16.00
412.250	1/4	.57	9.50	7.60
412.500	1/2	.57	9.50	7.60
412001	1	.54	9.00	7.20
41201.5	1-1/2	.54	9.00	7.20
412002	2	.54	9.00	7.20
41202.5	2-1/2	.54	9.00	7.20
412003	3	.54	9.00	7.20
412005	5	.45	7.50	6.00
412008	8*	.45	7.50	6.00

*125 volts.

4AG SLO BLO AIRCRAFT FUSES (250 V OR LESS)
 Blow Time: 110%, 4-hour min.; 135%, 1 hour max.; 200%, 5-sec. min. Length 1 1/4", dia. 3/32".

L.F. No.	Amp Rating	Net per 5	Net per 100	
			100	500
413.062	1/16	\$1.47	\$24.50	\$19.60
413.100	1/10	1.47	24.50	19.60
413.125	1/8	1.47	24.50	19.60
413.150	15/100	1.47	24.50	19.60
413.200	2/10	1.47	24.50	19.60
413.250	1/4	1.47	24.50	19.60
413.300	3/10	1.47	24.50	19.60
413.400	4/10	1.47	24.50	19.60
413.500	1/2	1.47	24.50	19.60
413.600	6/10	1.47	24.50	19.60
413.750	3/4	1.47	24.50	19.60
413.800	8/10	1.47	24.50	19.60
413001	1	1.47	24.50	19.60
4131.25	1-1/4	1.47	24.50	19.60
41301.5	1-1/2	1.47	24.50	19.60
41301.6	1-6/10	1.47	24.50	19.60
413002	2	1.47	24.50	19.60
41302.5	2-1/2	1.11	18.50	14.80
413003	3	1.11	18.50	14.80
41303.2	3-2/10	1.11	18.50	14.80
413004	4	1.11	18.50	14.80
413005	5	1.11	18.50	14.80
4136.25	6-1/4	1.11	18.50	14.80
413008	8	1.11	18.50	14.80
413010	10	1.11	18.50	14.80
413015	15	1.11	18.50	14.80
413020	20	1.11	18.50	14.80
413025	25	1.11	18.50	14.80
413030	30	1.11	18.50	14.80

4AG AIRCRAFT FUSES
 Blow Time: 110%, 4-hour min.; 135%, 1 hour max.; 200%, 10-sec. max. Length 1 1/4", dia. 3/32".

L.F. No.	Amp Rating	Net per 5	Net per 100	
			100	500
411010	10	\$0.45	\$7.50	\$6.00
411015	15	.45	7.50	6.00
411020	20	.45	7.50	6.00
411025	25	.45	7.50	6.00
411030	30	.45	7.50	6.00
411035	35	.54	9.00	7.20
411040	40	.54	9.00	7.20

4AB FUSES (STEATITE)
 Blow Time: 110%, 4-hour min.; 135%, 1 hour max.; 200%, 30-sec. max. Length 1 1/4", dia. 3/32".

L.F. No.	Amp Rating	Net per 5	Net per 100	
			100	500
414001	1	\$1.14	\$19.00	\$15.20
414002	2	1.14	19.00	15.20
414003	3	1.14	19.00	15.20
414005	5	1.02	17.00	13.60
414006	6	1.02	17.00	13.60
414008	8	1.02	17.00	13.60
414010	10	1.02	17.00	13.60
414015	15	1.02	17.00	13.60
414020	20	1.02	17.00	13.60
414025	25	1.02	17.00	13.60
414030	30	1.02	17.00	13.60
414035	35	1.14	19.00	15.20
414040	40	1.14	19.00	15.20

5AG AIRCRAFT FUSES
 Blow Time: 110%, 4-hour min.; 135%, 1 hour max.; 200%, 20-sec. max. Length 1 1/2", dia. 3/32".

L.F. No.	Amp Rating	Net per 5	Net per 100	
			100	500
511010	10	\$0.63	\$10.50	\$8.40
511015	15	.63	10.50	8.40
511020	20	.63	10.50	8.40
511025	25	.63	10.50	8.40
511030	30	.63	10.50	8.40
511035	35	.66	11.00	8.80
511040	40	.66	11.00	8.80
511050	50	.66	11.00	8.80
511060	60	.66	11.00	8.80

5AG QUICK-ACTING FUSES (250 V OR LESS)
 Blow Time: 110%, 4-hour min.; 135%, 1 hour max.; 200%, 10-sec. max. Length 1 1/2", dia. 3/32".

L.F. No.	Amp Rating	Net per 5	Net per 100	
			100	500
512001	1	\$0.66	\$11.00	\$8.80
512002	2	.66	11.00	8.80
512003	3	.66	11.00	8.80
512004	4	.66	11.00	8.80
512005	5	.63	10.50	8.40
512008	8*	.63	10.50	8.40

*125 volts.

5AG SLO BLO FUSES (250 V OR LESS)
 Blow Time: 110%, 4-hour min.; 135%, 1 hour max.; 200%, 5-sec. min. Length 1 1/2", dia. 3/32".

L.F. No.	Amp Rating	Net per 5	Net per 100	
			100	500
513.500	1/2	\$1.89	\$31.50	\$25.20
513001	1	1.89	31.50	25.20
513002	2	1.89	31.50	25.20
513003	3	1.47	24.50	19.60
513004	4	1.47	24.50	19.60
513005	5	1.47	24.50	19.60
513010	10	1.47	24.50	19.60
513015	15	1.47	24.50	19.60
513020	20	1.47	24.50	19.60
513025	25	1.65	27.50	22.00
513030	30	1.65	27.50	22.00

5AB AIRCRAFT FUSES
 Blow Time: 110%, 4-hour min.; 135%, 1 hour max.; 200%, 30-sec. max. Length 1 1/2", dia. 3/32".

L.F. No.	Amp Rating	Net per 5	Net per 100	
			100	500
514001	1	\$1.23	\$20.00	\$16.40
514002	2	1.23	20.00	16.40
514003	3	1.23	20.00	16.40
51403.5	3-1/2	1.23	20.00	16.40
514005	5	1.20	20.00	16.00
514006	6	1.20	20.00	16.00
5146.25	6-1/4	1.20	20.00	16.00
514007	7	1.20	20.00	16.00
514008	8	1.20	20.00	16.00
514010	10	1.20	20.00	16.00
514015	15	1.20	20.00	16.00
514020	20	1.20	20.00	16.00
514025	25	1.20	20.00	16.00
514030	30	1.20	20.00	16.00

HIGH VOLTAGE FUSES
 Designed for use in aircraft radio equipment, transmitting equipment, X-ray apparatus, high voltage rectifiers, etc., for circuits up to 20 kW DC or 30 kVA AC Fuses are fiber enclosed with cadmium plated end caps. Two principles of arc suppression are employed: (1) Multi-break fuse wire which blows at each half inch of its length; (2) Ceramic baffles break the arc into several parts and quench it. Blow Time: 110%, 4-hour min.; 135%, 0-1 hour; 200% 0-2 minutes.

1000-VOLT (3" x 1 3/8")

L.F. No.	Amp Rating	Net Each	Net per 100	
			100	500
621.375	3/8	\$0.32	\$26.50	\$21.20
621.500	1/2	.32	26.50	21.20
621.750	3/4	.32	26.50	21.20
621001	1	.32	26.50	21.20
62101.5	1-1/2	.32	26.50	21.20
621002	2	.32	26.50	21.20

2500-VOLT (4 1/2" x 1 3/8")

L.F. No.	Amp Rating	Net Each	Net per 100	
			100	500
622.500	1/2	\$0.43	\$36.00	\$28.80
622.750	3/4	.43	36.00	28.80
622001	1	.43	36.00	28.80
62201.5	1-1/2	.43	36.00	28.80
622002	2	.43	36.00	28.80

3000-VOLT (5 1/2" x 1 3/8")

L.F. No.	Amp Rating	Net Each	Net per 100	
			100	500
623.500	1/2	\$0.64	\$53.00	\$42.40
623.750	3/4	.64	53.00	42.40
623001	1	.64	53.00	42.40
62301.5	1-1/2	.64	53.00	42.40
623002	2	.64	53.00	42.40

1000-VOLT (3" x 1 1/8")

L.F. No.	Amp Rating	Net Each	Net per 100	
			100	500
701.062	1/16	\$0.77	\$64.50	\$51.60
701.125	1/8	.77	64.50	51.60
701.250	1/4	.77	64.50	51.60
701.375	3/8	.77	64.50	51.60
701.500	1/2	.77	64.50	51.60
701.750	3/4	.77	64.50	51.60
701001	1	.77	64.50	51.60
70101.5	1-1/2	.77	64.50	51.60
701002	2	.77	64.50	51.60

5000-VOLT (5" x 1 3/8")

L.F. No.	Amp Rating	Net Each	Net per 100	
			100	500
702.062	1/16	\$0.79	\$65.50	\$52.40
702.125	1/8	.79	65.50	52.40
702.250	1/4	.79	65.50	52.40
702.375	3/8	.79	65.50	52.40
702.500	1/2	.79	65.50	52.40
702.750	3/4	.79	65.50	52.40
702001	1	.79	65.50	52.40
70201.5	1-1/2	.79	65.50	52.40
702002	2	.79	65.50	52.40
70202.5	2-1/2	.79	65.50	52.40
702003	3	.79	65.50	52.40

10,000-VOLT (10" x 1 3/8")

L.F. No.	Amp Rating	Net Each	Net per 100	
			100	500
703.062	1/16	\$1.59	\$132.50	\$106.00
703.125	1/8	1.59	132.50	106.00
703.250	1/4	1.59	132.50	106.00
703.175	3/8	1.59	132.50	106.00
703.500	1/2	1.59	132.50	106.00
703.750	3/4	1.59	132.50	106.00
703001	1	1.59	132.50	106.00
70301.5	1-1/2	1.59	132.50	106.00
703002	2	1.59	132.50	106.00
703003	3	1.59	132.50	106.00

FUSE PULLER AND ASSORTMENT

Handy tool provides safe, easy method of extracting any blown fuse. Hooks around fuse permitting easy jerk-out. Available singly (097006) or in card-mounted assortment of 20 pullers, pressure sensitively attached on a card (094066).



L.F. No.	Net Ea. Lots	
	1-100	500Up
097006	\$0.13	\$0.12
094066	5.00	4.17

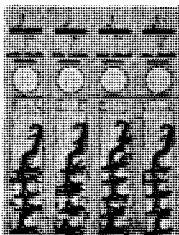

LITTELFUSE

CIRCUIT BREAKERS, MOUNTINGS AND CLIPS

MOUNTINGS FOR SARKES TARZIAN AND INTERNATIONAL RECTIFIERS

L.F. No.	Description	Net Each, Lots of 5	Net per 100	
			100	500
099062	Single pole, 3/16" base	\$0.18	\$15.00	\$12.00
099063	Double pole, 3/16" base	.34	28.50	22.80
099065	Double pole, 1/8" base	.22	18.50	14.80
099065-3	1/8" Bakelite insulator	.017	1.45	1.16
099067	Single pole 1/16" base	.10	8.00	6.40
099067-3	1/16" Bakelite insulator	.02	.90	.72

STANDARD FUSE CLIPS (PHOSPHOR BRONZE, NICKEL PLATED)

L.F. No.	Fuse Adaptation	Type	Net Each, Lots of 5	Net per 100	
				100	500
101001	SFE, 3AG, 8AG, 3AB	Ear	\$0.0246	\$ 2.05	\$ 1.64
101002	SFE, 3AG, 8AG, 3AB	Earless	.0246	2.05	1.64
101003*	SFE, 3AG, 8AG, 3AB	Lug	.0336	2.80	2.24
103001	4AG, 4AB	Ear	.0414	3.45	2.76
104002	4AG, 4AB	Earless	.0414	3.45	2.76
105001	5AG	Ear	.0504	4.20	3.36
105002	5AG	Earless	.0504	4.20	3.36
107001	3/16" dia.	Ear	.084	7.00	5.60
107002	3/16" dia.	Earless	.084	7.00	5.60
109001	13/16" dia.	Ear	.222	18.50	14.80
109002	13/16" dia.	Earless	.222	18.50	14.80

*Unplated, bright dip.

STANDARD FUSE CLIPS (BERYLLIUM COPPER, SILVER PLATED)

L.F. No.	Description	Type	Net Each, Lots of 5	Net per 100	
				100	500
121001	SFE, 3AG, 8AG, 3AB	Ear	\$0.0504	\$ 4.20	\$ 3.36
121002	SFE, 3AG, 8AG, 3AB	Earless	.0504	4.20	3.36
121004	SFE, 3AG, 8AG, 3AB	Lug	.126	10.50	8.40
123001	4AG, 4AB	Ear	.084	7.00	5.60
123002	4AG, 4AB	Earless	.084	7.00	5.60
125001	5AG, hi-volt	Ear	.126	10.50	8.40
125002	5AG, hi-volt	Earless	.126	10.50	8.40
127001	3/16" dia.	Ear	.276	23.00	18.40
127002	3/16" dia.	Earless	.276	23.00	18.40
129001	13/16" dia.	Ear	.648	54.00	43.20
129002	13/16" dia.	Earless	.648	54.00	43.20

3AG MOUNTINGS

L.F. No.	Description	Net Each, Lots of 5	Net per 100	
			100	500
351009	Hinged can cover, 2 pole	\$1.482	\$123.50	\$98.80
351010	Spare, 1 pole	.174	14.50	11.60
352001	Through panel, 1 pole	.288	24.00	19.20
353001	Panel, 1 pole	.51	42.50	34.00

3AG MOUNTINGS WITH SCREW TERMINALS—TYPE T

L.F. No.	Description	Net Ea. Lots of 5	Net per 100	
			100	500
356001	1 pole	\$0.36	\$ 30.00	\$ 24.00
356002	2 pole	.69	57.50	46.00
356003	3 pole	1.04	87.00	69.60
356004	4 pole	1.80	150.00	120.00
356005	5 pole	2.23	186.00	148.80
356006	6 pole	2.63	219.00	175.20
356007	7 pole	3.10	258.00	206.40
356008	8 pole	3.53	294.00	235.20
356009	9 pole	3.95	329.00	263.20
356010	10 pole	4.35	362.50	290.00
356011	11 pole	4.76	397.00	317.60
356012	12 pole	5.11	425.50	340.40

3AG MOUNTINGS WITH SOLDER TERMINALS—TYPE S

L.F. No.	Description	Net Ea. Lots of 5	Net per 100	
			100	500
357001	1 pole	\$0.18	\$ 15.00	\$ 12.00
357002	2 pole	.34	28.50	22.80
357003	3 pole	.51	42.50	34.00
357004	4 pole	.65	54.00	43.20
357005	5 pole	.80	66.50	53.20
357006	6 pole	.94	78.00	62.40
357007	7 pole	1.06	88.50	70.80
357008	8 pole	1.21	101.00	80.80
357009	9 pole	1.36	113.50	90.80
357010	10 pole	1.52	126.50	101.20
357011	11 pole	1.67	139.00	111.20
357012	12 pole	1.82	151.50	121.20

8AG MOUNTINGS

383001	1 pole*	\$0.51	\$42.50	\$34.00
383002	1 pole†	.34	28.50	22.80

*Thru-panel. †Meter back.

8AG MOUNTINGS WITH SOLDER TERMINALS—TYPE S

L.F. No.	Description	Net Ea. Lots of 5	Net per 100	
			100	500
387001	1 pole	\$0.18	\$ 15.00	\$ 12.00
387002	2 pole	.34	28.50	22.80
387003	3 pole	.51	42.50	34.00
387004	4 pole	.65	54.00	43.20
387005	5 pole	.80	66.50	53.20
387006	6 pole	.94	78.00	62.40
387007	7 pole	1.06	88.50	70.80
387008	8 pole	1.21	101.00	80.80
387009	9 pole	1.36	113.50	90.80
387010	10 pole	1.52	126.50	101.20
387011	11 pole	1.67	139.00	111.20
387012	12 pole	1.82	151.50	121.20

4AG FUSE MOUNTINGS WITH SCREW TERMINALS—TYPE T

L.F. No.	Description	Net Ea. Lots of 5	Net per 100	
			100	500
456001	1 pole	\$0.46	\$ 38.50	\$ 30.80
456002	2 pole	.89	74.00	59.20
456003	3 pole	1.32	110.00	88.00
456004	4 pole	2.38	198.50	158.80
456005	5 pole	2.99	249.00	199.20
456006	6 pole	3.53	294.50	235.60
456007	7 pole	4.16	346.50	277.20
456008	8 pole	4.73	394.50	315.60
456009	9 pole	5.31	442.50	354.00
456010	10 pole	5.89	490.50	392.40
456011	11 pole	6.46	538.50	430.80
456012	12 pole	6.95	579.00	463.20

5AG MOUNTINGS WITH SCREW TERMINALS—TYPE T

L.F. No.	Description	Net Ea. Lots of 5	Net per 100	
			100	500
556001	1 pole	\$0.53	\$ 44.50	\$ 35.60
556002	2 pole	1.03	85.50	68.40
556003	3 pole	1.52	126.50	101.20
556004	4 pole	2.90	242.00	193.60
556005	5 pole	3.62	301.50	241.20
556006	6 pole	4.29	357.50	286.00
556007	7 pole	5.04	420.00	336.00
556008	8 pole	5.74	478.50	382.80
556009	9 pole	6.45	537.50	430.00
556010	10 pole	7.12	593.00	474.40
556011	11 pole	7.81	651.00	520.80
556012	12 pole	8.40	700.00	560.00

HIGH VOLTAGE FUSE HOLDERS For 701000 Series Fuses.

L.F. No.	Size, L. x H.	Net Each	Net per 100	
			100	500
711001	2 1/2 x 1 3/8	\$1.76	\$146.50	\$117.20

For 702000 Series Fuses.

711002	6 1/2 x 1 3/8	\$1.97	\$164.00	\$131.20
--------	---------------	--------	----------	----------

For 703000 Series Fuses.

711003	12 x 3	\$4.70	\$392.00	\$313.60
--------	--------	--------	----------	----------

For 621000 Series Fuses.

631001	4 x 1 3/8	\$0.98	\$ 82.00	\$ 65.60
--------	-----------	--------	----------	----------

For 622000 Series Fuses.

631002	5 1/4 x 1 3/8	\$1.40	\$116.50	\$ 93.20
--------	---------------	--------	----------	----------

For 623000 Series Fuses.

631003	6 1/4 x 1 3/8	\$1.52	\$126.50	\$101.20
--------	---------------	--------	----------	----------

TV SNAP-ON FUSE HOLDERS

094025	10 holders*	\$2.10		
350130	Holder†	.21	\$ 12.50	\$ 10.00

*In plastic box. †Bulk.

MANUAL RESET CIRCUIT BREAKERS

Exact replacement protector for TV circuits. Ideal for current overload protection for model railroads, toy transformers, hair dryers, small appliances, tools, wiring, etc. For 125 VAC operation. Size, 1 1/4" x 1 3/8" x 1/2".

L.F. No.*	Trip Rating Amps	Skin Pack Net Ea.*	Bulk Pkg. Box of 5
815.650	.650	\$0.84	\$3.90
815.800	.800	.84	3.90
815001	1	.84	3.90
8151.25	1.25	.84	3.90
81501.5	1.5	.84	3.90
8151.75†	1.75	.84	3.90
815002†	2	.84	3.90
8152.25†	2.25	.84	3.90
81502.5	2.5	.84	3.90
8152.75†	2.75	.84	3.90
815003†	3	.84	3.90
8153.25†	3.25	.84	3.90
815004†	4	.84	3.90
81504.5†	4.5	.84	3.90
815005	5	.84	3.90
815006	6	.84	3.90
815007†	7	.84	3.90

*Add C when ordering (i.e., 815002C).
L.F. No. 094084 Bulk Assortment—Ten circuit breakers from the above listing as indicated by (†). Net Each \$7.80
L.F. No. 094085 Card Assortment—Same, but card packaging. Net Each \$8.40
L.F. No. 094073 Card Assortment for Color TV—One each 8151.75, 8152.25, 8152.75, 815003, 815007; two 81504.5, three 8153.25. Net Each \$8.40
L.F. No. 094074 Bulk Assortment for Color TV—Same, but bulk packaging. Net Each \$7.80
L.F. No. 815(000) PA-Circuit Breaker Adapter Plate—Net Each \$0.18; 100 Net: \$15.00 (\$100 lots); \$12.00 (\$500 lots).

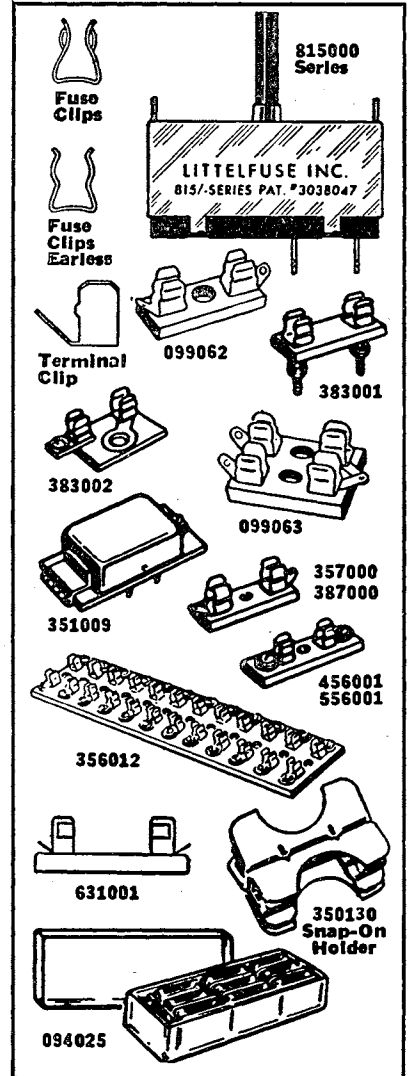

LITTELFUSE Fuses and Holders

FUSES AND ASSORTMENTS

ECON TIME-DELAY PLUG FUSES

Dual-element plug type fuses provide additional protection against blowing during motor starting cycle. U/L Approved. For 125-volt operation.

L.F. No.	Amp Rating	Net per Box of 4	Net per 100
TE3/10	3/10	\$0.72	\$16.00
TE4/10	4/10	.72	16.00
TE8/10	8/10	.72	16.00
TE1	1	.72	16.00
TE1-1/8	1-1/8	.72	16.00
TE1-1/4	1-1/4	.72	16.00
TE1-4/10	1-4/10	.72	16.00
TE1-6/10	1-6/10	.72	16.00
TE1-8/10	1-8/10	.72	16.00
TE2	2	.72	16.00
TE2-1/4	2-1/4	.72	16.00
TE2-1/2	2-1/2	.72	16.00
TE3-2/10	3-2/10	.72	16.00
TE3-1/2	3-1/2	.72	16.00
TE4	4	.72	16.00
TE4-1/2	4-1/2	.72	16.00
TE5	5	.72	16.00
TE5-6/10	5-6/10	.72	16.00
TE6-1/4	6-1/4	.72	16.00
TE7	7	.72	16.00
TE8	8	.72	16.00
TE9	9	.72	16.00
TE10	10	.72	16.00
TE12	12	.72	16.00
TE14	14	.72	16.00
TE15	15	.37	8.40
TE20	20	.37	8.40
TE25	25	.37	8.40
TE30	30	.37	8.40

CLEARSITE ONE-TIME PLUG HOUSE FUSES

Full visibility design for positive, clear indication of fuse condition. For 125 VAC or DC. U/L Approved. Use with standard Edison base fuse holders.

L.F. No.	Amp Rating	Net per Box of 5	Net per 100
CP10	10	\$0.40	\$7.20
CP15	15	.37	7.00
CP20	20	.37	7.00
CP25	25	.37	7.00
CP30	30	.37	7.00

UNIVERSAL AUTO FUSE ASSORTMENT

Emergency fuse kit with ten popular replacement fuses for any car.

Littelfuse No. 094080—Net Each... 78c

FUSE CADDY

Standard fuse caddy for servicemen to carry in tube caddy. Fifteen compartments for 75 fuses; three spare compartments. See-thru plastic top for easy identification.

Littelfuse No. 094037—Net Each... \$9.11

LIMITED-CURRENT FUSE CADDY

Handy, all-inclusive limited-current fuse caddy complete with 75 fuses of 15 different types. Three extra (spare) compartments.

Littelfuse No. 094041—Net Each... \$12.35

FUSEMASTER DISPLAY

Fuse wall rack with 60 individual compartments for easy, instant self-service. Holds index card on back of rack. Ideal for servicemen, laboratories, etc.

Littelfuse No. 094047—Complete with 100 assorted fuses. Net Each... \$15.00
Littelfuse No. 094048—Empty rack. Net Each... 99c

FUSE HOLDERS, RETAINERS

MICROFUSE HOLDERS

For mounting of 273000 Series Microfuse. Type 281002 is front panel mounting; 281001 ideal for printed circuit board mtg.; 284000 Series front panel mtg. with indicator bulb.

L.F. No.	Voltage Range	Net Each	Net per 100	
			100	500
281001		\$0.28	\$ 23.00	\$ 18.40
281002		.68	56.50	45.20
282001		1.31	109.00	87.20
282002		1.24	103.00	82.40
284004	2 1/2-7	2.21	184.00	147.20
284005	7-16	2.21	184.00	147.20
284006	16-32	2.21	184.00	147.20
284003	100-125	1.55	129.00	103.20

3AG FUSE EXTRACTOR POSTS

L.F. No.	Type	Net Each	Net per 100	
			100	500
340255A	R/F shld'd (FHN26G2)	\$4.50	\$375.00	\$300.00
340256A	R/F shld'd (FHN20G)	4.50	375.00	300.00
341001A	Screw	.54	45.00	36.00
342001A	Finger	.54	45.00	36.00
342004A	Miniature	.45	37.50	30.00
342005A	Miniature*	.54	45.00	36.00
342006	Watertight	4.10	342.00	273.60
342007	Non-water	2.29	190.50	152.40
342012A	Miniature	.40	33.00	26.40
342013A	Miniature*	.47	39.00	31.20
342014A	Miniature	.40	33.00	26.40
342015A	Miniature*	.47	39.00	31.20
342021A	FHN 26W	4.10	342.00	273.60
342022A	Miniature	.45	37.50	30.00
342023A	Miniature*	.54	45.00	36.00
342024A	FHN 26G2	1.24	103.50	82.80
342025A	FHN 20G	1.28	107.00	85.60

*Dust-proof.

8AG FUSE EXTRACTOR POSTS

L.F. No.	Type	Net Each	Net per 100	
			100	500
371001	Screw	\$0.54	\$ 45.00	\$ 36.00
372001	Finger	.54	45.00	36.00
372003	FHN31G2	2.50	208.50	166.80

4AG FUSE EXTRACTOR POSTS

442001	Finger	\$1.13	\$ 94.00	\$ 75.20
442006	Watertight	4.10	342.00	273.60
442007	Non-water	2.29	190.50	152.40
442008	Watertight	4.10	342.00	273.60

5AG FUSE EXTRACTOR POSTS

L.F. No.	Type	Net Each	Net per 100	
			100	500
570001	Non-watertight	\$2.90	\$241.50	\$193.20
571004	Watertight	3.51	292.50	234.00

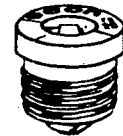

Econ Plug Fuse



Clearsite Fuse

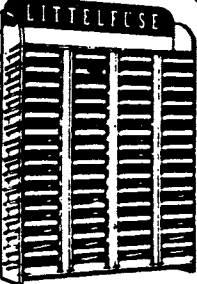
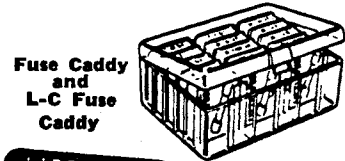

Fusemaster Display



4AG Fuse Extractor Post 442001

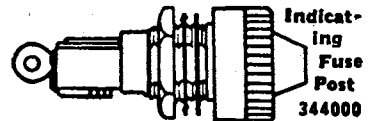

Indicating Fuse Post 344000

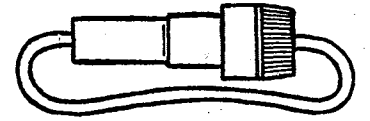

Bakelite In-Line Fuse Retainer Assembled with Lead

3AG QUICK-CONNECT POSTS

L.F. No.	Description	Net Each	Net per 100	
			100	500
342028A	3/8" terminals	\$0.49	\$40.50	\$32.40
342038A	3/8" terminals	.49	40.50	32.40
342048A	3/8" terminals	.49	40.50	32.40
342058A	3/8" terminals	.49	40.50	32.40

3AG INDICATING FUSE POSTS

L.F. No.	Voltage	Net Each	Net per 100	
			100	500
344006	2 1/2-7 V	\$2.65	\$220.50	\$176.40
344012	7-16 V	2.65	220.50	176.40
344024	16-32 V	2.65	220.50	176.40
344125	100-125 V	1.61	134.50	107.60
344250	200-250 V	1.61	134.50	107.60

SERIES 346000 LIMITED CURRENT FUSE HOLDERS

For use with regular and Slo-Blo Type C and N limited current fuses. Specify amperage when ordering. **\$1300**
Net per 100... \$1300
Net per 500... \$5200

UNIVERSAL FUSE RETAINER

Comes with three different length springs for fuse sizes 7/8 SFE thru 3AG. **40c**
L.F. No. 150145—Net Each... 40c
Net 100... \$33.00. Lots 500, Net 100... \$26.40

BAKELITE® IN-LINE FUSE RETAINERS ASSEMBLED WITH 19" LEAD

L.F. No.	Use with Fuses	Net Ea. Lots of 5	Net per 100	
			100	500
155004A	SFE 4, 1AG	\$0.40	\$33.00	\$26.40
155006A	SFE 6	.40	33.00	26.40
15507.5A	SFE 7 1/2	.40	33.00	26.40
155009A	SFE 9, 7AG	.40	33.00	26.40
155014A	SFE 14	.40	33.00	26.40
155020A	SFE 20, 3AG	.40	33.00	26.40

©Bakelite Corp.

© United Technical Publications

281001, 281002, 284000 Indicating Microfuse Holders

3AG Fuse Extractor Post 341001

3AG Fuse Extractor Post 342001

3AG Fuse Extractor Post 342004

3AG Fuse Extractor Post 342012

3AG Fuse Extractor Post 342014

3AG Fuse Extractor Post 342022

8AG Fuse Extractor Post 371001

8AG Fuse Extractor Post 372001

MILITARY FUSES, MICROFUSES and FUSEHOLDERS

Cross Reference of Littelfuse Part Number vs. Military Type Designation as per Specification MIL-F-15160D (Qualified Product Listing-Fuses), MIL-F-23419/2F (Microfuses), MIL-F-19207B (Fuse Holders).

New Type Designation (MIL-F-15160D)	Series	Littelfuse Cat. No.			Price per M			1-89	100-499	500-999	New Type Designation (MIL-F-15160D)	Series	Littelfuse Cat. No.			Price per M		
		Nickel Plated Caps	Silver Plated Caps	List Each	1-89	100-499	500-999						Nickel Plated Caps	Silver Plated Caps	List Each	1-89	100-499	500-999
FO1A250V 1/200A	361000 Series	364.005	366.005	\$0.75	\$450.00	\$375.00	\$300.00				FO2B250V 1/8A	313000 Series (Cont'd)	393.125	398.125	\$0.37	\$222.00	\$185.00	\$148.00
FO1A250V 1/100A		364.010	366.010	.69	414.00	345.00	276.00				FO2B250V 1/4A		393.250	398.250	.37	222.00	185.00	148.00
FO1A250V 1/32A		364.031	366.031	.59	354.00	295.00	238.00				FO2B250V 3/8A		393.375	398.375	.37	222.00	185.00	148.00
FO1A250V 1/16A		364.062	366.062	.38	228.00	190.00	152.00				FO2B250V 1/2A		393.500	398.500	.37	222.00	185.00	148.00
FO1A250V 1/8A	362000 Series	364.125	366.125	.27	182.00	135.00	108.00				FO2B250V 3/4A	393.750	398.750	.37	222.00	185.00	148.00	
FO1A250V 1/4A		364.250	366.250	.18	108.00	90.00	72.00				FO2B250V 1A	393001	398001	.37	222.00	185.00	148.00	
FO1A250V 3/8A		364.375	366.375	.18	108.00	90.00	72.00				FO3A250V 1A	394001	399001	.23	138.00	115.00	92.00	
FO1A250V 1/2A		364.500	366.500	.18	108.00	90.00	72.00				FO3A250V 3A	394003	399003	.23	138.00	115.00	92.00	
FO1A125V 3/4A		364.750	366.750	.18	108.00	90.00	72.00				FO3A250V 5A	394005	399005	.22	132.00	110.00	88.00	
FO1A125V 1A		364001	366001	.11	68.00	55.00	44.00				FO3A250V 8A	394008	399008	.22	132.00	110.00	88.00	
FO1A125V 1-1/2A		36401.5	36601.5	.11	68.00	55.00	44.00				FO3A250V 10A	394010	399010	.22	132.00	110.00	88.00	
FO1A125V 2A		364002	366002	.11	68.00	55.00	44.00				FO3A250V 12A	394012	399012	.23	138.00	115.00	92.00	
FO2A250V 1/100A		312000 Series	392.010	397.010	.69	414.00	345.00	276.00				FO3A250V 15A	394015	399015	.23	138.00	115.00	92.00
FO2A250V 1/32A			392.031	397.031	.59	354.00	295.00	238.00				FO3A125V 20A	394020	399020	.23	138.00	115.00	92.00
FO2A250V 1/16A	392.062		397.062	.27	182.00	135.00	108.00				FO3A125V 30A	394030	399030	.28	168.00	140.00	112.00	
FO2A250V 1/8A	392.125		397.125	.27	182.00	135.00	108.00				FO3B250V 1/16A	390.062	395.062	.58	348.00	290.00	232.00	
FO2A250V 1/4A	392.250		397.250	.18	108.00	90.00	72.00				FO3B250V 1/8A	390.125	395.125	.58	348.00	290.00	232.00	
FO2A250V 3/8A	392.375		397.375	.18	108.00	90.00	72.00				FO3B250V 15/100A	390.150	395.150	.58	348.00	290.00	232.00	
FO2A250V 1/2A	392.500		397.500	.18	108.00	90.00	72.00				FO3B250V 3/16A	390.187	395.187	.58	348.00	290.00	232.00	
FO2A250V 3/4A	392.750		397.750	.18	108.00	90.00	72.00				FO3B250V 1/4A	390.250	395.250	.58	348.00	290.00	232.00	
FO2A250V 1A	392001		397001	.11	66.00	55.00	44.00				FO3B250V 3/8A	390.375	395.375	.58	348.00	290.00	232.00	
FO2A250V 1-1/2A	39201.5		39701.5	.11	68.00	55.00	44.00				FO3B250V 1/2A	390.500	395.500	.58	348.00	290.00	232.00	
FO2A250V 2A	392002	397002	.11	68.00	55.00	44.00				FO3B250V 3/4A	390.750	395.750	.58	348.00	290.00	232.00		
FO2A250V 3A	392003	397003	.10	60.00	50.00	40.00				FO3B250V 1A	390001	395001	.58	348.00	290.00	232.00		
FO2A250V 4A	392004	397004	.14	84.00	70.00	58.00				FO8A250V 1A	494001	499001	.38	228.00	190.00	152.00		
FO2A250V 5A	392005	397005	.14	84.00	70.00	58.00				FO8A250V 2A	494002	499002	.38	228.00	190.00	152.00		
FO2A250V 6A	392006	397006	.14	84.00	70.00	58.00				FO8A250V 3A	494003	499003	.38	228.00	190.00	152.00		
FO2A32V 10A	(311000) 307000 for 20 ampere	392010	397010	.072	43.00	38.00	28.80				FO8A250V 5A	494005	499005	.34	204.00	170.00	136.00	
FO2A32V 15A		392015	397015	.072	43.00	36.00	28.80				FO8A250V 10A	494010	499010	.34	204.00	170.00	136.00	
FO2A32V 20A		392020	397020	.066	40.00	33.00	26.40				FO8A250V 15A	494015	499015	.34	204.00	170.00	136.00	
FO2B250V 1/100A	313000 Series	393.010	398.010	.51	308.00	255.00	204.00				FO7A250V 1A	590081	595001	.22	132.00	110.00	88.00	
FO2B250V 1/32A		393.031	398.031	.51	308.00	255.00	204.00				FO7A250V 2A	590002	595002	.22	132.00	110.00	88.00	
FO2B250V 1/16A		393.062	398.062	.37	222.00	185.00	148.00				FO7A250V 3A	590003	595003	.22	132.00	110.00	88.00	

NOTE: Add \$9.00 Stamping Charge per item, per order, and \$3.00 Silver Plating Charge per item, per order when required. The suffix "S" to the type designation indicates that Silver Plated fuse caps are required, for example: FO2A250V 3/4A "S".

MICROFUSES TO MILITARY SPECIFICATION MIL-F-23419/2F

NOTE: STAMPING OR PLATING CHARGES NOT APPLICABLE TO MIL-F-23419/2F.

Mil. Std. Designation (MIL-F-23419/2F)	Type	Littelfuse Catalog No.	List Each	1-89	Price Per M 100-499	500-999
M23419/2-001	FM02 125V 2MA (1/500A)	274.002	\$2.50	\$1,500.00	\$1,250.00	\$1,000.00
M23419/2-002	FM02 125V 5MA (1/200A)	274.005	2.50	1,500.00	1,250.00	1,000.00
M23419/2-003	FM02 125V 10MA (1/100A)	274.010	2.50	1,500.00	1,250.00	1,000.00
M23419/2-004	FM02 125V 15MA (1/64A)	274.015	2.50	1,500.00	1,250.00	1,000.00
M23419/2-005	FM02 125V 31MA (1/32A)	274.031	2.50	1,500.00	1,250.00	1,000.00
M23419/2-006	FM02 125V 62MA (1/16A)	274.062	2.15	1,290.00	1,080.00	860.00
M23419/2-007	FM02 125V 1/10A	274.100	2.15	1,290.00	1,080.00	860.00
M23419/2-008	FM02 125V 1/8A	274.125	2.15	1,290.00	1,080.00	860.00
M23419/2-009	FM02 125V 2/10A	274.200	2.15	1,290.00	1,080.00	860.00
M23419/2-010	FM02 125V 1/4A	274.250	2.15	1,290.00	1,080.00	860.00
M23419/2-011	FM02 125V 3/10A	274.300	2.15	1,290.00	1,080.00	860.00
M23419/2-012	FM02 125V 4/10A	274.400	2.15	1,290.00	1,080.00	860.00
M23419/2-013	FM02 125V 1/2A	274.500	2.15	1,290.00	1,080.00	860.00
M23419/2-014	FM02 125V 6/10A	274.600	2.15	1,290.00	1,080.00	860.00
M23419/2-015	FM02 125V 3/4A	274.750	2.15	1,290.00	1,080.00	860.00
M23419/2-018	FM02 125V 1A	274001	2.15	1,290.00	1,080.00	860.00
M23419/2-017	FM02 125V 1 1/2 A	27401.5	2.15	1,290.00	1,080.00	860.00
M23419/2-018	FM02 125V 2A	274002	2.15	1,290.00	1,080.00	860.00
M23419/2-019	FM02 125V 3A	274003	2.15	1,290.00	1,080.00	860.00
M23419/2-020	FM02 125V 4A	274004	2.15	1,290.00	1,080.00	860.00
M23419/2-021	FM02 125V 5A	274005	2.15	1,290.00	1,080.00	860.00

(Continued on next page)

SECTION 5100

FUSEHOLDERS TO MILITARY SPECIFICATION MIL-F-19207B

Type Designation (MIL-F-19207B)	Description	Catalog No.	Littelfuse		List Each	Price per M		
			Commercial Equivalent			1-99	100-499	500-999
FHL 17G2	90-300V INDICATING	349250		\$3.31	\$1,988.00	\$1,988.00	\$1,324.00
FHL 18G2-1	12- 22V INDICATING	349012		5.00	3,000.00	2,900.00	2,000.00
FHL 18G2-2	23- 33V INDICATING	349023		5.00	3,000.00	2,900.00	2,000.00
FHL 18G2-3	34- 45V INDICATING	349034		5.00	3,000.00	2,900.00	2,000.00
FHL 18G2-4	46- 60V INDICATING	349046		5.00	3,000.00	2,900.00	2,000.00
FHL 18G2-5	61- 80V INDICATING	349061		5.00	3,000.00	2,900.00	2,000.00
FHL 18G2-6	81- 90V INDICATING	349081		5.00	3,000.00	2,900.00	2,000.00
FHL 44G2-1	Microfuse-Indicating	284007		5.35	3,210.00	2,975.00	2,140.00
FHL 44G2-2	Microfuse-Indicating	284008		6.07	3,642.00	3,038.00	2,428.00
FHL 44G2-3	Microfuse-Indicating	284009		6.07	3,642.00	3,038.00	2,428.00
FHL 44G2-4	Microfuse-Indicating	284010		6.10	3,680.00	3,080.00	2,440.00
FHL 44G2-5	Microfuse-Indicating	284011		6.10	3,680.00	3,080.00	2,440.00
FHL 44G2-6	Microfuse-Indicating	284012		6.10	3,680.00	3,080.00	2,440.00
FHL 45G	Microfuse-Indicating	284013		4.17	2,502.00	2,085.00	1,688.00
FHN 20G	3AG MINIATURE	342025		342004	2.14	1,284.00	1,070.00	856.00
FHN 28G2	3AG MINIATURE	342024		342012	2.07	1,242.00	1,036.00	828.00
FHN 31G2	8AG EXTRACTOR	372003		372001	4.17	2,502.00	2,085.00	1,688.00
FHN 19W	4AG WATERPROOF	442008		442006	6.84	4,104.00	3,420.00	2,736.00
FHN 28W	3AG WATERPROOF	342021		342006	6.84	4,104.00	3,420.00	2,736.00
FHN 28G2	R/F SHIELDED	340255A		7.00	4,200.00	3,500.00	2,800.00
FHN 20G	R/F SHIELDED	340256A		7.00	4,200.00	3,500.00	2,800.00

NOTE: The Suffixes "W" and "G" to the Type Designation Denote Waterproof and Drip-proof, Respectively.

MICROFUSE INDICATING FUSEHOLDERS—RF SHIELDED

Littelfuse Catalog No.	List Each	Price Per M		
		1-99	100-499	500-999
284107	\$13.03	\$7,818.00	\$6,518.00	\$5,212.00
284108	14.71	8,828.00	7,358.00	5,884.00
284109	14.71	8,828.00	7,358.00	5,884.00
284110	14.71	8,828.00	7,358.00	5,884.00
284111	14.71	8,828.00	7,358.00	5,884.00
284112	14.71	8,828.00	7,358.00	5,884.00
284113	10.11	6,068.00	5,058.00	4,044.00
370011 (FHN31G2 Type)	9.03	5,418.00	4,518.00	3,612.00

LITTELFUSE

**It's so easy to order
from this catalog . . .**

When ordering products shown in this book
or writing for additional information, please
be sure to specify:

- 1. Manufacturer's Catalog Numbers
and Page Numbers.**
- 2. The Year and Edition of This
MASTER.**

This will avoid confusion and expedite delivery.

Thank you!

The 
RADIO-ELECTRONIC
MASTER
A United Technical Publication

MALLY Switches

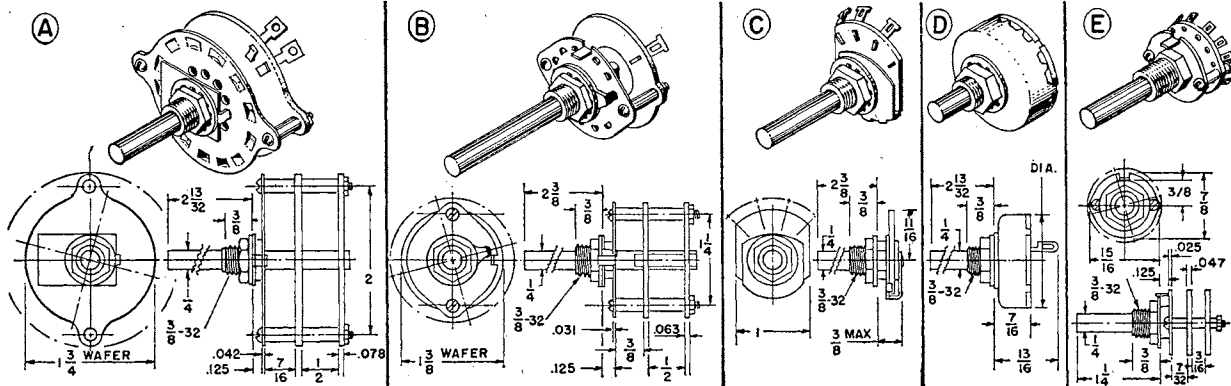

Mally switches are available in three general styles: Rotary, lever-action and pushbutton. Most styles are supplied in both shorting and non-shorting contacts. Shorting switches have contacts with "make" before "breaking" and are widely used in audio circuits. Contacts in non-shorting switches "break" before "making". These switches may be chosen with phenolic, ceramic or glass-epoxy wafer materials. Ceramic is usually selected for high voltage circuits as in switching RF equipment. All switches are supplied with normal mounting hardware. Dial plates are not included (except for Type 13124L).

PHENOLIC WAFER ROTARY SWITCHES

Mally phenolic wafer rotary switches come in several sizes and contact arrangements. Supplied with nut, washer and 366-1 black knob. Phenolic is MIL grade Richardson T725.

STANDARD 1 3/8" DIAMETER (FIG. A)

Rated 1 amp at 300 VDC; 4 amps, 50 VDC; 2 amps, 300 VAC rms; 12 amps, 6 VAC rms. Maximum non-breaking resistive load, 12 amps. Breakdown, 1000 VAC/DC. Contact resistance less than 0.01 ohm. Supplied with adjustment pin and stop plate.

Mally Number		Index	Poles per Section	No. of Sections	Max. Positions	Net Each
Shorting	Non-Shorting					
1211L	1311L	30°	1	1	11	\$2.10
1215L	1315L	30°	2	1	5*	2.10
1213L	1313L	30°	3	1	3*	2.10
1212L	1312L	30°	4	1	2*	2.10
1221L	1321L	30°	1	2	11	2.58
1225L	1325L	30°	2	2	5*	2.58
1223L	1323L	30°	3	2	3*	2.58
1222L	1322L	30°	4	2	2*	2.58
1231L	1331L	30°	1	3	11	3.24
1235L	1335L	30°	2	3	5*	3.24
1233L	1333L	30°	3	3	3*	3.24
1232L	1332L	30°	4	3	2*	3.24
1241L	1341L	30°	1	4	11	3.81
1245L	1345L	30°	2	4	5*	3.81
1243L	1343L	30°	3	4	3*	3.81
1242L	1342L	30°	4	4	2*	3.81
1251L	1351L	30°	1	5	11	4.11
1256L	1356L	30°	2	5	6*	4.53
1261L	1361L	30°	1	6	11	4.83
1266L	1366L	30°	2	6	6*	5.52

*Plus "off" position.

24-POSITION TAP SWITCH (FIG. A)

Includes Mally No. 394 dial.

.....	13124L	15°	1	1	24	\$2.76
-------	--------	-----	---	---	----	--------

5-POSITION HAMSWITCH® (FIG. A)

For measuring up to 5 circuits with a single switch.

.....	151L	60°	1	1	5*	\$2.70
-------	------	-----	---	---	----	--------

*Plus "off" position.

CIRCUIT OPENING SWITCH (FIG. A)

For meter switching or inserting resistors, capacitors, etc. Adjustable stop.

1400L	30°	1	1	11	\$4.68
-------	-------	-----	---	---	----	--------

DECADE SWITCHES (FIG. A)

Use four resistors or capacitors for full decade. Type 153L for capacitors; 154L for resistors. Connect in series for multiple decades. Complete with instructions.

.....	153L	36°	Spec.	1	10	\$2.70
.....	154L	36°	Spec.	1	10	2.94

MINIATURE 1 3/8" DIAMETER (FIG. B)

Rated 350 mA at 500 VAC rms resistive. Breakdown 1700 VAC rms, 60 Hz. Contact resistance 0.005 ohm. Supplied with adjustable stop, 366-1 knob and hex nut.

4M1111	4M2111	30°	1	1	11	\$1.80
4M1215	4M2215	30°	2	1	5	1.80
4M1313	4M2313	30°	3	1	3	1.80
4M1412	4M2412	30°	4	1	2	1.80
4M1121	4M2121	30°	1	2	11	2.58
4M1225	4M2225	30°	2	2	5	2.58
4M1323	4M2323	30°	3	2	3	2.58
4M1422	4M2422	30°	4	2	2	2.58
4M1131	4M2131	30°	1	3	11	3.24
4M1235	4M2235	30°	2	3	5	3.24
.....	4M2432	30°	4	3	2	3.24

MINIATURE SWITCHES (CONT'D)

Mally Number		Index	Poles per Section	No. of Sections	Max. Positions	Net Each
Shorting	Non-Shorting					
4M1141	4M2141	30°	1	4	11	\$3.81
4M1245	4M2245	30°	2	4	5	3.81
4M1151	4M2151	30°	1	5	11	4.47
4M1255	4M2255	30°	2	5	5	4.47
4M1161	4M2161	30°	1	6	11	5.04
.....	4M2265	30°	2	6	5	5.04

MINIATURE SPECIAL PURPOSE (FIG. C)

For tone control, radio-phon use, etc. Suffix indicates: D, AC line switch; S, spring return; K, knurled shaft (no knob supplied).

5M1112	30°	1	1	2	\$1.08
5M1113	30°	1	1	3	1.08
5M1113K	30°	1	1	3	.75
4M1114D	30°	1	1	4	1.80
.....	42L2212S	30°	2	1	2	1.08
5M1213	5M2213	30°	2	1	3	1.08
.....	4M2412S	30°	4	1	2	1.80

STEREO SPEAKER SWITCH (FIG. C)

For switching stereo speakers. Has "Main", "Both" and "Remote" positions. Phenolic wafer 1 3/8" dia.; bushing 3/8"-32 x 3/8" lg.

RSA1213	30°	2	1	3	\$1.08
---------	-------	-----	---	---	---	--------

GENERAL PURPOSE ROTARY SWITCHES (FIG. D)

Single section with formed cup enclosing contacts. Rated 0.2 amp at 300 VDC; 5 amps, 6 VDC; 0.25 amp, 300 VAC; 6 amps, 6 VAC. Maximum non-breaking resistive load, 5 amps. Breakdown 500 VAC/DC. Contact resistance 0.01 ohm or less. Comes with 366-1 knob and nut.

Mally Number		Index	No. of Poles	Max. Positions	Base Dia., In.	Net Each
Shorting	Non-Shorting					
3115J	3215J	30°	1	5	1 1/4	\$1.02
3112J	3212J	30°	1	12	1 1/4	1.02
3122J	3222J	30°	2	2	1 1/4	1.02
3123J	3223J	30°	2	3	1 1/4	1.02
3126J	3226J	30°	2	6	1 1/4	1.02
3134J	3234J	30°	3	4	1 1/4	1.05
3142J	3242J	30°	4	2	1 1/4	1.05
3143J	3243J	30°	4	3	1 1/4	1.05
31117J	32117J	20°	1	17*	1 1/16	1.56
3129J	3229J	20°	2	9*	1 1/16	1.56
3136J	3236J	20°	3	6*	1 1/16	1.65
3163J	3263J	20°	6	3*	1 1/16	1.65

*Furnished with adjustable stop.

ANTENNA SWITCH

For selecting from two TV or FM antennas. Comes with all mounting hardware.

3122TV	30°	2	2	1 1/4	\$1.31
--------	-------	-----	---	---	-------	--------

GLASS-EPOXY WAFER ROTARY SWITCHES (FIG. E)

Subminiature size employs wafers 7/8" dia. Glass-epoxy per MIL-P-18177. Rated 150 mA at 150 V rms. Max. voltage, 225 V rms. Max. current, 2.5 amps at 6 VAC rms. (All specifications at resistive load.) Supplied with nut, washer and 366-1 knob.

Mally Number		Index	Poles per Section	No. of Sections	Max. Positions	Net Each
Shorting	Non-Shorting					
12M1215G	12M2111G	30°	1	1	11	\$4.52
.....	12M2215G	30°	2	1	5	4.52
12M1313G	12M2313G	30°	3	1	3	4.52
.....	12M2412G	30°	4	1	2	4.52
.....	12M2121G	30°	1	2	11	5.58
.....	12M2225G	30°	2	2	5	5.58
.....	12M2323G	30°	3	2	3	5.58
.....	12M2422G	30°	4	2	2	5.58
.....	12M2131G	30°	1	3	11	6.64
12M1235G	12M2235G	30°	2	3	5	6.64
12M1333G	12M2333G	30°	3	3	3	6.64
.....	12M2432G	30°	4	3	2	6.64

MALLORY Switches

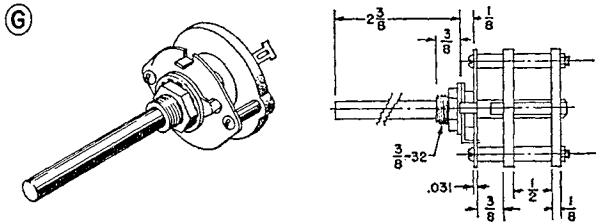
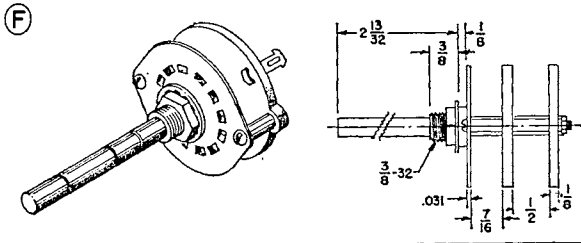

CERAMIC WAFER ROTARY SWITCHES

Mallory ceramic wafer switches are available in two wafer sizes and a variety of circuits. Generally used where high voltages are encountered or in RF circuitry. Ceramic is MIL grade Steatite with Dow-Corning 200 treatment. Switches supplied with 366-1 knob and hex nut.

STANDARD 1/4" DIAMETER (FIG. F)

Rated 0.75 amp at 300 VAC; 10 amps, 6 VAC/DC. Breakdown, 1000 VAC/DC rms. Max. non-breaking resistive load, 5 amps.

Mallory Number		Index	Poles per Section	No. of Sections	Max. Positions	Net Each
Shorting	Non-Shorting					
.....	172C	30°	1	1	10	\$2.37
.....	173C	30°	2	1	5*	2.37
.....	174C	30°	3	1	3*	2.37
.....	176C	30°	1	2	10	3.39
.....	177C	30°	2	2	5*	3.39
.....	178C	30°	3	2	3*	3.39
.....	180C	30°	1	3	10	4.32
.....	181C	30°	2	3	5*	4.32
.....	161C	90°	1	1	4	2.16
.....	162C	90°	1	2	4	3.06
.....	163C	90°	1	3	4	3.96
.....	164C	90°	1	4	4	4.86
.....	165C	90°	1	5	4	5.76

*Plus "off" position.

MINIATURE 1/8" DIAMETER (FIG. G)

Rated 350 mA at 500 VAC rms resistive. Breakdown, 1700 VAC rms, 60 cps. Contact resistance, 0.005 ohm. Adjustable stop.

Mallory Number		Index	Poles per Section	No. of Sections	Max. Positions	Net Each
Shorting	Non-Shorting					
4M11112C	4M21112C	30°	1	1	12	\$2.37
4M1216C	4M2216C	30°	2	1	6	2.37
4M1315C	4M2315C	30°	3	1	5	2.37
.....	4M2513C	30°	5	1	3	2.37
.....	4M2612C	30°	6	1	2	2.37
4M11212C	4M21212C	30°	1	2	12	3.39
4M1226C	4M2226C	30°	2	2	6	3.39
.....	4M2325C	30°	3	2	5	3.39
.....	4M2523C	30°	5	2	3	3.39
.....	4M2622C	30°	6	2	2	3.39
4M11312C	4M21312C	30°	1	3	12	4.32
4M1236C	4M2236C	30°	2	3	6	4.32
.....	4M2335C	30°	3	3	5	4.32
.....	4M2533C	30°	5	3	3	4.32
.....	4M2632C	30°	6	3	2	4.32
.....	4M21412C	30°	1	4	12	5.19
.....	4M2246C	30°	2	4	6	5.19
.....	30°	3	4	5	5.19
4M1345C	4M21512C	30°	1	5	12	6.18
4M11512C	4M2256C	30°	2	5	6	6.18
.....	4M21612C	30°	1	6	12	7.20
4M11612C	4M2266C	30°	2	6	6	7.20
.....	60°	1	1	6	2.16
.....	4M2126H	60°	1	2	6	3.06
.....	4M2136H	60°	1	3	6	3.96
.....	4M2146H	60°	1	4	6	4.86
.....	4M2114N	90°	1	1	4	2.16
.....	4M2124N	90°	1	2	4	3.06
.....	4M2134N	90°	1	3	4	3.96

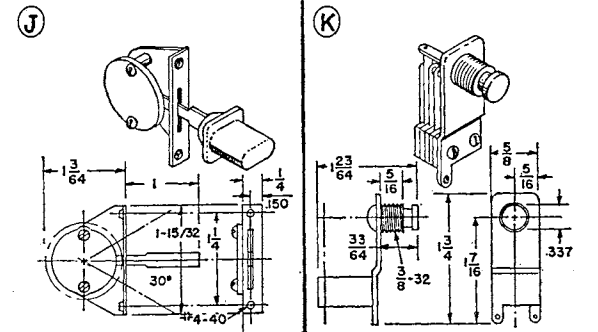
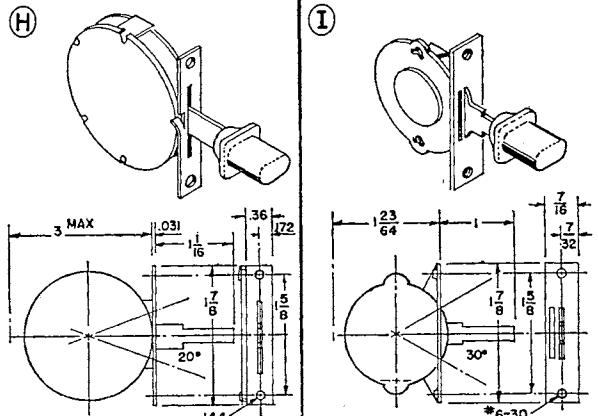

LEVER ACTION SWITCHES

Mallory lever action switches utilize MIL grade phenolic or glass-epoxy for wafer materials. Three wafer sizes available with a variety of circuits and actions. Supplied with mounting screws and knob.

STANDARD 1/4" DIA. PHENOLIC (FIG. H)

Rated 0.2 amp at 300 VDC; 5 amps, 6 VDC; 0.25 amp, 300 VAC; 6 amps, 6 VAC. Positive action. Breakdown, 500 VAC/DC rms. Max. non-breaking resistive load, 5 amps.

Mallory Number		Index	Number of Poles	Number of Positions	Net Each
Shorting	Non-Shorting				
5124	5224	20°	2	4	\$1.38
6142	6242	20°	4	2	1.20
6143	6243	20°	4	3	1.20

MINIATURE 1/8" DIA. PHENOLIC (FIG. I)

Rated 350 mA at 500 VAC rms resistive. Breakdown, 1700 VAC rms, 60 cps. Suffix indicates action (e.g., 6M1213S): S, spring return to center; U, spring return to one side, positive opposite; no suffix, positive action.

Mallory Number		Index	Number of Poles	Number of Positions	Net Each
Shorting	Non-Shorting				
6M1213	6M2213	30°	2	3	\$1.20
.....	6M2213S	30°	2	3	1.50
6M1213U	6M2213U	30°	2	3	1.50
.....	6M2412	30°	4	2	1.20
6M1412S	6M2412S	30°	4	2	1.50

SUBMINIATURE 7/8" DIA. GLASS-EPOXY (FIG. J)

Glass epoxy wafers per MIL-P-18177. Rated 150 mA at 150 VAC rms, resistive. Max. voltage, 225 V rms. Max. current, 2.5 amps at 6 VAC rms, resistive. Suffix indicates action (e.g., 12L1213S): S, spring return to center; U, spring return one side, positive opposite; no suffix, positive action.

Mallory Number		Index	Number of Poles	Number of Positions	Net Each
Shorting	Non-Shorting				
12L1213	12L2213	30°	2	3	\$3.12
.....	12L2213S	30°	2	3	3.38
12L1413	12L2413	30°	4	3	3.63
12L1612	12L2612	30°	6	2	4.24
12L1612S	12L2612S	30°	6	2	4.47

PUSHBUTTON SWITCHES (FIG. K)

Non-locking for test panels, etc. Silver contacts on alloy springs. Rated 0.4 amp at 300 VDC and 220 VAC; 4 amps, 6 VDC. Bushing 3/8"-32 x 3/8" lg. Integral phenolic knob. With nut and washer.

Mallory No.	Circuit Arrangement	Net Each
1011	SPST—Make	\$0.69
1012	SPST—Break	.69
1013	SPDT	.78
1014	DPST—Make 2	.87
1015	DPST—Break 2	.87
1016	DPDT	1.05
1017	DP—Make 2, Break 1	1.05
1018	DPDT—Make before break	1.44

OHMITE power tap switches, high current, non-shorting type

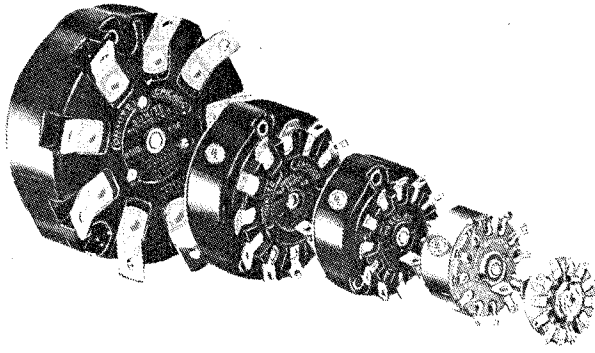

Introducing

MODEL 711
Smallest Switch for Its Rating

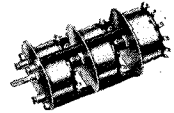
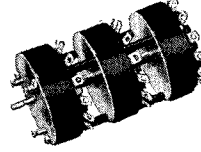

Ohmite single pole, rotary, multi-position switches have proven their durability over many years in demanding applications. Such applications are found in switchboards, arc welders, spot welders, battery chargers, motor controls, tapped transformers, X-ray equipment, diathermy equipment, radio transmitters, electrical machine tools and many other products. Six sizes, including the new, miniature Model 711, provide a choice of ratings from 7 amperes at 125 volts to 100 amperes at 300 volts AC. A choice of the number of taps is provided up to the maximums indicated. All switches are enclosed except for the Models 711 and 111. All switches feature the slow-break, quick-make action deemed so desirable for switching of AC current.

The five sizes offering ratings from 15 amperes to 100 amperes (Models 111, 212, 312, 412 and 608) feature all ceramic, arc-proof bodies and solid silver alloy, fixed and movable contacts. The large, thick, silver-alloy fixed contact disks are permanently welded to copper studs. These, in turn, are riveted and soldered to sturdy terminal lugs, assuring a permanent mechanical and electrical joint. The rotor (moving) contact, also of solid silver-alloy, is riveted and soldered to the contact arm. Face of the rotor contact is slightly rounded assuring a perfect seating of the contacts with a slight rubbing, self-cleaning motion on every operation.

MODEL 711 TAP SWITCH

Alternating Current Rating **7 Amps. 125 Volts** — Diameter 1 1/8" — Shaft Diameter 1/4" — Standard Mounting: For 1/8" panel maximum, by means of 3/8"-32 threaded bushing and hex. nut. See mounting illustration "A." Weight, single unit: .047 lb. approximately. Dual-purpose terminals accept 3/16" quick-connectors as well as soldering. Non-turn lug can be positioned at "12, 3, 6, and 9 o'clock."

Depth Behind Panel		Single Unit			
		1 1/8"			
No. of Taps	Total Rotation	Stock No. 1	Net* 1-4		
3	60°	711-3	\$3.44		
4	90°	711-4	3.55		
5	120°	711-5	3.65		
6	150°	711-6	3.76		
7	180°	711-7	3.87		
8	210°	711-8	3.98		
9	240°	711-9	4.08		
10	270°	711-10	4.19		
11	300°	711-11	4.30		

Recommended Knobs—
See p. 20 for description

Stock No.
5103

* Without Knob.

MODEL 212 TAP SWITCH

Alternating Current Rating **20 Amps. 150 Volts** — Diameter 2 1/4" — Shaft Diameter 1/4" — Standard Mounting: For 1/4" panel maximum, by means of 3/8"-32 threaded bushing and hex. nut — See mounting illustration "C." Tandem Mounting for 1/4" panel maximum, three No. 10-32 flat-head machine screws 3/8" long — See mounting illustration "D." Weight, single unit: .4 lb. approximately.

Depth Behind Panel		Single Unit		2 in Tandem		3 in Tandem	
		1 3/4"		4 3/4"		6 3/4"	
No. of Taps	Total Rotation	Stock No. 1	Net* 1-4	Stock No. 1	Net* 1-2	Stock No. 1	Net* 1 Qty.
3	60°	212-3	\$7.80	212-3 -T2	\$19.05	212-3 -T3	\$28.60
4	90°	212-4	8.00	212-4 -T2	19.45	212-4 -T3	29.20
5	120°	212-5	8.15	212-5 -T2	19.80	212-5 -T3	29.75
6	150°	212-6	8.35	212-6 -T2	20.20	212-6 -T3	30.30
7	180°	212-7	8.55	212-7 -T2	20.55	212-7 -T3	30.90
8	210°	212-8	8.75	212-8 -T2	20.95	212-8 -T3	31.45
9	240°	212-9	8.95	212-9 -T2	21.30	212-9 -T3	32.05
10	270°	212-10	9.10	212-10-T2	21.70	212-10-T3	32.60
11	300°	212-11	9.30	212-11-T2	22.05	212-11-T3	33.15
12	330°	212-12	9.50	212-12-T2	22.45	212-12-T3	33.75

Recommended Knobs—See p. 20 for description

* Without Knob.

ITEMS APPEARING IN BOLD PRINT ARE POPULAR MODELS AND ARE USUALLY STOCKED BY AUTHORIZED OHMITE DISTRIBUTORS

MODEL 111 TAP SWITCH

Alternating Current Rating **15 Amps. 125 Volts** — Diameter 1 3/4" — Shaft Diameter 1/4" — Standard Mounting: For 1/4" panel maximum, by means of 3/8"-32 threaded bushing and hex. nut. See mounting illustration "A." For Tandem Mounting see illustration "B." Weight, single unit: .16 lb. approximately.

Depth Behind Panel		Single Unit		2 in Tandem	
		1 1/8"		2 3/4"	
No. of Taps	Total Rotation	Stock No. 1	Net* 1-4	Stock No. 1	Net* 1-4
3	60°	111-3	\$4.00	111-3 -T2	\$11.50
4	90°	111-4	4.15	111-4 -T2	11.75
5	120°	111-5	4.25	111-5 -T2	12.00
6	150°	111-6	4.40	111-6 -T2	12.25
7	180°	111-7	4.50	111-7 -T2	12.50
8	210°	111-8	4.65	111-8 -T2	12.75
9	240°	111-9	4.75	111-9 -T2	13.00
10	270°	111-10	4.90	111-10-T2	13.25
11	300°	111-11	5.00	111-11-T2	13.50

Recommended Knobs—
See p. 20 for description

Stock No.
5150 or 5116

Stock No.
5109 or 5110

* Without Knob.

MODEL 312 TAP SWITCH

Alternating Current Rating **30 Amps. 300 Volts** — 150V A.C. between taps — Diameter 3 1/2" — Shaft Diameter 1/4" — Standard Mounting: For 1/4" panel maximum, three No. 10-32 flat-head machine screws 3/8" long — See mtg. illus. "D." Weight, single unit: .75 lb. approx.

Depth Behind Panel		Single Unit		2 in Tandem		3 in Tandem	
		2 1/4"		4 5/8"		7"	
No. of Taps	Total Rotation	Stock No. 1	Net* 1-4	Stock No. 1	Net* 1-2	Stock No. 1	Net* 1 Qty.
3	60°	312-3	\$10.50	312-3 -T2	\$25.60	312-3 -T3	\$38.45
4	90°	312-4	10.70	312-4 -T2	26.00	312-4 -T3	39.00
5	120°	312-5	10.90	312-5 -T2	26.40	312-5 -T3	39.55
6	150°	312-6	11.05	312-6 -T2	26.75	312-6 -T3	40.15
7	180°	312-7	11.25	312-7 -T2	27.15	312-7 -T3	40.70
8	210°	312-8	11.45	312-8 -T2	27.50	312-8 -T3	41.25
9	240°	312-9	11.65	312-9 -T2	27.90	312-9 -T3	41.85
10	270°	312-10	11.80	312-10-T2	28.25	312-10-T3	42.40
11	300°	312-11	12.00	312-11-T2	28.65	312-11-T3	42.95
12	330°	312-12	12.20	312-12-T2	29.00	312-12-T3	43.55

Recommended Knobs—See p. 20 for description

* Without Knob.

OHMITE power tap switches, high current, non-shorting type

MODEL 412 TAP SWITCH

Alternating Current Rating 50 Amps. 300 Volts — 150V. A.C. between taps — Diameter $4\frac{3}{8}$ " — Shaft Diameter $\frac{1}{4}$ " — Standard Mounting: For $\frac{1}{4}$ " panel maximum three No. 10-32 flat-head machine screws $\frac{3}{8}$ " long — See mtg. illus. "E." Weight, single unit: 1.4 lbs. approx.

Depth Behind Panel		Single Unit		2 in Tandem		3 in Tandem	
		$2\frac{3}{8}$ "		$5\frac{1}{2}$ "		$7\frac{5}{8}$ "	
No. of Taps	Total Rotation	Stock No. 1	Net* 1-4	Stock No. 1	Net* 1-2	Stock No. 1	Net* 1 Qty.
3	60°	412-3	\$13.80	412-3 -T2	\$32.15	412-3 -T3	\$48.25
4	90°	412-4	14.05	412-4 -T2	32.70	412-4 -T3	49.10
5	120°	412-5	14.30	412-5 -T2	33.25	412-5 -T3	49.90
6	150°	412-6	14.60	412-6 -T2	33.80	412-6 -T3	50.70
7	180°	412-7	14.85	412-7 -T2	34.35	412-7 -T3	51.55
8	210°	412-8	15.15	412-8 -T2	34.90	412-8 -T3	52.35
9	240°	412-9	15.40	412-9 -T2	35.45	412-9 -T3	53.15
10	270°	412-10	15.70	412-10-T2	36.00	412-10-T3	54.00
11	300°	412-11	15.95	412-11-T2	36.55	412-11-T3	54.80
12	330°	412-12	16.25	412-12-T2	37.10	412-12-T3	55.65
Recommended Knobs—See p. 20		Stock No. 5111 or 5112		Stock No. 5111 or 5112		Stock No. 5111 or 5112	

* Without Knob.

MODEL 608 TAP SWITCH

Alternating Current Rating 100 Amps. 300 Volts — Diameter 6" — Shaft Diameter $\frac{3}{8}$ " — Standard Mounting: For 1" panel maximum, three flat-head machine screws $\frac{1}{4}$ "-20 x $1\frac{1}{4}$ " — See mounting illustration "F." Weight, single unit: 5 lbs. approx.

Depth Behind Panel		Single Unit		2 in Tandem		3 in Tandem	
		$3\frac{1}{2}$ "		$6\frac{1}{2}$ "		$10\frac{1}{2}$ "	
No. of Taps	Total Rotation	Stock No. 1	Net* 1-4	Stock No. 1	Net* 1-2	Stock No. 1	Net* 1 Qty.
3	80°	608-3	\$25.05	608-3-T2	\$57.00	608-3-T3	\$84.35
4	120°	608-4	25.40	608-4-T2	57.70	608-4-T3	85.40
5	160°	608-5	25.75	608-5-T2	58.40	608-5-T3	86.50
6	200°	608-6	26.10	608-6-T2	59.15	608-6-T3	87.55
7	240°	608-7	26.45	608-7-T2	59.85	608-7-T3	88.60
8	280°	608-8	26.80	608-8-T2	60.55	608-8-T3	89.70
Recommended Knobs—See p. 20		Stock No. 5104 or 5105		Stock No. 5104 or 5115 or 5105		Stock No. 5115	

* Without Knob.

ITEMS APPEARING IN BOLD PRINT ARE POPULAR VALUES AND ARE USUALLY STOCKED BY AUTHORIZED OHMITE DISTRIBUTORS

ALL CERAMIC OPEN TYPE TAP SWITCHES

Designed to transfer currents of several amperes in circuits requiring high voltage insulation. Ceramic body construction is the same as employed in Models J and K rheostats (see page 19). Monel metal taps; silver-graphite brush.

SHORTING TYPE SWITCH: Moving contact bridges closely spaced taps completing a new circuit before breaking the previous one. Switch arm is not indexed and can be left in any position.

NON-SHORTING SWITCH: Positively indexed, moving contact completely disconnects from one tap before contacting succeeding tap.

Switches up to 8 taps are approximately $3\frac{1}{4}$ " diameter including lugs; 9 to 12 tap switches are approximately $4\frac{1}{4}$ " diameter. Switches can be ordered assembled 2 or 3 in tandem. Single hole mounting by means of $\frac{3}{8}$ " diameter bushing and hexagon nut accommodates panels up to $\frac{1}{4}$ " thick (maximum). The "non-turn" lug requires a $\frac{3}{8}$ " panel hole $\frac{1}{2}$ " below the center of the shaft. Shaft diameter is $\frac{1}{4}$ ". Recommended knob, Stock No. 5150, see page 20.

Maximum current capacity is 7 amperes but only 3 amperes at 120 V.A.C. should be interrupted. Current ratings are less for all direct current circuits above 20 volts, for inductive circuits and high voltages.

TAP SWITCH DIALS

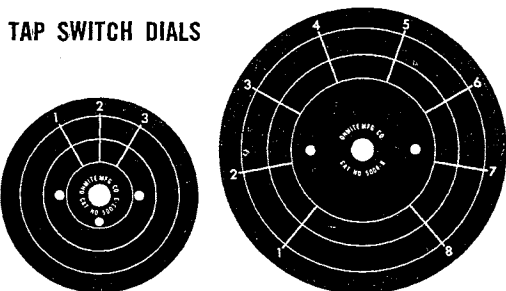

Dials for Ohmite tap switches are made of aluminum, etched and enameled black. Dial markings are bright aluminum. The number of dial calibrations or position markings agree with the actual number of positions on the switch. Note, in the table, that dials for switches Models 212 and 312 are available in two diameters to suit the recommended knob.

TAP SWITCH MOUNTING DIMENSIONS

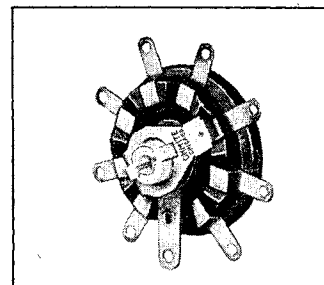
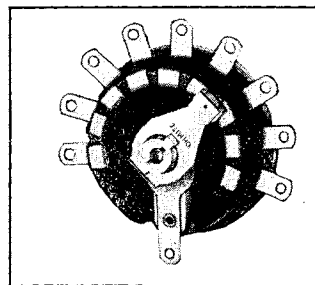
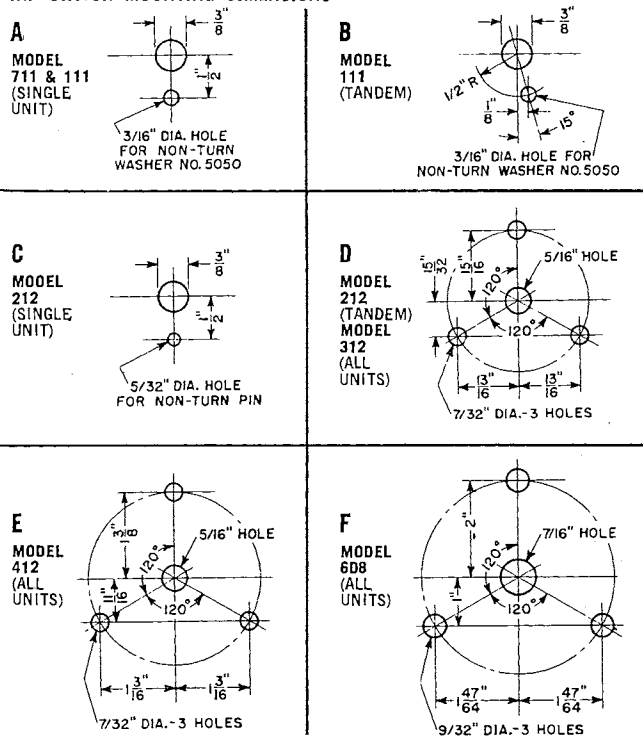

SHORTING TYPE†

No. of Contacts	Stock No.	Net 1-4 Qty.
4	T-504-S	\$4.15
5	T-505-S	4.40
6	T-506-S	4.65
7	T-507-S	4.90
8	T-508-S	5.15
9	T-1009-S	7.40
10	T-10010-S	7.65
11	T-10011-S	7.85
12	T-10012-S	8.15

NON-SHORTING TYPE†

No. of Contacts	Stock No.	Net 1-4 Qty.
3	T-503	\$4.40
4	T-504	4.65
5	T-505	4.90
6	T-506	5.15
7	T-507	5.40
8	T-508	5.65
9	T-1009	7.90
10	T-10010	8.10
11	T-10011	8.40
12	T-10012	8.65

† Avg. Wt. T-500 Series .28 lb.; T-100 Series .68 lb.

Stock No.	For Model	For Knob	Dial Dia.	Net 1-4
5002-*	111	5109	$2\frac{3}{4}$ "	\$.46
	212 (Single)	5116		
	312 (Single)	5150		
5003-*	212 (Tandem)	5111	$3\frac{3}{4}$ "	.69
	312 (Tandem)	5152A		
	412			
5004-*	608	5104	$5\frac{1}{2}$ "	.77
		5115		

* Specify no. of positions as a suffix.

POTTER & BRUMFIELD PRECISION SWITCHES

PRECISION GENERAL PURPOSE SWITCHES—TYPES A1 G

Illustration Fig. Nos.—See back page for Drawing Fig. Nos.

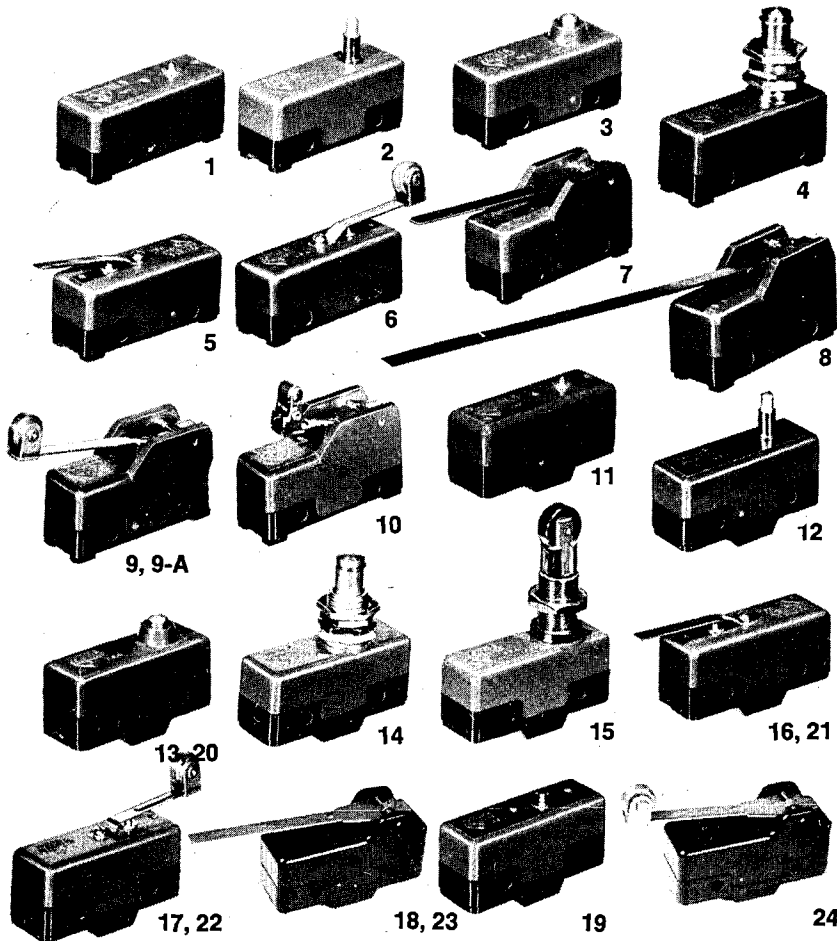

PRECISION MINIATURE SWITCHES—TYPES A1 M

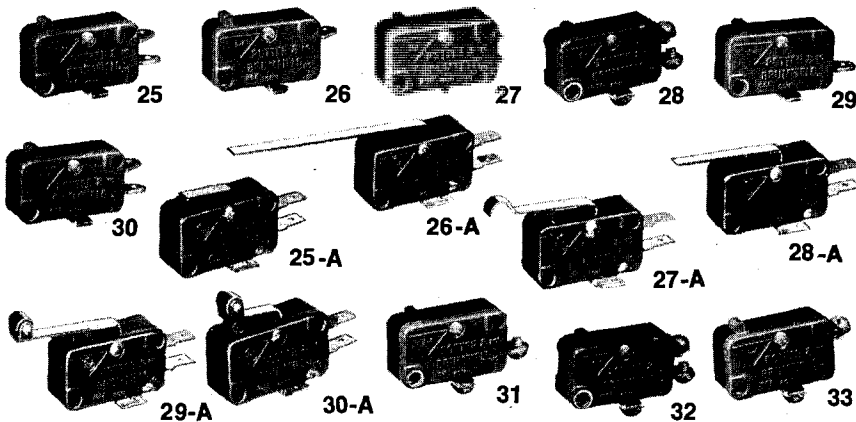

PRECISION SUBMINIATURE SWITCHES—TYPES A1 S

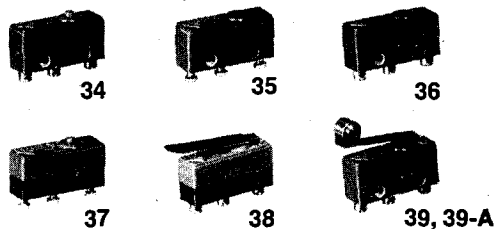

SPECIFICATIONS

PRECISION GENERAL PURPOSE SWITCHES—TYPES A1 G

Meet Underwriters' Laboratories and Canadian Standards Association Requirements

For Types A1 G1—Contact arrangement: SPDT. Ratings: 15 amps, 125, 250, or 480 volts AC; ½ amp 125 volts DC; ¼ amp 250 volts DC; ⅛ HP 125 volts AC; ¼ HP 250 volts AC.

For Types A1 G2—Contact arrangement: SPDT. Ratings: 20 amps, 125, 250, or 480 volts AC; 1 HP 125 volts AC; 2 HP 250 volts AC; 10 amps 125 volts when controlling tungsten filament lamp loads on AC circuits.

PRECISION MINIATURE SWITCHES TYPES A1 M

For Types A1 M1—Contact arrangements: SPDT. Ratings: 30 volts DC; inductive: 10 amps at sea level, 6 amps at 50,000 feet; resistive: 10 amps; motor load: 6 amps.

Meet Underwriters' Laboratories requirements for 15 amps, 125, or 250 volts AC; ⅛ HP 125/250 volts AC; ½ amp 125 volts DC; ¼ amp 250 volts DC.

For Types A1 M2 (low operating force)—Contact arrangements: SPDT. Rating: 30 volts DC; inductive: 5 amps at sea level, 5 amps at 50,000 feet; resistive: 5 amps; motor load: 5 amps.

Meet Underwriters' Laboratories requirements for 10 amps, 125 or 250 volts AC; ½ amp 125 volts DC; ¼ amp 250 volts DC; ⅛ HP 125 volts AC.

For Type A1 M4 (low differential)—Contact arrangement: SPDT. Ratings: 30 volts DC; inductive: 1 amp at sea level, 1 amp at 50,000 feet; resistive: 2 amps; motor load: 1 amp.

Meet Underwriters' Laboratories requirements for 10 amps, 125 or 250 volts AC.

For Type A1 M5 (gold contacts)—Contact arrangement: SPDT. Rating: 28 volts DC; inductive: ½ amp; resistive: 1 amp; inrush: 2 amps.

PRECISION SUBMINIATURE SWITCHES TYPES A1 S

For Types A1 S1—Contact arrangement: SPDT. Rating:

Meet Underwriters' Laboratories requirements for 5 amps, 125 or 250 volts AC. The 30 volt DC rating is as follows: inductive: 3 amps at sea level and 2.5 amps at 50,000 feet; resistive: 5 amps at sea level and 50,000 feet; maximum inrush: 24 amps.

For Types A1 S5 (gold contacts)—Contact arrangement: SPDT. Rating: 28 volts DC; inductive: ½ amp; resistive: 1 amp; inrush: 2 amps.

POTTER & BRUMFIELD PRECISION SWITCHES

PRECISION GENERAL PURPOSE SWITCHES—TYPES A1 G1

POTTER & BRUMFIELD TYPE	MICRO SWITCH EQUIVALENT	PRE-TRAVEL IN. MAX.	OVER-TRAVEL IN. MIN.	MOVEMENT DIFFERENTIAL INCHES	OPER. FORCE OZS.	RELEASE FORCE OZS. MIN.	Fig. No. Pages 2 & 4	SUGG. RESALE PRICE
A1 G1 111-1	BZ-2R	.016	.005	.0004-.002	9-13	4	1	\$1.57
A1 G1 112-1	BZ-2RS	.016	.062	.0004-.002	9-13	4	2	1.95
A1 G1 113-1	BZ-2RD	.016	.062	.0004-.002	9-13	4	3	1.95
A1 G1 114-1	BZ-2RQ1	.015	.219	.0004-.002	9-13	4	4	3.55
A1 G1 115-1	BZ-2RL	.156	.062	.050	5 Max.	0.5	5	1.73
A1 G1 116-1	BZ-2RL2	.141	.062	.050	5 Max.	0.5	6	2.22
A1 G1 117-1	BZ-2RW80	.359	.219	.007 -.050	2½ Max.	0.5	7	2.00
A1 G1 117-1-3	BZ-2RW863	.907	.578	.018 -.140	1 Max.	—	8	2.11
A1 G1 177-1	BZ-2RW84	.203	.219	.007 -.050	1 Max.	.125	7	2.00
A1 G1 119-1	BZ-2RW822	.109	.094	.003 -.020	6 Max.	1.5	9	2.54
A1 G1 117-1-2	BZ-2RW825	.141	.109	.015	8 Max.	1.5	10	3.03
A1 G1 118-1	BZ-2RW82	.249	.156	.004 -.040	3½ Max.	.75	9-A	2.54
A1 G1 111-8	BZ-2R-A2	.016	.005	.0004-.002	9-13	4	11	1.71
A1 G1 112-8	BZ-2RS-A2	.016	.062	.0004-.002	9-13	4	12	2.03
A1 G1 113-8	BZ-2RD-A2	.016	.062	.0004-.002	9-13	4	13	2.03
A1 G1 114-8	BZ-2RQ1-A2	.015	.219	.0004-.002	9-13	4	14	3.64
A1 G1 114-8-1	BZ-2RQ18-A2	.015	.140	.0004-.002	9-13	4	15	6.34
A1 G1 115-8	BZ-2RL-A2	.156	.062	.050	5 Max.	0.5	16	1.87
A1 G1 116-8	BZ-2RL2-A2	.141	.062	.050	5 Max.	0.5	17	2.35
A1 G1 117-8	BZ-2RW80-A2	.359	.219	.007 -.050	2½ Max.	0.5	18	2.09
A1 G1 119-8	BZ-2RW822-A2	.109	.094	.003 -.020	6 Max.	1.5	9	2.62

PRECISION GENERAL PURPOSE SWITCHES—TYPES A1 G2

A1 G2 111-8	BA-2R-A2	.050	.010	.002 -.0075	14-22	10	19	\$1.71
A1 G2 113-8	BA-2RB-A2	.050	.093	.002 -.0075	14-22	10	20	2.03
A1 G2 114-1	BA-2RQ1	.050	.219	.002 -.0075	14-22	10	4	3.87
A1 G2 114-8	BA-2RQ1-A2	.050	.219	.002 -.0075	14-22	10	14	3.64
A1 G2 115-1	BA-2RL	.344	.062	.065	9 Max.	1	5	2.00
A1 G2 115-8	BA-2RL-A2	.344	.062	.065	9 Max.	1	21	1.87
A1 G2 116-8	BA-2RL2-A2	.344	.062	.065	9 Max.	1	22	2.35
A1 G2 117-8	BA-2RV-A2	.625	.078	.109	2½ Max.	0.5	23	2.14
A1 G2 118-1	BA-2RV2	.469	.062	.085	2½ Max.	0.5	24	2.86
A1 G2 118-8	BA-2RV2-A2	.469	.062	.085	2½ Max.	0.5	24	2.68

PRECISION MINIATURE SWITCHES—TYPES A1 M

A1 M1 111-B	V3-1	.047	.031	.006 -.016	6-14	4	25	\$1.10
A1 M1 111-1	V3-19	.047	.031	.006 -.016	6-14	4	25	1.04
A1 M1 211-1	V3-7	.047	.031	.006 -.016	6-14	4	26	.96
A1 M1 111-2	V3-15	.047	.031	.006 -.016	6-14	4	27	1.04
A1 M1 121-B	V3-29	.047	.031	.006 -.016	6-14	4	28	1.15
A1 M1 311-1	V3-32	.047	.031	.006 -.016	6-14	4	29	.96
A1 M1 181-1	V3-419	.047	.031	.006 -.016	6-14	4	30	2.04
A1 M1 117-6	V3L-1-D8	.060	.031	.016	14 Max.	3	25-A	1.05
A1 M1 117-6-1	V3L-2-D8	.125	.062	.050	8 Max.	1	28-A	1.05
A1 M1 117-6-2	V3L-5-D8	.125	.062	.050	8 Max.	1	27-A	1.05
A1 M1 117-6-3	V3L-6-D8	.260	.100	.090	4 Max.	0.5	26-A	1.05
A1 M1 118-6	V3L-4-D8	.125	.062	.050	8 Max.	1	29-A	1.25
A1 M1 119-6	V3L-3-D8	.060	.031	.016	14 Max.	3	30-A	1.25
A1 M1 311-B	V3-23	.047	.031	.006 -.016	6-14	4	31	1.00
A1 M4 191-B	V3-26	.047	.031	.002 -.006	7-12	5	28	1.25
A1 M1 131-B	V3-601	.047	.010-.024	.006 -.016	6-14	4	32	1.50
A1 M2 171-B	V3-101	.047	.031	.006 -.016	8 Max.	2	28	1.10
A1 M2 271-B	V3-121	.047	.031	.006 -.016	8 Max.	2	33	1.00
A1 M2 371-B	V3-123	.047	.031	.006 -.016	8 Max.	2	31	1.00
A1 M2 171-1	V3-119	.047	.031	.006 -.016	8 Max.	2	25	1.04
A1 M5 151-B	V3-75	.047	.031	.006 -.016	6-14	4	28	3.75

PRECISION SUBMINIATURE SWITCHES—TYPES A1 S

A1 S1 111-1	1SM1	.030	.005	.004	3-5	1	34	\$1.20
A1 S1 111-3	1SM1-T	.030	.005	.004	3-5	1	35	1.20
A1 S1 131-1	11SM1	.020	.003	.004	3-5	1	36	1.20
A1 S5 151-1	1SM23	.030	.005	.004	3-5	1	34	2.20
A1 S5 161-1	11SM23	.020	.003	.004	3-5	1	36	2.20
A1 S1 131-3	11SM1-T	.020	.003	.004	3-5	1	37	1.20
A1 S1 115-1-11	111SM1	.219	.030	.030	7 Max.	2	38	1.65
A1 S1 116-1-11	111SM2	.219	.030	.025	7 Max.	2	39	2.00
A1 S1 116-3-11	111SM2-T	.219	.030	.025	7 Max.	2	39-A	2.00
A1 S1 121-1	1SM3	.030	.005	.004	3-5	1	34	1.20
A1 S1 141-1	11SM3	.020	.003	.004	3-5	1	36	1.20



ILLUMINATED SWITCHES & INDICATORS

FEATURES

- Magnetic dry reed type
- Hermetically sealed
- P.C. board mount
- Dry circuits through .5 amps
- High reliability through millions of operations

ELECTRICAL SPECIFICATIONS

Contact Rating:
 KBDP — Illuminated and non-illuminated .5 amps, 125 volts, 10 watts max. (resistive)
 KB — Non-illuminated .5 amps, 125 volts, 10 watts; illuminated .250 amps, 125 volts, 3 watts

Dielectric Strength: 500 VAC, terminals to case

Contact Bounce: 500 microseconds max.

Contact Resistance: 200 milliohms max.

Insulation Resistance: 100 Megohms

Life Expectancy: 20 million operations at full load
 50 million operations at half load
 (Resistive load at 28 VDC)

Each Pole Isolated

MECHANICAL SPECIFICATIONS

Internal Atmosphere: Inert gas

Mounting Position: Any plane

Internal Terminal Construction: Welded

Terminal to Case Insulation: Glass-filled Nylon

Switch Case: Glass-filled Nylon

External Switch Terminals: "A" Nickel Alloy, weldable or solderable

Mounting Stud: 2-56 stainless steel (base of switch)

Identification: Switches printed with model number, contact rating, schematic diagram, switch form

	KBDP	KB
Pre-Travel062 min.	.062 min.
Differential Travel062 max.	.062 max.
Total Travel175 ± .020	.175 max.

SERIES KBDP

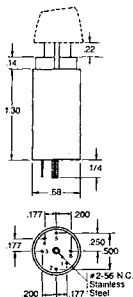

SERIES KB

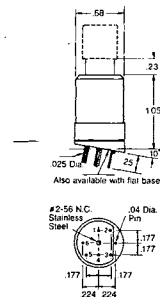

STANDARD SWITCH FORMS (KBDP indicated by light-face numbers, KB by bold-face numbers)

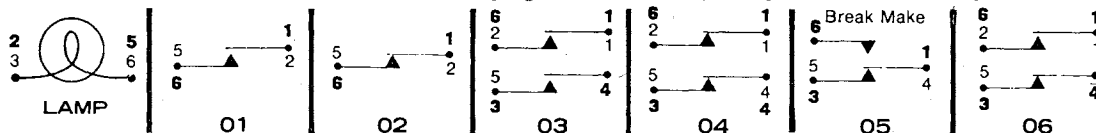

STANDARD KEY TOP SPECIFICATIONS

Colors: Light Gray, Dark Gray, Red, White, Blue, Black — others on request.

Materials: Illuminated = polycarbonate; non-illuminated = ABS

KB available with snap-off, see-through top for inserting specific key information.

(Other key top materials available on request)

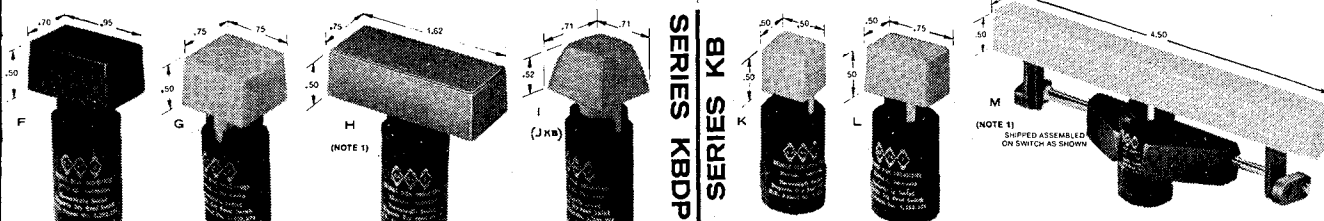

TYPICAL ORDERING PATTERN* (with switch form, key top, lamp and pressure specifications)

KBDP or KB		XX	X	XX.X	XX	When ordering Series KB, specify whether "flat base" or "slant base" is desired.	
Switch Forms		Key Tops KBDP		T-1 3/4 Bi-Pin		Operating Pressure ±.5 oz.	
01	SPST-NO	-F	.95 x .70 x .50	Lamp Voltage		-01	2.5 oz.
02	SPST-NC	-G	.75 x .75 x .50	1.35 10.0		-02	5.0 oz.
03	DPST-NO	-H	1.62 x .75 x .50	2.5 14.0		-03	8.0 oz.
04	DPST-NC	-I	.71 x .71 x .52	2.7 18.0			
05	SPDT-BM	Key Tops KB		3.0 24.0			
06	DPST-NO-NC	-J	.71 x .71 x .52	6.0 28.0			
		-K	.50 x .50 x .50	6.3 —			
		-L	.75 x .50 x .50				
		-M	4.50 x .50 x .50				

* To order non-illuminated switches, indicators and key tops, use applicable areas of the above ordering pattern. For example: KB-01-F-01. (Non-illuminated Series KB; .95" x .70" x .50" key top; 2.5 oz. operating pressure.)

Other operating pressures available on request.

NOTE 1: Illumination is not evenly dispersed over entire key top due to length. If full illumination is required on H and M, auxiliary external lamps would be required.



Dry Reed Type PUSH BUTTON SWITCHES

- FEATURES**
- Hermetically sealed contacts
 - Life expectancy in the millions
 - Exceeds Mil Specs.
 - Explosion proof
 - Low closed contact resistance
 - Low bounce characteristics
 - Ideal for dry circuits or higher current application
 - Terminals weldable and solderable.

Fig. & Dimensions (L x D)	Mfg. Type	Switch Form	Resistive Current	Resistive Watts	Volts	1-9	10-24	25-49	50-99	100-249			
	1—Series T 1.75 x .890 Momentary Action	TI-TA4 TI-HA3 TI-HA2 TE-HA4 TE-HA3 TE-HA2 TB-HC4 TB-HC3 TB-HC2	4PST-NO 3PST-NO 2PST-NO 4PST-NO 3PST-NO 2PST-NO 4PDT-BM 3PDT-BM 2PDT-BM	3 3 3 1 1 1 .250 .250 .250	50 250 250 250 250 250 10 10 10	250 250 250 250 250 250 250 250 250	17.44 14.78 12.32 15.60 13.40 10.35 19.44 16.30 12.32	15.70 13.30 11.00 14.05 12.00 9.30 17.50 14.70 11.10	13.95 11.80 9.90 12.50 10.70 8.30 15.50 13.00 9.85	12.20 10.30 8.70 10.90 9.40 7.25 13.60 11.40 8.65	11.35 9.65 8.05 10.15 8.70 6.70 12.60 10.60 8.00		
		2—Series W 1.75 x .625 Momentary Action	WI-HA WE-HA WB-HC	SPST-NO SPST-NO SPDT-BM	3 1 .250	50 15 250	250 250 250	6.96 6.50 8.96	6.30 5.85 8.10	5.60 4.55 7.15	4.90 4.55 6.30	4.55 4.20 5.75	
			3—Series G .975 x .625 Momentary Action	GC-HA4 GC-HA3 GC-HA2 GC-HA GB-HC2 GB-HC	4PST-NO 3PST-NO 2PST-NO SPST-NO 2PDT-BM SPDT-BM	.5 .5 .5 .5 .250 .250	12 12 12 12 4 4	125 125 125 125 125 125	13.30 11.06 8.82 6.58 14.64 10.04	12.00 10.00 7.95 5.90 13.20 9.10	10.60 8.90 7.05 5.25 11.70 8.05	9.30 7.75 6.15 4.60 10.20 7.05	8.65 7.20 5.75 4.30 9.55 6.55
				4—Series D .850 x .330 Momentary Action	DC-HA DB-HC	SPDT-NO SPDT-BM	.5 .250	12 3	125 125	6.66 10.12	6.05 9.15	5.35 8.15	4.70 7.10
				5—Series R .625 x .375 Momentary Action	RB-HA RB-HC	SPST-NO SPDT-BM	.250 .250	3 3	125 125	7.28 10.14	6.55 9.10	5.80 8.10	5.10 7.10
				6—Series K .750 x .300 Momentary Action	KB-HA KB-HB KB-HC	SPST-NO SPST-NC SPDT-BM	2.50 2.50 2.50	3 3 3	250 250 250	4.93 4.93 5.28	4.37 4.37 4.72	3.82 3.82 4.17	3.26 3.26 3.61
				7—Series J 1.0 x .375 Momentary Action	JC-HA JB-HC	SPST-NO SPDT-BM	.5 .250	12 3	250 250	1.68 1.52	1.52 1.35	1.18 1.18	1.11 1.11
					8—Series B 1" Lx.4Wx.170 Th"K Momentary Action Nylon Actuating Roller avail. upon request	BC-HA	SPST-NO	.5	12	125	6.60	6.30	6.00
		9—Series MV .975 x .625 Merc.-Wetted Reed Momentary Action	MVI-HA	A-SPST-NO	3	50	100	8.30	7.90	7.55	7.15	6.70	
		10—Series MH .750 x 1.225 Momentary Action	CC-HA4 CC-HA3 CC-HA2 CC-HA CB-HC2 CB-HC	4PST-NO 3PST-NO 2UST-NO SPST-NO 2PDT-BM SPDT-BM	.5 .5 .5 .5 .250 .250	12 12 12 12 4 4	125 125 125 125 125 125	14.30 12.06 9.82 7.58 15.64 11.04	13.00 11.00 8.95 6.90 14.20 10.10	11.60 9.90 8.05 6.25 12.70 9.05	10.30 8.75 7.15 5.60 11.20 8.05	9.65 8.20 6.75 5.30 10.55 7.55	

LENGTH OF ALL TERMINALS .300" MAX.

*NOTE: Button operating force = 8 oz. — all momentary action. Button operating force of 17 grams can be supplied, if needed. To specify, change letter "H" in "Mfg. Type"; (Example: TI-HA4) to "F" (Example: TI-FA4). **To obtain GRI switches in "normally closed" form, use the letter "B" in suffix of "Mfg. Type." (Example: TI-HB4, WI-HB, etc.)

BUTTONS & ACCESSORIES

Information on a complete range of button accessories (Delrin and Aluminum) can be obtained by contacting the factory. Colors available for standard buttons and accessories include: white, red, black, green, blue. Illuminated buttons also available.

NO-BOUNCE SWITCHES

GRI now offers mercury-wetted reed switches (momentary). Contact Bounce — none. Maximum contact resistance 50 milliohms after 10 million operations at full load. Mounting Position — 30° out of plane (horizontal or vertical). Write for full information.

Robertshaw



PRECISION SNAP SWITCHES WITH PATENTED ROLLING SPRING

MODEL B — Long Life

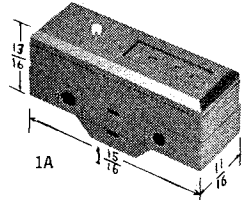

ELECTRICAL
15 amps, 120-240-480 volts A.C.
1/2 amp, 120 VDC
1/4 amp, 240 VDC
Listed by U.L. and C.S.A.

MECHANICAL LIFE
20 Million cycles.

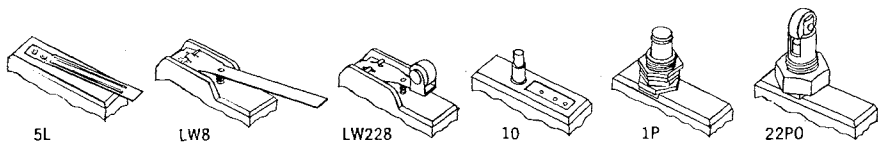

MODEL No.	OPERATING FORCE	RELEASE FORCE	PRETRAVEL	OVERTRAVEL	MOVEMENT DIFFERENTIAL	TERMINAL
BRD2-1A-1S	9-13 oz.	4 oz. Min.	.020 in. Max.	.005 in. Min.	.003 in. Max.	Screw
BRD2-5L-1S	5 oz. Max.	1/2 oz. Min.	.156 in. Max.	1/32 in. Min.	.050 in. Max.	Screw
BRD2-LW8-1S	2 1/2 oz. Max.	1/2 oz. Min.	3/32-1/2 in.	.187 in. Min.	.016-.078 in.	Screw
BRD2-LW228-1S	6 oz. Max.	1 1/2 oz. Min.	.045-.140 in.	.080 in. Min.	.006-.031 in.	Screw
BRD2-10-1S	9-13 oz.	4 oz. Min.	.010-.025 in.	1/16 in. Min.	.003 in. Max.	Screw
BRD2-1P-1S	9-13 oz.	4 oz. Min.	.010-.025 in.	1/32 in. Min.	.003 in. Max.	Screw
BRD2-22PO-1S	9-13 oz.	4 oz. Min.	.010-.025 in.	.140 in. Min.	.003 in. Max.	Screw

TOTAL OF 18 ACTUATORS AVAILABLE.

To order solder terminal, drop "1S" from Model number.

MODEL F — Horsepower Rated

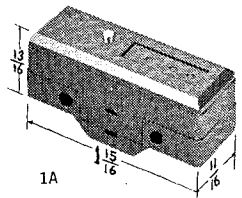

ELECTRICAL
21 amps, 120-240-480 VAC
1 Hp. 120 VAC
2 Hp. 240 VAC
Listed by U.L. and C.S.A.

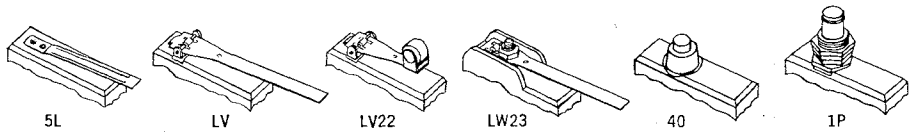

MODEL No.	OPERATING FORCE	RELEASE FORCE	PRETRAVEL	OVERTRAVEL	MOVEMENT DIFFERENTIAL	TERMINAL
FAD2-1A-1S	10-18 oz.	6 oz. Min.	.050 in. Max.	.005 in. Min.	.0075 in. Max.	Screw
FAD2-5L-1S	9 oz. Max.	1 oz. Min.	1/32 in. Max.	1/32 in. Min.	.065 in. Max.	Screw
FAD2-LV-1S	2 1/2 oz. Max.	1/2 oz. Min.	3/8 in. Max.	.078 in. Min.	.109 in. Max.	Screw
FAD2-LV22-1S	6 oz. Max.	1 oz. Min.	1/4 in. Max.	1/32 in. Min.	3/64 in. Max.	Screw
FAD2-LW23-1S	2 1/2 oz. Max.	1/2 oz. Min.	.375 in. Max.	.093 in. Min.	.007-.050 in.	Screw
FAD2-40-1S	10-18 oz.	6 oz. Min.	.050 in. Max.	3/32 in. Min.	.0075 in. Max.	Screw
FAD2-1P-1S	10-18 oz.	6 oz. Min.	.050 in. Max.	.219 in. Min.	.0075 in. Max.	Screw

TOTAL OF 13 ACTUATORS AVAILABLE.

To order solder terminal, drop "1S" from Model number.

MODEL BH — Split Housing

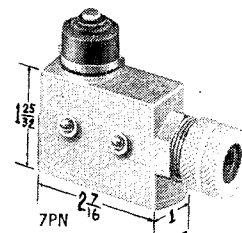

ELECTRICAL
15 amps, 120-240-480 VAC
The combination of metal enclosure and switch is U.L. and C.S.A. listed.

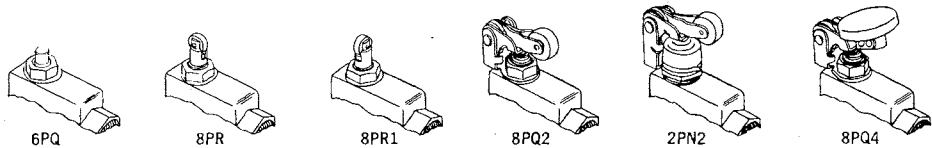

MODEL No.	OPERATING FORCE	RELEASE FORCE	PRETRAVEL	OVERTRAVEL	MOVEMENT DIFFERENTIAL
SBHT-7PN	9-24 ozs.	4 ozs. Min.	.078 in. Max.	.219 in. Min.	.003 in. Max.
SBH-6PQ	9-13 ozs.	4 ozs. Min.	.020 in. Max.	.219 in. Min.	.003 in. Max.
SBH-8PR	9-13 ozs.	4 ozs. Min.	.020 in. Max.	.140 in. Min.	.003 in. Max.
SBH-8PR1	9-13 ozs.	4 ozs. Min.	.020 in. Max.	.140 in. Min.	.003 in. Max.
SBH-8PQ2	10-18 ozs.	6 ozs. Min.	1/16 in. Max.	.219 in. Max.	.006 in. Max.
SBH-2PN2	10-20 ozs.	6 ozs. Min.	.188 in. Max.	.219 in. Min.	.006 in. Max.
SBH-8PQ4	10-18 ozs.	6 ozs. Min.	1/16 in. Max.	.219 in. Max.	.006 in. Max.

10 ACTUATORS AVAILABLE

"T" designates externally threaded housing. These are available with 7PN, 2PN2, 2PN28, and 2PN4 actuators. Split-housing is available with internally threaded housing. One-piece externally threaded housing models are available with same 10 actuators.

MODEL FH — Mounts Either Side

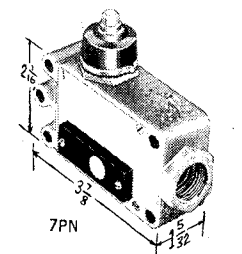

ELECTRICAL
21 amps at 120, 240, 480 VAC
1 Hp — 120 VAC
2 Hp — 240 VAC

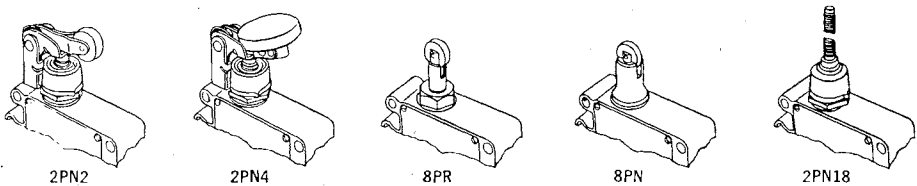

MODEL No.	OPERATING FORCE	RELEASE FORCE	PRETRAVEL	OVERTRAVEL	MOVEMENT DIFFERENTIAL
L-FHD2-7PN	2 1/2 lbs. Max.	8 oz. Min.	.094 in. Max.	.219 in. Min.	.010 in. Max.
FHD2-2PN2	2 lbs. Max.	8 oz. Min.	.219 in. Max.	.218 in. Min.	.020 in. Max.
FHD2-2PN4	2 lbs. Max.	8 oz. Min.			
FHD2-8PR	2 1/2 lbs. Max.	8 oz. Min.	.094 in. Max.	.156 in. Min.	.010 in. Max.
FHD2-8PN	8 lbs. Max.	2 lbs. Min.	.125 in. Max.	.175 in. Max.	.0075 in. Max.

FHD2-2PN18

Above characteristics do not apply to this model switch.

6 ACTUATORS AVAILABLE.

* Switch with one Acrolite, Silicone boot for 0 F to 200 F range is available.
Switch operates by moving flexible actuator 15° or more in any direction, except a direct pull.

WRITE FOR CATALOG D

— Robertshaw Controls Company, Acro Division

21 MODELS

- SUBMINIATURE
- MINIATURE
- GENERAL PURPOSE
- METAL CLAD

Robertshaw



MODEL Z — Subminiature

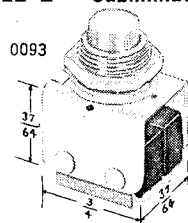
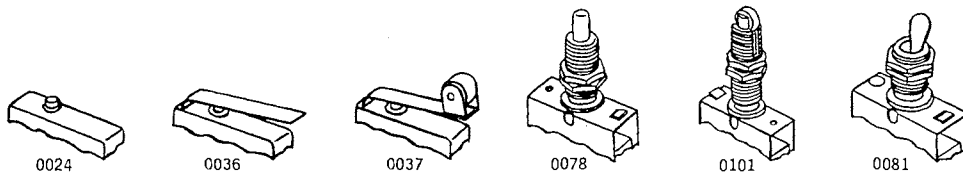

MODEL No.	OPERATING FORCE	RELEASE FORCE	PRETRAVEL	OVERTRAVEL	MOVEMENT DIFFERENTIAL
ZD-0024	85-140 gms.	1 oz. Min.	.008-.020 in.	.010 in. Min.	.001-.004 in.
ZLD-0036	2 oz. Max.	1/2 oz. Min.	3/32 in. Max.	.045 in. Min.	.015 in. Max.
ZLD-0037	2 oz. Max.	1/2 oz. Min.	3/32 in. Max.	.045 in. Min.	.015 in. Max.
ZPD-0078	10 oz. Max.	2 oz. Min.	.050 in. Max.	.125 in. Min.	.030 in. Max.
ZPD-0101	10 oz. Max.	2 oz. Min.	.050 in. Max.	.125 in. Min.	.030 in. Max.
ZTD-0081	20 oz. Max.	5 oz. Min.	.010 in. Max.	.010 in. Min.	.010 in. Max.
ZPD-0093	20 oz. Max.	5 oz. Min.	.010 in. Max.	.010 in. Min.	.010 in. Max.

(Hand operated and these characteristics do not apply)

13 ACTUATORS AVAILABLE.

Available with these terminals: Turret, Double Turret, Post, Baton, and Tab.

ELECTRICAL
 5 amp, 120-240 VAC
 3 amp sea level and 2.5 amp
 50,000 ft., 30 VDC inductive
 4 amp sea level and 4 amp
 50,000 ft., 30 VDC resistive
 U.L. listing, 5 amp., 120-240 VAC

MECHANICAL LIFE
 One million cycles with .010 gap
 and .005 overtravel

MODEL CM — Low Force

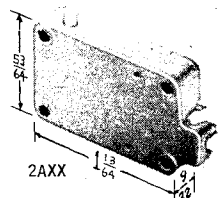
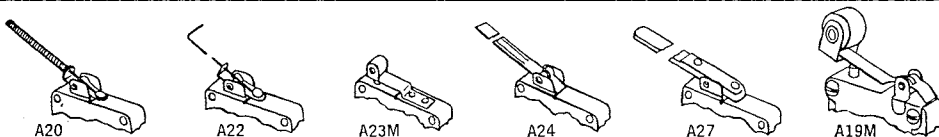

MODEL No.	OPERATING FORCE	RELEASE FORCE	PRETRAVEL	OVERTRAVEL	MOVEMENT DIFFERENTIAL
1CMD1-2AXX	20-27 gms.	12 gms. Min.	.040 in. Max.	.050 in. Max.	.030 in. Max.
1CMD1-18AXX-A20	8 gms. Max.		.400 in. Max.		
1CMD1-2AXX-A22	2.5 gms. Max.		Above characteristics are not applicable to this switch		.500 in. Max.
1CMD1-1AXX-A23M	5-8 oz.	2 oz. Min.	.040 in. Max.	.050 in. Max.	.030 in. Max.
1CMD1-2AXX-A24	2.5 gms. Max.		Above characteristics are not applicable to this switch		.500 in. Max.
*1CMD1-18AXX-A27	6 gms. Max.		Above characteristics are not applicable to this switch		.233 in. Max.
1CMD1-2AXX-A19M	20-27 gms.	12 gms. Min.	.040 in. Max.		.030 in. Max.

8 ACTUATORS AVAILABLE

*Actuator bracket and switch are shipped separately.

ELECTRICAL
 3 amp, 125-250 VAC
 3 amp, 28 VDC
 U.L. listing, 3 amp, 125-250 VAC

MECHANICAL LIFE
 50 Million cycles.

MODEL V — Economical

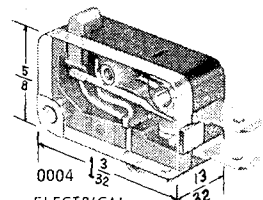
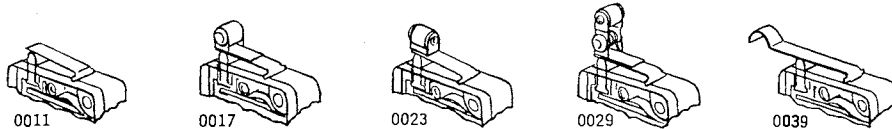

MODEL No.	OPERATING FORCE	RELEASE FORCE	PRETRAVEL	OVERTRAVEL	MOVEMENT DIFFERENTIAL
VD-0004	14 oz. Max.	4 oz. Min.	.047 in. Max.	.031 in. Min.	.014 in. Max.
VLD-0011	14 oz. Max.	2 oz. Min.	.062 in. Max.	.031 in. Min.	.016 in. Max.
VLD-0017	14 oz. Max.	2 oz. Min.	.062 in. Max.	.031 in. Min.	.016 in. Max.
VLD-0023	14 oz. Max.	2 oz. Min.	.062 in. Max.	.031 in. Min.	.016 in. Max.
VLD-0029	14 oz. Max.	2 oz. Min.	.062 in. Max.	.015 in. Min.	.016 in. Max.
VLD-0039	8 oz. Max.	1 oz. Min.	.125 in. Max.	.062 in. Min.	.050 in. Max.

10 ACTUATORS AVAILABLE.

Available with these terminals: Quick Connect, Solder and Screw.
 Actuators are also available with 8 oz. operating force on pin plunger.

ELECTRICAL
 15 amps, 125-250 volts A.C.
 10 amps, 30 VDC
 Listed by U.L. and C.S.A.

MECHANICAL LIFE
 20 Million cycles.

MODEL H — Rotary

ELECTRICAL
 5 amp. — 120-240 VAC
 U.L. and C.S.A. listed.
 Hi-pot tested 1250 VAC terminal to exposed rivet head.

MECHANICAL LIFE
 Minimum operating life of one million cycles. Static load of 15 inch ounces will not change switch characteristics when applied at full travel or start positions and in a direction opposite to normal movement.
 Axial movement of shaft will not exceed .010 in.

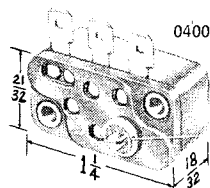

MODEL No.	ROTATION	OPERATING FORCE	OPERATING LIMITS DOWN STROKE	AFTER TRAVEL	MOVEMENT DIFFERENTIAL	TERMINAL
HD-0200	CW	3 gms. in. Max.	15-21°	5° Min.	8° Min.	Solder
HD-0300	CW	3 gms. in. Max.	15-21°	5° Min.	8° Min.	Tab .187
HD-0400	CW	3 gms. in. Max.	15-21°	5° Min.	8° Min.	Tab .205
HD-0500	CCW	4 gms. in. Max.	15-21°	5° Min.	8° Min.	Solder
HD-0600	CCW	4 gms. in. Max.	15-21°	5° Min.	8° Min.	Tab .187
HD-0700	CCW	4 gms. in. Max.	15-21°	5° Min.	8° Min.	Tab .205

MODEL D — Panel Mounted

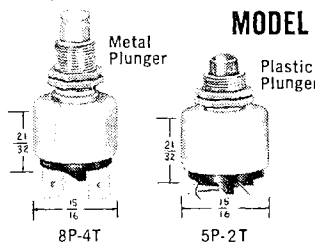

U.L. ELECTRICAL RATING
 12 amps — 125 VAC
 6 amps — 230 VAC

MECHANICAL LIFE
 250,000 cycles

MODEL No.	CIRCUIT	PRETRAVEL	OPERATING FORCE
3D05-5P	N.O.	.100 in. Max.	10-15 oz.
3D05-5P-4T	N.O.	.100 in. Max.	10-15 oz.
3DC5-5P	N.C.	.070 in. Max.	10-15 oz.
3DC5-5P-4T	N.C.	.070 in. Max.	10-15 oz.
3D05-8P	N.O.	.100 in. Max.	10-15 oz.
3D05-8P-4T	N.O.	.100 in. Max.	10-15 oz.
3DC5-8P	N.C.	.070 in. Max.	10-15 oz.
3DC5-8P-4T	N.C.	.070 in. Max.	10-15 oz.

4T Tab.

NATIONWIDE SALES ASSISTANCE THROUGH LOCAL DISTRIBUTOR OR FACTORY ENGINEER

SPEMCO® H & H SWITCHES

BALL LEVER TOGGLE SWITCHES

Underwriters' approved, 1 amp. 250 V 3 amp. 125 volts. AC/DC. Laminated bakelite base. Nickel plated finish, except 1120 and 1121.

3 Amp.

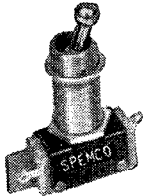

No.	Description	Sleeve	Base Dimensions			Net Price
			L.	W.	H.	
*1120	SPST	1 5/32"	1 3/16"	1/2"	3 5/64"	.66 ea.
1122	SPDT	1 5/32"	1 3/16"	1/2"	3 5/64"	.84 ea.
1124	DPST	1 5/32"	1 3/16"	2 1/32"	3 5/64"	1.20 ea.
1126	DPDT	1 5/32"	1 3/16"	2 1/32"	2 9/32"	1.38 ea.
*1121	SPST	1"	1 3/16"	1/2"	3 5/64"	.90 ea.
1123	SPDT	1"	1 3/16"	1/2"	3 5/64"	1.05 ea.
1125	DPST	1"	1 3/16"	2 1/32"	3 5/64"	1.44 ea.
1127	DPDT	1"	1 3/16"	2 1/32"	2 9/32"	1.62 ea.

Sleeve Diameter—1 5/32"
*3 amp. 250 V AC/DC.

BAT LEVER TOGGLE SWITCHES

3 Amp.

Underwriters' approved, 1 amp. 250 V 3 amp. 125 volts. AC/DC. Laminated bakelite base. Nickel plated finish, except 1135 and 1121B.

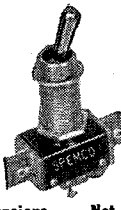
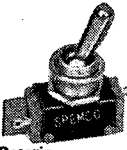

No.	Description	Sleeve	Base Dimensions			Net Price
			L.	W.	H.	
*1135	SPST	1 5/32"	1 3/16"	1/2"	3 5/64"	.66 ea.
1136	SPDT	1 5/32"	1 3/16"	1/2"	3 5/64"	.84 ea.
1137	DPST	1 5/32"	1 3/16"	2 1/32"	3 5/64"	1.20 ea.
1138	DPDT	1 5/32"	1 3/16"	2 1/32"	2 9/32"	1.38 ea.
*1121-B	SPST	1"	1 3/16"	1/2"	3 5/64"	.90 ea.
1123-B	SPDT	1"	1 3/16"	1/2"	3 5/64"	1.05 ea.
1125-B	DPST	1"	1 3/16"	2 1/32"	3 5/64"	1.44 ea.
1127-B	DPDT	1"	1 3/16"	2 1/32"	2 9/32"	1.62 ea.

Sleeve Diameter—1 5/32"
*3 amp. 250 V AC/DC.

"COMPACT" SWITCH

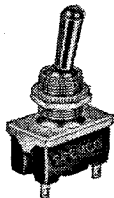

3 Amp.

Ideal for aircraft, missile, and electronic applications. Underwriter's approved 1 amp. 250 v., 3 amp. 125 v., AC-DC. Bakelite base. Bright nickel finish.

No.	Description	Sleeve	Base Dimensions			Net Price
			L.	W.	H.	
1205	SPST	1 5/32"	1 3/16"	4 1/64"	1 3/16"	.90 ea.
1206	SPDT	1 5/32"	1 3/16"	4 1/64"	1 3/16"	1.05 ea.
1207	DPST	1 5/32"	1 3/16"	4 1/64"	1 3/16"	1.32 ea.
1208	DPDT	1 5/32"	1 3/16"	4 1/64"	1 3/16"	1.50 ea.

Sleeve Diameter—1 5/32"

MOLDED BAKELITE SWITCH, BAT LEVER

U.L. approved for 6 amp. 125 volts, 3 amp. 250 volts. *Except for 1143 which is rated at 1 amp. 250 volts, 6 amp. 125 volts. All back connected, slotted sleeve. Positive action.



6 Amp.

No.	Description	Sleeve	Base Dimensions			Net Price
			L.	W.	H.	
*1142	SPST	1 5/32"	1 1/4"	1 1/16"	1 5/16"	.90 ea.
*1143	SPDT	1 5/32"	1 1/4"	1 1/16"	1 5/16"	1.05 ea.
1144	DPST	1 5/32"	1 1/4"	1 1/16"	1 5/16"	1.32 ea.
1145	DPDT	1 5/32"	1 1/4"	1 1/16"	1 5/16"	1.50 ea.

Sleeve Diameter—1 5/32"
*1 amp. 250 volts, 6 amp. 125 volts

BALL or BAT* LEVER TOGGLE SWITCH

6 Amp.



Underwriters' approved 3A 250V, 6A 125V, molded bakelite base. Nickel plated finished. WITH 6" WIRE LEADS

No.	Description	Sleeve	Base Dimensions			Net Price
			L.	W.	H.	
1154	SPST	3/8"	7/8"	1/2"	3 1/6"	.93 ea.
*1154B	SPST	3/8"	7/8"	1/2"	3 1/6"	.93 ea.

Sleeve Diameter—1 5/32"

UTILITY SWITCHES—Toggle Type For AC Uses

1185 15 Amp. 1186 1188 1194

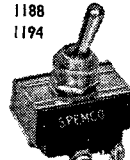

Underwriters' approved, 10 amp. 250 volts AC, 15 amp. 125 volts AC, 3/4 H.P. 115V-230V AC.

No.	Description	Sleeve	Base Dimensions			Net Price
			L.	W.	H.	
1185	SPST	1 5/32"	1 1/2"	5/8"	1 5/16"	.78 ea.
1186	SPDT	1 5/32"	1 1/2"	5/8"	1 5/16"	.93 ea.
1188	DPST	1 5/32"	1 1/2"	3/4"	1 1/16"	1.26 ea.
1194	DPDT	1 5/32"	1 1/2"	3/4"	1 1/16"	1.56 ea.

Sleeve Diameter—1 5/32"

MOMENTARY BAT LEVER TOGGLE SWITCHES



Underwriters' approved, 3 amp. 125 volts, laminated bakelite base. Nickel plated finished.

No.	Description	Sleeve	Base Dimensions			Net Price
			L.	W.	H.	
*1166	SPST	1 5/32"	1 3/16"	1/2"	3 5/64"	1.20 ea.
1167	SPDT	1 5/32"	1 3/16"	1/2"	3 5/64"	1.23 ea.
*1155	DPST	1 5/32"	1 3/16"	2 1/32"	3 5/64"	1.56 ea.
1150	DPDT	1 5/32"	1 3/16"	2 1/32"	2 9/32"	1.77 ea.

*1166 Normally Off *1155 Normally Off
*3 Amp 250V

15 Amp.



Underwriters' approved, 10 amp. 250 volts AC, 15 amp. 125 volts AC, 3/4 H.P. 115V-230V AC.

No.	Description	Sleeve	Base Dimensions			Net Price
			L.	W.	H.	
*1196	SPST	1 5/32"	1 1/8"	5/8"	1 5/16"	1.14 ea.
*1197	DPST	1 5/32"	1 1/8"	3/4"	1 1/16"	1.80 ea.

*Normally Off Sleeve Diameter—1 5/32"

NEUTRAL CENTER MOMENTARY BOTH ENDS

15 Amp.

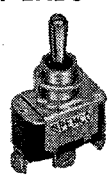

Underwriters' approved, 10 amp. 250 volts AC, 15 amp. 125 volts AC, 3/4 H.P. 115V-230V AC.

No.	Description	Sleeve	Base Dimensions			Net Price
			L.	W.	H.	
1193	DPDT	1 5/32"	1 3/16"	3/4"	1 1/16"	2.10 ea.
1195	SPDT	1 5/32"	1 1/8"	5/8"	1 5/16"	1.29 ea.

Sleeve Diameter—1 5/32"

NEUTRAL CENTER

15 Amp.



Underwriters' approved, 10 amp. 250 volts AC, 15 amp. 125 volts AC, 3/4 H.P. 115V-230V AC.

No.	Description	Sleeve	Base Dimensions			Net Price
			L.	W.	H.	
1187	SPDT	1 5/32"	1 3/8"	5/8"	1 5/16"	.93 ea.
1189	DPDT	1 5/32"	1 3/8"	3/4"	1 5/16"	1.56 ea.

Sleeve Diameter—1 5/32"

BAT LEVER TOGGLE SWITCH 6 Amp. Neutral Center

Underwriters' approved, 6 amp. 125 volts, either AC or DC. A 3 position switch, on-off-on. Black bakelite case.

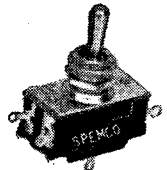

No.	Description	Sleeve	Base Dimensions			Net Price
			L.	W.	H.	
1175	SPDT	1 5/32"	1 3/16"	1 1/16"	1 1/16"	1.71 ea.
1176	DPDT	1 5/32"	1 3/16"	1 1/16"	1 1/16"	2.07 ea.

Sleeve Diameter—1 5/32"

BAT AND PADDLE LEVER TOGGLE SWITCH 5 Amp.



1232 1232-P 1232-DF
1233 1233-P

This series is unique and used where other switches cannot be reliably used or have no counterpart. Smallest two and three position wiping blade toggle switches at their ratings on the market. Bat lever is nickel-plated brass; paddle lever is black Nylon standard.

Mechanical life expectancy, 100,000 cycles min. Electrical life expectancy, 50,000 cycles min. at full load. Terminals: combination solder lug and quick-connect push-on type terminals. Quick-connect accepts .110" AMP type connector or equal. When wires are soldered, up to two #18 wires or three #20 wires. Weight: double pole, 22.5 grams. Bat lever is 3/4" long; paddle lever is 1 3/16" long, both with a 28 degree throw. 5 amp. 225 volts, 2 amp. 250 volts AC. 4 amps. 125 volts, 1 amp. 250 volts DC.

No.	Description	Sleeve	Base Dimensions			Net Price Each
			L.	W.	H.	
1232	DPDT (on-off-on)	5/8"	1 3/4"	4 3/4"	1/2"	\$2.55
1232-P	DPDT (on-off-on)	5/8"	1 3/4"	4 3/4"	1/2"	2.67
1233	SPDT (on-off-on)	5/8"	1 3/4"	4 3/4"	1/2"	2.04
1233-P	SPDT (on-off-on)	5/8"	1 3/4"	4 3/4"	1/2"	2.25
1232-DF	Dress face nut (optional)				.178" thick	.15

Sleeve Diameter—1 5/32"

SPECIALTIES MANUFACTURING CO.

SPEMCO® H & H SWITCHES

PUSH BUTTON DOUBLE ACTION 6 Amp. SWITCH



Underwriters' approved, 6 amp. 125 volts. Press lever to make contact, press lever to break contact. Nickel plated finish or snap-on plastic button, in red or black.

No.	Description	Sleeve	Base Dimensions			Net Price
			L.	W.	H.	
1156	Nickel Plated	3/16"	1 1/8"	1/2"	3/16"	1.02 ea.
1156-A	Red	3/16"	1 1/8"	1/2"	3/16"	1.32 ea.
1156-B	Black	3/16"	1 1/8"	1/2"	3/16"	1.32 ea.

Sleeve Diameter—1 3/32"

"COMPACT" DOUBLE ACTION (PUSH-PUSH) SWITCH QUICK MAKE AND BREAK ACTION 3 Amp.

Rated at 1 Amp. 250 Volts and 3 Amps. 125 Volts, A.C. and D.C.
Solder lug terminals with double wiping blade mechanism.

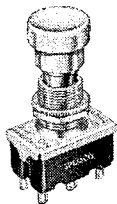

No.	Description	Sleeve	L.	W.	H.	Net Price Each
1215	SPST	3/16"	1 1/2"	4/16"	1 3/4"	1.17
1215-B	SPST	3/16"	1 1/2"	4/16"	1 3/4"	1.41
1215-R	SPST	3/16"	1 1/2"	4/16"	1 3/4"	1.41
1216	SPDT	3/16"	1 1/2"	4/16"	1 3/4"	1.35
1216-B	SPDT	3/16"	1 1/2"	4/16"	1 3/4"	1.62
1216-R	SPDT	3/16"	1 1/2"	4/16"	1 3/4"	1.62
1217	DPST	3/16"	1 1/2"	4/16"	1 3/4"	1.71
1217-B	DPST	3/16"	1 1/2"	4/16"	1 3/4"	1.89
1217-R	DPST	3/16"	1 1/2"	4/16"	1 3/4"	1.89
1218	DPDT	3/16"	1 1/2"	4/16"	1 3/4"	1.83
1218-B	DPDT	3/16"	1 1/2"	4/16"	1 3/4"	2.04
1218-R	DPDT	3/16"	1 1/2"	4/16"	1 3/4"	2.04

(B, means black button, R, means Red button and just the number, nickel.)
Sleeve Diameter — 1 3/32"

"COMPACT" MOMENTARY ACTION PUSH SWITCH QUICK MAKE AND BREAK ACTION 3 Amp.

Rated at 1 Amp. 250 Volts
3 Amps. 125 Volts A.C.-D.C.

Solder lug terminals with double wiping blade mechanism



No.	Description	Sleeve	L.	W.	H.	Net Price Each
*1219	SPST	3/16"	1 3/32"	4/16"	1 3/4"	1.44
*1219-B	SPST	3/16"	1 3/32"	4/16"	1 3/4"	1.65
*1219-R	SPST	3/16"	1 3/32"	4/16"	1 3/4"	1.65
1220	SPDT	3/16"	1 3/32"	4/16"	1 3/4"	1.71
1220-B	SPDT	3/16"	1 3/32"	4/16"	1 3/4"	1.95
1220-R	SPDT	3/16"	1 3/32"	4/16"	1 3/4"	1.95
*1221	DPST	3/16"	1 3/32"	4/16"	1 3/4"	1.98
*1221-B	DPST	3/16"	1 3/32"	4/16"	1 3/4"	2.19
*1221-R	DPST	3/16"	1 3/32"	4/16"	1 3/4"	2.19
1222	DPDT	3/16"	1 3/32"	4/16"	1 3/4"	2.13
1222-B	DPDT	3/16"	1 3/32"	4/16"	1 3/4"	2.31
1222-R	DPDT	3/16"	1 3/32"	4/16"	1 3/4"	2.31

Sleeve Diameter—1 3/32"
(B, means black button, R, means Red button and just the number, nickel.)
*SPST & DPST—Normally Off.

MIDGET MOMENTARY PUSH BUTTON SWITCHES

3 Amp.

Underwriters' approved, 3 amp. 120 volts, A.C. Molded bakelite base, nickel plated finish.



No.	Description	Sleeve	Base Dimensions			Net Price
			L.	W.	H.	
1141	SP Norm. Closed	3/16"	1 1/2"	3/16"	2 3/4"	.57 ea.
1141-A	SP Norm. Open	3/16"	1 1/2"	3/16"	2 3/4"	.57 ea.

Sleeve Diameter—1 3/32"

3 Amp.

Underwriters' approved, 3 Amp. 120v, AC, Nickel plated finish, Molded bakelite base, Single Pole, slow make and slow break with bakelite snap-On button in red or black. Also white button on request.



No.	Description	Sleeve	Base Dimensions			Net Price
			L.	W.	H.	
1157-A	Open—Red	3/16"	1 3/32"	3/16"	2 3/4"	.96 ea.
1157-B	Open—Black	3/16"	1 3/32"	3/16"	2 3/4"	.96 ea.
1157-C	Closed—Red	3/16"	1 3/32"	3/16"	2 3/4"	.96 ea.
1157-D	Closed—Black	3/16"	1 3/32"	3/16"	2 3/4"	.96 ea.

Sleeve Diameter—1 3/32"

INTERMEDIATE MOMENTARY PUSH SWITCH 6 Amp.

U.L. approved for 6 amp. 125 volts, 3 amp. 250 volts. *Except for 1147 which is rated at 1 amp. 250 volts, 6 amp. 125 volts. All back connected, slotted sleeve.

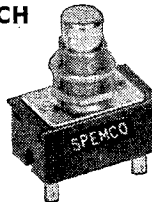

No.	Description	Sleeve	Base Dimensions			Net Price
			L.	W.	H.	
**1146	SPST	1/2"	1 3/4"	1 1/16"	1 3/4"	1.71 ea.
**1147	SPDT	1/2"	1 3/4"	1 1/16"	1 3/4"	1.89 ea.
**1148	DPST	1/2"	1 3/4"	1 1/16"	1 3/4"	2.13 ea.
1149	DPDT	1/2"	1 3/4"	1 1/16"	1 3/4"	2.28 ea.

*1 amp. 250 volts, 6 amp 125 volts
**1146 & 1148 Normally off. Sleeve Diameter—1 3/32"

MOMENTARY PUSH BUTTON SWITCH 16 Amp.

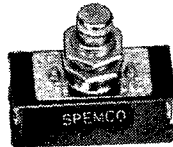

Underwriters' approved, 16 amp. 125 V., 8 amp. 250 V., 1 H.P. 125-250 V. AC-DC.

No.	Description	Sleeve	Base Dimensions			Net Price
			L.	W.	H.	
1160	DPST Normally Off	1 1/2"	1 3/4"	1 3/4"	2 3/2"	1.95 ea.
1160-A	DPST Normally On	1 1/2"	1 3/4"	1 3/4"	2 3/2"	1.95 ea.

Sleeve Diameter—1 3/32"

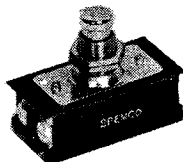

20 Amp.

Underwriters' Approved: 20 Amp. 125 V., 10 Amp. 250 V., AC-DC. 1 1/2 H.P. 125-250 V., AC-DC.

No.	Description	Sleeve	Base Dimensions			Net Price
			L.	W.	H.	
1230	DPST (Normally Open)	1 3/4"	2 1/4"	1 1/8"	1 3/4"	3.06 ea.
1231	DPST (Normally Closed)	1 3/4"	2 1/4"	1 1/8"	1 3/4"	3.06 ea.

Sleeve Diameter—1 3/32"

1 Amp.
Two circuit, slow make and slow break, momentary switch. One circuit normally on, the other off, with snap-on plastic button, in red or black. (Pushing the button reverses the contact.) 1 Amp. 125 Volts AC. White button on request. Underwriters' Approved.

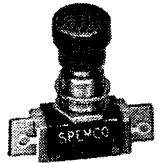

No.	Description	Sleeve	Base Dimensions			Net Price
			L.	W.	H.	
1158-A	Red	7/16"	1 1/2"	1 3/32"	1 7/32"	1.17 ea.
1158-B	Black	7/16"	1 1/2"	1 3/32"	1 7/32"	1.17 ea.

Sleeve Diameter—1 3/32"

POWER SWITCHES 10 Amp.

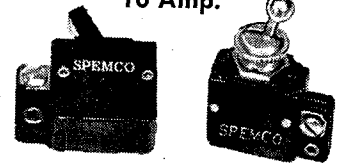

Underwriters' approved, 10 amp. 125 volts. 5 amp. 250 A.C., 3/4 H.P. 250V. A.C. 1/2 H.P. 250V A.C.

No.	Description	Sleeve	Base Dimensions			Net Price
			L.	W.	H.	
*1133	SPST	1 3/32"	1 5/16"	1 7/32"	1 9/16"	1.14 ea.
1133-B	Bakelite lever	1 3/16"	1 7/32"	1 7/16"	1 7/16"	.75 ea.

*1 3/32" sleeve diameter

16 Amp.

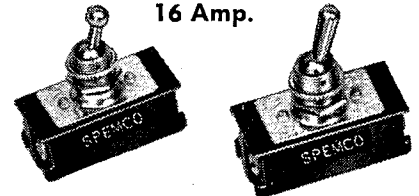

Underwriters' approved, 16 amp. 125V., 8 amp. 250V. A.C.-D.C.

No.	Description	Sleeve	Base Dimensions			Net Price
			L.	W.	H.	
1159	DPST	1 5/32"	1 3/4"	1 3/4"	2 3/2"	1.35 ea.
1159-B	DPST	1 5/32"	1 3/4"	1 3/4"	2 3/2"	1.35 ea.
1159-C	SPDT	1 5/32"	1 3/4"	1 3/4"	2 3/2"	1.35 ea.

1159—Ball Lever 1159-B—Bat Lever
Sleeve Diameter—1 3/32"

20 Amp.



Underwriters' approved 20 amp, 125 V., 10 amp. 250 V. 1 1/2 H.P. 125-250 V. AC-DC.

No.	Description	Sleeve	Base Dimensions			Net Price
			L.	W.	H.	
1134	DPST	1 5/8"	2"	1"	7/8"	2.28 ea.
1134-B	DPST	1 5/8"	2"	1"	7/8"	2.28 ea.

1134—Ball Lever 1134-B Bat Lever
Sleeve Diameter—1 3/32"



20 Amp.

Fully enclosed tumbler switch, 20 amp. 250V., 1 1/2 H.P. 125V., 2 H.P. 250V.

No.	Description	Sleeve	Base Dimensions			Net Price
			L.	W.	H.	
1170-S	DPST	1 3/4"	2 1/4"	1 1/8"	1 3/4"	3.15 ea.

Sleeve Diameter—1/2"

20 Amp.

Fully enclosed tumbler switch, 20 amp. 250V., 1 1/2 H.P. 125V., 2 H.P. 250V.



No.	Description	Sleeve	Base Dimensions			Net Price
			L.	W.	H.	
1170	DPST	1 3/4"	2 1/4"	1 1/8"	1 3/4"	3.15 ea.

Sleeve Diameter—1 3/32"

SPECIALTIES MANUFACTURING CO.

SPEMCO® H & H SWITCHES

EXTRA HEAVY DUTY SWITCH NEUTRAL CENTER 10 Amp.

Used in heavy current circuits, such as transmitters, power amplifiers, motors, etc. Contacts have fast 'break' which reduces the tendency to arc. Rated at 10 amp. 125 volts, 5 amp. 250 volts, 3/4" HP 250 volts.



Positive off in center.

No.	Description	Sleeve	Base Dimensions			Net Price
			L.	W.	H.	
*1161-A	DPDT	1 1/2"	2"	1 3/16"	1"	4.95 ea.
1161	DPDT	1 1/2"	2"	1 3/16"	1"	4.95 ea.

Straight thru, no off-center* Sleeve Diameter—3/4"

20 Amp. & 30 Amp.

3/32" mounting centers

1161-B & 1161-D
10 Amp. 250 Volts
20 Amp. 125 Volts

1161-C
20 Amp. 250 Volts
30 Amp. 125 Volts
Both AC-DC

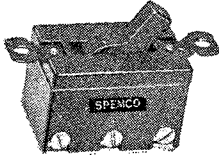

No.	Description	Sleeve	Base Dimensions			Net Price
			L.	W.	H.	
1161-B	DPDT	2 1/2"	1 1/2"	1 3/32"	1 3/4"	7.80 ea.
1161-C	DPDT	2 7/8"	1 3/8"	1 3/32"	2"	10.65 ea.
*1161-D	DPDT	2 1/2"	1 1/2"	1 3/32"	1 3/4"	7.80 ea.

*20 Amp. Straight thru-no off center.

10 Amp.

Rated 10 amp. 125 volts, 1/2 HP, 115-230 volts AC. 5 amp. 250 volts.

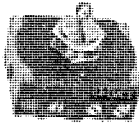

No.	Description	Sleeve	Base Dimensions			Net Price
			L.	W.	H.	
1177	3 PDT	1 3/32"	2 5/16"	2"	1 1/8"	7.50 ea.
1178	4 PDT	1 3/32"	2 3/16"	2"	1 1/8"	9.45 ea.

Sleeve Diameter—3/4"

THREE & FOUR POLE AC UTILITY SWITCHES

15 Amp. AC



15 amp. 125V., 10 amp. 250V. AC, except Nos. 1200, 1201, 1228 and 1237 which are 10 amp. 250V. AC.

No.	Description	Sleeve	Base Dimensions			Net Price
			L.	W.	H.	
1198	3PST On-None-Off	1 3/32"	1 3/8"	1 3/16"	1 1/4"	2.70 ea.
1199	3PDT On-Off-On	1 3/32"	1 3/8"	1 3/16"	1 1/4"	3.30 ea.
1227	3PDT On-None-On	1 3/32"	1 3/8"	1 3/16"	1 1/4"	3.30 ea.
1235	3PDT on-off-Mom. on	1 3/32"	1 3/8"	1 3/16"	1 1/4"	3.60 ea.
1236	3PDT Mom. on-off-Mom. on	1 3/32"	1 3/8"	1 3/16"	1 1/4"	3.60 ea.
*1200	4PST On-None-Off	1 3/32"	1 3/8"	1 3/16"	1 1/4"	3.75 ea.
*1201	4PDT On-Off-On	1 3/32"	1 3/8"	1 3/16"	1 1/4"	4.50 ea.
*1228	4PDT On-None-On	1 3/32"	1 3/8"	1 3/16"	1 1/4"	4.50 ea.
1237	4PDT Mom. on-off-Mom. on	1 3/32"	1 3/8"	1 3/16"	1 1/4"	7.20 ea.

*10 amp. 250 V. A.C. *1/2 H.P. 115-230 V. A.C.

TOOL HANDLE SWITCH

4 Amp.

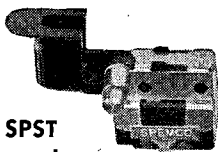

Direct Pull Trigger with Latch.
Plug-in Terminal
2 amp., 250 volts.
4 amp., 125 volts.

SPST Momentary Contact

No.	BASE DIMENSIONS			Net Price
	L.	W.	H.	
1169	1 3/4"	3/32"	1 3/4"	1.14 ea.

HEAVY DUTY SWITCHES Toggle Type

Underwriters' approved, 30 amp. 250 volts, AC DC. 2 H.P., 115V-230V AC; 1 H.P., 460V AC
For use on Food Machines, Grinders, Sanders, Machine Tools, Gasoline Pumps, etc.

Square Bakelite Lever 30 Amp.

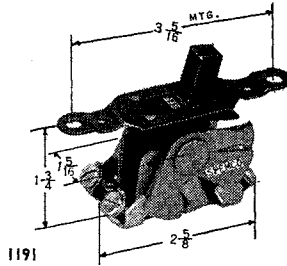

No.	Description	Net Price
1191	DPST Square Lever	2.85 ea.
1190	DPST Roller Type Lever	2.85 ea.

METAL PUSH BUTTON TYPE NORMALLY OPEN 20 Amp.

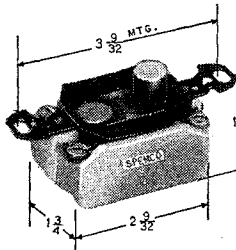

No.	Description	Net Price
1192	DPST	3.10 ea.

Underwriters' approved, 20 amp. 250 volts, 2 H.P. 230V AC, 2 H.P. 250V DC.
For use on Floor Sander, as a foot switch, etc.

PUSH-BUTTON SWITCH Normally Open 20 Amp.

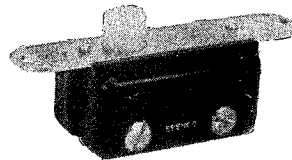

Enclosed Bakelite—Screw Terminals. Side wired only. Natural color Nylon push button. 20 amp. 120-240 volts AC, 2 H.P., 240 volts AC. U.L. approved.

No.	Description	Base Dimensions			Net Price
		L.	W.	H.	
1240	DPST	2 1/4"	1 1/4"	1"	3.10 ea.

PORTABLE TOOL HANDLE SWITCHES 16 Amp.

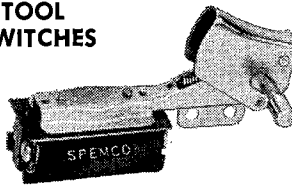

Tool handle switch, fully enclosed, normally OFF with locking latches. Rated and approved by the Underwriters' for 8 amp. 250 volts, 16 amp. 125 volts, 1 H.P. 250 volts, 1 1/4" long, 1 3/8" wide, 7/8" high.

No.	Description	Net Price
1168	DPST	2.10 ea.

INDICATING SLIDE LEVER SWITCH



6 Amp.

Rated at
3 Amp.—250 volts
6 Amp.—125 volts

No.	Base Dimensions			Net Price
	L.	W.	H.	
1174	7/8"	1/2"	1 1/2"	1.41 ea.

SINGLE POLE Screw Terminal

ROTARY CANOPY SWITCH

With Fixed Plastic Handle



3 Amp.

Underwriters' approved, 3 amp. 125 volts. 1 amp. 250 volts.

No.	Stem	Wire Lead	Net Price
1179	3/16"	6"	.60 ea.

ROTARY SWITCHES

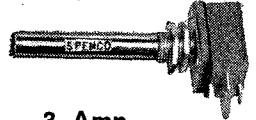

3 Amp.

Underwriters' approved, 1 amp. 250 V., 3 amp. 125 V. AC-DC (Except #1128). Nickel plated finish Laminated bakelite base.

No.	Description	Base Dimensions			Net Price		
		Shaft	Sleeve	L.			
*1128	SPST	1 1/8"	3/8"	1 3/4"	3/4"	9/16"	.96 ea.
1129	SPBT	1 3/8"	3/8"	1 7/8"	3/4"	3/16"	1.23 ea.
1130	DPST	1 3/8"	3/8"	1 3/4"	3/4"	1/16"	1.56 ea.
1131	DPDT	1 3/8"	3/8"	1 1/2"	3/4"	1 1/8"	1.92 ea.

*1128 rated 3 amp. 250 V. AC-DC.
Sleeve Diameter—1 1/32"

ROTO-LOCK SWITCH

Underwriters' Approved,
3 amp. 250 volts.
Except #1129-K & 1131-K

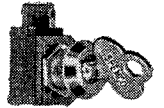

No.	Description	Base Dimensions			Net Price	
		Sleeve	L.	H.		
1128-K	SPST (With Key) (above key removable in off position only)	1 3/32"	1 3/16"	3/4"	9/16"	1.74 ea.
1128-KA	Key only for above					.228 ea.
1128-KE	SPST (With Key) (above key removable in either position)	1 3/32"	1 3/16"	3/4"	9/16"	1.74 ea.
*1129-K	SPDT (With Key) (above key removable in either position)	1 3/32"	1 3/16"	1/2"	3/4"	1.80 ea.
*1131-K	DPDT (With Key) (above key removable in either position)	1 3/32"	1 3/16"	3/4"	3/4"	2.34 ea.
1128-KEA	Key-fits 1128-KE, 1129-K, and 1131-K					.228 ea.

*1129-K & 1131-K—U.L. approved, 1 amp. 250 V., 3 amp. 125V., AC-DC. Sleeve Diameter—1 3/32"

ROTO-LOCK SWITCH

20 Amp.

Underwriters' approved.
20 amp. 120 volts,
240 volts AC.

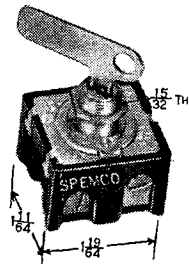

1 1/2 H.P.—120 volts AC
2 H.P.—240 volts AC

No.	Description	Sleeve	Net Price
1130-K	DPST	9/16"	2.76 ea.
1130-KA	Key Only for above		.30 ea.

SPECIALTIES MANUFACTURING CO.

SPEMCO® H & H SWITCHES

TUMBLER LOCK SWITCH

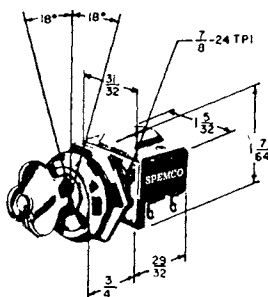

Security type tumbler lock switch, with single hole mounting sleeve. Quick make and break wiping action, and therefore can be considered for both medium power (up to maximum rating) or low energy circuits.

All 6 amp. 125V. AC-DC, 3 amp. 250 V. AC-DC—except 1261 and 1265, which are rated at 6 amp. 125 V. AC-DC, 1 amp 250 V. AC-DC.

Circuit	Key Removable Both Positions	Net Price
SPST	1260	9.00 ea.
SPDT	1261	9.30 ea.
DPST	1262	9.50 ea.
DPDT	1263	9.80 ea.
	Key Removable Off Position Only	
SPST	1264	9.00 ea.
SPDT	1265	9.30 ea.
DPST	1266	9.50 ea.
DPDT	1267	9.80 ea.

HARDWARE

for 1 1/2" diameter sleeve.



No.	Description	Price
1132-HL	Hi-Lo Plate	.042 ea.
1132	On and Off Plate	.042 ea.
1132-H	Hex Nut	.03 ea.
1132-K	Knurled Nut	.03 ea.
1210	Lockwasher	2.55C
1211	Locking Ring	4.20C

PHENOLIC SNAP-ON BUTTON

No.	Color	Net Price
1212-B	Black	.27 ea.
1212-R	Red	.27 ea.
1212-W	White	.27 ea.

LOCKING BRACKET

For all bat handle toggle or momentary switches. Any Amp.

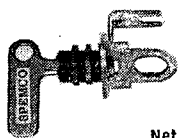

No.	Description	Net Price
1226	Fits over 1 1/2" sleeve diameter. 1.83 ea.	
1226-A	Key Only .30 ea.	
	Sleeve diameter 1 1/4"	

FEED-THROUGH CORD SWITCH

Underwriters approved, black bakelite case, sliding lever, 10 Amp. 125 V., 5 Amp. 250 V.



No.	Description	Net Price
1163	SP	1.62 ea.

FEED THROUGH CORD SWITCH 15 Amp.

1 3/32 (.406) Inch Cord Hole

For Appliance Use Only:

Rated at 10 Amp.—250 volts
15 Amp.—125 volts

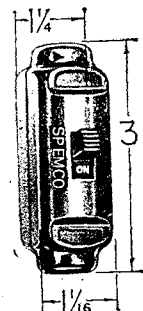

No.	Description	Net Price
1164	DP (with 3rd wire ground)	5.28 ea.

CORD CONNECTORS 10 Amp.

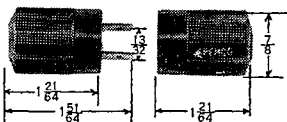

Brown Bakelite Cord Connector Complete, 7/8" O.D. x 2 1/2" long. 10 amps. 250 volts. End opening for wire size up to 3/8" O.D.

No.	Description	Net Price
1162	Complete	2.10 ea.
1162-F	Female Part	1.11 ea.
1162-M	Male Part	1.11 ea.

RECEPTACLES

Underwriters' approved, 10 amp. 250 volts AC. Short Female Flush Receptacle 10 Amp.

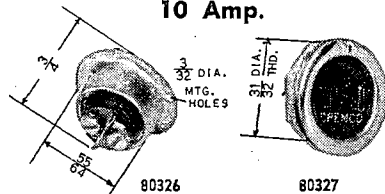

No.	Description	Net Price
80326	2 Screw Mounting	1.29 ea.
80327	Lock Nut Mounting	2.04 ea.

Recessed Male Receptacle 10 Amp.

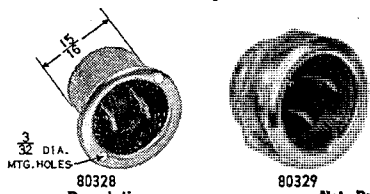

No.	Description	Net Price
80328	2 Screw Mounting	1.44 ea.
80329	Lock Nut Mounting	2.04 ea.

Recessed Female Receptacle 10 Amp.

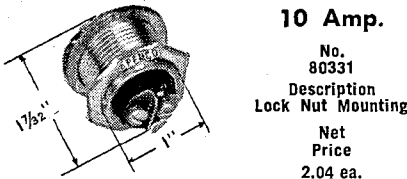

No.	Description	Net Price
80331	Lock Nut Mounting	2.04 ea.

Female Receptacle

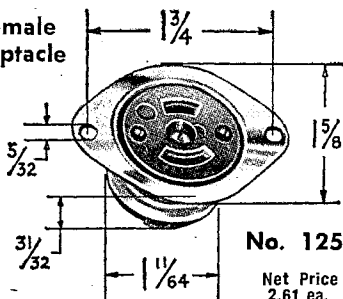

No.	Net Price
1253	2.61 ea.



Male Receptacle

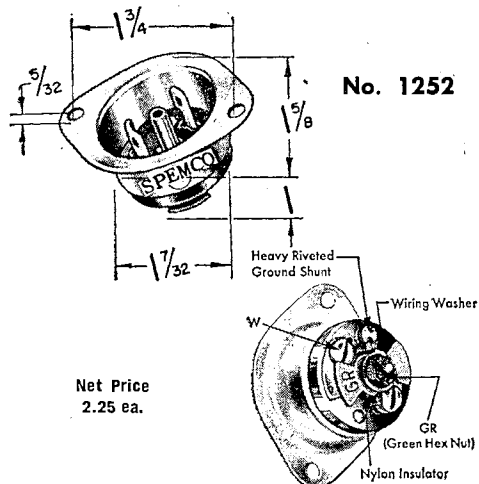

Net Price
2.25 ea.

TURN TO LOCK COMPACT RECEPTACLES 3-WIRE GROUNDING TYPE 15 Amp. 125 Volt

Brass metal casings, finished to resist corrosion. Black bakelite is standard.

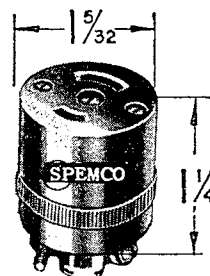

Female Connector No. 1250

Net Price
2.46 ea.

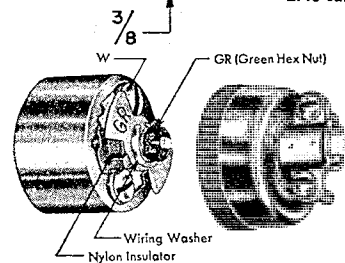

Male Connector

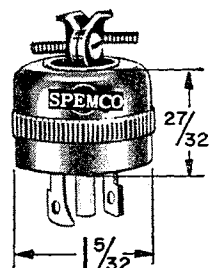

No.	Net Price
1251	1.89 ea.

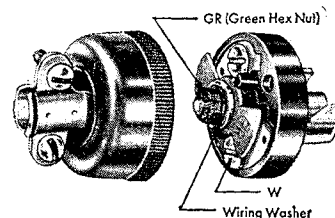

SPEMCO® H & H SUBMINIATURE SWITCHES

SUBMINIATURE TOGGLE SWITCHES



Spemco Subminiature Switches are 1/10 the volume of the standard switch.

Photos are actual size of switches.



Meeting requirements of MIL-S-3950 as applicable to SCL-6305

OPERATING CHARACTERISTICS

CONTACT RATINGS: Low level to 5 amp. resistive at 29 volts DC or 115 volts AC.
 INITIAL CONTACT RESISTANCE: 0.01 ohms maximum.
 DIELECTRIC STRENGTH: 1000 volts RMS at sea level.
 VIBRATION: 5-28 CPS at 0.5 inches double amplitude, 28-2000 CPS at 20 G.
 SHOCK: 50G for 11 milliseconds.
 ELECTRICAL LIFE (minimum): 20,000 make-and-break cycles.
 SEAL: Low temperature rubber boot for panel is available.
 WEIGHT: From 3.0 to 5.0 grams maximum.
 TERMINALS: Solder lugs.

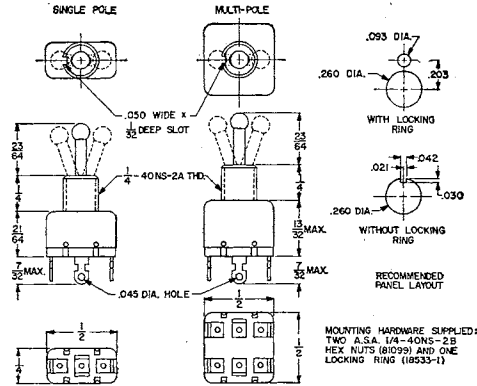

SPEMCO®

Number	(MS Part No.)	Circuit	Action	Net Price Each
TC-3		SPDT	On-Off-On	\$3.00
TC-3-M	(MS-75028-21)	SPDT	On-Off-On	3.20
TE-3		SPDT	On*-Off-On	3.20
TE-3-M	(MS-75028-31)	SPDT	On*-Off-On	3.40
TG-3		SPDT	On*-Off-On*	3.20
TG-3-M	(MS-75028-27)	SPDT	On*-Off-On*	3.40
TM-3		SPDT	On*-None-On	3.20
TM-3-M	(MS-75028-26)	SPDT	On*-None-On	3.40
TS-1		SPST	Off-None-On	2.80
TS-1-M	(MS-75028-22)	SPST	Off-None-On	3.00
TS-2		DPST	Off-None-On	3.40
TS-2-M	(MS-75029-22)	DPST	Off-None-On	3.60

Number	(MS Part No.)	Circuit	Action	Net Price Each
TS-3		SPDT	On-None-On	3.00
TS-3-M	(MS-75028-23)	SPDT	On-None-On	3.20
TC-6		DPDT	On-Off-On	3.90
TC-6-M	(MS-75029-21)	DPDT	On-Off-On	4.10
TE-6		DPDT	On*-Off-On	5.00
TE-6-M	(MS-75029-31)	DPDT	On*-Off-On	5.20
TG-6		DPDT	On*-Off-On*	5.00
TG-6-M	(MS-75029-27)	DPDT	On*-Off-On*	5.20
TM-6		DPDT	On*-None-On	5.00
TM-6-M	(MS-75029-26)	DPDT	On*-None-On	5.20
TS-6		DPDT	On-None-On	3.90
TS-6-M	(MS-75029-23)	DPDT	On-None-On	4.10
11-B		Black Rubber Boot		1.00

Basic catalog numbers supplied with ball lever.
 Military type (suffix "M") supplied with bat lever — suffix "M" switches meet requirements of MIL-S-3950-B.
 *Momentary action.



Spemco Subminiature Switches are 1/10 the volume of the standard switch.

Photo is actual size of switch.

SUBMINIATURE PUSH BUTTON SWITCHES, MOMENTARY

Featuring gold plated coin silver contacts and gold plated brass terminals. Ideal for aircraft, missile, electronic and other applications demanding small size and dependability.

OPERATING CHARACTERISTICS

CONTACT RATINGS: 2 amp 29 volt. DC resistive; 1 amp 115 volts AC. Minimum rating for dry circuit application 10 micro amps at 50 MV.
 ELECTRICAL LIFE EXPECTANCY: At full load min. 20,000 make-and-break cycles pulsed at rate of 100 cycles per minute.
 INITIAL CONTACT RESISTANCE: 0.05 ohms maximum.
 VIBRATION: Tested per Mil-Std. - 202, Method 204, Condition A.
 DIELECTRIC STRENGTH: 1000 volts RMS at sea level for one minute.
 TEMPERATURE RANGE: -87°F (-65°C to +200°F (+94°C).
 PRETRAVEL: .015" maximum.
 MOVEMENT DIFFERENTIAL: .002" maximum.
 OVERTRAVEL: .010" maximum.
 OPERATE FORCE: 6.6 oz. maximum.
 When colored buttons are required, specify the color and add 10c each to the list price. Colors: Black, Red, Yellow, Green, Brown.

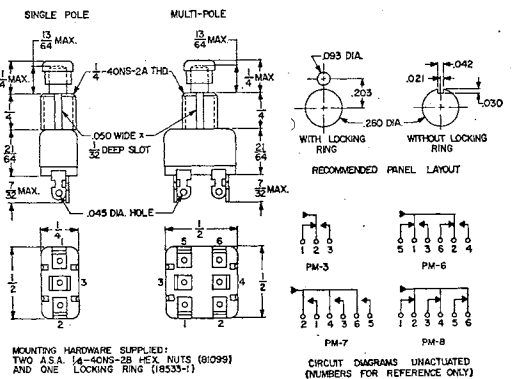

SPEMCO®

Number	Circuit	Action	Net Price Each
PM-3	SPDT	Leaf Contact — NO/NC	\$2.86
PM-6	DPDT	Leaf Contact — NO/NC	3.51
PM-7	3PST	Leaf Contact — 3P/NO	3.31
PM-8	3PST	Leaf Contact — 3P/NC	4.65
10-B	Black Rubber Boot		1.00

Switches supplied with standard .215" white (natural) button.

SPECIALTIES MANUFACTURING CO.

SPEMCO® H & H SWITCHES

MILITARY TYPE TOGGLE SWITCHES

Manufactured of materials and in accordance with specification Mil-S-3950
MS-25098 and MS-35058—Single Pole MS-25100 and MS-35059—Double Pole

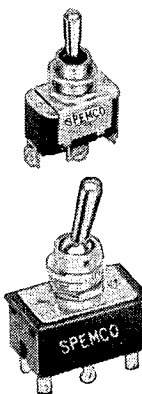

MS Part No.	Up Position	Center Position	Down Position	Net Price	MS Part No.	Up Position	Center Position	Down Position	Net Price
MS-25098-22	On	None	Off	\$234.00C	MS-35058-30	Off	None	Mom. On	\$193.50C
MS-25098-23	On	None	On	252.00C	MS-35058-31	On	Off	Mom. On	229.50C
MS-25100-22	On	None	Off	287.25C	MS-35059-21	On	Off	On	282.75C
MS-25100-23	On	None	On	306.00C	MS-35059-22	On	None	Off	234.75C
MS-35058-21	On	Off	On	211.50C	MS-35059-23	On	None	On	282.75C
MS-35058-22	On	None	Off	175.50C	MS-35059-24	On	Off	None	234.75C
MS-35058-23	On	None	On	211.50C	MS-35059-25	On	Mom. Off	None	282.75C
MS-35058-24	On	Off	None	175.50C	MS-35059-26	On	None	Mom. On	306.00C
MS-35058-25	On	Mom. Off	None	193.50C	MS-35059-27	Mom. Off	Off	Mom. On	306.00C
MS-35058-26	On	None	Mom. On	229.50C	MS-35059-28	None	Off	Mom. On	282.75C
MS-35058-27	Mom. On	Off	Mom. On	229.50C	MS-35059-29	On	None	Mom. Off	282.75C
MS-35058-28	None	Off	Mom. On	193.50C	MS-35059-30	Off	None	Mom. On	282.75C
MS-35058-29	On	None	Mom. Off	193.50C	MS-35059-31	On	Off	Mom. On	306.00C

SPEMCO® H & H PRECISION SWITCHES — SPDT

GP3-Z1 — Z2
HD3-Z1 — Z2

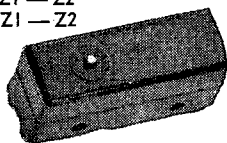

GP3-Q1 — Q2
HD3-Q1 — Q2



GP3-X1 — X2
HD3-X1 — X2

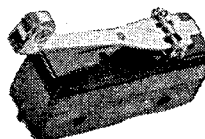

GP3-V1 — V2
HD3-V1 — V2

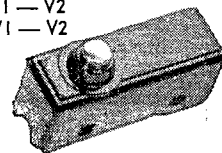

GP3-T1 — T2
HD3-T1 — T2

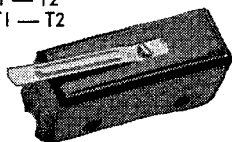

GP3-Y1 — Y2
HD3-Y1 — Y2

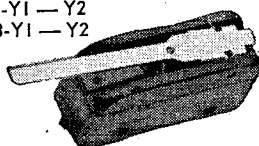

GP3-W1 — W2
HD3-W1 — W2

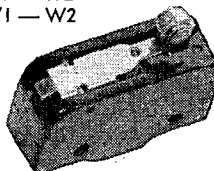

GP3-U1 — U2
HD3-U1 — U2

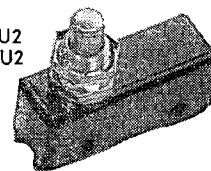

GP indicates General Purpose Switches. HD indicates Heavy Duty Switches. All UL and CSA approved. GENERAL PURPOSE SWITCHES: 15 amp. 480 V. AC; ½ amp. 125 V. DC; ¼ amp. 250 V. DC. HEAVY

DUTY SWITCHES: 20 amp. 480 V. AC; 10 amp 125 V. AC "L" load, ½ amp. 125 V. DC; ¼ amp. 250 V. DC; 1 H.P. 120 V. AC; 2 H.P. 240 V. AC.

SPEMCO NUMBER		ACTUATOR	OPERATING FORCE	PRETRAVEL	OVERTRAVEL	LIST PRICE	
Solder Lug	Screw Term.					Solder Lug	Screw Term.
GP3-Z1	GP3-Z2	Pin Type	9 to 13 oz.	.015" max.	.005" min.	\$155.00 C.	\$165.00 C.
GP3-T1	GP3-T2	Flexible Leaf	5 oz. max.	5/32" max.	Not over 1/16"	170.00 C.	180.00 C.
GP3-Q1	GP3-Q2	Std. Roller Leaf	5 oz. max.	5/32" max.	Not over 1/16"	215.00 C.	220.00 C.
GP3-Y1	GP3-Y2	Rigid Hinge Lever	2½ oz.	3/8" max.	.219" min.	200.00 C.	205.00 C.
GP3-X1	GP3-X2	Std. Roller Lever	3½ oz. max.	9/32" max.	.156" min.	250.00 C.	260.00 C.
GP3-W1	GP3-W2	Short Roller Lever	6 oz. max.	9/64" max.	3/32" min.	250.00 C.	260.00 C.
GP3-V1	GP3-V2	Short Overtravel Button	9 to 13 oz.	1/64" max.	1/16" min.	190.00 C.	195.00 C.
GP3-U1	GP3-U2	Panel Mounted Plunger	9 to 13 oz.	1/64" max.	7/32" min.	345.00 C.	350.00 C.
HD3-Z1	HD3-Z2	Pin Type	14 to 22 oz.	.050" max.	.010" min.	\$160.00 C.	\$170.00 C.
HD3-T1	HD3-T2	Flexible Leaf	9 oz. max.	11/32" max.	Not over 1/16"	180.00 C.	185.00 C.
HD3-Q1	HD3-Q2	Std. Roller Leaf	9 oz. max.	11/32" max.	Not over 1/16"	225.00 C.	230.00 C.
HD3-Y1	HD3-Y2	Rigid Hinge Lever	2½ oz. max.	5/8" max.	.078" min.	205.00 C.	210.00 C.
HD3-X1	HD3-X2	Std. Roller Lever	2½ oz. max.	15/32" max.	1/16" min.	260.00 C.	265.00 C.
HD3-W1	HD3-W2	Short Roller Lever	6 oz. max.	1/4" max.	1/32" min.	260.00 C.	265.00 C.
HD3-V1	HD3-V2	Short Overtravel Button	14 to 22 oz.	.050" max.	.093" min.	195.00 C.	200.00 C.
HD3-U1	HD3-U2	Panel Mounted Plunger	14 to 22 oz.	.050" max.	.219" min.	355.00 C.	360.00 C.

*1 Switches are mounted by two .140 inch diameter holes on one inch centers. Discount: 1-9, none; 10-19, 10%; 20-49, 20%; 50 & over, 30%.

All aforementioned switches, connectors and receptacles are manufactured by H&H for Specialties Manufacturing Company.

Housings are made of steel and are cadmium plated 11 3/32" long, 35/64" wide and 1/8" mounting centers.

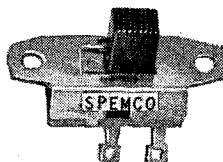

SLIDE SWITCHES

No.	Description	Net Price
1180	SPST 3A-AC .5A-DC 125V	.156 ea.
1181	SPDT .75A AC-DC 125V	.168 ea.
1182	DPST .5A AC-DC 125V	.216 ea.
1183	DPDT 3A-AC .5A-DC 125V	.258 ea.

SPECIALTIES MANUFACTURING CO.

SWITCHES

waldom



LIGHTED PUSH-BUTTON SWITCHES



The Molex 1175 is a light push button switch that is sturdy, well designed and offers a wide choice of features. It is available in alternate action; momentary normally open or momentary normally closed models. The switch snap mounts into place and is offered with spade terminals. Many variations are possible. The button comes in blue, red, amber, yellow, white and green.

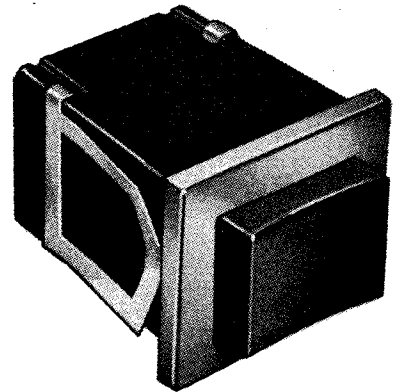
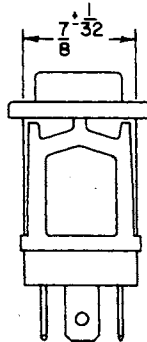
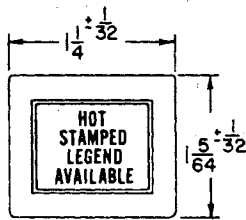
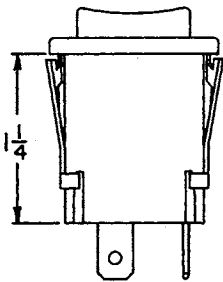

Part Number	Volts AC	Amps	Lamp See Note 1	Switch Action See Note 2	Button Color See Note 3	Legend See Note 4	Legend Color See Note 5	1-24 Each	25-49 Each	50-Over Each
117510	6	2	Incandescent	PP, MNO, MNC	W, R, B, G, A, Y	None	N/A	\$3.85	\$3.55	\$3.25
117520	14	2	Incandescent	PP, MNO, MNC	W, R, B, G, A, Y	None	N/A	3.85	3.55	3.25
117530	28	2	Incandescent	PP, MNO, MNC	W, R, B, G, A, Y	None	N/A	4.20	3.85	3.60
117540	125*	8.5	Neon	PP, MNO, MNC	W, R, A, Y	None	N/A	3.45	3.20	2.95
117560	6	2	Incandescent	PP, MNO, MNC	W, R, B, G, A, Y	OFF, ON START, STOP	W, B	4.50	4.20	3.85
117570	14	2	Incandescent	PP, MNO, MNC	W, R, B, G, A, Y	OFF, ON START, STOP	W, B	4.50	4.20	3.85
117580	28	2	Incandescent	PP, MNO, MNC	W, R, B, G, A, Y	OFF, ON START, STOP	W, B	4.90	4.50	4.15
117590	125*	8.5	Neon	PP, MNO, MNC	W, R, A, Y	OFF, ON START, STOP	W, B	4.15	3.85	3.50

*Component U. L. Recognized.

Mechanical life of switch is 25,000 cycles, many test out at considerably more. Bezels are all high quality chrome-plated. Housings are precision molded of durable phenolic, buttons are mar-resistant nylon. All units are supplied with mounting clips for friction locking. Minimum panel thickness, .031". Terminals are standard 1/4" male tab for acceptance of WALDOM Type No. SS-1090 1/4" Female Quick Disconnect. Tab also has solder hole for installing wire lead if soldering is desirable.

Notes:

- Pricing includes permanently installed lamp. 6-volt application, Bulb No. 2114; 14-volt application, Bulb No. 2182; 28-volt application, Bulb No. 2185; 125-volt application, NE 2H, 35K resistor.
- a. Push-On; Push-Off—add suffix PP to catalog number.

b. Momentary-Normally Open—add suffix MNO to catalog number.

c. Momentary-Normally Closed—add suffix MNC to catalog number.

- Buttons available in White, Red, Blue, Green, Amber and Yellow. Add first initial of color to suffix after designating switch action.
- Four standard legends are available. They are OFF, ON, START, STOP. Add actual word to catalog number after designating switch action and button color.
- Color of hot stamping on button is standardized as follows:

Hot Stamping Color	Button Color
White	Red, Blue, Green,
Black	Amber, Yellow,
	White

Recommended Panel Cutout Dimension:
1.115" x .915"

Ordering Examples:

- To obtain a 6-volt unit, momentary action, normally open, with red button and no legend—Specify Catalog No. 117510-MNO-R
- To obtain a 125-volt unit, push-on, push-off, with yellow button, hot stamped START—Specify Catalog No. 117590-PP-Y-START

These products are manufactured by Molex Products Company, and are available from Electronic/Electrical Distributors through Waldom Electronics.

**whatever electronic products
you require...**



**...you'll find it
faster in
this catalog...**

**...the world's largest catalog
of electronic
products
sold through
distributors**



American Beauty

SOLDERING IRONS AND SOLDERING ACCESSORIES

Specify voltage, wattage and other options on each order. If your plug needs differ from standard — plug cap on 2-wire cords, NEMA-type plugs on 3-wire cords — specify plug manufacturer's name and catalog number.

LITTLE DANDY



The economy-priced miniature iron that stands up to production line conditions. Steel cored heating element with non-ceramic insulator. Molded handle, aerated finger grip (impervious to oil, perspiration). Balanced, non-roll design. Plug type tips.

Cat. No.	Wattage Std.	Spec.	Tip Dia.	Shpg. Wt.	Net
3108	20	25/30	1/8"	1/2 lb.	\$4.45
3110	25	30/35	3/16"	1/2 lb.	4.45
3112	40	50/60	1/4"	1/2 lb.	5.95

NOTES: Three wattage options each model (3108: 20, 25, 30. 3110: 25, 30, 35. 3112: 40, 50, 60.) For 3-wire cord with NEMA plug, add "S3" to catalog number and \$0.70 to price.

BANTAMS



Small irons of traditional American Beauty quality in various inputs and tip diameters.

Cat. No.	Wattage	Tip Dia.	Shpg. Wt.	Net
3114	60	1/4"	1 lb.	\$7.45
3118	30	1/8"	3/4 lb.	5.95
3118-X	50	1/8"	3/4 lb.	6.70
3118-XP	50	1/8"	3/4 lb.	6.70
3118-SC	30	1/8"	3/4 lb.	5.95
3118-SCP	30	1/8"	3/4 lb.	5.95
3120	30	3/16"	3/4 lb.	5.95
3120-X	50	3/16"	3/4 lb.	6.70
3120-XP	50	3/16"	3/4 lb.	6.70
3120-SC	30	3/16"	3/4 lb.	5.95
3120-SCP	30	3/16"	3/4 lb.	5.95

NOTES: In above catalog numbers, "X" means "extra heat for continuous duty only"; "SC" means "short casing"; "P" means "pencil type handle". For 3-wire cord with NEMA plug, add "S3" to catalog number and \$1.40 to price.

B-SERIES IRONS



Best miniature at any price. Advanced design. Precise balance, floating element for fast heat recovery. Boxed with 3 assorted tips.

Cat. No.	Wattage	Tip Point Diameter	Shpg. Wt.	Net
B-2000L	22.5	*	1/2 lb.	\$9.30
B-2000P	22.5	1/8"	1/2 lb.	9.30

Cat. No.	Wattage	Tip Point Diameter	Shpg. Wt.	Net
B-2000PM	22.5	1/16"	1/2 lb.	\$9.30
B-2000C	22.5	1/16"	1/2 lb.	9.30
B-2000B	22.5	1/8"	1/2 lb.	9.30
B-2500-L	30	*	1/2 lb.	9.30
B-2500-C	30	3/16" Csl.	1/2 lb.	9.30
B-2500-D	30	3/16" Cone	1/2 lb.	9.30
B-2500-B	30	1/32" Cone	1/2 lb.	9.30
B-2500-PM	30	3/32" Csl.	1/2 lb.	9.30

NOTES: *1 each 1/8" chisel, 1/16" chisel, 1/8" cone. For 3-wire cord with NEMA plug, add "S3" to catalog number and \$0.70 to price.

STANDARD IRONS



Production lines around the world use hundreds of thousands of these proven American Beauties.

Cat. No.	Wattage Std.	Spec.	Tip Dia.	Shpg. Wt.	Net
3125	60	75	1/4"	1 lb.	\$7.45
3128	60	75	1/4"	1 lb.	6.70
3138	100	130/150	3/8"	2 lbs.	9.65
3138-X	175	—	3/8"	2 lbs.	10.80
3138-Y	100	130/150	1/4"	2 lbs.	9.65
3138-XY	175	—	1/4"	2 lbs.	10.80
3158	200	—	5/8"	3 lbs.	11.90
3158-X	250	300	5/8"	3 lbs.	13.05
3178	300	—	7/8"	4 lbs.	15.65
3178-X	300	400	7/8"	4 lbs.	16.75
3198	550	675	1 1/8"	5 3/4 lbs.	19.35

NOTES: "X" in catalog number means "extra hot, for continuous duty only." For 3-wire cord with NEMA plug, add "S3" to catalog number and \$1.40 to price.

ANGLE TYPE IRONS

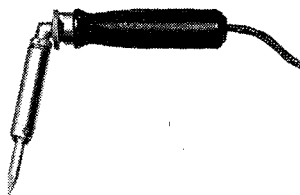

Same quality as American Beauty Standard Irons but angled for soldering hard-to-reach connections.

Cat. No.	Wattage Std.	Spec.	Tip Dia.	Shpg. Wt.	Net
3118-A	30	40	1/8"	3/4 lb.	\$6.70
3118-XA	50	40	1/8"	3/4 lb.	7.45
3120-A	30	40	3/16"	3/4 lb.	6.70
3120-XA	50	40	3/16"	3/4 lb.	7.45
3125-A	60	75	1/4"	1 lb.	8.15
3128-A	60	75	1/4"	1 lb.	7.45
3138-A	100	130/150	3/8"	1 1/4 lb.	10.45

NOTES: "X" in catalog number means "extra hot, for continuous duty only." For 3-wire cord with NEMA plug, add "S3" to catalog number and \$1.40 to price.

TRANSFORMER TYPE IRONS

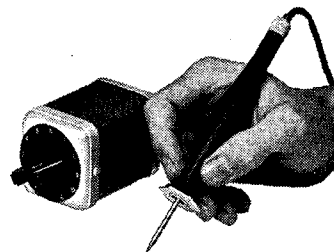

Use these American Beauties where isolation from line voltage is necessary. Heating elements in tips for quick tip heat changes. T-6 has variable heat dial. T-12 and T-30, non-variable.

Cat. No.	Wattage Std.	Spec.	Tip Dia.	Shpg. Wt.	Net
T-6	Variable	—	3/4"	1 1/2 lbs.	\$17.00
T-12E/W T-1216	17	20	3/16"	1 1/2 lbs.	14.90
T-12E/W T-1218	17	20	1/8"	1 1/2 lbs.	14.90
T-12E/W T-1225	17	20	1/4"	1 1/2 lbs.	14.90
T-12E/W T-1232	12	—	3/32"	1 1/2 lbs.	14.90
T-30E/W T-3016	30	25	1/16"	2 lbs.	16.40
T-30E/W T-3018	30	25	1/8"	2 lbs.	16.40
T-30E/W T-3025	30	25	1/4"	2 lbs.	16.40
T-30E/W T-3032	12	—	3/32"	2 lbs.	16.40

V-3000 SYSTEM

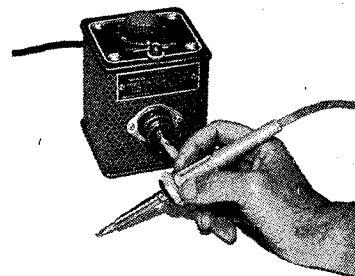

New type system dependably dials and maintains any tip temperature from 350° to 750°. High reserve for fast recovery. Iron is 40-watt, uses any 3/16" plug type tip.

Cat. No.	Wattage	Shpg. Wt.	Net
V-3000	Variable	5 lbs.	\$49.00

TEMPERATURE REGULATING STANDS

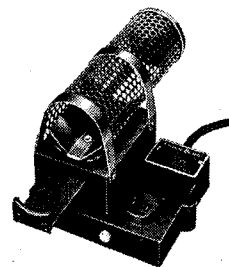

Maintain soldering iron at preset temperature during idle and intermittent use. Minimizes warmup, prevents over-

American Beauty

SOLDERING IRONS AND SOLDERING ACCESSORIES

heating, saves current. Pilot light. Adjustable to length of iron.

Cat. No.	Use	Shpg. Wt.	Net
475	For 100W-600W irons	3¼ lbs.	\$9.70
476	For 30W-85W irons	3¼ lbs.	9.70

NOTES: For perforated guard (as shown) add "SG" to catalog number and \$1.40 to price. Standard cord is HPD; if you want either 2-wire or 3-wire SJO cord specify on order.

GENERAL PURPOSE SOLDER POTS

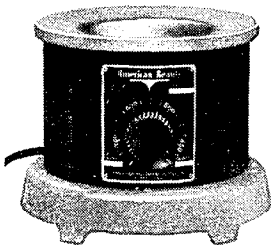

Crucibles of cast iron, chemically stable to keep solder pure. Center tapped for dross skimmer or extra fixturing. Wide lipped for extra fixture mounting. Shallow; 1½" deep. Heat solder to 400° in 15 minutes — 750° in 25 minutes. Adjustable, direct reading thermostat.

Cat. No.	Solder Capacity	Shpg. Wt.	Net
300	1 lb.	6½ lbs.	\$28.40
301	(Same as NO. 300, with dross skimmer)	6½ lbs.	31.20
600	2½ lbs.	9 lbs.	29.80
601	(Same as NO. 600, with dross skimmer)	9 lbs.	32.65

NOTES: Standard cords are 2-wire SJO; for 3-wire cord, add "S3" to catalog number and \$1.40 to price.

INFINITELY VARIABLE POWER CONTROL UNIT

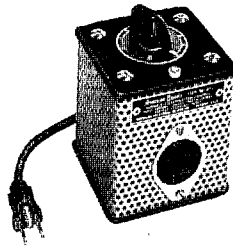

Dials and accurately controls soldering iron tip heat. (Also reliably controls small motor speeds.) Wattage: zero to 125W; infinitely variable, stepless. Fused. Pilot lighted.

Cat. No.	Shpg. Wt.	Net
477	3¾ lbs.	\$16.80

ONE-PASS TIP CLEANERS

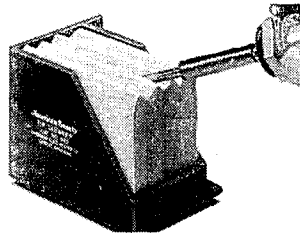

Cleans all sides of tip in one motion. Eliminates tip damage, linting, stray solder pellets. Rubberized base, bored for mounting.

Cat. No.	Descrip.	Shpg. Wt.	Net
480	Complete set	½ lb.	\$2.10
480-S	Sponges only (ea.)	3 oz.	.15

SAFETY SOLDERING IRON STAND

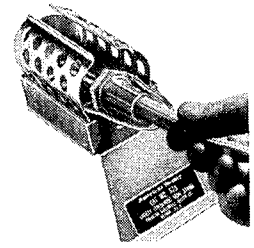

Gravity controlled. Opens, closes automatically. Operator doesn't look up from work. Accommodates all miniature irons.

Cat. No.	Descrip.	Shpg. Wt.	Net
575	Soldering Stand	1 lb.	\$2.80

PARAGON QUALITY SOLDERING TIPS

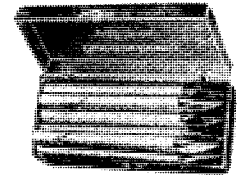

Iron clad tips. Outlast unclad tips many times. Pretinned; point retins self as it works. Clad shank does away with pitting, scaling. Overall chromecoat and minute tapering make tip drip-proof, freeze-free.

ORDERING: Use American Beauty Catalog No. TC-2. Or order tips by carefully specifying shank diameter, overall length, and style of point (diamond, chisel, screwdriver, cone).

PRICES SUBJECT TO CHANGE WITHOUT NOTICE.

RESISTANCE-TYPE SOLDERING & THERMAL WIRE STRIPPING EQUIPMENT

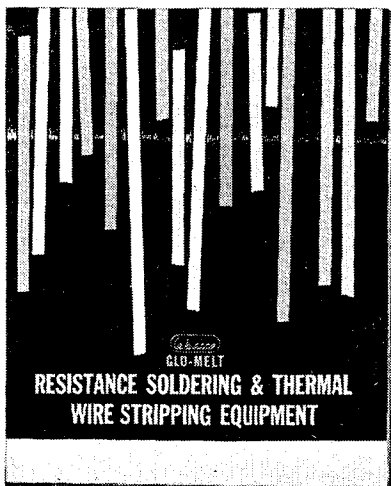

Complete, single source for newest equipment from simplest to most sophisticated

RESISTANCE-TYPE SOLDERING

Power units, control consoles, handpieces, accessories . . . Basic building blocks for your automated soldering systems

THERMAL WIRE STRIPPING

Combinations of power and control units, handpieces and accessories for fast, nick free stripping of thermoplastics and other heat strippable insulations

NEW CATALOGS AND PRICING NOW READY

Ask for "American Electrical Heater Company publication Nos. 25PSW & 37WCP"

AMERICAN ELECTRICAL HEATER COMPANY

BEAUCHAINE & SONS INC.

Subsidiary of
VERNITRON CORPORATION



**BEAU-TECH®
SOLDERING AIDS**

The hallmark of quality shows in each detail. Examine the straight or angled tips for the hard-to-reach areas... you'll find they're twist-proof, hard-chrome plated to shed solder. More, both ends are insulated from one another. The practical fork-ends are a "must" for twisting or holding wires. And when you want to scrape joints, connections or ream out lug holes, just flip your Beau-Tech soldering aid to the spade end. Non-slipping, non-rolling "hex" handles. Available in standard, miniature and single ended models.

STANDARD

BEAU-TECH SOLDERING AID SH20A

Fig. A, Beau-Tech SH-20A Straight Reamer & Forked Tips.
Federal stock no. cross reference: FSN-5120-629-2697.
FSN-3439-330-5075, USAF-3439-608-2392 Net 98¢

BEAU-TECH SOLDERING AID SH20B

Fig. B, Beau-Tech SH-20B Angled Reamer & Forked Tips.
FSN-3439-633-6232, USAF-3439-019-9882 Net 98¢
Fig. , Beau-Tech SH-20-A-SE Straight Tip Net 87¢
Fig. , Beau-Tech SH-20-B-SE Angled Tip Net 87¢
Fig. , Beau-Tech SH-20-F-SE Forked Tip Net 87¢

BEAU-TECH SOLDERING AID SH20K

Fig. C, Beau-Tech SH-20K Brush & Scraper Tips.
FSN-5120-767-9126 Net 98¢
Fig. , Beau-Tech SH-20KF Brush & Forked Tip Net 98¢

PRINTED CIRCUIT

Fig. D, Beau-Tech SH-20C Printed Circuit Type.
Straight Reamer & Forked Tip USAF-3439-562-7066 Net 85¢
Fig. E, Beau-Tech SH-20D Printed Circuit Type.
Angled Reamer & Forked Tips USAF-3439-562-7067 Net 85¢

Fig. F, Beau-Tech SH-20E Printed Circuit Type.
Reamer & Scraper Tips USAF-3439-562-7068 Net 85¢
Fig. G, Beau-Tech SH-20G Printed Circuit Type.
Brush & Scraper Tip Net 92¢

Fig. H, Beau-Tech SH-20GF Printed Circuit Type.
Brush & Forked Tip Net 92¢

Fig. H

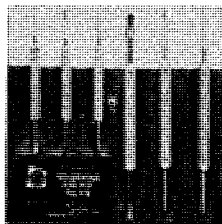

Soldering Aid Kit includes:

Fig. H, BeauTech SH-120
SH-20E, SH-20D, SH-20C,
SH-20K, SH-20B, SH-20A Net 5.35

SCISSORS

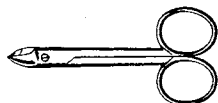

Beau-Tech SH-112 Filament Scissors,
chrome plated over surgical steel Net 2.75

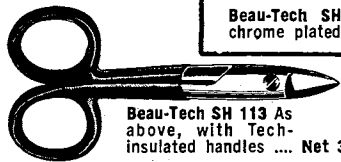

Beau-Tech SH 113 As
above, with Tech-
insulated handles ... Net 3.50

Beau-Tech SH-114 Fine Filament Scissors,
stainless steel, with serrated
edges Net 2.75

**BEAU-TECH®
SOLDERING AID KIT**

MINIATURE

Beau-Tech SH-121, consists of 4 popular, BEAU-TECH miniature soldering aids, each approx. 5 1/2" long, with flexible case. Working tips of tool steel, heat-treated in Swedish manner, hand-ground, machined and polished before chrome plating. Stainless brushes. Varnished New Hampshire hardwood handles. Kit includes: SH-20-C Soldering Aid straight tip and forked tip, SH-20-D Soldering Aid angled tip and forked tip, SH-20-G Soldering Aid brush and scraper tip, SH-20-GF Soldering Aid brush and forked tip.

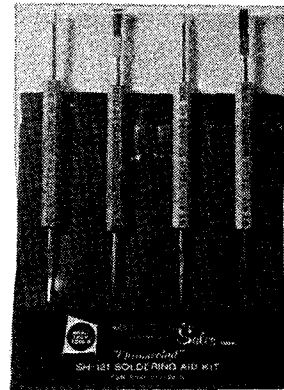

SH-121 Kit Net 4.35

BEAU-TECH®

SPUDGERS

BEAU-TECH SPUDGER SH-80

Fig. K, Beau-Tech SH-80 Spudger. Widely used by telephone and electronics technicians for checking circuitry, wiring, and as a soldering aid. WE 709, 733; KS-1102 Net 55¢

Fig. L, Beau-Tech SH-81 Spudger. Same as SH-80, meets MIL-specs and Federal Stock Number requirements. Both are made of red vulcanized fibre. FSN-5120-408-1764, FSN-5120-293-3112, ORD Dwg. A-7578690 Net 55¢

Fig. L BEAU-TECH SPUDGER SH-81

BEAU-TECH®

PROBERS

Fig. M, Beau-Tech SH-116 Prober #6, stainless steel, vinyl hang-up pouch Net 98¢

Fig. N, Beau-Tech SH-117 Prober #17, stainless steel, vinyl hang-up pouch Net 98¢

Fig. O, Beau-Tech SH-123 Prober #23, stainless steel, vinyl hang-up pouch Net 98¢

Fig. P, Beau-Tech SH-141 Prober #1, stainless steel, vinyl hang-up pouch Net 98¢

BEAU-TECH®

INSPECTION MIRRORS

INSULATING HARWOOD HANDLES

Fig. Q, Beau-Tech SH-131 Inspection Mirror, 3/4", 3x magnification Net 85¢
Fig. Q, Beau-Tech SH-132 Inspection Mirror, 1", 3x magnification Net 85¢
Fig. Q, Beau-Tech SH-133 Inspection Mirror, 3/4" plain Net 85¢
Fig. Q, Beau-Tech SH-134 Inspection Mirror, 1" plain Net 85¢

BEAUCHAINE

A
SUBSIDIARY
OF
VERNITRON CORPORATION

BEAUCHAINE & SONS INC.

Subsidiary of
VERNITRON
CORPORATION



BEAU-TECH®

MICRO-MINIATURE TWEEZERS

These tools have been specifically designed and precision-shaped for ease of handling micro-miniature parts in electronic instrumentation and related fields — where extremely sharp, strong points and delicate tension are required.

Fig. A, Beau-Tech SH-380 General use, strong blades, fine points, stainless steel, non-magnetic, 4½" Net 3.50

Fig. B, Beau-Tech SH-382 General use, tapered, fine points, stainless steel, non-magnetic, 4½" Net 3.85

Fig. C, Beau-Tech SH-383 Assembly work, very fine points, stainless steel, non-magnetic, 4½" Net 3.75

Fig. D, Beau-Tech SH-384 Extra-fine work, blades taper sharply from body, stainless steel, superfine points, non-magnetic, 4½" Net 4.75

Fig. E, Beau-Tech SH-385 Assembly work, superfine points, stainless steel, non-magnetic, 4½" Net 5.00

Fig. F, Beau-Tech SH-394 Extra-fine work, blades taper sharply from body, bent points, stainless steel, non-magnetic, 4½" Net 5.00

STANDARD TWEEZERS

Fig. G, Beau-Tech SH-24A 7" Probing Tweezer, Plastic Net 50¢

Fig. I, Beau-Tech SH-100 Filament Holder, stainless steel. Includes vinyl hang-up pouch Net 2.00

Fig. J, Beau-Tech SH-101 Angular Filament Holder, stainless steel. Includes vinyl hang-up pouch. Redstone Arsenal Stock No. 025-29075-5 Net 2.00

Fig. K, Beau-Tech SH-102 Utility Tweezer No. 1, plated. Includes vinyl hang-up pouch Net 79¢

Fig. M, Beau-Tech SH-104 Fine Filament Holder, stainless steel. Includes vinyl hang-up pouch. Redstone Arsenal Stock No. 025-29075-5 Net 2.00

Fig. N, Beau-Tech SH-105 Lock-type Filament Holder, stainless steel Net 3.25

Fig. O, Beau-Tech SH-106 Heavy Gripper, stainless steel. Includes vinyl hang-up pouch Net 2.25

Fig. P, Beau-Tech SH-111 Filament Holder, stainless steel, tec-insulated handle. Includes vinyl hang-up pouch Net 2.25



BEAU-TECH® VACUUM SYSTEM

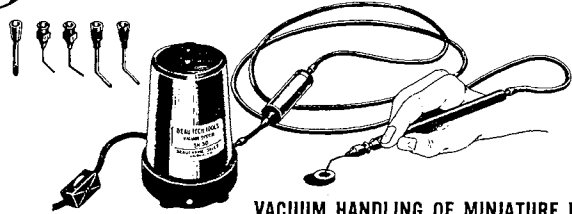

VACUUM HANDLING OF MINIATURE PARTS

System normally supplied with Tips No. 11, 12, 20, 22, and 24, however, you may specify the exact tips which you require.

Tip No.	I. D.	O. D.	Style	Matl of Hub	Matl of Tip	All Plastic	Lot	Over 20 Each No.
SH-50-11	.03	.10	E	Metal	X	X	.95	.85
SH-50-12	.06	.12	E	Metal	X	X	.95	.85
SH-50-13	.12	.19	L	Metal	X	X	.95	.85
SH-50-14	.03	.10	F	Metal	X	X	1.50	1.21
SH-50-15	.06	.12	F	Metal	X	X	1.50	1.21
SH-50-16	.12	.19	F	Metal	X	X	1.50	1.21
SH-50-17	.25	.31	F	Metal	X	X	1.50	1.21
SH-50-20	.007	.016	A	Metal	X	X	1.25	1.13
SH-50-21	.010	.020	A	Metal	X	X	1.25	1.13
SH-50-22	.013	.023	A	Metal	X	X	1.25	1.13
SH-50-23	.016	.028	A	Metal	X	X	1.25	1.13
SH-50-24	.025	.032	A	Metal	X	X	1.25	1.13
SH-50-25	.025	.036	A	Metal	X	X	1.25	1.13
SH-50-26	.033	.050	A	Metal	X	X	1.25	1.13
SH-50-27	.035	.057	A	Metal	X	X	1.60	1.44
SH-50-28	.045	.064	A	Metal	X	X	1.60	1.44
SH-50-29	.052	.071	A	Metal	X	X	1.60	1.44
SH-50-30	.070	.095	A	Metal	X	X	1.60	1.44

Beau-Tech SH-50, consists of a small electric vacuum generator producing up to 14" Hg vacuum, an inline filter which protects the generator from foreign matter, an SH-52 Cylindrical Probe and five Probe tips from the selection listed at left, and a 4" length of vacuum tubing. The operation of the SH-50 Vacuum System is simplicity itself—plug in the generator line cord, turn on the switch and you're in business. Objects are picked up by holding the index finger over the hole in the handpiece, raising the finger to release.Net 36.95 ea., 10 or more 33.25 ea.



SH-52
CYLINDRICAL
PROBE
(Handpiece)
Net 6.25

COMPONENT LEAD CLEANERS

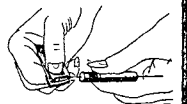
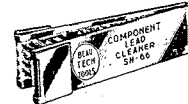

Beau-Tech SH-66, NASA Quality Publication NPC-200-4 specifies component leads must have all oxides removed before being soldered in place. Beau-Tech SH-66 is a unique and inexpensive hand tool (Stainless Steel) and complies completely with these specs.Net \$1.50 ea., 10 or more 1.35 ea.

LOCK-TYPE HOLDERS

Beau-Tech SH-90-C and SH-90-S, Stainless Steel tools have 2-position snap-locks. Excellent clamp and heat sink for the soldering of diodes, transistors, components. Handy as a "third hand". With TEC-COATED handles, and vinyl hang-up pouch. Length, approx. 5½".

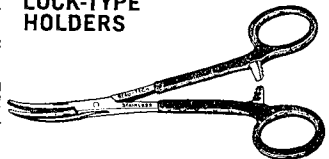

SH-90-C (Curved Jaws) Net 4.80 ea., 10 or more 4.32 ea.
SH-90-S (Straight Jaws) Net 4.80 ea., 10 or more 4.32 ea.

MICRO-MINIATURE TWEEZERS

"Made in Switzerland"
STAINLESS STEEL "DUMONT STYLE"

Fig. R, Beau-Tech SH-301 Tweezers #1Net 3.00
10 & up 2.70

Fig. S, Beau-Tech SH-303C Tweezers #3CNet 3.20
10 & up 2.88

Fig. T, Beau-Tech SH-305 Tweezers #5Net 4.00
10 & up 3.60

Fig. U, Beau-Tech SH-307 Tweezers #7, Fine PointsNet 4.30
10 & up 3.87

BEAUCHAINE

A
SUBSIDIARY
OF
VERNITRON
CORP.

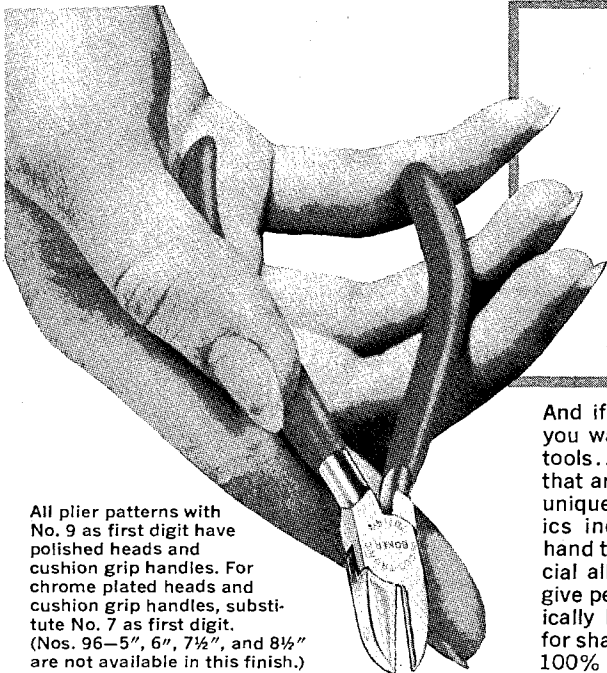

Boker In-Dus-Tronic hand tools have a nose for every special electronics application

All plier patterns with No. 9 as first digit have polished heads and cushion grip handles. For chrome plated heads and cushion grip handles, substitute No. 7 as first digit. (Nos. 96-5", 6", 7½", and 8½" are not available in this finish.)

And if you have a nose for quality, you want Boker In-Dus-Tronic hand tools...top quality, precision tools that are designed specifically for the unique requirements of the electronics industry. Boker In-Dus-Tronic hand tools are drop-forged from special alloy steel. Precision ground to give perfect jaw alignment. Electronically heat-treated and hand honed for sharp, long-lasting cutting edges. 100% inspected to maintain Boker's

high standards for hardness, strength and cutting ability. Cushion-grip handles for comfort and efficient operation. And, best of all, no matter how tight the area, Boker has a nose shaped to do the job from any angle.

There's a wide range of fine quality tools in the Boker line...487 pliers, nippers, snips, punches, adjustable wrenches, knives, industrial scissors and shears.

No. 981-4½"	No. 982-4½"	No. 983-4½"	No. 984-4½"	No. 985-4½"	No. 91-6"
Midget Diagonal Cutting Pliers	Midget End Cutting Nippers	Midget Needle Nose Pliers	Midget Flat Nose Pliers	Midget Round Nose Pliers	Standard Diagonal Cutting Pliers
No. 991-7"	No. RA91-5½"	No. 917-5½"	No. 913-5½"	No. XA982-4½"	No. 902-6"
Heavy Duty Diagonal Cutting Pliers	Thin, Narrow Pointed, Diagonal Cutting Pliers	Diagonal Cutters with "W" Notches, Skinning Holes and Insulation Crusher	Needle Point Diagonal Cutting Pliers	Midget Electronic End Cutting Nippers	End Cutters and Lead In Strippers
No. 932-6"	No. 939-4½" No. 939-6"	No. S939-6"	No. 903-4½" (smooth jaws) No. 903-6" (milled jaws)	No. 908-4½" (smooth jaws) No. 908-6" (milled jaws)	No. 933-6"
Transverse End Cutting Nippers	Radio & TV Nose Cutting Pliers	Tip Nose Side Cutting Pliers	Short, Extra Fine, Needle Nose Pliers	Curved, Short, Extra Fine, Needle Nose Pliers	Long Needle Nose Pliers
No. 938-6"	No. P6507-6½" No. P6507-8" No. P6507-10"	No. 96-5" No. 96-6" No. 96-7½" No. 96-8½"	No. 93-5" (with side cutters) No. 930-5" (no side cutters)	No. 93-6" (with side cutters) No. 930-6" (no side cutters)	No. 6041-6½"
Curved Needle Nose Pliers	"Groove Grip" Utility Pliers. Five Positions	Heavy Duty Linemen's Side Cutting Pliers	Short Chain Needle Nose Pliers	Long Chain Needle Nose Pliers	Combination Slip Joint Pliers
No. 6042-6½" No. 6043-6½" (with bent jaws)	No. 709-5" IDT	No. P4-7½" (1½" cut) No. P4E-6½" (½" cut)	No. HF-5½" No. HF-6½" No. HFC-6½" (curved blades)	6W-4" 6W-15" 6W-6" 6W-18" 6W-8" 6W-10" 6W-12"	No. 9229
Thin Nose Combination Slip Joint Pliers	Electricians Scissors	Electronic Snips	Holding Forceps	Adjustable Wrenches -Thin Pattern	Electrician's Pocket Knife

BOKER MANUFACTURING CO.
A Subsidiary of THE NEW BRITAIN MACHINE CO.



CAIG LABORATORIES INC.

SOLDER BATHS and GENERAL USE HEATING CONTROLS

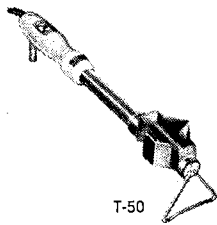

T-50

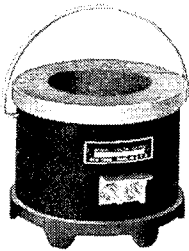

R-4A

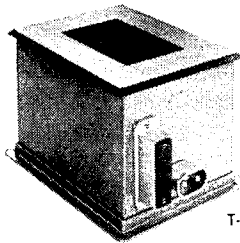

T-6

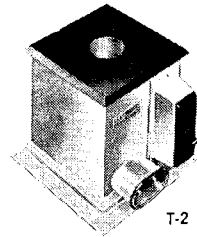

T-2

RECTANGULAR AND ROUND SOLDER BATHS

Catalog No.	Watts	Volts	Approx. Temperature		Internal Dimensions Approx. (Inches)			Contents Approx. (CC)	Heat Control	Weight Approx. (Lbs.)	Price
			(°C)	(°F)	Length	Width	Depth				
T-50	65	110	300	572	1.10	0.78	0.55	7	Full Heat	1.00	\$ 9.75
T-100	130	110	340	644	2.37	1.18	1.18	25	Full Heat	1.50	10.50
T-250A*	260	110	420	788	2.94	2.37	1.56	100	Full & Half	5.00	34.50
T-2*	240	110	600	1112	—	0.97 dia.	1.84	17	Full & Half	3.00	28.00
T-3*	350	110	430	806	3.94	1.18/0.59	2.14	120	Full & Half	5.50	32.00
T-4*	400	110	410	770	2.00	2.00	3.28	220	Full & Half	8.50	40.00
T-6*	1000	110	560	1040	4.69	3.13	2.39	570	Full & Half	11.25	61.00
T-9**	2800	230	650	1202	6.50	5.33	3.94	2080	3 Step Sw.	31.00	175.00
T-1212	2000	230	372	700	12.00	12.00	2.00	90 lbs.	Automatic	55.00	175.00
T-1218‡	2800	230	372	700	18.00	12.00	2.00	135 lbs.	Automatic	70.00	210.00
T-1418‡	3000	230	372	700	18.00	14.00	2.00	175 lbs.	Automatic	60.00	290.00
R-1.5A	200	110	288	550	—	1.50 dia.	1.50	1 lb.	Automatic	5.00	33.00
R-4A†	300	110	288	550	—	3.00 dia.	1.50	4 lbs.	Automatic	6.00	34.00
R-10A†	500	110	288	550	—	3.50 dia.	2.50	10 lbs.	Automatic	11.00	47.00
R-20A†	1100	110	372	700	—	5.00 dia.	4.00	20 lbs.	Automatic	33.00	91.00
R-40A	1500	230	372	700	—	6.00 dia.	6.00	40 lbs.	Automatic	40.00	103.00
R-80X	3000	230	538	1000	—	8.00 dia.	5.50	80 lbs.	Full Heat	45.00	150.00
R-80AXP	3000	230	538	1000	—	8.00 dia.	5.50	80 lbs.	Automatic	60.00	280.00
R-4X	800	110	538	1000	—	3.00 dia.	1.50	4 lbs.	Full Heat	6.00	42.00
R-4AX†	900	110	538	1000	—	3.00 dia.	1.50	4 lbs.	Automatic	9.00	73.00

NOTES: (*) Can be Switched to Half Wattage Rating. (**) With 3-Step Switch. (†) Non-Indicating Thermostat Bimetal Control. (‡) For Partlow Indicating Control add \$150.00 to Base Price. Otherwise non-indicating thermostat supplied, control knob.

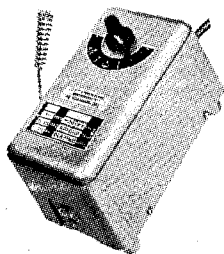

MODEL 30 CONTROL TRANSFORMER

FOR ALL 6 VOLT SOLDERING IRONS

The R30, transformer model has a primary voltage regulator for 110, 125, 150, 220 and 240 volts. The secondary voltage is also variable within the range of 5 to 6.5 volts, thus making it possible to select a temperature range between 240 to 480°C. When not in use, a solder iron may rest on a special nozzle provided on the transformer. This protects against overheating. The R30, permits universal use of all the various 6 volt irons with their different capacities, up to 30 watts.

MODEL R30, rated 30 VA, 5.1#. Price...\$28.00

INPUT VOLTAGE REGULATOR

(SOLID STATE CONTROL)

Model RSCR-400, infinite, constant control of voltage, rated up to 400 watts @ 115 volts A.C. Control in-put voltage to any resistive load — such as soldering iron, solder pot, even control speed of small fractional HP-A.C.-D.C. motors. Amps. 3.5 max. Just plug-in load and set knob for any heat or speed requirement. Supplied with 3 wire rubber covered conductor wire, 5 feet, and standard grounding plug. Red Light Indicator. On-Off switch. Size 2 1/4 x 2 1/4 x 4. Weight approx. 1 lb. Price\$28.00

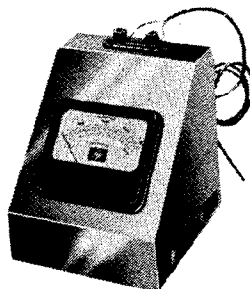

PYROMETERS INDICATING

Model IPL-500, low temperature, indicating pyrometer, range 0° to +650°F, scale 3 1/2", graduations: 5°F, Dimensions 7" H. x 6" W. x 6" L., #14 ga. #20 ga. I/C thermocouple & lead wire. Weight 4 lb. Price.....\$38.00 Extra thermocouple. Price.....\$14.50

Model IPH-500, high temperature, indicating pyrometer, range 0° to +2000°F, scale 3 1/2", graduations: 20°F, Dimensions 7" H. x 6" W. x 6" L., #14 ga. C/A thermocouple 1/4" dia. x 12" long, protected ceramic beads, 3 feet lead wire. Weight 4 lb. Price.....\$40.50 Extra thermocouple. Price.....\$14.50

INPUT VOLTAGE REGULATOR

(BI-METAL CONTROL)

Model R-1800, infinite control, bi-metal, proportion input voltage of any resistive load up to 15 amps, 115 volts. Just plug-in your load and set knob for any heat requirement. Behaves as a percentage timer. Supplied with 3 wire rubber covered lead wire 5 feet and standard grounding plug. On-Off switch. Red Light indicator. Size 4" x 4" x 4". Weight approx. 2 lbs. Price.....\$28.00

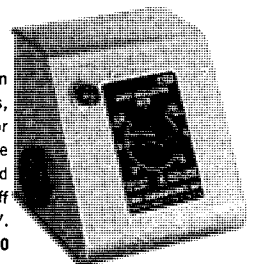

CHANNEL LOCK®

Specially Designed ELECTRONICS PLIERS

Four matched, long-reach pliers with precision matched jaws, hand honed cutting edges. Drop forged of special analysis steel, properly heat treated. Polished finish. Smooth, dipped plastic, blue grips.

No.	Size	Net
718G	8"	\$2.27
728G	7½"	2.80
738G	8"	2.27
748G	8"	2.53

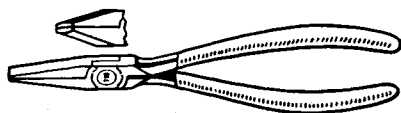

NO. 718G FLAT NOSE PLIERS

Precision-matched jaws give firm grip in hard-to-reach places.

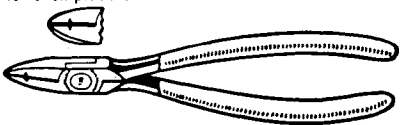

NO. 728G DIAGONAL CUTTER

Patented wire-stripping notch that really works!

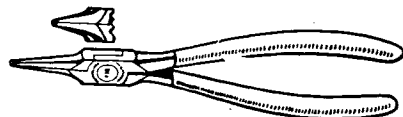

NO. 738G ROUND NOSE PLIERS

You can pick up a hair with these precision machined points.

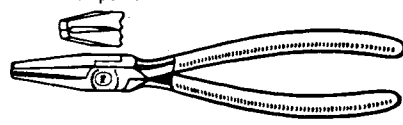

NO. 748G END CUTTER

Fine enough to cut a human hair, sturdy enough to cut 12 gauge copper wire.

TONGUE AND GROOVE PLIERS

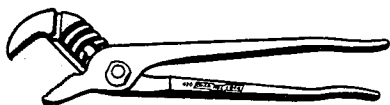

The original, genuine tongue and groove plier. Patented, non-slip undercut channels. Patented reinforcing rib for extra strength. Dipped plastic grips optional at slight extra cost.

No.	Size	Adjust	Capacity	Net
420	9½"	5	1½"	\$2.40
424	4½"	4	¾"	1.80
426	6½"	5	1"	1.80
430	10"	7	2"	2.60
440	12"	7	2¼"	2.67
460G	16"	8	4¼"	3.80

WIREMASTER PLIER



Finest wire-cutting plier ever made. Joint rivet closer to cutting edge provides 40% more cutting power than standard design pliers. Special enclosed-joint construction holds cutter edges in perfect alignment for life of plier. Dipped plastic grips optional at slight extra cost.

No.	Size	Net
349	9"	\$4.53

LONG NOSE PLIER



Point ⅜" round. Polish steel finish. Knurled grips. Dipped plastic grips optional at slight extra cost.

No.	Size	Side Cutter	Net
317½	7½"	With	\$2.87
3017½	7½"	Without	2.27
326	6"	With	2.53
3026	6"	Without	2.07

LINEMEN'S PLIER—Bevel Nose

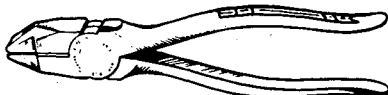

Polished steel finish. Knurled grips. Side cutter. Dipped plastic grips optional at slight extra cost.

No.	Size	Net
3046	6"	\$2.53
3047	7"	2.80
3048½	8½"	3.54

ELECTRICIAN'S WIRING PLIER



Triple-use wiring plier: Cuts, strips insulation, loops wire. Patented wire stripping notches strip insulation from 14 and 12 gauge copper wire quickly, cleanly. Dipped plastic grips optional at slight extra cost.

No.	Size	Net
337-W	7"	\$2.73

DIAGONAL CUTTER—Box Joint



Precision honed cutting edges. Polished steel finish. Knurled grips. Dipped plastic grips optional at slight extra cost.

No.	Size	Net
435	5"	\$2.33
436	6"	2.53
437	7"	2.87

LINEMEN'S PLIER—Rounded Nose



Polished steel finish. Knurled grips. Side cutter. Dipped plastic grips optional at slight extra cost.

No.	Size	Net
346	6"	\$2.53
347	7"	2.80
348½	8½"	3.53

HEATSORB CLAMP



Specially designed "heat sink" that prevents heat damage to electronic components during soldering. Also a handy, self-gripping "third hand" that holds and retrieves small parts in close work.

No.	Size	Net
46	5"	\$1.00

SLIP JOINT PLIERS



Thin Nose. Polished steel. Wire cutting shear.

No.	Size	Net
516	6"	\$1.67

With Side Cutter. Polished steel. Precision tool with fine cutting edge.

No.	Size	Net
537	7"	\$2.80

Heavy Duty With Cutter. Finest quality. Polished steel.

No.	Size	Net
546	6"	\$1.80
548	8"	2.20
5410	10"	2.47

CHANNEL LOCK®

Little Champ PRECISION PLIERS

Finest quality, small precision pliers specially designed for electronic work. Drop forged from high grade steel, polished to jeweller's finish. Dipped blue plastic grip handles.

No.	Style	Length	Net
41G	Diagonal Cutter	4 1/4"	\$2.40
41GS	Diagonal Cutter, Coiled Spring	4 1/4"	2.60
42G	End Cutting Nipper	4"	2.53
43G	Needle Nose, No Side Cutter, Plain Nose	4 3/4"	2.13
43GS	Needle Nose, No Cutter, Plain Nose, Coiled Spring	4 3/4"	2.33
44G	Plain Nose	4 3/4"	2.20
45G	Round Nose	4 1/2"	2.27
47G	Needle Nose, Side Cutter, Nose Serrations	4 3/4"	2.60
47GS	Needle Nose, Side Cutter, Nose Serrations, Coiled Spring	4 3/4"	2.80
48G	Transverse End Cutter	4 3/4"	2.60
49G	Curved Needle Nose	4 1/2"	2.53

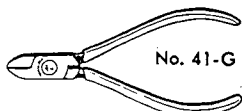

No. 41-G

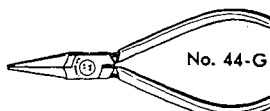

No. 44-G



No. 48-G

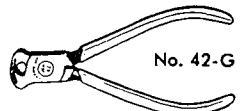

No. 42-G

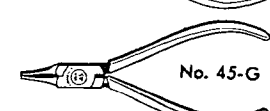

No. 45-G

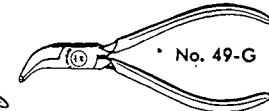

No. 49-G

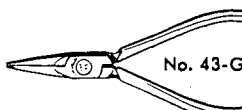

No. 43-G

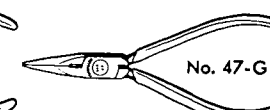

No. 47-G

SCREWDRIVERS AND NUTDRIVERS

Blades forged from tough chrome vanadium steel. Tips ground lengthwise for greater end strength and snug fit in screw slot. Opaque blue plastic (UL) handles are shockproof, breakproof and shaped for non-slip grip.

ROUND SHANK

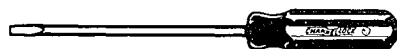

No.	Blade Size, In.	Net	No.	Blade Size, In.	Net
181RD	1/4 x 1	.53	31610RD	1/16 x 10	\$.96
3164RD	3/16 x 4	.67	144RD	1/4 x 4	.84
3166RD	3/16 x 6	.73	146RD	1/4 x 6	.93
3168RD	3/16 x 8	.84	5166RD	1/16 x 6	1.07

SQUARE SHANK

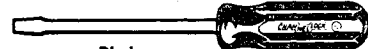

No.	Blade Size, In.	Net	No.	Blade Size, In.	Net
141SQ	1/4 x 1	\$.53	5166SQ	1/16 x 6	\$1.12
3164SQ	3/16 x 4	.72	5168SQ	1/16 x 8	1.23
144SQ	1/4 x 4	.88	388SQ	3/8 x 8	1.47
146SQ	1/4 x 6	.99	3812SQ	3/8 x 12	2.34
148SQ	1/4 x 8	1.09			

PHILLIPS SCREWDRIVERS



No.	Blade Size, In.	Net
102-SP	1/4 x 1 1/16	\$.77
101-P	3/16 x 3	.75
102-P	1/4 x 4	.91
103-P	3/16 x 6	1.23
104-P	1/4 x 8	1.55

NUTDRIVERS



Hex	Lgth.	Net	Hex	Lgth.	Net
3/16	3	\$.75	1/2	3	\$.75
7/32	3	.75	3/4	3	.75
1/4	3	.75	7/8	3 3/8	.96
9/32	3	.75	1	3 1/4	.96
5/16	3	.75			

SCREWDRIVER KIT

Pocket-size, handy bench sets, color coded. Special E-Z Grip handle included.

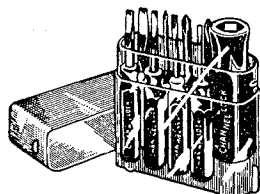

SD-5 Set Includes—
5 Screwdrivers: 1/32", 1/16", 1/8", 3/16", 1/4"
3 Phillips Head: No. 0, No. 1 and No. 2
Net \$3.73

NUTDRIVER KIT

Pocket-size, handy bench sets, color coded. Special E-Z Grip handle included.

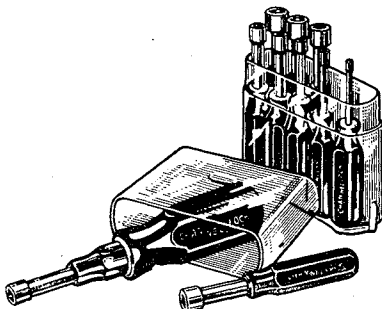

ND-1 Set Includes—
10 Nutdrivers: 3/32", 1/8", 5/32", 3/16", 7/32", 1/4", 5/16", 3/8", 11/32", 3/4"
Net \$5.20

ADJUSTABLE WRENCHES



Drop forged of special analysis steel. Chrome plated. Dipped plastic grips optional at slight extra cost.

No.	Size	Capacity	Net	No.	Size	Capacity	Net
804	4"	1/2"	\$2.11	810	10"	1 1/4"	\$3.08
806	6"	3/4"	2.13	812	12"	1 5/8"	4.46
808	8"	1 1/8"	2.41	815	15"	1 7/8"	6.70

ELECTRICIAN'S KNIFE

2 1/2" precision-honed blade. 3" self-locking screwdriver. Unbreakable phenolic plastic handle.



No.	Closed Length	Net
11	3 1/4"	\$2.46

SKINNING KNIFE

3" precision-honed blade. Self-locking. Unbreakable phenolic plastic handle.



No.	Closed Length	Net
10	4"	\$2.53

TOOL HOLSTERS

Highest quality top grain leather. Stress points reinforced with rivets. Convenient knife or wrench snap.

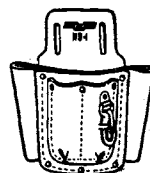

No.	Size	Pkts. Net
1	9 1/4" x 8 1/2"	5 \$3.74
2	9 1/4" x 10 1/2"	5 4.00

SUPERIOR PLASTIC GRIPS

For maximum hand comfort, durable molded plastic grips. Blue color for good visibility, reduces plier loss. Easy to install. Order by desired grip size.

Plier Size	Grip Size	Net
6"	Small	\$.43
7"	Medium	.47
8", 9 1/2", 10"	Large	.50





PROPERLY PROPORTIONED MINIATURE TOOLS

For precision instrument and model work use Desco "7" Miniature Nut Drivers. Available with Tenite handles, or for use with jewelers' screw driver handles. Also made with 5 1/2" long shanks for those hard-to-get-to places.

DESCO "7" Sizes across flats
 5/64 3/32 7/64 1/8 5/32 3/16 1/4

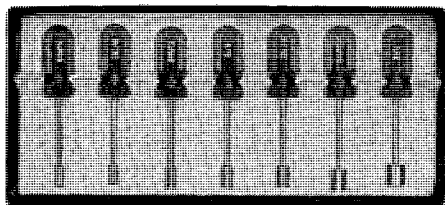

Set HS 7 List \$5.95

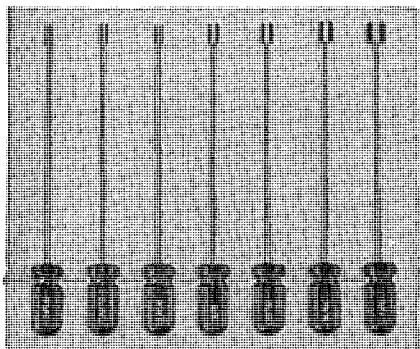

Set HL 7 List \$5.95

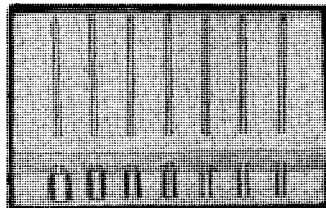
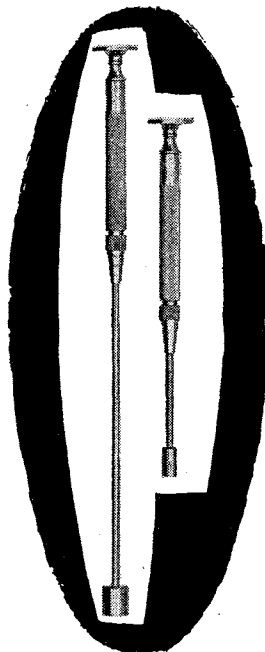

Set JS 7 List \$4.95

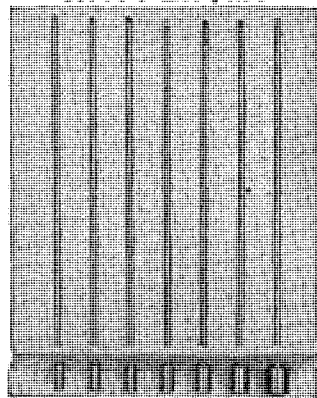

Set JL7 List \$4.95

NON-MAGNETIC NUT DRIVERS available in HL7 and HS 7 series only. Specify "No-Mag" with the code number — same prices.

INTRODUCING THE DESCO "5" Series of Miniature Tools

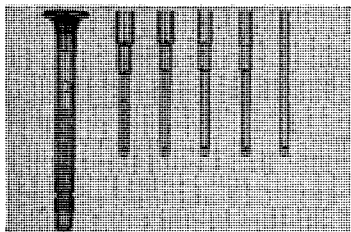

Set JD 5 List \$3.50

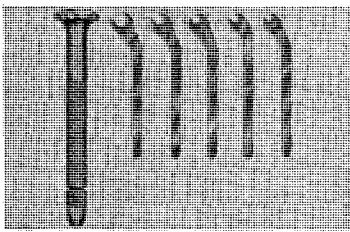

Set EW 5 Steel List \$2.50

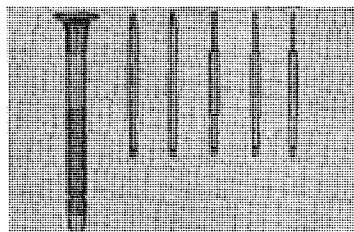

Set PA 5 List \$2.50

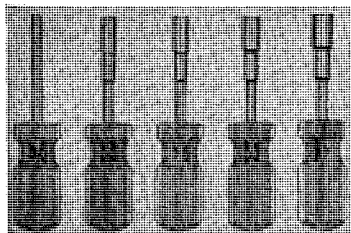

Set HD 5 List \$4.50

Deeper and more rugged than the "7" Series. Made only in 5/64, 3/32, 7/64, 1/8 and 5/32.

Set EWN 5 Non-Magnetic List \$2.50
 A practical miniature end wrench to fit the smallest nuts made 5/64 3/32 7/64 1/8 5/32.

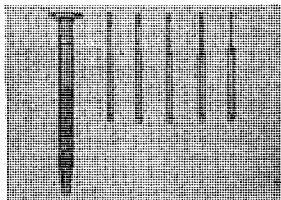

Set SS 5 List \$1.98

Contains four screw driver blades and a fine scriber.

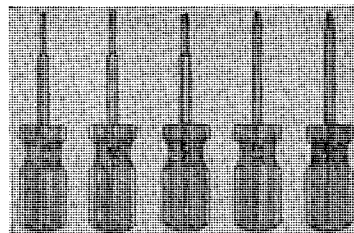

Set PAH 5 List \$3.50

Includes the two smallest Phillips drivers and the three smallest Allen wrenches.

* T. M.

All of the DESCO "5" and "7" Series are complete as shown.

DESCO MFG. CO.



SECTION 5400
ENTERPRISE DEVELOPMENT CORPORATION

**THE ORIGINAL VACUUM DESOLDERING/RESOLDERING IRON
 INDUSTRIAL PRICE SCHEDULE**

DESOLDERING IRONS

MODEL 100-A
 120 VAC 75 W

	List	1-11	30-96	108-up
Model 100-A (with 2-wire cord)	\$27.50	\$20.65	\$18.60	\$16.75
Model 100-A-3 (with 3-wire cord)	28.85	21.65	19.50	17.55
Model 100-A-3TL (with 3-wire cord twist lock cap)	Prices on Request			

MODEL 300
 120 VAC 40 W

	List	1-11	30-96	108-up
Model 300 (with 2-wire cord)	14.60	10.95	9.85	8.85
Model 300 (with 3-wire cord)	15.95	11.95	10.75	9.70

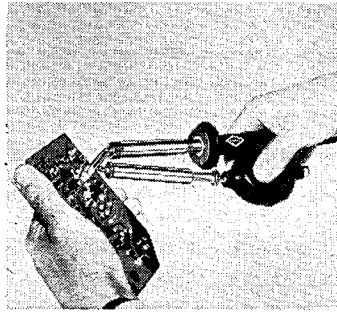

MODEL 100-A

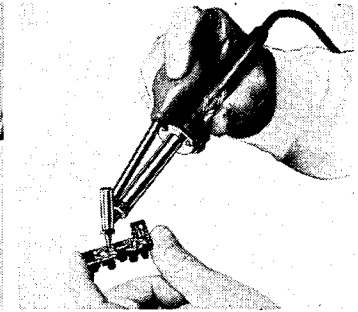

MODEL 300

9-Piece Desoldering Kit

Kit Model 300K with Model 300 iron illustrated. Military models available. Prices on request.
 Kit Model 300MDK Stock No. FSN 3439-907-5806.
 Kit Model 100A-MDK Stock No. FSN 3439-917-5632.
 New Kit Model 100-AK with Model 100-A iron also available.

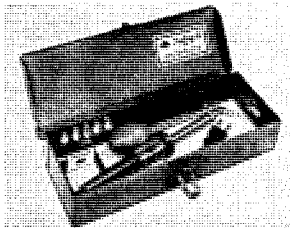

Here in one convenient lifetime package is all you need to handle almost any desoldering and resoldering job. For even though the Model 300 Endeco is only 8" long and weighs just 3½ ounces, it's a giant in performance. It removes miniature soldered components in seconds without damage. . . then resolders new connections even faster and better than regular soldering irons with its 360° "wrap-around" contact. One-hand operation . . . self-cleaning . . . 40 watts . . . 120 volts. Order from your distributor.

KIT PRICES

MODEL	List	1-11	12-49	50-up
300K (w/2 wire cord)	\$26.55	\$19.90	\$17.90	\$16.10
300K-3 (w/3 wire cord)	27.85	20.90	18.80	16.90
100-AK (w/2 wire cord)	36.50	27.40	24.65	22.20
100-AK-3 (w/3 wire cord)	37.85	28.40	25.55	23.00

ONLY DESOLDERING IRON APPROVED FOR MILITARY USE

(BOX, STAND AND CLEANING TOOL AVAILABLE SEPARATELY—WRITE FOR PRICES.)

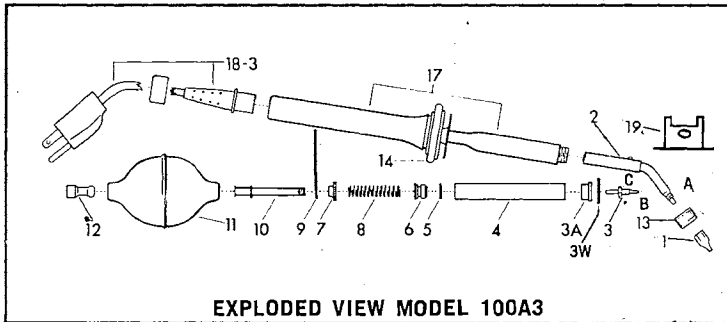

EXPLODED VIEW MODEL 100A3

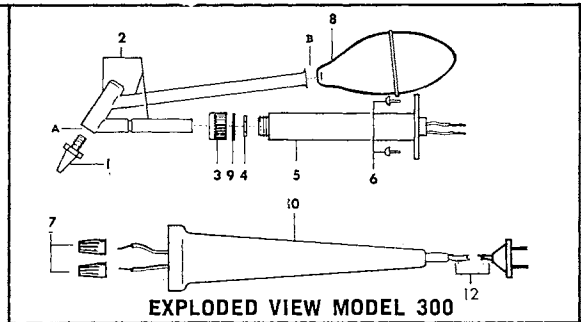

EXPLODED VIEW MODEL 300

PART NOS. FOR MODEL 100-A PARTS SCHEDULE

Fig. No.	Part No.	Description	List	Industrial Cost
1	100T.096	Desoldering Tip Formerly 1B	\$3.00/3PK	\$2.25/3PK
1	100T.018*	Desoldering Tip Formerly 1A	3.00/3PK	2.25/3PK
1	100T.067	Desoldering Tip	3.00/3PK	2.25/3PK
1	100T.059	Desoldering Tip Formerly 1C	3.00/3PK	2.25/3PK
1	100T.046	Desoldering Tip	3.00/3PK	2.50/3PK
1	100T.035	Desoldering Tip Formerly 1D	3.00/3PK	2.50/3PK
1	100TP	6 Assorted Tips for Model 100-A..	6.00	4.50
2	2A	Tip Body (750°F Standard) (600°F Special)	3.35	2.50
3	3S	Front Connecting Tube60	.45
3A	3B	Front Air Seal60	.45
3W	3W	Protective Washer15	.10
4	4A	Solder Collection Tube	1.45	1.10
5	5A	"O" Ring (2 Required)40/2	.30/2
6	6A	Rear Air Seal	1.50	1.15
7	7A	Knurled Sleeve55	.40
8	8	Tension Spring35	.25
9	9A	Supporting Bracket68	.50
10	10A	Rear Connecting Tube	1.15	.85
11	11	Vacuum Bulb	1.35	1.00
12	12	Valve60	.45
13	13	Female Tip Fastening Nut90	.65
14	14	Rubber Shock Absorber90	.65
17	17	75W Iron (Less Cord)	11.00	8.25
17	17-2	75W Iron (w/2-wire Cord)	12.50	9.40
17	17-3	75W Iron (w/3-wire Cord)	13.95	10.45
18	18-2	2-wire Cord Only	2.00	1.50
18	18-3	3-wire Cord Only	3.35	2.50
18	18-3TL	3-wire Twist Lock Cord Only	4.65	3.50
19	300-KS	Iron Stand35	.25

PART NOS. FOR MODEL 300

Fig. No.	Part No.	Description	List	Industrial Cost
1	300T.090	Replaceable Desoldering Tip	\$3.00/3PK	\$2.25/3PK
1	300T.078	Replaceable Desoldering Tip	3.00/3PK	2.25/3PK
1	300T.063*	Replaceable Desoldering Tip	3.00/3PK	2.25/3PK
1	300CT.063	Industrial Desoldering Tip	4.50/3PK	3.30/3PK
1	300T.059	Replaceable Desoldering Tip	3.00/3PK	2.25/3PK
1	300T.046	Replaceable Desoldering Tip	3.00/3PK	2.25/3PK
1	300T.038	Replaceable Desoldering Tip	3.00/3PK	2.25/3PK
1	300TP	6 Assorted Tips for Model 300 ..	6.00	4.50
2	300-BE	Sub-Assembly	5.70	4.30
2	300-BECO	Sub-Assembly Complete with Tip Fastening Nut & Bulb	8.50	6.35
3	300-13	Sub-Assembly Fastening Nut50	.35
4	300-5	Sub-Assembly Retaining Pin14	.10
5	300-17E	(New) Ceramic Filled Heating Element 40W	4.35	3.25
6	300-17SC	Screws (3 Required)30/3	.23/3
7	300-17TC	Terminal Connectors (2 Required) ..	.40/2	.30/2
8	300-11.75	Vacuum Bulb ¾ oz. Light Duty ..	.90	.65
8	300-11.100	Vacuum Bulb 1 oz. Heavy Duty (Standard)	1.10	.80
9	300-6	Sub-Assembly Retaining Ring10	.08
10	300-17HA	Handle60	.45
12	300-18-2	2-wire Cordset	1.50	1.15
12	300-18-3	3-wire Cordset	2.70	2.00
	300-17CO-2	40W Iron w/2-wire Cord	8.25	6.20
	300-17CO-3	40W Iron w/3-wire Cord	9.50	7.30

REPLACEABLE TIPS FOR ENDECO MODEL 100-A

Fig. No.	Part No.	Description	Formerly	Tip I.D.	Tip O.D.
1	100T.096	Desoldering Tip	1B	.096	.187
1	100T.078*	Desoldering Tip	1A	.078	.156
1	100T.067	Desoldering Tip		.067	.135
1	100T.059	Desoldering Tip	1C	.059	.125
1	100T.046	Desoldering Tip		.046	.095
1	100T.035	Desoldering Tip	1D	.035	.078

* Standard as Supplied on Iron.

REPLACEABLE TIPS FOR ENDECO MODEL 300

Fig. No.	Part No.	Description	Tip I.D.	Tip O.D.
1	300T.090	Desoldering/Resoldering Tip090	.170
1	300T.078	Desoldering/Resoldering Tip078	.155
1	300T.063	Desoldering/Resoldering Tip063	.135*
1	300CT.063	Industrial Desoldering Tip063	.135
1	300T.059	Desoldering/Resoldering Tip059	.125
1	300T.046	Desoldering/Resoldering Tip046	.095
1	300T.038	Desoldering/Resoldering Tip038	.078

* Standard as Supplied on Iron.

Price Subject to Change Without Notice



Norseman ELECTRONIC TOOLS

STICKLE-BACK DRILSAWS

Made in Germany, this tool will drill holes in wood, plaster board, etc. and saw in any direction.



#0-5 x 5/32" dia.	\$.98 net
#1-7 x 3/16" dia.	1.85 net
#2-10 x 1/4" dia.	2.45 net
#3-13 x 5/16" dia.	2.95 net
#4-15 x 3/8" dia.	3.25 net
#5-13 x 1/2" dia.	(saw rasp) 2.25 net

REVERSIBLE RATCHETS

A rugged ratcheting box wrench. No buttons, no levers — just turn it over to reverse the ratchet.

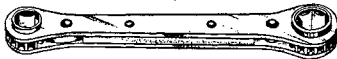

1/4" x 5/16".....	\$2.60 net	5/8" x 11/16".....	\$4.25 net
3/8" x 7/16".....	2.90 net	5/8" x 3/4".....	4.25 net
1/2" x 9/16".....	3.90 net	3/4" x 7/8".....	4.80 net

DRILL ROUTERS

Another "Stickle-back" tool, similar to the Drillsaw, but for use in electric drills.

#318-1 2 3/8" x 1/4" dia.	\$1.40 net
#318-2 4 1/2" x 1/4" dia.	1.60 net



TIPPY STICKS

Flexible alignment tools of tenite II with a non-magnetic stainless steel tip. Permits snaking around obstructions and still turn screws and slugs.

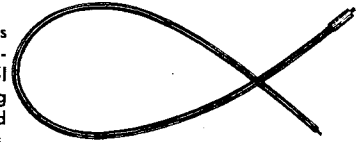

ST-186 6" long40 net
ST-1810 10" long45 net
ST-1814 14" long50 net

TRI-TAPS

The original 3-in-1 tool with 6/32", 8/32" and 10/32" taps to clean or cut three of the most common threads used in electronic work.



T-3	\$2.50 net	T-4 tap only for HT-24.....	\$1.65 net
		HT-24 with replaceable tap.....	\$3.00 net

TOOL POUCHES

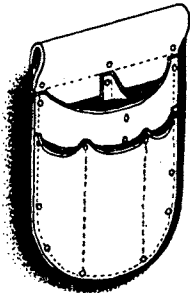

#14 Telephone lineman's pouch of chrome-tanned cowhide. One large separated pocket with three smaller ones in front. Riveted and stitched with linen thread. 6" x 9 1/4"\$4.95 net

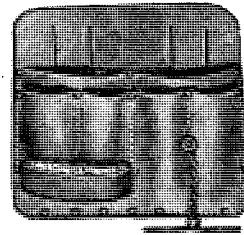

Electrician's Pouch. Bark-tanned top grain cowhide, riveted and stitched with linen thread. 7 pockets, loop for hammer, T-chain for roll of tape #17 10" x 9"\$4.95 net

12 OTHER POUCHES AVAILABLE



MADE IN ESKILSTUNA, SWEDEN, BY E. A. BERG MFG. CO. LTD. • EST. 1880

Only the best Swedish Charcoal Steel is used in the manufacture of Berg Pliers. Produced under exacting standards of control, they embody the most modern techniques of heat treatment and manufacture. Each plier is carefully engineered and designed to afford the greatest practical utility; lightness and ease of operation; and strength coupled with durability.

Special Electronic Diagonal Cutting Pliers with extra thin cutting edges, pointed nose and BOX JOINT

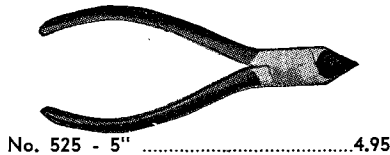

No. 525 - 5"4.95

ANGLE NOSE Diagonal Cutting Pliers

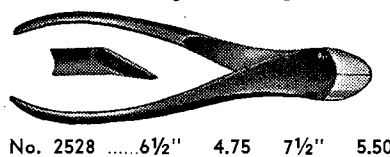

No. 2528 6 1/2" 4.75 7 1/2" 5.50

PIANO WIRE Diagonal Cutting Pliers

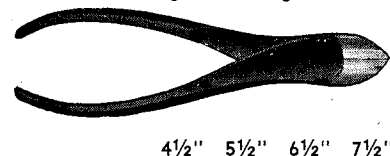

No. 1528 4 1/2" 3.50 5 1/2" 4.25 6 1/2" 4.75 7 1/2" 5.25

PIANO WIRE Side Cutting Nippers with replaceable blades



No. 1518 9" 7.50 10" 8.50
Extra Blades 9" 2.30 10" 2.55

PIANO WIRE End Cutting Nippers with replaceable blades



No. 1519-9"9.50
Extra Blades2.90

PIANO WIRE End Cutting Nippers

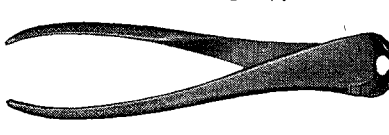

No. 527 - 7"4.25

50 OTHER SIZES AND TYPES AVAILABLE

Straight Cutting Pliers with extended jaws



No. 1529 - 6 1/2"4.50

Special Bent Nose Pliers

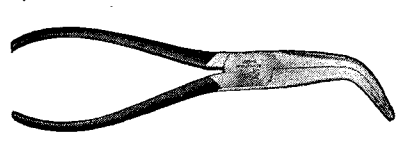

No. 2533-B - 8"5.50

Curved Nose Pliers

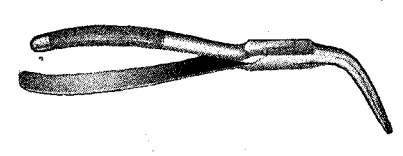

No. 1631 - 5 1/2"4.50

ERIKSON SPECIALIZED TOOL COMPANY



Norseman ELECTRONIC TOOLS

JIGGLE STICKS

Probes of Lucite, 1 end forked for pushing other end pointed for probing, notched on side for pulling wires.

PR 532-6 5/32" dia. .30 net
PR 316-8 3/16" dia. .35 net

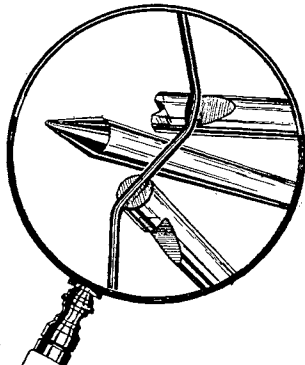

NORSEMAN SOLDERING AID KIT

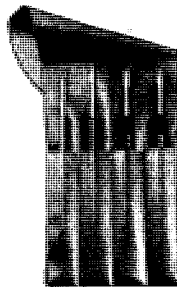

MTSA-4 miniature soldering aid kit with 4 tools M2T, M3T, M4T, M5T in vinyl kit complete \$4.50 net

Vinyl plastic kit, packed with 4 Norseman Soldering Aids (TN-22, TN-33, TN-44, TN-55) as illustrated.

TNSA-4 complete kit \$4.50 net

Kit with 4 Norseman Soldering Aids with unbreakable aluminum handles (AL-22, AL-33, AL-44 & AL-55).

ALSA-4 complete kit \$4.50 net

NORSEMAN SOLDERING AIDS

ERIKSON PICO-CALIF. TN-22

Red Handle

TN-22 Tenite II Handle 7 5/8" Long \$.90 net
M2T Tenite II Handle 5 1/4" Long \$.90 net
AL-22 Aluminum Handle 7 5/8" Long \$.90 net

ERIKSON PICO-CALIF. TN-44

Black Handle

TN-44 Tenite II Handle 7 1/2" Long \$1.05 net
M4T Tenite II Handle 5 1/4" Long \$1.05 net
AL-44 Aluminum Handle 7 1/2" Long \$1.05 net

ERIKSON PICO-CALIF. TN-33

Green Handle

TN-33 Tenite II Handle 7 5/8" Long \$.90 net
M3T Tenite II Handle 5 1/4" Long \$.90 net
AL-33 Aluminum Handle 7 5/8" Long \$.90 net

ERIKSON PICO-CALIF. TN-55

Blue Handle

TN-55 Tenite II Handle 6 3/4" Long \$1.05 net
M5T Tenite II Handle 5 1/4" Long \$1.05 net
AL-55 Aluminum Handle 6 3/4" Long \$1.05 net

PLASTIC HANDLES—(TN-22, TN-33, TN-44, TN-55) (M2T, M3T, M4T, M5T) are of Tenite II, hex and will not roll off the work bench. Shock-proof, practically unbreakable and will stand rough use on industrial production lines.

METAL HANDLES—(AL-22, AL-33, AL-44, AL-55) are aluminum alloy 4" x 3/8" hex and won't roll off the work bench. Being metal, are NOT SHOCK-PROOF and hence not recommended for ordinary radio-TV service work, especially on a 'live' unit. However, these handles are practically unbreakable and were designed to take rough use on industrial assembly lines and can be used as PRY BARS in lining up components.

METAL ENDS—(separated from each other) non-magnetic stainless steel, to which solder won't adhere. Are firmly seated in handles and are twist-proof.

FORKED END—straddles the wire and with a slight twist, grips it for easy unwinding and removal, or guides it into another lug for soldering. Since plastic handles act as insulation, there is no danger of shock when working on sets in operation. 1/8" forks are made especially for use on printed circuits and transistors.

SPADE END—is a reamer to clean lug holes of solder.

CURVED END—can be used as a scribe for marking chassis. As a circuit tracer when looking for loose connections. As a dial cord stringer. Hook can be bent to a 90 degree angle if desired.

KNIFE & SCRAPER—for cutting and repairing printed circuits.

WIRE BRUSH—has approx. 200 bristles of stainless wire .0035 in dia. to which solder will not adhere. For use in cleaning connections before soldering, brushing out splattered solder and in repairing printed circuits.



STAINLESS STEEL WIRE BRUSHES

on steel shaft approximately 2" long overall. Can be used in a regular pin vise. .35 net

Packed 25 or 50 per box

DIDDLE STICKS

Alignment tools —
Lucite 3/32" dia.

LU-53210 10" long ...25 net
LU-53214 14" long ...35 net

Rigid Vinyl 3/16" dia.
RV-31610 10" long.....25 net
RV-31614 14" long.....35 net

Fibre Glass 1/8" dia.
FG-1810 10" long.....35 net
FG-1814 14" long.....50 net
FG-1818 18" long.....65 net

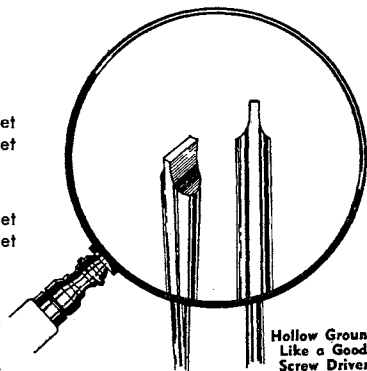

Hollow Ground
Like a Good
Screw Driver

SLAB-HEAD DRIVERS

Drivers for SLAB-HEAD screws as used in Delco auto radios, Zenith & Arvin TV and 1956 models of Webcor recorders.

246-P\$2.00 net

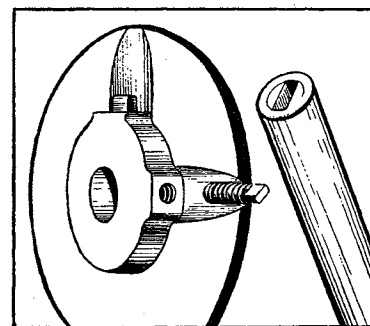

Clutch Head Screw and Driver

ERIKSON SPECIALIZED TOOL COMPANY

SERVICE AIDS



GC 7-PIN MINIATURE TEST SOCKET ADAPTER
Cat. No. 9247 Net 1.65

GC 9-PIN MINIATURE TEST SOCKET ADAPTER
Cat. No. 9249 Net 1.87

GC 8-PIN OCTAL TEST SOCKET ADAPTER
Cat. No. 9248 Net 1.57

GC DUAL TUBE PIN STRAIGHTENER
A handy, miniature pin straightener for 7-pin and 9-pin miniature tubes. Metal inserts on either end of the tool body, each of hardened metal for accuracy and long life.
Cat. No. 9092 Net 3.20

GC HEX-KEY AND SPLINE WRENCH KIT
For both hex and spline type screws. 12 wrenches in leatherette case.
Cat. No. 5028 GC 550 Walsco Net 1.35

GC NE-O-LITE
Electrical circuit tester... easy to use with a Neon Glow Lamp which varies in light intensity according to voltages. Traces all types of trouble, such as grounded lines, open circuits, short circuits, etc.
Cat. No. 5100 Net .50

GC MINIATURE TUBE PIN STRAIGHTENER
Precision-constructed steel die, for straightening pins on fragile miniature tubes of the 1S5, 6AK5, 9002 variety.
For 7-pin Min. Tubes (red base) Cat. No. 5191 Net 1.00
For 9-pin Jumbo Tubes (blue base) Cat. No. 8105 Net 1.00

GC "QUICK-RIG" RADIO-PHONO CHASSIS REPAIR CRADLE
Complete 360 degree rotation to lock chassis at best working angle. Clamps security, makeshift setups, all metal.
Cat. No. 5212 Net 7.50

GC TUBE & PARTS EXTRACTOR
Originally designed by the U.S. Signal Corps. as standard equipment. Skillfully constructed of spring steel, cadmium plated. Has rubber cushion on the prongs.
Cat. No. 5092 Net .98

GC TV "HIGH-VOLT" SAFETY PROBE & TESTER
Handy tester for quickly checking TV high voltage circuits. Tester will glow when high voltage is okay.
Cat. No. 8836 Net 2.13

GC NO-JOLT TOOL GRIPS
Modernizes old tools with new safety-grip handles. Grease and oil resistant.
Cat. No. 5647 GC Small (1 pair) Net .23
Cat. No. 521 Walsco
Cat. No. 5648 GC Med. (1 pair) Net .27
Cat. No. 522 Walsco
Cat. No. 5649 GC Large (1 pair) Net .33
Cat. No. 523 Walsco

GC POCKET HEX KEY WRENCH SET
7 popular size wrenches. .050 to 3/16" fitted in a steel case-like pocket knife blades.
Cat. No. 9124 GC 564 Walsco Net 1.83

GC SPEEDX FUSE PULLERS
Inexpensive... non-slip, fuse puller. Safe and handy for cartridge fuses.
Cat. No. 5525 Midsize size for fuses 1/4" to 1/2" diameter Net .60
Cat. No. 5526 Pocket size for fuses 1/2" to 1-1/2" dia. Voltages to 200 amps at 250 volts and 100 amps at 600 volts.

GC AMO MINIATURE TUBE PULLER
AMO makes it possible to easily remove or insert miniature tubes such as 6AG5, 50B5, etc. It works on the suction and vacuum principle.
Cat. No. 5093 For 7-pin tubes Net 2.50
Cat. No. 8106 For 9-pin tubes Net 2.50

GC HANDY PICK-UP TOOL
One of the handiest tools you can have in your home, shop, office or farm. Tool is 15 inches long.
Cat. No. 5089 GC 2563 Walsco Net 1.15

GC TWEEZERS
Self-closing tweezers opens when squeezed; blunt points.
Cat. No. 7946 GC 570 Walsco Net .99
6 1/2" heavy duty type, with slide lock feature; blunt points.
Cat. No. 7947 GC 571 Walsco Net 1.10
4 1/2" tweezers, narrow pointed ends for delicate work.
Cat. No. 7948 GC 572 Walsco Net .75

GC PHONO TURNTABLE STAND
Stand raises the turntable about 15" above the bench for repairs. Easily adjusted to all sizes and types of phono turntables. Sturdily made of steel.
Cat. No. 5205 Net 4.95

GC DUPLEX TUBE PIN STRAIGHTENER
The handiest tube pin straightener for both miniature and jumbo miniature tubes of the 7- and 9-pin types.
Cat. No. 8655 Net 2.00

GC TWEEZER KIT
For the shop or laboratory to pick up and examine small parts, start screws and nuts, etc.
Cat. No. 7950 GC 575 Walsco Net 2.84

COLOR TV SERVICE MIRROR
High quality polished glass mirror in metal frame, nickel plated. 10" x 12". Complete with adjustable, collapsible stand for easy storage.
Cat. No. 8390 Net 5.91

COLOR TV SERVICE AIDS

RCA COLOR TV HARNESSSES & SOCKETS FOR SERVICE & REPLACEMENT

Part No.	Description	Net
9436	ADAPTER SOCKET Converts 23" & 25" CRT Base to 21" type for use with current test equipment. RCA No. 937848; Admiral No. BP196.	3.50
9437	UNIVERSAL KINESCOPE SOCKET EXTENSION CABLE —fits all 21", 23" and 25" round and rectangular CRT. 48" leads. RCA No. 13B111 and 937846; Admiral No. BP191.	7.50
9438	KINESCOPE EXTENSION SOCKET 48" leads—converts a 23" or 25" CRT base to 21" type for use with current test equipment. RCA No. 13B111 and 937847; Admiral No. BP190.	8.95
9439	KINESCOPE SOCKET EXTENSION CABLE . For all 21AXP or equivalent round picture tubes. Extends kinescope socket cable for chassis removal when servicing, or use with color test tube jig, Admiral No. BP192.	4.95
9441	REPLACEMENT SOCKET & LEADS For 21" color tubes—24" leads.	2.25
9443	REPLACEMENT SOCKET & LEADS For 23" and 25" color tubes—24" leads.	2.25
9447	DEFLECTION YOKE EXTENSION CABLE . For 21" color tubes—48" leads. Use with all 21AXP22 or equivalent tubes. Extends yoke cable for servicing chassis without removing picture tube.	4.85
9448	DEFLECTION YOKE EXTENSION CABLE . 48" leads extend yoke cable when chassis is removed for servicing. For 23" or 25" picture tubes. Male octal plug one end, push-on connectors on other end for connecting to deflection yoke, or test jig.	1.95
9453	ANODE EXTENSION High voltage extension cable with 48" leads for use when TV chassis is removed from set for servicing.	1.95
9445	CONVERGENCE MAGNET DEFLECTION YOKE EXTENSION . For RCA, Admiral, Motorola, Zenith. Extension leads for chassis removal without removing picture tube. For RCA CTC7 to CTC15 chassis. Deflection yoke extension for RCA 600 & 700 series.	4.95

7" DEGAUSSING COIL IN-THE-HOME MODEL
For the home or serviceman. Molded of hi-impact plastic with momentary push-button switch, this coil will easily fit into tube caddy or will hang on the back of TV set. Low cost...easy resale to TV set owner.
Cat. No. 2592 Net 5.95



GC DEGAUSSING COIL PROFESSIONAL MODEL
Eliminates stray magnetic fields in color TV sets as required prior to purity adjustment. Durable, molded hi-impact case. Supplied with 9' cord, momentary push-button switch which permits de-energizing of coil without pulling plug. Safe, easy to use; will last a lifetime.
Cat. No. 9317 Net 19.95

GC SERVICE AIDS

SLAB TYPE CLUTCH-HEAD SCREWDRIVERS
The only tools for servicing the Admiral Tilt-Out Tuner TV sets. Two sizes are available. A must for working on Color TV sets.
Cat. No. 12-015 for No. 6 clutch-head screws Net 1.95
Cat. No. 12-016 for No. 8 clutch-head screws Net 1.95

GC TV 3-WAY ANTENNA KLIP
Buy them by the bag and have clips ready to sell and ready to install on TV sets.
Cat. No. 9015-X bag of 10 Net 1.63

"QUICK SNAP" ANTENNA CLIP
New side clip allows fast connecting with antenna lines; ideal for the service bench. Accepts A-N-P. Pin, and flat terminal type lines.
Cat. No. 9030 bag of 2 clips Net .49

GC TUBE PIN STRAIGHTENER
Plastic 6" ruler tube pin straightener for Compactions, large 7-pin, 9 and 10 pin, and 7-pin tubes. Drilled holes for bench mounting.
Cat. No. 9135 Net .59

WALSCO SPECIAL TOOLS

PROTECTO TUBE
Insulate the handles of your pliers, wire cutters, screwdriver shanks neatly and effectively with Walsco Protecto Tube.
Cat. No. 18K Net 1.20

GC 3-STEP TAP
Three-in-1 tool for tapping or rethreading holes. 3 most popular tap sizes: 6/32, 8/32 and 10/32. Heavy plastic handle.
Cat. No. 8871 G.C. 2574 Walsco Net 3.75

REACH-ALL PEN OILER
Precision instrument oiler. Features extending and retracting tube. Disposes a drop or fraction of a drop of high quality oil.
Cat. No. 984 Net .99

WRITE FOR CATALOG #FR-69 FOR COMPLETE LISTINGS



ALIGNMENT TOOLS & Service Aids

REAMER AND SCRAPER TIP

Twist-proof, chrome plated steel to shed solder. Printed circuit type solder aid tool with straight tip. Reamer and scraper tips for scraping joints or reaming out lug holes. Both ends are insulated from one another.

No. **9069** Reamer and Scraper.....**12** Std. Pkg. **.85** Net



SPEEDEX AUTOMATIC WIRE STRIPPER

Equipped with "Trig-O-Matic" Stay-Open feature; keeps wires from being crushed.

No. For Sizes Listed Below
 744-12 to 20 Wire
 744-A 14 to 30 Wire
 744-B 10 to 18 Wire
 744-C 8 to 10 Wire
 744-D 15, 18, 20, 22 Wires
 744-E 14, 16, 18 Wires
 744-F 10, 12, 14 Wires
 744-G For No. 18 POSJ or Parallel Wire
 744-H For 300 ohm TV and FM twin transmission line
 744-I 10, 12, 14, 16, 18, 20, 22 Wire
 744-M 10 to 20 Wire
 744-N Straight Cutter Blades
 Cat. No. 744.....Net **\$5.93**



SPEEDEX STANDARD WIRE STRIPPER

Popular inexpensive Speedex model for 90% of all stripping jobs. Blades are inter-changeable, hardened and precision ground to razor sharp edges.

No. For Sizes Listed Below
 733-12 to 20 Wire
 733-A 14 to 30 Wire
 733-B 10 to 18 Wire
 733-C 8 to 10 Wire
 733-D 16, 18, 20, 22 Wires
 733-E 14, 16, 18 Wires
 733-F 10, 12, 14 Wires
 733-G For No. 18 POSJ or Parallel Wire
 733-H For 300 ohm TV and FM twin transmission line
 733-I 10, 12, 14, 16, 18, 20, 22 Wire
 733-M 10 to 20 Wire
 733-N Straight Cutter Blades
 Cat. No. 733.....Net **\$4.77**

BRUSH AND FORKED TIP

Chrome plated steel to shed solder. Printed circuit type solder aid tool with brush on one end, forked tip on the other. Forked tip is for twisting or holding wires. Both ends are insulated from one another.

No. **9073** Brush and Forked Tip.....**12** Std. Pkg. **.92** Net

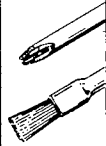

BRUSH AND SCRAPER TIP

Printed Circuit type solder aid with brush on one end for dusting away excess solder chips, and scraper tip for scraping joints. Both ends are insulated from one another.

No. **9074** Brush and Scraper Tip.....**12** Std. Pkg. **.92** Net



STRAIGHT PROBE AND FORKED TIP

Prevents solder from sticking. A must for the serviceman's bench or tool kit. Made from heat-treated tool steel, nickel plated to eliminate solder from sticking. Forked tip on one end, straight probe on the other.

GC No. **9075** Walsco **2570** Forked and Straight Tip.....**12** Std. Pkg. **.80** Net



ANGLE PROBE AND FORKED TIP

Nickel plated tool steel prevents solder from sticking to tool. Forked tip on one end for twisting or holding wires, angled probe on the other end.

GC No. **9076** Walsco **2571** Forked and Angled Tip.....**12** Std. Pkg. **.80** Net



SPEEDEX SPEED-O-MATIC WIRE STRIPPER

Fully automatic delayed return action to prevent crushing fine wires. The Speed-O-Matic combines the features of all Speedex Wire Strippers.

No. For Sizes Listed Below
 765-12 to 20 Wire
 766-A 14 to 30 Wire
 766-B 10 to 18 Wire
 766-C 8 to 10 Wire
 766-D 16, 18, 20, 22 Wire
 766-E 14, 16, 18 Wire
 766-F 10, 12, 14 Wire
 766-G For No. 18 POSJ or Parallel Wire
 766-H For 300 ohm TV and FM twin transmission line
 766-I 10, 12, 14, 16, 18, 20, 22 Wire
 766-M 10 to 20 Wire
 766-N Straight Cutter Blades
 Cat. No. 766.....Net **\$5.93**



G-C TV CHASSIS SUPPORT

Prop chassis to easy working position on your bench or in the home. Simply slip on the flange of chassis, tighten thumb screws and tilt chassis to position desired.

Cat. No. 9176 Pair.....Net **\$1.80**



SPEEDEX WIRE STRIPPER KITS

Complete with Wire Strippers and seven different size blades in plastic box. Handy for tool box, home workshop, maintenance and production.

Cat. No. 733-K...Standard Stripper Kit...Net **\$10.83**
 744-K...Automatic Stripper Kit...Net **\$13.16**
 766-K...Speed-O-Matic Stripper Kit...Net **\$13.16**

CHASSIS PUNCHES

DESCRIPTION	PART NO.	GREENLEE PART NO.	PUNCH SIZE	PILOT BOLT SIZE	PILOT HOLE DRILL SIZE	NET EACH	
ROUND PUNCHES	3050-R	730 1/2	1/2"	1/4"	5/16"	2.70	
	3052-R	730 9/16	9/16"	1/4"	5/16"	2.70	
	3062-R	730 5/8	5/8"	1/4"	3/8"	2.70	
	3069-R	730 11/16	11/16"	3/8"	7/16"	2.70	
	3075-R	730 3/4	3/4"	3/8"	7/16"	2.70	
	3081-R	730 13/16	13/16"	3/8"	7/16"	2.70	
	3087-R	730 7/8	7/8"	3/8"	7/16"	2.70	
	3094-R	730 15/16	15/16"	3/8"	7/16"	3.00	
	3100-R	730 1"	1"	3/8"	7/16"	3.00	
	3106-R	730 1-1/16	1-1/16"	3/8"	7/16"	3.15	
	3112-R	730 1-1/8	1-1/8"	3/8"	7/16"	3.15	
	3116-R	730 1-5/32	1-5/32"	3/8"	7/16"	3.15	
	3119-R	730 1-3/16	1-3/16"	3/8"	7/16"	3.15	
	3125-R	730 1-1/4	1-1/4"	3/8"	7/16"	3.15	
	3131-R	730 1-5/16	1-5/16"	3/8"	7/16"	3.75	
	3137-R	730 1-3/8	1-3/8"	1/2"	9/16"	3.75	
	3150-R	730 1-1/2	1-1/2"	1/2"	9/16"	4.25	
	3162-R	730 1-5/8	1-5/8"	3/4"	7/8"	5.10	
	3175-R	730 1-3/4	1-3/4"	3/4"	7/8"	5.85	
	3187-R	730 1-7/8	1-7/8"	3/4"	7/8"	7.30	
	3200-R	730 2"	2"	3/4"	7/8"	7.80	
	3212-R	730 2-1/8	2-1/8"	3/4"	7/8"	8.45	
	3225-R	730 2-1/4	2-1/4"	3/4"	7/8"	8.45	
	3250-R	730 2-1/2	2-1/2"	3/4"	7/8"	13.75	
	3275-R	730 2-3/4	2-3/4"	3/4"	7/8"	19.00	
	3300-R	730 3"	3"	3/4"	7/8"	26.50	
	SQUARE PUNCHES	3050-S	731 1/2	1/2"	1/4"	3/8"	6.45
		3062-S	731 5/8	5/8"	3/8"	1/2"	6.35
		3075-S	731 3/4	3/4"	3/8"	1/2"	7.10
		3087-S	731 7/8	7/8"	3/8"	1/2"	8.30
		3100-S	731 1"	1"	3/8"	1/2"	8.60
	METER HOLE PUNCHES (Round) For Standard Meters	3278	730 M	2-25/32"	3/4"	7/8"	13.10

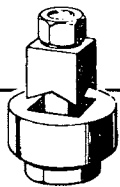
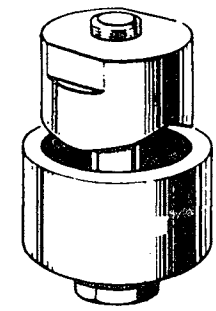

SQUARE PUNCHES

METER HOLE PUNCHES (Round) For Standard Meters



WRITE FOR CATALOG #FR-69 FOR COMPLETE LISTINGS



GC ALIGNMENT TOOLS & Service Aids



(D) WALSCO STRIP-ER-CLIP. A brand new precision tool with an exclusive safeguard that prevents accidental nicking or cutting while wires are being stripped. Strips and clips all wires ranging from 12 to 26 gauge.
Cat. No. 595X Walsco Net \$1.38
760 G.C.

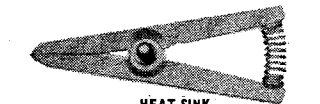

HEAT SINK
Protects Transistors and Diodes when Soldering, firm grip. Aluminum will not stick to solder.
Cat. No. 9077 GC Net \$.36
2577 Walsco

ALIGNMENT TOOL FOR WESTINGHOUSE, ETC.
Especially designed to fit Westinghouse and other sets. Very thin tip for small can openings.
Cat. No. 2541 Net \$.57

1/4" HEX I.D. NEUTRALIZING WRENCH.
Made of tough, flexible, Lo-loss plastic. If corners wear round, just trim back, 7-1/2" long, 3/8" round O.D.
Cat. No. 2503 Net \$.37

CAPACITOR AND TUNER ADJUSTING TOOL
For trimmer capacitors, sealed capacitors, and miniature L. C. Tuners. White Delrin with .050" hex head one end and screwdriver tip on the other end. Overall length 5-1/8".
Cat. No. 8605 Net \$.63

MASTER DELUXE TOOL KIT
A super-deluxe kit in a leatherette roll type case. Contains 25 tools and includes all TV alignment tools except extra long ones (over 9").
Cat. No. 8283 Net 15.83

G-C ALIGNMENT SCREWDRIVER
Low inductance metal tip screwdriver made of Butyrate material.
5000 GC 1/4" Dia. x 6" Tool. . . . Net \$.42
2525 Walsco

COLOR TV ALIGNMENT TOOL KIT
Kit contains 5 different Hex alignment tools for all standard adjustments in Color TV. Tools packed in pocket sizer and includes extender to make each tool a long reach aligner when needed.
Pat. No. 8454 Net \$2.49

NEW "SLIM FIBREGLASS STICKS." New precision made Walsco Slim-Sticks are made of durable fiberglass. Completely non-metallic.
Cat. No. 2531-X Walsco 1/8" Dia. x 12 Net \$.53
8728 G.C. 1/8" Dia. x 12 Net .70
2532-X Walsco 1/8" Dia. x 16 Net .48
8729 G.C. 1/8" Dia. x 16 Net .48
2534-X Walsco 5/32" Dia. x 12 Net .48
9293 G.C. 5/32" Dia. x 12 Net .48
2535-X 5/32" Dia. x 16" Long Net .72

WALSCO "GLAS-STICKS." Precision made machined fiberglass reinforced polyester alignment screwdriver.
Cat. No. 2537 Walsco 5/32" Dia., 7" blade Net \$.85
9291 G.C. Net 1.15
2538 Walsco 5/32" Dia., 14" blade Net 1.15

G-C ZENITH-ADMIRAL NYLON HEX WRENCH
New nylon hex wrench alignment tool for Zenith, Admiral and other sets.
Cat. No. 8606 5" wrench, 11" long. .Net \$.48
Cat. No. 8606-L 11" wrench, 11" long.63

(N) I.F. ALIGNER TOOL. Designed for I.F. Alignment of Zenith, RCA and other similar types. Made of molded plastic 5-1/2" long.
Cat. No. 2521 Net \$.53

GC MAGNAVOX TUNING TOOL
Head for Magnavox chassis Nos. 201 and 202 and other sets. Hex wrench on both ends, one end undercut so it will reach bottom slugs in iron coils.
Cat. No. 8284 Net \$.48

G-C TV CHANNEL TUNING TOOL
Completely insulated, non-metallic tool with long 1/8" narrow blade. Made of bone fibre.
Cat. No. 8195 7-1/4" long, 1/8" shaft dia. Net \$.72

G-C TV AND FM TUNING TOOL
Special short tool with fine recessed screwdriver top for Television and FM adjustments. Made of Butyrate
Cat. No. 8196 Net \$.42
2-1/2" long, 7/32" shaft dia.

G-C TV CORE ALIGNER
For Motorola and other sets using Stackpole or other stud type cores that are not slotted. Milled steel insert on one end, thin screwdriver blade on other end.
Cat. No. 8271 16" long, 7/32" shaft dia. Net \$.60

G-C TV I.F. OSCILLATOR ALIGNER
Specially made for I.F. and oscillator adjustments. Will fit all makes of sets—R.C.A., G.E., Philco, Admiral and others.
Cat. No. 8272 GC 6-1/2" long, 1/4" tip dia. Net \$1.20
2518 Walsco

G-C TV ALL-PURPOSE ALIGNER
Specially made for TV I.F. adjustments. Very thin spring steel tip is recessed so the tool will guide itself over the screws.
Cat. No. 8273 GC 8" long, 7/32" shaft dia. Net \$.92
2516 Walsco

G-C TV LONG REACH ALIGNER
Specially made for Admiral, Zenith, R.C.A. and other sets for adjustments of nested iron cores that are hard to reach.
Cat. No. 8274 9" long, 1/8" shaft dia. . . Net \$.90

G-C TV ZENITH UNIVERSAL ALIGNER
Specially designed for Zenith and other sets. Made of bone fibre and plastic handle.
Cat. No. 8275 5" long, 1/8" shaft dia. 1/4" Net \$.52

G-C TV DUPLEX ALIGNER
An all-purpose TV aligner for trimmers and I.F. transformers. Made of Butyrate material with extra thin spring steel tips.
Cat. No. 8276 6" long, 7/32" shaft dia. Net \$.52

G-C TV "SHORTY" DUPLEX ALIGNER
Specially made for trimmer and I.F. transformers where space does not permit the use of a longer tool.
Cat. No. 8277 2-1/2" long, 7/32" shaft dia. Net \$.52

G-C TV TUNING WAND
Brass insert on end reduces inductance and iron core on other end increases the inductance.
Cat. No. 8278 6" long, 7/32" shaft dia. Net \$.60

G-C TV CORE ALIGNER
Tool has a recessed steel milled slot to fit over the Stackpole and other type stud cores that are not slotted.
Cat. No. 8279 Net \$1.00
7-1/2" long, 7/32" shaft dia.

G-C "SHORTY" TV ALIGNMENT SCREW DRIVER
Only 2" long overall to adjust hard-to-get-at places under TV tubs, etc.
Cat. No. 8289 2" long, 7/32" shaft dia. Net \$.60

G-C UNIVERSAL SCREW DRIVER ALIGNER
Made of unbreakable flexible clear plastic shaft and an amber plastic handle.
Cat. No. 8290 7" long, 7/32" shaft dia. Net \$.70

G-C NEW ALL PLASTIC INSPECTION MIRROR
Use to inspect coils, resistors, sockets, etc. while the chassis is hot. No danger of shorting.
Cat. No. 5090-P 7-7/8" Plastic Mirror. . . Net \$.38

G-C K-TRAN TOOL
Specially designed for K-tran and I.F. transformers. Butyrate material, screwdriver on both ends.
Cat. No. 5097 Net \$.78
6" long, 5/32" Delrin tip, 1/8" metal tip

G-C SHORTY ALIGNMENT TOOL
A convenient tool for hard-to-get-at places. Has 3/16" shaft, 2" length. Over 3/16" shaft, 2" length. Overall length of tool 4".
Cat. No. 9296 Net \$.48

GC ALIGNMENT TOOLS ● GC ALIGNMENT TOOLS ● GC ALIGNMENT TOOLS

G-C NEW NYLON TV LONG REACH ALIGNER
Long-reach TV aligner with insulated metal shaft and nylon tip. 12-1/4" long overall, .395 Shaft Dia.
Cat. No. 8607 GC TV Tool Net \$1.60
2523 Walsco

G-C CONTACT BURNISHING TOOL KIT
A complete kit for the servicing of relays, switches, etc. where critical contact points must be kept clean.
Cat. No. 9339 Net \$.95

G-C TV 2-IN-1 LONG-REACH DUPLEX ALIGNER
Made of clear, unbreakable plastic material. Ends colored red and blue for size identification. Tips are made of spring steel recessed for easy location of stud.
Cat. No. 8721 9" long, 7/32" Shaft Dia. Net \$.78
8722 7" long, 7/32" Shaft Dia. Net \$.67
Walsco 8721 9" long, 7/32" Shaft Dia. Net \$.78
8722 7" long, 7/32" Shaft Dia. Net \$.67

DELUXE ALIGNMENT TOOL KIT
Case is made of durable leatherette for long service. Steel tips are extra thin and of the best grade hardened spring steel. Kit contains one each of 16 tools.
Cat. No. 8280 Net 10.30

NEW G-C K-TRAN TELEVISION ALIGNER
Specially made for K-Tran I.F. Transformer tuner slugs. Precision made of bone fibre.
Cat. No. 8727 6-1/4" long, 5/32" Tip Dia. Net \$.65

TV LONG REACH ALIGNMENT SCREWDRIVER
Made of bone fibre, extra thin 1/8" diameter screw drivers for adjustment of TV receivers. Screw driver tip on both ends—can be re-ground.
Cat. No. 8728A 1/8" x 7" long Net \$.43
8728 1/8" x 12" long53
8729 1/8" x 16" long70

G-C LONG ARM TV TOOL PLASTIC SHAFT
Extra-long-reach alignment tool for Zenith sets and others where adjustments are hard to get at. Tool is 18" long overall, 18" long, 7/32" Shaft Diameter.
Cat. No. 8821 TV Tool (Type A) Net \$1.00
8896 TV Tool (Type B) 1.00
8897 TV Tool (Type C) 1.00

ZENITH-RCA ALIGNING TOOL WITH HANDLE
For better grip and easier adjustments. Length is 2-1/2" with a 1-1/2" shaft length, 7/32" diameter blade with recessed slot in blade end.
Cat. No. 9051 GC Net \$.58
2527 Walsco

G-C STANDARD COIL SLUG TUNER ADJUSTING TOOL
A new special slug tuning tool for adjusting Standard Tuners, etc. Completely insulated. 7-1/2" long, 1/4" shaft diameter. shaft ends .170 diameter.
Cat. No. 9087 Net \$.75

K-TRAN ALIGNMENT TOOL. This tough, double-use tool is machined at one end to fit the slots on all K-Tran miniature I.F. transformers.
Cat. No. 2515 Net \$.60

G-C ADJUSTABLE SHORTY
Recessed tip TV alignment tool. Adjustable from 1-1/4" to 2" in length, for hard-to-get-at places.
Cat. No. 9090 Net \$.65

G-C DOUBLE END IRON CORE TOOL
All nylon hex tool for cores with .125 hex opening. One end of tool undercut so it can reach the bottom slug in coils without turning the top slug.
Cat. No. 9091 GC 5" long. . . . Net \$.48
Walsco 2542
9091-L GC 11" long. . . . Net .70

G-C PRINT KOTE SOLDER AID PROBE
Handy, fine point probe specially designed to aid in probing and soldering printed circuits.
Cat. No. 9093 GC 8" Length Net \$1.00
2530 Walsco

STUBBY STD DRIVER. The only screwdriver only 2" long overall. Fits No. 6 studs.
Cat. No. 2517 Net \$.60

G-C PRINT KOTE BRUSH AND SCRAPER
Fine Stainless Steel brush and hardened steel scraper are required to scrape and clean the Silicone Resin from printed circuits.
Cat. No. 9094 8" Length Net \$.98

G-C SLUG RETRIEVER TOOL
A precision made tool with hardened steel tips made for removing lost TV tuner slugs in Standard Coil tuners. Ends ground to fit standard coils.
Cat. No. 9096 12" Retriever Net \$2.70
9097 15" Retriever 3.25

G-C MINI HOLD SCREWDRIVERS
Designed with exclusive "Wedge Action" for gripping of tiny screws. (Nos. 0, 1, 2, 3 and No. 8 set screws and smaller) Special short length (2-7/8" when in use).
Cat. No. 9346 GC 3-1/4" long, 2-7/8" in use Net \$2.14
2558 Walsco
9347 GC 7" long, 6-3/4" in use 2.40
2559 Walsco

G-C RCA TV ALIGNMENT TOOL
Double end nylon tool with a recessed metal tip on one end and a plastic slot on the other end.
Cat. No. 9150 6" Length Net \$.83

G-C SCREW STARTER SCREW DRIVER
A handy screw holding screwdriver that will start screws in hard-to-get-at places. Holds the screw securely while it starts it.
Cat. No. 9148 12" Net \$2.75

G-C QUAL NUT STARTER
New tool that holds and starts hex nuts or hex head screws in hard-to-get-at places. Fits 1/4" and 5/16" hex nuts. Pat. 2664021.
Cat. No. 9147 Net \$2.85

(F) "SLUG SAVER" TUNER TOOL. New patented tool for aligning "Standard Coil" front ends. Prevents "loosing" slugs, thru ingenious "step" design.
Cat. No. 2528 7-1/2" long Net \$.75

G-C TV AND AUTO RADIO WRENCH
Special female slotted wrench to remove screws and stud screws from auto radios and backs of TV sets, etc.
Cat. No. 9211 Net \$1.20

G-C FIBREGLASS SCREWDRIVER
Gives full protection on hot chassis when adjusting high potentials. For close-up hard-to-reach places.
Cat. No. 9291 7" Net \$.85

G-C NYLON HEX TOOLS
For adjusting iron cores inside mounted chassis, and tuner adjustment of iron and brass slugs with hex heads. Has .100" hex and 5/32" handle.
Cat. No. 9295 GC 11" x .100" Hex. . . . Net \$.63
2544 Walsco
9296 GC 11" x .075" Hex.63
2545 Walsco
9297 GC 11" x .075" Hex.63
2547 Walsco

WRITE FOR CATALOG #FR-69 FOR COMPLETE LISTINGS



GREENLEE TOOL CO
DIVISION OF GREENLEE BROS & CO

CHASSIS PUNCHES

ROUND, SQUARE, "KEY," AND "D" TYPES



NO. 730 ROUND PUNCH

Swiftly cuts clean, accurate holes in radio chassis for sockets, switches, controls and other equipment. Operates simply with an ordinary wrench for drive power . . . just insert in a small drilled hole and turn drive screw. No reaming or filing . . . hole is smooth, perfect. 29 sizes from 1/2" to 3 1/8" diameter. New Ball-Bearing Drive available for even easier, speedier operation.



NO. 731 SQUARE PUNCH

Cuts square or oblong openings as desired. Available in five sizes for making 1/2", 5/8", 3/4", 7/8", and 1" square holes. Drive screw fits into 1/2" hole, which can be drilled or made with 1/2" No. 730 GREENLEE Round Punch. Operates with an ordinary wrench for drive power. Individually packed.



NO. 731-R KHP RELAY PUNCH

Makes clean, accurate, *finished* holes in up to 16-gauge metal for Potter & Brumfield KHP miniature relay sockets. Makes 1.015" x .859" hole.



NO. 732 "KEY" PUNCH

Quickly, easily cuts holes for keyed radio sockets. Operates on same principle as other GREENLEE Radio Chassis Punches . . . an ordinary wrench supplies the drive power. In five sizes to make openings of 1 1/32", 1 1/16", 1 1/8", 1 1/4", 1 1/2". Drive screw fits into 1/2" hole. Individually packed.



NO. 733 "D" PUNCH

Simplifies and speeds the work of making "D"-shaped openings for high-frequency, miniature tube sockets and other equipment using this type opening. Available in 1/2" and 3/8" sizes. Operates on same principle as other GREENLEE Radio Chassis Punches with an ordinary wrench supplying the drive power. Drive screw fits into 3/8" drilled hole. Individually packed.



NO. 734 DOUBLE "D" PUNCH

Quickly makes standard electrical receptacle openings. Cuts standard hole 1 1/8" dia. across parallel sides, 1 3/8" dia. across rounded ends. Simply insert into a 1/2" hole and turn with an ordinary wrench. Does the work in less than five minutes . . . eliminates all tedious hand filing . . . gives a smooth, perfect opening.



No. 730 ROUND PUNCH

Size	Net User Price	Size	Net User Price
1/2"	\$2.70	1 3/4"	\$5.85
9/16"	2.70	1 7/8"	7.30
5/8"	2.70	2"	7.80
1 1/16"	2.70	2 1/8"	8.45
3/4"	2.70	2 1/4"	8.45
13/16"	2.70	2 1/2"	13.75
7/8"	2.70	2 3/4"	19.00
1 5/16"	3.00	2 5/8"	13.10
1"	3.00	3"	26.50
1 1/16"	3.15	3 1/8"	28.75
1 1/8"	3.15	Following sizes also available with larger drive screw for cutting thicker metals (No. 730X)	
1 5/32"	3.15	1 1/8"	6.40
1 3/16"	3.15	1 3/16"	6.40
1 7/32"	5.75	1 1/4"	6.40
1 1/4"	3.15	1 3/8"	7.35
1 5/16"	3.75	1 1/2"	8.30
1 3/8"	3.75		
1 1/2"	4.25		
1 5/8"	5.10		

No. 731 SQUARE PUNCH

Size	Net User Price	Size	Net User Price
1/2"	\$6.45	7/8"	\$8.30
5/8"	6.35	1"	8.60
3/4"	7.10		

No. 731-R KHP RELAY PUNCH

Size	Net User Price
1.018" x .861"	\$14.30

No. 731-R KU & KUP RELAY PUNCH

Size	Net User Price
1 1/4" x 1 3/8"	\$19.00

No. 732 "KEY" PUNCH

Size	Net User Price	Size	Net User Price
1 5/32"	\$6.00	1 1/4"	\$7.60
1 1/16"	6.10	1 1/2"	8.50
1 1/8"	6.80		

No. 733 "D" PUNCH

Size	Net User Price	Size	Net User Price
1/2"	\$4.90	3/8"	\$5.25

No. 734 DOUBLE "D" PUNCH

Size	Net User Price
1 1/8" x 1 3/8"	\$28.00



SOLDERING IRONS





6 to 230 VOLTS 12 to 140 WATTS

A complete line of high quality soldering irons specifically designed for production-line soldering in the electronic, instrument, and communications industries—including irons for soldering miniature and subminiature components. Also ideally suited for intermittent operations such as repair, maintenance, laboratory work, and electronic kit construction. Irons up to 1250 watts are available.

PENLINE-120 SOLDERING IRONS — 120 VOLTS; 25, 30, 40 AND 45 WATTS — UL LISTED

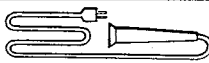
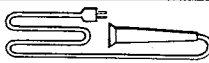
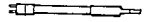
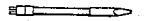
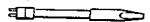

Lowest cost GE iron; ideally suited for light to medium production in electronics, communications, and allied industries, for repair and maintenance operations, and by the "do-it-yourself" electronics kit builder.







Description	Cat. No.
Handle and 6-foot Cordset	
 Two-conductor	6D400
 Three-conductor, with NEMA standard plug	6D400G2
Tip and Heater Units — Ironclad	
 1/8" Chisel Tip 30 watts	6D410
 5/32" Chisel Tip 30 watts	6D411
 3/32" Chisel Tip 45 watts	6D412
Heater for Threaded Tips	
 25 watts	6D415
 30 watts	6D414
 40 watts	6D413

Use interchangeable threaded tips listed on next page.

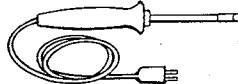
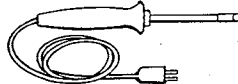
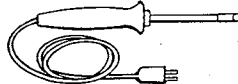
LIGHTWEIGHT SOLDERING IRONS — 120 VOLTS; 40 AND 60 WATTS — UL LISTED

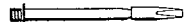

Ideal for light and medium production-line soldering and maintenance and repair operations in electronics and communications industries. Tip and heater units can be changed in seconds.

Complete Iron — Includes handle and 6-foot cordset, and tip and heater unit	
 3/32" Ironclad Chisel Tip	6A273
 3/16" Ironclad Pyramid Tip	6A283
 3/16" Ironclad Chisel Tip	6A283G23
Handle and 6-foot Cordset	
 Two-conductor	6A273G62
 Three-conductor with NEMA standard plug	6A273G63
Tip and Heater Units	
 3/32" Ironclad Chisel Tip	6A300
 3/16" Ironclad Pyramid Tip	6A301
 3/16" Ironclad Chisel Tip	6A301G4
Heater Units for Threaded Tips	
 40 watts	6A304
 60 watts	6A301G7

Use interchangeable threaded tips listed on next page.

PISTOL-GRIP SOLDERING IRONS — 120 VOLTS; 40 AND 60 WATTS

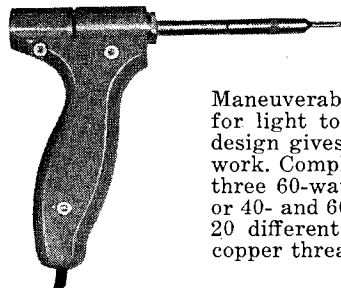

Maneuverable and comfortable, excellent for light to medium production. Unique design gives operator a clear view of the work. Complete versatility with choice of three 60-watt tip and heater assemblies; or 40- and 60-watt heater assemblies with 20 different interchangeable ironclad or copper threaded tips.

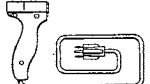

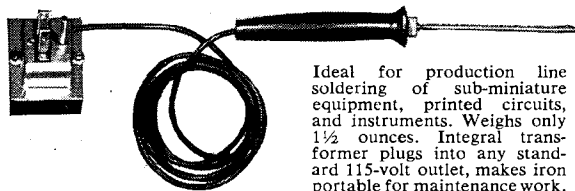

Description	Cat. No.
 Handle and cordset, three-wire with NEMA plug	6A303

Can be used with Lightweight tip and heater units, or with Lightweight heater units and interchangeable threaded tips listed on next page.

MINIATURE SOLDERING IRONS — 6 VOLTS, 12 WATTS

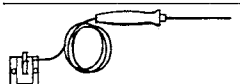
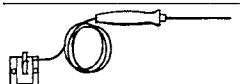
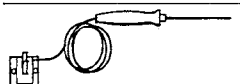
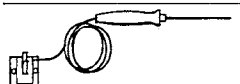

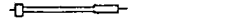
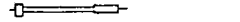
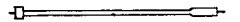
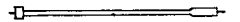
Ideal for production line soldering of sub-miniature equipment, printed circuits, and instruments. Weighs only 1 1/2 ounces. Integral transformer plugs into any standard 115-volt outlet, makes iron portable for maintenance work.

Complete Iron — Includes tip and heater unit, 6-foot cordset, and transformer with grounded plug.			
 3/4" Chisel Tip 3" Shank		6A428G3	
 3/4" Chisel Tip 6" Shank		6A428G4	
 3/4" Pyramid Tip 3" Shank		6A428G7	
 3/4" Pyramid Tip 6" Shank		6A428G8	
Complete Iron Less Transformer — Includes tip and heater unit, and 6-foot cordset with terminals			
 3/4" Chisel Tip 3" Shank		6A428G5	
 3/4" Chisel Tip 6" Shank		6A428G6	
Renewal Tip and Heater Units			
 3/4" Chisel Tip 3" Shank		6A429G3	
 3/4" Chisel Tip 6" Shank		6A429G4	
 3/4" Pyramid Tip 3" Shank		6A429G5	
 3/4" Pyramid Tip 6" Shank		6A429G6	
Handle and Cordset Only			
 6-foot Cordset with Terminals		6A428G62	
Renewal Transformer — Includes — 6-foot integral cordset			
 6-volt Secondary 115-volt Primary		6A430	

**MIDGET SOLDERING IRONS — 6 VOLTS;
18 to 45 WATTS (with transformers) — UL LISTED**



A versatile iron for light production in electronics, and communication industries—handles like a pencil, weighs but 1½ oz. Tip renewal is easy and fast—complete tip and heater unit can be changed in a few seconds. Heat output can be varied from 18 to 45 watts with standard GE transformers.

Description		Cat. No.
Handle and 6-foot cordset		
	For single- and 4-tap transformers	6A203
	For transformer with 3-heat switch	6A203G2
Tip and Heater Units — All ironclad tips		
	3/8" Chisel Tip 25 watts	6A211
	1/8" Cone Tip 25 watts	6A213
	3/16" Pyramid Tip 25 watts	6A215
	1/8" Chisel Tip 25 watts	6A217
	3/16" Chisel Tip 45 watts	6A211G31

Heater for Threaded Tips		Cat. No.
	25 watts	6A221

Transformers for Midget Iron — 115-volt Primary*

	Single Tap 6.3-volt secondary	6A362G2
	Four Tap 5.4/5.7/6.0/6.3-volt secondary	6A364G2
	With Three-heat Switch 4.9/6.3/6.9-volt secondary For use only with Handle and Cordset 6A203G2.	6A434

* Single- and four-tap transformers are available with 240-volt primary in quantities of 36 or more, specify catalog number desired and note on order, "except with 240-volt primary." Use interchangeable threaded tips.

**MIGHTY MIDGET SOLDERING IRON — 12 VOLTS;
100 WATTS**

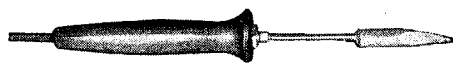

A lightweight iron with high heat capacity for heavy soldering where larger irons, up to 200 watts, prove unwieldy for rapid repetitive soldering, such as production soldering of tuner chassis, tinware, can seams, etc.

Handle and Cordset — Two-conductor		Cat. No.
		6A210G61

Tip and Heater Unit		Cat. No.
	1/2" Ironclad Chisel Tip	6A211G33

Transformer for Mighty Midget — 115-volt primary		Cat. No.
	Four Tap — for 55/70/85/100 watts	6A364G7

**6A160 SERIES SOLDERING IRONS — 115 VOLTS§,
75 TO 140 WATTS — UL LISTED**



Ideal for medium to heavy production, and maintenance and repair operations. Available with any of 12 different tips, calorized or ironclad.

Description	Cat. No.
Complete Iron Less Tip — Includes 6-foot two-conductor cordset	
	75 Watts 100 Watts 110 Watts 125 Watts 140 Watts
	6A161 6A162 6A162G6 6A162G3 6A162G12

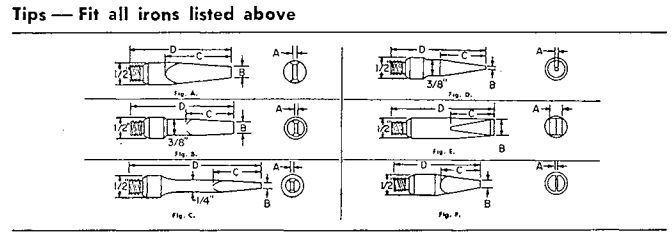

Fig.		A	B	C	D	
A. 1/2"-Dia. Chisel	Calorized	1/32	3/16	1 1/2	2 3/8	6D1P1
	Ironclad	1/16	3/32	1 1/2	2 3/8	6D1P2
	Calorized	1/16	3/32	2 3/4	4	6D1P3
	Ironclad	1/16	3/32	2 3/4	4	6D1P4
B. 3/8"-Dia. Chisel	Calorized	1/16	3/16	1 1/8	2 3/8	6D1P8
	Ironclad	1/16	3/32	1 1/8	2 3/8	6D1P6
	Ironclad	1/16	3/16	1 1/8	2 3/8	6D1P7
C. 1/4"-Dia. Chisel	Ironclad	1/16	1/8	1	3 1/8	6D1P5
D. Cone	Ironclad	1/16	1/16	1 1/16	2 3/16	6D1P12
E. Pointed Chisel	Ironclad	1/4	1 1/32	1	1 7/8	6D1P9
	Ironclad	1/4	1 1/32	1	2 3/8	6D1P10
F. Slim Chisel	Ironclad	1/16	3/32	7/8	2	6D1P19

Renewal Heater — 115 Volts§		Cat. No.
	75 Watts 100 Watts 110 Watts 125 Watts 140 Watts	6A31 6A32 7C342 8A88 7C474

§ Also available for 230-volt operation.

**INTERCHANGEABLE THREADED TIPS
For Penline-120, Pistol-grip, Lightweight, and Midget Irons**

Description (Copper Tip, Surface Plating)	Cat. No.
Spade Tips	
	6D4P1
	6D4P2
	6D4P3
	6D4P4
Chisel Tips	
	6D4P5
	6D4P21
	6D4P6
	6D4P7
	6D4P22
	6D4P8
	6D4P9
	6D4P10
	6D4P11
	6D4P12
Long Chisel Tips	
	6D4P13
	6D4P14
Pyramid Tips	
	6D4P15
	6D4P16
	6D4P17
	6D4P18
Cone Tips	
	6D4P19
	6D4P20



ELECTRIC SOLDERING IRONS



VOLTAGE RANGE: 6 to 250 OPERATES IDENTICALLY ON A.C. OR D.C., ANY CYCLE
STANDARD VOLTAGES 110/120, 121/130, 220/250 SPECIFY VOLTAGE ON ORDER

Equipped with flexible 6-ft. approved Neoprene rubber heater cord, which is water-proof, kink-free, and resistant to oil, abrasion and heat. Nickel-chromium replaceable heating elements, insulated with finest mica, protected by rugged outer housing. Replaceable tips.

PLUG-TIP IRONS

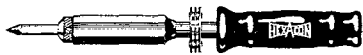

Cat. No.	Watts	Tip Dia.	Ship. Wt.	Net Price	Less Tip
P70	100	3/8"	1 1/8 lbs.	8.33	7.95
P100	110	3/8"	1 3/8 lbs.	8.89	8.44
P111	125	3/8"	1 3/8 lbs.	8.89	8.44
P115	150	3/8"	1 1/2 lbs.	9.03	8.58
P150	150	3/8"	1 1/2 lbs.	9.73	9.28
P153	175	3/8"	1 1/2 lbs.	10.08	9.63
P155	200	3/8"	1 1/2 lbs.	10.08	9.63
P151	175	1/2"	1 1/2 lbs.	10.50	9.66
P152	200	1/2"	1 1/2 lbs.	10.50	9.66
P200	200	5/8"	2 3/8 lbs.	11.06	9.94
P250	250	5/8"	2 3/8 lbs.	12.60	11.48



P300	300	7/8"	3 lbs.	14.28	12.01
P550	550	1 1/8"	4 3/8 lbs.	19.32	14.95

SUPER-POWERED IRONS

HIGHER SPEED SMALLER TIPS



Cat. No.	Watts	Tip Dia.	Ship. Wt.	Net Price	Less Tip
P114	100	1/4"	1 3/8 lbs.	9.73	9.42
P154	150	1/4"	1 1/2 lbs.	10.50	10.19
P238	200	3/8"	2 1/4 lbs.	11.34	10.89
P212	200	1/2"	2 1/4 lbs.	11.69	10.85
P338	300	3/8"	2 3/4 lbs.	16.24	15.79

HATCHET TYPE IRONS



Perfect Balance
Less Fatigue
See What You
Soldier

Cat. No.	Watts	Tip Dia.	Ship. Wt.	Net Price	Less Tip
70H	100	3/8"	1 3/8 lbs.	10.50	10.12
100H	110	3/8"	1 1/2 lbs.	10.78	10.33
150H	150	3/8"	1 3/8 lbs.	11.55	11.10
151H	175	1/2"	1 1/2 lbs.	12.18	11.34
153H	175	3/8"	1 1/2 lbs.	11.97	11.52
200H	200	5/8"	2 1/4 lbs.	12.67	11.55
300H	300	7/8"	3 lbs.	16.24	14.00

SCREW TIP IRONS



Cat. No.	Watts	Tip Dia.	Ship. Wt.	Net Price	Less Tip
85	90	1/2"	1 1/8 lbs.	9.73	9.17
120	120	5/8"	1 3/8 lbs.	10.50	9.63
170	175	1"	2 1/4 lbs.	13.37	11.52



225	250	1 1/8"	2 3/4 lbs.	15.82	13.37
350	350	1 3/8"	3 1/2 lbs.	18.49	14.81
500	500	1 5/8"	4 3/8 lbs.	20.93	15.51
700	700	1 3/4"	5 5/8 lbs.	38.15	31.15

SUPER-PENCIL IRONS

HOT TIP

Weights
only 2 oz



COOL HANDLE

Short
Reach 3"

All the advantages of a Soldering Pencil, but a full-fledged industrial soldering iron with nickel-chromium mica-wound element. Tiny tips outperform irons with larger tips and higher wattages.

Cat. No.	Watts	Tip Dia.	Ship. Wt.	Net Price	Less Tip
25S25	25	1/8"	1/2 lb.	5.39	5.22
25S20	20	1/8"	1/2 lb.	5.39	5.22
25S30	30	1/8"	1/2 lb.	5.39	5.22
25S35	35	1/8"	1/2 lb.	5.39	5.22
25S50	50	1/8"	1/2 lb.	6.09	5.92
26S30	30	3/16"	1/2 lb.	5.46	5.25
26S35	35	3/16"	1/2 lb.	5.46	5.25
26S40	40	3/16"	1/2 lb.	6.16*	5.95
26S50	50	3/16"	1/2 lb.	6.16	5.95

FASTEST AND MOST DURABLE PENCIL
IRON. Weighs but 2 oz.

24S40	50	1/4"	1/2 lb.	6.23	5.95
24S50	40	1/4"	1/2 lb.	6.23	5.95
24S60	60	1/4"	1/2 lb.	6.23	5.95

BANTAM HATCHET IRONS

PERFECT BALANCE

FOR INACCESSIBLE PLACES

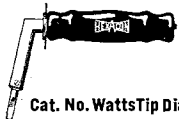

Weights only 3 oz.

Cat. No.	Watts	Tip Dia.	Ship. Wt.	Net Price	Less Tip
25H25	25	1/8"	1/2 lb.	6.51	6.34
25H35	35	1/8"	1/2 lb.	6.51	6.34
25H50	50	1/8"	1/2 lb.	6.51	6.34
26H30	30	3/16"	1/2 lb.	6.58	6.37
26H35	35	3/16"	1/2 lb.	6.58	6.37
26H50	50	3/16"	1/2 lb.	6.58	6.37
24H40	40	1/4"	1/2 lb.	6.65*	6.37
24H50	50	1/4"	1/2 lb.	6.65*	6.37
24H60	60	1/4"	1/2 lb.	6.65	6.37

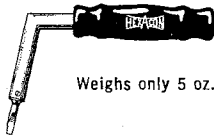

Weights only 5 oz.

30H40	40	1/4"	7/8 lb.	7.21	6.93
30H50	50	1/4"	7/8 lb.	7.21	6.93
30H60	60	1/4"	7/8 lb.	7.21	6.93
30H70	70	1/4"	7/8 lb.	7.28*	7.00
30H80	80	1/4"	7/8 lb.	7.28*	7.00

*STANDARD EQUIPMENT DUROTHERM
NON-STICKING LONG-LIFE TIPS.

HEXA CON HORNET Model H10

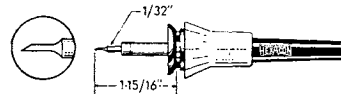

World's Smallest Industrial Soldering
Iron for Micro-Electronic Soldering

Cat. No. H10 Iron less tip, 12 Watts.....Net \$5.81
Cat. No. H11 Iron less tip, 17 Watts.....Net \$5.81
Cat. No. H14 Iron less tip, 20 Watts.....Net \$5.81
Iron with 3-wire cord and Nema plug available

- Smallest Iron — Only 5/8"
- Lowest Wattage — 12 Watts
- Hot tip Gets In and Out Fast
- No Damage to Insulation
- Lightweight • Cool Handle

DUROTHERM and XTRADUR long-life tips
1/32", 1/16" and 1/8" diameters

MINI-IRONS



Cat. No.	Tip Dia.	Price Less tip	
21A	1/8"	4.55	Slim Design
22A	3/16"	4.55	Rugged Construction
23A	1/4"	5.81	Dependable Performance Up to 60 Watts

PINPOINT SOLDERING IRONS



FOR PINPOINT ACCURACY
ON PRECISION SOLDERING
Long Reach 4 1/2" (Weight Only 3 oz.)

Cat. No.	Watts	Tip Dia.	Ship. Wt.	Net Price	Less Tip
P2525	25	1/8"	1/2 lb.	5.39	5.22
P2530	30	1/8"	1/2 lb.	5.39	5.22
P2535	35	1/8"	1/2 lb.	5.39	5.22
P2550	50	1/8"	1/2 lb.	5.39	5.22
P2630	30	3/16"	1/2 lb.	5.46	5.25
P2635	35	3/16"	1/2 lb.	5.46	5.25
P2640	40	3/16"	1/2 lb.	5.46*	5.25
P2650	50	3/16"	1/2 lb.	5.46	5.25
P2440	40	1/4"	1/2 lb.	5.95	5.67
P2450	50	1/4"	1/2 lb.	5.95	5.67
P2460	60	1/4"	1/2 lb.	5.95	5.67
P3040	40	1/4"	7/8 lb.	6.58	6.30
P3050	50	1/4"	7/8 lb.	6.58	6.30
P3060	60	1/4"	7/8 lb.	6.58	6.30
P3070	70	1/4"	7/8 lb.	6.65*	6.37
P3080	80	1/4"	7/8 lb.	6.65*	6.37

*STANDARD EQUIPMENT DUROTHERM
NON-STICKING LONG-LIFE TIPS.

TEMPERATURE CONTROL UNITS

Solid State
Soldering Iron Controls

Cat. No.	Net Price
TC 870	Control Socket 14.67
TC 871	Voltmeter and Control Socket 22.37
TC 872	Voltmeter and Two Sockets 27.97

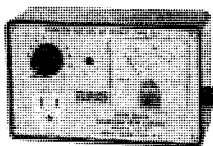

CORD AND CORD SETS

2 WIRE 18 GAUGE, 2 CONDUCTOR 18/2

Cat. No.	Extra Net	Cat. No.	Extra Net
*SP2S	No	SP2S	1.12
**PN2S	Extra	PN2S	1.12
SJ2S	Charge	SJ2S	1.19
HD2S	.35	HD2S	1.40
*KSV2S	2.03	*KSV2S	2.73
KPN2S	.70	KPN2S	1.40

3 WIRE 18 GAUGE, 3 CONDUCTOR 18/3

Cat. No.	Net	Cat. No.	Net
*SP3N	1.12	SP3N	1.89
SP3C	1.12	SP3C	1.89
**SJ3N	1.19	SJ3N	1.96
*HD3N	1.19	*HD3N	1.96
*KSV3N	3.29	*KSV3N	3.99

*Standard on INSTRUMENT IRONS **Standard on LARGE IRONS



LONG-LIFE SOLDERING TIPS

OUTLAST COPPER TIPS UP TO 20 TO 1



DÜROTHERM NON-FREEZING TIPS: Iron coated and immunized. Absolutely prevents tips from sticking. Minimum loss of heat delivery.

Note: Also available; XTRADUR Iron-coated Pretinned Tips. Multi-coated for extra long wear which immunizes shank of tip from solder, thus preventing adhering of solder, except on working surface of tip—prevents creeping and spilling of solder.

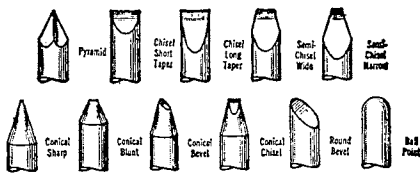

BASIC TIP SHAPES

**YOUR SPECIAL TIPS QUOTED ON REQUEST
FIT ALL MAKES**

CONSTRUCTION OF DÜROTHERM NON-FREEZING TIP — U.S. Pat. No. 3,109,231

A — Heavy Iron Coating
B — Scale-Resistant
DÜROTHERM COATING
Bonded to Base Copper
C — Pretinned Section
D — Multi-coated
and immunized

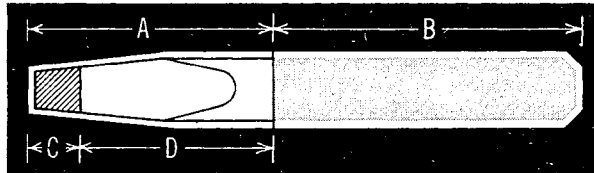

LONGEST WEARING AND BEST PERFORMING TIP EVER PRODUCED

HEXCLAD, XTRADUR AND DÜROTHERM TIPS AVAILABLE IN ALL CATALOG NUMBERS LISTED BELOW

Tip No.	Style of Point	Net Price	Tip No.	Style of Point	Net Price	Tip No.	Style of Point	Net Price	Tip No.	Style of Point	Net Price			
1/8" x 2 1/4"	Fit Iron Nos. 25S, P25, 25H		HT356D	Chisel, M, TT 1/8"	2.00	HT177D	S-chisel, W, TT 1/4"	2.42	HT371D	Semi-chisel, N	3.57			
HT248D	Pyramid	\$1.61	HT685D	Chisel, Lg, TT 1/8"	2.00	HT577D	S-chisel, N, TT 1/4"	2.42	HT180D	Semi-chisel	3.43			
HT249D	Chisel, short	1.61	HT452D	Conical, TT 1/8"	2.00	HT145D	Chisel, Sh, TT 3/16"	2.42	HT802D	S-chisel, TT 3/8"	3.71			
HT376D	Chisel, long	1.61	HT580D	Conical, TT 3/16"	2.00	HT475D	S-chisel, N, TT 3/16"	2.42	HT766D	Chisel, TT 1/4"	3.71			
HT560D	Semi-chisel	1.61	HT473D	Chisel, TT 3/16"	2.00	HT289D	Pyramid, TT 1/8"	2.42						
HT222D	Conical, blunt	1.61	HT130D	Round, bevel	1.93									
HT331D	Conical, sharp	1.61	1/4" x 3" Extra long for P30, 30H Also for competitive makes											
HT638D	Round, bevel	1.61	HT413D	Pyramid, long	1.93	3/8" x 4" Fit Iron Nos. P100, P150, P238, 100H, 150H; Extra long for P70, 70H; Also other makes								
HT361D	Chisel, TT 1/8"	2.00	HT468D	Chisel, long	1.93	HT566D	Pyramid	2.07	7/8" x 4 3/4" Fit Iron Nos. P300, 300H					
HT693D	R. B., TT 1/8"	2.00	HT298D	Semi-chisel, W	1.93	HT198D	Chisel, short	2.07	HT261D	Chisel, short	5.53			
HT104D	R. B., TT 1/8"	2.00	HT328D	Semi-chisel, N	2.00	HT918D	S-chisel, Sh, M	2.07	HT179D	Semi-chisel, W	5.32			
HT609	Chisel, long	1.61	HT708D	S-chisel, N, Lg	2.00	HT365D	Semi-chisel, thin	2.07	1 1/8" x 5 1/4" Fits No. 500					
HT610	Semi-chisel	1.61	HT453D	Conical, bevel	2.00	HT370D	S-chisel, Lg, N	2.42	HT262X	Chisel	7.74			
3/16" x 2 1/4" Fit Iron Nos. 26S, P26, 26H			HT234D	Chisel, Lg, TT 3/32"	2.00	HT140D	Semi-chisel, W	2.07	HT229X	Semi-chisel	7.74			
HT251D	Pyramid	1.68	HT487D	Chisel, Lg, TT 1/8"	2.00	HT430D	Round, bevel	2.07	HT233X	Pyramid	7.74			
HT294D	Chisel, short	1.68	HT519D	Chisel, Lg, TT 1/8"	2.00	HT319D	S-chisel, N, TT 1/4"	2.42						
HT195D	Chisel, long	1.68	HT362D	Conical groove	2.21	HT481D	Chisel, N, Sh, TT 1/8"	2.42						
HT207D	Semi-chisel, N	1.68	1/4" x 3 3/4" Extra long for P30, 30H Also for competitive makes											
HT190D	Semi-chisel, W	1.68	HT563D	Pyramid, long	1.93	3/8" x 3 3/4" Fit Iron Nos. P70, 70H; Also fit other makes								
HT214D	Conical, blunt	1.68	HT188D	Chisel, long	1.93	HT254D	Pyramid	2.07	All Conventional Semi-chisel Types					
HT281D	Conical, sharp	1.68	HT382D	Semi-chisel, W	1.93	HT488D	Chisel, short	2.07	Fits All Makes					
HT288D	Pyramid, TT 1/8"	1.79	HT626D	Pyramid, TT 1/8"	2.00	HT129D	Semi-chisel, W	2.07	Tip No.	Dia.	Thread	Iron No.	Net	
HT290D	Chisel, TT 1/8"	1.79	HT698D	S-chisel, TT 1/8"	2.00	HT510D	Conical, sharp	2.07	HT267X	3/16"	1/4-20	50	1.82	
HT548D	S-chisel, N, TT 1/8"	1.79	HT603D	Chisel, Lg, TT 1/8"	2.00	HT309D	Conical, blunt	2.07	HT268X	1/2"	1/4-18	60	2.35	
HT479D	Conical TT 1/8"	1.79	HT391D	Semi-chisel, N	2.00	HT464D	Conical, chisel	2.21						
HT220D	R.B., TT 1/8"	2.07	HT277D	Chisel, Lg, TT 3/16"	2.00	HT339D	S-chisel, N, TT 1/4"	2.42						
HT392D	Chisel, long	1.68	1/4" x 4" Fit Irons P114, P154, P214				HT581D	Chisel, Sh, TT 1/4"	2.42					
HT423D	Semi-chisel	1.68	HT496D	Chisel, long	2.14	HT498D	Chisel, Lg, TT 1/4"	2.42						
1/4" x 2 1/4" Fit Iron Nos. 24S, P24, 24H			HT494D	Semi-chisel, N	2.14	HT291D	S-chisel, W, TT 1/4"	2.42						
HT325D	Pyramid	1.93	HT495D	Chisel, Lg, TT 3/16"	2.24	HT497D	Chisel, Lg, TT 3/16"	2.42						
HT553D	Chisel, short	1.93	1/4" x 4 1/2" Fit Irons P114, P154, P214											
HT313D	Semi-chisel, W	1.93	HT258D	Pyramid	2.21	1/2" x 4 1/8" Fit Iron Nos. P151, 151H, P212								
HT397D	Semi-chisel, M	1.93	HT259D	Chisel, short	2.21	HT257D	Pyramid	3.26						
HT417D	Semi-chisel, N	1.93	HT230D	Semi-chisel, W	2.21	HT293D	Chisel, short	3.26						
HT418D	Conical, blunt	1.93	HT460D	Conical, bevel	2.31	HT323D	Chisel, short, blunt	3.26						
HT102D	Round, bevel	1.93	3/8" x 4 1/4" Fit Iron Nos. P100, P150, P238, P338, 100H, 150H				HT163D	S-chisel, N	3.26					
HT586D	Conical, S-chisel	2.00	HT255D	Pyramid	2.07	HT194D	Semi-chisel, thin	3.40						
HT691D	Chisel, TT 1/4"	2.17	HT493D	Chisel, short	2.07	HT444D	S-chisel, Lg, Taper	3.50						
HT699D	S-chisel, Lg, TT 1/8"	2.00	HT151D	Semi-chisel, W	2.07	HT203D	Conical, blunt	3.26						
HT451D	Chisel, L, TT 1/8"	2.00	HT183D	Semi-chisel, N	2.07	HT446D	S-chisel, Lg, Taper	3.50						
HT324D	Chisel, S, TT 1/8"	2.00	HT108D	Conical, sharp	2.07	HT123D	S-chisel, N, TT 3/8"	3.50						
HT513D	Conical, TT 1/8"	2.00	HT114D	Conical, blunt, Sm	2.07	5/8" x 4" Fit Iron Nos. P125, P200, 200H, P250								
HT463D	Chisel, L, TT 3/16"	2.00	HT240D	Conical, blunt M	2.07	HT256D	Pyramid	3.43						
HT841D	S-chisel, N, TT 1/8"	2.00	HT374D	Semi-chisel, W	2.07	HT891D	Chisel, long	3.43						
HT692D	Chisel, L, TT 1/8"	2.17	HT265D	Pyramid, TT 1/4"	2.42	HT178D	Semi-chisel, W	3.43						
HT552D	S-chisel, 3/8" Shank	2.42	HT266D	Chisel, Sh, TT 1/4"	2.42	5/8" x 4 3/8" Fit Iron Nos.								
1/4" x 2 3/4" Fit Iron Nos. P30, 30H			HT335D	Chisel, Lg, TT 1/4"	2.42	HT260D	Pyramid	3.43						
HT252D	Pyramid	1.93				HT499D	Chisel, long	3.43						
HT253D	Chisel, short	1.93												
HT202D	S-chisel, Wide	1.93												
HT426D	S-chisel, N	1.93												
HT131D	Conical, sharp	1.93												
HT263D	Pyramid, TT 1/8"	2.00												
HT264D	Chisel, Sh, TT 1/8"	2.00												

SCREW TIPS

All Conventional Semi-chisel Types

Tip No.	Dia.	Thread	Iron No.	Net
HT267X	3/16"	1/4-20	50	1.82
HT268X	1/2"	1/4-18	60	2.35
			and 85	
HT269X	5/8"	3/4-18	120	2.94
HT270X	7/8"	1/2-13	130	4.27
HT271X	1"	1/2-13	170	4.87
HT272X	1 1/8"	5/8-11	225	6.48
HT273X	1 3/8"	5/8-11	350	9.10
HT274X	1 5/8"	5/8-11	500	12.29
HT275X	1 3/4"	5/8-11	700	14.60

HORNET TIPS

TIPS FOR IRONS Nos. H10 and H11

No.	Dia.	Duotherm	
		Net	Xtradur Net
HT866D	1/8"	.84	
HT867D	1/8"	.84	
HT868D	1/8"	.84	
HT869D	1/8"	.84	
HT864X	1/8"		.63
HT870X	1/8"		.63
HT871X	1/8"		.63
HT873X	1/8"		.63

TIPS FOR IRON No. H14

No.	Dia.	Xtradur	
		Net	Net
HT654X	1/8"	.84	
HT655X	1/8"	.84	
HT656X	3/16"	.63	
HT657X	3/16"	.63	
HT658X	3/16"	.84	
HT659X	3/16"	.84	

CATALOG NOS. shown are for DÜROTHERM. For HEXCLAD drop "D"; cost approximately 30% less than DÜROTHERM. For XTRADUR substitute "X" for "D"; cost approximately 10% less than DÜROTHERM. ABBREVIATIONS: TT, Turned to; S-chis, Semi-chisel; W, Wide; N, Narrow; Lg, Long; Sh, Short; L, Large; M, Medium; Sm, Small; RB, Round Bevel. SAMPLE TIPS for your evaluation. Ask for new Tip Sketch Catalog with detailed sketches of 180 Standard Coated Tips.

SOLDERING ACCESSORIES

HEAT SINKS — Copper Tipped Clips

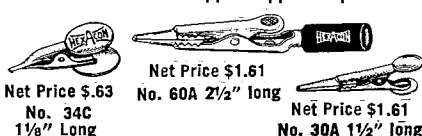

Net Price \$1.61
No. 60A 2 1/2" long

Net Price \$1.61
No. 30A 1 1/2" long

Protect heat sensitive components such as transistors and diodes from thermal damage.

TIP CLEANING SPONGE IN METAL TRAY

Insures reliability of soldered joints and extends tip life. Eliminates contamination. Pure cellulose sponge contains no harmful acids.

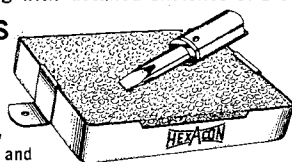

PRICES
Sponge in Metal Tray #81D.... \$1.19 Net
Sponge only #8101.... .46 Net
Tray only #8102.... .77 Net

ANTI-WICKING TWEEZERS Solid Berillium Copper

Cat. No.	Gauge	Net Price	Cat. No.	Gauge	Net Price
817	16-18	\$5.67	820N	20*	\$5.67
821	20-22	5.67	822N	22*	5.67
825	24-26	5.67	824N	24*	5.67
830	28-30	5.67	826N	26*	5.67

Prevents harmful effects of excess capillary action of solder along stranded wire beneath insulation. Order tool number by wire size being used. *"N" Type Tweezers are made for one gauge wire only (not for a range of sizes). Therefore give better fit on wire for greater efficiency. Shorter tip hole provides for close inspection gap on precision soldering such as called for in current NASA specifications.

Lindstrom® Swedish PLIERS AND NIPPERS

MINIATURE TOOLS for use on the compact electronic circuits, assemblies and components in today's space age technology. The heads easily reach into confined spaces to perform intricate work, while their light weight, perfect balance, and comfortable grip provide fatigue-free use during continuous operations.



FULL-FLUSH EDGES

For cutting soft wires straight and flush... leaves no wire peak



SEMI-FLUSH EDGES

For cutting copper and insulated wires... leaves a very small peak



Relieved Backs allows entry between "flat packs."

NON-JAMMING Double-leaf springs

SWEDISH STEEL for toughness and wear!

ZONE TEMPERED

- Cutting edges induction hardened for long wear.
- Joint tempered to withstand strain
- Handles tempered to withstand compression

Comfortable VINYL PLASTISOL cushion grips

Precision "BOX JOINTS" Outlast and outperform all other types, because they:

- Retain precise alignment even under strain and after considerable use.
- Jaws never develop looseness or wobble, and yet open and close smoothly.



DIAGONAL CUTTERS—Popular type for side cutting. Have relieved backs, and come complete with double-leaf return springs.
No. 36-237S—semi flush
No. 36-238S—full flush

CHAIN NOSE—Popular snipe nose tapers to a $\frac{1}{32}$ " tip—insides of jaws are smooth, and edges are rounded. Length of jaws $\frac{3}{4}$ ".
No. 36-226

All Supreme Tools are Approximately 4 $\frac{1}{2}$ " Long.

Supreme NIPPERS

All Nippers have vinyl plastisol handles and double-leaf return springs.

OBLIQUE—Head is angled 15°, with tip coming to a point. No. 36-234S semi-flush edges. No. 36-235S full flush edges

OBLIQUE WITH SHORT HEAD—Similar to above except back edge is ground off so head can be fitted into inaccessible areas. No. 36-242S full flush edges

END NIPPERS—Jaws are set straight across with both ends coming to a point. No. 36-231S semi-flush edges. No. 36-232S full flush edges

END WITH NARROW HEAD—Head is only $\frac{1}{8}$ " wide at cutting edge. No. 36-246S flush edges

Supreme PLIERS

All pliers have vinyl Plastisol handles. Double-leaf return springs available

FLAT— $\frac{1}{8}$ " wide at tip. Insides of jaws are smooth and edges are rounded. Length of jaws $\frac{3}{4}$ ". No. 36-221

ROUND—Jaws are smooth and taper to a $\frac{1}{32}$ " tip. Insides of jaws are smooth and edges are rounded. Length of jaws $\frac{3}{4}$ ". No. 36-224

CHAIN—Popular snipe nose tapers to a $\frac{1}{32}$ " diameter at the tip. Length of jaws $\frac{3}{4}$ ". No. 36-226

BENT NOSE CHAIN—Tips are angled at 45° for picking up and manipulating precision wires. Length of jaws $\frac{3}{4}$ ". No. 36-227

LONG NOSE BENT CHAIN—Tips are angled at 60° for picking up and manipulating precision wires. Length of jaws 1 $\frac{1}{4}$ ". No. 36-229

LONG NOSE CHAIN—Extra length jaws for getting into tight places. Snipe nose tapers to $\frac{1}{32}$ ". Length of jaws 1 $\frac{1}{4}$ ". No. 36-228

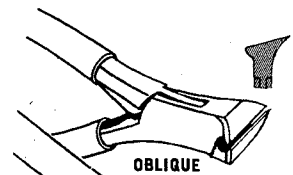

OBLIQUE



END NIPPERS

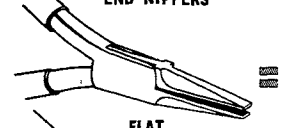

FLAT

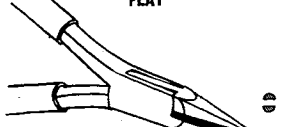

CHAIN

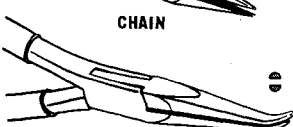

LONG NOSE BENT CHAIN

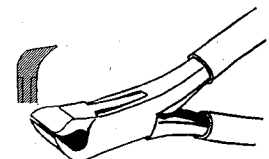

OBLIQUE WITH SHORT HEAD

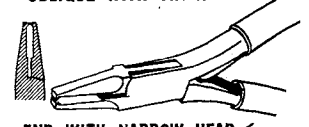

END WITH NARROW HEAD

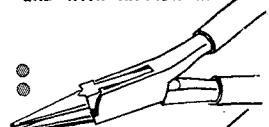

ROUND

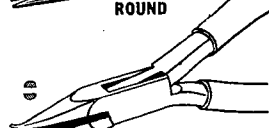

BENT NOSE CHAIN



LONG NOSE CHAIN

Catalog showing full Lindstrom line on request.

HAMMEL, RIGLANDER & COMPANY, INCORPORATED

YOUR SINGLE SOURCE FOR THE MOST COMPLETE LINE OF PRECISION ELECTRONIC ASSEMBLY TOOLS

LEAD BENDING GAUGE

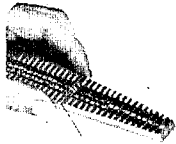

Fast, accurate lead forming with perfect reliability... no nicks! Up to 1200 components leads per hour may be formed with the simple precise Hunter Gauge offered in 4 standard sizes. All models have 40 lead forming positions. Light-weight, high-impact, Cyclocac plastic.

Stock No.	Description	Price
51KL	1/4 watt size, .375 to 1.50"	4.50
51KM	1/2 watt size, .050 to 1.50"	4.50
51KN	Set of 1 ea. 51KL and 51KM	9.00
51KP	1 watt size, .75 to 2.50"	5.63
51KQ	2 watt size, .875 to 2.50"	5.63
51KR	Set of 1 ea. 51KP and 51KQ	11.21

QUICK ADJUST VISE

Fully adjustable, quick action vise, to meet the needs of the electronics/aerospace industry. Combination of vise, positioner, and cast iron base.

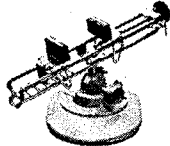

- 62E4 — Price 34.13 Net
- Each unit is also available separately.
- 61E1 — Positioner only. Price — 12.00 Net
- 62E2-1 — Vise only. Price 14.40 Net
- 62E3 — Combination of positioner (62E1) and vise (62E2) only. Price 26.40 Net
- 62K3 — Cast iron base. Price 7.73 Net

PANA-VISE

Solves holding problems for small complicated assemblies. 62 — Complete with base and vertical head. Unit 8" high, 6" long, 5" wide. Pivots work 360 degrees in any tangent to half a sphere, achieves any compound angle. Price 17.30 Net

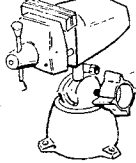

CIRCUIT TESTERS

Traces any circuit — dead or alive — to 600 volts A.C. or D.C. Signal light clearly visible in the tip at point of contact. Sturdy — pocket size — with plated brass parts; shock proof case. Price 4.98 Net

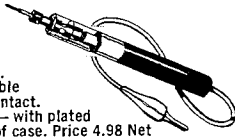

MAGIC TIP SCREWHOLDER

Holds screws tight when inserting or removing. Center pin grips screw tightly at slightest pressure.



Stock No.	Overall Length	Slot Fits	Net Price
10E3	2 1/2"	#00 to #2	1.92
10E4	4"	#00 to #2	2.27
10E7	7"	#00 to #2	2.33
10M3	3 1/2"	#3 to #6	1.80
10M5	5 1/4"	#3 to #6	2.22
10M8	8 3/4"	#3 to #6	2.45
10M12	11 1/4"	#3 to #6	2.67
10A	4"	#6 to #10	1.92
10B	6 1/4"	#7 to #10	2.33
10C	7 1/2"	#7 to #10	2.37
10D	11 1/4"	#7 to #10	2.66

NUT DRIVERS

These nut drivers have hollow shafts. Color coded Tenite II plastic handles identify size.

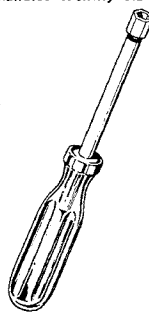

Stock No.	Hex Size	Overall Length	Color	Net Price
19W	3/32"	6 3/4"	Maroon	.98
20	1/16"	6 3/4"	Black	.98
20A	3/32"	6 3/4"	Brown	.98
20B	1/4"	6 3/4"	Red	.98
20C	5/32"	6 3/4"	Orange	.98
20D	3/16"	6 3/4"	Amber	.98
20E	1/8"	6 3/4"	Green	.98
20F	3/8"	6 3/4"	Blue	.98
20G	1/2"	7"	Brown	1.13
20H	3/4"	7"	Red	1.13
20H1	1/2"	7 1/4"	Orange	1.28
20I	3/4"	3"	Red	.87
20J	1/2"	3"	Amber	.87
20K	3/8"	3"	Blue	.87

HUNTER KNIVES

E20 — Utility knife. Blade is replaceable. Made of light weight aluminum. Knife is 3/16" in diameter and 5" long. Price .57 Net

HEX DRIVERS

Screwdriver type wrenches for speedy drive socket screws. Tempered shafts. Plastic handles.

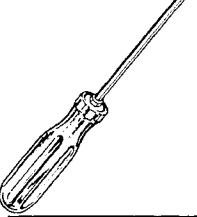

Stock No.	Size	Overall	Net Price
4Y	.028	4"	.69
4Z	.035	4"	.69
5	.050	4 5/8"	.57
5A	3/16"	5 3/8"	.60
5B	3/16"	6"	.63
5C	3/16"	6 3/8"	.66
5C1	3/16"	6 3/4"	.69
5D	1/8"	6 3/4"	.69
5D1	3/16"	7"	.69
5E	3/16"	7 5/8"	.69
5F	3/16"	8"	.75
5G	3/16"	8 3/8"	.84

"SMITTY" WRENCHES

Convenient, easy to use, gives the right key size when you want it.



- 1P4 — 6" handle, 5" blades. 3/32, 1/8, 5/32, 3/16, 7/32, 1/4. Price 2.43 Net
- 1P5 — 4" handle, 2" blades. 3/32, 1/8, 5/32, 3/16, 7/32. Price 1.20 Net
- 1P6 — 3" handles, 2" blades. .050, 1/16, 3/64, 5/32, 1/8, 3/32. Price 1.16 Net
- 1P7 — 3" handle, 2" blades. .050, 1/16, 3/64, 5/32, 7/64, 1/8, 3/4. Price 1.20 Net
- 1P8 — 4" handle, 3" blades. 3/32, 7/64, 1/8, 3/64, 5/32, 1/4, 3/2. Price 1.73 Net

THERMAL WIRE STRIPPER

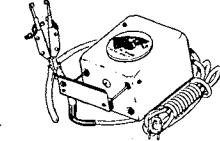

Plier is 8" long, 1/2" wide at tip, 2 1/2" wide at handle, 7/8" thick with 36" cord. Plier stripper weighs only 8 oz., total unit weighs only 3 lbs. Ideal for research and development work.

- 80 — Standard control box, plier-type wire stripper. Price 81.00 Net
- 80C — Same as above but with heavy duty (3-wire) cord and grounds. Price 85.28 Net
- 80A — Replacement filaments for plier-type stripper. Price 3.00 Net

HUNTER WIRE STRIPPERS



Cuts and strips both stranded and insulated wire. Positive adjustment, user can preset tool for any wire size from #10 to #20.

HUNTER SUB-MINIATURE TOOLS

K24M — Master set of sub-miniature tools consisting of jewelers handle, red plastic handle, wrench blades 3/32, 1/8, 5/32, screwdriver blades .055, .070, .080, .100, Phillips blades #0, #1, awl, spline blades .033-4, .048-4, .060-6, .069-4, nut driver blades 3/64, 1/8, 3/32 and hex key blades .028, .035, .050, 1/16, 3/32. Price 12.38 Net

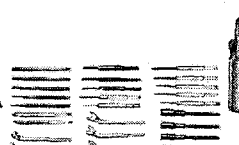

HUNTER EREMADIUM CUTTERS

These specially tempered eremadium cutting edges are designed for cutting newer wires containing nickel, iron, etc., up to 22 gauge wire. The most popular are the cutters with full flush or semi-flush cutting edges, lasting 3 to 5 times longer.



- A95E — Full flush cut plier 4" long, designed to cut 22 gauge wire or less. Price 5.42 Net
- A95EL — Same as A95 only with leaf spring. Price 5.72 Net
- A97E — Semi-flush cut plier 4" long, designed to cut 22 gauge wire or less. Price 4.55 Net
- A97EL — Same as A97E only with leaf spring. Price 4.85 Net
- A86E — Taper Jaw Dyke 4 3/4" long for No. 20-22 gauge wire. Semi-flush cut. Price 5.91 Net
- A86EL — Same as an A86E only with leaf spring. Price 6.23 Net

EREMADIUM
CHROME VANADIUM STEEL

HUNTER TIP-O-DYKE



Special precise full flush cutting instruments that will cut flat, soft nickel ribbon wire and increase reliability. Cuts at tip with perfect angle. A90E — 4 3/8" overall, 22 gauge AS copper wire. Price 9.91 Net

A90EL — Same as an A90E only with leaf spring. Price 10.15 Net

EREMADIUM
CHROME VANADIUM STEEL

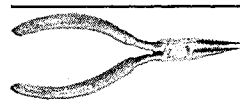

HUNTER PLIERS

- A11 — 4 1/2" narrow chain nose. Smooth jaws, radius edges will not mar wire. Price 3.74 Net
- A11L — Same as A11 only with leaf spring. Price 4.04 Net
- A14-4 1/2 — A14-6 — Extra long needle nose, 4 1/2" Optional: 6". Radius edges. Price 4.20, 6" Price 4.70.
- A14L-4 1/2 — A14L-6 — Same as an A14-4 1/2 only with leaf spring. Price 4.62, 6" 5.00

HUNTER NIPPER

CHROME PLATED STEEL

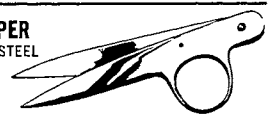

- F213 — Straight Blade nipper, 4 1/2" long. Designed to be held in palm of hand and keep fingers free for use. Price 2.63 Net
- F213A — Same as an F213 only heavy duty. Price 2.97 Net
- F214 — Same as an F213 only with curved blades. Price 2.85 Net

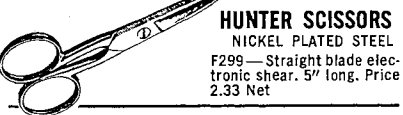

HUNTER SCISSORS

NICKEL PLATED STEEL
F299 — Straight blade electronic shear. 5" long. Price 2.33 Net

HUNTER SCISSOR CLAMPS

STAINLESS STEEL

- F35 — Straight end scissor clamp. 5" long. Precision box joint, fine serrated jaws. Lock, opens easily. Cushion-grip handles. Price 4.80 Net
- F36 — Same as an F35, only with curved end. Price 4.80 Net

HUNTER SOLDERING IRON & TIPS

S4725 — 720° iron with 3/16" copper tip. Price 3.32 Net

- 3/16" SCREWDRIVER
- 1/8" SCREWDRIVER (Heavy Duty)
- 1/8" PYRAMID
- S13C — Screwdriver type 3/16" copper tip. Price .36 Net
- S14C — Pyramid type 1/8" copper tip. Price .36
- S25C — Screwdriver type heavy duty 1/8" copper tip. Price .36 Net

HUNTER HEAT SINKS

Absorbs and dissipates heat instantly during soldering — protects delicate components.

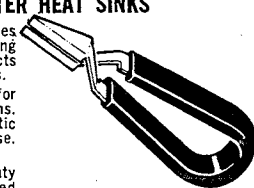

- 51G — Small model for delicate work. 1 1/4-ins. long. Coated plastic handle. Tweezer nose. Price .56 Net
- 51F — Medium Duty Unit. Plastic coated handles. Fed. Stock No. 3439-856-9497. Price .69 Net
- 51E — Heavy Duty. Has copper jaw. Plastic covered handle. Fed. Stock No. 3439-856-9496. Price .72 Net

HUNTER SOLDERING AIDS

Blades of non-magnetic steel to which solder won't adhere. Turquoise plastic handle; hex shaped, won't roll off table.

- REGULAR MODELS
- 51 — Fork & Hook. Overall length 7"; hex handle size 3/8" x 3"; blade size 3/32" x 2". Price .90
- 51A — Fork & Brush. Overall length 7"; hex handle size 3/8" x 3"; blade size 3/32" x 2". Price .90
- 51B — Knife & Brush. Overall length 7"; hex handle size 3/8" x 3"; blade size 3/32" x 2". Price .90
- 51C — Fork & Reamer. Overall length 7"; hex handle size 3/8" x 3"; blade size 3/32" x 2". Price .90
- MICRO MODELS
- 51C1 — Fork & Hook. Overall length 6"; hex handle size 1/4" x 3"; blade size 1/8" x 1 1/2". Price .90
- 51C2 — Fork & Reamer. Overall length 6"; hex handle size 1/4" x 3"; blade size 1/8" x 1 1/2". Price .90

The original "wedge-type" screwdriver

QUICK-WEDGE®

SCREW-HOLDING SCREWDRIVERS

HOLDS - STARTS - DRIVES - SETS the Screw — Unconditionally Guaranteed

17 Different Sizes Handle Every Screwdriving Job!

Last digit(s) of model number indicates blade length. "E" after number indicates electrical sizes with color-matched, shockproof, Vinyl covered tubing. Not available on No. 1732.



© 1968 by Kedman Company, Quick-Wedge Reg. U.S. Pat. Off.

- One screwdriver drives many sizes of screws
- Shockproof, unbreakable Tenite II handle
- Hollow-ground bit fits any slotted screw
- Use instead of conventional screwdriver
- Tough, durable spring steel blades. Positively will not mar screw slot
- Fast positive action — easy to use
- No pressure wedge to wear out
- Foolproof construction.

Prices subject to change without notice. Net Prices effective November 1, 1966.

ULTRA-MINIATURE



1253B

0-80 and other extremely tiny screws

No.	Blade Diam.	Wt. Per Box*	Lbs. Per Box*	Per Box†	Each Price
1253B	1/8"	9 oz.	\$15.00	\$1.50	
1253B-E	1/8"	9 oz.	16.50	1.65	

MIDGET



1253



1253A

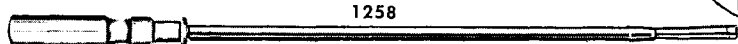

1258

Wood Screws, Bolts—No. 0 to No. 4 Sheet Metal Screws—No. 2 to No. 4

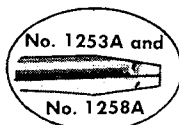

No. 1253A and No. 1258A

1253	1/8"	9 oz.	12.50	1.25
1253E	1/8"	9 oz.	14.00	1.40
1253A	1/8"	9 oz.	14.00	1.40
1253AE	1/8"	9 oz.	15.50	1.55
1258	1/8"	15 oz.	15.00	1.50
1258E	1/8"	15 oz.	16.50	1.65
1258A	1/8"	15 oz.	16.50	1.65
1258AE	1/8"	15 oz.	18.00	1.80

SMALL



1732



1734



1736

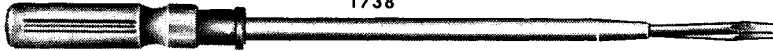

1738



17312

Wood Screws, Bolts—No. 4 to No. 7 Sheet Metal Screws—No. 4 to No. 6

1732	3/16"	3/4	13.00	1.30
1734	3/16"	1	13.50	1.35
1734E	3/16"	1	15.00	1.50
1736	3/16"	1 1/4	14.00	1.40
1736E	3/16"	1 1/4	15.50	1.55
1738	3/16"	1 1/2	14.50	1.45
1738E	3/16"	1 1/2	16.00	1.60
17312	3/16"	2	16.00	1.60
17312E	3/16"	2	17.50	1.75

MEDIUM



1834

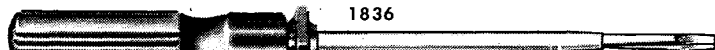

1836



1838

Wood Screws, Bolts—No. 6 to 12 Sheet Metal Screws—No. 6 to No. 12

1834	3/16"	1 3/4	18.50	1.85
1834E	3/16"	1 3/4	20.00	2.00
1836	3/16"	2	19.00	1.90
1836E	3/16"	2	20.50	2.05
1838	3/16"	2 1/4	19.50	1.95
1838E	3/16"	2 1/4	21.00	2.10

HEAVY DUTY



2354

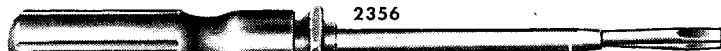

2356



2358



23514

Wood Screws, Bolts—No. 8 to No. 24 Sheet Metal Screws—No. 8 to 3/8"

2354	1/4"	2 1/4	19.50	1.95
2354E	1/4"	2 1/4	21.00	2.10
2356	1/4"	2 3/4	20.00	2.00
2356E	1/4"	2 3/4	21.50	2.15
2358	1/4"	3	20.50	2.05
2358E	1/4"	3	22.00	2.20
23514	1/4"	2 3/4	28.80†	2.40
23514E	1/4"	2 3/4	30.60†	2.55

*Packaged in quantities of 10 per box. †Price per dozen, packaged 6 per box.

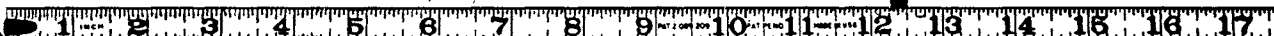

KEDMAN COMPANY

Get Fast, Safe Heat With The World's Finest...

MASTER FLAMELESS HEAT TOOLS!

- shrink tubing
- de-solder • set pre-coated rivets • soften, mold, weld, form plastics • dry paint, plastic finishes, condensation, or parts after washing • speed plastic and epoxy curing • handle hundreds of other jobs.

Flameless Heat Guns

MODEL	VOLTAGE	AMP.	TEMP. F.°	NET
HG 201	115	5	200/300	\$44.30
HG 202	230	3	200/300	51.95
HG 301	115	12	300/500	44.30
HG 302	230	5	300/500	51.95
HG 501	115	14	500/750	49.90
HG 502	230	8	500/750	55.25
HG 751	115	20	750/1000	59.95
HG 752	230	9	750/1000	67.85

Master
UP TO 1000° F.

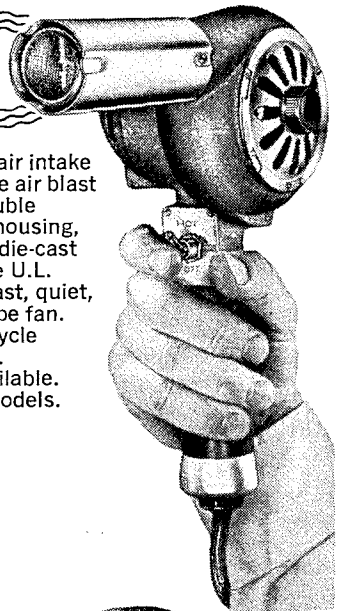

Have adjustable air intake for controlling the air blast temperature; double jacketed heater housing, made of rugged, die-cast aluminum; 3-wire U.L. approved cord; fast, quiet, efficient turbo type fan. 50/60 and 400 cycle models available. Attachments available. Choose from 8 models.

Flameless Continuous Duty Air Heater Blowers

MODEL	VOLTAGE A.C.	CYCLE	AMP.	TEMP. F°	AIR VOLUME C.F.M.	AIR VELOCITY F.P.M.	NET RESALE
AH 301	115	60	10	300	14.82	1425	\$56.65
AH 302	230	60	5	300	16.2	1550	68.35
AH 501	115	60	14	500	13.75	1375	59.95
AH 502	230	60	6	500	14	1400	71.65
AH 751	115	60	18	750	13.5	1350	78.35
AH 752	230	60	11	750	13.5	1350	90.25

Master
UP TO 750°

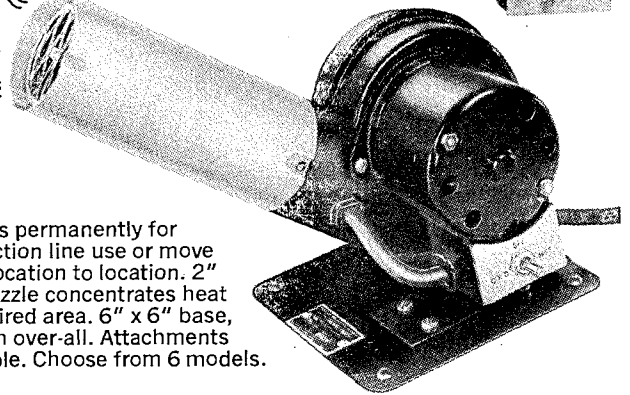

Mounts permanently for production line use or move from location to location. 2" dia. nozzle concentrates heat on desired area. 6" x 6" base, 6" high over-all. Attachments available. Choose from 6 models.

New Master Flameless Air Heat Torch

CHART OF APPROXIMATE TEMPERATURES OBTAINED 1/4" FROM NOZZLE IN F° @ 120 VOLTS									
SPECIFY RATING WHEN ORDERING	NET RESALE	POUNDS OF PRESSURE							
		RATING 8 lbs.	7 lbs.	6 lbs.	5 lbs.	4 lbs.	3 lbs.	2 lbs.	
FHT-67-1 W/Shield	\$88.00	250 Watts	250°	300°	330°	360°	390°	420°	500°
FHT-67-2 Less/Shield	85.00								
FHT-67-1 W/Shield	90.50	350 Watts	350°	400°	450°	550°	550°	600°	700°
FHT-67-2 Less/Shield	87.50								
FHT-67-1 W/Shield	92.50	450 Watts	450°	500°	550°	600°	650°	700°	850°
FHT-67-2 Less/Shield	89.50								
FHT-67-1 W/Shield	94.50	550 Watts	550°	600°	650°	700°	775°	875°	1050°
FHT-67-2 Less/Shield	91.50								

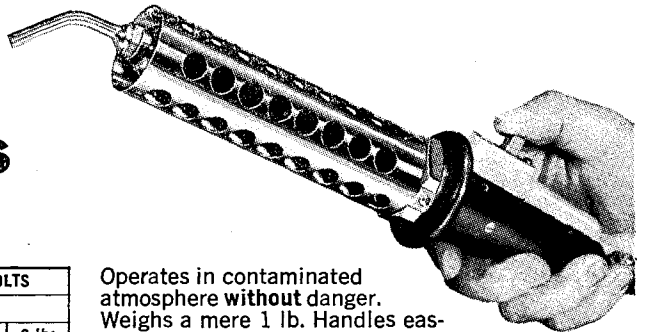

Operates in contaminated atmosphere without danger. Weighs a mere 1 lb. Handles easily. Pinpoints heat in small areas at any selected pressure. Lets you hold temperatures plus or minus 1°. Works off conventional air compressors, small motor driven compressors or inert gas. Has a molded handle, all stainless steel barrel and nozzle. Comes with 10' contaminate-proof hose. Welds PVC's, polypropylenes, polyethylenes, Welding tips and carrying case available as optional equipment.

WHY INDUSTRY LEADERS EVERYWHERE SPECIFY MASTER FLAMELESS HEAT TOOLS!

The reason is simple. Master Appliance Corporation pioneered flameless heat tool development. So it's natural that they know more about designing and building quality heat tools than any other manufacturer. In short, people who want the best insist on Master capacity, performance and trouble-free dependability. Isn't it time you found out for yourself?

AVAILABLE AT LEADING DISTRIBUTORS.

Moody® PRECISION HAND TOOLS

Screw Driver & Awl Set

Contains four interchangeable screw driver blades and an awl. Complete with swivel top, knurled chuck type handle.

Sizes .055", .070", .080",
.100", awl

Cat. No. SC-5 List \$1.75

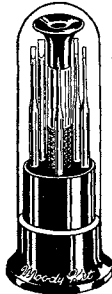

Socket Wrench Set

Five interchangeable box or socket wrenches that fit the same magnetic handle. Thread sizes #00, #0, #1.

Sizes (all hex) 5/64", 3/32",
7/64", 1/8", 5/32"

Cat. No. BW-5 List \$3.95

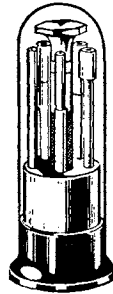

Offset Open End Wrench Set

Contains five offset open end wrenches, interchangeable in the chuck handle.

Sizes 5/64", 3/32", 7/64",
1/8", 5/32"

Cat. No. OE-5 List \$2.50

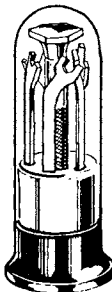

Tap Drill Set

Contains five tap drills. Handle has a solid-locking chuck-nose and swivel-top. A companion piece to the Moody TS-5 Tap Set.

Drill Sizes 3/64", #53, #50,
#47, #43

Cat. No. 70 List \$3.50

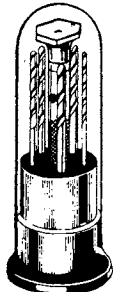

Cross Recessed Driver & Allen Type Wrench Set

Contains five interchangeable tools with chuck-type, swivel top handle. A torque hole in the handle enables fastenings to be set up tight.

Cross recessed drivers #0, #1
Allen type wrenches #4, #6, #8

Cat. No. PA-5 List \$2.50

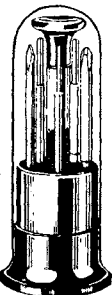

Tap Set

Contains five interchangeable taps and handle for cutting inside threads. Torque hole in handle enables you to maintain a steady firm leverage.

Tap Sizes 0-80, 1-72, 2-56
3-48, 4-40

Cat. No. TS-5 List \$6.95

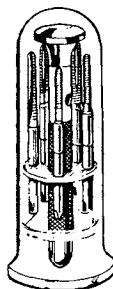

Utility Screw Driver Set

Consists of a precision screw driver and six interchangeable blades. The screw driver handle is knurled for positive gripping.

Sizes .025", .040", .055",
.070", .080", .100"

Cat. No. 52 List \$2.50

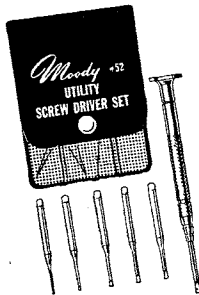

Machinist Scriber



Approximately 8 1/2" overall with a right angle point and a straight point, both properly tapered and swaged into a knurled aluminum finger grip handle.

Cat. No. MS-2

List \$.75

Moody Master Kit

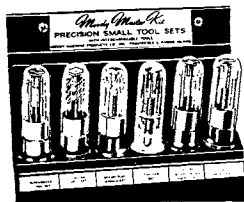

A popular compact kit of six tool sets, stored in a leatherette case. Contains Screw Driver & Awl Set, Cross Recessed Driver & Allen Type Wrench Set, Socket Wrench Set, Offset Open End Wrench Set, Tap Drill Set, Tap Set.

Cat. No. MMK-6 List \$22.95

Send for Free Catalog on the complete line of Moody Tools

MOODY MACHINE PRODUCTS CO., INC.



Moody® MACHINE PRODUCTS CO., INC.

ERSIN

Multicore

5-core solder

Available in 1-lb.
and 7-lb. reels**TECHNICAL ADVANTAGES:**

Ersin Flux is exclusive to Multicore and will not be found in any other solder. It is a high-grade, water-white rosin, homogeneously activated.

Ersin Flux has a vigorous fluxing action and possesses the non-corrosive and protective features of the original rosin. Soldered joints made with Ersin Flux do not corrode even after prolonged exposure to any degree of humidity. Ersin Flux reduces the surface tension of molten solder, causing it to wet metals rapidly, increasing speed of operation with resultant production economies.

Free from objectionable odor. Non-toxic in use.

Leaves nothing but pure rosin on the work after soldering, and may be used wherever plain rosin is specified.

Conforms with all pertinent federal specifications.

Multicore construction: Five separate cores of flux eliminate possibility of no flux in a portion of the wire, which may occur in single cored solder. Guaranteed continuity of the flux stream prevents "dry" joints, i.e., those having high electrical resistance.

Although there are five cores of flux in Multicore, the total percentage of flux to solder is less than many single cored solders.

Very rapid melting results from the multiple core construction which provides thinner walls of solder than are found in same gauge single cored solder. Multicore's unique properties make perfect joints possible on difficult metals and alloys, even if oxidized.

Ability to tin rapidly produces perfect joints with less solder. Greater coverage per pound.

NOTE: Multicore presents an entirely new concept in solder packaging designed to bring the solder to you in perfect condition at all times. The attractive polystyrene foam container resists damage in shipping and each individual reel is skin packed to keep the solder clean and fresh and to minimize oxidation no matter how long it may be stored.

STANDARD TIN/LEAD ALLOYS AND GAUGES

Available from stock: 63/37; 60/40, 50/50, 40/60; Savbit; Special Alloys — H.M.P. (High melting point, 565°F); L.M.P. (low melting point, 354°F). Other alloys upon request.
Gauges: 14 s.w.g. (.080") through 24 s.w.g. (.009").

NOTE: Soldering iron tips should always be 108°F above melting point of alloy.

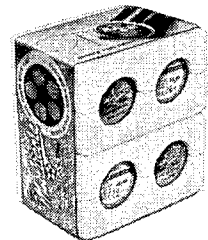
**NEEDLE FINE GAUGES**

For microminiaturization, integrated circuits and other similar requirements. Off-the-shelf delivery in alloys 63/37 and 60/40, in even gauges from 22 s.w.g. (.022") through 34 s.w.g. (.009").

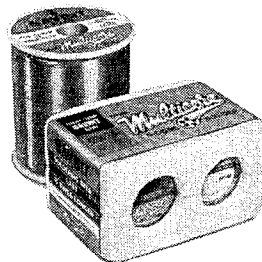
**COPPER-LOADED SAVBIT ALLOY**

Copper-loaded SAVBIT stops the wear and erosion of copper soldering iron tips . . . increases tip life by 1,000%.

Characteristics and specifications: Savbit Alloy is available in Ersin Multicore 5-core solder containing non-corrosive extra-fast Ersin Flux in 14, 16, 18, 20, 22 and 24 gauge. Melting point: Virtually the same as standard tin/lead alloys. Excellent conductivity, tensile and shear strength.

Available in new 1-lb. and 7-lb. reels, skin wrapped and foam packaged.

NEW ERSIN LIQUID FLUXES

Meet the same high quality standards as Ersin Multicore Solder. Three new Fluxes: Formula No. 5380 and Formula No. 0360 meet Government MIL specifications for active and non-activated liquid fluxes, respectively. Formula No. 4370 is an activated liquid flux which is the external counterpart of the flux contained in Ersin Multicore 5-Core Solder. Conforms to the latest Federal Specification QQ-S-571d.

NEW MULTICORE HIGH PURITY EXTRUDED SOLID BAR SOLDER

Offers higher purity achieved through greater quality control, only possible with extrusions. Available in skin packaging as well as bulk. Available in two alloys: 60/40 and 63/37.

**PC (PRINTED CIRCUIT) PAK
60/40—22 s.w.g. (.028")****NEW EASY DISPENSER PAK
60/40—18 s.w.g. (.048")**

Ideal for servicemen, hobbyists, lab technicians. Paks are flameproof—can be used close to the heat.

ERSIN Multicore's national network of industrial distributors, in 50 states, facilitates prompt off-the-shelf delivery at factory-low prices.

NEW SOLDERABILITY TEST MACHINE

Designed and built by Multicore Solders Ltd., this precision machine accurately measures the degree of solderability of terminal component wires and affords positive and totally reliable results. Complies with International Specification I.E.C. Publication 68-2 Test T.; developed in association with the International Electrotechnical Commission.

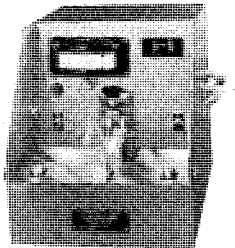

Free Evaluation Test Samples and "Modern Solders" technical booklet available.

Imported from England
Conforms to all applicable Federal Specifications QQS-571.

Multicore Sales Corp.
Div. British Industries, Corp.

ORYX

PRECISION SOLDERING INSTRUMENTS

*News for
Production
Engineers*

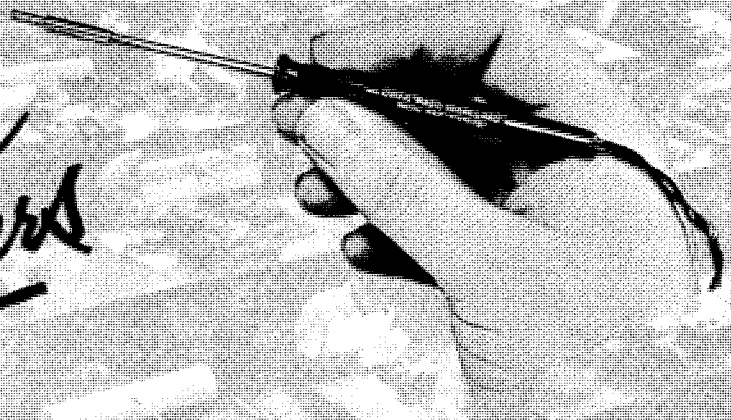

Oryx industrial soldering instruments offer these important advantages:

MINIATURE SIZE
FEATHER WEIGHT
HIGH EFFICIENCY
SAFETY

ORYX soldering irons are small and easy to handle as pencils. Their miniature size helps to speed any precision soldering operation. Damage to adjacent components is eliminated. If you can see it, you can solder it with ORYX!

A standard, utility-type 100 watt soldering iron weighs about 2 lbs. The so-called pencil-type irons typically weigh between 2 and 6 ounces. ORYX soldering irons, by contrast, weigh as little as ¼ ounce. This true feather weight virtually eliminates hand fatigue. Workers can turn out many more joints per hour with fewer rejects.

All ORYX soldering irons utilize a unique element-in-the-tip design principle. By generating the heat within the tip, far fewer watts are needed to achieve results comparable to much larger irons. This principle also provides quicker heat recovery because the heat path between element and joints is so very short. The need for large insulating handles is eliminated.

ORYX low-voltage irons are polarized, making it possible to directly ground the shaft, tip, and one side of the heating element. This provides a maximum degree of safety, both to the operator and to delicate circuitry. The ORYX line of 115 V. plug-in models includes 3-wire styles whose shafts and tips may be connected to ground for safety.

LOW-VOLTAGE, MINIATURE PRODUCTION SOLDERING IRONS

	Model	Volts	Watts	Temp.	Length	Weight	Tip Type	Tip Dia.	Net Ea.	12 or More
MICROCIRCUIT MODELS for joints having negligible mass.	5S	4.5	4.5	575°F.	4¾"	½ oz.	S	⅛"	\$5.95	\$5.35
	6	6	6	652°F.	6"	¼ oz.	Fixed	⅛"	5.95	5.35
PRINTED CIRCUIT MODELS for normal component parts such as diodes, ¼ and ½ watt resistors, transistors, etc.	6A	6	6	690°F.	6"	¼ oz.	B	⅜"	5.95	5.35
	9-6	6*	8.3	750°F.	6"	¼ oz.	A	⅜"	5.95	5.35
HIGH-TEMPERATURE MODEL for special solder alloys.	11-6	6	10	835°F.	6"	¼ oz.	E	⅜"	7.45	6.70
HEAVY-DUTY MODELS for tube socket terminals, lugs, 1 and 2 watt resistors, etc.	12-6	6*	12	700°F.	6¼"	½ oz.	C	⅜"	5.95	5.35
	18-6	6	18	800°F.	7¼"	¾ oz.	F	⅜"	7.95	7.15

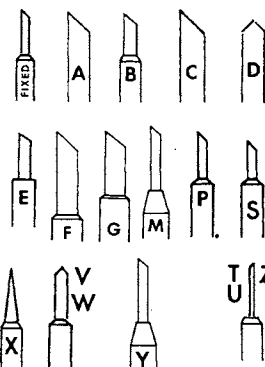

* 12-volt models also available on special order at no additional charge.

NOTE: See following page for Telvac transformers to operate low-voltage soldering irons.

REPLACEMENT TIPS for low-voltage soldering irons

Oryx tips are precision machined from a special copper alloy with outstanding heat conduction characteristics. Nickel plating reduces scaling. Iron-plated tips and solid nickel tips give much longer life with slightly reduced heat transfer. Gold tips recommended for microcircuits only.

Type	Material	Plating	Diameter	For Model	Net Ea.	Type	Material	Plating	Diameter*	For Model	Net Ea.
A	Copper alloy	Nickel	⅜"	9-6	\$.54	S	Copper alloy	Nickel	⅛" (short)	5S	\$.60
B	Copper alloy	Nickel	⅜"	6A, 9-6	.54	T	Gold end, copper body	Nickel	1/25"	5S, 6A	2.35
C	Copper alloy	Nickel	⅜"	12-6	.54	U	Gold end, nickel body	—	1/25"	5S, 6A	2.35
D	Solid Nickel	—	⅜"	11-6	1.80	V-PL	Copper alloy	Iron	⅜"	6A, 9-6	1.50
E	Solid Nickel	—	⅜"	11-6	1.80	W	Copper alloy	Bare (NASA)	⅜"	6A, 9-6	.45
F	Copper alloy	Nickel	⅜"	18-6	1.25	X	Copper alloy	Nickel	1/25"	5S, 6A	.85
G	Solid nickel end	Nickel	⅜"	18-6	1.85	X-PL	Copper alloy	Iron	1/25"	6A, 9-6	1.50
M	Solid nickel end	Nickel	⅜"	18-6	1.85	Y-PL	Copper alloy	Iron	⅜"	18-6	2.25
N	Copper alloy	Nickel	1/8"	TW-12	1.25	Z	Copper alloy	Nickel	1/25"	5S	.85
P	Copper alloy	Nickel	⅜"	5S, 6A	.60	Z-PL	Copper alloy	Iron	1/25"	6A, 9-6	1.50

TELVAC INSTRUMENT CO.

National Sales Agency

ORYX

PRECISION SOLDERING EQUIPMENT

15 W. MINIATURE PLUG-IN IRON

- **NO TRANSFORMER.** Standard model furnished with U/L approved 4½' cord set. Ready to plug in! Three-wire model (less plug) also available.
- **COMPACT DESIGN** for light production, laboratory, and service use. Irons weigh only 1 oz., plus cord.
- **HEATS QUICKLY** (about 1 minute) to 725°F. (15 W.)
- **REPLACEABLE TIPS.** Furnished with ⅜" J tip (also takes other tips and solder cups listed below).

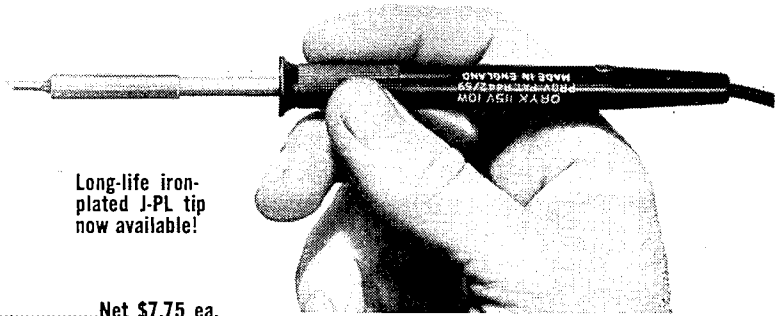

Long-life iron-plated J-PL tip now available!

MODEL 115-15J Net \$7.75 ea.
(12 or more, \$6.95 ea.)

NOTE: This model previously furnished with ⅜" K tip. Because of trend to smaller components, the ⅜" J tip is now furnished as standard. A 3-wire grounding-cord model (less plug) is also available at no extra cost. Add "-3" to catalog number.

REPLACEMENT TIPS AND ELEMENTS for model 115-15J

Type	Material	Diameter	Net ea.
J	Copper alloy	⅜"	\$1.55
J-PL	Copper, Iron plated	⅜"	2.25
K	Copper alloy	⅜"	1.70

Type	Material	Diameter	Net ea.
R	Solid nickel end	⅜"	\$1.85
115-10E	Replacement element — 10 watts (special)		3.60
115-15E	Replacement element — 15 watts (standard)		3.60

SOLDERING TWEEZERS



MODEL TW-6 — Precision model for semiconductors, solid state, hairspring movements, miniature relays, thermostats, etc. Solid Nickel ⅜" fixed tips. Nominal temperature 550°F. Weighs 1 oz. 6-volts, 18-watts, AC or DC.

MODEL TW-6, complete with 4½' cord Net \$14.95 ea.
MODEL TW-6E (spare element assembly) Net \$ 5.30 ea.

Unique tools with heating elements in each arm. Speed soldering time by heating both sides of joint. Tweezer action conducts heat quickly into joint. Low-voltage operation assures safety to circuitry and to operator.



MODEL TW-12 Heavy duty model for regular production-line soldering of radio, TV, radar, telephone, and switchboard assemblies. Furnished with replaceable ⅜" N tips. Nominal temperature 625°F. Weighs 2 oz. 12-volts, 25-watts, AC or DC.

MODEL TW-12, complete with 4½' cord Net \$16.50 ea.
Spare Tips "N" Net \$ 1.25 ea.
SK-12 stripper heads for TW-12 (kit of 2 heads and 2 screws) Net \$ 1.35 kit

MINIATURE SOLDER POT

Quick-heating, miniature solder pot for production, service, or laboratory use. Heats to 550°F in just 4 minutes. For tinning wires and component leads; heating waxes and potting compounds. Capacity 2.5 cc. For 115 V. AC or DC.

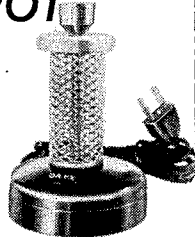

SP-115. With cord set ready to plug in.
SP-115-3. 3-wire grounding model, less plug.
EITHER MODEL Net \$12.95 ea.
SPC. Replacement cup and stem 2.85 ea.
SP-115-E. Replacement element 3.60 ea.
60-40 solder slugs for above54 ea.

THERMAL STRIPPER FOR TEFLON*

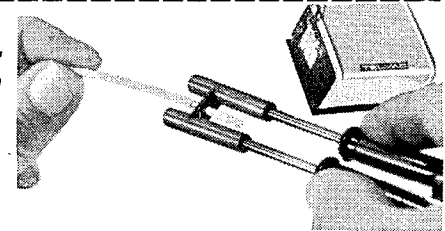

Here is the tool you've been asking for — a thermal wire stripper to remove those difficult p.t.f.e. insulations. The new ORYX ST-60 has special high-temperature heads that quickly melt through tough insulation, yet will not damage those critical inner conductors. This compact 2-oz. stripper reaches easily into hard-to-get-at spots, making it ideal for repair and prototype use, as well as for production. Use the ST-60 with Telvac transformer #5024, or any other 24-volt 60-watt power source. Transformer #5024 has a 12-volt tap, allowing use of the ST-60 on PVC and other low-temperature insulations. (Transformer may also be used to power other Oryx 12-volt and 24-volt tools.)

MODEL ST-60 (Stripper only) Net \$19.95 ea.
MODEL 5024 (Transformer only) Net 8.95 ea.
MODEL ST-60E (Spare element assembly) Net 9.95 ea.

SOLDER CUPS

Solder cups replace tips on Oryx model 18 and 115-15 soldering irons. For tinning wires and component leads. Hold 2.5 cc. Nominal temperature 550-600°F.



SC-18 (Use with Oryx 18-6 soldering iron.)
SC-115 (Use with Oryx 115-15 soldering iron.)
EITHER MODEL Net \$2.25 ea.

SOLDER SUCKER

Removes excess solder from circuit boards and terminals. Small and light — easily used with one hand. Has its own built-in stand, so it can simply be put down on the bench between operations. Solder reservoir is stainless steel, easily cleaned. Suction tip is heavily chrome plated so that solder will not adhere.



The Oryx solder sucker operates on safe low voltage. Requires just 18 watts at 6 volts AC or DC. May be used with transformer 54203-6V or 54204-T listed below, or other 6-volt power source.

MODEL SS-18-6 Net \$19.95 ea.

"PVC" WIRE STRIPPERS

Reach those hard-to-get-at spots. Miniature tweezer design.



Ideal for repair and prototype work where a bench stripper is unsuitable. Strips Nylon, rubber, PVC, Kel-F, Polystyrene, and similar medium-temperature insulations. Stainless steel stripping heads are abrasive-tumbled to eliminate sharp edges which might damage conductors. Operating temperature: 400°F. Furnished with 4½' cord.

MODEL ST-6. For 6-volts, AC-DC, 12 watts Net \$15.95 ea.
ST-6E Replacement element-head assembly for ST-6 Net 5.30 ea.

TRANSFORMERS

6-VOLT TRANSFORMER — Model 54203-6V. Output 6-volts, 18-watts. For use with all 6-volt Oryx tools. Operates on 115 V. AC. with 4½' cord set — ready to plug in. Clip-holder on top for iron Net \$5.50 ea.

TAPPED TRANSFORMER — Output 4½ to 6-volts in ½ v. steps. For exact temperature control on all Oryx 6-volt tools. Operates on 115 V. AC — ready to plug in. Model 54204-T Net \$6.50 ea.

24-VOLT/12-VOLT TRANSFORMER — Output 24-volts with 12-volt tap. For use with ST-60 thermal stripper and Oryx 12-volt tools. For 115 V. AC. Ready to plug in Model 5024 Net \$8.95 ea.

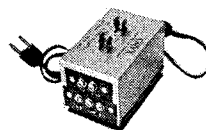

STAND

A small, adjustable stand to fit all Oryx soldering instruments. Designed to be screwed to bench. Heavily plated.



MODEL S-1 Net \$1.95 ea.

VACUUM TWEEZER SYSTEM

This new parts-handling system positively and precisely lifts parts varying in size from microscopic to those weighing several ounces. Parts are handled without damage or contamination. Defects caused by pinching, scratching, or marring are eliminated. Critical surfaces are protected. Vacuum is turned on and off with the forefinger. For 115 V. A.C. Complete system, ready to plug in.

Individual Vacuum Components

Cat. No.	Description	Net ea.	Cat. No.	Description	Net ea.
1505	Vacuum generator	\$22.50	1565	Tip, .047" i.d., #16	\$.49
1575	Probe	4.95	1568*	Tip, .085" i.d., #12	.69
1550	Tip, .006" i.d., #30	.49	1580	Neoprene cup, .5" dia.	.90
1555	Tip, .01" i.d., #25	.49	1585	Neoprene cup, .25" i.d.	.90
1560	Tip, .016" i.d., #22	.49	1587*	Neoprene cup, .18" i.d.	.90
1562*	Tip, .023" i.d., #20	.49	1510	Tubing, 4' length	1.00
1564*	Tip, .033" i.d., #18	.49	1590	Filter	.90

* Not included in K-150 system.

Complete System K-150

Net ea. **\$34.50**

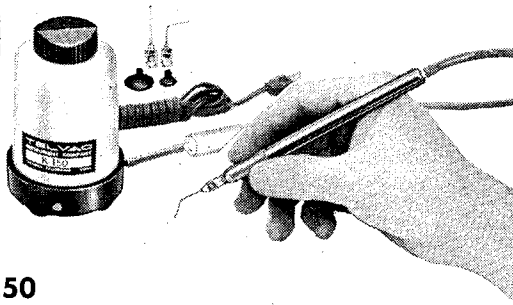

"IN-CIRCUIT" TRANSISTOR TESTER

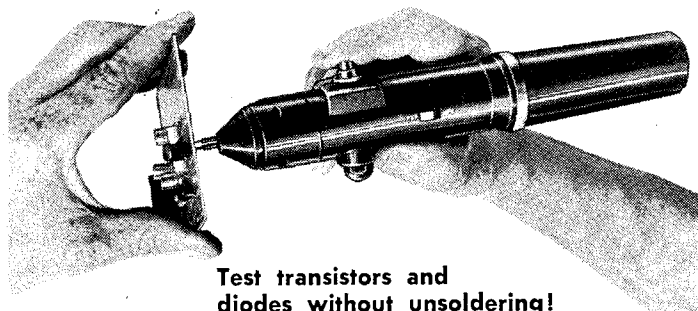

Test transistors and diodes without unsoldering!

A new test instrument for the circuit designer or test technician. Makes rapid "go-no go" evaluations of semiconductors while they are still in the circuit. Checks cut-off and conduction on PNP and NPN transistors and diodes without the need for costly unsoldering. To use, the operator sets the selector switch to NPN or PNP. He then presses the tester's sharp spring-loaded pins (arranged in TO-5 configuration) against the transistor's printed circuit connections. Open and shorted transistors are readily identified by noting the condition of the tester's pilot light. Diodes and unmounted transistors are similarly tested using a set of extending leads and clips. An optional 7-position diode adapter may be used to test diodes in the circuit. Furnished complete with extending leads and alkaline battery, ready to operate.

- MODEL SC-4 TESTERNet \$72.50 ea.
- MODEL 1330 DIODE ADAPTERNet 16.50 ea.
- APX-24 BATTERY\$1.00 223 LAMP35 ea.

"MICRO-MAN" MANIPULATOR

A new micromanipulator used for probing microcircuits, aligning laser and maser systems, handling radioactive samples. Has many applications in fields of physics, microelectronics, and biology. Resolution 0.0001" in the vertical plane—0.004" in the horizontal plane. Left and right movements: approximately 2". Fore and back movements approximately 1". Tilt capability 60°. Overall height 7". Heavy cast iron base.

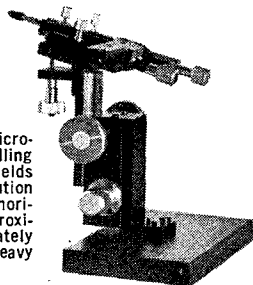

MODEL MMNet \$135.00 ea.

INSTRUMENT REPAIR KIT

A 35-piece kit of fine precision tools for the instrument shop or laboratory. Includes miniature soldering iron, taper-jaw diagonal cutter, needle-nose plier, precision screwdriver kit, tiny stub-nose scissors, eye loupe, needle-file set, 11-piece knife set, hex wrench set, spline-key set, soldering aid set, and a precision Dumont-type tweezer.



MODEL K-50Net \$49.50 ea.

POCKET MICROSCOPE

- ADJUSTS 40 to 60 POWER
- REFLECTING MIRROR

An outstanding instrument that makes microscopic inspection possible wherever you may be. High magnification (x 60) reveals much more than ordinary magnifiers. Reflecting mirror almost doubles surface illumination. Model 890-M has calibrating scale that measures in both millimeters and thousandths of an inch. Both models have dustproof optics and are furnished with a case.

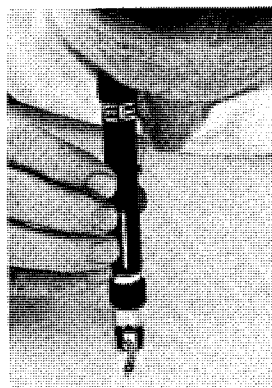

MODEL 890Net \$12.95 ea.
MODEL 890-MNet 19.95 ea.

ANTI-SEIZE

Provides gas- and moisture-tight seal to screw threads, antenna, or conduit connections. Eliminates seizing and galling. No mixing—ready to use. Meets MIL-A-907.



NSTK-1 (1-oz. sample tin)Net \$.29 ea.
NSTK-16 (1-lb. can)Net 3.50 ea.

INSTRUMENT OILER

The Telvac Reach-All pen oiler is fitted with an extending/retracting stainless tube that lets you reach a full 9 1/2" to put oil exactly where you want it. Dispenses one drop at a time. Comes filled with highest quality instrument oil that meets MIL-L-6085. Pen size—handy pocket clip.

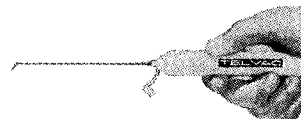

MODEL TVONet \$.99 ea.

"LAB-VAC" VACUUM CLEANER

A compact vacuum cleaner to keep everything "clean room" clean. Clean inside chassis, instruments, racks, optical apparatus, etc. Has a 5" tapered accessory nozzle to reach into corners and tight spots. A brush is also included for cleaning flat surfaces and table tops. For 115 V. AC.

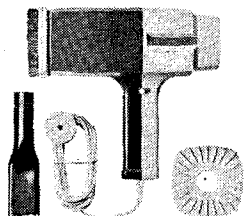

MODEL TVMNet \$24.95 ea.

HEADBAND VIEWER

Stereoscopic magnifier for precision work. Accurately ground lenses with required prismatic effect prevent eyestrain. Magnification 2 1/2X at 8". Watchmaker's glass folds down to increase magnification to 5X at 2-3". A hood shields the eyes from glare. The lower side is open, allowing downward vision for handling tools and taking notes. May be used with glasses.



MODEL 606Net \$17.95 ea.

INSTRUMENT PLIERS

Precision tools for delicate instrument and electronic work. Featuring box joints and unusually small, fine heads. Each pair of pliers accurately adjusted. All models have vinyl cushion hand grips.



Description	5½" Models Cat. No.	4½" Models Cat. No.	Prices - Either Size Net ea.	10 or more
Flat nose	11B	10B	\$3.75	\$3.35
Round nose	21B	20B	3.75	3.35
Needle nose	26B	25B	3.95	3.55
Chain nose	31B	30B	3.75	3.35
Diagonal cutter	—	40B	5.25	4.75
Diagonal cutter (hard wire)	—	46B	8.90	7.95
Flush end cutter	—	50B	5.25	4.75
Relay adjusting (straight)	53B	—	4.75	4.25
Relay adjusting (angled)	57B	—	4.95	4.45

Plastic cushion grips on all models to reduce operator fatigue. Needle-nose pliers have smooth surfaces with radius edges for bending fine wires. Chain-nose pliers have fine serrations on tips for gripping. Diagonal cutter 40B is a fine taper-jaw style that gives flush cut on soft wires. Diagonal cutter 46B is Swedish-style made of special steel for use on nickel and hardwires and for extra-long life on normal wires. Cutters only are available with return spring. Add X to catalog number and 25¢ to net price. Relay adjusting pliers have thin, flat surfaces for reaching into restricted spaces.

WIRE STRIPPERS

Unique wire-stripping pliers for wires #8 through #24. Just squeeze and pull! T-52 has 11 narrow cutting blades that close in around the wire to automatically provide the correct stripper opening and cutting tension. No operator adjustments required when changing from one wire size to another! T-22 is set to required wire size by operator. Tool steel heads have razor-sharp edges. Both models have red vinyl cushion handle grips.

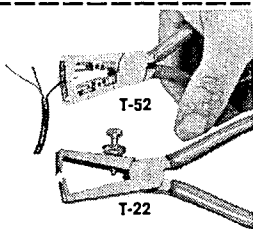

T-52Net \$6.95 ea. T-22Net \$4.15 ea.

SCISSORS

Four models for electronic work. T-3 is box joint cutter for very fine wires. T-6 is popular "electrician's" model for all cutting jobs. T-7 has small cut length for close-quarter jobs and wire cutting. T-9 is a high-leverage cutter for very hard wires and light sheet metal. T-10 is extra-fine pointed scissor for cutting the very finest wires and materials.



Cat. No.	Description	Length	Net ea.	10 or more
T-3	Fine wire nipper	4"	\$3.55	\$3.20
T-6	Electrician's scissors	5"	2.65	2.40
T-7	Stub-nosed scissors	4"	2.65	2.40
T-9	High-leverage cutter	4¾"	7.49	6.75
T-10	Fine pointed scissors	4½"	3.25	2.95

NEEDLE FILES

Precision Swiss needle files with vinyl cushion finger grips. 8 styles in 2 sizes. For delicate work. No. 2 cut.

Style	Cat. No. 4"	Cat. No. 6¼"	Cut Symbol	Net Price per file
Round	1000	1100	○	4" styles\$59 (10 or more, \$53)
Square	1001	1101	□	
Triangular	1002	1102	△	6¼" styles ..\$.82 (10 or more, \$.78)
Knife	1003	1103	▽	
Equalling	1004	1104	◇	
Oval	1005	1105	◊	
Flat	1006	1106	▭	
Half round	1007	1107	◐	

FILE KITS

Set of 8 precision Telvac files in plastic case.
Cat. No. 2000 (4" styles)Net \$5.75 ea.
Cat. No. 2100 (6¼" styles)Net 6.95 ea.

HEMOSTATS

Versatile tools with unusual holding qualities. Three-position snap lock clamps work tightly. Holds wire for soldering; acts as a heat sink; retrieves small parts. Box joints.
T-20 (straight — 6")Net \$3.85 ea. T-30 (curved — 6")Net \$3.95 ea.
T-25 (straight — 5")Net 3.25 ea. T-35 (curved — 5")Net 3.35 ea.

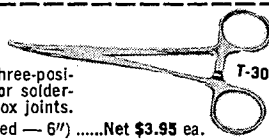

TWEEZERS

ASSEMBLY TWEEZERS

Industrial assembly tweezers with vinyl cushion finger grips to reduce operator fatigue. Bright nickel plated. 11 models.

Cat. No.	End Style	Configuration	Length	Net ea.	10 or more
102	Pointed	Straight	4"	\$1.35	\$1.22
112	Pointed	Angled	4"	1.35	1.22
202	Round	Straight	4"	1.35	1.22
302	Flat	Straight	4"	1.10	1.00
312	Flat	Angled	4"	1.55	1.35
612	Medium oblong	Angled	4½"	1.45	1.30

STAINLESS STEEL

TEFLON-COATED TWEEZERS

All models are stainless steel. All models have broad holding surfaces. 700-series are reverse-action clamping types for holding or heat-sink. Teflon coated models are used where metal cannot touch parts being handled.

Cat. No.	Style	Length	Configuration	Teflon Coated?	Net ea.	10 or more
603	Semiconductor	4½"	Straight	No	\$1.95	\$1.75
613	Semiconductor	4½"	Angled	No	2.35	2.10
653	Semiconductor	4½"	Straight	Yes	3.75	3.35
663	Semiconductor	4½"	Angled	Yes	4.00	3.60
216	Heavy-duty	7"	Angled	No	3.85	3.45
266	Heavy-duty	7"	Angled	Yes	6.25	5.65
702	Small clamping	4"	Straight	No	2.95	2.65
712	Small clamping	4"	Angled	No	3.15	2.85
752	Small clamping	4"	Straight	Yes	4.65	4.20
762	Small clamping	4"	Angled	Yes	4.95	4.45

DUMONT STYLE TWEEZERS

For extremely delicate work. Dumont-style tweezers are an order of magnitude finer than ordinary tweezers. 103, 105 and 107 are stainless steel.

Cat. No.	Style	Description	Length	Net ea.	10 or more
103	#3	Fine points	4½"	\$3.90	\$3.50
105	#5	Extra-fine points	4½"	4.20	3.80
107	#7	Fine points, curved	4½"	4.60	4.15
10-D	D	Top flush cutter	4½"	3.75	3.35

PRECISION DRIVERS

SCREWDRIVER SETS in plastic cases

Precision jewelers-type screwdriver sets for miniature slotted fasteners. Set 540 has 5 insulated-handle drivers from .04 to .12". Set 579 has 6 drivers from .025 to .1", with removable chrome-vanadium blades. Set 583 includes 6 fixed-blade drivers from .025 to .1".

MODEL 540 (Insulated set)	Net \$4.95 ea.
MODEL 579 (Removable-blade set)	Net 9.95 ea.
Cat. No. B-579H (Set of blades for #579)	Net 1.75 ea.
MODEL 583 (Fixed-blade set)	Net 2.95 ea.

SPLINE- AND HEX-KEY SETS

10-piece short-arm key sets in plastic cases. Includes all small sizes used in instruments and precision electronics. Set 850 has Allen wrenches from .028" to ¾". Set 870 includes all Bristol-type spline keys from .033-4 to .133-6.

MODEL 850 (Hex-key set)	Net \$1.10 ea.
MODEL 870 (Spline-key set)	Net 1.10 ea.

INSTRUMENT DRIVER SET

24-PIECES WITH CASE

A new 24-piece driver set for use on miniature instrument fasteners. Includes two jewelers-type handles, 6 slotted driver blades .025 to .1", marking awl, #0 to #1 Phillips driver blades, 5 nut-driver blades ¼ to ¾", 5 open-end wrench blades ¼ to ¾", and 3 Allen-type blades for #4, #6 and #8 screws. Plastic case.

MODEL K-200

PRECISION KNIFE SET

A beautifully-made set for deburring, scraping, stripping fine wires, printed-circuit repairs, etc. Kit consists of handle and an assortment of 10 tiny blades in a plastic case.

KIT, MODEL K-90	Net \$3.15
EXTRA BLADES, Cat. No. 9100 Package of 10 blades (assorted)	Net 1.98

BURNISHER

Inexpensive, non-residual contact burnisher for silver, platinum, gold, palladium, tungsten, molybdenum, and all other precious-metal contacts. This tool leaves no filings, grit, or film. Plastic insulating handle. Vinyl case.

Cat. No. 960 (Package of 3 burnishers)



SCREW DRIVERS

- Precision Ground... Unconditionally Guaranteed
- Comfordome® Slo-Burn S/B AMBERYL® Handles are easy on the hands
- Nickel-Chrome Plated #6150 Steel Blades will not rust or corrode

ROUND BLADE SCREW DRIVERS

Pocket Clip Styles

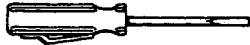

Stock No.	Blade Diameter and Length	Overall Length	Price
A 010	3/8" x 1 3/8"	3 3/8"	\$.26
A 230-2	1/8" x 2"	3 3/4"	.27
A 130-2	1/8" x 2"	3 3/8"	.33
A 130-3	3/8" x 3"	4 1/2"	.33
A 116-2	3/8" x 2"	4 1/2"	.39
A 116-3	3/8" x 3"	5 1/2"	.39
A 116-4	3/8" x 4"	6 1/2"	.39
A 131-2	1/8" x 2"	4 1/4"	.39
A 131-3	1/8" x 3"	5 1/2"	.39

Electrical and Cabinet Styles

A 216-2	1/8" x 2"	4 3/4"	.56
A 216-3	1/8" x 3"	5 3/4"	.62
A 216-4	1/8" x 4"	6 3/4"	.63
A 216-6	1/8" x 6"	8 3/4"	.65
A 216-8	1/8" x 8"	10 3/4"	.70
A 216-10	1/8" x 10"	12 3/4"	.78

General Service Styles

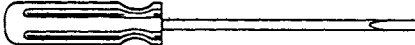

A 316-3	3/8" x 3"	6 1/2"	.78
A 316-4	3/8" x 4"	7 1/2"	.83
A 316-6	3/8" x 6"	9 1/2"	.93
A 316-8	3/8" x 8"	11 1/2"	.98
A 316-10	3/8" x 10"	13 1/2"	1.06
A 416-3	1/4" x 3"	6 3/8"	.99
A 416-4	1/4" x 4"	7 3/8"	1.01
A 416-6	1/4" x 6"	9 3/8"	1.06
A 416-8	1/4" x 8"	11 3/8"	1.12
A 416-10	1/4" x 10"	13 3/8"	1.22

Heavy Duty Styles (Keystone)

A 516-4	3/8" x 4"	8"	1.29
A 516-6	3/8" x 6"	10"	1.34
A 516-8	3/8" x 8"	12"	1.43

Extra Heavy Duty Styles (Keystone)

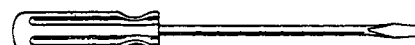

A 816-6	3/8" x 6"	10 1/2"	1.60
A 616-8	3/8" x 8"	12 1/4"	1.71
A 616-10	3/8" x 10"	14 1/4"	1.94

Stubby Styles



A 132	1/4" x 1 1/4"	3"	.76
A 135	3/8" x 1 3/4"	3 3/8"	.99

OFFSET SCREW DRIVERS— REGULAR TYPE

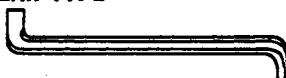

Stock No.	For Screw No.	Overall Length	Price
VO 1	2 to 6	3"	\$.44
VO 2	6 to 10	4"	.70
VO 3	8 to 12	5"	.80
VO 4	12 to 16	6"	1.01

SQUARE BLADE SCREW DRIVERS

General Service Styles

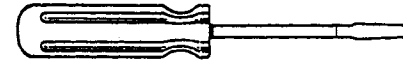

Stock No.	Blade Size and Length	Overall Length	Price
C 33	3/16" x 3"	6 1/2"	\$.98
C 34	3/16" x 4"	7 1/2"	1.01
C 36	3/16" x 6"	9 1/2"	1.05
C 38	3/16" x 8"	11 1/2"	1.12

Medium Duty Styles

C 43	1/4" x 3"	6 3/4"	1.14
C 44	1/4" x 4"	7 3/4"	1.21
C 46	1/4" x 6"	9 3/4"	1.26
C 48	1/4" x 8"	11 3/4"	1.39
C 410	1/4" x 10"	13 3/4"	1.60
C 54	3/8" x 4"	8 1/4"	1.60
C 56	3/8" x 6"	10 1/4"	1.66
C 58	3/8" x 8"	12 1/4"	1.68
C 510	3/8" x 10"	14 1/4"	1.84

Heavy Duty Styles

C 68	3/8" x 6"	10 1/2"	1.84
C 68	3/8" x 8"	12 1/2"	1.97
C 610	3/8" x 10"	14 1/2"	2.24
C 612	3/8" x 12"	16 1/2"	2.35

PHILLIPS SCREW DRIVERS

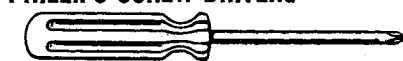

Stock No.	Handle Diameter and Length	Point No.	Overall Length	Price
P 01	3/8" x 2 3/4"	0	5 1/4"	\$.67
P 1	1/2" x 3 1/2"	1	6 1/2"	.90
P 2	1" x 3 3/4"	2	7 1/2"	1.14
P 3	1 1/4" x 4"	3	10"	1.55
P 4	1 3/8" x 4 1/2"	4	12 1/2"	1.84
P 5	1 1/2" x 2 3/8"	2	3 3/8"	.99
P 6	1 1/8" x 1 3/4"	1	3"	.90

Pocket Clip Type

P 12	1/2" x 2 1/4"	0	5"	.67
------	---------------	---	----	-----

Extra Long Blade

P 18	7/8" x 3 1/4"	1	11 1/2"	1.01
P 22	1" x 3 3/4"	2	11 3/4"	1.18
P 212	1" x 3 3/8"	2	15 3/4"	1.32
P 202	1 3/8" x 4 1/2"	2	24 1/2"	2.18

Phillips Offset Type

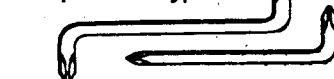

Stock No.	Style	Point Size On End	Price
P 111	Single End	#1 on Both Ends	\$.49
P 120	Double End	#1 and #2	.62
P 222	Single End	#2 on Both Ends	.54
P 230	Double End	#2 and #3	1.01
P 340	Double End	#3 and #4	1.18

REVERSIBLE SCREW DRIVERS

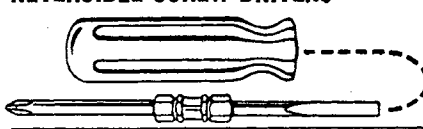

Stock No.	Type and Size of Blade	Price
DU 2	No. 1 Phillips x 3/8" Regular	\$1.31
DUH 4	No. 2 Phillips x 1/2" Regular	1.58
DU 5	No. 2 Phillips x 1/2" Reg. (Stubby)	1.58
DU 11	No. 1 Phillips x 3/8" Reg. plus 1/4" Hex.	1.53
DUP 12	No. 1 Phillips x No. 2 Phillips	1.74
DU 34	3/8" Regular x 1/2" Regular	1.53
DU 45	1/2" Clutch Head x 3/8" Clutch Head	1.34
DU 68	3/8" Clutch Head x 1/2" Clutch Head	1.73

SPECIALTY SCREW DRIVERS

Radio & Television Aligners

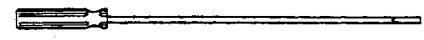

Stock No.	Size or Type	Overall Length	Price
AT 55	—	7 1/2"	\$.67
AT 510	—	12 1/2"	.78

Neon Tester Screw Drivers

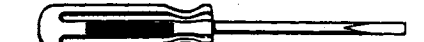

AN 2	Pocket Clip	5 1/2"	.98
AN 44	—	7 3/4"	1.60

Double End Nut Drivers

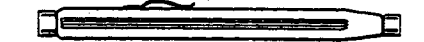

DE 810	1/4" & 3/8"	6"	.98
DE 1210	3/8" & 3/4"	6"	1.18

Combination Screw & Nut Drivers



ND 141	Regular	5 1/2"	.98
--------	---------	--------	-----

Midget 1/4" Nut Drivers



PK 8	—	3 3/4"	.58
------	---	--------	-----

Slimline Drivers



A 86	—	5 3/4"	.72
A 99	—	8"	.86

Non-Magnetic Metal Tip Aligner



AT 49	—	5 1/2"	.54
-------	---	--------	-----

Insulated Screw Drivers



Stock No.	Handle Size	Overall Length	Color Key	Price
VR 241	3/4" x 3"	7"	Grey	\$.84
VR 261	3/2" x 3"	9"	Grey	.95
VR 281	3/2" x 3"	11"	Grey	.99
VR 341	3/2" x 3 1/2"	7 1/2"	Black	1.06
VR 381	3/2" x 3 1/2"	9 1/2"	Black	1.10
VR 381	3/2" x 3 1/2"	11 1/2"	Black	1.16
VR 441	1" x 3 3/4"	7 3/4"	Red	1.26
VR 481	1" x 3 3/4"	9 3/4"	Red	1.34
VR 481	1" x 3 3/4"	11 3/4"	Red	1.43
VR 581	1 1/4" x 4"	10"	Yellow	1.70
VR 581	1 1/4" x 4"	12"	Yellow	1.79
VR 581	1 3/8" x 4"	14"	Yellow	1.94

Beryllium Copper (Non-Magnetic)



Round			
Stock No.	Handle Size	Overall Length	Price
VB 26	3/4" x 2 3/4"	8 3/4"	\$1.21
VB 210	3/2" x 2 3/4"	12 3/4"	1.34
VB 38	3/2" x 3 1/2"	11 1/2"	2.14
VB 48	1" x 3 3/4"	9 3/4"	2.66
VB 48	1" x 3 3/4"	11 3/4"	2.92

Square			
Stock No.	Handle Size	Overall Length	Price
VB 550	1 1/4" x 4 1/4"	9 1/4"	3.85
VB 680	1 3/8" x 4 1/2"	10 1/2"	5.83

Phillips			
Stock No.	Handle Size	Overall Length	Price
PB 14	3/4" x 3 1/2"	6 1/4"	1.99
PB 26	1" x 3 3/8"	7 3/4"	2.80



NUT DRIVERS SCREW LAUNCHERS SPECIALTY TOOLS

HOLLOW SHAFT NUT DRIVERS



- Extra Hard Tempered Sockets
- Beautiful Polished Nickel-Chrome Finish
- Large Colored-For-Size Handles

Extra Small Hex Size

Stock No.	Handle Dia. and Length	Hex Size	Overall Length	Handle Color	Price
S 4	7/8" x 3 1/2"	1/8"	6 1/2"	Amber	\$.93
S 5	7/8" x 3 1/2"	3/32"	6 1/2"	Amber	\$.93

3" Shaft Length

S	Handle Dia. and Length	Hex Size	Overall Length	Handle Color	Price
S 6	1" x 3 3/8"	3/16"	6 5/8"	Black	.93
S 7	1" x 3 3/8"	1/8"	6 5/8"	Amber	.93
S 8	1" x 3 3/8"	1/4"	6 5/8"	Red	.93
S 9	1" x 3 3/8"	3/32"	6 5/8"	Amber	.93
S 10	1" x 3 3/8"	3/16"	6 5/8"	Amber	.93
S 11	1" x 3 3/8"	1/2"	6 5/8"	Green	.93
S 12	1" x 3 3/8"	3/8"	6 5/8"	Blue	.93
S 14	1 1/8" x 4"	3/8"	7"	Brown	1.14
S 16	1 1/8" x 4"	1/2"	7"	Orange	1.14

Extra Large Hex Size 4" Shaft Length

S 18	1 1/8" x 4"	3/8"	8"	Amber	1.48
S 20	1 1/8" x 4"	5/8"	8"	Amber	1.68

Extra Long 6" Shaft Length

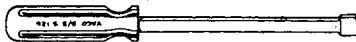

S 66	1" x 3 3/8"	3/16"	9 5/8"	Black	1.19
S 86	1" x 3 3/8"	1/4"	9 5/8"	Red	1.19
S 106	1" x 3 3/8"	3/8"	9 5/8"	Amber	1.19
S 116	1" x 3 3/8"	1/2"	9 5/8"	Green	1.19
S 126	1" x 3 3/8"	3/4"	9 5/8"	Blue	1.19
S 146	1 1/8" x 4"	3/4"	10"	Brown	1.41
S 166	1 1/8" x 4"	1/2"	10"	Orange	1.41

Stubby Style 1 1/4" Shaft Length

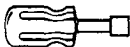

SS 8	1 1/4" x 2 1/4"	1/4"	3 1/2"	Amber	.83
SS 10	1 1/4" x 2 1/4"	3/8"	3 1/2"	Amber	.83
SS 12	1 1/4" x 2 1/4"	3/4"	3 1/2"	Amber	.83

SP-500 Plastic Boxed Set

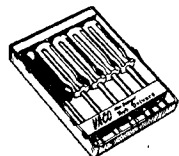

An elegant two tone gift or storage box with hinged cover contains these five popular sizes: 3/16", 1/4", 3/8", 1/2", 3/4". Size of box is 5" wide x 7" long x 1 1/8" deep.
Price\$5.13

K-7 Stand Up—Hang Up Kit

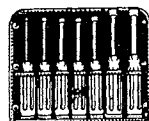

An ideal kit for the workbench or to roll up and store in the tool box. Contains the following drivers: S6, S8, S10, S11, S12, S14, S16.
Price\$8.15

S-700 All Metal Stand

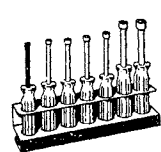

Seven of the most popular nut driver sizes are fitted into this metal stand especially designed for the workbench or for hanging on the wall. Contains one each of: S6, S8, S10, S11, S12, S14, S16.
Price\$7.65

SCREW LAUNCHERS

hold... start... drive
screws with power and comfort

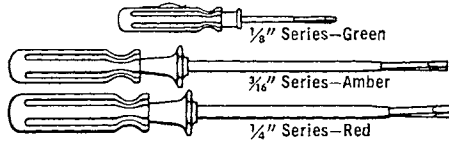

Unique design, double blade bit grips screws securely while working in tight quarters or awkward places. Easy to operate.

Stock No.	Blade Size	Handle Size	Overall Length	Price
K-21*	Mini Tip	3/8" x 2 3/4"	5 3/4"	\$1.20
K-23*	1/8" x 3"	5/8" x 2 3/4"	5 3/4"	1.08
K-28	1/8" x 8"	5/8" x 2 3/4"	10 3/4"	1.28
K-34	3/16" x 4"	7/8" x 3 1/2"	7 1/2"	1.56
K-36	3/16" x 4"	7/8" x 3 1/2"	9 1/2"	1.60
K-38	3/16" x 8"	7/8" x 3 1/2"	11 1/2"	1.64
K-44	1/4" x 4"	1" x 3 3/8"	7 3/4"	1.64
K-46	1/4" x 6"	1" x 3 3/8"	9 3/4"	1.72
K-48	1/4" x 8"	1" x 3 3/8"	11 3/4"	1.76

Phillips Screw Launchers



Stock No.	Length	Price
K-13	3"	\$1.48
K-14*	5"	1.84
K-15	5"	1.72
K-16	7"	1.80
K-19	9"	1.88

*Pocket Clip Style

SNAP DRIVERS & COMPONENTS

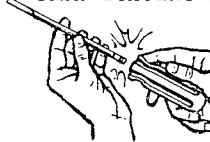

Interchangeable blades snap into Vaco handle... holds like one piece tool. Build your own kit of specialty blades.

Stock No.	Description	Price
ZH-1	Medium Duty Handle	\$.98
ZH-2	Heavy Duty Handle	1.34
ZA-1	1/4" Allen Hex Bit	.63
ZA-2	3/8" Allen Hex Bit	.65
ZA-3	1/2" Allen Hex Bit	.67
ZA-35	1/4" Allen Hex Bit	.70
ZA-4	1/2" Allen Hex Bit	.70
ZA-45	3/8" Allen Hex Bit	.72
ZA-5	1/2" Allen Hex Bit	.72
ZA-6	3/4" Allen Hex Bit	.76
ZB-24	1/4" Regular Bit	.49
ZB-34	3/8" Regular Bit	.62
ZB-45	1/2" Regular Bit	.62
ZP-01	No. 0 Phillips Bit	.58
ZP-14	No. 1 Phillips Bit	.62
ZP-24	No. 2 Phillips Bit	.65
ZS-6	3/8" Nut Driver Bit	.70
ZS-8	1/2" Nut Driver Bit	.70
ZS-10	5/8" Nut Driver Bit	.70
ZS-11	1 1/8" Nut Driver Bit	.70
ZS-12	3/4" Nut Driver Bit	.70
ZS-14	1" Nut Driver Bit	.90
ZS-16	1 1/2" Nut Driver Bit	.90
ZT-310	3-in-1 Tapping Tool Blade	2.08
ZX-56	5" Extension Piece	.98

SPECIALTY TOOLS

Stock No.	Description	Price
WS-150	Wire Stripper & Cutter	\$1.28
ML-7	Magnetic Level & Protractor	2.80
TT-31	3-in-1 Tapping Tool	2.20
DU-1*	Mini Reversible Driver	1.00
SA-711	Adjustable Nut Driver	3.00
210	Internal Snap Ring Pliers	2.35
220	External Snap Ring Pliers	2.35
K-21*	Mini Screw Launcher	1.20
K-23*	1/8" x 3" Screw Launcher	1.08
K-14*	5" Phillips Screw Launcher	1.84
TK-500	100-500V Circuit Tester	.80
HK-17	Hex Key Wrench Set	1.18
810	1/4" x 3/4" Ratchet Box Wrench	2.30
1214	3/8" x 3/4" Ratchet Box Wrench	2.60
1618	1/2" x 3/4" Ratchet Box Wrench	3.45
2022	3/4" x 3/4" Ratchet Box Wrench	3.60
2024	5/8" x 3/4" Ratchet Box Wrench	3.60
AL 2	3/4" x 3"	.82
AL 4	3/4" x 3"	.82
AL 5	3/4" x 3"	.82
AL 6	3/4" x 3 1/2"	.82
AL 7	3/4" x 3 1/2"	.94
AL 8	3/4" x 3 1/2"	.94
AL 9	3/4" x 3 1/2"	.94
AL 10	3/4" x 3 1/2"	.94
AL 12	3/4" x 3 1/2"	.94
AL 14	1" x 3 3/8"	1.04
AL 18	1" x 3 3/8"	1.04

HEX KEY WRENCHES, In above sizes, are available in short, long, extra long, and 12" lengths.

PLIERS • WRENCHES



- Precision Ground and Polished Heads
- Milled Sure Grip Jaws, Hand Honed Cutters
- Cushion Grip Handles
- Unconditionally Guaranteed

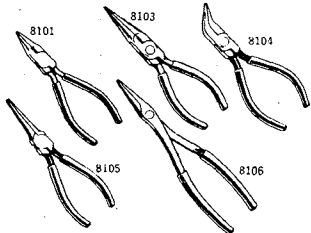

Stock No.	Description	Price
8101	Short Nidle. Nose w/Cut. 5"	\$3.12
8102	Long Nidle. Nose w/Cut. 6"	3.36
8103	Long Nidle. Nose w/Cut. 7"	3.92
8104	Curved Nose 6"	3.44
8105	Long Nose 6"	3.20
8106	Long Needle Nose 7½"	3.40

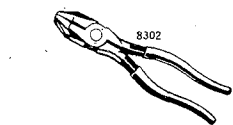

8301	Lineman's Side Cut. 6½"	\$3.28
8302	Lineman's Side Cut. 7½"	3.80
8303	Lineman's Side Cut. 8¾"	4.56



8400	Slip Joint Plier	\$1.04
8401	Slip Joint 6½"	1.56
8402	Slip Joint 8"	1.92
8403	6" Slip Joint w/Cutter	2.20

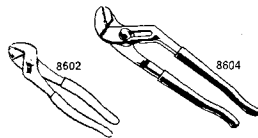

8602	Vacgruv Plier Wrench 6"	\$2.64
8604	Vacgruv Plier Wrench 10"	3.36

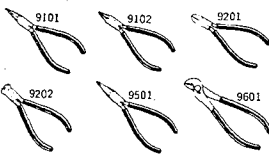

9101	Midget Long Nose 4½"	\$3.20
9102	Midget Round Nose 4½"	3.20
9201	Midget Diagonal 4½"	3.20
9202	Midget End Cutter 4½"	3.20
9501	Midget Flat Nose 4½"	3.20
9601	Midget Vacgruv 5"	3.20

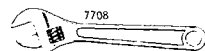

7704	4" Adjustable Wrench	\$2.68
7706	6" Adjustable Wrench	2.68
7708	8" Adjustable Wrench	3.00
7710	10" Adjustable Wrench	3.92
7712	12" Adjustable Wrench	5.60

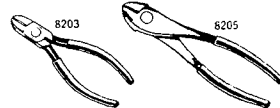

8201	Diagonal Cutter 4½"	\$2.96
8202	Diagonal Cutter 5"	3.00
8203	Diagonal Cutter 6"	3.36
8204	Diagonal Cutter 7½"	3.84
8205	H. D. Diagonal Cutter 7½"	3.52

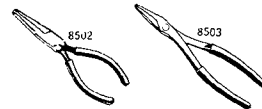

8501	Flat Nose w/ Cutter 6"	3.44
8502	Flat Nose 6"	2.96
8503	Flat Nose 7½"	3.28

VACOMBO® KITS



KIT NO. TV-27 Deluxe 27-piece kit contains practically every hand tool necessary for TV and radio work, plus extra pockets for pliers and other personal tools. Size, 20" x 13½". Price...\$23.86

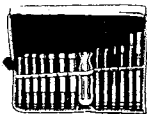

KIT NO. RT-14 Handy 14-piece snap driver kit for radio and TV service men. Contains nut drivers, Phillips and regular drivers, heavy duty handle, and 5" blade extension which doubles the usefulness of each blade. Size, 10½" x 8". Price...\$10.82



KIT NO. ZB-50 A fine, all-purpose snap driver kit of interchangeable regular and Phillips blades that fit same handle. Includes durable leatherette bag. Size, 6½" x 7". Price...\$3.77

KIT NO. ZBX-51 Same as Vaco No. ZB-50 except includes 5" blade extension. Price...\$4.70



KIT NO. ZS-60 A most versatile and complete hexagon nut driver kit for radio, TV or any other work requiring speedy nut setting. All sockets are super hard. Size, 6½" x 7". Price...\$4.84

KIT NO. ZSX-61 Same as Vaco Kit No. ZS-60 except includes 5" blade extension. Price...\$5.69

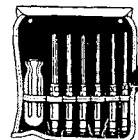

KIT NO. ZA-70 This useful snap driver kit consists of 6 Allen type hexagon blades plus handle and bag. Services screw numbers 4, 5, 6, 8, 10, ¼", ⅜", and ⅝". Size, 6½" x 7". Price...\$4.62

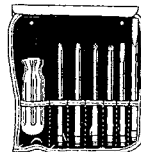

KIT NO. ZC-80 Specially designed snap driver kit includes socket head (Robertson), Phillips, and regular blades; particularly suited for Canadian use. Size, 6½" x 7". Price...\$5.02

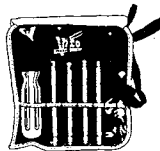

KIT NO. ZF-40 Here is a special snap driver kit designed to take care of all popular sizes of fluted spline or Bristol type recess head screws used on electronic and electrical equipment, air conditioning, refrigeration, and office machines. Size, 6½", x 7". Price...\$4.35

RATCHET DRIVERS

QUALITY FASTENERS

VACO POW'RIVETS . . . the blind rivet for foolproof fastening every time

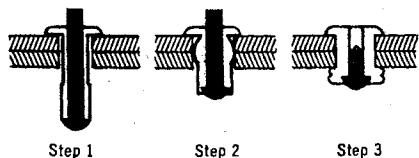

THERE IS A DIFFERENCE! Only Vaco Pow'Rivets adapt to hole size variance, and pull up snug regardless of material thickness. That's why 4 sizes do the job of 11 ordinary rivets. Three step illustration at left shows unique "bubble action" sequence which assures positive, goof-proof fastening every time.

Illustration	Stock No.	Dia. "D"	Length "L"	Grip Range	Head Dia. "HD"	Head Ht. "HH"	Hole Size	Drill	
	425	¼	.400	To .250	.215	.044	.136	#29	
	528	⅜	.470	To .280	.255	.057	.166	#19	
	631	½	.530	To .312	.349	.070	.199	#8	
	650	¾	.720	To .500	.349	.070	.199	#8	
	400	Assortment Pak							

Available in 50¢ Paks, Dollar \$ Paks, "C" (100) Paks, and "MB" (1000) Paks.

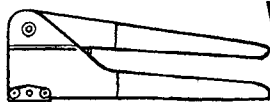

VACO POW'RIVETER

Stock No.	Description	List Price
495	Popular Rivet Tool for ¼", ⅜", ½" Rivets	\$4.95

RATCHET DRIVERS



3 Way Finger Tip Ratchet Control

Ratchet Handle for Interchangeable Snap Blades



Patent Pending

Stock No.	Handle Dia. and Length	Overall Length	Blade Dia.	Price
111001	1½" x 4¼"	10"	¼"	\$2.40
111002	1¾" x 4½"	10½"	⅜"	2.60
111004	1½" x 4¼"	Handle Only	For use with Snap Blades	2.80

VACO PROFESSIONAL POW'RIVETER

Exclusive Dual Stroke Adjustment

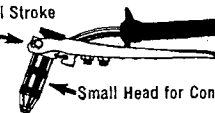

Small Head for Confined Quarters

Stock No.	Description	List Price
175002	Unique 2 in 1 Action for Professional Applications	\$22.95

MOST VERSATILE SOLDERING IRON EVER INVENTED

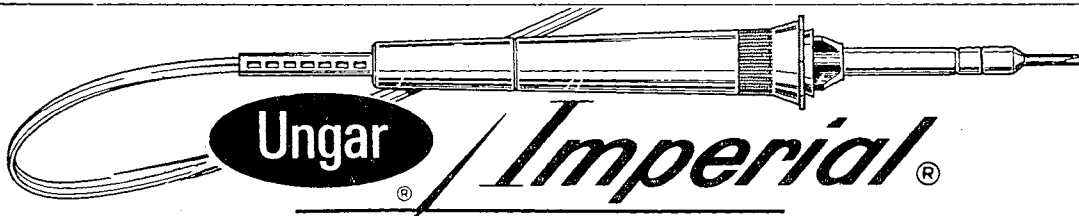

COOL, LIGHTWEIGHT, EASY-HANDLING

Ungar...developers of the industry's first miniature, low wattage, high temperature, pencil type iron...now brings you the ultimate in time-saving, money-saving soldering irons.



PERMA COOL COLORED HANDLES



#6100 turquoise, beige, ivory, and black*
1 to 9 each \$1.47

INTERCHANGEABLE CORD SETS 2-wire or grounded 3-wire

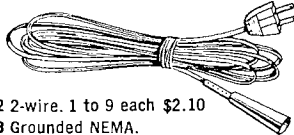

#6102 2-wire. 1 to 9 each \$2.10
#6103 Grounded NEMA.
1 to 9 each \$3.12

*Note: Designate color for handles and cord sets by adding suffix (-1 for turquoise, -2 for beige, -3 for ivory, -5 for black).

NEW 100 WATT

"Long Life" Interchangeable Heat Cartridges.

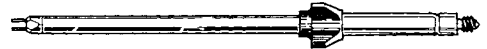

#6207 100 Watt (850-1150°F temp. range). 1 to 9 each \$6.56
#6203 60 Watt (850-1050°F temp. range). 1 to 9 each \$4.53
#6200 40 Watt (750-950°F temp. range). 1 to 9 each \$3.93
#6201 30 Watt (650-850°F temp. range). 1 to 9 each \$3.93
#6202 25 Watt (600-800°F temp. range). 1 to 9 each \$3.93
#6206 15 Watt (700-750°F temp. range). 1 to 9 each \$3.93

IMPERIAL MINI-TIP®

Thread-on soldering tips

All easy-thread tips are completely interchangeable.

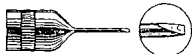

#6304 Micro-Chisel, Iron Clad, Gold Plated (24 kt.)
3/64 x 1/2 1 to 9 each \$1.03



#6305 Micro-Spade, Iron Clad, Gold Plated (24 kt.)
3/64 x 1/2 1 to 9 each \$1.03



#6482 Micro-Spade, Stepped, Iron Clad, Gold Plated (24 kt.)
3/64 x 1/2 1 to 9 each \$1.03



#6481 Tapered Screwdriver, Iron Clad, Gold Plated (24 kt.)
3/4 x 3/32. 1 to 9 each \$1.03



#6312 Pencil, Rugged Copper Alloy, 1/8 x 3/4
1 to 9 each \$4.46



#6313 Pencil, Iron Clad, Gold Plated (24 kt.) 1/8 x 3/4
1 to 9 each \$1.03



#6316 Pencil, Offset, Iron Clad, Gold Plated (24 kt.)
1 to 9 each \$1.03



#6318 Long Taper Chisel, Rugged Copper Alloy, 1/8 x 3/4
1 to 9 each \$4.46



#6319 Long Taper Chisel, Iron Clad, Gold Plated (24 kt.)
1/8 x 3/4 1 to 9 each \$1.03



#6324 Long Taper Pyramid, Rugged Copper Alloy, 1/8 x 3/4
1 to 9 each \$4.46



#6325 Long Taper Pyramid, Iron Clad, Gold Plated (24 kt.)
1/8 x 3/4 1 to 9 each \$1.03



#6331 Screwdriver, Iron Clad, Gold Plated (24 kt.)
1/8 x 3/4 1 to 9 each \$1.03



#6333 Needle, Iron Clad, Gold Plated (24 kt.) 1/8 x 3/4
1 to 9 each \$1.03



#6336 Spade, Iron Clad, Gold Plated (24 kt.) 1/8 x 3/4
1 to 9 each \$1.03

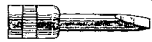

#6366 Long Taper Chisel, Iron Clad, Gold Plated (24 kt.)
3/16 x 3/4 1 to 9 each \$1.18



#6368 Long Taper Pyramid, Rugged Copper Alloy,
3/16 x 3/4 1 to 9 each \$5.4



#6372 Screwdriver, Iron Clad, Gold Plated (24 kt.)
3/16 x 3/4 1 to 9 each \$1.18



#6373 Slotted Tip, Rugged Copper Alloy, 3/16 x 3/4
1 to 9 each \$1.03



#6390 Screwdriver, Iron Clad, Gold Plated (24 kt.)
3/16 x 1 1/2 1 to 9 each \$1.22



#6424 Long Taper Chisel, Iron Clad, Gold Plated (24 kt.)
1/4 x 3/4 1 to 9 each \$1.22



#6473 Long Taper Chisel, Rugged Copper Alloy, 3/8 x 3/4
1 to 9 each \$5.54



#6474 Long Taper Chisel, Iron Clad, Gold Plated (24 kt.)
3/8 x 3/4 1 to 9 each \$1.50



New heavy duty tips.
#6500 Long taper chisel, Tellurium Copper, Iron Clad, Gold Plated.
1 to 9 each \$2.38
#6520 Long taper chisel, Tellurium Copper.
Use above tips only with #6207 Cartridge.
1 to 9 each \$1.22

NEW MICRO-TIPS Thread-on soldering tips For use with Imperial 15 watt cartridges only.



#6550 Tapered Screwdriver, Iron Clad, Gold Plated (24 kt.) .040 x .40
1 to 9 each \$1.18



#6551 Stepped Spade, Iron Clad, Gold Plated (24 kt.) .050 x .40 1 to 9 each \$1.18



#6553 Stepped Chisel, Iron Clad, Gold Plated (24 kt.) .050 x .40 1 to 9 each \$1.18



#6554 Stepped Pencil, Iron Clad, Gold Plated (25 kt.) .050 x .40 1 to 9 each \$1.18

NEW...FOR MICROSCOPIC ASSEMBLY



#6391 Precision Point, Tellurium Copper, .770 L. x .125 D. stepped to .090 D., ground and honed to .005 P. 1 to 9 each \$7.74

#6392 Precision Point, Tellurium Copper, Iron Clad, Gold Plated (24 kt.) .770 L. x .135 D. stepped to .098 D., ground and honed to .010 P. 1 to 9 each \$1.50



Specially Designed IMPERIAL HOLDER

Protects iron, keeps it safely out of the way. Black with gold cage guard and heat sink. #6800.

1 to 9 each \$1.96
STANDARD HOLDER for Ungar Standard Line Irons.
1 to 9 each \$1.96

ALL ABOVE PRICES ARE USER NET. PRICES ARE SUBJECT TO CHANGE WITHOUT NOTICE.



STANDARD LINE SOLDERING IRON

NEW #859 IC REMOVER

DESOLDERING TIP

For fast accurate desoldering of 14 and 16 pin dual inline ICs. Chrome plated for longer life. Pre-tinned to inhibit oxidation. 1-9 each \$1.65 10-49 each \$1.35 50-up each \$1.25
FOR TIP ONLY. Use only with Ungar handles and #4045 heating unit (47 1/2 watt).

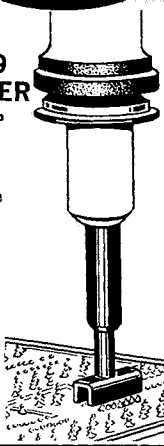

#8001 ANTI-SEIZE

1/2 oz. tube. Ungar's Anti-Seize guards against thread and tip seizure. 1 to 9 each \$.61

#7805 SOLDER-OFF

TFE Tipped bulb for safe, easy removal of components from printed circuit boards. 1 to 9 each \$1.19

#400 KLEEN-TIP SPONGE and TRAY

Removes oxidation, doubles tip life. 1 to 9 each \$1.09

#455 REFILL SPONGES 1-9 each \$.42

#7800 HOT-VAC DE-SOLDERING TOOL







Vacuum action lifts solder from board. Coating on tip and metal parts prevents solder from sticking or clogging. 1 to 9 each \$11.49

NEW



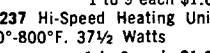
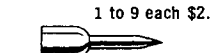







Replacement tips for #7800 HOT-VAC

- #7812 Hole Dia. .033 1 to 9 ea. \$.75
- #7813 Hole Dia. .069 1 to 9 ea. \$.75
- #7806 Hole Dia. .057 1 to 9 ea. \$.75

New UNGAR HEATING UNITS AND THREAD-ON TIPS for Hi-Speed Repeat Soldering

-  #537 Hi-Speed Heating Unit - 600° to 650°F - 23 1/2 Watts 1 to 9 each \$1.66
-  #1237 Hi-Speed Heating Unit - 750°-800°F. 37 1/2 Watts 1 to 9 each \$1.99
-  #4037 Hi-Speed Heating Unit - 850°-900°F. 47 1/2 Watts. 1 to 9 each \$2.97
-  #PL 111 PENCIL TIP. 1/8" x 3/4" iron clad, Silver Plated. 1 to 9 each \$.75
- #111 Plain Copper 1 to 9 each \$3.7
-  #PL 113 CHISEL TIP. 1/8" x 3/4" iron clad, Silver Plated. 1 to 9 each \$.75
- #113 Plain Copper. 1 to 9 each \$3.7
-  #PL 114 Stepped Micro-Spade, Iron Clad, Silver Plated 1 to 9 each \$.75
- #116 5/16" Pyramid, Rugged Copper Alloy 1 to 9 each \$3.7
- #PL 116 5/16" Pyramid, Iron Clad, Silver Plated 1 to 9 each \$.75

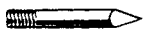
UNGAR TIPLET Soldering Tips for Heating Units shown below

- 800 Series TIPLETS fits Ungar #4045 heating unit only.
-  #PL 331 Pencil Tip. 1/8" x 1", iron clad, Silver Plated. 1 to 9 each \$.57
 - #331 Plain Copper. 1 to 9 each \$.23
 -  #PL 332 Pencil Offset. 1/8" x 1", iron clad, Silver Plated. 1 to 9 each \$.57
 - #332 Plain Copper. 1 to 9 each \$.23
 -  #PL 333 Chisel, Long Taper. 1/8" x 1", iron clad, Silver Plated. 1 to 9 each \$.57
 - #333 Plain Copper. 1 to 9 each \$.23
 -  #PL 338 Tapered Needle. 1/4" x 1 3/4", iron clad. Silver Plated. 1 to 9 each \$.57
 -  #PL 340 Micro-Needle. 3/4" x 3/4", for microscopic soldering, iron clad, Silver Plated—Actual size. 1 to 9 each \$.57
 -  #7154 Stepped Pencil, 1/8" pencil tip. Iron clad, silver plated. Fits #535, 1235, and 4035. 1 to 9 each \$.57
 -  #7155 Stepped Chisel, 3/8" chisel tip. Iron clad, silver plated. Fits #535, 1235 and 4035. 1 to 9 each \$.57
 -  #PL 833 Chisel, Long Taper. 3/8" x 1 3/4", iron clad. Silver Plated. 1 to 9 each \$.95
 -  #PL 834 Chisel, Long Taper, Offset. 3/8" x 1 3/4", iron clad, Silver Plated. 1 to 9 each \$.95
 -  #PL 823 Pyramid, 3/8" x 1", iron clad, Silver Plated. 1 to 9 each \$.65
 - #823 Plain Copper. 1 to 9 each \$.25
 -  #PL 824 Chisel, Long Taper. 3/8" x 1", iron clad. Silver Plated. 1 to 9 each \$.65
 - #824 Plain Copper. 1 to 9 each \$.25

New #777 "CLEANROOM" Soldering Handle

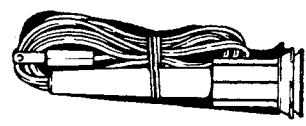

"CLEAN ROOM" GRIP • STAINLESS STEEL HEAT REFLECTOR • FULL-CONTACT SPRING SOCKET, NO TIP WOBBLE • HANDLE IN PASTEL COLOR • NEW POLY-VINYL INSULATED CORD • OCTAGON SHAPE GUARD WASHER 1 to 9 each \$1.76

#776 SOLDERING HANDLE

Ungar's red handle with cork grip. Same features as above.

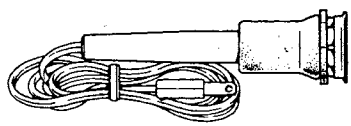



1 to 9 each \$1.55

New... Special Purpose Tiplets

- #7012 Precision Point, Cadmium Copper. .770 L. x .125 D., stepped to .090 D., ground and honed to .005 P. 1 to 9 each \$.57
- #7062 Precision Point, Cadmium Copper, Iron Clad, Silver Plated. .770 L. x .135 D. stepped to .098 D., ground and honed to .010 P. 1 to 9 each \$1.11

Ungar Interchangeable Tips... the right tip at the right temperature.

TIP TEMPERATURES	CHISEL TIP LONG TAPER	PYRAMID TIP	CHISEL TIP SHORT TAPER	THREAD-IN HEATING UNITS
850° to 1000° F. #4000 Super Hi-Heat Series 47-1/2 Watt	 #4033 Tip 1-5/8" long, 1/4" wide. New copper alloy, iron clad, silver plated. 1 to 9 each \$2.97	 #4036 Tip 1-1/8" long, 3/8" diameter. Copper, iron clad, silver plated. 1 to 9 each \$2.97	 #4039 Tip 1-1/8" long, 3/8" diameter. Copper, iron clad, silver plated. 1 to 9 each \$2.97	#4035 Steel body, nickel plated. For use with 300 Series Tiplets. #4045. For use with 800 Series Tiplets. ABOVE 1 to 9 each \$2.97
750° to 800° F. #1200 Hi-Heat Series 37-1/2 Watt	#1233 Tip 1-5/8" long, 1/4" wide. Copper, unplated. 1 to 9 each \$1.80	#1236 Tip 1-1/8" long, 5/16" diameter. Pure solid Armco iron, silver plated. 1 to 9 each \$1.80	#1239 Tip 1-1/8" long, 3/8" diameter. Pure solid Armco iron, silver plated. 1 to 9 each \$1.80	#1235 37 1/2 watt. Hi-Temperature steel body specially treated for corrosion resistance. 1 to 9 each \$1.80
650° to 750° F. #500 Standard Series 23-1/2 Watt	#533 Tip 1-5/8" long, 3/16" wide. Copper, unplated. 1 to 9 each \$1.44	#536 Tip 1-1/8" long, 5/16" diameter. Copper, unplated. 1 to 9 each \$1.44	#539 Tip 1-1/8" long, 5/16" diameter. Copper, unplated. 1 to 9 each \$1.44	#535 23 1/2 watt. Hi-Temperature steel body specially treated for corrosion resistance. 1 to 9 each \$1.44

ALL ABOVE PRICES ARE USER NET. PRICES ARE SUBJECT TO CHANGE WITHOUT NOTICE.

Ungar

Princess™



NEW for MICROelectronic soldering

UNGAR Electric Tools, alert to the changing profile of the electronic industry, introduces Princess, a completely new miniature soldering iron.

HANDLES

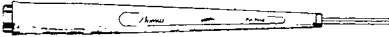

Turquoise, molded of heat resistant ABS. Two and three conductor cords are flexible, vinyl covered. Rated 120V AC-DC.

#6902—Two wire handle. U.L. listed 1 to 9 each \$2.84

#6903—Three wire handle with molded NEMA plug. 1 to 9 each \$3.84

HEAT CAPSULES



Rated at 120V; copper alloy heating conductor is threaded to accept 1/8" Nibs. Over-all-length: 3 1/8". Extends 1 5/8" from handle. U.L. listed.

#6906—Tip temperature from 400°F to 450°F. 6W. 1 to 9 each \$3.47

#6910—Tip temperature from 550°F to 650°F. 10W. 1 to 9 each \$3.47

#6915—Tip temperature from 700°F to 800°F. 15W. 1 to 9 each \$3.47

#6918—Tip temperature from 900°F to 1000°F. 18W. 1 to 9 each \$3.47

SOLDERING NIBS

Copper alloy; also in iron clad, gold plated (24K). Threaded (1/8") to fit PRINCESS Heat Capsules.

#6950—Pencil Nib. Cad. copper, .61" L. stepped to .080" D. x .015" P. 1 to 9 each \$.36

#6960—Iron clad, gold plated. Same as #6950. 1 to 9 each \$.63

#6951—Screwdriver Nib. Cad. copper, .68" L. stepped to .080" D. x .055" P. 1 to 9 each \$.36

#6961—Iron clad, gold plated. Same as #6951. 1 to 9 each \$.63

#6952—Spade Nib. Cad. copper, .61" L. stepped to .080" D. with 45° spade tip. 1 to 9 each \$.36

#6962—Iron clad, gold plated. Same as #6952. 1 to 9 each \$.63

#6953—Precision Point Nib. Cad. copper, .61" L. stepped to .080" D. x .005" P. 1 to 9 each \$.64

#6963—Iron clad, gold plated. Same as #6953. 1 to 9 each \$1.22

PRINCESS HOLDER

#6990—Base and sponge holder molded of thermoset plastic. Stainless steel cage mounted on a swivel. Equipped with specially processed sponge. 1 to 9 each \$3.05

#6991—Refill sponge. 1 to 9 each \$.48

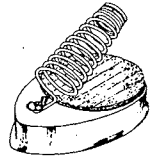

PRE-ASSEMBLED PACKAGED COMBINATIONS

#6975—Assembled and Packaged Princess Soldering Iron. Consists of the following parts:

(1) One #6902 Handle, Two-Wire

(2) One #6910 10-Watt Heat Capsule

(3) One each of the following Princess copper Soldering Nibs:

#6950—Pencil

#6951—Screwdriver

#6952—Spade

1 to 9 each \$6.95

#6900—Princess Packaged Soldering Station. Consists of the following units: A complete assembled iron consisting of:

One #6902 Handle, Two-Wire

One #6910 10-Watt Head Capsule

One #6950 Pencil Copper Nib

One #6951 Screwdriver, Copper Nib

One #6952 Spade Copper Nib

One #6990 Princess Soldering Iron Holder, equipped with one (1) #6991 Sponge

NEW PRINCESS de-Solderette'

#6992 For removal of Microminiature Components... ideal for I.C. Chip re-word and repair... Fast... Safe... Efficient. 1 to 9 each \$13.95

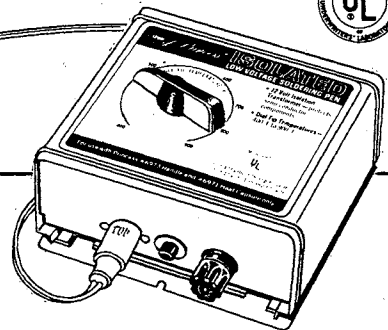
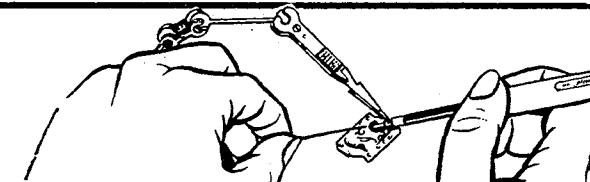
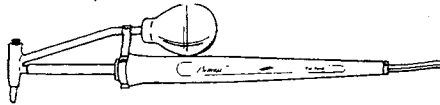

PRINCESS ISOLATED LOW VOLTAGE SOLDERING SYSTEM #6970

For safer assembly of discrete components and IC systems.

Its single heat capsule permits tip temperature range from 450°F to 900°F.

The isolated low voltage transformer prevents current leakage which destroys the thin insulating film of bi-polar or metal oxide silicone ICs.

The isolated heat capsule eliminates current paths that degrade the thin metalization in bi-polar ICs.

A Clean Room unit. Input: 120 volts 60 cycle. Output: 6 volts to 12 volts.

COMPLETE STATION INCLUDES: Low voltage ISOLATED transformer with temperature setting dial, 1.35 amp. 3-amp. bayonet type fuse, pilot light and 3 wire cord with Nema attachment plug; Princess handle, heat capsule and 3 soldering nibs, #s 6971, 6950 and 6952. Shipping weight: 3 lbs. 14 ozs. #6970: 1-3 each \$24.95, 4-11 each \$22.95, 12-up each \$21.00.

LOW VOLTAGE ISOLATED REPLACEMENT PARTS

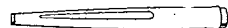

PRINCESS LOW VOLTAGE HANDLE: (For use only with transformer #6970 and #6971 heat capsule.) Highly flexible vinyl cord with 4 pin connector. #6973 1-3 each \$3.98, 4-11 each \$3.69, 12-up each \$3.39



LOW VOLTAGE HEAT CAPSULE: (Use only with transformer #6970 and handle #6973.) Rated 18 watts at 12 volts. Heating unit located in tip of capsule makes for maximum heat transfer and recovery. #6971: 1-3 each \$3.98, 4-11 each \$3.69, 12-up each \$3.39



SOLDERING NIBS: All Princess nibs and Standard Line 1/8" tiplets thread into the #6971 heat capsule.

ALL ABOVE PRICES ARE USER NET. PRICES ARE SUBJECT TO CHANGE WITHOUT NOTICE.

YIGOR®

Tool Company

Division of: B. JADOW and SONS, INC.

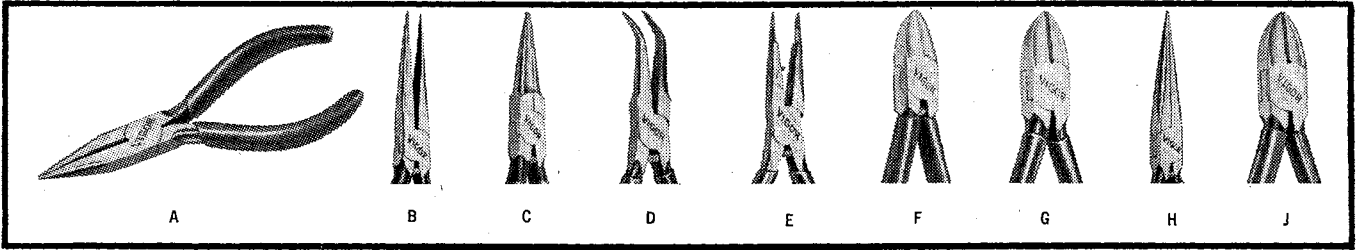

VIGOR® PRECISION PLIERS

Drop forged of the finest tool steel. All have fully polished heads and red cushion grip non-slip handles. Perfectly proportioned for all day production use. Points taper to 1/16" on all long nose pliers except PL-118 which tapers to 3/32". Available with and without coil spring as indicated.

Fig.	Stock No.	Length Overall Jaws	Description	List Price	Fig.	Stock No.	Length Overall Jaws	Description	List Price
A	PL-108	5"	Chain Nose — Side Cutting — Serrated Jaws	\$2.75	D	PL-118		Curved Slim Nose — Serrated Jaws — Coil Spring	3.76
A	PL-110	5 1/2"	Chain Nose — Side Cutting — Serrated Jaws	2.82	E	PL-119	5 1/2"	Chain with Cutter Tips and Centering Pin — Smooth Jaws — Coil Spring	4.90
A	PL-111	6"	Chain Nose — Side Cutting — Serrated Jaws	2.88	F	PL-120	4 1/2"	Semi-Flush Diagonal with Coil Spring	3.50
A	PL-112	5"	Chain Nose — Side Cutting with Coil Spring — Serrated Jaws	3.85	F	PL-121	5"	Semi-Flush Diagonal with Coil Spring	3.78
A	PL-113	5 1/2"	Chain Nose — Side Cutting with Coil Spring — Serrated Jaws	3.12	F	PL-122	6"	Semi-Flush Diagonal with Coil Spring	4.44
A	PL-114	6"	Chain Nose — Side Cutting with Coil Spring — Serrated Jaws	3.18	G	PL-123	4 1/2"	Electricians Diagonal	2.68
B	PL-115	6"	Long Chain Nose — Serrated Jaws	2.88	G	PL-126	5"	Electricians Diagonal	2.80
B	PL-116	6"	Long Chain Nose with Coil Spring — Serrated Jaws	3.36	G	PL-127	6"	Electricians Diagonal	3.36
C	PL-117	5 1/2"	Slim Nose — Serrated Jaws — Coil Spring	3.30	H	PL-130	6"	Box Joint — Long Slim Nose — Coil Spring	4.20
					J	PL-131	5"	Box Joint Diagonal Cutter	4.10

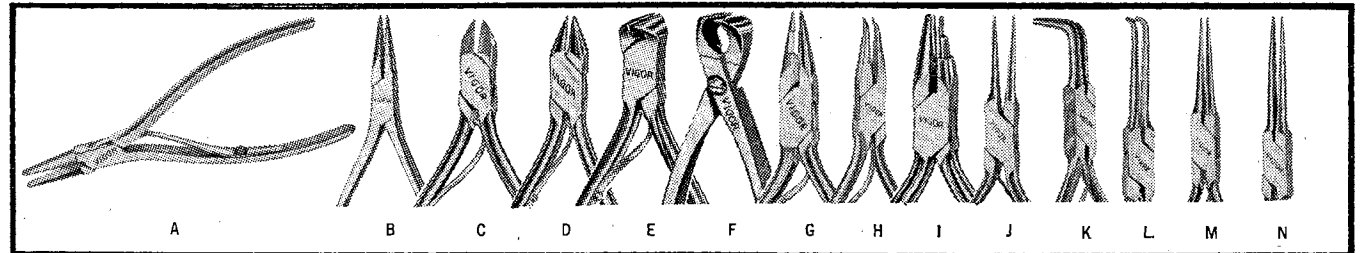

VIGOR® SWEDISH STEEL BOX JOINT ELECTRONIC PLIERS

For Special Purpose Applications

Fully polished from head to handle. Lightweight for miniature assembly and soft wire cutting and bending. Very popular with female production workers because special designs reduce fatigue yet box joints and Swedish steel add strength and durability. For cushion grips specify CG after stock number and add 25¢ per plier.

Fig.	Stock No.	Length Overall Jaws	Description	List Price	Fig.	Stock No.	Length Overall Jaws	Description	List Price		
A	PL-1005	4 3/4"	7/8"	Flat Nose — Smooth Jaw Light Work	\$3.20	F	PL-217C	4 1/8"	9/16"	Oblique Flush Nipper with Adjustment Screw — Straight Handles	8.00
A	PL-1105	4 3/4"	3/4"	Chain Nose — Smooth Jaws Light Work	3.20	F	PL-219	4 5/8"	5/8"	Oblique Flush Nipper with Adjustment Screw Curved Handles	8.00
A	PL-1205	4 3/4"	3/4"	Round Nose — Light Work	3.20	F	PL-219N	4 5/8"	5/8"	Same as PL-219 but Nickeled and with Leaf Spring	14.75
B	PL-281	4 1/2"	7/8"	Flat Nose — Smooth Jaws Delicate Work Only	2.95	G	PL-204 1/2 E	4 1/2"	1 1/2"	Chain Nose with Cutter Coil Spring Only — Smooth Jaws	6.75
B	PL-286	4 1/2"	7/8"	Chain Nose — Smooth Jaws Delicate Work Only	2.95	G	PL-704 1/2 E	4 1/2"	1 1/2"	Chain Nose with Cutter Coil Spring Only — Serrated Jaws	6.75
B	PL-291	4 1/2"	3/4"	Round Nose — Delicate Work Only	2.95	H	PL-204 1/2 L	4 1/2"	1"	Chain Nose with Curved Tips Smooth Jaw — Coil Spring Only	5.50
C	PL-297	4 1/2"	3/4"	Flush Midget Diagonal Cutter for Soft Wire Only — Coilspring Only	7.35	I	PL-39	4 1/2"		Wire Coiling Plier with Stepped Nose	4.30
D	PL-301	4 1/2"	1/2"	Flush Pointed Midget — Diagonal Cutter for Soft Wire Only — Coilspring Only	7.20	J	PL-1405 1/2 F	5 1/2"	1 9/16"	Long Chain Nose with Flush Cut Nipper Tips Leaf Spring Only	8.20
E	PL-804 1/2	4 1/2"	3/4"	Flush Right Angle End Cutter for Soft Wire Leaf Spring Only	7.20	K	PL-1405 1/2 H	5 1/2"	1 1/4"	Curved Needle Nose — Serrated Tips	7.45
E	PL-850	4 1/2"	3/4"	Same as 804 1/2 but with Square Handles no springs	7.35	L	PL-1406 J	6"	7/16"	Long Needle Nose with Curved Tips Smooth Jaws	7.45
E	PL-904 1/2	4 1/2"	1 3/32"	Flush Oblique Angle End Cutter for Soft Wire Leaf Spring Only	7.45	M	PL-1406 K	6"	2 1/4"	Fine Long Needle Nose — Smooth Jaw	7.10
E	PL-950	4 1/2"	1 3/32"	Same as 904 1/2 but with square Handles no spring	7.35	M	PL-1456 K	6"	2 1/4"	Fine Long Needle Nose — Serrated Jaw	7.10
F	PL-217	4 3/8"	2 1/32"	Oblique Flush Nipper with Adjustment Screw — Straight Handles	8.00	N	PL-1406 L	6"	1 7/8"	Long Chain Nose Plier — Smooth Jaw	7.10

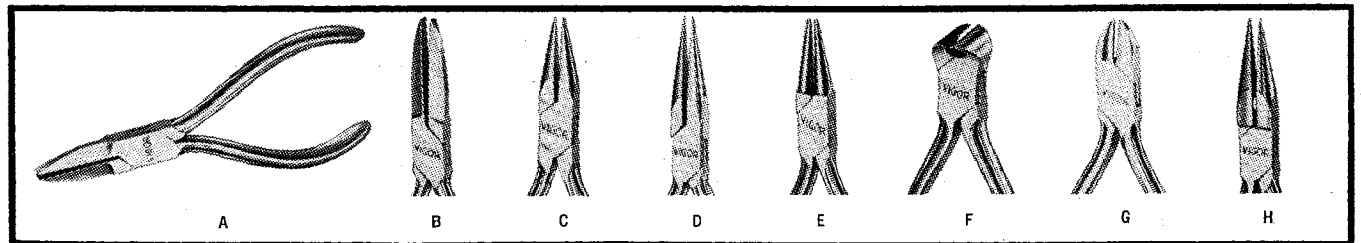

DESCRIPTION ON FOLLOWING PAGE



Division of: B. JADOW and SONS, INC.

VIGOR® SWEDISH STEEL BOX JOINT JEWELERS PLIERS

Drop forged of selected Swedish Tool Steel, carefully machined and heat treated. Hand finished and fully polished from head to handle. Box joints assure perfect alignment of points and cutting edges and guarantee durability. For Cushion Grips specify CG after stock number and add 25¢ per plier.

Fig.	Stock No.	Length Overall Jaws	Description	List Price
A...	PL-104	4" 2 3/2"	Flat Nose — Smooth Jaws	\$4.60
A...	PL-604	4" 2 3/2"	Flat Nose — Serrated Jaws	4.60
A...	PL-104 1/2	4 1/2" 1 1/2"	Flat Nose — Smooth Jaws	4.75
A...	PL-604 1/2	4 1/2" 1 1/2"	Flat Nose — Serrated Jaws	4.75
A...	PL-105	5" 1 1/8"	Flat Nose — Smooth Jaws	5.00
A...	PL-605	5" 1 1/8"	Flat Nose — Serrated Jaws	5.00
B...	PL-1504 1/2	4 1/2" 1 5/8"	Long Flat Nose — Smooth Jaws	4.75
B...	PL-1554 1/2	4 1/2" 1 5/8"	Long Flat Nose — Serrated Jaws	4.75
B...	PL-1505	5" 1 1/2"	Long Flat Nose — Smooth Jaws	5.00
B...	PL-1555	5" 1 1/2"	Long Flat Nose — Serrated Jaws	5.00
C...	PL-204	4" 2 3/2"	Chain Nose — Smooth Jaws	4.60
C...	PL-704	4" 2 3/2"	Chain Nose — Serrated Jaws	4.60
C...	PL-204 1/2	4 1/2" 1 3/2"	Chain Nose — Smooth Jaws	4.75
C...	PL-704 1/2	4 1/2" 1 3/2"	Chain Nose — Serrated Jaws	4.75
C...	PL-205	5" 1 3/8"	Chain Nose — Smooth Jaws	5.00
C...	PL-705	5" 1 3/8"	Chain Nose — Serrated Jaws	5.00
D...	PL-1404 1/2	4 1/2" 1 3/8"	Long Chain Nose — Smooth Jaws	4.75

Fig.	Stock No.	Length Overall Jaws	Description	List Price
D...	PL-1454 1/2	4 1/2" 1 3/8"	Long Chain Nose — Serrated Jaws	4.75
D...	PL-1405	5" 1 1/2"	Long Chain Nose — Smooth Jaws	5.00
D...	PL-1455	5" 1 1/2"	Long Chain Nose — Serrated Jaws	5.00
E...	PL-304	4" 7/8"	Round Nose	4.60
E...	PL-304 1/2	4 1/2" 1"	Round Nose	4.75
E...	PL-305	4" 1 1/8"	Round Nose	5.00
F...	PL-404	4" 3/4"	End Cutter	5.65
F...	PL-404 1/2	4 1/2" 7/8"	End Cutter	5.65
F...	PL-405	4" 1"	End Cutter	5.95
G...	PL-504	4" 1 3/2"	Diagonal Cutter	5.25
G...	PL-504 1/2	4 1/2" 4 3/4"	Diagonal Cutter	5.65
G...	PL-505	5" 3/4"	Diagonal Cutter	5.95
H...	PL-254 1/2	4 1/2" 1 1/8"	Combination Pliers — Smooth Jaws	6.15
H...	PL-754 1/2	4 1/2" 1 1/8"	Combination Pliers — Serrated Jaws	6.15
H...	PL-255	5" 1 1/2"	Combination Pliers — Smooth Jaws	6.40
H...	PL-755	5" 1 1/2"	Combination Pliers — Serrated Jaws	6.40

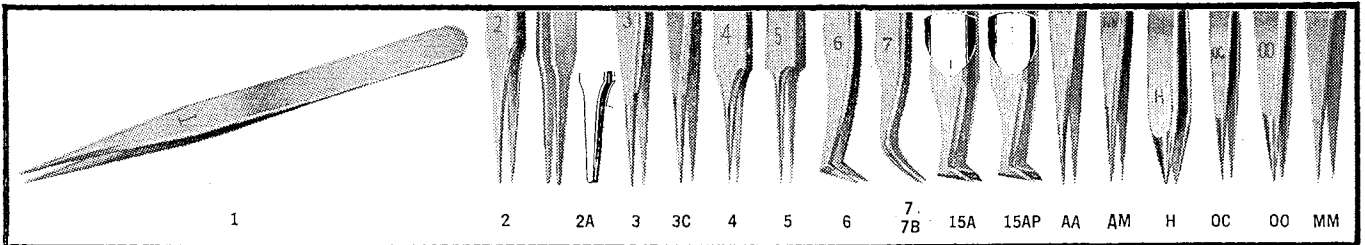

VIGOR® SWISS PRECISION TWEEZERS For MINIATURE and MICROMINIATURE ASSEMBLY
Precise Sharp and Shaped Points

VIGOR Swiss Precision Tweezers are made in carbon (C), non-magnetic steel (NM), stainless steel (SS), carbon steel with nickel plating (CNP), and brass (B), as indicated below. Non-magnetic VIGOR Tweezers will not rust and are acid resistant. All points are ground flat on the inside. Beveled and rounded points refer to the outside diameter.

Style No.	Vigor Stock No.	Type Steel Used	Total Length	Points	List Price
1	TW-201	C	4 3/4"	Beveled — Sharp	\$2.25
1	TW-601	NM	4 3/4"	Beveled — Sharp	3.25
1	TW-701	SS	4 3/4"	Beveled — Sharp	2.65
2	TW-202	C	4 3/4"	Beveled — Dull	2.45
2	TW-602	NM	4 3/4"	Beveled — Dull	3.45
2	TW-702	SS	4 3/4"	Beveled — Dull	2.85
2A	TW-602A	NM	4 3/4"	Dull — Flat — .050" tip.	4.50
3	TW-203	C	4 3/4"	Round — Sharp	2.45
3	TW-603	NM	4 3/4"	Round — Sharp	3.45
3	TW-703	SS	4 3/4"	Round — Sharp	2.85
3C	TW-203C	C	4 1/4"	Round — Sharp	2.45
3C	TW-603C	NM	4 1/4"	Round — Sharp	3.45
3C	TW-703C	SS	4 1/4"	Round — Sharp	3.30
4	TW-204	C	4 1/2"	Round — Sharp	2.90
4	TW-604	NM	4 1/2"	Round — Sharp	3.90
4	TW-704	SS	4 1/2"	Round — Sharp	3.30
5	TW-205	C	4 3/8"	Round — Sharp	3.20
5	TW-605	NM	4 3/8"	Round — Sharp	4.20
5	TW-705	SS	4 3/8"	Round — Sharp	3.60

Style No.	Vigor Stock No.	Type Steel Used	Total Length	Points	List Price
6	TW-206	C	4 1/4"	Beveled — Sharp	\$3.50
6	TW-606	NM	4 1/4"	Beveled — Sharp	4.50
6	TW-706	SS	4 1/4"	Beveled — Sharp	3.90
7	TW-207	C	4 3/8"	Round — Sharp	3.50
7	TW-607	NM	4 3/8"	Round — Sharp	4.50
7	TW-707	SS	4 3/8"	Round — Sharp	3.90
7B	TW-207B	C	4 3/8"	Same as #7 with	
7B	TW-707B	SS	4 3/8"	Serrated tip	3.90
15A	TW-215A	C	4 1/4"	Flush Cutting Nipper	8.25
15AP	TW-215AP	C	4 1/4"	Flush Cutting Nipper	8.25
AA	TW-301	CNP	4 3/8"	Beveled — Medium	1.25
AM	TW-363	B	5"	Round — Sharp	1.80
H	TW-229	C	3 1/2"	Stubby — Sharp	2.25
H	TW-729	SS	3 1/2"	Stubby — Sharp	2.65
OC	TW-230C	C	3 1/2"	Round — Sharp	2.65
OC	TW-730C	SS	3 1/2"	Round — Sharp	3.05
OO	TW-200	C	4 1/2"	Heavy — Dull	2.65
OO	TW-700	SS	4 1/2"	Heavy — Dull	3.05
MM	TW-306	CNP	5"	Beveled — Medium	1.35

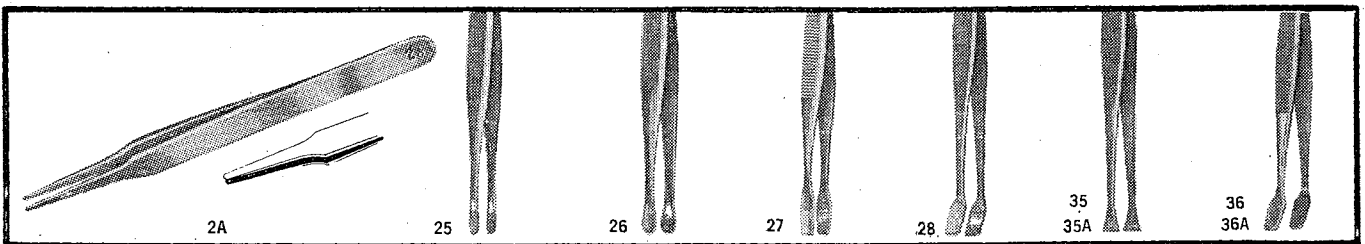

VIGOR® SEMI-CONDUCTOR TWEEZERS

Mirror-smooth finish will hold discs such as germanium and silicone wafers without scratching surface. Large surface provides positive grip. Thin edge permits simple pick-up. Available in nickel finish; stainless steel or non-magnetic, anti-acid steel as indicated below.

Vigor Stock No.	Pattern	Description	List Price
TW-602A	2A	Thin extra narrow jaws. Approximate width at tip .050". Rustless — Length 4 3/4"	\$3.45
TW-702A	2A	Same as above but stainless	2.85
TW-902A	2A	Same as above but Carpenter 20 steel	5.00
TW-325	25	Thin narrow round jaws. Approximate width at tip 3/4". Serrated handle grip. Carbon Steel, Nickel Plated — Length 4 3/4"	1.75
TW-326	26	Thin round jaws. Approximate width at tip 1 1/4". Serrated handle grip. Carbon Steel, Nickel Plated — Length 4 3/4"	1.75
TW-327	27	Oblong and offset jaws. Approximate width at tips 3/8". Serrated handle grip. Carbon Steel, Nickel Plated — Length 4"	1.75

Vigor Stock No.	Pattern	Description	List Price
TW-328	28	Oblong and offset jaws. Approximate width at tips 3/8". Serrated handle grip. Carbon Steel, Nickel Plated — Length 4"	1.95
TW-335	35	Medium flange jaws. Approximate width at tip 1 1/4". Serrated handle grip. Carbon Steel, Nickel Plated — Length 4 3/4"	1.95
TW-335A	35A	Same as above but Rustless, Non-magnetic and Anti-acid	3.50
TW-336	36	Oblong and Offset jaw. Approximate width at tip 1 1/4". Serrated handle grip. Carbon Steel, Nickel Plated — Length 4 3/4"	1.95
TW-336A	36A	Same as above, but Rustless, Non-magnetic and Anti-acid	3.50

Weller® DUAL HEAT Soldering Guns

Dual heat. All Weller guns offer Dual Heat—an original Weller feature that provides two tip temperatures from the same gun. Two trigger positions permit instant switching to high or low heat, whichever is best suited for the job. The use of low heat prevents damage when soldering near heat-sensitive components and prolongs tip life. High heat is instantly available when needed.

Instant heat. Solders in seconds. No waiting for the tip to heat. No wasted current.

High-efficiency tip. Made of copper for superior heat transfer and optimum soldering results. Slips easily into difficult places.

Exclusive tip grip. Wiping action of tip fastening nuts eliminates contact resistance and oxidation. This assures full, constant heat.

Spotlight. Illuminates the work and eliminates shadows.

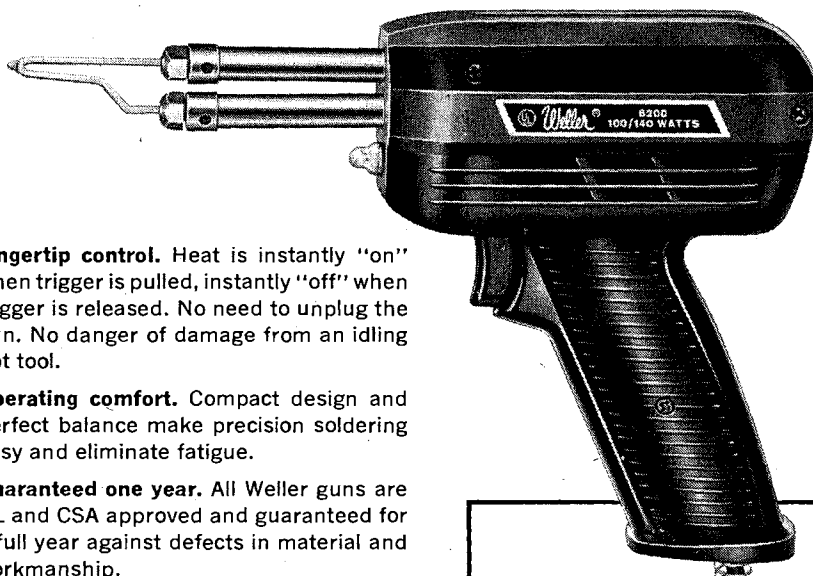

Fingertip control. Heat is instantly "on" when trigger is pulled, instantly "off" when trigger is released. No need to unplug the gun. No danger of damage from an idling hot tool.

Operating comfort. Compact design and perfect balance make precision soldering easy and eliminate fatigue.

Guaranteed one year. All Weller guns are UL and CSA approved and guaranteed for a full year against defects in material and workmanship.

Accessory and Replacement Tips for Weller Dual Heat Guns



SOLDERING

For gun models 8200 and D-440—Tip 7135N
For gun model D-550—Tip 7250N



SMOOTHING

For gun models D-440 and 8200—Tip 6120
For gun model D-550—Tip 6140



CUTTING

For gun models D-440 and 8200—Tip 6110
For gun model D-550—Tip 6130

3 Dual Heat Models

MODEL 8200—100/140 watts
MODEL D-440—145/210 watts
MODEL D-550—240/325 watts

KITS WITH ACCESSORIES

MODEL 8200PK—Dual heat 100/140 watt gun, 3 soldering tips, tip-changing wrench, flux brush, soldering aid, solder, plastic case.

MODEL D-550PK—Heavy-duty 240/325 watt dual heat gun; soldering, cutting and smoothing tips; tip-changing wrench; solder; plastic case.

Weller® TEMPERATURE-CONTROLLED Soldering Irons

... with Energy Reserve

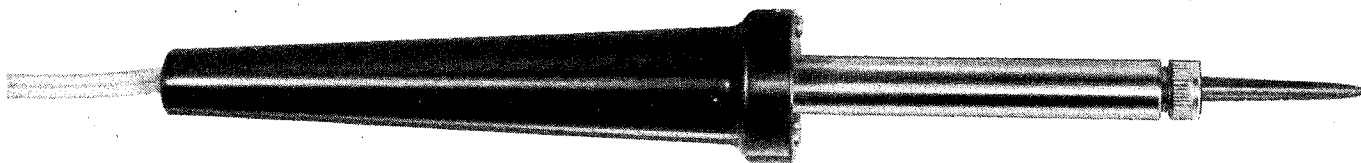

Three temperature-controlled line voltage tools cover the 15 through 300-watt spectrum with Weller's exclusive Energy Reserve design. Interchangeable Weller tips triple the working capacity over conventional irons which often weigh twice as much. All sizes are available with standard 2-wire or 3-wire cords.

- Tip temperature constant to within $\pm 3\%$ when idling
- Energy Reserve provides ample working temperature, quick recovery

STANDARD WELLER IRONS

MODEL NO.	WATTAGE/120V	WEIGHT	TIP SUPPLIED*
W-60	60, covers 15 to 100-watt loads	2½ oz.	800°F ¼" screwdriver
W-100	100, covers 50 to 150-watt loads	3½ oz.	800°F ¼" screwdriver
W-200	200, covers 150 to 300-watt loads	10 oz.	800°F 7/16" chisel

*Weller "Temperature Sensing" tips are available in standard industrial configurations at 500°, 600°, 700° and 800°F for these tools.

- One tool does the work of several higher wattage irons
- Light weight and cool handles increase operator comfort

Weller® UTILITY Soldering Irons

THE "MARKSMAN" LINE

Five ruggedly designed general-purpose tools featuring stainless steel construction, long-reach barrels, and replaceable tips.

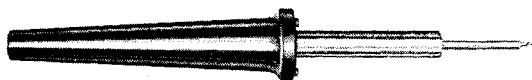

Model SP-23*



Model SP-40



Model SP-80



Model SP-120

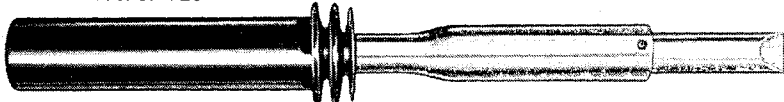

Model SP-175

"INDUSTRIAL RATED" SOLDERING PENCIL



Ideal for soldering transistor sockets and other miniaturized circuit components, this low-cost 115-volt iron provides a tip temperature of 860°F with a 25-watt input. Other features include:

- High efficiency and rapid recovery
- Does the work of higher wattage irons
- Lightweight design reduces operator fatigue
- Rugged heating element for long-life service
- Readily replaceable parts

Interchangeable $\frac{1}{16}$ ", $\frac{3}{32}$ ", $\frac{1}{8}$ " and $\frac{3}{16}$ " screwdriver tips available—premium plated for long life. Model WPS.

MODEL NO.	WATTAGE/120V	WEIGHT
SP-23*	25	1¼ oz.
SP-40	40	2 oz.
SP-80	80	4 oz.
SP-120	120	10 oz.
SP-175	175	16 oz.

*Also available as kit model SP-23K, including iron; screwdriver, cone and chisel tips; soldering aid and solder.

NEW! . . . with Energy Reserve
Weller 12 Volt Soldering Iron
 For field servicing requirements

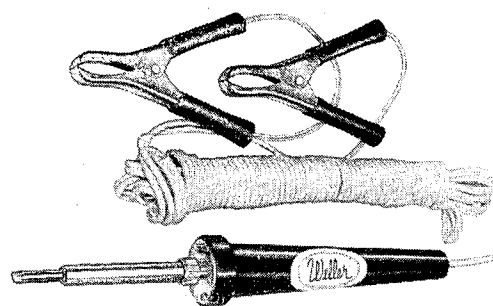

A modern service tool for 12-volt battery or AC/DC power supply operation. Model TCP-12 requires only 30-41 watts, weighs only 1¼ oz., yet provides all the advantages of Weller's "Temperature Sensing" system. Supplied complete with 700°F $\frac{3}{16}$ " screwdriver tip, 12-ft. power cord and clips, and impact resistant handle. Also available for 24-28 volt operation (Model TCP-24).

Weller® TEMPERATURE-CONTROLLED Soldering Stations

... with Energy Reserve

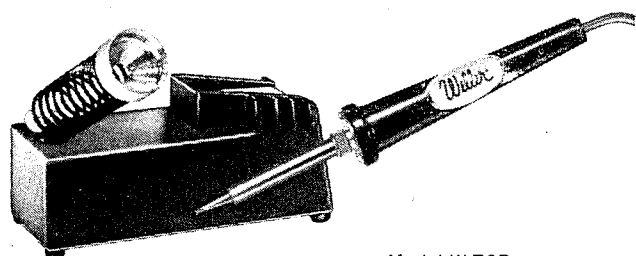

Model W-TCP

Model W-TCP is a low voltage soldering unit featuring a 2½ oz. pencil that does the work of several irons. Efficient 24-volt operation with interchangeable Weller "Temperature Sensing" tips, burn-proof cord, self-contained 120 or 230-volt transformer, pencil holder and cleaning sponge. Wide selection of tip configurations provide a choice of controlled temperatures from 500° to 800°F. Also available with thermistor and SCR switching circuit for continuously variable 200°-450°F tip temperature—20-watt Model W-TCP-2.

SPECIFICATIONS

MODEL	WATTAGE	VOLTAGE	WT. WITH TIP, LESS POWER UNIT & CORD	OVERALL LENGTH WITH RETAINER TIP	TIP O.D.
W-TCP	60	120V,* 50-60 cycles	1¼ oz.	7½"	$\frac{3}{16}$ "
W-TCP-2	20	"	"	"	"

*230/250V, 50-60 cycle version available

WELLER ELECTRIC CORPORATION
WORLD LEADER IN SOLDERING TOOLS

SINCE
1864



**WALL
BRAND**

SOLDERING PENCILS, IRONS, GUNS AND HOLDERS

WallBrand pencils and irons are Thermogram Rated for better efficiency, with cooler handles, feather weight, perfect balance. Production Line models are engineered for continuous precision soldering applications. Wall's own plating facilities produce tips to meet the demanding applications of micro-circuitry, high density packaging, precision work on solid state devices, printed circuits, or production line work requiring continuous heat. The Wall line includes soldering pencils with a plug-in type system. All heating elements for the 614-618 are interchangeable with one handle and cord assembly. HD Type for continuous, heavy duty soldering requirements have triple-life resistance wire wound on pure mica; constant tip temperature with extra fast recovery; excellent balance. 120 volts AC or DC (other voltages on request).

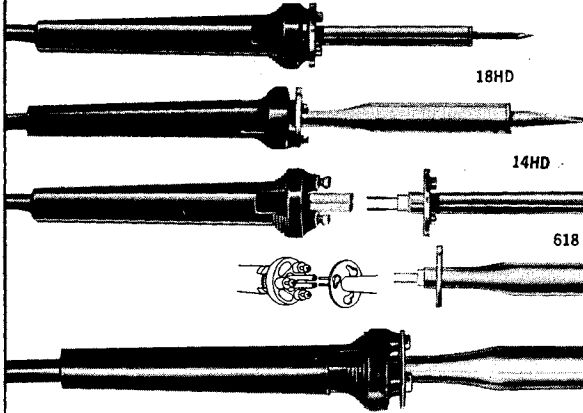

Model	Watt Input	Tip Size	Length W/O Tip	Therma/Gram Value
18HD	25	1/8"	6 5/8"	300
14HD	40	1/4"	7 1/2"	900
618HD*	25	1/8"	6 5/8"	300
614HD	40	1/4"	7 1/2"	900
38HD	80	3/8"	10 1/4"	1500
12HD	125	1/2"	10 1/4"	2000
58HD	200	5/8"	12 1/4"	3500
78HD	250	7/8"	12 3/8"	5400

*Also available in 11, 15 or 20 watts

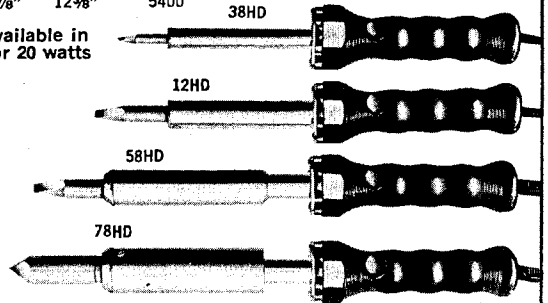

Model	Tip Size	Watts	Volts
316 (Light duty)	3/16	30	120

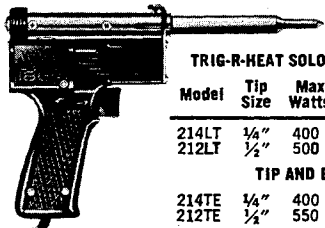

TRIG-R-HEAT SOLDERING GUN SPECIFICATIONS

Model	Tip Size	Max. Watts	Min. Watts	Voltage AC or DC	Weight W/O Cord
214LT	1/4"	400	150	120	14 oz.
212LT	1/2"	500	300	120	24 oz.

TIP AND ELEMENT ASSEMBLY

Model	Tip Size	Max. Watts	Min. Watts	Voltage
214TE	1/4"	400	150	120
212TE	1/2"	550	300	120

214LT
TRIG-R-Heat Soldering Gun—Feather light, 14 oz., no heavy transformer. Reaches hard-to-get-at spots; tip will not deform. Heats and recovers instantly. Rugged, precision-built. Easily changed tip and element assemblies.

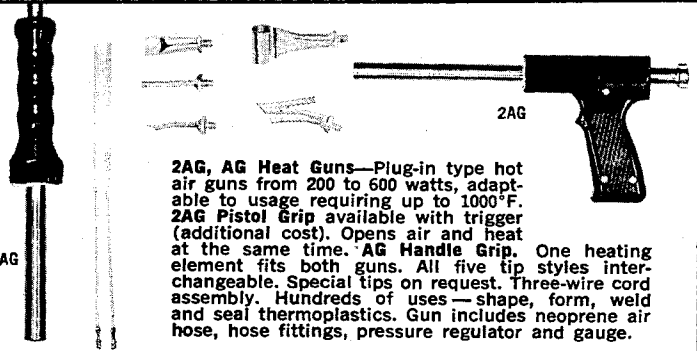

2AG, AG Heat Guns—Plug-in type hot air guns from 200 to 600 watts, adaptable to usage requiring up to 1000°F. **2AG Pistol Grip** available with trigger (additional cost). Opens air and heat at the same time. **AG Handle Grip**. One heating element fits both guns. All five tip styles interchangeable. Special tips on request. Three-wire cord assembly. Hundreds of uses—shape, form, weld and seal thermoplastics. Gun includes neoprene air hose, hose fittings, pressure regulator and gauge.

14DS Desoldering Tool—Keeps solder in a molten state in reservoir, operated with one hand, fits existing Wall 14HD Iron. Replaceable tip, .080 opening. Other sizes by special request.



14DS

Hatchet Irons—New high reserve models that enable user to make more solder connections faster. Reduces operator fatigue, with better quality control and higher production. 1/4" and 3/8" tips available. Unless otherwise specified, irons are equipped with 2-wire HPN cords and WallBrand Tip Style "C"

Model	Tip Size	Watts	Volts
714-60	1/4 in.	60	120
714-75	1/4 in.	75	120
738-80	3/8 in.	80	120
738-100	3/8 in.	100	120

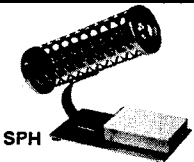
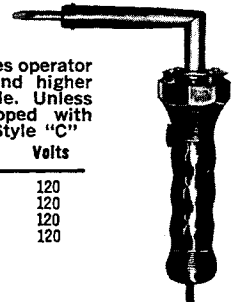

SPH

SPH Soldering Pencil Holder for units up to 3/8" diameter shaft—**SIH Soldering Iron Holder** for units up to 1" diameter shaft. Can be mounted on top, in front or below bench. Adjusts to any angle. Bench models include tip cleaning sponge.

Soldering Tips for Pencils and Irons—Three grades: Anniversary: Industrial, highest quality. Copper core, special iron coating. Anti-seize life for rigorous production line demand. WallKlad—Industrial, copper core, iron coating chrome plated. Production line and critical laboratory use. WallBrand—Commercial, copper, nickel plated. All commercial applications. Tip sizes from 1/8" through 7/8". Special tips to specifications designed on request.

Send for illustrated catalog I-1265 about Wall's tips, irons, pencils, and holders.

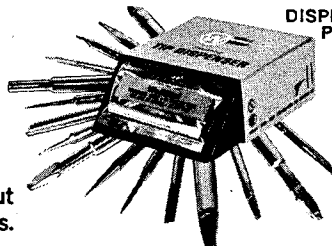

DISPENSER
PAC

Soldering Tip Dispenser Pac—Iron-plated or copper tips, 1/8" through 3/8", are available in handy tip dispenser pac. Keeps tips individually sealed in color-coded, continuous belting, plastic envelope. Ideally suited for production line station or stock distribution.

WALL BRAND MANUFACTURING CO.

Industrial Soldering Pencils are built to exceed federal specification W-S-570a as amended. WallBrand soldering products are UL and CSA listed.



QUALITY PROFESSIONAL TOOLS

SCREWDRIVERS

AISI 6150 chrome vanadium steel blades. Shockproof, breakproof, plastic (UL) handles.

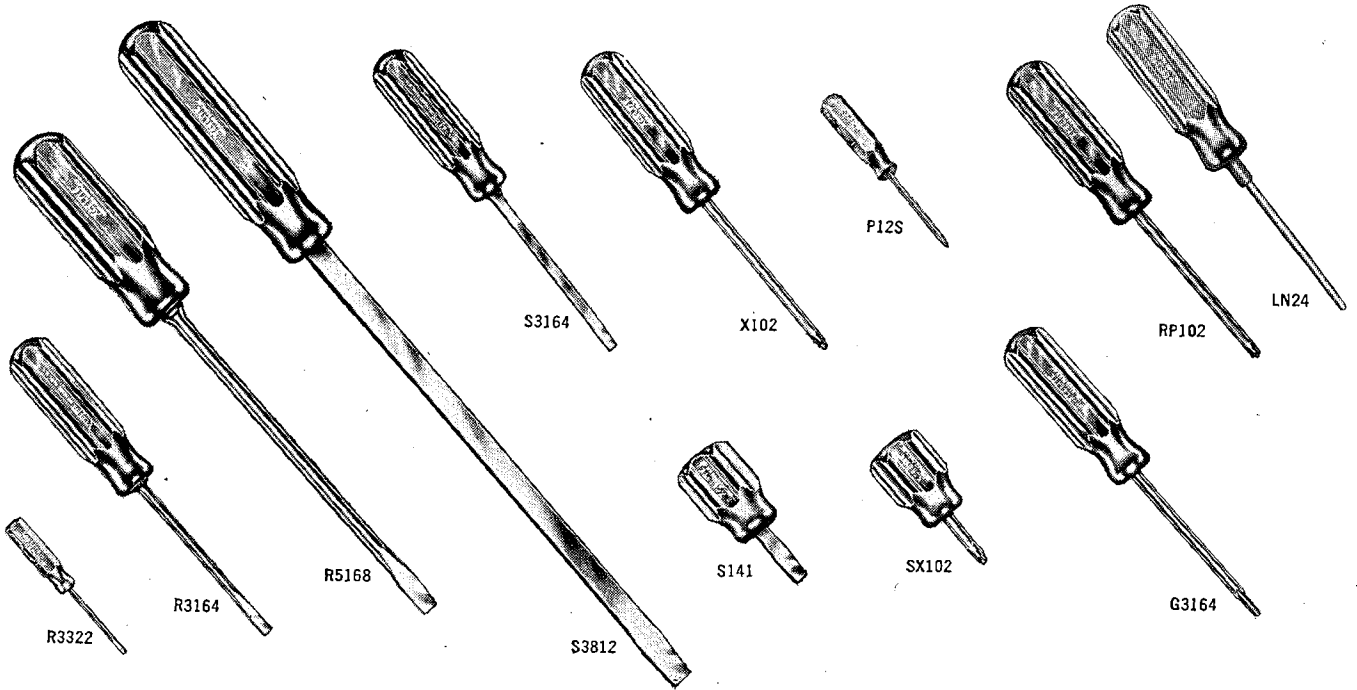

ROUND BLADE			
Regular			
Number	Blade	Overall	List
R182	1/8" x 2"	4 5/8"	\$.65
R184	1/8" x 4"	6 5/8"	.75
R186	1/8" x 6"	8 5/8"	.85
R188	1/8" x 8"	10 5/8"	1.00
R1810	1/8" x 10"	12 5/8"	1.15
R5323	3/32" x 3"	5 5/8"	.80
R5324	3/32" x 4"	6 5/8"	.80
R5325	3/32" x 5"	7 5/8"	.85
R5328	3/32" x 8"	10 5/8"	1.10
R3163	3/16" x 3"	6 5/8"	1.10
R3164	3/16" x 4"	7 5/8"	1.20
R3166	3/16" x 6"	9 5/8"	1.25
R3168	3/16" x 8"	11 5/8"	1.45
R31610	3/16" x 10"	13 5/8"	1.65
R142	1/4" x 2"	6 1/8"	1.25
R144	1/4" x 4"	8 1/8"	1.55
R146	1/4" x 6"	10 1/8"	1.70
R148	1/4" x 8"	12 1/8"	1.80
R1410	1/4" x 10"	14 1/8"	1.90
R5164	3/8" x 4"	8 1/8"	1.75
R5166	3/8" x 6"	10 1/8"	1.90
R5168	3/8" x 8"	12 1/8"	2.05
R388	3/8" x 8"	12 1/2"	2.75
Pocket Clip Style			
R3322	3/32" x 2"	4 1/4"	\$.55
R3323	3/32" x 3"	5 1/4"	.60
R3324	3/32" x 4"	6 1/4"	.65
R181	1/8" x 2"	4 1/4"	.55
R183	1/8" x 3"	5 1/4"	.60
R184 1/2	1/8" x 4"	6 1/4"	.65

SQUARE BLADE			
Regular			
Number	Blade	Overall	List
S3163	3/16" x 3"	6 5/8"	\$1.15
S3164	3/16" x 4"	7 5/8"	1.25
S3166	3/16" x 6"	9 5/8"	1.45
S3168	3/16" x 8"	11 5/8"	1.70
S31610	3/16" x 10"	13 5/8"	2.00
S142	1/4" x 2"	6 1/8"	1.30
S144	1/4" x 4"	8 1/8"	1.55
S146	1/4" x 6"	10 1/8"	1.70
S148	1/4" x 8"	12 1/8"	1.90
S1424	1/4" x 24"	28 1/8"	4.25
S5162	5/16" x 2"	6 1/4"	1.50
S5164	5/16" x 4"	8 1/4"	1.75
S5166	5/16" x 6"	10 1/4"	2.00
S5168	5/16" x 8"	12 1/4"	2.20
S51610	5/16" x 10"	14 1/4"	2.50
S51612	5/16" x 12"	16 1/4"	3.00
S388	3/8" x 8"	12 1/2"	2.75
S3812	3/8" x 12"	17 7/8"	4.00
S3818	3/8" x 18"	23 7/8"	4.50
S7166	7/16" x 6"	11 7/8"	3.50
S71612	7/16" x 12"	17 7/8"	4.25
S71618	7/16" x 18"	23 7/8"	5.00
Stubby			
S3161	3/16" x 1"	2 3/4"	\$.85
S141	1/4" x 1"	3 1/4"	.90
S5161	5/16" x 1"	3 1/4"	.90

PHILLIPS				
Number	Point	Blade	Overall	List
Extra Long				
X1010	1	3/16" x 10"	13 5/8"	\$1.90
X1020	2	1/4" x 10"	14 1/8"	2.15
Regular				
X100	0	1/8" x 2"	4 1/2"	\$.85
X101	1	3/16" x 3"	6 5/8"	1.30
X108	1	3/16" x 6"	9 5/8"	1.50
X102	2	1/4" x 4"	8 1/8"	1.60
X103	3	5/16" x 6"	10 1/4"	2.25
X104	4	3/8" x 8"	12 1/2"	2.75
Stubby				
SX101	1	3/16" x 1 3/8"	2 1/2"	\$1.20
SX102	2	1/4" x 1 3/8"	3 3/8"	1.35
Pocket Clip Style				
P12S	0	1/8" x 2"	4 1/4"	\$.75
ALLEN TYPE				
Number	Hex	Blade	Overall	List
LN20	.050"	4"	6 5/8"	\$1.25
LN21	3/16"	4"	6 5/8"	1.25
LN22	3/8"	4"	6 5/8"	1.25
LN23	3/32"	4"	7 1/8"	1.25
LN764	1/2"	4"	7 1/8"	1.25
LN24	1/8"	4"	7 1/8"	1.35
LN964	3/4"	4"	7 1/8"	1.35
LN25	5/16"	6"	9 1/8"	1.35
LN26	3/16"	6"	10 1/8"	1.35
LN27	3/32"	6"	10 1/8"	1.50
LN28	1/2"	6"	10 1/8"	1.50
FREARSON (Reed & Prince)				
Number	Point	Blade	Overall	List
RP101	1	3/16" x 3"	6 5/8"	\$1.30
RP102	2	1/4" x 4"	8 1/8"	1.60
RP103	3	5/16" x 6"	10 1/4"	2.25
RP104	4	3/8" x 8"	12 1/2"	2.75

CLUTCH HEAD (Type G)				
Number	Tip	Blade	Overall	List
G3324	3/32"	1/8" x 4"	6 1/4"	\$1.40
G183	1/8"	3/16" x 3"	6 5/8"	1.40
G5324	3/32"	3/16" x 4"	7 5/8"	1.65
G3164	3/16"	1/4" x 4"	8 1/8"	1.65
G146	1/4"	3/32" x 6"	10 1/8"	2.05
G5166	3/16"	3/8" x 6"	10 1/2"	2.50
SCRULOX®				
Number	Tip	Blade	Overall	List
SL-00-FH	#0	3 1/2"	7 1/4"	\$1.50
SL-0-FH	#0	3 1/2"	7 1/4"	1.50
SL-1-FH	#1	3 1/2"	7 1/4"	1.50
SL-2-FH	#2	3 1/2"	7 1/4"	1.50
SL-3-FH	#3	3 1/2"	7 1/4"	1.50
BERYLLIUM COPPER				
Non-magnetic • Non-sparking				
Higher fatigue resistance than steel.				
Regular				
Number	Blade	Overall	List	
BR186	1/8" x 6"	8 5/8"	\$1.55	
BR1810	1/8" x 6"	12 5/8"	1.80	
BR3168	3/16" x 8"	11 5/8"	3.00	
BR146	1/4" x 6"	10 1/8"	3.30	
BR148	1/4" x 8"	12 1/8"	3.60	
Pocket Clip Style				
BR181	1/8" x 2"	4 1/4"	\$.80	
PHILLIPS				
Number	Point	Blade	Overall	List
BRX100	#0	1/8" x 2"	4 1/2"	\$1.13
BRX101	#1	3/16" x 3"	6 5/8"	2.80
BRX102	#2	1/4" x 4"	8 1/8"	3.00
BRX103	#3	5/16" x 6"	10 1/4"	6.13
BRX104	#4	3/8" x 8"	12 1/2"	8.25

SUBJECT TO DISCOUNT



QUALITY PROFESSIONAL TOOLS

COMBINATION-REVERSIBLE BLADE SCREWDRIVERS AND KITS

AISI 6150 chrome vanadium steel blades. Shockproof, breakproof, plastic (UL) handles.
Patented spring holds blades securely. 3/16" hex opening doubles as a nutdriver.

COMPLETE UNITS

Regular Type	List
CR1—No. 25 handle & RB1 blade	\$2.50
CR2—No. 25 handle & RB2 blade	2.50
CR3—No. 25 handle & RB3 blade	2.50

Stubby Type

CS1—No. 26 handle & SB1 blade	\$2.40
CS2—No. 26 handle & SB2 blade	2.40

HANDLES ONLY

25—Regular	\$1.05
26—Stubby	1.00

BLADES ONLY

Regular Type	List
RB1—No. 1 Phillips & 3/16" Slotted	\$1.45
RB2—No. 2 Phillips & 1/4" Slotted	1.45
RB3—No. 3 Phillips & 3/8" Slotted	1.45
RB12—No. 1 & No. 2 Phillips	1.70
GB1—3/16"G & 5/32"G Clutch	1.75
GB2—3/16"G & 1/4"G Clutch	1.75

Stubby Type

SB1—No. 1 Phillips & 3/16" Slotted	\$1.40
SB2—No. 2 Phillips & 1/4" Slotted	1.40
GS1—3/16"G & 5/32"G Clutch	1.50

POCKET ROLL KITS

CK2—Contains RB1, RB2 blades and No. 25 handle	\$4.85
CK3—Same as CK2, plus RB3 blade	6.25
CK5—Same as CK2, plus RB3, GB1, and GB2 blades	9.75

PLASTIC VIEW KITS

SK20—Contains SB1, SB2 blades and No. 26 handle	\$4.25
CK20—Contains RB1, RB2 blades and No. 25 Handle	5.00
CK23—Same as CK20, plus RB3 blade	6.45

COMBINATION SCREW AND NUTDRIVER TOOL

600—Handy 4-way tool with pocket clip. 1/4" and 3/16" hex openings. Reversible SB1 blade	List \$2.75
--	-------------

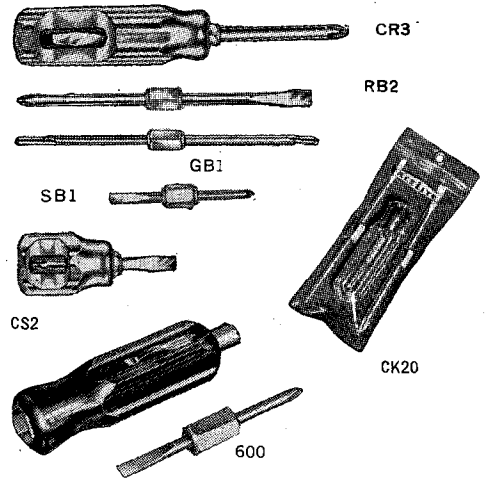

NUTDRIVERS (Color-Coded Handles)

Polished-plated, steel shafts. Shockproof, breakproof, plastic (UL) handles. Precision, cold drawn, case hardened sockets.

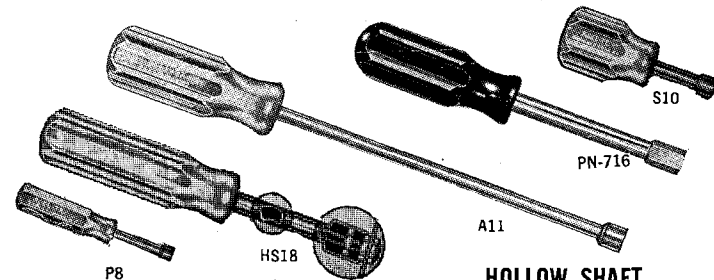

Number	Handle Color	Hex Opening	List
REGULAR SHAFT			
(6 1/8" Overall Length)			
5	Amber	5/32"	\$1.40
6	Black	3/16"	1.40
7	Brown	7/32"	1.40
8	Red	1/4"	1.40
9	Orange	9/32"	1.40
10	Amber	5/16"	1.40
11	Green	11/32"	1.40
12	Blue	3/8"	1.40
(6 1/2" Overall Length)			
14	Brown	7/16"	\$1.70
16	Red	1/2"	1.70

Number	Handle Color	Hex Opening	List
STUBBY			
(3 1/8" Overall Length)			
S6	Black	3/16"	\$1.25
S8	Red	1/4"	1.25
S10	Amber	5/16"	1.25
S11	Green	11/32"	1.25
S12	Blue	3/8"	1.25

Number	Handle Color	Hex Opening	List
POCKET CLIP STYLE			
(3 1/2" Overall Length)			
P3	Amber	3/32"	\$.90
P4	Red	1/8"	.90
P5	Amber	5/32"	.90
P6	Black	3/16"	.90
P7	Brown	7/32"	.90
P8	Red	1/4"	.90
P9	Orange	9/32"	.90
P10	Amber	5/16"	.90
P11	Green	11/32"	.90
P12	Blue	3/8"	.90

Number	Handle Color	Hex Opening	List
HOLLOW SHAFT			
(6 1/4" Overall Length)			
HS6	Black	3/16"	\$1.65
HS7	Brown	7/32"	1.65
(7 1/4" Overall Length)			
HS8	Red	1/4"	\$1.65
HS9	Orange	9/32"	1.65
HS10	Amber	5/16"	1.65
HS11	Green	11/32"	1.65
HS12	Blue	3/8"	1.65
HS13	Amber	13/32"	1.90
HS14	Brown	7/16"	1.90
HS15	Amber	15/32"	1.90
HS16	Red	1/2"	1.90
HS17	Amber	17/32"	2.00
HS18	Orange	9/16"	2.00
HS19	Amber	19/32"	2.25
(7 5/8" Overall Length)			
HS20	Amber	5/8"	\$2.25
HS22	Amber	13/16"	3.25
HS24	Amber	3/4"	3.25

Number	Handle Color	Hex Opening	List
EXTRA LONG			
(9" Overall Length)			
A6	Black	3/16"	\$1.95
A7	Brown	7/32"	1.95
A8	Red	1/4"	1.95
A9	Orange	9/32"	1.95
A10	Amber	5/16"	1.95
A11	Green	11/32"	1.95
A12	Blue	3/8"	1.95

Number	Handle Color	Hex Opening	List
EXTERNAL HEX			
(For control shaft nuts on Arvin and Philco portable stereo sets. 6 1/4" Overall Length. 1/4" External Hex.)			
PN-716	Black	\$1.55

NUTDRIVER SETS (Color-Coded Handles)

Nos. 77 and HS6-18 plastic cases keep tools orderly on workbench or in tool caddy. Molded plastic "Tray Bien" bench trays have fold-away stands and provision for wall mounting. Snap lock feature holds tools securely, yet permits easy removal.

No. 77 CARRYING CASE List \$11.25
Contains solid shaft Nos. 6, 7, 8, 9, 10, 11 and 12.

No. HS6-18 CARRYING CASE List \$19.38
Contains hollow shaft Nos. HS6, HS7, HS8, HS9, HS10, HS11, HS12, HS14, HS16 and HS18.

No. 127TB "TRAY BIEN" List \$11.00
Contains solid shaft Nos. 6, 7, 8, 9, 10, 11 and 12.

No. 137TB "TRAY BIEN" List \$12.25
Contains solid shaft Nos. 6, 8, 10, 11 and 12 and hollow shaft Nos. HS16 and HS18.

No. 147TB "TRAY BIEN" List \$14.50
Contains hollow shaft Nos. HS8, HS9, HS10, HS11, HS12, HS14 and HS16.

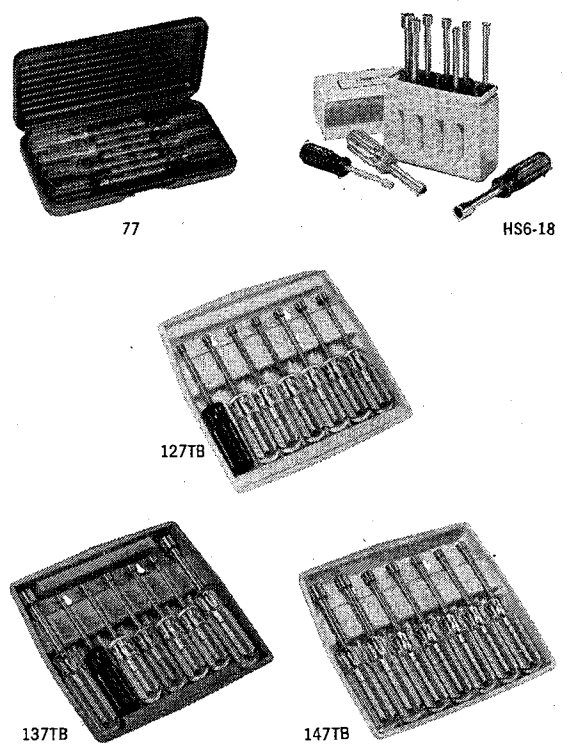

SUBJECT TO DISCOUNT



QUALITY PROFESSIONAL TOOLS

SERIES "99" SERVICE KITS, BLADES, AND HANDLES

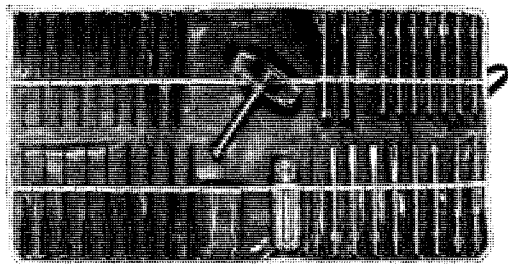

No. 99MP MULTI-PURPOSE TOOL KIT List \$47.25

39-piece kit contains 99-1 (Regular) and 99-4 (Tee) handles, ten regular nutdrivers (99-5 thru 99-16), nine Allen Hex type screwdrivers (99-20, thru 99-26), nine Bristol Multiple Spline screwdrivers (99-61 thru 99-69), three slotted screwdrivers (99-811, 99-250, 99-312), two Phillips screwdrivers (99-821, 99-822), two reamers (99-38, 99-39), awl/scriber (99-70), extension blade (99-X5).

99MPK, Canvas case only..... List \$5.45

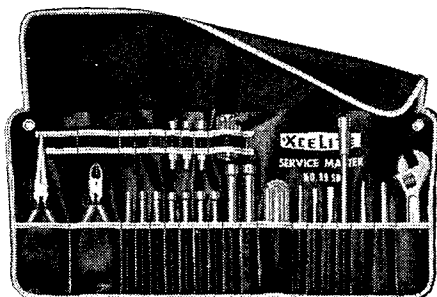

No. 99SM SERVICE MASTER List \$43.00

23-piece kit contains 99-1 (Regular) and 99-3 (Stubby) handles, nine regular and three stubby nutdrivers (99-6 thru 99-16), two slotted screwdrivers (99-811, 99-812), one Phillips screwdriver (99-821), two reamers (99-38, 99-39), extension blade (99-X10), 6" long nose cushion grip plier (52CG), 5" diagonal cushion grip plier (55CG), 6" adjustable wrench (46C).

99SMK, Canvas case only..... List \$3.75

ROLL KITS

No. 99PR ROLL KIT List \$15.70

Contains nine regular nutdrivers (99-6 thru 99-16), 99-811 and 99-250 (slotted) and 99-821 and (Phillips) screwdriver blades, 99-1 handle (Regular).

99PK, Kit only List \$1.75

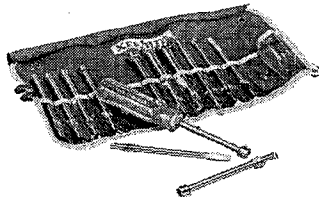

No. 99JR ROLL KIT List \$13.80

Contains seven regular nutdrivers (99-6 thru 99-12) four screwdriver blades 99-811 and 99-812 (Slotted), and 99-821 and 99-822 (Phillips), 99-2 handle (Junior).

99JKR, Kit only List \$1.75

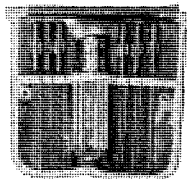

No. 99LN ROLL KIT List \$7.45

Contains six Allen type screwdriver blades (99-21, 22, 23, 24, 25, 26) and 99-1 handle (Regular).

No. 99-30 CLEAR PLASTIC POUCH List \$5.40

Heat sealed plastic snap case with size numbers on pockets for convenient selecting and storing. Contains six Allen type screwdriver blades (99-21, 22, 23, 24, 25 and 26).

PLASTIC VIEW KITS

No. 99SL List \$6.25

Contains five Scrulox® screwdriver blades for square recess screws (SL 00, 0, 1, 2, 3), 99-1 handle (Regular).

No. 99PV4 List \$4.45

Contains three slotted screwdriver blades (99-811, 99-250, 99-312), 99-1 handle (Regular).

No. 99PV6 List \$6.25

Contains three slotted screwdriver blades (99-811, 99-250, 99-312), two Phillips screwdriver blades (99-821, 99-822), 99-1 handle (Regular).

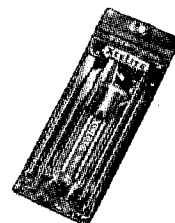

Handles: 99-1 Regular (1 1/8" x 4 1/8") — for all blades, single-end and reversible 1.15
 99-2 Junior (1" x 3 1/8") — for single-end blades only 1.05
 99-3 Stubby (1 1/8" x 2") — for single-end blades only 1.00
 99-4 Tee (1" x 3 3/8") — for single-end blades only 1.50



Nutdriver Blades: 99-5 (5/32"), 99-6 (3/16"), 99-7 (7/32"), 99-8 (1/4"), 99-9 (1/2"), 99-10 (3/8"), 99-11 (1 1/32"), 99-12 (3/8") 1.05
 99-14 (7/16"), 99-16 (1/2") 1.30
 Stubby Nutdriver Blades: 99-S8, 99-S10, 99-S1285

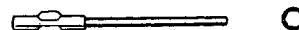

Allen Hex Type Screwdriver Blades: 99-20 (.050"), 99-21 (1/16"), 99-22 (3/64"), 9-23 (3/32"), 99-764 (7/64"), 99-24 (1/8"), 99-964 (3/64"), 99-25 (5/32"), 99-26 (3/16")95



Bristol Multiple-Spline Type Screwdriver Blades: 99-61 (.048" flute), 99-62 (.060", 6-flute), 99-63 (.069", 4-flute), 99-64 (.072", 6-flute), 99-65 (.076", 4-flute), 99-66 (.096", 6-flute), 99-67 (.111", 6-flute), 99-68 (.145", 6-flute), 99-69 (.183", 6-flute)95

Frearson and Clutch Head Reversible Screwdriver Blades:

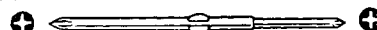

99-83 Frearson (3/16" and 5/32") 1.75
 99-84 Clutch Head (3/16" G and 5/32" G) 1.75



Slotted Screwdriver Blades: 99-811 (3/16"), 99-250 (1/4"), 99-812 (5/32"), 99-312 (3/16") 1.05

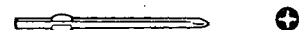

Phillips Screwdriver Blades: 99-821 (#1), 99-822 (#2) 1.05

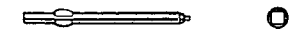

Scrulox Screwdriver Blades: 99SL-00 (#00), 99SL-0 (#0), 99SL-1 (#1), 99SL-2 (#2), 99SL-3 (#3) 1.05

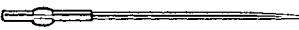

Awl/Scriber: 99-70 (4 1/2" overall length) 1.00

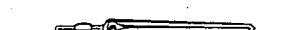

Reamers: 99-38 (1/8" - 3/8") 2.25
 99-39 (1/4" - 1/2") 2.85



Extension Blades:
 99-X5 (adds 4" reach to single-end blades) 1.55
 99-X10 (adds 7" reach to single-end blades) 1.60

SUBJECT TO DISCOUNT

XCELITE®

QUALITY PROFESSIONAL TOOLS

COMPACT SETS

No. HSC-1 INTERCHANGEABLE HOLLOW SHAFT NUTDRIVER SET

Contains special thru-drilled handle and eight interchangeable hollow nutdriver shafts in $\frac{3}{16}$ ", $\frac{1}{4}$ ", $\frac{5}{16}$ ", $\frac{1}{2}$ ", $\frac{3}{8}$ ", $\frac{7}{16}$ ", $\frac{1}{2}$ ", $\frac{5}{8}$ " hex sizes. Screwdriver blade may be run down through center of handle and hollow nutdriver shaft to make combination locknut/slotted screw adjustments. List \$14.75

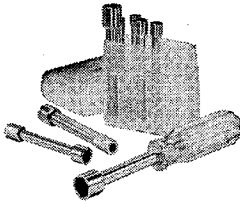

Series "99" Sets

Each set contains a Series "99" regular handle and various Series "99" interchangeable blades and extension. See-thru plastic case is pocket size, has flat base that permits its use as a bench stand.

No. 99PS-40 ALLEN HEX TYPE SCREWDRIVER SET

Includes nine Allen Hex type screwdriver blades (99-20 thru 99-26), 99-X5 extension blade, 99-1 handle, and see-thru case. List \$11.25

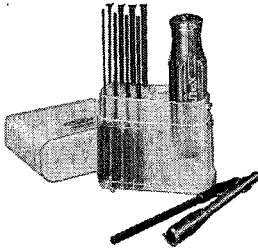

No. 99-PS50 NUTDRIVER/SCREWDRIVER SET

Includes seven regular nutdriver blades (99-6 thru 99-12), two slot tip screwdriver blades (99-811 and 99-812), two Phillips screwdriver blades (99-821 and 99-822), 99-X5 extension blade, 99-1 handle, and see-thru case. List \$14.25

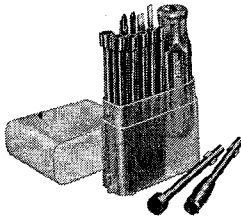

No. 99PS-60 BRISTOL MULTIPLE-SPLINE TYPE SCREWDRIVER SET

Includes nine Bristol Multiple-Spline type screwdriver blades (99-61 thru 99-69), 99-X5 extension blade, 99-1 handle, and see-thru case. List \$11.25

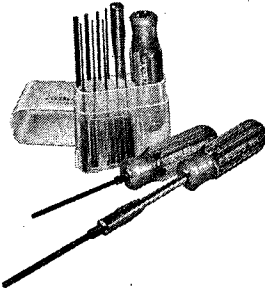

No. K22 ELECTRICIAN'S KNIFE

Two blades. One is combination insulation-scraper and screwdriver. Has positive lock when openList \$3.40

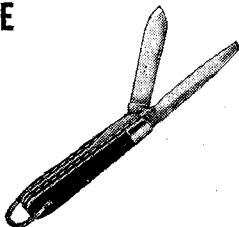

Convertible Nutdriver and Screwdriver Sets

Black plastic torque amplifier handle (1" x $\frac{3}{8}$ ") slips over handles of pocket size ($\frac{3}{16}$ ") nutdrivers and screwdrivers . . . provides larger grip, extends reach and increases driving power to that of standard size tools. See-thru plastic case fits pocket, stands upright on bench.

No. PS7 NUTDRIVER/SCREWDRIVER SET

Contains two nutdrivers ($\frac{1}{4}$ " and $\frac{3}{16}$ "), two slot tip screwdrivers ($\frac{3}{16}$ " and $\frac{3}{32}$ "), two Phillips screwdrivers (#0 and #1), hollow handle, and case. List \$6.50

No. PS44 SCRULOX SCREWDRIVER SET

Includes five Scrulox screwdrivers (#1 thru #14), one nutdriver ($\frac{1}{4}$ "), hollow handle, and case. List \$5.75

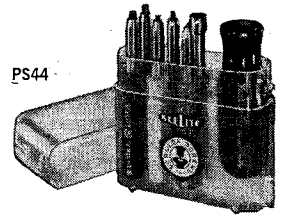

No. PS88 SCREWDRIVER SET

Contains five slot tip screwdrivers ($\frac{3}{32}$ ", $\frac{1}{8}$ ", $\frac{3}{32}$ ", $\frac{3}{16}$ ", $\frac{1}{4}$ "), three Phillips screwdrivers (#0, #1, #2), hollow handle, and case. List \$7.00

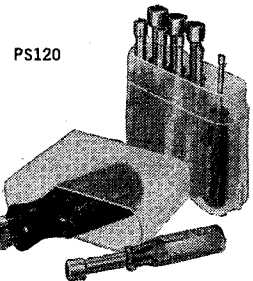

No. PS120 NUTDRIVER SET

Contains ten color coded nutdrivers ($\frac{3}{32}$ " thru $\frac{3}{8}$ "), hollow handle, and case. List \$9.75

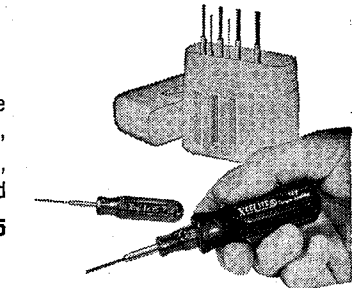

No. PS89 ALLEN HEX TYPE SCREWDRIVER SET

Contains eight Allen hex type screwdrivers (hex sizes .028", .035", .050", $\frac{1}{16}$ ", $\frac{5}{64}$ ", $\frac{3}{32}$ ", $\frac{7}{64}$ ", $\frac{1}{8}$ "), hollow handle, and case. List \$7.25

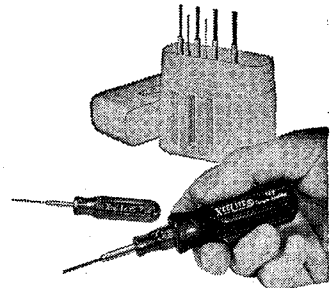

No. 150 TOOL HOLSTER

Has tape holder, knife clip, and 5 tool pockets. Durably made of pliable saddle leather with natural cowhide finish. Features comfortable hip-contoured back, hot-waxed stitching, and brass rivets ..List \$6.40

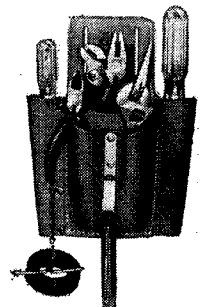



QUALITY PROFESSIONAL TOOLS

PLIERS

Precision-machined forged alloy steel. Perfectly aligned jaws. Hand-honed, mated cutting edges. Polished heads.

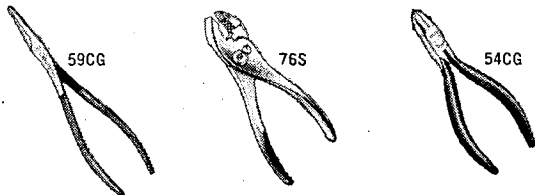

Number	List
59CG — CHAIN NOSE ELECTRICIAN'S PLIERS (8")—Cushion Grip.....	\$4.84
75C — COMBINATION SLIP JOINT PLIER (5")—Chrome-Plated.....	2.30
76C — COMBINATION SLIP JOINT PLIER (6")—Chrome-Plated.....	2.36
76S — Satin Finish.....	1.44
78C — COMBINATION SLIP JOINT PLIER (8")—Chrome-Plated.....	2.90
54 — DIAGONAL PLIER (Midget 4").....	4.20
54CG — Cushion Grip.....	4.44
55 — DIAGONAL PLIER (5").....	4.28
55CG — Cushion Grip.....	4.52
66CG — DIAGONAL PLIER (6")—Cushion Grip.....	4.92

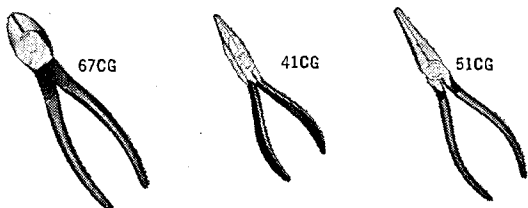

Number	List
67 — DIAGONAL PLIER (7").....	4.56
67CG — Cushion Grip.....	4.92
41CG — LONG NOSE PLIER (Midget 4")—Without Side Cutters—Cushion Grip.....	4.04
52 — LONG NOSE PLIER (6")—Without Side Cutters.....	3.76
52CG — Cushion Grip.....	4.00
51 — LONG NOSE PLIER (6")—With Side Cutters.....	4.86
51CG — Cushion Grip.....	5.12

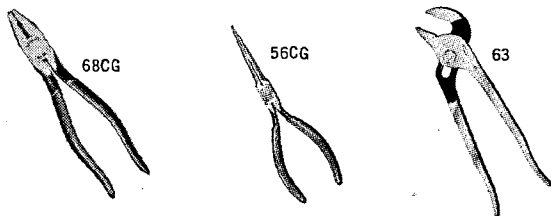

Number	List
56CG — NEEDLE NOSE PLIER (6")—Cushion Grip.....	4.72
58CG — RADIO AND TV PLIER (6")—Cushion Grip.....	5.96
60CG — SIDE CUTTING PLIER (6")—Cushion Grip.....	4.80
68CG — SIDE CUTTING PLIER (8")—Cushion Grip.....	5.96
62CG — TRAVERSE CUTTING PLIER (6")—Cushion Grip.....	5.56
53CG — UTILITY PLIER (6")—Forged Rib-Lock—Cushion Grip.....	4.00
63 — UTILITY PLIER (10")—Forged Rib-Lock.....	4.84
63CG — Cushion Grip.....	5.40

MINIATURE ELECTRONIC PLIERS

Small, lightweight. For handling fine wires. All cushion grip handles. Coil spring openers. Polished heads and shoulders.

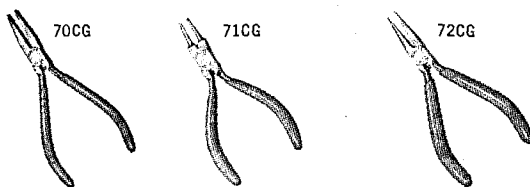

Number	List
70CG — FLAT NOSE PLIERS (4½").....	\$5.20
71CG — ROUND NOSE PLIERS (4½").....	5.10
72CG — CHAIN NOSE PLIERS (4").....	5.20

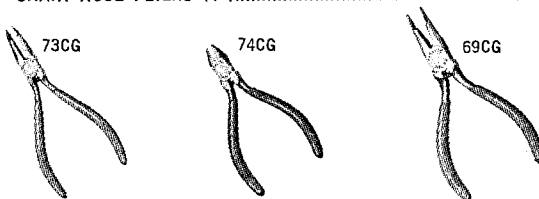

Number	List
73CG — SPECIAL TIP CUTTING PLIERS (4½").....	7.00
74CG — DIAGONAL FLUSH CUTTING PLIERS (4").....	6.80
69CG — RADIO AND TV PLIER (5").....	7.60

No. 86CG ELECTRONIC SNIPS

6½" size. Shearing action of pointed blades (1½" cut) prevents peaks on fine wire and filaments. Useful also for removing insulation and cutting light sheet metal. Coil spring opens blades... latch holds them closed. Cushion grip List \$4.60

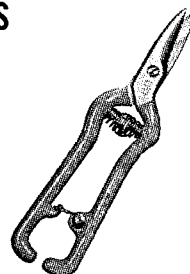

TERMINAL WRENCHES

For spanner nuts on external antenna and earphone jacks of transistor radios and CB walkie-talkies. 3¾" overall length.

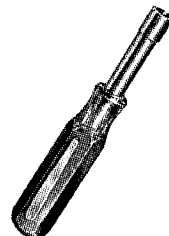

Number	Handle Color	Spanner Nut O.D.	List
TW32	Green	¼"	\$.80
TW140	Red	⅜"	.80

ADJUSTABLE WRENCHES

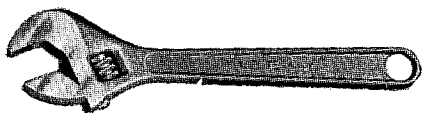

Thin-pattern permits access to close-quarter work. Chrome-plated forged alloy steel. Polished heads.

Plain Handle		Cushion Grip		
Number	List	Size	Number	List
44C	\$3.80	4"	44CG	\$4.20
46C	3.80	6"	46CG	4.20
48C	4.32	8"	48CG	4.72
40-10C	5.56	10"	40-10CG	6.12
40-12C	8.20	12"	40-12CG	8.72

REGULAR AND JR. SEIZER®

Outreach, outhold needle nose pliers. Clamp tightly. Hold wires for soldering and serve as heat sinks. Retrieve small parts. Two-position snap-lock. Stainless steel, box-joint construction. Precision machined and tempered.

Regular 6" Seizers have serrated jaws. Jr. Seizers are 5" long, have smooth jaws that won't mar delicate materials.

Number	List
42H—6" Straight Nose.....	\$5.90
43H—6" Curved Nose.....	6.10
32H—5" Straight Nose.....	5.90
33H—5" Curved Nose.....	6.10

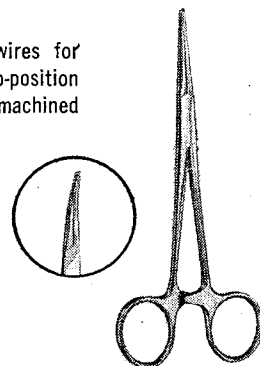

*You can depend on your local
ELECTRONIC DISTRIBUTOR for ...*

- *Instant off-the-shelf delivery*
- *In-depth inventories*
- *Wide varieties*
- *Prompt service*
- *Technical assistance*
- *Availability of the latest products*
- *Speedy purchasing — one order does the job*

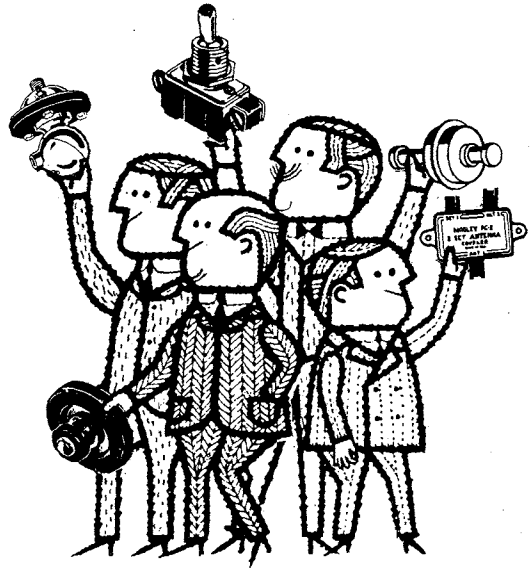

*Contact your local **ELECTRONIC DISTRIBUTOR**
for all your requirements!*

Need custom constant voltage transformers? Acme Electric can design and build to your specs.

Acme Electric's engineering and experience have developed thousands of custom-designed constant voltage transformers for a variety of industrial markets. These areas of production and development include such industries as: data processing, communications, automation, instrumentation,

office copying equipment, medicine, photography, to name but a few. And, each unit has been designed to meet the customer's exact requirements.

Does your equipment or system require a regulated AC voltage for maximum performance? If so, draw on the engineering know-how of Acme Elec-

tric Corporation to solve your problem. Our business is to satisfy the functions of power control, conversion and/or regulation, whatever the industry or application.

Acme Electric
ACME ELECTRIC CORPORATION

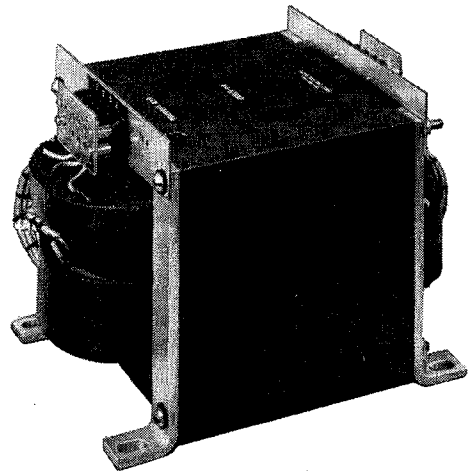
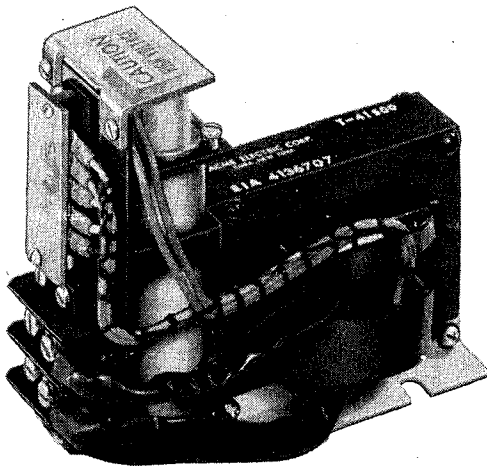
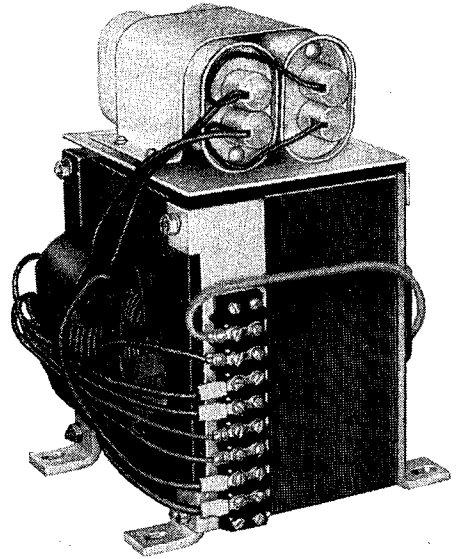
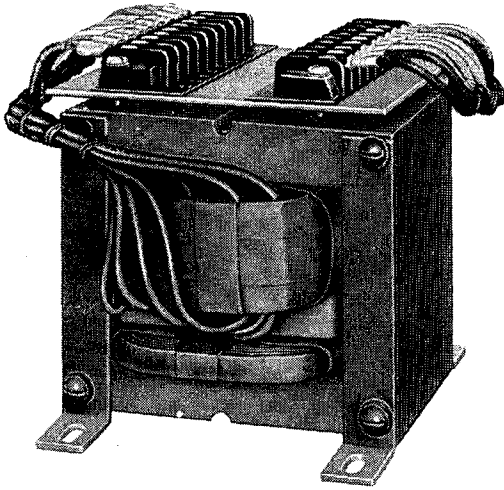

FREED TRANSFORMER CO., INC.

BROADCAST QUALITY COMPONENTS

CASE DIMENSIONS

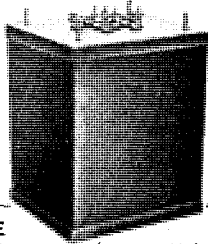

DC-2B CASE		DC-4A CASE	
Height:	3 1/2"	Height:	3 3/4"
Width:	2 5/8"	Width:	3 1/8"
Depth:	2 1/4"	Depth:	3"
Mtg. Cen.:	2" x 1 3/4"	Mtg. Cen.:	2 1/2" x 2 1/2"
Studs:	4 8-32	Studs:	4 8-32
Knockout:	1 1/2" dia.	Knockout:	2" dia.

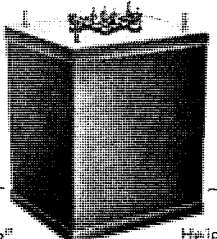

DC-2B CASE		DC-4A CASE	
Height:	3 1/2"	Height:	3 3/4"
Width:	2 5/8"	Width:	3 1/8"
Depth:	2 1/4"	Depth:	3"
Mtg. Cen.:	2" x 1 3/4"	Mtg. Cen.:	2 1/2" x 2 1/2"
Studs:	4 8-32	Studs:	4 8-32
Knockout:	1 1/2" dia.	Knockout:	2" dia.

DC-4B CASE
Same as 4A—4" high

DC-5B CASE		DC-6A CASE	
Height:	4 1/2"	Height:	4 7/8"
Width:	4 1/8"	Width:	5"
Depth:	3 1/2"	Depth:	4 1/8"
Mtg. Cen.:	3" x 2 5/8"	Mtg. Cen.:	3 3/4" x 3"
Studs:	4 10-32	Studs:	4 10-32
Knockout:	3" dia.	Knockout:	3" dia.

DC-6B CASE		DC-7 CASE	
Height:	6"	Height:	5 3/8"
Width:	5"	Width:	5 1/2"
Depth:	4 1/8"	Depth:	5"
Mtg. Cen.:	3 3/4" x 3"	Mtg. Cen.:	4 1/4" x 3 3/4"
Studs:	4 10-32	Studs:	4 1/4"-20
Knockout:	3" dia.	Knockout:	3" dia.

LOW LEVEL OUTPUT, MIXING, MATCHING TRANSFORMERS

Frequency Response 20-20,000 C.P.S. ±1.0 DB *50-20,000 C.P.S. ±1.0 DB

Catalog No.	Application	Impedance Level Ohms		Maximum Power Level DBM	Ratio	Equivalent Shielding D.B.	Maximum Pri. D.C. per Side Ma.	D.C. Unbalance Ma.	Case Number
		Primary	Secondary						
QGA 16	Single plate or bridging line to Universal 500 ohm line. Shunt feed.	15,000	U-500	+18	5.5:1	70	0	0	DC-2B
QGA 17	Single plate to Universal 500 ohm line.	15,000	U-500	+18	5.5:1	70	8	8	DC-2B
QGA 18	Push-pull triode plates to Universal 500 ohm line.	20,000 C.T.	U-500	+25	6.3:1	70	8	0.5	DC-2B
QGA 19	Mixing, low impedance microphone or line to Universal 500 ohm line.	U-500	U-500	+12	1:1	70	0	0	DC-2B
QGA 20	Line level mixing and matching.	U-500	U-500	+30	1:1	70	0	0	DC-2B
QGA 21	High mu triode photo-cell to Universal 500 ohm line.	100,000	U-500	+12	14.1:1	70	0	0	DC-2B

DRIVER TRANSFORMERS

Frequency Response 20-20,000 C.P.S. ±1.0 DB

Catalog No.	Application	Primary Impedance Ohms	Maximum Power Level DBM	Turn Ratio Pri. to 1/2 Sec.	Maximum Pri. D.C. per Side Ma.	D.C. Unbalance Ma.	Case Number
QGA 23	Push-pull 6J5, etc. to push-pull 2A3's, 6L6's, etc.	20,000 C.T.	+30	3.2:1	8	0.5	DC-2B
QGA 24	Push-pull 2A3, 6B4 to push-pull 809, T2-40, 4J125A.	5,000 C.T.	+40	3.1:1	50	5	DC-4B

INPUT TRANSFORMERS

Frequency Response 20-20,000 C.P.S. ±1.0 DB

Catalog No.	Application	Impedance Level Ohms		Maximum Power Level DBM	Ratio	Equivalent Shielding D.B.	Maximum Pri. D.C. per Side Ma.	D.C. Unbalance Ma.	Case Number
		Primary	Secondary						
QGA 1	Universal 500 ohm line to push-pull grids	U-500	100,000 split	+10	1:14.1	70	0	0	DC-2B
QGA 2	Universal 500 ohm line to push-pull grids	U-500	100,000 split	+10	1:14.1	90	0	0	DC-2B
QGA 3	Universal 500 ohm line to single or push-pull grids	U-500	60,000 split	+10	1:11	70	0	0	DC-2B
QGA 4	Universal 500 ohm line to single or push-pull grids	U-500	60,000 split	+10	1:11	90	0	0	DC-2B
QGA 5	Universal low impedance microphone, pickup or line to single or push-pull grids	U-60	60,000 split	+10	1:31.6	70	0	0	DC-2B
QGA 6	Universal low impedance microphone, pickup or line to single or push-pull grids	U-60	60,000 split	+10	1:31.6	90	0	0	DC-2B

U-60 IMPEDANCES IN OHMS: 2.5, 5, 10, 15, 20, 30, 40, 60

U-500 IMPEDANCES IN OHMS: 50, 125, 200 C.T., 250, 330, 500 C.T. 125 and 500 ohms can be used for 150 and 600 ohms.

HYBRID AND REPEAT COILS

Frequency Response 20-20,000 C.P.S. ±1.0 DB

Catalog No.	Application	Impedance Level Ohms		Maximum Power Level DBM	Ratio	Equivalent Shielding D.B.	Maximum Pri. D.C. per Side Ma.	D.C. Unbalance Ma.	Case Number
		Primary	Secondary						
QGA 7	Hybrid, Unbalanced 500/600 ohm lines to 600 ohms.	Total Pri 1200/1000 split or 300/250 300/250	600/150 or 500/125 split	+10	1.41:1	70	0	0	DC-2B
QGA 8	Hybrid, Balanced 500/600 ohm lines to 600 ohms. Longitudinal balance 70 DB	Total Pri 1200/1000 split or 300/250 C.T. 300/250 C.T.	600/150 or 500/125 split	+10	1.41:1	70	0	0	DC-2B
QGA 9	Hybrid, Unbalanced 500/600 ohm lines to triode plate. No. D.C. in secondary	Total Pri 1200/1000 split or 300/250 300/250	15,000 or 12,500	+10	1.354	70	0	0	DC-2B
QGA 10	Hybrid, Balanced 500/600 ohm lines to triode plate. No. D.C. in secondary. Longitudinal balance 70 DB.	Total Pri 1200/1000 split or 300/250 C.T. 300/250 C.T.	15,000 or 12,500	+10	1.354	70	0	0	DC-2B
QGA 11	Repeat coil for low frequency ringing. Longitudinal balance 70 DB.	600/500 split	600/500 split	1:1	90	0	0	0	DC-4A

INTERSTAGE TRANSFORMERS

Frequency Response 20-20,000 C.P.S. ±1.0 D.B. *50-20,000 C.P.S. ±1.0 D.B.

Catalog No.	Application	Impedance Level Ohms		Maximum Power Level DBM	Ratio	Equivalent Shielding D.B.	Maximum Pri. D.C. per Side Ma.	D.C. Unbalance Ma.	Case Number
		Primary	Secondary						
QGA 12	Bridging line to single or push-pull grids.	10,000	60,000 split	+10	1.245	70	0	0	DC-2B
QGA 13	Single 6C4, 6J5 1/2 6SN7 triode to push-pull grids. Shunt feed.	15,000	60,000 split	+18	1:2	45	0	0	DC-2B
QGA 14*	Single 6C4, 6J5 1/2 6SN7 triode to push-pull grids.	15,000	60,000 split	+18	1:2	45	8	8	DC-2B
QGA 15	Push-pull triode plates to push-pull class A grids.	20,000 split	45,000 split	+25	1:1.5	30	8	0.5	DC-4A

HIGH LEVEL OUTPUT TRANSFORMERS

Frequency Response 20-30,000 C.P.S. ±0.5 DB

Catalog No.	Application	Impedance Level Ohms		Maximum Power Level DBM	Watts	Ratio	Maximum D.C. per Side Ma.	D.C. Unbalance Ma.	Case Number
		Primary	Secondary						
QGA 25	PP5881, 6B4, 6L6, 300A, 275A to Universal 500 ohm line.	5,000 split	U-500	+42	15	3.16:1	70	7	DC-5B
QGA 26	As above to Universal voice coil.	5,000 split	U-16	+42	15	17.7:1	70	7	DC-5B
QGA 27	Push-pull 6V6, 6AQ5, 7C5, 6N7 to Universal 500 ohm line.	8,000 split	U-500	+42	15	4:1	50	5	DC-5B
QGA 28	As above to Universal voice coil.	8,000 split	U-16	+42	15	22.4:1	50	5	DC-5B
QGA 29	P.P. 6F6, 6V6, 6AQ5, 7C5, 7B5, 6AR5, 6B6, 6L6 to Universal 500 ohm line.	10,000 split	U-500	+42	15	4.47:1	40	4	DC-5B
QGA 30	As above to Universal voice coil.	10,000 split	U-16	+42	15	25:1	40	4	DC-5B
QGA 31	P.P. 607, 1614, K1-66, (Williamson Amplifier) to Universal 500 ohm line.	10,000 split	U-500	+45.5	36	4.47:1	60	6	DC-6A
QGA 32	As above to Universal voice coil.	10,000 split	U-16	+45.5	36	25:1	60	6	DC-6A
QGA 33	P.P. Parallel, 6AS6, 300A to Universal 500 ohm line.	2,500 split	U-500	+45.5	36	2.24:1	100	10	DC-6A
QGA 34	As above to Universal voice coil.	2,500 split	U-16	+45.5	36	12.5:1	100	10	DC-6A
QGA 35	P.P. 6L6 or P.P. Parallel 6L6 to Universal 500 ohm line.	3,800 split	U-500	+47	50	2.75:1	140	14	DC-6B
QGA 36	As above to Universal voice coil.	3,800 split	U-16	+47	50	15.4:1	140	14	DC-6B
QGA 37	High level multiple line to Universal voice coil.	U-500	U-16	+42	15	5.6:1	0	0	DC-5B
QGA 38	High level multiple line to Universal voice coil.	U-500	U-16	+47	50	5.6:1	0	0	DC-6B
QGA 39*	5881 or 6146 Class AB1 to Universal 500 ohm line.	6,600 split	U-500	+45.5	36	3.64:1	70	7	DC-6A
QGA 40*	5881 or 6146 Class AB1 to Universal voice coil.	6,600 split	U-16	+45.5	36	20:1	70	7	DC-6A
QGA 41	6550 AB1 or 6146 AB2 to Universal 500 ohm line.	5,000 split	U-500	+50	100	3.16:1	140	14	DC-7
QGA 42	6550AB1 or 6146AB2 to Universal voice coil.	5,000 split	U-16	+50	100	17.7:1	140	14	DC-7

*These units supplied with taps for applying screen feedback U-16 IMPEDANCES IN OHMS: 2, 4, 8, 12, 16. U-500 IMPEDANCES IN OHMS: 50, 125, 200, C.T., 250, 330, 500 C.T. 125 and 500 ohms can be used for 150 and 600 ohms.

FREED TRANSFORMER CO., INC.

MINIATURE TRANSISTOR AUDIO TRANSFORMERS

These high quality miniature transformers are high efficiency audio components featuring hermetic sealing for maximum protection against electrolysis and subsequent corrosion of fine wires caused by moisture penetration. The units are constructed in accordance with MIL-T-27A Specifications. Transistor transformers can also be supplied in an open or encapsulated type of construction.

TYPE		TSA			TNA			TPA			TTA		
MAX. POWER		500 MW			1 W			3 W			5 W		
FREQ. RESPONSE		.3 — 15 KC ± 2DB			.2 — 15 KC ± 2 DB			.15 — 15 KC ± 2 DB			.15 — 15 KC ± 2 DB		
UNCASED													
CASED MIL-T-27A-4RX		¼ D., ½ H.			¼ D. x ½ H.			¼ x ½ x ½			¼ x ½ x ½		
MOLDED MIL-T-27A-5RX		½ D. x ½ H.			½ x ½ x ½			½ x ½ x ½			1½ x 1 x ½		
MATCHING IMP.		Cat. No.			Cat. No.			Cat. No.			Cat. No.		
Pri.	Sec.	Max. I (MA) Total Pri.	Max. I dc (MA) Unbal. ½ Pri.	Max. I (MA) Total Pri.	Max. I dc (MA) Unbal. ½ Pri.	Max. I (MA) Total Pri.	Max. I dc (MA) Unbal. ½ Pri.	Max. I (MA) Total Pri.	Max. I dc (MA) Unbal. ½ Pri.	Max. I (MA) Total Pri.	Max. I dc (MA) Unbal. ½ Pri.	Max. I (MA) Total Pri.	Max. I dc (MA) Unbal. ½ Pri.
150 (CT)	3.2	28	35	12	28	40	16	30	45	20	15	130	50
150 (CT)	12	29	35	12	29	40	16	31	45	20	17	130	50
150 (CT)	50	30	35	12	30	40	16	32	45	20	18	130	50
300 (CT)	3.2	31	30	8	31	32	14	33	35	16	20	100	35
300 (CT)	12	32	30	8	32	32	14	34	35	16	21	100	35
300 (CT)	50	33	30	8	33	32	14	35	35	16	22	100	35
500 (CT)	500	34	20	6	34	22	10	36	20	12	1	80	25
600 (SP)	3.2	1	16	6	1	18	8	2	20	10	23	65	25
600 (SP)	12	2	16	6	2	18	8	3	20	10	24	65	25
600 (SP)	50	35	16	6	35	18	8	4	20	10	25	65	25
600 (SP)	600 (SP)	3	16	6	3	18	8	4	20	10	26	65	25
600 (SP)	1.2K (CT)	22	16	6	22	18	8	8	10	7	7	65	25
1K (CT)	3.2	26	14	4	26	15	6	38	16	8	19	50	20
1K (CT)	12	27	14	4	27	15	6	39	16	8	20	50	20
1K (CT)	50	28	14	4	28	15	6	40	16	8	21	50	20
1.2K (SP)	3.2	39	14	4	39	15	6	5	16	8	28	40	15
1.2K (SP)	12	4	12	4	4	14	6	6	16	8	29	40	15
1.2K (SP)	50	38	12	4	38	14	6	7	16	8	30	40	15
2K (SP)	600 (SP)	6	7	9	6	10	9	8	14	10	24	40	15
2K (SP)	12	8	9	9	8	10	10	10	14	6	32	225	12
2K (SP)	600 (SP)	1	10	6.5	1	10	8	11	14	9	33	200	10
4K (SP)	12	11	11	6.5	11	8	8	11	9	9	34	200	10
4K (SP)	600 (SP)	13	13	6.5	13	8	8	15	7	7	35	150	10
10K (SP)	12	14	14	6	14	6	6	15	7	7	36	150	9
10K (SP)	600 (SP)	15	15	6	15	6	6	17	7	7	37	150	9
10K (SP)	1K	40	15	1	40	6	6	18	7	7	38	150	9
10K (SP)	10K (SP)	16	16	1	16	6	6	19	7	7	39	150	9
20K (CT)	50	25	25	.8	25	3	3	5	5	5	12	16	8
20K (CT)	600 (CT)	41	41	.8	41	3	3	21	5	5	13	16	8
25K (CT)	600 (CT)	23	23	.8	23	3	3	22	5	5	14	16	8
25K (CT)	1.2K (CT)	21	21	.8	21	3	3	23	5	5	15	16	8
50K (CT)	6 (CT)	18	18	.6	18	2.5	2.5	24	3.5	3.5	5	5	4
50K (CT)	500 (CT)	17	17	.6	17	2.5	2.5	25	3.5	3.5	2	2	2
50K (CT)	1.2K (CT)	20	20	.6	20	2.5	2.5	27	3.5	3.5	6	6	4
100K (CT)	1K (CT)	27	27	.4	27	2	2	28	2	2	14	4	4
100K (CT)	1.2K (CT)	19	19	.4	19	2	2	29	2	2	4	4	4

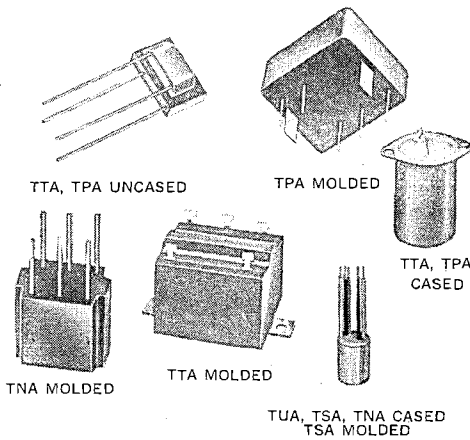

TYPE		TUA		
MAX. POWER		500 MW		
FREQ. RESPONSE		.4 — 15 KC ± 2 DB		
UNCASED				
CASED MIL-T-27A-4RX		½ D. x ½ H.		
MOLDED				
MATCHING IMP.		MATCHING IMP.		
Pri.	Sec.	Cat. No.	Max. I (MA) Total Pri.	Max. I dc (MA) Unbal. ½ Pri.
150 (CT)	3.2	16	15	10
150 (CT)	12	17	15	10
150 (CT)	50	21	15	10
300 (CT)	3.2	20	9	7
300 (CT)	12	19	9	7
300 (CT)	50	22	9	7
500 (CT)	500	23	7	7
600 (CT)	3.2	2	7	7
600 (CT)	12	2	7	7
600 (CT)	50	13	7	7
600 (CT)	600	3	7	7
600 (CT)	1.2K	24	7	7
1K (CT)	3.2	4	6	3.5
1K (CT)	12	25	6	3.5
1K (CT)	50	14	6	3.5
1.2K (CT)	3.2	26	6	3.5
1.2K (CT)	12	5	6	3.5
1.2K (CT)	50	27	6	3.5
1.2K (CT)	600	6	6	3.5

CT = Center Tap. SP = Split Winding.

MINIATURE AUDIO TRANSFORMERS

These high quality, miniature transformers feature hermetically sealing for maximum protection from moisture penetration with subsequent electrolysis and corrosion of fine wires. While primarily intended for non-military equipment, these units are constructed in accordance with MIL-T-27A Specifications.

Frequency response: ± 2DB 30-20,000 CPS *± 2DB 200-10,000 CPS.

CASE DIMENSIONS

DM-20 CASE
 Height: 1 1/16"
 Dia.: 1 3/16"
 Mtg. Cen.: 1 1/8" to 1 1/32"
 Flange Lgth.: 1 1/32"
 Flange D.: .975"

Catalog No.	Application	MIL Type	Impedance Level Ohms		Max. Power Level DBM	Ratio	Equivalent Shielding D.B.	Max. Pri. D.C. per Side Ma.	D.C. Unbalance Ma.	Case Number
			Primary	Secondary						
PMA 1	Line or microphone to single or push-pull grids.	TF4RX10YY	50/200/500	60,000 C.T.	+8	1:11	0	0	DM-20	
PMA 2	Dynamic microphone or speaker voice coil to single or P. P. grid.	TF4RX10YY	4/8	60,000 C.T.	+8	1:86.6	0	0	DM-20	
PMA 3	Line or microphone to single or push-pull grids. Magnetically shielded.	TF4RX10YY	50/200/500	60,000 C.T.	+8	1:11	30	0	DM-20	
PMA 4	Single triode plate to single or push-pull grids.	TF4RX10YY	15,000	60,000 C.T.	+8	1:2	0	0	DM-20	
PMA 5*	Single triode plate to push-pull grids.	TF4RX12YY	15,000	60,000	+8	1:2	2	2	DM-20	
PMA 6	Single triode plate to multiple line.	TF4RX15YY	15,000	50/200/500	+8	5.48:1	0	0	DM-20	
PMA 7*	Single triode plate to multiple line.	TF4RX12YY	15,000	50/200/500	+8	5.48:1	3	2	DM-20	
PMA 8	Push-pull triode plates to multiple line.	TF4RX12YY	30,000 C.T.	50/200/500	+8	7.75:1	2	.025	DM-20	
PMA 9	Crystal mike or pickup to multiple line.	TF4RX12YY	60,000 C.T.	50/200/500	+8	11:1	0	0	DM-20	
PMA 10	Mixing or matching.	TF4RX16YY	50/200	50/200/500	+8	1:1.50	0	0	DM-20	
PMA 11	Parallel Feed Reactor.	TF4RX20YY	40 hy, 3 ma dc.	3500 ohms d.c. resistance					DM-20	
PMA 12	Microphone or line to grid.	TF4RX10YY	50/200/500 C.T.	60,000	+5	1:11	0	0	DM-20	
PMA 13	Mixing and matching.	TF4RX16YY	150/600	600 C.T.	+8	1:1	0	0	DM-20	
PMA 14*	Single triode plate to push-pull grids.	TF4RX15YY	15,000	95,000 Split	+5	1:2.5	0	0	DM-20	
PMA 15*	Single triode plate to push-pull grids.	TF4RX15YY	15,000	95,000 Split	15	1:2.5	4	4	DM-20	

FREED TRANSFORMER COMPANY, INC.

FREED TRANSFORMER CO., INC.

MINIATURE TRANSISTOR TRANSFORMERS

These high quality miniature transformers are high efficiency audio components featuring hermetically sealing for maximum protection against electrolysis and subsequent corrosion of fine wires caused by moisture penetration. The units are constructed in accordance with MIL-T-27A Specifications.

Transistor Transformers can also be supplied in an open or encapsulated type of construction

CASE DIMENSIONS

DM-01 CASE

Height: 2"
Width: 1 1/2"
Depth: 1 1/2"
Mtg. Cen.: 1 1/8" x 1 1/8"
Studs: 4 8-32
Knockout: 1 3/8" dia.

Catalog No.	MIL Type	Impedance Ohms				Frequency Response		Unbalance Primary Current		D.C. Resistance Ohms		Max. Power Output M.W.	Case No.
		Pri.	CT.	Sec.	CT.	D.B.	C.P.S.	M.A./D.C.	Pri.	Sec.			
TMA 1*	TF4RX16YY	500		500		1	200 to 15,000	0		18	24	250	DM-20
TMA 2*	TF4RX12YY	50K		500		2	300 to 15,000	3		2,200	49	250	DM-21
TMA 3*	TF4RX13YY	50K		6		2	300 to 15,000	3		2,200	.55	250	DM-20
TMA 4*	TF4RX12YY	100K		1.2K		3	300 to 15,000	1		2,790	95	100	DM-20
TMA 5*	TF4RX12YY	25K		1.2K		2	200 to 15,000	3		1,740	110	250	DM-20
TMA 6*	TF4RX12YY	50K		1.2K		2	300 to 15,000	3		2,200	106	250	DM-20
TMA 7*	TF4RX17YY	600/150		1.2K		1	200 to 15,000	4		30	95	250	DM-20
TMA 8*	TF4RX12YY	25K		600		2	200 to 15,000	3		1,740	61	250	DM-20
TMA 9*	TF4RX12YY	4K		600/150		1	200 to 15,000	1		274	43	250	DM-20
TMA 10*	TF4RX13YY	2K		3.2		2	200 to 15,000	10		160	.28	250	DM-20
TMA 11*	TF4RX13YY	4K		3.2		1	200 to 15,000	1		274	.26	250	DM-20
TMA 12*	TF4RX13YY	20K		50		2	300 to 15,000	4		1,340	2.9	250	DM-20
TMA 13*	TF4RX17YY	1K		50		2	300 to 15,000	8		42.6	2.5	250	DM-20
TMA 14*	TF4RX16YY	100K		1K		2	300 to 15,000	0		1,550	16.8	100	DM-20
TMO 15		20K		50		2	300 to 15,000	1		2,215	7.25	40	open
TMO 16		20K		600		2	300 to 15,000	1		2,215	102	40	open
TMO 17		1K		50		2	300 to 15,000	3		93	5.6	60	open
TMO 18		100K		1K		2	300 to 15,000	0		3,000	57.5	100	open
TMA 19*	TF4RX13YY	1K		3.2		2	200 to 15,000	20		38	.19	1000	DM-01

*When ordering open units specify TMO -- when ordering encapsulated units specify TMC.

UNCASED DIMENSIONS



TMO 1 TO 14
Height: 1 3/8"
Width: 1 1/8"
Depth: 2 1/4"
Mtg. Cen.: 1 1/8"
2 Mtg. Holes: .120 dia.
Flange Lgth: 1 1/8"

TMO 15 TO 18

Height: 2 3/8"
Width: 3/8"
Depth: 1 3/8"

TMO-19

Height: 1 3/8"
Width: 1 1/8"
Depth: 1 1/2"
Mtg. Cen.: 1 1/8"
2 Mtg. Holes: 3/8" dia.
Flange Lgth: 2 3/8"

PROFESSIONAL GRADE COMPONENTS

This group of components has been designed for use in high fidelity and professional equipment and for public address service. Freed has developed this series of units employing the latest design techniques and the best commercially available materials. Except for units carrying unbalanced direct current the frequency response is ± 1 DB from 30 to 15,000 cps. All units feature excellent performance characteristics with minimum size and weight.

All units are vacuum varnished and then potted in compound to insure long life and trouble free performance.

Professional Grade components are supplied cased. Upon request these units can be supplied open or in shell type construction.

All cased Professional Grade Components supplied with terminals meet "EIA" standards.

Transformers PGA 1 through PGA 10 are supplied in hermetically sealed cases.

INPUT TRANSFORMERS

Frequency Response 30-15,000 C.P.S. ± 1.0 DB

Catalog No.	Application	Impedance Level Ohms		Maximum Power Level DBM	Ratio	Equivalent Shielding D.B.	Max. Pri. D.C. Per Side Ma.	D.C. Unbalance Ma.	Case Number
		Primary	Secondary						
PGA 1	Universal 500 ohm line to single grid.	U-500	50,000	+12	1:10	50	0	0	DM-01
PGA 2	Universal 500 ohm line to push-pull grids.	U-500	60,000 split	+12	1:11	50	0	0	DM-01
PGA 3	Universal 500 ohm line to push-pull grids.	U-500	100,000 split	+12	1:14.1	50	0	0	DM-01
PGA 4	Bridging line to single grid.	10,000	60,000	+12	1:2.45	50	0	0	DM-01
PGA 5	Bridging line to push-pull grids.	10,000	60,000 center tap	+12	1:2.45	50	0	0	DM-01
PGA 6	Low level line matching.	U-500	U-500	+18	1:1	50	0	0	DM-01

LOW LEVEL OUTPUT AND MIXING TRANSFORMERS

Frequency Response 30-15,000 C.P.S. ± 1.0 DB.

Catalog No.	Application	Impedance Level Ohms		Maximum Power Level DBM	Ratio	Max. Pri. D.C. Per Side Ma.	D.C. Unbalance Ma.	Case Number
		Primary	Secondary					
PGA 7	Single triode plate to Universal 500 ohm line. Shunt feed.	15,000	U500	+18	5.48:1	0	0	DM-01
PGA 8	Single triode plate to Universal 500 ohm line.	15,000	U500	+18	5.48:1	8	8	DM-01
PGA 9	Push-pull triode plates to Universal 500 ohm	20,000 CT	U500	+30	6.32:1	8	0.5	DM-01
PGA 10	Low level line matching.	U500	U500	+18	1:1	0	0	DM-01

U-500 IMPEDANCES IN OHMS: 50, 125, 200 CT, 250, 330, 500 CT. 125 and 500 ohms can be used for 150 and 600 ohms.

DRIVER TRANSFORMERS

Frequency Response 30-15,000 C.P.S. ± 1.0 DB

Catalog No.	Application	Primary Impedance Ohms	Turn Ratio Pri: 1/2 Sec.	Max. Level DBM	Max. Pri. D.C. Per Side Ma.	Max. D.C. Unbalance Ma.	Case Number
PGA 12	Push-pull 6C4, 6SN7 triodes to push-pull 2A3, 6L6 grids.	20,000 C.T.	3.0:1	+30	10	1	DC-1A
PGA 13	Push-pull 2A3, 6B4, 6A5G to push-pull 809, 7Z-40, 4/125A	5,000 C.T.	3.2:1	+40	50	5	DC-2A

All units supplied with leads.

CASE DIMENSIONS

DM-01 CASE
Height: 2 1/4"
Width: 1 1/2"
Depth: 1 1/2"
Mtg. Cen.: 1 1/8" x 1 1/8"
Studs: 2 6-32
Knockout: 1 3/8" dia.

DC-1A CASE
Height: 2 1/2"
Width: 2 1/8"
Depth: 1 3/4"
Mtg. Cen.: 1 1/2" x 1 1/4"
Studs: 4 8-32

DC-2A CASE
Height: 3"
Width: 2 3/8"
Depth: 2 1/4"
Mtg. Cen.: 2" x 1 3/8"
Studs: 4 8-32

FREED TRANSFORMER CO., INC.

PROFESSIONAL GRADE COMPONENTS

HIGH LEVEL OUTPUT TRANSFORMERS

Frequency Response 30-15,000 C.P.S. ±1.0 DB

CASE DIMENSIONS

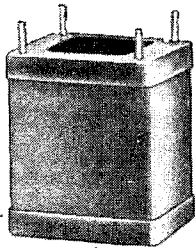

<p>DC-1A CASE</p> <p>Height: 2 1/2" Width: 2 1/4" Depth: 1 1/2" Mtg. Cen.: 1 1/2" x 1 1/4" Studs: 4 8-32 Knockout: 1 1/4" dia.</p>	<p>DC-4A CASE</p> <p>Height: 3 1/2" Width: 3 1/4" Depth: 3" Mtg. Cen.: 2 1/2" x 2 1/2" Studs: 4 8-32 Knockout: 2" x 1 1/4"</p>
<p>DC-2A CASE</p> <p>Height: 3" Width: 2 5/8" Depth: 2 1/4" Mtg. Cen.: 2" x 1 3/4" Studs: 4 8-32 Knockout: 1 1/2" x 1 3/8"</p>	<p>DC-5A CASE</p> <p>Height: 3 7/8" Width: 4 1/8" Depth: 3 1/2" Mtg. Cen.: 3 1/2" x 2 5/8" Studs: 4 10-32 Knockout: 2 1/2" x 2"</p>
<p>DC-2B CASE</p> <p>Height: 3 1/2" Width: 2 5/8" Depth: 2 1/4" Mtg. Cen.: 2" x 1 3/4" Studs: 4 8-32 Knockout: 1 1/2" x 1 3/8"</p>	<p>DC-6A CASE</p> <p>Height: 4 7/8" Width: 5" Depth: 4 1/8" Mtg. Cen.: 3 3/4" x 3" Studs: 4 10-32 Knockout: 3" x 2 1/2"</p>

CASE DIMENSIONS

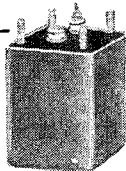

DM-01 CASE

Height: 2"
Width: 1 1/2"
Depth: 1 1/2"
Mtg. Cen.: 1 1/2" x 1 1/4"
Studs: 4 6-32

DC CASE STYLE

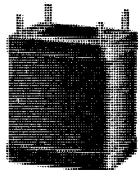

DC-2B

Height: 3 1/2"
Width: 2 5/8"
Depth: 2 1/4"
Mtg. Cen.: 2" x 1 3/4"
Studs: 4 8-32

DC-1A

Height: 2 1/2"
Width: 2 1/4"
Depth: 1 1/2"
Mtg. Cen.: 1 1/2" x 1 1/4"
Studs: 4 8-32

DC-4A

Height: 3 3/4"
Width: 3 1/8"
Depth: 3"
Mtg. Cen.: 2 1/2" x 2 1/2"
Studs: 4 8-32

DC-2A

Height: 3"
Width: 2 5/8"
Depth: 2 1/4"
Mtg. Cen.: 2" x 1 3/4"
Studs: 4 8-32

DC-5A CASE

Height: 3 7/8"
Width: 4 1/8"
Depth: 3 1/2"
Mtg. Cen.: 3 1/2" x 2 5/8"
Studs: 4 10-32

DC-5B

Height: 4 1/2"
Width: 4 1/8"
Depth: 3 1/2"
Mtg. Cen.: 3 1/2" x 2 5/8"
Studs: 4 10-32

Catalog No.	Application	Impedance Level Ohms		Maximum Power Level		Ratio	Max. Pri. D.C. Per Side	DC Unbalance Ma	Case Number
		Primary	Secondary	DBM	Watts				
PGA 14	P.P. 6K6, 6AR5, 7B5 Class A to Universal voice coil.	12,000 C.T.	U16	+40	10	27.4:1	40	4	DC-2B
PGA 15	P.P. 6F6 Cl. AB, P.P. 6V6, 6AQ5, 7C5, Cl. AB, 6L6 or 5881 Triode to Universal voice coil.	10,000 C.T.	U16	+43	20	25:1	50	5	DC-4A
PGA 16	P.P. 6L6 Cl. AB, self bias to Universal 500 ohm line.	9,000	U500	+44.8	30	4.23:1	50	5	DC-4A
PGA 17	As above to Universal voice coil.	9,000	U16	+44.8	30	23.7:1	50	5	DC-4A
PGA 18	P.P. 6N7 Cl. B, P.P. 6V6, 6AQ5, 7C5, Cl. AB, to Universal voice coil.	8,000 C.T.	U16	+41.8	15	22.3:1	45	5	DC-4A
PGA 19*	P.P. 6L6, fixed bias, Cl. AB, to Universal 500 ohm line.	6,600 C.T.	U500	+44.8	30	3.63:1	70	7	DC-4A
PGA 20	As above to Universal voice coil.	6,600 C.T.	U16	+44.8	30	20.3:1	70	7	DC-4A
PGA 21	P.P. 6L6 Cl. A, P.P. 2A3, 6A5G, 6B4 self bias P.P. Par. 6V6 Cl. AB, to Universal voice coil.	5,000 C.T.	U16	+43	20	17.7:1	80	8	DC-4A
PGA 22	P.P. Par 6L6 Cl. AB, self bias P.P. 6L6 Cl. AB, fixed bias PP807 Cl. AB, to Universal 500 ohm line.	4000 C.T.	U500	+47	50	2.83:1	100	10	DC-5A
PGA 23	As above to Universal voice coil.	4000 C.T.	U16	+47	50	15.8:1	100	10	DC-5A
PGA 24	P.P. 6A5G, 6B4, 2A3, fixed bias Universal voice coil.	3000 C.T.	U16	+41.8	15	13.7:1	75	7.5	DC-4A
PGA 25	P.P. Par. 807 Cl. AB, to Universal 500 ohm line.	2100 C.T.	U500	+51.8	150	2.05:1	240	12	DC-6A
PGA 26	P.P. Par 2A3, 6A5G, fixed bias 6B4, 300A Cl. AB, P.P. Par 6L6 Cl. A to Universal 500 ohm line.	1500 C.T.	U500	+44.8	30	1.73:1	180	15	DC-4A
PGA 27	As above to Universal voice coil.	1500 C.T.	U16	+44.8	30	9.7:1	150	15	DC-4A
PGA 28	Matching line to Universal voice coil.	U500	U16	+44.8	30	5.6:1	0	0	DC-4A
PGA 29	Matching line to Universal voice coil.	U500	U16	+47	50	5.6:1	0	0	DC-5A
PGA 30	Matching line to Universal voice coil.	U500	U16	+50	100	5.6:1	0	0	DC-5A

*Available with taps to apply screen feedback.

U-16 IMPEDANCES IN OHMS:

2, 4, 8, 12, 16

U-500 IMPEDANCES IN OHMS:

50, 125, 200 C.T., 250, 330, 500 C.T., 125 and 500 ohms can be used for 150 and 600 ohms.

*PGA 28, 29 & 30 supplied with terminals, all other units with leads.

A 70 volts level can be obtained for the following impedances:

- 500 ohms — 10 watts +40 DBM
- 330 ohms — 15 watts +42 DBM
- 250 ohms — 20 watts +43 DBM
- 200 ohms — 25 watts +44 DBM
- 125 ohms — 40 watts +46 DBM
- 50 ohms — 100 watts +50 DBM

FILTER REACTORS

Inductance measured at 50V, 60 cycles with rated direct current in the winding

Catalog No.	Inductance in Henries	Rated Current D.C. Ma.	D.C. Resistance Ohms	Dielectric Test Voltage VRMS	Case Number
PGC 1	40	15	2000	1000	DM-01
PGC 2	12	40	400	1000	DC-1A
PGC 3	8	50	300	1000	DC-1A
PGC 4	20	50	425	2500	DC-2A
PGC 5	10	70	250	2500	DC-2A
PGC 6	6	100	160	2500	DC-2A
PGC 7	6	150	115	2500	DC-2B
PGC 8	10	150	160	2500	DC-4A
PGC 9	5.5	200	95	2500	DC-4A
PGC 10	10	200	150	2500	DC-4A
PGC 11	10	250	135	2500	DC-5B
PGC 12	8	300	95	2500	DC-5B
PGC 13	7	400	60	2500	DC-5B
			PARALLEL FEED	AUDIO CHOKES	
PGC 14	100	10	3500	1000	DM-01
PGC 15	30	50	650	1500	DC-2A
PGC 16	400	1	6000	1000	DM-01

SWINGING INPUT REACTORS

Catalog No.	Inductance in Henries*	Rated Current D.C. Ma.	D.C. Resistance Ohms	Dielectric Test Voltage VRMS	Case Number
PGC 17	5-20 *	150	160	1500	DC-4A
PGC 18	5-20	250	135	1500	DC-5B
PGC 19	3-15	300	95	1500	DC-5B
PGC 20	3-15	400	60	1500	DC-5B

*Inductance values for 100% and 10% of rated Direct Current.

FREED TRANSFORMER COMPANY, INC.

FREED TRANSFORMER CO., INC.

PROFESSIONAL GRADE COMPONENTS

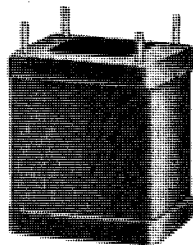

POWER TRANSFORMERS

ALL PRIMARIES ARE FOR 115V., 50/60 c.p.s.

Temperature rises range from 45° to 50°C.

Catalog No.	Py Va	Hi Volt	Choke Input D.C.V. D.C. Ma	Con. Input D.C.V. D.C. Ma.	Bias Tap.	Rectifier	Fil. No. 1	Fil. No. 2	Fil. No. 3	Case No.
PGP 1	15	440V C.T.	Low flux density, hum-bucking. For Pre-amplifier service.	270 15		6X4	6.3VCT @ 0.6A	6.3V @ 0.3A		DC-2B
PGP 2	30	550V C.T.	Low flux density, hum-bucking. For Pre-amplifier service.	310 35		6X4	6.3VCT @ 0.6A	6.3VCT @ 0.9A		DC-4A
PGP 3	45	500V C.T.		270 40		6X4, 5Y3	5/6.3V @ 2A	6.3V @ 2A		DC-4A
PGP 4	57	600V C.T.		330 50		6X4, 5Y3	5/6.3V @ 2A	6.3V @ 2.5A		DC-4A
PGP 5	64	650V C.T.		370 50		6X4, 5Y3	5/6.3V @ 2A	6.3V @ 3A		DC-4A
PGP 6	73	600V C.T.		320 70		6X4, 5Y3	5/6.3V @ 2A	6.3V @ 3A		DC-4A
PGP 7	110	650V C.T.	225 140	330 100		5Y3, 5U4	5V @ 3A	6.3V @ 5A		DC-5B
PGP 8	76	700V C.T.	260 100	385 70		5Y3	5V @ 2A	6.3V @ 2.5A		DC-5A
PGP 9	108	700V C.T.	250 125	370 90		5Y3, 5U4	5V @ 3A	6.3V @ 5A		DC-5B
PGP 10	127	700V C.T.	260 170	350 120		5U4	5V @ 3A	6.3V @ 5A		DC-5B
PGP 11	110	700V C.T.	260 210	350 150		5U4	5V @ 3A	6.3V @ 5A	6.3V @ 1A	DC-6A
PGP 12	207	800V C.T.	295 280	400 200		5U4, 2-5Y3	5V @ 4A	6.3V @ 6A		DC-6A
PGP 13	225	800V C.T.	295 280	400 200	80	5U4, 2-5Y3	5V @ 4A	6.3V @ 6A	5/6.3V @ 2A	DC-6A
PGP 14	268	840V C.T.	330 350	450 250	80	2-5U4	5V @ 6A	6.3V @ 6A	5/6.3V @ 2A	DC-6A
PGP 15	320	900V C.T.	340 420	490 300	80	2-5U4	5V @ 6A	6.3V @ 6A	5/6.3V @ 2A	DC-7B
PGP 16	127	900V C.T.	360 150			5U4	5V @ 3A	6.3V @ 5A		DC-6A
PGP 17	150	960V C.T.	350 200			5U4	5V @ 3A	6.3V @ 5A		DC-6A
PGP 18	203	1100V C.T.	400 250			5R4GY	5V @ 3A	6.3V @ 5A		DC-6A
PGP 19	248	1100V C.T.	420 300			2-5R4GY	5V @ 4A	6.3V @ 7A		DC-6A
PGP 20	310	1280V C.T.	480 350			2-5R4GY	5V @ 4A	6.3V @ 7A		DC-7B

All units supplied with leads.

DC-2B Height: 3 1/4" Width: 2 5/8" Depth: 2 1/4" Mtg. Cen.: 2" x 1 1/4" Studs: 4 8-32	DC-5B Height: 4 1/2" Width: 4 1/8" Depth: 3 1/2" Mtg. Cen.: 3 1/8" x 2 5/8" Studs: 4 10-32
DC-4A Height: 3 3/4" Width: 3 3/8" Depth: 3" Mtg. Cen.: 2 1/2" x 2 1/2" Studs: 4 8-32	DC-6A CASE Height: 4 7/8" Width: 5" Depth: 4 1/8" Mtg. Cen.: 3 3/4" x 3" Studs: 4 10-32
DC-5A CASE Height: 3 7/8" Width: 4 1/8" Depth: 3 1/2" Mtg. Cen.: 3 1/8" x 2 5/8" Studs: 4 10-32	DC-7B CASE Height: 6 3/4" Width: 5 1/2" Depth: 5" Mtg. Cen.: 4 3/8" x 3 3/4" Studs: 4 1/2-20

PQC HIGH Q REACTORS

PQC-Reactors are low-priced High Q components designed for use in selective circuits such as wave filters, wave traps, and noise suppressors.

Catalog No.	Application	Rated Ind. in Henries	Q	Tuning Capacitor (MF)	Case Size
PQC 1	60 cps resonant trap	14.00	10	.5	DM-02
PQC 2	400 cps resonant trap	1.58	15	.1	DM-02
PQC 3	1000 cps resonant trap	1.00	20	.025	DM-02
PQC 4	Dynamic noise suppression inductor	2.40	20 @ 4 KC		DM-02
PQC 5	Dynamic noise suppression inductor	2.00	15 @ 4 KC		DM-02
PQC 6	Dynamic noise suppression inductor	1.30	15 @ 4 KC		DM-02
PQC 7	Dynamic noise suppression inductor	.80	15 @ 4 KC		DM-02
PQC 8	Dynamic noise suppression inductor	.60	15 @ 4 KC		DM-02
PQC 9	Dynamic noise suppression inductor	.40	15 @ 4 KC		DM-02

CASE DIMENSIONS

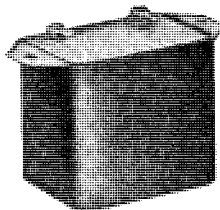

DM-02 CASE

Height: 1 1/2"
Width: 1 1/2"
Depth: 1 1/2"
Flange L: 2 3/8"
Mtg. Cen.: 2"

MINIATURE VARIABLE HIGH FREQUENCY INDUCTORS

- Continuous variation of inductance
- Q practically constant over whole range of variation
- Hermetically sealed
- Inductances other than those listed can be supplied to special order

Catalog No.	Test Freq. (Mc)	Inductance		Variations of Q		RDC (Ω) Nominal	Self Res. Freq. (Mc) @ L Max.	Max. Non Destruct Current (MA)	Case Size
		Min.	Max.	@ L Min.	@ L Max.				
VHI-1	.1	1.1 MH	1.75 MH	93.5	100.5	.75	2.2	250	VI-1
VHI-2	.1	1.7 MH	2.5 MH	94.5	96.5	1.1	1.9	200	VI-1
VHI-3	.1	2.3 MH	3.7 MH	94.5	97.2	1.4	1.6	200	VI-1
VHI-4	.1	3. MH	4.5 MH	100.7	101.7	1.9	1.4	160	VI-1
VHI-5	.1	4. MH	5.7 MH	107.	108.	2.2	1.3	160	VI-1
VHI-6	.1	5.5 MH	7.5 MH	112.	119.	3.1	1.	130	VI-1
VHI-7	.1	7. MH	10.5 MH	116.	120.5	4.5	.9	100	VI-1
VHI-8	.1	10. MH	15. MH	106.	109.	6.6	.85	80	VI-1
VHI-9	.1	14.5 MH	20.5 MH	101.	101.5	9.2	.6	60	VI-1
VHI-10	.1	20. MH	30. MH	105.	115.	13.7	.55	50	VI-1
VHI-11	1.	9.50 μH	11.0 μH	104.	114.	.24	>10	150	VI-1
VHI-12	1.	14.0 μH	15.6 μH	113.	127.	.29	>10	150	VI-1
VHI-13	1.	24.5 μH	28.0 μH	145.	156.	.37	>10	150	VI-1
VHI-14	1.	47.0 μH	52.0 μH	178.	195.	.46	>10	150	VI-1
VHI-15	.5	71.0 μH	79.5 μH	152.	168.	.56	>10	150	VI-1
VHI-16	.5	94.0 μH	105.0 μH	165.	173.	.64	>10	150	VI-1
VHI-17	.5	145.0 μH	165.0 μH	200.	222.	.75	9.7	150	VI-1
VHI-18	.5	191.0 μH	218.0 μH	204.	229.	.9	9.4	150	VI-1
VHI-19	.5	234.0 μH	265.0 μH	216.	238.	1.0	8.3	150	VI-1
VHI-20	.5	279.0 μH	318.0 μH	219.	236.	1.1	7.	150	VI-1
VHI-21	.5	380.0 μH	416.0 μH	216.	230.	1.3	6.5	150	VI-1
VHI-22	.5	480.0 μH	545.0 μH	220.	237.	1.5	7.	150	VI-1

CASE DIMENSIONS

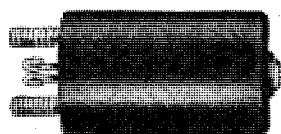

VI-1

Height: 1"
Diameter: 3/4"
2 Studs: 4-40
Mtg. Cen.: 3/8"





FREED TRANSFORMER CO., INC.

HIGH "Q" REACTORS

QGC—are hermetically sealed, MIL-T-27A, Grade 4, Class R, High Q Reactors for low audio frequency application with an excellent inductance stability with variations of A.C. and D.C. currents, frequencies and temperatures.

SPECIAL REACTORS:

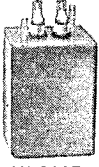
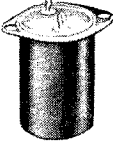
- (1) with a center tap
- (2) with a split winding
- (3) with inductances other than those listed can be supplied.

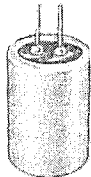
		
DC-2A CASE	AJ CASE	AH CASE
Height: 3" Width: 2 3/8" Depth: 2 1/2" Mtg. Cen.: 2 1/8" x 1 3/4" Studs: 4 8-32 Knockout: 1 1/2" x 1 3/8"	Height: 2 3/8" Width: 1 3/8" Depth: 1 1/2" Mtg. Cen.: 1 3/8" x 1 3/8" Studs: 4 6-32	Height: 1 3/8" Width: 1 3/8" Depth: 1 3/8" Mtg. Cen.: 1 1/2" Studs: 2 6-32
		
DM-20 CASE	DM-30 CASE	DM-40 CASE
Height: 1 3/8" Diameter: 1 3/8" Flange L: 1 1/2" Flange D: 0.975" Mtg. Cen.: 1 1/8" x 1 3/2" 2 Slots: .165" x .120" Knockouts: .875"	Height: 2 3/8" Diameter: 1 3/8" Flange L: 1 1/2" Flange D: 0.975" Mtg. Cen.: 1 3/8" to 1 3/2" 2 Slots: .165" x .120" Knockouts: .875"	Height: 2 3/8" Diameter: 3/8" Pig Tails:

Catalog No.	Ind. H (±2%)	Ω/H Max.	Max. Norm DC*	Max. Norm AC**	Self Res. Freq. ±25%	Case	"Q" Max.	@ Freq.
QGC-1	100						40	250
QGC-2	75						48	280
QGC-3	50						51	300
QGC-4	25	20	85	0.58	F ₀ = 22/√LH	DC-2A	53	320
QGC-5	10						58	350
QGC-6	5						59	400
QGC-7	1						60	400
QGC-8	75						32	600
QGC-9	50						37	600
QGC-10	25						39	700
QGC-11	10	55	60	0.5	F ₀ = 7.2/√LH	AJ	43	700
QGC-12	5						46	700
QGC-13	1						53	800
QGC-14	50						29.5	500
QGC-15	25						31.5	500
QGC-16	10	70	40	0.25	F ₀ = 35/√LH	AH	32	600
QGC-17	5						33	600
QGC-18	1						36	700
QGC-19	10						23	700
QGC-20	7.5						23	730
QGC-21	5	110	15	0.15	F ₀ = 34/√LH	DM-20	24	730
QGC-22	2.5						24	750
QGC-23	1						25	750
QGC-24	.5						25	750
QGC-25	5						23	1500
QGC-26	2.5						23	1550
QGC-27	1						24	1600
QGC-28	.75	250	13	0.11	F ₀ = 35/√LH	DM-30	24	1650
QGC-29	.5						24	1700
QGC-30	.2						25	1750
QGC-31	.1						25	1800
QGC-32	2						15	1500
QGC-33	1.5						15	1500
QGC-34	1						15	1800
QGC-35	.75						15	1800
QGC-36	.5						16	2000
QGC-37	.25	500	10	0.04	F ₀ = 45/√LH	DM-40	16	2000
QGC-38	.1						16	2000
QGC-39	.075						17	2200
QGC-40	.05						17	2200
QGC-41	.025						17	2500
QGC-42	.01						17	2500

*Max. Norm. D.C. = I D.C. (MA) √LH } at which the inductance will decrease by 20%.
 **Max. Norm. A.C. = V/F ~ √LH }

STANDARD MILITARY TRANSFORMERS

The group comprises audio and power units designed to meet MIL-T-27 A specifications.

The functional characteristics of these transformers were established by the Armed Service Standardization Program. These units are supplied in standard MIL cases.

CASE DIMENSIONS

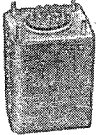
	AJ CASE
	Height: 2 3/8" Width: 1 3/8" Depth: 1 1/2" Mtg. Cen.: 1 3/8" x 1 3/8" Studs: 4 6-32 Cut Out: 1 1/8" D

	HA CASE	LB CASE
Height: 4 1/4" Width: 3 1/8" Depth: 2 3/8" Mtg. Cen.: 2 3/8" x 1 5/8" Studs: 4 8-32	Height: 4 1/2" Width: 4 1/8" Depth: 3 1/8" Mtg. Cen.: 3 1/8" x 2 1/16"	Height: 4 1/2" Width: 4 1/8" Depth: 3 1/8" Mtg. Cen.: 3 1/8" x 2 1/16"
JB CASE	MB CASE	
Height: 3 7/8" Width: 3 1/8" Depth: 3 3/8" Mtg. Cen.: 2 3/8" x 2 1/8" Studs: 4 8-32	Height: 4 1/8" Width: 4 1/8" Depth: 4" Mtg. Cen.: 3 1/8" x 3" Studs: 4 1/4-20	
KB CASE	NB CASE	
Height: 4 3/8" Width: 3 1/8" Depth: 3 3/8" Mtg. Cen.: 3 1/8" x 2 1/8" Studs: 4 10-32	Height: 5 1/2" Width: 5 1/8" Depth: 4 5/8" Mtg. Cen.: 4 1/8" x 3 3/8" Studs: 4 1/4-20	

Transformers meeting MIL-T-27A specifications Grade 1 through 6 with temperature characteristics of Class S, T, or U can be supplied on special order.

Encapsulated units using either Epoxy-Resins or Fosterite can be supplied for Grade 2 and 5. Class U components can be supplied molded in special high temperature Freed resin.

STANDARD MILITARY AUDIO TRANSFORMERS

Frequency Response 300-10,000 C.P.S. ±2 DB

Catalog No.	Application	Type Designation	Impedance Level in Ohms		Ratio	Max. Power Level DBM	Pri. D.C. Per Side in Ma	Max. D.C. unbalance	Case
			Primary	Secondary					
MGA 1	Transformer; interstage, single or P.P. plates to single or P.P. grid line to voice coil.	TF4RX15AJ	10,000 C.T.	90,000 split and C.T.	1:3 overall	+15	10	10	AJ
MGA 2	Transformer; matching 600 ohm line to voice coil.	TF4RX16AJ	600 split	4, 8, 16	6.12:1 overall	+33	0	0	AJ
MGA 3	Transformer; input, 600 ohm line to single or P.P. grids.	TF4RX10AJ	600 split	135,000 C.T.	1:15	+15	0	0	AJ
MGA 4	Transformer; matching, 600 ohm line to 600 ohm line.	TF4RX16AJ	600 split	600 split	1:1	+15	0	0	AJ
MGA 5	Transformer; output, single plate 7,600 ohm; 4,800 ohm to 600 ohm line.	TF4RX13AJ	7,600 tap @ 4,800	600 split	3.56:1	+33	40	40	AJ
MGA 6	Transformer; output, single plate 7,600 ohm; 4,800 ohm to voice coil.	TF4RX13AJ	7,600 tap @ 4,800	4, 8, 16	21.8:1	+33	40	40	AJ
MGA 7	Transformer; output, single or P.P. plates to 600 ohm line.	TF4RX13AJ	15,000 C.T.	600 split	5:1	+33	10	10	AJ
MGA 8	Transformer; output, P.P. plates to 600 ohm line.	TF4RX13AJ	24,000 C.T.	600 split	6.32:1	+30	10	1	AJ
MGA 9	Transformer; output, P.P. plates to 600 ohm line.	TF4RX13AJ	60,000 C.T.	600 split	10:1	+27	10	1	AJ

STANDARD MILITARY POWER TRANSFORMERS

Primary 105/115/125V 60~

SINGLE PHASE 400 CPS, AND THREE PHASE 60 AND 400 CPS TRANSFORMERS CAN BE SUPPLIED ON SPECIAL ORDER.

Catalog No.	MIL-T-27 Type Designation	Hi Volt	D.C. Volts	D.C. Amps	Fil. No. 1	Fil. No. 2	Case
MGP 1	TF4RX03HA001	200/100/0/100/200	185	.070	5/6. 3V @ 2A	6. 3V @ 3A	JA
MGP 2	TF4RX03JB002	650 C.T.	260	.070	5/6. 3V @ 2A	6. 3V @ 4A	JB
MGP 3	TF4RX03KB006	650 C.T.	245	.150	6. 3V @ 5A	5V @ 3A	KB
MGP 4	TF4RX03LB003	800 C.T.	318	.175	5V @ 3A	6. 3V @ 8A	LB
MGP 5	TF4RX03MB004	900 C.T.	345	.250	5V @ 3A	6. 3V @ 8A	MB
MGP 6	TF4RX02KB001	700 C.T.	255	.250			KB
MGP 7	TF4RX02LB002	1100 C.T.	419	.250			LB
MGP 8	TF4RX02NB003	1600 C.T.	640	.250			NB

FREED TRANSFORMER COMPANY, INC.

FREED TRANSFORMER CO., INC.

STANDARD MILITARY TRANSFORMERS

STANDARD MILITARY FILAMENT TRANSFORMERS

Primary 105/115/125V 60~

SINGLE PHASE 400 CPS, AND THREE PHASE 60 AND 400 CPS TRANSFORMERS CAN BE SUPPLIED ON SPECIAL ORDER.

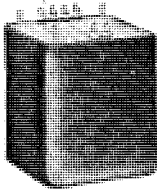

EB CASE

Height: 2 7/16"
Width: 1 1/8"
Depth: 1 3/16"
Mtg. Cen.: 1 3/8"x1 1/4"
Studs: 4 6-32

FB CASE

Height: 2 1/2"
Width: 2 5/8"
Depth: 2 1/8"
Mtg. Cen.: 1 1/8"x1 1/8"
Studs: 4 6-32

GB CASE

Height: 2 3/8"
Width: 2 3/8"
Depth: 2 3/8"
Mtg. Cen.: 2 1/8"x1 3/4"
Studs: 4 6-32

HB CASE

Height: 3 3/8"
Width: 3 1/8"
Depth: 2 5/8"
Mtg. Cen.: 2 1/8"x1 5/8"
Studs: 4 8-32

Catalog No.	MIL-T-27 Type Designation	Secondary Volts	Secondary Current Amps	Secondary Test Volts RMS	Case
MGF 1	TF4RX01EB002	2.5	3.0	2,500	EB
MGF 2	TF4RX01GB003	2.5	10.0	2,500	GB
MGF 3	TF4RX01FB004	5.0	3.0	2,500	FB
MGF 4	TF4RX01HB005	5.0	10.0	2,500	HB
MGF 5	TF4RX01FB006	6.3	2.0	2,500	FB
MGF 6	TF4RX01GB007	6.3	5.0	2,500	GB
MGF 7	TF4RX01JB008	6.3	10.0	2,500	JB
MGF 8	TF4RX01KB009	6.3	20.0	2,500	KB
MGF 9	TF4RX01JB012	2.5	10.0	10,000	JB
MGF 10	TF4RX01KB013	5.0	10.0	10,000	KB

*Standard Military Filament and Power Transformers are also available in Grade 4.

HERMETICALLY SEALED PULSE TRANSFORMERS

Hermetically sealed Pulse Transformers for use in blocking oscillator, low level interstage coupling, and modulator output circuits. These components meet MIL-T-27 A specifications. The pulse transformers are designed for maximum power, efficiency, and optimum pulse performance. Balanced coil structures permit series or parallel connection of windings for turn ratios other than unity. Pulse characteristics, voltages and impedance levels will depend upon the interconnections made.

PULSE TRANSFORMERS

Catalog No.	MIL Type	Block-ing Osc.	Inter-Stage Cou-pling	Low Power Out-put	Pulse Voltage Kilovolts	Pulse Duration Micro-seconds	Duty Cycle	No. of Wind-ings	Test Voltage KV., RMS	Character-istic Impedance Ohms	Case No.
MPT-1	TF4RX35YY	✓	✓	✓	0.25/0.25/0.25	0.2-1.0	.004	3	0.7	250	DM-20
MPT-2	TF4RX35YY	✓	✓	✓	0.25/0.25	0.2-1.0	.004	2	0.7	250	DM-20
MPT-3	TF4RX35YY	✓	✓	✓	0.5/0.5/0.5	0.2-1.5	.002	3	1.0	250	DM-18
MPT-4	TF4RX35YY	✓	✓	✓	0.5/0.5	0.2-1.5	.002	2	1.0	250	DM-18
MPT-5	TF4RX35YY	✓	✓	✓	0.5/0.5/0.5	0.5-2.0	.002	3	1.0	500	DM-20
MPT-6	TF4RX35YY	✓	✓	✓	0.5/0.5	0.5-2.0	.002	2	1.0	500	DM-20
MPT-7	TF4RX35YY	✓	✓	✓	0.7/0.7/0.7	0.5-1.5	.002	3	1.5	200	DM-18
MPT-8	TF4RX35YY	✓	✓	✓	0.7/0.7	0.5-1.5	.002	2	1.5	200	DM-18
MPT-9	TF4RX35YY	✓	✓	✓	1.0/1.0/1.0	0.7-3.5	.002	3	2.0	200	DM-18
MPT-10	TF4RX35YY	✓	✓	✓	1.0/1.0	0.7-3.5	.002	2	2.0	200	DM-18
MPT-11	TF4RX35YY	✓	✓	✓	1.0/1.0/1.0	1.0-5.0	.002	3	2.0	500	DM-01
MPT-12	TF4RX35YY	✓	✓	✓	0.15/0.15/0.3/0.3	0.2-1.0	.004	4	0.7	700	DM-8

ULTRA MINIATURE PULSE TRANSFORMERS

- Meet all requirements of MIL-T-27 A.
- Exceedingly small size.
- Negligible weight.
- Encapsulated or hermetically sealed.

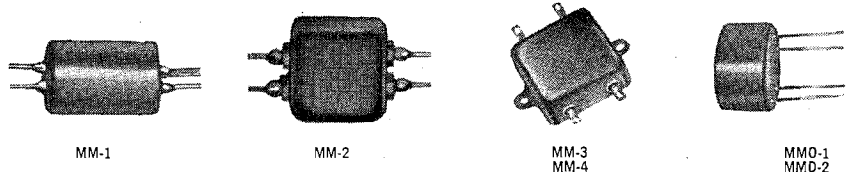

Catalog No.	MIL Type	Application	Pulse Volts	Pulse Width usec	Rise time usec	Inductance		PPS. Mcs	Turns Ratio	Zo ohms	Case Des.
						Prin. uhy	Leakage uhy				
EPT-1	TF4RX31YY	Impedance matching & Interstage coupling	20	.07	.03	125	12	2	1:1	200	MM-1
EPT-2	TF4RX31YY		20	.07	.03	150	15	2	2:1	200	MM-1
EPT-3	TF4RX31YY		20	.07	.03	160	15	2	3:1	100	MM-1
EPT-4	TF4RX31YY		20	.07	.03	200	20	2	4:1	100	MM-1
EPT-5	TF4RX31YY		17	.10	.04	200	6	2	4:1	100	MM-1
EPT-6	TF4RX31YY	15	.10	.04	200	5	2	5:1	100	MM-1	
EPT-7	TF4RX31YY	25	.50	.05	1,200	20	1	7:1:1		MM-1	
EPT-8	TF4RX31YY	10	10	.04	12,000	70	.01	5:1		MM-2	
EPT-9	TF4RX31YY	10	5	.04	7,500	22	.01	3:1	100	MM-2	
EPT-11	TF4RX35YY	Blocking oscillator	100	.25	.02	200	2	.012	1:1		MM-1
EPT-12	TF4RX35YY		50	.33	.07	240	2	.002	1:1		MM-1
EPT-13	TF4RX35YY		40	.5	.07	6,000	15		2:1		MM-2
EPT-14	TF4RX35YY		15	6	.1	16,000	15	.0004	1:1.4		MM-2
EPT-15	TF4RX36YY	Memory core & Current driver	5	1.5	.25	4,000	300		5:5:1PP	10	MM-4
EPT-16	TF4RX36YY		2.5	2.4	.2	2,800	200		3:3:3:1PP	6	MM-4
EPT-17	TF4RX32YY		Current driver	21	1.4	.22	18,000	800	.250	6:1	200
EPT-18	TF4RX32YY	Current transformer	10	6	.2	90,000	200	.05	11:1	75	MM-3
EPT-19	TF4RX36YY	Pulse inversion	22	1.7	.25	55,000	300	.05	6:1.1	400	MM-3

When ordering encapsulated units add "M" to the catalog number.

CASE DIMENSIONS



DM-8 CASE

Height: 1 1/2"
Width: 1 3/2"
Flange D.: 1 1/4"



DM-01 CASE

Height: 2"
Width: 1 1/2"
Depth: 1 1/2"
Mtg. Cen.: 1 1/8"x1 1/8"
Studs: 4 6-32
Knockout: 1/4 dia.



DM-20 CASE

Height: 1 1/8"
Diameter: 1 1/8"
Flange L: 1 1/8"
Flange D: 0.975"
Mtg. Cen.: 1 1/8"x1 1/8"
2 Holes: .147 wide
Knockout: .875



DM-18 CASE

Height: 1"
Width: 2 1/4"
Depth: 1 1/8"
Mtg. Cen.: 3/8"
Studs: 2 6-32

MM-1

Length: 3/4"
Diameter: 1/2"

MM-2

Length: 2 3/2"
Width: 2 3/2"
Height: 1/2"

MM-3

Length: 1 1/4"
Width: 1 1/4"
Height: 1/2"
Mtg. Cen.: 1 1/2"
Mtg. Flange: 1 1/8"

MM-4

Length: 1 1/4"
Depth: 1 1/4"
Height: 1 1/2"
Mtg. Cen.: 2 1/8"
Mtg. Flange: 2 1/2"

MOLDED DIMENSIONS

MMO-1

Diameter: 1 1/8"
Thickness: 2 3/4"

MMO-2

Diameter: 1 3/8"
Thickness: 1 3/2"

FREED TRANSFORMER CO., INC.

HERMETICALLY SEALED, MIL-T-27A, GRADE 5, CLASS S FILTER REACTORS

These reactors have a split winding for series or parallel connections.

When using two sections in parallel, double the Idc. Both inductance and resistance are divided by 4.

Catalog No.	Min. Inductance @ Idc (Series Connection)				Max. Rdc	Test Voltage	Case No.
MGC-32	3.2 H @ Odc	2.1 H @ 25 MA	1.70 H @ 35 MA	1.4 H @ 45 MA	220 Ohms	1000 V	MC-10
MGC-33	1.3 H @ Odc	1.1 H @ 50 MA	0.8 H @ 70 MA	0.5 H @ 90 MA	100 Ohms	1000 V	MC-10
MGC-34	400 MH @ Odc	300 MH @ 100 MA	240 MH @ 130 MA	190 MH @ 160 MA	35 Ohms	1000 V	MC-10
MGC-35	105 MH @ Odc	100 MH @ 200 MA	80 MH @ 250 MA	50 MH @ 300 MA	10 Ohms	1000 V	MC-10
MGC-36	25 MH @ Odc	23.5 MH @ 400 MA	15 MH @ 500 MA	11 MH @ 600 MA	2 Ohms	1000 V	MC-10
MGC-37	5.7 MC @ Odc	4.5 MH @ 0.8 A	3.9 MH @ 1 A	3 MH @ 1.2 A	0.5 Ohms	1000 V	MC-10

TOROIDAL INDUCTORS

Using the latest developments in the field of magnetic materials and new impregnation and molding techniques the Freed Transformer Co. makes available to the industry the most extensive line of toroidal inductors.

Freed toroids are available in three types of constructions. Open units coated with a special high temperature extremely low loss compound, hermetically sealed in metal cases or molded in special **Freed Epoxy Resin**. Both hermetically sealed and molded units meet the latest military specification MIL-T-27A(graded 1 or 4 and 2 or 5 respectively.) Freed toroidal inductors are supplied with either molypermalloy or carbonyl iron powder cores

1. Temperature Stabilization:

The molypermalloy and carbonyl iron powder cores have a temperature coefficient of inductance. Depending on the degree of temperature stabilization the cores have different temperature coefficients. The degree of stabilization is denoted by a two-letter code.

- SF Non-stabilized cores, ±2½% inductance variations from -55°C to +85°C.
- SN Non-stabilized cores, +2% inductance variations from -55°C to +85°C.
- SE Temperature stabilized cores, +0.1% to -0.4% inductance variations from -1.5°C to +54°C.
- SB Temperature stabilized cores, ±0.1% inductance variations from +13°C to +35°C.
- SD Temperature stabilized cores, ±0.1% inductance variations from -1.5°C to +54°C.
- SW Temperature stabilized cores, ±0.25% inductance variations from -54°C to +85°C.
- SM Temperature stabilized cores, ±.25% -65°C to +125°C.
- SP Temperature stable carbonyl iron cores, ±0.3% inductance variations from -55°C to +85°C.

The temperature (stabilization) coefficient of an inductor will depend upon the nominal inductance value, operating frequency and A.C. voltage across the coil. Under some unfavorable working conditions the temperature coefficient of inductance corresponding to a given stability characteristic may be exceeded.

Toroids with special requirements such as tapped toroids, toroidal transformers, molded and cased units with dimensions other than standard sizes and high temperature toroids can be supplied on request. Our engineering and laboratory facilities are available for consultation, research and development.

CASED, UNCASED AND MOLDED UNITS

TOROIDAL INDUCTORS

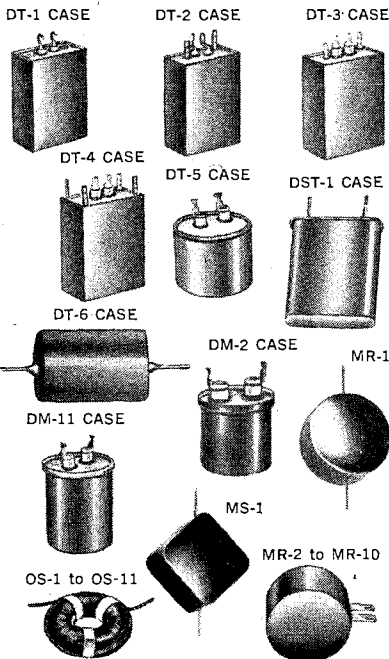

Type	Ω/H	Max. Norm. Idc	Max. Norm. Iac	Max. Norm. Vac	Type	Ω/H	Max. Norm. Idc	Max. Norm. Iac	Max. Norm. Vac
TI-1	70	55	73.5	0.46	TI-19	4,500	25	29	0.18
TI-1A	68	75	90.5	0.57	TI-20	2,750	100	*	*
TI-2	160	90	135	0.85	TI-21	1,200	350	*	*
TI-3	600	100	67	0.42	TI-22	5,600	210	*	*
TI-3A	310	150	240	1.5	TI-23	7,000	250	*	*
TI-4	110	55	67	0.42	TI-24	330	15	18	0.11
TI-5	260	28	35	0.22	TI-25	200	20	24	0.15
TI-6	230	75	125	0.80	TI-26	150	25	32	0.20
TI-7	480	40	53	0.33	TI-27	76.5	50	62	0.39
TI-8	1,500	50	80	0.5	TI-28	48.5	50	64	0.40
TI-9	150	200	240	1.5	TI-29	33.5	70	88	0.55
TI-10	430	125	270	1.7	TI-30	28	100	135	0.84
TI-11	30	120	190	1.2	TI-31	19.5	100	136	0.85
TI-12	45	100	160	1	TI-32	48.5	6	14.5	0.09
TI-13	55	140	175	1.1	TI-33	2,150	8	13	0.08
TI-14	580	150	—	—	TI-34	1,700	8	9.5	0.06
TI-15	900	100	—	—	TI-35	4,100	10	18	0.11
TI-16	600	16	21	0.13	TI-36	3,950	10	11	0.07
TI-17	1,200	20	29	0.18	TI-37	23.5	10	32	0.20
TI-18	2,600	30	40	0.25	TI-38	100	4	9.5	0.06

*TI-20 through TI-23 have a very low voltage coefficient and inductance will change very little with voltage. Because of high frequency application, the maximum voltage is limited rather by breakdown than by saturation.

UNCASED		
Type	O.D.	Hi.
OS-1	3/8"	3/16"
OS-2	3/8"	3/8"
OS-3	1"	3/8"
OS-4	1"	3/8"
OS-5	1 1/8"	3/8"
OS-6	1 1/8"	7/8"
OS-7	1 1/4"	3/4"
OS-8	1 1/2"	1 1/8"
OS-9	2 1/4"	1 1/8"
OS-10	2 3/8"	1 1/4"
OS-11	2 3/8"	1 1/8"
OS-12	1 3/8"	3/4"
OS-13	3/8"	1/4"
OS-14	3/8"	1/2"

CASE							
Type	Hi.	Dia.	Length	Width	Mtg.	Mtg. Cen.	Cutout
DT-1	1 1/2"		1 1/8"	1/2"	2 4-40 inserts	3/4"	3/8" x 1/2"
DT-2	1 3/4"		1 1/8"	1 1/8"	2 6-32 studs	7/8" x 3/2"	3/8" x 1 1/8"
DT-3	2"		1 3/2"	7/8"	2 6-32 studs	1 1/4" x 3/4"	3/4" x 3/4"
DT-4	3 3/8"		2 3/4"	1 3/8"	4 8-32 studs	2 1/8" x 1 1/8"	3/4" x 3/8"
DT-5	1 3/8"	1 1/8"			2 6-32 inserts	1 1/8"	3/8" x 1"
DT-6	5/8"	1/2"			Pig Tails		
DM-2	1"	1 1/8"			2 4-40 inserts	5/8"	3/8" x 3/8"
DM-11	1 1/2"	1 3/8"			2 6-32 inserts	3/8"	3/8" x 7/8"
DST-1	2 3/2"		3/4"	1 1/2"	1/4" long pins	To fit 1/2" crystal socket	

MOLD			
Type	O.D.	Hi.	Clearance Hole Mounting
MR-1	3/8"	1 1/2"	Pig Tails
MR-2	1 1/8"	1 1/2"	No. 4
MR-3	1 3/8"	1 1/2"	No. 6
MR-3A	1 3/8"	1 1/8"	No. 6
MR-4	1 1/2"	3/4"	No. 8
MR-5	1 1/2"	1"	No. 8
MR-6	2 1/2"	7/8"	No. 8
MR-7	2 3/8"	1 3/8"	No. 10
MR-8	2 1/2"	1 3/8"	No. 10
MR-9	2 3/8"	1 3/8"	No. 10
MR-10	2 3/8"	1 3/8"	No. 10
MR-11	3/8"	1/4"	Pig Tails
MS-1	2 3/2" x 2 3/2"	1 3/2"	Pig Tails

FREED TRANSFORMER COMPANY, INC.

FREED TRANSFORMER CO., INC.**LOW FREQUENCY TOROIDAL INDUCTORS**

Freq. Range		100 ~ to 10 KC						200 ~ to 12 KC						Freq. Range	
TYPE		TI-38	TI-32	TI-37	TI-24	TI-25	TI-26	TI-27	TI-28	TI-29	TI-30	TI-31	TYPE		
Temp. Stability		SF	SF	SF	SN	SN	SN	SN	SN	SN	SN	SN	Temp. Stability		
Size	Uncased Case Mold	OS1 DST1 MR1, MS1	OS3 DT1, DM2 MR3	OS5 DT2, DM11 MR4	OS1 OST1 MR1, MS1	OS12 DT1 MR2	OS3 DT1, DM2 MR3	OS5 DT2, OM11 MR4	OS8 DT3, DT5 MR6	OS9 DT4 MR7	OS9 DT4 MR8	OS11 DT4 MR10	Size	Uncased Case Mold	
	CATALOG NUMBER														
Nominal Inductance														Nominal Inductance	
1	MH				F2400	F2450	F2500	F2550	F2600	F2650	F2700	F2750	1	MH	
2	MH				F2401	F2451	F2501	F2551	F2601	F2651	F2701	F2751	2	MH	
3	MH				F2402	F2452	F2502	F2552	F2602	F2652	F2702	F2752	3	MH	
5	MH	F3550			F2403	F2453	F2503	F2553	F2603	F2653	F2703	F2753	5	MH	
7.5	MH	F3551			F2404	F2454	F2504	F2554	F2604	F2654	F2704	F2754	7.5	MH	
10	MH	F3552			F2405	F2455	F2505	F2555	F2605	F2655	F2705	F2755	10	MH	
15	MH	F3553			F2406	F2456	F2506	F2556	F2606	F2656	F2706	F2756	15	MH	
20	MH	F3554			F2407	F2457	F2507	F2557	F2607	F2657	F2707	F2757	20	MH	
30	MH	F3555			F2408	F2458	F2508	F2558	F2608	F2658	F2708	F2758	30	MH	
50	MH	F3556	F2800	F4000	F2409	F2459	F2509	F2559	F2609	F2659	F2709	F2759	50	MH	
75	MH	F3557	F2801	F4001	F2410	F2460	F2510	F2560	F2610	F2660	F2710	F2760	75	MH	
100	MH	F3558	F2802	F4002	F2411	F2461	F2511	F2561	F2611	F2661	F2711	F2761	100	MH	
150	MH	F3559	F2803	F4003	F2412	F2462	F2512	F2562	F2612	F2662	F2712	F2762	150	MH	
200	MH	F3560	F2804	F4004	F2413	F2463	F2513	F2563	F2613	F2663	F2713	F2763	200	MH	
300	MH	F3561	F2805	F4005	F2414	F2464	F2514	F2564	F2614	F2664	F2714	F2764	300	MH	
400	MH	F3562	F2806	F4006	F2415	F2465	F2515	F2565	F2615	F2665	F2715	F2765	400	MH	
500	MH	F3563	F2807	F4007	F2416	F2466	F2516	F2566	F2616	F2666	F2716	F2766	500	MH	
750	MH	F3564	F2808	F4008	F2417	F2467	F2517	F2567	F2617	F2667	F2717	F2767	750	MH	
1	H	F3565	F2809	F4009	F2418	F2468	F2518	F2568	F2618	F2668	F2718	F2768	1	H	
1.25	H	F3566	F2810	F4010	F2419	F2469	F2519	F2569	F2619	F2669	F2719	F2769	1.25	H	
1.5	H	F3567	F2811	F4011	F2420	F2470	F2520	F2570	F2620	F2670	F2720	F2770	1.5	H	
1.75	H	F3568	F2812	F4012	F2421	F2471	F2521	F2571	F2621	F2671	F2721	F2771	1.75	H	
2	H	F3569	F2813	F4013	F2422	F2472	F2522	F2572	F2622	F2672	F2722	F2772	2	H	
2.25	H	F3570	F2814	F4014		F2473	F2523	F2573	F2623	F2673	F2723	F2773	2.25	H	
2.5	H	F3571	F2815	F4015		F2474	F2524	F2574	F2624	F2674	F2724	F2774	2.5	H	
3	H	F3572	F2816	F4016		F2575	F2525	F2575	F2625	F2675	F2725	F2775	3	H	
3.5	H	F3573	F2817	F4017		F2476	F2526	F2576	F2626	F2676	F2726	F2776	3.5	H	
4	H	F3574	F2818	F4018		F2477	F2527	F2577	F2627	F2677	F2727	F2777	4	H	
4.5	H	F3575	F2819	F4019		F2478	F2528	F2578	F2628	F2678	F2728	F2778	4.5	H	
5	H	F3576	F2820	F4020		F2479	F2529	F2579	F2629	F2679	F2729	F2779	5	H	
7.5	H	F3577	F2821	F4021		F2480	F2530	F2580	F2630	F2680	F2730	F2780	7.5	H	
10	H	F3578	F2822	F4022		F2481	F2531	F2581	F2631	F2681	F2731	F2781	10	H	
15	H		F2823	F4023			F2532	F2582	F2632	F2682	F2732	F2782	15	H	
20	H		F2824	F4024			F2533	F2583	F2633	F2683	F2733	F2783	20	H	
25	H			F4025									25	H	
30	H									F2684	F2734	F2784	30	H	
40	H									F2685	F2735	F2785	40	H	
50	H									F2686	F2736	F2786	50	H	
75	H											F2787	75	H	
100	H											F2788	100	H	

FREED TRANSFORMER COMPANY, INC.

FREED TRANSFORMER CO., INC.

**LOW
FREQUENCY
TOROIDAL
INDUCTORS**

Freq. Range		1 KC to 15 KC										Temp. Stability
TYPE	TI-33	TI-34	TI-16	TI-5	TI-4	TI-1	TI-1A	TI-12	TI-11	TYPE		
Temp. Stability	SN	SN	SN	SN, SE, SD	SN, SD, SW	SN	SN, SD, SW	SN, SD, SW	SN, SD, SW	Temp. Stability		
Uncased Case Mold	OS13 DT6 MR11	OS14 DT6 MR11	OS1 DST1 MR1, MS1	OS3 DT1, DM2, MR3	OS5 DT2, DM11, MR4	OS8 DT3, DT5, MR6	OS9 DT4 MR7	OS9 DT4 MR8	OS11 DT4 MR10	Uncased Case Mold		
Nominal Inductance	Catalog Number										Nominal Inductance	
.25 MH	F2850	F2900									.25 MH	
.5 MH	F2851	F2901									.5 MH	
.75 MH	F2852	F2902									.75 MH	
1 MH	F2853	F2903	F2050					F1500	F1655	F1747	1 MH	
1.5 MH	F2854	F2904									1.5 MH	
2 MH	F2855	F2905						F1501	F1656	F1748	2 MH	
2.5 MH	F2856	F2906									2.5 MH	
3 MH	F2857	F2907	F2051					F1502	F1657	F1749	3 MH	
4 MH	F2858	F2908						F1503	F1658	F1750	4 MH	
5 MH	F2859	F2909	F2052	F1700	F850	F800		F1504	F1659	F1751	5 MH	
7.5 MH	F2860	F2910						F1505	F1660		7.5 MH	
10 MH	F2861	F2911	F2053	F1701	F851	F801		F1506	F1661	F1752	10 MH	
12.5 MH	F2862	F2912									12.5 MH	
15 MH	F2863	F2913	F2054	F1702	F852	F802		F1507	F1662	F1753	15 MH	
17.5 MH	F2864	F2914									17.5 MH	
20 MH	F2865	F2915									20 MH	
25 MH	F2866	F2916									25 MH	
30 MH	F2867	F2917	F2055	F1703	F853	F803	F1508	F1663	F1754	30 MH		
50 MH			F2056	F1704	F854	F804	F1509	F1664	F1755	50 MH		
75 MH			F2057	F1705	F855	F805	F1510	F1665	F1756	75 MH		
100 MH			F2058	F1706	F856	F806	F1511	F1666	F1757	100 MH		
150 MH			F2059	F1707	F857	F807	F1512	F1667	F1758	150 MH		
200 MH			F2060	F1708	F858	F808	F1513	F1668	F1759	200 MH		
300 MH			F2061	F1709	F859		F1514	F1669	F1760	300 MH		
400 MH			F2062	F1710	F860		F1515	F1670	F1761	400 MH		
500 MH			F2063	F1711	F861	F809	F1516	F1671	F1762	500 MH		
600 MH					F1712	F862		F1517	F1672		600 MH	
700 MH					F1713	F863					700 MH	
750 MH			F2064			F810	F1518	F1673	F1763		750 MH	
800 MH					F1714	F864					800 MH	
900 MH					F1715	F865					900 MH	
1.0 HY			F2065	F1716	F866	F811	F1519	F1674	F1764		1.0 HY	
1.25 HY			F2066	F1717	F867	F812					1.25 HY	
1.5 HY			F2067	F1718	F868	F813	F1520	F1675	F1765		1.5 HY	
1.75 HY			F2068	F1719	F869	F814					1.75 HY	
2 HY			F2069	F1720	F870	F815	F1521	F1676	F1766		2 HY	
2.25 HY						F816					2.25 HY	
2.5 HY						F817	F1522	F1677	F1767		2.5 HY	
2.75 HY						F818					2.75 HY	
3 HY						F819	F1523	F1678	F1768		3 HY	
3.5 HY						F820	F1524	F1679	F1769		3.5 HY	
4 HY						F821	F1525	F1680	F1770		4 HY	
4.5 HY						F822	F1526	F1681	F1771		4.5 HY	
5 HY						F823	F1527	F1682	F1772		5 HY	
6 HY						F824	F1528	F1683			6 HY	
7 HY						F825	F1529	F1684			7 HY	
7.5 HY										F1773	7.5 HY	
8 HY						F826	F1530	F1685			8 HY	
9 HY						F827	F1531	F1686			9 HY	
10 HY						F828	F1532	F1687	F1774		10 HY	
12 HY							F1533	F1688			12 HY	
15 HY						F829	F1534	F1689	F1775		15 HY	
17 HY							F1535	F1690			17 HY	
20 HY						F830	F1536	F1691	F1776		20 HY	
25 HY							F1537	F1692	F1777		25 HY	
30 HY							F1538	F1693	F1778		30 HY	
40 HY									F1779		40 HY	
50 HY									F1780		50 HY	

**MEDIUM
FREQUENCY
TOROIDAL
INDUCTORS**

Freq. Range		10 KC to 50 KC							30 KC to 75 KC				Temp. Stability
TYPE	TI-35	TI-36	TI-17	TI-7	TI-6	TI-2	TI-13	TI-18	TI-8	TI-10	TI-9	TYPE	
Temp. Stability	SN	SN	SN	SN	SN, SD, SW	SD	SN	SN	SN, SD	SB	SB	Temp. Stability	
Uncased Case Mold	OS13 DT6 MR11	OS14 DT6 MR11	OS1 DST1 MR1, MS1	OS3 DT1, DM2 MR3	OS5 DT3, DT5 MR4	OS6 DT3, DT5 MR5	OS9 DT4 MR6	OS1 DST1 MR1, MS1	OS3 DT1, DM2 MR3	OS7 DT3, DT5 MR5	OS10 DT4 MR9	Uncased Case Mold	
Nominal Inductance	Catalog Number											Nominal Inductance	
.1 MH			F2100					F2140	F1821			.1 MH	
.2 MH			F2101					F2141	F1822			.2 MH	
.25 MH	F2850	F3000										.25 MH	
.3 MH			F2102					F2142	F1823			.3 MH	
.4 MH			F2103					F2143	F1824			.4 MH	
.5 MH	F2951	F3001	F2104	F1781				F2144	F1825			.5 MH	
.75 MH	F2952	F3002										.75 MH	
1 MH	F2953	F3003	F2105	F1782	F1726	F1800	F1629	F2145	F1826	F1579	F1554	1 MH	
1.5 MH	F2954	F3004										1.5 MH	
2 MH	F2955	F3005	F2106	F1783	F1727	F1801	F1630	F2146	F1827	F1580	F1555	2 MH	
2.5 MH	F2956	F3006										2.5 MH	
3 MH	F2957	F3007	F2107	F1784	F1728	F1802	F1631	F2147	F1828	F1581	F1556	3 MH	
4 MH	F2958	F3008	F2108	F1785	F1729	F1803	F1632	F2148	F1829	F1582	F1557	4 MH	
5 MH	F2959	F3009	F2109	F1786	F1730	F1804	F1633	F2149	F1830	F1583	F1558	5 MH	
7.5 MH	F2960	F3010	F2110	F1787	F1731		F1634	F2150	F1831	F1584	F1559	7.5 MH	
10 MH	F2961	F3011	F2111	F1787	F1732	F1805	F1635	F2151	F1832	F1585	F1560	10 MH	
12.5 MH	F2962	F3012										12.5 MH	
15 MH	F2963	F3013	F2112	F1788	F1733	F1806	F1636	F2152	F1833	F1586	F1561	15 MH	
17.5 MH		F3014										17.5 MH	
20 MH		F3015	F2113	F1789	F1734			F2153	F1834			20 MH	
25 MH		F3016		F1790					F1835			25 MH	
30 MH		F3017	F2114	F1791	F1735	F1807	F1637	F2154	F1836	F1587	F1562	30 MH	
40 MH				F1792					F1837			40 MH	
50 MH			F2115	F1793	F1736	F1808	F1638	F2155	F1838	F1588	F1563	50 MH	
75 MH			F2116	F1794	F1737	F1809	F1639	F2156	F1839	F1589	F1564	75 MH	
100 MH			F2117	F1795	F1738	F1810	F1640	F2157	F1840	F1590	F1565	100 MH	
150 MH				F1796	F1739	F1811	F1641			F1591	F1566	150 MH	
200 MH				F1797	F1740	F1812	F1642			F1592	F1567	200 MH	
250 MH					F1741							250 MH	
300 MH					F1742	F1813	F1643				F1568	300 MH	
400 MH						F1814	F1644				F1569	400 MH	
500 MH					F1743	F1815	F1645				F1570	500 MH	

FREED TRANSFORMER CO., INC.**HIGH FREQUENCY TOROIDAL INDUCTORS**

Freq. Range		10 KC to 100 KC		50 KC to 200 KC			20 KC to 2 MC	50 KC to 5 MC		100 KC to 10 MC	Freq. Range	
TYPE		TI-15	TI-14	TI-19	TI-3	TI-3A	TI-20	TI-22	TI-23	TI-21	TYPE	
Temp. Stability		SN	SN	SN	SD	SB	SP	SP	SP	SP	Temp. Stability	
Size	Uncased Case Mold	OS3 DT1, DM2 MR3	OS5 DT2, DM11 MR4	OS1 DST 1 MR1, MS1	OS6 DT3, DT5 MR5	OS10 DT4 MR8	OS4 DT2 MR3A	OS2 DT1 MR2	OS2 DT1 MR2	OS1 DT1 MR1, MS1	Size	Uncased Case Mold
	Nominal Inductance	Catalog Number										Nominal Inductance
.010 MH								F2270	F2301	F2240	.010 MH	
.015 MH								F2271	F2302	F2241	.015 MH	
.020 MH								F2272	F2303	F2242	.020 MH	
.030MH								F2273	F2304	F2243	.030MH	
.040 MH								F2274	F2305	F2244	.040 MH	
.050 MH							F2201	F2275	F2306	F2245	.050 MH	
.075 MH								F2276	F2307	F2246	.075 MH	
.100 MH	F1870			F2180	F1846		F2202	F2277	F2308	F2247	.100 MH	
.125 MH										F2248	.125 MH	
.150 MH								F2278	F2309	F2249	.150 MH	
.200 MH	F1871			F2181	F1847		F2203	F2279	F2310		.200 MH	
.300 MH	F1872			F2182	F1848		F2204	F2280	F2311		.300 MH	
.400 MH	F1873			F2183	F1849			F2281	F2312		.400 MH	
.500 MH	F1874			F2184	F1850		F2205	F2282	F2313		.500 MH	
.600 MH				F2185				F2283			.600 MH	
.700 MH				F2186				F2284			.700 MH	
.750 MH							F2206				.750 MH	
.800 MH				F2187							.800 MH	
.900 MH				F2188							.900 MH	
1 MH	F1875	F1920		F2189	F1851		F2207				1 MH	
1.5 MH							F2208				1.5 MH	
2 MH	F1876	F1921		F2190	F1852		F2209				2 MH	
2.5 MH							F2210				2.5 MH	
3 MH	F1877	F1922		F2191	F1853		F2211				3 MH	
3.5 MH							F2212				3.5 MH	
4 MH	F1878	F1923		F2192	F1854		F2213				4 MH	
4.5 MH							F2214				4.5 MH	
5 MH	F1879	F1924		F2193	F1855		F2215				5 MH	
7.5 MH	F1880	F1925			F1845						7.5 MH	
10 MH	F1881	F1926			F1844	F1856					10 MH	
15 MH	F1882	F1927				F1857					15 MH	
20 MH	F1883	F1928				F1858					20 MH	
25 MH	F1884										25 MH	
30 MH	F1885	F1929				F1659					30 MH	
40 MH	F1886					F1860					40 MH	
50 MH	F1887	F1930				F1861					50 MH	
75 MH	F1888	F1931				F1862					75 MH	
100 MH	F1889	F1932				F1863					100 MH	
150 MH		F1933									150 MH	
200 MH		F1934									200 MH	
250 MH		F1935									250 MH	
300 MH		F1936									300 MH	

FREED TRANSFORMER COMPANY, INC.

FREED TRANSFORMER CO., INC.

MAGNETIC AMPLIFIERS AND SATURABLE TRANSFORMERS

The ever increasing demand for reliability, ruggedness, miniaturization and high performance has made the magnetic amplifier an indispensable component of many military and industrial automatic control and servo systems. Recent advances in materials and techniques permit an even greater utilization of the well-known inherent advantages of magnetic amplifiers such as direct operation from line voltage, no warm-up time, long-life components, ease of signal mixing and hermetic sealing.

Freed Transformer Co. manufactures an extensive line of magnetic amplifiers, ranging from saturable transformers to half-wave type, fast-response servo amplifiers. Choice of catalog amplifiers assures standardization, lowest possible cost and rapid delivery.

All standard units are designed for continuous operation and will operate in an ambient temperature range of -55°C to $+75^{\circ}\text{C}$.

In addition to standard items, Freed Transformer Co. has extensive facilities for the design and production of special amplifiers, saturable reactors and magnetic components.

ALL ITEMS LISTED ARE AVAILABLE FROM STOCK.

FAST RESPONSE MAGNETIC AMPLIFIERS

The MAF Type of fast response magnetic amplifier combines high power gain, ruggedness, and reliability with a maximum 2 cycle response. All MAF units are phase-reversible.

Freed No.	MAF-4*	MAF-5*	MAF-6	MAF-7
Power Supply	115V 400 cps	115V 400 cps	115V 400 cps	115V 400 cps
Maximum Output Wattage	10	15	10	15
Output Voltage	57.5V RMS	57.5V RMS	57.5V RMS	57.5V RMS
Typical Load	Kearfott R110-2 Kearfott R111-2	Kearfott R112-2	Kearfott R110-2 Kearfott R111-2	Kearfott R111-2 Kearfott R112-2
Input Signal Required for Full Output	8V AC	8V AC	R110-2 10K 1K 1.2V .4V R111-2 10K 1K 1.6V .6V	R111-2 10K 1K 1.2V .6V R112-2 10K 1K 2.5V 1.0V
Control Winding Resistance	60 Ohms CT 150 Ohms CT	60 Ohms CT 150 Ohms CT	AC or DC 10,000 Ohms Min. 1,000 Ohms Min.	AC or DC 10,000 Ohms Min. 1,000 Ohms Min.
Physical Dimensions	2 $\frac{3}{4}$ " O.D. x 2 $\frac{3}{4}$ " H	2 $\frac{1}{2}$ " O.D. x 2 $\frac{1}{2}$ " H	4 $\frac{3}{8}$ " x 4 $\frac{1}{4}$ " x 2 $\frac{1}{2}$ " H	4 $\frac{3}{8}$ " x 4 $\frac{1}{4}$ " x 2 $\frac{1}{2}$ " H
Weight	13 oz.	18 oz.	4 $\frac{1}{2}$ lbs.	4 $\frac{1}{2}$ lbs.

*Designed for use with MAT-1 Transistor Preamplifier.

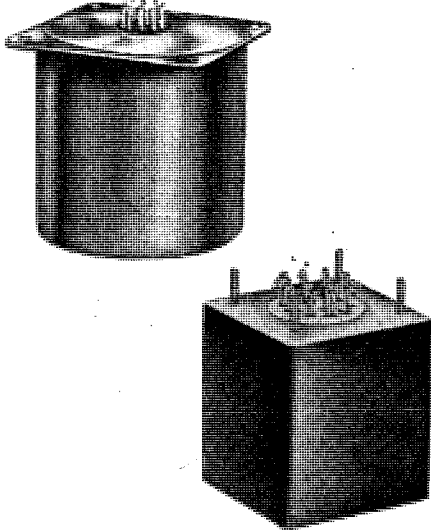

PUSH-PULL MAGNETIC AMPLIFIERS

The map line of push-pull magnetic amplifiers features high gain, polarity-sensitive amplification and a phase-reversible output.

Freed No.	MAP-1	MAP-2	MAP-3	MAP-301
Power Supply	115V A.C. 60 Cycles (To MAPT-1)	115V A.C. 60 Cycles (To MAPT-2)	115V A.C. 60 Cycles (To MAPT-3)	115V A.C. 60 Cycles (To MAPT-301)
Maximum Output Wattage	2.8 Watts	15 Watts	50 Watts	50 Watts
Voltage	140V	150V	120V	140V
Typical Load	Kollsman 951-0160	Diehl FPE 25-11	Diehl FPF 49-9	Diehl FPF 49-9
Input Signal Required for Full Output	1.2 ma.	1 ma.	2 ma.	4.5 ma.
Resp. Time	ON OFF 15 cycles 60	ON OFF 5 cycles 38	ON OFF 3 cycles 15	ON OFF 5 cycles 20
Control Winding Resistance	620 ohms each	1230 ohms each	250 ohms each	1700 ohms each
Physical Dimensions	3 $\frac{3}{4}$ "x3 $\frac{1}{4}$ "x5 $\frac{1}{2}$ "H M.A. 2 $\frac{5}{8}$ "x2 $\frac{1}{2}$ "x3 $\frac{1}{2}$ "H T.	3 $\frac{3}{4}$ "x4 $\frac{3}{8}$ "x7"H M.A. 2 $\frac{5}{8}$ "x2 $\frac{1}{2}$ "x3 $\frac{1}{4}$ "H T.	5 $\frac{1}{4}$ "x6 $\frac{7}{8}$ "x8"H M.A. 3 $\frac{3}{8}$ "x3 $\frac{3}{8}$ "x4 $\frac{1}{4}$ "H T.	5 $\frac{1}{4}$ "x5"x8"H M.A. 3 $\frac{3}{8}$ "x4 $\frac{1}{4}$ "x3 $\frac{1}{2}$ "H T.
Weight	6 lbs. M.A. 3 lbs. T.	11 lbs. M.A. 3 $\frac{1}{2}$ lbs. T.	26 $\frac{1}{2}$ lbs. M.A. 8 lbs. T.	20 lbs. M.A. 8 lbs. T.

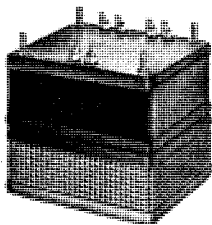

Freed No.	MAP-4	MAP-7	MAP-8	MAP-11
Power Supply	115V A.C. 60 Cycles (To MAPT-4)	115V A.C. 400 Cycles	115V A.C. 100 Cycles (To MAPT-8)	115V A.C. 400 Cycles
Maximum Output Wattage	175 Watts	15 Watts	50 Watts	10 Watts
Voltage	130V	125V	115V	115V
Typical Load	Diehl FPF 85-18-1	Kearfott R112-2A	Bendix CK-3000-1-A	Kearfott R111-2A
Input Signal Required for Full Output	8 ma.	.5 ma.	1.8 ma.	.9 ma.
Resp. Time	ON OFF 17 cycles 66	ON OFF 5 cycles 15	ON OFF 45 cycles 60	ON OFF 4 cycles 75
Control Winding Resistance	3000 ohms each	4,400 ohms each	320 ohms each	3300 ohms each
Physical Dimensions	7 $\frac{1}{4}$ "x5"x7 $\frac{1}{2}$ "H M.A. 4"x4 $\frac{1}{2}$ "x5 $\frac{1}{2}$ "H T.	3 $\frac{1}{4}$ "x3 $\frac{3}{8}$ "x7"H	3 $\frac{3}{8}$ "x3 $\frac{3}{8}$ "x7 $\frac{3}{8}$ "H M.A. 2 $\frac{1}{8}$ "x2 $\frac{1}{4}$ "x3 $\frac{3}{4}$ "H T.	4 $\frac{1}{8}$ "x3 $\frac{1}{2}$ "x5 $\frac{1}{4}$ "H
Weight	35 lbs. M.A. 12 lbs. T.	7 lbs.	7 $\frac{1}{2}$ lbs. M.A. 4 lbs. T.	5 lbs.

FREED TRANSFORMER CO., INC.

SINGLE ENDED MAGNETIC AMPLIFIERS

THE MAO LINE OF SINGLE-ENDED MAGNETIC AMPLIFIERS PROVIDES A SINGLE STAGE OF DC CONTROLLED AMPLIFICATION, UTILIZING POSITIVE FEEDBACK TO OBTAIN MUCH HIGHER GAIN THAN THAT OF A SATURABLE REACTOR.

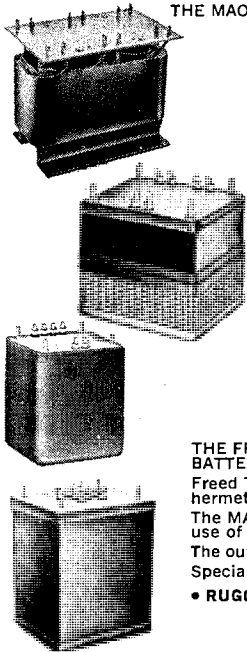

Freed No.	MAO-1	MAO-2	MAO-3	MAO-4	MAO-5
Power Supply	115V A.C. 60 Cycles	115V A.C. 60 Cycles	115V A.C. 60 Cycles	115V A.C. 60 Cycles	115V A.C. to the MAO-T-5 Transformer 60 Cycles
Maximum Output Wattage	4 watts	20 watts	100 watts	400 watts	575 watts
Voltage	120V	120V	100V	100V	135V
Typical Load	4000 ohms	700 ohms	100 ohms	25 ohms	25 ohms
Input Signal Req. for Full Output	3 ma.	1.8 ma.	9 ma.	9 ma.	6 ma.
Control Winding Resistance	300 ohms each	700 ohms each	5600 ohms each	4500 ohms each	4,500 ohms
Physical Dimensions	3 3/4" x 4" x 3 1/2" H	4 1/4" x 3 3/8" x 6 3/8" H	3 1/4" x 5 1/2" x 4 1/8" H	5" x 7 1/2" x 6" H	5" x 7 1/2" x 6" H Trans. 3 3/8" x 3 3/4" x 3 1/2" H
Weight	4 lbs.	7 lbs.	8 1/2 lbs.	21 lbs.	21 lbs. Trans. 7 1/4 lbs.

TRANSISTOR CONVERTERS

THE FREED LINE OF DC TO AC AND DC TO DC TRANSISTOR CONVERTERS PROVIDE A HIGH EFFICIENCY VOLTAGE CONVERSION FROM BATTERY SOURCES TO AN AC LINE VOLTAGE OR HIGH DC VOLTAGE WITHOUT THE USE OF MOVING PARTS.

Freed Transformer Co. maintains a stock line of reliable, highly efficient static DC to DC and DC to AC converters. DC to DC converters in hermetically sealed cans. RF filters included inside case.

The MAC Line of Static DC to AC Converters provide a highly efficient voltage conversion from battery sources to AC voltage without the use of moving parts.

The output voltage and/or frequency is directly proportional to source voltage variation.

Special regulators can be supplied to compensate for this variation.

- RUGGED, QUIET, MAINTENANCE FREE, LONG LIFE OPERATION.
- HIGH POWER TO WEIGHT RATIO, ARC-FREE OPERATION.

UNREGULATED TDC STOCK UNITS

Type No.	NOM. V in	V out	MAX 1 out MA	Case Size	Type No.	NOM. V in	V out	MAX 1 out MA	Case Size
TDC 6-15-03	6v	150	50	2 x 2 1/4 x 3 1/8	TDC 28-30-15	28v	300	150	2 5/8 x 2 1/4 x 3 1/2
TDC 12-30-15	12v	300	150	2 5/8 x 2 1/4 x 3 1/2	TDC 28-25-12	28v	250	120	2 5/8 x 2 1/4 x 3 1/2
TDC 12-25-12	12v	250	120	2 5/8 x 2 1/4 x 3 1/2	TDC 28-30-05	28v	300	50	2 x 2 1/4 x 3 1/8
TDC 12-30-05	12v	300	50	2 x 2 1/4 x 3 1/2	TDC 28-20-05	28v	200	50	2 x 2 1/4 x 3 1/8
TDC 12-20-05	12v	200	50	2 x 2 1/4 x 3 1/8	TDC 48-20-15	48v	200	150	2 5/8 x 2 1/4 x 3 1/2
					TDC 48-30-15	48v	300	150	2 5/8 x 2 1/4 x 3 1/2

DC TO DC CONVERTERS

All TDC units are Hermetically Sealed, Oil Filled. Mtg. base plate must be mounted on a sink of sufficient area to maintain a base temperature of 70°C. Maximum output regulation 5% from half load to full load. Ripple frequency 4 to 5 KC; Ripple content 0.1%.

DC TO AC TRANSISTOR CONVERTERS

Input Voltage—12 VDC

Output Frequency—60 CPS.—Square Wave

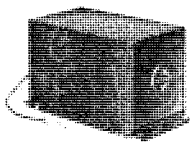

OPEN CASE

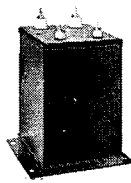

SEALED CASE

Freed No.	Output Voltage	Power	Type of Case	Dimensions
MAC 12-3-60	115 VRMS	30 VA	Cased	7 1/4" x 3 3/8" x 4 3/8"
MAC 12-10-1	115 VRMS	100 VA	Cased	7 1/4" x 4" x 5"
MAC 12-10-2	115 VRMS	100 VA	Herm. Sealed	7 1/4" x 4 1/8" x 4 3/8"
MAC 12-20-1	115 VRMS	180 VA	Cased	6" x 4 1/8" x 6"
MAC 12-20-2	115 VRMS	180 VA	Herm. Sealed	6" x 4 1/8" x 6"
MAC 12-30-1	115 VRMS	250 VA	Cased	5 7/8" x 6 3/8" x 7 1/8"
MAC 12-30-2	115 VRMS	250 VA	Herm. Sealed	5 7/8" x 6 3/8" x 7 1/8"

- Output Waveform — Square Wave
- Output Frequency — 60 cps (Adjustment Control)
- Frequency Stability ±3%
- Hermetically Sealed
- Maximum Ambient Temperature 50°C
- Temperature of Base Mounting Plate must not exceed 70°C.
- Output Voltage Variation — Varies Directly with Input Voltage

	Nominal Input V.D.C.	Output @ 115V VA	Case Size
TAC 6-50	6	50	4 1/8 x 3 1/2 x 4 1/2 H
TAC 12-50	12	50	4 1/8 x 3 1/2 x 4 1/2 H
TAC 12-90	12	90	4 1/8 x 3 1/2 x 4 7/8 H
TAC 12-175	12	175	5 x 4 1/8 x 6 H
TAC 28-50	28	50	4 1/8 x 3 1/2 x 4 1/2 H
TAC 28-100	28	100	4 1/8 x 3 1/2 x 4 7/8 H
TAC 28-175	28	175	5 x 4 1/8 x 6 H
TAC 28-250	28	250	5 1/2 x 5 x 6 3/4 H

400 CYCLE TRANSISTOR CONVERTERS

Frequency Regulation ±2%

Type No.	Nom. Input V.D.C.	Output VA	Case Size
TAC-12-50-4	12	50	3 x 3 3/8 x 3 3/4
TAC-12-100-4	12	100	4 1/8 x 3 1/2 x 4 1/2
TAC-28-50-4	28	50	3 x 3 3/8 x 3 3/4
TAC-28-150-4	28	150	4 1/8 x 3 1/2 x 4 1/2

MINIATURIZED SILICON TRANSISTOR PREAMPLIFIER

THE MAT TYPE OF TRANSISTOR PREAMPLIFIER COMBINES LOW POWER CONSUMPTION, HIGH POWER GAIN AND SMALL SIZE AND WEIGHT.

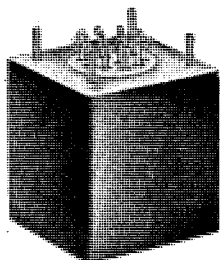

Freed No.	MAT-1-1
Power Supply	115V 400~
Voltage Gain	400
Maximum Output Voltage	10V (RL = 1.5K)
Typical Load	Freed MAF-4 and MAF-5 Magnetic Amplifiers
Input Signal Required for Full Output	50MV
Input Impedance	>10,000 OHMS
Physical Dimensions	1 3/4" x 1 1/8" x 2 5/8" H
Weight	10 oz.

TRANSFER CHARACTERISTIC CURVE

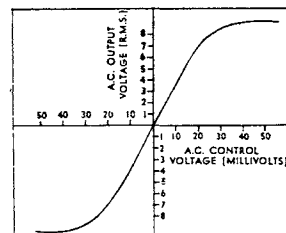

FREED TRANSFORMER CO., INC.

FREED SATURABLE TRANSFORMERS

DC CONTROLLED

The MAS line of saturable transformers, commonly controlled by dual-triodes or transistors, emphasizes low cost, small size, extreme reliability (no rectifiers) and phase-reversible output.

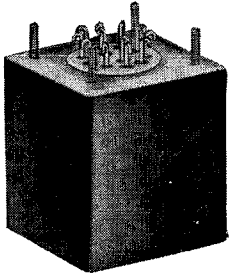

Freed No.	MAS-1	MAS-101	MAS-2	MAS-3	MAS-4	MAS-5	MAS-6	MAS-7	MAS-9
Power Supply	115V A.C. 60 Cycles	115V A.C. 60 Cycles	115V A.C. 400 Cycles	115V A.C. 60 Cycles	115V A.C. 60 Cycles	115V A.C. 400 Cycles	115V A.C. 60 Cycles	115V A.C. 60 Cycles	115V A.C. 60 Cycles
Maximum Output	15 watts	15 watts	6 watts	30 watts	60 watts	2.7 watts	30 watts	40 watts	125 watts
Wattage Voltage	130V	120V	120V	120V	120V	26V	120V	115V	115V
Typical Load	Diehl FPE 25-11	Diehl FPE 25-11	Kearfott R-110	Diehl FPE 49-7	250 ohms	Kearfott R-118	Diehl FPE 49-13-1	Bendix CK-3000-1A	110 Ω
Input Signal Required for Full Output	6 ma.	9 ma.	3 ma	8 ma.	20 ma.	4 ma.	4 ma.	6 ma.	15 ma. D-C
Resp. Time	ON OFF 2 cycles 5	ON OFF 3 cycles 6	ON OFF 3 cycles 6	ON OFF 3 cycles 30	ON OFF 5 cycles 35	ON OFF 10 cycles 35	ON OFF 12 cycles 9	ON OFF 12 cycles 9	ON OFF 5 cycles 35
Control Winding Resistance	14 K ohms each	3200 ohms each	2000 ohms each	6800 ohms each	2000 ohms each	1500 ohms each	4000 ohms each	4000 ohms each	500 ohms each
Physical Dimensions	3 1/2" x 4 1/4" x 5 1/2" H	3 1/2" x 4 1/4" x 5 1/2" H	1 1/2" x 2 3/8" x 2 3/8" H	4 3/4" x 5 1/4" x 5 1/2" H	7" x 5 1/4" x 7" H	2 1/4" x 2 1/4" x 2 1/4" H	3 1/4" x 3 1/4" x 4" H	3 1/4" x 3 1/4" x 4" H	9" x 6 3/4" x 8" H
Weight	9 lbs.	9.75 lbs.	2 lbs.	18.5 lbs.	29 lbs.	1.25 lbs.	6 lbs.	6 lbs.	65 lb.

CONSTANT VOLTAGE TRANSFORMERS

The MCV line of constant voltage transformers provides accurate regulation against line and/or load variations, without the use of tubes or moving parts.

- MILITARY SPECIFICATIONS
- NO TUBES
- COMMERCIAL
- NO MOVING PARTS
- ACCURATE REGULATIONS
- FAST RESPONSE
- FULLY AUTOMATIC

Rated output within ±2% of nominal value. Regulation automatically maintained within ±1%. Regulation from 25% to full load ±2%.

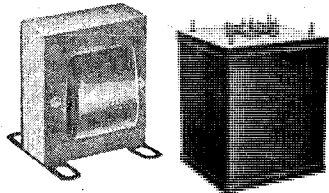

COMMERCIAL

MILITARY

Reg. Output in R.M.S. Volts	Input Range in R.M.S. Volts	Output in V.A. P.F.-1	CATALOG NUMBERS			
			60 Cycles		400 Cycles	
			Comm.	Military*	Comm.*	Military*
115	95-130	5	MCV65LC	MCV45LC	MCV45LC	MCV45LM
115	95-130	25	MCV625LC	MCV625LM	MCV425LC	MCV425LM
115	95-130	75	MCV675LC	MCV675LM	MCV475LC	MCV475LM
115	95-130	125	MCV6125LC	MCV6125LM	MCV4125LC	MCV4125LM
115	95-130	175	MCV6175LC	MCV6175LM	MCV4175LC	MCV4175LM
115	95-130	250	MCV6250LC	MCV6250LM	MCV4250LC	MCV4250LM
115	95-130	375	MCV6375LC	MCV6375LM	MCV4375LC	MCV4375LM
115	95-130	500	MCV6500LC	MCV6500LM	MCV4500LC	MCV4500LM
115	95-130	750	MCV6750LC	MCV6750LM	MCV4750LC	MCV4750LM
115	95-130	1000	MCV61000LC	MCV61000LM	MCV41000LC	MCV41000LM
26	95-130	5	MCV654FC	MCV654FM	MCV454FC	MCV454FM
26	95-130	25	MCV6254FC	MCV6254FM	MCV4254FC	MCV4254FM
26	95-130	75	MCV6754FC	MCV6754FM	MCV4754FC	MCV4754FM
26	95-130	125	MCV61254FC	MCV61254FM	MCV41254FC	MCV41254FM
6.4	95-130	5	MCV655FC	MCV655FM	MCV455FC	MCV455FM
6.4	95-130	25	MCV6255FC	MCV6255FM	MCV4255FC	MCV4255FM
6.4	95-130	75	MCV6755FC	MCV6755FM	MCV4755FC	MCV4755FM
6.4	95-130	125	MCV61255FC	MCV61255FM	MCV41255FC	MCV41255FM

*Condensers are not provided with units. Where condensers are provided they are external to units.

TELEMETERING COMPONENTS

A complete line of Band Pass Filters, Low Pass Filters and Discriminators is available for multi-channel telemetering applications. These components cover the frequency range from 400 cps to 70,000 cps. The filters feature exceptional phase linearity, excellent selectivity characteristics and plug-in construction. The Discriminators, either fixed or slug tuned, have exceptional linearity, high amplification, and utmost stability.

TELEMETERING BAND PASS FILTERS

Hermetically sealed to MIL-T-27A and MIL-F-18327

These filters cover the frequencies from 400 c.p.s. to 70KC. Narrow frequency B.P.F. have a band width of ±9 1/2% of center frequency and 45 DB (minimum) points at ±7 1/2% of center frequency of higher or lower adjacent channels. Wide frequency B.P.F. have a band width of ±19 1/2% of center frequency and 50 D.B. points at ±15% of center frequencies of higher or lower second adjacent channels.

Characteristic Impedance 500 Ω			
Catalog No.	Center Frequency c.p.s.	3 DB Band Width % of C.F.	Case No.
FBP-10	400	± 9%	FA-10
FBP-11	560	± 9%	FA-10
FBP-12	730	± 9%	FA-10
FBP-13	950	± 9%	FA-10
FBP-14	1,300	± 9%	FA-10
FBP-15	1,700	± 9%	FA-10
FBP-16	2,300	± 9%	FA-10
FBP-17	3,000	± 9%	FA-15
FBP-18	3,900	± 9%	FA-15
FBP-19	5,400	± 9%	FA-15
FBP-20	7,350	± 9%	FA-15
FBP-21	10,500	± 9%	FA-15
FBP-22	12,300	± 9%	FA-15
FBP-23	14,500	± 9%	FA-15
FBP-24	22,000	± 9%	FA-15
FBP-25	22,000	±19 1/2%	FA-15
FBP-26	30,000	± 9%	FA-15
FBP-27	30,000	±19 1/2%	FA-15
FBP-28	40,000	± 9%	FA-15
FBP-29	40,000	±19 1/2%	FA-15
FBP-30	52,500	± 9%	FA-15
FBP-31	52,500	±19 1/2%	FA-15
FBP-32	70,000	± 9%	FA-15
FBP-33	70,000	±19 1/2%	FA-15

Characteristic Impedance 2,500 Ω			
Catalog No.	Center Frequency c.p.s.	3 DB Band Width % of C.F.	Case No.
FBP-34	400	± 9%	FA-5
FBP-35	560	± 9%	FA-5
FBP-36	730	± 9%	FA-5
FBP-37	950	± 9%	FA-5
FBP-38	1,300	± 9%	FA-5
FBP-39	1,700	± 9%	FA-5
FBP-40	2,300	± 9%	FA-5
FBP-41	3,000	± 9%	FA-5
FBP-42	3,900	± 9%	FA-5
FBP-43	5,400	± 9%	FA-5
FBP-44	7,350	± 9%	FA-5
FBP-45	10,500	± 9%	FA-5
FBP-46	12,300	± 9%	FA-5
FBP-47	14,500	± 9%	FA-5
FBP-48	22,000	± 9%	FA-5
FBP-49	22,000	±19 1/2%	FA-5
FBP-50	30,000	± 9%	FA-5
FBP-51	30,000	±19 1/2%	FA-5
FBP-52	40,000	± 9%	FA-5
FBP-53	40,000	±19 1/2%	FA-5
FBP-54	52,500	± 9%	FA-5
FBP-55	52,500	±19 1/2%	FA-5
FBP-56	70,000	± 9%	FA-5
FBP-57	70,000	±19 1/2%	FA-5

SUBMINIATURE TELEMETERING BAND PASS FILTERS

Manufactured to Specification MIL-F-18327A—Type FR-4RX22YR
RBD Standard Frequency Channels

Input and Output Impedance 10K ohms							
Type No.	Center Frequency Fo - in KC	Band Width <3DB	Stop Band Attenuation	Type No.	Center Frequency Fo - in KC	Band Width <3DB	Stop Band Attenuation
MTN-4	.4	±7 1/2%	38 DB @ 1.75 & .58 Fo	MTN-14.5	14.5	±7 1/2%	38 DB @ 1.75 & .58 Fo
MTN-5.6	.56	±7 1/2%	38 DB @ 1.75 & .58 Fo	MTN-22	22	±7 1/2%	38 DB @ 1.75 & .58 Fo
MTN-7.3	.73	±7 1/2%	38 DB @ 1.75 & .58 Fo	MTN-30	30	±7 1/2%	38 DB @ 1.75 & .58 Fo
MTN-9.6	.96	±7 1/2%	38 DB @ 1.75 & .58 Fo	MTN-40	40	±7 1/2%	38 DB @ 1.75 & .58 Fo
MTN-1.3	1.3	±7 1/2%	38 DB @ 1.75 & .58 Fo	MTN-52.5	52.5	±7 1/2%	38 DB @ 1.75 & .58 Fo
MTN-1.7	1.7	±7 1/2%	38 DB @ 1.75 & .58 Fo	MTN-70	70	±7 1/2%	38 DB @ 1.75 & .58 Fo
MTN-2.3	2.3	±7 1/2%	38 DB @ 1.75 & .58 Fo	MTN-22	22	±15%	40 DB @ 2.5 & .4 Fo
MTN-3.0	3.0	±7 1/2%	38 DB @ 1.75 & .58 Fo	MTW-30	30	±15%	40 DB @ 2.5 & .4 Fo
MTN-3.9	3.9	±7 1/2%	38 DB @ 1.75 & .58 Fo	MTW-40	40	±15%	40 DB @ 2.5 & .4 Fo
MTN-5.4	5.4	±7 1/2%	38 DB @ 1.75 & .58 Fo	MTW-52.5	52.5	±15%	40 DB @ 2.5 & .4 Fo
MTN-7.35	7.35	±7 1/2%	38 DB @ 1.75 & .58 Fo	MTW-70	70	±15%	40 DB @ 2.5 & .4 Fo
MTN-10.5	10.5	±7 1/2%	38 DB @ 1.75 & .58 Fo				

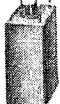

FA-5 CASE
Height: 4 1/2"
Width: 3 1/2"
Depth: 2 1/2"
Mtg. Cen.: 2 3/8" x 1 1/8"
Studs: 5 8-32 x 1/2"
Octal Header

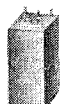

FA-10 CASE
Height: 4 1/2"
Width: 3 1/2"
Depth: 2 1/8"
Mtg. Cen.: 1 1/8" x 1 1/8"
Studs: 4 8-32 x 1/2"
Knockout: 1 1/2" dia.

FA-15 CASE
Height: 4 1/2"
Width: 2 7/8"
Depth: 2 1/8"
Mtg. Cen.: 1 1/8" x 1 1/8"
Studs: 4 8-32 x 1/2"
Knockout: 1 1/2" dia.

CASE SIZES



DF-01
3/4" x 3/4" x 1 1/8"

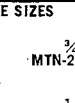

MTN-2.3 Thru MTW-70



DF-02
1" x 1" x 1 3/8"

MTN-4 Thru MTN 1.7

FREED TRANSFORMER CO., INC.

DISCRIMINATOR INPUT LOW PASS FILTER

HERMETICALLY SEALED TO MIL-T-27A AND MIL-F-18327 SPECIFICATIONS

CASE DIMENSIONS



FA-1 CASE

Height: 4 1/2"
Width: 1 1/2"
Depth: 1 1/2"
Mtg. Cen.: 3 1/2" sq.
4 Inserts: 6-32
Knockout: 1"

FA-185 CASE

Height: 4 1/2"
Width: 1 7/8"
Depth: 1 5/8"
Mtg. Cen.: 1 1/4" x 1 1/4"
4 Inserts: 6-32
Knockout: 1 1/2"

Catalog No.	Fo Center Freq. in c.p.s.	Characteristic Impedance Ohms	Case No.
LPI-10	400	30,000	FA-1
LPI-11	560	30,000	FA-1
LPI-12	730	30,000	FA-1
LPI-13	960	30,000	FA-1
LPI-14	1,300	30,000	FA-1
LPI-15	1,700	30,000	FA-1
LPI-16	2,300	30,000	FA-1
LPI-17	3,000	30,000	FA-1
LPI-18	3,900	30,000	FA-1

Band Pass Attenuation: 0.05 DB ± 9% of Center Frequency
30 DB at second harmonic of Pass Band Frequencies
50 DB at third harmonic of Pass Band Frequencies
40 DB above third harmonic of Pass Band Frequencies

Catalog No.	Fo Center Freq. in c.p.s.	Characteristic Impedance Ohms	Case No.
LPI-19	5,400	30,000	FA-1
LPI-20	7,350	30,000	FA-1
LPI-21	10,500	30,000	FA-1
LPI-22	12,300	30,000	FA-1
LPI-23	14,500	30,000	FA-1
LPI-24	22,000	5,100	FA-1
LPI-25	30,000	5,100	FA-1
LPI-26	40,000	5,100	FA-1
LPI-27	52,500	5,100	FA-1
LPI-28	70,000	5,100	FA-1

Band Pass Attenuation: 0.05 DB ± 15% of Center Frequency
30 DB at second harmonic of Pass Band Frequencies
50 DB at third harmonic of Pass Band Frequencies
40 DB above third harmonic of Pass Band Frequencies

DISCRIMINATOR OUTPUT LOW PASS FILTER

HERMETICALLY SEALED TO MIL-T-27A AND MIL-F-18327 SPECIFICATIONS

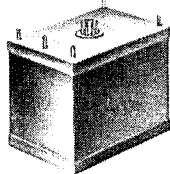
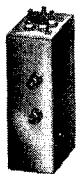

FA-190 CASE

Height: 4 1/2"
Width: 2 1/2"
Depth: 1 1/2"
Mtg. Cen.: 1 1/2" x 1 1/4"
4 Inserts: 6-32
Knockout: 1 1/2"

FA-410 CASE

Height: 4 1/2"
Width: 6"
Depth: 4"
Mtg. Cen.: 5 1/4" x 3 1/4"
5 Studs: 10-32
Octal Header

Catalog No.	Fo c.p.s.	Characteristic Impedance Ohms	Case No.
LPO-10	6	330	FA-410
LPO-11	8	330	FA-410
LPO-12	11	330	FA-410
LPO-13	14	330	FA-410
LPO-14	20	330	FA-410
LPO-15	25	330	FA-410
LPO-16	35	330	FA-410
LPO-17	45	330	FA-410
LPO-18	60	330	FA-410
LPO-19	81	330	FA-410
LPO-20	110	330	FA-410
LPO-21	160	330	FA-410
LPO-22	185	330	FA-410

Catalog No.	Fo c.p.s.	Characteristic Impedance Ohms	Case No.
LPO-23	220	330	FA-410
LPO-24	330	330	FA-410
LPO-25	450	330	FA-410
LPO-26	600	330	FA-410
LPO-27	660	330	FA-410
LPO-28	790	330	FA-410
LPO-29	900	330	FA-410
LPO-30	1,050	330	FA-410
LPO-31	1,200	330	FA-410
LPO-32	1,600	330	FA-410
LPO-33	2,100	330	FA-410
LPO-34	7,200	330	FA-410
LPO-35	10,000	330	FA-410

Attenuation: <0.2 DB up to 0.5 times Fo
<0.7 DB from 0.5 to 1. times Fo
>20 DB at 2 Fo to 2.5 Fo
>30 DB from 2.5 times Fo to 100 Kc

FIXED DISCRIMINATORS

HERMETICALLY SEALED TO MIL-T-27A AND MIL-F-18327 SPECIFICATIONS

Catalog No.	Center Frequency (cps)	% Deviation of Fo	Linearity	D.C. Output Volts	Case No.
DST-10	400	± 8 1/2	± 0.5%	32.5	FA-185
DST-11	560	± 8 1/2	± 0.5%	32.5	FA-185
DST-12	730	± 8 1/2	± 0.5%	32.5	FA-185
DST-13	960	± 8 1/2	± 0.5%	32.5	FA-185
DST-14	1,300	± 8 1/2	± 0.5%	32.5	FA-185
DST-15	1,700	± 8 1/2	± 0.5%	32.5	FA-185
DST-16	2,300	± 8 1/2	± 0.5%	32.5	FA-185

SLUG TUNED DISCRIMINATORS

Catalog No.	Center Frequency (Kc.)	% Deviation of Fo	Linearity	D.C. Output Volts	Case No.
DST-17	3.0	± 8 1/2	± 0.5%	32.5	FA-190
DST-18	3.9	± 8 1/2	± 0.5%	32.5	FA-190
DST-19	5.4	± 8 1/2	± 0.5%	32.5	FA-190
DST-20	7.35	± 8 1/2	± 0.5%	32.5	FA-190
DST-21	10.5	± 8 1/2	± 0.5%	32.5	FA-190
DST-22	12.3	± 8 1/2	± 0.5%	32.5	FA-190
DST-23	14.5	± 8 1/2	± 0.5%	32.5	FA-190
DST-24	22.0	± 8 1/2	± 0.5%	32.5	FA-190
DST-25	30.0	± 8 1/2	± 0.5%	32.5	FA-190

Catalog No.	Center Frequency (Kc)	% Deviation of Fo	Linearity	D.C. Output Volts	Case No.
DST-26	40.0	± 8 1/2	± 0.5%	32.5	FA-190
DST-27	52.5	± 8 1/2	± 0.5%	32.5	FA-190
DST-28	70.0	± 8 1/2	± 0.5%	32.5	FA-190
DST-29	22.0	± 15	± 1.0%	26.0	FA-190
DST-30	30.0	± 15	± 1.0%	26.0	FA-190
DST-31	40.0	± 15	± 1.0%	26.0	FA-190
DST-32	52.5	± 15	± 1.0%	26.0	FA-190
DST-33	70.0	± 15	± 1.0%	26.0	FA-190

FREED FILTERS

To MIL-T-27A and MIL-F-18327

Freed Standard Filters are Hermetically Sealed Miniature and Sub-Miniature high performance components designed for both production and laboratory applications in the Communications and Electronic industry. In order to achieve attenuation requirements not obtainable with one single filter, one can combine several standard filters of different transmission characteristics. Wide Band Pass characteristics are obtainable by combining low and high Pass Units. The astatic construction of inductive components together with special shielding reduces the hum pick-up of the standard filters.

The standard filters are available in Low Pass, High Pass and Band Pass Filters.

Low Pass Filters: The attenuation characteristics of Low Pass Filters are 6db or less at cut-off frequency, 35db or more at 1.5 cut-off frequency and 40db or more at 2 cut-off frequency.

ILP Interstage Low Pass Filter. Characteristic Impedance 10,000 ohms, in and out.

LLP Line Low Pass Filter. Characteristic Impedance 500 to 600 Ω, in and out.

High Pass Filters: The attenuation characteristics of High Pass Filters are 6db or less at cut-off frequency, 35db and 40db or more at 0.67 and 0.5 cut-off frequency.

IHP Interstage High Pass Filter. Characteristic Impedance 10,000 ohms, in and out.

LHP Line High Pass Filter. Characteristic Impedance 500 to 600 Ω, in and out.

Band Pass Filters: The attenuation characteristics of Band Pass Filters are 2db or less at plus or minus 3% of center frequency 40db or more at 0.5 and 2 center frequency.

IBP Interstage Band Pass Filter. Nominal input impedance—10,000 ohms. Nominal output impedance 5 megohms or grid of vacuum tube. Effective voltage step-up 2:1. (Output voltage to source voltage.)

LBP Line Band Pass Filter. Nominal input impedance 500 to 600 ohms. Nominal output impedance 5 megohms or grid of vacuum tube. Effective voltage step-up 9:1. (Output voltage to source voltage.)

FREED TRANSFORMER COMPANY, INC.

FREED TRANSFORMER CO., INC.

FREED FILTERS TO MIL-T-27A AND MIL-F-18327

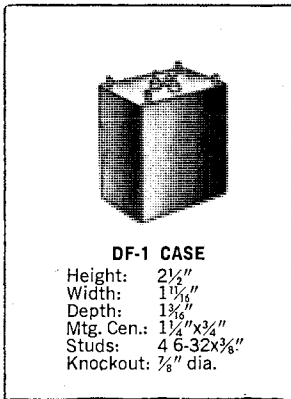

DF-1 CASE

Height: 2 1/2"
Width: 1 1/8"
Depth: 1 3/8"
Mtg. Cen.: 1 1/4" x 3/4"
Studs: 4 6-32 x 3/8"
Knockout: 7/8" dia.

Catalog No.	Cut-off Frequency c.p.s.
ILP- 100	100
ILP- 200	200
ILP- 300	300
ILP- 500	500
ILP- 750	750
ILP- 1,000	1,000
ILP- 1,500	1,500
ILP- 2,000	2,000
ILP- 2,500	2,500
ILP- 3,000	3,000
ILP- 5,000	5,000
ILP- 7,000	7,000
ILP- 10,000	10,000
ILP- 15,000	15,000
ILP- 20,000	20,000
ILP- 23,000	23,000
ILP- 25,000	25,000
ILP- 32,000	32,000
ILP-130,000	130,000
ILP-150,000	150,000

Special filters in all six types are available for any frequency from 100 to 20,000 cycles

Catalog No.	Cut-off Frequency c.p.s.
LLP- 500	500
LLP- 1,000	1,000
LLP- 1,500	1,500
LLP- 1,600	1,600
LLP- 2,000	2,000
LLP- 2,500	2,500
LLP- 3,000	3,000
LLP-16,000	16,000
LLP-20,000	20,000
LLP-70,000	70,000
LLP-80,000	80,000
IHP- 200	200
IHP- 250	250
IHP- 300	300
IHP- 400	400
IHP- 500	500
IHP- 1,000	1,000
IHP- 2,000	2,000
IHP- 3,000	3,000
IHP-10,000	10,000
IHP-15,000	15,000
LHP- 200	200
LHP- 300	300
LHP- 400	400
LHP- 500	500
LHP- 800	800
LHP- 1,000	1,000
LHP- 2,000	2,000
LHP- 6,000	6,000
LHP-10,000	10,000

Catalog No.	Cut-off Frequency c.p.s.
IBP- 100	100
IBP- 200	200
IBP- 250	250
IBP- 400	400
IBP- 500	500
IBP- 700	700
IBP- 800	800
IBP- 900	900
IBP- 1,000	1,000
IBP- 1,500	1,500
IBP- 2,000	2,000
IBP- 3,000	3,000
IBP- 5,000	5,000
IBP- 7,200	7,200
IBP-10,000	10,000
IBP-12,000	12,000
IBP-15,000	15,000
IBP-30,000	30,000
IBP-57,600	57,600
LBP- 100	100
LBP- 300	300
LBP- 400	400
LBP- 600	600
LBP- 800	800
LBP- 1,000	1,000
LBP- 1,500	1,500
LBP- 2,000	2,000
LBP- 3,000	3,000
LBP- 7,200	7,200
LBP-10,000	10,000
LBP-14,400	14,400
LBP-20,000	20,000
LBP-28,800	28,800

HERMETICALLY SEALED SUB-MINIATURE FILTERS

Low Pass Filters: The attenuation characteristics of Low Pass Filters are 6db or less at cut-off frequency, 30db or more at 1.5 cut-off frequency and 40db or more at 2 cut-off frequency.

ILM Interstage Low Pass Filter. Characteristic impedance 10,000 ohms, in and out.

LLM Line Low Pass Filter. Characteristic Impedance 500 to 600 ohms, in and out.

High Pass Filters: The attenuation characteristics of High Pass Filters are 6db or less at cut-off frequency, 30db and 40db or more at 0.67 and 0.5 cut-off frequency.

IHM Interstage High Pass Filter. Characteristic Impedance 10,000 ohms, in and out.

LHM Line High Pass Filter. Characteristic Impedance 500 to 600 ohms, in and out.

Band Pass Filters: The attenuation characteristics of Band Pass Filters are 2db or less at plus or minus 3% of center frequency 35db or more at 0.5 and 2 center frequency.

IBM Interstage Band Pass Filter. Nominal input impedance—10,000 ohms. Nominal output impedance 5 megohms or grid of vacuum tube. Effective voltage step-up 2:1. (Output voltage to source voltage.)

LBM Line Band Pass Filter. Nominal input impedance 500 to 600 ohms. Nominal output impedance 5 megohms or grid of vacuum tube. Effective voltage step-up 5:1. (Output voltage to source voltage.)

Special filters in all six types are available for any frequency from 200 to 20,000 cycles.

Catalog No.	Cut-off Freq. c.p.s.	Case No.
IBM- 400	400	DF-02
IBM- 500	500	DF-02
IBM- 700	700	DF-02
IBM- 800	800	DF-02
IBM- 900	900	DF-02
IBM- 1,000	1,000	DF-02
IBM- 1,500	1,500	DF-02
IBM- 2,000	2,000	DF-01
IBM- 3,000	3,000	DF-01
IBM- 5,000	5,000	DF-01
IBM- 7,200	7,200	DF-01
IBM-10,000	10,000	DF-01
IBM-12,000	12,000	DF-01
IBM-15,000	15,000	DF-01
IBM-30,000	30,000	DF-01
IBM-57,600	57,600	DF-01
IHM- 300	300	DF-01
IHM- 400	400	DF-01
IHM- 500	500	DF-01
IHM- 1,000	1,000	DF-01
IHM- 2,000	2,000	DF-01
IHM- 3,000	3,000	DF-01
IHM-10,000	10,000	DF-01
IHM-15,000	15,000	DF-01

Catalog No.	Cut-off Freq. c.p.s.	Case No.
ILM- 300	300	DF-01
ILM- 500	500	DF-01
ILM- 750	750	DF-01
ILM- 1,000	1,000	DF-01
ILM- 1,500	1,500	DF-01
ILM- 2,000	2,000	DF-01
ILM- 2,500	2,500	DF-01
ILM- 3,000	3,000	DF-01
ILM- 5,000	5,000	DF-01
ILM- 7,000	7,000	DF-01
ILM- 10,000	10,000	DF-01
ILM- 15,000	15,000	DF-01
ILM- 20,000	20,000	DF-01
ILM- 23,000	23,000	DF-01
ILM- 25,000	25,000	DF-01
ILM- 32,000	32,000	DF-01
ILM-130,000	130,000	DF-01
ILM-150,000	150,000	DF-01
LHM- 300	300	DF-03
LHM- 400	400	DF-03
LHM- 500	500	DF-03
LHM- 800	800	DF-03
LHM- 1,000	1,000	DF-02
LHM- 2,000	2,000	DF-02
LHM- 6,000	6,000	DF-02
LHM-10,000	10,000	DF-02

Catalog No.	Cut-off Freq. c.p.s.	Case No.
LBM- 300	300	DF-02
LBM- 400	400	DF-02
LBM- 600	600	DF-02
LBM- 800	800	DF-02
LBM- 1,000	1,000	DF-01
LBM- 1,500	1,500	DF-01
LBM- 2,000	2,000	DF-01
LBM- 3,000	3,000	DF-01
LBM- 7,200	7,200	DF-01
LBM-10,000	10,000	DF-01
LBM-14,400	14,400	DF-01
LBM-20,000	20,000	DF-01
LBM-28,800	28,800	DF-01
LLM- 500	500	DF-03
LLM- 1,000	1,000	DF-03
LLM- 1,500	1,500	DF-02
LLM- 1,600	1,600	DF-02
LLM- 2,000	2,000	DF-02
LLM- 2,500	2,500	DF-02
LLM- 3,000	3,000	DF-02
LLM-16,000	16,000	DF-02
LLM-20,000	20,000	DF-02
LLM-70,000	70,000	DF-02
LLM-80,000	80,000	DF-02

CASE DIMENSIONS

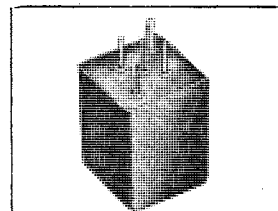

DF CASE STYLE

DF-01

Height: 1 3/4"
Width: 3/4"
Depth: 3/4"
Mtg. Cen.: 3/8" Diag.
Studs: 2 - 4-40

DF-02

Height: 1 3/4"
Width: 1"
Depth: 1"
Mtg. Cen.: 3/4" Diag.
Studs: 2 - 4-40

DF-03

Height: 1 3/4"
Width: 1"
Depth: 1"
Mtg. Cen.: 3/4" Diag.
Studs: 2 - 4-40

SERIES 1950 NULL "T" FILTERS

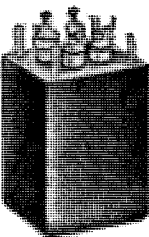

The Freed Series 1950 Null T networks consist of two resistance capacitance networks, whose outputs completely cancel each other at the balance frequency. They may be used as rejection networks particularly at low frequencies where LC filters become excessively large and unstable.

Standard models are available for 30, 60 and 120 cycles in a wide range of impedances. Each network will give a minimum of 50 db attenuation at the null frequency.

The null frequency is adjusted to a tolerance of ±2%.

All Null T Filters are hermetically sealed.

Prices on request.

Catalog No.	Frequency
NTF- 30	30 cps
NTF- 60	60 cps
NTF-120	120 cps

FREED TRANSFORMER CO., INC.

TELEGRAPH TONE CHANNEL FILTERS

RECEIVING FILTERS

HERMETICALLY SEALED TO MIL-T-27A AND MIL-F-18327 SPECIFICATIONS

Freed Band Pass Filters are extensively used in multiplex frequency shift transmitting and receiving. Stop filters cover all narrow and wide band channels. All units are built with a standard octal socket.

FBT Transmitting Filters are built for a 600 ohm in and out characteristic impedance. Filter configuration allows paralleling of channel outputs. 10db adjacent channel crossover attenuation.

Catalog No. Case FA-950	Center Frequency (c.p.s.) Insertion Loss 6db	Pass Band (c.p.s.) Attenuation 20b	Stop Band (c.p.s.) Attenuation 330b
FBR-10	425	±42.5	±130
FBR-11	595	±42.5	±130
FBR-12	765	±42.5	±130
FBR-13	935	±42.5	±130
FBR-14	1,105	±42.5	±130
FBR-15	1,275	±42.5	±130
FBR-16	1,445	±42.5	±130
FBR-17	1,615	±42.5	±130
FBR-18	1,785	±42.5	±130
FBR-19	1,955	±42.5	±130
FBR-20	2,125	±42.5	±130
FBR-21	2,295	±42.5	±130
FBR-22	2,465	±42.5	±130
FBR-23	2,635	±42.5	±130
FBR-24	2,805	±42.5	±130
FBR-25	2,975	±42.5	±130
FBR-26	1,955	±85	±260
FBR-27	2,380	±85	±260
FBR-28	2,805	±85	±260
FBR-29	3,230	±85	±260

TRANSMITTING FILTERS

Catalog No. Case FA-955	Center Frequency (c.p.s.) Insertion Loss 5db	Pass Band (c.p.s.) Attenuation 2db	Stop Band (c.p.s.) Attenuation 20db
FBT-10	425	±42.5	±130
FBT-11	595	±42.5	±130
FBT-12	765	±42.5	±130
FBT-13	935	±42.5	±130
FBT-14	1,105	±42.5	±130
FBT-15	1,275	±42.5	±130
FBT-16	1,445	±42.5	±130
FBT-17	1,615	±42.5	±130
FBT-18	1,785	±42.5	±130
FBT-19	1,955	±42.5	±130
FBT-20	2,125	±42.5	±130
FBT-21	2,295	±42.5	±130
FBT-22	2,465	±42.5	±130
FBT-23	2,635	±42.5	±130
FBT-24	2,805	±42.5	±130
FBT-25	2,975	±42.5	±130
FBT-26	1,955	±85	±260
FBT-27	2,380	±85	±260
FBT-28	2,805	±85	±260
FBT-29	3,230	±85	±260

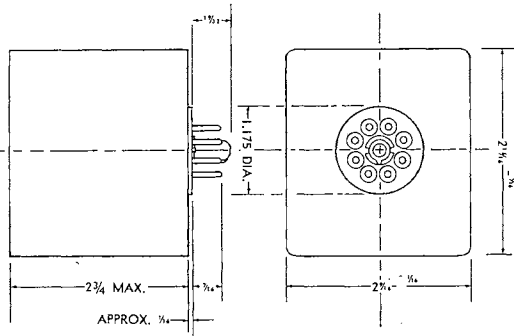

FBR Receiving Filters are designed for a characteristic impedance of 600 ohms in and out. Filter configuration permits paralleling of channel inputs. 20db adjacent channel crossover attenuation.

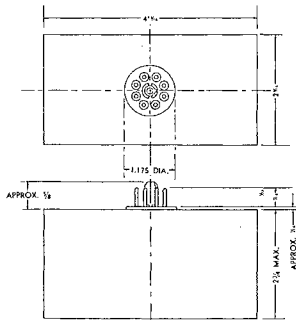
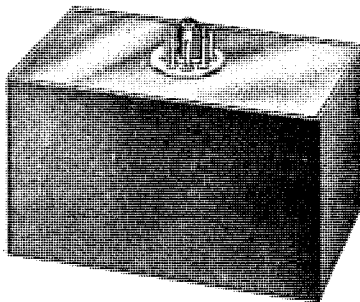

ULTRASONICS

New developments and applications of ultrasonics for industrial cleaning, soldering, welding, and mixing have created a demand for generators and components specifically designed for ultrasonic applications.

Using the latest developments in the field of special magnetic materials the FREED ultrasonic transformers are designed for greatest efficiency and maximum reliability. They feature small size excellent performance and long life under continuous duty operation.

Transformers with an extended frequency range (frequencies up to 2 MC) can be supplied upon request.

ULTRASONIC DRIVER AND INPUT TRANSFORMERS

Frequency Response: ±1 DB 10 KC to 60 KC.

Catalog No.	Application	Primary Impedance Ohms	Ratio	Maximum Power Watts	Maximum Primary D.C. per Side Ma.	Case Size
ULI-20	Transducer to PP 811A	1, 2, 4	1:17.3	5		DM-03
ULD-20	PP 6CM6 to PP 811A	10,000	4.4:1	5	50	DM-03
ULO-50	PP 5881 to PP 8000	7,200	1.7:1	25	90	EA

ULTRASONIC OUTPUT TRANSFORMERS

Frequency response: ±1 DB 20 KC to 60 KC.

Catalog No.	Application	Impedance in Ohms		Maximum Power Watts	Maximum Primary D.C. per Side Ma.	Case Size
		Primary	Secondary			
ULO-10	PP 6083 to transducer	7,600	1/4	100	120	DC-4B
ULO-11	Same	7,600	2/8	100	120	DC-4B
ULO-12	Same	7,600	4/16	100	120	DC-4B
ULO-13	Same	7,600	7.5/30	100	120	DC-4B
ULO-30	PP 811A to transducer	12,400	1/4	300	170	DC-4B
ULO-31	Same	12,400	2/8	300	170	DC-4B
ULO-32	Same	12,400	4/16	300	170	DC-4B
ULO-33	Same	12,400	7.5/30	300	170	DC-4B
ULO-34	Same	12,400	25	300	170	DC-4B
ULO-35	Same	12,400	125/500	300	170	DC-4B
ULO-36	Same	12,400	250/1000	300	170	DC-4B
ULO-37	Same	12,400	75/300	300	170	DC-4B
ULO-52	PP 8000 to transducer	10,800	4/16	500	230	MA-2
ULO-53	Same	10,800	7.5/30	500	230	MA-2
ULO-54	Same	10,800	25/100	500	230	MA-2
ULO-55	Same	10,800	125/500	500	320	MA-2
ULO-56	Same	10,800	250/1000	500	230	MA-2
ULO-101	PP. Par. 8000 to transducer	5,400	25/100	1000	430	DC-6B
ULO-104	Same	5,400	75/300	1000	430	DC-6B
ULO-110	PP 4-250A to transducer	10,900	18.8/75/300	800	250	OL-112-1

CASE DIMENSIONS

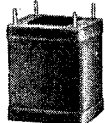

OL-112-1 CASE

Height: 6"
Width: 5 7/8"
Length: 4 1/2"
Mounting: 4 1/4-20 Studs
Mtg. Cen.: 4 1/4"x3 3/4"
Cutout: 3" dia.

DC-4B CASE

Height: 4 3/8"
Width: 3 1/2"
Length: 3"
Mounting: 4 8-32 Studs
Mtg. Cen.: 2 1/2"x2 1/2"
Cutout: (2) 1 3/4"x3/4"

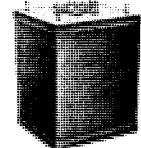
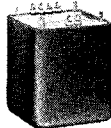

DC-6B CASE

Height: 6"
Width: 5"
Length: 4 1/4"
Mounting: 4 10-32 Studs
Mtg. Cen.: 3 3/4"x3"
Cutout: 3" Dia.

EA CASE

Height: 2 1/2"
Width: 1 1/2"
Length: 1 3/4"
Mounting: 4 6-32 Studs
Mtg. Cen.: 1 3/4"x1 1/4"
Cutout: 1 3/8"



MA-2 CASE

Height: 4"
Width: 4 5/8"
Length: 3 3/8"
Mounting: 4 10-32 Studs
Mtg. Cen.: 2 1/4"x3 3/4"
Cutout: (2) 2 3/4"x3/4"



DM-03 CASE

Height: 2 1/2"
Width: 1 1/2"
Length: 1 3/4"
Mounting: 4 6-32 Studs
Mtg. Cen.: 1 3/4"x1 1/4"
Cutout: 1 3/4" Dia.

FREED TRANSFORMER CO., INC.

COMMERCIAL GRADE COMPONENTS

These components are designed to meet the demand for low-cost replacement parts for commercial electronic equipment.

The best commercially available materials have been utilized in the design of these units, to insure reliability and excellent performance characteristics. Vacuum impregnation with a non-hygroscopic varnish to prevent penetration of humidity are employed to give these units long life and trouble-free performance.

230-115 V, 50-60 C.P.S. Stepdown Transformers rated from 25 V A up to 5,000 V A Rating and line booster transformers are included in this series.

All units, with only a few exceptions, are uncased or of shell-type construction.

Isolation transformers and Stepdown transformers are equipped with line cord and receptacle.

CASE DIMENSIONS

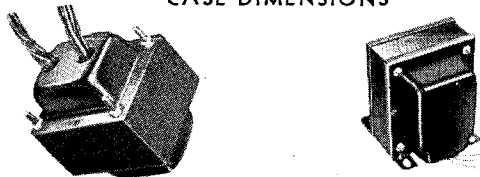

Case No.	Height	Width	Depth	Neg. Centers	Neg. Studs
HS300	2 3/8	3	2 1/2	2 1/2 x 2	(4) 3/8 x 3/8
HS303	2 3/8	3	2 1/2	2 1/2 x 2	(4) 3/8 x 3/8
HS306	3 1/4	3	2 1/2	2 1/2 x 2	(4) 3/8 x 3/8
HS307	3 3/8	3	2 1/2	2 1/2 x 2	(4) 3/8 x 3/8
HS503	3 1/2	3 3/4	3 1/8	3 1/8 x 2 1/2	(4) 3/8 x 3/8
HS505	3 3/4	3 3/4	3 1/8	3 1/8 x 2 1/2	(4) 3/8 x 3/8
HS603	3 3/4	4 1/2	3 3/4	3 3/4 x 3	(4) 3/8 x 3/8
HS605	4	4 1/2	3 3/4	3 3/4 x 3	(4) 3/8 x 3/8
HS606	4 3/8	4 1/2	3 3/4	3 3/4 x 3	(4) 3/8 x 3/8
HS610	4 3/8	4 1/2	3 3/4	3 3/4 x 3	(4) 3/8 x 3/8
HS612	4 3/8	4 1/2	3 3/4	3 3/4 x 3	(4) 3/8 x 3/8
HS708	5 1/8	5 1/2	4 3/8	4 3/8 x 3 1/2	(4) 3/8 x 3/8
HS709	6	5 1/2	4 3/8	4 3/8 x 3 1/2	(4) 3/8 x 3/8

Case No.	Height	Width	Depth	Neg. Centers	Neg. Studs
DC2B	3 1/2	2 3/8	2 1/4	2 x 1 3/4	(4) 8-32
DC4A	3 3/4	3 1/8	3	2 1/2 x 2 1/2	(4) 8-32
DC5C	4 1/4	4 1/8	3 1/2	3 1/8 x 2 3/8	(4) 10-32
DC6A	4 3/8	5	4 1/4	3 3/4 x 3	(4) 10-32
CH50	1 1/8	2 1/8	1 3/4	2 3/8	(2) 3/8
CH60	2	3 1/4	1 3/4	2 3/8	(2) 3/8
CH62	2	3 1/4	2 1/8	2 3/8	(2) 3/8
CH70	2 3/8	3 1/8	2 1/4	3 1/8	(2) 3/8
CH80	2 3/8	4	2 3/8	3 1/8	(2) 3/8
FV10	3 3/8	2 1/2	2 3/8	2 x 2	(4) 1 3/8 x 3/4
FV12	3 3/8	2 1/2	2 3/8	2 x 2 3/8	(4) 1 3/8 x 3/4
FV22	3 3/8	2 3/8	2 3/8	2 1/2 x 2 1/2	(4) 3/8 x 3/8
FV30	4 3/8	3 1/8	3	2 1/2 x 2 1/2	(4) 1 3/8 x 3/4
HB718	6 1/2	6 1/2	8 1/2	4 3/4 x 4 1/2	(4) 3/8 x 3/8
HB728	6 1/2	6 1/2	9 3/4	4 3/4 x 5 3/4	(4) 3/8 x 3/8
HB828	6 1/2	7 3/8	9 3/4	5 3/8 x 5 3/4	(4) 3/8 x 3/8
HB920	6 1/2	7 7/8	10 1/2	6 1/2 x 7 3/8	(4) 3/8 x 3/8
VS300	3 3/8	2 3/8	3	2 x 2	(4) 3/8 x 3/8
VS401	3 3/8	2 3/8	3 3/4	2 1/4 x 1 1/2	(4) 3/8 x 3/8
VS501	3 3/8	3 1/8	3 3/8	2 1/2 x 2 1/2	(4) 3/8 x 3/8
VS503	3 3/8	3 1/8	3 3/8	2 1/2 x 2 1/2	(4) 3/8 x 3/8
VS601	4 3/8	3 1/8	3 3/8	3 x 2 1/2	(4) 3/8 x 3/8
VS604	4 3/8	3 1/8	4	3 x 2 1/2	(4) 3/8 x 3/8
VS611	4 3/8	3 1/8	4 3/8	3 x 3 1/8	(4) 3/8 x 3/8
VS612	4 3/8	3 1/8	5	3 x 3 1/8	(4) 3/8 x 3/8
VS700	5 1/8	3 1/8	5	3 1/2 x 3 1/2	(4) 3/8 x 3/8
VS706	5 1/8	4 3/8	5 1/2	3 1/2 x 3 3/4	(4) 3/8 x 3/8
VS714	5 1/8	4 3/8	6 1/2	3 1/2 x 4 3/4	(4) 3/8 x 3/8
VS718	5 1/8	4 3/8	7	3 1/2 x 5 1/4	(4) 3/8 x 3/8
VS728	5 1/8	4 3/8	8 1/4	3 1/2 x 6 1/2	(4) 3/8 x 3/8

ISOLATION TRANSFORMERS

Electrostatic shield between primary and secondary. Equipped with standard receptacle and line cord.

Catalog Number	Primary Voltage 50/60 c.p.s.	Secondary Voltage	VA Rating	Case Size
IT 1	115	115	50	VS-401
IT 2	115	115	100	VS-503
IT 3	115	115	300	VS-700
IT 4	115	115	500	VS-714
IT 5*	220/440	110/220	250	VS-612
IT 6*	220/440	110/220	500	VS-714

*Supplied with leads without line cords and receptacle.

POWER TRANSFORMERS

All primaries designed for 115-volt, 50-60 cycle operation.

Catalog No.	Py Va	Ht Volt	Choke Input D.C.V. D.C.Ma.	Cond. Input D.C.V. D.C.Ma.	Bias Tap	Rectifier	Fil. No. 1	Fil. No. 2	Fil. No. 3	Case No.
RGP 1	45	500V CT	270	40		6X4.5Y3	5/6.3V @ 2A	6.3V @ 2A		VS300
RGP 2	45	500V CT	270	40		6X4.5Y3	5/6.3V @ 2A	6.3V @ 2A		HS300
RGP 3	57	600V CT	330	50		6X4.5Y3	5/6.3V @ 2A	6.3V @ 2.5A		VS303
RGP 4	57	600V CT	330	50		6X4.5Y3	5/6.3V @ 2A	6.3V @ 2.5A		HS303
RGP 5	64	650V CT	370	50		6X4.5Y3	5/6.3V @ 2A	6.3V @ 3A		VS303
RGP 6	64	650V CT	370	50		6X4.5Y3	5/6.3V @ 2A	6.3V @ 3A		HS303
RGP 7	73	600V CT	320	70		6X4.5Y3	5/6.3V @ 2A	6.3V @ 3A		VS306
RGP 8	73	600V CT	320	70		6X4.5Y3	5/6.3V @ 2A	6.3V @ 3A		HS306
RGP 9	110	650V CT	225	140		5Y3.5U4	5V @ 3A	6.3V @ 5A		VS503
RGP 10	110	650V CT	225	140		5Y3.5U4	5V @ 3A	6.3V @ 5A		HS503
RGP 11	76	700V CT	260	100		5Y3	5V @ 2A	6.3V @ 2.5A		VS307
RGP 12	76	700V CT	260	100		5Y3	5V @ 2A	6.3V @ 2.5A		HS307
RGP 13	108	700V CT	250	125		5Y3.5U4	5V @ 3A	6.3V @ 5A		VS503
RGP 14	108	700V CT	250	125		5Y3.5U4	5V @ 3A	6.3V @ 5A		HS503
RGP 15	127	700V CT	260	170		5U4	5V @ 3A	6.3V @ 5A		VS505
RGP 16	127	700V CT	260	170		5U4	5V @ 3A	6.3V @ 5A		HS505
RGP 17	145	700V CT	260	210		5U4	5V @ 3A	6.3V @ 5A	6.3V @ 1A	VS603
RGP 18	145	700V CT	260	210		5U4	5V @ 3A	6.3V @ 5A	6.3V @ 1A	HS603
RGP 19	207	800V CT	295	280		5U4-2-5Y3	5V @ 4A	6.3V @ 6A		VS606
RGP 20	207	800V CT	295	280		5U4-2-5Y3	5V @ 4A	6.3V @ 6A		HS606
RGP 21	225	800V CT	295	280		5U4-2-5Y3	5V @ 4A	6.3V @ 6A	5/6.3V @ 2A	VS606
RGP 22	225	800V CT	295	280		5U4-2-5Y3	5V @ 4A	6.3V @ 6A	5/6.3V @ 2A	HS606
RGP 23	268	840V CT	330	350		2-5U4	5V @ 6A	6.3V @ 6A	5/6.3V @ 2A	VS612
RGP 24	268	840V CT	330	350		2-5U4	5V @ 6A	6.3V @ 6A	5/6.3V @ 2A	HS612
RGP 25	320	900V CT	340	420		2-5U4	5V @ 6A	6.3V @ 6A	5/6.3V @ 2A	VS708
RGP 26	320	900V CT	340	420		2-5U4	5V @ 6A	6.3V @ 6A	5/6.3V @ 2A	HS708
RGP 27	127	900V CT	360	150		5U4	5V @ 3A	6.3V @ 5A		VS603
RGP 28	127	900V CT	360	150		5U4	5V @ 3A	6.3V @ 5A		HS603
RGP 29	150	900V CT	350	200		5U4	5V @ 3A	6.3V @ 5A		VS605
RGP 30	150	900V CT	350	200		5U4	5V @ 3A	6.3V @ 5A		HS605
RGP 31	203	1100V CT	400	250		5R4GY	5V @ 3A	6.3V @ 5A		VS610
RGP 32	203	1100V CT	400	250		5R4GY	5V @ 3A	6.3V @ 5A		HS610
RGP 33	248	1100V CT	420	300		2-5R4GY	5V @ 4A	6.3V @ 7A		VS612
RGP 34	248	1100V CT	420	300		2-5R4GY	5V @ 4A	6.3V @ 7A		HS612
RGP 35	310	1280V CT	480	350		2-5R4GY	5V @ 4A	6.3V @ 7A		VS709
RGP 36	310	1280V CT	480	350		2-5R4GY	5V @ 4A	6.3V @ 7A		HS709

FILAMENT TRANSFORMERS

All primaries are for 115V, 50/60 c.p.s.

Catalog No.	Secondary Voltage	Secondary Current Amps	Secondary Test Voltage RMS	Case Size
TF 1	2.5 (C.T.)	7.5	1500	CH60
TF 2	2.5 (C.T.)	10	1500	CH70
TF 3	2.5 (C.T.)	5	7500	DC2B
TF 4	2.5 (C.T.)	10	7500	DC4A
TF 5	5.0 (C.T.)	4	1500	CH60
TF 6	5.0 (C.T.)	6	1500	CH70
TF 7	5.0 (C.T.)	10	1500	CH80
TF 8	5.0 (C.T.)	10	1500	FV10
TF 9	5.0 (C.T.)	20	2500	FV30
TF 10	5.0 (C.T.)	20	10,000	DC6A
TF 11	6.3 (C.T.)	1.35	1500	CH59
TF 12	6.3 (C.T.)	3	1500	CH60
TF 13	6.3 (C.T.)	5	1500	CH70
TF 14	6.3 (C.T.)	7	1500	FV12
TF 15	6.3 (C.T.)	10	1500	FV22
TF 16	10 (C.T.)	5	2500	CH80
TF 17	10 (C.T.)	5	2500	FV10
TF 18	11 (C.T.) (tapped primary)	12 or 11	7500	DC-5C
TF 19	12.6 (C.T.)	2	1500	CH62

TF 3, 4, 10 & 18 supplied with terminals. All others with leads.

AUTO TRANSFORMERS

To be used as step-down transformer. Equipped with standard receptacle and line cord.

Catalog No.	Transformation	VA Rating	Weight (lbs.)	Case Size
SDT 1*	230/115 V, 50/60 c.p.s.	25	1	CH-60
SDT 2*	230/115 V, 50/60 c.p.s.	50	1 1/4	CH-62
SDT 3	230/115 V, 50/60 c.p.s.	50	2 1/2	VS-300
SDT 4	230/115 V, 50/60 c.p.s.	100	3	VS-401
SDT 5	230/115 V, 50/60 c.p.s.	200	5	VS-501
SDT 6	230/115 V, 50/60 c.p.s.	300	6 1/2	VS-601
SDT 7	230/115 V, 50/60 c.p.s.	400	8	VS-604
SDT 8	230/115 V, 50/60 c.p.s.	500	11	VS-611
SDT 9	230/115 V, 50/60 c.p.s.	750	15	VS-706
SDT 10	230/115 V, 50/60 c.p.s.	1000	23	VS-718
SDT 11	230/115 V, 50/60 c.p.s.	1500	29 1/2	VS-728
SDT 12*	230/115 V, 50/60 c.p.s.	2000	37	HB-718
SDT 13*	230/115 V, 50/60 c.p.s.	2500	47	HB-728
SDT 14*	230/115 V, 50/60 c.p.s.	3000	58	HB-828
SDT 15*	230/115 V, 50/60 c.p.s.	5000	72	HB-920

*Supplied with leads without line cord and receptacle.

LINE BOOSTER TRANSFORMERS

Operates from 90 to 110 volts input to provide 10% step-up.

Catalog Number	Primary Voltage	Secondary Voltage	VA Rating	Case Size
LB-1	90-110	1.1 x input	350	VS-300
LB-2	90-110	1.1 x input	2000	VS-611

FREED TRANSFORMER CO., INC.

COMMERCIAL GRADE COMPONENTS

AUDID TRANSFORMERS

COMMERCIAL GRADE CHDKES

Catalog No.	Application	Impedance Level Primary Secondary	Max. Power Level DBM or Power in Watts	Ratio	Max. Pri. P.P. Ma.	D.C. Voltage	Freq. Resp. C.P.S.	Case No.
RGA 1	Input; multiple line or double button mike to single or push-pull grids.	500 CT 200 CT	100,000 CT	+20	1:14.1	50	5 ±20B 200-5000	CH-40
RGA 2	Input; single button mike to single or push-pull grids.	100	100,000 CT	+20	1:31.6	50	±20B 200-5000	CH-40
RGA 3	Input; voice coil to grid.	3.2	100,000	+20	1:179	50	±20B 200-5000	CH-40
RGA 4	Mixing and matching line to line	600 CT 500 CT 200 CT 150/125/50	600 CT 500 CT 200 CT 150/125/50	+20	1:1	10	±20B 100-5000	CH-40
RGA 5	Interstage; single triode plate to single or P.P. grids.	10,000	90,000 CT	+30	1:3	10	±20B 200-5000	CH-40
RGA 6	Output; single plate to line or mixer.	10,000	600 CT 500 CT 200 CT 150/125/50	+30	4.8:1	10	±20B 200-5000	CH-40
RGA 7	Output; Push-pull plate to line or mixer.	20,000 CT	600 CT 500 CT 200 CT 150/125/50	+30	6.32:1	10	±20B 200-5000	CH-40
RGA 8	Output; plate to V.C. 6AL6, 6L6, 6V6, 25B6, 25C6, 35A5, 35B5, 35C5, 50B5, 50C5, 50D6, 50L5, 117W7.	2500	3.2	5W	7	20	±30B 200-10000	CH-40
RGA 9	Output; plate to V.C. 6V6, 6A05, 6AS5, 7C5.	5000	3.2	5W	50	50	±30B 200-10000	CH-40
RGA 10	Output; plate to V.C. 6AR5, 6K6, 6V6, 7B5, 14A5, 35A, 30A, 304, 305, 3C5, 3A4.	10,000 or 7500	3.2	5W	30	30	±30B 200-10000	CH-40
RGA 11	Output; P.P. plates to V.C. P.P. 6V6, 6P6K6.	12,000 CT or 8000 CT	3.2	15W	50	50	±20B 200-5000	CH-60
RGA-12	Output; TP to V.C. 6V6, 6A05, 7C5, 6L6.	10,000 CT	3.2	10W	5.6:1	40	±30B 200-10000	CH-60

Catalog No.	Inductance in Henries	Rated Current D.C. Ma.	D.C. Resistance	Dielectric Test Voltage	Case Number
RGC 17	40	15	2000	1000	CH-40
RGC 1	4	40	200	1000	CH-40
RGC 2	9	40	400	1000	CH-40
RGC 3	6	50	400	1000	CH-40
RGC 18	20	50	425	1500	CH-60
RGC 4	10	55	400	1500	CH-50
RGC 19	3	75	200	1500	CH-40
RGC 5	10	75	250	1500	CH-60
RGC 6	10	75	250	1500	VS-100
RGC 7	6	100	150	1500	CH-60
RGC 8	6	100	150	1500	VS-100
RGC 9	3.5	150	100	1500	CH-60
RGC 10	3.5	150	100	1500	VS-100
RGC 20	12	150	180	2500	VS-306
RGC 11	2	200	60	1500	CH-60
RGC 12	2	200	60	1500	VS-100
RGC 13	3.7	200	65	1500	CH-80
RGC 21	7	200	100	2500	VS-303
RGC 14	3.7	200	65	1500	VS-300
RGC 15	2.8	300	65	1500	CH-80
RGC 16	2.8	300	65	1500	VS-300
RGC 22	5	300	65	2500	VS-308

CASE DIMENSIONS

CH CASE

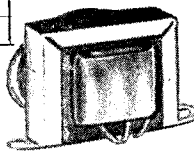

VS CASE

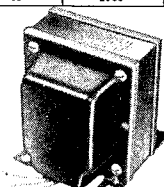

CH-40 CASE
Height: 1 3/4"
Width: 2 3/4"
Depth: 1 3/4"
Mtg. Cen.: 2"

CH-50 CASE
Height: 1 1/4"
Width: 2 1/2"
Depth: 1 1/4"
Mtg. Cen.: 2 1/2"

CH-60 CASE
Height: 2"
Width: 3 1/2"
Depth: 1 3/4"
Mtg. Cen.: 2 1/4"

CH-80 CASE
Height: 2 3/4"
Width: 4 1/2"
Depth: 2 3/4"
Mtg. Cen.: 3 3/4"

VS-100 CASE
Height: 2 1/2"
Width: 1 7/8"
Depth: 2 1/2"
Mtg. Cen.: 1 1/2" x 1 1/8"

VS-300 CASE
Height: 3 3/8"
Width: 2 5/8"
Depth: 2 1/2"
Mtg. Cen.: 2 1/4" x 1 1/8"

VS-303 CASE
Height: 3 3/8"
Width: 2 5/8"
Depth: 2 1/2"
Mtg. Cen.: 2x1 1/8"
Mtg. Hole: (4) 3/16" x 3/16"

VS-306 CASE
Height: 3 3/8"
Width: 2 5/8"
Depth: 2 1/2"
Mtg. Cen.: 2x2 3/8"
Mtg. Hole: (4) 3/16" x 3/16"

VS-308 CASE
Height: 3 3/8"
Width: 2 5/8"
Depth: 2 1/2"
Mtg. Cen.: 2" x 2 3/8"

PRICE LIST

Catalog No.	Net Price	Catalog No.	Net Price	Catalog No.	Net Price	Catalog No.	Net Price	Catalog No.	Net Price	Catalog No.	Net Price				
EPT-1	8.75	MAS-1	55.00	MCV-6-5FC	12.00	MGC-31	*	MPT-20C	17.00	PGC-9	8.70				
EPT-2	8.75	MAS-2	37.00	MCV-6-25FC	18.00	MGC-32	7.90	MPT-20M	21.40	PGC-10	9.00				
EPT-3	8.75	MAS-3	65.00	MCV-6-75FC	28.00	MGC-33	7.90	MPT-20H	27.60	PGC-11	12.30				
EPT-4	8.75	MAS-4	73.00	MCV-6-125FC	35.00	MGC-34	7.90	MPT-21M	24.00	PGC-12	12.30				
EPT-5	8.75	MAS-5	33.00	MCV-6-SLM	20.00	MGC-35	7.90	MPT-21H	27.00	PGC-13	13.95				
EPT-6	8.75	MAS-6	50.00	MCV-6-25LM	26.00	MGC-36	7.90	MPT-21M	27.60	PGC-14	8.75				
EPT-7	8.75	MAS-7	60.00	MCV-6-75LM	37.00	MGC-37	7.90	MPT-22C	22.40	PGC-15	9.45				
EPT-8	11.00	MAS-8	24.00	MCV-6-125LM	45.00	*Not stocked, available on short delivery. Prices on request.						PGC-16	9.45		
EPT-9	11.00	MAS-9	87.50	MCV-6-175LM	53.00							MPT-22M	26.00	PGC-17	8.70
EPT-11	8.75	MAS-101	62.50	MCV-6-250LM	62.00							MPT-22H	30.60	PGC-18	12.20
EPT-12	8.75	MAT-1-1	148.50	MCV-6-375LM	76.00							MPT-23C	24.00	PGC-19	12.20
EPT-13	11.00	MCV-4-5LC	14.00	MCV-6-500LM	90.00							MPT-23M	27.10	PGC-20	12.20
EPT-14	11.00	MCV-4-25LC	20.00	MCV-6-750LM	123.00							MGF-1	13.50	PGC-21	13.85
EPT-15	14.00	MCV-4-75LC	30.00	MCV-6-1000LM	150.00							MGF-2	15.00	PGC-22	16.20
EPT-16	14.00	MCV-4-125LC	38.00	MCV-6-54FM	20.00							MGF-3	13.50	PGC-23	18.00
EPT-17	13.50	MCV-4-175LC	45.00	MCV-6-25-4FM	26.00							MGF-4	18.00	PGC-24	9.60
EPT-18	13.50	MCV-4-250LC	54.00	MCV-6-75-4FM	37.00							MGF-5	13.00	PGC-25	20.80
EPT-19	13.50	MCV-4-375LC	69.00	MCV-6-125-4FM	45.00	MGF-6	15.00	PGC-26	26.60						
Note—Molded Units \$1.00 additional.		MCV-4-500LC	85.00	MCV-6-5FM	21.00	MGF-7	19.50	MPT-26C	24.00	PGC-27	10.780				
IT-1	7.25	MCV-4-1000LC	115.00	MCV-6-25FM	27.00	MGF-8	24.00	MPT-26M	25.30	PGC-28	12.60				
IT-2	11.40	MCV-4-750LC	143.00	MCV-6-75FM	38.00	MGF-9	19.50	MPT-26H	34.50	PGC-29	10.80				
IT-3	26.40	MCV-4-45FC	14.00	MCV-6-125FM	38.00	MGF-10	22.50	MPT-27C	23.40	PGC-30	12.60				
IT-4	31.95	MCV-4-25-4FC	20.00	MGA-1	17.75	MGF-11	22.00	MPT-27M	22.20	PGC-31	13.00				
IT-5	26.40	MCV-4-75-4FC	30.00	MGA-2	13.25	MGP-2	24.00	MPT-27H	34.50	PGC-32	16.60				
IT-6	34.95	MCV-4-125-4FC	38.00	MGA-3	12.75	MGP-3	26.40	PGA-1	16.50	PGC-33	19.80				
KA-10	19.60	MCV-4-5FC	15.00	MGA-4	12.75	MGP-4	33.00	PGA-2	16.50	PGC-34	21.80				
KA-11	10.50	MCV-4-25FC	21.00	MGA-5	11.65	MGP-5	39.00	PGA-3	16.50	PGC-35	26.15				
KC-10	7.50	MCV-4-75FC	31.00	MGA-6	12.00	MGP-6	21.00	PGA-4	14.10	PGC-36	30.40				
KC-11	1.90	MCV-4-5LM	28.00	MGA-7	11.65	MGP-7	28.50	PGA-5	14.85	PGC-37	15.12				
LB-1	8.40	MCV-4-25LM	28.00	MGA-8	12.00	MGP-8	17.25	PGA-6	18.15	PGC-38	16.20				
LB-2	23.25	MCV-4-75LM	39.00	MGA-9	11.65	MGP-9	17.25	PGA-7	18.15	PGC-39	21.80				
MAC-5-2-F1	42.50	MCV-4-125LM	48.00	MGC-1	8.65	MGP-10	24.00	PGA-8	12.40	PGC-40	26.15				
MAC-5-1-F2	42.50	MCV-4-175LM	55.00	MGC-2	7.10	MGP-11	25.90	PGA-9	12.40	PMA-1	10.90				
MAC-5-3-F2	42.50	MCV-4-250LM	66.00	MGC-3	7.50	MGP-12	23.00	PGA-10	13.20	PMA-2	8.93				
MAC-5-4-F2	42.50	MCV-4-375LM	81.00	MGC-4	8.35	MGP-13	17.25	PGA-11	14.05	PMA-3	12.58				
MAC-12-3-60	29.95	MCV-4-500LM	104.00	MGC-5	8.65	MGP-14	20.20	PGA-12	16.50	PMA-4	8.93				
MAC-12-10-1	36.50	MCV-4-750LM	131.00	MGC-6	7.10	MGP-15	20.20	PGA-13	17.25	PMA-5	8.93				
MAC-12-10-2	44.20	MCV-4-1000LM	160.00	MGC-7	7.50	MGP-16	25.90	PGA-14	20.65	PMA-6	10.90				
MAC-12-20-1	46.50	MCV-4-5-4FM	22.00	MGC-8	8.05	MGP-17	23.00	PGA-15	20.65	PMA-7	10.90				
MAC-12-20-2	57.00	MCV-4-25-4FM	28.00	MGC-9	7.50	MGP-18	20.20	PGA-16	20.65	PMA-8	10.90				
MAC-12-30-1	63.70	MCV-4-75-4FM	39.00	MGC-10	8.05	MGP-19	31.60	PGA-17	19.00	PMA-9	10.90				
MAP-4-12-30-2	78.00	MCV-4-125-4FM	48.00	MGC-11	19.00	MGP-20	13.40	PGA-18	20.65	PMA-10	10.23				
MAF-4	78.00	MCV-4-5FM	28.00	MGC-12	7.50	MGP-21	17.70	PGA-19	17.70	PMA-11	22.30				
MAF-5	80.00	MCV-4-25FM	48.00	MGC-13	8.05	MGP-22	22.10	PGA-20	20.65	PMA-12	13.00				
MAF-6	180.00	MCV-4-75FM	40.00	MGC-14	10.00	MGP-23	19.45	PGA-21	22.55	PMA-13	9.90				
MAF-7	180.00	MCV-4-125FM	49.00	MGC-15	10.90	MGP-24	24.00	PGA-22	22.55	PMA-14	11.10				
MAF-8	180.00	MCV-4-5LC	11.00	MGC-16	8.05	MGP-25	29.00	PGA-23	20.65	PMA-15	10.90				
MAO-1	70.00	MCV-6-25LC	17.00	MGC-17	10.00	MGP-26	17.95	PGA-24	36.30	PQC-1	9.40				
MAO-2	102.00	MCV-6-75LC	27.00	MGC-18	11.50	MGP-27	22.40	PGA-25	20.65	PQC-2	9.40				
MAO-3	110.00	MCV-6-125LC	34.00	MGC-19	14.40	MGP-28	30.50	PGA-26	30.50	PQC-3	9.40				
MAO-4	175.00	MCV-6-175LC	42.00	MGC-20	10.00	MGP-29	21.70	PGA-27	20.65	PQC-4	9.40				
MAP-1	90.00	MCV-6-250LC	50.00	MGC-21	11.00	MGP-30	26.30	PGA-28	20.65	PQC-5	9.40				
MAP-2	150.00	MCV-6-375LC	64.00	MGC-22	10.90	MGP-31	32.30	PGA-29	36.30	PQC-6	9.40				
MAP-3	225.00	MCV-6-500LC	76.00	MGC-23	8.05	MGP-32	22.40	PGA-30	36.30	PQC-7	9.40				
MAP-301	175.00	MCV-6-750LC	104.00	MGC-24	20.70	MGP-33	26.00	PGA-31	14.70	PQC-8	9.40				
MAP-7	280.00	MCV-6-1000LC	128.00	MGC-25	18.40	MGP-34	30.60	PGA-32	20.65	PQC-9	9.40				
MAP-8	105.00	MCV-6-54FC	11.00	MGC-26	17.00	MGP-35	14.70	PGA-33	7.05	PQC-10	27.70				
MAP-9	133.00	MCV-6-75-4FC	27.00	MGC-27	18.40	MGP-36	22.40	PGA-34	7.05	PQC-11	19.80				
MAP-11	95.00	MCV-6-125-4FC	34.00	MGC-28	*	MGP-37	26.00	PGA-35	7.65	PQC-12	27.70				
				MGC-29	*	MGP-38	26.00	PGA-36	8.70	PQC-13	11.50				
				MGC-30	*	MGP-39	26.00	PGA-37	7.65	PQC-14	11.50				
				MGC-31	*	MGP-40	26.00	PGA-38	8.70	PQC-15	11.50				

FREED TRANSFORMER CO., INC.

PRICE LIST

Catalog No.	Net Price	Catalog No.	Net Price	Catalog No.	Net Price	Catalog No.	Net Price	Catalog No.	Net Price	Catalog No.	Net Price	Catalog No.	Net Price
QCC-25	10.50	TDC-28-25-12	54.80	TPA-38	8.03	TUA-38	7.59	DST-30	60.00	LPO-19	62.60	F-1519	6.35
QCC-26	10.50	TDC-28-30-05	45.30	TPA-39	8.03	ULD-20	12.50	DST-31	60.00	LPO-20	61.15	F-1520	8.35
QCC-27	10.50	TDC-28-20-05	42.90	TPA-40	8.03	ULD-50	19.55	DST-32	60.00	LPO-21	55.60	F-1521	8.55
QCC-28	10.50	TDC-48-20-15	72.50	TPA-1	7.15	ULI-20	12.50	DST-33	60.00	LPO-22	55.60	F-1522	8.55
QCC-29	10.50	TDC-48-30-15	75.00	TPA-2	7.15	ULO-10	31.20	FBB-10	86.00	LPO-23	48.20	F-1523	8.75
QCC-30	10.50	TF-1	3.42	TPA-3	7.70	ULO-11	31.20	FBB-11	86.00	LPO-24	47.10	F-1524	8.75
QCC-31	10.50	TF-2	4.55	TPA-4	6.93	ULO-12	31.20	FBB-12	86.00	LPO-25	47.10	F-1525	9.05
QCC-32	10.50	TF-3	11.40	TPA-5	6.93	ULO-13	31.20	FBB-13	86.00	LPO-26	47.10	F-1526	9.05
QCC-33	10.50	TF-4	14.00	TPA-6	7.70	ULO-30	35.75	FBB-14	70.80	LPO-27	47.10	F-1527	9.25
QCC-34	10.50	TF-5	3.42	TPA-7	7.15	ULO-31	35.75	FBB-15	70.80	LPO-28	47.10	F-1528	9.75
QCC-35	10.50	TF-6	4.55	TPA-8	7.15	ULO-32	35.75	FBB-16	70.80	LPO-29	47.10	F-1529	10.10
QCC-36	10.50	TF-7	5.00	TPA-9	7.15	ULO-33	35.75	FBB-17	70.80	LPO-30	47.10	F-1530	10.10
QCC-37	10.50	TF-8	7.15	TPA-10	7.70	ULO-34	35.75	FBB-18	70.80	LPO-31	48.20	F-1531	10.35
QCC-38	10.80	TF-9	8.74	TPA-11	7.70	ULO-35	35.75	FBB-19	70.80	LPO-32	47.10	F-1532	10.75
QCC-39	10.50	TF-10	18.20	TPA-12	8.25	ULO-36	35.75	FBB-20	70.80	LPO-33	47.10	F-1533	11.25
QCC-40	10.50	TF-11	2.28	TPA-13	8.25	ULO-37	35.75	FBB-21	70.80	LPO-34	47.10	F-1534	11.75
QCC-41	10.50	TF-12	3.42	TPA-14	8.25	ULO-52	93.75	FBB-22	70.80	LPO-35	47.10	F-1535	11.75
QCC-42	10.50	TF-13	4.55	TPA-15	8.80	ULO-53	93.75	FBB-23	70.80	NTF-30	25.00	F-1536	12.75
QCC-43	4.50	TF-14	5.53	TPA-16	7.70	ULO-54	93.75	FBB-24	86.00	NTF-60	25.00	F-1537	13.10
QCC-44	3.63	TF-15	6.74	TPA-17	7.70	ULO-55	93.75	FBB-25	70.80	NTF-120	25.00	F-1538	13.60
QCC-45	3.63	TF-16	5.00	TPA-18	7.70	ULO-56	93.75	FBB-26	86.00				
QCC-46	3.63	TF-17	7.15	TPA-19	8.25	ULO-101	181.00	FBB-27	86.00				
QCC-47	3.63	TF-18	18.20	TPA-20	7.70	ULO-104	181.00	FBB-28	86.00				
QCC-48	4.33	TF-19	3.80	TPA-21	7.15	ULO-110	181.00	FBB-29	86.00				
QCC-49	4.50	TMA-1	8.25	TPA-22	7.42	VHI-1	9.50	FBB-30	86.00				
QCC-50	2.06	TMA-2	10.56	TPA-23	7.15	VHI-2	9.50	FBB-31	86.00				
QCC-51	2.06	TMA-3	8.60	TPA-24	7.15	VHI-3	9.50	FBB-32	86.00				
QCC-52	2.48	TMA-4	6.90	TPA-25	6.60	VHI-4	9.50	FBB-33	86.00				
QCC-53	3.63	TMA-5	10.90	TPA-26	6.90	VHI-5	9.50	FBB-34	73.00				
QCC-54	3.63	TMA-6	10.90	TPA-27	6.60	VHI-6	9.50	FBB-35	73.00				
QCC-55	1.69	TMA-7	8.90	TPA-28	6.60	VHI-7	9.50	FBB-36	73.00				
QCC-56	1.69	TMA-8	10.56	TPA-29	6.93	VHI-8	9.50	FBB-37	73.00				
QCC-57	1.69	TMA-9	8.60	TPA-30	6.60	VHI-9	9.50	FBB-38	73.00				
QCC-58	1.90	TMA-10	8.25	TPA-31	6.60	VHI-10	9.50	FBB-39	80.00				
QCC-59	2.29	TMA-11	8.60	TPA-32	6.60	VHI-11	9.50	FBB-40	80.00				
QCC-60	3.41	TMA-12	10.90	TPA-33	6.93	VHI-12	9.50	FBB-41	88.00				
QCC-61	3.41	TMA-13	8.25	TPA-34	7.15	VHI-13	9.50	FBB-42	71.10				
QCC-62	3.41	TMA-14	10.90	TPA-35	6.60	VHI-14	9.50	FBB-43	86.00				
QCC-63	2.29	TMO-15	4.30	TPA-36	6.60	VHI-15	9.50	FBB-44	88.00				
QCC-64	3.41	TMO-16	4.30	TPA-37	6.60	VHI-16	9.50	FBB-45	88.00				
QCC-65	2.29	TMO-17	3.64	TPA-38	7.70	VHI-17	9.50	FBB-46	88.00				
QCC-66	3.41	TMO-18	4.30	TPA-39	7.70	VHI-18	9.50	FBB-47	88.00				
QCC-67	3.62	TMA-19	8.25	TPA-40	7.15	VHI-19	9.50	FBB-48	88.00				
QCC-68	5.17	TNA-1	6.95	TPA-41	7.42	VHI-20	9.50	FBB-49	88.00				
QCC-69	3.62	TNA-2	6.95	TPA-42	7.42	VHI-21	9.50	FBB-50	88.00				
QCC-70	5.17	TNA-3	7.38	TPA-43	9.46	VHI-22	9.50	FBB-51	88.00				
QCC-71	2.07	TNA-4	6.60	TPA-44	10.00			FBB-52	88.00				
QCC-72	2.60	TNA-5	6.60	TPA-45	9.46			FBB-53	88.00				
QCC-73	1.69	TNA-6	7.38	TPA-46	7.26			FBB-54	88.00				
QCC-74	5.85	TNA-7	6.95	TPA-47	9.63			FBB-55	88.00				
QCC-75	5.85	TNA-8	6.95	TPA-48	9.46			FBB-56	88.00				
QCC-76	7.60	TNA-9	8.15	TPA-49	9.76			FBB-57	88.00				
QCC-77	6.62	TNA-10	7.50	TPA-50	9.30			FBR-10	89.50				
QCC-78	6.62	TNA-11	7.50	TPA-51	9.30			FBR-11	89.50				
QCC-79	7.04	TNA-12	8.15	TPA-52	9.35			FBR-12	89.50				
QCC-80	7.04	TNA-13	8.15	TPA-53	8.90			FBR-13	89.50				
QCC-81	7.04	TNA-14	8.25	TPA-54	10.00			FBR-14	89.50				
QCC-82	7.75	TNA-15	8.25	TPA-55	8.90			FBR-15	89.50				
QCC-83	7.75	TNA-16	7.38	TPA-56	9.40			FBR-16	89.50				
QCC-84	7.75	TNA-17	7.38	TPA-57	8.90			FBR-17	89.50				
QCC-85	9.50	TNA-18	7.38	TPA-58	8.90			FBR-18	89.50				
QCC-86	9.50	TNA-19	7.93	TPA-59	8.90			FBR-19	89.50				
QCC-87	7.75	TNA-20	7.38	TPA-60	8.90			FBR-20	89.50				
QCC-88	7.75	TNA-21	6.60	TPA-61	8.90			FBR-21	89.50				
QCC-89	9.50	TNA-22	6.95	TPA-62	8.90			FBR-22	89.50				
QCC-90	9.50	TNA-23	6.95	TPA-63	9.30			FBR-23	89.50				
QCC-91	10.00	TNA-24	6.95	TPA-64	9.30			FBR-24	89.50				
QCC-92	10.00	TNA-25	6.50	TPA-65	9.30			FBR-25	89.50				
QCC-93	10.00	TNA-26	6.50	TPA-66	9.79			FBR-26	89.50				
QCC-94	11.74	TNA-27	7.93	TPA-67	8.90			FBR-27	89.50				
QCC-95	11.74	TNA-28	6.38	TPA-68	9.30			FBR-28	89.50				
QCC-96	12.40	TNA-29	6.38	TPA-69	9.30			FBR-29	89.50				
QCC-97	12.40	TNA-30	6.38	TPA-70	9.30			FBR-30	89.50				
QCC-98	16.20	TNA-31	6.38	TPA-71	9.79			FBT-11	42.50				
QCC-99	21.80	TNA-32	6.60	TPA-72	9.30			FBT-12	42.50				
QCC-100	21.80	TNA-33	6.95	TPA-73	9.79			FBT-13	42.50				
QCC-101	26.00	TNA-34	6.95	TPA-74	9.30			FBT-14	42.50				
QCC-102	26.00	TNA-35	6.50	TPA-75	9.46			FBT-15	42.50				
QCC-103	9.65	TNA-36	6.50	TPA-76	9.46			FBT-16	42.50				
QCC-104	9.65	TNA-37	6.50	TPA-77	9.35			FBT-17	42.50				
QCC-105	11.74	TNA-38	6.95	TPA-78	10.00			FBT-18	42.50				
QCC-106	11.74	TNA-39	6.95	TPA-79	9.20			FBT-19	42.50				
QCC-107	17.30	TNA-40	7.15	TPA-80	9.46			FBT-20	42.50				
QCC-108	17.30	TPA-1	8.36	TUA-1	6.60			FBT-21	42.50				
QCC-109	21.80	TPA-2	8.36	TUA-2	6.60			FBT-22	42.50				
QCC-110	21.80	TPA-3	8.36	TUA-3	6.60			FBT-23	42.50				
QCC-111	26.00	TPA-4	8.85	TUA-4	6.60			FBT-24	42.50				
QCC-112	26.00	TPA-5	8.36	TUA-5	6.60			FBT-25	42.50				
QCC-113	2.63	TPA-6	8.36	TUA-6	6.60			FBT-26	42.50				
QCC-114	3.07	TPA-7	8.36	TUA-7	6.93			FBT-27	42.50				
QCC-115	5.39	TPA-8	8.85	TUA-8	6.93			FBT-28	42.50				
QCC-116	7.18	TPA-9	8.36	TUA-9	6.93			FBT-29	42.50				
QCC-117	6.98	TPA-10	8.36	TUA-10	7.26			FBI-10	43.25				
QCC-118	12.05	TPA-11	8.85	TUA-11	7.15			FBI-11	43.25				
QCC-119	12.78	TPA-12	8.36	TUA-12	5.94			LPI-12	43.25				
QCC-120	13.51	TPA-13	8.36	TUA-13	6.93			LPI-13	43.25				
QCC-121	18.30	TPA-14	8.85	TUA-14	7.26			LPI-14	43.25				
QCC-122	23.30	TPA-15	9.13	TUA-15	6.27			LPI-15	43.25				
QCC-123	36.10	TPA-16	9.13	TUA-16	6.27			LPI-16	43.25				
QCC-124	42.00	TPA-17	8.60	TUA-17	6.27			LPI-17	43.25				
QCC-125	54.80	TPA-18	9.35	TUA-18	6.27			LPI-18	43.25				
QCC-126	72.00	TPA-19	9.13	TUA-19	6.27			LPI-19	43.25				
QCC-127	112.50	TPA-20	9.13	TUA-20	6.27			LPI-20	43.25				
QCC-128	18.30	TPA-21	8.58	TUA-21	6.32			LPI-21	43.25				
TAC-6-50	55.75	TPA-22	9.13	TUA-22	6.32			LPI-22	43.25				
TAC-12-50	65.35	TPA-23	9.13	TUA-23	6.60			LPI-23	43.25				
TAC-12-90	73.00	TPA-24	9.13	TUA-24									

FREED TRANSFORMER CO., INC.

PRICE LIST

Catalog No.	Net Price	Catalog No.	Net Price	Catalog No.	Net Price	Catalog No.	Net Price	Catalog No.	Net Price	Catalog No.	Net Price	Catalog No.	Net Price		
Type TI-5															
F-1700	5.70	F-1793	8.65	F-2053	5.85	Type TI-23s				F-2556	8.10	F-2711	13.60	Type TI-34	
F-1701	5.70	F-1794	8.65	F-2054	5.85	F-2301	6.25	F-2557	8.10	F-2712	13.60	F-2800	5.60	F-2901	5.60
F-1702	5.70	F-1795	9.00	F-2055	6.30	F-2302	6.25	F-2558	8.40	F-2713	14.10	F-2902	5.60	F-2903	5.60
F-1703	6.20	F-1796	9.45	F-2056	6.80	F-2303	6.25	F-2559	8.20	F-2714	14.20	F-2904	5.60	F-2905	5.60
F-1704	6.65	F-1797	10.00	F-2057	7.05	F-2304	6.25	F-2560	8.30	F-2715	14.30	F-2906	5.60	F-2907	5.60
F-1705	6.90	Type TI-2s				F-2305	6.25	F-2561	8.50	F-2716	14.50	F-2908	6.00	F-2909	6.00
F-1706	7.10	F-1800	14.20	F-2058	7.25	F-2306	6.25	F-2562	8.60	F-2717	14.70	F-2910	6.30	F-2911	6.60
F-1707	7.35	F-1801	14.20	F-2059	7.70	F-2307	6.75	F-2563	8.80	F-2718	15.10	F-2912	6.60	F-2913	7.30
F-1708	7.60	F-1802	14.20	F-2060	8.00	F-2308	6.75	F-2564	8.85	F-2719	15.20	F-2914	8.30	F-2915	8.30
F-1709	7.85	F-1803	14.20	F-2062	8.20	F-2309	6.75	F-2565	8.10	F-2720	15.30	F-2916	8.50	F-2917	8.50
F-1710	8.05	F-1804	14.20	F-2063	8.45	F-2310	6.75	F-2566	9.30	F-2721	15.50	F-2918	8.80	F-2919	8.80
F-1711	8.30	F-1805	14.20	F-2064	9.75	F-2311	7.50	F-2567	9.50	F-2722	15.70	F-2920	8.90	Type TI-35	
F-1712	9.00	F-1806	14.65	F-2065	10.80	F-2312	7.50	F-2568	9.90	F-2723	15.80	F-2950	6.80	F-2951	6.80
F-1713	9.60	F-1807	14.65	F-2066	11.00	F-2313	7.50	F-2569	10.50	F-2724	15.95	F-2952	6.80	F-2953	6.80
F-1714	9.80	F-1808	14.65	F-2067	11.40	Type TI-24				F-2570	10.70	F-2725	16.05	F-2954	7.20
F-1715	10.25	F-1809	14.65	F-2068	11.65	F-2400	5.90	F-2571	11.40	F-2726	16.20	F-2955	7.40	F-2956	7.40
F-1716	10.60	F-1810	14.65	F-2069	12.00	F-2402	5.90	F-2572	11.60	F-2727	16.30	F-2957	7.60	F-2958	7.60
F-1717	10.95	F-1811	14.90	Type TI-17				F-2403	5.90	F-2573	11.80	F-2728	16.70	F-2959	7.80
F-1718	11.20	F-1812	14.90	F-2100	7.90	F-2101	7.90	F-2404	6.05	F-2574	12.10	F-2729	17.00	F-2960	8.30
F-1719	11.50	F-1813	14.90	F-2102	7.90	F-2103	7.90	F-2405	6.05	F-2575	12.40	F-2730	17.50	F-2961	8.50
F-1720	11.90	F-1814	14.90	F-2104	7.90	F-2105	7.90	F-2406	6.05	F-2576	12.90	F-2731	18.90	F-2962	8.80
Type TI-5s															
F-1700s	7.90	Type TI-8 and 8s				F-2106	7.90	F-2407	6.05	F-2577	13.40	F-2732	19.45	Type TI-36	
F-1701s	7.90	F-1821	8.65	F-2107	7.90	F-2408	6.30	F-2578	13.70	F-2733	20.40	F-3000	5.90	F-3001	5.90
F-1702s	7.90	F-1822	8.65	F-2108	7.90	F-2409	6.30	F-2579	14.00	F-3002	5.90	F-3003	6.00	F-3004	6.00
F-1703s	7.90	F-1823	8.65	F-2109	7.90	F-2410	6.80	F-2580	14.50	F-3005	6.00	F-3006	6.30	F-3007	6.30
F-1704s	8.15	F-1824	8.65	F-2110	7.90	F-2411	7.05	Type TI-28				F-3008	6.60	F-3009	6.60
F-1705s	8.15	F-1825	8.65	F-2111	8.05	F-2412	7.25	F-2600	6.75	F-2601	6.75	F-2770	16.50	F-3010	6.80
F-1706s	8.25	F-1826	8.65	F-2112	8.05	F-2413	7.35	F-2602	6.90	F-2603	6.95	F-2771	16.80	F-3011	7.40
F-1707s	8.50	F-1827	8.65	F-2113	8.25	F-2414	7.70	F-2604	7.05	F-2605	7.10	F-2772	17.00	F-3012	7.40
F-1708s	8.80	F-1828	8.65	F-2114	8.25	F-2415	8.00	F-2606	7.15	F-2607	7.40	F-2773	17.10	F-3013	7.70
F-1709s	8.95	F-1829	8.65	F-2115	8.65	F-2416	8.20	F-2608	7.60	F-2609	7.80	F-2774	17.10	F-3014	8.20
F-1710s	9.05	F-1830	8.65	F-2116	8.65	F-2417	8.45	F-2610	7.80	F-2611	7.80	F-2775	17.50	F-3015	8.50
F-1711s	9.20	F-1831	8.65	F-2117	8.65	F-2418	8.75	F-2612	8.40	F-2613	8.50	F-2776	17.50	F-3016	8.80
F-1712s	9.30	F-1832	8.75	F-2118	9.05	F-2419	10.50	F-2614	8.50	F-2615	9.20	F-2777	18.05	F-3017	8.90
F-1713s	9.60	F-1833	8.75	Type TI-18				F-2421	11.00	F-2616	9.40	F-2778	18.45	Type TI-38	
F-1714s	9.80	F-1834	8.85	F-2140	8.65	F-2141	8.65	F-2422	11.40	F-2617	9.55	F-2779	19.00	F-3550	7.50
F-1715s	10.25	F-1835	9.00	F-2142	8.65	F-2143	8.65	Type TI-25				F-3551	7.50		
F-1716s	10.65	F-1836	9.00	F-2143	8.65	F-2144	8.65	F-2450	7.90	F-2618	9.70	F-3552	7.50	F-3553	7.45
F-1717s	10.85	F-1837	9.10	F-2145	8.65	F-2146	8.65	F-2451	7.90	F-2619	9.90	F-3554	7.40	F-3555	7.35
F-1718s	11.50	F-1838	9.40	F-2147	8.65	F-2148	8.65	F-2452	7.90	F-2620	10.05	F-3556	7.30	F-3557	7.25
F-1719s	11.90	F-1839	9.50	F-2149	8.65	F-2149	8.65	F-2453	7.90	F-2621	10.15	F-3558	7.50	F-3559	8.00
F-1720s	11.90	F-1840	9.90	F-2150	8.65	F-2151	8.65	F-2454	7.70	F-2622	10.20	F-3560	8.25	F-3561	8.50
Type TI-6 and 6s															
F-1726	8.15	Type TI-3s				F-2152	8.85	F-2455	7.50	F-2623	10.30	F-3562	8.65	F-3563	8.85
F-1727	8.15	F-1844	14.25	F-2153	8.75	F-2154	8.85	F-2456	7.50	F-2624	10.50	F-3564	9.00	F-3565	9.30
F-1728	8.15	F-1845	14.25	F-2154	8.85	F-2155	9.00	F-2457	7.50	F-2625	10.80	F-3566	9.60	F-3567	9.60
F-1729	8.15	F-1846	14.25	F-2155	9.00	F-2156	9.20	F-2458	7.50	F-2626	11.80	F-3568	9.80	F-3569	10.20
F-1730	8.15	F-1847	14.25	F-2156	9.20	F-2157	9.70	F-2459	7.50	F-2627	12.20	F-3570	10.60	F-3571	10.80
F-1731	8.15	F-1848	14.25	F-2157	9.70	Type TI-19				F-2460	12.80	F-3572	11.15	F-3573	11.50
F-1732	8.45	F-1849	14.25	F-2158	9.50	F-2180	7.90	F-2461	7.00	F-2462	7.10	F-3574	11.90	F-3575	12.30
F-1733	8.45	F-1850	14.25	F-2159	8.65	F-2181	7.90	F-2463	7.00	F-2464	7.05	F-3576	12.70	F-3577	13.10
F-1734	8.55	F-1851	14.25	F-2160	8.65	F-2182	7.90	F-2465	7.20	F-2466	7.20	F-3578	13.10	F-3579	13.50
F-1735	8.55	F-1852	14.25	F-2161	8.65	F-2183	7.90	F-2467	7.20	F-2468	7.20	Type TI-38			
F-1736	8.55	F-1853	14.25	F-2162	8.65	F-2184	7.90	F-2469	7.40	F-2470	7.40	F-3550	7.50	F-3551	7.50
F-1737	9.00	F-1854	14.25	F-2163	8.65	F-2185	7.90	F-2471	7.40	F-2472	7.60	F-3552	7.45	F-3553	7.40
F-1738	10.00	F-1855	14.25	F-2164	8.65	F-2186	7.90	F-2473	7.60	F-2474	7.80	F-3554	7.40	F-3555	7.35
F-1739	10.00	Type TI-3As				F-2187	7.90	F-2475	8.40	F-2476	8.80	F-3556	7.40	F-3557	7.30
F-1740	10.00	F-1856	20.00	F-2188	7.90	F-2189	7.90	F-2477	8.80	F-2478	9.50	F-3558	7.25	F-3559	8.00
F-1741	10.00	F-1857	20.50	F-2189	7.90	F-2190	7.90	F-2479	9.80	F-2480	9.95	F-3560	8.25	F-3561	8.50
F-1742	10.45	F-1858	20.50	F-2190	7.90	F-2191	7.90	F-2481	10.20	Type TI-29				F-3562	8.50
F-1743	11.90	F-1859	22.30	F-2191	7.90	F-2192	7.90	F-2482	10.50	F-2650	8.05	F-2800	7.40	F-2801	7.60
Type TI-11s															
F-1747	14.20	Type TI-15				F-2192	7.90	Type TI-20s				F-2651	8.10	F-2802	7.80
F-1748	14.20	F-1870	7.25	F-2201	6.40	F-2202	6.40	Type TI-26				F-2652	8.20	F-2803	8.40
F-1749	14.20	F-1871	7.25	F-2203	6.95	F-2204	6.95	F-2500	5.70	F-2501	5.70	F-2804	8.60	F-2805	8.70
F-1750	14.20	F-1872	7.25	F-2205	6.95	F-2206	7.15	F-2502	5.70	F-2503	5.70	F-2806	8.80	F-2807	8.90
F-1751	14.20	F-1873	7.25	F-2207	7.45	F-2208	8.10	F-2504	5.70	F-2505	5.70	F-2808	9.60	F-2809	9.80
F-1752	15.20	F-1874	7.25	F-2209	8.10	F-2210	8.10	F-2506	5.70	F-2507	5.70	F-2810	10.20	F-2811	10.40
F-1753	15.20	F-1875	7.25	F-2211	8.10	F-2212	8.10	F-2508	6.05	F-2509	6.20	F-2812	10.60	F-2813	10.80
F-1754	15.20	F-1876	7.25	F-2213	8.10	F-2214	8.10	F-2510	6.60	F-2511	6.80	F-2814	11.05	F-2815	11.20
F-1755	15.20	F-1877	7.25	F-2215	8.10	Type TI-21s				F-2512	7.10	F-2816	11.40	F-2817	11.65
F-1756	15.20	F-1878	7.25	F-2240	6.00	F-2241	6.00	F-2513	7.35	F-2514	7.60	F-2818	12.10	F-2819	12.20
F-1757	14.20	F-1879													

FREED TRANSFORMER CO., INC.

HIGH "Q" INDUCTORS

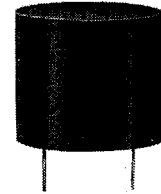
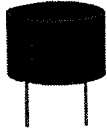

FREQUENCY RANGE: 1 KHz to 30 KHz

MIL-T-27B: TF4(OR 5)RX

TYPE		PFL 1	PFL 2	PFL 3	PFL 4	PFL 5	PFL 6	PFL 7	PFL 8
Size	Dia.	21/32	27/32	1"	1-1/4	1-3/8	1-1/2	1-3/4	2"
	H'ght	15/32	9/16	5/8	1-1/8	1-1/4	1-5/16	1-7/16	1-1/2
Typi- cal	Ind.	1.5 MH	2.7 MH	3.9 MH	10 MH	22 MH	39 MH	68 MH	180 MH
	Freq.	250KHz	200KHz	180KHz	50KHz	35KHz	15KHz	10KHz	5KHz
"Q"	"Q"	300	350	300	400	400	450	380	300

Inductance	Catalog Number							
1.0 MH	F5000	F5050	F5100	F5150	F5200	F5250	F5300	F5400
1.2 MH	F5001	F5051	F5101	F5151	F5201	F5251	F5301	F5401
1.5 MH	F5002	F5052	F5102	F5152	F5202	F5252	F5302	F5402
1.8 MH	F5003	F5053	F5103	F5153	F5203	F5253	F5303	F5403
2.2 MH	F5004	F5054	F5104	F5154	F5204	F5254	F5304	F5404
2.7 MH	F5005	F5055	F5105	F5155	F5205	F5255	F5305	F5405
3.3 MH	F5006	F5056	F5106	F5156	F5206	F5256	F5306	F5406
3.9 MH	F5007	F5057	F5107	F5157	F5207	F5257	F5307	F5407
4.7 MH	F5008	F5058	F5108	F5158	F5208	F5258	F5308	F5408
5.6 MH	F5009	F5059	F5109	F5159	F5209	F5259	F5309	F5409
6.8 MH	F5010	F5060	F5110	F5160	F5210	F5260	F5310	F5410
8.2 MH	F5011	F5061	F5111	F5161	F5211	F5261	F5311	F5411
10 MH	F5012	F5062	F5112	F5162	F5212	F5262	F5312	F5412
12 MH	F5013	F5063	F5113	F5163	F5213	F5263	F5313	F5413
15 MH	F5014	F5064	F5114	F5164	F5214	F5264	F5314	F5414
18 MH	F5015	F5065	F5115	F5165	F5215	F5265	F5315	F5415
22 MH	F5016	F5066	F5116	F5166	F5216	F5266	F5316	F5416
27 MH	F5017	F5067	F5117	F5167	F5217	F5267	F5317	F5417
33 MH	F5018	F5068	F5118	F5168	F5218	F5268	F5318	F5418
39 MH	F5069	F5119	F5169	F5219	F5269	F5319	F5419	
47 MH	F5070	F5120	F5170	F5220	F5270	F5320	F5420	
56 MH	F5071	F5121	F5171	F5221	F5271	F5321	F5421	
68 MH	F5072	F5122	F5172	F5222	F5272	F5322	F5422	
82 MH	F5073	F5123	F5173	F5223	F5273	F5323	F5423	
100 MH	F5074	F5124	F5174	F5224	F5274	F5324	F5424	
120 MH	F5075	F5125	F5175	F5225	F5275	F5325	F5425	
150 MH	F5076	F5126	F5176	F5226	F5276	F5326	F5426	
180 MH	F5077	F5127	F5177	F5227	F5277	F5327	F5427	
220 MH	F5078	F5128	F5178	F5228	F5278	F5328	F5428	
270 MH	F5079	F5129	F5179	F5229	F5279	F5329	F5429	
330 MH	F5130	F5180	F5230	F5280	F5330	F5430		
390 MH	F5131	F5181	F5231	F5281	F5331	F5431		
470 MH	F5132	F5182	F5232	F5282	F5332	F5432		
560 MH	F5133	F5183	F5233	F5283	F5333	F5433		
680 MH	F5184	F5234	F5284	F5334	F5434			
820 MH	F5185	F5235	F5285	F5335	F5435			
1.0 H	F5186	F5236	F5286	F5336	F5436			
1.2 H	F5187	F5237	F5287	F5337	F5437			
1.5 H	F5188	F5238	F5288	F5338	F5438			
1.8 H	F5189	F5239	F5289	F5339	F5439			
2.2 H	F5190	F5240	F5290	F5340	F5440			
2.7 H	F5241	F5291	F5341	F5441				
3.3 H	F5242	F5292	F5342	F5442				
3.9 H	F5243	F5293	F5343	F5443				
4.7 H	F5244	F5294	F5344	F5444				
5.6 H	F5245	F5295	F5345	F5445				
6.8 H	F5296	F5346	F5446					
8.2 H	F5297	F5347	F5447					
10 H	F5298	F5348	F5448					
12 H	F5349	F5449						
15 H	F5350	F5450						
18 H	F5351	F5451						
22 H	F5352	F5452						
27 H	F5453							
33 H	F5454							

FREQUENCY RANGE: 200 KHz to 2,500 KHz

MIL-T-27B: TF4(OR 5)RX

TYPE		PFM 1	PFM 2	PFM 3	PFM 4	PFM 5	PFM 6	PFM 7	PFM 8
Size	Dia.	21/32	27/32	1"	1-1/4	1-3/8	1-1/2	1-3/4	
	H'ght	15/32	9/16	5/8	1-1/8	1-1/4	1-5/16	1-7/16	
Typi- cal	Ind.	56 μ H	68 μ H	100 μ H	150 μ H	270 μ H	680 μ H	2.2 MH	
	Freq.	1 MHz	400KHz	400KHz	250KHz	200KHz	150KHz	100KHz	
"Q"	"Q"	300	300	400	500	700	650	750	

Inductance	Catalog Number							
15 μ H	F5500	F5550	F5600	F5650	F5700	F5750	F5800	
18 μ H	F5501	F5551	F5601	F5651	F5701	F5751	F5801	
22 μ H	F5502	F5552	F5602	F5652	F5702	F5752	F5802	
27 μ H	F5503	F5553	F5603	F5653	F5703	F5753	F5803	
33 μ H	F5504	F5554	F5604	F5654	F5704	F5754	F5804	
39 μ H	F5505	F5555	F5605	F5655	F5705	F5755	F5805	
47 μ H	F5506	F5556	F5606	F5656	F5706	F5756	F5806	
56 μ H	F5507	F5557	F5607	F5657	F5707	F5757	F5807	
68 μ H	F5508	F5558	F5608	F5658	F5708	F5758	F5808	
82 μ H	F5509	F5559	F5609	F5659	F5709	F5759	F5809	
100 μ H	F5510	F5560	F5610	F5660	F5710	F5760	F5810	
120 μ H	F5511	F5561	F5611	F5661	F5711	F5761	F5811	
150 μ H	F5512	F5562	F5612	F5662	F5712	F5762	F5812	
180 μ H	F5513	F5563	F5613	F5663	F5713	F5763	F5813	
220 μ H	F5514	F5564	F5614	F5664	F5714	F5764	F5814	
270 μ H	F5515	F5565	F5615	F5665	F5715	F5765	F5815	
330 μ H	F5516	F5566	F5616	F5666	F5716	F5766	F5816	
390 μ H	F5517	F5567	F5617	F5667	F5717	F5767	F5817	
470 μ H	F5518	F5568	F5618	F5668	F5718	F5768	F5818	
560 μ H	F5519	F5569	F5619	F5669	F5719	F5769	F5819	
680 μ H	F5520	F5570	F5620	F5670	F5720	F5770	F5820	
820 μ H	F5521	F5571	F5621	F5671	F5721	F5771	F5821	
1.0 MH	F5522	F5572	F5622	F5672	F5722	F5772	F5822	
1.2 MH	F5523	F5573	F5623	F5673	F5723	F5773	F5823	
1.5 MH	F5524	F5574	F5624	F5674	F5724	F5774	F5824	
1.8 MH	F5525	F5575	F5625	F5675	F5725	F5775	F5825	
2.2 MH	F5526	F5576	F5626	F5676	F5726	F5776	F5826	
2.7 MH	F5527	F5577	F5627	F5677	F5727	F5777	F5827	
3.3 MH	F5528	F5578	F5628	F5678	F5728	F5778	F5828	
3.9 MH	F5529	F5579	F5629	F5679	F5729	F5779	F5829	
4.7 MH	F5530	F5580	F5630	F5680	F5730	F5780	F5830	
5.6 MH	F5531	F5581	F5631	F5681	F5731	F5781	F5831	
6.8 MH	F5532	F5582	F5632	F5682	F5732	F5782	F5832	
8.2 MH	F5533	F5583	F5633	F5683	F5733	F5783	F5833	
10.0 MH	F5534	F5584	F5634	F5684	F5734	F5784	F5834	
12.0 MH	F5535	F5585	F5635	F5685	F5735	F5785	F5835	
15.0 MH	F5536	F5586	F5636	F5686	F5736	F5786	F5836	
18.0 MH	F5537	F5587	F5637	F5687	F5737	F5787	F5837	
22.0 MH	F5588	F5638	F5688	F5738	F5788	F5838		
27.0 MH	F5589	F5639	F5689	F5739	F5789	F5839		
33.0 MH	F5590	F5640	F5690	F5740	F5790	F5840		
39.0 MH	F5591	F5641	F5691	F5741	F5791	F5841		
47.0 MH	F5592	F5642	F5692	F5742	F5792	F5842		
56.0 MH	F5643	F5693	F5743	F5793	F5843			
68.0 MH	F5644	F5694	F5744	F5794	F5844			
82.0 MH	F5695	F5745	F5795	F5845				
100.0 MH	F5796	F5846						



volt-pac®

VARIABLE TRANSFORMERS

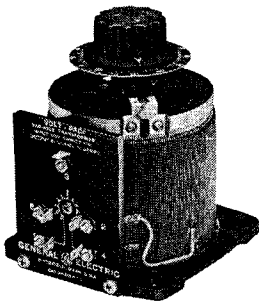

Manual uncased unit—exposed terminals

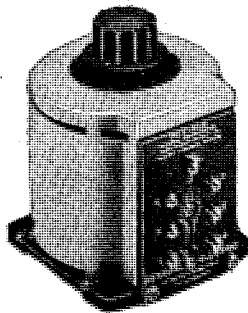

Manual cased unit—exposed terminals

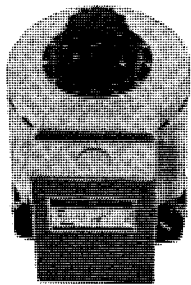

Manual cased unit—enclosed terminals

The Volt-Pac variable transformer is a control device which provides continuously adjustable output voltage from a fixed line input to vary the voltage applied to a particular electrical load. With Volt-Pac units, output voltage is changed by flux transformation... in the unsaturated range of the magnetic core. The results... low cost, versatility, reliability, simplicity, and no wave form distortion.

Volt-Pac units, for surface or back-of-panel mounting, are designed for operation in ambients of -20C to +40C at full rated load, and under all load conditions have low electrical losses.

* When Overvoltage Connection is used, rated current should not be exceeded. Output kva for Overvoltage Connection is maximum output voltage times rated current.

† When using extended tap connections, operation is for 60 cycles per second only.

‡ Output at Overvoltage Connection is 0-132 volts.

§ When operated on lower input-voltage tap, rated current must be reduced when output voltage exceeds 140 percent of input voltage.

¶ For Line-voltage Connection only—No Over-voltage Connection provided.

■ For 240-volt input, 0-240-volt output, application only.

• For 480-volt input, 0-480-volt output, application only.

φ 60 cycles only.

Line-voltage Connection		Over-voltage Connection, Amp*	UNCASED MODELS Exposed Terminals		CASED MODELS			
Rated Amp	Max Amp		Model Number	List Price	Exposed Terminals		Enclosed Terminals	
				Model Number	List Price	Model Number	List Price	

MANUAL — SINGLE-PHASE, 50/60 CYCLES

120 VOLT INPUT: OUTPUT — 0-120 VOLT (LINE VOLTAGE CONN.) 0-140 VOLT (OVERVOLTAGE CONN.)

2.5†	3.2	2.5	9T92A1	\$11.00				
4.5†	6.5	4.0	9T92Y5	16.00				
7.5†	10.8	7.5	9T92Y7	20.00	9T92Y7G2	\$25.00	9T92Y7G3	\$26.00
9.0†	11.5	9.0	9T92Y9	21.00	9T92Y9G2	26.00	9T92Y9G3	27.00
10.0φ	13.0	None	9T92Y8†	21.00	9T92Y8G2†	26.00	9T92Y8G3†	27.00
11.5φ	14.5	None	9T92Y10†	23.00	9T92Y10G2†	28.00	9T92Y10G3†	29.00
15.0†	19.0	15.0	9T92Y27	39.00	9T92Y27G2	44.00	9T92Y27G3	47.00
18.0†	21.7	18.0	9T92Y28	49.00	9T92Y28G2	54.00	9T92Y28G3	57.00
30.0†	34.0	30.0	9T92Y37	93.00	9T92Y37G2	99.00	9T92Y37G3	104.00
37.0†	37.0	37.0	9T92Y38	114.00	9T92Y38G2	120.00	9T92Y38G3	125.00
50.0	55.0	50.0	9T92Y49	140.00	9T92Y49G2	146.00	9T92Y49G3	154.00
60.0	60.0	60.0	9T92Y50	215.00	9T92Y50G2	221.00	9T92Y50G3	229.00
74.0†	74.0	74.0	9T92Y41	256.00	9T92Y41G2	268.00	9T92Y41G3	278.00
100.0	110.0	100.0	9T92Y53	311.00	9T92Y53G2	323.00	9T92Y53G3	339.00
120.0	120.0	120.0	9T92Y54	460.00	9T92Y54G2	472.00	9T92Y54G3	488.00
150.0	165.0	150.0	9T92Y55	543.00	9T92Y55G2	561.00	9T92Y55G3	585.00
180.0	180.0	180.0	9T92Y56	710.00	9T92Y56G2	728.00	9T92Y56G3	752.00
240.0	240.0	240.0	9T92Y57	1010.00	9T92Y57G2	1034.00	9T92Y57G3	1068.00
300.0	300.0	300.0	9T92Y58	1260.00	9T92Y58G2	1290.00	9T92Y58G3	1332.00
360.0	360.0	360.0	9T92Y59	1560.00	9T92Y59G2	1596.00	9T92Y59G3	1646.00

120/240 VOLT INPUTS OUTPUT 0-240 VOLT (LINE VOLTAGE CONN.) 0-280 VOLT (OVERVOLTAGE CONN.)

4.0†	5.0	4.0	9T92Y13	\$25.00	9T92Y13G2	\$30.00	9T92Y13G3	\$31.00
4.0φ	5.8	None	9T92Y12‡	25.00	9T92Y12G2‡	30.00	9T92Y12G3‡	31.00
5.0φ	6.8	None	9T92Y14‡	27.00	9T92Y14G2‡	32.00	9T92Y14G3‡	33.00
7.0†	10.1	7.0	9T92Y29	39.00	9T92Y29G2	44.00	9T92Y29G3	47.00
8.5†	11.0	8.5	9T92Y30	49.00	9T92Y30G2	54.00	9T92Y30G3	57.00
14.0†	14.0	14.0	9T92Y39	93.00	9T92Y39G2	99.00	9T92Y39G3	104.00
16.0†	16.0	16.0	9T92Y40	114.00	9T92Y40G2	120.00	9T92Y40G3	125.00
30.0	33.0	30.0	9T92Y51	140.00	9T92Y51G2	146.00	9T92Y51G3	154.00
35.0	35.0	35.0	9T92Y52	215.00	9T92Y52G2	221.00	9T92Y52G3	229.00
60.0	66.0	60.0	9T92Y60	357.00	9T92Y60G2	369.00	9T92Y60G3	385.00
70.0	70.0	70.0	9T92Y61	460.00	9T92Y61G2	472.00	9T92Y61G3	488.00
90.0	99.0	90.0	9T92Y62	580.00	9T92Y62G2	598.00	9T92Y62G3	622.00
105.0	105.0	105.0	9T92Y63	710.00	9T92Y63G2	728.00	9T92Y63G3	752.00
120.0	132.0	120.0	9T92Y5021	830.00	9T92Y5021G2	854.00	9T92Y5021G3	888.00
140.0	140.0	140.0	9T92Y64	1025.00	9T92Y64G2	1049.00	9T92Y64G3	1083.00
175.0	175.0	175.0	9T92Y65	1260.00	9T92Y65G2	1290.00	9T92Y65G3	1332.00
210.0	210.0	210.0	9T92Y66	1560.00	9T92Y66G2	1596.00	9T92Y66G3	1646.00

240/480 VOLT INPUTS OUTPUT 0-480 VOLT (LINE VOLTAGE CONN.) 0-560 VOLT (OVERVOLTAGE CONN.)

4.0†	5.0	4.0	9T92Y17	\$64.00	9T92Y17G2	\$74.00	9T92Y17G3	\$76.00
4.0φ	5.8	None	9T92Y16‡	66.00	9T92Y16G2‡	76.00	9T92Y16G3‡	78.00
5.0φ	6.8	None	9T92Y18‡	68.00	9T92Y18G2‡	78.00	9T92Y18G3‡	80.00
7.0†	10.1	7.0	9T92Y31	86.00	9T92Y31G2	96.00	9T92Y31G3	102.00
8.5†	11.0	8.5	9T92Y32	118.00	9T92Y32G2	128.00	9T92Y32G3	134.00
14.0†	14.0	14.0	9T92Y42	202.00	9T92Y42G2	214.00	9T92Y42G3	224.00
16.0†	16.0	16.0	9T92Y43	236.00	9T92Y43G2	248.00	9T92Y43G3	258.00
30.0	33.0	30.0	9T92Y67	311.00	9T92Y67G2	323.00	9T92Y67G3	339.00
35.0	35.0	35.0	9T92Y68	440.00	9T92Y68G2	452.00	9T92Y68G3	468.00
60.0	66.0	60.0	9T92Y69	810.00	9T92Y69G2	834.00	9T92Y69G3	868.00
70.0	70.0	70.0	9T92Y70	990.00	9T92Y70G2	1014.00	9T92Y70G3	1048.00
90.0	99.0	90.0	9T92Y71	1230.00	9T92Y71G2	1266.00	9T92Y71G3	1316.00
105.0	105.0	105.0	9T92Y72	1530.00	9T92Y72G2	1566.00	9T92Y72G3	1616.00

MANUAL — THREE-PHASE, 50/60 CYCLES

240 VOLT LINE TO LINE INPUT: OUTPUT — 0-240 VOLT (LINE VOLTAGE CONN.) 0-280 VOLT (OVERVOLTAGE CONN.)

2.5φ	3.2	None	9T92Y3†	\$60.00				
4.5φ	6.5	None	9T92Y6†	71.00				
7.5	10.8	7.5	9T92Y19	75.00	9T92Y19G2	\$90.00	9T92Y19G3	\$93.00
9.0	11.5	9.0	9T92Y21	77.00	9T92Y21G2	92.00	9T92Y21G3	95.00
10.0φ	13.0	None	9T92Y20†	70.00	9T92Y20G2†	85.00	9T92Y20G3†	88.00
11.5φ	14.5	None	9T92Y22†	77.00	9T92Y22G2†	92.00	9T92Y22G3†	95.00
15.0	19.0	15.0	9T92Y33	138.00	9T92Y33G2	153.00	9T92Y33G3	162.00
18.0	21.7	18.0	9T92Y34	175.00	9T92Y34G2	190.00	9T92Y34G3	199.00
30.0	34.0	30.0	9T92Y44	307.00	9T92Y44G2	325.00	9T92Y44G3	340.00
37.0	37.0	37.0	9T92Y45	368.00	9T92Y45G2	386.00	9T92Y45G3	401.00
50.0	55.0	50.0	9T92Y74	517.00	9T92Y74G2	535.00	9T92Y74G3	559.00
60.0	60.0	60.0	9T92Y75	680.00	9T92Y75G2	698.00	9T92Y75G3	722.00
74.0	74.0	74.0	9T92Y48	830.00	9T92Y48G2	866.00	9T92Y48G3	896.00
100.0	110.0	100.0	9T92Y78	1120.00	9T92Y78G2	1156.00	9T92Y78G3	1206.00
120.0	120.0	120.0	9T92Y79	1530.00	9T92Y79G2	1566.00	9T92Y79G3	1616.00

240/480 VOLT LINE TO LINE INPUTS OUTPUT — 0-480 VOLT (LINE VOLTAGE CONN.) 0-560 VOLT (OVERVOLTAGE CONN.)

4.0	5.0	4.0	9T92Y25	\$89.00	9T92Y25G2	\$104.00	9T92Y25G3	\$107.00
4.0φ	5.8	None	9T92Y24‡	86.00	9T92Y24G2‡	101.00	9T92Y24G3‡	104.00
5.0φ	6.8	None	9T92Y26‡	90.00	9T92Y26G2‡	115.00	9T92Y26G3‡	118.00
7.0	10.1	7.0	9T92Y35	138.00	9T92Y35G2	153.00	9T92Y35G3	162.00
8.5	11.0	8.5	9T92Y36	175.00	9T92Y36G2	190.00	9T92Y36G3	199.00
14.0	14.0	14.0	9T92Y46	307.00	9T92Y46G2	325.00	9T92Y46G3	340.00
16.0	16.0	16.0	9T92Y47	368.00	9T92Y47G2	386.00	9T92Y47G3	401.00
30.0	33.0	30.0	9T92Y76	520.00	9T92Y76G2	538.00	9T92Y76G3	562.00
35.0	35.0	35.0	9T92Y77	680.00	9T92Y77G2	693.00	9T92Y77G3	722.00
60.0	66.0	60.0	9T92Y80	1120.00	9T92Y80G2	1156.00	9T92Y80G3	1206.00
70.0	70.0	70.0	9T92Y81	1530.00	9T92Y81G2	1566.00	9T92Y81G3	1616.00



VARIABLE TRANSFORMERS

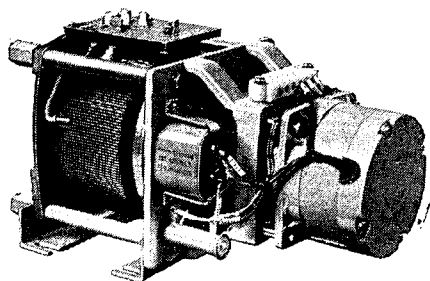

Motor uncased unit — exposed terminals

Line Voltage Connection		Over-voltage Connection Amp*	UNCASED MODELS Exposed Terminals		CASED MODELS Enclosed Terminals	
Rated Amp	Max Amp		Model Number (For 28-second Operation Only Δ)	List Price	Model Number (For 28-second Operation Only Δ)	List Price

MOTOR-OPERATED — THREE-PHASE, 50/60 CYCLES†

240 VOLT LINE TO LINE INPUT: OUTPUT 0-240 VOLT (LINE VOLTAGE CONN)
0-280 VOLT (OVERVOLTAGE CONN)

2.5 ϕ	3.2	None	9T92A3G51	\$166.00
4.5 ϕ	6.5	None	9T92Y6G51	177.00
7.5	10.8	7.5	9T92Y19G51	185.00	9T92Y19G54	\$203.00
9.0	11.5	9.0	9T92Y21G51	187.00	9T92Y21G54	205.00
10.0 ϕ	13.0	None	9T92Y20G51 \ddagger	180.00	9T92Y20G54 \ddagger	198.00
11.5 ϕ	14.5	None	9T92Y22G51 \ddagger	187.00	9T92Y22G54 \ddagger	205.00
15.0	19.0	15.0	9T92Y33G51	274.00	9T92Y33G54	298.00
18.0	21.7	18.0	9T92Y34G51	311.00	9T92Y34G54	335.00
30.0	34.0	30.0	9T92Y44G51	442.00	9T92Y44G54	476.00
37.0	37.0	37.0	9T92Y45G51	504.00	9T92Y45G54	537.00
50.0	55.0	50.0	9T92Y74G51	653.00	9T92Y74G54	695.00
60.0	60.0	60.0	9T92Y75G51	816.00	9T92Y75G54	858.00
74.0	74.0	74.0	9T92Y48G51	966.00	9T92Y48G54	1032.00
100.0	110.0	100.0	9T92Y78G51	1256.00	9T92Y78G54	1342.00
120.0	120.0	120.0	9T92Y79G51	1666.00	9T92Y79G54	1752.00
150.0	165.0	150.0	9T92Y82G51	1905.00	9T92Y82G54	2035.00
180.0	180.0	180.0	9T92Y83G51	2500.00	9T92Y83G54	2630.00

240/480 VOLT LINE TO LINE INPUTS: OUTPUT 0-480 VOLT (LINE VOLTAGE CONN) 0-560 VOLT (OVERVOLTAGE CONN)

4.0 ϕ	5.0	4.0	9T92Y25G51	\$199.00	9T92Y25G54	\$217.00
4.0 ϕ	5.8	None	9T92Y24G51*	196.00	9T92Y24G54*	214.00
5.0 ϕ	6.8	None	9T92Y26G51*	200.00	9T92Y26G54*	228.00
7.0	10.1	7.0	9T92Y35G51	274.00	9T92Y35G54	298.00
8.5	11.0	8.5	9T92Y36G51	311.00	9T92Y36G54	335.00
14.0	14.0	14.0	9T92Y46G51	442.00	9T92Y46G54	476.00
16.0	16.0	16.0	9T92Y47G51	504.00	9T92Y47G54	537.00
30.0	33.0	30.0	9T92Y76G51	656.00	9T92Y76G54	698.00
35.0	35.0	35.0	9T92Y77G51	816.00	9T92Y77G54	858.00
60.0	66.0	60.0	9T92Y80G51	1256.00	9T92Y80G54	1342.00
70.0	70.0	70.0	9T92Y81G51	1666.00	9T92Y81G54	1752.00
90.0	99.0	90.0	9T92Y84G51	1905.00	9T92Y84G54	2035.00
105.0	105.0	105.0	9T92Y85G51	2500.00	9T92Y85G54	2630.00

PLUG-IN SETS

For laboratory or shop source of adjustable a-c voltage. Provides output voltage of 0-117% of input voltage. Equipped with a line switch and a fuse for overload protection.

Cord is 6 feet long.

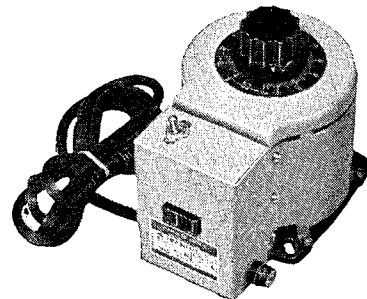

Connection† Line Voltage		Over-voltage Connection Amp*	New Model Number	List Price	Type Plug and Rec	Receptacle Configuration Fig. No.
Rated Amp†	Max Amp					

120 VOLT INPUT: OUTPUT 0-120 VOLT (LINE VOLTAGE CONN) 0-140 VOLT (OVERVOLTAGE CONN)

7.5	10.8	7.5	9T92Y90	\$27.00	Ungrounded	Fig. 2
7.5	10.8	7.5	9T92Y86	31.00	Grounded	Fig. 1
9.0	11.5	9.0	9T92Y91	28.00	Ungrounded	Fig. 2
9.0	11.5	9.0	9T92Y87	33.00	Grounded	Fig. 1
15.0	19.0	15.0	9T92Y88	54.00	Grounded	Fig. 1
18.0	21.7	18.0	9T92Y89	70.00	Grounded	Fig. 3

120/240 VOLT INPUT: OUTPUT 0-240 (LINE CONN) 0-280 VOLT (OVERVOLTAGE CONN)

4.0	5.0	4.0	9T92Y93	\$33.00	Ungrounded	Fig. 2
4.0	5.0	4.0	9T92Y95	39.00	Grounded	Fig. 4
7.0	10.1	7.0	9T92Y96	53.00	Grounded	Fig. 4
8.5	11.0	8.5	9T92Y97	70.00	Grounded	Fig. 4

RECEPTACLE CONFIGURATIONS



Fig. 1



Fig. 2



Fig. 3



Fig. 4

Prices subject to change without notice.

GENERAL ELECTRIC

Line Voltage Connection		Over-voltage Connection Amp*	UNCASED MODELS Exposed Terminals		CASED MODELS Enclosed Terminals	
Rated Amp	Max Amp		Model Number (For 28-second Operation Only Δ)	List Price	Model Number (For 28-second Operation Only Δ)	List Price

MOTOR-OPERATED — SINGLE-PHASE, 50/60 CYCLES

120 VOLT INPUT: OUTPUT 0-120 VOLT (LINE VOLTAGE CONN)
0-140 VOLT (OVERVOLTAGE CONN)

2.5 ϕ	3.2	2.5	9T92A1G51	\$117.00
4.5 ϕ	6.5	4.5	9T92Y5G51	122.00
7.5 ϕ	10.8	7.5	9T92Y7G51	130.00	9T92Y7G54	\$136.00
9.0 ϕ	11.5	9.0	9T92Y9G51	131.00	9T92Y9G54	137.00
10.0 ϕ	13.0	None	9T92Y8G51 \ddagger	131.00	9T92Y8G54 \ddagger	137.00
11.5 ϕ	14.5	None	9T92Y10G51 \ddagger	133.00	9T92Y10G54 \ddagger	139.00
15.0 ϕ	19.0	15.0	9T92Y27G51	175.00	9T92Y27G54	183.00
18.0 ϕ	21.7	18.0	9T92Y28G51	185.00	9T92Y28G54	193.00
30.0 ϕ	34.0	30.0	9T92Y37G51	229.00	9T92Y37G54	240.00
37.0 ϕ	37.0	37.0	9T92Y38G51	250.00	9T92Y38G54	261.00
50.0	55.0	50.0	9T92Y49G51	276.00	9T92Y49G54	280.00
60.0	60.0	60.0	9T92Y50G51	351.00	9T92Y50G54	359.00
74.0 ϕ	74.0	74.0	9T92Y41G51	392.00	9T92Y41G54	414.00
100.0	110.0	100.0	9T92Y53G51	447.00	9T92Y53G54	475.00
120.0	120.0	120.0	9T92Y54G51	576.00	9T92Y54G54	624.00
150.0	165.0	150.0	9T92Y55G51	679.00	9T92Y55G54	721.00
180.0	180.0	180.0	9T92Y56G51	846.00	9T92Y56G54	888.00
240.0	240.0	240.0	9T92Y57G51	1146.00	9T92Y57G54	1204.00
300.0	300.0	300.0	9T92Y58G51	1396.00	9T92Y58G54	1468.00
360.0	360.0	360.0	9T92Y59G51	1696.00	9T92Y59G54	1782.00

120/240 VOLT INPUTS: OUTPUT 0-240 VOLT (LINE VOLTAGE CONN) 0-280 VOLT (OVERVOLTAGE CONN)

4.0 ϕ	5.0	4.0	9T92Y13G51	\$135.00	9T92Y13G54	\$141.00
4.0 ϕ	5.8	None	9T92Y12G51	135.00	9T92Y12G54	141.00
5.0 ϕ	6.8	None	9T92Y14G51	137.00	9T92Y14G54	143.00
7.0	10.1	7.0	9T92Y29G51	175.00	9T92Y29G54	183.00
8.5 ϕ	11.0	8.5	9T92Y30G51	185.00	9T92Y30G54	193.00
14.0 ϕ	14.0	14.0	9T92Y39G51	229.00	9T92Y39G54	240.00
16.0 ϕ	16.0	16.0	9T92Y40G51	250.00	9T92Y40G54	261.00
30.0	33.0	30.0	9T92Y51G51	276.00	9T92Y51G54	290.00
35.0	35.0	35.0	9T92Y52G51	351.00	9T92Y52G54	365.00
60.0	66.0	60.0	9T92Y60G51	493.00	9T92Y60G54	521.00
70.0	70.0	70.0	9T92Y61G51	596.00	9T92Y61G54	624.00
90.0	99.0	90.0	9T92Y62G51	716.00	9T92Y62G54	758.00
105.0	105.0	105.0	9T92Y63G51	846.00	9T92Y63G54	888.00
120.0	132.0	120.0	9T92Y5021G51	966.00	9T92Y5021G54	1024.00
140.0	140.0	140.0	9T92Y64G51	1161.00	9T92Y64G54	1219.00
175.0	175.0	175.0	9T92Y65G51	1396.00	9T92Y65G54	1468.00
210.0	210.0	210.0	9T92Y66G51	1696.00	9T92Y66G54	1782.00

240/480 VOLT INPUTS: OUTPUT 0-480 VOLT (LINE VOLTAGE CONN) 0-560 VOLT (OVERVOLTAGE CONN)

4.0 ϕ	5.0	4.0	9T92Y17G51	\$174.00	9T92Y17G54	\$186.00
4.0 ϕ	5.8	None	9T92Y16G51*	176.00	9T92Y16G54*	188.00
5.0 ϕ	6.8	None	9T92Y18G51*	178.00	9T92Y18G54*	190.00
7.0 ϕ	10.1	7.0	9T92Y31G51	222.00	9T92Y31G54	238.00
8.5 ϕ	11.0	8.5	9T92Y32G51	254.00	9T92Y32G54	270.00
14.0 ϕ	14.0	14.0	9T92Y42G51	338.00	9T92Y42G54	360.00
16.0 ϕ	16.0	16.0	9T92Y43G51	372.00	9T92Y43G54	394.00
30.0	33.0	30.0	9T92Y67G51	447.00	9T92Y67G54	475.00
35.0	35.0	35.0	9T92Y68G51	576.00	9T92Y68G54	604.00
60.0	66.0	60.0	9T92Y69G51	946.00	9T92Y69G54	1004.00
70.0	70.0	70.0	9T92Y70G51	1126.00	9T92Y70G54	1184.00
90.0	99.0	90.0	9T92Y71G51	1366.00	9T92Y71G54	1452.00
105.0	105.0	105.0	9T92Y72G51	1666.00	9T92Y72G54	1752.00
140.0	140.0	140.0	9T92Y73G51	2320.00	9T92Y73G54	2435.00

Δ Time to change output from 0 to 100%. Other times, from 2.5 to 60 sec, are available.

\circ When operated on 120-volt input taps, rated current must be reduced when output voltage exceeds 168 volts.

For other footnotes, see opposite page.

GOTHAM

BEYER TRANSFORMERS MINIATURE AUDIO

WOW & FLUTTER METERS ME 101/102

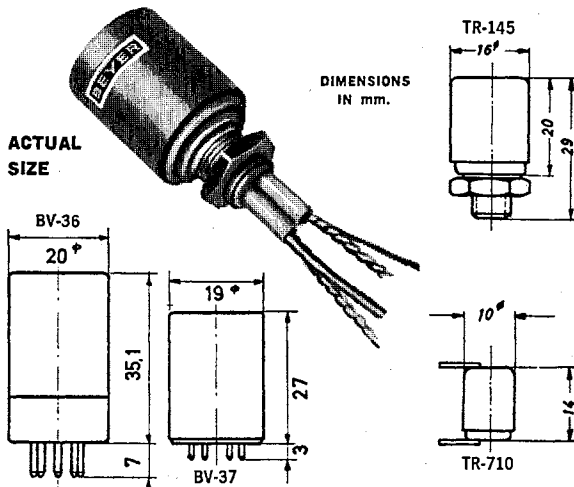

The BEYER line of miniature audio transformers distributed by GOTHAM represents over 30 years of experience in the field on the part of one of Europe's largest quality microphone manufacturers. It is for this reason that we make only one type of transformer in two sizes: A low level audio transformer suitable for microphones, tape playback heads, etc.

A special winding process permits these transformers to be made in this miniature size while maintaining studio quality frequency response, distortion, and level capability. The coil is wound on a continuous laminated core which means the elimination of the split core with its inherent losses. Result is a semi-toroidal construction with its superior resistance to hum induction.

BEYER transformers are used in professional audio equipment by such outstanding manufacturers as Ampex, Bauer, Collins, Precision Instrument, Rust, and many others. All transformers are made to special order to O.E.M. users' specifications. Samples can be supplied within 2 weeks, production usually within 4 weeks.

FOUR PHYSICAL MOUNTINGS ARE AVAILABLE:

Threaded Stud: The Model TR-45 Commercial Quality and TR-145 Studio Quality units are offered in mu-metal housing with threaded stud supplied with two nuts.

Solder Lug: The Model TR-45L and TR-145L are same as above but have radial lugs each end of housing to permit terminal board or Vector socket mounting. Also available in sub-miniature TR-710 Model (see fig.). Primary and secondary windings brought out opposite ends of mu-metal can.

Plug-in: The Model BV-36 is encapsulation of TR-45 and TR-145 Models shown above in molded plastic housing with 7-pin miniature plug base. Same mu-metal shielding.

Printed Circuit: The Model BV-37 is encapsulation of TR-45 and TR-145 Models shown above in molded plastic housing only 1.09" high with special 7-pin, 8-pin, or 9-pin printed circuit base.

ELECTRICAL CHARACTERISTICS:

Transformers are supplied with any turns ratio from 1:1 to 1:150, tapped and split windings, static shielding, high voltage test, vacuum impregnating or other requirements.

TYPICAL TRANSFORMER SPECIFICATIONS: Model TR-145/BV35570 (This Model stocked)

Turns ratio	1:15 ± 10%
Impedance ratio	200/45,000 Ohms nominal
Frequency response	± 0.2 dB 20 - 20,000 cps.
Maximum input level at 1% THD	370 mV at 30 cps.
Primary open circuit inductance (50 cps)	6.0 H
Primary open circuit impedance (50 cps)	1000 Ohms
Primary DC resistance	70 Ohms
Secondary DC resistance	10,000 Ohms
Hum shielding (EIA std.)	> 70 dB.
BASIC PRICE IN QUANTITY OF 1000 UNITS	\$5.37 each

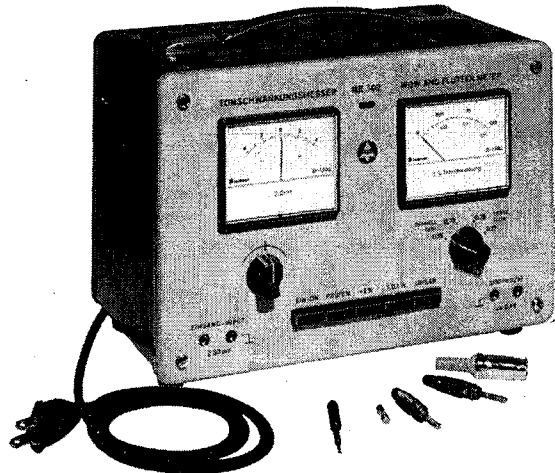

The ME-101/102 instruments are intended for the measurement of the wow and flutter content of all types of recording and reproducing devices. They are fully transistorized, simple and convenient to use. The units are particularly suited for production testing and service work in addition to laboratory testing.

An internal signal generator provides the standard frequency of 3150 Hz. For the purpose of static and dynamic recalibration of the measuring unit, the generator can be detuned in a definite manner or can be frequency modulated from the power line.

Tone fluctuations from ±0.02 to ±2.5% for the ME-101 and ±0.01 to ±0.75% for the ME-102 can be read linearly or weighted as quasi-peak values (according to CCIR and DIN). Hence the properties of high quality tape and record playing equipment, as well as those of dictating machines and home equipment come within the ranges of the instruments. The fluctuation meter ballistics conform to the CCIR standard. A second instrument, the "drift" indicator, measures the frequency deviation of the recorded tone from 3150 Hz. Both indicating instruments can be switched to "rapid" or "slow" indication, as desired.

Besides the normal measuring connections on the front of the instruments, the back is provided with a connector for testing home tape recorders and record players. Other connectors are provided for the connection of external filters, oscilloscopes and graphic recorders.

SPECIFICATIONS

POWER:.....110-125/220-240V, 40-60 Hz.

OSCILLATOR UNIT:

Measuring frequency: 3150 Hz (constancy 1×10^3 after starting up period).

Output voltage: Approx. 0.4Vrms at test output connector.

Calibrating device: ±2% detuning for static and ±0.3% (60 Hz) for dynamic recalibration of measuring unit.

MEASURING UNIT:

Input voltage:.....30mV to 30V, 3150 Hz ±5%.

Input impedance:.....>10 kOhm.

Measuring ranges: ME-101 — ±0.02 to ±0.5% and ±0.1 to ±2.5%; ME-102 — ±0.15% and ±0.75%.

Frequency response of fluctuation indication: Linear position, 0.50 to 500 Hz (-3 dB points). Weighted position, according to CCIR standard with external filter as required.

Drift indication:.....Max. ±4.5%.

Auxiliary output:.....Approx. 20V peak to peak at 22 kOhm.

Dimensions:.....7" x 8" x 1 3/4".

Weight:.....Approx. 11 lbs.

ME-101 — net price F.O.B. N.Y.....\$375.

ME-102 — net price F.O.B. N.Y.....\$395.



GOTHAM AUDIO CORPORATION

DIRECTRON

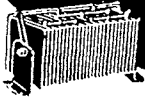

Industrial Transformers, Selenium and Silicon Rectifiers, Chokes and Power Supplies

RECTIFIER TRANSFORMERS

Transformers are with 2 — 18 volt center-tapped windings. Connected in series delivers 36 volts as rated. Connected in parallel — delivers 18 volts at twice rated current. (Taps 9, 18, 27, 36 V.)

Primary taps at 100, 105, 110 and 115 volts available on 12 amp, 24 amp, 30 amp and 50 amp transformers. No extra charge.

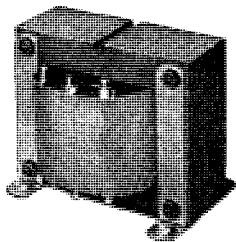
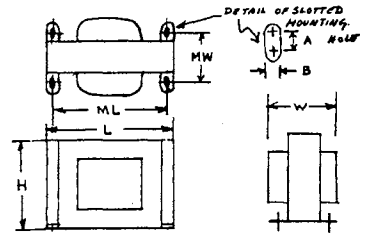

12 amp. Transformer 18T12

Part No.	Amp.	Users Net Price	L (MAX)	W (MAX)	H (MAX)	ML ±1/16	MW ±1/8	A ±1/64	B ±1/64	Weight
18 T 1	1	\$ 6.20	2 3/32	3	2 3/4	2 1/2	2 1/4	1/8	1 3/64	2.5
18 T 2	2	8.55	3 1 1/16	3	2 3/8	3 1/8	2	↓	↓	3.4
18 T 4	4	11.70	4 3/16	3	3 3/4	3 3/8	2 3/8	↓	↓	5.5
18 T 8	8	17.85	4 3/8	3 3/8	4	3 3/4	3	↓	↓	9.5
18 T 12	12	19.90	5 3/16	4 1/4	4 1/2	4 3/8	3 3/8	↓	3/32	14.5
18 T 24	24	42.25	6 1/2	4 5/8	5 1/2	5 5/16	3 3/8	3/32	↓	22
18 T 30	30	52.00	6 1/2	5	5 1/2	5 5/16	3 3/8	↓	↓	25
18 T 50	50	61.20	6 1/2	5 3/4	5 1/2	5 5/16	4 3/8	↓	↓	33

WITH 2-28 CENTER TAP WINDINGS

28 T 2	2	\$10.15	3 7/8	3 1/4	3 1/8	2 1/2	2 3/8	1/8	1 1/16	5
28 T 4	4	14.85	4 1/4	3 3/4	3 3/16	3	3	↓	↓	8
28 T 6	6	27.50	5 3/16	4 1/4	4 1/2	4 3/8	3 3/8	3/8	3/32	14
28 T 12	12	36.30	6 1/2	5	5 1/2	5 5/16	3 3/8	↓	↓	21
28 T 24	24	74.00	6 1/2	6 1/2	5 1/2	5 3/8	3 1/2	↓	↓	24.5

STEP UP TRANSFORMERS

PRIMARY WINDINGS — 100-105-110-115 VOLT			SECONDARY WINDINGS — 130-135-140 VOLT		
Part No.	Amps.	Users Net Price	Part No.	Amps.	Users Net Price
SU 10	10	\$ 70.00	SU 25	25	\$128.00
SU 15	15	85.00	SU 30	30	160.00
SU 20	20	112.50	SU 35	35	185.00

HIGH CURRENT CHOKES

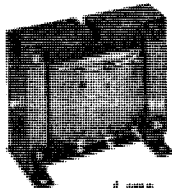

4 WPP Choke CK4

Part No.	Amps.	Hy.	Ohms	Users Net Price	L (MAX)	W (MAX)	H (MAX)	ML ±1/16	MW ±1/8	A ±1/64	B ±1/64	Weight
CK 1	1	.1	1.5	\$ 5.90	3 1/32	2 3/4	2 3/4	2 1/2	2	1/8	1 3/64	2
CK 2	2	.04	.9	7.20	3 3/16	3 3/4	3 1/8	2 13/16	2 1/8	↓	↓	3.1
CK 4	4	.07	.6	9.25	3 1 1/16	3 3/8	3 3/8	3 1/8	2 1/2	↓	↓	5
CK 8	8	.03	.3	14.60	4 3/16	3 3/8	3 3/4	3 3/8	3	↓	↓	8
CK 12	12	.01	.1	18.00	5 3/16	3 3/4	4 1/2	4 3/8	2 7/8	↓	3/32	11.5
CK 20	20	.004	.05	21.00	5 1/4	5	4 1/2	4 1/2	4	1/2	↓	14
CK 24	24	.004	.025	31.25	5 5/16	4 3/4	4 1/2	4 3/8	3 7/8	↓	↓	17.5
CK 30	30	.003	.01	41.75	6 1/2	4 3/8	5 1/2	5 5/16	3 3/8	↓	↓	22
CK 50	50	.001	.001	53.85	6 1/2	4 7/8	5 1/2	5 5/16	3 3/8	↓	↓	23
CK 100	100	.0005	.005	62.35	6 1/2	6	5 1/2	5 5/16	4 1/8	↓	↓	30

CUSTOM BUILT TRANSFORMERS AND CHOKES — 48 HOUR SERVICE

POWER SUPPLIES TO YOUR SPECIFICATIONS, QUOTATIONS ON REQUEST

SEE OUR AD UNDER "RECTIFIERS" IN SECTION 4800 FOR SELENIUM AND SILICON STACKS

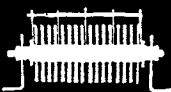

Mfd. by **SANFORD MILLER CORP.**

MICROTRAN

MINIATURIZED MILITARY TRANSFORMERS



PICO MINIATURE TRANSFORMERS—PM SERIES

PM-M (Fig. A): Epoxy molded finish; gold plated leads, 0.020" x 3/4". Frequency response = ±2 db, 300 Hz to 100 kHz (PM3 and PM5, to 45 kHz). Power level given for 15% max. distortion, except PM35, 20% and PM37, 25%. Size, .410" x .465" x .310" max. Wt., 0.1 oz. MIL type TF5RX—ZZ. **PM-F (Fig. B):** Open frame, resin impregnated, 4" #30 plastic leads. Size, .250" x .375" x .406" max. Wt., .05 oz. MIL type TF6RX—ZZ.

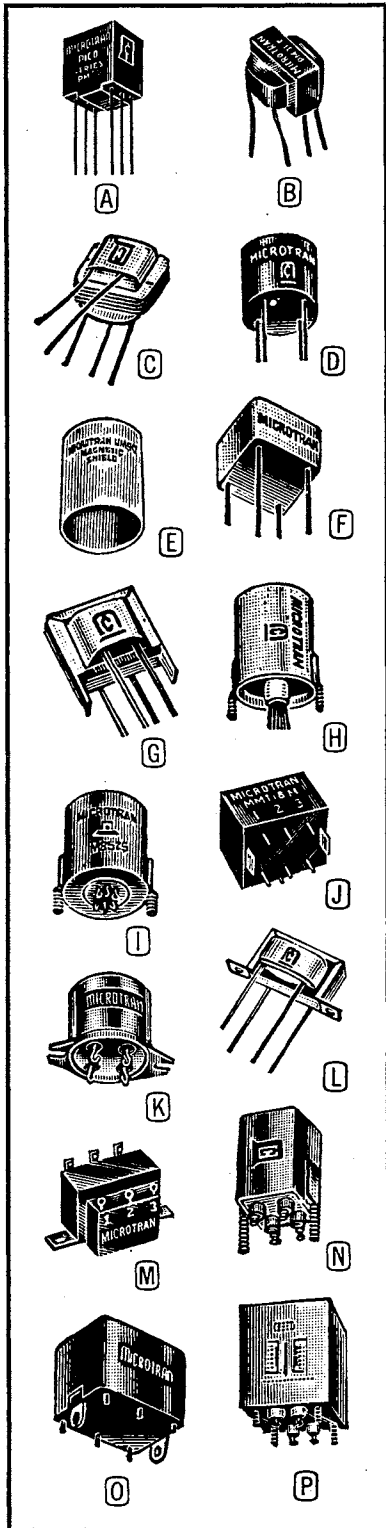

Microtran No.†	Application	Impedance		Pri. DC mA*	DC Resist., Ohms		Power Level, mW	MIL No.	Net Each, Lots of 1-9*		
		Primary	Secondary		Pri.	Sec.			-M	-F	
PM3-	Input	200K CT	1K CT	0	5300	110	10	16	\$10.80	
PM5-	Input	200K	1K	0	5300	110	10	16	10.20	
PM7-	Interstage	50K CT	1K CT	0	3300	75	10	16	10.35	
PM9-	Interstage	50K	1K/250†	0	3300	75	10	16	10.50	
PM11-	Interstage	25K CT	1K CT	0.5	1700	110	40	12	9.75	
PM13-	Interstage	25K	1K/250†	0.25	1700	110	40	12	10.20	
PM15-	Interstage	25K	1K	0.25	1700	110	40	12	8.85	\$5.10	
PM17-	Isolation	10K CT	10K CT	1	1000	1300	50	12	9.15	
PM19-	Driver	10K CT	2K CT	1	1000	300	50	12	9.00	
PM21-	Driver	10K	2K/500†	0.5	1000	300	50	12	9.15	
PM23-	Driver	10K CT	1200 CT	1	1050	280	50	12	9.00	
PM25-	Driver	10K	1200/300†	0.5	1050	280	50	12	9.30	
PM27-	Driver	10K	1200	0.5	1050	280	50	12	8.10	4.80	
PM29-	Driver	10K CT	500 CT	1	1050	80	50	12	9.15	
PM31-	Isolation	2500	2500 CT	1	250	325	50	12	8.55	6.60	
PM33-	Output	1500 CT	600	3	170	135	50	12	8.40	4.95	
PM34-	Output	600 CT	600 CT	3	72	92	50	17	8.55	
PM35-	Output	500	50	3	60	8	50	17	7.80	4.35	
PM36-	Output	500	500/125†	3	72	85	50	17	9.00	
PM37-	Output	120 CT	3.2	10	16	0.75	50	17	8.10	4.65	
PM38-	Output	300 CT	600	7	41	98	50	17	8.10	4.80	
PM39-	Audio	6 H		2	1800			20	7.65	4.20	
PM40-	Choke	3.5 H		2	560			20	7.20	4.05	
PM41-		3 H		4	43			20	6.75	3.90	
PM90-	Magnetic shield mu-metal slip-on can; 20 db shld.									1.05

*Unbalanced. †Split.

ULTRA-MINIATURE TRANSISTOR TRANSFORMERS—UM SERIES

Frequency Response: ±2 db, 300-10K Hz. Leads supplied, 4" #27 color-coded. Power levels given for 7 1/2% max. distortion. **UM-F (Fig. C):** Size, 3/8" x 3/8" x 1/2". Weight, 0.08 oz. MIL type TF6RX—ZZ (Insert MIL No. from table). **UM-M (Fig. D):** Size, 1/2" dia. x 1/2", with 1" leads. Weight, 0.14 oz. MIL type TF5RX—ZZ.

Microtran No.†	Application	Impedance		Unbal. Pri., DC mA	DC Resist., Ohms		Level at 1 kHz, mW	MIL No.	Net Each, Lots of 1-9*		
		Primary	Sec.		Pri.	Sec.			-F	-M	
UM21-	Input	100K	1K	0	1900	135	70	16	\$6.00	\$7.20	
UM22-	Driver	20K	1K	0.5	1100	100	300	13	4.35	5.85	
UM23-	Driver	20K	1200 CT	0.5	1100	110	300	13	4.65	6.60	
UM24-	Output	1K	50	3	65	10	500	17	3.90	5.40	
UM25-	Output	400	50	3	35	5	500	17	3.90	5.40	
UM26-	Output	400 CT	11	3	35	1.5	500	17	3.90	5.40	
UM27-	Output	400 CT	11	6	35	1.5	500	17	4.20	5.70	
UM28-	Choke	10 H, 0 DC;	8 H, 0.5 mA		650			20	3.75	5.70	
UM29-	Interstage	600 CT	600 CT	17	45	60	400	21	4.65	6.30	
UM30-	Choke	1.5 H, 0 DC;	7 H, 2 mA		100			20	3.60	4.80	
UM31-	Interstage	10K CT	1200 CT	2	850	120	500	23	4.80	7.20	
UM32-	Output	1500 CT	600	5	135	65	500	13	4.35	5.85	
UM33-	Output	1K CT	600	6	80	65	500	17	4.35	5.85	
UM34-	Driver	10K CT	600 CT	2	850	40	500	13	4.50	6.90	
UM35-	Isolation	15K CT	15K CT	1	930	120	300	15	4.95	7.05	
UM36-	Driver	20K CT	800 CT	0.5	1100	80	500	13	4.80	6.75	
UM37-	Driver	10K	2K CT	1	850	200	500	13	4.50	6.00	
UM39-	Interstage	2.5K CT	600 CT	2	250	50	500	13	4.50	6.00	
UM90-	Magnetic shield mu-metal slip-on can; 20 db shld. (Fig. E)									1.35

VERI-MINIATURE TRANSISTOR TRANSFORMERS—VM SERIES

Frequency Response: ±2 db, 200-10K Hz. Leads supplied, 4" #27 color-coded. Power levels given for 7 1/2% max. distortion. **VM-M (Fig. F):** For plug-in printed circuit applications. Cast epoxy resin provides high resistance. Size, 1/4" x 1/4" x 1/2". Weight, 0.25 oz. MIL type TF5RX—ZZ (Insert MIL No. from table). **VM-FPB (Fig. G):** Plug-in tab mounted channel. Size, 1/4" x 1/4" x 1/4". Weight, 0.2 oz. MIL type TF6RX—ZZ.

Microtran No.†	Application	Impedance		DCR, Ohms		Level, mW	MIL No.	Net Each, 1-9*			
		Primary	Secondary	Pri.	Sec.			-FPB	-M		
VM1-	Input	50	600, 1.5 mA	7	90	15	21	\$4.20	\$5.55		
VM2-	Input or intrstg.	200K	600, 1.0 mA	3000	110	2.5	21	5.70	7.20		
VM3-	Interstage	25K	600, 1.0 mA	720	45	2.5	21	4.50	6.30		
VM4-	Input or intrstg.	200K	1200, .72 mA	3100	165	5	21	5.70	7.20		
VM5-	Interstage	50K	600, 1.0 mA	830	55	5	21	4.65	6.60		
VM6-	Interstage	100K	1200†.72 mA	2000	150	5	21	5.85	7.35		
VM7-	Output	500, 3.5 mA	3.4	50	0.5	15	21	4.20	5.55		
VM8-	Output	1250, 2.0 mA	3.4	135	0.5	15	21	4.35	5.70		
VM9-	Output	1250, 2.0 mA	50	135	6.5	15	21	4.35	5.70		
VM10-	Interstage	2500, 1.5 mA	2500 CT.	225	215	3	21	4.65	6.90		
VM11-	Choke	20 H, 0 mA;	12 H, .5 mA	1000			21	4.05	5.10		
VM12-	Interstage	20K	1000, .75 mA	625	85	5	21	4.50	6.30		
VM13-	Interstage	20K	1000†.75 mA	625	85	5	21	4.65	6.90		
VM14-	Interstage	600†.7 mA	600 CT	50	65	15	17	4.50	6.75		
VM15-	Isolation	50K CT	50K CT	2000	2600	5	15	6.00	8.40		
VM16-	Driver	500†.75 mA	250 CT	40	13	15	17	4.50	6.75		
VM17-	Interstage	10K CT	5K CT	400	300	5	17	5.85	7.35		
VM90-	Magnetic shield mu-metal slip-on can; 20 db shld.									1.95

†CT.

LOW LEVEL CHOPPER INPUT TRANSFORMERS

Efficiently transfer 30-500 Hz signals to instrument amplifiers. Signal level range, 0.5 μV to 0.5 V. Resin impregnated. Three CASED (Fig. H)

Microtran No.	Turn Ratio			Full Pri. H*	Full Imped.*	DC Resist.		Net Each, 1-9*
	Full Pri. Full Sec.	1/2 Pri. Full Sec.	1/4 Pri. Full Sec.			Full Pri.	Sec.	
M8025	1:7.7	1:15.4	1:17.5	6600	365Ω	4140Ω	\$13.80	
M8026	1:3.2	1:6.4	60	22,500	455Ω	3500Ω	13.80	
M8052	1:4.53	1:9.06	90	34,000	760Ω	5220Ω	14.25	
M8053†	1:0.5	1:1	140	53,000	920Ω	653Ω	13.65	
M8112	1:0.5	1:1	450	80,000	2300Ω	1600Ω	14.40	

mu-metal, two copper shields; 90 db shielding. Size, 1 1/2" dia. x 1 1/2" h. with 6-32 x 3/8" studs on 1 1/2" ctrs. Wt., 5 oz.

HERMETIC (Fig. I)

Microtran No.	Turn Ratio			Full Pri. Imped.*	DC Resist.		Net Each, 1-9*
	Full Pri. Full Sec.	1/2 Pri. Full Sec.	1/4 Pri. Full Sec.		Full Pri.	Sec.	
M8525	1:7.7	1:15.4	17.5	6600	365Ω	4140Ω	\$16.65
M8526	1:3.2	1:6.4	60	22,500	455Ω	3500Ω	16.65
M8552	1:4.53	1:9.06	90	34,000	760Ω	5220Ω	17.10
M8553†	1:0.5	1:1	140	53,000	920Ω	653Ω	16.50

*At 0.5 V, 60 Hz. †Secondary is center tapped.

★SEE OTHER MICROTRAN PAGES FOR QTY. PRICING, MIL CASE SIZES. †ORDER BY COMPLETE MICROTRAN NO. (PM3-M)

MICROTRAN MINIATURIZED MILITARY TRANSFORMERS



MICRO-MINIATURE AUDIO AND TRANSISTOR TRANSFORMERS—MM AND MMT SERIES

MM-M (Fig. J): Molded, for plug-in printed circuit applications. Cast epoxy resin for high resistance to extremes of ambient temperature. MIL Type TF5RX—ZZ. Size, $\frac{3}{8}$ " x $\frac{25}{64}$ " x $\frac{17}{64}$ " with $\frac{3}{64}$ " pins, .020" dia. Weight, $\frac{1}{2}$ oz. **MM-H (Fig. K):** Hermetically sealed with high compression glass terminals. Gray enamel finish. MIL Type TF4RX—YY. Size, $\frac{13}{16}$ " dia. x $\frac{11}{16}$ ". Weight, $\frac{3}{4}$ oz.

MM-FB (Fig. L): Open frame with channel. Available with plug-in tab channel or without channel on special order. MIL type TF6RX—ZZ. Size, $\frac{13}{16}$ " x $\frac{19}{64}$ " x $\frac{13}{64}$ ", plus tabs. **MM-CM (Fig. M):** Contour molded on special order only; for mtg. on top of chassis. Size, $\frac{7}{8}$ " x $\frac{9}{16}$ " x $\frac{25}{64}$ ". Prices on request.

Microtran No.†	Application	Impedance		Pri. Unbal. DC mA	Oper. Level, dbm	Freq. Resp. ±2 db, Hz	MIL No.	Net Each, Lots of 1-9*		
		Pri.	Sec.					-FB	-H	-M
MM1-	Input	200/50	250K/62.5K	0	4	200-10K	10	\$4.50	\$7.35	\$8.55
MM2-	Interstage 3:1	10K	90K	0	4	150-10K	10	4.80	7.50	8.70
MM3-	Plate to line	10K	200	3	20	150-10K	13	4.20	7.20	8.40
MM4-	Output	30K	50	1	20	150-10K	13	4.05	7.05	8.25
MM5-	Reactor 50 H at 1 mil DC	4.7K	ohms DC Res.	20	4.05	6.90	8.10
MM6-	Output	100K	60	0.5	20	250-10K	13	4.20	7.20	8.40
MM7-	Output	30K	1200	0.5	20	200-10K	13	3.30	6.45	7.65
MMT1-	Line to base	600	600	8	22	200-15K	17	3.90	7.35	8.55
MMT3-	Coll. to base or line	50K	600	0.7	20	200-15K	13	4.05	7.50	8.70
MMT4-	P-p coll. to p-p base	50K CT	600 CT	1.4	20	200-15K	13	4.80	8.55	9.75
MMT5-	Coll. to speaker	50K	6	1	20	200-15K	13	4.35	7.95	9.15
MMT7-	Coll. to p-p base	25K	1200 CT	1	20	200-15K	13	4.50	8.40	9.60
MMT8-	P-p coll. to p-p base	50K CT	1200 CT	1.4	20	200-15K	13	4.65	8.55	9.75
MMT9-	Line to p-p base	600 CT	1200 CT	16	22	200-15K	17	4.20	7.65	8.85
MMT10-	Coll. to base	25K	600	1	20	200-15K	13	3.45	7.20	8.40
MMT11-	P-p coll. to p-p base or line	4K CT	600 CT	5	28	200-15K	12	4.35	7.80	9.00
MMT12-	Coll. to speaker	2K	3.4	5	28	200-15K	13	3.90	7.35	8.55
MMT13-	Output p-p coll. to speaker	4K CT	3.4	5	28	200-15K	13	4.05	7.50	8.70
MMT16-	Coll. to p-p base	10K	1500 CT	1	20	200-15K	13	4.50	8.40	9.60
MMT17-	P-p coll. to p-p base	10K CT	200 CT	6	20	200-15K	13	4.50	8.10	9.30
MMT18-	P-p coll. to p-p base	25K CT	1200 CT	2	20	200-15K	13	4.65	8.55	9.75
MMT19-	Coll. to p-p base	2500	2500 CT	2	23	200-15K	13	4.05	7.50	8.70
MMT21-	P-p coll. to p-p base	4K CT	600/150 split	5	28	200-15K	13	4.65	8.55	9.75
MMT25-	P-p coll. to p-p base	7500 CT	600 CT	4	22	200-15K	13	4.35	7.80	9.00
MMT26-	Line to base	600 CT	600 CT	16	22	200-15K	17	4.20	7.65	8.85
MMT27-	P-p coll. to p-p base	25K CT	600 CT	2	20	200-15K	13	4.50	8.40	9.60
MMT28-	P-p coll. to p-p base	10K CT	1500 CT	2	20	200-15K	13	4.65	8.55	9.75
MMT29-	Driver/Isolation	10K CT	10K CT	2	20	200-15K	13	4.65	8.55	9.75
MMT30-	P-p coll. to p-p base	7500 CT	1200 CT	4	22	200-15K	13	4.50	8.40	9.60
MMT31-	P-p coll. to p-p base	2K CT	500 CT	10	28	200-15K	13	4.35	8.25	9.45
MMT32-	Line to p-p base	600 CT	1.2K/300 split	16	22	200-15K	17	4.65	8.55	9.75
MMT33-	Line to p-p base	600 CT	600/150 split	16	22	200-15K	10	4.50	8.40	9.75
MMT35-	P-p coll. to p-p base	10K CT	150/37.5 split	2	20	200-15K	13	4.80	8.70	9.90

SUBMINIATURE AUDIO AND TRANSISTOR TRANSFORMERS—SM AND SMT SERIES

SM-AF (Fig. N): MIL-T-27B-AF modified case; compression sealed ceramic terminals; gray enamel finish. MIL type TF4RX—YY. Size, $\frac{3}{4}$ " x $\frac{3}{4}$ " x $1\frac{1}{8}$ " max. with two 4-40NC-2 spade mtg. bolts. Wt., $1\frac{1}{4}$ oz. **SM-H (Fig. K):** Hermetically sealed; high compression glass terminals; gray enamel finish. MIL type TF4RX—YY. Size, $\frac{13}{16}$ " dia. x $\frac{11}{16}$ " h. Weight, 1 oz.

SM-FB (Fig. L): Open frame with channel. With plug-in tab mounted channel or without channel on special order. MIL type TF6RX—ZZ. Size, $\frac{13}{16}$ " x $\frac{19}{64}$ " x $\frac{3}{4}$ ", plus tabs. Wt., 0.750 oz. **SM-M (Fig. O):** Molded, for plug-in PC applications. MIL type TF5RX—ZZ. Size, $\frac{15}{16}$ " x $\frac{7}{8}$ " x $\frac{3}{4}$ " max. Wt., $1\frac{1}{2}$ oz. **SM-CM (Fig. M):** Contour molded on special order; prices on request.

Microtran No.†	Application	Impedance		Pri. Unbal. DC mA	Oper. Level, dbm	Frequency Resp. ±2 db, Hz	MIL No.	Net Each, Lots of 1-9*			
		Pri.	Sec.					-AF	-FB	-H	-M
SM1-	Input	200/50	250K/62.5K	0	6	80-10K	10	\$9.00	\$4.35	\$7.20	\$9.00
SM2-	Interstage 3:1	10K	90K	0	8	100-10K	10	8.70	3.90	6.90	9.00
SM3-	Plate to line	10K	200	3	21	150-10K	13	8.70	3.90	6.90	9.00
SM4-	Output	30K	50	1	21	150-10K	13	8.70	3.90	6.90	9.00
SM5-	Reactor 50 H at 1 mil DC	3K	ohms DC Res.	20	7.20	3.30	6.30	8.40
SM6-	Output	100K	60	0.5	21	150-10K	13	8.70	4.35	7.05	9.00
SMT1-	Line to base	600	600	9	23	200-15K	17	6.75	3.90	6.00	7.20
SMT3-	Coll. to base or line	50K	600	1	20	300-15K	13	7.35	4.50	6.60	7.80
SMT4-	P-p coll. to p-p base	50K CT	600 CT	2	20	200-15K	13	4.95	7.05	8.25
SMT5-	Coll. to speaker	50K	6	1	20	300-15K	13	7.20	4.35	6.45	7.65
SMT7-	Coll. to p-p base	25K	1200 CT	1.5	20	200-15K	13	7.50	4.65	6.75	7.95
SMT8-	P-p coll. to p-p base	50K CT	1200 CT	2	20	200-15K	13	4.95	7.05	8.25
SMT9-	Line to p-p base	600 CT	1200 CT	18	23	200-15K	17	4.20	6.30	7.50
SMT10-	Coll. to base	25K	600	2	20	200-15K	13	7.05	4.20	6.30	7.50
SMT12-	Output coll. to speaker	2K	3.4	5	30	200-15K	13	6.75	3.90	6.00	7.20
SMT13-	Output p-p coll. to speaker	4K CT	3.4	5	30	200-15K	13	6.90	4.05	6.15	7.35
SMT16-	Coll. to p-p base	10K	1500 CT	1	23	200-15K	13	7.50	4.65	6.75	7.95
SMT17-	P-p coll. to p-p base	10K CT	200 CT	6	20	200-15K	13	4.80	6.90	8.10
SMT18-	P-p coll. to p-p base	25K CT	1200 CT	3	20	200-15K	13	4.95	7.05	8.25
SMT19-	Coll. to p-p base	2500	2500 CT	5	26	200-15K	13	7.50	4.65	6.75	7.95
SMT26-	Line to base	600 CT	600 CT	18	23	200-15K	17	4.50	6.60	7.80
SMT36-	Interstage	2.5K CT	2.5K/62.5 split	10	26	200-15K	13	5.10	7.20	8.40

TRANSISTOR DRIVER AND OUTPUT TRANSFORMERS (FIG. P)

Hermetically sealed to MIL-T-27B construction. MIL type TF4RX—(Add MIL No. 17 except as noted, and case from table). When present stock is depleted, M8006, M8007 and M8014 will be available on special order only.

Micro. No.	Application	Impedance		Pri. Unb. DC mA	Level Watts	Freq. Resp. ±2 db, Hz	MIL No.	Net Ea., 1-9*
		Pri.	Sec.					
M8002*	Coll. to p-p base	560	400 CT	18	0.15	200-20K	AJ	\$12.75
M8003*	Coll. to p-p base	625 CT	100 CT	20	1.5	200-20K	AJ	13.05
M8004	Coll. to p-p base	5400	600 CT	15	0.075	200-15K	AH#	14.85
M8005	Coll. to p-p base	7000	320 CT	7	0.040	70-15K	AH#	14.85
M8006	Coll. to p-p base	10K	6500 CT	0.75	0.005	200-15K	YY#	9.45
M8008	Coll. to speaker	25	3-4	600	3	200-20K	AJ	12.30
M8007*	P-p auto transformer	30 CT	3-4	200	2	100-20K	AJ	12.60
M8009	P-p output to spkr.	48 CT	3.2/8	50	5	200-20K	AJ	12.75
M8010	P-p coll. to servo	120 CT	1K	40	6	300-15K	AJ	12.60
M8011	P-p output to spkr.	125 CT	3-4	20	1.5	200-15K	AH	14.55
M8012*	P-p coll. to servo	140 CT	500	50	6	300-15K	AJ	12.75
M8013*	P-p output to spkr.	250 CT	3-4	20	0.4	70-15K	AH	14.55
M8014	P-p output to spkr.	400 CT	11	2	0.25	300-15K	YY	9.15
M8015	P-p coll. to servo	1600 CT	800	5	2.5	150-20K	AJ#	12.90
M8016	P-p output to spkr.	2500 CT	12	4	0.10	300-15K	YY#	9.30
M8054	P-p output to servo	250 CT	130	20	3	200-15K	AH	14.55

*Bifilar wound to minimize switching transients. #MIL No. 13.

MODEL 400K TRANSISTOR

TRANSFORMER SELECTOR KIT

Set of nine transistor transformer covers impedance range of 150 through 200K ohms, matching most new transistor impedance ratings. Ideal for breadboard circuitry. Sizes range from a $\frac{3}{8}$ " cube to $\frac{3}{4}$ " x $\frac{3}{4}$ " x $1\frac{1}{2}$ ". All are vacuum resin impregnated and have 4" color-coded leads. Includes full design data; nomographs and circuitry for determining correct impedances for Class A and B transistor amplifiers; power versus dbm chart; terminal connection sheet; MIL-T-27B guide; cross reference index; outline drawings for later selection of stock items with same electrical ratings in many other mechanical constructions and reactance chart. Each transformer individually boxed in transparent plastic case.

Microtran Model 400K Transistor Transformer Selector Kit—Net Each. \$29.50

★SEE OTHER MICROTRAN PAGES FOR QTY. PRICING, MIL CASE SIZES. †ORDER BY COMPLETE MICROTRAN NO. (MM1-FB)

MINIATURIZED MILITARY TRANSFORMERS



MICROTRAN

MINIATURE TRANSISTOR AND AUDIO TRANSFORMERS—M AND MT SERIES

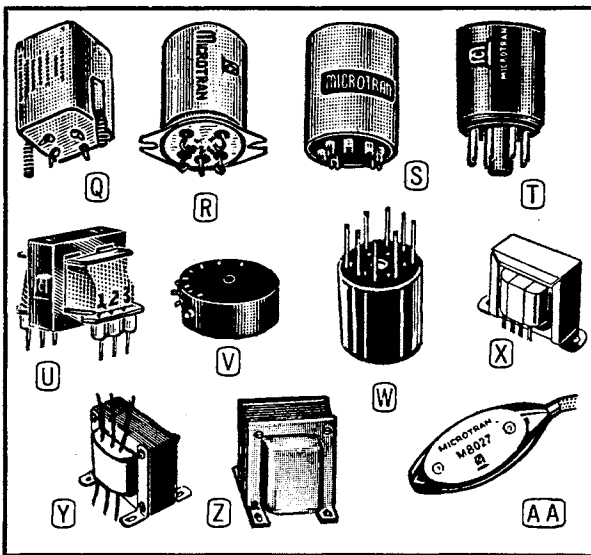

M-M (Fig. O): Molded, for plug-in printed circuit use. Cast epoxy resin provides highest resistance to temperature extremes. MIL Type TF5RX—ZZ (Insert MIL No. from table). Max. Size, 1 1/2" x 1/2" x 1/8". Weight, 1 1/2 oz. **M-AG (Fig. Q):** Enclosed in modified MIL-T-27B AG case with compression sealed ceramic terminals. MIL Type TF4RX—YY. Max. Size, 1" x 1" x 1 3/8". Weight, 2 3/8 oz. **M-H (Fig. R):** Hermetically sealed with high compression glass terminals, gray enamel finish. Available on special order with .120" holes. MIL Type TF4RX—YY. Size, 1 1/4" dia. x 1 1/4" max. Weight, 1 1/2 oz. **M-A (Fig. S):** Aluminum case with 2-56 screws. MIL Type TF3RX—ZZ. Size, .875" dia. x 1 1/4". Weight, 1.25 oz. **M-FB (Fig. L):** Open frame with channel. Available with plug-in tab channel or without channel on special order. MIL Type TF6RX—ZZ. Size, 1 1/4" x 1 3/8" x 2 7/8" max., plus tabs. Weight, 1.13 oz. **M-P (Fig. T):** Octal plug-in type in sealed plastic housing. MIL Type TF6RX—ZZ. Size, 1 1/2" dia. x 1 1/2". Wt., 2 oz. **M90 Shield (Fig. E):** 25 db magnetic shield for Type M-A. Two clearance holes on 1/4" centers. **M-PC (Fig. U):** Open frame PC with terminals molded into bobbin to maintain accurate dimensions for PC board. MIL Type TF6RX—ZZ. Size, 1/2" x 1 1/2" x 1"; terminals 1/4" below bobbin. Wt., 1.2 oz. **M-CM (Fig. M):** Contour molded on special order only; for mtg. on top of chassis. Size, 1 1/2" x 1/8" x 1/8". Prices on request.

MINIATURE AUDIO TRANSFORMERS—M SERIES

Microtran No.	Application	Impedance		Pri. DC mA*	Oper. Level, dbm	Freq. Resp. = 2 db, Hz	MIL No.	Net Each, Lots of 1-9*					
		Pri.	Sec.					-A	-AG	-FB, -PC	-H	-M	-P
M1-†	Mike or line to 1 grid	†	50K	0	5	20-20K	10	\$8.10	\$ 9.90	\$5.10	\$ 9.00	\$ 9.90	\$8.85
M2-†	Mike or line to 2 grids	†	50K CT	0	5	20-20K	10	8.25	10.35	5.25	9.45	10.20	8.85
M3-	Dynamic mike to 1 grid	7.5/30	50K	0	5	20-20K	10	7.80	9.90	4.95	9.00	9.75	8.40
M4-	Single plate to 1 grid	15K	60K	0	6	20-15K	10	6.75	8.55	3.75	7.65	8.55	7.50
M5-	Single plate to 1 grid	15K	60K	4	14	200-20K	15	6.75	8.55	3.75	7.65	8.55	7.50
M6-	Single plate to 2 grids	15K	95K CT	0	5	20-15K	10	7.65	9.45	4.65	8.55	9.45	8.25
M7-	Single plate to 2 grids	15K	95K CT	4	11	200-20K	15	7.65	9.75	3.90	8.85	9.75	8.25
M8-†	Single plate to line	15K	†	0	8	20-20K	16	8.25	10.50	5.10	9.60	10.50	8.85
M9-†	Single plate to line	15K	†	4	21	150-20K	13	8.25	10.50	4.20	9.60	10.50	8.85
M10-†	Push-pull plates to line	30K, †	†	0	8	30-50K	16	8.40	10.80	5.25	9.60	10.80	9.00
M11-†	Crystal mike to line	50K	p-p	†	0	20-20K	16	8.10	10.50	5.10	9.30	10.50	8.85
M12-†	Mixing and matching	†	†	0	8	20-20K	16	7.80	10.50	4.95	9.30	10.50	9.00
M13-	Reactor	300#	†	†	†	6K ohms DCR	20	6.30	8.25	3.45	7.35	8.25	7.50
M14-	50:1 mike to grid	200	1/2 meg.	0	9	80-3K	10	7.50	9.90	4.65	9.00	10.20	8.85
M15-	10:1 plate to grid	10K	1 meg.	0	11	100-2500	10	7.50	9.30	4.50	8.40	9.30	8.85
M90	Magnetic shield mu-metal slip on can; 25 db shielding							1.35					

MINIATURE TRANSISTOR TRANSFORMERS—MT SERIES

MT No.	Line to base	600	600	10	23	200-15K	17	\$7.20	\$8.70	\$3.60	\$7.80	\$9.00	\$7.35
MT2-†	Coll. to p-p base 2N57	100	10 CT/40 CT	100	27	200-20K	17	8.10	9.60	4.20	8.70	9.90	8.25
MT3-	Coll. to base or line	50K	600	3	20	300-15K	13	7.80	9.30	3.90	8.40	9.60	7.95
MT5-	Coll. to speaker	50K	6	3	20	300-15K	13	7.80	9.30	3.90	8.40	9.60	7.95
MT6-	Coll. to p-p base	100K	1200 CT	1.4	17	200-15K	13	7.95	9.45	4.20	8.55	9.75	8.10
MT7-†	Coll. to p-p base	25K	1200 CT	3	22	200-15K	13	7.95	9.45	4.20	8.55	9.75	8.10
MT8-	P-p coll. to p-p base	50K CT	1200 CT	3	20	300-15K	13	8.10	9.60	4.35	8.70	9.90	8.25
MT9-	Line to p-p base	600 CT	1200 CT	4	23	200-15K	17	8.10	9.60	4.35	8.70	9.90	8.00
MT10-†	Coll. to base	25K	600	3	22	200-15K	13	7.80	9.30	3.90	8.40	9.60	7.95
MT11-	P-p coll. to p-p base	4K CT	600 CT	3	32	200-15K	13	8.10	9.60	4.35	8.70	9.90	8.25
MT12-	Output coll. to spkr.	2K	3.4	10	32	200-15K	13	7.80	9.30	3.90	8.40	9.60	7.95
MT13-†	P-p coll. to spkr.	4K CT	3.4	3	32	200-15K	13	7.95	9.45	4.05	8.55	9.75	8.10
MT14-	Coll. to spkr. 2N179	400	10	50	25	200-20K	17	7.20	8.70	3.60	7.80	9.00	7.35
MT15-†	P-p servo output 2N57	500 CT	210	30	27	300-20K	17	7.80	9.30	3.90	8.40	9.60	7.95
MT18-†	P-p coll. to p-p base	25K CT	1200 CT	6	22	200-15K	13	8.10	9.60	4.35	8.70	9.90	8.25
MT20-†	P-p coll. to p-p base	50K CT	†	3	20	300-15K	13	8.40	9.90	4.65	9.00	10.20	8.55
MT21-†	P-p coll. to p-p base	4K CT	†	3	32	200-15K	13	8.25	9.75	4.50	8.85	10.05	8.40
MT22-†	Line to p-p base	†	1200 CT	4	23	200-15K	17	8.25	9.75	4.50	8.85	10.05	8.40
MT23-	P-p coll. to servo	250 CT	1000	10	30	200-15K	17	7.80	9.30	3.90	8.40	9.60	7.95
MT24-	Coll. to p-p base	2500	600 CT	10	32	200-15K	13	7.80	9.30	3.90	8.40	9.60	7.95
MT25-	P-p coll. to p-p base	7500CT	600 CT	8	32	200-15K	12	8.10	9.60	4.35	8.70	9.90	8.25
MT26-	Line to p-p base	600 CT	600 CT	20	23	200-15K	17	7.95	9.45	4.20	8.55	9.75	8.10
MT29-	P-p coll. to servo	1600CT	450	15	30	200-15K	13	7.80	9.30	3.90	8.40	9.60	7.95
MT30-	P-p coll. to servo	250 CT	500	10	30	200-15K	17	7.80	9.30	3.90	8.40	9.60	7.95
MT33-†	Line to p-p base	†	†	20	23	200-20K	17	8.40	9.90	4.65	9.00	10.20	8.55
MT34-†	P-p coll. to p-p base	10K/2500 split	2000/500 split	4	20	200-20K	13	8.55	10.05	4.80	9.15	10.35	8.70

*Unbalanced. †50/250/600 CT. ‡50/250 CT. #H 0 DC. *50 H at 3 mA. †1200/300 split. ‡600/150 split. †Not available in -PC type.

DC TO DC CONVERTER TRANSFORMERS—BLOCKING OSCILLATOR TYPE

Laminated series blocking oscillator type. Approximate repetition rate, 400 Hz. All are Fig. L except M8051, Fig. Q. DC output voltage for all but M8073 is given for transformer used in blocking oscillator circuit with single capacitor-input rectifier. DC input current, output current and output voltage of Model M8073 depend on load and bias; frequency varies from 100 to 2800 Hz. Fig. L types are open

frame units meeting MIL designation TF6RX09ZZ; Fig. Q type is enclosed unit meeting MIL designation TF4RX09YY.

Microtran No.	Turns Ratio	Input		Output		Size, Inches W. x D. x H.	Mtg. Ctr., In.	Net Each, 1-9*
		DC V	DC mA	DC Volts	DC μA			
M8050	600:12:1	3	20	1000	25	1 1/4 x 1 1/4 x 1 1/2	1 1/2	\$ 6.30
M8051	600:12:1	3	20	1000	25	1 1/4 x 1 1/4 x 1 1/2	1 1/2	\$ 11.85
M8073	44:1:1	4	2-15	425-500	50*	3/8 x 3/8 x 3/8	5.25
M8074	65.5:33:1	3	45	535	90	1 1/4 x 1 1/4 x 2 1/2	1 1/2	5.10

*Maximum.

MICROTRAN TRANSFORMERS ARE AVAILABLE IN MANY OTHER MECHANICAL AND ELECTRICAL TYPES ON SPECIAL ORDER. WRITE FOR COMPLETE INFORMATION.

★SEE LAST MICROTRAN PAGE FOR QUANTITY PRICING.

†ORDER BY COMPLETE MICROTRAN NUMBER (M1-A)

MICROTRAN MINIATURIZED MILITARY TRANSFORMERS



DC TO DC CONVERTER TRANSFORMERS—SWITCHING TYPE LAMINATED SERIES

Provide improved reliability and efficiency over vibrator and rotary power converters. Approximate repetition rate, 800 Hz. Full wave and CT loads may be simultaneously drawn, but total VA output should not be exceeded for continuous-duty operation. All are Fig. P except M8072 and M8120. Fig. L. Transistors listed are for reference only; user must verify that max. ratings will not be exceeded.

Microtran No.	In-put VDC	Out-put VA	Transistors Suggested	DC Output				Size, Inches W. x D. x H.	Mtg. Ctrs., In.		MIL Case	Net Each, 1-9*
				FW V	mA†	CT FW V	CT FW mA		ML	MW		
M8034	28	125	2N174	500	250	250	420	2 3/8 x 2 3/4 x 3 15/16	2 1/8	1 3/4	GA	\$31.50
M8035	13.6	125	2N442	500	250	250	420	2 3/8 x 2 3/4 x 3 15/16	2 1/8	1 3/4	GA	\$31.50
M8036	13.6	40	2N442	450	90	225	155	2 1/2 x 2 1/2 x 3 3/8	1 1/2	1 1/4	ZZ	\$30.00
M8072	2.7	190‡	2N1307	480*	400†	1 5/8 x 1 1/2 x 2 1/2	1 3/8	...	ZZ	\$7.20
M8120	2.8	190‡	2N3417	480*	400†	1 5/8 x 1 1/2 x 2 1/2	1 3/8	...	ZZ	\$7.20

TOROIDAL SERIES (FIG. V)

Permit conversion of low-voltage direct current to higher voltages for operating mobile electronic equipment. Operating frequencies between 1500 and 5000 Hz. Case is epoxy molded with terminals and clearance hole for mounting. DC output shown is based on 1 volt drop per rectifier.

M8113	13.8	50	2N278	28	1750	14	3500	2 1/2 x 1 1/4 #	.170*	...	\$16.05
M8114	28	50	2N375	28	1750	14	3500	2 1/2 x 1 1/4 #	.170*	...	\$16.05
M8115	13.8	5	2N376	500	10	250	20	1 1/4 x 1 1/4 #	.140*	...	\$12.30
M8116	13.8	50	2N278	70	700	35	1400	2 1/2 x 1 1/4 #	.170*	...	\$16.05
M8117	28	5	2N375	500	10	250	20	1 1/4 x 1 1/4 #	.140*	...	\$12.30
M8118	28	50	2N375	70	700	35	1400	2 1/2 x 1 1/4 #	.170*	...	\$16.05

*Output when used with half-wave capacitor-input rectifier. †Bridge. ‡μA. §mW. #Dia. x ht. *Clearance hole dia.

POWER SUPPLY TRANSFORMERS (FIG. P)

For silicon rectifier circuitry and filament applications. Hermetically sealed. Primary, 105/115/125 V. Output voltage given for resistive or inductive loads, based on approx. 1 V drop per rectifier. MIL Type TF4RX01— (add MIL case type from table) per MIL-T-27B.

400 Hz TYPE

Micro. No.	Secondary		Rect. Cir.		Size, Inches W. x D. x H.	MIL Case	Net, 1-9*
	VAC	rms	VDC†	VDC‡			
M8063†	2.85	.045 A	1.5‡	3‡	1 1/2 dia. x 1 1/2	YY	\$10.50
M8064†	6.3 CT	.6 A	1.9	3.8	1 1/2 x 1 1/2 x 1 1/2	AH	\$11.10
M8075†	6.3 CT	.3 A	1.9	3.8	1 1/2 dia. x 1 1/2	YY	\$9.75
M8076†	12.6 CT	.3 A	4.7	9.4	1 1/2 x 1 1/2 x 1 1/2	AH	\$11.70
M8039	12.6	.8 A	10.5‡	21‡	1 1/2 x 1 1/2 x 2 3/8	AJ	\$18.00
M8077	12.6 CT	.8 A	10.5‡	21‡	2 1/2 x 2 1/2 x 3 3/8	FA	\$19.05
M8038	12.6	.3 A	16‡	32‡	1 1/2 x 1 1/2 x 2 3/8	AJ	\$18.60
M8018	18.5 CT	1 A	7.4	14.8	1 1/2 x 1 1/2 x 2 3/8	EA	\$16.50
M8019	18.5 CT	3 A	7.4	14.8	2 1/2 x 2 1/2 x 3 3/8	FA	\$18.00
M8065	26 CT	1.5 A	10.8	21.6	1 1/2 x 1 1/2 x 2 3/8	EA	\$16.35
M8066	26 CT	3 A	10.7	21.5	2 1/2 x 2 1/2 x 3 3/8	FA	\$25.50
M8079	26 CT	4 A	10.8	21.6	2 3/8 x 3 1/4 x 4 1/4	HA	\$26.85
M8067	30 CT	1.5 A	12.5	25	2 1/2 x 2 1/2 x 2 3/8	FB	\$21.09
M8020	35 CT	3 A	14.5	29	2 3/8 x 2 3/8 x 3 13/16	GA	\$24.00
M8068	40 CT	2 A	17	34	1 1/2 x 1 1/2 x 2 3/8	AJ	\$13.20
M8041†	50 CT	.25 A	21.5	43	1 1/2 x 1 1/2 x 1 1/2	AH	\$11.10
M8080	50 CT	2 A	21.5	43	1 1/2 x 1 1/2 x 2 3/8	AJ	\$13.80
M8069†	60 CT	.003 A	26	52	1 1/2 dia. x 1 1/2	YY	\$9.75
M8070†	65 CT	.170 A	28.4	56.8	1 1/2 x 1 1/2 x 1 1/2	AH	\$11.25
M8081†	65 CT	.030 A	28.4	56.8	1 1/2 dia. x 1 1/2	YY	\$9.75
M8021†	70 CT	1 A	30	60	2 1/2 x 2 1/2 x 3 3/8	FA	\$23.25
M8071	80 CT	.90 A	35	70	2 1/2 x 2 1/2 x 3 3/8	FA	\$22.20

60 Hz TYPE

M8042	6.3 CT	.6 A	1.9	3.8	1 1/2 x 1 1/2 x 2 3/8	AJ	\$12.00
M8043	6.3 CT	2 A	1.9	3.8	2 1/2 x 2 1/2 x 2 3/8	FB	\$15.60
M8086	6.3 CT	.6 A	1.9	3.8	2 3/8 x 2 3/8 x 3 13/16	GA	\$18.90
M8087	12.6 CT	3 A	4.7	9.4	2 3/8 x 2 3/8 x 3 13/16	GA	\$18.90
M8044	12.6	2 A	10.5‡	21‡	3 1/2 x 3 1/2 x 3 3/8	JB	\$21.60
M8022	18.5 CT	3 A	7.4	14.8	3 1/2 x 3 1/2 x 3 3/8	JB	\$22.80
M8088	26 CT	2.5 A	10.8	21.6	2 3/8 x 3 1/2 x 4 3/4	HA	\$22.20
M8045	28 CT	6 A	11.7	23.4	2 3/8 x 2 3/8 x 3 3/8	FA	\$18.00
M8055	30 CT	2.5 A	12.5	25	3 1/2 x 3 1/2 x 4 3/4	JA	\$25.65
M8023	35 CT	3 A	14.5	29	3 3/8 x 3 1/2 x 5 1/4	KA	\$26.10
M8089	40 CT	1 A	17	34	1 1/2 x 1 1/2 x 2 3/8	AJ	\$12.00
M8090	40 CT	.3 A	17	34	1 1/2 x 1 1/2 x 2 3/8	EA	\$18.00
M8091	40 CT	.75 A	17	34	1 1/2 x 1 1/2 x 2 3/8	EA	\$18.00
M8046	49 CT	2.5 A	21	42	3 1/2 x 3 1/2 x 5 1/4	LA	\$29.70
M8024	70 CT	1 A	30	60	3 1/2 x 3 1/2 x 4 3/8	JA	\$25.65
M8056	80 CT	.6 A	35	70	2 3/8 x 3 1/2 x 4 3/4	HA	\$22.20

*Full-wave CT. †Full-wave bridge. ‡Primary 115 V only. §Series. †Fig. K.

400 Hz ISOLATION TRANSFORMERS (FIG. P)

Electrostatic shielding. Also for use in either FW bridge or FW CT circuit. MIL Type TF4RX01—

Micro. No.	Input Volts	Output Volts	rms Amps	VA	Size, Inches W. x D. x H.	MIL Case	Net, 1-9*
M8059	115	115 CT	.35	40	1 1/2 x 1 1/2 x 2 1/2	EB	\$4.70
M8060	115	115 CT	1.3	150	2 3/8 x 2 3/8 x 3 13/16	GA	\$26.40
M8061	115*	115 CT	2.6	300	3 1/2 x 3 1/2 x 4 3/4	JA	\$36.30
M8062	115*	115 CT	4.4	500	3 3/8 x 3 1/2 x 5 1/4	KA	\$43.50
M8082†	26	12.6 CT	.15	1.9	1 1/2 dia. x 1 1/2	YY	\$10.50
M8083	115	115 CT	.03	10	1 1/2 x 1 1/2 x 2 3/8	AJ	\$18.60
M8084	115	115 CT	.12	14	1 1/2 x 1 1/2 x 2 3/8	AJ	\$13.50
M8085	115	115 CT	.7	80	2 1/2 x 2 1/2 x 3 3/8	FA	\$23.55

*Primary 105/115/125 V. †Fig. K.

★SEE LAST MICROTRAN PAGE FOR QUANTITY PRICING

400 Hz TOROIDAL POWER TRANSFORMERS (FIG. W)

Ideal for applications requiring minimum size and weight. Feature epoxy molded case and printed circuit pins which can be bent for chassis mounting. Toroidal cores provide greater efficiency and low phase shift. All have 115 V primary windings and center .170" clearance hole for #8 screw. MIL Type TF5SX01ZZ.

Micro. No.	Secondary		VA	Size, Inches O.D. x Ht.	Wt., Oz.	Net Ea., 1-9*
	V	mA				
M8106	28 CT	320	9	1 1/2 x 1 1/2	2	\$15.30
M8107	28 CT	710	20	1 1/2 x 1 1/2	4	\$15.90
M8108	56 CT	160	9	1 1/2 x 1 1/2	2	\$15.60
M8109	56 CT	356	20	1 1/2 x 1 1/2	4	\$16.20
M8110	115 CT	78	9	1 1/2 x 1 1/2	2	\$15.90
M8111	115 CT	170	20	1 1/2 x 1 1/2	4	\$16.50

60 Hz ISOLATION/POWER TRANSFORMERS (FIG. P)

Electrostatic shielding. Center tap permits use in either FW bridge or FW CT circuit. MIL type TF4X01—

Micro. No.	Input Volts	Output Volts	rms Amps	VA	Size, Inches W. x D. x H.	MIL Case	Net Ea., 1-9*
M8095	115	115 CT	.03	3.5	1 1/2 x 1 1/2 x 2 3/8	EA	\$18.90
M8096*	115	115 CT	.35	40	2 3/8 x 2 3/8 x 3 3/8	GA	\$19.50
M8078*	115	115 CT	.9	100	3 3/8 x 3 1/2 x 5 1/4	KA	\$29.10

*Primary 105/115/125 V.

FILTER INDUCTORS (FIG. P)

For transistor and low-voltage applications. May be connected in series or parallel for varied inductive requirements. MIL Type TF4RX04— Tested 1500 V.

Microtran No.	Series Connected			Parallel Connected			MIL Case	Net Each, 1-9*
	Induct. H	DC Amps	DC Res. Ohms	Induct. H	DC Amps	DC Res. Ohms		
M8098	3.5	.05	200	.875	.10	50	AH	\$ 9.90
M8099	1.0	.15	65	.25	.30	16	AJ	\$12.90
M8100	.5	.3	30	.125	.6	7.5	EB	\$14.70
M8101	.32	.6	16	.08	1.2	4	FB	\$16.65
M8102	.2	1.0	4	.05	2.0	1	JA	\$21.60
M8103	.07	2.5	.84	.0175	5.0	.21	JA	\$24.00
M8104	.022	4.0	.4	.0055	8.0	.1	JA	\$22.80
M8105	.022	5.0	.2	.0055	10	.05	KA	\$25.65

STANDARD MIL-T-27B CASE SIZES

Case symbol YY—all metal cases not included below or with non-standard mounting centers. Case symbol ZZ—open type and encapsulated units. In tabulation below, * indicates not in conformance with MIL-T-27B; † indicates two studs in a diagonal.

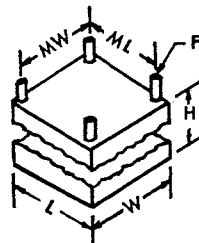

Case Type	Size, Inches W. x L. x H.	Mtg. Centers, In.		Stud Type F
		MIL	MW	
AF	3/4 x 3/4 x 1 1/8	1 1/8*	...	4-40 x 3/8
AG	1 x 1 x 1 1/8	1 1/8*	...	6-32 x 3/8
AH	1 1/2 x 1 1/2 x 2 3/8	1 3/4†	...	6-32 x 3/8
AJ	1 1/2 x 1 1/2 x 2 3/8	1 1/2	...	6-32 x 3/8
EA	1 1/2 x 1 1/2 x 2 3/8	1 1/2	...	6-32 x 3/8
EB	2 1/2 x 2 1/2 x 3 1/8	2 1/2	...	6-32 x 3/8
FB	2 1/2 x 2 1/2 x 3 1/8	1 1/2	...	6-32 x 3/8
FA	2 1/2 x 2 1/2 x 3 1/8	2 1/2	...	6-32 x 3/8
GA	2 3/8 x 3 1/2 x 4 3/4	2 1/8	1 3/4	6-32 x 3/8
HA	2 3/8 x 3 1/2 x 4 3/4	2 1/8	1 3/4	6-32 x 3/8
JA	3 1/2 x 3 1/2 x 5 1/4	3	2 1/8	8-32 x 3/8
JB	3 1/2 x 3 1/2 x 5 1/4	3	2 1/8	8-32 x 3/8
KA	3 3/8 x 3 1/2 x 5 1/4	3	2 1/8	10-32 x 3/8
LA	3 1/2 x 4 1/2 x 5 1/4	3 1/2	2 1/8	10-32 x 3/8
LB	4 1/2 x 5 1/2 x 5 1/2	4 1/2	3 1/8	1/4-20 x 3/8
OA	4 3/8 x 5 3/8 x 6 3/8	3 3/4	3	1/4-20 x 3/8

MICROTRAN MINIATURIZED MILITARY TOROIDAL INDUCTORS



ULTRA-MINIATURE TOROIDAL INDUCTORS—QE-M SERIES

Affords new application opportunities in high density packaging. Ultra miniaturized with low height design. Exceptionally high "Q" and wide frequency range. Available on special order with =1% inductance tolerance. Frequency range of QEL Series 1 to 300 kHz; QEM, 3 to 500 kHz. Accuracy, =2%. Molded in epoxy resin with .020" x 2" gold-plated nickel alloy leads. Size, .450" dia. x .285".

Induc-tance	QEL-M Series				QEM-M Series			
	Microtran No.	Typ. DC Res., Ohms	Typ. Dist. Cap., pF	Net Ea., Lots of 1-9*	Microtran No.	Typ. DC Res., Ohms	Typ. Dist. Cap., pF	Net Ea., Lots of 1-9*
.5 mH								
1 mH	*QEL1-M	1.5	9	\$7.90	*QEM05-M	1.6	9	\$8.40
2 mH	*QEL2-M	2.7	10	7.90	*QEM1-M	2.8	10	8.40
5 mH	*QEL5-M	6.7	13	8.40	*QEM2-M	6.1	12	8.40
10 mH	*QEL10-M	15.6	15	8.40	*QEM5-M	16	15	8.85
15 mH	*QEL15-M	24	18	9.00	*QEM10-M	29	19	9.15
25 mH	*QEL25-M	38	22	9.15	*QEM15-M	43	21	9.45
50 mH	*QEL50-M	55	25	9.15	*QEM25-M	56	25	9.75
100 mH	*QEL100-M	125	30	9.60	*QEM50-M	127	30	

*These items not normally carried in stock; available on special order only.

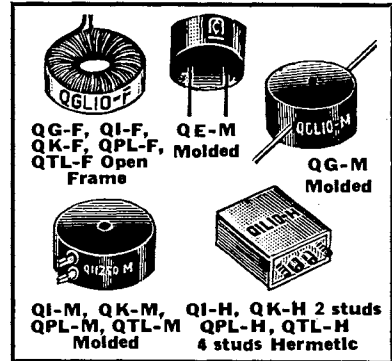

MICRO-MINIATURE TOROIDAL INDUCTORS—QG SERIES

Frequency range of QGL Series, to 20 kHz; QGM Series, 2 to 100 kHz. Accuracy, =2%. **QG-F:** Open frame, microcrystalline wax dipped with 4" #28 plastic leads. Size, 3/8" dia. x 3/16". **QG-M:** Molded in high temperature epoxy resin with .020" x 2" gold plated nickel alloy leads. Leads may be bent downward for plug-in

printed circuit use. Size, 7/8" dia. x 3/8". **QGH:** Hermetically sealed on special order only (\$12.50 setup charge in Lots of 1-49). Size, 1 1/4" dia. x 1 3/8". **QG-HC:** Hermetic crystal can. Special order only; prices setup charge same as QG-H Series. Size, 2 3/4" x 1 1/2" x 4 9/16".

QGL SERIES

Microtran No.†	Induc-tance	Typ. DC Res., Ohms	Typ. Dist. Cap., pF	Net Each, Lots of 1-9*		
				-F	-H	-M
QGL5-	5 mH	2.5	30	\$4.35	\$7.50	\$6.60
QGL10-	10 mH	5	33	4.35	7.50	6.60
QGL15-	15 mH	8	34	4.50	7.65	6.75
*QGL30-	30 mH	17	37	4.65	7.80	6.90
QGL50-	50 mH	28	40	4.80	7.95	7.05

Microtran No.†	Induc-tance	Typ. DC Res., Ohms	Typ. Dist. Cap., pF	Net Each, Lots of 1-9*		
				-F	-H	-M
QGL100-	100 mH	50	42	\$4.95	\$ 8.40	\$7.20
QGL250-	250 mH	130	46	5.10	8.40	7.35
QGL500-	500 mH	290	48	5.85	9.15	8.85
QGL1000-	1.0 H	530	51	6.75	9.60	9.45
QGL1500-	1.5 H	825	53	6.90	10.20	9.90

QGM SERIES

QGM1-	1 mH	1.4	22	\$4.80	\$8.10	\$7.05
QGM2-	2 mH	2.5	25	4.80	8.10	7.05
QGM5-	5 mH	6	28	5.10	8.25	7.20
QGM10-	10 mH	12	31	5.25	8.25	7.35

QGM15-	15 mH	18	32	\$5.40	\$8.40	\$7.50
QGM25-	25 mH	30	35	5.70	8.55	7.65
QGM50-	50 mH	52	37	6.30	9.60	7.80
*QGM100-	100 mH	115	39	6.45	9.90	8.55

SUBMINIATURE TOROIDAL INDUCTORS—QIL SERIES

Frequency range to 20 kHz; accuracy, =2%. **QIL-M:** Molded in high temperature epoxy with silver plated turret lugs. Size, 1 1/4" dia. x 3/4". **QIL-H:** Hermetically sealed in metal case with Teflon®

terminals. Size, 1 1/4" x 1 1/2" x 1 1/2". **QIL-F:** Open frame. Microcrystalline wax dipped with 4" #28 plastic leads. Size, 1" dia. x 1 1/2". @Registered DuPont trademark

*QIL3-	3 mH	.73	36	\$3.90	\$6.75	\$6.30
QIL5-	5 mH	1.1	38	3.90	6.75	6.30
QIL10-	10 mH	2.1	40	3.90	6.75	6.30
*QIL15-	15 mH	3.3	42	3.90	6.75	6.45
QIL25-	25 mH	5.3	45	4.05	7.20	6.45
QIL50-	50 mH	11	47	4.05	7.20	6.60
QIL100-	100 mH	22	49	4.20	7.65	6.90

*QIL150-	150 mH	34	50	\$4.35	\$ 7.80	\$ 7.05
QIL250-	250 mH	55	53	4.50	8.25	7.20
QIL500-	500 mH	95	55	4.80	8.55	7.65
QIL1000-	1.0 H	210	57	5.10	9.00	8.10
*QIL1500-	1.5 H	335	59	5.85	9.45	8.85
QIL2500-	2.5 H	550	61	6.75	10.80	10.35

MINIATURE TOROIDAL INDUCTORS—QK SERIES

Frequency range of QKL Series, to 10 kHz; QKM Series, 5 to 50 kHz. Accuracy, =2%. **QK-F:** Open frame, microcrystalline wax dipped; 4" #28 plastic leads. Size, 1 1/4" dia. x 3/8". **QK-H:** Hermetic

with Teflon terminals. Size, 1 1/2" x 2 3/8" x 1 1/4". **QK-M:** Molded in high temperature epoxy resin; silver plated turret lugs. Size, 1 3/8" dia. x 3/8"; #8 clearance hole.

QKL SERIES

*QKL5-	5 mH	.62	60	\$4.35	\$7.05	\$6.90
QKL10-	10 mH	1.1	66	4.50	7.20	6.90
*QKL15-	15 mH	1.7	68	4.50	7.35	6.90
*QKL25-	25 mH	2.8	72	4.65	7.50	7.05
QKL50-	50 mH	6	76	4.65	7.80	7.05
QKL100-	100 mH	11	81	4.80	8.40	7.50
*QKL150-	150 mH	17	83	4.95	8.55	7.65

QKL250-	250 mH	28	87	\$4.95	\$ 8.85	\$ 7.80
QKL500-	400 mH	63	91	5.10	9.15	7.95
QKL1000-	1.0 H	110	96	5.25	9.60	8.40
*QKL1500-	1.5 H	175	98	5.40	9.75	8.55
*QKL2500-	2.5 H	275	103	6.00	10.05	8.70
QKL5000-	5 H	645	106	6.75	11.10	9.60
QKL10,000-	10 H	1175	112	7.50	12.45	10.95

QKM SERIES

QKM2-	2 mH	.45	52	\$5.10	\$8.25	\$7.50
QKM5-	5 mH	1.1	58	5.25	8.40	7.50
QKM10-	10 mH	2.5	62	5.25	8.55	7.65
*QKM25-	25 mH	6.5	70	5.40	8.85	7.80
*QKM50-	50 mH	11	74	5.55	9.00	7.95

*QKM100-	100 mH	25	79	\$5.70	\$ 9.00	\$8.10
*QKM250-	250 mH	65	87	5.85	9.30	8.40
*QKM500-	500 mH	115	92	6.15	9.60	8.70
*QKM1000-	1.0 H	250	97	6.45	10.65	9.90

HIGH-Q TOROIDAL INDUCTORS—QPL SERIES

Frequency range to 10 kHz; accuracy, =2%. **QPL-F:** Open frame, microcrystalline wax dipped; 4" #24 leads. Size, 1 1/4" dia. x 3/8". **QPL-H:** Hermetically sealed with Teflon terminals. Size, 1 1/4" x 9/16"

1 1/4" x 2 3/8". **QPL-M:** Molded in high temperature epoxy resin; silver plated turret lugs. Size, 2" dia. x 1".

QPL25-	25 mH	1.5	100	\$6.90	\$10.35	\$ 9.90
QPL50-	50 mH	2.5	105	7.05	10.50	10.05
QPL100-	100 mH	6	110	7.20	10.65	10.20
*QPL250-	250 mH	15	115	7.35	10.80	10.50
QPL500-	500 mH	25	120	7.50	10.95	10.80
QPL1000-	1.0 H	60	125	7.80	11.40	11.25
*QPL1500-	1.5 H	90	130	8.10	11.70	11.55

*QPL2500-	2.5 H	150	133	\$ 8.70	\$12.30	\$12.15
QPL5000-	5.0 H	350	138	9.45	13.20	12.90
*QPL7500-	7.5 H	525	140	10.05	14.10	13.65
QPL10,000-	10 H	600	142	11.10	15.00	14.85
*QPL15,000-	15 H	900	146	12.00	15.75	15.60
QPL25,000-	25 H	1500	150	13.05	17.55	17.40

HIGH-Q TOROIDAL INDUCTORS—QTL SERIES

Frequency range to 15 kHz; accuracy, =2%. **QTL-F:** Open frame, microcrystalline wax dipped; 4" #24 leads. Size, 2 1/4" dia. x 1".

QTL-H: Hermetic, Teflon terminals. Size, 2 1/4" x 1 1/2" x 2 1/4". **QTL-M:** Molded in epoxy resin. Size, 2 3/8" dia. x 1 3/8".

*QTL25-	25 mH	0.85	127	\$10.80	\$13.50	\$12.60
QTL50-	50 mH	1.5	136	10.95	13.65	12.75
QTL100-	100 mH	2.8	144	11.25	13.95	13.05
*QTL150-	150 mH	3.9	149	11.70	14.25	13.65
*QTL250-	250 mH	7	156	12.00	14.55	13.95
QTL500-	500 mH	15	164	12.15	14.85	13.95
*QTL1000-	1.0 H	27	173	12.15	15.15	13.95

*QTL1500-	1.5 H	40	177	\$12.45	\$15.45	\$14.25
QTL2500-	2.5 H	70	184	13.05	16.05	14.85
QTL5000-	5 H	140	192	13.05	16.65	15.00
*QTL10,000-	10 H	270	200	14.25	17.25	16.20
*QTL15,000-	15 H	430	205	15.30	18.30	17.25
QTL25,000-	25 H	850	212	16.50	19.50	18.45
*QTL50,000-	50 H	1500	221	22.20	25.20	24.15

*These items not normally carried in stock; available on special order.

★SEE LAST MICROTRAN PAGE FOR QUANTITY PRICING. †ORDER BY COMPLETE MICROTRAN NUMBER (QGL5-F)

MICROTRAN TRANSFORMERS AND CHOKES



60 Hz CONTROL/POWER SUPPLY TRANSFORMERS

For low voltage, high current applications such as filament supplies, relays, silicon rectifiers, etc. Primary 105/115/125 VAC. Open frame construction.

Micro. No.	Fig.	Secondary		Rectifier		Size, Inches W. x D. x H.	Net Ea., 1-9*
		VAC	rms A	VDC*	VDC†		
M8242	X	6.3 CT	.6	1.9	3.8	2 3/8 x 1 3/8 x 1 1/2	\$ 3.75
M8243	X	6.3 CT	2.0	1.9	3.8	2 3/8 x 1 3/8 x 1 1/2	4.50
M8286	X	6.3 CT	6.0	1.9	3.8	3 11/16 x 2 1/2 x 2 1/4	5.55
M8287	X	12.6 CT	3.0	4.7	9.4	3 11/16 x 2 1/2 x 2 1/4	5.55
M8247#	Y	12	4.0	9.95	19.85	4 1/8 x 3 1/8 x 3 3/4	12.15
		12	4.0	9.95	19.85		
M8244	Y	12.6 CT	2.0	10.55	21.5	3 3/8 x 2 3/8 x 3 3/8	7.95
		12.6	2.0	10.55	21.5		
M8222	Y	18.5 CT	3.0	7.4	14.8	3 3/8 x 2 1/2 x 3 3/8	7.20
M8288	X	26 CT	2.5	10.8	21.6	3 x 2 3/4 x 2 3/4	7.05
M8245	X	28 CT	6	11.7	23.4	2 3/8 x 2 1/2 x 1 1/2	5.55
M8255	Y	30 CT	2.5	12.5	25	3 3/8 x 2 3/8 x 3 1/2	8.25
M8223	Y	35 CT	3.0	14.5	29	4 1/4 x 3 x 3 3/4	12.45
M8289	X	40 CT	.1	17	34	2 3/8 x 1 3/8 x 1 1/2	3.75
M8290	X	40 CT	.1	17	34	2 13/16 x 1 3/8 x 1 1/2	4.50
M8291	X	40 CT	.75	17	34	3 11/16 x 2 1/2 x 2 1/4	5.55
M8246	Y	49 CT	2.5	21	42	4 1/2 x 3 1/2 x 4 1/2	8.70
M8224	Y	70 CT	1.0	30	60	3 3/8 x 2 3/8 x 3 1/2	8.25
M8256	Y	80 CT	.6	35	70	3 x 2 3/8 x 2 3/8	7.05

DC output for resistive or inductive load, output volts based on 1 V approx., drop/rectifier. Full wave *CT; †bridge. †Series. †Sec. connected series, 24 V at 4 A; parallel, 12 V at 8 A.

60 Hz ISOLATION AND POWER TRANSFORMERS

With center tap for use in either full wave bridge or full wave CT circuitry. Electrostatic shielding; open frame.

Micro. No.	Fig.	Volts		rms Amps	VA	Size, Inches W. x D. x H.	Net Ea., 1-9*
		Input	Output				
M8294	X	115	115 CT	.0085	1	2 1/8 x 1 1/8 x 1 1/8	\$ 3.90
M8295	X	115	115 CT	.030	3.5	2 13/16 x 1 1/8 x 1 1/8	5.25
			12.6 CT	.25	3.15		
			12.6	.25	3.15		
M8296	Z	115*	115 CT	.35	40	2 3/8 x 3 3/8 x 2 3/4	7.20
M8278	Y	115*	115 CT	.9	100	3 3/8 x 3 1/8 x 3 1/2	12.45

*Primary 105/115/125 volts.

FILTER INDUCTORS (FIG. X)

Windings may be connected in series or parallel for varied inductive requirements. Tested at 1500 volts.

Micro- tran No.	Series Connected			Parallel Connected			Mtg. Ctrs., Inches	Net Each, 1-9*
	Ind., H.	DC Amps	DCR Ohms	Ind., H.	DC Amps	DCR Ohms		
M8198	3.5	.050	200	.875	.10	50	1 3/4	\$ 2.85
M8199	1.0	.15	65	.25	.30	16	2	3.00
M8200	.5	.3	30	.125	.6	7.5	2 3/8	3.30
M8201	.32	.6	16	.08	1.2	4	2 1/2	4.20
M8202*	.2	1.0	4	.05	2.0	1	2 1/8 x 2 1/8	9.60
M8203*	.07	2.5	.84	.0175	5.0	.21	3 1/2 x 2 1/2	11.25
M8204*	.022	4.0	.4	.0055	8.0	.1	2 3/8 x 2 1/2	10.95
M8205*	.022	5.0	.2	.0055	10	.05	3 3/8 x 2 1/2	13.20

*Fig. Y.

DECI-MINIATURE PC CHOKES (FIG. U)

For audio frequency, servo mechanisms, computer applications, etc. Size: 1 1/8" w. x 1 1/2" d. x 1 1/4" h. Open frame.

Micro. No.	Inductance, Henries		DC Res., Ohms	Net Each, 1-9*
	At 0 mA	At Rated Cur.		
DCM51-PC	10	5 at 3 mA	300	\$3.60
DCM52-PC	5	2 at 5 mA	155	3.30
DCM53-PC	2.5	1 at 7 mA	75	3.15

TRANSISTOR AUDIO TRANSFORMERS (FIG. X)

Designed for input, interstage, isolation, output and impedance matching of solid state circuits. Primary and secondary windings may be interchanged with only slight differences in impedance ratios. Open frame construction. Size: 8316, 1 1/8" w. x 1 1/8" d. x 2 1/8" h.; 8304, 5, 11 and 13, 2 1/8" w. x 1 1/4" d. x 1 3/8" h.; all others, 2 3/8" w. x 1 3/8" d. x 1 3/8" h.

Micro- tran No.	Impedance		Unbal. Pri. mADC	Level Watts	Freq. Resp. ± 2 db, Hz	Net Each, 1-9*
	Pri.	Sec.				
M8302	560	400 CT	18	.15	200-20K	\$4.20
M8303	825 CT	100 CT	20	1.5	200-20K	4.35
M8304	5400	600 CT	15	.075	200-20K	3.90
M8305	7000	320 CT	7	.040	70-15K	4.05
M8308	25	3-4	600	3.0	200-20K	3.90
M8309	48 CT	3.2/8.0	50	5.0	200-20K	4.05
M8310	120 CT	1000	40	6.0	300-15K	4.20
M8311	125 CT	3-4	20	1.5	200-15K	4.20
M8312	140 CT	500	50	6.0	300-15K	4.20
M8313	250 CT	3-4	20	.4	70-15K	3.75
M8315	1600 CT	800	5.0	2.5	150-20K	4.05
M8316	2500 CT	12	4.0	.1	300-15K	3.60

MICROPHONE INPUT TRANSFORMERS (FIG. T)

Broadcast fidelity type, double mu-metal shielded. M8030 designed to replace Ampex No. 1733-1. Frequency response, ± 2 db, 20-20,000 Hz except M8027, 50-20,000 Hz, and M8031, 30-20,000 Hz. Magnetic shielding, 65 db; low level, 5 dbm.

Micro. No.	Impedance, Ohms		Size, In. H. x Dia.	Base	Wt., Oz.	Net Ea., 1-9*
	Primary	Sec.				
M8027	200	40K	2 3/8 x 1 1/8 x 1 1/8	*	2	\$ 9.00
M8030	200/50 CT	50K	2 1/8 x 1 1/8	Octal	6	13.50
M8031	600 CT/150	50K	2 1/8 x 1 1/8	Octal	6	13.35
M8032	250 CT	50K	2 1/8 x 1 1/8	9-pin†	6	13.05
M8033	50 CT	50K	2 1/8 x 1 1/8	9-pin†	6	13.05
M1-S	50/250 CT	50K	1 1/2 x 1 1/8	Wire leads§	3	10.95

*In-line, 20" shielded cable; 25 db single mu-metal magnetic shield; Fig. AA. †Mates with many RCA amplifier sockets. §Fig. II.

DECI-MINIATURE PC TRANSFORMERS (FIG. U)

Primary and secondary windings may be interchanged to obtain varied matching requirements such as input, interstage, output and isolation. Designed for printed circuits; frequency response: ± 2 db, 200-15,000 Hz. Size: 1 3/8" w. x 1 1/2" d. x 3/4" h.

Micro. No.	Impedance		Unbal. Pri. mADC	Oper. Level dbm	Net Each, 1-9*
	Primary	Secondary			
1-PC	25K CT	1200 CT	2	18	\$4.95
2-PC	15K CT	15K CT	3	19	5.10
3-PC	15K CT	600 CT	3	19	4.80
4-PC	10K CT	5000 CT	4	20	4.95
5-PC	10K CT	2500/625 split	2	20	4.95
6-PC	10K CT	1500 CT	4	20	4.65
7-PC	5000 CT	80K CT	6	15	5.25
8-PC	4000 CT	1200 CT	6	20	4.50
9-PC	4000 CT	600 CT	6	20	4.35
10-PC	4000	600/150 split	3	20	4.80
11-PC	2500 CT	2500 CT	8	20	4.50
12-PC	2500	2500/625 split	4	20	4.80
13-PC	2500 CT	625 CT	8	20	4.35
14-PC	2500 CT	200 CT	8	20	4.20
18-PC	600 CT	50K CT	16	20	4.65
19-PC	600	8000/2000 split	8	20	4.80
20-PC	600 CT	200 CT	16	20	4.05
21-PC	600 CT	600 CT	16	20	4.05
22-PC	250 CT	600 CT	25	20	4.05

*QUANTITY PRICING

Net Each, 1-9	Net Each, Lots of			Net Each, 1-9	Net Each, Lots of			Net Each, 1-9	Net Each, Lots of			Net Each, 1-9	Net Each, Lots of		
	10- 49	50- 99	100- 249		10- 49	50- 99	100- 249		10- 49	50- 99	100- 249		10- 49	50- 99	100- 249
\$1.05	\$0.95	\$0.88	\$0.70	\$ 7.35	\$ 6.62	\$ 6.13	\$4.90	\$12.30	\$11.07	\$10.25	\$ 8.20	\$17.55	\$15.80	\$14.63	\$11.70
1.35	1.22	1.13	.90	7.50	6.75	6.25	5.00	12.45	11.21	10.38	8.30	18.00	16.20	15.00	12.00
1.95	1.76	1.63	1.30	7.65	6.89	6.38	5.10	12.60	11.34	10.50	8.40	18.30	16.47	15.25	12.20
2.85	2.57	2.38	1.90	7.80	7.02	6.50	5.20	12.75	11.48	10.63	8.50	18.45	16.61	15.38	12.30
3.00	2.70	2.50	2.00	7.95	7.16	6.63	5.30	12.90	11.61	10.75	8.60	18.60	16.74	15.50	12.40
3.15	2.84	2.63	2.10	8.10	7.29	6.75	5.40	13.05	11.75	10.88	8.70	18.90	17.01	15.75	12.60
3.30	2.97	2.75	2.20	8.25	7.43	6.88	5.50	13.20	11.88	11.00	8.80	19.05	17.15	15.88	12.70
3.45	3.11	2.88	2.30	8.40	7.56	7.00	5.60	13.35	12.02	11.13	8.90	19.50	17.55	16.25	13.00
3.60	3.24	3.00	2.40	8.55	7.70	7.13	5.70	13.50	12.15	11.25	9.00	21.60	19.44	18.00	14.40
3.75	3.38	3.13	2.50	8.70	7.83	7.25	5.80	13.65	12.29	11.38	9.10	21.90	19.71	18.25	14.60
3.90	3.51	3.25	2.60	8.85	7.97	7.38	5.90	13.80	12.42	11.50	9.20	22.20	19.98	18.50	14.80
4.05	3.65	3.38	2.70	9.00	8.10	7.50	6.00	13.95	12.56	11.63	9.30	22.80	20.52	19.00	15.20
4.20	3.78	3.50	2.80	9.15	8.24	7.63	6.10	14.10	12.69	11.75	9.40	23.25	20.93	19.38	15.50
4.35	3.92	3.63	2.90	9.30	8.37	7.75	6.20	14.25	12.83	11.88	9.50	23.55	21.20	19.63	15.70
4.50	4.05	3.75	3.00	9.45	8.51	7.88	6.30	14.40	12.96	12.00	9.60	24.00	21.60	20.00	16.00
4.65	4.19	3.88	3.10	9.60	8.64	8.00	6.40	14.55	13.10	12.13	9.70	24.15	21.74	20.13	16.10
4.80	4.32	4.00	3.20	9.75	8.78	8.13	6.50	14.70	13.23	12.25	9.80	24.50	22.68	21.00	16.80
4.95	4.46	4.13	3.30	9.90	8.91	8.25	6.60	14.85	13.37	12.38	9.90	25.50	22.95	21.25	17.00
5.10	4.59	4.25	3.40	10.05	9.05	8.38	6.70	15.00	13.50	12.50	10.00	25.65	23.09	21.38	17.10
5.25	4.73	4.38	3.50	10.20	9.18	8.50	6.80	15.15	13.64	12.63	10.10	26.10	23.49	21.75	17.

OHMITE variable transformers

Unique for the design innovations they incorporate, Ohmite "OHMITRAN" v.t.® variable transformers include exclusive field-proven features. They offer long, low maintenance operation with excellent regulation at any voltage setting within the rated load plus an output free of waveform distortion. Six frame sizes offer a wide range of electrical ratings to meet most industrial applications. These include three new, compact, low-power models (VT1, VT02, VT3,) which permit a fine choice of six ratings from 1 to 3 amperes.

The VT1, rated 1 ampere, is the smallest commercial variable transformer available.

UL LISTING: Most single and tandem VT4, VT8 and VT20 transformers used for 120 volt line operation are Underwriters' Laboratories listed. Consult factory for specific approvals.

POSITIVE CURRENT TRANSFER... achieved with specially designed brushes connected through high conductivity contact arms or pigtails to a large slip ring which contacts a wide area of the collector ring. The brush contact assembly on the VT1, VT02, and VT3 is instantly replaceable, when necessary, as a result of a slide-on, snap-in design. Brushes of the other models are easily replaced also.

ADJUSTABLE SHAFT: On all Ohmite transformers, except the VT2LN, the shaft may be extended out from either the brush or opposite side as desired. On the VT1, VT02 and VT3, both single and tandem assemblies, this is an exclusive Ohmite feature which affords greater versatility of mounting and application. For example, substitution of a longer shaft or extension of the standard shaft allows actuation of other devices, such as switches or potentiometers without special construction. The shaft is freed simply by loosening set screw in the hub assembly. A double flat on the shaft permits two knob positions.

On the VT4, VT8, and VT20 types, the adjustable shaft feature permits table or panel use. "Ganged" or tandem VT4, VT8 and VT20 units employ a thru-shaft offering the same flexibility. On VT4 and VT8 units, shafts are fixed in the desired position by means of socket head screws located in the hub of each "brush-radiator" plate. The VT20 employs a unique collet-type shaft lock.

INTERCHANGEABLE WITH OTHER POPULAR TYPES: Basic "v.t." units have mounting provisions which match those of virtually all popular transformers

of comparable current rating. Models VT4, VT8 and VT20 mount by means of bolts. Normally 3-hole mounting, single VT4 units can be "4-hole mounted" by means of adapter plate, see page 34. Individual Model VT1, VT02, VT2LN, or VT3 units mount by means of a standard 3/8-32 threaded bushing. All tandem assemblies mount by means of bolts or nuts. Knob, dial and mounting hardware are included with each transformer.

DIRECT READING, TWO SCALE DIAL... calibrated on one side for over-voltage connection; on the reverse side for line voltage connection. Dials normally included with transformer read clockwise for increasing voltage; counter-clockwise calibration available—see page 27.

WIRING AND CONNECTIONS: Wiring instructions to arrange various modes of operation are enclosed with all OHMITE variable transformers. Terminal panels or adjacent nameplate carry convenient wiring diagram, coded terminals and input and output data. Three way terminals on VT1, VT2LN, VT02, VT3 will accept 1/4" push-on connectors, screws and nuts, or conventional soldering.

ROTATION OPTION: On VT4, VT8 and VT20 transformers connected for over-voltage, either clockwise or counter-clockwise increase of voltage can be arranged easily by the user. Increasing voltage in either direction can be arranged on all units connected for no-overvoltage output. Dials for counter-clockwise operation are stocked. See "Accessories."

OVERVOLTAGE OPTION: On all transformers with overvoltage feature, no-overvoltage operation can be arranged on the terminal panel.

NO-OVERVOLTAGE TRANSFORMERS ("N" suffix): Provide considerably more current due to heavier gage winding.

240-VOLT INPUT ("H" suffix): On units which are wound for 240-volt input, a 120 volt input tap is also provided. With the use of this input, the maximum current rating applies up to 120 volts output but beyond this reduces proportionately to approximately 50% at maximum voltage output.

LOW VOLTAGE INPUT ("L" feature): Designed for a maximum input of approximately 40 volts, with high current output.

GROUNDING INPUT & OUTPUT ("C" feature): Units in type F or G cases can be provided with a three-conductor cord and outlet. One conductor is grounded to the case. This feature standard on all cased VT20 units and on all metered units.

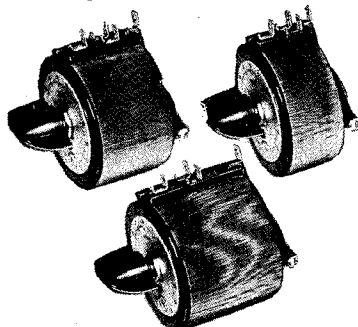

VT1, VT02, VT2LN, VT3, SINGLE, UNCASED
Angle of rotation 320° ± 5°

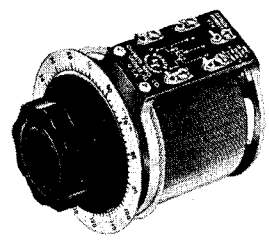

VT4 TYPES, SINGLE, UNCASED
Angle of rotation: 324° ± 5°

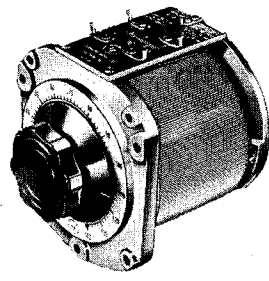

VT8 TYPES, SINGLE, UNCASED
Angle of rotation: 324° ± 5°

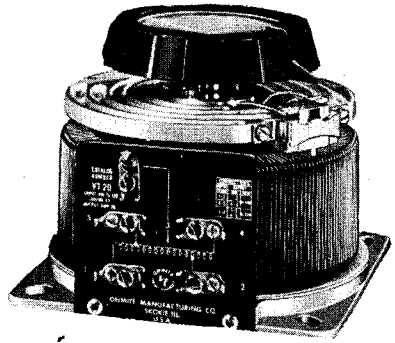

VT20 TYPES, UNCASED
Angle of rotation: 317° ± 5°

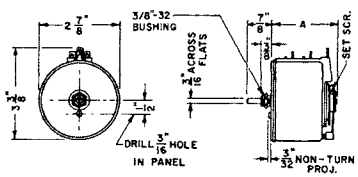

"A" DIMENSION

VT1, VT1N	1 13/16"
VT02, VT02N	2 5/16"
VT2, VT3N	2 1/16"

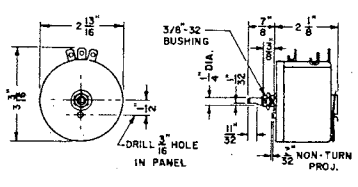

VT2LN
U.S. Patent Nos. 2,790,882
2,985,857

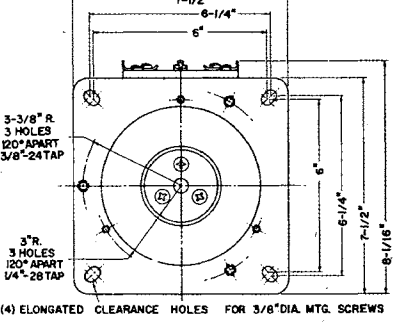
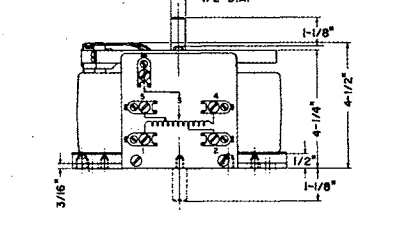
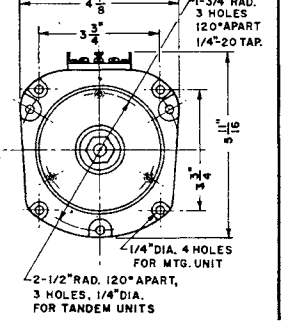
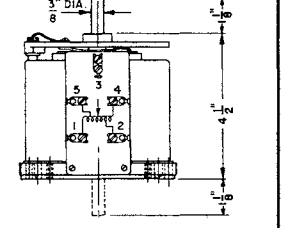
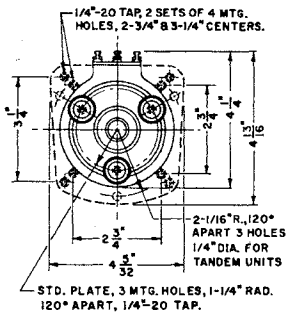
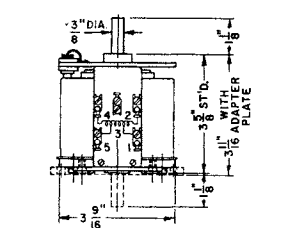

ENCLOSED OR CASED UNITS: In grey wrinkle finish. "Basic protective enclosures" (Type B) expose the transformer's terminal panel and mounting base and are supplied presently on VT20 models only. (See tandems in "B" enclosures below.) "Fixed mounting enclosures" (Type E) are intended for permanent mounting on table, panel or in-conduit-line. Standard portable units (Type F) carry a line cord, outlet socket, and fuse except for VT20F which has a circuit breaker. Deluxe portable units (Type G) utilize a circuit breaker, can be switched to overvoltage or no-overvoltage as desired, have a handle which also serves as an easel.

METERED ENCLOSURES: VT8NFC, VT8GC, VT20NFC and VT20GC transformers are available with voltmeter (V), voltmeter and ammeter (A) or voltmeter and wattmeter (W). The metered transformer enclosures are larger than the non-metered types of comparable designation, (see dimensions below). All stock metered units have the three-conductor grounded cord and outlet and all, except the VT8NF group, are equipped with carrying handles.

SINGLE UNIT CASE DIMENSIONS

Series	Case	W	D	H
VT1 or VT02	E	3 $\frac{3}{8}$ "	2 $\frac{1}{2}$ "*	4 $\frac{1}{4}$ "
	F	3 $\frac{3}{8}$ "	2 $\frac{1}{2}$ "*	4 $\frac{1}{4}$ "
VT4	E	4 $\frac{1}{2}$ "	4 $\frac{1}{2}$ "*	6 $\frac{1}{16}$ "
	F	4 $\frac{7}{8}$ "	4 $\frac{1}{2}$ "*	6 $\frac{1}{4}$ "
VT8	E	5 $\frac{1}{16}$ "	5 $\frac{1}{4}$ "*	7 $\frac{3}{16}$ "
	F	5 $\frac{1}{32}$ "	5 $\frac{1}{4}$ "*	7 $\frac{3}{8}$ "
	FV, FVA, FVW	7 $\frac{3}{8}$ "	5 $\frac{1}{4}$ "*	10 $\frac{1}{2}$ "
	G	5 $\frac{1}{16}$ "†	5 $\frac{1}{4}$ "*	7 $\frac{3}{8}$ "‡
	GV, GVA, GCW	7"	5 $\frac{1}{4}$ "*	10 $\frac{1}{2}$ "‡
	3E	5 $\frac{1}{16}$ "	15 $\frac{3}{4}$ "*	7 $\frac{3}{16}$ "
VT20	B	7 $\frac{3}{8}$ "	8 $\frac{1}{8}$ "	4 $\frac{7}{8}$ "*
	E	7 $\frac{3}{4}$ "	5 $\frac{1}{2}$ "*	10 $\frac{1}{16}$ "
	F	8 $\frac{1}{4}$ "	5 $\frac{1}{2}$ "*	11 $\frac{1}{4}$ "
	FV, FVA, FVW	8 $\frac{1}{4}$ "	5 $\frac{1}{2}$ "‡	14 $\frac{1}{2}$ "
	G	7 $\frac{3}{8}$ "§	5 $\frac{1}{2}$ "*	11 $\frac{1}{4}$ "‡
	GV, GVA, GW	8 $\frac{1}{4}$ "	5 $\frac{1}{2}$ "‡	14 $\frac{1}{2}$ "

* Add 1" for knob thickness for VT8 types; $\frac{7}{8}$ " for VT1, 02 and VT4 types, $1\frac{1}{4}$ " for VT20 types.

† 5 $\frac{1}{16}$ " including handle fittings.

‡ Case height only.

§ 9" including handle fittings.

◆ V, A and W = voltmeter, ammeter and wattmeter respectively.

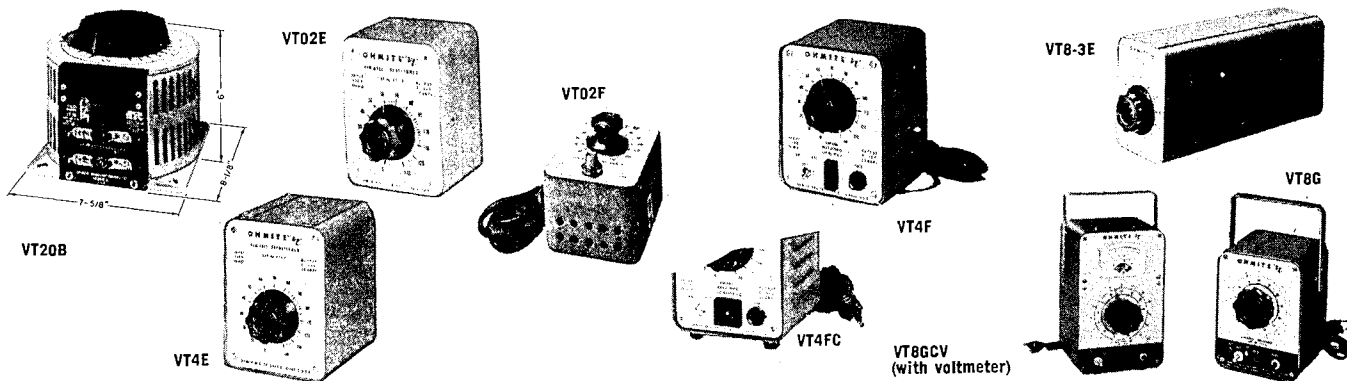

TANDEM OR GANGED UNITS: Two or 3-in-tandem assemblies are standard. Larger tandem assemblies available made to order. All tandem assemblies are normally furnished with inter-connections between the units. A few cased tandems are stocked. Tandems in "B" type enclosures have individual cases on each transformer.

TANDEM VT1, VT02, VT3 DIMENSIONS

	A	B	C
VT1	4 $\frac{7}{32}$ "	6 $\frac{17}{32}$ "	4 $\frac{1}{4}$ "
VT02	5 $\frac{7}{32}$ "	8 $\frac{1}{32}$ "	4 $\frac{1}{2}$ "
VT3	6 $\frac{17}{32}$ "	9 $\frac{27}{32}$ "	4 $\frac{1}{2}$ "

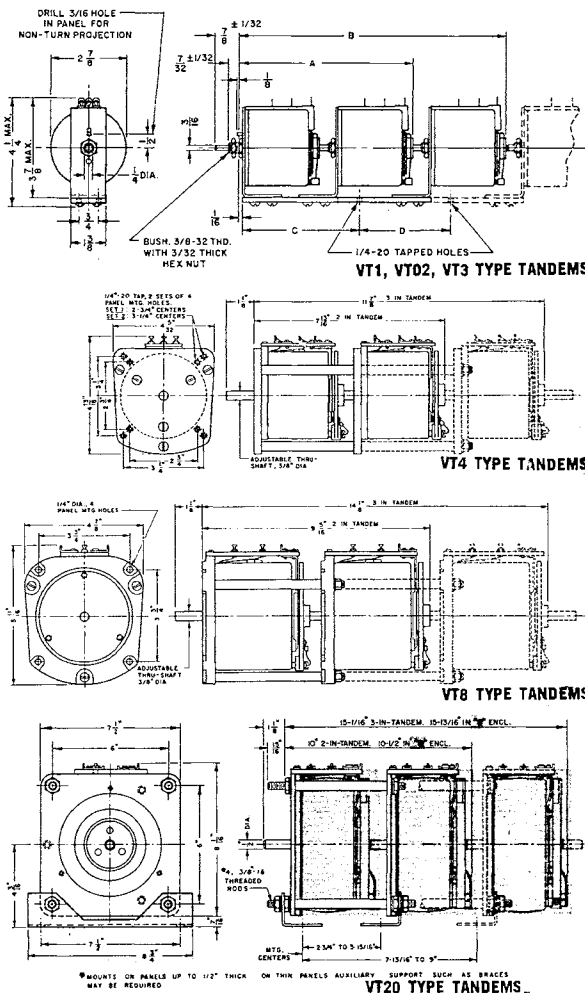
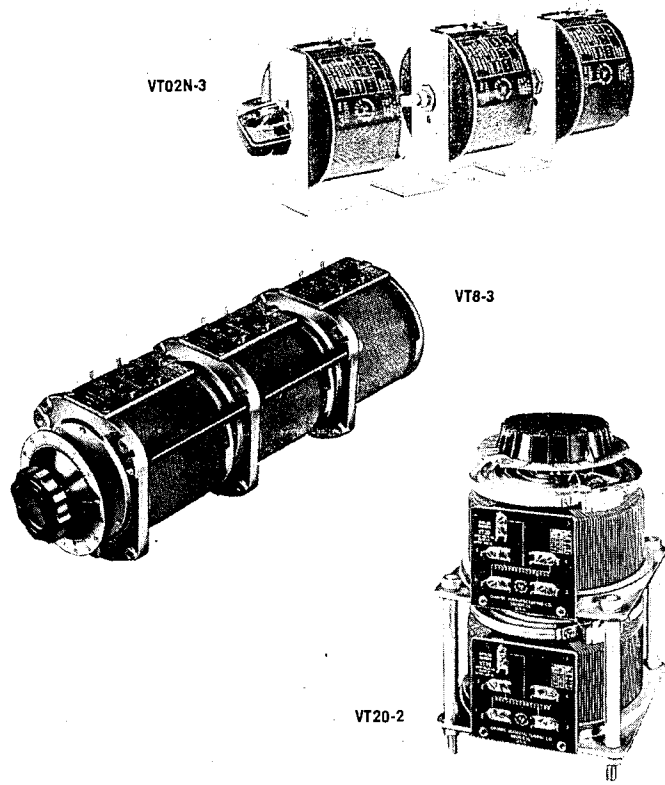

OHMITE variable transformers

STOCK VARIABLE TRANSFORMERS

SINGLE PHASE

SINGLE TRANSFORMERS — UNCASSED (Dimensions p. 24)

Input Volts	Freq. cps. from	Maximum Output Amps	Output Volts	Feature or Connection	Stock No. ¹¹	Wt. Lbs. ⁷	Net ⁵ 1-9
40	60	5	0-40	Hi-amps, low volts	VT2LN	2.4	12.25
40	50	12.0	0-40	Hi-amps, low volts	VT4LN	5.25	17.25
40	50	22.0	0-40	Hi-amps, low volts	VT8LN	10.25	22.25
120	60*	1.0	0-120/132	Basic 1.0A Model	VT1	1.5	9.00
120	60	1.2	0-120	No overvoltage	VT1N	1.5	9.00
120	60*	1.75	0-120/132	Basic 1.75A Model	VT02	2.25	10.00
120	60	2.0	0-120	No overvoltage	VT02N	2.25	10.00
120	60*	2.6	0-120/132	Basic 2.6A Model	VT3	3.0	11.50
120	60	3.0	0-120	No overvoltage	VT3N	3.0	11.50
120	50	3.5	0-120/140	Basic 3.5A Model	VT4	5.25	15.00
120	50	4.75	0-120	No overvoltage	VT4N	5.25	15.00
120	50	7.5	0-120/140	Basic 7.5A Model	VT8	10.25	20.00
120	50	10.0	0-120	No overvoltage	VT8N	10.25	20.00
120	50	20.0	0-120/140	Basic 20A Model	VT20	22.0	55.00
120	50	25.0	0-120	No overvoltage	VT20N	22.0	55.00
240 ²	50	3.0	0-240/280	240V Input ²	VT8H	10.25	22.25
240 ²	50	4.0	0-240	240V In. No ovrvlt. ²	VT8HN	10.25	22.25
240 ²	50	9	0-240/280	240V Input ²	VT20H	22.0	57.25
240 ²	50	11	0-240	240V In. No ovrvlt. ²	VT20HN	22.0	57.25

SINGLE TRANSFORMERS — CASSED (Dimensions p. 25)

120	60*	.8	0-120/132 ⁴	Fixed Mtg.	VT1E	1.9	14.50
120	60*	1.0	0-132 ²	Portable	VT1F	2.3	16.50
120	60	1.0	0-120	Fixed Mtg.	VT1NE	1.9	14.50
120	60	1.2	0-120	Portable	VT1NF	2.3	16.50
120	60*	1.4	0-120/132 ⁴	Fixed Mtg.	VT02E	2.8	15.50
120	60*	1.75	0-132 ²	Portable	VT02F	3.2	17.50
120	60	1.6	0-120	Fixed Mtg.	VT02NE	2.8	15.50
120	60	2.0	0-120	Portable	VT02NF	3.2	17.50
120	50	2.8	0-120/140 ⁴	Fixed Mtg.	VT4E	7.4	20.50
120	50	3.5	0-140 ³	Portable	VT4F	7.8	22.50
120	50	3.5	0-140 ³	VT4F w/gnd. in. & out.	VT4FC	7.8	26.00
120	50	3.8	0-120	Fixed Mtg.	VT4NE	7.4	20.50
120	50	4.75	0-120	Portable	VT4NF	7.8	22.50
120	50	4.75	0-120	VT4NF w/gnd. in. & out.	VT4NFC	7.8	26.00
120	50	6.0	0-120/140 ⁴	Fixed Mtg.	VT8E	13.5	25.50
120	50	7.5	0-140 ³	Portable	VT8F	13.8	27.50
120	50	7.5	0-140 ³	VT8F w/gnd. in. & out.	VT8FC	13.8	31.00
120	50	6.0	0-120/140 ³	Deluxe Portable	VT8G	14.2	31.00
120	50	6.0	0-120/140 ³	VT8G w/gnd. in. & out.	VT8GC	14.2	34.50
120	50	8.0	0-120	Fixed Mtg.	VT8NE	13.5	25.50
120	50	10.0	0-120	Portable	VT8NF	13.8	27.50
120	50	10.0	0-120	VT8NF w/gnd. in. & out.	VT8NFC	13.8	31.00
120	50	20.0	0-120/140	Basic Case	VT20B	22.5	61.00
120	50	25.0	0-120	Basic Case	VT20NB	22.5	61.00
120	50	20.0	0-120/140 ⁴	Fixed Mtg.	VT20E	29.0	75.00
120	50	20.0	0-140	Portable	VT20FC	31.0	83.50
120	50	20.0	0-120/140 ³	Portable	VT20GC	31.0	97.00
120	50	25.0	0-120	Fixed Mtg.	VT20NE	29.0	75.00
120	50	25.0	0-120	Portable	VT20NFC	31.0	83.50
240 ²	50	9.0	0-240/280	Basic Case	VT20HB	21.5	63.25
240 ²	50	11.0	0-240	Basic Case	VT20HNB	21.5	63.25
240 ²	50	9.0	0-240/280 ⁴	Fixed Mtg.	VT20HE	28.0	77.25
240 ²	50	11.0	0-240	Fixed Mtg.	VT20HNE	28.0	77.25
240 ²	50	9.0	0-240/280	Portable	VT20HFC	30.0	85.75
240 ²	50	11.0	0-240	Portable	VT20HNFC	30.0	85.75

SINGLE TRANSFORMERS — CASSED WITH METERS (Dimensions p. 25)

120	50	6.0	0-120/140 ³	w/voltmeter, gnd. conn.	VT8GCV	15.2	64.50
120	50	6.0	0-120/140 ³	w/volt. & ammtr., gnd. conn.	VT8GCVA	15.5	97.50
120	50	6.0	0-120/140 ³	w/volt. & wattmtr., gnd. conn.	VT8GCVW	15.5	130.50
120	50	10.0	0-120	w/voltmeter, gnd. conn.	VT8NFCV	14.8	61.00

SINGLE PHASE (contd.)

SINGLE TRANSFORMERS — CASSED WITH METERS (Dimensions p. 25) (contd.)

Input Volts	Freq. cps. from	Maximum Output Amps	Output Volts	Feature or Connection	Stock No. ¹¹	Wt. Lbs. ⁷	Net ⁵ 1-9
120	50	10.0	0-120	w/volt. & ammtr., gnd. conn.	VT8NFCVA	15.2	94.00
120	50	10.0	0-120	w/volt. & wattmtr., gnd. conn.	VT8NFCVW	15.2	127.00
120	50	20.0	0-120/140 ³	w/voltmeter, gnd. conn.	VT20GCV	32.0	139.00
120	50	20.0	0-120/140 ³	w/volt. & ammtr., gnd. conn.	VT20GCVA	32.2	172.00
120	50	20.0	0-120/140 ³	w/volt. & wattmtr., gnd. conn.	VT20GCVW	32.2	246.00
120	50	25.0	0-120	w/voltmeter, gnd. conn.	VT20NFCV	32.0	125.50
120	50	25.0	0-120	w/volt. & ammtr., gnd. conn.	VT20NFCVA	32.2	158.50
120	50	25.0	0-120	w/volt. & wattmtr., gnd. conn.	VT20NFCVW	32.2	232.50

TWO-IN-TANDEM ASSEMBLIES^{5 10} (Dimensions p. 25)

240	60*	1.0	0-240/264	Series Conn. ⁶	VT1-2	3.5	28.00
240	60	1.2	0-240	Series Conn. ⁶	VT1N-2	3.5	28.00
240	60*	1.75	0-240/264	Series Conn. ⁶	VT02-2	5.25	30.00
240	60	2.0	0-240	Series Conn. ⁶	VT02N-2	5.25	30.00
240	60*	2.6	0-240/264	Series Conn. ⁶	VT3-2	6.5	33.00
240	60	3.0	0-240	Series Conn. ⁶	VT3N-2	6.5	33.00
240	50	3.5	0-240/280	Series Conn. ⁶	VT4-2	11.3	42.50
240	50	4.75	0-240	Series Conn. ⁶	VT4N-2	11.3	42.50
240	50	7.5	0-240/280	Series Conn. ⁶	VT8-2	20.6	52.50
240	50	10.0	0-240	Series Conn. ⁶	VT8N-2	20.6	52.50
240	50	20.0	0-240/280	Series Conn. ⁶	VT20-2	45.0	126.00
240	50	20.0	0-240/280	Above unit, B case	VT20-2B	46.0	138.00
240	50	25.0	0-240	Series Conn. ⁶	VT20N-2	45.0	126.00
240	50	25.0	0-240	Above unit, B case	VT20N-2B	46.0	138.00
480 ²	50	3.0	0-480/560	Series Conn. ⁶	VT8H-2	20.6	57.00
480 ²	50	4.0	0-480	Series Conn. ⁶	VT8HN-2	20.6	57.00
480 ²	50	9.0	0-480/560	Series Conn. ⁶	VT20H-2	43	130.50
480 ²	50	11.0	0-480	Series Conn. ⁶	VT20HN-2	43	130.50

THREE PHASE

120	60*	1.0	0-120/132	Open Delta Conn.	VT1-2	3.5	28.00
120	60	1.2	0-120	Open Delta Conn.	VT1N-2	3.5	28.00
120	60*	1.75	0-120/132	Open Delta Conn.	VT02-2	5.25	30.00
120	60	2.0	0-120	Open Delta Conn.	VT02N-2	5.25	30.00
120	60*	2.6	0-120/132	Open Delta Conn.	VT3-2	6.5	33.00
120	60	3.0	0-120	Open Delta Conn.	VT3N-2	6.5	33.00
120	50	3.5	0-120/140	Open Delta Conn.	VT4-2	11.3	42.50
120	50	4.75	0-120	Open Delta Conn.	VT4N-2	11.3	42.50
120	50	7.5	0-120/140	Open Delta Conn.	VT8-2	20.6	52.50
120	50	10.0	0-120	Open Delta Conn.	VT8N-2	20.6	52.50
120	50	20.0	0-120/140	Open Delta Conn.	VT20-2	45.0	126.00
120	50	20.0	0-120/140	Above unit, B case	VT20-2B	46.0	138.00
120	50	25.0	0-120	Open Delta Conn.	VT20N-2	45.0	126.00
120	50	25.0	0-120	Above unit, B case	VT20N-2B	46.0	138.00
240 ²	50	3.0	0-240/280	Open Delta Conn.	VT8H-2	20.6	57.00
240 ²	50	4.0	0-240	Open Delta Conn.	VT8HN-2	20.6	57.00
240 ²	50	9.0	0-240/280	Open Delta Conn.	VT20H-2	43	130.50
240 ²	50	11.0	0-240	Open Delta Conn.	VT20HN-2	43	130.50

THREE-IN-TANDEM ASSEMBLIES^{5 10} (Dimensions p. 25)

240	60	1.0	0-240*	"Y" Conn.	VT1-3	5.3	41.00
240	60	1.75	0-240*	"Y" Conn.	VT02-3	8.0	44.00
240	60	2.6	0-240*	"Y" Conn.	VT3-3	9.8	48.50
240	60*	3.5	0-240/280	"Y" Conn.	VT4-3	17.0	61.00
240	60*	7.5	0-240/280	"Y" Conn.	VT8-3	31.0	76.00
240	60*	6.0	0-240/280	Above unit, E case	VT8-3E	40.0	92.50
240	60*	20.0	0-240/280	"Y" Conn.	VT20-3	68.0	185.00
240	60*	20.0	0-240/280	Above unit, B case	VT20-3B	69.5	203.00
240	60	25.0	0-240	"Y" Conn.	VT20N-3	68.0	185.00
240	60	25.0	0-240	Above unit, B case	VT20N-3B	69.5	203.00
480 ²	60*	3.0	0-480/560	"Y" Conn.	VT8H-3	31.0	82.75
480 ²	60*	9.0	0-480/560	"Y" Conn.	VT20H-3	65.0	191.75
480 ²	60	11.0	0-480	"Y" Conn.	VT20HN-3	65.0	191.75

Footnotes for Stock Table

- Frequency shown is a minimum — units may be used up to 1000 cps.
- VT8H and VT20H and 240V output for VT8HN and VT20HN. With use of 120V input VT8H, VT8HN, VT20H, VT20HN also have taps for 120V input with 280V output for the max. current rating applies up to 120V output but reduces to approx. 50% at max. output voltage. In the case of tandem units, use of the low voltage inputs would correspondingly derate the current at the higher output voltages.
- Connected at factory for overvoltage output — easily reconnected by user for no-overvoltage output. On VT8G and VT20G, switch selects overvoltage or no-overvoltage.
- User wires for desired output. Dial normally calibrated for overvoltage.

⁵ 2-in-tandem normally wired for series connection; 3-in-tandem for Y connection.

⁶ When transformers are series connected, load cannot be grounded.

⁷ Includes knob, dial and mounting hardware.

⁸ May be used at 50 cps if connected for no-overvoltage output.

⁹ Overvoltage connection must not be used.

¹⁰ 240/280 volt cw dial standard except on VT1, VT02 and VT3 tandems where 240/264 volt dial is standard or on VT8-2, VT8HN-2, VT8H-3, VT20H-2, VT20HN-2, VT20H-3 and VT20HN-3 where 480/560 volt dial is standard. Request other dials if desired — see "Dials" above.

ITEMS APPEARING IN BOLD PRINT ARE POPULAR MODELS AND ARE USUALLY STOCKED BY AUTHORIZED OHMITE DISTRIBUTORS

OHMITE variable transformers

ACCESSORIES — PARTS

ADAPTER PLATE for 4-hole mtg. of VT4 — matches other popular 4-hole mtgs.; dimensions same as shown for front plate of VT4 tandems, page 35.
 Stock No. 6512 Net 1-9 \$1.00

Brush-Contact Assemblies for . . .

	Stock No.	Net 1-9
VT1, VT1N, VT02, VT02N, VT3, VT3N	6507	\$1.00
VT2LN	6517	2.00
VT4 Types except VT4LN	6515	1.00
VT8 Types except VT8H, HN, LN	6515	1.00
VT4LN	6518	2.00
VT8H, HN only	6516H	1.25
VT8LN only	6519	2.50
VT20 Types and VT20N	6594	1.75
VT20H, HN only	6596	1.75

ADJUSTABLE STOP for limiting rotational arc of transformers.

	Stock No.	Net 1-9
Stop for VT4 types	6536	\$.50
Stop for VT8 types	6537	.50
Stop for VT20 types	6538	1.00

EXTRA DIALS OR DIALS WITH C.C.W. CALIBRATION

"v.t."	Dial Calibration	Stock No.	Net 1-9
VT1	0-120, 0-132 CW	5005	\$.25
VT02		5011	.25
VT2LN		5019	.25
VT3	0-240, 0-264 CW		
VT4	0-120, 0-140 CW	5006	.50
	0-120, 0-140 CCW	5008	.50
	0-240, 0-280 CW	5009	.50
and	0-240, 0-280, CCW	5010	.50
VT8	0-100, 100-0* CW	5012	.50
	0-480, 0-560 CW	5018	.50
	0-120, 0-140 CW	5013	1.20
	0-120, 0-140 CCW	5014	1.20
VT20	0-240, 0-280 CW	5015	1.20
	0-240, 0-280 CCW	5016	1.20
	0-100, 100-0 CW	5017	1.20

*Percent-of-output dial furnished with "LN" series units.

EXTRA KNOBS FOR UNCASED UNITS

	Stock No.	Net 1-9
--	-----------	---------

For VT1, VT02, VT2LN, VT3 types 5158 \$3.50

For VT4, VT8 types 5155 1.00

For VT20 Types 5157 1.75

MOTOR-DRIVEN ASSEMBLIES

Single or tandem assemblies can be supplied with motor drives, direct from the factory. Either AC or DC motors are available. Standard AC motor drives have traverse speeds of 3-4, 10-12, 40-50, 100-120 seconds. Typical traverse speeds for DC drives are 4, 8, 16, 30 and 45 seconds. Write to the factory for more information.

solid state electronic dimmers for incandescent lighting

600 WATTS

Replace Any
 2 or 3-Way
 Switch
 Made by OHMITE
 Famous Producer of
 Quality Components

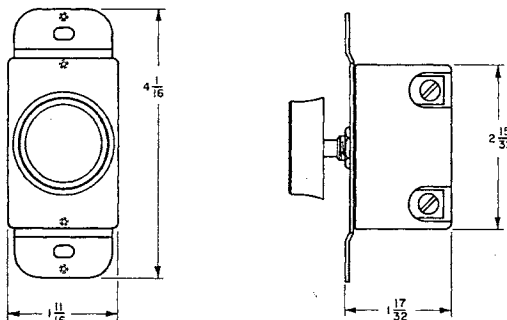
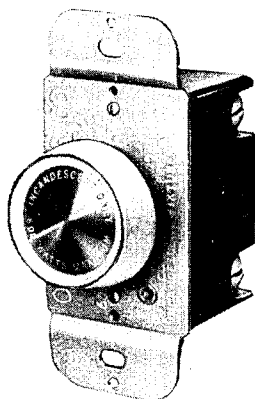

CONTINUOUSLY VARIABLE DIMMING by means of silicon symmetrical switch — a modern semiconductor device.

PUSH-PUSH KNOB for ON/OFF at any light setting.

CONSERVES POWER — Draws only the power needed by the circuit at the light level desired.

SCREW TERMINALS for convenient wiring without splicing or wire fastening nuts — eliminates space consuming leads — permits use of dimmer even in shallow boxes.

NO RADIO OR TV INTERFERENCE due to special filter.

GUARANTEED for 1 year against defects in materials and workmanship provided units have been properly installed and operated.

INSTALLATION NOTES

Maximum Ambient — 120°F.
 Use only 1 dimmer for each lighting circuit.
 Install dimmer with power OFF.

Ganging — Several dimmers may be installed in a common box provided units are derated as follows: two units, 500 watts each; three or more units, 400 watts each.

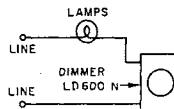
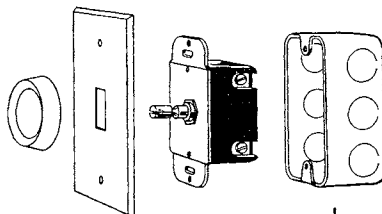

CONNECTIONS—
DIMMER SINGLE POLE

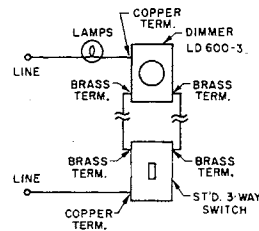

CONNECTIONS—
3-WAY

ORDERING INFORMATION

Stock No.	UL Listed	Description	Net \$
LD600 N	—	Single-Pole Push-Push Switch	7.00
LD600	Yes	600 Watts, 120 Volts, 60 Cycle	9.30
LD600-3 N	—	3-Way Push-Push Switch	9.50
LD600-3	Yes	600 Watts, 120 Volts, 60 Cycle	11.30

ITEMS APPEARING IN BOLD PRINT ARE POPULAR MODELS AND ARE USUALLY STOCKED BY AUTHORIZED OHMITE DISTRIBUTORS



NORTH HILLS ELECTRONICS, INC.

**WIDEBAND TRANSFORMERS — PULSE AND CW
20 Hz TO 400 MHz**

OVERALL DIMENSIONS (In.)

Case Style	W	L	H	Package
AA	1.4	1.4	1.4	Aluminum Can
BA	1.3	2.3	1.1	Hermetically Sealed Steel Can
BB	1.3	2.6	1.1	Hermetically Sealed Steel Can
FA	0.9	0.9	1.0	Hermetically Sealed Steel Can
GA	0.9 Dia.		1.1	Hermetically Sealed Steel Can
HB	0.9	0.9	0.7	Hermetically Sealed Steel Can
JA	0.8	2.0	0.8	Hermetically Sealed Steel Can
LA	1.7	2.8	1.2	Hermetically Sealed Steel Can
NA	0.56	0.56	0.3	Molded Case

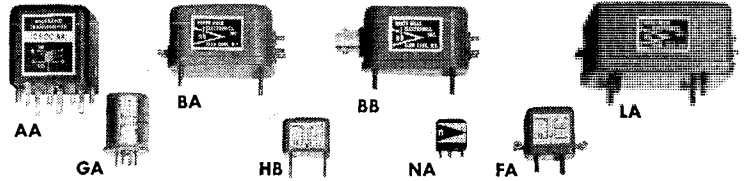

1 Watt Series in AA, BA, BB, FA, GA, HB Cases

Unbalanced to Balanced Designs. Secondaries are center-tapped and d.c. isolated.

Type No.	Impedance Ratio	Bandwidth MHz	Type No.	Impedance Ratio	Bandwidth MHz
0001	50:50	.1-125	1300	75:100	.1-100
0101	50:75	.1-125	1302	75:124	.1-100
0300	50:100	.1-100	1400	75:150	.1-100
0307	50:124	.1-100	1500	75:200	.1-100
0400	50:150	.1-100	1501	75:300	.1-100
0500	50:200	.1-100	1600	75:450	.1-60
*0503	50:200	.5-250	1700	75:600	.1-60
0501	50:300	.1-100	1701	75:600	.3-100
0600	50:450	.1-65	1702	75:600	.007-8
0700	50:600	.1-65	1800	75:800	.1-30
0800	50:800	.1-60	1900	75:1200	.1-30
0900	50:1200	.1-30	1901	75:1850	.01-10
1100	75:75	.1-100	7700	600:600	.1-30

* No d.c. isolation.

Unbalanced to Unbalanced Designs (No d.c. Isolation)

0103	50:75	.1-200	0504	50:200	.1-200
------	-------	--------	------	--------	--------

25 Watt Series in BA and BB Cases

Unbalanced to Balanced Designs. Secondaries are center-tapped and d.c. isolated.

0106	50:75	30-80	1303	75:100	30-80
0305	50:100	30-80	1304	75:100	.1-30
0308	50:100	.1-30	1401	75:150	.1-30
0402	50:150	.1-30	1402	75:150	30-80
0403	50:150	30-80	1509	75:300	30-80
0507	50:200	30-80	1510	75:300	.1-30
0512	50:200	.1-30	1703	75:600	.1-30
0701	50:600	.1-30			

100 Watt Series in BA and BB Cases

Unbalanced to Balanced Designs. Secondaries are center-tapped and d.c. isolated.

0105	50:75	.5-30	0506	50:300	.5-30
0304	50:100	.5-30	1403	75:150	.5-30
0404	50:150	.5-30	1505	75:300	.5-30

1KW Power Units Wide Band 2-30 MHz

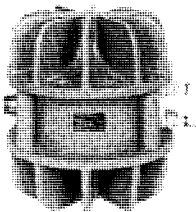

Type No.	Impedance Unb/Bal
0501 KA	50 ohms/300 ohms
0700 KA	50 ohms/600 ohms
1501 KA	75 ohms/300 ohms
1700 KA	75 ohms/600 ohms

Special — Specify ratio, bandwidth, power

Type 0102 JA Wide Band Adapter



50Ω Unbalanced to 75Ω Unbalanced
Low VSWR
Flat 1 db 0.08 to 250 MHz
BNC Connectors.

TYPICAL CHARACTERISTICS

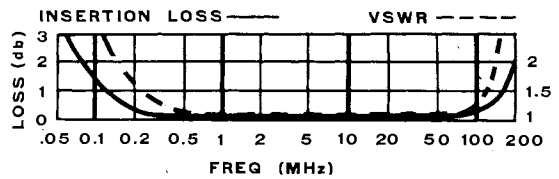

Subminiature Series in NA Case

Unbalanced to Unbalanced Designs			Unbalanced to Balanced Designs Balanced side center-tapped		
Type No.	Impedance Ratio	Bandwidth MHz	Type No.	Impedance Ratio	Bandwidth
Non-inverting			0004	50:50	.1-400
0002	50:12.5	.1-400	0509	50:200	.1-400
0508	50:200	.1-400	1101	75:75	.1-400
1506	75:300	.1-400	1507	75:300	.1-400
Phase reversing			Balanced to Balanced Designs center-tapped		
0003	50:50	.1-400	0007	50:50	.1-400
1106	75:75	.1-400	1107	75:75	.1-400
2200	90:90	.1-400	2201	90:90	.1-400
Phase-reversing, d.c. isolated			0510	50:200	.1-400
0007	50:50	.1-400	1508	75:300	.1-400
1107	75:75	.1-400			
2201	90:90	.1-400			

Video Series in LA Case

Unbalanced to Balanced Designs. Secondaries are center-tapped and d.c. isolated.

0306	50:124	.001-20	1704	75:600	.001-10
0511	50:200	.001-15	1902	75:1200	.001-9
1301	75:124	.001-20	1903	75:1850	.001-6
1502	75:300	.001-15	2300	90:124	.001-15

Unbalanced to Unbalanced Designs — d.c. Isolated.

0005	50:50	.001-40	*1103	75:75	.001-40
*0006	50:50	.001-15	*1104	75:75	.001-15
0505	50:200	.001-15	1504	75:300	.001-10

* Phase Rev.

**Hybrids-Power Dividers and Adders
Wide Band 2-32 MHz**

	50-201 BD (50Ω)		50-401 MA (50Ω)
	75-201 BD (75Ω)		75-401 MA (75Ω)
Impedance at all ports (Ohms):		2:1	
		50 (50-201)	50 (50-401)
		75 (75-201)	75 (75-401)
Frequency range (MHz)		4:1	
		2-32	2-32
Isolation (Minimum db):		30	
		30	
VSWR (Maximum):		1.1	
		1.1	
Insertion loss (db maximum):		0.2	
		0.2	
Size of can:		1.1" x 1.9" x 1.3"	
		1" x 1.7" x 2.5"	
Connectors:		BNC	
		BNC	
Mounting:		2 #4-40 Studs	
		4 #6-32 Studs	

SPRAGUE**PULSE TRANSFORMERS****Type 11Z****TRIGATE[®] PULSE TRANSFORMERS**

**FLEXIBLE LEAD AND PRINTED WIRING BOARD DESIGNS
FOR LOW-COST SCR CIRCUIT APPLICATIONS**

- Specifically Designed For Commercial and Industrial SCR Triggering Applications Where Low Cost and Excellent Performance Are Required
- Single-ended Pulse Transformers Are Designed With Leads Especially Intended For Mounting On Printed Wiring Boards; These Units are Self Supporting
- Balanced Pulse Characteristics and Energy Transfer Between Windings
- Minimum Saturation Effect To Allow Operation Where Increased Pulse Widths Are Required
- Fast Pulse Rise Time and Increased Current Capability To Prevent SCR di/dt Failure
- Operating Temperature Range of -10 C to $+70\text{ C}$
- For Complete Technical Data, See Latest Issue of Sprague Engineering Bulletin 40003
- Call Your Sprague Industrial Distributor For Current Quantity Prices

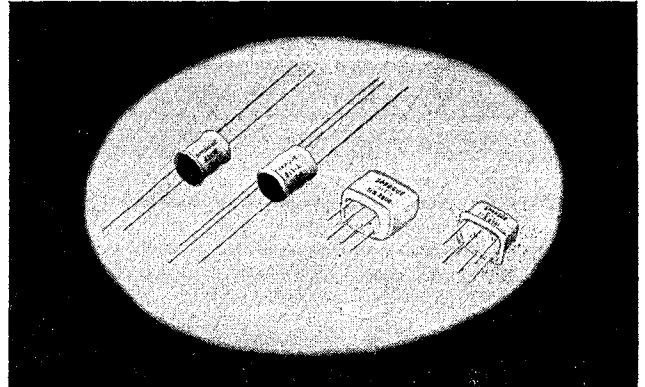
**DIMENSIONS**

FLEXIBLE LEAD		HORIZONTAL PLUG-IN		
D. x L.		L. x W. x H.		
.593 x .828		.968	.775	.800

FLEXIBLE LEAD DESIGN

Turns Ratio	Catalog Number	Min. Lp (μH)	Max. L ₁ (μH)	Max. C _c (pF)	Max. DCR (Ω)	60 Cycle Dielectric Test (Volts RMS)	Max. 60 Cy A-C Line Voltage (Volts RMS)
1:1	11Z12	200	3	800	1.5-1.5	1600	240
1:1:1	11Z13	200	3	800	2-2-2	1600	240
2:1	11Z14	1000	10	1300	10-2	1600	240
2:1:1	11Z15	1000	15	1300	10-2-2	1600	240
5:1	11Z16	5000	1500	400	19-3	1600	240

HORIZONTAL PLUG-IN DESIGN

Turns Ratio	Catalog Number	Min. Lp (μH)	Max. L ₁ (μH)	Max. C _c (pF)	Max. DCR (Ω)	60 Cycle Dielectric Test (Volts RMS)	Max. 60 Cy A-C Line Voltage (Volts RMS)
1:1	11Z2000	200	3.0	800	1.5-1.5	1600	240
1:1	11Z2001	1000	12.0	2000	8-8	1600	240
2:1	11Z2003	1000	10.0	1300	10-2	1600	240
5:1	11Z2004	5000	1500	400	19-3	1600	240
1:1:1	11Z2100	200	3.0	800	2-2-2	1600	240
1:1:1	11Z2101	1000	12.0	1400	10-10-10	1600	240
2:1:1	11Z2103	1000	15.0	1300	10-2-2	1600	240
5:1:1	11Z2104	5000	1500	400	20-4-4	1600	240

SHIPPED FROM STOCK IMMEDIATELY

HIGH & LOW CURRENT TRANSFORMERS

OPEN FRAME • EPOXY ENCAPSULATED (GRADE 5) • HERMETICALLY SEALED (GRADE 4)

SECONDARY VOLTS

10 or 5 V C.T.
Series 0 - 2.5 - 5 - 7.5 - 10 V
Parallel 0 - 2.5 - 5 V @ 2 x Current

12.8 or 6.4 C.T.
Series 0 - 3.2 - 6.4 - 9.6 - 12.8 V
Parallel 0 - 3.2 - 6.4 V @ 2 x Current

16 or 8 V C.T.
Series 0 - 4 - 8 - 12 - 16 V
Parallel 0 - 4 - 8 @ 2 x Current

24 or 12 C.T.
Series 0 - 6 - 12 - 18 - 24 V
Parallel 0 - 6 - 12 V @ 2 x Current

36 or 18 V C.T.
Series 0 - 9 - 18 - 27 - 36 V
Parallel 0 - 9 - 18 V @ 2 x Current

56 or 28 V C.T.
Series 0 - 14 - 28 - 42 - 56 V
Parallel 0 - 14 - 28 V @ 2 x Current

Part No.	Primary Volts	SECONDARY AMPS		OPEN FRAME OR EPOXY ENCAPSULATED*										HERMETICALLY SEALED IN STEEL CASE†					
		Series	Parallel	Mtg. Style	L	W	H	ML	MW	Mtg. Screw	Appr. Lbs.	L	W	H	ML	MW	Mtg. Stud		
10-0.1	115	0.1	0.2	C	2	1 1/2	1 3/4	1 3/2	—	#8	0.3	1 5/8	1 5/8	2 3/4	1 3/4	1 3/4	6-32 x 3/8		
10-0.25	115	0.25	0.5	C	2	1 1/2	2	2	—	#8	0.5	1 1 3/8	1 1 3/8	2 3/4	1 3/4	1 3/4	6-32 x 3/8		
10-0.5	115	0.5	1.0	C	2	1 3/4	2	2	—	#8	0.8	1 1 3/8	1 1 3/8	2 3/4	1 3/4	1 3/4	6-32 x 3/8		
10-1	115	1	2	C	2	1 3/4	2 3/4	2 3/8	—	#8	1.0	2 1/8	2 1/8	2 3/4	1 3/4	1 3/4	6-32 x 3/8		
10-2	115	2	4	C	3	1 3/4	2 3/4	2 3/8	—	#8	1.5	2 3/8	2 3/8	2 3/4	1 3/4	1 3/4	6-32 x 3/8		
10-4	115	4	8	C	3	3/8	2 3/8	3 1/8	—	#8	2.3	3 3/4	3 3/4	2 3/4	2	2	8-32 x 3/8		
10-6	115	6	12	B	3	3/8	2 3/4	2 3/8	2 1/8	#8	3.3	3 5/8	3 3/4	2 3/8	2 1/8	2 1/8	8-32 x 3/8		
10-8	115	8	16	B	3	3/8	3 1/8	2 3/8	2 1/8	#8	4.0	3 5/8	3 3/4	2 3/8	2 3/8	2 3/8	8-32 x 3/8		
10-12	115	12	24	B	3	3/8	3 3/4	3 1/8	2 1/8	#8	5.0	4 1/8	3 3/4	3 1/8	2 1/8	2 1/8	10-32 x 1/2		
10-25	115	25	50	B	4	1/2	3/4	3/4	3/4	#10	8.7	4 3/4	5 1/4	4 3/4	3 3/4	4 1/4	10-32 x 1/2		
10-50	105, 115, 125	50	100	B	5	1/2	5/8	4 3/8	4 3/8	3/8	17.0	5 1/2	7	5 1/2	4 3/8	5 7/8	1/4-20 x 5/8		
10-100	105, 115, 125	100	200	B	6	3/4	7/8	5 1/8	5 1/8	1/4	34.5	6 3/4	8 3/4	6 1/2	5 5/8	6 3/4	1/4-20 x 5/8		
12.8-0.1	115	0.1	0.2	C	2	1 1/2	1 3/4	1 3/2	—	#8	0.3	1 5/8	1 5/8	2 3/4	1 3/4	1 3/4	6-32 x 3/8		
12.8-0.25	115	0.25	0.5	C	2	1 1/2	2	2	—	#8	0.5	1 1 3/8	1 1 3/8	2 3/4	1 3/4	1 3/4	6-32 x 3/8		
12.8-0.5	115	0.5	1	C	2	1 3/4	2	2	—	#8	0.8	1 1 3/8	1 1 3/8	2 3/4	1 3/4	1 3/4	6-32 x 3/8		
12.8-1	115	1	2	C	2	1 3/4	2 3/4	2 3/8	—	#8	1.2	2 1/8	2 1/8	2 3/4	1 3/4	1 3/4	6-32 x 3/8		
12.8-2A	115	2	4	C	3	1/2	2 1/8	2 1/8	—	#8	1.5	2 3/8	2 3/8	2 3/4	1 3/4	1 3/4	6-32 x 3/8		
12.8-2	115	2	4	B	3	1/2	2 1/2	2 1/2	2	#8	2.3	3 1/4	3 1/4	2 3/4	2	2	8-32 x 3/8		
12.8-4	115	4	8	B	3	1/2	2 1/2	2 1/2	2 1/8	#8	2.8	3 1/4	3 1/8	2 3/4	2 1/2	2 3/8	8-32 x 3/8		
12.8-6	115	6	12	B	3	3/8	3 1/4	2 3/8	2 1/8	#8	4.0	3 5/8	3 3/4	2 3/8	2 1/8	2 1/8	8-32 x 3/8		
12.8-8	115	8	16	B	3	3/8	3 1/8	3 1/8	2 1/4	#8	4.5	4 1/8	3 3/4	3 1/4	2 1/4	2 1/4	10-32 x 1/2		
12.8-12	115	12	24	B	4	1/2	3/4	3/4	3/4	#10	6.0	4 1/2	5 1/4	4 3/4	3 3/4	4 1/4	10-32 x 1/2		
12.8-25	115	25	50	B	5	1/2	5/8	4 3/8	4 3/8	2/8	12.5	5 1/2	7	5 1/4	4 3/8	4 5/8	1/4-20 x 5/8		
12.8-50	105, 115, 125	50	100	B	5	1/2	5/8	4 3/8	4 3/8	1/4	20.7	6 1/2	7 1/2	5 1/2	4 3/8	5 7/8	1/4-20 x 5/8		
12.8-100	105, 115, 125	100	200	B	6	3/4	7/8	5 1/8	5 1/8	1/4	34.5	5 3/4	8 3/4	6 1/2	5 5/8	6 1/4	1/4-20 x 5/8		
16-0.1	115	0.1	0.2	C	2	1 1/2	1 3/4	1 3/2	—	#8	0.4	1 5/8	1 5/8	2 3/4	1 3/4	1 3/4	6-32 x 3/8		
16-0.25	115	0.25	0.5	C	2	1 1/2	2	2	—	#8	0.7	1 1 3/8	1 1 3/8	2 3/4	1 3/4	1 3/4	6-32 x 3/8		
16-0.5	115	0.5	1	C	2	1 3/4	2	2	—	#8	0.8	1 1 3/8	1 1 3/8	2 3/4	1 3/4	1 3/4	6-32 x 3/8		
16-1	115	1	2	C	2	1 3/4	2 3/4	2 3/8	—	#8	1.2	2 1/8	2 1/8	2 3/4	1 3/4	1 3/4	6-32 x 3/8		
16-2	115	2	4	C	3	1/2	2 1/4	2 1/4	—	#8	1.7	2 3/8	2 3/8	2 3/4	1 3/4	1 3/4	6-32 x 3/8		
16-4	115	4	8	B	3	3/8	2 3/4	2 3/8	2 1/8	#8	3.3	3 3/8	3	2 3/8	2 1/8	2 1/8	8-32 x 3/8		
16-6	115	6	12	B	3	3/8	3 1/8	3 1/8	2 1/4	#10	4.5	4 1/8	3 3/4	3 1/4	2 1/4	2 1/4	10-32 x 1/2		
16-8	115	8	16	B	3	3/8	3 1/2	3 1/8	2 3/8	#10	5.4	4 1/8	3 3/4	3 1/8	2 1/2	2 1/2	10-32 x 1/2		
16-12	115	12	24	B	4	1/2	3/8	3/8	3/4	#10	7.9	4 1/2	5 1/4	4 3/4	3 3/4	3 3/4	10-32 x 1/2		
16-25	115	25	50	B	4	1/2	5/8	4 3/4	4 3/4	#10	14.5	4 3/4	6 1/2	4 3/4	3 3/4	5 1/2	10-32 x 1/2		
16-50	105, 115, 125	50	100	B	5	1/2	5/8	4 3/4	4 3/4	1/4	26.5	6 3/4	6 5/8	6	5 1/2	5 1/2	1/4-20 x 5/8		
16-100	105, 115, 125	100	200	B	6	3/4	7/8	5 1/8	5 1/8	1/4	50.0	8	8 1/2	7	6 3/4	7 1/4	1/4-20 x 5/8		
24-0.1	115	0.1	0.2	C	2	1 1/2	2	2	—	#8	0.5	1 5/8	1 5/8	2 3/4	1 3/4	1 3/4	6-32 x 3/8		
24-0.25	115	0.25	0.5	C	2	1 1/2	2 1/8	2 3/8	—	#8	1.0	1 1 3/8	1 1 3/8	2 3/4	1 3/4	1 3/4	6-32 x 3/8		
24-0.5	115	0.5	1	C	2	1 3/4	2 1/8	2 3/8	—	#8	1.2	2 1/8	2 1/8	2 3/4	1 3/4	1 3/4	6-32 x 3/8		
24-1A	115	1	2	C	3	1/2	2 1/4	2 1/4	—	#8	1.5	2 3/8	2 3/8	2 3/4	1 3/4	1 3/4	6-32 x 3/8		
24-1	115	1	2	B	3	1/2	2 1/2	2 1/2	2	#8	2.3	3 1/4	3 1/4	2 3/4	2 1/2	2	8-32 x 3/8		
24-2	115	2	4	B	3	1/2	2 1/2	2 1/2	2 3/8	#8	2.9	3 1/4	3 1/8	2 3/4	2 1/2	2 3/8	8-32 x 3/8		
24-4	115	4	8	B	3	3/8	3 1/8	3 1/8	2 1/4	#8	4.5	4 1/8	3 3/4	3 1/4	2 1/4	2 1/4	10-32 x 1/2		
24-6	115	6	12	B	4	1/2	3/4	3/4	3/8	#10	5.8	4 1/2	5 1/4	4 3/4	3 3/4	3 3/4	10-32 x 1/2		
24-8	115	8	16	B	4	1/2	3/8	3/8	3/4	#10	7.9	4 1/2	5 1/4	4 3/4	3 3/4	3 3/4	10-32 x 1/2		
24-12	105, 115, 125	12	24	B	4	1/2	3/8	3/8	3/8	#10	11.0	4 1/2	5 3/8	4 3/4	3 3/4	4 3/8	10-32 x 1/2		
24-20	105, 115, 125	20	40	B	5	1/2	4 1/4	4 3/8	4 3/8	1/4	15.3	5 1/2	6 1/2	5 1/4	4 3/8	5 1/2	1/4-20 x 5/8		
24-25	105, 115, 125	25	50	B	5	1/2	5 3/8	4 3/8	4 3/8	1/4	19.5	5 1/2	6 1/2	5 1/4	4 3/8	5 1/2	1/4-20 x 5/8		
24-50	105, 115, 125	50	100	B	6	3/4	6 1/4	5 1/8	5 1/8	1/4	31.3	6 3/4	7 1/2	6	5 1/2	6	1/4-20 x 5/8		
24-100	105, 115, 125	100	200	B	7	1/2	7	6 3/8	6 3/4	1/4	43	8	8	7	6 3/4	6 3/4	1/4-20 x 5/8		
36-0.1	115	0.1	0.2	C	2	1 1/2	2	2	—	#8	0.5	1 5/8	1 5/8	2 3/4	1 3/4	1 3/4	6-32 x 3/8		
36-0.25	115	0.25	0.5	C	2	1 1/2	2 1/8	2 3/8	—	#8	0.8	1 1 3/8	1 1 3/8	2 3/4	1 3/4	1 3/4	6-32 x 3/8		
36-0.5	115	0.5	1	C	2	1 3/4	2 1/8	2 3/8	—	#8	1.3	2 3/8	2 3/8	2 3/4	1 3/4	1 3/4	6-32 x 3/8		
36-1A	115	1	2	C	3	1/2	2 3/8	3 1/8	—	#8	2.3	3 1/4	3 1/4	2 3/4	2 1/2	2	8-32 x 3/8		
36-1	115	1	2	B	3	1/2	2 1/2	2 1/2	2 1/4	#8	2.6	3 1/4	3 1/8	2 3/4	2 1/2	2 3/8	8-32 x 3/8		
36-2	115	2	4	B	3	3/8	2 1/8	2 1/8	2 3/8	#8	3.8	3 5/8	3 3/4	2 3/4	2 1/2	2 3/8	8-32 x 3/8		
36-4	115	4	8	B	4	1/2	3/8	3 1/8	2 5/8	#10	6.8	4 1/2	5 1/4	4 3/4	3 3/4	3 3/4	10-32 x 1/2		
36-6	115	6	12	B	4	1/2	3/4	3 3/4	2 3/4	#10	8.7	4 3/4	4 1/4	4 3/4	3 3/4	3 3/4	10-32 x 1/2		
36-8	105, 115, 125	8	16	B	4	1/2	4 1/4	4 3/8	3 3/8	#10	11.0	4 3/4	5	4 3/4	3 3/4	3 3/4	10-32 x 1/2		
36-12	105, 115, 125	12	24	B	5	1/2	4 3/8	4 3/8	3 3/8	1/4	15.0	5 1/2	6 1/2	5 1/4	4 3/8	5 1/2	1/4-20 x 5/8		
36-20	105, 115, 125	20	40	B	6	3/8	5 3/8	5 1/8	5 1/8	1/4	22								

HIGH & LOW CURRENT TRANSFORMERS

FOR POWER OR RECTIFIER APPLICATIONS
CURRENTS FROM 0.1 TO 200 AMPS
VOLTAGES FROM 2.5 TO 300 VOLTS

IDEAL FOR USE IN SINGLE OR DUAL DC POWER SUPPLIES

SECONDARY VOLTS	Part No.	Primary Volts	SECONDARY AMPS		OPEN FRAME OR EPOXY ENCAPSULATED*							Mtg. Screw	Appr. Lbs.	HERMETICALLY SEALED IN STEEL CASE†					
			Series	Parallel	Mtg. Style	L	W	H	ML	MW	L			W	H	ML	MW	Stud Mtg.	
68 or 34 C.T. Series 0 - 17 - 34 - 51 - 68 V Parallel 0 - 17 - 34 V @ 2 x Current	68-0.1	115	0.1	0.2	C	2 7/8	1 9/8	2 3/8	2 3/8	—	#8	0.8	2 1/8	2 1/8	2 1/2	1 7/8	1 7/8	6-32 x 3/8	
	68-0.25	115	0.25	0.5	C	2 7/8	2	2 3/8	2 3/8	—	#8	1.2	2 3/8	2 3/8	2 1/2	1 7/8	1 7/8	6-32 x 3/8	
	68-0.5A	115	0.5	1	C	3 1/8	2 3/8	2 3/8	2 3/8	—	#8	1.7	2 3/8	2 3/8	2 1/2	1 7/8	1 7/8	6-32 x 3/8	
	68-0.5	115	0.5	1	B	3	2 3/4	2 1/2	2 1/2	—	#8	2.7	3 1/4	3 1/8	2 7/8	2 1/2	2 3/8	8-32 x 3/8	
	68-1	115	1	2	B	3 3/8	2 3/8	2 1/2	2 1/2	—	#8	3.8	3 3/8	3 3/8	3 1/4	2 3/8	2 3/8	8-32 x 3/8	
	68-2	115	2	4	B	4 1/8	3 3/8	3 1/2	3 1/2	—	#10	6.8	4 1/2	3 3/4	3 7/8	3 1/2	2 3/8	10-32 x 1/2	
	68-4	115	4	8	B	4 1/2	4 1/2	4 1/8	3 3/4	—	#10	11.5	4 3/8	5	4 3/8	3 3/4	2 3/8	10-32 x 1/2	
	68-6	105, 115, 125	6	12	B	5 1/4	5	4 3/8	4 3/8	—	1/4	15.0	5 1/2	5 1/2	5 1/4	4 3/8	3 1/2	1 1/2 - 20 x 5/8	
	68-8	105, 115, 125	8	16	B	5 1/4	5 1/4	4 3/8	4 3/8	—	1/4	19.0	5 1/2	6	5	4 3/8	3 7/8	1 1/2 - 20 x 5/8	
	68-12	105, 115, 125	12	24	B	6 3/8	5 3/4	5 1/2	5 1/2	—	1/4	26.5	6 3/8	6 5/8	6	5 1/2	5 1/4	1 1/2 - 20 x 5/8	
80 or 40 C.T. Series 0 - 20 - 40 - 60 - 80 V Parallel 0 - 20 - 40 V @ 2 x Current	80-0.1	115	0.1	0.2	C	2 7/8	1 9/8	2 3/8	2 3/8	—	#8	0.8	2 1/8	2 1/8	2 1/2	1 7/8	1 7/8	6-32 x 3/8	
	80-0.25	115	0.25	0.5	C	3 1/8	2	2 3/4	2 3/8	—	#8	1.3	2 3/4	2 3/8	2 1/2	1 7/8	1 7/8	6-32 x 3/8	
	80-0.5A	115	0.5	1	C	3 1/8	2 3/8	2 3/8	2 3/8	—	#8	2.2	3 1/4	2 3/4	2 1/2	2	2	8-32 x 3/8	
	80-0.5	115	0.5	1	B	3	2 3/4	2 1/2	2 1/2	—	#8	2.8	3 1/4	3 1/8	2 7/8	2 1/2	2 3/8	8-32 x 3/8	
	80-1	115	1	2	B	3 3/8	2 3/8	2 1/2	2 1/2	—	#8	4.0	3 3/8	3 3/8	3 1/4	2 3/8	2 3/8	8-32 x 3/8	
	80-2	115	2	4	B	4 1/8	3 3/8	3 1/2	3 1/2	—	#10	6.8	4 1/2	3 3/4	3 7/8	3 1/2	2 3/8	10-32 x 1/2	
	80-4	115	4	8	B	5 1/4	4 1/2	4 3/8	4 3/8	—	1/4	12.3	5 1/2	4 3/4	5	4 3/8	3	1 1/2 - 20 x 5/8	
	80-6	105, 115, 125	6	12	B	5 1/4	5 1/2	4 3/8	4 3/8	—	1/4	19.0	5 1/2	6	5	4 3/8	3 7/8	1 1/2 - 20 x 5/8	
	80-8	105, 115, 125	8	16	B	6 3/8	5 3/4	5 1/2	5 1/2	—	1/4	20.5	6 3/8	5 3/4	5 3/4	5 1/4	4 1/4	1 1/2 - 20 x 5/8	
	80-12	105, 115, 125	12	24	B	6 3/8	6 1/2	5 1/2	5 1/2	—	1/4	29.0	6 3/8	6 5/8	6	5 1/2	5 1/4	1 1/2 - 20 x 5/8	
88 or 44 C.T. Series 0 - 22 - 44 - 66 - 88 V Parallel 0 - 22 - 44 V @ 2 x Current	88-0.1	115	0.1	0.2	C	2 7/8	1 9/8	2 3/8	2 3/8	—	#8	1.0	2 1/8	2 1/8	2 1/2	1 7/8	1 7/8	6-32 x 3/8	
	88-0.25	115	0.25	0.5	C	3 1/8	2 1/8	2 3/4	2 3/8	—	#8	1.5	2 3/4	2 3/8	2 1/2	1 7/8	1 7/8	6-32 x 3/8	
	88-0.5	115	0.5	1	C	3 1/8	2 3/8	2 3/8	2 3/8	—	#8	2.2	3 1/4	2 3/4	2 1/2	2	2	8-32 x 3/8	
	88-1	115	1	2	B	3 3/4	3	3 1/8	3 1/8	—	#8	4.5	4 1/8	3 3/2	3 1/2	2 1/2	2 1/2	10-32 x 1/2	
	88-2	115	2	4	B	4 1/8	3 3/8	3 1/2	3 1/2	—	#10	6.8	4 1/2	3 3/4	3 7/8	3 1/2	2 3/8	10-32 x 1/2	
	88-4	115	4	8	B	5 1/4	4 1/2	4 3/8	4 3/8	—	1/4	13.4	5 1/2	4 3/4	5	4 3/8	3	1 1/2 - 20 x 5/8	
	88-6	105, 115, 125	6	12	B	5 1/4	5 1/2	4 3/8	4 3/8	—	1/4	19.0	5 1/2	6	5	4 3/8	3 7/8	1 1/2 - 20 x 5/8	
	88-8	105, 115, 125	8	16	B	6 3/8	5 3/8	5 1/2	5 1/2	—	1/4	22.8	6 3/8	5 3/4	5 3/4	5 1/4	4 1/4	1 1/2 - 20 x 5/8	
	88-12	105, 115, 125	12	24	B	6 3/8	6 1/2	5 1/2	5 1/2	—	1/4	35.0	6 3/8	7	5 3/4	5 3/4	5 1/2	1 1/2 - 20 x 5/8	
	88-25	115/230	25	50	B	7 1/2	8	6 1/4	6 1/4	—	1/4	62.0	8	10	7	6 3/4	8 3/4	1 1/2 - 20 x 5/8	
120 or 60 C.T. Series 0 - 30 - 60 - 90 - 120 V Parallel 0 - 30 - 60 V @ 2 x Current	120-0.5	115	0.5	1.0	B	3 3/8	2 7/8	2 1/2	2 1/2	—	#8	3.2	3 3/8	3 3/4	3 1/4	2 3/8	2 3/8	8-32 x 3/8	
	120-1	115	1	2	B	3 3/4	3 3/8	3 1/8	3 1/8	—	#8	5.8	4 1/4	4	3 1/2	3 1/8	2 7/8	10-32 x 1/2	
	120-2	115	2	4	B	4 1/2	3 3/4	3 3/4	3 3/4	—	#10	8.5	4 3/4	4 1/4	4 1/4	3 3/4	2 7/8	10-32 x 1/2	
	120-4	115	4	8	B	5 1/4	5 1/2	4 3/8	4 3/8	—	1/4	17.0	5 1/2	6	5	4 3/8	3 7/8	1 1/2 - 20 x 5/8	
	120-6	105, 115, 125	6	12	B	6 3/8	6	5 1/2	5 1/2	—	1/4	27.0	6 3/8	6 5/8	6	5 1/2	5 1/4	1 1/2 - 20 x 5/8	
	120-8	105, 115, 125	8	16	B	6 3/8	6 1/2	5 1/2	5 1/2	—	1/4	34.0	6 3/8	7	5 3/4	5 1/2	5 1/2	1 1/2 - 20 x 5/8	
	120-12	105, 115, 125	12	24	B	6 3/8	7 1/4	5 1/2	5 1/2	—	1/4	42.0	6 3/8	8	6	5 1/2	6 1/2	1 1/2 - 20 x 5/8	
	120-20	105, 115, 125	20	40	B	7 1/2	8	6 1/4	6 3/4	—	1/4	57.0	8	9	7	6 3/4	7 3/4	1 1/2 - 20 x 5/8	
	160 or 80 C.T. Series 0 - 40 - 80 - 120 - 160 V Parallel 0 - 40 - 80 V @ 2 x Current	160-0.5	115	0.5	1	B	3 3/8	2 7/8	2 1/2	2 1/2	—	#8	4.0	3 3/8	3 3/4	3 1/4	2 3/8	2 3/8	8-32 x 3/8
		160-1	115	1	2	B	4 1/8	3 3/8	3 1/2	3 1/2	—	#10	6.5	4 1/2	3 3/8	3 7/8	3 1/2	2 3/8	10-32 x 1/2
160-2		115	2	4	B	4 1/2	4 3/8	3 3/4	3 3/4	—	#10	11.0	4 3/4	5	4 3/8	3 3/4	3 3/8	10-32 x 1/2	
160-4		105, 115, 125	4	8	B	6 3/8	5 1/2	5 1/2	5 1/2	—	1/4	21.0	6 3/8	5 3/4	5 3/4	5 1/4	4 1/4	1 1/2 - 20 x 5/8	
160-8		105, 115, 125	8	16	B	6 3/8	6 3/4	5 1/2	5 1/2	—	1/4	36.0	6 3/8	7 1/2	6	5 1/2	6	1 1/2 - 20 x 5/8	
160-12		115/230	12	24	B	7 1/2	6 1/2	6 1/4	6 3/4	—	1/4	39.8	6 3/8	8	7	6 3/4	6 3/4	1 1/2 - 20 x 5/8	
180 or 90 C.T. Series 0 - 45 - 90 - 135 - 180 V Parallel 0 - 45 - 90 V @ 2 x Current		180-0.5	115	0.5	1	B	3 3/4	3 3/8	3 1/2	3 1/2	—	#8	5.8	4 1/4	4	3 1/2	3 1/8	2 3/8	10-32 x 1/2
		180-1	115	1	2	B	4 1/8	3 3/8	3 3/8	3 3/8	—	#10	8.2	4 1/2	4 1/2	3 7/8	3 3/8	3	10-32 x 1/2
		180-2	115	2	4	B	5 1/4	5	4 3/8	4 3/8	—	1/4	15.8	5 1/2	5 1/2	5 1/4	4 3/8	3 1/2	1 1/2 - 20 x 5/8
		180-4	115	4	8	B	6 3/8	5 3/4	5 1/2	5 1/2	—	1/4	27.0	6 3/4	6 5/8	6	5 1/2	5 1/4	1 1/2 - 20 x 5/8
	180-6	105, 115, 125	6	12	B	6 3/8	7 1/4	5 1/2	5 1/2	—	1/4	37.0	6 3/4	8	6	5 1/2	6 1/2	1 1/2 - 20 x 5/8	
	180-8	105, 115, 125	8	16	B	6 3/8	7 3/4	5 1/2	5 1/2	—	1/4	42.0	6 3/4	8	6	5 1/2	6 1/2	1 1/2 - 20 x 5/8	
	180-12	105, 115, 125	12	24	B	7 1/2	8 1/4	6 1/4	6 3/4	—	1/4	62.0	8	9	7	6 3/4	7 3/4	1 1/2 - 20 x 5/8	
	230 or 115 C.T. Series 0-57 1/2-115-172 1/2-230 V Parallel 57 1/2 - 115 V @ 2 x Current	230-0.5	115	0.5	1	B	3 3/4	3 3/8	3 1/2	3 1/2	—	#8	6.5	4 1/4	4	3 1/2	3 1/8	2 7/8	10-32 x 1/2
		230-1	115	1	2	B	4 1/2	3 3/4	3 3/4	3 3/4	—	#10	9.4	4 3/4	4 1/4	4 1/4	3 3/4	2 7/8	10-32 x 1/2
		230-2	115	2	4	B	5 1/4	4 3/4	4 3/8	4 3/8	—	1/4	14.5	5 1/2	5 1/2	5 1/4	4 3/8	3 1/2	1 1/2 - 20 x 5/8
230-4		105, 115, 125	4	8	B	6 3/8	6	5 1/2	5 1/2	—	1/4	28.4	6 3/4	6 3/8	6	5 1/2	5 1/4	1 1/2 - 20 x 5/8	
230-6		105, 115, 125	6	12	B	6 3/8	7 1/4	5 1/2	5 1/2	—	1/4	38.0	6 3/4	8	6	5 1/2	6 1/2	1 1/2 - 20 x 5/8	
300 or 150 C.T. Series 0-75-150-225-300V Parallel 0-75-150V @ 2 x Current		300-0.5	115	0.5	1	B	4 1/2	3 1/2	3 3/4	3 3/4	—	#10	7.0	4 3/4	4 1/4	4 1/4	3 3/4	2 7/8	10-32 x 1/2
		300-1	115	1	2	B	5 1/4	4 1/8	4 3/8	4 3/8	—	1/4	12.8	5 1/2	4 3/4	5	4 3/8	3	1 1/2 - 20 x 5/8
		300-2	115	2	4	B	5 1/4	5 3/4	4 3/8	4 3/8	—	1/4	21.0	5 1/2	6 1/4	5	4 3/8	5 1/8	1 1/2 -

HIGH & LOW CURRENT CHOKES 0.1 to 1000 AMPS

OPEN FRAME • EPOXY ENCAPSULATED (GRADE 5) • HERMETICALLY SEALED (GRADE 4)

Signal's line of High Current Chokes is the most extensive available. It is designed to complement the selection of High Current Transformers so that a set may be specified for power supplies using inductive filters.

The inductance ratings given are minimum values guar-

anteed at full DC current. All resistance ratings are maximum values.

Special variations or intermediate values of inductance, current, or resistance can be supplied promptly and accurately.

PART No.	IND. (MHY)	CURR. (Amps)	RES. (Ohm.s)	MTG. STYLE	OPEN FRAME OR EPOXY ENCAPSULATED*							HERMETICALLY SEALED IN STEEL CASE†						
					L	W	H	ML	MW	MTG. SCREW	APPR. LBS.	L	W	H	ML	MW	MTG. STUD	
CH-0.1	1000	0.1	25	C	2	1½	1¾	1¾ ₂	—	#8	0.3	1½	1½	2¼	1¾	1¾	6-32 x ¾	
CH-0.2	800	0.2	15	C	2¾	1½	2	2	—	#8	0.7	1¾	1¾	2¼	1¾	1¾	6-32 x ¾	
CH-0.25	800	0.25	10.0	C	2¾	1¾	2¾	2¾	—	#8	1.0	2¼	2¼	2½	1¾	1¾	6-32 x ¾	
CH-0.5	400	0.5	4.0	C	3¼	2½	2¾	2¾ ₆	—	#8	1.5	2¾	2¾	2¾	1¾	1¾	6-32 x ¾	
CH-1	100	1	1.5	B	3	2½	2½	2½	2	#8	2.3	3¼	2¾	2¾	2½	2	8-32 x ¾	
CH-2	70	2	0.9	B	3¾	2¾	2¾	2¾ ₆	2½	#8	3.2	3½	3	3¼	2¾ ₆	2½	8-32 x ¾	
CH-4	70	4	0.6	B	3¾	3¼	3¼	3¼ ₆	2½	#8	5.3	4½	3½	3½	2½	2	8-32 x ¾	
CH-6	40	6	0.4	B	3¾	3¾	3¼	3¼ ₆	3	#8	6.5	4½	4	3½	3¼	2¾	8-32 x ¾	
CH-8	30	8	0.3	B	4½	3¾	3½	3¾ ₆	3	#10	8	4½	4	3¾	3¾ ₆	3	10-32 x ½	
CH-12	15	12	0.1	B	5¼	4	4¾	4¾ ₆	3½	#10	13.7	5½	4½	5	4¾	3¾	10-32 x ½	
CH-16	15	16	.08	B	5¼	4¾	4¾ ₆	4¾ ₆	3¾	#10	17.5	5½	5½	5	4¾	3¾	10-32 x ½	
CH-20	7	20	.05	B	5¼	4	4¾ ₆	4¾ ₆	3¾	#10	13.3	5½	4¾	5	4¾	3¾	10-32 x ½	
CH-25	5	25	.025	B	5¼	4¾	4¾ ₆	4¾ ₆	3¾	#10	17.8	5½	5¾	5	4¾	3¾	¼-20 x 5/8	
CH-30	4	30	.01	B	6¾	5	5¾	5¾ ₆	3¾	¼	24.4	6¾	5¼	5¾	5¾ ₆	3¾	¼-20 x 5/8	
CH-50	1.4	50	0.01	B	6¾	5¼	5¾	5¾ ₆	3¾	¼	26.7	6¾	5¼	5¾	5¾ ₆	3¾	¼-20 x 5/8	
CH-100	0.5	100	0.005	B	6¾	6¼	5¾	5¾ ₆	4½	¼	31.4	6¾	6¾	5¾	5¾ ₆	4½	¼-20 x 5/8	
CH-200	0.3	200	0.0025	B	7½	7	6¾	6¾	4½	¼	48.0	NOT AVAILABLE						
CH-500	0.055	500	0.00027	B	7½	6½	6¾	6¾	4½	¼	50.0	NOT AVAILABLE						
CH-1000	0.015	1,000	0.000065	B	7½	6½	6¾	6¾	4¾	¼	70.0	NOT AVAILABLE						

AVAILABLE IN
3 STYLES

FOR MECHANICAL DIMENSIONS REFER TO TRANSFORMER OUTLINES ON PREVIOUS PAGE.

* For epoxy encapsulation add prefix "E" to Part No., e.g., E-CH-1 add ¾ to L, W, H Dim. Grade 5.

† For hermetically sealed units add prefix "H" to Part No., e.g., H-CH-1, Grade 4.

INDUCTANCE VARIATION WITH DC CURRENT

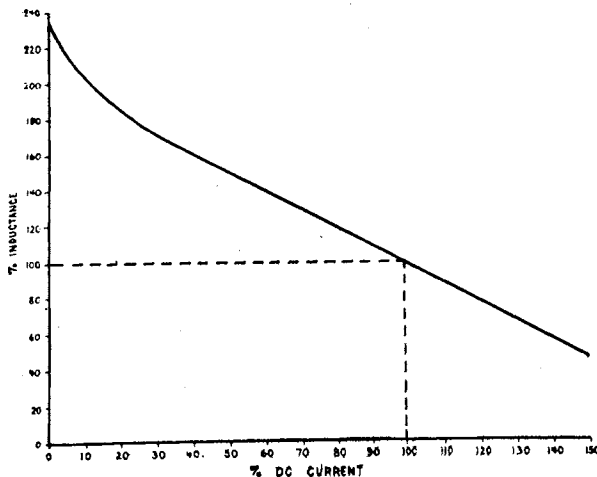

The curve shown applies to the whole line of chokes. It allows the user to determine the value of inductance which will be obtained at intermediate and overload values of DC current. The values on the curve are stated in generalized coordinates of % inductance versus % DC current.

For example, the CH-100 at 50 amperes (50% DC Current) will have an inductance of 0.75 MHY (150% of rating), the CH-25 at 31 amperes (125% DC current) will have an inductance of 3.5 MHY (70% of rating).

It is not recommended that chokes be used at over 100% of rated current since temperature rise will then be excessive. However, if load current is intermittent, and RMS current is less than maximum rated current, it is permissible.

Special "swinging chokes" can be supplied where the slope of this characteristic is emphasized. Specify minimum inductance required at two current values (usually maximum and minimum current) and we will furnish prompt quotations.

MULTI-VOLT
1 to 54 VOLTS
in 1 VOLT STEPS

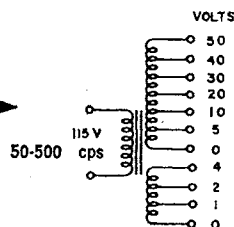

"MV" LINE

MV (multi-voltage) secondaries may be series connected for any output from 1 to 54 volts, in 1 volt steps, at rated current. This is accomplished by using the small buck-boost secondary.

Part No.	Secondary Amps.	DIMENSIONS					Appr. Wt.
		L	W	H	ML	MW	
MV-1	1	3¾	2¾	2¾ ₆	2¾ ₆	2¾	3.2
MV-2	2	3¾	3¾	3¾	3¾	2¾	5.0
MV-4	4	4½	3¾	3¾	3¾	2½	7.5
MV-6	6	5¼	4	4¾	4¾	2¾	12
MV-12	12	5¼	6	4¾	4¾	4¾	23

SIGNAL TRANSFORMER CO., INC

ENGINEERS • DESIGNERS • MANUFACTURERS

VERY HIGH CURRENT

STOCKED
FOR SAME DAY
SHIPMENT

TRANSFORMERS & CHOKES

500 to 1400 AMPERES

NEVER AVAILABLE BEFORE

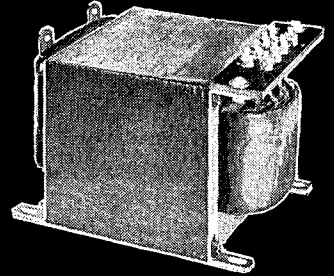

TRANSFORMERS

Part No.	Secondary Volts	Secondary Amps.		Dimensions					Mtg. Screw	Appr. Lbs.
		Nominal (45°C rise)	Max. (100°C rise)	L	W	H	ML	MW		
6-500	6	500	700	7½	6	7¼	6¾	4¾	¼	40
9-500	9	500	700	7½	7½	7¼	6¾	6¼	¼	60
12-500	12	500	700	7½	9	7¼	6¾	7¼	¼	80
3-1000	3	1000	1400	7½	6	7¼	6¾	4¾	¼	40
6-1000	6	1000	1400	7½	9	7¼	6¾	7¼	¼	80

CHOKES

Part No.	Inductance (Milli-hy)	Current (Amperes)	Resis. (Ohms)	L	W	H	ML	MW	Mtg. Screw	Appr. Lbs.
CH-500	.055	500	.00027	7½	6½	6¼	6¾	4¾	¼	50
CH-1000	.015	1000	.000065	7½	7½	6¼	6¾	5¾	¼	70

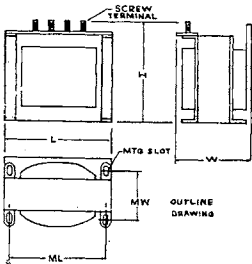

As shown on the schematic diagram dual primaries are provided. This permits parallel connection for 104, 110, or 120 volts or series connection for 208, 214, 220, 230, and 240 volts. Frequency range is 50 to 500 cps.

It is important to note that primary taps may be used to adjust the secondary voltages. Line voltages up to 125V (parallel) or 250V (series) may be used on the lowest primary tap. Nickel plated screw terminals are provided on a heavy phenolic board for easy primary connections.

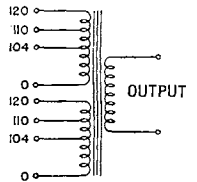

WINDINGS OF HEAVY COPPER STRIP

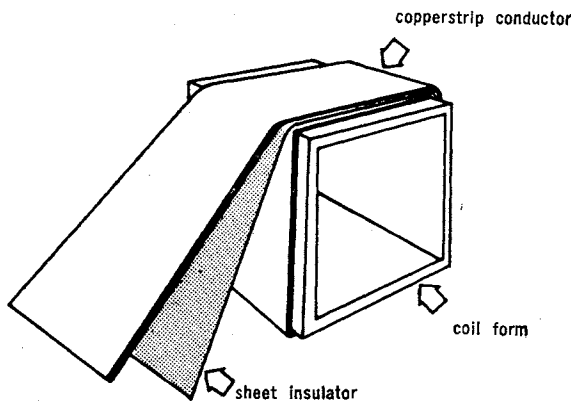

STRIP-WOUND SECONDARIES

At the heavy current used in this line it becomes practical and desirable to use wide copper strip (as wide as the coil itself) for windings. Besides the obvious advantages of excellent winding space factor, the heat dissipation of the coil is improved. This improvement is due to the fact that the heat generated in the windings has a pure copper path to the coil ends, where it can be dissipated. In conventional windings of many turns per layer this heat flow is impeded by wire insulation and air spaces between turns. Therefore, the use of copper strip windings yields a dramatic reduction in size and weight.

GRAIN-ORIENTED STEEL CORE

These cores permit the use of higher peak flux densities for the same core loss. This results in a lower number of turns required and therefore, a smaller, more compact transformer.

CLASS F INSULATION USED THROUGHOUT

Class F insulation is rated for unlimited life at a total temperature of 155°C (ambient plus temperature rise).

Class A insulation has a maximum temperature rating of 105°C. The "nominal" current ratings given to this series are for a temperature rise of 45°C above 55°C ambient (Class A). Since Class F insulation is used it is permissible to increase these ratings by 40% (700 and 1400 amperes) without reducing the reliability of the transformer. The temperature rise will be 100°C over a 55°C ambient. The only limitation is not the transformer, but the temperature rating of surrounding components which may be affected by the additional heat radiated by the transformer.



SIGNAL TRANSFORMER CO., INC

ENGINEERS • DESIGNERS • MANUFACTURERS

INDUSTRIAL GRADE STEP-UP OR STEP-DOWN POWER ISOLATION OR AUTO-TRANSFORMERS

HIGH DEGREE OF VERSATILITY OFFERS MANY POSSIBLE VOLTAGE RATINGS

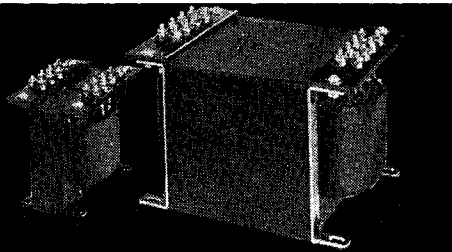

AVAILABLE FROM STOCK FOR IMMEDIATE SHIPMENT

The "DU" and "UP" lines are designed for a maximum of 55°C rise above ambient, for use on standard power lines from 50 to 500 Cps. Only prime raw materials are used. Units are thoroughly impregnated and baked with Signal's own high gloss black baking varnish. The transformers are rugged in construction, well-insulated, and have a consistently uniform appearance. All ratings are at full load current, continuous operation.

Heavy ¼ inch phenolic terminal boards are provided with plated brass screws and flat washers. Connections can be easily made with a nut driver. It is also simple to alter the inter-connections to change transformer ratings.

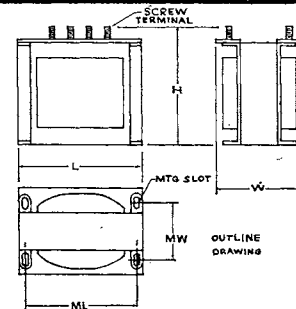

"DU SERIES" 110/220 Dual Primary To 110/220 Dual Sec.

As shown on the schematic diagram the "DU" line is designed with dual primaries and secondaries. All four windings are identically rated at 0/104/110/120 volts. This permits series or parallel connections on either primary or secondary. Therefore, a nominal 110 to 110 volt, 220 to 220 volt, 110 to 220 volt, or 220 to 110 volt transformer can be set up. The winding taps permit intermediate series ratings such as

208, 214, or 230 volts.

It is also possible to make auto-transformer connections by connecting a primary group in series with a secondary group. Such nominal ratings as 440 to 220 volts or 220 to 440 volts can be set-up, in addition to the standard ratings described above. A further advantage to auto-transformer connection is the fact that the KVA rating of a particular type is doubled.

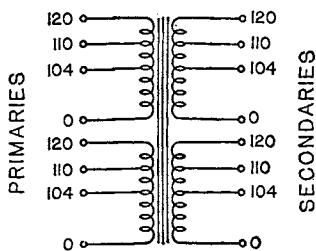

Part No.	KVA	Series Secondaries		Parallel Secondaries		Mechanical Dimensions						
		Volts	Max. Amps	Volts	Max. Amps	L (Max.)	W (Max.)	H (Max.)	ML ± 1/32	MW ± 1/16	Mtg. Screw	Appr. Lbs.
DU-¼	¼	0/208/220/240	1.1	0/104/110/120	2.2	5½ ₁₆	4¼	5¼	4¾	2½	#10	12
DU-½	½	0/208/220/240	2.3	0/104/110/120	4.6	5½ ₁₆	5½ ₁₆	5¼	4¾	3¾	#10	18
DU-1	1	0/208/220/240	4.5	0/104/110/120	9	7½ ₁₆	6¼	7¼	6¾	4½	¼	33
DU-2	2	0/208/220/240	9	0/104/110/120	18	7½ ₁₆	8¼	7¼	6¾	6	¼	56
DU-3	3	0/208/220/240	14	0/104/110/120	28	7½ ₁₆	9¼	7¼	6¾	7	¼	70
DU-5	5	0/208/220/240	23	0/104/110/120	46	7½ ₁₆	10¾	7¼	6¾	8½	¼	89
DU-7.5	7.5	0/208/220/240	31	0/104/110/120	62	9	9	8	7½	6½	¼	105
DU-10	10	0/208/220/240	41	0/104/110/120	83	9	12	8	7½	9	¼	150

"UP SERIES" 110/220 Dual Primary To 0/130/135/140 V. Sec.

The "UP" line utilizes the same dual primary as the "DU" line. It has, however, a single secondary rated at 0/130/135/140 volts. This type is quite useful to boost -low line

voltages or raise line voltages to compensate for drops in series elements. It also finds application in bridge rectifiers for DC voltage outputs of approximately 115 to 130 volts.

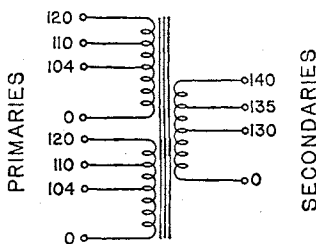

Part No.	KVA	Secondary Volts	Max. Secondary Amps	L (Max.)		W (Max.)	H (Max.)	ML ± 1/32		MW ± 1/16	Mtg. Screw	Appr. Lbs.
				(Max.)	(Max.)			± 1/32	± 1/16			
UP-2	¼	0/130/135/140	2	5½ ₁₆	4¼	5¼	4¾	2½	#10	12		
UP-4	½	0/130/135/140	4	5½ ₁₆	5½ ₁₆	5¼	4¾	3¾	#10	18		
UP-8	1	0/130/135/140	8	7½ ₁₆	6¼	7¼	6¾	4½	¼	33		
UP-15	2	0/130/135/140	15	7½ ₁₆	8¼	7¼	6¾	6	¼	56		
UP-25	3	0/130/135/140	25	7½ ₁₆	9¼	7¼	6¾	7	¼	70		
UP-40	5	0/130/135/140	40	7½ ₁₆	10¾	7¼	6¾	8½	¼	89		

SIGNALS CUSTOM SERVICE

Many of our customers do not realize that the major portion of our shipments consists of "special" or "custom" items.

Usually, the final application of one of our stock transformers does not require the full number of taps or windings provided. These naturally are part of the cost of the item. If we are advised as to

the specific taps used or as to what intermediate voltage or current is required we can begin production quickly on this variation of our stock item. If we define production quantities as roughly over 50 pieces, the customer will do better price-wise on his custom made item than on the standard.

SIGNAL TRANSFORMER CO., INC

ENGINEERS • DESIGNERS • MANUFACTURERS

3 PHASE HIGH CURRENT RECTIFIER TRANSFORMERS

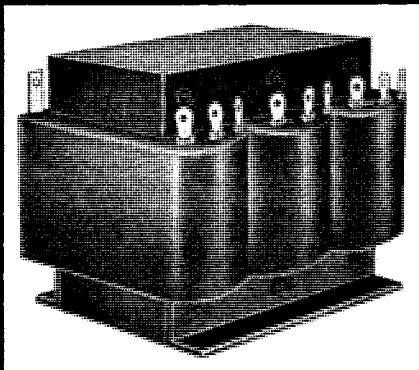

SCHEMATIC DIAGRAM

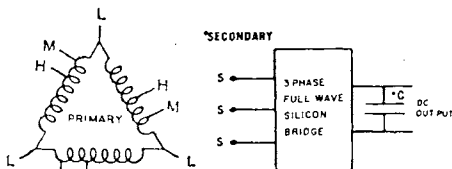

*C — Optional, no capacitor will give DC output shown at approx. 5% ripple.

MECHANICAL DIMENSIONS

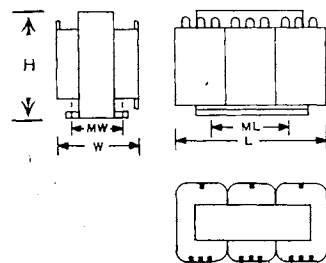

DC OUTPUT VOLTAGE

PART NO.	PRI TAP "L" SUPPLY VOLTAGE		PRI TAP "M" SUPPLY VOLTAGE		PRI TAP "H" SUPPLY VOLTAGE		DC RATED AMPS	APPROX. DIMENSIONS					APX. LBS.
	208	220	208	220	208	220		L	W	H	ML	MW	
3PH 24-50	24	25	26	27.5	28	30	50	7 $\frac{3}{4}$	6	5 $\frac{1}{2}$	4.8	4 $\frac{7}{8}$	35
3PH 24-100	24	25	26	27.5	28	30	100	11 $\frac{1}{2}$	5	8 $\frac{1}{4}$	7.2	4	42
3PH 24-200	24	25	26	27.5	28	30	200	11 $\frac{1}{2}$	8 $\frac{5}{8}$	8 $\frac{1}{4}$	7.2	6 $\frac{1}{4}$	90
3PH 48-30	42	44	47	50	52	55	30	7 $\frac{3}{4}$	6	5 $\frac{1}{2}$	4.8	4 $\frac{7}{8}$	35
3PH 48-60	42	44	47	50	52	55	60	11 $\frac{1}{2}$	5	8 $\frac{1}{4}$	7.2	4	42
3PH 48-120	42	44	47	50	52	55	120	11 $\frac{1}{2}$	8 $\frac{5}{8}$	8 $\frac{1}{4}$	7.2	6 $\frac{1}{4}$	90

At higher power loads (above 2-3 KVA) it becomes inefficient to use single phase 115 or 230 volt standard lines. With this in mind, our engineering staff has developed a line of 3 phase transformers for use off 208 or 220V 3 phase power lines. These offer the significantly higher

conversion efficiency and lighter power line drain of 3 phase systems. Since the principal application of these items is in high power dc power supplies, output ratings are given in dc voltage and current assuming the use of a 3 phase full wave rectifier.

STEP DOWN AUTO TRANSFORMERS

230 TO 115 VOLTS 50/60 CPS

"SD" SERIES — LINE CORD & RECEPTACLE

VA Rating	Part No.	W	D	H	MW	MD	Mtg. Screw	Appr. Lbs.
100	SD-100	2 $\frac{5}{8}$	2 $\frac{7}{8}$	3 $\frac{1}{8}$	2	1 $\frac{1}{16}$	#8	2.3
150	SD-150	2 $\frac{5}{8}$	3 $\frac{1}{2}$	3 $\frac{1}{8}$	2	2 $\frac{1}{16}$	#8	3.6
250	SD-250	3 $\frac{7}{8}$	3 $\frac{1}{2}$	4 $\frac{5}{8}$	3	2 $\frac{3}{8}$	#8	6.2
350	SD-350	3 $\frac{7}{8}$	4 $\frac{1}{4}$	4 $\frac{5}{8}$	3	3 $\frac{1}{16}$	#8	8.3
500	SD-500	3 $\frac{7}{8}$	4 $\frac{3}{4}$	4 $\frac{5}{8}$	3	3 $\frac{3}{16}$	#8	10.5
750	SD-750	4 $\frac{5}{8}$	5 $\frac{3}{8}$	5 $\frac{5}{8}$	3 $\frac{1}{2}$	3 $\frac{3}{4}$	1/4	14.5
1000	SD-1000	4 $\frac{5}{8}$	5 $\frac{7}{8}$	5 $\frac{5}{8}$	3 $\frac{1}{2}$	4 $\frac{1}{4}$	1/4	18
1500	SD-1500	4 $\frac{5}{8}$	6 $\frac{5}{8}$	5 $\frac{5}{8}$	3 $\frac{1}{2}$	5	1/4	22
2000	SD-2000	4 $\frac{5}{8}$	7 $\frac{1}{8}$	5 $\frac{5}{8}$	3 $\frac{1}{2}$	5 $\frac{1}{2}$	1/4	26

(100-2000 VA) TYPE SD

Low Regulation • Fully enclosed — Black Wrinkle Finish • 45°C Temperature Rise • U/L Approved 2 prong line cord and receptacle.

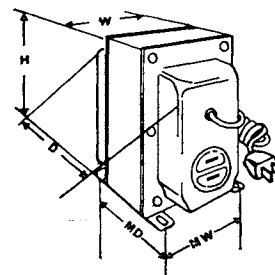

"SDO" SERIES — OPEN FRAME • SOLDER LUGS

VA Rating	Part No.	L	W	H	ML	MW	Mtg. Screw	Appr. Lbs.
100	SDO-100	3	2 $\frac{1}{2}$	2 $\frac{1}{2}$	2 $\frac{1}{2}$	2 $\frac{1}{8}$	#8	2.3
150	SDO-150	3	3 $\frac{1}{4}$	2 $\frac{1}{2}$	2 $\frac{1}{2}$	2 $\frac{3}{4}$	#8	3.6
250	SDO-250	4 $\frac{1}{2}$	2 $\frac{3}{4}$	3 $\frac{3}{4}$	3 $\frac{3}{4}$	2	#10	6.2
350	SDO-350	4 $\frac{1}{2}$	3 $\frac{3}{4}$	3 $\frac{3}{4}$	3 $\frac{3}{4}$	2 $\frac{3}{4}$	#10	8.3
500	SDO-500	4 $\frac{1}{2}$	4 $\frac{1}{4}$	3 $\frac{3}{4}$	3 $\frac{3}{4}$	3 $\frac{1}{4}$	#10	10.5
750	SDO-750	5 $\frac{1}{4}$	4 $\frac{1}{2}$	4 $\frac{3}{8}$	4 $\frac{3}{8}$	3 $\frac{3}{8}$	1/4	14.5
1000	SDO-1000	5 $\frac{1}{4}$	5	4 $\frac{3}{8}$	4 $\frac{3}{8}$	3 $\frac{7}{8}$	1/4	18
1500	SDO-1500	5 $\frac{1}{4}$	5 $\frac{3}{4}$	4 $\frac{3}{8}$	4 $\frac{3}{8}$	4 $\frac{5}{8}$	1/4	22
2000	SDO-2000	5 $\frac{1}{4}$	6 $\frac{1}{4}$	4 $\frac{3}{8}$	4 $\frac{3}{8}$	5 $\frac{1}{8}$	1/4	26

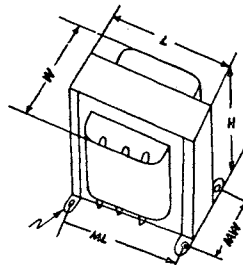

TYPE SDO

Same Electrically as Type SD. Open Frame • Black Enamel Finish • Solder Lugs • Inexpensive Version for Use in Equipment.

"HSD" SERIES RUGGED • HEAVY DUTY • PHENOLIC TERMINAL BOARDS

VA Rating	Part No.	W	D	H	MW	MD	Mtg. Screw	Appr. Lbs.
3000	HSD-3000	7 $\frac{1}{2}$	6	6 $\frac{3}{4}$	6 $\frac{3}{4}$	4 $\frac{1}{8}$	1/4	40
4000	HSD-4000	7 $\frac{1}{2}$	6 $\frac{1}{2}$	6 $\frac{3}{4}$	6 $\frac{3}{4}$	4 $\frac{5}{8}$	1/4	46
5000	HSD-5000	7 $\frac{1}{2}$	7	6 $\frac{3}{4}$	6 $\frac{3}{4}$	5 $\frac{1}{8}$	1/4	52
6000	HSD-6000	7 $\frac{1}{2}$	8	6 $\frac{3}{4}$	6 $\frac{3}{4}$	6 $\frac{1}{8}$	1/4	65

(3000-6000 VA) TYPE HSD

Very low Regulation • 45°C Temperature Rise • Black High Gloss Enamel Finish • Screw type terminals on phenolic board.

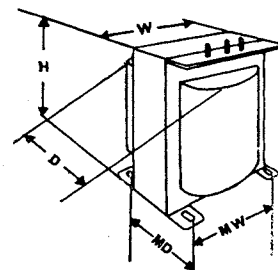

SIGNAL TRANSFORMER CO., INC

ENGINEERS • DESIGNERS • MANUFACTURERS

CONSTANT VOLTAGE TRANSFORMERS

FOR USE IN DC POWER SUPPLIES (TYPE CDC)

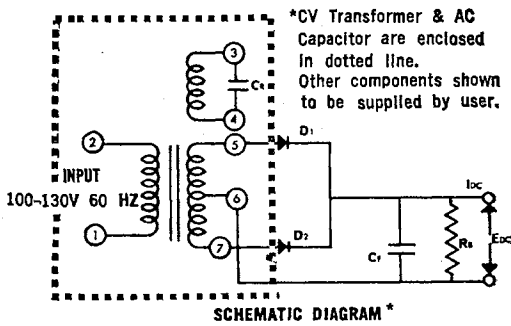

CDC CONSTANT VOLTAGE TRANSFORMERS

Signal's CDC Regulating Transformers are specifically manufactured for use in DC Power Supplies. They are designed and rated for use with a full wave center-tapped silicon rectifier. CDC transformers are operated in ferro-resonance and are used in conjunction with an AC tuning capacitor (Cr in schematic diagram), which is supplied with the transformer.

In order to construct a regulated power supply the only other parts necessary are two diodes (D₁ and D₂), an electrolytic computer grade capacitor (C_r) and a bleeder resistor (R_b). These are standard shelf items.

The specification chart lists specific outputs available and the recommended auxiliary components. Part numbers are coded in terms of DC outputs, e.g., CDC-15-2 will give an output of 15V DC at 2 amps DC.

Electrical performance is completely specified. The DC voltage is constant to $\pm 1\%$ over the line voltage range of 100 to 130V at 60 HZ. The nominal output is held to $\pm 2\%$. Closer tolerance on nominal output ($\pm 1\%$) can be obtained on special order at slightly higher cost.

Load regulation is specified as the rise in dc voltage output (increase in E_{dc}) from full load to the no load, 1/4 load, and 1/2 load points. The filter capacitor (C_r) specified should be used and will yield the values of ripple voltage shown.

A significant protection feature is the fact that the DC short circuit current is limited to a maximum of 2 times rated current (3 times in size "C-6" units). This protects the entire circuit against shorts.

OUTPUT D.C. VOLTS	DC Amps I _{dc}	Part Number	Load Regulation (Rise in DCV from FL)			Ripple Volts (RMS)	Recommended Diodes (D ₁ & D ₂)		Filter Cap. (C _r)		Bleeder† Resistor (R _b)		Style* & Size
			NL-FL	1/4-FL	1/2-FL		P.I.V.	I/Cell	MFD.	DCWV	Ohms	Watts	
6 vdc	0.8	CDC-6-0.8	2.0	1.5	0.8	0.3	50	1	3K	10	50	2	C-6
	4.5	CDC-6-4.5	1.0	0.7	0.5	0.4	50	6	15K	10	10	5	B-25
	9.0	CDC-6-9	1.0	0.7	0.5	0.4	50	16	25K	10	6	10	B-50
	16	CDC-6-16	1.0	0.7	0.4	0.4	50	16	75K	10	5	10	B-120
	40	CDC-6-40	0.7	0.4	0.2	0.4	50	60	150K	10	3	20	B-250
75	CDC-6-75	0.8	0.6	0.4	0.4	50	100	200K	10	1	40	B-500	
12 vdc	0.4	CDC-12-0.4	3.0	2.2	1.1	0.3	100	1	2K	15	150	2	C-6
	2.2	CDC-12-2.2	1.5	1.0	0.6	0.4	100	3	8K	15	25	10	B-25
	4.5	CDC-12-4.5	1.2	0.7	0.5	0.4	100	6	15K	15	25	10	B-50
	9.0	CDC-12-9	1.0	0.7	0.4	0.4	100	16	40K	15	10	20	B-120
	20	CDC-12-20	0.8	0.5	0.3	0.3	100	40	75K	15	5	40	B-250
38	CDC-12-38	0.9	0.7	0.4	0.4	100	60	120K	15	4	50	B-500	
15 vdc	0.35	CDC-15-0.35	3.5	2.3	1.3	0.3	100	1	1.5K	20	200	2	C-6
	2.0	CDC-15-2	1.6	1.0	0.6	0.4	100	2	7K	20	50	5	B-25
	3.5	CDC-15-3.5	1.3	0.8	0.6	0.3	100	6	15K	20	25	10	B-50
	8	CDC-15-8	1.5	0.9	0.6	0.4	100	16	30K	20	15	20	B-120
	16	CDC-15-16	1.0	0.8	0.5	0.3	100	16	75K	20	10	30	B-250
30	CDC-15-30	1.0	0.6	0.4	0.3	100	40	120K	20	5	50	B-500	
18 vdc	0.32	CDC-18-0.32	3.7	2.3	1.3	0.4	100	1	1K	20	300	2	C-6
	1.8	CDC-18-1.8	2.0	1.2	0.7	0.4	100	2	7K	20	100	5	B-25
	3	CDC-18-3	1.7	1.2	0.7	0.3	100	3	12K	20	50	10	B-50
	6	CDC-18-6	1.7	0.9	0.6	0.3	100	6	30K	20	25	20	B-120
	13	CDC-18-13	1.3	1.0	0.7	0.3	100	16	50K	20	15	30	B-250
26	CDC-18-26	1.5	0.6	0.5	0.3	100	40	120K	20	10	50	B-500	
24 vdc	0.25	CDC-24-0.25	4.0	3.4	1.5	0.3	200	1	1K	25	350	2	C-6
	1.2	CDC-24-1.2	2.0	1.2	0.7	0.4	200	2	5K	25	100	10	B-25
	2.1	CDC-24-2.1	1.8	1.5	1.0	0.3	200	3	10K	25	50	20	B-50
	4.5	CDC-24-4.5	2.0	1.0	0.7	0.3	200	6	25K	25	50	20	B-120
	11	CDC-24-11	1.3	1.0	0.5	0.3	200	16	50K	25	25	30	B-250
20	CDC-24-20	1.5	0.7	0.3	0.3	200	40	75K	25	15	50	B-500	
28 vdc	0.22	CDC-28-0.25	5.6	4.0	2.3	0.3	200	1	1K	35	500	2	C-6
	1.0	CDC-28-1	2	1.5	0.6	0.3	200	1	5K	35	100	10	B-25
	2.0	CDC-28-2	2.5	1.5	1.0	0.3	200	2	10K	35	100	10	B-50
	4.0	CDC-28-4	2.0	1.2	0.8	0.3	200	6	25K	35	50	20	B-120
	9.0	CDC-28-9	1.3	1.0	0.5	0.3	200	16	50K	35	25	40	B-250
16	CDC-28-16	1.7	0.8	0.3	0.3	200	16	75K	35	15	60	B-500	
36 vdc	0.18	CDC-36-0.18	7.0	5.5	3.5	0.3	200	1	1K	50	1K	2	C-6
	0.9	CDC-36-0.9	2.0	1.4	0.8	0.3	200	1	5K	50	150	10	B-25
	1.8	CDC-36-1.8	3.0	2.0	1.3	0.3	200	2	8K	50	100	20	B-50
	3.2	CDC-36-3.2	2.5	1.4	0.7	0.3	200	3	20K	50	100	20	B-120
	6	CDC-36-6	2.0	1.5	1.0	0.3	200	16	25K	50	25	60	B-250
12	CDC-36-12	1.8	1.0	0.7	0.3	200	16	50K	50	25	60	B-500	
48 vdc	0.12	CDC-48-0.12	8.0	6.0	4.0	0.2	200	1	1K	50	1.5K	2	C-6
	0.6	CDC-48-0.6	2.5	2.0	1.0	0.3	200	1	3K	50	300	10	B-25
	1.5	CDC-48-1.5	3.0	1.5	1.0	0.3	200	2	6K	50	250	10	B-50
	2.5	CDC-48-2.5	3.0	1.5	1.0	0.2	200	2	15K	50	200	20	B-120
	5.0	CDC-48-5	2.0	1.0	0.6	0.3	200	6	15K	50	50	50	B-250
10	CDC-48-10	2.0	1.0	0.5	0.4	200	16	25K	50	50	50	B-500	
60 vdc	0.1	CDC-60-0.1	8.0	6.0	4.0	0.2	400	1	1K	75	2.5K	2	C-6
	0.5	CDC-60-0.5	3.0	2.0	1.2	0.4	400	1	2K	75	500	10	B-25
	1.2	CDC-60-1.2	4.2	3.0	2.0	0.3	400	2	5K	75	400	10	B-50
	2.0	CDC-60-2	3.5	2.0	1.0	0.3	400	2	10K	75	300	20	B-120
	4	CDC-60-4	1.5	1.2	1.0	0.4	400	6	12K	75	75	50	B-250
8	CDC-60-8	3.0	2.0	0.6	0.4	400	16	20K	75	75	50	B-500	
120 vdc	0.05	CDC-120-0.05	9.0	8.0	5.0	0.2	400	1	0.5K	150	10K	2	C-6
	0.3	CDC-120-0.3	6.0	4.0	2.5	0.3	400	1	2K	150	2K	10	B-25
	0.6	CDC-120-0.6	5.5	3.5	2.5	0.3	400	1	3K	150	1.5K	10	B-50
	1.0	CDC-120-1	5.5	3.2	2.0	0.4	400	1	4K	150	1K	20	B-120
	2	CDC-120-2	4.0	3.0	2.0	0.3	400	2	9K	150	250	60	B-250
4	CDC-120-4	4.0	2.0	0.8	0.4	400	6	15K	150	150	100	B-500	

* See mechanical dimensions on opposite page.

† Bleeder resistor may be eliminated if load current does not fall to zero. DC amp rating may be increased accordingly.

SIGNAL TRANSFORMER CO., INC

ENGINEERS • DESIGNERS • MANUFACTURERS

CONSTANT VOLTAGE TRANSFORMERS

FOR USE IN AC APPLICATIONS (TYPE ACV)

PART NO.	VOLTS AC	AMPS AC	STYLE & SIZE
6 ACV-6.4	6.4	1	C-6
6 ACV-12.8	12.8	0.5	C-6
6 ACV-26	26	0.25	C-6
6 ACV-118	118	0.05	C-6
25 ACV-6.4	6.4	4	B-25
25 ACV-12.8	12.8	2	B-25
25 ACV-26	26	1	B-25
25 ACV-118	118	0.25	B-25
50 ACV-6.4	6.4	8	B-50
50 ACV-12.8	12.8	4	B-50
50 ACV-26	26	2	B-50
50 ACV-118	118	0.43	B-50
120 ACV-6.4	6.4	20	B-120
120 ACV-12.8	12.8	10	B-120
120 ACV-26	26	5	B-120
120 ACV-118	118	1	B-120
250 ACV-12.8	12.8	20	B-250
250 ACV-26	26	10	B-250
250 ACV-118	118	2.2	B-250
500 ACV-118	118	4.5	B-500

Signal ACV transformers are manufactured for use with AC loads. They are simple and rugged designs and will regulate to within plus or minus 1% for input variations from 95-130V at 60 cps. If regulation of plus or minus ½% or better is desired, special units can be made to your order. ACV transformers will regulate with loads that are not unity power factor.

Full regulation is maintained at any load from about 20% to 100%. Overload current is limited to a maximum of 200% of rated current at short circuit. The 6.4 and 12.8V ratings are ideal for use with tube or lamp loads since the short circuit current rating limits the inrush current to cold filaments. Stabilization of the voltage results in longer filament life.

ACV transformers are "normal" harmonic type with approximately a square wave output.

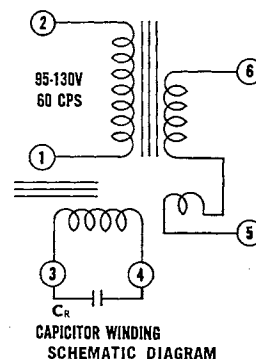

MECHANICAL DIMENSIONS

STYLE & SIZE	L	W	H	ML	MW	MTG. SCREW
C-6	3¼	1⅞	1⅝	2⅜	—	#8
B-25	3	2⅝	3⅞	2⅝	1⅝	#8
B-50	3	3⅝	3⅞	2⅝	2⅞	#8
B-120	4	3⅞	4⅞	3½	2⅞	#10
B-250	4	5¾	4⅞	3½	3⅞	#10
B-500	5	5¾	5⅞	4⅞	3⅞	#10

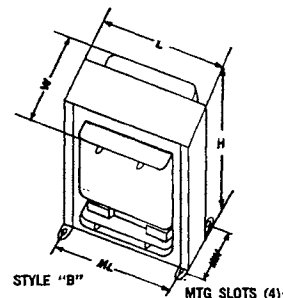
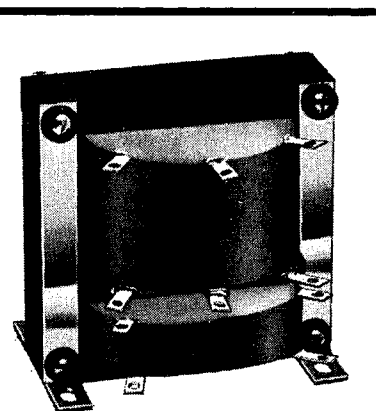
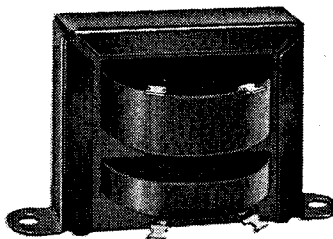
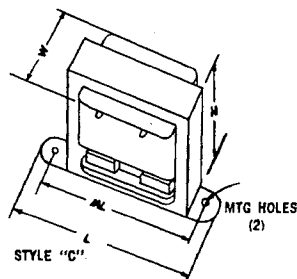

ADVANTAGES OF CONSTANT VOLTAGE TRANSFORMERS

REGULATION — output regulated to plus or minus 1% for line voltage variations of 95 to 130V at 60 cps.

SELF-PROTECTION — against output short circuit. Current limited to a maximum of 2 times rated current.

MECHANICALLY RUGGED — as resistant to mechanical shock as conventional power transformers.

NO MOVING PARTS — no adjustment or maintenance necessary.

SQUARE WAVE OUTPUT — ideal for use in rectifier circuits — little filtering needed.

HIGH DEGREE OF ISOLATION — between input and output circuits — both physical and electrical isolation, electro-static shields not necessary.

RESONATING CAPACITOR — supplied with transformers.

EPOXY IMPREGNATION — minimizes acoustic noise.

CONSULT WITH US
FOR YOUR SPECIAL
CV TRANSFORMERS
PROMPT QUOTATIONS



SIGNAL TRANSFORMER CO., INC

ENGINEERS • DESIGNERS • MANUFACTURERS

IGNAL TRANSFORMER CO., INC

PRICE LIST

Part No.	User Net	Part No.	User Net	Part No.	User Net	Part No.	User Net	Part No.	User Net
10-0.1	3.40	36-50	55.00	180-0.5	9.10	E-16-1	6.52	E-80-0.5A	8.50
10-0.25	3.60	36-100	108.00	180-1	14.20	E-16-2	8.16	E-80-0.5	10.30
10-0.5	3.75			180-2	20.00	E-16-4	12.45	E-80-1	13.10
10-1	4.15	56-0.1	3.80	180-4	36.00	E-16-6	14.70	E-80-2	19.60
10-2	5.20	56-0.25	4.45	180-6	42.50	E-16-8	16.05	E-80-4	32.60
10-4	6.50	56-0.5	5.00	180-8	52.00	E-16-12	20.00	E-80-6	42.00
10-6	8.40	56-1	8.00	180-12	78.00	E-16-25	38.00	E-80-8	51.00
10-8	9.00	56-2	8.90			E-16-50	61.00	E-80-12	64.70
10-12	10.50	56-4	14.90	230-0.5	10.50	E-16-100	102.00	E-80-25	110.00
10-25	18.20	56-6	21.50	230-1	15.00			E-80-50	198.00
10-50	26.50	56-8	26.50	230-2	21.50	E-24-0.1	5.25		
10-100	43.00	56-12	35.00	230-4	42.00	E-24-0.25	6.20	E-88-0.1	6.15
		56-25	57.00	230-6	50.00	E-24-0.5	6.85	E-88-0.25	7.23
12.8-0.1	3.40	56-50	102.00			E-24-1A	7.50	E-88-0.5	8.65
12.8-0.25	3.65	66-100	151.00	300-0.5	11.00	E-24-1	9.77	E-88-1	13.45
12.8-0.5	4.00			300-1	19.70	E-24-2	11.22	E-88-2	19.90
12.8-1	4.45	68-0.1	3.90	300-2	31.00	E-24-4	14.20	E-88-4	34.10
12.8-2A	5.15	68-0.25	4.40	300-4	48.50	E-24-6	17.05	E-88-6	42.80
12.8-2	6.35	68-0.5A	5.10	CH-0.1	2.25	E-24-8	23.60	E-88-8	52.50
12.8-4	7.70	68-0.5	6.75	CH-0.2	2.60	E-24-12	27.80	E-88-12	66.30
12.8-6	9.00	68-1	7.90	CH-0.25	3.00	E-24-20	35.00	E-88-25	114.00
12.8-8	9.60	68-2	10.00	CH-0.5	3.80	E-24-25	47.10	E-88-50	204.00
12.8-12	11.00	68-4	18.80	CH-1	5.70	E-24-50	69.50		
12.8-25	22.40	68-6	21.50	CH-2	6.60	E-24-100	111.00	E-120-0.5	12.30
12.8-50	30.50	68-8	25.80	CH-4	8.80	E-36-0.1	5.40	E-120-1	15.70
12.8-100	44.00	68-12	38.00	CH-6	11.00	E-36-0.25	6.03	E-120-2	22.40
		68-25	57.00	CH-8	14.00	E-36-0.5	6.88	E-120-4	43.10
		68-50	103.00	CH-12	18.00	E-36-1A	8.55	E-120-6	52.60
16-0.1	3.50			CH-16	20.00	E-36-1	10.05	E-120-8	65.80
16-0.25	3.70	80-0.1	4.00	CH-20	19.50	E-36-2	11.90	E-120-12	83.00
16-0.5	3.95	80-0.25	4.60	CH-25	27.50	E-36-4	16.80	E-120-20	122.00
16-1	4.30	80-0.5A	5.60	CH-30	33.00	E-36-6	24.20	E-160-0.5	13.05
16-2	5.35	80-0.5	6.75	CH-50	38.00	E-36-8	26.00	E-160-1	19.50
16-4	8.10	80-1	8.50	CH-100	43.00	E-36-12	31.20	E-160-2	27.40
16-6	9.50	80-2	12.70	CH-200	68.00	E-36-20	52.80	E-160-4	47.70
16-8	10.30	80-4	21.00	CH-500	92.00	E-36-25	62.20	E-160-8	75.60
16-12	12.75	80-6	27.00	CH-1000	102.00	E-36-30	69.50	E-160-12	103.00
16-25	24.00	80-8	32.50			E-36-50	87.50	E-180-0.5	13.65
16-50	38.00	80-12	41.00	E-10-0.1	5.10	E-36-100	173.00	E-180-1	21.40
16-100	64.00	80-25	69.50	E-10-0.25	5.43			E-180-2	30.40
		80-50	124.00	E-10-0.5	5.80	E-56-0.1	5.70	E-180-4	55.50
24-0.1	3.50			E-10-1	6.35	E-56-0.25	6.70	E-180-6	65.80
24-0.25	4.10	88-0.1	4.10	E-10-2	8.00	E-56-0.5	7.55	E-180-8	81.00
24-0.5	4.50	88-0.25	4.80	E-10-4	11.10	E-56-1	12.10	E-180-12	123.00
24-1A	4.90	88-0.5	5.70	E-10-6	13.00	E-56-2	13.50		
24-1	6.35	88-1	8.80	E-10-8	14.00	E-56-4	22.80	E-230-0.5	15.75
24-2	7.30	88-2	12.90	E-10-12	16.55	E-56-6	33.10	E-230-1	22.80
24-4	9.15	88-4	22.00	E-10-25	28.80	E-56-8	41.10	E-230-2	33.00
24-6	11.00	88-6	27.50	E-10-50	42.20	E-56-12	54.50	E-230-4	65.00
24-8	15.20	88-8	33.50	E-10-100	69.00	E-56-25	89.50	E-230-6	77.50
24-12	17.80	88-12	42.00			E-56-50	161.00	E-300-0.5	16.50
24-20	22.40	88-25	72.00	E-12.8-0.1	5.10	E-56-100	240.00	E-300-1	30.00
24-25	30.00	88-50	128.00	E-12.8-0.25	5.51			E-300-2	48.00
24-50	44.00			E-12.8-0.5	6.05	E-68-0.1	5.85	E-300-4	75.60
24-100	70.00	120-0.5	8.20	E-12.8-1	6.75	E-68-0.25	6.62		
		120-1	10.40	E-12.8-2A	7.85	E-68-0.5A	7.70	E-CH-0.1	2.90
36-0.1	3.60	120-2	14.70	E-12.8-2	9.75	E-68-0.5	10.22	E-CH-0.2	3.40
36-0.25	4.00	120-4	28.00	E-12.8-4	11.85	E-68-1	12.00	E-CH-0.25	3.95
36-0.5	4.55	120-6	34.00	E-12.8-6	13.90	E-68-2	15.30	E-CH-0.5	5.00
36-1A	5.65	120-8	42.50	E-12.8-8	14.90	E-68-4	28.80	E-CH-1	7.60
36-1	6.60	120-12	52.50	E12.8-12	17.20	E-68-6	33.10	E-CH-2	8.80
36-2	7.80	120-20	76.50	E-12.8-25	35.40	E-68-8	40.00	E-CH-4	11.80
36-4	10.90			E-12.8-50	48.60	E-68-12	59.50	E-CH-6	14.80
36-6	15.60	160-0.5	8.70	E-12.8-100	70.50	E-68-25	90.00	E-CH-8	18.90
36-8	16.70	160-1	12.90			E-68-50	165.00	E-CH-12	24.50
36-12	20.00	160-2	18.00	E-16-0.1	5.25			E-CH-16	27.40
36-20	33.70	160-4	31.00	E-16-0.25	5.57	E-80-0.1	6.00	E-CH-20	26.80
36-25	39.60	160-8	48.50	E-16-0.5	5.96	E-80-0.25	6.95		
36-30	44.00	160-12	65.00						

SIGNAL TRANSFORMER PRICE LIST

Part No.	User Net	Part No.	User Net	Part No.	User Net	Part No.	User Net	Part No.	User Net
E-CH-25	38.00	H-36-4	32.10	H-160-0.5	25.20	SD-2000	35.00	CDC-24-4.5	29.00
E-CH-30	45.70	H-36-6	46.00	H-160-1	37.70	SD0-100	5.00	CDC-24-11	43.80
E-CH-50	52.70	H-36-8	49.50	H-160-2	52.80	SD0-150	6.00	CDC-24-20	67.30
E-CH-100	60.00	H-36-12	59.40	H-160-4	92.00	SD0-250	7.40	CDC-28-0.25	13.75
E-CH-200	96.00	H-36-20	100.00	H-160-8	145.00	SD0-350	10.50	CDC-28-1	19.40
E-CH-500	132.00	H-36-25	118.00	H-160-12	195.00	SD0-500	12.40	CDC-28-2	23.00
E-CH-1000	148.00	H-36-30	131.00	H-180-0.5	26.40	SD0-750	16.50	CDC-28-4	28.90
H-10-0.1	9.85	H-36-50	165.00	H-180-1	41.50	SD0-1000	20.20	CDC-28-9	43.70
H-10-0.25	10.50	H-36-100	326.00	H-180-2	58.70	SD0-1500	23.50	CDC-28-16	67.20
H-10-0.5	10.95	H-56-0.1	11.00	H-180-4	106.00	SD0-2000	31.80	CDC-36-0.18	13.65
H-10-1	12.10	H-56-0.25	12.90	H-180-6	126.00	HSD-3000	55.00	CDC-36-0.9	19.30
H-10-2	15.25	H-56-0.5	14.55	H-180-8	155.00	HSD-4000	60.00	CDC-36-1.8	22.90
H-10-4	19.30	H-56-1	23.30	H-180-12	234.00	HSD-5000	69.00	CDC-36-3.2	28.80
H-10-6	25.20	H-56-2	26.00	H-230-0.5	30.50	HSD-6000	76.00	CDC-36-6	43.50
H-10-8	27.10	H-56-4	43.60	H-230-1	43.80	DU-1/4	27.80	CDC-36-12	67.00
H-10-12	31.70	H-56-6	63.10	H-230-2	63.10	DU-1/2	34.50	CDC-48-0.12	13.60
H-10-25	55.20	H-56-8	78.40	H-230-4	124.00	DU-1	55.00	CDC-48-0.6	19.20
H-10-50	77.80	H-56-12	104.00	H-230-6	149.00	DU-2	75.00	CDC-48-1.5	22.80
H-10-100	133.00	H-56-25	170.00	H-300-0.5	31.90	DU-3	107.00	CDC-48-2.5	28.70
H-12.8-0.1	9.85	H-56-50	305.00	H-300-1	57.50	DU-5	144.00	CDC-48-5	43.40
H-12.8-0.25	10.60	H-56-100	455.00	H-300-2	91.00	DU-7 1/2	185.00	CDC-48-10	66.80
H-12.8-0.5	11.65	H-56-0.1	11.30	H-300-4	143.00	DU-10	235.00	CDC-60-0.1	13.40
H-12.8-1	13.00	H-68-0.25	12.78	H-CH-0.1	6.50	UP-2	28.00	CDC-60-0.5	19.10
H-12.8-2A	15.10	H-68-0.5A	14.90	H-CH-0.2	7.55	UP-4	32.50	CDC-60-1.2	22.70
H-12.8-2	18.75	H-68-0.5	19.70	H-CH-0.25	8.75	UP-8	53.00	CDC-60-2	28.50
H-12.8-4	22.80	H-68-1	23.00	H-CH-0.5	11.10	UP-15	77.00	CDC-60-4	43.30
H-12.8-6	26.70	H-68-2	29.30	H-CH-1	16.70	UP-25	99.00	CDC-60-8	66.70
H-12.8-8	28.80	H-68-4	55.50	H-CH-2	19.50	UP-40	138.00	CDC-120-0.05	13.40
H-12.8-12	33.20	H-68-6	63.80	H-CH-4	26.20	CDC-6-0.8	14.00	CDC-120-0.3	19.00
H-12.8-25	68.30	H-68-8	77.00	H-CH-6	33.00	CDC-6-4.5	19.90	CDC-120-0.6	22.60
H-12.8-50	93.70	H-68-12	113.50	H-CH-8	42.20	CDC-6-9	23.50	CDC-120-1	28.40
H-12.8-100	137.00	H-68-25	174.00	H-CH-12	54.50	CDC-6-16	29.50	CDC-120-2	43.20
H-16-0.1	10.20	H-68-50	316.00	H-CH-16	60.80	CDC-6-40	44.40	CDC-120-4	66.50
H-16-0.25	10.75	H-80-0.1	11.60	H-CH-20	59.30	CDC-6-75	68.00	6ACV-6.4	14.10
H-16-0.5	11.50	H-80-0.25	13.35	H-CH-25	83.80	CDC-12-0.4	13.95	6ACV-12.8	13.90
H-16-1	12.60	H-80-0.5A	16.45	H-CH-30	101.00	CDC-12-2.2	19.80	6ACV-26	13.70
H-16-2	15.70	H-80-0.5	20.00	H-CH-50	117.00	CDC-12-4.5	23.40	6ACV-118	13.40
H-16-4	23.80	H-80-1	25.10	H-CH-100	133.00	CDC-12-9	29.40	25ACV-6.4	20.00
H-16-6	28.00	H-80-2	37.70	6-500	98.00	CDC-12-20	44.10	25ACV-12.8	19.80
H-16-8	30.50	H-80-4	62.50	9-500	127.00	CDC-12-38	67.80	25ACV-26	19.50
H-16-12	38.00	H-80-6	81.00	12-500	158.00	CDC-15-0.35	13.90	25ACV-118	19.00
H-16-25	72.00	H-80-8	97.80	3-1000	104.00	CDC-15-2	19.70	50ACV-6.4	23.60
H-16-50	114.00	H-80-12	124.00	6-1000	168.00	CDC-15-3.5	23.30	50ACV-12.8	23.20
H-16-100	192.00	H-80-25	212.00	MV-1	13.50	CDC-15-8	29.20	50ACV-26	22.70
H-24-0.1	10.20	H-80-50	380.00	MV-2	16.00	CDC-15-16	43.90	50ACV-118	22.20
H-24-0.25	11.90	H-88-0.1	11.90	MV-4	21.00	CDC-15-30	67.60	120ACV-6.4	29.10
H-24-0.5	13.10	H-88-0.25	13.95	MV-6	29.00	CDC-18-0.32	13.85	120ACV-12.8	28.90
H-24-1A	14.35	H-88-0.5	16.75	MV-12	40.00	CDC-18-1.8	19.60	120ACV-26	28.60
H-24-1	18.70	H-88-1	26.00	3PH-24-50	90.00	CDC-18-3	23.20	120ACV-118	28.20
H-24-2	21.50	H-88-2	38.30	3PH-24-100	127.00	CDC-18-6	29.10	250ACV-12.8	44.00
H-24-4	27.20	H-88-4	65.50	3PH-24-200	207.00	CDC-18-13	43.90	250ACV-26	43.00
H-24-6	32.80	H-88-6	82.50	3PH-48-30	90.00	CDC-18-26	67.50	250ACV-118	41.90
H-24-8	45.70	H-88-8	101.00	3PH-48-60	127.00	CDC-24-0.22	13.80	500ACV-6.4	29.10
H-24-12	53.50	H-88-12	127.00	3PH-48-120	207.00	CDC-24-1.2	19.50	500ACV-12.8	28.90
H-24-20	67.40	H-88-25	219.00	SD-100	7.30	CDC-24-2.1	23.10	500ACV-26	43.00
H-24-25	90.50	H-88-50	392.00	SD-150	8.60			500ACV-118	68.00
H-24-50	134.00	H-120-0.5	23.80	SD-250	10.00				
H-24-100	214.00	H-120-1	30.40	SD-350	13.00				
H-36-0.1	10.45	H-120-2	43.20	SD-500	15.10				
H-36-0.25	11.60	H-120-4	83.00	SD-750	19.25				
H-36-0.5	13.25	H-120-6	100.00	SD-1000	23.00				
H-36-1A	16.50	H-120-8	127.00	SD-1500	27.00				
H-36-1	19.35	H-120-12	157.00						
H-36-2	22.90	H-120-20	232.00						

DEM DISCOUNT SCHEDULE

QTY.	DISCOUNT	QTY.	DISCOUNT
1-9	NET	50-99	33 1/3%
10-24	15%	100-199	40%
25-49	25%	200 Over	QUOTE

TERMS: NET 30 DAYS ON APPROVED CREDIT
FOB: FACTORY, BROOKLYN, N. Y.

SIGNAL TRANSFORMER CO., INC

ENGINEERS • DESIGNERS • MANUFACTURERS

SOLA®

constant voltage transformers

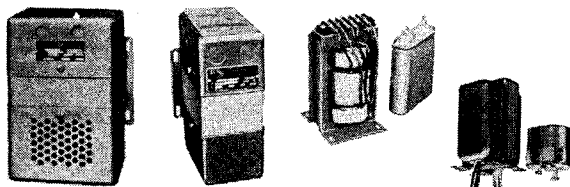

The SOLA® constant-voltage (CV) transformer is a static-magnetic voltage regulator which provides a stabilized output voltage even though the input voltage varies over a wide range.

Stabilized voltage is required for the efficient operation of many types of electrical and electronic equipment, and also prolongs the life of electronic components by eliminating over-and-under-voltages and protects against excessive inrush and fault currents.

Sola transformers are available in designs with harmonic neutralized (CVS) and normal harmonic (CVN) wave-shape outputs. The CVS is used where a distortion-free output is required to drive sensitive instruments and equipment. Electronic-power types are also available for filament (CVF) and plate-filament (CVE) service.

This catalog lists the wide range of stock ratings and types available off-the-shelf from your nearest Sola stocking distributor. For custom designs in OEM quantities, contact your nearest Sola sales offices or the factory.

SOLA® CVS-harmonic neutralized type

Sola CVS type transformers contain less than 3% total rms harmonic content in the output. Recommended for all AC applications where harmonics can affect operation, CVS types are the only constant voltage

transformers with built-in harmonic neutralizing circuits. CVS transformers use no filters and therefore do not need extra capacitors and noisy chokes. CVS transformers are smaller and more rugged than

transformers employing filters for wave-shape improvement. Regulation is ±1% for an input range of ±15% of nominal voltage.

60 Hertz single phase

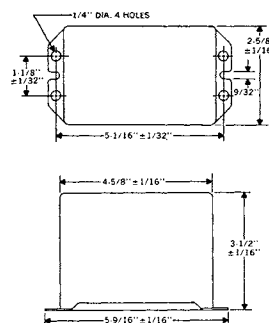

Structure Code 1

VA	Voltage Rating		Catalog Number	Structure/Adapter Code	Dimensions (inches)					Price 1-4 pcs.	Approx. Shipping Weight (Lbs.)
	Regulated Output	Input Range			A	B	C	E	F		
30	118	95-130	23-13-030-2	4/d	6 1/8	5 3/4	3 1/4	3 1/2	3	\$ 28.35	8
60		95-130	23-13-060-2	4/d	6 1/8	5 3/4	3 1/4	3 1/2	3	33.60	10
60		190-260X380-520	23-23-060-2	4/d	6 1/8	5 3/4	3 1/4	3 1/2	3	36.75	10
120		95-130X190-260	23-22-112-2	4/d	8 1/8	5 3/4	3 1/4	3 1/2	3	43.05	14
120		190-260X380-520	23-23-112-2	4/d	8 1/8	5 3/4	3 1/4	3 1/2	3	46.20	14
250		95-130X190-260	23-22-125	4/b	9 3/8	7 1/8	4 1/2	4 3/4	4 1/8	58.80	28
250		190-260X380-520	23-23-125	4/b	9 3/8	7 1/8	4 1/2	4 3/4	4 1/8	63.00	29
500		95-130X190-260	23-22-150	4/c	12 1/8	6 1/8	7 3/8	8 1/8	5 5/8	91.35	45
500		190-260X380-520	23-26-150	4/c	12 1/8	6 1/8	7 3/8	8 1/8	5 5/8	97.65	46
750		95-130X175-235X190-260	23-25-175	4/c	16 1/8	6 1/8	7 3/8	8 1/8	5 5/8	126.00	54
1000		95-130X175-235X190-260	23-25-210	4/-	17 7/8	6 1/8	7 3/8	8 1/8	5 5/8	153.30	72
1000		190-260X380-520	23-26-210	4/-	17 7/8	6 1/8	7 3/8	8 1/8	5 5/8	153.30	72
1500	95-130X175-235X190-260	23-25-215	5/-	19 3/8	9 3/8	10 1/8	11 3/4	3 1/8	204.75	128	
2000	95-130X175-235X190-260	23-25-220	5/-	19 3/8	9 3/8	10 1/8	11 3/4	4 1/2	278.25	140	
2000	190-260X380-520	23-26-220	5/-	19 3/8	9 3/8	10 1/8	11 3/4	4 1/2	278.25	148	
3000	95-130X175-235X190-260	23-25-230-3	5/-	21 7/8	9 3/8	10 1/8	11 3/4	6 1/8	373.80	194	
3000	190-260X380-520	23-26-230	5/-	21 7/8	9 3/8	10 1/8	11 3/4	6 1/8	373.80	196	
5000	95-130X175-235X190-260	23-25-250	6/-	20 1/8	9 3/8	25 1/8	24 1/8	5 1/8	583.80	335	
5000	190-260X380-520	23-26-250	6/-	20 1/8	9 3/8	25 1/8	24 1/8	5 1/8	583.80	342	
7500	190-260X380-520	23-28-275	7/-	20 1/8	9 3/8	38 1/4	37 3/8	5 1/8	867.30	502	

† Triplex assembly, same as structure code 6 except addition of one more transformer.

50 Hertz single phase

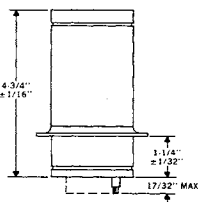

Structure Code 2

VA	Regulated Output	Input Range	Catalog Number	Structure/Adapter Code	A	B	C	E	F	Price	Approx. Shipping Weight (Lbs.)
60	118	95-130	23-13-560-2	4/d	7 1/4	5 1/4	3 1/4	3 1/2	3	\$ 38.85	11
60		190-260X380-520	23-23-560-2	4/d	7 1/4	5 1/4	3 1/4	3 1/2	3	42.00	11
120		95-130X190-260	23-22-612	4/b	8 3/4	7 1/8	4 1/2	4 3/4	4 1/8	49.35	21
250		95-130X190-260	23-22-625	4/c	11 1/8	6 1/8	7 3/8	8 1/8	5 5/8	67.20	35
500		95-130X190-260	23-22-650-1	4/c	13	6 1/8	7 3/8	8 1/8	5 5/8	105.00	53
1000		95-130X175-235X190-260	23-25-710	5/-	18 7/8	9 3/8	10 1/8	11 3/4	3 1/2	176.40	120
2000		95-130X175-235X190-260	23-25-720	5/-	20 5/8	9 3/8	10 1/8	11 3/4	5 1/4	320.25	170
3000		95-130X175-235X190-260	23-25-730	5/-	26 5/8	9 3/8	10 1/8	11 3/4	7 1/8	429.25	227

SOLA® plate-filament service (CVE) 60 Hertz

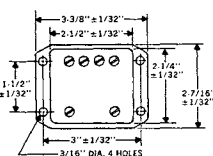

Structure Code 2

Typical Rectifier Tube	Average D.C. Input Volts to Filter	Filament Windings		Input Voltage Range	Catalog Number	Structure Code	Dimensions (inches)					Price 1-9 pcs.	Approx. Shipping Weight (Lbs.)
		6.3 Volts	5.0 Volts				A	B	C	E	F		
5Y3	275v D.C. @ 50 M.A.	2.5 amps C.T.	2.0 amps	100-130	7104	3	3 1/8	4 1/8	3 1/8	2 1/8	2 1/2	\$14.04	6
5Y3	385v D.C. @ 110 M.A.	3.0 amps C.T.	2.0 amps	100-130	7106	3	3 1/8	4 1/8	3 1/8	2 7/8	2 1/2	17.28	8
5U4	380v D.C. @ 250 M.A.	No. 1:40 amps No. 2:80 amps unregulated	3.0 amps	100-130	7107	3	4 1/2	7	4 7/8	3 3/8	3 3/8	32.40	19

50 Hertz

VA	Regulated Output	Input Range	Output Capacity in Amps	Catalog Number	Structure Code	A	B	C	E	F	Price	Approx. Shipping Weight (Lbs.)	
5Y3	175v D.C. @ 50 M.A.	2.5 amps C.T.	2.0 amps	100-130	71B04	3	3 1/8	4 1/8	3 3/8	2 1/4	2 1/2	\$16.20	6
				180-250	71MB04	3	3 1/8	4 1/8	3 3/8	2 1/4	2 1/2	16.20	6
				100-130	71B06	3	3 1/8	4 1/8	4 3/8	3 1/4	2 1/2	19.44	10
				180-250	71MB06	3	3 1/8	4 1/8	4 3/8	3 1/4	2 1/2	19.44	10

SOLA® filament service (CVF) 60 Hertz

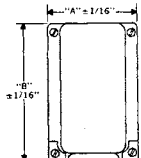

Structure Code 3

VA	Voltage Rating		Output Capacity in Amps	Catalog Number	Structure Code	Dimensions (inches)					Price 1-4 pcs.	Approx. Shipping Weight (Lbs.)
	Regulated ±1% Output	Input Range				A	B	C	E	F		
15	6.0	95-130	2.50	20-01-015	1	*	*	*	*	*	\$16.80	4
				20-06-015	3	2 1/2	4 3/8	2 1/8	1 3/4	1 7/8	15.75	3
15	6.3	95-130	2.38	20-02-015	1	*	*	*	*	*	16.80	4
				20-03-015	2	*	*	*	*	*	23.10	4
				20-04-015	3	2 1/2	4 3/8	2 1/8	1 3/4	1 7/8	15.75	3
				20-04-030	3	3 1/8	4 1/8	3 1/8	2 1/8	2 1/2	17.85	6
32	6.3	95-130X190-260	5.0	20-04-065	3	3 1/8	4 1/8	3 1/8	2 1/8	2 1/2	23.10	8
10.0				20-04-065	3	3 1/8	4 1/8	3 1/8	2 1/8	2 1/2	23.10	8
15.0				20-04-095	3	3 1/8	4 1/8	4 1/8	3 5/8	2 1/2	27.30	11
25.0				20-04-116	3	4 1/2	7	5 1/8	4 1/8	3 5/8	39.90	23

50 Hertz

VA	Regulated Output	Input Range	Output Capacity in Amps	Catalog Number	Structure Code	A	B	C	E	F	Price	Approx. Shipping Weight (Lbs.)		
15	6.3	95-130	2.38	20-02-515	1	*	*	*	*	*	\$18.90	4		
32				95-130X190-260	5.0	20-04-530	3	3 1/8	4 1/8	3 3/8	2 1/4	2 1/2	21.00	7
63				95-130X190-260	10.0	20-04-565	3	3 1/8	4 1/8	4 1/8	3	2 1/2	26.25	9

(1) Adapter Kit code designates type of adapter required to convert standard internal wiring hookup to line cord and plug input and plug receptacle output.

SOLA® constant voltage transformers

SOLA® CVN-normal harmonic type

Sola CVN type transformers provide the same ±1% regulation as the sinusoidal series. CVN transformers contain an average of 20% rms harmonic content and are recommended for

electrical loads not affected by harmonics, such as solenoids, relays, filaments and where rectification is required.

60 Hertz single phase

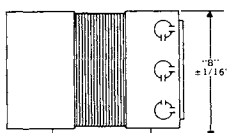
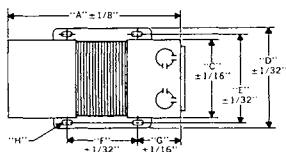

Structure Code 4

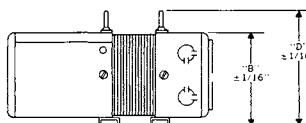
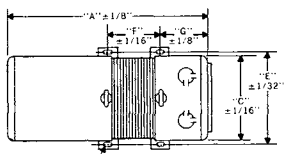

Structure Code 5

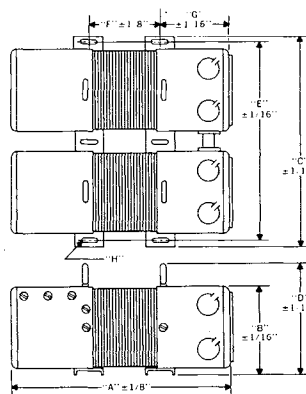

Structure Code 6

VA	Voltage Rating		Catalog Number	Structure/Adapter Code	Dimensions (inches)					Price 1-4 pcs.	Approx. Shipping Weight (Lbs.)
	Regulated Output	Input Range			A	B	C	E	F		
15	118	95-130	20-10-015	1/—	*	*	*	*	*	\$ 16.80	4
			20-11-015	2/—	*	*	*	*	*	23.10	4
			20-14-015	3/—	2 1/32	4 3/16	2 1/8	1 3/4	1 7/8	15.75	3
			20-14-030	3/—	2 1/32	4 3/16	3 1/8	2 5/8	1 7/8	17.85	5
			20-13-030-2	4/d	5 7/8	5 3/16	3 3/4	3 1/2	3	23.10	7
			20-13-060-2	4/d	6 1/32	5 3/16	3 3/4	3 1/2	3	28.35	10
30	118	95-130	20-14-060	3/—	3 3/8	4 1/16	3 7/8	2 1/8	2 1/2	24.15	8
			20-14-112	3/—	3 3/8	4 1/16	4 1/16	3 7/8	2 1/2	32.55	11
60	118	95-130	20-13-112-2	4/d	7 3/8	5 3/16	3 3/4	3 1/2	3	37.80	12
			20-21-112-2	4/d	7 3/8	5 3/16	3 3/4	3 1/2	3	37.80	13
120	118	95-130	20-13-115	4/b	8 3/4	7 1/8	4 1/2	4 3/4	4 1/8	45.15	22
			20-13-125	4/c	11 1/8	6 1/8	5 23/32	6 1/8	4 3/8	55.65	25
150	236	190-260	20-22-125	4/c	11 1/8	6 1/8	5 23/32	6 1/8	4 3/8	55.65	25
			20-23-125	4/c	11 1/8	6 1/8	5 23/32	6 1/8	4 3/8	55.65	25
250	118	95-130X190-260	20-13-150	4/c	12 3/8	6 1/8	5 23/32	6 1/8	4 3/8	87.15	36
			20-22-150	4/c	12 3/8	6 1/8	5 23/32	6 1/8	4 3/8	87.15	36
			20-23-150	4/c	12 3/8	6 1/8	5 23/32	6 1/8	4 3/8	87.15	36
			20-24-150	4/c	12 3/8	6 1/8	5 23/32	6 1/8	4 3/8	87.15	36
			20-26-150	4/c	12 3/8	6 1/8	5 23/32	6 1/8	4 3/8	93.45	37
			20-22-150	4/c	12 3/8	6 1/8	5 23/32	6 1/8	4 3/8	87.15	36
500	236	190-260X380-520	20-23-150	4/c	12 3/8	6 1/8	5 23/32	6 1/8	4 3/8	87.15	36
			20-24-150	4/c	12 3/8	6 1/8	5 23/32	6 1/8	4 3/8	87.15	36
1000	118x236	190-260X380-520	20-26-150	4/c	12 3/8	6 1/8	5 23/32	6 1/8	4 3/8	93.45	37
			20-13-210	4/—	15 1/8	6 1/8	5 23/32	6 1/8	4 3/8	144.90	48
2000	118x236	190-260X380-520	20-20-210	4/—	15 1/8	6 1/8	5 23/32	6 1/8	4 3/8	144.90	48
			20-22-210	4/—	15 1/8	6 1/8	5 23/32	6 1/8	4 3/8	144.90	48
3000	118x236	190-260X380-520	20-25-220	5/—	20	9 3/32	8 3/8	9 1/2	4 3/8	263.55	128
			20-25-230	5/—	22	9 3/32	8 3/8	9 1/2	6 3/8	357.00	170
5000	118x236	190-260X380-520	20-27-250	5/—	21	12 5/8	11 7/8	13	7	555.45	290
			20-36-310	6/—	21	12 5/8	29 1/8	27 1/8	7	1048.95	590

50 Hertz single phase

15	95-130	20-10-515	1/—	*	*	*	*	*	\$ 18.90	5	
30	95-130	20-13-530-2	4/d	6 3/32	5 3/16	3 3/4	3 1/2	3	26.25	6	
30	95-130	20-14-530	3/—	3 3/8	4 1/16	3 3/8	2 3/8	2 1/2	21.00	6	
60	95-130	20-13-560-2	4/d	6 3/8	5 3/16	3 3/4	3 1/2	3	32.55	11	
60	95-130	20-14-560	3/—	3 3/8	4 1/16	4 3/8	3 1/8	2 1/2	27.30	9	
120	118	95-130	20-13-612	4/b	8 3/4	7 1/8	4 1/2	4 3/4	4 1/8	43.05	22
			20-13-615	4/b	9 3/8	7 1/8	4 1/2	4 3/4	4 1/8	51.45	25
150	118	95-130	20-13-625-1	4/c	11 1/8	6 1/8	5 23/32	6 1/8	4 3/8	64.05	27
			20-22-625	4/c	11 1/8	6 1/8	5 23/32	6 1/8	4 3/8	64.05	28
250	118	190-260X380-520	20-23-625-1	4/c	11 1/8	6 1/8	5 23/32	6 1/8	4 3/8	64.05	28
			20-13-650-1	4/c	12 1/8	6 1/8	5 23/32	6 1/8	4 3/8	99.75	43
500	118	95-130X190-260	20-22-650	4/c	12 3/8	6 1/8	5 23/32	6 1/8	4 3/8	99.75	41
			20-23-650-1	4/c	12 3/8	6 1/8	5 23/32	6 1/8	4 3/8	99.75	41
500	118x236	190-260X380-520	20-26-650	4/c	12 3/8	6 1/8	5 23/32	6 1/8	4 3/8	107.10	42
			20-20-710	5/—	18 3/8	9 3/32	8 3/8	9 1/2	3 1/8	166.95	125
1000	118	95-130X190-260	20-22-710	5/—	18 3/8	9 3/32	8 3/8	9 1/2	3 1/8	166.95	125
			20-25-720	5/—	20 3/4	9 3/32	8 3/8	9 1/2	5 3/8	303.45	144

cord/receptacle adapter kits

Adapter kits may be used when the convenience of input plug and output receptacle is preferred to the standard arrangement of terminals in the transformer housing.

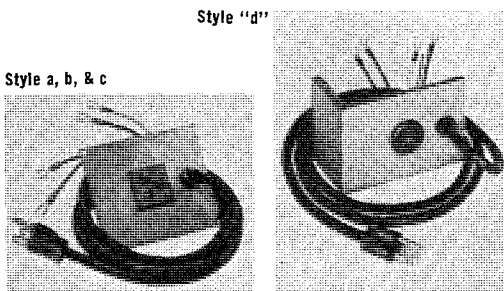

Adapter Code	Adapter Kit Catalog No.	Input Cord	Output Connections	Price 1-4 pcs.
a	999-004	2-wire	2-wire receptacle	2.50
	999-018	3-wire	3-wire receptacle	3.75
	999-005	2-wire	2-wire receptacle	2.50
b	999-019	3-wire	3-wire receptacle	3.75
	999-009	2-wire	2-wire receptacle	3.25
c	999-020	3-wire	3-wire receptacle	3.75
	999-104	2-wire	2-wire receptacle	3.75
d	999-105	3-wire	3-wire receptacle	3.75



SOLATRON® line voltage regulators

The Solatron® LVR is the first regulator to combine in one unit the qualities of fast response, "tight" voltage regulation, no moving parts, adjustable output, compactness, and high kva capacity.

The Solatron® regulator holds voltage constant within $\pm 1\%$ for any combination of line, load, and frequency, in the face of line variations up to $\pm 10/-20\%$, load variation from 0-100%, and frequency variation of $\pm 5\%$ or greater.

The Solatron is a solid-state device with no moving parts, requiring no adjustment, maintenance, or attention. It combines the ruggedness typical of transformers with the light weight of electronic control circuitry, resulting in a regulator of remarkable compactness. It has great versatility in location, floor or wall mounting, and installation.

60 cycle (57-63 Hz) single-phase

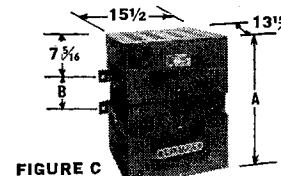
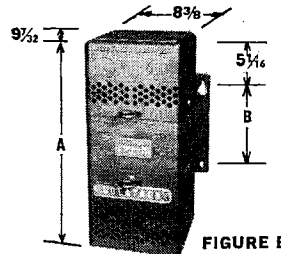
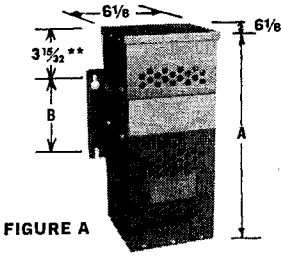

ELECTRICAL SPECIFICATIONS				MECHANICAL SPECIFICATIONS			
Output KVA Rating	Nominal Output Voltage	Input Voltage Range	Catalog Number	A	B	Outline Dimensions Figure	Approx. Shipping Weight
.5	120	$\pm 10\%$	31-16-150	12 $\frac{3}{4}$	5 $\frac{3}{8}$	A	30
.5	120	+10/-20%	33-16-150	13 $\frac{7}{8}$	5 $\frac{3}{8}$	A	40
1	120	$\pm 10\%$	31-16-210	13 $\frac{7}{8}$	5 $\frac{3}{8}$	A	40
1	120	+10/-20%	33-16-210	16 $\frac{1}{8}$	5 $\frac{3}{8}$	A	58
1	240	$\pm 10\%$	31-26-210	13 $\frac{7}{8}$	5 $\frac{3}{8}$	A	40
2	120	$\pm 10\%$	31-16-220	16 $\frac{1}{8}$	5 $\frac{3}{8}$	A	55
2	120	+10/-20%	33-16-220	21	6 $\frac{1}{4}$	B	100
2	240	+10/-20%	33-26-220	21	6 $\frac{1}{4}$	B	100
3	120	$\pm 10\%$	31-16-230	15 $\frac{1}{8}$	4 $\frac{1}{2}$	B	78
3	120	+10/-20%	33-16-230	22 $\frac{1}{4}$	6 $\frac{1}{4}$	B	130
3	240	$\pm 10\%$	31-26-230	15 $\frac{1}{8}$	4 $\frac{1}{2}$	B	78
3	240	+10/-20%	33-26-230	22 $\frac{1}{4}$	6 $\frac{1}{4}$	B	130
5	120	$\pm 10\%$	31-16-250	16 $\frac{3}{4}$	6 $\frac{1}{4}$	B	100
5	120	+10/-20%	33-16-250	25 $\frac{1}{4}$	10 $\frac{1}{4}$	B	185
5	240	$\pm 10\%$	31-26-250	16 $\frac{3}{4}$	6 $\frac{1}{4}$	B	100
5	240	+10/-20%	33-26-250	25 $\frac{1}{4}$	10 $\frac{1}{4}$	B	185
7.5	120	$\pm 10\%$	31-16-275	18 $\frac{3}{8}$	8 $\frac{1}{4}$	B	132
7.5	120	+10/-20%	33-16-275	19 $\frac{1}{8}$	4 $\frac{1}{2}$	C	275
10	120	$\pm 10\%$	31-16-310	20 $\frac{3}{8}$	10 $\frac{1}{4}$	B	170
10	120	+10/-20%	33-16-310	20	5 $\frac{3}{8}$	C	310
10	240	$\pm 10\%$	31-26-310	20 $\frac{3}{8}$	10 $\frac{1}{4}$	B	170
10	240	+10/-20%	33-26-310	20	5 $\frac{3}{8}$	C	310
15	120	$\pm 10\%$	31-16-315	20	5 $\frac{3}{8}$	C	275
15	120	+10/-20%	33-16-315	23 $\frac{3}{8}$	9	C	400
25	120	$\pm 10\%$	31-16-325	22 $\frac{3}{8}$	7 $\frac{3}{4}$	C	400
25	120	+10/-20%	33-16-325	31 $\frac{1}{8}$	9 $\frac{3}{4}$	C	520
25	240	$\pm 10\%$	31-26-325	22 $\frac{3}{8}$	7 $\frac{3}{4}$	C	400
25	240	+10/-20%	33-26-325	31 $\frac{1}{8}$	9 $\frac{3}{4}$	C	520
37.5	120	$\pm 10\%$	31-16-337	24 $\frac{3}{8}$	9 $\frac{3}{4}$	C	525

NOTE: Output Voltage Adjustable $\pm 5\%$.
 NOTE: 7%* Harmonics Max. for $\pm 10\%$ range; 5% Harmonics Max. for +10/-20% range.
 * Filter Available for 3% Harmonics Max.
 ** For Catalog Number 31-16-150, dim. is 2 $\frac{3}{8}$.

Also available in 208, 277 & 480 volt
 Also available 50 Hz & 400 Hz
 Also available 3 ϕ Δ or Y up to 112.5 KVA

SOLA® Multi-tap™ CVR regulated power supply transformer

The SOLA Multi-tap™ CVR is a constant voltage transformer with taps to provide special voltages ready for rectification with stock silicon rectifiers to complete a regulated d.c. power supply. In effect, the Multi-tap CVR is a custom SOLA CV transformer with off-the-shelf availability, at low cost, for small quantity requirements. Six models provide over 100 regulated output voltages. The relatively square

wave-shape makes the Multi-tap CVR especially suited to rectifier applications.

All CVR transformers are designed to operate in Full wave center tap or bridge type circuits with readily available stock silicon rectifiers. The regulating ability and typical characteristics of the CVR are similar to the familiar Sola constant voltage (CVN) transformer.

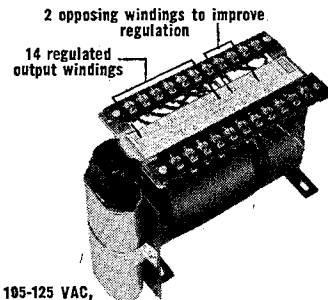

Designed for 105-125 VAC, 60-cycle input.

applications for the Multi-tap™ CVR

- Design of a regulated d.c. power supply requiring custom output for short-run production.
- Building block systems requiring voltage adjustability for later additions of components.
- Systems requiring voltage adjustability to compensate for line drop to remote units.
- Immediate requirements when custom Sola CV is being designed and manufactured.
- Short-run production requiring low-cost, and "off-the-shelf" custom Sola CV.
- Prototypes requiring custom Sola CV transformers.
- Immediate requirements for experimentation.

schematics for CVR series

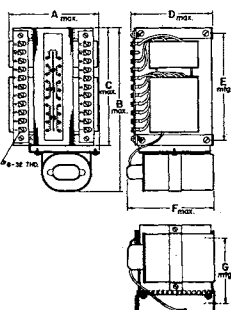

Connection for Full-wave center tap rectification for maximum output.



Connection for Full-wave Bridge rectification, for maximum output.

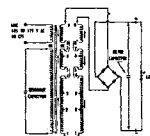

Each CVR model has the winding arrangement and terminal numbering shown in the schematics at left. The primary winding is connected to the two terminals marked "line" on the capacitor side of the transformer or terminals marked #11. Write for complete hook-up tables showing output possibilities.

DIMENSIONS

Capacity VA	Price 1 - 4 pcs.	Catalog No.	Dimensions, inches						
			A	B	C	D	E	F	G
40	27.82	73-13-040	4 $\frac{1}{4}$	6 $\frac{1}{8}$	4 $\frac{7}{8}$	3 $\frac{1}{8}$	4 $\frac{1}{8}$	3 $\frac{3}{8}$	2 $\frac{1}{2}$
75	36.38	73-13-075	4 $\frac{1}{4}$	6 $\frac{1}{8}$	4 $\frac{7}{8}$	3 $\frac{1}{8}$	4 $\frac{1}{8}$	3 $\frac{3}{8}$	3 $\frac{1}{4}$
150	50.29	73-13-115	4 $\frac{3}{4}$	8 $\frac{5}{8}$	6 $\frac{7}{8}$	4 $\frac{7}{8}$	6 $\frac{1}{8}$	5 $\frac{5}{8}$	2 $\frac{5}{8}$
225	62.06	73-13-122	5 $\frac{5}{8}$	9 $\frac{5}{8}$	6 $\frac{7}{8}$	4 $\frac{7}{8}$	6 $\frac{1}{8}$	4 $\frac{1}{4}$	3 $\frac{3}{8}$
300	72.76	73-13-130	5 $\frac{1}{2}$	9 $\frac{5}{8}$	6 $\frac{7}{8}$	4 $\frac{7}{8}$	6 $\frac{1}{8}$	5 $\frac{3}{8}$	3 $\frac{3}{8}$
450	100.58	73-13-145	6 $\frac{5}{8}$	9 $\frac{5}{8}$	6 $\frac{7}{8}$	4 $\frac{7}{8}$	6 $\frac{1}{8}$	5	4 $\frac{1}{8}$



120 VOLTS SINGLE PHASE PANEL MOUNTING

Cased and unCased units designed for mounting in panels 1/4" thick to 3/4" thick. Most panel mounting units can also be bench mounted.

Mfr's Type No.	Mfr's Old Type No.	Volts	Output Amps	KVA	Size	Weight Lbs.	Price
121	100BU	*0-132	1.25	.165	2 1/16 x 2 1/16	3	\$10.00
171	175BU	*0-132	1.75	.23	2 1/16 x 2 1/16	3	10.25
241	T21U	0-120/140	2.4	.33	2 1/16 x 2 1/16	4	17.50
251	250BU	*0-132	2.5	.33	3 1/4 x 3 1/4 x 3 1/4	3.5	11.25
301	300BU	*0-120/140	3.0	.42	3 1/16 x 3 1/16	5	15.50
371	375BU	*0-120/140	3.75	.53	3 3/4 x 3 3/4 x 3 3/4	5	14.75
501	451	0-120/140	5.0	.70	3 3/4 x 3 3/4 x 3 3/4	5	16.00
601	T51U	0-120/140	6.0	.84	4 1/2 x 4 1/2 x 3 1/2	6	21.00
751	500BU	0-120/140	7.5	1.05	5 1/16 x 5	10	20.00
SQ751	SQ500BU	0-120/140	7.5	1.05	4 1/2 x 4 1/2 x 3 1/2	10	19.50
1010	1000	0-120/140	10.0	1.4	5 1/16 x 5 x 4 1/16	11	20.50
1010CT	1000CT	0-120/140	10.0	1.4	6 1/2 x 5 x 4 1/16	11.5	27.50
SQ1010	T101U	0-120/140	10.0	1.4	5 1/2 x 5 1/2 x 3 1/2	14	35.00
1210	1200	**0-120	12.5	1.4	5 1/16 x 5 x 4 1/16	11	22.50
1210CT	1200CT	**0-120	12.5	1.4	6 1/2 x 5 x 4 1/16	11.5	28.75
1510	T1500U	0-120/140	15.0	2.1	6 1/2 x 6 1/2 x 4 1/2	20	38.50
R1510C	1500B	†0-140	15.0	2.1	8 x 8 1/16 x 5 1/16	20	52.50
2510	2500BU	0-120/140	25.0	3.5	8 1/16 x 7 1/2 x 4 1/2	25	56.50
2510CT	2500B	0-120/140	25.0	3.5	9 1/2 x 7 1/2 x 4 1/2	25	62.00
5010	T501U	0-140	50.0	7.0	12 1/2 x 12 1/2 x 6 1/2	60	139.50
5010CT	T501B	†0-140	50.0	7.0	15 1/2 x 14 x 6 1/2	65	145.00

*60 cycle operation only at overvoltage. †Factory connection for line voltage output. **60 cycle operation only.

120 VOLT SINGLE PHASE MODELS WITH CORD & RECEPTACLE

All models housed in rugged cases include pilot light, switch, fuse, line cord, plug and matching receptacle.

2PF models are equipped with 2-wire cords, plugs and receptacles.
3PN models are equipped with 3-wire grounded cords, plugs, and receptacles.
Model 2PFR1510BV is equipped with output voltmeter.

Mfr's Type No.	Mfr's Old Type No.	Volts	Output Amps	KVA	Size	Weight Lbs.	Price
2PF121	PA-1	**0-132	1.25	.165	3 3/4 x 3 3/4 x 3 3/4	3.5	\$18.50
2PF171	PA-175	**0-132	1.75	.23	3 3/4 x 3 3/4 x 3 3/4	3.5	19.00
3PN171	3PNPA-175	**0-132	1.75	.23	3 3/4 x 3 3/4 x 3 3/4	3.5	21.00
2PF371	PA-375	*0-120/140	3.75	.53	6 1/2 x 6 1/2 x 6 1/2	7	21.75
3PN371	3PNPA-375	*0-120/140	3.75	.53	6 1/2 x 6 1/2 x 6 1/2	7	24.00
2PF501	2PF451	0-120/140	5.0	.70	6 1/2 x 6 1/2 x 6 1/2	7	22.50
3PN501	3PN451	0-120/140	5.0	.70	6 1/2 x 6 1/2 x 6 1/2	7	24.50
3PN601	3PNT51B	0-140	6.0	.84	4 1/2 x 4 1/2 x 6 1/2	8	35.00
2PF751	500B	0-120/140	7.5	1.05	5 1/16 x 7 1/2 x 5 1/2	11	28.00
3PN751	3PN500B	0-120/140	7.5	1.05	5 1/16 x 7 1/2 x 5 1/2	11	32.00
2PF1010	2PF1000	0-120/140	10.0	1.4	6 1/2 x 5 x 4 1/16	12.5	28.50
3PN1010	3PN1000	0-120/140	10.0	1.4	6 1/2 x 5 x 4 1/16	12.5	32.50
2PF1210	2PF1200	**0-120	12.5	1.4	6 1/2 x 5 x 4 1/16	12.5	30.50
3PN1210	3PN1200	**0-120	12.5	1.4	6 1/2 x 5 x 4 1/16	12.5	34.50
2PFR1510BV	1500BD	0-140	15.0	2.1	8 1/16 x 10 x 5 1/16	22.5	85.00
3PN1710	3PN180'B	0-140	17.0	2.4	10 1/2 x 7 1/2 x 4 1/2	28	79.00

*60 cycle operation only on overvoltage. **60 cycle operation only.

240 VOLT SINGLE PHASE PANEL MOUNTING

Cased and unCased units designed for mounting in panels 1/4" thick to 3/4" thick. Most panel mounting units can also be bench mounted.

Mfr's Type No.	Mfr's Old Type No.	Volts	Output Amps	KVA	Size	Weight Lbs.	Price
752	520BU	0-240/280	3.0	.84	5 1/16 x 5	10	\$22.50
1020	—	0-240/280	3.5	.98	5 1/16 x 5 x 4 1/16	11	23.50
1020CT	—	0-240/280	3.5	.98	6 1/2 x 5 x 4 1/16	11.5	30.00
1220	1030	0-240	5.0	1.2	5 1/16 x 5 x 4 1/16	11	25.50
1220CT	1030CT	0-240	5.0	1.2	6 1/2 x 5 x 4 1/16	11.5	33.00
1520	T1520U	0-240/280	9.5	2.7	6 1/2 x 6 1/2 x 4 1/2	23	38.50
R1520C	1520B	*0-280	9.0	2.5	8 x 8 1/16 x 5 1/16	24	52.50
2520	2520BU	0-240/280	10.0	2.8	8 1/16 x 7 1/2 x 4 1/2	25	56.50
2520CT	2520B	0-240/280	10.0	2.8	9 1/2 x 7 1/2 x 4 1/2	25	62.00
5020	T502U	0-240/280	28.0	7.8	12 1/2 x 12 1/2 x 6 1/2	60	139.50
5020CT	T502B	0-240/280	28.0	7.8	15 1/2 x 14 x 6 1/2	65	145.00

*Factory connection for line voltage output.

240 VOLT SINGLE PHASE MODELS WITH CORD & RECEPTACLE

All models housed in rugged cases include pilot light, switch, fuse, line cord, plug, and matching receptacle.

2PF models are equipped with 2-wire cords, plugs, and receptacles.
3PN models are equipped with 3-wire grounded cords, plugs, and receptacles.
Model 2PFR1520BV is equipped with output voltmeter.

Mfr's Type No.	Mfr's Old Type No.	Volts	Output Amps	KVA	Size	Weight Lbs.	Price
2PF752	520B	0-280	3.0	.84	5 1/16 x 7 1/2 x 5 1/2	11	\$32.50
3PN752	3PN520B	0-280	3.0	.84	5 1/16 x 7 1/2 x 5 1/2	11	36.00
2PF1020	—	0-280	3.5	.98	6 1/2 x 5 x 4 1/16	12.5	33.00
3PN1020	—	0-280	3.5	.98	6 1/2 x 5 x 4 1/16	12.5	37.00
2PF1220	2PF1030	**0-240	5.0	1.2	6 1/2 x 5 x 4 1/16	12.5	35.00
3PN1220	3PN1030	**0-240	5.0	1.2	6 1/2 x 5 x 4 1/16	12.5	39.50
2PFR1520BV	1520BD	0-240	9.0	2.5	8 1/16 x 10 x 5 1/16	22.5	85.00
3PN2520	3PN2520B	0-240	10.0	2.8	9 1/2 x 7 1/2 x 4 1/2	28	79.00

**60 cycle Operation only.

120 VOLT VARIABLE ISOLATION TRANSFORMERS

STACO Isolated Variable Autotransformers provide a means for smooth control of an electrically isolated AC voltage output. UnCased models offer isolated, non-isolated, voltage doubler, and series connections with proper external hook-up. Cased models feature circuit breaker (except fused type J201BV), switch, pilot light, output voltmeter, 3-wire grounded cord, plug, and matching receptacles. Cased models available in isolated connection only. Ratings shown are for isolated connections.

Mfr's Type No.	Mfr's Old Type No.	Volts	Output Amps	KVA	Size	Weight Lbs.	Price
J201	1V-1-2U	0-140	2.0	.28	4 1/2 x 4 1/2 x 4 1/16	8	\$33.50
J401	1V-1-4U	0-140	4.0	.56	6 1/2 x 6 1/2 x 4 1/2	15	46.25
J901	1V-1-9U	0-140	9.0	1.26	8 1/16 x 7 1/2 x 5 1/2	28	65.00
J201BV	1V-1-2M	0-140	2.0	.28	8 x 6 1/2 x 8 1/16	13	78.00
J401BV	1V-1-4M	0-140	4.0	.56	8 1/2 x 7 1/2 x 9 1/2	20	89.50
J901BV	1V-1-9M	0-140	9.0	1.26	9 1/2 x 9 1/2 x 11 1/2	32	110.00

STACO®
Variable
Autotransformers

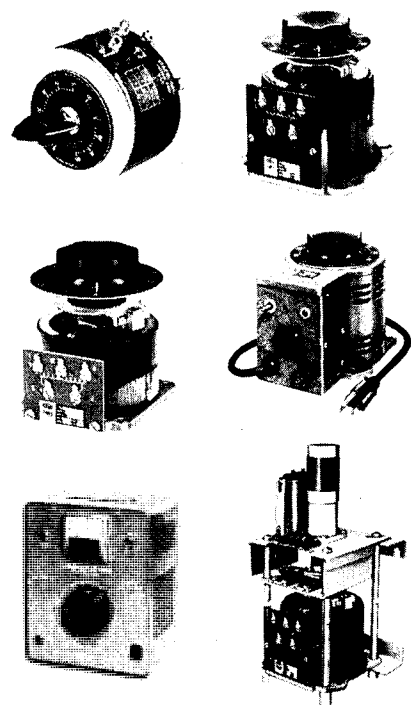

When you specify Staco Variable Autotransformers you get all these important advantages: Variable output voltages with high efficiency, reliability and minimum maintenance; epoxy coated coils (where possible) that increase commutator stability; optimum core and coil design results in higher current ratings and greater overload capabilities; delivery of output voltages of zero to line voltage or zero to 17% above line voltage; terminals permit connection for increasing voltage in either clockwise or counter-clockwise rotation of knob; regulation is independent of load . . . zero wave form distortion; moderate temperature rise; precious metal plating of commutator surface eliminates oxidation and deterioration; all units designed for 50/60 cycle operation except as noted.



STANCOR STANDARD TRANSFORMERS

**When you use STANCOR STANDARD
Transformers you are assured of . . .**

IMMEDIATE AVAILABILITY

Sold by Industrial Electronic Distributors in major marketing areas — AT
FACTORY PRICES IN ANY QUANTITY.

HIGHEST QUALITY

Millions of standard transformers, time-tested and field-proven for over
35 years.

COMPETITIVE PRICES

Mass production facilities — to supply its extensive distributor organization
— enable Stancor to manufacture at lowest costs.

STOCK IN DEPTH

Over 300,000 transformers stocked in our warehouses strategically located
throughout the country.

SERVICE REPLACEMENT

Available from over 1000 Industrial and Service Parts Electronic Distributors
located in over 500 cities.

SOLD NATIONALLY
THROUGH ELECTRONIC DISTRIBUTORS BY

ESSEX WIRE
CORPORATION

CONTROLS DIVISION
STANCOR / RBM CONTROLS



PRODUCT INDEX

Commercial		TV/Radio Replacement	
Audio	5-6-7-8-9-10-11	Audio	5-6-7-8
Control	25-26	Deflection Yokes	31
Filament	19-20	Filament	19-20-33
Filter Chokes	21-22	Filter Chokes	21-22
Isolation/auto	27	Flybacks	29
Plate	28	Power	15-16-17-18
Power	15-16-17-18	Vertical Output	32
Rectifier	23-24-25	Vibrator	33
Transistor—Miniature	12-13-14	Width Coils	33

PART NUMBER INDEX

Stancor No.	Page	Price	Stancor No.	Page	Price	Stancor No.	Page	Price	Stancor No.	Page	Price	Stancor No.	Page	Price	Stancor No.	Page	Price
1BC-150	18c	18.20	A-3838	8e	6.65	A-4744	9a	2.56	A-8105	8b	3.57	C-1706	21a	1.64	COS-1	6a	16.16
1BS-150	18c	24.37	A-3839	6d	6.37	A-4745	10e	7.14	A-8106	8c	4.45	C-1707	21a	1.92	COS-2	6b	14.73
*2BC-150	18c	14.69	A-3841	6b	6.55	A-4747	9b	3.73	A-8107	8c	6.65	C-1708	21b	2.94	DCT-1	24b	18.51
2BS-150	18c	25.23	A-3842	6d	6.76	A-4748	9a	3.55	A-8108	8c	3.47	C-1709	21b	2.97	DCT-2	24b	22.91
A-52C	10e	2.83	A-3845	11c	7.58	A-4749	9a	8.94	A-8109	8b	3.17	C-1710	21c	4.65	OGC-100	33	20.07
A-53	10d	2.58	A-3848	7a	3.33	A-4752	11a	3.90	BD-1	11c	40.12	C-1718	22b	5.91	*DY-1A	31a
A-53C	10e	3.02	A-3849	7a	4.02	A-4761	11b	13.57	BI-1	10a	35.47	C-1720	22b	14.73	DY-2A	31a
A-62C	10e	3.33	A-3850	7a	4.21	A-4762	11b	15.67	BI-2	10a	45.24	C-1721	21d	9.43	DY-8A	31a
A-63C	10e	3.55	A-3851	6c	9.89	A-4765	11b	16.80	BI-3	10a	39.14	C-1722	21d	13.19	DY-9A	31a
A-64C	10e	3.51	A-3852	7a	5.03	A-4770	6b	7.09	BI-4	10a	39.22	C-1723	21a	2.04	DY-10A	31a
A-73C	10e	4.18	A-3856	7a	3.52	A-4773	10g	7.42	BI-5	10a	69.85	C-2303	21c	2.79	DY-11A	31a
A-2203	6a	2.92	A-3857	6d	3.05	A-4774	10g	4.04	BI-6	10a	40.12	C-2304	21c	2.83	*DY-12A	31a
A-2312	6d	3.67	A-3870	7a	5.19	A-4778	9c	5.36	BI-7	10a	37.15	C-2305	21b	4.55	DY-13A	31b
A-2313	6b	3.36	A-3871	11c	5.75	A-4779	9c	3.37	BM-1	11e	84.55	C-2307	22b	15.24	DY-14A	31b
A-2855	7a	5.57	A-3872	6c	5.75	A-4780	9c	5.93	BO-1	7c	18.67	C-2308	21d	15.61	DY-15A	31b
A-3250	6bd	5.09	A-3876	6a	1.84	A-7947	8d	3.62	BO-2	7c	22.55	C-2309	21c	3.33	OY-16A	31b
A-3303	6d	8.66	A-3877	6a	1.84	A-7949	8d	4.24	BO-5	7c	28.71	C-2317	11f	7.31	*DY-17A	31b
A-3304	6c	8.06	A-3878	6b	1.92	A-8050	7b	17.48	BO-6	7c	34.64	C-2318	21a	2.42	DY-21A	31c
A-3307	6c	9.34	A-3879	6b	1.87	A-8052	7b	16.89	BO-9	7c	36.22	C-2325	21c	3.60	DY-23A	31c
A-3309	6a	2.41	A-3880	7a	5.52	A-8053	7b	17.90	BR-1	11e	132.60	C-2326	21d	3.60	DY-24A	31c
A-3310	6a	7.70	A-3881	6b	2.39	A-8054	7b	17.93	C-1001	21c	4.52	C-2327	21c	2.41	*DY-25A	31c
A-3311	6c	8.13	A-3882	8d	10.01	A-8056	7b	17.93	C-1002	21b	3.47	C-2328	22a	4.54	DY-26A	31c
A-3315	6bd	11.41	A-3883	8d	4.24	A-8060	7b	13.34	C-1003	21b	2.62	*C-2332-1	7d	18.19	DY-27A	31c
A-3327	6b	2.36	A-3885	6c	10.89	A-8061	7b	16.99	C-1080	21a	2.01	C-2334	21d	6.79	DY-28A	31d
A-3328	6a	1.79	A-3890	7a	7.69	A-8062	7b	16.94	C-1215	21a	2.08	C-2335	21c	6.51	DY-29A	31d
A-3329	6b	1.86	A-3891	11d	12.92	A-8063	7b	16.93	*C-1227	21a	2.41	C-2340	11g	40.26	OY-30A	31d
A-3330	6a	2.72	A-3892	11d	16.69	A-8064	7b	16.99	*C-1277	21a	2.45	C-2343	21d	2.14	DY-31A	31d
A-3332	6a	1.73	A-3893	11d	17.30	A-8070	6a	2.79	C-1279	21a	2.04	C-2344	21a	1.55	DY-32A	31d
A-3335	6d	3.93	A-3894	11d	22.70	A-8072	7b	21.42	C-1325	21a	2.17	C-2345	21a	4.34	DY-33A	31d
A-3336	6a	2.53	A-3898	11d	145.75	A-8080	8b	3.55	C-1333	21a	2.25	C-2346	21a	2.15	OY-34A	31d
A-3337	6a	2.89	A-3899	11d	166.71	A-8081	8b	3.90	C-1355	21b	3.30	C-2347	22a	3.47	OY-35A	31e
A-3496	6d	3.68	A-4208	10f	8.00	A-8082	8b	4.73	C-1400	22b	6.46	C-2685	22c	4.35	DY-37A	31e
A-3800	6c	8.55	A-4212	11b	6.87	A-8083	8b	2.75	C-1401	22b	7.81	C-2686	22c	7.59	DY-38A	31e
A-3801	6c	10.88	A-4292	11a	3.13	A-8084	8b	3.64	C-1402	22b	8.91	C-2687	22c	9.95	OY-39A	31e
A-3802	6c	19.75	A-4350	8e	5.28	A-8087	8a	2.67	C-1403	22b	15.60	C-2688	22c	11.55	OY-40A	31e
A-3808	11c	21.27	A-4351	9c	6.01	A-8088	8a	3.40	C-1404	22b	20.85	C-2689	22c	17.32	DY-41A	31e
A-3812	11c	3.08	A-4352	9c	6.30	A-8090	9a	2.44	C-1405	22b	62.37	C-2690	22c	9.45	DY-42A	31e
A-3817	9a	4.17	A-4407	8e	12.24	A-8091	9a	2.63	C-1410	21c	5.93	C-2691	22c	13.15	*DY-43A	31f
A-3818	8d	6.13	A-4431	6a	2.40	A-8092	6a	2.74	C-1411	21c	7.12	C-2692	22c	DY-44A	31f
*A-3820	8d	15.21	A-4432	6c	3.60	A-8093	6d	2.86	C-1412	21d	8.77	C-2704	21c	3.99	OY-45A	31f
A-3822	7a	2.52	A-4702	11a	6.49	A-8094	6c	5.45	C-1413	22a	15.34	C-2705	21d	9.32	DY-46A	31f
A-3823	7a	4.17	A-4705	9b	4.15	A-8095	8a	3.19	C-1414	22a	20.12	C-2706	22a	7.92	DY-47A	31f
A-3824	7a	4.04	A-4706	9b	3.01	A-8096	8a	4.67	C-1415	22a	67.64	C-2707	21a	1.90	DY-48A	31f
A-3825	7a	3.35	A-4708	9b	4.29	A-8097	8a	5.75	C-1420	21b	6.21	C-2708	22a	3.84	OY-49A	31f
A-3829	11c	25.94	A-4709	9c	7.26	A-8098	6c	10.64	C-1421	21c	5.67	C-2709	22a	5.71	*DY-50A	31f
A-3830	7a	5.38	A-4711	10f	4.24	A-8099	8a	3.52	C-1515	21a	2.86	*C1C-1	9c	17.89	DY-51A	31g
A-3831	6c	3.47	A-4713	11a	2.75	A-8101	8d	2.22	C-1645	22b	8.63	C1S-1	9c	23.93	DY-52A	31g
A-3833	9a	4.64	A-4719	10e	6.81	A-8102	8b	4.37	C-1646	21c	8.73	*C1S-2	9c	11.47	DY-53A	31g
A-3836	9a	3.49	A-4723	11a	2.81	A-8103	8b	5.99	C-1702	22b	8.85	COC-1	6a	9.96	DY-54A	31g
A-3837	8d	5.33	A-4742	9b	4.55	A-8104	8d	5.25	C-1703	21d	7.94	*COC-2	6b	10.84	OY-56A	31g

• New part number.
* Available until stock is depleted.

Prices subject to change without notice. Contact your STANCOR Distributor for quantity discount schedule. For prices not shown, contact your authorized STANCOR distributor.



transformers

PART NUMBER INDEX

Stancor No.	Page	Price	Stancor No.	Page	Price	Stancor No.	Page	Price	Stancor No.	Page	Price	Stancor No.	Page	Price	Stancor No.	Page	Price
DY-57AT	31h	*HO-225	29	HO-329	29	•HO-403	29	P-6131	33c	9.84	P-6482	33b	11.96
DY58AT	31h	HO-226	29	HO-331	29	•HO-404	29	P-6133	19a	5.04	P-6489	33b	5.25
DY-59AT	31h	HO-234	29	HO-332	29	•HO-405	29	P-6134	19b	2.63	P-6490	33a	4.44
DY-61AT	31h	HO-235	29	HO-333	29	•HO-600C	29	P-6135	19a	6.62	P-6491	33c	4.83
•DY-62A	31h	HO-238	29	HO-334	29	•HO-601C	29	P-6137	19b	11.77	P-6492	19b	14.74
•DY-63A	31h	HO-239	29	HO-335	29	•HO-602C	29	P-6138	19c	9.47	P-6493	33b	6.95
•DY-64A	31h	HO-240	29	HO-336	29	•HO-607C	29	P-6139	19d	9.49	P-6494	33b	4.97
•DY-90AC	31h	HO-242	29	HO-337	29	IS-50	27d	18.34	P-6141	27a	21.53	P-6495	33b	7.16
•DY-91AC	31h	HO-243	29	HO-338	29	IS-100	27d	25.12	P-6143	17e	15.23	P-6496	24d	16.39
F-25	19a	16.09	HO-244	29	HO-339	29	IS-150	27d	30.27	P-6144	20a	11.11	P-6497	33b	5.00
F-54	19a	11.70	HO-245	29	HO-340	29	IS-250	27d	35.30	P-6146	15b	10.77	P-6499	33a	11.27
F-58	19a	17.68	*HO-246	29	HO-341	29	NCF-1550	26a	10.56	P-6160	27e	19.07	P-8025	28b	120.15
F-63	19b	11.94	HO-247	29	HO-342	29	NCF-1650	26a	8.94	P-6161	27e	26.27	P-8026	28b	120.64
F-65	19c	14.69	HO-248	29	HO-343	29	NCF-2425	26a	7.47	P-6166	24d	18.80	P-8027	28b	118.29
F-104	19c	14.52	*HO-249	29	HO-344	29	NCF-2450	26a	8.83	P-6287	27a	9.30	P-8028	28b	134.80
*F-106	19d	21.59	HO-251	29	HO-345	29	NCF-2475	26a	9.82	P-6298	27e	67.41	P-8029	28b	165.45
F-210	19a	16.22	HO-252	29	HO-346	29	NCF-24100	26a	13.15	P-6302	19b	41.82	P-8030	28c	131.46
F-210H	19a	18.73	HO-254	29	HO-347	29	NCF-24150	26a	17.63	P-6305	19b	42.37	P-8031	28b	161.00
F-215H	19a	30.90	HO-255	29	HO-348	29	NCF-3250	26a	9.34	P-6308	19c	8.08	P-8032	28c	150.27
F-510H	19b	32.31	HO-256	29	HO-349	29	NCF-3275	26a	10.56	P-6309	19c	12.31	P-8033	28c	194.12
F-516	19b	22.36	*HO-257	29	HO-350	29	NCF-32150	26a	16.61	P-6315	17b	18.54	P-8034	28c	185.00
F-520HB	19b	38.79	HO-259	29	HO-351	29	P-45	28a	37.15	P-6317	18c	15.78	P-8035	28c	219.94
F-530	19b	32.50	HO-264	29	HO-352	29	P-67	28a	36.46	P-6318	18c	19.39	P-8040	28a	19.55
F-610	19c	21.78	HO-265	29	HO-353	29	P-1240	28b	56.97	P-6333	20d	13.01	P-8041	28a	21.84
F-615	19b	15.06	HO-267	29	HO-354	29	P-1512	28b	146.73	P-6338	20a	11.01	P-8042	28a	28.59
F-712	19c	24.19	HO-268	29	HO-355	29	P-1834-3	20g	14.40	P-6348	15d	7.32	P-8043	28a	111.64
F-725	19c	36.66	HO-269	29	HO-356	29	P-2126	28c	249.39	P-6358	16b	7.18	*P-8044	28b	52.93
F-751	19c	64.05	HO-271	29	HO-357	29	P-2520	28c	151.64	P-6371	27e	24.33	P-8130	19d	4.35
F-1010	19d	23.15	HO-272	29	HO-358	29	P-3020	19d	12.70	P-6375	26d	4.04	P-8150	18d	10.99
HO-158	29	HO-274	29	HO-359	29	P-3024	19a	6.16	P-6376	26d	4.73	P-8151	18d	16.27
HO-159	29	*HO-275	29	HO-360	29	P-3026	19a	6.48	P-6377	26d	5.89	P-8155	15c	10.64
HO-160	29	HO-276	29	HO-361	29	P-3060	19a	8.47	P-6378	26d	9.57	P-8158	15a	14.18
HO-161	29	*HO-277	29	HO-362	29	P-3062	19a	6.11	P-6379	26d	15.68	P-8164	16b	20.67
*HO-162	29	HO-279	29	HO-363	29	P-3064	19c	6.38	P-6383	27f	19.46	P-8166	16d	26.29
HO-163	29	HO-280	29	HO-364	29	P-4004	17d	20.56	P-6385	27f	28.66	P-8167	15e	25.79
HO-164	29	HO-281	29	HO-365	29	P-4019	19c	6.44	P-6387	27f	75.98	P-8169	17c	22.93
HO-165	29	HO-282	29	HO-366	29	P-4022	20c	11.36	P-6389	27f	91.49	P-8170	17c	21.20
HO-166	29	HO-283	29	HO-367	29	P-4026	19a	3.66	P-6390	27f	35.62	P-8171	17c	23.13
*HO-167	29	HO-284	29	HO-368	29	P-4062	33c	6.43	P-6410	27e	9.34	P-8172	15e	18.09
HO-169	29	HO-285	29	HO-369	29	P-4063	33c	7.86	P-6411	27e	4.01	P-8173	15d	6.26
HO-173	29	HO-287	29	HO-370	29	P-4082	19a	6.41	P-6415	27g	30.42	P-8174	15d	6.46
HO-175	29	HO-289	29	HO-371	29	P-4083	19a	7.03	P-6425	18f	4.59	P-8175	16b	10.04
*HO-177	29	HO-290	29	HO-372	29	P-4086	19b	42.21	P-6426	18f	2.03	P-8176	16e	13.44
HO-178	29	HO-293	29	HO-373	29	P-4088	19a	5.11	P-6428	20e	8.06	P-8177	16b	11.85
*HO-179	29	HO-294	29	HO-374	29	P-8088	19c	8.31	P-6429	20f	10.77	P-8178	18d	12.87
HO-180	29	HO-295	29	HO-375	29	P-4091	19c	8.97	P-6430	20e	7.14	P-8179	18d	13.96
HO-181	29	*HO-296	29	HO-376	29	P-4096	19d	9.20	P-6431	20f	10.67	P-8180	19d	4.10
HO-182	29	HO-297	29	HO-377	29	P-4097	19d	9.45	P-6432	19b	10.84	P-8181	15b	4.23
HO-183	29	HO-299	29	HO-378	29	P-4353	28c	572.67	P-6433	19f	9.23	P-8190	19b	3.41
HO-184	29	HO-301	29	HO-379	29	P-5000	19a	7.26	P-6454	19e	5.14	P-8191	19b	4.01
HO-185	29	HO-303	29	HO-380	29	P-5002	19d	45.74	P-6455	19a	5.72	P-8192	33	4.94
*HO-188	29	HO-304	29	HO-381	29	P-5008	20c	11.05	P-6456	19c	4.72	P-8193	23e	10.97
*HO-189	29	HO-305	29	HO-382	29	P-5009	20c	10.82	P-6457	19c	16.55	P-8194	23e	18.48
HO-190	29	HO-307	29	HO-383	29	P-5014	19c	5.50	P-6458	19d	5.88	P-8195	24c	16.39
HO-191	29	HO-308	29	HO-384	29	P-5015	19c	6.27	P-6459	18e	6.44	P-8196	23e	8.42
HO-194	29	HO-311	29	HO-385	29	P-5016	19d	7.42	P-6461	19d	10.64	*P-8197	23e	6.46
HO-198	29	HO-312	29	HO-386	29	P-5059	16d	16.55	P-6462	19c	7.26	*P-8198	23e	5.99
HO-202	29	HO-313	29	HO-387	29	P-5062	27a	10.01	P-6463	20d	10.53	P-8331	16b	19.44
HO-203	29	HO-314	29	HO-388	29	P-5063	27a	11.64	P-6464	19c	8.41	P-8332	15e	21.20
HO-204	29	HO-315	29	*HO-389	29	P-5064	27a	12.60	P-6465	19b	2.47	P-8333	16a	20.44
HO-205	29	HO-316	29	•HO-390	29	P-5065	27a	16.25	P-6466	19c	3.99	P-8334	15e	21.95
HO-211	29	HO-317	29	•HO-391	29	P-6007	17d	16.67	P-6467	19a	4.02	P-8335	16b	23.27
HO-212	29	HO-318	29	•HO-392	29	F-6010	16c	9.71	P-6468	19b	17.66	P-8336	15a	16.82
HO-213	29	HO-319	29	•HO-393	29	P-6011	16d	9.18	P-6469	19d	4.06	P-8337	16b	18.12
HO-214	29	HO-320	29	•HO-394	29	P-6012	16d	10.89	P-6471	33a	6.82	P-8338	16c	24.53
HO-215	29	HO-321	29	•HO-395	29	P-6013	16e	11.41	P-6476	33a	6.98	P-8339	16c	17.54
HO-216	29	*HO-322	29	•HO-396	29	P-6014	17b	12.82	P-6477	33a	3.91	P-8340	16e	25.66
*HO-217	29	HO-323	29	•HO-397	29	P-6123	27e	139.67	P-6478	33a	4.55	P-8341	17a	20.85
*HO-220	29	HO-324	29	•HO-398	29	P-6124	27a	63.99	P-6480	33a	4.80	P-8342	17a	23.84
*HO-221	29	*HO-327	29	•HO-402	29	P-6125	27e	98.07	P-6481	33a	5.71	P-8343	17a	22.74

* New part number.
 * Available until stock is depleted.

Prices subject to change without notice. Contact your STANCOR Distributor for quantity discount schedule.
 For prices not shown, contact your authorized STANCOR distributor.



PART NUMBER INDEX

Table with 15 columns: Stancor No., Page, Price, Stancor No., Page, Price, Stancor No., Page, Price, Stancor No., Page, Price, Stancor No., Page, Price, Stancor No., Page, Price. Lists various transformer part numbers and their corresponding page and price information.

* New part number.
* Available until stock is depleted.

Prices subject to change without notice. Contact your STANCOR Distributor for quantity discount schedule.
For prices not shown, contact your authorized STANCOR distributor.

STANCOR

OUTPUT TRANSFORMER CHART

A simplified selection of the proper transformer for use as a replacement in radio receivers or in the construction of audio amplifiers. To use this chart, check the first column for the tube being used, then read across for the applicable operating characteristics and correct Stancor transformer. In most cases, two Stancor part numbers are indicated in order to give a choice of Mounting styles.

audio transformers

audio transformers						audio transformers						audio transformers							
Tube	Use	Class	Watts	Load Res. in Ohms	Stancor Universal Part No. Type	Tube	Use	Class	Watts	Load Res. in Ohms	Stancor Universal Part No. Type	Tube	Use	Class	Watts	Load Res. in Ohms	Stancor Universal Part No. Type		
1A5-GT	S.	A	.10	25K	A-3327	6D28	S.P.	A	2.0	2.5K	A-3822	25F5	S.	A	1.2	2.5K	A-3332	A-3825	
1A5S	S.	A	.05	25K	A-3327	6E6	S.P.	A	1.6	14K	A-3496	25L6(GT)	S.P.	A	2.9	4.5K	A-3672	A-3823	
1AG4	S.	A	.035	12K	A-3879	6EH5	S.	A	1.4	3K	A-3328		S.	A	2.1	2K	A-3676	A-3849	
1B8-GT	S.	A	.21	14K	A-3881		P.P.	A	3.8	6K	A-3822		S.	A	4.3	3K		A-3823	
1C5-GT	S.	A	.24	8K	A-3329	6F6(GT)	S.	A	4.8	7K	A-3878		S.	A	3.8	4K	A-2283	A-3823	
1D8-GT	S.	A	.20	12K	A-3879		P.P.	AB	18.5	10K	A-3111	25N6-G	S.	A	3.8	4K	A-2283	A-3822	
1E7-G(GT)	S.	A	.29	16K	A-3879		S.	A1	4	1K	A-8070	25W6	S.	A	3.8	4K	A-3877	A-3856	
	P.P.	A	5.75	24K	A-3857	6FE5	P.P.	A1	8	1.6K		26A7-GT	S.	A	.18	1.5K	A-3332	A-3825	
1F4	S.	A	.31	16K	A-3881		P.P.	A	1.1	10K	A-3879	26E6-G	S.	A	6.0	2.6K		A-3825	
1F5-G	S.	A	.31	16K	A-3881		S.	A1	2	2K	A-3876	28D7	S.	A	.1	4K	A-3328	A-3848	
1G5-G	S.	A	.55	9K	A-3879	6GC5	S.	A1	4	4K	A-2203	32E75	S.	A	1.2	2.8K	A-3328	A-3825	
1G6-GT	P.P.	B	.675	12K	A-3831	6GK6	S.	A1	5.7	5.2K	A-3877	32L7-GT	S.	A	1	2.6K	A-3332	A-3822	
1J5-G	S.	A	.45	13.5K	A-3881		P.P.	AB1	17	8K	A-3852	34G05A	S.	A	1.4	2.5K	A-3332	A-3856	
1J6-G(GT)						6HG5	S.	A1	4.5	5K	A-8092	35A5	S.	A	1.5	2.5K	A-3332	A-3856	
(GX)	P.P.	B	2.1	10K	A-3831	6KG-GT	S.	A	4.5	9K	A-3879		S.	A	3	5K	A-3877	A-3849	
1LA4	S.	A	.1	25K	A-3327		P.P.	A	10.5	12K	A-2312	35B5	S.	A	1.5	2.5K	A-3332	A-3856	
1LB4	S.	A	.2	12K	A-3879	6J10	S.	A1	4.2	5K	A-8092	35C5	S.	A	1.5	2.5K	A-3332	A-3849	
1N6-G(GT)	S.	A	.1	25K	A-3327	6L6(G)(GA)	S.	A	6.5	2.5K	A-3876	35D28	S.	A	2.0	2.5K	A-3332	A-3825	
1O5-GT	S.	A	.27	8K	A-3329		P.P.	A	10.8	4.2K	A-2203	35EH5	S.	A1	1.2	3K	A-3332	A-3856	
1S4	S.	A	.27	8K	A-3329		P.P.	AB1	17.5	5K	A-3872	35L6-GT	S.	A	1.5	2.5K	A-3332	A-3856	
1T5-GT	S.	A	.17	14K	A-3881		P.P.	AB1	26.5	6.6K	A-3801		S.	A	3	5K	A-3877	A-3849	
1W5	S.	A	.05	25K	A-3327	6M5	P.P.	AB2	31	6K	A-3302								
1W4	S.	A	.35	2.5K	A-3876		P.P.	AB2	47	3.8K	A-3807	42	S.	A	4.8	7K	A-3878	A-3849	
2A3	P.P.	AB1	15	3K	A-3301		S.	A	3.9	7K	A-3878	50A5	S.	A	2.1	2K	A-3876	A-3856	
2A5	S.	A	4.8	7K	A-3878		P.P.	AB1	9.4	7K	A-3801		S.	A	3.8	4K	A-2203	A-3825	
	P.P.	AB2	18.5	10K	A-3311	6N6-G	S.	A	4	7K	A-3878	50B5	S.	A	1.9	2.5K	A-3332	A-3825	
2E24	S.	A	3.9	6K	A-3878	6N7	P.P.	B	10	8K	A-3880	50BK5	S.	A	3.5	6.5K	A-3878	A-3856	
2E26	S.	A	4.0	5.5K	A-3877	6R8	S.	A	0.3	10K	A-3879	50C5	S.	A	1.9	2.5K	A-3332	A-3825	
2E30	S.	A	4.5	4.5K	A-3877	6SR7	S.	A	0.3	10K	A-3879	50CG-G	S.	A	3.6	2K	A-3876	A-3825	
3A4	S.	A	.7	8K	A-8114	6UG-GT	S.	A	5.5	3K	A-3849	50CA5	S.	A	1.1	3.5K	A-3328	A-3825	
3B5-GT	S.	A	.2	5K	A-3878	6V5-GT	S.	A	4.5	5K	A-3877	50EH5	S.	A	1.4	3K	A-3328	A-3825	
3B7/1291	P.P.	AB2	1.5	16K	A-2312		P.P.	AB1	10	10K	A-3111		P.P.	S.	A	3.8	6K	A-3877	A-3822
3C5-GT	S.	A	.2	8K	A-3329	6V6(GT)	S.	A	5.5	5K	A-3877	50FE5	S.	A1	4	1K	A-8070		
	S.	A	.26	10K	A-3879		P.P.	AB1	10	10K	A-3111		P.P.	A1	8	1.6K			
3D6	S.	A	.6	14K	A-3881	6V7-G	S.	A	0.35	20K	A-3327	50FK5	S.	A1	1.2	3K	A-3336	A-3856	
3E5	S.	A	.325	6K	A-3329	6W6-GT	S.	A	3.8	5K	A-3877	50L6-GT	S.	A	2.1	2K	A-3876	A-3856	
3LE4	S.	A	.4	8K	A-3329	6Y6-G(GT)	S.	A	6.0	2.6K	A-3876		S.	A	3.8	4K	A-2203	A-3825	
3LF4	S.	A	.4	8K	A-3329	6Y7-G	P.P.	B	8.0	14K	A-2312	60FX5	S.	A1	1.3	3K	A-3336	A-3856	
3Q4	S.	A	.27	10K	A-3879	6Z7-G	P.P.	B	4.2	12K	A-3831	70A7-GT	S.	A	1.5	2.5K	A-3332	A-3825	
3Q5-GT	S.	A	.4	8K	A-3329	7A5	S.	A	1.5	2.5K	A-3332	70L7-GT	S.	A	1.8	2K	A-3332	A-3825	
3S4	S.	A	.18	5K	A-3877	7B5	S.	A	4.5	9K	A-3879	117L7/M7-GT	S.	A	8.5	4K	A-2203	A-3825	
3V4	S.	A	.27	8K	A-3329	7C5	P.P.	AB2	19	10K	A-2312	117N7-GT	S.	A	1.2	3K	A-3332	A-3825	
3W4	S.	A	0.25	11K	A-3879		P.P.	A	8	10K	A-3335	117P7-GT	S.	A	.85	4K	A-2203	A-3825	
4A6-G	P.P.	B	1.0	8K	A-3856	8BQ5	S.	A	5.7	4.5K	A-8092	1631	P.P.	AB1	26.5	6.6K	A-3801		
5A05	S.	A	2.0	5.5K	A-3877		P.P.	AB1	11.0	8K	A-3335	1632	S.	A	2.1	2K	A-3332	A-3825	
5CM6	S.	A	4.5	5K	A-3877	9D28	S.	A	2.0	2.5K	A-3332	1644	P.P.	A	1.0	10K	A-3831	A-3856	
5CZ5	P.P.	AB1	10	10K	A-3335	10AL11	S.	A1	4	5K	A-3877	5640	S.	A	1.25	3K	A-3332	A-3825	
	S.	A	5.4	8K	A-3877	11C5	S.	A	1.5	2.5K	A-3877	5670	P.P.	AB1	1.0	27K	A-3327		
5V6(GT)	P.P.	AB1	21.5	7.5K	A-3830	12A5	S.	A	3.4	3.3K	A-3332	5682	S.	A	.065	20K	A-3878	A-3822	
	S.	A	5.5	5K	A-3877	12A6(GT)	S.	A	3.4	7.5K	A-6114	5812	S.	A	4.3	1.7K	A-3876	A-3825	
6A3	S.	A	3.2	2.5K	A-3876	12A7	S.	A	.55	13.5K	A-3881	5824	S.	A	4.3	1.7K	A-3876	A-3825	
	P.P.	AB1	15	3K	A-3301	12AB5	S.	A	4.5	5K	A-3877	5871	S.	A	5.5	8.5K	A-3879	A-3822	
6A4/LA	S.	A	1.4	8K	A-8114		P.P.	AB1	10.0	10K	A-3335	5902	S.	A	1	3K	A-3328	A-3825	
6A5-G	S.	A	3.75	2.5K	A-3876	12AL8	S.	A	0.02	8K	TA-9	6005	S.	A	2.0	5.5K	A-4431	A-3856	
	P.P.	A	15	3K	A-3301	12AL11	S.	A1	4	5K	A-3877	6095	P.P.	AB1	10.0	10K	A-3335	A-3852	
6A6	P.P.	B	10	8K	A-3329	12AQ5	S.	A	4.5	5K	A-3877	6216	S.	A	3.8	4.5K	A-3877	A-3856	
6A8B	S.	A	1.4	11K	A-3879		P.P.	AB1	10.0	10K	A-3335	6287	S.	A	4.5	6K	A-4431	A-3823	
6AC5-GT	P.P.	B	8	10K	A-3335	12BF6	S.	A	0.3	10K	A-3879	6360	P.P.	AB1	9.3	8K	A-3335	A-3852	
6AC6-GT	S.	A	3.6	3.5K	A-2203	12BK5	S.	A	3.5	6.5K	A-3878	6516	S.	A	1.4	16K	A-3881	A-3856	
6AD7-G	S.	A	3.2	7K	A-2313	12BU6	S.	A	0.3	10K	A-3879	6526	S.	A	0.375	10K	A-3879	A-3856	
6AE7-GT	P.P.	AB1	9.5	10K	A-2312	12C5	S.	A	2.3	2.5K	A-3332	6668	S.	A	4.5	5K	A-3877	A-3823	
6AG6-G	S.	A	3.8	8.4K	A-3329	12CA5	S.	A	1.5	4.5K	A-3877		P.P.	AB1	10.0	10K	A-8093	A-3880	
6AG7	S.	A	3	10K	A-3879	12CM6	S.	A1	2.0	5.5K	A-3877	6677	P.P.	AB1	2.8	7.5K	A-8114	A-3822	
6AH5-G	S.	A	10.8	4.2K	A-3337		S.	A1	5.5	8.5K	A-3879	6945	S.	A	0.8	3K	A-3328	A-3825	
6AJ5	P.P.	AB1	1.0	28K	A-3857	12CS5	S.	A	2.3	4K	A-3877	6973	P.P.	AB1	15	5.5K	A-3307	A-3880	
6AK6	S.	A	1.1	10K	A-3879	12CU5	S.	A	2.3	2.5K	A-3332	7061	S.	A	20	7.5K	A-3885	A-3830	
						12DB5	S.	A	3.8	4K	A-3877								
						12DL8	S.	A	0.04	.8K	TA-9								
6AK7	S.	A	3	10K	A-3879	12DM5	S.	A	1.9	2.5K	A-3332	High Fidelity Applications							
6AL5-G	S.	A	6.5	2.5K	A-3876	12DU7	S.	A	0.025	2.7K	TA-29	Tube	Use	Class	Watts	Load Res. in Ohms	Stancor Part No.		
6AL11	S.	A1	4	5K	A-3877	12DV8	S.	A	0.005	1.25K	TA-26	807/W	P.P.	A*	8.0	10K	A-8054		
6AM5	S.	A	1.4	16K	A-3881	12DZ8	S.	A	2.0	2.5K	A-3332								

SECTION 5600

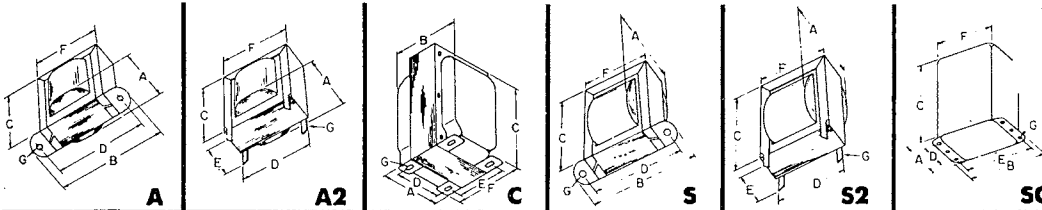

STANCOR
COMMERCIAL
output
transformers

OUTPUT: SINGLE PLATE TO VOICE COIL AND/OR LINE

	Catalog No.	Impedance in Ohms		Max Pri DCMA	Audio Watts	Termination		Style	Dimensions							WT. Lbs.
		Primary	Secondary			Pri	Sec		A	B	C	D	E	F	G	
a	A-8070	1000	4.0	90	4	Leads	Leads	A	1 1/2	2 3/8	1 3/8	2	—	1 3/4	3/16	0.4
	A-3332	2000	3.2	50	3	Leads	Leads	A	1 1/4	2 1/8	1 1/4	1 3/4	—	1 1/2	3/16	0.4
	A-3330	2000 a	3.5	60	5	Leads	Leads	A	1 1/2	2 3/8	1 3/8	2	—	1 3/4	3/16	0.4
	A-3876	2000	4.0	60	5	Leads	Leads	A	1 3/8	2 3/8	1 3/8	2	—	1 3/4	3/16	0.4
	A-3336	2500 b	3.5	50	5	Leads	Leads	A	1 5/8	2 3/8	1 3/8	2	—	1 3/4	3/16	0.4
	A-3328	4000	3.5	10	3	Leads	Leads	A	1 1/8	2 1/8	1 1/4	1 3/4	—	1 1/2	3/16	0.4
	A-2203	4000	8.0	40	5	Leads	Leads	A	1 1/2	2 3/8	1 3/8	2 3/8	—	2	3/16	0.7
	A-3877	5000	4.0	40	5	Leads	Leads	A	1 3/8	2 3/8	1 3/8	2	—	1 3/4	3/16	0.4
	A-3309	5000	3-4	35	3	Leads	Leads	A	1 3/8	2 1/8	1 1/4	1 3/4	—	1 1/2	3/16	0.4
	A-8092	5000	3-4	50	8	Leads	Leads	A	1 1/2	2 3/8	1 3/8	2 3/8	—	2	3/16	0.5
	A-3337	5000	6-8	40	10	Leads	Leads	S	1 3/4	2 3/8	2 3/8	2 3/8	—	2	3/16	1.0
	A-3310	5000	500/15/8/4	55	20	Leads	Leads	C	2 1/2	2 3/4	3 1/8	2	1 3/4	2 3/8	3/16 x 3/8	2.5
	COC-1	5000	600/150/16/8/4	55	5	Leads	Leads	SC	2 1/2	3	3 1/8	1 3/4	2 1 1/16	2 3/8	3/16	2.25
	COS-1	5000	600/150/16/8/4	55	5	Lugs	Lugs	SC	2 1/2	3	3 1/8	1 3/4	2 1 1/16	2 3/8	3/16	2.25
A-4431	6000	3-4	35	5	Leads	Leads	A2	1 1/2	—	1 3/8	1 3/4	1 1/16	2	3/32	0.8	
b	A-3878	7000	4.0	30	5	Leads	Leads	A	1 1/4	2 3/8	1 3/8	2	—	1 3/4	3/16	0.4
	A-2313	7000	8.0	40	10	Leads	Leads	A	2	3 1/4	2	2 13/16	—	2 3/8	3/16	1.0
	A-3841	{7000/6000/5000} 4000/2500	500	60	10	Lugs	Lugs	S	2	3 3/8	2 3/4	2 13/16	—	2 1/4	3/16	1.5
	A-4770	{7000/6000/5000} 4000/2500	500	60	20	Leads	Lugs	S	2 1/8	3 3/8	3 1/8	3 1/8	—	2 3/8	3/16	2.4
	A-8114	7600	3.2	32	5	Leads	Leads	A	1 3/8	2 3/8	1 3/8	2	—	1 3/4	3/16	0.4
	A-3329	8000	3.5	10	3	Leads	Leads	A	1 1/8	2 1/8	1 1/4	1 3/4	—	1 1/2	3/16	0.4
	COS-2	8000	600/150/16/8/4	55	5	Leads	Leads	SC	2 1/2	3	3 1/8	1 3/4	2 1 1/16	2 3/8	3/16	2.25
	COC-1	8000	600/150/16/8/4	55	5	Lugs	Lugs	SC	2 1/2	3	3 1/8	1 3/4	2 1 1/16	2 3/8	3/16	2.25
	A-3879	10000	4.0	30	5	Leads	Leads	A	1 3/8	2 3/8	1 3/8	2	—	1 3/4	3/16	0.4
	A-3881	15000	4.0	10	5	Leads	Leads	A	1 3/8	2 3/8	1 3/8	2	—	1 3/4	3/16	0.4
	A-3250	{20000/10000} 5000	{500/333/200} 125/50	15	5	Lugs	Lugs	A	1 7/8	3 1/4	2	2 13/16	—	2 3/8	3/16	1.0
	A-3315	{20000/10000} 5000	{500/333/200} 125/50	35	20	Lugs	Lugs	C	2 1/2	2 3/4	3 1/8	2	1 3/4	2 3/8	3/16 x 3/8	2.7
	A-3327	25000	4.0	5	5	Leads	Leads	A	1 3/8	2 3/8	1 3/8	2	—	1 3/4	3/16	0.4

OUTPUT: PUSH-PULL PLATES TO VOICE COIL AND/OR LINE

c	A-8098	2000 C.T.	32/16/8	140	15	Leads	Leads	C	2 1/2	3 1/4	3 3/8	2	2 1/4	2 3/8	3/16 x 3/8	3.3
	A-3802	3800/3300 C.T.	500/250/8/4	125	75	Leads	Leads	C	3 3/4	4	4 1 1/16	3	2 13/16	3 3/8	3/16 x 3/8	7.9
	A-8094	4000 C.T.	32/16/8	80	7.5	Leads	Leads	A	2 1/4	3 1/4	2 3/8	3 3/8	—	2 3/4	3/16	1.5
	A-3851	4400 C.T. c	500/250/15/8/4	70	30	Leads	Leads	C	2 13/16	3 3/4	3 1/2	2 1/4	2	2 3/4	3/16 x 3/8	3.6
	A-3872	5000 C.T.	15/8/4	75	18	Leads	Leads	SC	2 1/4	2 3/4	2 1 1/16	1 1/2	2 3/8	2	3/16	1.7
	A-3800	5000 C.T.	500/250/15/8/4	80	30	Leads	Leads	C	2 13/16	3 1/4	3 1/2	2 1/4	2	2 3/4	3/16 x 3/8	3.7
	A-3307	6000 C.T.	500/15/8/4	100	30	Leads	Leads	C	2 13/16	3 1/4	3 1/2	2 1/4	2	2 3/4	3/16 x 3/8	3.5
	PCO-200	6000 C.T. c	600/150/16/8/4	250	30	Leads	Leads	SC	4 3/16	5 1/4	5 5/16	2 1/2	4 3/4	4 1/8	7/32	9.0
	PSO-200	6000 C.T. c	600/150/16/8/4	250	30	Lugs	Lugs	SC	4 3/16	5 1/4	5 5/16	2 1/2	4 3/4	4 1/8	7/32	9.0
	A-3801	6600 C.T.	500/250/15/8/4	150	35	Leads	Leads	C	3 3/8	3 3/4	3 3/8	2 1/2	2 3/16	3 1/16	3/16 x 3/8	4.8
	A-3885	9000 C.T.	500/250/15/8/4	150	35	Leads	Leads	C	3 3/8	3 3/8	3 3/8	2 1/2	2 3/16	3 1/16	3/16 x 3/8	4.8
	A-4432	10000 C.T.	4.0	50	10	Leads	Leads	S2	1 5/8	—	2 3/8	1 7/8	1 1/16	2	3/32	1.0
	A-3304	10000/7000 C.T.	500/15/8/4	60	25	Leads	Leads	C	2 1/2	2 3/4	3 1/8	2	1 3/4	2 3/8	3/16 x 3/8	2.7
	A-3311	10000 C.T.	500/15/8/4	70	25	Leads	Leads	C	2 13/16	3 1/4	3 1/2	2 1/4	2	2 3/4	3/16 x 3/8	3.5
A-3831	10000 C.T.	8/4/2	40	5	Leads	Leads	A	1 3/4	2 3/8	1 5/8	2 3/8	—	2	3/16	0.7	
d	A-8093	10000 C.T.	3-4	40	10	Leads	Leads	A	1 1/2	2 3/8	1 3/8	2 3/8	—	2	3/16	0.7
	A-3335	10000 C.T.	6-8/3.2-4	40	10	Leads	Leads	S	2	2 3/8	2 3/8	2 3/8	—	2	3/16	1.0
	PCO-150	10000 C.T. c	600/150/16/8/4	200	15	Leads	Leads	SC	3 1/4	4	4 1/4	2 1/4	3 1/2	2 1 1/16	7/32	5.0
	PSO-150	10000 C.T. c	600/150/16/8/4	200	15	Lugs	Lugs	SC	3 1/4	4	4 1/4	2 1/4	3 1/2	2 1 1/16	7/32	5.0
	A-3839	10000 C.T.	2000 and 15/8/4	30	10	Leads	Leads	SC	2 1/4	2 3/4	2 1 1/16	1 1/2	2 3/8	2	3/16	1.3
	PCO-150A	12000 C.T.	600/150/16/8/4	200	15	Leads	Leads	SC	3 1/4	4	4 1/4	2 1/4	3 1/2	2 1 1/16	7/32	5.0
	A-2312	14000 C.T.	4.0	40	10	Leads	Leads	A	1 3/8	2 3/8	1 3/8	2 3/8	—	2	3/16	1.0
	A-3496	14000 C.T.	4.0	25	5	Leads	Leads	A	1 3/8	2 3/8	1 3/8	2	—	1 3/4	3/16	0.4
	A-3303	14000 C.T.	500/15/8/4	55	20	Leads	Leads	C	2 1/2	2 3/8	3 1/8	2	1 1 1/16	2 3/16	3/16 x 3/8	2.7
	A-3842	{14000/12000} 10000/8000 C.T.}	500	55	10	Lugs	Lugs	S	2	3 3/8	2 3/4	2 13/16	—	2 1/4	3/16	1.7
	A-3250	20000 C.T.	{500/333/200} 125/50	15	5	Lugs	Lugs	A	1 7/8	3 1/4	2	2 13/16	—	2 3/8	3/16	1.0
A-3315	20000 C.T.	{500/333/200} 125/50	35	20	Lugs	Lugs	C	2 1/2	2 3/4	3 1/8	2	1 1 1/16	2 1/2	3/16 x 3/8	2.7	
A-3857	25000 C.T.	4.0	10	5	Leads	Leads	A	1 1/2	2 3/8	1 3/8	2	—	1 3/4	3/16	0.4	

a Has 4.5% primary Tap.

c. Has Tertiary Winding to provide 10% inverse feedback.

b Has 3% and 6% primary Taps.

* Available until stock is depleted

STANCOR

COMMERCIAL

output transformers

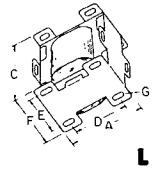
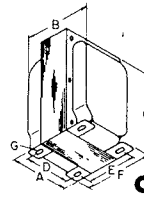
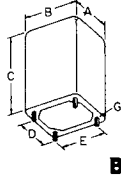
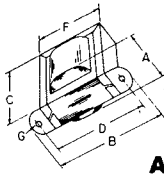

UNIVERSAL OUTPUT

Catalog No.	Impedance in Ohms		Max Pri DCMA	Audio Watts	Termination		Style	Dimensions							WT. Lbs.
	Primary	Secondary			Pri	Sec		A	B	C	D	E	F	G	
A-3856	{ S. or P.P. Plates 4000 to 14000 }	.05 to 122	35	4	Leads	Lugs	A	1 1/2	2 3/8	1 3/8	2	—	1 3/8	3/8	0.4
A-3822	{ S. Plate 7000 to 10000 }	.7 to 4	35	4	Leads	Lugs	A	1 3/8	2 3/8	1 3/8	2	—	1 3/8	3/8	0.4
A-3848	{ S. Plate 7000 to 16000 }	.4 to 4	10	5	Leads	Lugs	A	1 3/8	2 3/8	1 3/8	2	—	1 3/8	3/8	0.4
A-3823	{ S. or P.P. Plates 4000 to 14000 }	.05 to 122	40	8	Leads	Lugs	A	1 3/8	2 3/8	1 3/8	2 3/8	—	2	3/8	0.7
A-3850	{ S. or P.P. Plates 4000 to 14000 }	.05 to 122	40	8	Leads	Lugs	S	1 3/8	2 3/8	2	2	—	1 3/8	3/8	0.7
A-3825	{ S. Plate 1500 to 4500 }	.3 to 4	75	8	Leads	Lugs	A	1 3/4	3 1/4	2	2 13/16	—	2 3/8	3/8	0.9
A-3824	{ S. or P.P. Plates 6000 to 10000 }	.6 to 4	75	8	Leads	Lugs	A	2	3 1/4	2	2 13/16	—	2 3/8	3/8	1.4
A-3849	{ S. Plate 1500 to 10000 }	.02 to 21	55	10	Lugs	Lugs	A	1 1/2	2 3/8	1 3/8	2 3/8	—	2	3/8	0.7
A-3880	{ P.P. Plates 4000 to 14000 }	.05 to 122	40	15	Lugs	Lugs	A	2 1/8	3 3/4	2 3/8	3 1/8	—	2 3/8	3/8	1.7
A-2855	{ P.P. Plates 4000 to 14000 }	.05 to 122	50	15	Lugs	Lugs	L	2 3/8	—	2	1 1/2	1 3/8	1 3/8	3/8 x 1/2	1.0
A-3890	{ P.P. Plates 4000 to 14000 }	.05 to 122	50	15	Leads	Leads	SC	2 1/4	2 3/4	2 11/16	1 1/2	2 3/8	2	3/8	1.5
A-3852	{ P.P. Plates 4000 to 14000 }	.05 to 122	40	18	Leads	Lugs	S	2	2 3/8	2 3/8	2 3/8	—	2	3/8	1.3
A-3870	{ P.P. Plates 4000 to 14000 }	.05 to 122	50	18	Lugs	Lugs	A	2	3 1/4	2	2 13/16	—	2 3/8	3/8	1.3
A-3830	{ P.P. Plates 3000 to 10000 }	.04 to 122	60	20	Leads	Lugs	S	2 1/8	3 1/8	2 3/8	2 13/16	—	2 1/4	3/8	1.8

OUTPUT: HIGH FIDELITY: FREQ. RESPONSE ± 1 DB 20 TO 20,000 CYCLES

A-8050	1500 C.T.	16/8	200	50	Leads	Leads	C	3 3/8	4 1/4	4 1/4	2 3/4	3 1/8	3 3/8	3/8 x 3/8	6.5
A-8060	1500 C.T.	500	200	50	Leads	Leads	C	3 3/8	4 1/4	4 1/4	2 3/4	3 1/8	3 3/8	3/8 x 3/8	6.5
A-8061	2500 C.T.	500	150	50	Leads	Leads	C	3 3/8	4 1/4	4 1/4	2 3/4	3 1/8	3 3/8	3/8 x 3/8	6.5
A-8052	3000 C.T.	16/8	175	50	Leads	Leads	C	3 3/8	4 1/4	4 1/4	2 3/4	3 1/8	3 3/8	3/8 x 3/8	6.5
A-8062	3000 C.T.	500	175	50	Leads	Leads	C	3 3/8	4 1/4	4 1/4	2 3/4	3 1/8	3 3/8	3/8 x 3/8	6.5
A-8053	5000 C.T.	16/8	150	50	Leads	Leads	C	3 3/8	4 1/4	4 1/4	2 3/4	3 1/8	3 3/8	3/8 x 3/8	6.5
A-8063	5000 C.T.	500	150	50	Leads	Leads	C	3 3/8	4 1/4	4 1/4	2 3/4	3 1/8	3 3/8	3/8 x 3/8	6.5
A-8056	6600 C.T.	16/8	125	50	Leads	Leads	C	3 3/8	4 1/4	4 1/4	2 3/4	3 1/8	3 3/8	3/8 x 3/8	6.5
A-8066	6600 C.T.	500	125	50	Leads	Leads	C	3 3/8	4 1/4	4 1/4	2 3/4	3 1/8	3 3/8	3/8 x 3/8	6.5
A-8072	7600 C.T. a	16/8/4	100	25	Leads	Leads	C	3 3/8	4 1/4	4 1/4	2 3/4	3 1/8	3 3/8	3/8 x 3/8	6.5
A-8054	9000 C.T.	16/8	100	50	Leads	Leads	C	3 3/8	4 1/4	4 1/4	2 3/4	3 1/8	3 3/8	3/8 x 3/8	6.5
A-8064	9000 C.T.	500	100	50	Leads	Leads	C	3 3/8	4 1/4	4 1/4	2 3/4	3 1/8	3 3/8	3/8 x 3/8	6.5

OUTPUT: HIGH FIDELITY: FREQ. RESPONSE ± 1 1/2 DB 30 TO 20,000 CYCLES

BO-1	15,000 b	600/150	10	.032	Lugs	Lugs	B	2 3/8	2 1/2	3 1/8	1 11/16	1 3/8	—	6-32	2.25
BO-2	20,000 C.T.	600/150	10	1.0	Lugs	Lugs	B	2 11/16	2 3/8	3 1/2	1 7/8	2	—	8-32	3.0
BO-5	10,000 C.T.	600/150/16/8/4	45	5.0	Lugs	Lugs	B	3	3 1/4	3 3/8	2 1/2	2 3/8	—	8-32	4.0
BO-6	7500 C.T.	20/8	80	20	Lugs	Lugs	B	3 3/8	3 11/16	4 1/8	2 3/8	2 3/8	—	10-32	5.75
BO-9	5000/3000 C.T.	600/150/16/8/4	75	15	Lugs	Lugs	B	3 3/8	3 11/16	4 1/8	2 3/8	2 3/8	—	10-32	6.0

TONE CONTROL CHOKE: WRITE FOR BULLETIN 456R

d	* C-2332-1	1.6 hy	For use in Pre-amplifiers for Separate Tone Control				h=2 1/2, w=2, d=2 1/8,	1.3
---	------------	--------	---	--	--	--	------------------------	-----

a. Has Screen grid taps on primary. b. Has Tertiary Winding to provide 15% inverse feedback. c. Has cathode feedback Winding.
* Available until stock is depleted

STANCOR-WILLIAMSON ULTRA-LINEAR HIGH FIDELITY AMPLIFIER

Has had wide acceptance due to its fine performance characteristics and ease of assembly.
Power output — 25 watts with less than 1% total Harmonic distortion and negligible intermodulation distortion. Frequency response — flat from 20 cycles to 40KC. Write for Bulletin 479 for complete Parts List, schematic and performance curves.

Parts Available from Stancor:

- WM-8 Chassis set — Completely punched and finished
 - PC-8412 Power Transformer
 - C-1411 Choke
 - A-8072 Output Transformer
- For Transformer ratings, refer to index.

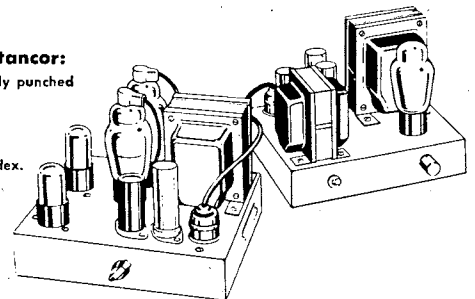

SECTION 5600

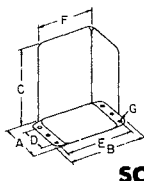
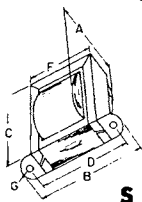
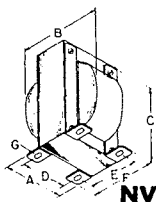

STANCOR
COMMERCIAL
audio
transformers

25 VOLT LINE TO VOICE COIL

Catalog No.	Impedance in Ohms		Audio Watts	Termination		Style	Dimensions							WT Lbs.
	Primary	Secondary		Pri	Sec		A	B	C	D	E	F	G	
A-8099	312/625/1250	8/4	2/1/5	Lugs	Lugs	A	1 3/8	2 1/8	1 1/4	1 3/4	—	1 1/2	3/8	0.3
A-8087	312/625/1250	8	2/1/5	Leads	Leads	A	1 3/8	2 3/8	1 3/8	2	—	1 3/4	3/8	0.4
A-8088	{156/312/625/1250/2500/5000}	8	{4/2/1/5/25/12}	Leads	Leads	A	1 3/8	2 7/8	1 3/8	2 3/8	—	2	3/8	0.7
A-8095	{125/250/500/1000/2000}	8/4	{5/2.5/1.25/.62/.31}	Lugs	Lugs	A	1 1/2	2 3/8	1 3/8	2	—	1 3/4	3/8	0.4
A-8096	78/156/312/625/1250	16/8/4	8/4/2/1/5	Lugs	Lugs	S	1 3/8	2 3/8	2	2	—	1 3/8	3/8	0.65
A-8097	{39/78/156/312/625/1250}	16/8/4	16/8/4/2/1/5	Lugs	Lugs	S	2 1/8	3 1/8	2 3/8	2 1/8	—	2 1/4	3/8	1.6

70.7 VOLT LINE TO VOICE COIL

A-8109	2500/5000/10000	8/4	2/1/5	Lugs	Lugs	A	1 3/8	2 1/8	1 1/4	1 3/4	—	1 1/2	3/8	0.3
A-8083	2500/5000/10000	8	2/1/5	Leads	Leads	A	1 3/8	2 3/8	1 3/8	2	—	1 3/4	3/8	0.4
A-8084	{1250/2500/5000/10000/20000/40000}	8	{4/2/1/5/25/12}	Leads	Leads	A	1 3/8	2 7/8	1 3/8	2 3/8	—	2	3/8	0.7
A-8105	{1000/2000/4000/8000/16000}	8/4	{5/2.5/1.25/.62/.31}	Lugs	Lugs	A	1 1/2	2 3/8	1 3/8	2	—	1 3/4	3/8	0.4
A-8080	{1000/1250/1667/2500/5000}	16/8	5/4/3/2/1	Lugs	Lugs	A	1 1/2	2 3/8	1 3/8	2	—	1 3/4	3/8	0.4
A-8102	{625/1250/2500/5000/10000}	16/8/4	8/4/2/1/5	Lugs	Lugs	S	1 1/2	2 3/8	2	2	—	1 3/8	3/8	0.7
A-8081	{500/555/625/715/833}	16/8	10/9/8/7/6	Lugs	Lugs	S	1 3/8	2 3/8	2	2	—	1 3/8	3/8	0.7
A-8082	{333/357/384/417/455}	16/8	{15/14/13/12/11}	Lugs	Lugs	S	1 3/8	2 7/8	2 3/8	2 3/8	—	2	3/8	1.2
A-8103	{312/625/1250/2500/5000/10000}	16/8/4	{16/8/4/2/1/5}	Lugs	Lugs	S	2 1/8	3 1/8	2 3/8	2 1/8	—	2 1/4	3/8	1.5

140 VOLT LINE TO VOICE COIL

A-8108	{4000/8000/16000/32000}	8/4	{5/2.5/1.25/.62}	Lugs	Lugs	A	1 1/2	2 3/8	1 3/8	2	—	1 3/4	3/8	0.4
A-8106	{2500/5000/10000/20000}	16/8/4	8/4/2/1	Lugs	Lugs	S	1 3/8	2 3/8	2	2	—	1 3/8	3/8	0.7
A-8107	{1250/2500/5000/10000/20000}	16/8/4	16/8/4/2/1	Lugs	Lugs	S	2	3 1/8	2 3/8	2 1/8	—	2 1/4	3/8	1.8

LINE TO VOICE COIL

A-8101	500	6-8/3.2	5	Lugs	Leads	A	1 1/2	2 3/8	1 3/8	2	—	1 3/4	3/8	0.4
A-3883	500	15/8/6/4	25	Lugs	Lugs	S	1 3/4	2 3/8	2 3/8	2 3/8	—	2	3/8	1.1
A-3882	500/333/250	15/8/4	25	Lugs	Lugs	C	2 1/2	2 3/4	3 1/2	2	1 3/4	2 3/8	3/8 x 3/8	2.4
A-3818	1500/1000/500	15/8/4	25	Lugs	Lugs	S	2 1/2	3 3/8	3 3/8	3 3/8	—	2 3/8	3/8	2.2
A-7947	{2000/1500/1000/500}	6-8/3.2	8	Lugs	Lugs	A	1 3/8	2 7/8	1 3/8	2 3/8	—	2	3/8	0.7
A-7949	{2000/1500/1000/500}	6-8/3.2	12	Lugs	Lugs	S	1 3/4	2 7/8	2 3/8	2 3/8	—	2	3/8	1.1
A-3820	{2000/1500/1000/500}	15/8/4	40	Lugs	Lugs	C	3 3/8	3 3/4	4 1/2	2 3/4	2 3/8	3 3/8	3/8 x 3/8	5.0
A-8104	{3000/2000/1500/1000/500}	16/8/4	10	Lugs	Lugs	S	1 3/4	2 7/8	2 3/8	2 3/8	—	2	3/8	1.5
A-3837	500	.06 to 48	15	Lugs	Lugs	S	2	2 7/8	2 3/8	2 3/8	—	2	3/8	1.4

LINE TO LINE

A-4350	{500/333/200/125/50}	{500/333/200/125/50}	10	Lugs	Lugs	A	1 7/8	3 1/4	2	2 1/8	—	2 3/8	3/8	1.0
A-4407	{500/333/200/125/50}	{500/333/200/125/50}	20	Lugs	Lugs	C	2 1/2	2 3/4	3 3/8	2	1 3/4	2 3/8	3/8 x 3/8	2.4
A-3838	500	{250/166/125/100/84}	30	Lugs	Lugs	NV	2 1/2	2 3/8	3 3/8	2	2	2 1/8	3/8 x 3/8	2.3

* Available until stock is depleted

The following table lists various amplifier power outputs with the corresponding impedance tap on the output transformer which will supply these three basic line voltages:

POWER OUTPUT WATTS	IMPEDANCE FOR 140 VOLT LINE	IMPEDANCE FOR 70.7 VOLT LINE	IMPEDANCE FOR 25 VOLT LINE
	OHMS	OHMS	OHMS
5	4,000	1,000	125
10	2,000	500	62.5
15	3,333	333	41.7
20	1,000	250	31.2
25	800	200	25
30	666	166	21
40	500	125	15.6
50	400	100	12.5
60	333	83	10.5
80	250	62.5	7.8
100	200	50	6.3

For power ratings not shown in this table, use the following formula:

$$Z = \frac{E^2}{W}$$

$$Z = \text{Ohms}$$

$$E = \text{Volts}$$

$$W = \text{Watts Output}$$

Impedance
Tap for:

$$140 \text{ volt line} = \frac{20,000}{W}$$

$$70.7 \text{ volt line} = \frac{5,000}{W}$$

$$25 \text{ volt line} = \frac{625}{W}$$

SECTION 5600

STANCOR
COMMERCIAL
audio
transformers

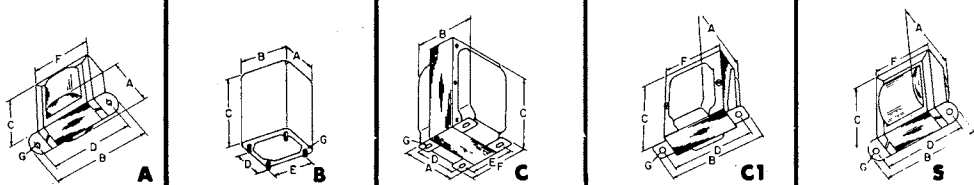

FOR INTERCOMS AND TRANSCEIVERS

Catalog No.	Application	Impedance in Ohms		Audio Watta	Termination		Style	Dimensions							WT. Lbs.
		Primary	Sec.		Pri	Sec		A	B	C	D	E	F	G	
A-4744	Intercom Input	4	25,000	—	Leads	Leads	VE	1 1/2	2 3/8	1 3/8	2	—	1 3/4	3/8	0.5
A-4748	Intercom Input	45 or 50	50,000	—	Leads	Leads	A	1 3/8	2 1/2	1 1/4	1 3/4	—	1 1/2	3/8	0.4
A-8090	Line to Voice Coil	45 or 50	6-8/3-4	3	Lugs	Lugs	A	1 1/2	2 3/8	1 3/8	2	—	1 3/4	3/8	0.5
A-8091	Line to Voice Coil	45 or 50	6-8/3-4	8	Lugs	Lugs	A	1 1/2	2 3/8	1 3/8	2 3/8	—	2	3/8	0.7
A-3817	Transceiver Modulation and Output	5000 / 6750	4	10	Leads	Leads	S	2	2 3/8	2	2	—	1 3/8	3/8	0.7
A-3833	Transceiver Input Mic. or Plate to Grid	@ 50Madc 5000/200	60,000	5	Leads	Leads	A	1 3/8	2 3/8	1 3/8	2 3/8	—	2	3/8	0.7
A-3836	Transceiver Output	10,000	2000/50	5	Leads	Leads	A	1 1/8	2 3/8	1 3/8	2 3/8	—	2	3/8	0.7
A-4749	Telephone patch Circuit	10,000	500	—	Leads	Leads	TD	1 1/2	2 1/4	1 3/8	—	1 1/8	1 1/2	3/8	1.0

MICROPHONE, PICKUP OR LINE TO GRID

Catalog No.	Application	Impedance in Ohms		Ratio	Termination		Style	Dimensions							WT. Lbs.
		Primary	Secondary		Pri	Sec		A	B	C	D	E	F	G	
A-4705	{ S.B. Mic. to S. Grid }	200/70	80,000	1:20	Leads	Leads	A	1 3/8	2 3/8	1 3/8	2	—	1 3/4	3/8	0.5
A-4706	{ S.B. Mic. to S. Grid }	100	60,000	1:24.5	Leads	Leads	A	1 1/2	2 3/8	1 3/8	2	—	1 3/4	3/8	0.5
A-4708	{ D.B. Mic. to S. Grid }	200 C.T.	57,000	1:17	Lugs	Lugs	S	1 1/2	2 3/8	2	2	—	1 5/8	3/8	0.7
A-4742	{ S.B. Mic. to P.P. Grids }	100	400,000 C.T.	1:64	Leads	Leads	S	1 3/8	2 3/8	2 3/8	2 3/8	—	2	3/8	1.2
A-4747	{ S.B. Mic. or Line to S. Grid }	70	1,300,000	1:137	Leads	Leads	VE	1 1/4	1 13/16	1 3/8	1 1/2	—	1 1/4	3/8	0.5

MICROPHONE, PICKUP OR LINE TO GRID

Catalog No.	Application	Impedance in Ohms		Ratio	Termination		Style	Dimensions							WT. Lbs.
		Primary	Secondary		Pri	Sec		A	B	C	D	E	F	G	
A-4351	{ Mic. or Line to S. Grid }	500/333/200/125/50	89,000	1:13.3	Leads	Leads	SC	2 1/4	2 11/16	2 11/16	1 1/2	2 3/8	2	3/8	1.4
A-4352	{ Mic. or Line to P.P. Grids }	500/333/200/125/50	89,000 C.T.	1:13.3	Lugs	Lugs	A	1 3/8	3 1/4	2	2 13/16	—	2 3/8	3/8	1.0
A-4709	{ Dyn. mic. or Pickup to S. Grid }	30/15/8/4	106,000	1:60	Leads	Leads	SC	2 1/4	2 11/16	2 11/16	1 1/2	2 3/8	2	3/8	1.7
A-4778	Line to S. Grid	600/500 C.T.	240,000	1:20	Leads	Leads	C1	1 13/16	2 3/8	2 1/4	2 3/8	—	2	3/8	1.0
A-4779	{ Line to S. or P.P. Grids }	600/500 C.T.	60,000 C.T.	1:10	Leads	Leads	A	1 3/8	2 3/8	1 3/8	2	—	1 3/4	3/8	0.5
A-4780	{ Line to P.P. Grids }	600/500 C.T.	240,000 C.T.	1:20	Leads	Leads	VE	1 11/16	3 1/4	2	2 13/16	—	2 3/8	3/8	1.0
CIC-1	{ Line to P.P. Grids }	600/150	100,000 C.T.	1:13	Leads	Leads	TD	1 1/2	2 1/4	2 1/8	—	1 13/16	1 1/2	3/8	0.75
CIS-1	{ Line to P.P. Grids }	600/150	100,000 C.T.	1:13	Lugs	Lugs	TD	1 1/2	2 1/4	2 1/8	—	1 13/16	1 1/2	3/8	0.75
* CIS-2	{ S.B. or D.B. Mic. to P.P. Grids }	125/50	125,000	1:32	Lugs	Lugs	TD	1 1/2	2 1/4	2 1/8	—	1 13/16	1 1/2	3/8	0.75

* Available until stock is depleted

SECTION 5600

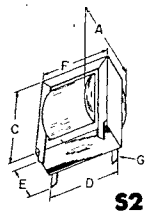

S2

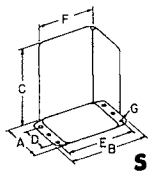

SC

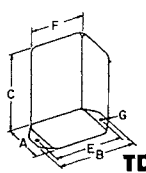

TD

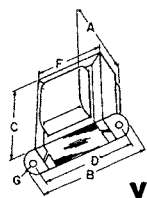

VE

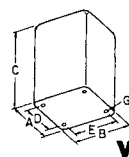

WF

STANCOR
COMMERCIAL
audio
transformers

INPUT: HIGH FIDELITY—SHIELDED—FREQ. RESPONSE ± 1 DB 30 TO 15,000 CYCLES

Catalog No.	Application	Impedance in Ohms		Audio Level	Termination		Style	Dimensions							WT. Lbs.
		Primary	Secondary		Pri	Sec		A	B	C	D	E	F	G	
BI-1	{Line to S. or P.P. Grids}	600/150 C.T.	50,000 C.T.	+15 dbm	Lugs	Lugs	B	2 1/2	2 1/4	2 1/16	1 3/8	1 1/8	—	6-32	1.5
BI-2	{Line to S. or P.P. Grids}	600/150 C.T.	50,000 C.T.	+15 dbm	Lugs	Lugs	B	2 1/2	2 1/4	2 1/16	1 3/8	1 1/8	—	6-32	1.5
BI-3	{Line Bridging to P.P. Grids}	800/6000 C.T.	50,000 C.T.	+15 dbm	Lugs	Lugs	B	2 1/2	2 1/4	2 1/16	1 3/8	1 1/8	—	6-32	1.5
BI-4	Line to Line	600/150 C.T.	600/150 C.T.	+15 dbm	Lugs	Lugs	B	2 1/2	2 1/4	2 1/16	1 3/8	1 1/8	—	6-32	1.5
BI-5	Line to Line	600/150 C.T.	600/150 C.T.	+30 dbm	Lugs	Lugs	B	3	3 3/4	3 3/8	2 1/2	2 3/8	—	8-32	3.25
BI-6	{P.P. Plates to S. or P.P. Grids}	20,000 C.T.	50,000 C.T.	+15 dbm	Lugs	Lugs	B	2 1/2	2 1/4	2 1/16	1 3/8	1 1/8	—	6-32	1.5
BI-7	{Mic., Pickup or Line to Grid}	{600/250/150/50}	50,000 C.T.	+15 dbm	Lugs	Lugs	B	2 1/2	2 1/4	2 1/16	1 3/8	1 1/8	—	6-32	1.5

INPUT: WF SERIES—SHIELDED—FREQ. RESPONSE ± 2 DB 30 TO 20,000 CYCLES

WF-20	{Mic., pickup or Line to Grid}	{500-600/333/250/200/125-.50/50}	50,000 C.T.	+7 db	Lugs	Lugs	WF	1 1/2	1 1/2	2	1 3/8	1 3/8	—	4-40	0.6
WF-21	{Mic., pickup or Line to Grid}	500/200/50	50,000 C.T.	+7 db	Lugs	Lugs	WFa	1 1/2	1 1/2	2	1 3/8	1 3/8	—	4-40	0.6
WF-22	{Mic., pickup or Line to Grid}	{500-600/333/250/200/125-150/50}	80,000 C.T.	+7 db	Lugs	Lugs	WF	1 1/2	1 1/2	2	1 3/8	1 3/8	—	4-40	0.6
WF-28	{S. or P.P. Plates to S. or P.P. Grids}	15,000 C.T.	80,000 C.T.	+7 db	Lugs	Lugs	WF	1 1/2	1 1/2	2	1 3/8	1 3/8	—	4-40	0.6
WF-30	{Mixer, Mic., pickup, or Line to Line}	{500-600/333/250/200/125-150/50}	{500-600/333/250/200/125-150/50}	+7 db	Lugs	Lugs	WF	1 1/2	1 1/2	2	1 3/8	1 3/8	—	4-40	0.6
WF-35	S. Plate to Line	15,000	{500-600/333/250/200/125-150/50}	+7 db	Lugs	Lugs	WF	1 1/2	1 1/2	2	1 3/8	1 3/8	—	4-40	0.6
WF-36	{PP. Plates to Line}	30,000 C.T.	{500-600/333/250/200/125-150/50}	+7 db	Lugs	Lugs	WF	1 1/2	1 1/2	2	1 3/8	1 3/8	—	4-40	0.6

INTERSTAGE: SINGLE PLATE (7,000 TO 20,000 OHM) TO SINGLE GRID

Catalog No.	Ratio	Max. Pri DCMA	Termination		Style	Dimensions							WT. Lbs.
			Pri	Sec		A	B	C	D	E	F	G	
A-53	1:3	10	Leads	Leads	A	1 3/8	2 3/8	1 3/8	2	—	1 3/8	3/8	0.5

INTERSTAGE: SINGLE PLATE (7,000 TO 15,000 OHM) TO PUSH PULL GRIDS

A-52C	1:2	10	Leads	Leads	A	1 1/2	2 3/8	1 3/8	2	—	1 3/8	3/8	0.4
A-62C	1:2	10	Leads	Leads	A	1 3/8	2 7/8	1 3/8	2 3/8	—	2	3/8	0.7
A-4745	1:2	10	Leads	Leads	SC	2 1/4	2 1/16	2 1/16	1 1/2	2 3/8	2	3/8	1.7
A-53C	1:3	10	Leads	Leads	A	1 3/8	2 3/8	1 3/8	2	—	1 3/8	3/8	0.5
A-63C	1:3	10	Leads	Leads	A	1 1/2	2 7/8	1 3/8	2 3/8	—	2	3/8	0.7
A-73C	1:3	10	Leads	Leads	A	1 3/8	3 1/4	2	2 1/16	—	2 3/8	3/8	1.0
A-4719	1:3	10	Leads	Leads	SC	2 1/4	2 1/16	2 1/16	1 1/2	2 3/8	2	3/8	1.7
A-64C	1:4	10	Leads	Leads	S	1 3/8	2 3/8	2	2	—	1 3/8	3/8	0.7

INTERSTAGE: PUSH-PULL PLATES (7,000 TO 15,000 OHMS) TO PUSH-PULL GRIDS

Catalog No.	Ratio	Max. Pri DCMA	Termination		Style	Dimensions							WT. Lbs.
			Pri	Sec		A	B	C	D	E	F	G	
A-4711	1:1	10	Leads	Leads	A	1 3/8	2 3/8	1 3/8	2 3/8	—	2	3/8	0.7
A-4208	1:1.4	15	Leads	Leads	C	2 1/2	2 3/4	3 3/8	2	1 3/8	2 3/8	3/8 x 3/8	2.5

INTERSTAGE: MULTI-PURPOSE (7,000 TO 15,000 OHM PLATES)

A-4774	1:3	10	Leads	Leads	S	1 3/8	2 3/8	2 3/8	2 3/8	—	2	3/8	1.2
A-4773	1:3	10	Leads	Leads	SC	2 1/4	2 1/16	2 1/16	1 1/2	2 3/8	2	3/8	1.7

Proper Connections will provide Ratios of 1:1, 1:3, or 1:6 May be Used for Single or Push-Pull Plates to Single or Push-Pull Grids

* Available until stock is depleted

a. Has multiple infernal magnetic shields.

SECTION 5600

STANCOR
COMMERCIAL
audio
transformers

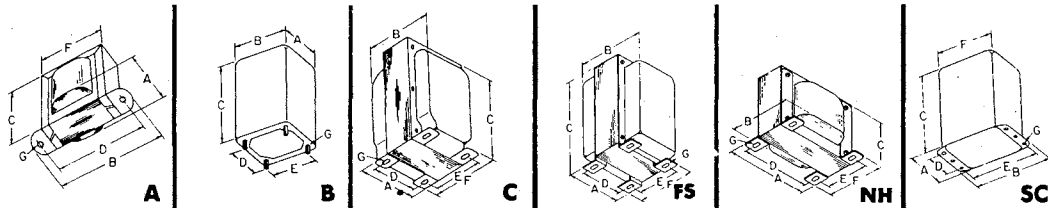

DRIVER: SINGLE PLATE TO PUSH-PULL GRIDS

a	Catalog No.	Pri. Impedance in Ohms	Max Pri DCMA	Ratio Pri: 1/2 Sec	Audio Watts	Termination		Style	Dimensions							WT. Lbs.
						Pri	Sec		A	B	C	D	E	F	G	
	A-4713	10,000	30	2:1	5	Leads	Leads	A	1 3/8	2 3/8	1 3/8	2 3/8	—	2	3/8	0.7
	A-4752	10,000	40	2/1.5/1:1	10	Leads	Leads	A	1 3/8	3 3/8	2	2 13/16	—	2 3/8	3/8	1.2
	A-4292	10,000	20	2.5:1	5	Leads	Leads	A	1 1/2	2 1/2	1 1/2	2 3/8	—	2	3/8	0.7
	A-4723	10,000	30	3:1	5	Leads	Leads	A	1 3/8	2 3/8	1 3/8	2 3/8	—	2	3/8	0.7
	A-4702	1500 to 5000	80	5:1	20	Leads	Leads	C	2 1/2	2 3/4	3 3/8	2	1 3/4	2 3/8	3/8 x 3/8	2.5

DRIVER: PUSH-PULL PLATES TO PUSH-PULL GRIDS

b	Catalog No.	Pri. Impedance in Ohms	Max Pri DCMA	Ratio Pri: 1/2 Sec	Audio Watts	Termination Pri	Termination Sec	Style	A	B	C	D	E	F	G	WT. Lbs.
	A-4208	10,000 to 30,000 C.T.	15	2.8:1	15	Leads	Leads	C	2 1/2	2 3/4	3 3/8	2	1 3/4	2 3/8	3/8 x 3/8	2.5
	A-4212	1500 to 5000 C.T.	50	3.2:1	20	Leads	Leads	C	2 1/2	2 3/4	3 3/8	2	1 3/4	2 3/8	3/8 x 3/8	2.5

DRIVER: "POLY-PEDANCE"—MULTIPLE TAPS OFFER A WIDE RANGE OF RATIO SELECTION

b	Catalog No.	Pri. Impedance in Ohms	Max Pri DCMA	Ratio Pri: 1/2 Sec	Audio Watts	Termination Pri	Termination Sec	Style	A	B	C	D	E	F	G	WT. Lbs.
	A-4761	5000 to 15,000 C.T.	100	{ 2.4/2.2/2.1/1.8/ 1.6/1.4/1.25:1 }	15	Leads	Leads	C	2 1/2	3 3/8	3 3/8	2	2 1/8	2 3/8	3/8 x 3/8	3.4
	A-4762	5000 to 15,000 C.T.	100	{ 5/4.5/4/3.4/3.2 3.1/2.6:1 }	15	Leads	Leads	C	2 1/2	2 3/4	3 3/8	2	1 3/4	2 3/8	3/8 x 3/8	2.7
	A-4765	500	—	{ 1.33/1.2/1/8/7/ .5/45/4/36 1.32:1 }	15	Leads	Leads	C	2 1/2	2 3/4	3 3/8	2	1 3/4	2 3/8	3/8 x 3/8	3.2

DRIVER: BROADCAST FREQ. RESPONSE ± 1 DB 30 TO 15,000 CYCLES

c	Catalog No.	Pri. Impedance in Ohms	Max Pri DCMA	Ratio Pri: 1/2 Sec	Audio Watts	Termination Pri	Termination Sec	Style	A	B	C	D	E	F	G	WT. Lbs.
	ad-1	3000 C.T.	100	3.5:1	10	Terms	Terms	B	3 3/4	3 3/8	4 3/8	2 3/8	2 3/8	—	10-32	6.5

MODULATION

c	Catalog No.	Impedance in Ohms		Max. Sec DCMA	Audio Watts	Termination		Style	Dimensions							WT. Lbs.
		Primary	Secondary			Pri	Sec		A	B	C	D	E	F	G	
	A-3812	10,000 C.T.	4000	50	5	Leads	Leads	A	1 3/8	2 3/8	1 3/8	2 3/8	—	2	3/8	0.7
	A-3871	4500	8500	50	10	Leads	Leads	SC	2 1/4	2 11/16	2 11/16	1 1/2	2 3/8	2	3/8	1.4
	A-3845	10,000 C.T.	8000/6500/5000/3000	100	25	Leads	Leads	C	2 1/2	2 3/4	3 3/8	2	1 3/8	2 1/2	3/8 x 3/8	2.8
	A-3808	3800/3300 C.T.	{ 10 000/7500/5000/ 4000 }	170	60	Lugs	Lugs	C	3 3/4	4	4 11/16	3	2 13/16	3 3/8	3/8 x 3/8	7.7
	A-3829	9000/6900 C.T.	6250/5000/4000/3300	300	175	Lugs	Lugs	C	3 3/4	5	4 11/16	3	3 13/16	4 3/8	3/8 x 3/8	11.4

MODULATION: "POLYPEDANCE"—MULTIPLE TAPS OFFER A WIDE RANGE OF IMPEDANCE MATCH

d	Catalog No.	Pri. Impedance in Ohms	Max Pri DCMA	Ratio Pri: 1/2 Sec	Audio Watts	Termination Pri	Termination Sec	Style	A	B	C	D	E	F	G	WT. Lbs.
	A-3891	2000 to 20,000	2000 to 20,000	100	15	Lugs	Lugs	C	2 1/2	2 3/4	3 3/8	2	1 3/4	2 3/8	3/8 x 3/8	2.5
	A-3892	2000 to 20,000	2000 to 20,000	150	30	Lugs	Lugs	C	3 3/4	3 3/4	3 3/8	2 1/2	2 3/8	3	3/8 x 3/8	4.3
	A-3893	2000 to 20,000	2000 to 20,000	180	60	Lugs	Lugs	C	3 3/4	4	3 3/8	2 1/2	2 11/16	3 1/2	3/8 x 3/8	6.2
	A-3894	2000 to 20,000	2000 to 20,000	225	125	Lugs	Lugs	C	3 3/4	4 1/2	4 11/16	3	3 3/8	4 3/8	3/8 x 3/8	9.4
	A-3898	2000 to 20,000	2000 to 20,000	260	300	Terms	Terms	FS	5 3/4	7 3/8	8 1/8	4 3/8	4 3/4	5 3/4	3/8 x 1/2	3.8
	A-3899	2000 to 20,000	2000 to 20,000	500	600	Terms	Terms	FS	7 1/4	10 1/4	9 3/8	6	5 3/8	6 3/8	3/8 x 3/8	7.0

MODULATION: BROADCAST FREQ. RESPONSE ± 1 DB 30 TO 15,000 CYCLES

e	Catalog No.	Pri. Impedance in Ohms	Max Pri DCMA	Ratio Pri: 1/2 Sec	Audio Watts	Termination Pri	Termination Sec	Style	A	B	C	D	E	F	G	WT. Lbs.
	BM-1	7500 C.T.	5000	0	125	Terms	Terms	SC	6 3/8	6 1/2	7 1/8	4 1/4	6	5 1/4	1/4	25

MODULATION REACTOR:

e	Catalog No.	Inductance in Henries	DCMA	Insul. Test RMS Volts	Termination	Style	Dimensions							WT. Lbs.
							A	B	C	D	E	F	G	
	BR-1	65	250	7500	Terms	SC	7 1/8	7 7/8	8 1/8	5	7	5 1/4	1/4	41

SPLATTER CHOKES: FOR HIGH LEVEL "CLIPPER" FILTERS

f	Catalog No.	Pri. Impedance in Ohms	Max Pri DCMA	Ratio Pri: 1/2 Sec	Audio Watts	Termination	Style	A	B	C	D	E	F	G	WT. Lbs.
	C-2317	.048 to 0.9	300	5000	Lugs	NH	3	3	2 3/8	2 1/2	2	2 3/8	3/8 x 3/8	2.3	

BAND PASS FILTER: 200 TO 3,000 CYCLES

g	Catalog No.	Pri. Impedance in Ohms	Max Pri DCMA	Ratio Pri: 1/2 Sec	Audio Watts	Termination	Style	A	B	C	D	E	F	G	WT. Lbs.
	* C-2340	10,000	500 or 100,000	10 V. output	Lugs	Lugs	SC	2 1/4	2 11/16	2 11/16	1 1/2	2 3/8	2	3/8	0.6

FOR TRANSISTOR MOBILE MODULATOR (WRITE FOR BULLETIN 545 FOR CIRCUIT)

h	Catalog No.	Application	Impedance in Ohms		Max Pri DCMA	Audio Watts	Termination		Style	Dimensions							WT. Lbs.
			Pri	Sec			Pri	Sec		A	B	C	D	E	F	G	
	TA-15	Input	50 to 100	10	50	.005	Leads	Leads	A	1	1 3/8	1 3/8	1 3/8	—	1 1/8	1/8	0.15
	TA-16	Driver	20	36 C.T.	400	1.0	Leads	Leads	A	1 1/8	2 1/8	1 1/4	1 3/8	—	1 1/2	3/8	0.20
	TA-17	Modulation	8 C.T.	{ 7500/5000/ @ 120 Ma }	—	35.0	Leads	Leads	C	2 1/2	3	3 3/8	2	2	2 3/8	3/8 x 3/8	3.0

* Available until stock is depleted

SECTION 5600

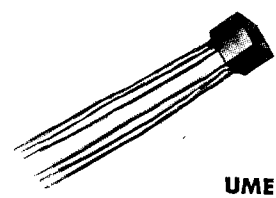
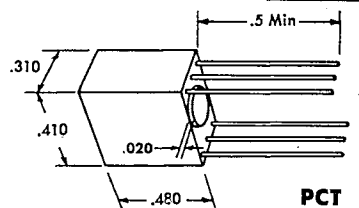
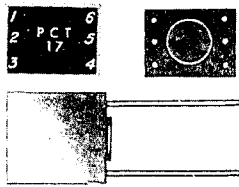

STANCOR
COMMERCIAL
miniature
audio

POLYCHROMATRANS With Multiples of 0.1" Grid Spacing for Printed Circuits.

COLOR CODING by application to assure immediate and positive transformer identification.
RECTANGULAR SHAPE allows the utmost utilization of space and stacking in limited area.

PROTECTIVE STAND-OFF prevents solder flow-back and maximum lead exit protection.
SPACED LEADS of fatigue resistant gold plated nickel-iron alloy are .020" in diameter, 9/16" long and have multiples of 0.1" grid spacing for printed circuit application.

	Catalog No.	Power Level in M.W.	Application	Color Application Guide	Matching Impedance		Max. MA. D.C. Unbal. in Pri.	D.C. Resistance		Overall Turns Ratio	RMS Test Volts
					Primary	Secondary		Primary	Secondary		
a	PCT-14	15	Input	Brown	200,000 CT	1,000 CT	0	6300	130	14.1:1	500
	PCT-15	35	Input	Brown	50,000 CT	1,000 CT	0	4600	90	7.1:1	500
	PCT-16	.5	Input	Brown	250,000	250,000	0	3500	4500	1:1	500
	PCT-17	15	Input	Brown	200,000	1,000	0	6300	130	14.1:1	500
	PCT-21	55	Interstage	Red	25,000	1,000	.5	2000	140	5:1	500
	PCT-23	55	Interstage	Red	25,000 CT	1,000 CT	.5	2000	140	5:1	500
	PCT-25	75	Interstage	Red	10,000 CT	1,500 CT	1	1250	360	2.57:1	500
	PCT-30	75	Driver	Orange	10,000 CT	1,200 CT	1	1250	240	2.88:1	500
	PCT-31	75	Driver	Orange	10,000 CT	2,000 CT	1	1250	400	2.24:1	500
	PCT-39	75	Driver	Orange	10,000 CT	500 CT	1	1250	100	4.47:1	500
	PCT-43	75	Output	Yellow	1,000	50	3	175	9.5	4.4:1	500
	PCT-54	75	Output	Yellow	600 CT	12	4.5	92	3.6	7.06:1	500
PCT-60	75	Output	Yellow	500 CT	600	3	80	118	1.1:1	500	
PCT-61	75	Output	Yellow	900 CT	600	4	125	115	1.22:1	500	
PCT-62	75	Output	Yellow	1,500 CT	600	3	200	110	1.58:1	500	
b	PCT-70	75	Output	Yellow	320 CT	3.2	6	52	.9	10:1	500
	PCT-71	75	Output	Yellow	600 CT	3.2	4.5	84	1	13.6:1	500
	PCT-76	75	Output Isolation	Green	10,000 CT	10,000 CT	1	1100	1400	1:1	500
	PCT-77	75	Output Isolation	Green	600 CT	600 CT	3	85	110	1:1	500
	PCT-116	—	Choke	Blue	6 HYS.	—	2	1800	—	—	500
	PCT-117	—	Choke	Blue	1.25 HYS.	—	2	200	—	—	500
	PCT-118	—	Choke	Blue	3.5 HYS.	—	2	1200	—	—	500
	PCT-128	—	Choke	Blue	.3 HY.	—	4	50	—	—	500

SPCT-10 Magnetic Alloy Shield-fits all PCT Transformers.

ULTRA MINIATURE ENCAPSULATED TRANSFORMERS Size .312" x .400" x .426". Insulation Test — 100 Volts

	Catalog No.	Application	Pri. Res.	Pri. Imp. in Ohms	D.C. MA in Pri.	Sec. Imp. in Ohms	Sec. Res.	Mw. Level
c	UME-11	interstage	1500	30,000	.5	1200	185	50
	UME-12	output	120	600	3	60	13	100
	UME-13	output	250	1200	3	60	17	100
	UME-14	output	70	600	3	3.2	.7	100
	UME-15	output	170	1200	2	3.2	.75	100
	UME-16	output	1200	10,000	1	3.2	.7	100
	UME-17	input	7500	200,000	0	1000	260	25
	UME-18	reactor	1000	3 hy @ 2 MADC	2	—	—	—
	UME-19	output or driver	1100	12,500 CT	1	600 CT	45	100
	UME-20	driver	1000	12,500	1	1500 CT	100	100
d	UME-21	driver	1100	12,500	1	2500 CT	160	100
	UME-22	single or PP output	25	200 CT	10	16	3	500
	UME-23	single or PP output	35	400 CT	7	16	2.5	500
	UME-24	single or PP output	75	800 CT	5	16	2	500
	UME-25	single or PP output	85	1070 CT	4	16	2	500
	UME-26	single or PP output	120	1330 CT	3.5	16	2	500
	UME-27	single or PP output	225	2000 CT	3	16	2.5	500
	UME-28	single or PP output	750	10,000 CT	1	16	2.5	500
	UME-29	output	35	300 CT	7	600	110	500
	UME-30	output	60	500 CT	5.5	600	110	500
UME-31	output	105	900 CT	4	600	110	500	
UME-32	output	200	1500 CT	3	600	120	500	
UME-33	interstage	1500	30,000 CT	.5	1200 CT	175	100	
UME-34	input	6500	200,000 CT	0	1000 CT	250	25	
UME-35	interstage	1000	12,000 CT	1	1800 CT	115	100	
UME-36	reactor	2600	6 hy @ 2 MADC	2	—	—	—	
UME-37	reactor	190	1 hy @ 2 MADC	2	—	—	—	
UME-38	reactor	1800	12 hy @ 0 DC	0	—	—	—	
UME-39	reactor	2700	20 hy @ 0 DC	0	—	—	—	

Typical Response Curves

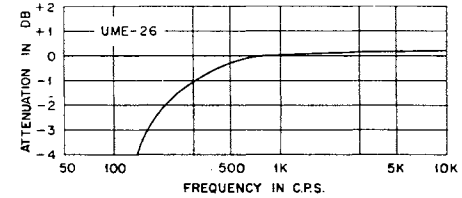
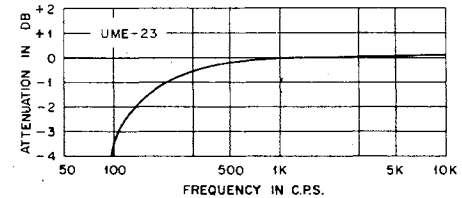
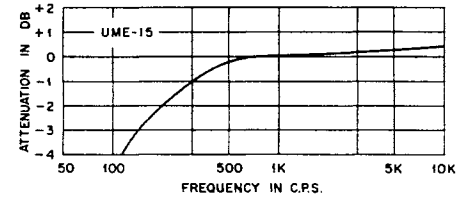

STANCOR

COMMERCIAL
transistor
transformers

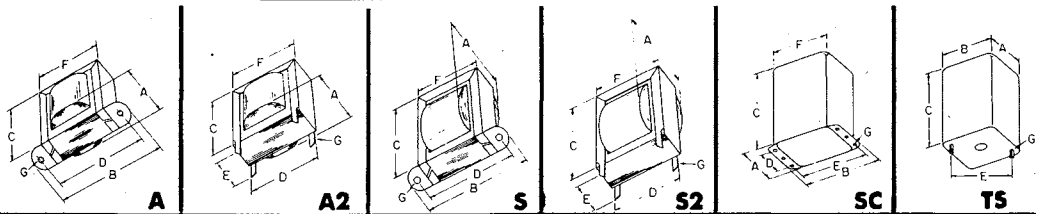

FOR AUDIO APPLICATIONS: ALL UNITS TERMINATE WITH LEADS

Catalog No.	Application	Impedance in Ohms		Max. Pri. DCMA	Audio Watts	D.C. Res. in Ohms		Style	Dimensions							WT Lbs.	
		Pri.	Sec.			Pri	Sec		A	B	C	D	E	F	G		
TA-1	Input	600 C.T.	10	20	.05	42	0.8	A	1	1 1/8	1 3/8	1 3/8	1 3/8	---	1 1/8	1/8	.07
TA-2	Interstage	100 C.T.	10 C.T.	100	.25	4.3	0.8	A	1 1/2	2 1/8	1 1/4	1 3/4	---	1 1/2	3/16	.25	
TA-3	Interstage	100	1000 C.T.	100	.25	5.8	4.5	A	1 1/2	2 3/8	1 3/8	2	---	1 3/4	3/16	.35	
TA-4	Interstage	500 C.T.	5000 C.T.	12	.03	37	250	A	1 5/8	2 3/8	1 3/8	2	---	1 3/4	3/16	.35	
TA-5	Driver	1000	200 C.T.	10	.05	400	115	A	5/8	1 1/8	1 1/8	1 1/8	---	1 3/8	1/8	.05	
TA-6	Driver	2000	200 C.T.	5	.05	720	115	A	5/8	1 1/8	1 1/8	1 1/8	---	1 3/8	1/8	.05	
TA-7	Driver	100	100 C.T.	100	.5	12	12	A	1 3/8	2 3/8	1 3/8	2 3/8	---	2	3/16	.60	
TA-8	Output	9800	15	2	.05	640	2	A	5/8	1 1/8	1 1/8	1 1/8	---	1 3/8	1/8	.05	
TA-9	Output	1000	16/8/4	10	.2	180	3.5	A	3/8	1 1/8	1 3/8	1 3/8	---	1 1/8	1/8	.07	
TA-10	Output	2000 C.T.	16/8/4	---	.2	250	4	A	7/8	1 3/8	1 3/8	1 3/8	---	1 1/8	1/8	.08	
TA-11	Output	48 C.T.	16/8	275	5	5	1.5	A	1 7/8	3 1/4	2	2 13/16	---	2 3/8	3/16	1.0	
TA-12	Output	20 C.T.	8	500	10	.55	.35	A	1 3/8	2 3/8	1 3/8	2	---	1 3/4	3/16	.45	
TA-13	Driver	200 C.T.	400 C.T.	10	.6	4	7	SC	2 1/4	2 11/16	2 3/16	1 1/2	2 3/8	2	3/16	1.5	
TA-14	Output	24 C.T.	16/4	200	10	2	1.2	SC	3 11/16	4 1/16	4 3/16	2 3/4	3 3/8	3 3/4	3/16	6.6	
TA-56	Output	48 C.T.	16/8/3.2	550	10	3.6	1.4	S†	1 3/4	2 3/8	2 3/8	2 3/8	---	2	3/16	.90	
TA-57	Output	100 C.T.	16/8/3.2	500	10	6.6	1.5	S	1 7/8	2 3/8	2 3/8	2 3/8	---	2	3/16	.95	
TA-58	Driver	100	200 C.T.	200	.5	6.5	15.5	A	1 1/4	2 1/8	1 1/4	1 3/4	---	1 1/2	3/16	.20	
TA-59	Driver	500 C.T.	200 C.T.	50	.5	36.5	15.5	A	1 3/8	2 1/8	1 1/4	1 3/4	---	1 1/2	3/16	.20	
TA-60	Output	125 C.T.	8	50	1.5	7.5	0.9	TS	1 5/8	1 1/8	1 1/8	---	1 3/8	---	6-32	.30	
TA-61	Driver	*	*	---	---	1.8	1.8	S	1 1/2	2 3/8	2	2	---	1 3/8	3/16	.60	
TA-62	Output	25	4	400	4	1.5	0.4	A	1 5/8	2 3/8	1 3/8	2 3/8	---	2	3/16	.60	

FOR TRANSISTORIZED AUTO RADIOS

TA-48	Interstage	1000	40	10	2	136	2.8	S2	1 1/4	---	1 3/4	1 3/8	7/16	1 1/8	1/8	.35
TA-49	Output	30 C.T.	4	50	10	2.2	0.3	S	1 1/2	2 3/8	2 3/8	2 3/8	---	2	3/16	.80
TA-50	Output	9	4	920	10	1.5	1.0	A2	1 3/8	---	2	2	3/4	2 3/8	3/16	1.0
TA-51	Interstage	1000	10	10	2	170	1.0	S2	1 1/4	---	1 3/4	1 3/8	7/16	1 1/8	1/8	.35

*Trifilar Wound-Ratio 1:1:1. †Has Lugs on Secondary.

TYPICAL FREQUENCY RESPONSE CURVES

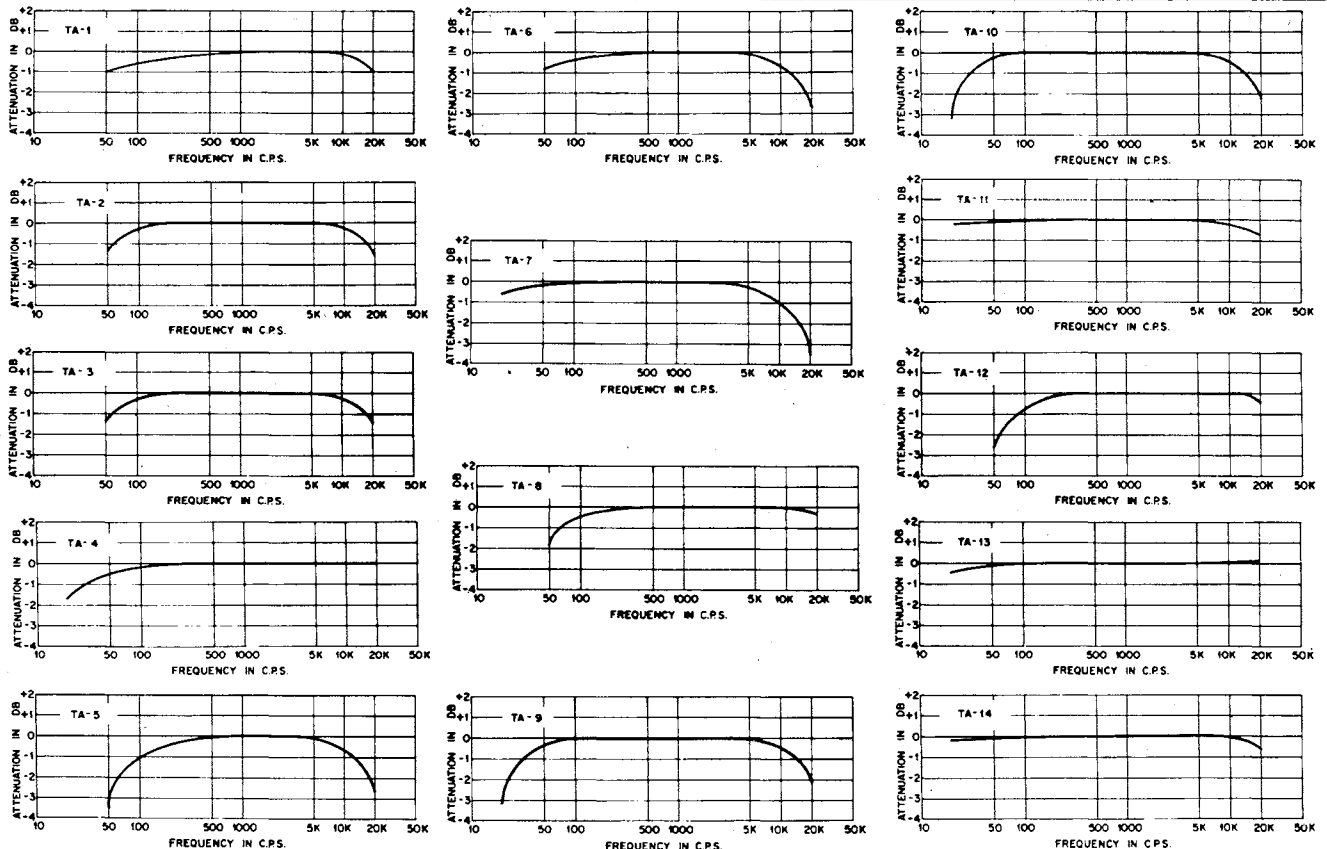

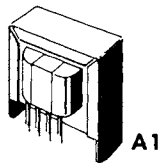
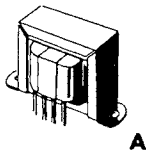

STANCOR

COMMERCIAL

transistor transformers

MINIATURE AUDIOS

.150 WATT GROUP — Dimensions: HxWxD, 2½" x 1½" x ⅜". Mounting tabs ⅜" wide, ⅜" centers • Weight .65 oz. Mounting Type A1.

Catalog No.	Application	Turns Ratio Pri. to Sec.	Impedance in Ohms		D.C. Res. in Ohms	
			Pri.	Sec.	Pri.	Sec.
TA-18	Input	1.00:45.5	30 CT	50,000	14.7	4060
TA-19	Interstage	3.08:1	100 CT	10 CT	19	1.27
TA-20	Output	5.22:1	350 CT	4, 12	38	1.45
TA-21	Output	5.53:1	500 CT	4, 8, 16	75.3	3.55
TA-22	Interstage	3.16:1	500 CT	50	59.7	7.9
TA-23	Output	5.65:1	600 CT	4, 8, 16	73.2	3.2
TA-24	Interstage	10.0:1	500 CT	50,000	76.8	5135
TA-25	Output	6.75:1	825 CT	4, 8, 16	74	2.7
TA-26	Output	9.80:1	1,250	4, 12	132.5	1.4
TA-27	Interstage	1:4.08	1,200	20,000 CT	142	1860
TA-28	Interstage	1.65:1	1,500	500 CT	104	46.5
TA-29	Output	11.8:1	2,500	4, 16	370	2.3
TA-30	Interstage	1.00:1.22	5,000 CT	7,500 CT	650	790
TA-31	Interstage	1.00:1.41	5,000 CT	10,000 CT	635	825
TA-53	Interstage	3:1	5,000 CT	45,000	310	1400
TA-32	Interstage	1.00:4	5,000 CT	80,000 CT	500	5200
TA-33	Output	24.6:1	10,000 CT	4, 8, 16	1174	2.6
TA-34	Interstage	6.97:1	10,000	200 CT	1200	33.4
TA-35	Interstage	2.24:1	10,000	2,000 CT	1200	257
TA-36	Interstage	1.83:1	10,000	3,000 CT	1200	385
TA-54	Interstage	5:1	20,000	800 CT	1350	95
TA-37	Output	5.55:1	400 CT	11	71.5	1.5
TA-38	Interstage	1.72:1	500 CT	150 CT	62	21.2

Transistor Impedance Characteristic Curves

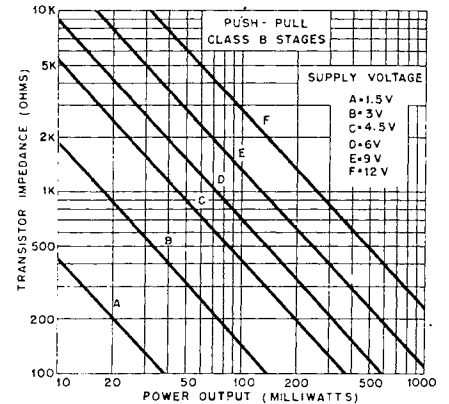

.300 WATT GROUP — Dimensions: HxWxD, 1⅜" x 1⅜" x ¼". Mounting Centers: 1⅜" • Weight 1.2 oz. Mounting Type A.

Catalog No.	Application	Turns Ratio Pri. to Sec.	Impedance in Ohms		D.C. Res. in Ohms	
			Pri.	Sec.	Pri.	Sec.
TA-39	Output	2.5:1	100 CT	4, 8, 16	10.9	1.45
TA-40	Output	3.27:1	160	4, 8, 16	18.7	1.4
TA-41	Output	5.00:1	400 CT	4, 8, 16	34	1.5
TA-42	Output	5.60:1	500 CT	4, 8, 16	47	.85
TA-52	Interstage	1:1	500 CT	500 CT	40	55
TA-43	Output	6.63:1	700 CT	4, 8, 16	77	1.15
TA-44	Output	12.5:1	2,500	4, 8, 16	172	1.15
TA-45	Output	13.7:1	3,000	4, 8, 16	192	1.2
TA-46	Interstage	8.17:1	100,000	1,500 CT	3250	143
TA-55	Input	50:1	500,000	200 CT	7000	8.5
TA-47	Input	1.00:14.1	1,000 CT	200,000 CT	123	1815
TA-63	Driver	3.17:1	20,000 CT	2,000 CT	2140	32.5

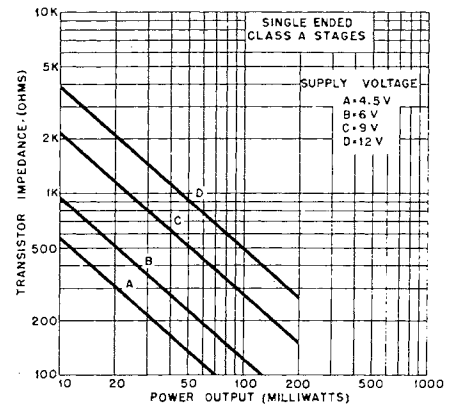

ULTRA MINIATURE

Here are the smallest iron core audio transformers ever built. They weigh less than 1/10 ounce and are no larger than the transistors they power.

These transformers are designed primarily for transistor audio applications but they can be used wherever low power is involved. Useful range, below 1 mw level. They are constructed of extremely fine wire, wound on molded nylon bobbins, with special nickel alloy steel laminations.

Catalog No.	Application	Pri. Imp.	Sec. Imp.	Pri. DC Res.	Sec. DC Res.	Weight
*UM-110	Interstage	20,000	1,000	1675	285	0.07
*UM-113	Interstage	20,000	1,000	1350	205	0.10
*UM-114	Output or matching	500	50/60	70	9.0	0.10

Dimensions* UM-110, ¼" x ⅜" x ⅜"; UM-113, 114, ⅜" x ⅜" x ⅜". Dimensions ±.015". *Available until stock is depleted.

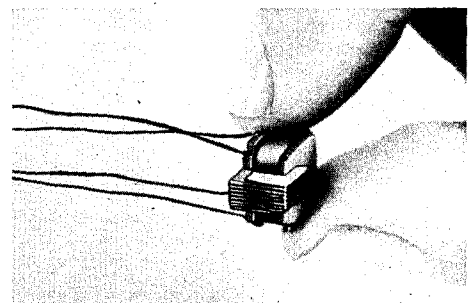

STANCOR

COMMERCIAL

power transformers

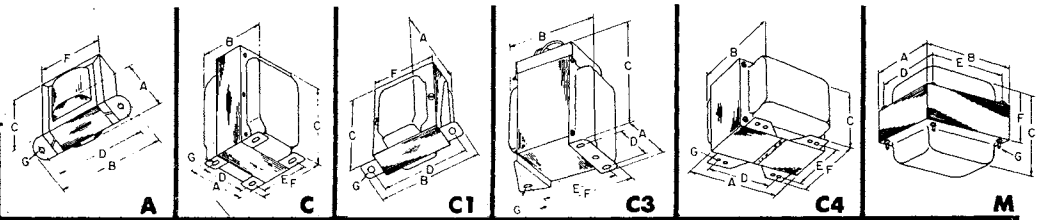

Stancor's broad line of commercial grade power transformers offers a choice of standard mounting styles. Listings are in ascending order of plate-supply voltage for ease of selection.

All units are designed and built to meet the exacting requirements of EIA for electrical tolerances, dielectric strength, temperature rise and construction. All are insulated with class A materials; (105°C max. operating temperature).

Transformers designed for full-wave C.T. rectification with capacitor input filter may be used with choke input filter allowing an increase in D.C. current of 30%.

Transformers designed for full-wave C.T. rectification with choke input filter may be used with capacitor input filter requiring a decrease in D.C. current of 25%.

CONSULT FACTORY for detailed information concerning electrical rating and/or mechanical characteristics.

FOR CAPACITOR INPUT SYSTEMS

PRIMARIES 117 VOLTS 60 CYCLES

Catalog No.	Plate Windings		Rectifier Fil.		Other Windings		Termination		Style	Dimensions							Wt. lbs.	
	AC Volts	DCMA	Volts	Amps	Volts	Amps	Pri.	Sec.		A	B	C	D	E	F	G		
a	P-8379	115 ^a	290		2.7 6.3 6.3	.45 8.0 4.25	Leads	Leads	M†	2 1/8	3 3/8	4	2 3/8	3	2 3/8	8-32	5.7	
	P-8158	117 ^a	200		6.3 6.3 6.3	4.0 2.0 9.5	Leads	Leads	M†	3 3/8	4 3/8	3 3/8	2 3/4	3 3/8	2 3/8	8-32	6.2	
	P-8336	117 ^a	280		6.3 6.3 6.3	2.0 1.2 .6	Leads	Leads	M†	3 3/4	4 3/8	4 1/4	3 3/4	4 1/8	3	8-32	8.0	
	P-8386	117 ^a	300		6.3	10.0	Leads	Leads	C4†	3 3/4	4	3 3/8	2 1/8	2 1/2	2 3/8	3/16 x 3/8	6.9	
b	P-6146	120-0-120	250	5.0	3.0			Leads	Leads	C	3 1/8	3 3/4	3 3/8	2 1/2	1 13/16	2 13/16	3/16 x 3/8	4.2
	PS-8415	125 ^b	15			6.3	.6	Leads	Leads	S	1 3/8	2 3/8	1 13/16	2	—	1 11/16	3/16	.7
	PS-8416	125-0-125	25			6.3	1.0	Leads	Leads	S	1 3/4	2 13/16	2 3/8	2 3/8	—	2	3/16	1.0
	PA-8421	125 ^b	50			6.3	2.0	Leads	Leads	A	2 1/8	3 11/16	2 1/4	3 1/8	—	2 3/4	3/16	1.5
	P-8181	150 ^b	25			6.3	.5	Leads	Leads	VE	1 13/16	2 3/8	1 13/16	2	—	1 3/8	3/16	.8
	P-8372	150 ^b	250			6.3 6.3 6.3	8.0 1.2 2.0	Leads	Leads	M	3 3/4	4 1/2	4 1/8	3	3 3/4	2 3/8	8-32	8.7
	P-9000C	155 ^a	450			6.3 6.3 6.3	2.0 13.5 3.0	Leads	Leads	C†	3 1/2	4 7/8	4 3/8	3 3/8	3 3/8	4 1/2	1/4 x 3/8	12.0
	P-8359	190-160-0-160-190	70			6.3	3.0	Leads	Leads	C	2 1/2	2 3/8	3 1/8	2	1 7/8	2 3/8	3/16 x 3/8	2.8
	P-8383	200-0-200	110			6.3	.6	Leads	Leads	C	2 1/2	3 1/4	3 1/8	2	2 1/4	2 3/8	3/16 x 3/8	3.0
	PC-8417	220-0-220	50			6.3 25.2	.6 .5	Leads	Leads	C	2 1/2	2 3/8	3 1/8	2	1 1/8	2 3/8	3/16 x 3/8	2.2
c	PCC-40	225-0-225	40	5.0	2.0	6.3	3.0	Leads	Leads	SC	2 3/8	3 1/2	3 1/2	2	3 3/8	2 13/16	3/16	3.2
	PSC-40	225-0-225	40	5.0	2.0	6.3	3.0	Lugs	Lugs	SC	2 3/8	3 1/2	3 3/4	2	3 3/8	2 13/16	3/16	3.2
	P-8155	225-0-225	90	5.0	2.0	6.3	5.15	Leads	Leads	M	2 13/16	3 3/8	3 3/4	2 1/4	2 13/16	2 1/2	8-32	4.5
	PC-8418	230-0-230	50			6.3	2.5	Leads	Leads	C	2 1/2	2 3/8	3 1/8	2	1 1/8	2 3/8	3/16 x 3/8	2.2
	PM-8418	230-0-230	50			6.3	2.5	Leads	Leads	M	2 1/2	3	2 3/8	2	2 1/2	1 1/2	8-32	2.2
	PC-8401	235-0-235	40	5.0	2.0	6.3	3.0	Leads	Leads	C	2 1/2	2 3/8	3 1/8	2	1 1/8	2 3/8	3/16 x 3/8	2.2
	PM-8401	235-0-235	40	5.0	2.0	6.3	3.0	Leads	Leads	M	2 1/2	3	2 3/8	2	2 1/2	1 1/8	8-32	2.2
	P-8374	235-0-235	260	5.0	6.0	6.3 6.3	5.0 1.2	Leads	Leads	M†	3 3/8	4 3/8	4 7/8	3	3 13/16	3 3/8	8-32	10.0
	P-8382	235 ^b	20	5.0	2.0	6.3	2.85	Leads	Leads	M6	2 3/8	2 3/8	3 1/8	2 13/16	—	—	.136	2.5
	PC-8402	240-0-240	55	5.0	2.0	6.3	3.0	Leads	Leads	C	2 1/2	2 3/4	3 1/8	2	1 3/4	2 3/8	3/16 x 3/8	2.4
PM-8402	240-0-240	55	5.0	2.0	6.3	3.0	Leads	Leads	M	2 1/2	3	2 3/4	2	2 1/2	1 1/8	8-32	2.4	
d	P-6348	240-0-240	60			6.3	3.0	Leads	Leads	M	2 3/8	2 3/8	2 3/4	1 13/16	—	2 3/8	6-32	2.3
	PC-8419	240-0-240	70			6.3	3.0	Leads	Leads	C	2 1/2	2 3/8	3 1/8	2	1 13/16	2 3/8	3/16 x 3/8	2.6
	PM-8419	240-0-240	70			6.3	3.0	Leads	Leads	M	2 1/2	3	2 3/8	2	2 1/2	2	8-32	2.6
	P-8173	250-0-250	10			6.3 6.3	.6 1.2	Leads	Leads	CI	2 3/8	2 3/8	2 1/4	2 3/8	—	1 1/2	3/16	1.0
	P-8174	250-0-250	20			6.3	.6	Leads	Leads	CI	3 3/8	2 1/4	2 3/8	2 13/16	—	2 3/8	3/16	1.5
	PC-8403	250-0-250	70	5.0	2.0	6.3	3.0	Leads	Leads	C	2 1/2	3 1/8	3 1/8	2	2 1/2	2 13/16	3/16 x 3/8	3.2
	PM-8403	250-0-250	70	5.0	2.0	6.3	3.0	Leads	Leads	M	2 1/2	3	3 1/8	2	2 1/2	2 1/4	8-32	3.2
	PC-8404	260-0-260	90	5.0	2.0	6.3	3.0	Leads	Leads	C	2 13/16	3 1/8	3 1/2	2 1/4	2 1/4	3 1/8	3/16 x 3/8	4.0
	PM-8404	260-0-260	90	5.0	2.0	6.3	3.0	Leads	Leads	M	2 13/16	3 3/8	3 1/2	2 1/4	2 13/16	2 3/8	8-32	4.0
	PC-8420	260-0-260	90			6.3	4.0	Leads	Leads	C	2 13/16	3 3/4	3 1/2	2 1/4	2	2 13/16	3/16 x 3/8	3.5
	PM-8420	260-0-260	90			6.3	4.0	Leads	Leads	M	2 13/16	3 3/8	3 1/2	2 1/4	2 13/16	2 3/8	8-32	3.5
	P-8354	260-0-260	325	5.0	6.0	6.3	11.0	Leads	Leads†	M5†	3 3/4	4 1/2	5 1/4	3 3/8	4 1/8	4	8-32	11.0
P-8353	265-0-265	300	5.0	6.0	12.6	6.0	Leads	Leads†	C3	3 3/4	4 3/4	5 7/8	3 3/8	4	5 1/4	3/16 x 1/2	12.5	
e	PCC-55	270-0-270	55	5.0	2.0	6.3	3.0	Leads	Leads	SC	2 3/8	3 1/2	3 1/2	2	3 3/8	2 13/16	3/16	3.5
	PSC-55	270-0-270	55	5.0	2.0	6.3	3.0	Lugs	Lugs	SC	2 3/8	3 1/2	3 3/4	2	3 3/8	2 13/16	3/16	3.5
	PC-8405	270-0-270	120	5.0	3.0	6.3	3.5	Leads	Leads	C	3 3/8	3 1/2	3 3/8	2 1/2	2 3/8	3 1/8	3/16 x 3/8	4.9
	PM-8405	270-0-270	120	5.0	3.0	6.3	3.5	Leads	Leads	M	3 3/8	3 3/4	3 3/4	2 1/2	3 3/8	2 3/8	8-32	4.9
	P-8172	270-0-270	200	5.0	3.0	6.3	8.5	Leads	Leads	M	3 3/8	3 3/4	4 7/8	2 13/16	3 3/8	3 1/4	8-32	7.0
	P-8356	270-0-270	260	5.0	3.0	6.3	8.8	Leads	Leads	C†	3 1/4	3 3/8	3 3/8	2 1/2	2 1/4	2 13/16	.136	6.5
	P-8376	270-0-270	320	5.0	4.0	6.3	10.0	Leads	Leads	M†	3 3/8	4 1/4	4 1/2	3	3 11/16	2 3/8	8-32	8.5
	P-8377	270-0-270	280	5.0	3.0	6.3	10.0	Leads	Leads	M†	3 3/8	3 13/16	3 3/8	2 13/16	3 3/8	2 3/4	8-32	6.7
	P-8334	275-0-275	305	5.0	5.0	6.3 6.3	8.5 1.2	Leads	Leads	M†	3 3/4	4 3/8	5 1/8	3 3/4	4 1/8	4	8-32	13.0
	P-8167	280-0-280	400	5.0	6.0	6.3 6.3	4.5 8.5	Leads	Leads	M†	3 3/4	4 3/8	5 1/2	3 3/4	4 1/8	4 1/4	8-32	13.0
	P-8332	280-0-280	260	5.0	5.0	6.3 6.3	1.2 .9	Leads	Leads	M†	3 3/4	4 3/8	4 13/16	3 3/4	4 1/8	3 3/8	8-32	11.0

a. For use in Voltage Doubler Circuits. b. For use in Half-Wave Circuits. † With Copper shorting band to reduce external Magnetic Field.
‡ Plate wdg and rectifier filament wdg Connected to Tube Socket. * Available until stock is depleted

STANCOR PAGE 15 ALL SECONDARY A.C. VOLTAGES ±3% ALL PCC AND PSC NUMBERS MAY BE OPERATED AT 50 CYCLES

SECTION 5600

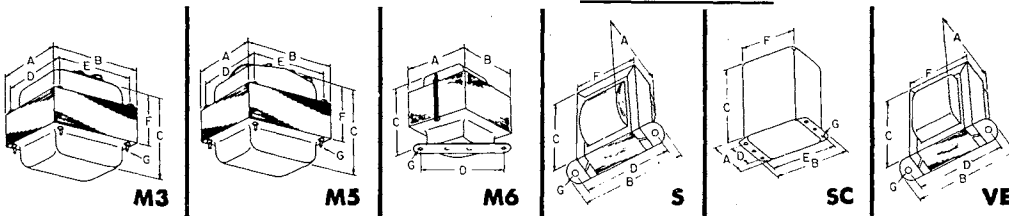

STANCOR
COMMERCIAL
power transformers

FOR CAPACITOR INPUT SYSTEMS

PRIMARIES 117 VOLTS 60 CYCLES

Catalog No.	Plate Windings		Rectifier Fil.		Other Windings		Termination		Style	Dimensions							Wt. lbs.	
	AC Volts	DCMA	Volts	Amps	Volts	Amps	Pri.	Sec.		A	B	C	D	E	F	G		
a	P-8373	280-0-280	280	5.0	3.0	6.3	10.0	Leads	Leads	M	3 1/8	3 3/4	4 1/4	2 1/2	3 3/8	3 1/2	8-32	8.0
	P-8378	280-0-280	300	5.0/3.0	4.5	6.3	10.0	Leads	Leads	C†	3 1/8	4 3/8	3 3/8	2 1/2	3 1/4	4 3/8	3/8 x 3/8	7.9
		250-0-250				6.3	1.2											
	P-8375	283-0-283	210	5.0 C.T.	3.0	6.3	1.2	Leads	Leads †	M3†	3 3/4	4 3/8	4 3/8	3	3 3/4	3 1/4	8-32	8.3
	P-8355	285-0-285	250	5.0	3.0	6.3	9.5	Leads	Leads	C4†	3 3/4	3 1/2	3 3/8	2 1/2	2 3/8	2 3/4	8-32	6.5
	P-8365	285-0-285	325	5.0	6.0	12.6 C.T.	6.0	Leads	Leads	M†	3 3/4	4 3/8	4 3/8	3	3 3/4	3	8-32	10.2
	P-8352	290-0-290	240	5.0	3.0	12.6 C.T.	5.25	Leads	Leads	C	3 3/4	3 1/8	4 1/8	3	3 3/8	4 3/4	3/8 x 1/2	8.5
	P-8367	290-0-290	270	5.0	6.0	6.3	8.5	Leads	Leads †	M5†	3 3/4	4 1/2	5 1/8	3	3 3/4	3 3/4	8-32	12.5
	P-8381	290-0-290	290	5.0	3.0	6.3	5.0	Leads	Leads	M†	3 1/8	3 1/8	5	2 1/16	3 3/8	3 3/8	8-32	6.9
P-8333	295-0-295	225	5.0 C.T.	3.0	6.3	11.4	Leads	Leads †	M3†	3 3/4	4 3/8	4 3/8	3 1/4	4 1/8	3 3/8	8-32	10.0	
b	PCC-60	300-0-300	60	5.0	2.0	6.3 C.T.	3.0	Leads	Leads	SC	3 1/4	4	3 3/8	2 3/4	3 1/2	2 1/16	7/32	4.5
	PSC-60	300-0-300	60	5.0	2.0	6.3 C.T.	3.0	Lugs	Lugs	SC	3 1/4	4	4 1/4	2 1/4	3 1/2	2 1/16	7/32	4.5
	P-6358	300-0-300	65			6.3 C.T.	2.7	Lugs	Leads	C	2 1/2	2 1/2	3 3/8	2	1 3/4	2 3/8	3/8 x 3/8	3.0
	P-8175	300-0-300	70	5.0	3.0	6.3 C.T.	3.0	Leads	Leads	C	2 1/2	3 3/8	3 1/2	2 1/4	2 1/4	3 3/8	3/8 x 7/16	4.0
	PM-8423	300-0-300	90	5.0	2.0	6.3 C.T.	3.5	Leads	Leads	M	2 1/16	3 3/8	3	2 1/4	2 1/16	2	8-32	4.0
	P-8177	300-0-300	120	5.0	3.0	6.3 C.T.	3.0	Leads	Leads	C	3 3/8	3 3/8	3 3/8	2 3/4	2 3/8	3 3/8	3/8 x 1/2	5.8
	P-8164	300-0-300	225	5.0	3.0	6.3	9.0	Leads	Leads	M†	3 3/8	4 3/8	4 1/8	2 3/4	3 3/8	3 3/8	8-32	7.5
	P-8335	300-0-300	325	5.0	6.0	6.3	8.8	Leads	Leads	M†	3 3/4	4 3/8	5 1/8	3 1/4	4 1/8	4	8-32	13.0
	P-8331	310-0-310	240	5.0	3.0	6.3	6.4	Leads	Leads	M†	3 3/4	4 3/8	4 1/2	3 1/4	4 1/8	3 1/4	8-32	9.0
	P-8370	310-0-310	320	5.0 C.T.	6.0	6.3	11.0	Leads	Leads †	M5†	3 3/4	4 3/8	5 3/8	3	3 3/4	4 3/8	8-32	14.0
	P-8337	315-0-315	225	5.0	3.0	6.3	8.25	Leads	Leads †	M3†	3 3/4	4 1/2	4 1/2	3 1/4	4 1/8	3 1/4	8-32	8.5
c	P-8338	315-0-315	310	5.0	6.0	6.7	10.0	Leads	Leads	M†	3 3/8	4 3/4	5 3/8	3	3 3/4	4	10-32	12.5
	P-8371	320-0-320	200	5.0 C.T.	3.0	6.3	4.0	Leads	Leads †	M3†	3 3/4	4 3/8	5 3/8	3	3 3/4	4	8-32	11.3
		200-0-200				6.3	3.0											
	P-6010	325-0-325	40	5.0 C.T.	2.0	6.3 C.T.	2.0	Leads	Leads	M	2 1/2	3	2 3/4	2	2 1/2	1 7/8	8-32	2.4
	PC-8406	325-0-325	40	5.0	2.0	6.3 C.T.	2.0	Leads	Leads	C	2 1/2	2 3/4	3 3/8	2	1 11/16	2 3/8	3/8 x 3/8	2.4
	PM-8407	325-0-325	40	5.0	2.0	6.3 C.T.	2.0	Leads	Leads	M	2 1/2	3	2 3/4	2	2 1/2	1 7/8	8-32	2.4
	PC-8407	325-0-325	55	5.0	2.0	6.3 C.T.	2.0	Leads	Leads	C	2 1/2	3 3/8	3 3/8	2	2 1/2	2 1/16	3/8 x 3/8	3.2
	PM-8407	325-0-325	55	5.0	2.0	6.3 C.T.	2.0	Leads	Leads	M	2 1/2	3	3 3/8	2	2 1/2	2 1/4	8-32	3.2
	PC-8422	325-0-325	150	5.0	3.0	6.3 C.T.	5.0	Leads	Leads	C	3 3/8	3 3/8	3 3/8	2 1/2	2 3/8	3 3/8	3/8 x 3/8	5.8
	PM-8422	325-0-325	150	5.0	3.0	6.3 C.T.	5.0	Leads	Leads	M	3 3/8	3 3/8	3 3/8	2 1/2	2 3/8	3 3/8	8-32	5.8
	P-8339	325-0-325	255	5.0	3.0	12.6 C.T.	5.25	Leads	Leads	C	3 3/4	4	4 3/8	3	3 3/4	4 3/4	3/8 x 1/2	8.5
P-8369	325-0-325	240	5.0 C.T.	3.0	6.3	10.0	Leads	Leads †	M3†	3 3/4	4 3/8	5 3/8	3	3 3/4	4 3/8	8-32	11.5	
d	PCC-85	330-0-330	85	5.0	2.0	6.3 C.T.	3.0	Leads	Leads	SC	3 1/16	4 7/8	4 7/8	2 3/4	3 3/8	3 1/4	7/16	6.0
	PSC-85	330-0-330	85	5.0	2.0	6.3 C.T.	3.0	Lugs	Lugs	SC	3 1/16	4 7/8	4 7/8	2 3/4	3 3/8	3 1/4	7/32	6.0
	PCC-70	335-0-335	70	5.0	2.0	6.3 C.T.	3.0	Leads	Leads	SC	3 1/4	4	3 7/8	2 1/4	3 1/2	2 1/16	7/32	4.5
	PSC-70	335-0-335	70	5.0	2.0	6.3 C.T.	3.0	Lugs	Lugs	SC	3 1/4	4	4 1/4	2 1/4	3 1/2	2 1/16	7/32	4.5
	P-5059	337-0-337	200	5.0 C.T.	3.0	6.3 C.T.	5.0	Leads	Leads	C	3 3/4	4 3/8	4 1/8	3	3 3/8	4	3/8 x 3/8	9.6
	PC-8408	340-0-340	70	5.0	2.0	6.3 C.T.	2.5	Leads	Leads	C	2 1/16	3 3/8	3 1/2	2 1/4	2 1/2	2 1/16	3/8 x 3/8	3.8
	PM-8408	340-0-340	70	5.0	2.0	6.3 C.T.	2.5	Leads	Leads	M	2 1/16	3 3/8	3 1/2	2 1/4	2 1/16	2 1/4	8-32	3.8
	P-8166	340-0-340	330	5.0	6.0	6.3	5.0	Leads	Leads	M†	3 3/4	4 3/8	5 3/8	3 1/4	4 1/8	4 1/8	8-32	13.0
	PCC-105	345-0-345	105	5.0	2.0	6.3 C.T.	3.5	Leads	Leads	SC	3 1/16	4 7/8	4 7/8	2 3/4	3 3/8	3 1/4	7/32	6.5
	PSC-105	345-0-345	105	5.0	2.0	6.3 C.T.	3.5	Lugs	Lugs	SC	3 1/16	4 7/8	4 7/8	2 3/4	3 3/8	3 1/4	7/32	6.5
	P-6011	350-0-350	70	5.0 C.T.	3.0	6.3 C.T.	2.5	Leads	Leads	M	2 1/2	3	3 3/8	2	2 1/2	2 1/4	8-32	3.5
P-6012	350-0-350	90	5.0 C.T.	3.0	6.3 C.T.	3.5	Leads	Leads	M	2 1/16	3 3/8	3 1/2	2 1/4	2 1/16	2 1/2	8-32	4.2	
PC-8409	350-0-350	90	5.0	2.0	6.3 C.T.	3.0	Leads	Leads	C	2 1/16	3 3/8	3 1/2	2 1/4	2 3/8	3 3/8	3/8 x 3/8	4.5	
PM-8409	350-0-350	90	5.0	2.0	6.3 C.T.	3.0	Leads	Leads	M	2 1/16	3 3/8	3 1/2	2 1/4	2 1/16	2 1/2	8-32	4.5	
e	P-8176	350-0-350	110	5.0	2.0	6.3 C.T.	3.0	Leads	Leads	C	3 1/4	3 3/8	3 1/8	2 3/4	3	3 3/8	3/8 x 1/2	5.5
	P-6013	350-0-350	120	5.0 C.T.	3.0	6.3 C.T.	4.7	Leads	Leads	M	3 1/8	3 3/4	3 3/8	2 1/2	3 1/8	2 3/8	8-32	5.2
	P-8345	350-0-350	215	5.0	3.0	6.3	9.0	Leads	Leads	M†	3 3/4	4 3/8	5	3 1/4	4 1/8	3 3/8	8-32	11.5
						6.3	1.2											
	P-8350	350-0-350	270	5.0	6.0	6.3	7.8	Leads	Leads	M†	3 3/4	4 3/8	5 1/2	3 1/4	4 1/8	4	8-32	13.0
						6.6	9.5											
P-8340	355-0-355	270	5.0	6.0	6.3	1.65	Leads	Leads	M†	3 3/4	4 3/8	5 3/8	3 1/4	4 1/8	4 1/8	8-32	12.0	
					6.3	2.4												2.4
PC-8410	360-0-360	120	5.0	3.0	6.3 C.T.	3.5	Leads	Leads	C	3 1/8	3 3/4	3 3/8	2 1/2	2 7/8	3 3/8	3/8 x 3/8	5.5	
PM-8410	360-0-360	120	5.0	3.0	6.3 C.T.	3.5	Leads	Leads	M	3 1/8	3 3/4	3 3/2	2 1/2	3 1/8	2 1/2	8-32	5.5	

† With Copper shorting band to reduce external Magnetic Field.

‡ Plate wdg and rectifier filament wdg Connected to Tube Socket.

▲ Primary for 117-107 volts.

* Available until stock is depleted
ALL SECONDARY A.C. VOLTAGES ±3%

ALL PCC AND PSC NUMBERS MAY BE OPERATED AT 50 CYCLES

STANCOR PAGE 16

SECTION 5600

STANCOR
COMMERCIAL
power
transformers

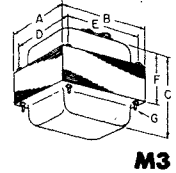
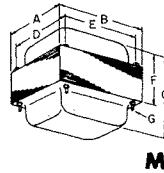
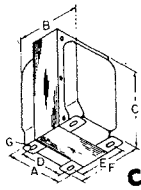

FOR CAPACITOR INPUT SYSTEMS

PRIMARIES 117 VOLTS 60 CYCLES

Catalog No.	Plate Windings		Rectifier Fil.		Other Windings		Termination		Style	Dimensions							Wt. lbs.	
	AC Volts	DCMA	Volts	Amps.	Volts	Amps.	Pri.	Sec.		A	B	C	D	E	F	G		
a	P-8341	360-0-360 220-0-220	175 110	5.0 5.0	3.0 2.0	12.6 C.T.	5.45	Leads	Leads	C†	3 3/4	4 7/8	4 3/4	3	3 1/2	4 1/16	3/8 x 1/2	11.0
	P-8349	360-0-360	260	5.0	6.0	5.0 6.3	2.0 8.85	Leads	Leads	M†	3 3/4	4 1/16	5 1/2	3 1/4	4 1/16	4	8-32	13.0
	P-8351	360-0-360	240	5.0	6.0	6.5	9.3	Leads	Leads	M	3 3/4	4 1/16	4 1/16	3 1/4	4 1/16	3 3/8	8-32	10.5
	P-8343	360-0-360 220-0-220	220 110	5.0 5.0	3.0 2.0	12.8 C.T.	5.8	Leads	Leads	C	3 3/4	5 1/4	4 3/4	3	3 3/8	4 1 3/16	3/8 x 1/2	11.5
	P-8344	365-0-365 200-0-200	170 84	5.0 5.0	3.0 2.0	12.6	4.25	Leads	Leads	C†	3 3/4	4 1/2	4 3/4	3	3 3/8	4 1/16	3/8 x 1/2	9.0
	P-8342	365-0-365	260	5.0	6.0	6.3 6.3	8.85 1.2	Leads	Leads	M†	3 3/4	4 1/16	5 3/8	3 1/4	4 1/16	4	8-32	13.0
b	P-8348	365-0-365	270	5.0	6.0	6.7	4.5	Leads	Leads	M†	3 3/4	4 1/16	4 7/8	3 1/4	4 1/16	3 3/8	8-32	10.0
	PCC-150	370-0-370	150	5.0	3.0	6.3 C.T. 6.3 C.T.	4.0 1.0	Leads	Leads	SC	4 1/16	5 1/4	5 1/8	2 1/2	4 3/4	4 1/8	1 3/4	11.5
	PSC-150	370-0-370	150	5.0	3.0	6.3 C.T. 6.3 C.T.	4.0 1.0	Lugs	Lugs	SC	4 1/16	5 1/4	5 1/8	2 1/2	4 3/4	4 1/8	1 3/4	11.5
	P-6315	370-0-370	275	5.0 C.T.	3.0	6.3 C.T.	7.0	Leads	Leads	M	3 3/4	4 1/2	4 1/4	3	3 3/4	3	8-32	9.3
	P-8366	370-0-370	220	5.0	6.0	6.3 6.3 6.3	6.0 4.0 1.2	Leads	Leads	M†	3 3/4	4 1/16	5 1/4	3	3 3/4	3 1/2	8-32	11.0
	*PCC-120	375-0-375	120	5.0	3.0	6.3 C.T.	4.0	Leads	Leads	SC	4 1/16	5 1/4	5 1/8	2 1/2	4 3/4	4 1/8	1 3/4	9.5
	PSC-120	375-0-375	120	5.0	3.0	6.3 C.T.	4.0	Lugs	Lugs	SC	4 1/16	5 1/4	5 1/8	2 1/2	4 3/4	4 1/8	1 3/4	9.5
	P-6014	375-0-375	150	5.0 C.T.	3.0	6.3 C.T.	5.0	Leads	Leads	M	3 3/8	3 3/4	3 3/4	2 1/2	3 3/8	2 3/4	8-32	6.0
	PC-8411	375-0-375	150	5.0	3.0	6.3 C.T.	4.5	Leads	Leads	C	3 3/8	4	4 1/4	2 3/4	2 1 3/16	3 1 1/16	3/8 x 3/8	5.8
	PM-8411	375-0-375	150	5.0	3.0	6.3 C.T.	4.5	Leads	Leads	M	3 3/8	4 1/8	3 7/8	2 3/4	3 3/8	2 1/2	8-32	5.8
c	P-8171	375-0-375	225	5.0 C.T.	3.0	6.3 6.3 6.3	2.0 9.0 1.2	Leads	Leads ‡	M3†	3 3/4	4 1/2	4 7/8	3	3 3/4	3 3/8	8-32	10.5
	P-8169	380-0-380	220	5.0	3.0	6.3 6.3 6.3	5.0 7.0 1.2	Leads	Leads	M†	3 3/4	4 1/16	4 3/4	3	3 3/4	3 1/2	8-32	10.5
	P-8170	380-0-380	220	5.0	3.0	6.3 6.3 6.3	5.0 7.0 1.2	Leads	Leads	C†	3 3/4	4 3/4	4 3/4	3	3 3/8	4 1/16	3/8 x 3/8	10.5
	PCC-200	385-0-385	200	5.0	3.0	6.3 C.T. 6.3 C.T.	4.5 1.0	Leads	Leads	SC	4 1/16	5 1/4	5 1/8	2 1/2	4 3/4	4 1/8	1 3/4	12.0
	PSC-200	385-0-385	200	5.0	3.0	6.3 C.T. 6.3 C.T.	4.5 1.0	Lugs	Lugs	SC	4 1/16	5 1/4	5 1/8	2 1/2	4 3/4	4 1/8	1 3/4	12.0
d	P-8347	385-0-385	230	5.0	3.0	5.0 6.45 6.3	2.0 7.4 1.6	Leads	Leads	M†	3 3/4	4 1/16	5 1/8	3 1/4	4 1/16	4	8-32	13.0
	*P-8161	385-0-385	230	5.0	3.0	5.0 6.3	2.0 9.0	Leads	Leads	M†	3 3/4	4 1/2	5 1/8	3 1/4	4 1/16	3 7/8	8-32	11.8
	P-6007	400-0-400	110	5.0 C.T.	3.0	2.5 C.T. 2.5 C.T.	15.0 3.5	Leads	Leads	M	3 1/8	3 3/4	3 1/2	2 1/2	3 1/8	2 1/2	8-32	5.4
	P-4004	400-0-400 80v. Bias	175	5.0 C.T.	3.0	2.5 6.3 C.T. 6.3 C.T.	1.75 2.5 2.5	Leads▲	Leads	C	3 3/4	3 3/8	4 1 1/16	3	2 1 3/16	3 3/16	3/8 x 3/8	8.3
e	P-8346	400-0-400 330-0-330	180 180	5.0 5.0	3.0 3.0			Leads	Leads	C	3 3/4	4 3/4	4 3/4	3	3 1/2	4 7/8	3/8 x 1/2	11.0
	PC-8412	400-0-400	200	5.0	3.0	6.3 C.T.	5.0	Leads	Leads	C	3 3/4	4	4 1 1/16	3	2 1 3/16	3 1 1/16	3/8 x 3/8	8.2
	PM-8412	400-0-400	200	5.0	3.0	6.3 C.T.	5.0	Leads	Leads	M	3 3/4	4 1/2	3 7/8	3	3 3/4	2 5/8	8-32	8.2
	PC-8413	400-0-400	250	5.0	4.0	6.3 C.T.	5.0	Leads	Leads	C	3 3/4	4 1/2	4 1 1/16	3	3 3/16	4 3/8	3/8 x 3/8	10.0
	PCC-250	400-80-0-80-400	250	5.0	6.0	5.0 6.3 C.T.	2.0 7.0	Leads	Leads	SC	5 1/8	5 7/8	6 1/8	3 1/2	5 3/8	4 3/4	1 3/4	15.0
	*PSC-250	400-80-0-80-400	250	5.0	6.0	5.0 6.3 C.T.	2.0 7.0	Lugs	Lugs	SC	5 1/8	5 7/8	6 1/8	3 1/2	5 3/8	4 3/4	1 3/4	15.0
	P-8360	437-0-437	185	5.0	3.0	6.3 6.3	3.0 4.0	Leads	Leads	C	3 3/4	4 1/2	4 1 1/16	3	3 3/8	4 3/8	3/8 x 3/8	9.5
	P-6143	440-0-440	130	5.0	3.0	6.3 C.T.	3.5	Leads	Leads	C	3 3/8	4 1/16	4 1/4	2 3/4	2 1 3/16	3 3/4	3/8 x 3/8	7.0
	PC-8414	600-0-600	200	5.0	3.0	6.3 6.3	3.0 3.0	Leads	Leads	C	3 3/4	4 1/4	4 1 1/16	3	3 1/16	3 1 1/16	3/8 x 3/8	8.3

† With Copper shorting band to reduce external Magnetic Field. ‡ Plate wdg and rectifier filament wdg Connected to Tube Socket. ▲ Primary for 117-107 Volts. f. Intermittent duty.
* Available until stock is depleted

SECTION 5600

STANCOR

COMMERCIAL

power transformers

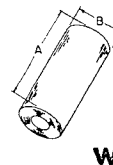
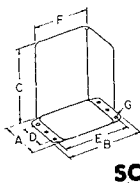
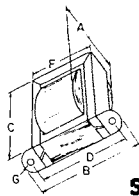
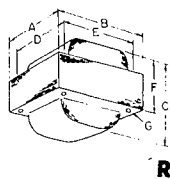

FOR REACTOR INPUT SYSTEMS

PRIMARYS 117 VOLTS 50/60 CYCLES

Catalog No.	Plate Windings		Rectifier Fil.		Other Windings		Termination		Style	Dimensions							Wt. lbs.
	AC Volts	DCMA	Volts	Amps.	Volts	Amps.	Pri.	Sec.		A	B	C	D	E	F	G	
PCR-55	350-0-350	55	5.0	2.0	6.3 C.T.	2.0	Leads	Leads	SC	2 7/8	3 1/2	3 1/2	2	3 1/8	2 1/16	3/16	3 1/4
PSR-55	350-0-350	55	5.0	2.0	6.3 C.T.	2.0	Lugs	Lugs	SC	2 7/8	3 1/2	3 1/2	2	3 1/8	2 1/16	3/16	3 1/4
PCR-70	425-0-425	70	5.0	2.0	6.3 C.T.	3.0	Leads	Leads	SC	3 3/4	4	3 7/8	2 1/4	3 1/2	2 1/16	3/16	4 1/2
PSR-70	425-0-425	70	5.0	2.0	6.3 C.T.	3.0	Lugs	Lugs	SC	3 3/4	4	3 7/8	2 1/4	3 1/2	2 1/16	3/16	4 1/2
PCR-85	440-0-440	85	5.0	2.0	6.3 C.T.	3.0	Leads	Leads	SC	3 11/16	4 7/16	4 3/16	2 3/4	3 7/8	3 3/4	3/16	6
PSR-85	440-0-440	85	5.0	2.0	6.3 C.T.	3.0	Lugs	Lugs	SC	3 11/16	4 7/16	4 3/16	2 3/4	3 7/8	3 3/4	3/16	6
PCR-105	450-0-450	105	5.0	2.0	6.3 C.T.	3.5	Leads	Leads	SC	3 11/16	4 7/16	4 3/16	2 3/4	3 7/8	3 3/4	3/16	6 1/2
PSR-105	450-0-450	105	5.0	2.0	6.3 C.T.	3.5	Lugs	Lugs	SC	3 11/16	4 7/16	4 3/16	2 3/4	3 7/8	3 3/4	3/16	6 1/2
PCR-120	500-0-500	120	5.0	3.0	6.3 C.T.	4.0	Leads	Leads	SC	4 7/16	5 1/4	5 3/16	2 1/2	4 3/4	4 1/8	1 3/4	9 1/2
PSR-120	500-0-500	120	5.0	3.0	6.3 C.T.	4.0	Lugs	Lugs	SC	4 7/16	5 1/4	5 3/16	2 1/2	4 3/4	4 1/8	1 3/4	9 1/2
a PCR-150	510-0-510	150	5.0	3.0	6.3 C.T.	1.0	Leads	Leads	SC	4 7/16	5 1/4	5 3/16	2 1/2	4 3/4	4 1/8	1 3/4	11 1/2
					6.3 C.T.	4.0											
PSR-150	510-0-510	150	5.0	3.0	6.3 C.T.	1.0	Lugs	Lugs	SC	4 7/16	5 1/4	5 3/16	2 1/2	4 3/4	4 1/8	1 3/4	11 1/2
					6.3 C.T.	4.0											
PCR-200	520-0-520	200	5.0	3.0	6.3 C.T.	1.0	Leads	Leads	SC	4 7/16	5 1/4	5 3/16	2 1/2	4 3/4	4 1/8	1 3/4	12 1/4
					6.3 C.T.	4.5											
PSR-200	520-0-520	200	5.0	3.0	6.3 C.T.	1.0	Lugs	Lugs	SC	4 7/16	5 1/4	5 3/16	2 1/2	4 3/4	4 1/8	1 3/4	12 1/4
					6.3 C.T.	4.5											
PCR-300	550-370-75-0	300	5.0	6.0	6.3 C.T.	1.0	Leads	Leads	SC	5 7/16	5 7/8	6 1/16	3 1/2	5 3/8	4 3/4	1 7/8	17 1/2
	-75-370-550				6.3 C.T.	5.0											
PSR-300	550-370-75-0	300	5.0	6.0	6.3 C.T.	1.0	Lugs	Lugs	SC	5 7/16	5 7/8	6 1/16	3 1/2	5 3/8	4 3/4	1 7/8	17 1/2
	-75-370-550				6.3 C.T.	5.0											

FOR REGULATED POWER SUPPLIES

PRIMARYS 117 VOLTS 50/60 CYCLES

b PSC-165	440-0-440	165	5.0	3.0	6.3	0.6	Lugs	Lugs	SC	4 7/16	5 1/4	5 3/16	2 1/2	4 3/4	4 1/8	1 3/4	12
					6.3	3.0											
					6.3	3.0											
					6.3	7.5											
PSC-205	450-0-450	200	5.0	2.0	6.3	0.6	Lugs	Lugs	SC	4 7/16	5 1/4	5 3/16	2 1/2	4 3/4	4 1/8	1 3/4	12
					6.3	4.0											
					6.3	4.0											
					6.3	4.0											

FOR BIAS SUPPLIES

PRIMARYS 117 VOLTS 50/60 CYCLES

c IBC-150	180-160-140-	150	5.0	3.0			Leads	Leads	SC	3 3/4	4	4 1/4	2 1/4	3 1/2	2 1/16	7/32	5
	120-0-120-																
IBS-150	140-160-180	150	5.0	3.0			Lugs	Lugs	SC	3 3/4	4	4 1/4	2 1/4	3 1/2	2 1/16	7/32	5
	180-160-140-																
2BC-150	120-0-120-	150	5.0	3.0	(Pri.-230v.)		Leads	Leads	SC	3 3/4	4	4 1/4	2 1/4	3 1/2	2 1/16	7/32	5
	140-160-180																
2BS-150	180-160-140-	150	5.0	3.0	(Pri.-230v.)		Lugs	Lugs	SC	3 3/4	4	4 1/4	2 1/4	3 1/2	2 1/16	7/32	5
	120-0-120-																
P-6317	200-170-130-	200	5.0	3.0			Leads	Leads/Lugs	C	3 3/8	3 7/8	3 7/8	2 1/2	2 3/16	3 1/16	3/16 x 3/8	4.9
	90-0-90-																
P-6318	130-170-200	200	5.0	3.0			Leads	Leads/Lugs	C	3 7/16	4 1/4	4 3/16	2 3/4	2 13/16	3 13/16	3/16 x 3/8	7.0
	450-400-350-																
	250-0-250-																
	350-400-450																

FOR CATHODE RAY TUBES

PRIMARYS 117 VOLTS 60 CYCLES

d P-8150	1550 ^b	1.5	2.5	1.75			Leads	Leads	SC	2 1/2	3	3 1/16	1 3/4	2 11/16	2 3/16	3/16	1.8																																
																		P-8179	1600 ^b	3.0			Lugs	Lugs	M	2 1/2	3	3 1/2	2	2 1/2	2 1/2	8-32	3.5																
																																		P-8178	1800 ^b	2.0	2.5	1.8	Lugs	Lugs	C	3 3/8	3 3/4	3 7/8	2 1/2	2 1/2	3 3/16	3/16 x 3/8	5

FOR SOLAR CF-160 CONDENSER TESTER

PRIMARY 117 VOLTS 60 CYCLES

e P-6459	550 ^b	30	60				Leads	Leads	R	2 3/16	2 3/8	2 1/4	1 3/4	2 3/16	1 11/16	3/32	1.4

FOR 100 WS ELECTRONIC PHOTOFLASH

PRIMARY 105/115/125 VOLTS 60 CYCLES

f P-6425	380 ^b	20					Leads	Leads	S	2	2 7/8	2 3/16	2 3/8	—	2	3/16	1.4
P-6426							Leads	Leads	W	3/4	3/16	—	—	—	—	—	.2

b. For use in Half-Wave Circuits.

SECTION 5600

STANCOR

COMMERCIAL

filament
transformers

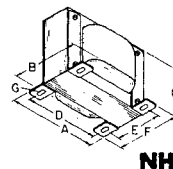
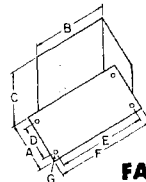
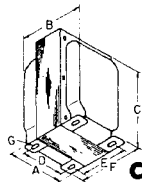
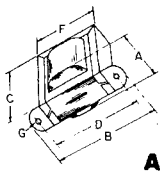

WITH SINGLE SECONDARY: ALL PRIMARIES 50/60 CYCLES

Catalog No.	Secondary		Insulation Test RMS Volts	Primary Volts	Termination		Style	Dimensions							WT Lbs.
	Volts	Amps.			Pri	Sec		A	B	C	D	E	F	G	
P-4026	2.5	1.5	2500	117	Leads	Leads	A	1 3/8	2 7/8	1 3/8	2 3/8	—	2	3/16	0.7
P-4082	2.5 CT	2.5	2500	117/107	Leads	Leads	S	2 1/4	2 11/16	2 11/16	1 1/2	2 3/8	—	3/16	1.5
P-6133†	2.5 CT	5.0	7500	117	Leads	Leads	SC	2 1/4	3 1/8	2 3/4	2 11/16	—	2 1/4	3/16	1.5
F-25	2.5 CT	5.25	3500	115/230	Lugs	Lugs	SC	2 1/2	3	3 3/8	1 3/4	2 11/16	2 3/8	3/16	2.0
P-4083†	2.5 CT	6.0	2500	117/107	Leads	Leads	C	2 1/2	2 1/2	3 1/2	2	1 1/2	2 3/8	3/16 x 3/8	2.2
P-3024†	2.5 CT	10.0	2500	117/107	Leads	Leads	C	2 1/2	2 3/4	3 3/8	2	1 3/4	2 3/8	3/16 x 3/8	2.5
P-6454	2.5 CT	10.0	7500	117/107	Leads	Leads	S	2 1/2	3 3/8	3 3/8	3 3/8	—	2 3/8	3/16	2.5
P-3060	2.5 CT	10.0	10000	117	Lugs	Lugs	NV	2 11/16	2 3/8	3 3/8	2 1/4	1 7/8	2 1/2	3/16 x 3/8	2.5
F-210	2.5 CT	10.0	5000	115/230	Terms	Terms	SC	2 7/8	3 1/2	3 3/4	2	3 3/8	2 11/16	3/16	3.0
F-210H	2.5 CT	10.0	9000	115/230	Terms	Terms	SC	3 1/4	4	4 1/4	2 1/4	3 1/2	3	3/16	4.0
F-215H	2.5 CT	15.0	9000	115/230	Terms	Terms	SC	3 11/16	4 7/8	4 3/8	2 3/4	3 7/8	3 1/4	3/16	6.0
P-3026†	5.0 CT	3.0	2500	117/107	Leads	Leads	C	2 1/2	2 5/8	3 1/8	2	1 7/8	2 1/4	3/16 x 3/8	2.4
P-4088†	5.0 CT	3.0	2500	117	Lugs	Lugs	NV	2 1/2	1 3/8	3 3/8	2	1 7/8	2 1/4	3/16 x 3/8	1.8
P-6467	5.0 CT	3.0	2500	117	Leads	Leads	A	2 1/8	3 1/4	2	2 11/16	—	2 3/8	3/16	1.4
F-54†	5.0 CT	4.0	2500	115/230	Lugs	Lugs	SC	2 1/2	3	3 3/16	1 3/4	2 11/16	2 3/8	3/16	2.2
P-6455	5.0 CT	6.0	2000	117/107	Leads	Leads	S	2 1/8	3 1/8	2 3/4	2 11/16	—	2 1/4	3/16	2.0
P-3062†	5.0 CT	6.0	2500	117	Lugs	Lugs	NV	2 1/2	2 1/4	3 3/8	2	2	2 3/8	3/16 x 3/8	2.3
P-5000†	5.0 CT	6.0	2500	117/107	Leads	Leads	C	2 1/2	3	3 1/4	2	2	2 3/8	3/16 x 3/8	3.1
P-6135	5.0 CT	10.0	2500	117	Leads	Leads	NV	2 1/2	2 3/4	3 3/8	2	2 3/8	3	3/16 x 3/8	3.0
F-58	5.0 CT	10.0	2500	115/230	Terms	Terms	SC	2 7/8	3 1/2	3 3/4	2	3 3/8	2 11/16	3/16	3.5
F-510H†	5.0 CT	10.0	10000	115/230	Terms	Terms	SC	3 11/16	4 7/8	4 11/16	2 3/4	3 7/8	3 1/4	3/16	6.5
P-4086†	5.0 CT	14.0	10000	117/107	Terms	Terms	FA	4 1/4	5 1/2	5 1/2	2 3/4	6	7	1/4	12.3
P-6433†	5.0 CT	15.0	2500	117	Leads	Leads	NV	2 1/2	2 3/4	3 3/8	2	2 1/4	2 7/8	3/16 x 3/8	3.0
F-516	5.0 CT	20.0	2500	115/230	Terms	Terms	SC	3 11/16	4 7/8	4 11/16	2 3/4	3 7/8	3 1/4	3/16	6.5
F-520HB	5.0 CT	20.0	10000	115/230	Terms	Terms	SC	4 1/8	5 1/4	5 1/8	2 1/2	4 3/4	4 1/8	3/16	13.0
P-6432†	5.0 CT	21.0	2500	117	Leads	Leads	NV	3 1/8	2 7/8	3 11/16	2 1/2	2 1/4	2 7/8	3/16 x 3/8	4.5
P-6302†	5.0 CT	22.0	10000	117/107	Terms	Terms	FA	4 1/4	5 1/2	5 1/8	2 3/4	6	7	1/4	13.5
P-6492	5.0 CT	30.0	2500	117	Leads	Leads	C	3 3/4	4	4 11/16	3	2 11/16	3 3/8	3/16 x 3/8	7.5
P-6468†	5.0 CT	30.0	2500	117/107	Lugs	Lugs	C	3 7/8	3 7/8	4 1/4	2 3/4	2 11/16	3 1/2	3/16 x 3/8	6.3
F-530	5.0 CT	30.0	2500	115/230	Terms	Terms	SC	4 1/8	5 1/4	5 1/8	2 1/2	4 3/4	4 1/8	3/16	10.5
P-6305†	5.0 CT	30.0	10000	117/107	Terms	Terms	FA	4 1/4	7	5	3 3/8	7 3/8	8 1/2	1/4	18.3
P-6137†	5.25 CT	13.0	2500	117	Leads	Leads	NV	3 3/8	2 7/8	3 11/16	2 1/2	2 1/2	3 3/8	3/16 x 3/8	5.2
P-8385	6.3 CT	0.3	1500	117	Leads	Leads	A	1 3/8	2 1/8	1 1/4	1 3/4	—	1 1/2	3/16	0.3
P-6465	6.3 CT	.6	1500	117	Leads	Leads	A	1 1/2	2 3/8	1 3/8	2	—	1 3/4	3/16	0.4
P-8389	6.3	1.0	1500	117	Leads	Leads	A	1 1/2	2 7/8	1 3/8	2 3/8	—	2	3/16	0.6
P-6134	6.3 CT	1.2	3000	117	Leads	Leads	A	1 7/8	2 7/8	1 3/8	2 3/8	—	2	3/16	0.8
P-8190	6.3	1.2	5000	117	Leads	Leads	A	1 7/8	3 1/4	2	2 11/16	—	2 3/8	3/16	1.0
P-8191	6.3	1.2	5000	6.3	Leads	Leads	A	2	3 1/4	2	2 11/16	—	2 3/8	3/16	1.0
F-615†	6.3 CT	1.5	2500	115/230	Lugs	Lugs	SC	2 1/4	2 11/16	2 11/16	1 1/2	2 3/8	2	3/16	1.0
F-63†	6.3 CT	3.0	2500	115/230	Lugs	Lugs	SC	2 1/2	3	3 1/8	1 3/4	2 11/16	2 3/8	3/16	2.0
P-5014†	6.3 CT	3.0	2500	117	Lugs	Lugs	NV	2 1/2	2	3 3/8	2	1 3/4	2 3/8	3/16 x 3/8	2.0
P-6466	6.3 CT	3.0	2500	117	Leads	Leads	A	2 1/8	3 1/4	2	2 11/16	—	2 3/8	3/16	1.4
P-6462	6.3	3.0	7000	117/107	Leads	Leads	S	2 3/8	3 3/8	3 3/8	3 3/8	—	2 3/8	3/16	2.0
P-4019†	6.3 CT	4.0	2500	117/107	Leads	Leads	C	2 1/2	2 3/4	3 3/8	2	1 3/4	2 3/8	3/16 x 3/8	2.7
F-65	6.3 CT	5.5	2500	115/230	Lugs	Lugs	SC	2 7/8	3 1/2	3 3/4	2	2 3/8	2 11/16	3/16	3.0
P-3064†	6.3 CT	6.0	2500	117	Lugs	Lugs	NV	2 1/2	2 3/8	3 3/8	2	2	2 3/8	3/16 x 3/8	2.4
P-4089†	6.3 CT	6.0	2500	117/107	Leads	Leads	C	2 11/16	3 1/4	3 1/2	2 1/4	2	2 3/4	3/16 x 3/8	3.5
P-6456	6.3 CT	6.0	2000	117/107	Leads	Leads	A	2 3/8	3 3/4	2 3/8	3 3/8	—	2 3/4	3/16	2.0
P-6464	6.3 CT	10.0	2000	117	Leads	Leads	C	2 11/16	3 3/4	3 1/2	2 1/4	2	2 3/4	3/16 x 3/8	3.5
P-6308†	6.3 CT	10.0	2500	117/107	Leads	Leads	NV	2 11/16	2 3/8	3 7/8	2 1/4	2 1/8	2 3/4	3/16 x 3/8	3.4
F-610	6.3 CT	10.0	2500	115/230	Terms	Terms	SC	3 1/4	4	4 1/4	2 1/4	3 1/2	3	3/16	5.0
P-6309†	6.3 CT	20.0	2500	117/107	Leads	Leads	NV	3 3/4	3 3/8	4 1/8	3	2 3/8	3	3/16 x 3/8	6.7
P-5015†	7.5 CT	4.0	2500	117	Lugs	Lugs	NV	2 1/2	2 1/4	3 3/8	2	2 1/2	2 3/4	3/16 x 3/8	2.7
P-4091†	7.5 CT	5.0	2500	117/107	Leads	Leads	C	2 11/16	3 1/8	3 1/2	2 1/4	1 7/8	2 3/8	3/16 x 3/8	3.4
P-6138†	7.5 CT	8.0	2500	117	Leads	Leads	NV	3 3/8	2 3/4	3 11/16	2 1/2	2 3/8	3	3/16 x 3/8	4.7
F-712	7.5 CT	12.0	2500	115/230	Terms	Terms	SC	3 11/16	4 7/8	4 11/16	2 3/4	3 7/8	3 1/4	3/16	6.5
P-6457	7.5 CT	21.0	2000	117/107	Leads	Leads	C	3 3/4	4	4 3/8	3	2 3/4	4	1/4 x 1/2	8.0
F-725	7.5 CT	25.0	2500	115/230	Terms	Terms	SC	4 1/8	5 1/4	5 1/8	2 1/2	4 3/4	4 1/8	3/16	12.0
F-751	7.75 CT	51.0	2500	115/230	Terms	Terms	SC	6 1/8	6 1/2	7 1/8	4 1/4	6	5 1/4	1/4	29.0
P-8380	10.0 CT	3.0	1500	117	Leads	Leads	A	2 1/4	3 3/4	2 3/8	3 3/8	—	2 3/4	3/16	1.6
F-104	10.0 CT	4.0	2500	115/230	Lugs	Lugs	SC	2 7/8	3 1/2	3 3/4	2	3 3/8	2 11/16	3/16	3.2
P-5016†	10.0 CT	4.0	2500	117	Lugs	Lugs	NV	2 11/16	2 1/2	3 3/8	2 1/4	2	2 3/8	3/16 x 3/8	3.3
P-6458	10.0 CT	5.0	2000	117/107	Leads	Leads	NV	2 1/2	2 1/2	3 1/8	2 1/8	1 11/16	2 3/4	3/16 x 1/2	3.0
P-4096†	10.0 CT	5.0	2500	117/107	Leads	Leads	C	3 3/8	3 1/4	3 7/8	2 1/2	1 11/16	2 3/4	3/16 x 3/8	4.0
F-106	10.0 CT	6.5	2500	115/230	Terms	Terms	SC	3 3/4	4	4 1/4	2 1/4	3 1/2	3	3/16	5.0
P-6139†	10.0 CT	8.0	2500	117	Leads	Leads	NV	3 3/8	3	3 11/16	2 1/2	2 3/8	3	3/16 x 3/8	4.9
P-4097†	10.0 CT	8.0	2500	117/107	Leads	Leads	C	3 3/8	3 3/4	3 7/8	2 1/2	2 3/8	3 3/8	3/16 x 3/8	5.2
P-6461	10.0 CT	10.0	2000	117	Leads	Leads	C	3 3/4	3 3/8	3 7/8	2 3/4	2 11/16	2 11/16	3/16 x 1/2	5.0
F-1010	10.0 CT	10.0	2500	115/230	Terms	Terms	SC	3 11/16	4 7/8	4 11/16	2 3/4	3 11/16	3 1/4	3/16	6.5
P-5002†	10.0 CT	12.0	7500	117/107	Terms	Terms	FA	4 1/4	5 1/2	5 1/8	2 3/4	6	7	1/4	14.7
P-3020†	11.0 CT	10.0	2500	117/107	Leads	Leads	C	3 3/4	3 3/8	4 11/16	3	2			

SECTION 5600

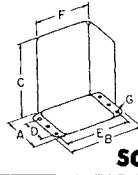
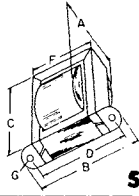
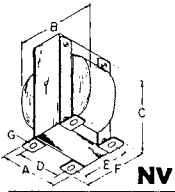

STANCOR
COMMERCIAL
filament
transformers

WITH MULTIPLE SECONDARIES: ALL PRIMARIES 50/60 CYCLES

	Catalog No.	Secondary		Insulation Test RMS Volts	Primary Volts	Termination		Style	Dimensions							WT Lbs.					
		Volts	Amps.			Pri	Sec		A	B	C	D	E	F	G						
a	P-6144†	{ 2.5 CT 5.0 CT 6.3 CT	{ 3.5 3.0 3.0	2500	117	Leads	Leads	C	2 1/16	3 1/4	3 1/2	2 1/4	2	2 3/4	3/16 x 3/8	3.7					
	P-6338	{ 2.5 5.0 CT 5.0 CT 6.3 CT	{ 3.0 3.0 2.0 3.0						2500	117	Leads	Leads	NH	3 3/8	2 3/4	2 7/8	2 1/16	2 1/8	2 3/4	3/16 x 5/16	3.4
c	P-5009†	{ 5.0 CT 6.3 CT	{ 3.0 6.0	2500	117/107	Leads	Leads	C						3 1/8	3 3/8	3 3/8	2 1/2	2 1/16	2 7/8	3/16 x 3/8	4.5
	P-5008†	{ 5.0 CT 6.3 CT	{ 4.0 3.6						2500	117/107	Leads	Leads	C	2 13/16	3 1/4	3 1/2	2 1/4	2	2 3/4	3/16 x 3/8	3.8
	P-4022†	{ 5.0 CT 6.3 CT	{ 6.0 6.0											2500	117/107	Leads	Leads	C	3 1/8	3 1/2	3 7/8
d	P-6333	{ 5.0 5.0 CT 6.3 CT 7.5/6.3 CT	{ 3.0 3.0 4.0 3.0	2500	117	Lugs	Lugs	NH	3 3/8	3 1/4	2 7/8	2 13/16	2 3/4						3 3/8	3/16 x 3/16	4.7
	P-6463	{ 6.0 CT or 6.5 CT or 7.0 CT	{ 13						2000	117	Lugs	Lugs	NV	2 13/16	2 7/8	3 7/16	2 1/4	2 13/16	3 3/16	3/16 x 3/16	4.5
e	P-6428†	{ 6.3 6.3 6.3 6.3 CT	{ 1.75 1.75 1.75 1.75	2500	117	Leads	Leads	C						2 1/2	3 1/8	3 1/8	2	2	2 5/8	3/16 x 3/8	3.0
	P-6430†	{ 6.3 CT 6.3 CT	{ 3.0 3.0						2500	117	Leads	Leads	C	2 1/2	2 7/8	3 1/8	2	1 7/8	2 1/2	3/16 x 3/8	2.8
f	P-6429†	{ 6.3 6.3 6.3 6.3 CT	{ 3.5 3.5 3.5 3.5	2500	117	Leads	Leads	C						3 1/8	3 1/2	3 7/8	2 1/2	2 3/16	3	3/16 x 3/8	4.8
	P-6431†	{ 6.3 CT 6.3 CT	{ 6.0 6.0						2500	117	Leads	Leads	C	3 1/8	3 1/2	3 7/8	2 1/2	2 3/16	3	3/16 x 3/8	4.8

MULTI-TAPPED FOR TUBE CHECKERS: PRIMARY 50/60 CYCLES

g	Catalog No.	Secondary Rating (RMS)		Primary Volts	Termination	Style	Dimensions							WT Lbs.	
		Volts	Amps.				A	B	C	D	E	F	G		
	P-1834-3	117/110/85 70 50 35 30/25/20/12 7.5/7/6.3/5 4/3.3/2.5/2 1.5/1.4/1.1	@ .20A @ .30A @ .50A @ .60A @ .80A @ 3.0A	105/115/125	Leads	Leads/ Lugs	A	2 7/8	4	2 5/8	3 3/16	—	3 1/8	3/16	2.4

* Available until stock is depleted

Insulation Test Voltage: Twice Allowable RMS Working Voltage plus 1000 Volts.

†Has Electrostatic shield.

ALL SECONDARY VOLTAGES ±3%

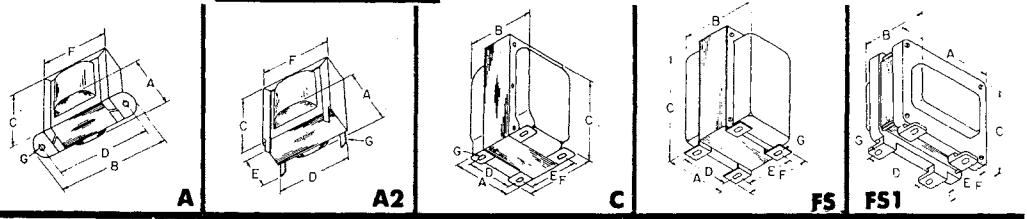

SMOOTHING CHOKES: INDUCTANCE TOLERANCE-MINUS 15% PLUS 50% AT 10 VOLTS 60 CYCLES

Catalog No.	Inductance Henries	DCMA	DC. Res. ohms	Insul. Test RMS Volts	Termination	Style	Dimensions							WT Lbs	
							A	B	C	D	E	F	G		
a	C-2345	350	5	5600	2500	Leads	A	1 3/4	3 3/4	2	2 13/16	—	2 3/8	3/16	1.0
	C-2344	1.5	10	85	2500	Leads	A	1 1/8	2 1/8	1 1/4	1 3/4	—	1 1/2	3/16	0.4
	C-2707	2.0	15	70	1500	Leads	A	1 1/8	2 1/8	1 1/4	1 3/4	—	1 1/2	3/16	0.4
	C-1515	20.0	15	900	1500	Leads	A	1 3/8	2 7/8	1 5/8	2 3/8	—	2	3/16	0.7
	C-2346	35	15	1800	1500	Leads	A	1 3/8	2 3/8	1 3/8	2	—	1 3/4	3/16	0.5
	C-2318	12.0	30	400	2000	Leads	A	1 3/8	2 3/8	1 3/8	2	—	1 3/4	3/16	0.5
	RC-1540	15.0	40	475	2500	Leads	SC	2 1/4	2 11/16	2 11/16	1 1/2	2 3/8	2	3/16	1.5
	RS-1540	15.0	40	475	2500	Lugs	SC	2 1/4	2 11/16	2 11/16	1 1/2	2 3/8	2	3/16	1.5
	C-1080	3.5	50	200	1500	Leads	A	1 3/8	2 7/8	1 5/8	2 3/8	—	2	3/16	0.7
	C-1706	4.5	50	300	1500	Leads	A	1 1/4	2 3/8	1 3/8	2	—	1 3/4	3/16	0.5
	C-1723	4.5	50	325	1500	Leads	A	1 3/8	2 3/8	1 3/8	2	—	1 3/4	3/16	0.5
	C-1325	5.0	50	250	1500	Leads	A	1 1/4	2 7/8	1 5/8	2 3/8	—	2	3/16	0.7
	* C-1277	7.0	50	300	1500	Leads	A	1 3/8	2 7/8	1 5/8	2 3/8	—	2	3/16	0.7
	* C-1227	7.0	50	350	1500	Leads	A	1 3/8	2 7/8	1 5/8	2 3/8	—	2	3/16	0.7
	C-1707	7.0	50	550	1500	Leads	A	1 1/4	2 3/8	1 3/8	2	—	1 3/4	3/16	0.5
	C-1333	8.0	50	450	1500	Leads	A	1 3/8	2 7/8	1 5/8	2 3/8	—	2	3/16	0.7
	C-1279	8.5	50	400	1500	Leads	A	1 3/8	2 7/8	1 5/8	2 3/8	—	2	3/16	0.7
	C-1215	9.0	50	500	1500	Leads	A	1 3/8	2 7/8	1 5/8	2 3/8	—	2	3/16	0.7
b	C-1003	16.0	50	580	1500	Leads	A	1 3/8	3 1/4	2	2 13/16	—	2 3/8	3/16	1.0
	RC-1055	10.0	55	230	2500	Leads	SC	2 1/4	2 11/16	2 11/16	1 1/2	2 3/8	2	3/16	1.7
	RS-1055	10.0	55	230	2500	Lugs	SC	2 1/4	2 11/16	2 11/16	1 1/2	2 3/8	2	3/16	1.7
	RC-1555	15.0	55	380	2500	Leads	SC	2 1/4	2 11/16	2 11/16	1 1/2	2 3/8	2	3/16	2.0
	RS-1555	15.0	55	380	2500	Lugs	SC	2 1/4	2 11/16	2 11/16	1 1/2	2 3/8	2	3/16	2.0
	C-1708	13.0	65	500	1500	Leads	A	1 3/4	3 1/4	2	2 13/16	—	2 3/8	3/16	1.0
	C-1355	8.0	75	290	1500	Lugs	L	2 3/8	—	2	1 1/2	1 3/16	1 5/8	3/16 x 1/2	1.0
	C-1002	15.0	75	400	1500	Leads	A	1 3/8	3 3/4	2 3/8	3 3/8	—	2 3/4	3/16	1.7
	C-1420	16.0	80	360	1500	Leads	C	2 1/2	2 3/4	3 3/8	2	1 3/4	2 3/8	3/16 x 3/8	2.5
	C-1709	8.0	85	250	1500	Leads	A	1 3/8	3 1/4	2	2 13/16	—	2 3/8	3/16	1.4
	RC-1085	10.0	85	175	2500	Leads	SC	2 1/2	3	3 1/16	1 3/4	2 11/16	2 3/8	3/16	2.5
	RS-1085	10.0	85	175	2500	Lugs	SC	2 1/2	3	3 3/16	1 3/4	2 11/16	2 3/8	3/16	2.5
	RC-1585	15.0	85	285	2500	Leads	SC	2 1/2	3	3 1/16	1 3/4	2 11/16	2 3/8	3/16	2.7
	RS-1585	15.0	85	285	2500	Lugs	SC	2 1/2	3	3 3/16	1 3/4	2 11/16	2 3/8	3/16	2.7
	C-2305	5.0	100	300	1500	Leads	SC	2 1/4	2 11/16	2 11/16	1 1/2	2 3/8	2	3/16	1.5
	RC-8105	8.0	105	100	2500	Leads	SC	2 3/8	3 1/2	3 1/2	2	3 3/8	2 11/16	3/16	3.7
	RS-8105	8.0	105	100	2500	Lugs	SC	2 3/8	3 1/2	3 3/4	2	3 3/8	2 11/16	3/16	3.7
	RC-12105	12.0	105	170	2500	Leads	SC	2 3/8	3 1/2	3 1/2	2	3 3/8	2 11/16	3/16	4.0
c	RS-12105	12.0	105	170	2500	Lugs	SC	2 3/8	3 1/2	3 3/4	2	3 3/8	2 11/16	3/16	4.0
	C-1001	10.5	110	225	3000	Leads	A	2 1/8	4	2 5/8	3 3/16	—	3 3/8	3/16	2.3
	C-2704	9.0	125	250	1500	Leads	A	1 7/8	3 3/4	2 3/8	3 1/8	—	2 3/4	3/16	1.8
	C-2303	2.5	130	100	2000	Leads	A	1 5/8	3 3/4	2	2 13/16	—	2 3/8	3/16	1.0
	C-1421	7.0	140	165	3000	Leads	C	2 1/2	2 3/4	3 3/8	2	1 3/4	2 3/8	3/16 x 3/8	2.5
	C-2304	2.3	150	60	1500	Leads	A	1 3/4	3 3/4	2	2 13/16	—	2 3/8	3/16	1.0
	C-2309	3.0	150	90	2000	Leads	A	1 7/8	3 3/4	2 3/8	3 3/8	—	2 3/4	3/16	1.7
	C-2335	7.0	150	170	1500	Leads	SC	2 1/2	3	3 1/16	1 3/4	2 11/16	2 3/8	3/16	2.3
	C-1710	7.0	150	200	1500	Leads	A	2	4	2 5/8	3 3/16	—	3 3/8	3/16	2.2
	RC-8150	8.0	150	100	2500	Leads	SC	3 3/4	4	3 3/8	2 1/4	3 1/2	3	3/16	5.2
	RS-8150	8.0	150	100	2500	Lugs	SC	3 3/4	4	4 1/4	2 1/4	3 1/2	3	3/16	5.2
	RC-12150	12.0	150	150	2500	Leads	SC	3 3/4	4	3 3/8	2 1/4	3 1/2	3	3/16	5.5
	RS-12150	12.0	150	150	2500	Lugs	SC	3 3/4	4	4 1/4	2 1/4	3 1/2	3	3/16	5.5
	C-1410	4.0	175	100	3000	Leads	C	2 1/2	2 3/4	3 3/4	2	1 3/4	2 3/8	3/16 x 3/8	2.4
	C-2327	1.5	200	85	1500	Leads	A	1 1/2	2 7/8	1 5/8	2 3/8	—	2	3/16	0.7
	C-2325	2.0	200	60	1500	Leads	A	1 7/8	3 3/4	2 3/8	3 3/8	—	2 3/4	3/16	1.8
	C-1411	4.5	200	80	3000	Leads	C	2 13/16	4 1/4	3 1/2	2 1/4	2	2 3/4	3/16	3.5
	C-1646	5.0	200	90	5000	Leads	C	3 1/8	3 1/2	3 3/8	2 1/2	2 3/16	3	3/16 x 3/8	4.5
d	RC-8200	8.0	200	85	2500	Leads	SC	3 11/16	4 7/16	4 5/16	2 3/4	3 7/8	3 1/4	3/16	7.0
	RS-8200	8.0	200	85	2500	Lugs	SC	3 11/16	4 7/16	4 11/16	2 3/4	3 7/8	3 1/4	3/16	7.0
	C-1721	8.5	200	120	3000	Leads	NV	2 13/16	2 5/8	3 7/16	2 1/4	2 1/2	3 3/8	3/16 x 3/16	4.4
	C-2705	10.0	200	150	2500	Leads	C	2 13/16	3 3/16	3 1/2	2 1/4	2 5/16	3 3/16	3/16 x 3/8	4.5
	RC-12200	12.0	200	140	2500	Leads	SC	3 11/16	4 7/16	4 5/16	2 3/4	3 7/8	3 1/4	3/16	7.0
	RS-12200	12.0	200	140	2500	Lugs	SC	3 11/16	4 7/16	4 11/16	2 3/4	3 7/8	3 1/4	3/16	7.0
	C-1703	4.0	250	60	3000	Lugs	NV	2 13/16	2 5/8	3 7/16	2 1/4	2 1/2	3 3/8	3/16 x 3/16	4.2
	C-1412	4.0	250	60	3000	Leads	C	2 13/16	3 3/8	3 1/2	2 1/4	2 5/8	3 3/8	3/16 x 3/8	4.3
	RC-8250	8.0	250	90	2500	Leads	SC	4 7/16	5 1/4	5 5/16	2 1/2	4 3/4	4 1/8	3/16	10.5
	RS-8250	8.0	250	90	2500	Lugs	SC	4 7/16	5 1/4	5 5/16	2 1/2	4 3/4	4 1/8	3/16	10.5
	C-2343	0.75	300	32	1500	Leads	A	1 3/8	2 7/8	1 5/8	2 3/8	—	2	3/16	0.7
	C-2326	1.0	300	43	1500	Leads	A	2	3 3/4	2 3/4	3 3/8	—	2 3/4	3/16	1.7
	C-2334	2.8	300	60	1500	Leads	A	2 1/8	4	2 5/8	3 3/16	—	3 3/8	3/16	2.5
	* R-63	6.0	300	35	7500	Terms	SC	5 7/16	5 7/8	6 1/16	3 1/2	5 3/8	4 3/4	1/4	16.5
	RC-8300	8.0	300	60	3500	Leads	SC	4 7/16	5 1/4	5 5/16	2 1/2	4 3/4	4 1/8	3/16	12.5
	RS-8300	8.0	300	60	3500	Lugs	SC	4 7/16	5 1/4	5 5/16	2 1/2	4 3/4	4 1/8	3/16	12.5
	C-1722	8.0	300	80	3000	Leads	NV	3 3/4	3	4 3/16	3	2 1/2	3 3/8	3/16 x 3/16	7.3
	C-2308	8.0	300	80	3000	Leads	C	3 3/4	4	4 11/16	3	2 13/16	3 3/8	3/16 x 3/8	7.8

* Available until stock is depleted.

Insulation Test Voltage: Twice Allowable RMS Working Voltage plus 1000 Volts.

SECTION 5600

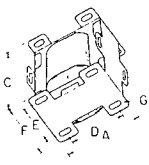

L

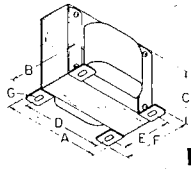

NH

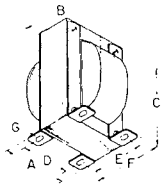

NV

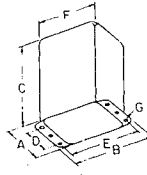

SC

STANCOR
COMMERCIAL
filter chokes

SMOOTHING CHOKES: INDUCTANCE TOLERANCE-MINUS 15% PLUS 50% AT 10 VOLTS 60 CYCLES

Catalog No.	Inductance Henries	DCMA	DC. Res. ohms	Insul. Test RMS Volts	Termination	Style	Dimensions							WT Lbs
							A	B	C	D	E	F	G	
C-1413	8.0	300	80	3000	Lugs	C	3 3/4	4	4 11/16	3	2 13/16	3 3/8	3/16 x 3/8	7.8
R-103	10.0	300	40	2500	Terms	SC	6 1/4	6 1/2	7 7/16	4 1/4	6	5 1/8	1/4	22.0
C-2706	2.6	310	50	1500	Leads	C	2 1/2	3 3/8	3 1/8	2	2 3/8	3	3/16 x 3/8	4.0
C-2347	1.0	350	40	1500	Leads	A	1 3/4	3 1/4	2	2 13/16	—	2 3/8	3/16	1.0
C-2328	0.8	375	25	1500	Leads	A	1 3/8	3 3/4	2 3/8	3 3/8	—	2 3/4	3/16	1.5
C-2709	2.0	400	40	2500	Leads	A	2 1/8	4	2 3/8	3 3/8	—	3 3/8	3/16	2.3
C-1414	7.5	400	60	5000	Lugs	C	3 3/4	5	4 11/16	3	3 13/16	4 3/8	3/16 x 3/8	11.8
R-65	6.0	500	35	9000	Terms	FS1	7 1/2	3 3/4	7	4 3/4	5 1/4	6 3/8	3/8 x 3/4	35.0
C-1415	6.0	500	75	7500	Terms	FS	5 5/8	5 1/2	7 7/8	4 5/8	3 5/8	4 5/8	3/8 x 1/2	23.7
R-105	10.0	500	40	9000	Terms	FS1	7 1/2	4	7	4 3/4	4 3/4	7 7/8	3/8 x 3/4	35.0
C-2708	0.32	600	10	1500	Leads	A	1 5/8	3 3/4	2	2 13/16	—	2 3/8	3/16	1.3

SWINGING CHOKES: INDUCTANCE MEASURED AT 50 VOLTS 60 CYCLES

C-1718	{ 13.5 3.5 150 }	130	2000	Leads	C	2 1/2	2 3/8	3 3/8	2	1 5/8	2 1/4	3/16 x 3/8	2.3
C-1400	{ 12.0 2.0 17.5 175 }	100	3000	Leads	C	2 1/2	2 3/4	3 3/8	2	1 3/4	2 3/8	3/16 x 3/8	2.4
C-1401	{ 12.0 2.0 20 200 }	80	3000	Leads	C	2 13/16	3 1/4	3 1/2	2 1/4	2	2 3/4	3/16 x 3/8	3.5
C-1645	{ 12.0 2.0 20 200 }	90	5000	Leads	C	3 3/8	3 1/2	3 3/8	2 1/2	2 3/16	3	3/16 x 3/8	4.5
C-1702	{ 12.0 2.0 25 250 }	60	3000	Lugs	NV	2 13/16	2 3/4	3 3/16	2 1/4	2 1/2	3 1/8	3/16 x 3/8	4.3
C-1402	{ 12.0 2.0 25 250 }	60	3000	Leads	C	2 13/16	3 5/8	3 1/2	2 1/4	2 3/8	3 1/8	3/16 x 3/8	4.3
C-1720	{ 20.0 4.0 30 300 }	80	3000	Leads	NV	3 3/4	3 3/8	4 1/16	3	2 1/2	3 1/8	3/16 x 3/8	7.2
C-2307	{ 20.0 4.0 30 300 }	80	3000	Leads	C	3 3/4	4	4 1/16	3	2 13/16	3 3/8	3/16 x 3/8	7.9
C-1403	{ 20.0 4.0 30 300 }	80	5000	Lugs	C	3 3/4	4	4 1/16	3	2 13/16	3 3/8	3/16 x 3/8	7.7
C-1404	{ 17.0 3.0 40 400 }	60	5000	Lugs	C	3 3/4	5	4 1/16	3	3 13/16	4 5/8	3/16 x 3/8	11.7
C-1405	{ 16.0 4.0 50 500 }	75	7500	Terms	FS	5 5/8	5 1/4	7 7/8	4 5/8	3 3/8	4 5/8	3/8 x 1/2	24.3

HIGH CURRENT CHOKES: INDUCTANCE MEASURED AT 1 VOLT 60 CYCLES

Catalog No.	Inductance Millihenries	DC Amps	DC. Res. ohms	Insul. Test RMS Volts	Termination	Style	Dimensions							WT Lbs
							A	B	C	D	E	F	G	
TC-1	3.0	1.0	.25	1000	Leads	A2	1 1/8	—	1 3/16	1 3/16	7/16	1 1/2	3/32	0.6
TC-2	11.0	1.0	.75	1000	Leads	A2	1 1/8	—	1 3/16	1 3/16	7/16	1 1/2	3/32	0.6
C-2690	{ 300 or 75 }	1.0 2.0	3.0 .75	1500	Leads	NV	2 13/16	3	3 7/16	2 1/4	2 3/8	3 3/4	3/16 x 3/8	5.0
C-2685	35	2.0	.75	1500	Leads	NH	2 5/8	2 1/8	2 5/16	2 3/16	2	2 5/8	3/16 x 3/8	1.9
C-2691	{ 80 or 20 }	2.5 5.0	.60 .15	1500	Leads	NV	3 1/8	3 1/2	3 3/16	2 1/2	3	3 3/8	3/16 x 3/8	7.0
C-2686	25	4.0	.425	1500	Leads	NH	3 3/8	2 5/8	2 7/8	2 13/16	2 3/8	2 3/4	3/16 x 3/8	3.4
C-2687	10	8.0	.15	1500	Leads	NH	3 3/4	3	3 3/16	3 1/8	2 1/2	3 3/8	3/16 x 3/8	5.3
C-2688	10	12.5	.11	1500	Leads	NH	4 1/8	2 3/8	3 1/2	3 3/16	2 3/8	3	3/16 x 3/8	5.9
C-2689	5	22.5	.03	1500	Leads	NH	4 1/2	4 3/8	3 13/16	3 3/4	3 1/2	4 1/8	3/16 x 3/8	11.9
C-2692	24	20	.12	1500	Self Leads	NV	4 1/8	5 1/4	5 1/4	3 1/2	4 1/4	4 7/8	3/16 x 3/8	21.2

TYPICAL INDUCTANCE CHARACTERISTIC CURVES

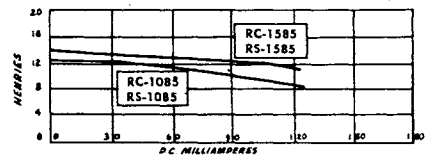
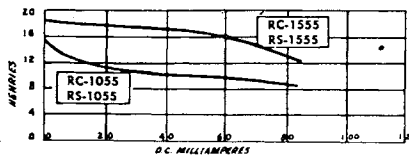
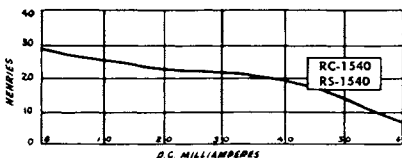

Insulation Test Voltage: Twice Allowable RMS Working Voltage plus 1000 Volts. *Available until stock is depleted.

STANCOR

COMMERCIAL

rectifier transformers

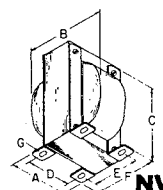
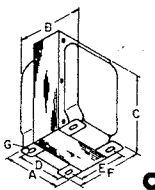

SILICON RECTIFIER POWER TRANSFORMERS: Primaries — 117 Volts 50/60 Cycle-Lead Wire Termination.

Catalog No.	Secondary #1		Secondary #2		Secondary #3		Style	Dimensions							WT. Lbs.
	Volts	DCMA †	Volts	Amps.	Volts	Amps.		A	B	C	D	E	F	G	
RP-400	400 C.T.	400	6.3	3.0	6.3	3.0	C	3 7/16	4 1/4	4 1/4	2 3/4	3 1/16	3 7/8	3/16 x 3/8	7.1
RP-600	300 C.T.	600	6.3	2.5	6.3	2.5	C	3 7/16	4 1/4	4 1/4	2 3/4	3 1/16	3 7/8	3/16 x 3/8	7.1
RP-800	200 C.T.	800	6.3	2.0	6.3	2.0	C	3 7/16	4 1/4	4 1/4	2 3/4	2 13/16	3 3/4	3/16 x 3/8	6.9
RP-1600	100 C.T.	1600	6.3	1.5	6.3	1.5	C	3 7/16	3 7/8	4 1/4	2 3/4	2 13/16	3 1/2	3/16 x 3/8	6.0
RP-2000	80 C.T.	2000	6.3	1.5	6.3	1.5	C	3 7/16	4	4 1/4	2 3/4	2 13/16	3 3/8	3/16 x 3/8	6.5
RP-2500	60 C.T.	2500	6.3	1.5	6.3	1.5	C	3 7/16	3 7/8	4 1/4	2 3/4	2 13/16	3 1/2	3/16 x 3/8	6.0

†Refer to operating. Conditions as shown below.

b	T Stancor No.	SR*	L Stancor No.	C1 (in MFD)	C2 (in MFD)	SPR*	D.C. Output		Rectifier Load
							Volts	MA.	
<p>FULL-WAVE C.T.</p>	RP-400	Four #F-4	C-2709	10	10	Yes	192	400	Capacitive
	RP-400	Four #F-4	C-2690	—	200	No	173	540	Inductive
	RP-600	Four #F-6	C-2690	80	80	Yes	190	600	Capacitive
	RP-600	Four #F-6	C-2690	—	125	No	126	1090	Inductive
	RP-800	Two #40-L	C-2690	40	150	Yes	105	800	Capacitive
	RP-800	Two #40-L	C-2690	—	350	No	86	1340	Inductive
	RP-1600	Two #40-L	C-2690	200	200	Yes	53	1600	Capacitive
	RP-1600	Two #40-L	C-2691	—	300	No	41	2600	Inductive
	RP-2000	Two #40-L	C-2690	500	500	Yes	47	2000	Capacitive
	RP-2000	Two #40-L	C-2686	—	1000	No	33	2950	Inductive
RP-2500	Two #40-LF	C-2691	500	500	Yes	31	2500	Capacitive	
RP-2500	Two #40-LF	C-2686	—	1000	No	23	3950	Inductive	
<p>FULL-WAVE BRIDGE</p>	RP-400	Four #F-4	C-1710	8	10	Yes	502	150	Capacitive
	RP-400	Four #F-4	C-1722	—	20	No	330	302	Inductive
	RP-600	Four #F-6	C-2334	8	20	Yes	322	305	Capacitive
	RP-600	Four #F-6	C-2690	—	125	No	285	425	Inductive
	RP-800	Four #F-6	C-2709	30	40	Yes	247	377	Capacitive
	RP-800	Four #F-6	C-2708	—	250	No	172	625	Inductive
	RP-1600	Four #F-4	C-2690	40	80	Yes	100	880	Capacitive
	RP-1600	Four #F-4	C-2690	—	300	No	88	1160	Inductive
	RP-2000	Four #F-4	C-2690	100	100	Yes	93	810	Capacitive
	RP-2000	Four #40-L	C-2690	—	250	No	71	1450	Inductive
RP-2500	Four #40-L	C-2690	200	200	Yes	70	1060	Capacitive	
RP-2500	Four #40-L	C-2690	—	500	No	50	1950	Inductive	
<p>FULL-WAVE DOUBLER</p>	RP-400	Four #F-6	C-1420	8	0.5	Yes	1040	75	Capacitive
	RP-600	Four #F-6	—	60	—	Yes	802	142	Capacitive
	RP-800	Two #F-6	—	80	—	Yes	536	188	Capacitive
	RP-1600	Two #F-6	C-2326	80	16	Yes	240	325	Capacitive
	RP-2000	Two #F-6	—	150	—	Yes	212	390	Capacitive
	RP-2500	Two #40-L	—	500	—	Yes	150	553	Capacitive

Note: Filtering shown permits maximum output ripple voltage of 3% or less.

*Quantity Shown is Total Number used in a given circuit. Rectifiers should be equivalent to Sarkes Tarzian numbers shown.

*Surge protection resistors are recommended when capacitor input filters are used. Allow 3.3 ohms per 70 volts R.M.S. applied voltage. Transformer secondary winding D.C. resistance may be used as part or all of the amount required.

FOR TRANSISTOR POWER SUPPLIES: Primary 117 Volts 60 Cycles — Lead Wire Termination.

Catalog No.	Secondary #1		Secondary #2		Style	Dimensions							WT. Lbs.
	Volts	Ampere	Volts	Ampere		A	B	C	D	E	F	G	
P-8197	50 C.T.	1.0 Amp. RMS	—	—	C	2 1/2	2 1/16	3 1/8	2	1 3/4	2 1/2	3/16 x 3/8	2.3
P-8198	54 C.T.	.5 Amp. RMS	6.3	.5 Amps. RMS	C	2 3/16	2 5/16	2 5/8	1 3/4	1 5/8	2 5/8	3/16 x 1/4	1.7
P-8193A	17/18	6 Amps. RMS	—	—	NV	3 1/8	3 1/4	3 13/16	2 1/2	2 3/8	3 1/8	3/16 x 3/8	6.0
P-8194A	36	3 Amps. RMS	36	3 Amps. RMS	NV	3 3/4	3 3/4	4 1/8	3	3	3 1/16	3/16 x 3/8	10
P-8196	80 C.T.	1.2 Amps. DC	—	—	C	2 13/16	3 3/8	3 1/2	2 1/4	2 3/8	3 1/8	3/16 x 3/8	4.5

• New part number

*Write for Bulletin #587 for Rectifier Circuits showing D.C. Voltages and allowable D.C. Current.

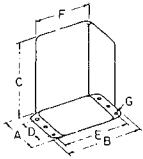

SC

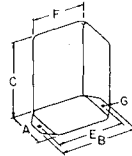

TD

SILICON OR SELENIUM RECTIFIER TRANSFORMERS:

Primary — 117 Volts 50/60 Cycles.
Solder Lug Termination

These transformers have been designed to operate in full-wave center tap or bridge rectifier circuits. The D.C. voltages shown are approximate since they depend on the internal drop of the rectifiers used.

Primary taps and an additional buck or boost tapped winding provides a wide range of output voltages. For detailed terminal connections, output voltages, etc. write for bulletin 518-R. For matching high current chokes see page 22.

FULL-WAVE C. T.

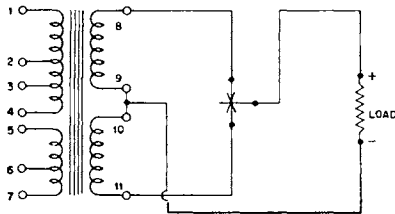

FULL-WAVE BRIDGE

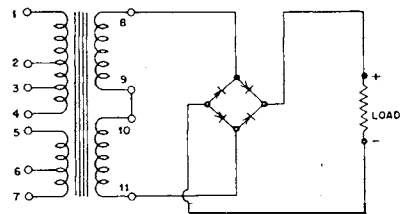

Catalog No.	Rectifier Circuit	Range of Applied A.C. Volts Under Load (Approx.)	Output Resistive or Inductive Load Max D.C.		Output Capacitive Load* Max. D.C.		Style	Dimensions							WT. Lbs.
			Volts	Amps.	Volts	Amps.		A	B	C	D	E	F	G	
RT-201	C. T.	11.7 to 29.4	11.2	2.0	13.8 ¹	2.0	NV	2 1/2	2 3/8	3 1/8	2	2 1/8	2 1/16	3/16 x 5/16	2.5
	Bridge	11.1 to 28.5	23.0	1.25	30.0 ²	1.25									
RT-202	C. T.	12.0 to 29.8	11.1	4.0	14.7 ³	4.0	NV	2 1/16	2 3/4	3 7/16	2 1/4	2 3/8	3 1/16	3/16 x 3/16	3.8
	Bridge	12.0 to 29.8	24.3	2.0	33.0 ¹	2.0									
RT-204	C. T.	11.7 to 29.2	12.0	8.0	14.5 ⁴	8.0	NV	3 1/8	3 1/2	3 1/16	2 1/2	2 7/8	3 3/16	3/16 x 3/16	6.1
	Bridge	11.6 to 29.2	24.0	4.0	32.4 ³	4.0									
RT-206	C. T.	12.0 to 29.7	11.5	12.0	14.4 ⁵	12.0	NV	3 7/16	4	4 3/16	2 3/4	3 1/4	3 1/16	3/16 x 3/16	9.1
	Bridge	12.0 to 29.7	24.0	6.0	32.0 ⁶	6.0									
RT-208	C. T.	12.1 to 29.2	11.4	15.0	14.8 ⁷	15.0	NV	3 3/4	5	4 1/16	2 1/16	3 3/4	4 7/16	3/16 x 3/16	12.6
	Bridge	12.1 to 29.2	23.7	8.0	32.5 ⁴	8.0									
RT-2012	C. T.	12.2 to 29.0	11.4	22.5	14.3 ⁸	22.5	NV	4 3/8	5 7/8	5 1/16	3 1/2	4 1/4	4 1/16	3/16 x 3/16	20.5
	Bridge	12.2 to 29.0	23.5	12.0	33.0 ⁵	12.0									
RT-408	Bridge	25.0 to 53.5	44.0	8.0	63.0 ⁴	8.0	NV	4 3/8	6 3/4	5 1/16	3 1/2	5 1/4	5 1/16	3/16 x 3/16	26.5
RT-4012	Bridge	25.0 to 53.0	43.5	12.0	60.0 ⁵	12.0	NV	5 3/8	6	7 1/8	4 5/8	5 1/2	6 1/2	3/8 x 1/2	34

*MFD Filter Capacitor 1-1000, 2-500, 3-2000, 4-4000, 5-6000, 6-3000, 7-7500, 8-12000.

TRANSISTOR INVERTER TRANSFORMERS:

Write for Bulletin CT-43 for Circuit Diagram.
Lead Wire Termination.

Catalog No.	Input	Output Volts	MADC	Style	Dimensions							WT. Lbs.
					A	B	C	D	E	F	G	
*DCT-1	12 Volts D.C.	275 D.C.	125	TD	1 7/8	2 7/16	2 1/4	—	2 1/8	1 7/8	3/16	0.9
*DCT-2	12 Volts D.C.	250 D.C. or 500 D.C.	275 165	SC	2 1/4	2 1/16	2 1/16	1 1/2	2 3/8	2	3/16	1.5

TRANSISTOR INVERTER TRANSFORMER:

With 12 Volts D.C. and 117 Volts 60 Cycle Primary.
Write for Bulletin 596 for Circuit Diagram.

Catalog No.	D.C. Output		Filament Winding	Style	Dimensions							WT. Lbs.
	Volts	DCMA			A	B	C	D	E	F	G	
P-8195	280	150 CCS 250 ICAS	12.6 V. @ 3 Amps. (with 117 V. Pri)	C	3 1/8	3 1/16	3 3/8	2 1/2	2 3/8	3 3/8	3/16 x 3/8	6.0

SPECIAL VIBRATOR TRANSFORMERS:

With D.C. and 117 Volts 60 Cycle Primary.
Lead Wire Termination.

Catalog No.	D.C. Pri.	Plate Winding		Buffer Cap.	Filament Winding		Style	Dimensions							WT. Lbs.
		A.C. Volts	DCMA		Volts	Amps.		A	B	C	D	E	F	G	
P-6166	6 V.	350-0-350	135	.01 mfd	6.3	2.25	C	3 3/4	3 3/4	4 1/16	3	2 3/16	3 3/8	3/16 x 3/8	6.9
P-6496	12 V.	350-0-350	100	.005 mfd	12.6 C.T.	2.0	C	3 3/4	4	4 1/16	3	2 1/16	3 3/8	3/16 x 3/8	7.9

*Available until stock is depleted.

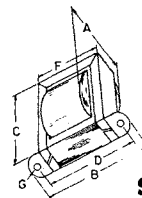
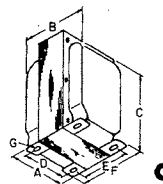
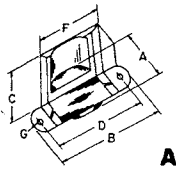

RECTIFIER TRANSFORMERS: Primary 117 Volts 60 Cycles—Lead Wire Termination

Multiple Primary and Secondary Taps offer a wide selection of output Voltages. All D.C. current ratings are based on capacitor input Filtering. Max. D.C. Ma For TP-1 is for each Secondary.

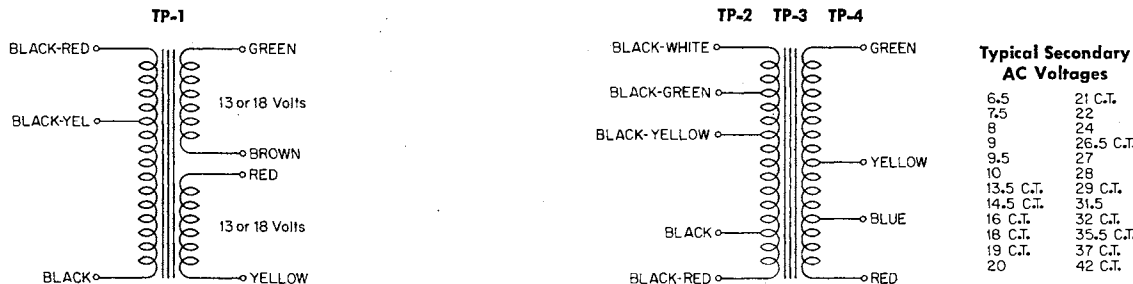

Typical Secondary AC Voltages

6.5	21 C.T.
7.5	22
8	24
9	26.5 C.T.
9.5	27
10	28
13.5 C.T.	29 C.T.
14.5 C.T.	31.5
16 C.T.	32 C.T.
18 C.T.	35.5 C.T.
19 C.T.	37 C.T.
20	42 C.T.

a	Catalog No.	MAX. D.C. MA.			Style	Dimensions							Wt. Lbs.
		Full-Wave CT	Bridge	Half-Wave		A	B	C	D	E	F	G	
	TP-1	1500	900	450	C	2½	3	3½	2	2	2½	¾ x ¾	2.7
	TP-2	150	100	50	A	1½	2½	1½	2½	—	2	¾	0.7
	TP-3	400	300	150	A	2½	3¾	2½	3½	—	2¾	¾	1.5
	TP-4	1500	1000	500	C	2½	3½	3½	2	2½	2¾	¾ x ¾	3.2

VERSATILE LOW CURRENT CONTROL TRANSFORMERS: Primary 117 Volts 50/60 Cycles Lead Wire Termination

Three isolated 12 Volt Secondaries (one with a center tap) provide many combinations of output voltages and current by series or parallel combinations.

b	Catalog No.	Amperes Each Sec.	Style	Dimensions							Wt. Lbs.
				A	B	C	D	E	F	G	
	●P-8361	.10	S	1½	2	1¾	1¾	—	1½	¾	.36
	●P-8362	.15	S	1¾	2½	2	2	—	1½	¾	.60
	●P-8363	.25	S	1¾	2½	2½	2½	—	2	¾	.85
	●P-8364	.50	S	2½	2½	2½	2½	—	2	¾	1.25

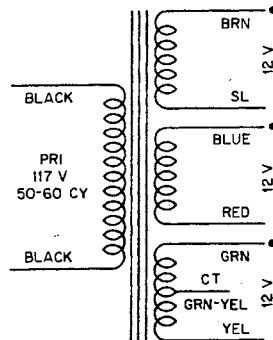

MINIATURIZED CONTROL TRANSFORMERS: Primary 117 Volts 60 Cycles Secondary 12 Volts—Lead Wire Termination

c	Catalog No.	Secondary Amperes			Style	Dimensions							Wt. Lbs.
		RMS	Bridge	Half-Wave		A	B	C	D	E	F	G	
	●P-8390	.150	.100 DC	.050 DC	A	1¼	2½	1¼	1¼	—	1½	¾	.25
	●P-8391	.350	.225 DC	.110 DC	A	1½	2½	1½	2	—	1¾	¾	.35
	●P-8392	.700	.450 DC	.225 DC	A	1½	2½	1½	2½	—	2	¾	.60
	●P-8393	1.200	.750 DC	.375 DC	A	1½	3¼	2	2½	—	2½	¾	.85

MINIATURIZED CONTROL TRANSFORMERS: Primary 117 Volts 60 Cycles Secondary 24 Volts C.T.—Lead Wire Termination

d	Catalog No.	Secondary Amperes			Style	Dimensions							Wt. Lbs.
		RMS	Full-Wave CT	Bridge		A	B	C	D	E	F	G	
	●P-8394	.085	.135 DC	.065 DC	A	1¼	2½	1¼	1¼	—	1½	¾	.25
	●P-8395	.200	.275 DC	.135 DC	A	1½	2½	1½	2	—	1¾	¾	.35
	●P-8396	.400	.550 DC	.270 DC	A	1½	2½	1½	2½	—	2	¾	.60
	●P-8397	.700	.925 DC	.450 DC	A	1½	3¼	2	2½	—	2½	¾	.85

●New Part Number

SECTION 5600

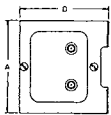

NCF & PCF

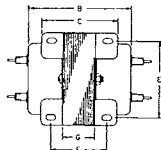

PCC

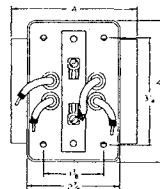

STANCOR
COMMERCIAL
control transformers

NORMAL REACTANCE TYPE: Primary 115 Volts 50/60 Cycles — Lead Wire Termination.

Catalog Number	Secondary			Dimensions in Inches								Approx. Weight Lbs.
	Volts	Amps.	V-A Cap.	A	B	C	D	E	F	G		
NCF-1650	16	3.15	50	3	3 1/4	2 3/8	2 3/4	2 3/8	1 3/4	1	3 1/2	
NCF-2425	24	1.05	25	2 5/8	2 1/2	2 1/8	2 1/2	2 1/8	1 1/2	7/8	2 1/4	
NCF-2450	24	2.1	50	3	3 1/4	2 3/8	2 3/4	2 3/8	1 3/4	1	3 1/2	
NCF-2475	24	3.15	75	3 1/2	3 3/8	2 7/8	3 3/8	3	2 1/4	1 7/16	4 1/2	
NCF-24100	24	4.15	100	3 13/16	3 13/16	3 13/16	3 1/2	3 3/16	2 13/16	1 1/16	5 1/4	
NCF-24150	24	6.25	150	4 1/2	4 1/8	3 3/4	4	3 3/4	3	1 1/2	8 1/2	
NCF-3250	32	1.55	50	3	3 1/4	2 3/8	2 3/4	2 3/8	1 3/4	1	3 1/2	
NCF-3275	32	2.35	75	3 1/2	3 3/8	2 7/8	3 3/8	3	2 1/4	1 7/16	4 1/2	
NCF-32150	32	4.7	150	4 1/2	4 1/8	3 3/4	4	3 3/4	3	1 1/2	8 1/2	
NCF-1550	550	(NL)	50	2 7/8	2 7/8	2 7/8	3 1/2	2 1/4	2 1/8	1 1/8	3 1/2	

POWER CIRCUIT TRANSFORMERS: Primary 50/60 Cycles. Lead Wire Termination.

Catalog Number	Primary Volts	Secondary			Dimensions in Inches								Weight Lbs.
		Volts	Amps.	V-A Cap.	A	B	C	D	E	F	G		
PCF-2025	230	115	.25	25	3	3	2 1/8	2 13/16	2 3/8	1 1/2	3/4	2	
PCF-2050	230	115	.45	50	3	3 1/2	2 5/8	2 13/16	2 3/8	2	1 1/4	2 3/4	
PCF-24075	230/460	115	.65	75	3 1/2	3 3/8	2 7/8	3 3/16	3	2 1/4	1 7/16	4 1/4	
PCF-24250	230/460	115	2.2	250	5 1/4	4 7/16	3 13/16	4 7/16	4 1/4	3	1 11/16	12	

POWER CIRCUIT TRANSFORMERS: Conduit Box Mounting

Catalog Number	Primary		Secondary			Dimensions in Inches					Weight Lbs.
	Volts	Cycles	Volts	Amps.	V-A Cap.	A	B	C	G		
*PCC-24250	230/460	50-60	115	2.2	250	5 1/4	4 7/16	4 7/16	1 11/16	11 1/2	

CONTROL TRANSFORMERS: Primary — 115/230 Volts 50/60 Cycles — Solder Lug Termination.

Typical Applications: Automatic Assembly equipment. Relays, Solenoids, Small Motors, Speed Changers, Recording Device, Pumps, Electronic Tubes, Heating Elements, Elevators, Door Openers, Automatic Musical Instruments, Low Voltage Lighting Signal Lamps, Spark Plug Testers, Control Valves for Fluids and Gases, Fans and Blowers, Mechanical and Electrical Signs and similar applications.

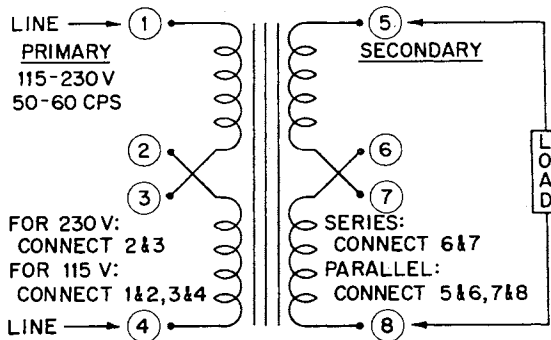
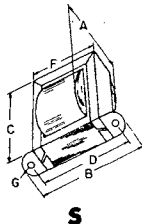
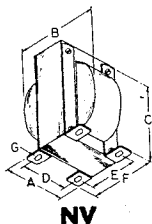

Catalog No.	VA Cap.	Secondary		Style	Dimensions							WT. Lbs.
		Parallel	Series		A	B	C	D	E	F	G	
P-6375	12	6V @ 2A	12V @ 1A	S	1 3/8	2 7/8	2 3/8	2 3/8	—	2	3/16	1.0
P-6376	24	6V @ 4A	12V @ 2A	S	1 7/8	3 1/8	2 3/4	2 13/16	—	2 1/4	3/16	1.5
P-6377	48	12V @ 4A	24V @ 2A	S	2 1/4	3 3/8	3 3/8	3 3/8	—	2 3/8	3/16	2.5
P-6378	96	12V @ 8A	24V @ 4A	NV	2 13/16	2 7/8	3 3/8	2 1/4	2 1/4	2 3/8	3/16 x 3/16	4.2
P-6379	192	12V @ 16A	24V @ 8A	NV	3 3/16	3 3/8	4 3/16	2 3/4	3	3 13/16	3/16 x 3/16	8.0

*Available until stock is depleted.

SECTION 5600

STANCOR
COMMERCIAL
isolation/auto
transformers

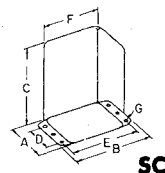
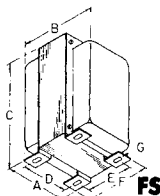
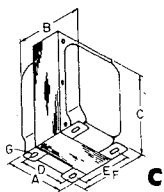

STEP-DOWN AUTO-TRANSFORMERS: Primary — 230 Volts 50/60 Cycles — Line Cord and Plug.
Secondary — 115 Volts — Standard Female Receptacle.

	Catalog No.	Watts	Style	Dimensions							Wt. Lbs.
				A	B	C	D	E	F	G	
a	P-6287	40	C	2 3/8	2 1/2	3 1/2	2	1 1/2	2 1/8	3/16 x 3/8	2.2
	P-5062	80	C	2 13/16	3 3/8	3 1/2	2 1/4	2 1/8	2 7/8	3/16 x 3/8	3.8
	P-5063	100	C	3 1/8	3 3/8	3 7/8	2 1/2	2 1/8	2 7/8	3/16 x 3/8	4.5
	P-5064	150	C	3 3/8	3 5/8	4 1/4	2 3/4	2 7/8	3 1/4	3/16 x 3/8	5.2
	P-5065	300	C	3 3/4	4 1/4	4 11/16	3	3 1/8	3 7/8	3/16 x 3/8	8.8
	P-6141	500	C	3 3/4	5 1/4	4 11/16	3	4 1/8	4 7/8	3/16 x 3/8	13.7
	P-6124	1000	FS	5 3/8	6 3/4	7 1/8	4 5/8	4	5	3/8 x 1/2	24.7
b	SD-50	50	SC	2 7/8	3 1/2	3 1/2	2	3 3/8	2 11/16	3/16	2.8
	SD-100	100	SC	3 11/16	4 3/16	4 3/16	2 3/4	3 7/8	3 1/4	3/16	4.3
	SD-150	150	SC	4 3/16	5 1/4	5 5/16	2 1/2	4 3/4	4 1/8	3/16	7.0
	SD-250	250	SC	4 7/16	5 1/4	5 3/16	2 1/2	4 3/4	4 1/8	3/16	8.8
	SD-500	500	SC	5 3/16	5 7/8	6 1/16	3 1/2	5 3/8	4 11/16	1/4	14.5
	SD-1000	1000	SC	6 1/8	6 1/2	7 1/16	4 1/4	6	5 1/8	1/4	22.5

LINE ADJUSTING AUTO-TRANSFORMERS: Primary — 50/60 Cycle. Line Cord and Selector Switch.
Secondary — Female Receptacle with Voltmeter.

	Catalog No.	Watts	Input Voltage	Output Voltage	Style	Dimensions							WT. Lbs.
						A	B	C	D	E	F	G	
c	PV-6441	150	65/75/90/100/115/130/145	115	C	3 3/4	5 3/8	5 1/2	3	4 3/16	5 1/8	3/16 x 3/8	6.4
	PV-6442	350	65/75/90/100/115/130/145	115	C	3 3/4	6 1/8	5 1/2	3	5 1/16	5 7/8	3/16 x 3/8	10.5
	PV-6443	500	65/75/90/100/115/130/145	115	C	3 3/4	6 7/8	5 1/2	3	5 13/16	6 5/8	3/16 x 3/8	15
	PV-6444	750	65/75/90/100/115/130/145	115	C	4 5/8	8 1/8	6 3/16	3 1/2	6 3/8	7 3/4	1/4 x 3/8	19

LINE ADJUSTING ISOLATION TRANSFORMERS: Primary — 50/60 Cycles. Line Cord and Selector Switch.
Secondary — Standard Female Receptacle.

d	IS-50	50	105/115/125	††125/115/105	SC	3 11/16	4 7/16	4 11/16	2 3/4	3 3/8	3 1/4	3/16	5
	IS-100	100	105/115/125	††125/115/105	SC	4 7/16	5 1/4	5 5/16	2 1/2	4 3/4	4 1/8	3/16	8.5
	IS-150	150	105/115/125	††125/115/105	SC	5 5/16	5 7/8	6 1/16	3 1/2	5 3/8	4 11/16	1/4	12.5
	IS-250	250	105/115/125	††125/115/105	SC	5 5/16	5 7/8	6 1/16	3 1/2	5 3/8	4 11/16	1/4	18.3

STRAIGHT ISOLATION: ELECTROSTATIC SHIELDS GROUNDED TO CORE: Primary — 50/60 Cycles. Line Cord.
Secondary — Female Receptacle except P-6411 lead termination.

e	•P-6411	15	115	115	A	1 7/8	3 1/4	2	2 13/16	—	2 3/8	3/16	1.0
	P-6410	50	115	115	C	2 13/16	3 3/8	3 1/2	2 1/4	1 7/8	2 3/8	3/16 x 3/8	3.7
	P-6160†	100	105/115/125	115	C	3 3/4	3 3/4	4 11/16	3	2 1/8	3 3/8	3/16 x 3/8	7.0
	P-6371	175	117	117	SC	4 7/16	5 1/4	5 3/16	2 1/2	4 3/4	4 1/8	3/16	9.0
	P-6161†	250	105/115/125	115	C	3 3/4	5 1/2	4 11/16	3	4 5/16	5 1/8	3/16 x 3/8	14.2
	P-6298†	500	105/115/125	115	FS	5 5/8	7 1/8	7 3/8	4 3/8	4 1/4	5 1/4	3/8 x 1/2	28
	P-6125▲	1000	105/115/125	115	FS	5 5/8	7 3/4	7 1/8	4 5/8	5	6	3/8 x 1/2	35
	P-6123▲	1500	105/115/125	115	FS	5 5/8	9	7 7/8	4 5/8	6 1/4	7 1/4	3/8 x 1/2	50

STEP-DOWN ISOLATION: ELECTROSTATIC SHIELDS GROUNDED TO CORE Primary — 50/60 Cycles. Line Cord.
Secondary — Female Receptacle.

f	P-6383†	100	210/230/250	115	C	3 3/4	3 3/4	4 11/16	3	2 7/16	3 3/8	3/16 x 3/8	7.3
	P-6385†	250	210/230/250	115	C	3 3/4	5 1/2	4 11/16	3	4 5/16	5 1/8	3/16 x 3/8	14.2
	P-6387†	500	210/230/250	115	FS	5 5/8	7 1/8	7 3/4	4 3/8	4 1/4	5 1/4	3/8 x 1/2	29.5
	P-6389▲	1000	210/230/250	115	FS	5 5/8	7 1/8	7 1/8	4 5/8	5	6	3/8 x 1/2	34
	P-6390▲	1500	210/230/250	115	FS	5 5/8	9 3/8	7 7/8	4 5/8	6 1/2	7 1/2	3/8 x 1/2	50

ISOLATION TESTING TRANSFORMERS: ELECTROSTATIC SHIELD GROUNDED TO CORE Primary—50/60 Cycles. Line Cord.
Secondary—Three Female Receptacles.

g	P-6415	350	117	105/115/125	C	4 5/8	5 11/16	5 3/8	3 1/2	4 11/16	5 3/16	1/4 x 5/8	17
----------	--------	-----	-----	-------------	---	-------	---------	-------	-------	---------	--------	-----------	----

STEP UP — STEP-DOWN AUTO-TRANSFORMERS: 208 V./230 V., or 230 V./208 V. 60 Cy.
(Three wire Line Cord and Receptacle) by means of Connection.
Change inside outlet Box.

	Catalog No.	Application	Style	Height	Base Area	Mtg Ctrs	Wt. Lbs.
j	PSU-2000	2.3 KVA for 1/2 to 1 hp Motors	PSU	3 1/2	3 3/4 x 6 1/2	2 7/8 x 3 3/4	9
	PSU-3000	3 KVA for 1 to 2 hp Motors	PSU	4	4 1/2 x 6	2 1/2 x 3 3/4	10

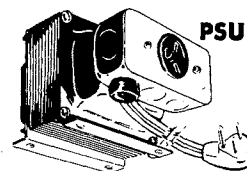

† Has Primary Switch.

▲ Has Primary Terminals.

†† With 115 volt input.

* Available until stock is depleted

SECTION 5600

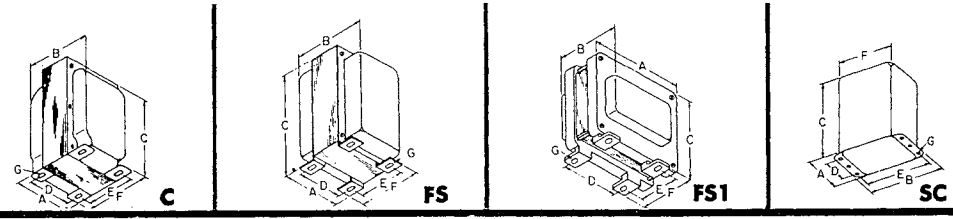

FOR REACTOR INPUT SYSTEMS: All Primaries — 50/60 Cycles.

	Catalog No.	Plate Winding AC Volts	DC Volts	DCMA		Primary Volts	Style	Dimensions							WT. Lbs.
				CCS	ICAS			A	B	C	D	E	F	G	
a	P-8040▲	500-40-0-500	{ 400 40 }	300	375	115	C	3 3/4	4 3/8	4 1/16	3	3 3/16	4 1/4	3/16 x 3/8	9.8
	P-8041▲	{ 615-520-40-0 520-615 }	{ 500 400 40 }	250	310	115	C	3 3/4	5 1/4	4 1/16	3	4 1/16	4 7/8	3/16 x 3/8	13.6
	P-45††	{ 675-575-0 575-675 }	{ 500 400 }	250	325	115/230	SC	4 1/16	5 1/4	5 3/16	2 1/2	4 3/4	4 1/8	3/16	12.0
	P-8042▲	{ 770-510-40-0 510-770 }	{ 600 400 40 }	300	375	115	C	3 3/4	6 1/2	4 1/16	3	5 5/16	6 1/8	3/16 x 3/8	18.0
	P-67††	{ 900-735-0 735-900 }	{ 750 600 }	250	325	115/230	SC	4 1/16	5 1/4	5 5/16	2 1/2	4 3/4	4 1/8	3/16	13.5
	P-8043▲	{ 950-750-40-0 750-950 }	{ 750 600 40 }	300	375	115	FS	5 3/8	6 3/4	7 1/8	4 3/8	4	5	3/8 x 1/2	29.0
b	*P-8044▲	{ 1200-0-1200† 535-0-535 940-1230 }	{ 1000 400 1000 750 }	150	190	115	FS	6 1/8	8 1/4	7 3/8	4 3/4	4	5	3/16 x 3/4	29.8
	P-8025▲	{ 1230-940-0 940-1230 }	{ 1000 750 }	400	500	115	FS	5 3/8	7 1/2	7 1/8	4 3/8	4 3/4	5 3/4	3/8 x 1/2	35.0
	P-1240††	{ 1425-0-1425† 600-0-600 }	{ 1250 400 }	150	200	115/230	SC	5 5/16	5 7/8	6 1/16	3 1/2	5 3/8	4 1/16	1/4	26.0
	P-8026▲	{ 1475-1175-0 1175-1475 }	{ 1250 1000 }	300	375	115	FS	5 3/8	7 1/2	7 1/8	4 3/8	4 3/4	5 3/4	3/8 x 1/2	36.5
	P-8027▲	{ 1510-1210-0 1210-1510 }	{ 1250 1000 }	500	625	115	FS	5 3/8	8 1/4	7 1/8	4 3/8	5 1/2	6 1/2	3/8 x 1/2	45.2
	P-1512††	{ 1710-1430-0 1430-1710 }	{ 1500 1250 }	300	425	115/230	FS-1	7 1/2	7	7	4 3/4	6	7 1/8	3/8 x 3/4	43.0
	P-8028▲	{ 1740-1460-0 1460-1740 }	{ 1500 1250 }	300	375	115	FS	5 3/8	7 3/4	7 1/8	4 3/8	5	6	3/8 x 1/2	38.7
	P-8029▲	{ 1775-1500-0 1500-1775 }	{ 1500 1250 }	500	625	115/230	FS	7 1/4	8 1/8	9	6	5 3/8	6 7/8	7/16 x 3/8	65.0
P-8031▲	{ 2075-1775-0 1775-2075 }	{ 1750 1500 }	500	625	115/230	FS	7 1/4	8 1/8	9	6	5 3/8	6 7/8	7/16 x 3/8	65.0	
c	P-8030▲	{ 2100-1800-0 1800-2100 }	{ 1750 1500 }	300	375	115	FS	5 3/8	7 1/4	7 1/8	4 3/8	5 1/2	6 1/2	3/8 x 1/2	45.8
	P-8033▲	{ 2375-2065-0 2065-2375 }	{ 2000 1750 }	500	625	115/230	FS	7 1/4	8 3/8	9	6	5 3/8	7 1/8	7/16 x 3/8	77.0
	P-8032▲	{ 2400-2100-0 2100-2400 }	{ 2000 1750 }	300	375	115	FS	5 3/8	8	7 1/8	4 3/8	6 1/4	7 1/4	3/8 x 1/2	46.0
	P-2520††	{ 2820-2260-0 2260-2820 }	{ 2500 2000 }	300	425	115/230	FS-1	8 7/8	7 1/2	8 1/2	5 1/2	6 3/8	8 1/8	3/8	71.0
	P-8034▲	{ 2900-2385-0 2385-2900 }	{ 2500 2000 }	300	375	115/230	FS	7 1/4	8 1/8	9	6	5 3/8	6 7/8	7/16 x 3/8	62.8
	P-2126††	{ 2900-2320-0 2320-2900 }	{ 2600 2100 }	500	700	115/230	FS	7 1/4	10 1/2	9	6	7 3/4	9	7/16 x 3/8	95.0
	P-8035▲	{ 2950-2375-0 2375-2950 }	{ 2500 2000 }	500	575	115/230	FS	7 1/4	9 3/8	9	6	7 1/16	8 3/8	7/16 x 3/8	80.0
P-4353††	{ 4600-4050-3400 0-3400-4050 4600 }	{ 4000 3500 3000 }	600	800	115/230	FS-1	13 3/8	10	12 3/4	9	8 7/8	10 1/2	1/2	150.	

WITH PLATE LEADS OUT OF TOP: For Reactor Input Systems. All Primaries — 50/60 Cycles.

d	PT-8311††	1200-0-1200	1000	225	280	117	C	3 3/4	5 1/4	4 1/16	3	4 1/16	4 7/8	3/16 x 3/8	13.0
	PT-8312††	1200-0-1200	1000	325	405	117	C	4 5/8	6 3/4	5 3/8	3 1/2	5 3/8	6 1/4	1/4 x 5/8	22.5
	PT-8313††	1475-0-1475	1250	250	310	117	C	4 5/8	6 3/8	5 3/8	3 1/2	5	6 1/8	1/4 x 3/8	22.0
	PT-8314††	1790-0-1790	1500	225	280	117	C	4 3/8	6 1/2	5 3/8	3 1/2	4 7/8	6	1/4 x 3/8	21.5
	PT-8315††	2065-0-2065	1750	200	250	117	C	4 3/8	6 3/8	5 3/8	3 1/2	5	6 1/8	1/4 x 3/8	22.0

CCS RATING FOR REACTOR INPUT — ICAS RATING FOR CAPACITOR INPUT: All Primaries — 50/60 Cycles.

e	PC-8301††	415-0-415	{ 300 425 }	200	160	117	C	3 1/8	3 1/2	3 3/8	2 1/2	2 3/16	3	3/16 x 3/8	4.8
	PC-8302††	515-0-515	{ 385 500 }	235	200	117	C	3 1/16	4 1/8	4 1/4	2 3/4	2 1/16	3 3/4	3/16 x 3/8	6.8
	PC-8303††	665-0-665	{ 500 750 }	250	200	117	C	3 3/4	4 3/8	4 1/16	3	3 3/16	4	3/16 x 3/8	9.6
	PC-8304††	750-0-750	{ 600 850 }	265	200	117	C	3 3/4	4 7/8	4 1/16	3	3 1/16	4 1/2	3/16 x 3/8	11.5
	PC-8305††	920-0-920	{ 750 1000 }	250	200	117	C	3 3/4	5	4 1/16	3	3 3/16	4 3/8	3/16 x 3/8	11.9
	PC-8306††	{ 920-0-920 500-0-500 }†	{ 750 1100 380 550 }	150	125	117	C	3 3/4	5	4 1/16	3	3 3/16	4 3/8	3/16 x 3/8	11.9

All "C" style have Leads; "SC" style have lugs; "FS" and "FS1" have Terminals.
 ††Secondary C.T. must be grounded.
 †Both Secondaries may be Loaded Simultaneously.
 ▲May be used with Secondary C.T. ungrounded.
 *Available until stock is depleted.
 All Secondary A.C. Voltages ±3%. **STANCOR PAGE 28**

STANCOR

COMMERCIAL











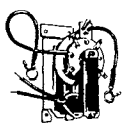
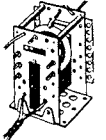
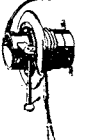
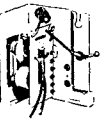
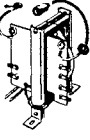

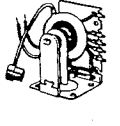
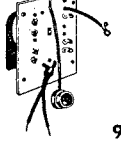
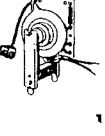
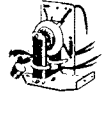
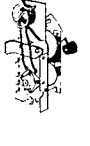
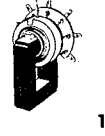
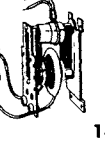
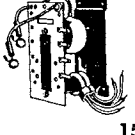
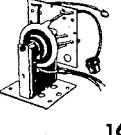
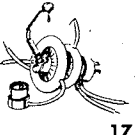
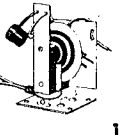
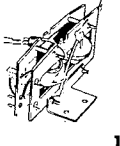
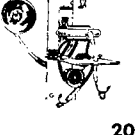
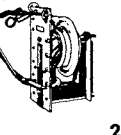
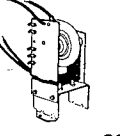
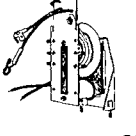
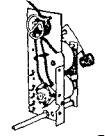
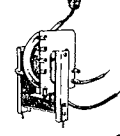
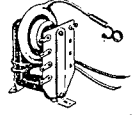
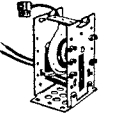
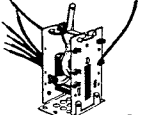
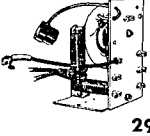
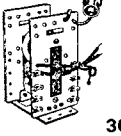
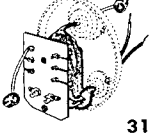
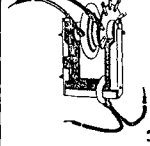
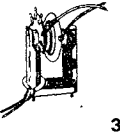
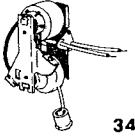
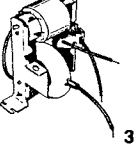
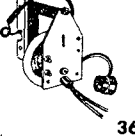
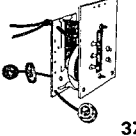
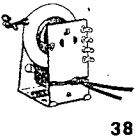
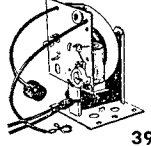
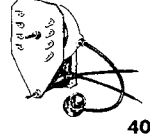
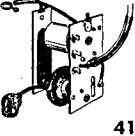

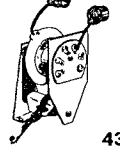
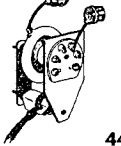
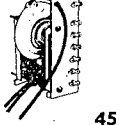
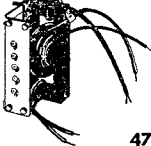
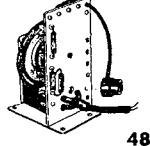

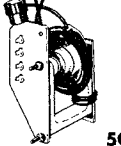
t.v.
replacement**T.V. REPLACEMENT FLYBACKS****REFER TO STANCOR T. V. REPLACEMENT GUIDE FOR APPLICATION**

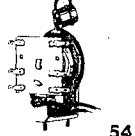
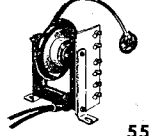
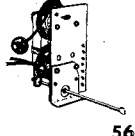
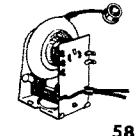
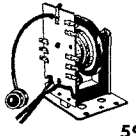
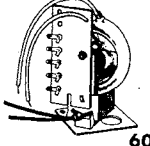
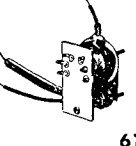
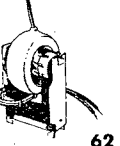
Part No.	Mtg. Type	Part No.	Mtg. Type	Part No.	Mtg. Type	Part No.	Mtg. Type
HO-158	1	HO-242	26	HO-311	38	HO-362	68
HO-159	2	HO-243	39	HO-312	9	HO-363	68
HO-160	3	HO-244	40	HO-313	8	HO-364	68
HO-161	4	HO-245	40	HO-314	8	HO-365	68
HO-162	5	HO-246	41	HO-315	42	HO-366	68
HO-163	5	HO-247	30	HO-316	50	HO-367	68
HO-164	6	HO-248	42	HO-317	26	HO-368	67
HO-165	7	HO-249	30	HO-318	26	HO-369	67
HO-166	8	HO-251	41	HO-319	40	HO-370	67
HO-167	8	HO-252	43	HO-320	40	HO-371	40
HO-169	10	HO-254	43			HO-372	40
HO-173	12	HO-255	45	HO-321	53	HO-373	40
HO-175	12	HO-256	8	HO-323	26	HO-374	40
HO-177	13	HO-259	13	HO-324	42	HO-375	55
HO-178	13	HO-264	42	HO-329	27	HO-376	49
HO-179	14	HO-265	49	HO-330	55	HO-377	44
HO-180	14	HO-267	62	HO-331	14	HO-378	44
HO-181	16	HO-268	35	HO-332	27	HO-379	40
HO-182	8	HO-269	35	HO-333	40	HO-380	68
HO-183	17					HO-381	40
HO-184	17	HO-271	52	HO-334	40	HO-382	40
HO-185	39	HO-272	53	HO-335	40	HO-383	40
HO-188	18	HO-274	54	HO-336	56	HO-384	40
HO-189	19	HO-275	16	HO-337	54	HO-385	40
HO-190	4	HO-276	48	HO-338	2	HO-386	40
HO-191	20	HO-277	47	HO-339	32	HO-387	26
HO-194	22	HO-279	55	HO-340	67	HO-388	40
HO-198	12	HO-280	56	HO-341	Coil Only	• HO-389	71
HO-202	8	HO-281	24	HO-342	56	• HO-390	71
HO-203	25	HO-282	56	HO-343	55	• HO-391	71
HO-204	26	HO-283	58	HO-344	55	• HO-392	71
HO-205	26	HO-284	59	HO-345	63	• HO-393	71
HO-211	2	HO-285	58	HO-346	63	• HO-394	71
HO-212	29	HO-287	60	HO-347	64	• HO-395	71
HO-213	20	HO-289	58	HO-348	65	• HO-396	71
HO-214	30	HO-290	53	HO-349	66	• HO-397	72
HO-215	8	HO-293	56	HO-350	40	• HO-398	72
HO-216	31	HO-294	9	HO-351	26	• HO-402	
HO-217	32	HO-295	9	HO-352	65	• HO-403	
HO-220	33			HO-353	61	• HO-404	
HO-221	33	HO-297	50	HO-354	40	• HO-405	
HO-225	35	HO-299	44	HO-355	40	HO-600C†	69
HO-226	35	HO-301	26	HO-356	40	HO-601C†	70
HO-234	36	HO-303	26	HO-357	40	HO-602C	
HO-235	37	HO-304	26	HO-358	61	• HO-607C	
HO-238	31	HO-305	20	HO-359	40		
HO-239	31	HO-307	54	HO-360	62		
HO-240	31	HO-308	54	HO-361	53		

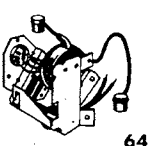
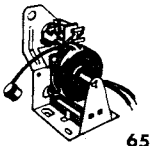
* Available until stock is depleted

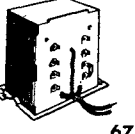
• New Part Number.

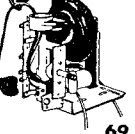
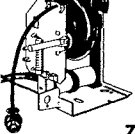
† For Color T.V.

FLYBACK MOUNTING TYPES						
 1	 2	 3	 4	 5	 6	 7
 8	 9	 10	 11	 12	 13	 14
 15	 16	 17	 18	 19	 20	 21
 22	 23	 24	 25	 26	 27	 28
 29	 30	 31	 32	 33	 34	 35
 36	 37	 38	 39	 40	 41	 42
 43	 44	 45	 47	 48	 49	 50
 52	 53	 54	 55	 56	 58	 59
 60	 61	 62	 63	 64	 65	 66
 67	 68	 69	 70	 71	 72	

STANCOR

COMMERCIAL

**t.v.
replacement**

DY



DY

DEFLECTION YOKES

Refer to Stancor T.V. replacement guide for Application.

	Part No.	Coil Inductance in MH		Coil Resistance in Ohms		Max. Scan.	Case Diam.	Unit Length	Mtg. Type	Application
		Horizontal	Vertical	Horizontal	Vertical					
a	*DY-1A	8.3	50	13.5	66	53°	3 1/8	3	DY	Multi-Purpose
	DY-2A	10.3	50	14.5	66	70°	3 1/8	2 3/4	DY	Multi-Purpose
	DY-8A	8.5	50	14.5	52.5	70°	3 1/8	2 3/4	DY	Multi-Purpose
	DY-9A	13.5	50	17.5	53.5	70°	3 1/8	2 3/4	DY	Multi-Purpose
	DY-10A	30.0	3.5	45	3.5	70°	3 1/8	2 3/4	DY	Multi-Purpose
	DY-11A	20.0	50	31	50	70°	3 1/8	2 3/4	DY	Multi-Purpose
	*DY-12A	30.0	50	22	50	70°	3 1/8	2 3/4	DY	Multi-Purpose
b	DY-13A	12.5	48	15	52	90°	3 1/2	3	DY	Muntz
	DY-14A	30.0	3.5	45	3.5	70°	3 1/8	2 3/4	DY	RCA
	DY-15A	25.0	40.0	35	50	70°	3 1/8	2 3/4	DY	Motorola.
	DY-16A	20	44.0	26	45	90°	3 3/8	3 1/8	DY	Multi-Purpose
	DY-17A	12.0	42.0	20	43	90°	3 3/4	3	DY	G. E.
c	DY-21A	14.5	3.1	10	3.5	70°	3 1/8	2 7/8	DY	RCA
	DY-23A	20.0	45.0	27	43	90°	3 3/4	3 1/8	DY	RCA
	DY-24A	18.5	11.0	34	11.5	90°	4	2 3/4	DY	RCA
	*DY-25A	24.0	11.0	46	11.0	90°	4	2 3/4	DY	Emerson
	DY-26A	19.0	11.5	34	16.5	110°	4 1/4	2 1/4	DY	RCA
	DY-27A	17.5	12.3	35.5	13.5	110°	4 1/4	2 1/4	DY	RCA
d	DY-28A	24	3.2	36	3.4	70°	3 1/4	2 7/8	DY	Motorola
	DY-29A	24	3.2	36	3.4	70°	3 1/4	2 7/8	DY	Motorola
	DY-30A	24	3.2	36	3.4	70°	3 1/4	2 7/8	DY	Motorola
	DY-31A	24	42	44.2	42	90°	4 1/4	3 1/4	DY	Motorola
	DY-32A	24	42	34	42	90°	4 1/8	3 1/4	DY	Motorola
	DY-33A	30.5	43	34	50	70°	3 3/4	2 1/2	DY	Philco
	DY-34A	30	47	45	42	90°	3 3/4	2 3/4	DY	Philco
e	DY-35A	20	45	28	45	90°	4	3	DY	Philco
	DY-37A	20	45	28	45	90°	4	3 1/4	DY	Emerson
	DY-38A	20	34.4	38	34	110°	4 1/4	3 3/4	DY	Emerson
	DY-39A	13	40	22	41	90°	4	3 1/4	DY	Zenith
	DY-40A	12	40	17	39	110°	4 1/4	3 3/4	DY	G. E.
	DY-41A	13.3	41	20	54	70°	3 1/4	3	DY	RCA
	DY-42A	30.4	34	47.2	34	110°	4 1/4	3 3/4	DY	RCA
f	*DY-43A	24	3.3	31	3	90°	4	3	DY	Motorola
	DY-44A	18.5	34	33	34	110°	4 1/4	2 1/8	DY	Westinghouse
	DY-45A	18.6	14.8	35	13.8	110°	4 1/4	3 3/4	DY	Admiral
	DY-46A	20	40	38	39	110°	4 1/4	3 3/4	DY	Olympic
	DY-47A	8.2	41	19.7	72	70°	3 1/2	2 1/2	DY	G. E.
	DY-48A	14	29	33	60	70°	3 1/2	2 1/2	DY	G. E.
	DY-49A	44	38	110	80	70°	3 3/8	2 7/8	DY	G. E.
	*DY-50A	12	33	28	83	70°	3 3/8	2 3/8	DY	G. E.
g	DY-51A	18.6	15	38	17.2	110°	3 3/4	3	DY	Pockard-Bell
	DY-52A	20.5	37.5	30	35	90°	3 1/4	3 3/4	DY	Westinghouse
	DY-53A	24	39	40	37.0	110°	3 1/8	3 3/8	DY	Philco
	DY-54A	24	40	40	37	110°	3 1/4	3 1/4	DY	Philco
	DY-56A	15	40	29.5	39.5	110°	3 3/4	3 1/4	DY	Zenith
h	DY-57AT	24	70	40	29	114°	3 1/4	2 3/4	DY	Multi-Purpose
	DY-58AT	18.5	70	30	29	114°	3 1/4	2 3/4	DY	Multi-Purpose
	DY-59AT	24	15	40	6	114°	3 1/4	2 3/4	DY	Multi-Purpose
	DY-61AT	20	20	22	5.5	114°	3 1/4	2 3/4	DY	Multi-Purpose
	*DY-62A	12.5	48	22	40	92°	4 1/4	3 1/4	DY	Zenith
	*DY-63A	18.5	13.5	35	14	110°	4 1/4	3 1/4	DY	Multi-Purpose
	*DY-64A	12.5	44	22	44	92°	4 1/4	3 1/4	DY	Zenith
	*DY-90AC	12	39	6.5	23	70°	6 7/8	4 1/4	DY	Multi-Purpose
	DY91AC	11.5	23.5	8.5	12.5	90°	6 1/2	3 3/4	DY	Zenith Color

* New part number

* Available until stock is depleted

* Adaptor plugs are available to extend the usability of the DY-91AC.
-For schematic and application list, write for YA series bulletin.

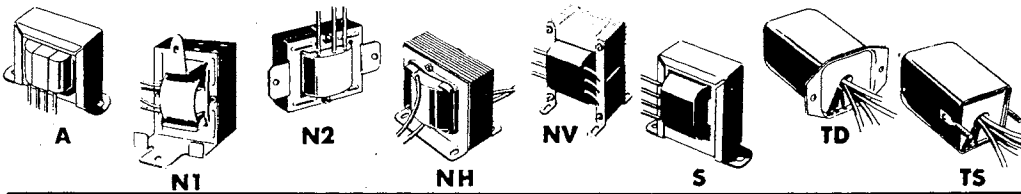

STANCOR
COMMERCIAL
t.v.
replacement

VERTICAL DEFLECTION OUTPUT TRANSFORMERS: Refer to Stancor T.V. replacement guide for Application.

	Part No.	Turns Ratio Pri./Sec.	Primary Impedance Ω	D.C. Res. In Ohms		Height Overall	Base Area	Mtg. Ctrs.	Mtg. Type	Shpg. Wt. In Lbs.
				Pri.	Sec.					
a	VO-83	10:1	18,000 Ω (at 12 DCMA)	1300	10	2	1 3/4 x 3 1/4	2 13/16	A	1.0
	VO-84	8:8:1	16,500 Ω (at 10 DCMA)	700	12	2	1 3/4 x 3 1/4	2 13/16	A	1.0
	VO-85	10:1	19,000 Ω (at 13 DCMA)	600	7	3 1/8	2 1/2 x 2 1/2	1 15/16 x 2	NV	2.5
	VO-87 \S	11.4:1	17,000 Ω (at 20 DCMA)	1200	11	2	1 3/4 x 3 1/4	2 13/16	A	1.2
	VO-88	44:1	11,000 Ω (at 20 DCMA)	400	0.3	3 1/8	2 1/2 x 2 1/2	1 15/16 x 2	NV	2.5
	VO-89 \S	18:1	30,000 Ω (at 10 DCMA)	1650	4.5	2 1/4	3 3/4 x 2 1/8	3 1/8	A	1.5
	VO-90	8:1	19,000 Ω (at 13 DCMA)	540	10.5	2 3/8	2 1/4 x 3	2 3/8 x 1 5/8	NH	2 1/2
	VO-91	10:1	14,000 Ω (at 15 DCMA)	625	14	2 1/4	2 1/4 x 3 5/8	3 1/8	A	2
	VO-92	9:1	9,500 Ω (at 30 DCMA)	540	15	2 1/4	1 3/4 x 3 5/8	3 1/8	A	1 1/2
b	VO-93	9:1	11,000 Ω (at 19 DCMA) 6,000 Ω (at 15 DCMA)	540	14	2 3/8	2 1/4 x 2 1/2	3	N1	2
	VO-94 \S A	6.9:1	4,700 Ω (at 50 DCMA)	375	10	2	1 7/8 x 3 1/4	2 13/16	A	1 1/2
	VO-95 \S	6:1	3,200 Ω (at 40 DCMA) 6,000 Ω (at 15 DCMA)	300	9	2	1 3/4 x 3 1/4	2 13/16	A	1
	VO-96 \S A	8:1	4,700 Ω (at 50 DCMA)	375	6.5	2	1 7/8 x 3 1/4	2 13/16	A	1 1/2
	VO-97 \S	6.9:1	11,500 Ω (at 20 DCMA)	330	8.5	2	1 5/8 x 3 1/4	2 13/16	A	1
	VO-98 \S	9:1	11,000 Ω (at 19 DCMA)	450	11.3	2	3 3/4 x 2 3/8	3 3/8	N2	1.7
	VO-99	7.5/15:1	8,500 Ω (at 19 DCMA)	580	6.7	2 1/4	3 3/4 x 2 1/4	3 1/8	N1	1.7
c	VO-100 \S +	9.2:1	7,500 Ω (at 30 DCMA)	360	14.0	2 1/8	3 5/8 x 1 7/8	3 1/8	A	1 1/2
	VO-101 \S	12:1	16,000 Ω (at 15 DCMA)	675	6.8	2 1/4	3 5/8 x 1 3/4	3 3/8	A	1 1/2
	VO-102 \S	6.5:1	6,700 Ω (at 25 DCMA)	275	10	2 3/8	4 x 2 1/4	3 3/8	A	2 1/2
	VO-103 \S	16:1	10,000 Ω (at 15 DCMA)	530	5.5	2	3 1/4 x 1 1/2	2 13/16	A	1 1/2
	VO-105 \S	44.5:1	24,000 Ω (at 15 DCMA)	740	.8	2	3 1/4 x 1 1/2	2 13/16	A	1 1/2
	VO-106	35.5:1	35,000 Ω (at 0 DCMA)	1400	3.8	1 5/8	2 7/8 x 1 1/2	2 3/8	A	1
	VO-108 \S	9:1	10,000 Ω (at 25 DCMA)	350	10.3	2	3 1/4 x 2	2 13/16	A	1.3
	VO-109	Multi-Ratio 5:1 to 50:1	40 MA Max.			2	3 1/4 x 2	2 13/16	A	1.3
	VO-110	16:1	18,000 Ω (at 20 DCMA)	1670	7.0	2	2 x 3 1/4	2 13/16	A	1.3
	VO-111	18:1	20,000 Ω (at 20 DCMA)	1425	7.5	2	2 x 3 1/2	2 13/16	A	1.3
	VO-112	8:1	7,000 Ω (at 30 DCMA)	384	3.5	2 1/4	3 5/8 x 2 1/8	3 1/8	A	1.8
d	VO-113 \S	15:1	13,000 Ω (at 20 DCMA)	1435	19.7	2 3/8	1 3/4 x 2 13/16	2 3/8	S	1.3
	VO-114	6:1	5,000 Ω (at 30 DCMA)	250	6.0	2	3 1/4 x 1 5/8	2 13/16	A	1
	VO-115 \S	12:1	7,000 Ω (at 35 DCMA)	360	2.4	2 3/8	3 3/4 x 1 7/8	3 1/8	A	1.4
	VO-116	18:1	32,000 Ω (at 15 DCMA) 11,000 Ω (at 30 DCMA)	1500	5.3	2 3/8	3 3/4 x 1 13/16	3 1/8	A	1.5
	VO-117	13:1	9,500 Ω (at 25 DCMA) 8,000 Ω (at 50 DCMA)	275	4.0	2 3/8	3 3/4 x 2 3/8	3 1/8	A	2.0
	VO-118	8:1	6,000 Ω (at 30 DCMA) 4,500 Ω (at 60 DCMA)	350	4.0	2 3/8	3 3/4 x 2	3 1/8	A	1.6
	VO-119 \S	7:1	9,000 Ω (at 35 DCMA) 3,000 Ω (at 70 DCMA)	385	8.0	2 3/8	3 3/4 x 1 7/8	3 1/8	A	1.5
	VO-120 \S	7.5:1	7,800 Ω (at 35 DCMA) 5,000 Ω (at 70 DCMA)	235	6.0	2 3/8	3 3/4 x 2 1/8	3 1/8	A	1.8
	e	VO-122 \S	6.5:1	3,500 Ω (at 45 DCMA) 2,000 Ω (at 65 DCMA)	145	4.0	2 3/8	3 3/4 x 1 7/8	3 1/8	A
VO-123+		7:1	5,300 Ω (at 35 DCMA) 2,000 Ω (at 70 DCMA)	180†	4.0	2 3/8	3 3/4 x 2	3 1/8	A	1.6
VO-126 \S		14.5:1	6,000 Ω (at 40 DCMA) 1,800 Ω (at 80 DCMA)	260	1.4	2 3/8	3 3/4 x 2	3 1/8	A	1.6
VO-127 \S		16:1	10,500 Ω (at 20 DCMA) 8,000 Ω (at 40 DCMA)	460	3.4	2 3/8	3 3/4 x 2	3 1/8	A	1.6
VO-128 \S A		17:1	20,000 Ω (at 20 DCMA) 4,800 Ω (at 45 DCMA)	2250	8.0	2	2 x 3 1/4	2 13/16	A	1
VO-129 \S A		11:1	6,000 Ω (at 50 DCMA) 4,000 Ω (at 75 DCMA)	430	4.5	2 3/8	2 x 3 3/4	3 1/8	A	1.6
VO-700C†		10:1	7,500 Ω (at 32 DCMA)	370	20	2 3/8	2 3/8 x 3 3/4	3 1/8	A	1.6
•VO-701C		10:1	4.5K @ 50ma	—	—	2 3/4	2 1/2 x 3 3/4	3 1/8	A	1.6

VERTICAL BLOCKING-OSCILLATOR TRANSFORMERS

	Part No.	Turns Ratio Pri./Sec.	Height Overall	Base Area	Mounting Centers	Mounting Type	Shpg. Wt. In Lbs.
f	VBO-194	1:4.2	1 3/8	1 1/2 x 2 1/2	2	A	0.4
	VBO-195	1:4.2	1 3/4	1 1/2 x 2 1/2	1 15/16	TD	0.4
	VBO-196	1:4.2	1 1/8	1 1/8 x 1 3/8	1 13/16	TS	0.3
	VBO-198	1:4.2	1 3/8	2 3/8 x 1 1/4	1 3/4	A	0.4
	VBO-199	1:1.5	1 3/4	1 1/2 x 2	1 3/4	S	0.5
	VBO-200	1:1.5	1 3/8	1 1/2 x 2 1/2	2	A	0.5
	VBO-201	1:3.33	1 3/8	2 3/8 x 1 1/4	1 3/4	A	0.4

* New part number †For color T.V.

•Has vertical blanking winding.

•Has screen grid tap.

•Autoformer.

STANCOR

COMMERCIAL

radio & t.v.
replacement

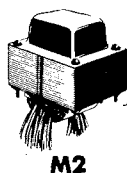

M2

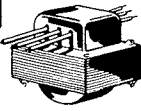

M4

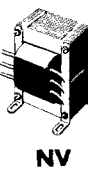

NV

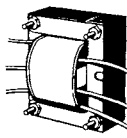

R

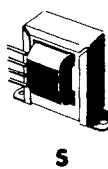

S

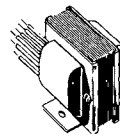

S1

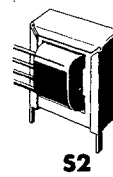

S2

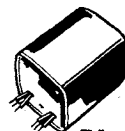

TA

AUTO RADIO VIBRATOR TRANSFORMERS Exact Duplicate for 6 Volt D.C. Primary.

	Part No.	Original Part No.	Trade Name	D.C. Volts at Filter Input	D.C. MA.	Mtg. Type	Recommended Buffer Cap. (mfd.)	Height Overall	Base Area	Shpg. Wt. In Lbs.
a	P-6471	25B472533 D71014	Motorola (40B, 50B, etc.) Colonial-Detroit No. 8072	235	70	TA	0.006	3	2 3/8 x 2 3/16	2.0
	P-6476	D70267 C70267	Colonial-Detroit No. 7070 Col.-Mot.-Det. No. 8030	220	53.5	TA	0.008	2 3/8	2 7/32 x 2 5/32	2.0
	P-6477	25C500189	Motorola	150	50	M2	0.03	2	1 7/8 x 2 1/4	1.0
	P-6478	25C501644	Motorola	225	70	R	0.02	2 1/4	2 3/16 x 2 5/8	1.5
	P-6480	65-0347	Philco	225	70	R	0.0033	2 3/16	2 1/4 x 2 5/8	1.5
	P-6481	32-8313-1	Philco	250	60	M4	0.0068	2 1/4	2 3/16 x 2 3/8	1.5
	P-6490	C 291787-1	Bendix (Ford Model 5B8F)	265	52	R	0.006	2 1/8	2 3/16 x 2 5/8	1.5
	P-6499	1220163 ¹	United Motors (Delco)	250	60	TA	0.006	3 7/32	2 3/8 x 2 1/2	2.3

Exact Duplicate For 12 Volt D.C. Primary

b	P-6482	6084	United Motors (Delco)	250	60	TA	.004	3 1/4	2 1/16 x 2 1/16	2.5
	P-6489	6067	United Motors (Delco)	250	60	R	.004	2 3/16	2 3/16 x 2 3/8	2.0
	P-6493	*25C535794	Motorola	275	75	S1	(See Footnote)	2 3/4	2 3/8 x 2	1.7
	P-6494	32-8592-1	Philco	245	70	R	0.0047	2 3/16	2 5/8 x 2 1/8	1.5
	P-6495	*25K535795	Motorola	275	75	S1	(See Footnote)	2 3/4	2 3/8 x 2 1/8	1.7
	P-6497	7265604 ²	United Motors (Delco)	250	55	S2	.007 ³	2 1/8	2 1/4 x 2	1.8

*2 buffer capacitors used 0.5 mfd. and 0.04 mfd. as in original circuit.

¹17261386 and 7262956 replaced by P-6499
²7269118 replaced by P-6497
³+15K-1W. Res.

UNIVERSAL VIBRATOR TRANSFORMERS With 6 Volts D.C. Primary

	Part No.	Secondary A.C. Volts	D.C. Volts At Filter Input	D.C. M.A.	Recommended Buffer Cap.	Mtg. Type	Height Overall	Base Area	Mtg. Ctrs.	Shpg. Wt. In Lbs.
c	P-6491	188-0-188	200	40	0.003 mfd.	S	2 1/4	3 1/8 x 2 1/8	2 1/16	1.5
	P-4062	300-0-300	260	65	0.006 mfd.	NV	3 1/8	2 1/2 x 2 3/8	2 x 2	2.3
	P-4063	320-0-320	285	75	0.006 mfd.	NV	3 1/8	2 1/2 x 2 3/4	2 x 2 1/4	2.8
	P-6131	370-0-370	330	100	0.007 mfd.	NV	3 1/2	2 7/8 x 2 7/8	2 1/4 x 2 1/4	3.5

WIDTH AND LINEARITY CONTROLS

	Stancor No.	Application	Ind. in Mh.	Res. in Ohms	AGC Ind. in Mh.	AGC Res. in Ohms
d	RTC-8628†	Width or Linearity Coil	2.5-17.	24	—	—
	RTC-8629†	Width or Linearity Coil	15-.60.	55	—	—
	WC-1*, WC-1A*‡	Width Coil	.05-50.	.53	—	—
	WC-2*, WC-2A*	Tapped Linearity Coil	.55-4.6	8.3	—	—
e	WC-5*, WC-5A*	Width or Linearity Coil	4-.39.	32.	2.7-7.6	19.5
	WC-6*, WC-6*A	Tapped Linearity Coil	1.3-4.1	5.6	—	—
	WC-7*, WC-7A*	Width Coil	.5-3.5	2.3	—	—
	WC-8*, WC-8A*	Width Coil	1.-10.	8.0	—	—
	WC-10*, WC-10A*‡	Width Coil with AGC	2.6-7.5	12.	4-.28.	32.
f	WC-11 [§]	Tapped Width Coil	2.3-11.8	10.	—	—
	WC-13 [§]	Width Coil with AGC	4-.30.	27.	.185-1.82	3.
	WC-14*, WC-14-A*	Width Coil	45-.215.	130.	—	—
	WC-18*, WC-18A*	Width Coil	4-.29.	29.	—	—

*Available for either 3/16" or 1/8" Mounting hole. Use suffix "A" for 1/8" hole.

†Adapter supplied for either 3/16" or 1/8" Mounting hole.

‡Only for 1/8" Mounting hole.

§For 1 1/4" Mounting Centers equipped with slider.

¶Shipped without core, use original core.

‡ Available until stock is depleted

COLOR DEGAUSSING COIL:

Catalog No. — DGC-100

With 10-foot Line Cord and In-Line Switch

Full 12" Diameter for
Faster — Better Demagnetizing
of Color TV Sets.



C.R. TUBE BOOSTER:

Catalog No. — P-8192 (For parallel heaters only)

- No connections to solder.
- HI-LO switch provides two levels of brilliance.
- Does not require AC line connections.
- Measures only 3 1/2" high, 1 1/2" in diameter.
- Does not change CR tube space requirements.

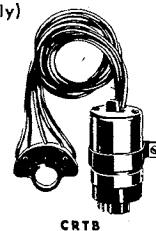

CRTB

SECTION 5600

TECHNICAL APPARATUS BUILDERS

RECTIFIERS — TRANSFORMERS — CHOKES

S I L T A B

Div. of "POWER ALTERNATING DIRECT CORP."

FOR ALL YOUR DC POWER REQUIREMENTS

Engineered for Industry

"TECHNICAL APPARATUS BUILDERS" mfr. Power Rectifiers to your specs. From one amp up to and above 1000 amps, convection or fan cooled, single or 3 phase. "NEMA" & Jan. Specs.

"SILTAB" ® FWB SILICON RECTIFIER FINNED STACKS -65% C to +150% C CONVECTION COOLED*

Max DC Amps	36VAC 32VDC	70VAC 62VDC	140VAC 125VDC	280VAC 250VDC	840VAC 750VDC	1120VAC 1000VDC	1400VAC 1250VDC	2800VAC 2500VDC	SELENIUM-SILICON-GERMANIUM COP-OX — ALL GOV'T TYPES — LOW PRICES!
1.5	JA36 \$1.50	JA70 \$ 1.60	JA140 \$ 1.75	JA280 \$ 1.90	JA840 \$6.00	JA1120 \$9.00	JA1400 \$12.00	JA2800 \$15.00	FAST REPLACEMENT DELIVERIES ON VICKERS
6	JJ36 5.90	JJ70 8.90	JJ140 7.90	JJ280 8.90	JJ840 18.00	JJ1120 21.00	JJ1400 24.00	JJ2800 36.00	KOTRON FEDERAL — CHATHAM — G.E.
12	JL36 7.50	JL70 8.80	JL140 11.75	JL280 15.00	JL840 29.45	JL1120 36.00	JL1400 43.00	JL2800 54.00	WESTINGHOUSE — MALLORY — I.R.C. —
24	JN36 10.00	JN70 15.00	JN140 20.00	JN280 30.00					S.C.A. — R.R. — I.T.T. — B.L. — OTHER
36	JR36 13.60	JR70 20.30	JR140 30.90	JR280 41.60					SIZES & TYPES AVAILABLE. SPECIFY YOUR NEEDS!
50	JS36 20.00	JS70 27.00	JS140 38.15	JS280 45.45					
100	JT35 27.00	JT70 36.75	JT140 45.90	JT280 63.00					
150	JO35 30.15	JO70 42.30	JO140 54.30	JO280 98.00					
*250	JY35 39.90	JY70 51.00	JY140 88.45	JY280 144.00					
*400	JZ35 70.60	JZ70 108.45	JZ140 147.30	JZ280 270.00					

DC Amps	36VAC 48VDC	THREE PHASE 3 φ FULL WAVE BRIDGE 105VAC 144VDC	185VAC 248VDC	280VAC 375VDC	DC 18V to C.T. 24VDC	C.T. 3 Star
2	YE36 \$3.90	YE105 \$ 7.30	YE185 \$10.00	YE280 \$13.45	2	FE36 1.15
12	YJ36 7.45	YJ105 13.75	YJ185 21.00	YJ280 30.00	8	FJ36 3.75
18	YW36 10.00	JW105 18.60	YW185 33.45	YW280 45.60	18	FW36 4.90
60	YS36 27.75	YS105 37.90	YS185 48.15	YS280 60.00	80	FS36 17.00
*100	YT36 36.00	YT105 48.60	YT185 57.90	YT280 69.30	100	FT36 22.00
*250	YY36 49.00	YY105 63.60	YY185 81.45	YY280 100.00	250	FY36 31.00
*400	YZ36 99.15	YZ105 148.00	YZ185 198.00	YZ280 290.00	400	FZ36 66.00

*Force Air Cool — for capacitive, battery & motor loads derate 20%
Fuse input & output DC use Amptap single cycle fuses available from us.

24-HOUR SERVICE ON REPLACEMENT
We can supply exact equals on all makes and types of rectifiers — size, type current to your specifications.

"SURGTAB" ® SILICON DIODE TRANSIENT PEAK VOLTAGE CLIPPER CLAMP! PROTECTS SILICON RECTIFIERS!

MFGR. TYPE	— VOLTS — RMS	— VOLTS — PEAK	USER NET	MFGR. TYPE	— VOLTS — RMS	— VOLTS — PEAK	USER NET	MFGR. TYPE	— VOLTS — RMS	— VOLTS — PEAK	USER NET	MFGR. TYPE	— VOLTS — RMS	— VOLTS — PEAK	USER NET
SB18	18	27	\$5.50	SB54	54	76	\$7.00	SB150	150	215	\$1.00	SB250	250	340	\$1.30
SB22	22	31	.50	SB70	70	100	.80	SB180	180	260	1.05	SB266	266	360	1.45
SB26	26	37	.50	SB75	75	108	.80	SB200	200	290	1.15	SB300	300	430	1.60
SB40	40	58	.60	SB100	100	145	.80	SB210	210	300	1.15	SP320	320	460	3.00
SB50	50	71	.70	SB125	125	180	.90	SB225	225	320	1.30	SP630	630	900	6.15

Other sizes & types available. Send data for correct type & size "Surgtab" clipper for diode protection from input & output transients!

"TEKSEL" SELENIUM RECTIFIER STACKS

Full Wave Bridge — Single Phase — Full Wave Bridge Dated and Guaranteed

Max. DC Amps	18VAC 14VDC	36VAC 28VDC	54VAC 42VDC	72VAC 56VDC	130VAC 100VDC	144VAC 118VDC	266VAC 217VDC	DC Amps Max.
0.5	BV18 \$1.00	BV36 \$1.90	BV54 \$2.90	BV72 \$3.85	BV130 \$5.00	BV144 \$6.75	BV266 \$9.75	0.5
1	BA18 1.40	BA36 2.30	BA54 3.45	BA72 4.90	BA130 5.45	BA144 10.65	BA266 16.00	1
2	BE18 2.30	BE36 3.00	BE54 5.25	BE72 6.25	BE130 7.60	BE144 14.00	BE266 21.90	2
3	BF18 2.90	BF36 4.15	BF54 6.40	BF72 8.60	BF130 9.00	BF144 17.25	BF266 39.75	3
4	BG18 3.65	BG36 7.35	BG54 11.40	BG72 16.00	BG130 19.90	BG144 28.50	BG266 47.60	4
6	BJ18 4.40	BJ36 7.90	BJ54 12.75	BJ72 18.75	BJ130 32.60	BJ144 36.00	BJ266 63.45	6
10	BK18 6.35	BK36 12.60	BK54 19.50	BK72 26.30	BK130 35.60	BK144 48.75	BK266 95.00	10
12	BL18 8.00	BL36 15.75	BL54 21.95	BL72 30.95	BL130 45.00	BL144 52.50	BL266 103.60	12
15	BW18 10.30	BW36 20.90	BW54 29.30	BW72 40.00	BW130 48.15	BW144 64.45	BW266 108.15	15
20	BM18 12.90	BM36 25.30	BM54 37.45	BM72 49.90	BM130 78.75	BM144 90.00	BM266 169.00	20
24	BN18 16.00	BN36 32.00	BN54 44.60	BN72 57.50	BN130 85.00	BN144 96.50	BN266 188.75	24

Three Phase 3 φ — Full Wave Bridge — Guaranteed

Max. DC Amps	16VAC 20VDC	30VAC 36VDC	120VAC 150VDC	208VAC 256VDC	240VAC 300VDC	420VAC 460VDC	Center Tap Full Wave 30VAC 12VDC	Max. DC Amps
1	PA16 \$3.75	PA30 \$4.90	PA120 \$17.90	PA208 \$33.75	PA240 \$36.00	PA420 \$63.20	CA30 \$2.40	1
2	PE16 5.95	PE30 7.45	PE120 21.75	PE208 39.90	PE240 42.00	PE420 66.90	CE30 2.90	2
4	PG16 8.60	PG30 9.90	PG120 33.15	PG208 62.15	PG240 65.00	PG420 93.75	CG30 3.60	4
6	PJ16 9.90	PJ30 12.90	PJ120 46.90	PJ208 81.75	PJ240 85.00	PJ420 108.60	CJ30 4.70	6
12	PL16 15.90	PL30 18.45	PL120 66.60	PL208 132.15	PL240 139.00	PL420 212.60	CL30 7.60	12

"TABTRAN" RECTIFIER TRANSFORMERS AND CHOKES

Transformer Number	Secondaries	Second AC Amps	Primary Volts	Net Price
TR4000R	Dual (2) Sec'd each 0-18V	1	115	\$4.00
TR4001	Dual (2) Sec'd each 0-9-15-18	1	115	5.45
TR4002	Volts at rated current per each winding.	2	115	7.15
TR4003	Secondary series connected.	5	115	12.30
TR4005	Taps give 0-3-6-9-12-15-18-21-24-27-30-33-36 Volts	12	115	18.90
TR4006		25	115	35.00
TR4007	Secondary parallel 0-9-15-18	50	115 & 220	50.00
TR4008	Volts at twice (2X) the current.	100	115 & 220	99.00

Choke Number	Inductance Henries	AC Amps	Resistance Ohms	IR Drop Volts	Net Price
CR6001	0.1	1	1.4	1.4	\$3.90
CR6002	0.1	2	0.67	1.34	5.60
CR6007	0.01	4	0.1	0.04	5.90
CR6003	0.07	5	0.6	3.00	11.00
CR6004	0.015	12	0.1	1.2	5.90
CR6005	0.005	25	0.025	0.80	25.45
CR6006	0.001	50	0.001	0.05	34.00
CR6010	0.5	100	.005	40.00	40.00
CR6011	0.3	200	.0025	60.00	60.00
CR6012	0.055	500	.00027	90.00	90.00
CR6013	0.015	1000	.000065	100.00	100.00

All prices and specifications subject to change

"TABTRAN" INDUSTRIAL TRANSFORMERS & CHOKES

Transformer Number	Secondaries	Second AC Amps	Primary Volts	Net Price
T5801	58V or 28 V.C.T.	1	115	\$8.25
T5802	Dual (2) sec'd each 28 V.C.T.	2	115	8.80
T5804	Series 0-14-28-42-56V	4	115	13.60
T5808	at Secondary AC-Amps	8	115	26.50
T5812	Parallel 0-14-28V	12	115	32.00
T5825	at 2X Current	25	115	53.00
T1200		5	115	8.20
T1201	120V or 60 V.C.T.	1	115	9.80
T1202	Dual (2) sec'd each 60 V.C.T.	2	115	14.70
T1204	Series 0-30-60-90-120V	4	115	25.60
T1206	At Secondary AC-Amps	6	115	32.70
T1208	Parallel 0-30-60V	8	115	39.50
T1212	at 2X Current	12	115	48.00
T1220		20	115	58.00

INDUSTRIAL ISOLATION & CONTROL TRANSFORMERS ELECTRO-STATIC SHIELDED

CT050/50 WATTS	\$15.00	CT500/500 WATTS	\$39.00
CT075/75 WATTS	18.00	CT750/750 WATTS	50.00
CT100/100 WATTS	22.00	CT1000/1KVA	80.00
CT150/150 WATTS	26.00	CT2000/2KVA	79.00
CT250/250 WATTS	31.00	CT3000/3KVA	115.00

FOR (230/460V/Sec'd) ADD LETTER (D) DCT & 25% TO PRICE.

"TABPOST" Heavy Duty Insulated Five Way Binding Posts

Type	Amps	Price
BP10*	10	.20
BP30*	30	.33
BP60*	60	2.75
BP100	100	4.00

WRITE FOR COMPLETE LISTING
QUANTITY DISCOUNTS

"TABCAP" Electrolytic Hi-Amp Filter Capacitors

Type	MFD	D.C.V.	Price
CE152M*	2000	15	\$1.00
CE158M	6000	15	2.00
CE505C*	500	50	1.00
CE5025M	2500	50	3.30
CE5080M	8000	50	6.00
CE2005C	500	200	3.00

Brackets for capacitors 25¢ each

We reserve the right to change specifications and prices without notice.



ENCAPSULATED 400 cps transformers

CLIPPER SERIES

Fig.	Cat. No.	Sec. Volts	Sec. Amp	Insul. Volts (RMS)	Pri. Volts	Mold Size	Net Price
19	4C1	6.3 CT	0.8	1500	115	SM3	13.80
19	4C2	6.3 CT	1.2	1500	115	SM2	13.80
19	4C3	6.3 CT	6.8	1500	110/115/120	2	22.15
20	4C4	6.3 6.3	4.9 2.7	1500	115	3	19.80
19	4C5	6.3 CT	7.2	1500	115	35	23.00
21	4C6	6.3 6.3 6.3	7 7 1.5	1500 1500 1500	120	35	22.40
22	4C7	6.3 CT 6.3 CT	7 7	1500 1500	120	4	26.65
21	4C8	6.3 6.3 6.3	13.7 2.9 0.3	1500 1500 1500	115	4	26.65
19	4C9	6.3 CT	12.3	1500	115	5	24.65
21	4C11	6.3 6.3 6.3	2.4 2.5 2.7	1500	115	3	24.65
19	4C26	6.3 CT	2	1500	115	SM1	17.55
19	4C27	6.3 CT	3	1500	115	1A	18.25
19	4C28	6.3 CT	5	1500	115	2	18.90
19	4C29	5 CT	3	2500	115	SM1	17.55
19	4C30	5 CT	6	2500	115	2	18.90
19	4C31	8.5 CT	12	1500	115	5	24.63
19	4C32	8.5 CT	23	1500	115	7	27.30
19	4C33	8.5 CT	35	1500	115	8	29.75
19	4C34	8.5 CT	45	1500	115	9	35.90
19	4C12	14.1	3	1500	115	3	18.79
19	4C35	21 CT	4.5	1500	115	5	24.63
19	4C13	21 CT	9	1500	115	7	21.30
19	4C36	21 CT	18	1500	115	9	35.90
19	4C10	20 CT	0.6	1500	115	SM1	17.55

FREQUENCY
380-1000 cps.

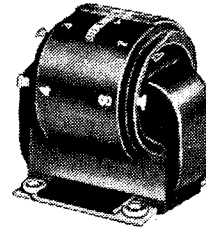

FOR MINIMUM SIZE &
MINIMUM WEIGHT

- CONTOUR MOLDED
- HIPERSIL CORES

MIL-T27B
Specifications

MIL Type
TF5SX01ZZ

85°C Max. Ambient
Operating Temp.

HIGH SHOCK
EXTREME
ENVIRONMENT
CONDITIONS
LIGHT WEIGHT FOR
AIRBORNE USE
10,000 HOUR
PLUS-LIFE
SERVO
APPLICATIONS
ISOLATION
POWER SUPPLIES
AIRBORNE CONTROL
CIRCUITS
MISSILE CIRCUITS

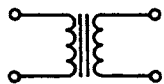

FIG. 18



FIG. 19

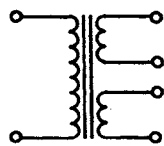

FIG. 20

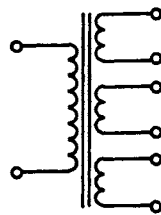

FIG. 21

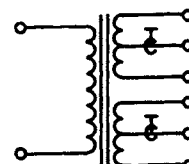

FIG. 22

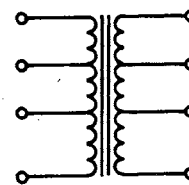

FIG. 23



ENCAPSULATED 400 cps transformers

CLIPPER SERIES

Fig.	Cat. No.	Sec. Volts	Sec. Amp.	Insul. Volts (RMS)	Pri. Volts	Mold Size	Net Price
19	4C37	21 CT	24	1500	115	10	43.10
19	4C38	24 CT	4	1500	115	5	24.63
19	4C39	24 CT	8	1500	115	7	27.30
19	4C40	24 CT	16	1500	115	9	35.90
19	4C41	24 CT	21	1500	115	10	43.10
19	4C14	26	0.5	1500	115	SM1	17.12
19	4C15	26 CT	1.5	1500	115	3	18.79
19	4C23	26 CT	3	1500	115	4	21.30
19	4C24	26 CT	5	1500	115	6	24.85
19	4C16	28 CT 6.3 CT	0.8 7	1500	115	3	26.62
19	4C42	41 CT	2.3	1500	115	5	24.63
19	4C43	41 CT	4.5	1500	115	7	27.30
19	4C44	41 CT	9	1500	115	9	35.90
19	4C45	41 CT	12	1500	115	10	43.10
19	4C46	48 CT	2	1500	115	5	24.63
19	4C47	48 CT	4	1500	115	7	27.30
19	4C48	48 CT	8	1500	115	9	35.90
19	4C49	48 CT	10	1500	115	10	43.10
19	4C25	52 CT	2	1500	115	5	24.63
19	4C17	52 CT	0.2	1500	115	SM1	18.99
19	4C18	90 CT	4.5	1500	115	9	35.90
18	4C19	115	.05	1500	115	SM2	14.10
18	4C21	115	2.8	1500	115	8	29.23
23	4C20	105/115/125	0.4	1500	105/115/125	2	20.30
23	4C50	105/115/125	1	1500	105/115/125	6	25.75
23	4C51	105/115/125	2.4	1500	105/115/125	8	30.20
23	4C52	105/115/125	3.2	1500	105/115/125	9	36.40
23	4C53	105/115/125	4	1500	105/115/125	10	43.70
23	4C22	334	0.3	1500	115	SM1	16.12

FREQUENCY
380-1000 cps.

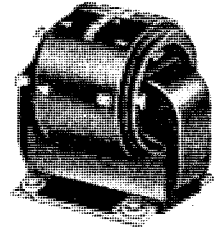

- FOR MINIMUM SIZE & MINIMUM WEIGHT
- CONTOUR MOLDED
 - HIPERSIL CORES

MIL-T27B
Specifications

MIL Type
TF5SX01ZZ

85°C Max. Ambient
Operating Temp.

HIGH SHOCK
EXTREME
ENVIRONMENT
CONDITIONS
LIGHT WEIGHT FOR
AIRBORNE USE
10,000 HOUR
PLUS-LIFE
SERVO
APPLICATIONS
ISOLATION
POWER SUPPLIES
AIRBORNE CONTROL
CIRCUITS
MISSILE CIRCUITS

MOLD NO.	OVERALL DIMENSIONS			MTG. DIMENSIONS		APP. WT. (LBS.)	MTG. METH.
	L	W	H	F	G		
SM3	1	1-1/4	1-3/16	1	Note 1	0.06	Note 1
SM2	1-1/2	1-1/4	1-11/16	1	Note 1	0.10	Note 1
SM1	1-1/2	1-1/2	1-11/16	1-1/8	Note 1	0.16	Note 1
1	1-13/16	1-7/8	1-13/16	1-1/4	1-7/16	0.25	Note 2
1A	1-11/16	1-17/32	1-13/16	1-5/32	1-1/8	0.25	Note 2
2	2	1-15/16	2-1/8	1-9/32	1-1/4	0.40	Note 2
3	2-5/16	1-13/16	2-1/8	1-9/32	1-7/16	0.45	Note 2
35	2-1/16	2-3/8	2-3/16	1-17/32	1-11/16	0.70	Note 2
4	2-5/16	2-3/8	2-9/16	1-17/32	1-11/16	0.90	Note 2
5	2-3/4	2-3/8	2-7/8	1-17/32	2-3/16	1.20	Note 2
6	2-3/4	2-5/8	3-1/8	1-17/32	2-3/16	1.50	Note 2
7	3	2-7/8	3-3/8	1-25/32	2-1/2	2.00	Note 2
8	3-3/8	2-7/8	3-3/8	1-25/32	2-1/2	2.50	Note 2
83	3-3/4	3-1/4	3-3/8	2-1/4	3	3.25	Note 3
84	3-3/4	3-3/4	3-3/8	2-3/4	3-1/8	4.25	Note 3
9	4-1/16	3-3/8	3-7/8	2-3/16	3-1/2	5.00	Note 3
10	4-1/2	3-15/16	3-15/16	2-3/4	3-1/8	6.00	Note 3

Note 1—SM series are two hole mounting with holes on center line. #4-40 Pem nuts are fastened to the bracket.

Note 2—#4-32 Pem nuts on bracket are standard.

Note 3—#8-32 Pem nuts on bracket are standard.

- All primaries 380-1000 cps
- Dielectric test voltages:
PRIMARYS 1500 Volts RMS
SECONDARIES 1500 Volts RMS
- Epoxy resin used as encapsulant
- Prices subject to change without notice

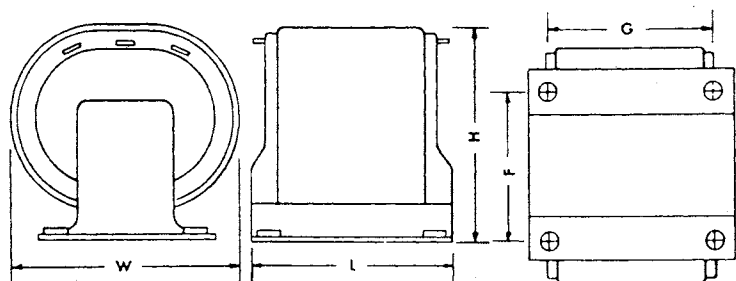

transistor transformers



UNIVERSAL DC POWER MODULE TRANSFORMERS

High reliability transformers having a tapped primary and single or dual secondary windings which may be connected F.W. bridge or F.W. center tap so as to obtain a wide range of DC voltages and current ratings.

INPUT PRIMARY 115 volts 50-500 cps

TYPE FIG.		F.W. BRIDGE								F.W. CT			MIL STD'D* HERM SEAL TF 45x02		INDUST. OPEN FRAME		
		40.5	32.25	28.5	24	20.25	16.5	12	8.25	40.5	24	16.5	Style	Net Pr.	Style	Net Pr.	
7K1	1	DC VOLT	53.0	41.0	34	25	24	18	12	6	24	12	6.6	H	12.90	F	7.90
	DC AMP	.025	.035	.040	.042	.055	.042	.070	.085	.042	.055	.068					
7K2	1	DC AMP	.085	.12	.13	.14	.18	.14	.23	.23	.14	.17	.21	H	14.20	L	9.20
	INPUT CAP	(.1)	(.1)	(.1)	(.1)	(.2)	(.2)	(.2)	(.2)	(.2)	(.2)	(.2)					
7K3	1	DC AMP	.48	.60	.60	.64	1.0	.8	1.2	1.52	.8	.883	.92	H	15.85	F	8.15
	INPUT CAP	(.5)	(.5)	(.5)	(.5)	(1.0)	(1.0)	(2.0)	(2.0)	(1.0)	(1.0)	(2.0)					
7K4	1	DC AMP	1.2	1.5	1.5	1.6	2.5	2.0	3.0	3.8	2.0	2.2	2.8	H	21.80	L	13.40
	INPUT CAP	(.5)	(.5)	(.5)	(.5)	(1.0)	(1.0)	(2.0)	(2.0)	(1.0)	(1.0)	(2.0)					
7K5	1	DC AMP	3.0	3.5	3.8	4.0	6.0	4.5	7.5	9.0	4.5	5.5	6.7	H	31.70	L	22.65
	INPUT CAP	(1.0)	(1.0)	(1.0)	(1.0)	(2.0)	(2.0)	(4)	(4)	(2.0)	(2.0)	(2.0)					
7K6	1	DC AMP	7.5	8.5	9.5	10	15	11	19	23	11	13.5	17	H	52.80	L	39.80
	INPUT CAP	(4.0)	(4.0)	(4.0)	(4.0)	(4.0)	(6.0)	(12)	(12)	(6)	(6)	(12)					
7K7	2	DC VOLT	81	64.5	57.0	48	40.5	33	24	16.5	81	48	33	H	22.44	L	14.05
	DC AMP	0.6	0.75	0.75	0.8	1.25	1.0	1.5	1.9	1.0	1.1	1.4					
		INPUT CAP	(.125)	(.125)	(.125)	(.125)	(.25)	(.25)	(.5)	(.5)	(.25)	(.25)	(.5)				

TYPE FIG.	PRI TAP	F.W. BRIDGE						F.W. CT					MIL STD * HERM SEAL		INDUST. OPEN FRAME			
		SEC.		CHOKE INPUT		CAP INPUT		CHOKE INPUT		CAP INPUT			Style	Net Pr.	Style	Net Pr.		
		AC Volt	AC Amp	DC Volt	DC Amp	DC Volt	DC Amp	Cap	DC Volt	DC Amp	DC Volt	DC Amp					Cap	
7K8	3	—	20CT	0.3	16.5	0.3	26	0.2	(.2)	8	0.43	12	0.3	(.5)	H	11.25	F	5.70
7K9	3	—	20CT	0.6	16.5	0.6	26	0.4	(.4)	9	0.85	13	0.6	(1.0)	H	14.20	F	8.65

TYPE FIG.	L	F.W. BRIDGE												Style	Net Pr.	L	Net Pr.
		SEC. in PARALLEL CONN.						SEC. in SERIES CONN.									
		17	1.5	14	3.0	18.5	2.0	(1.0)	28	1.5	45	1	(.5)				
7K10	H	21.5	1.5	17.5	3.0	25	2.0	(1.0)	35	1.5	36	1	(.5)	H	20.50	L	13.40
	L	17	4	14	8.0	18.5	5.0	(2.0)	28	4.0	45	2.5	(1.0)				
7K11	H	21.5	4	17.5	8.0	25	5.0	(2.0)	35	4.0	36	2.5	(1.0)	H	33.00	L	23.60
	L	17	9	14	18.0	18.5	12.0	(6.0)	28	9.0	45	6	(4.0)				
7K12	H	21.5	9	17.5	18.0	25	12.0	(6.0)	35	9.0	36	6	(4.0)	H	50.50	L	37.10
	L	34	4.5	28	9.0	43	6.0	(4.0)	56	4.5	85	3.0	(1.0)				
7K13	H	43	4.5	35	9.0	56	6.0	(4.0)	70	4.5	110	3.0	(1.0)	H	50.50	L	37.10
	L	10	20	8.2	20	10	13	(12)	—	—	—	—	—				
7K14	H	10	20	8.2	20	10	13	(12)	—	—	—	—	—	H	29.70	L	22.95

*FOR MILITARY USE REDUCE DC AMP 20%. Note Input Cap = (K) 1000 MFD. in Rectifier Circuit.

HIGH CURRENT TRANSFORMERS AND CHOKES

115V. 50-500 CPS

TRANSFORMERS

TYPE FIG.	SEC. IN PARALLEL		SEC. IN SERIES		Net Price	
	AC Volt	AC Amp	AC Volt	AC Amp		
7K15	5	3.2/6.4	16	3.2/6.4/9.6/12.8	8	7.55
7K16	5	3.2/6.4	24	3.2/6.4/9.6/12.8	12	8.95
7K17	5	3.2/6.4	50	3.2/6.4/9.6/12.8	25	18.90
7K18	5	3.2/6.4	100	3.2/6.4/9.6/12.8	50	26.20
7K19	5	6/12	16	6/12/18/24	8	12.55
7K20	5	6/12	24	6/12/18/24	12	15.70

TYPE FIG.	SEC. IN PARALLEL		SEC. IN SERIES		Net Price	
	AC Volt	AC Amp	AC Volt	AC Amp		
7K21	5	6/12	50	6/12/18/24	25	25.10
7K22	5	6/12	100	6/12/18/24	50	37.65
7K23	5	9/18	16	9/18/27/36	8	14.55
7K24	5	9/18	24	9/18/27/36	12	15.95
7K25	5	9/18	50	9/18/27/36	25	31.10
7K26	5	9/18	100	9/18/27/36	50	45.00

CHOKES

TYPE	FIG.	INDUCTANCE (Millihenries)	D.C. Amps	DCR (Ω)	Net Price
7K27	9	30	8	0.3	11.35
7K28	9	15	12	0.1	14.65

TYPE	FIG.	INDUCTANCE (Millihenries)	D.C. Amps	DCR (Ω)	Net Price
7K29	9	5	25	0.025	23.00
7K30	9	1.4	50	0.01	31.35

STERLING TRANSFORMER CORP



transistor transformers

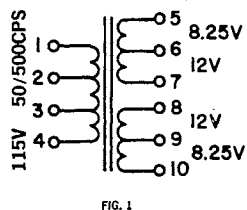

FIG. 1

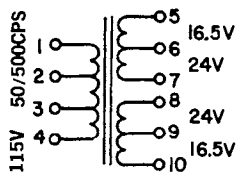

FIG. 2

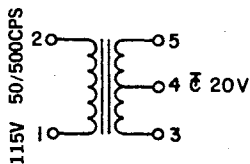

FIG. 3

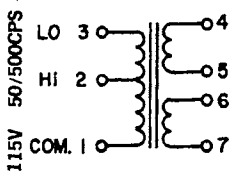

FIG. 4

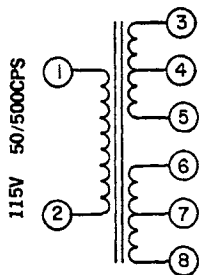

FIG. 5

TYPE	STYLE	FIG.	L	W	H	M1	M2	MTG. HOLES	STUDS
7K1	H	8	1 $\frac{3}{8}$	1 $\frac{3}{8}$	1 $\frac{3}{4}$	1 $\frac{1}{4}$	—	—	(2) 6-32
	F	6	2 $\frac{1}{8}$	1 $\frac{1}{4}$	1 $\frac{1}{4}$	1 $\frac{3}{4}$	—	(2) $\frac{3}{16}$	—
7K2	H	8	1 $\frac{5}{8}$	1 $\frac{5}{8}$	2 $\frac{3}{8}$	1 $\frac{3}{16}$	1 $\frac{3}{16}$	—	(4) 6-32
	L	7	1 $\frac{3}{8}$	1 $\frac{5}{8}$	2 $\frac{1}{8}$	1 $\frac{3}{16}$	1 $\frac{3}{8}$	(4) $\frac{5}{32}$	—
7K3	H	8	2 $\frac{5}{16}$	2 $\frac{1}{16}$	3 $\frac{1}{8}$	1 $\frac{1}{16}$	1 $\frac{1}{16}$	—	(4) 6-32
	F	6	3 $\frac{3}{4}$	2	2 $\frac{5}{16}$	3 $\frac{1}{8}$	—	(2) $\frac{3}{16}$	—
7K4	H	8	3 $\frac{1}{16}$	2 $\frac{5}{8}$	4 $\frac{1}{4}$	2 $\frac{1}{64}$	1 $\frac{5}{64}$	—	(4) 8-32
	L	7	2 $\frac{7}{8}$	2 $\frac{5}{8}$	3 $\frac{1}{16}$	2 $\frac{1}{4}$	2 $\frac{1}{8}$	(4) 1 $\frac{3}{64}$	—
7K5	H	8	3 $\frac{1}{16}$	3 $\frac{3}{8}$	5 $\frac{1}{4}$	3	2 $\frac{1}{16}$	—	(4) 10-32
	L	7	3 $\frac{7}{8}$	3 $\frac{1}{2}$	4 $\frac{5}{8}$	3	2 $\frac{1}{2}$	(4) 1 $\frac{3}{64}$	—
7K6	H	8	5 $\frac{1}{2}$	4 $\frac{1}{2}$	6 $\frac{3}{4}$	3 $\frac{3}{4}$	3	—	(4) $\frac{1}{4}$ -20
	L	7	4 $\frac{7}{16}$	4 $\frac{1}{2}$	5 $\frac{3}{8}$	3 $\frac{1}{2}$	3 $\frac{3}{8}$	(4) $\frac{3}{32}$	—
7K7	H	8	3 $\frac{1}{16}$	2 $\frac{5}{8}$	4 $\frac{1}{4}$	2 $\frac{1}{64}$	1 $\frac{5}{64}$	—	(4) 8-32
	L	7	2 $\frac{7}{8}$	2 $\frac{5}{8}$	3 $\frac{1}{16}$	2 $\frac{1}{4}$	2 $\frac{1}{8}$	(4) 1 $\frac{3}{64}$	—
7K8	H	8	1 $\frac{5}{16}$	1 $\frac{1}{16}$	2 $\frac{1}{16}$	1 $\frac{3}{8}$	1 $\frac{1}{4}$	—	(4) 6-32
	F	6	2 $\frac{7}{8}$	1 $\frac{1}{2}$	1 $\frac{1}{16}$	2 $\frac{3}{8}$	—	(2) $\frac{3}{16}$	—
7K9	H	8	1 $\frac{5}{16}$	1 $\frac{1}{16}$	2 $\frac{3}{4}$	1 $\frac{3}{8}$	1 $\frac{1}{4}$	—	(4) 6-32
	F	6	3 $\frac{5}{16}$	2 $\frac{1}{4}$	2	2 $\frac{1}{16}$	—	(2) $\frac{3}{16}$	—
7K10	H	8	3 $\frac{1}{16}$	2 $\frac{5}{8}$	4 $\frac{1}{4}$	2 $\frac{1}{64}$	1 $\frac{5}{64}$	—	(4) 8-32
	L	7	2 $\frac{7}{8}$	2 $\frac{1}{2}$	3 $\frac{1}{16}$	2 $\frac{1}{4}$	2	(4) 1 $\frac{3}{64}$	—
7K11	H	8	4 $\frac{5}{16}$	3 $\frac{1}{16}$	5 $\frac{1}{16}$	3 $\frac{1}{16}$	2 $\frac{1}{16}$	—	(4) 10-32
	L	7	3 $\frac{7}{8}$	3 $\frac{5}{8}$	4 $\frac{5}{8}$	3 $\frac{1}{16}$	2 $\frac{1}{4}$	(4) 1 $\frac{3}{64}$	—
7K12	H	8	5 $\frac{7}{8}$	4 $\frac{3}{4}$	6 $\frac{1}{16}$	4 $\frac{1}{8}$	3 $\frac{1}{2}$	—	(4) $\frac{1}{4}$ -20
	L	7	4 $\frac{1}{2}$	5 $\frac{1}{4}$	5 $\frac{3}{8}$	3 $\frac{1}{2}$	4 $\frac{1}{8}$	(4) $\frac{3}{32}$	—
7K13	H	8	5 $\frac{7}{8}$	4 $\frac{3}{4}$	6 $\frac{1}{16}$	4 $\frac{1}{8}$	3 $\frac{1}{2}$	—	(4) $\frac{1}{4}$ -20
	L	7	4 $\frac{1}{2}$	5 $\frac{1}{4}$	5 $\frac{3}{8}$	3 $\frac{1}{2}$	4 $\frac{1}{8}$	(4) $\frac{3}{32}$	—
7K14	H	8	3 $\frac{1}{16}$	3 $\frac{3}{8}$	5 $\frac{1}{4}$	3	2 $\frac{1}{16}$	—	(4) 10-32
	L	7	3 $\frac{7}{8}$	3 $\frac{1}{2}$	4 $\frac{5}{8}$	3	2 $\frac{1}{2}$	(4) 1 $\frac{3}{64}$	—
7K15	L	9	3 $\frac{1}{16}$	3	3 $\frac{1}{16}$	3 $\frac{1}{8}$	2 $\frac{1}{4}$	(4) 1 $\frac{3}{64}$	—
7K16	L	9	4 $\frac{1}{16}$	3 $\frac{1}{4}$	3 $\frac{1}{2}$	3 $\frac{1}{16}$	2 $\frac{3}{8}$	(4) 1 $\frac{3}{64}$	—
7K17	L	9	5 $\frac{3}{8}$	4 $\frac{1}{4}$	4 $\frac{5}{8}$	4 $\frac{3}{8}$	2 $\frac{7}{8}$	(4) $\frac{3}{32}$	—
7K18	L	9	5 $\frac{3}{8}$	5 $\frac{3}{4}$	4 $\frac{5}{8}$	4 $\frac{3}{8}$	4 $\frac{1}{8}$	(4) $\frac{3}{32}$	—
7K19	L	9	4 $\frac{1}{16}$	3 $\frac{7}{8}$	3 $\frac{1}{2}$	3 $\frac{1}{16}$	3	(4) 1 $\frac{3}{64}$	—
7K20	L	9	4 $\frac{1}{16}$	4 $\frac{1}{2}$	3 $\frac{7}{8}$	3 $\frac{3}{4}$	3 $\frac{3}{8}$	(4) 1 $\frac{3}{64}$	—
7K21	L	9	5 $\frac{3}{8}$	5 $\frac{3}{4}$	4 $\frac{5}{8}$	4 $\frac{3}{8}$	4 $\frac{1}{8}$	(4) $\frac{3}{32}$	—
7K22	L	9	6 $\frac{1}{2}$	6 $\frac{3}{8}$	5 $\frac{5}{8}$	5 $\frac{1}{16}$	4 $\frac{3}{8}$	(4) $\frac{3}{32}$	—
7K23	L	9	4 $\frac{1}{16}$	4 $\frac{3}{8}$	3 $\frac{7}{8}$	3 $\frac{3}{4}$	3 $\frac{3}{8}$	(4) 1 $\frac{3}{64}$	—
7K24	L	9	5 $\frac{3}{8}$	4 $\frac{7}{8}$	4 $\frac{5}{8}$	4 $\frac{3}{8}$	3 $\frac{3}{8}$	(4) $\frac{3}{32}$	—
K725	L	9	6 $\frac{1}{2}$	6	5 $\frac{5}{8}$	5 $\frac{1}{16}$	3 $\frac{3}{4}$	(4) $\frac{3}{32}$	—
7K26	L	9	6 $\frac{1}{2}$	7 $\frac{3}{4}$	5 $\frac{5}{8}$	5 $\frac{1}{16}$	5 $\frac{1}{8}$	(4) $\frac{3}{32}$	—
7K27	L	9	4 $\frac{1}{16}$	3 $\frac{3}{8}$	3 $\frac{1}{2}$	3 $\frac{1}{16}$	3	(4) 1 $\frac{3}{64}$	—
7K28	L	9	5 $\frac{3}{8}$	4 $\frac{1}{4}$	4 $\frac{5}{8}$	4 $\frac{3}{8}$	3 $\frac{1}{8}$	(4) $\frac{3}{32}$	—
7K29	L	9	5 $\frac{3}{8}$	4 $\frac{3}{4}$	4 $\frac{5}{8}$	4 $\frac{3}{8}$	3 $\frac{7}{8}$	(4) $\frac{3}{32}$	—
7K30	L	9	6 $\frac{1}{2}$	5 $\frac{3}{4}$	5 $\frac{5}{8}$	5 $\frac{1}{16}$	4 $\frac{1}{8}$	(4) $\frac{3}{32}$	—

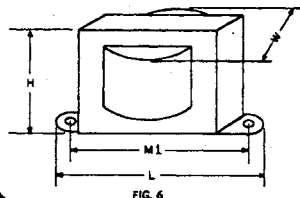

FIG. 6

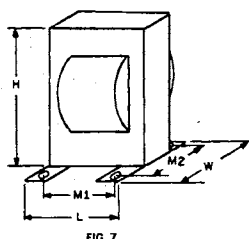

FIG. 7

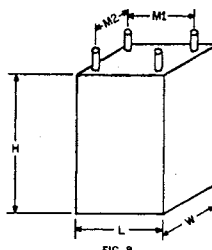

FIG. 8

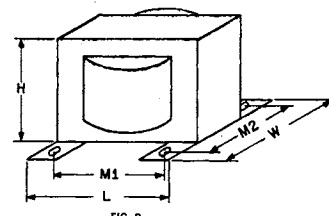

FIG. 9

STERLING TRANSFORMER CORP.

transistor transformers



MINISPEC TRANSISTOR TRANSFORMERS — 300 SERIES

Part No.	Application	Primary Impedance	Secondary Impedance	Pri. D.C. Unbal. Ma.	Oper. Lev. DBM	Freq. Response ± 2 db.	Net Price 1-9 pcs.	
							F	H
300	Line to Base	600	600	10	23	200-15,000	\$4.00	\$8.60
301	Coll. to P.P. Base	100	10 C.T./40 C.T.	100	27	200-20,000	4.65	9.60
302	Coll. to Base or line	50,000	600	3	20	300-15,000	4.30	9.25
303	Collector to speaker	50,000	6	3	20	300-15,000	4.30	9.25
304	Coll. to P.P. Base	100,000	1,200 C.T.	1.4	17	200-15,000	4.50	9.45
305	Coll. to P.P. Base	25,000	1,200 C.T.	3	22	200-15,000	4.50	9.45
306	P.P. Coll. to P.P. Base	50,000 C.T.	1,200 C.T.	3	20	300-15,000	4.65	9.60
307	Line to P.P. Base	600 C.T.	1,200 C.T.	4	23	200-15,000	4.65	9.60
308	Collector to Base	25,000	600	3	22	200-15,000	4.30	9.25
309	P.P. Coll. to P.P. Base	4,000 C.T.	600 C.T.	3	32	200-15,000	4.65	9.60
310	Output Coll. to speaker	2,000	3.4	10	32	200-15,000	4.30	9.25
311	P.P. Coll. to speaker	4,000 C.T.	3.4	3	32	200-15,000	4.50	9.45
312	Coll. to Speaker	400	10	50	25	200-20,000	4.00	8.60
313	P.P. Servo Output	500 C.T.	210	30	27	300-20,000	4.30	9.25
314	P.P. Coll. to P.P. Base	25,000 C.T.	1,200 C.T.	6	22	200-15,000	4.65	9.60
315	P.P. Coll. to P.P. Base	50,000 C.T.	1200/300 Split	3	20	300-15,000	4.95	9.90
316	P.P. Coll. to P.P. Base	4,000 C.T.	600/150 Split	3	32	200-15,000	4.80	9.75
317	Line to P.P. Base	600/150 Split	1,200 C.T.	4	23	200-15,000	4.80	9.75
318	P.P. Coll. to Servo	250 C.T.	1,000	10	30	200-15,000	4.30	9.25
319	Coll. to P.P. Base	2,500	600 C.T.	10	32	200-15,000	4.30	9.25
320	P.P. Coll. to P.P. Base	7,500 C.T.	600 C.T.	8	32	200-15,000	4.65	9.60
321	Line to P.P. Base	600 C.T.	600 C.T.	20	23	200-15,000	4.50	9.45
322	P.P. Coll. to Servo	1,600 C.T.	450	15	30	200-15,000	4.30	9.25
323	P.P. Coll. to Servo	250 C.T.	500	10	30	200-15,000	4.30	9.25

MINISPEC AUDIO TRANSFORMERS — 300 SERIES

Part No.	Application	Primary Impedance	Secondary Impedance	Pri. D.C. Unbal. Ma.	Oper. Lev. DBM	Freq. Response ± 2 db.	Net Price 1-9 pcs.	
							F	H
375	Mike or line to 1 grid	50/250/600 C.T.	50,000	0	5	20-20,000	\$4.50	\$9.90
376	Mike or line to 2 grids	50/250/600 C.T.	50,000 C.T.	0	5	20-20,000	4.65	10.40
377	Dynamic mike to 1 grid	7.5/30	50,000	0	5	20-20,000	4.30	9.90
378	Single plate to 1 grid	15,000	60,000	0	6	20-15,000	3.80	8.45
379	Single plate to 1 grid	15,000	60,000	4	14	200-20,000	3.80	8.45
380	Single plate to 2 grids	15,000	95,000 C.T.	0	5	20-15,000	4.00	9.45
381	Single plate to 2 grids	15,000	95,000 C.T.	4	11	200-20,000	4.15	9.75
382	Single plate to line	15,000	50/250/600 C.T.	0	8	20-20,000	4.15	10.60
383	Single plate to line	15,000	50/250/600 C.T.	4	21	150-20,000	4.15	10.60
384	Push pull plates to line	30,000 C.T.	50/250/600 C.T.	0	8	30-50,000	4.30	10.60
385	Crystal mike to line	50,000	50/250/600 C.T.	0	5	20-20,000	4.15	10.25
386	Mixing and matching	50/250 C.T.	50/250/600 C.T.	0	8	20-20,000	4.15	10.25
387	Reactor	300 hy. 0 d.c.	50 hy. @ 3 ma.			DCR 6,000	3.65	8.10
388	50:1 mike to grid	200	1/2 Megohm	0	9	80-3,000	4.30	9.90
389	10:1 plate to grid	10,000	1 Megohm	0	11	100-2,500	4.00	9.25

MINISPEC 300 SERIES

Highest efficiency miniature transformer for transistor and audio circuit applications.

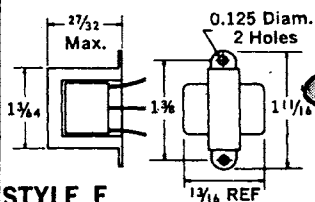

STYLE F
INDUSTRIAL

MILITARY STYLE ENCAPSULATED VERSIONS ARE AVAILABLE

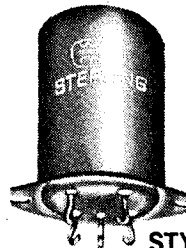
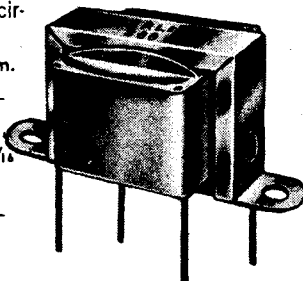

STYLE H
HERMETICALLY SEALED

Clearance Hole Required

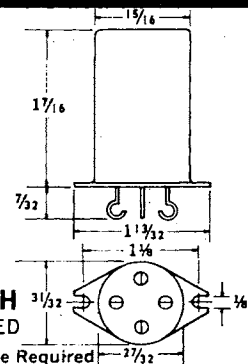

STERLING TRANSFORMER CORP.



transistor transformers

MICROSPEC TRANSISTOR TRANSFORMERS — 600 SERIES

Part No.	Application	Primary Impedance	Secondary Impedance	Pri. D.C. Unbal. Ma.	Oper. Lev. DBM	Freq. Response ± 2 db.	Net Price 1-9 pcs.	
							F	H
601	Line to Base	600	600	8	22	200-15,000	\$4.30	\$8.10
602	Coll. to Base or line	50,000	600	0.7	20	200-15,000	4.50	8.25
603	P.P. coll. to P.P. Base	50,000 C.T.	600 C.T.	1.4	20	200-15,000	5.30	9.45
604	Collector to speaker	50,000	6	1	20	200-15,000	4.80	8.75
605	Coll. to P.P. Base	25,000	1,200 C.T.	1	20	200-15,000	4.95	9.25
606	P.P. coll. to P.P. Base	50,000 C.T.	1,200 C.T.	1.4	20	200-15,000	5.15	9.45
607	Line to P.P. Base	600 C.T.	1,200 C.T.	16	22	200-15,000	4.65	8.45
608	Collector to Base	25,000	600	1	20	200-15,000	3.80	7.95
609	P.P. coll. to P.P. Base or line	4,000 C.T.	600 C.T.	5	28	200-15,000	4.80	8.60
610	Coll. to Spkr.	2,000	3.4	5	28	200-15,000	4.30	8.10
611	Output P.P. coll. to spkr.	4,000 C.T.	3.4	5	28	200-15,000	4.50	8.25
612	Coll. to P.P. Base	10,000	1,500 C.T.	1	20	200-15,000	4.95	9.25
613	P.P. Coll. to P.P. Base	10,000 C.T.	200 C.T.	6	20	200-15,000	4.95	8.95
614	P.P. Coll. to P.P. Base	25,000 C.T.	1,200 C.T.	2	20	200-15,000	5.15	9.45
615	Coll. to P.P. Base	2,500	2,500 C.T.	2	23	200-15,000	4.50	8.25
616	P.P. Coll. to P.P. Base	4,000 C.T.	600/150 split	5	28	200-15,000	5.15	9.45
617	P.P. Coll. to P.P. Base	7,500 C.T.	600 C.T.	4	22	200-15,000	4.80	8.60
618	Line to Base	600 C.T.	600 C.T.	16	22	200-15,000	4.65	8.45
619	P.P. Coll. to P.P. Base	25,000 C.T.	600 C.T.	2	20	200-15,000	4.95	9.25
620	P.P. Coll. to P.P. Base	10,000 C.T.	1,500 C.T.	2	20	200-15,000	5.15	9.45
621	Driver/Isolation	10,000 C.T.	10,000 C.T.	2	20	200-15,000	5.15	9.45
622	P.P. Coll. to P.P. Base	7,500 C.T.	1,200 C.T.	4	22	200-15,000	4.95	9.25
623	P.P. Coll. to P.P. Base	2,000 C.T.	500 C.T.	10	28	200-15,000	4.80	9.10
624	Line to P.P. Base	600 C.T.	1200/300 split	16	22	200-15,000	5.15	9.45

MICROSPEC AUDIO TRANSFORMERS — 600 SERIES

Part No.	Application	Primary Impedance	Secondary Impedance	Pri. D.C. Unbal. Ma.	Oper. Lev. DBM	Freq. Response ± 2 db.	Net Price 1-9 pcs.	
							F	H
675	Input	200/50	250,000/62,500	0	4	200-10,000	\$4.95	\$8.10
676	Interstage 3:1	10,000	90,000	0	4	150-10,000	5.30	8.25
677	Plate to line	10,000	200	3	20	150-10,000	4.65	7.95
678	Output	30,000	50	1	20	150-10,000	4.50	7.80
679	Reactor 50 HY at 1 made				4700	ohms DCR	4.50	7.60
680	Output	100,000	60	0.5	20	250-10,000	4.65	7.95
681	Output	30,000	1,200	0.5	20	200-10,000	3.65	7.10

MICROSPEC 600 SERIES

Subminiature transformers for high efficiency circuits.

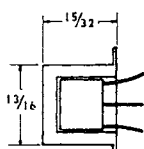

STYLE F
INDUSTRIAL

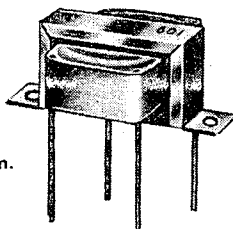
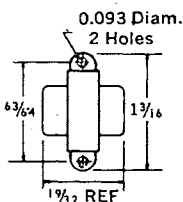

MILITARY STYLE ENCAPSULATED
VERSIONS ARE AVAILABLE

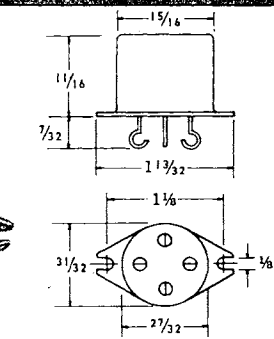
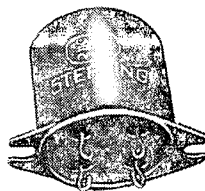

Clearance Hole Required
STYLE H
HERMETICALLY SEALED



transistor transformers

NANOSPEC TRANSISTOR TRANSFORMERS — 900 SERIES

Frequency Response ± 2 db 300 Cycles to 90 KC

Part No.	Application	Color Application Guide	Primary Impedance	Secondary Impedance	Unbal. Pri. DC Ma.	Power Level MW.	DC Resistance		Net Price 1-9 Pcs.
							Primary	Secondary	
903	Interstage	Red	50,000 CT	1,000 CT	0	10	3300	75	8.25
904	Interstage	Red	50,000	1000/250 Split	0	10	3300	75	8.95
905	Interstage	Red	25,000 CT	1,000 CT	0.5	40	1700	115	7.80
906	Interstage	Red	25,000	1000/250 Split	0.25	40	1700	115	8.45
907	Interstage	Red	25,000	1,000	0.25	40	1700	115	7.15
908	Isolation	Green	10,000 CT	10,000 CT	1	50	1200	1300	8.45
909	Driver	Orange	10,000 CT	2,000 CT	1	50	1050	300	7.45
910	Driver	Orange	10,000	2000/500 Split	0.5	50	1050	300	8.10
911	Driver	Orange	10,000 CT	1,200 CT	1	50	1050	280	7.45
912	Driver	Orange	10,000	1200/300 Split	0.5	50	1050	280	7.95
913	Driver	Orange	10,000	1,200	0.5	50	1050	280	6.60
914	Driver	Orange	10,000 CT	500 CT	1	50	1050	80	7.45
915	Isolation	Green	2,500	2,500 CT	1	50	250	325	6.95
916	Output	Yellow	1,500 CT	600	3	50	170	135	6.80
917	Output	Yellow	500	50	3	50	60	8	5.95
918	Output	Yellow	120 CT	3.2	10	50	17	.75	6.30
919	Audio Choke	Blue	6 HY.	DCR 1800 OHMS	2				5.95
920	Audio Choke	Blue	.3 HY.	DCR 45 OHMS	4				5.15
921	Audio Choke	Blue	1.25 H	DCR 180 OHMS	2				5.30
922	Audio Choke	Blue	3.5 H	DCR 1040 OHMS	2				5.30
923	Audio Choke	Blue	.9 H	DCR 110 OHMS	2				5.30
924	Audio Choke	Blue	.1 H	DCR 15 OHMS	5				5.30
925	Interstage	Red	10,000 CT	1,500 CT	1	50	1050	300	7.95
926	Isolation	Green	600 CT	600 CT	3	50	72	92	7.95
927	Output	Yellow	1,000	50	3	50	145	8	6.45
928	Output	Yellow	300 CT	600	7	50	41	98	6.60
929	Output	Yellow	500 CT	600	3	50	67	98	6.60
930	Output	Yellow	900 CT	600	4	50	104	96	6.80
931	Output	Yellow	150 CT	12	10	50	18	3.5	6.45
932	Output	Yellow	300 CT	12	7	50	42	3.4	6.45
933	Output	Yellow	600 CT	12	4.5	50	77	3	6.60
934	Output	Yellow	1,000 CT	12	3.5	50	120	3	6.80
935	Output	Yellow	1,500 CT	12	3	50	179	2.9	6.95
936	Output	Yellow	7,500 CT	12	1	50	796	2.9	7.45
937	Output	Yellow	320 CT	3.2	6	50	44	.77	6.45
938	Output	Yellow	600	3.2	3	50	70	.76	6.15
939	Output	Yellow	600 CT	3.2	4.5	50	70	.85	6.60
940	Output	Yellow	800 CT	3.2	4	50	107	.86	6.80
941	Output	Yellow	1,200	3.2	2	50	131	.76	6.15
942	Output	Yellow	1,200 CT	3.2	3	50	131	.87	6.80
943	Output	Yellow	1,600 CT	3.2	2.5	50	186	.8	6.95
944	Output	Yellow	10,000	3.2	1	50	1160	.81	6.80
945	Output	Yellow	8,000 CT	3.2	1	50	790	.76	7.45

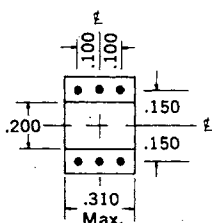
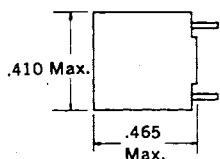

NANOSPEC 900 SERIES

Designed for printed circuit transistor use in high component density applications.
Epoxy resin encapsulated.

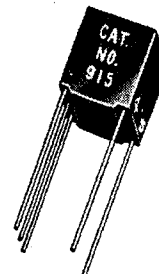

STERLING TRANSFORMER CORP



STANDARD INTERSTAGE AND LINE TRANSISTOR AND TUBE APPLICATIONS

filters

Hermetically Sealed - Manufactured to MIL-F-18327B Available in Other Frequencies

LOW PASS

INTERSTAGE

LI units have a loss of approximately 3 db at cutoff frequency, and an attenuation of 35 db at 1.5 cutoff frequency. Input and output 10,000 ohms. LI units are MIL type FR4RX11YY.

Part No.	Frequency	Case Size	Net Price
LI-60	60 cps	A	34.65
LI-100	100 cps	A	34.65
LI-200	200 cps	B	34.65
LI-400	400 cps	B	34.65
LI-500	500 cps	B	34.65
LI-800	800 cps	B	34.65
LI-1,000	1,000 cps	B	34.65
LI-1,500	1,500 cps	B	34.65
LI-2,000	2,000 cps	B	34.65
LI-2,500	2,500 cps	B	34.65
LI-3,000	3,000 cps	B	34.65
LI-4,000	4,000 cps	B	34.65
LI-5,000	5,000 cps	B	34.65
LI-10,000	10,000 cps	B	34.65

LINE

LL units have a loss of approximately 3 db at cutoff frequency, and an attenuation of 35 db at 1.5 cutoff frequency. Input and output 500/600 ohms. LL units are MIL type FR4RX11YY.

Part No.	Frequency	Case Size	Net Price
LL-600	600 cps	A	34.65
LL-1,000	1,000 cps	A	34.65
LL-1,500	1,500 cps	A	34.65
LL-2,000	2,000 cps	A	34.65
LL-2,500	2,500 cps	A	34.65
LL-4,000	4,000 cps	A	34.65
LL-8,000	8,000 cps	A	34.65
LL-10,000	10,000 cps	A	34.65
LL-12,000	12,000 cps	A	34.65

CASE DETAIL

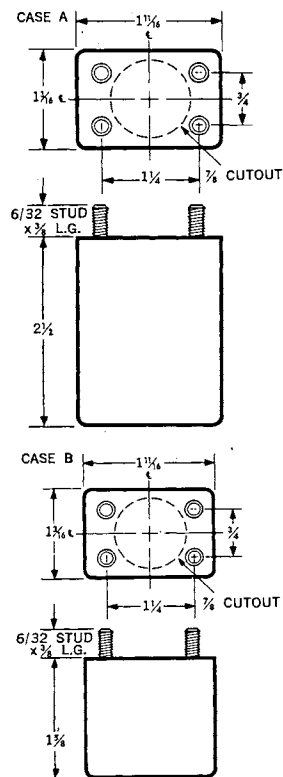

HIGH PASS

INTERSTAGE

HI units have a loss of less than 6 db at cutoff frequency, and an attenuation of 35 db at .67 cutoff frequency. Input and output 10,000 ohms. HI units are MIL type FR4RX33YY.

Part No.	Frequency	Case Size	Net Price
HI-100	100 cps	A	34.65
HI-200	200 cps	A	34.65
HI-300	300 cps	A	34.65
HI-400	400 cps	A	34.65
HI-500	500 cps	A	34.65
HI-800	800 cps	A	34.65
HI-1,000	1,000 cps	A	34.65
HI-2,000	2,000 cps	A	34.65
HI-3,000	3,000 cps	A	34.65

LINE

HL units have a loss of less than 6 db at cutoff frequency, and an attenuation of 35 db at .67 cutoff frequency. Input and output 500/600 ohms. HL units are MIL type FR4RX33YY.

Part No.	Frequency	Case Size	Net Price
HL-200	200 cps	A	42.90
HL-300	300 cps	A	42.90
HL-500	500 cps	A	42.90
HL-1,000	1,000 cps	A	42.90

FOR WIDE BAND PASS FILTERS THE LI & HI OR LL & HL MAY BE CONNECTED IN SERIES.

BAND PASS

INTERSTAGE

BI units have 2:1 voltage gain. They are sharply peaked, having approximately 2 db attenuation at plus or minus 3% from center frequency and attenuation greater than 40 db at 1/2 and twice center frequency. Input 10,000 ohms, output to grid. BI units are MIL type FR4RX22YY.

Part No.	Frequency	Case Size	Net Price
BI-50	50 cps	A	33.00
BI-60	60 cps	A	33.00
BI-100	100 cps	A	33.00
BI-120	120 cps	B	33.00
BI-200	200 cps	B	33.00
BI-240	240 cps	B	33.00
BI-400	400 cps	B	33.00
BI-500	500 cps	B	33.00
BI-750	750 cps	B	33.00
BI-800	800 cps	B	33.00
BI-1,000	1,000 cps	B	33.00
BI-1,500	1,500 cps	B	33.00
BI-2,000	2,000 cps	B	33.00
BI-3,000	3,000 cps	B	33.00
BI-4,000	4,000 cps	B	33.00
BI-5,000	5,000 cps	B	33.00
BI-10,000	10,000 cps	B	33.00

LINE

BL units have 9:1 voltage gain. They are sharply peaked, having approximately 2 db attenuation at plus or minus 3% from center frequency and attenuation greater than 40 db at 1/2 and twice center frequency. Input 500/600 ohms, output to grid. BL units are MIL type FR4RX22YY.

Part No.	Frequency	Case Size	Net Price
BL-400	400 cps	B	33.00
BL-1,000	1,000 cps	B	33.00

TRANSISTOR INTERSTAGE

are sharply peaked, having approximately 2 db attenuation at plus or minus 3% from center frequency and attenuation greater than 40 db at 1/2 and twice center frequency. Input 10,000 ohms, output 10,000 ohms. BIT units are MIL type FR4RX22YY.

Part No.	Frequency	Case Size	Net Price
BIT-60	60 cps	A	39.60
BIT-100	100 cps	A	39.60
BIT-120	120 cps	B	39.60

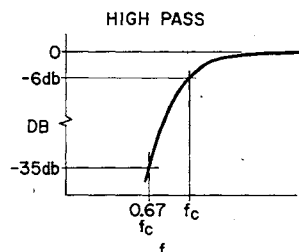
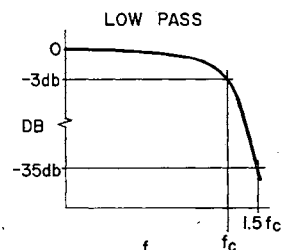
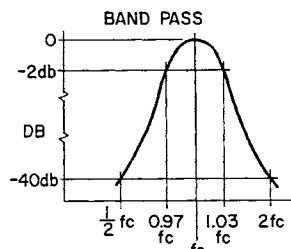



hi-Q toroidal inductors

MANUFACTURED TO MIL-T-27A. ALL HERMETICALLY SEALED UNITS (STYLE H) ARE MIL TYPE TF4RX20YY

■ ALL MOLDED UNITS STYLE M ARE MIL TYPE TF5RX20ZZ

■ ALSO TOROIDAL INDUCTORS IN OTHER SIZES AND VALUES AVAILABLE ON SPECIAL ORDER.

■ MOLYBDENUM PERMALLOY POWDER CORES USED IN ALL UNITS.

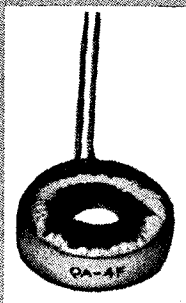

STYLE F
= ALL INDUCTORS SHOWN AVAILABLE IN OPEN STYLE F.

QA SERIES

FREQUENCY TO 20KC•ACCURACY ±2%

The QA series is designed to optimize small size and high "Q" for miniaturized applications. These units are available on special order with stabilized cores and inductance from 1MH to 4.0H.

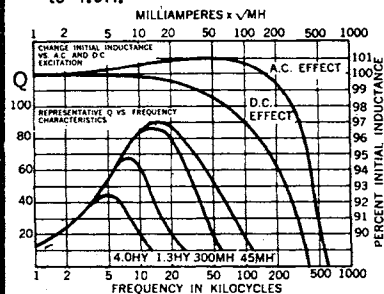

AVAILABLE ON SPECIAL ORDER
HERMETICALLY SEALED

Part No.	Inductance	Approx. DCR Ohms	Approx. Distributed Capacity PF	Net Price 1-9 pcs.	
				Style F	Style M
QA-1	5MH	2.5	30	4.80	6.30
QA-2	10	5	33	4.80	6.30
QA-3	15	8	34	4.95	6.45
QA-4	20	11.2	36	5.10	6.60
QA-5	30	17	37	5.15	6.80
QA-6	50	28	40	5.30	6.95
QA-7	100	50	42	5.45	7.10
QA-8	150	80	44	5.65	7.30
QA-9	200	120	45	5.75	7.40
QA-10	300	150	46	5.85	7.65
QA-11	500	290	48	5.95	7.95
QA-12	1.00H	530	51	6.80	8.75
QA-13	1.50	825	53	6.95	9.60

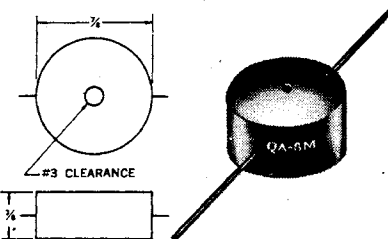

MOLDED STYLE M

Encapsulated in Epoxy Resin. Pigtail leads for printed circuit applications.

QB SERIES

FREQUENCY TO 20KC•ACCURACY ±2%

The QB series is designed for airborne applications where stable high "Q" is needed with minimized size and weight. Available on special order with stabilized cores and inductance to 7.0H.

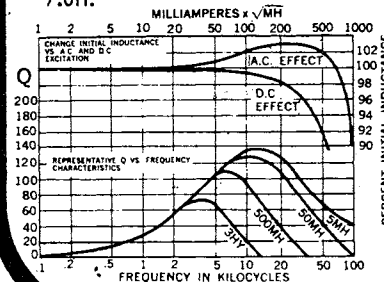

Part No.	Inductance	Approx. DCR Ohms	Approx. Distributed Capacity PF	Net Price 1-9 pcs.		
				Style F	Style H	Style M
QB-1	5MH	1.1	38	4.30	7.45	5.80
QB-2	10	2.1	40	4.30	7.45	5.80
QB-3	15	3.3	42	4.30	7.45	5.95
QB-4	20	3.7	43	4.35	7.55	6.05
QB-5	30	5.8	45	4.40	7.70	6.15
QB-6	50	11	47	4.50	7.95	6.25
QB-7	100	22	49	4.65	8.45	6.30
QB-8	150	34	50	4.80	8.60	6.45
QB-9	200	47	52	5.05	9.00	6.70
QB-10	300	60	53	5.15	9.25	6.80
QB-11	500	95	55	5.30	9.45	6.95
QB-12	1.00H	213	57	5.65	9.90	7.45
QB-13	1.50	335	59	6.45	10.40	8.10

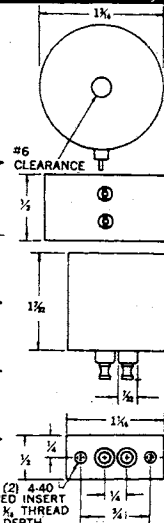

MOLDED STYLE M

Encapsulated in Epoxy Resin. Silver plated turret lugs.



HERMETIC STYLE H

Hermetically sealed in metal case. Teflon terminals assure permanent seal at temperature extremes.

STERLING TRANSFORMER CORP.

hi-Q toroidal inductors



QC SERIES FREQUENCY TO 10KC ACCURACY ± 2%

The QC series is designed for high "Q", increased power level & stability. Available on special order with stabilized cores and inductance to 20H.

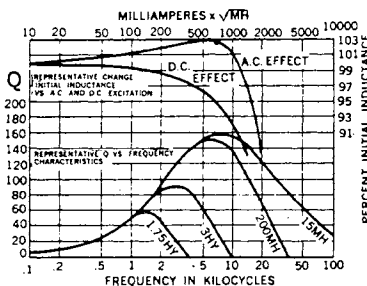

Part No.	Inductance	Approx. DCR Ohms	Approx. Distributed Capacity PF	Net Price 1-9 pcs.		
				Style F	Style H	Style M
QC-1	5MH	0.62	60	4.80	7.80	6.80
QC-2	10	1.1	66	4.95	7.95	6.80
QC-3	15	1.7	68	4.95	8.10	6.80
QC-4	20	1.9	70	5.05	8.25	6.80
QC-5	30	3	72	5.10	8.45	6.80
QC-6	50	6	76	5.15	8.60	6.80
QC-7	100	11	81	5.30	9.25	7.30
QC-8	150	17	83	5.45	9.45	7.30
QC-9	200	24	85	5.50	9.65	7.40
QC-10	300	37	88	5.60	9.80	7.50
QC-11	500	63	91	5.65	10.10	7.60
QC-12	1.00H	110	96	5.80	10.60	7.95
QC-13	1.50	185	98	5.95	10.75	8.10
QC-14	2.00	250	100	6.50	11.20	8.40
QC-15	3.00	380	103	7.05	11.65	8.80
QC-16	5.00	645	106	7.45	12.25	9.25
QC-17	7.50	950	109	8.00	13.00	10.05
QC-18	10.00	1175	112	8.25	13.70	10.60

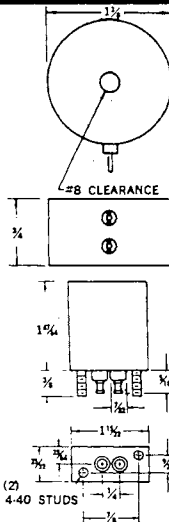

MOLDED STYLE M
Encapsulated in Epoxy Resin. Silver plated turret lugs.



HERMETIC STYLE H
Hermetically sealed in metal case. Teflon terminals assure permanent seal at temperature extremes.

QD SERIES

FREQUENCY TO 10KC-ACCURACY ± 2%

The QD series is designed for very high "Q" in the audio band allowing for application in sharp frequency filters with high power levels and low losses. They are excellent for tuned transformers and oscillators. Available on special order with stabilized cores and inductance to 50H.

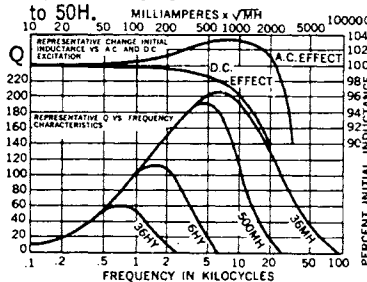

Part No.	Inductance	Approx. DCR Ohms	Approx. Distributed Capacity PF	Net Price 1-9 pcs.		
				Style F	Style H	Style M
QD-1	20MH	1.0	97	7.80	11.60	9.60
QD-2	30	1.5	100	7.80	11.60	9.60
QD-3	50	2.5	105	7.80	11.60	9.60
QD-4	100	6	110	7.95	11.75	9.75
QD-5	150	7	113	8.10	11.85	10.35
QD-6	200	10	115	8.10	11.85	10.35
QD-7	300	15	117	8.25	12.05	10.60
QD-8	500	25	121	8.25	12.05	10.60
QD-9	1.00H	60	126	8.60	12.55	10.90
QD-10	1.50	90	130	8.95	12.90	11.25
QD-11	2.00	100	131	9.85	13.90	11.70
QD-12	3.00	155	134	10.20	14.30	12.00
QD-13	5.00	275	138	10.40	14.55	12.25
QD-14	7.50	400	140	11.10	15.55	13.20
QD-15	10.00	600	142	12.25	16.50	14.20
QD-16	15.00	900	146	13.20	17.35	15.20
QD-17	20.00	1100	148	14.15	19.10	16.80
QD-18	25.00	1500	150	14.40	19.35	17.00

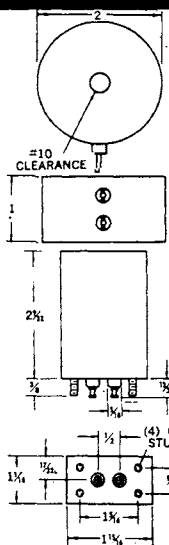

MOLDED STYLE M
Encapsulated in Epoxy Resin. Silver plated turret lugs.



HERMETIC STYLE H
Hermetically sealed in metal case. Teflon terminals assure permanent seal at temperature extremes.

QE SERIES

FREQUENCY TO 15KC
ACCURACY ± 2%

The QE series is most widely used in low audio frequency applications where high "Q" is essential. They are used where inductance stability over a wide voltage range is required. Available on special order with inductance to 75H.

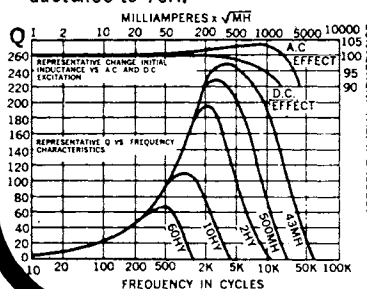

Part No.	Inductance	Approx. DCR Ohms	Approx. Distributed Capacity PF	Net Price 1-9 pcs.		
				Style F	Style H	Style M
QE-1	25MH	0.85	127	11.90	14.85	13.90
QE-2	50	1.6	136	12.05	15.05	14.05
QE-3	100	3	144	15.35	15.35	14.40
QE-4	150	3.9	149	15.70	15.70	15.05
QE-5	200	5.9	153	16.25	16.25	15.25
QE-6	300	8.5	158	16.30	16.30	15.30
QE-7	500	15	164	16.35	16.35	15.35
QE-8	1.00H	30	173	16.70	16.70	15.35
QE-9	1.50	40	177	17.00	17.00	15.70
QE-10	2.00	60	181	17.95	17.95	16.10
QE-11	3.00	85	185	18.05	18.05	16.30
QE-12	5.00	142	192	18.35	18.35	16.50
QE-13	7.50	215	196	18.70	18.70	17.55
QE-14	10.00	300	200	19.00	19.00	17.85
QE-15	15.00	430	205	20.15	20.15	19.00
QE-16	20.00	550	209	21.20	21.20	20.00
QE-17	25.00	800	212	21.45	21.45	20.30
QE-18	30.00	850	214	25.30	25.30	24.15
QE-19	50.00	1500	221	27.75	27.75	26.60

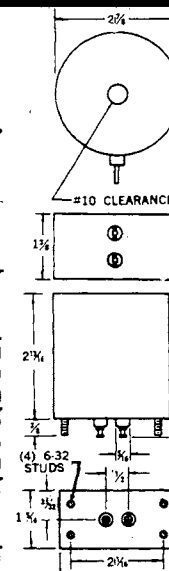

MOLDED STYLE M
Encapsulated in Epoxy Resin. Silver plated turret lugs.



HERMETIC STYLE H
Hermetically sealed in metal case. Teflon terminals assure permanent seal at temperature extremes.

POWERSTAT® Variable Transformers now

New epoxy-coated POWERKOTE Coils make the POWERSTAT line the most outstanding value in variable transformers today. *Without increase in price, size or weight*, only POWERSTAT Variable Transformers give an average of 20% higher current ratings, 10:1 greater overload capability, longer life, greater resistance to fungus, salt spray and other contaminating atmospheres. POWERKOTE Coil commutator bars are embedded in place preventing steady-state operating temperature and severe overloads from distorting the commutator.

POWERSTAT Variable Transformers are designed to deliver continuously adjustable voltage from a-c power lines. They introduce no waveform distortion and feature rugged construction, precious metal plated commutators, excellent regulation, high efficiency and conservative ratings. All manually operated types listed in the charts except the 10B-12, EN116B-EN216B and EN117B-EN217B Series are available with motor drives if desired. Motor-driven speeds are 5, 15, 30 or 60 seconds for full range travel on all except types having -4, -5, or -6 suffixes which do not offer the 5-second speed. Single types in the 116B-216B, 117B-217B, 126-226 and 136B-236B Series are also offered with 2- or 3-wire cord-plug sets. 1156D-1256D Series types are available in ratings to 244 kva.

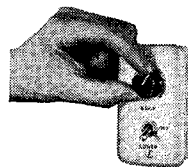

ADJUSTABLE SPEED DRIVES

All motor-driven units in the 116B-216B, 117B-217B, 126-226, 136B-236B and 146-246 Series are available with adjustable speed drives which permit the output voltage of the transformer to be controlled over the full range of zero to maximum output voltage at speeds ranging from 5 seconds to 200 seconds. All control circuitry is solid-state and adaptable for present speed systems. The Adjustable Speed Control Potentiometer BHP65455-G1 can be remotely located from the variable transformer.

RATINGS AND SPECIFICATIONS

INPUT		OUTPUT				TYPE	Ship. Wt. Lbs.
Volts	Cycles	Volts	Const. Current Load	Const. Impedance Load			
			Max. Amp.	Max. KVA	Max. Amp.	Max. KVA	
10B-12 SERIES							
Single Phase							
120	60	0-132	1	0.13	—	—	2PF10 3½
120	50/60	0-120	2.25*	0.27	3†	0.36	10B 2½
120	60	0-132	2.25*	0.30	—	—	12 2½
240	50/60	0-240	0.7*	0.17	0.9†	0.22	10B-2 2½
240	50/60	0-264	0.5**	0.13	—	—	10B-2 6
240	50/60	0-240	2.25*	0.54	3†	0.72	10B-2 6
240	60	0-264	2.25*	0.59	—	—	12-2 6
480	50/60	0-480	0.7*	0.34	0.9†	0.43	12-2 6
480	50/60	0-528	0.5**	0.26	—	—	
Three Phase							
120	50/60	0-120	2.25*	0.47	3†	0.62	10B-2 6
120	60	0-132	2.25*	0.51	—	—	
240	50/60	0-240	0.7*	0.29	0.9†	0.37	12-2 6
240	50/60	0-264	0.5**	0.23	—	—	
240	60	0-240	2.25*	0.94	3†	1.2	10B-3 8½
480	50/60	0-480	0.7*	0.58	0.9†	0.75	12-3 8½
480	60	0-528	0.5**	0.46	—	—	
21-22 SERIES							
Single Phase							
120	50/60	0-120	4.5	0.54	6.5	0.78	21 6
120	50/60	0-140	4.5	0.63	—	—	
240	50/60	0-240	2.25	0.54	3.25	0.78	22 6
240	50/60	0-280	2.25	0.63	—	—	
240	50/60	0-240	4.5	1.1	6.5	1.6	21-2 13½
240	50/60	0-280	4.5	1.3	—	—	
480	50/60	0-480	2.25	1.1	3.25	1.6	22-2 13½
480	50/60	0-560	2.25	1.3	—	—	
Three Phase							
120	50/60	0-120	4.5	0.94	6.5	1.4	21-2 13½
120	50/60	0-140	4.5	1.1	—	—	
240	50/60	0-240	2.25	0.94	3.25	1.4	22-2 13½
240	50/60	0-280	2.25	1.1	—	—	
240	50/60	0-240	4.5	1.9	6.5	2.7	21-3 19
240	60	0-280	4.5	2.2	—	—	
480	50/60	0-480	2.25	1.9	3.25	2.7	22-3 19
480	60	0-560	2.25	2.2	—	—	

*Rating when mounted on metal panel. On bracket or nonmetallic panel, derate 10B Series to 1.75 amp., 12 Series to 0.5 amp.

†Rating when mounted on metal panel. On bracket or nonmetallic panel, derate 10B Series to 2.5 amp., 12 Series to 0.75 amp.

**0.7 amp. maximum in range from 0 to line voltage when mounted on metal panel.



THE

SUPERIOR ELECTRIC COMPANY

INPUT		OUTPUT				TYPE	Ship. Wt. Lbs.
Volts	Cycles	Volts	Const. Current Load	Const. Impedance Load			
			Max. Amp.	Max. KVA	Max. Amp.	Max. KVA	
116B-216B and 117B-217B SERIES†							
Single Phase							
120	50/60	0-120	10	1.2	13	1.6	116B 12
120	50/60	0-140	10	1.4	—	—	117B† 12
120	60	0-120	12	1.4	15	1.8	216B 12
240	50/60	0-240	3.5	0.84	5	1.2	217B† 12
240	50/60	0-280	3.5	0.98	—	—	
240	60	0-240	5	1.2	7	1.7	116B†-2 24
240	50/60	0-240	10	2.4	13	3.1	116B†-2 24
240	50/60	0-280	10	2.8	—	—	
240	60	0-240	12	2.9	15	3.6	117B†-2 24
480	50/60	0-480	3.5	1.7	5	2.4	216B†-2 24
480	50/60	0-560	3.5	2.0	—	—	
480	60	0-480	5	2.4	7	3.4	217B†-2 24
Three Phase							
120	50/60	0-120	10	2.1	13	2.7	116B†-2 24
120	50/60	0-140	10	2.4	—	—	
120	60	0-120	12	2.5	15	3.1	117B†-2 24
240	50/60	0-240	3.5	1.5	5	2.1	216B†-2 24
240	50/60	0-280	3.5	1.7	—	—	
240	60	0-240	5	2.1	7	2.9	217B†-2 24
240	50/60	0-240	10	4.2	13	5.4	116B†-3 36
240	60	0-280	10	4.8	—	—	
240	60	0-240	12	5.0	15	6.2	117B†-3 36
480	50/60	0-480	3.5	2.9	5	4.2	216B†-3 36
480	60	0-560	3.5	3.4	—	—	
480	60	0-480	5	4.2	7	5.8	217B†-3 36
EN116B-EN216B and EN117B-EN217B SERIES							
Single Phase							
120	50/60	0-120	8	0.96	13	1.6	EN116B 15
120	50/60	0-140	8	1.1	—	—	
120	60	0-120	10	1.2	14.5	1.7	EN117B 15
240	50/60	0-240	3	0.72	4.5	1.1	EN216B 15
240	50/60	0-280	3	0.84	—	—	
240	60	0-240	4.4	1.1	5.8	1.4	EN217B 15
240	50/60	0-240	8	1.9	13	3.1	EN116B-2 28
240	50/60	0-280	8	2.2	—	—	
240	60	0-240	10	2.4	14.5	3.5	EN117B-2 28
480	50/60	0-480	3	1.4	4.5	2.2	EN216B-2 28
480	50/60	0-560	3	1.7	—	—	
480	60	0-480	4.4	2.1	5.8	2.8	EN217B-2 28
Three Phase							
120	50/60	0-120	8	1.7	13	2.7	EN116B-2 28
120	50/60	0-140	8	1.9	—	—	
120	60	0-120	10	2.1	14.5	3.0	EN117B-2 28
240	50/60	0-240	3	1.2	4.5	1.9	EN216B-2 28
240	50/60	0-280	3	1.5	—	—	
240	60	0-240	4.4	1.8	5.8	2.4	EN217B-2 28
240	50/60	0-240	8	3.3	13	5.4	EN116B-3 39
240	60	0-280	8	3.9	—	—	
240	60	0-240	10	4.2	14.5	6.0	EN117B-3 39
480	50/60	0-480	3	2.5	4.5	3.7	EN216B-3 39
480	60	0-560	3	2.9	—	—	
480	60	0-480	4.4	3.7	5.8	4.8	EN217B-3 39

†Also available with open construction. Suffix U when ordering.

SEE OTHER SUPERIOR ELECTRIC PRODUCT PAGES

with **POWERKOTE® COILS**

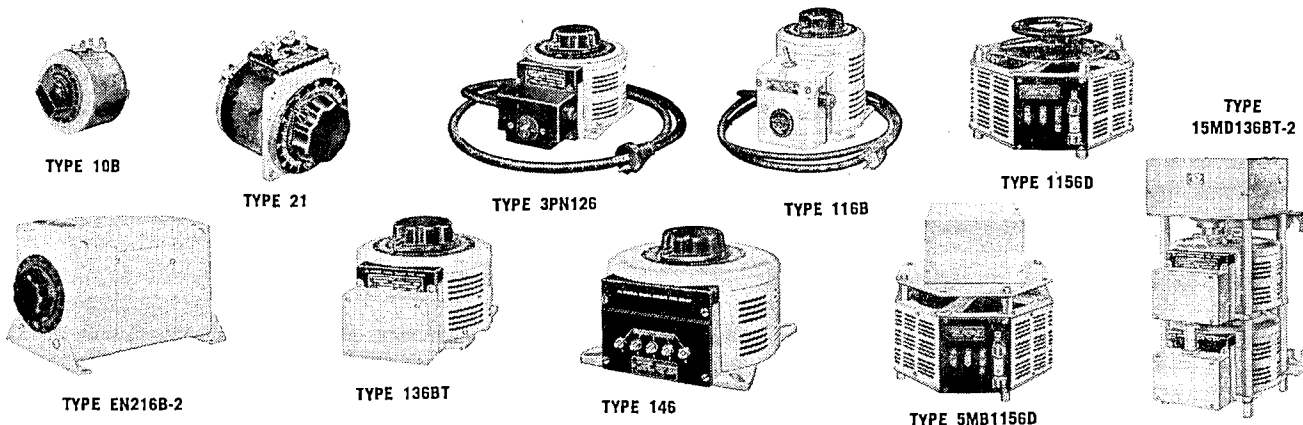

INPUT		OUTPUT				TYPE	Ship. Wt. Lbs.
Volts	Cycles	Volts	Const. Current Load Max. Amp.	Const. Impedance Load Max. KVA	Max. Amp.		
126-226 SERIES†							
Single Phase							
120	50/60	0-120	15	1.8	20	2.4	126
120	50/60	0-140	15	2.1	—	—	126
240	50/60	0-240	7.5	1.8	10	2.4	226
240	50/60	0-280	7.5	2.1	—	—	226
240	50/60	0-240	15	3.6	20	4.8	126-2
240	50/60	0-280	15	4.2	—	—	126-2
480	50/60	0-480	7.5	3.6	10	4.8	226-2
480	50/60	0-560	7.5	4.2	—	—	226-2
Three Phase							
120	50/60	0-120	15	3.1	20	4.2	126-2
120	50/60	0-140	15	3.6	—	—	126-2
240	50/60	0-240	7.5	3.1	10	4.2	226-2
240	50/60	0-280	7.5	3.6	—	—	226-2
240	50/60	0-240	15	6.2	20	8.3	126-3
240	60	0-280	15	7.3	—	—	126-3
480	50/60	0-480	7.5	6.2	10	8.3	226-3
480	60	0-560	7.5	7.3	—	—	226-3
136B-236B SERIES†							
Single Phase							
120	50/60	0-120	22	2.6	28	3.4	136B
120	50/60	0-140	22	3.1	—	—	136B
120	50/60	0-120	44	5.3	56	6.7	136B-2
120	50/60	0-140	44	6.2	—	—	136B-2
240	50/60	0-240	10	2.4	13	3.1	236B
240	50/60	0-280	10	2.8	—	—	236B
240	50/60	0-240	22	5.3	28	6.7	136B-2
240	50/60	0-280	22	6.2	—	—	136B-2
480	50/60	0-480	20	4.8	26	6.2	236B-2
480	50/60	0-560	20	5.6	—	—	236B-2
Three Phase							
120	50/60	0-120	22	4.6	28	5.8	136B-2
120	50/60	0-140	22	5.3	—	—	136B-2
240	50/60	0-240	10	4.2	13	5.4	236B-2
240	50/60	0-280	10	4.8	—	—	236B-2
240	50/60	0-240	22	9.1	28	11.6	136B-3
240	60	0-280	22	10.7	—	—	136B-3
480	50/60	0-480	10	8.3	13	10.8	236B-3
480	60	0-560	10	9.7	—	—	236B-3
146-246 SERIES†							
Single Phase							
120	50/60	0-120	30	3.6	35	4.2	146
120	50/60	0-140	30	4.2	—	—	146
120	50/60	0-120	60	7.2	70	8.4	146-2
120	50/60	0-140	60	8.4	—	—	146-2
240	50/60	0-240	15	3.6	19	4.6	246
240	50/60	0-280	15	4.2	—	—	246
240	50/60	0-240	30	7.2	35	8.4	146-2
240	50/60	0-280	30	8.4	—	—	146-2
480	50/60	0-480	15	7.2	19	9.1	246-2
480	50/60	0-560	15	8.4	—	—	246-2

INPUT		OUTPUT				TYPE	Ship. Wt. Lbs.
Volts	Cycles	Volts	Const. Current Load Max. Amp.	Const. Impedance Load Max. KVA	Max. Amp.		
146-246 SERIES† (contd.)							
Three Phase							
120	50/60	0-120	30	6.2	35	7.3	146-2
120	50/60	0-140	30	7.3	—	—	146-2
240	50/60	0-240	15	6.2	19	7.9	246-2
240	50/60	0-280	15	7.3	—	—	246-2
240	50/60	0-240	30	12.5	35	14.5	146-3
240	60	0-280	30	14.5	—	—	146-3
480	50/60	0-480	15	12.5	19	15.8	246-3
480	60	0-560	15	14.5	—	—	246-3
1156D-1256D SERIES†							
Single Phase							
120	50/60	0-120	50	6.0	55	6.6	1156D
120	50/60	0-140	50	7.0	—	—	1156D
120	50/60	0-120	100	12.0	110	13.2	1156D-2P
120	50/60	0-140	100	14.0	—	—	1156D-2P
120	50/60	0-120	150	18.0	165	19.8	1156D-3P
120	50/60	0-140	150	21.0	—	—	1156D-3P
240	50/60	0-240	28	6.7	28	6.7	1256D
240	50/60	0-280	28	7.9	—	—	1256D
240	50/60	0-240	50	12.0	55	13.2	1156D-2S
240	50/60	0-280	50	14.0	—	—	1156D-2S
240	50/60	0-240	56	13.4	56	13.4	1256D-2P
240	50/60	0-280	56	15.7	—	—	1256D-2P
240	50/60	0-240	84	20.2	84	20.2	1256D-3P
240	50/60	0-280	84	23.5	—	—	1256D-3P
240	50/60	0-240	100	24.0	110	26.4	1156D-4PS
240	50/60	0-280	100	28.0	—	—	1156D-4PS
480	50/60	0-480	28	13.4	28	13.4	1256D-2S
480	50/60	0-560	28	15.7	—	—	1256D-2S
480	50/60	0-480	56	26.9	56	26.9	1256D-4PS
480	50/60	0-560	56	31.4	—	—	1256D-4PS
Three Phase							
120	50/60	0-120	50	10.4	55	11.4	1156D-20
120	50/60	0-140	50	12.1	—	—	1156D-20
240	50/60	0-240	28	11.6	28	11.6	1256D-20
240	50/60	0-280	28	13.6	—	—	1256D-20
240	50/60	0-240	50	20.8	55	22.9	1156D-3T
240	60	0-280	50	24.2	—	—	1156D-3T
240	50/60	0-240	100	41.6	110	45.7	1156D-6T
240	50/60	0-280	100	48.5	—	—	1156D-6T
480	50/60	0-480	28	23.3	28	23.3	1256D-3T
480	60	0-560	28	27.2	—	—	1256D-3T
480	50/60	0-480	56	46.6	56	46.6	1256D-6T
480	60	0-560	56	54.3	—	—	1256D-6T

†Also available with open construction. Suffix U when ordering.
 ‡Requires also one paralleling choke type 1500Q.
 §§Requires also one paralleling choke type 16053.

VOLTBOX® A-C POWER SUPPLY

Contains POWERSTAT Variable Transformer, voltmeter, three output receptacles, two 5-WAY Binding Posts, "on-off" switch, line-load meter switch, fuse and six-foot cord-plug. Type UC1MB ratings are 120 volt, single phase 50/60 hertz input and 0-140 volt 10 ampere, 1.4 kva output.

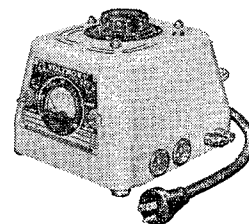

IN SECTIONS 2100, 3500 AND 4000

POWERSTAT® Variable Transformers

NOW WITH POWERKOTE* COILS

*PATENT PENDING

40-VOLT SERIES

Meet high current, low voltage requirements of low voltage power supplies and a wide range of transistor circuit applications. Manually-operated and motor-driven single, 2- and 3-gang single phase types available.



TYPE 10B-40



TYPE 21-40

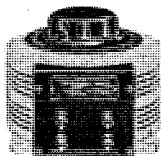

TYPE LC2106D

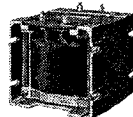

TYPE 5MBC2115E

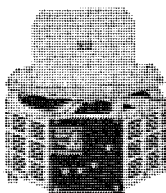

OIL-COOLED
TYPE Q-116B

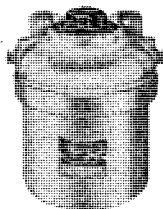

EXPLOSION-PROOF
TYPE X-116

LINE CORRECTORS

Used to correct line voltage variations to maintain a constant output voltage or to supply a limited range of output voltage from a stable a-c source. Manually operated and motor-driven types available.

OIL-COOLED AND EXPLOSION-PROOF

Oil-cooled units substantially increase ratings above equivalent air-cooled types and provide a measure of safety. Explosion-proof models are Underwriters' Laboratories listed for Class 1, Group D service. Both are manually operated only.

LW136B SERIES

Have three windings. Connections can be made for operation as a source of adjustable low output voltage, a line voltage corrector or a limited range variable transformer. Manually operated and motor-driven, open and enclosed construction types available. Full connections and ratings on request.

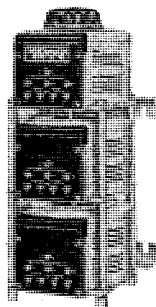

TYPE LW136B-3

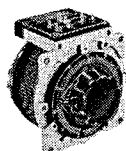

TYPE LW136BU

40-VOLT SERIES								
INPUT			OUTPUT				TYPE	Ship. Wt. Lbs.
Volts	Hertz	Volts	Const. Current Load		Const. Impedance Load			
			Max. Amps.	Max. KVA	Max. Amps.	Max. KVA		
Single Phase								
40	60	0-40	7	0.28	9	0.36	10B-40	3½
			18	0.72	22	0.88	21-40	6
			25	1.0	30	1.2	116BU-40	11

LINE CORRECTOR SERIES						
INPUT		OUTPUT			TYPE	Ship. Wt. Lbs.
Volts	Hertz	Volts	Max. Amps.	Max. KVA		
Used as Line Correctors — SINGLE PHASE						
95-135	50/60	115	52	6.0	LC2106D	80
95-135	50/60	115	130	15.0	LC2115E	200
195-255	50/60	230	32.5	7.5	LC2207D	85
205-250	50/60	230	120	27.5	LC2228E	205
400-520	50/60	460	40	18.4	LC2418E	205
Used as Line Correctors — THREE PHASE						
195-255	50/60	230	50	20.0	LC3220YD	241
195-255	50/60	230	113	45.0	LC3245YE	615
195-255	50/60	230	175	70.0	LC3270DE	795
400-520	50/60	460	33	26.3	LC3425YD	230
400-520	50/60	460	100	79.7	LC3475YE	630
420-500	50/60	460	131	104	LC34100YE	630

When units of the LC series are used as limited range adjustable transformers, the input voltage is the output voltage shown in the above chart and the output voltage is the input voltage shown in the above chart.

OIL-COOLED						
INPUT		OUTPUT			TYPE††	Ship. Wt. Lbs.
Volts	Hertz	Volts	Max. Amps.	Max. KVA		
120	50/60	0-120	15	1.8	O-116B	32
120	50/60	0-140	15	2.1		
120	50/60	0-140	30	4.2	O-117E	100
240	50/60	0-240	6	1.4	O-216B	32
240	50/60	0-280	6	1.7		
240	50/60	0-280	18	5.0	O-122E	105

†† Other Types available on special order.

EXPLOSION-PROOF						
Volts	Hertz	Volts	Max. Amps.	Max. KVA	TYPE	Ship. Wt. Lbs.
120	50/60	0-120	7.5	0.90	X-116	47
120	50/60	0-140	7.5	1.0		
120	50/60	0-140	12	1.7	X-112E	142
240	50/60	0-240	3	0.72	X-216	47
240	50/60	0-280	3	0.84		
240	50/60	0-280	6	1.7	X-122E	142

LW136B SERIES						
INPUT		OUTPUT††			TYPE	Ship. Wt. Lbs.
Volts	Hertz	Volts	Max. Amps.	Max. KVA		
Single Phase						
120/240	50/60	15-0-15	35	0.52	LW136B	25
120/240/480	50/60	30-0-30	35	1.0	LW136B-2	52
120/240	50/60	45-0-45	35	1.6	LW136B-3	76
120/240	50/60	0-30	25	0.75	LW136B	25
120/240/480	50/60	0-60	25	1.5	LW136B-2	52
120/240	50/60	0-90	25	2.2	LW136B-3	76
Three Phase						
120/240	50/60	0-30	25	1.3	LW136B-2	52
120/240	50/60	0-30	43.3	2.2	LW136B-3	76
120/240	50/60	0-52	25	2.2	LW136B-3	76
240/480	60	0-35	43.3	2.6	LW136B-3	76
240/480	60	0-60	25	2.6	LW136B-3	76

†† LW136B Series ratings are for use as low voltage isolated output transformer.

HIGH FREQUENCY POWERSTAT® VARIABLE TRANSFORMERS



TYPE 5-1011



TYPE 2HL15UK-3Y

Standard manually-operated types designed to meet applicable military specifications are available for 28, 120, 240 and 480 volt, 400/800 hertz single and three phase operation in ratings from 56 va to 7.3 kva; for 115 volt, 400/800 hertz single phase service with outputs of 0-28 volts, 2.5 or 8 amperes and 0-5 volts, 6 or 12 amperes; for 400/1600 hertz service as limited range variable transformers, low voltage output variable transformers or line correctors.

SEE OTHER SUPERIOR ELECTRIC PRODUCT PAGES



THE
SUPERIOR ELECTRIC
COMPANY

STATIONARY METERED KNOB POWERSTAT® Variable Transformers

- FOR BACK-OF-PANEL OR GENERAL UTILITY MOUNTING
- ACCURATE VOLTMETER REMAINS STATIONARY INSIDE KNOB RIM. . . DOES NOT TURN WITH THE KNOB
- AVAILABLE IN TYPES TO 4 KVA
- MAXIMUM APPLICATION FLEXIBILITY
- SAVES PANEL SPACE, WIRING AND INSTALLATION COSTS

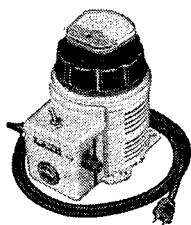

TYPE VS116B

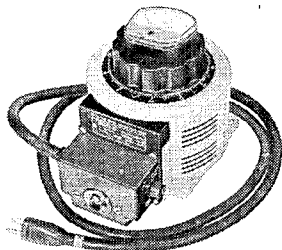

TYPE VS3PN126

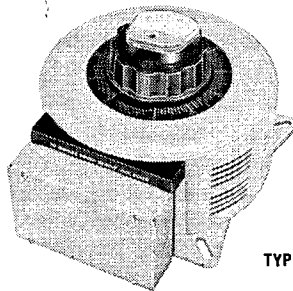

TYPE VS146T

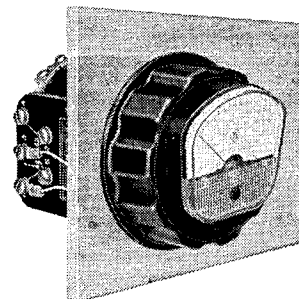

GENERAL UTILITY MOUNTING – Single units (those listed in charts without -2 or -3 suffixes) in the 116B-216B, 117B-217B, 126-226, 136B-236B and 146-246 series are also available with knobs incorporating direct-reading voltmeters. Voltmeters remain stationary as the knob rim is turned, have an accuracy of $\pm 3\%$ of full scale and are insensitive to stray magnetic fields. When ordering, add VS prefix to the type number given in the charts.

BACK-OF-PANEL MOUNTING – Standard cataloged POWERSTAT Variable Transformers in the 21-22 through the 146-246 series designed or adaptable for back-of-panel mounting can be combined with Metered Knob Assemblies. Models for 120 volt service require Metered Knob Assembly VS150 having a 0-150 volt scale and units for 240 volt use require Metered Knob Assembly VS300 having a 0-300 volt scale. Existing models can be retrofitted also.

ENCLOSED LABORATORY POWERSTAT® Variable Transformers



TYPE N10B



TYPE N21

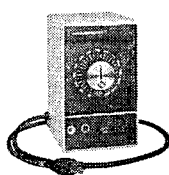

TYPE N116B

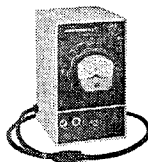

TYPE N116BK

Portable, single phase units having grounded NEMA cord-plug assembly, on-off switch, output receptacle, pilot light and fuse. The handle is integrally designed and the panel controls are recessed. A slot is provided at the rear of each unit to accept wall hanger brackets supplied with the assembly. Types N21, N116B, N116BK, N116BL and N116BLK have POWERKOTE Coils.

METERED KNOB types N116BK and N116BLK have metered knobs to conveniently measure load voltage without the necessity of providing a separate voltmeter. The knob is designed so that the voltmeter remains stationary as the knob is turned to vary the voltage, assuring accurate readings and maximum meter visibility.

INPUT		OUTPUT					TYPE
VOLTS	HERTZ	VOLTS	CONSTANT CURRENT LOAD		CONSTANT IMPEDANCE LOAD		
			MAX. AMP.	MAX. KVA	MAX. AMP.	MAX. KVA	
120	60	0-132	2.25	0.30	—	—	N10B
120	50/60	0-140	4.5	0.63	—	—	N21
120	50/60	0-140	10	1.4	—	—	N116B N116BK
120	50/60	0-120	10	1.2	13	1.6	N116BL N116BLK

FLEXIFORMER® Packaged Transformer Primaries



TYPE TP150

When used as a source of a-c voltage, the center opening permits hand-threading the correct number of secondary winding turns to obtain the desired output voltage. When used as a current transformer, the unit winding is shuted by an ammeter which indicates the current flow in a conductor hand-threaded through the center opening. For 50/60 hertz duty.

RATINGS AS A SOURCE OF A-C VOLTAGE

TYPE	NORMAL PRIMARY VOLTS	Hertz	MAXIMUM VA	VOLTS PER SECONDARY TURN	REGULATION AT MAXIMUM OUTPUT
TP150	120	50/60	150	0.3	25%
TP1000	120	50/60	1000	0.75	10%
TP152	240	50/60	150	0.3	25%
TP1020	240	50/60	1000	0.75	10%

RATINGS AS A CURRENT TRANSFORMER

TYPE	INPUT/OUTPUT RATIO	MAXIMUM PRIMARY AMPERES	MAXIMUM SECONDARY AMPERES	ACCURACY AT 60 Hertz
TP150	400/1	400	1.0	1%
TP1000	160/1	800	5.0	1%
TP152	800/1	400	0.5	1%
TP1020	320/1	800	2.5	1%

POWERSTAT DC Motor Speed Controllers

Continuously adjustable speed control of d-c shunt-wound motors from a-c power lines. Full rated torque available at any speed. Instantaneous start, stop and reverse, tubeless transient-protected circuitry. Rated for 120 volt, 60 hertz single phase input. Type MSC16 for motors to 1/8 hp, type MSC33 to 1/2 hp and type MSC75 to 3/4 hp. NEMA frame 1725 rpm, dc motors in 1/8, 1/2 and 3/4 hp also available.

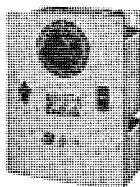

TYPE MSC33

IN SECTIONS 2100, 3500 AND 4000



HIGH CURRENT TRANSFORMERS & CHOKES

ELECTRICAL SPECIFICATIONS

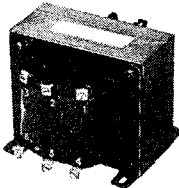
	SECONDARY VOLTS (& Taps)	PART NO.	PRIMARY VOLTS 50-500 CY	SECONDARY AMPS (RMS) FOR OPTIONAL WIRING	
				SERIES HOOKUP	PARALLEL HOOKUP
SHIP	10 VOLTS Series 2.5-5-7.5-10 Parallel 2.5-5	10 02	115	2 A	4 A
		10 05	115	5 M	10 M
		10 10	115	10 P	20 P
		10 20	115	20 S	40 S
B (UNDER 700 VA) 	12.6 VOLTS Series 3.1-6.3-9.4-12.6 Parallel 3.1-6.3	12 02	115	2 A	4 A
		12 05	115	5 M	10 M
		12 10	115	10 P	20 P
		12 20	115	20 S	40 S
24 VOLTS Series 6-12-18-24 Parallel 6-12	24 01	115	1	2	
	24 02	115	2	4	
	24 04	115	4	8	
	24 06	115	6	12	
	24 08	115	8	16	
	24 12	105, 115, 125	12	24	
	24 20	105, 115, 125	20	40	
	24 25	105, 115, 125	25	50	
	24 30	105, 115, 125	30	60	
	24 50	105, 115, 125	50	100	
	24 100	115, 230	100	200	
	36 VOLTS Series 9-18-27-36 Parallel 9-18	36 00	115	0.5	1
		36 01	115	1	2
		36 02	115	2	4
36 04		115	4	8	
36 06		115	6	12	
36 08		105, 115, 125	8	16	
36 12		105, 115, 125	12	24	
36 20		105, 115, 125	20	40	
36 30		105, 115, 125	30	60	
36 50		115, 230	50	100	
36 100		115, 230	100	200	
56 VOLTS Series 14-28-42-56 Parallel 14-28		56 00	115	0.5	1
		56 01	115	1	2
		56 02	115	2	4
	56 04	115	4	8	
	56 06	115	6	12	
	56 08	105, 115, 125	8	16	
	56 12	105, 115, 125	12	24	
	56 25	105, 115, 125	25	50	
	56 50	115, 230	50	100	
	56 100	115, 230	100	200	
	64 VOLTS Series 16-32-48-64 Parallel 16-32	64 00	115	0.5	1
		64 01	115	1	2
		64 02	115	2	4
		64 04	115	4	8
64 06		115	6	12	
64 08		105, 115, 125	8	16	
64 12		105, 115, 125	12	24	
64 25		105, 115, 125	25	50	
64 50		115, 230	50	100	
80 VOLTS Series 20-40-60-80 Parallel 20-40		80 00	115	0.5	1
		80 01	115	1	2
		80 02	115	2	4
		80 05	115	5	10
		80 10	105, 115, 125	10	20
	80 25	115, 230	25	50	
	80 50	115, 230	50	100	
	120 VOLTS Series 30-60-90-120 Parallel 30-60	120 00	115	0.5	1
		120 01	115	1	2
		120 02	115	2	4
120 04		115	4	8	
120 08		105, 115, 125	8	16	
120 12		105, 115, 125	12	24	
120 20		105, 115, 125	20	40	
180 VOLTS Series 45-90-135-180 Parallel 45-90		180 00	115	0.5	1
	180 01	115	1	2	
	180 02	115	2	4	
	180 05	115	5	10	
	180 10	105, 115, 125	10	20	
230 VOLTS Series 57.5-115-172.5-230 Parallel 57.5-115	230 00	115	0.5	1	
	230 01	115	1	2	
	230 02	115	2	4	
	230 05	105, 115, 125	5	10	
	230 08	115, 230	8	16	
300 VOLTS Series 75-150-225-300 Parallel 75-150	300 00	115	0.5	1	
	300 01	115	1	2	
	300 02	115	2	4	
	300 05	105, 115, 125	5	10	

DC TO RMS CONVERSION CHART

SECONDARY RMS CURRENT = DC CURRENT × FACTOR BELOW	Choke Input Filter or Inductive Load	Resistive Load	Capacitor Input Filter or Capacitive Load
FULL WAVE BRIDGE	1.0	1.0	1.8
FULL WAVE C.T.	.7	1.0	1.15

TODD ELECTRIC high current transformers and chokes are most widely used for high power rectifier and high current A.C. applications. They are built to the highest standards of workmanship. All types are designed for a nominal temperature rise of 45°C at full load and will easily withstand unusual overloads. The regulation is extremely low, varying from 10% on the smallest unit to 1% on the largest.

Four constructional types are available for maximum flexibility for use in either the laboratory, test rigs, OEM equipment, or production.

All Prices and Data Subject to Change Without Notice.

CERTIFIED DATA AVAILABLE — CUSTOM VARIATIONS QUOTED PROMPTLY

SERIES HOOKUP

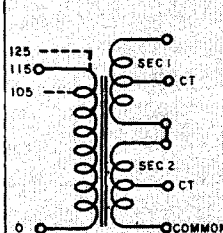

PARALLEL HOOKUP

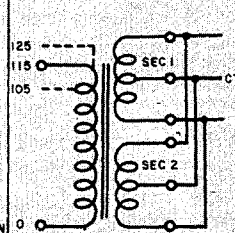

• ENGINEERING • RELIABILITY • SERVICE

TODD ELECTRIC CO., INC.

MECHANICAL SPECIFICATIONS

FOR HIGH CURRENT TRANSFORMERS & CHOKES

SPECIFY STYLE DESIRED WHEN ORDERING

45°
TEMPERATURE RISE
MINIMUM
REGULATION

All units have name plates and wiring diagrams for installation ease, future reference and permanent identification.

• BRACKET MTD (STYLE B) • ENCAPSULATED (STYLE BE)		STYLE B		STYLE BE		• FULLY MTD SHELLS (STYLE V)							STYLE V		• HERMETIC SEALED MIL-T (STYLE CM)					STYLE CM		Part No.	
L	W	H	ML	MW	WGT	Price	Price	L	W	H	ML	MW	WGT	Price	L	W	H	ML	MW	WGT	Price		Price
3	2 1/2	2 1/2	2 1/2	1 1/2	1.5	\$ 6.05	\$11.98	2 1/2	2 1/2	3 1/8	2	1 1/2	2.0	\$ 5.87	3	3 1/2	3 1/2	2 1/8	2 1/8	2 1/8	3.1	\$20.57	\$10.02
3	2 1/2	2 1/2	2 1/2	2 1/8	2.5	7.15	13.45	2 1/2	2 1/2	3 1/8	2	1 1/2	3.0	6.90	3	3 1/2	3 1/2	2 1/8	2 1/8	2 1/8	4.2	23.85	10 10
3 3/4	3 3/4	3 3/4	3 3/4	2 1/8	5.0	9.75	17.38	3 3/4	3 3/4	3 3/8	2 1/2	2 1/2	5.5	9.36	3 3/8	4 1/2	4 1/2	3 1/8	3 1/8	3 1/8	6.0	33.15	10 10
4 1/2	5 1/2	3 3/4	3 3/4	3 1/8	11.2	18.10	34.75	3 3/4	4 1/2	5 1/8	3 1/2	3	3 1/2	11.5	17.40	4 1/2	5	5 1/2	3 1/2	4 1/2	13.0	62.75	10 20
3	2 1/2	2 1/2	2 1/2	1 3/4	1.8	6.40	12.10	2 1/2	2 1/2	3 1/8	2	1 1/2	1.8	6.21	3	3 1/2	3 1/2	2 1/8	2 1/8	2 1/8	3.1	21.76	12 02
3	3	2 1/2	2 1/2	2 1/8	3.4	7.65	13.70	2 1/2	2 1/2	3 1/8	2	1 1/2	4.2	7.50	3	3 1/2	3 1/2	2 1/8	2 1/8	2 1/8	3.8	25.85	12 05
3 3/4	3 3/4	3 1/8	3 1/8	2 1/8	6.0	10.30	18.05	3 1/4	3 3/4	3 3/8	2 1/2	2 1/2	6.5	9.85	3 3/8	4 1/4	4 1/2	3 1/8	3 1/8	3 1/8	6.0	33.80	12 10
5 1/4	4 1/2	4 1/8	4 1/8	2 1/2	10.0	19.75	27.95	4 1/2	4 1/2	5 1/8	3 1/2	3	11.0	18.80	4 1/2	5 1/4	6 1/4	3 1/2	4 1/8	4 1/8	15.6	68.50	12 20
3	2 1/2	2 1/2	2 1/2	2	2.6	6.52	12.10	2 1/2	2 1/2	3 1/8	2	1 1/2	2.6	6.32	3	3 1/2	3 1/2	2 1/8	2 1/8	2 1/8	3.1	22.17	24 01
3	2 3/4	2 1/2	2 1/2	2	2.8	7.30	13.03	2 1/2	2 1/2	3 1/8	2	1 1/2	2.8	7.08	3	3 1/2	3 1/2	2 1/8	2 1/8	2 1/8	4.0	24.82	24 02
3 3/4	3 1/8	3 1/8	3 1/8	2 1/4	5.0	9.15	17.38	3 3/4	3 1/8	3 3/4	2 1/2	2 1/2	5.0	8.88	3 3/8	4 1/4	4 1/2	3 1/8	3 1/8	3 1/8	5.5	31.11	24 04
4 1/8	3 3/8	3 1/8	3 1/8	2 3/8	6.5	11.09	18.88	3 1/2	3 1/8	4 1/2	2 3/4	2 1/4	6.5	10.65	3 1/2	4 1/8	4 1/8	3	3 1/8	3 1/8	6.6	37.71	24 06
4 1/8	4 1/4	3 1/8	3 1/8	3	8.7	15.48	25.94	3 1/2	4 1/8	4 1/2	2 3/4	2 1/4	8.7	14.86	3 1/2	4 1/8	4 1/8	3	3 1/8	3 1/8	8.8	52.63	24 08
4 1/2	4 7/8	3 3/4	3 3/4	3 3/8	11.0	17.75	28.94	3 1/2	4 1/8	4 1/2	3	3 1/4	11.0	17.04	4 1/4	5	5 1/2	3 1/2	4 1/8	4 1/8	14.7	60.35	24 12
5 1/4	4 7/8	4 3/8	4 3/8	3 1/2	17.0	24.75	43.63	4 1/2	5 1/8	5 1/2	3 1/2	3 1/2	17.5	24.60	4 1/2	5 1/4	6 1/4	3 1/2	4 1/8	4 1/8	20.0	85.15	24 20
5 1/4	5 7/8	4 3/8	4 3/8	4 1/2	22.0	30.80	51.88	4 1/2	6 1/8	5 1/2	3 1/2	4 1/2	22.0	33.12	4 1/2	5 3/4	6 1/4	3 1/2	4 1/8	4 1/8	21.0	104.72	24 25
*6 3/8	5 3/4	5 1/8	5 1/8	5 1/4	34.0	36.25	58.80	5 1/2	4 3/4	6 1/2	4 1/4	4 3/4	30.0	38.00	5 1/2	6 1/8	7 1/2	4 1/2	5 1/8	5 1/8	31.0	121.60	24 30
*6 3/8	6 3/8	5 5/8	5 5/8	5 1/4	30.0	47.75	79.25	5 1/2	7 1/4	6 1/2	4 1/4	5 1/4	31.0	42.50	6 1/2	5 1/8	7 1/2	4 1/2	5 1/8	5 1/8	37.0	162.35	24 50
*7 1/2	8	6 5/8	6 5/8	6 3/4	54.0	71.50	113.88	5 1/2	8	6 1/2	4 1/4	5 1/4	31.0	42.50	6 3/4	8	8 3/4	4 1/2	6 3/4	6 3/4	60.0	243.10	24 100
3	2 1/2	2 1/2	2 1/2	1 3/4	2.4	6.40	12.15	2 1/2	2 1/2	3 1/8	2	1 1/2	2.4	6.30	3	3 1/2	3 1/2	2 1/8	2 1/8	2 1/8	3.2	20.80	36 00
3	2 1/2	2 1/2	2 1/2	2	2.7	6.60	12.69	2 1/2	2 1/2	3 1/8	2	1 1/2	2.7	6.40	3	3 1/2	3 1/2	2 1/8	2 1/8	2 1/8	3.4	22.44	36 01
3 3/8	3	2 1/8	2 1/8	2 1/4	3.6	7.61	14.10	2 1/2	3 1/8	3 1/2	2 1/4	2 1/4	3.6	7.38	3 3/8	3 7/8	4 1/4	2 1/8	3	3	4.8	25.87	36 02
4 1/8	4 1/8	3 1/8	3 1/8	2 5/8	6.9	11.40	19.06	3 1/2	4 1/8	4 1/2	2 3/4	2 1/4	6.9	11.06	3 1/2	4 1/8	4 1/8	3 1/8	3 1/8	3 1/8	7.8	38.76	36 04
4 1/2	4 3/8	3 3/4	3 3/4	2 3/4	9.0	15.60	26.44	3 1/2	4 1/8	4 1/2	3	3 1/4	9.0	14.98	4 1/4	5	5 1/2	3 1/2	4 1/8	4 1/8	10.7	53.04	36 06
4 1/2	5	3 3/4	3 3/4	2 3/4	12.0	16.40	27.25	3 1/2	4 1/8	4 1/2	3	3 1/4	12.0	15.74	4 1/4	5	5 1/2	3 1/2	4 1/8	4 1/8	13.1	55.76	36 08
5 1/4	5 1/4	4 3/8	4 3/8	3 3/4	17.2	27.75	39.83	4 1/2	5 1/8	5 1/2	3 1/2	4 1/2	17.2	26.64	4 1/2	5 3/4	6 1/4	3 1/2	4 1/8	4 1/8	16.9	94.35	36 12
*6 3/8	5 3/4	5 1/8	5 1/8	5 1/4	34.0	36.80	63.38	5 1/2	4 3/4	6 1/2	4 1/4	4 3/4	30.0	37.50	5 1/2	6 1/8	7 1/2	4 1/2	5 1/8	5 1/8	31.0	125.12	36 20
*6 3/8	6 3/4	5 5/8	5 5/8	5 1/4	36.0	48.78	76.25	5 1/2	6 1/8	6 1/2	4 1/4	4 3/4	37.0	49.10	5 1/2	6 1/8	7 1/2	4 1/2	5 1/8	5 1/8	38.0	165.85	36 30
*7 1/4	8	6 1/2	6 1/2	6 1/8	51.0	68.50	110.50	5 1/2	8	6 1/2	4 1/4	5 1/4	37.0	49.10	6 1/2	7 1/8	8 1/4	4 1/2	5 1/8	5 1/8	43.7	232.90	36 50
*7 1/2	9 3/8	6 3/4	6 3/4	7 5/8	70.0	109.00	168.88	5 1/2	9 3/8	6 1/2	4 1/4	5 1/4	37.0	49.10	6 3/4	8	10 3/8	5 1/2	6 3/4	6 3/4	58.0	370.60	36 100
3	2 5/8	2 1/2	2 1/2	2	2.5	7.10	13.50	2 1/2	2 5/8	3 1/8	2	1 5/8	2.4	6.80	3	3 1/2	3 1/2	2 1/8	2 1/8	2 1/8	3.0	20.60	56 00
3 3/8	3	2 1/8	2 1/8	2 1/4	3.6	8.06	13.56	2 1/2	3 1/8	3 1/2	2 1/4	2	3.8	7.82	3 3/8	3 7/8	4 1/4	2 1/8	3	3	3.9	27.40	56 01
3 3/4	3 1/2	3 1/8	3 1/8	2 1/2	5.6	8.98	17.48	2 1/2	3 1/8	3 1/2	2 1/4	2 1/4	5.6	8.71	3 3/8	4 1/4	4 1/4	2 1/8	3 1/8	3 1/8	6.3	30.53	56 02
4 1/8	4 5/8	3 3/8	3 3/8	3	8.4	15.45	25.56	3 1/2	4 1/8	4 1/2	2 3/4	2 3/4	8.7	14.99	3 1/2	4 1/8	4 1/8	3	3 1/8	3 1/8	10.1	52.53	56 04
5 1/4	4 3/4	4 3/8	4 3/8	3 1/4	13.0	20.98	31.13	4 1/4	4 1/8	4 1/2	3 1/2	3 1/2	14.0	20.35	4 1/2	5 1/4	6 1/4	3 1/2	4 1/8	4 1/8	15.6	71.33	56 06
5 1/4	6	4 3/8	4 3/8	3 3/4	17.3	26.10	42.06	4 1/2	5 1/8	5 1/2	3 1/2	4 1/2	17.3	25.32	4 1/2	5 3/4	6 1/4	3 1/2	4 1/8	4 1/8	18.6	88.74	56 08
*6 3/8	5 3/8	5 1/8	5 1/8	5 1/4	24.5	36.85	61.31	5 1/2	4 3/4	6 1/2	4 1/4	4 3/4	26.0	31.15	5 1/2	6 1/8	7 1/2	4 1/2	5 1/8	5 1/8	26.3	125.29	56 12
*6 3/8	6 7/8	5 7/8	5 7/8	5 1/4	39.7	57.10	92.38	5 1/2	6 1/4	6 1/2	4 1/4	5 1/4	41.0	49.20	5 1/2	6 1/8	7 1/2	4 1/2	5 1/8	5 1/8	43.0	194.14	56 25
*7 1/2	7 5/8	6 5/8	6 5/8	6 3/4	54.0	104.50	144.88	5 1/2	7 1/4	6 1/2	4 1/4	5 1/4	41.0	49.20	6 1/2	7 1/8	8 1/4	4 1/2	5 1/8	5 1/8	65.0	355.30	56 100
*9	10 1/4	9	7 5/8	7 1/2	100.0	152.65	228.13	5 1/2	10 1/4	6 1/2	4 1/4	5 1/4	41.0	49.20	6 3/4	8	10 3/8	5 1/2	6 3/4	6 3/4	65.0	355.30	56 100
3	2 3/8	2 1/2	2 1/2	2	2.3	6.55	12.50	2 1/2	2 3/8	3 1/8	2	1 5/8	2.3	6.35	3	3 1/2	3 1/2	2 1/8	2 1/8	2 1/8	3.2	22.35	64 00
3	3	2 1/2	2 1/2	2 1/8	3.4	7.55	13.75	2 1/2	3 1/8	3 1/2	2 1/4	2 1/4	3.4	7.48	3 1/2	3 7/8	4 1/4	2 1/8	3 1/8	3 1/8	7.0	25.50	64 01
3 3/4	3 3/4	3 1/8	3 1/8	2 5/8	6.0	10.18	18.10	3 1/2	3 1/8	3 1/2	2 1/4	2 1/4	6.5	9.85	3 1/2	4 1/8	4 1/8	3 1/8	3 1/8	3 1/8	6.0	34.75	64 02
4 1/2	4 3/4	3 3/4	3 3/4	3 3/4	10.0	20.10	28.05	3 1/2	4 1/8	4 1/2	3	3 1/4	11.0	19.30	4 1/4	5	5 1/2	3 1/2	4 1/8	4 1/8	12.6	69.15	64 04
5 1/4	4 1/4	4 3/8	4 3/8	3 1/4	14.0	23.45	38.75	4 1/2	4 1/8	4 1/2	3 1/2	3 1/2	15.0	23.15	4 1/2	5 3/4	6 1/4	3 1/2	4 1/8	4 1/8	16.4	81.75	64 06
5 1/4	6	4 3/8	4 3/8	3 3/4	1																		



HIGH CURRENT CHOKES

LINE ISOLATION

HIGH CURRENT CHOKES

50/400 CYCLES

(DIMENSIONS REFER TO HIGH CURRENT XFMR STYLES)

Part No.	Induc- ance	Cur. (D.C.)	Resist- ance	• BRACKET MTD (STYLE B) • ENCAPSULATED (STYLE BE)						• FULLY MTD. SHELLS (STYLE V)						• HERMETIC SEALED MIL-T (STYLE CM)										
				Style B		Style BE		Style V		Style V		Style CM		Style CM												
				L	W	H	ML	MW	WGT	Price	Price	L	W	H	ML	MW	WGT	Price	L	W	H	ML	MW	WGT	Price	
CH-00	140	.5	3	2 5/8	2 1/8	2 3/4	2 3/8	2	2.0	\$6.10	\$9.05	2 1/4	2 1/2	2 5/8	1 3/4	1 5/8	1.9	\$7.15	2 1/2	3	3 1/8	1 7/8	2 3/8	2 5/8	2.6	\$20.90
CH-01	100	1	1.5	3	2 3/8	2 1/2	2 1/2	2	2.6	6.65	9.48	2 1/2	2 5/8	3 1/8	2	1 11/16	2.6	7.58	3	3 1/2	3 1/8	2 1/8	2 5/8	3.0	22.40	
CH-02	80	2	.95	3	2 3/8	2 1/2	2 1/2	2	2.6	7.89	11.35	2 1/2	2 5/8	3 1/8	2	1 11/16	3.2	8.15	3	3 1/2	3 1/8	2 1/8	2 5/8	3.8	26.80	
CH-04	60	4	.60	3 3/4	3 1/8	3 1/8	3 1/8	2 5/8	5.2	8.66	13.90	3 1/2	3 7/8	3 1/8	2 1/2	2 5/8	5.8	10.85	3 5/8	4 1/4	4 1/8	2 1/4	3 1/8	6.8	33.10	
CH-05	50	5	.40	3 3/4	3 3/8	3 3/8	3 3/8	2 3/4	5.8	10.70	14.25	3 3/4	3 7/8	3 1/8	2 1/2	2 3/4	6.0	11.75	3 5/8	4 1/4	4 1/8	2 1/4	3 1/8	7.1	38.50	
CH-06	40	6	.30	3 3/4	3 1/2	3 1/8	3 1/8	2 7/8	6.4	12.87	18.60	3 3/4	3 7/8	3 1/8	2 1/2	2 7/8	6.2	14.45	3 5/8	4 1/4	4 1/8	2 1/4	3 1/8	7.8	43.50	
CH-08	30	8	.20	4 1/4	3 7/8	3 1/8	3 1/8	3	8.7	15.80	22.45	4 1/2	4 3/8	4 3/8	2 3/4	3 3/8	8.7	18.10	4	4 5/8	4 7/8	3	3 11/16	10.0	54.40	
CH-12	20	12	.10	5 1/4	4 3/4	4 3/8	4 3/8	3 1/2	13.0	19.60	28.40	5 1/2	5 1/4	5 3/8	3 1/2	3 3/4	13.0	21.80	4 7/8	5 3/4	6 1/4	3 1/2	4 3/8	15.0	66.50	
CH-16	15	16	.08	5 1/4	5 1/8	4 3/8	4 3/8	3 3/4	15.0	20.10	29.08	4 1/2	5 1/8	5 3/8	3 1/2	3 7/8	14.3	22.10	4 7/8	5 3/4	6 1/4	3 1/2	4 3/8	16.2	67.50	
CH-20	10	20	.05	5 1/4	4 3/4	4 3/8	4 3/8	3 1/2	13.0	20.40	29.10	4 1/2	5	5 3/8	3 1/2	3 1/2	13.0	22.95	4 7/8	5 3/4	6 1/4	3 1/2	4 3/8	17.5	69.10	
CH-25	7	25	.035	5 1/4	5 3/4	4 3/8	4 3/8	4 3/8	18.0	29.70	42.60	4 1/2	5 7/8	5 3/8	3 1/2	4 3/8	18.0	34.15	4 7/8	5 3/4	6 1/4	3 1/2	4 3/8	21.0	101.50	
CH-40	3.5	40	.02	6 3/8	5 1/4	5 1/8	5 1/8	3 1/2	20.0	36.50	50.20	5 1/2	5 1/4	6 3/8	4 1/4	3 1/4	24.0	38.75	5 1/8	6 7/8	7 1/2	4 1/4	5 3/8	26.0	128.50	
CH-50	2	50	.01	6 3/8	5 3/8	5 1/8	5 1/8	3 5/8	24.0	41.70	59.87	5 1/2	5 3/8	6 3/8	4 1/4	3 1/2	26.0	43.50	5 1/8	6 7/8	7 1/2	4 1/4	5 3/8	30.0	140.80	
CH-100	.7	100	.004	6 3/8	5 3/8	5 1/8	5 1/8	3 7/8	32.0	46.05	66.25	5 1/2	5 3/8	6 3/8	4 1/4	3 7/8	29.0	51.10	5 1/8	6 7/8	7 1/2	4 1/4	5 3/8	37.0	155.50	
CH-200	.35	200	.002	7 1/2	6 1/2	7	6 3/4	4 3/4	45.0	69.60	98.15	5 1/2	5 3/8	6 3/8	4 1/4	3 7/8	29.0	51.10	5 1/8	6 7/8	7 1/2	4 1/4	5 3/8	37.0	155.50	

† Includes height of terminals.

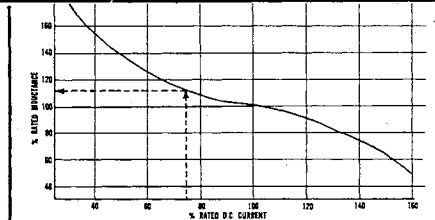

TODD ELECTRIC HIGH CURRENT CHOKES are the perfect companion to our High Current Transformers when utilizing inductive filtering in designing a power supply.

INDUCTANCE VARIATION

The inductance realized from any stock High Current Choke will vary from the normal rated values as shown by the graph when subjected to a non-rated current. Due to greater heating loss, steady state current should not be exceeded by more than 30% except for intermittent operation.

LINE ISOLATION

50/60 CYCLES - OUTPUT 115 VOLTS

UL COMPONENTS

STRAIGHT ISOLATION

ELECTROSTATIC SHIELD CONNECTED TO CORE

CONVENIENT MOUNTING STYLES

Part No.	(VA) Watts	Input Volts	Rms Hipot Test Volts	H	Dimensions				Weight	Price: Line Cord & Receptacle	Price Leads Only	**Add 3/8" to W & MW for Line Cord and Receptacle Model.**
					L	W*	MW*	ML				
LI-25	25	115	2000	3 1/2	2 7/8	2 7/8	1 7/8	2	3.2	\$ 8.70	\$ 8.40	
LI-50	50	115	2000	3 1/2	2 7/8	3 1/8	1 7/8	2 1/4	3.7	9.24	8.82	
LI-100	100	115	2000	4 3/4	3 3/4	3	2	3	6.2	12.32	11.67	
LI-175	175	115	2000	4 3/4	3 3/4	4 1/4	3 3/8	3	8.8	17.71	16.82	
LI-250	250	115	2000	4 3/4	3 3/4	5 1/8	4 1/8	3	12.0	21.88	20.80	
LI-500	500	115	2000	5 3/4	4 1/2	6 1/8	5 1/8	3 1/2	20.0	35.75	33.99	
LI-750	750	115	2000	5 3/4	4 1/2	7	6	3 1/2	25.2	42.08	40.04	
LI-1000	1000	115	2000	5 3/4	4 1/2	7 7/8	6 7/8	3 1/2	30.0	48.95	46.37	
LI-1500	1500	115	2000	7 3/8	6 1/4	7 1/4	6 1/8	4 3/4	36.2	62.84	59.75	
LI-2000	2000	115	2000	7 3/8	6 1/4	8 3/4	7 5/8	4 3/4	48.0	72.50	69.50	
LI-100-1	100	230	2500	4 3/8	3 3/4	3	2	3	6.5	12.60	11.98	
LI-250-1	250	230	2500	4 3/8	3 3/4	5 3/8	4 3/8	3	12.5	22.88	21.78	
LI-500-1	500	230	2500	5 1/8	4 1/2	6 3/8	5 1/8	3 1/2	21.0	36.41	38.01	
LI-1000-1	1000	230	2500	5 1/8	4 1/2	8	7	3 1/2	31.0	49.67	47.27	
LI-1500-1	1500	230	2500	7 3/8	6 1/4	7 1/4	6 1/8	4 3/4	37.0	63.40	60.25	
LI-2000-1	2000	230	2500	7 3/8	6 1/4	8 3/4	7 5/8	4 3/4	49.0	73.10	70.25	

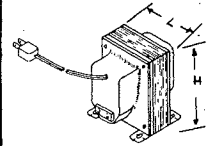

ALSO AVAILABLE W/LEAD TERMINALS

HI-POWER ISOLATION

ELECTROSTATIC SHIELD CONNECTED TO TERMINAL

BRACKET MOUNTED

Part No.	(VA) Watts	Input Volts	Rms Hipot Test Volts	H	Dimensions				Weight	Price
					L	W	MW	ML		
LI-2500-4	2500	115/230	2500	6 1/4	7 1/8	7 1/8	5 1/8	5 3/4	53.0	\$ 72.75
LI-3000-4	3000	115/230	2500	6 1/4	7 1/2	7 7/8	6	6 3/4	59.0	83.50
LI-4000-4	4000	115/230	2500	7 3/8	7 1/2	9 3/4	9	6 3/4	75.0	99.25
LI-5000-4	5000	115/230	2500	7 1/2	9	9	8 1/2	7 3/8	105.0	118.50
LI-6000-4	6000	115/230	2500	7 1/2	9	10	9 3/8	7 3/8	125.0	154.50
LI-2500-5	2500	230/460	3000	6 1/4	7 1/8	7 1/8	5 1/8	5 3/4	53.0	74.50
LI-3000-5	3000	230/460	3000	6 1/4	7 1/2	7 7/8	6	6 3/4	59.0	85.25
LI-4000-5	4000	230/460	3000	7 3/8	7 1/2	9 3/4	9	6 3/4	75.0	102.10
LI-5000-5	5000	230/460	3000	7 1/2	9	9	8 1/2	7 3/8	105.0	121.25
LI-6000-5	6000	230/460	3000	7 1/2	9	10	9 3/8	7 3/8	125.0	158.50

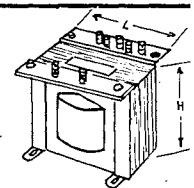

SCREW TERMINALS

ADJUSTABLE ISOLATION

ELECTROSTATIC SHIELD CONNECTED TO CORE

INPUT TAP SWITCH MOUNTED IN SHELL

Part No.	(VA) Watts	Input Volts	Rms Hipot Test Volts	H	Dimensions				Weight	Price: Line Cord & Receptacle	Price Leads Only
					L	W	MW	ML			
LI-100-2	100	105/115/125	2000	4 3/4	3 3/4	3 3/4	2 5/8	3	7.8	\$18.12	\$17.19
LI-250-2	250	105/115/125	2000	4 3/4	3 3/4	5 1/2	4 3/4	3	14.3	28.26	27.84
LI-500-2	500	105/115/125	2000	5 1/8	4 1/2	6 5/8	5 5/8	3 1/2	22	41.20	38.94
LI-1000-2	1000	105/115/125	2000	5 1/8	4 1/2	8 1/2	7 3/8	3 1/2	33.5	55.88	52.91
LI-100-3	100	210/230/250	2500	4 3/4	3 3/4	3 3/4	2 5/8	3	7.5	17.77	16.92
LI-250-3	250	210/230/250	2500	4 3/4	3 3/4	5 1/2	4 3/8	3	14	28.66	27.40
LI-500-3	500	210/230/250	2500	5 1/8	4 1/2	6 1/2	5 1/2	3 1/2	21	40.26	38.34
LI-1000-3	1000	210/230/250	2500	5 1/8	4 1/2	8 3/8	7 1/4	3 1/2	32	54.78	51.90

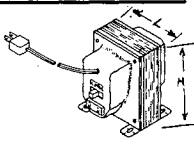

ALSO AVAILABLE W/LEAD TERMINALS

ENGINEERING • RELIABILITY • SERVICE
TODD ELECTRIC CO., INC.





FILAMENT TRANSFORMERS | CONTROL TRANSFORMERS

FILAMENT TRANSFORMERS

50/60 CYCLES

SINGLE SECONDARY — CENTER TAPPED

CHANNEL MOUNTED

PRIMARY 117 VOLTS

Part No.	Secondary Volts (CT)	Secondary Amps	Rms Hipot Test Volts	H	L	Dimensions W	MC	ML	Weight	Price
F2 15	2.5	1.5	2500	1 5/8	2	1 3/8	2 3/8	2 7/8	.75	\$2.53
F2 30	2.5	3	1500	1 5/8	2	1 3/8	2 3/8	2 3/4	.7	2.90
F2 50	2.5	5	1500	2	2 3/8	1 7/8	2 1 1/16	3 1/4	1.2	3.30
F5 30	5	3	2500	2	2 3/8	2 1/8	2 1 1/16	3 1/4	1.4	3.53
F5 60	5	6	1500	2 1/2	2 3/4	2 1/8	2 3/8	3 1/4	1.7	4.83
F5 80	5	8	2500	2 5/8	3 1/8	2 1/4	3 1/8	4	2.5	5.70
F6 06	6.3	.6	2500	1 3/8	1 3/4	1 1/2	2	2 3/8	.4	2.60
F6 12	6.3	1.2	2500	1 5/8	2	1 7/8	2 3/8	2 7/8	.8	2.98
F6 13	6.3	1.2	5000	2	2 3/8	1 7/8	2 1 1/16	3 1/4	.8	3.94
F6 30	6.3	3	2500	2	2 3/8	2 1/8	2 1 1/16	3 1/4	1.4	3.92
F6 60	6.3	6	2000	2 3/8	2 3/4	2 3/8	3 1/8	3 3/4	2	5.58
F7 30	7.5	3	1500	2 1/2	2 3/4	2	3 1/8	3 3/4	1.6	4.60
F7 50	7.5	5	1500	2 5/8	3 1/8	2 1/4	3 1/8	4	2.4	5.50
F12 20	12.6	2	1500	2	2 3/8	2 1/8	2 1 1/16	3 1/4	1.4	4.42
F12 30	12.6	3	1500	2 3/8	2 3/4	2 1/4	3 1/8	3 3/4	1.6	5.65
F25 10	25.2	1	1500	2	2 3/8	2 1/8	2 1 1/16	3 1/4	1.4	4.53
F25 20	25.2	2	1500	2 5/8	3 1/8	2 1/4	3 1/8	4	2.2	6.70

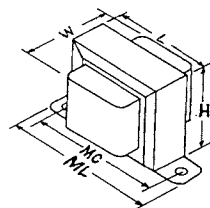

8" LEAD TERMINALS

BRACKET MOUNTED

PRIMARY 117 VOLTS

ELECTROSTATIC SHIELD GROUNDED TO FRAME

Part No.	Secondary Volts (CT)	Secondary Amps	Rms Hipot Test Volts	H	L	Dimensions W	MW	ML	Weight	Price
F2 100	2.5	10	10000	3 1/4	2 1 1/16	2 3/8	1 7/8	2 1/4	2.5	\$8.71
F2 150	2.5	15	1500	3	2 1/2	2 7/8	2	2	2.4	6.65
F5 050	5	5	2500	3 1/8	2 1/2	2 1/8	1 7/8	2	2.2	5.85
F5 100	5	10	2500	3 1/8	2 1/2	2 3/4	2 3/8	2	3.0	7.87
F5 150	5	15	2000	3 1/8	2 1/2	2 3/4	2 1/4	2	3.5	9.80
F5 250	5	25	2500	3 7/8	2 7/8	3 3/8	2 5/8	2 1/2	4.8	14.08
F6 040	6.3	4	2500	3 1/8	2 1/2	2 3/8	2 1/8	2	2.4	5.95
F6 060	6.3	6	2000	3 1/8	2 1/2	2 3/8	2	2	2.4	6.87
F6 100	6.3	10	2500	3 1/8	2 1/2	2 5/8	2 1/8	2 1/4	3.5	8.97
F6 200	6.3	20	2500	4 3/8	3 3/4	3 3/8	2 3/8	3	6.8	14.27
F7 040	7.5	4	2000	3 1/8	2 1/2	2 1/4	2 1/8	2	2.8	6.28
F7 080	7.5	8	2500	3 7/8	3 1/8	2 3/4	2 3/8	2 1/2	4.8	8.65
F10 040	10	4	2500	3 3/4	2 7/8	2 1/2	2	2 1/4	3.4	7.06
F10 080	10	8	2500	3 7/8	3 1/8	3	2 3/8	2 1/2	5.0	10.29

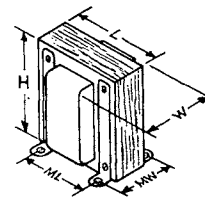

SOLDER LUG TERMINALS

VERTICAL SHELL MOUNTED

PRIMARY 117/105 VOLTS (Tapped)

ELECTROSTATIC SHIELD GROUNDED TO FRAME

Part No.	Secondary Volts (CT)	Secondary Amps	Rms Hipot Test Volts	H	L	Dimensions W	MW	ML	Weight	Price
F2 061	2.5	6	2500	3 1/8	2 1/2	2 1/2	1 1/2	2	2.2	\$7.24
F2 101	2.5	10	2500	3 1/8	2 1/2	2 7/8	1 3/4	2	2.5	6.31
F5 031	5	3	2500	3 1/8	2 1/2	2 1/2	1 1/2	2	2.4	6.71
F5 061	5	6	2000	3 1/8	2 1/2	3	2	2	3.1	7.41
F5 301	5	30	2500	4 1/4	3 1/4	3 7/8	2 3/4	2 3/4	6.3	18.81
F6 041	6.3	4	2000	3 1/8	2 1/2	2 3/8	1 3/4	2	2.7	6.69
F6 061	6.3	6	2500	3 1/2	2 7/8	3 1/8	2	2 1/4	3.5	8.58
F6 101	6.3	10	2000	3 1/2	2 7/8	3 3/8	2 3/8	2 1/4	3.8	8.77
F7 051	7.5	5	2500	3 1/2	2 7/8	3 1/8	2	2 1/4	3.4	9.25
F7 051	10	5	2500	3 3/8	3 1/8	3 1/4	1 7/8	2 1/2	4.0	10.07
F10 081	10	8	2000	3 7/8	3 1/8	3 3/4	2 1/2	2 1/2	5.2	9.58
F10 101	10	10	2000	3 7/8	3 1/8	3 7/8	2 3/4	2 1/2	5.8	11.23

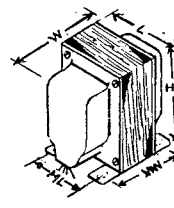

LEAD WIRE TERMINALS

CONTROL TRANSFORMERS

PRIMARY 117 VOLTS 50/60 ~ (Also Available 230 V)

LEAD WIRE TERMINALS

Part No.	Secondary (RMS)		Equivalent Secondary Current Bridge		H	L	W	MC	ML	Weight	Price
	Volts	Amps	1/2 Wave	Full Wave							
CT12-150	12	.150	.10 DC	.05 DC	1 1/4	1 1/2	1 1/4	1 3/4	2 1/8	.25	\$3.27
CT12-375	12	.375	.24 DC	.12 DC	1 3/8	1 3/4	1 3/8	2	2 3/8	.36	3.39
CT12-750	12	.750	.48 DC	.24 DC	1 5/8	2	1 1/2	2 3/8	2 7/8	.60	3.54
CT12-1250	12	1.250	.80 DC	.40 DC	2	2 3/8	1 5/8	2 3/4	3 1/4	.85	4.47
CT24-090	24 CT	.090	.07 DC	—	1 1/4	1 1/2	1 1/4	1 3/4	2 1/8	.25	3.57
CT24-220	24 CT	.220	.15 DC	.08 DC	1 3/8	1 3/4	1 3/8	2	2 3/8	.36	3.72
CT24-400	24 CT	.400	.27 DC	.15 DC	1 5/8	2	1 1/2	2 3/8	2 7/8	.60	3.87
CT24-750	24 CT	.750	.50 DC	.25 DC	2	2 3/8	1 5/8	2 3/4	3 1/4	.85	4.80

MINIATURE STYLE OPEN FRAME

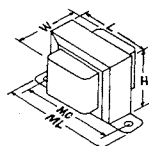

Part No.	Secondary (RMS) Volts	Secondary (RMS) Amps	VA Cap.	H	L	W	MW	ML	Weight	Price
CTR-2425	24	1.05	25	2 1/2	2 5/8	2 1/2	1 1/2	2 1/8	2.3	\$ 7.47
CTR-2450	24	2.1	50	2 3/4	3	3 1/4	1 3/4	2 3/8	3.6	8.83
CTR-2475	24	3.1	75	3 1/8	3 3/8	3 5/8	2 1/4	3	4.6	9.82
CTR-24100	24	4.1	100	3 1/2	3 3/4	3 7/8	2 3/8	3 1/4	5.2	13.15
CTR-24150	24	6.2	150	4	4 1/2	4 1/8	3	3 3/4	8.5	17.63
CTR-3225	32	.78	25	2 1/2	2 5/8	2 1/2	1 1/2	2 1/8	2.3	8.10
CTR-3250	32	1.55	50	2 3/4	3	3 1/4	1 3/4	2 3/8	3.6	9.34
CTR-3275	32	2.35	75	2 1/2	3 3/8	3 5/8	2 1/4	3	4.6	10.56
CTR-32100	32	3.1	100	3 1/2	3 3/4	3 7/8	2 3/8	3 1/4	5.2	14.05
CTR-32150	32	4.7	150	4	4 1/2	4 1/8	3	3 3/4	8.5	16.61

SHELL ENCLOSED W/THREADED PIPE NIPPLE

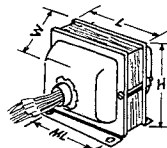

• ENGINEERING • RELIABILITY • SERVICE

TODD ELECTRIC CO., INC.





STEPDOWN AUTO TRANSFORMERS

BUCK-BOOST

STEPDOWN AUTO TRANSFORMERS

50/60 CYCLES - UL COMPONENTS
(MOST UNITS CAN BE REVERSED FOR STEPUP USE)

HEAVY DUTY MODEL

220/240 Input
110/120 Output

Catalog Number	Rating Watts	Weight Lbs.	Dimension Inches			Price
			H	L	W	
SD-15	75	2 1/4	3 1/4	2 3/4	3 1/4	\$10.72
SD-16	100	2 1/2	3 1/4	2 3/4	3 1/4	10.80
SD-17	150	3 3/8	3 1/4	2 3/4	3 1/4	12.40
SD-12	250	6	4 1/2	3 7/8	3 1/2	15.70
SD-18	350	6 3/4	4 1/2	3 7/8	3 3/4	17.80
SD-11	500	10 2/3	4 1/2	3 7/8	4 7/8	22.60
SD-19	750	12	4 1/2	3 7/8	5 1/4	27.50
SD-13	1000	15 1/2	4 1/2	3 7/8	6 1/4	38.50
SD-14	1500	20	4 1/2	3 7/8	7 1/4	44.50
SD-20	2000	24	6	4 1/2	6 1/2	89.95



UL LINE CORD & RECEPTACLE

NORMAL DUTY MODEL

220/240 Input
110/120 Output

Catalog Number	Rating Watts	Weight Lbs.	Dimension Inches			Price
			H	L	W	
SD-24	50	1 1/2	2 3/8	3 3/4	2 1/4	\$7.25
SD-21	65	1 1/2	2 3/8	3 3/4	2 1/4	7.40
SD-25	80	1 1/2	2 3/8	3 3/4	2 1/4	7.60
SD-23	100	1 1/2	2 3/8	3 3/4	2 3/8	7.80
SD-26	125	2	2 3/8	4	2 3/8	9.20
SD-27	150	2 1/4	2 3/8	4	2 3/8	9.60

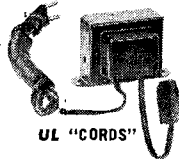

UL "CORDS"

INDUSTRIAL MODEL

208/220/240 Input
110/120 Output

Catalog Number	Rating Watts	Weight Lbs.	Dimension Inches			Price
			H	L	W	
SD-28	3000	38	6 1/2	7 1/2	6 1/4	\$192.50
SD-29	4000	47	6 1/2	7 1/2	6 1/4	249.75
SD-22	5000	58	6 1/2	7 1/2	6 1/4	284.40
SD-30	6000	70	6 1/2	7 1/2	6 1/4	346.20

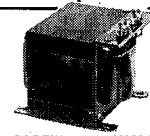

SCREW TERMINALS

*Available Panel MTD. Add Suffix "P"

REFRIGERATION

188/210
210/235
236/260 → 105/115 V

Catalog Number	Rating Watts	Weight Lbs.	Dimension Inches			Price
			H	L	W	
SD-31	350	7.0	4 3/4	3 7/8	4 1/4	\$29.80
SD-32	550	9.4	4 3/4	3 7/8	4 7/8	32.10
SD-33	750	12.9	4 3/4	3 7/8	5 1/2	37.75
SD-34	1000	16.8	4 3/4	3 7/8	6 1/2	51.60

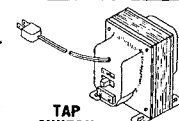

TAP SWITCH

Also Available Leads Only

HEAVY DUTY VOLTAGE REGULATOR

WITH METER & SWITCH

TYPE	PRIMARY INPUT TAPS ON SELECTOR SWITCH											OUTPUT VOLTS	
11	84	92	100	108	115	122	130	138					115
12	84	92	100	108	115	122	130	138					230
21	170	185	200	215	230	245	260	275					115
22	170	185	200	215	230	245	260	275					230

Catalog Number	Type	Rating	WT. W.	Lbs.	Dimension (") H	L	W	Price
TC-17	11 or 22	150	6	5 1/2	3 3/4	5		\$ 33.75
TC-18	11 or 22	350	7	5 1/2	3 3/4	5 3/8		47.70
TC-11	11 or 22	500	11	5 1/2	3 3/4	5 3/4		55.00
TC-19	11 or 22	750	15	5 1/2	3 3/4	6 3/8		69.00
TC-13	11 or 22	1000	20	5 1/2	3 3/4	7 1/8		83.50
TC-14	11 or 22	1500	25	5 1/2	3 3/4	8 1/8		109.50
TC-20	11 or 22	2000	30	6 1/2	4 1/4	8 3/4		204.75
TC-17	12 or 21	150	6	5 1/2	3 3/4	5 1/4		39.50
TC-18	12 or 21	350	7	5 1/2	3 3/4	5 3/4		54.50
TC-11	12 or 21	500	11	5 1/2	3 3/4	6		63.00
TC-19	12 or 21	750	15	5 1/2	3 3/4	6 3/4		81.50
TC-13	12 or 21	1000	20	6 1/2	4 1/2	7 3/4		101.25
TC-14	12 or 21	1500	25	6 1/2	4 1/2	8 3/4		124.50
TC-20	12 or 21	2000	30	6 1/2	4 1/2	9 3/4		233.50

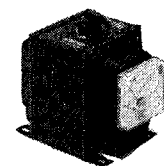

UL LINE CORD & RECEPTACLE

PANEL MOUNTED VOLTAGE REGULATOR

WITH METER & SWITCH
(Junction Box)

TYPE	PRIMARY INPUT TAPS ON SELECTOR SWITCH											OUTPUT VOLTS	
11	84	92	100	108	115	122	130	138					115
12	84	92	100	108	115	122	130	138					208/230
21	170	185	200	215	230	245	260	275					115
22	170	185	200	215	230	245	260	275					208/230

Catalog Number	Type	Rating	WT. W.	Lbs.	Dimension (") H	L	W	Price
TA-28	11 or 22	2000	40	6 7/8	7 1/2	17 3/8		\$239.00
TA-28	11 or 22	3000	50	6 7/8	7 1/2	17 3/8		273.50
TA-29	11 or 22	4000	60	6 7/8	7 1/2	17 3/8		334.25
TA-22	11 or 22	5000	70	6 7/8	7 1/2	17 3/8		386.50
TA-30	11 or 22	6000	85	6 7/8	7 1/2	17 3/8		458.30
TA-20	12 or 21	2000	40	6 7/8	7 1/2	17 3/8		259.60
TA-28	12 or 21	3000	50	6 7/8	7 1/2	17 3/8		291.40
TA-29	12 or 21	4000	60	6 7/8	7 1/2	17 3/8		357.50
TA-22	12 or 21	5000	70	6 7/8	7 1/2	17 3/8		414.70
TA-30	12 or 21	6000	85	6 7/8	7 1/2	17 3/8		491.30



LEAD TERMINALS CONDUIT KNOCKOUTS

Packed One Per Carton

BUCK-BOOST TRANSFORMERS

AUTO-TRANSFORMERS TO INCREASE OR DECREASE LINE VOLTAGE

50/60 ~

200 TO 240 V OUTPUT

32 OR 16 VOLT LINE ADJUSTMENT (UP OR DOWN)

Part No.	32 Volts		16 Volts		H	L	W	Weight Lbs.	Price
	KVA	Amps	KVA	Amps					
32BB-35	.35	1.55	.70	3.1	3	3 3/8	3 1/4	3.0	\$17.50
32BB-55	.55	2.35	1.10	4.7	3	3 3/8	4 1/2	3.8	21.30
32BB-75	.75	3.20	1.50	6.4	3 3/8	3 7/8	3 1/2	5.0	23.50
32BB1-1	1.10	4.25	2.20	8.5	3 3/8	3 7/8	4 1/4	6.5	25.80
32BB1-5	1.50	6.40	3.00	12.8	3 3/8	3 7/8	5	7.0	29.60
32BB2-0	2.00	8.50	4.00	17.0	3 3/8	3 7/8	5 1/2	7.8	33.75
32BB3-5	3.50	15.00	7.00	30.0	4 1/2	5 3/8	6 3/4	12.0	46.50
32BB5-0	5.00	21.00	10.00	42.0	4 1/2	5 3/8	8	15.0	57.00
32BB7-5	7.50	32.00	15.00	64.0	5 1/2	6 1/2	7 1/4	20.0	72.50
32BB10-0	10.00	42.00	20.00	84.0	5 1/2	6 1/2	8 1/2	30.0	87.70

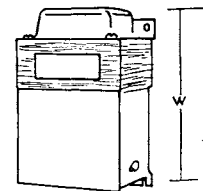

JUNCTION BOX W/KNOCKOUTS

200 TO 240 V OUTPUT

24 OR 12 VOLT LINE ADJUSTMENT (UP OR DOWN)

Part No.	24 Volts		12 Volts		H	L	W	Weight Lbs.	Price
	KVA	Amps	KVA	Amps					
16BB-50	.50	2.1	1.00	4.2	3	3 3/8	3 1/2	3.5	\$18.20
16BB-75	.75	3.2	1.50	6.4	3	3 3/8	4 3/4	4.2	22.00
16BB1-0	1.00	4.3	2.00	8.6	3 3/8	3 7/8	3 3/8	5.5	24.10
16BB1-5	1.50	6.4	3.00	12.8	3 3/8	3 7/8	4 3/4	6.9	25.90
16BB2-0	2.00	8.5	4.00	17.0	3 3/8	3 7/8	5 1/2	7.5	30.20
16BB2-5	2.50	10.5	5.00	21.0	3 3/8	3 7/8	6	8.2	34.50
16BB4-5	4.00	19.0	9.00	38.0	4 1/2	5 3/8	7 1/4	13.0	48.60
16BB7-0	7.00	30.0	14.00	60.0	4 1/2	5 3/8	8 3/4	16.5	59.40
16BB10-0	10.00	42.0	20.00	84.0	5 1/2	6 1/2	7 3/4	21.0	74.80
16BB15-0	15.00	64.0	30.00	128.0	5 1/2	6 1/2	9	31.5	92.30

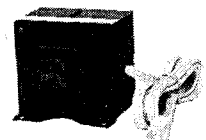

UNITS MARKED * ALSO AVAILABLE LINE CORD & RECEPTACLE

BUCK-BOOST ALSO AVAILABLE FOR 115/120 VOLTS

• ENGINEERING • RELIABILITY • SERVICE

TODD ELECTRIC CO., INC.



*You can depend on your local
ELECTRONIC DISTRIBUTOR for ...*

- *Instant off-the-shelf delivery*
- *In-depth inventories*
- *Wide varieties*
- *Prompt service*
- *Technical assistance*
- *Availability of the latest products*
- *Speedy purchasing – one order does the job*

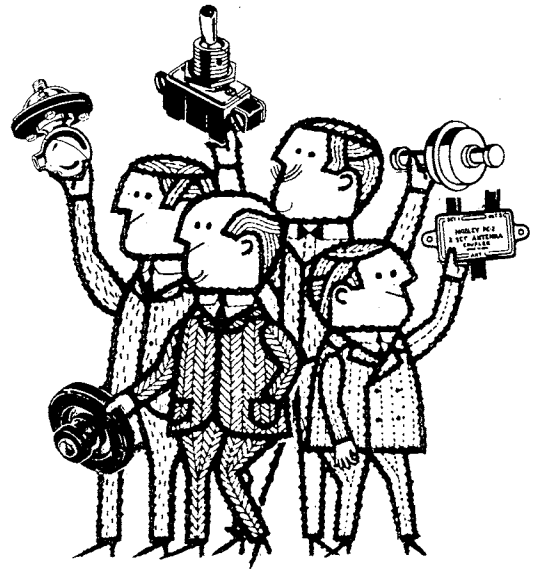

*Contact your local **ELECTRONIC DISTRIBUTOR**
for all your requirements!*

TRIAD DISTRIBUTOR DIVISION



A DIVISION OF LITTON INDUSTRIES



MINIATURES

†† JAF SERIES — Hermetically Sealed

Type No.	Primary Impedance	Secondary Impedance	Max. Level-DBM	Freq. Resp.	** MTG.
JAF-1†	600/250/50	50000	0	60-15000	AF
JAF-2†	600/250/50	250000	0	100-15000	AF
JAF-3	600/250/50	60000 CT.	0	60-15000	AF
JAF-5†	30/12/4	50000	0	50-15000	AF
JAF-11	15000	50000	10	60-15000	AF
JAF-12	15000	60000 CT.	10	60-15000	AF
JAF-13	15000 (3 Ma.)	95000 CT.	10	350-7000	AF
JAF-14†	200	½ megohm	10	300-3000	AF
JAF-15	15000	1 megohm	10	350-5000	AF
JAF-21	15000	600/250/50	10	60-15000	AF
JAF-22	15000 (3 Ma.)	600/250/50	10	350-7000	AF
JAF-23	20000 CT.	600/250/50	10	60-15000	AF
JAF-24	10000 CT.	2000 CT.	10	50-20000	AF
JAF-25	12000 CT.(2Ma.)	600 CT./150	12	50-15000	AF
JAF-26	50000 CT.(.5Ma.)	600 CT./150	10	50-20000	AF
JAF-31†	600/250/50	600/250/50	10	60-15000	AF
JAF-32	1500 CT.(2Ma.)	600 CT./150	14	50-20000	AF
JAF-33†	5000 CT.	5000 CT.	10	60-15000	AF
JAF-34	500 CT.	500 CT./125	14	50-20000	AF
JAF-35	600 CT.	2000 CT./500,14	50-20000	AF	
JAF-101	50 h.-.75 Ma.				AF
JAF-102	6 HY.—3 MA. or 4 HY.—6 Ma.				AF

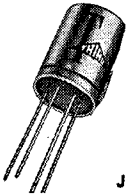

JZ

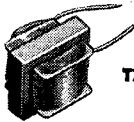

TZ

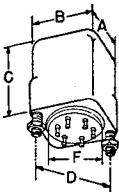

AF
AJ

SUB-MINIATURE AUDIO — Hermetically Sealed

Type No.	Primary Impedance	Secondary Impedance	DC Res. Ohms (Approx.) Pri.	Sec.	** Case
JZ-1	600/250/50	60000	350	4100	JZ
JZ-5	30/12/4	50000	11.5	3800	JZ
JZ-13	15000 (1. Ma.)	135000 CT.	1150	4400	JZ
JZ-15	20000 (.5 Ma.)	1200/600/100	2700	350	JZ
JZ-25	10000 (1 Ma.)	200	1500	120	JZ
JZ-26	1000 (5 Ma.)	50	355	20	JZ

SUB-MINIATURE AUDIO — Open Frame

Type No.	Primary Impedance	Secondary Impedance	DC Res. Ohms (Approx.) Pri.	Sec.
TZ-1	600/250/50	60000	350	4100
TZ-2XT	200 CT.	200000	35	5000
TZ-5	30/12/4	50000	6	3500
TZ-7	30/12/4	1000	5	480
TZ-13	15000 (1 Ma.)	135000 CT.	985	4400
TZ-15	20000 (.5 Ma.)	1200/600/100	2700	350
TZ-24XT	25000 CT.	500 CT.	2000	60
TZ-29XT	10000 CT.	10,000 CT	1100	1400
TZ-25	10000 1 Ma.)	200	1500	120
TZ-32XT	1500 CT.	600 CT./150	160	65
TZ-26	1000 (5 Ma.)	50	355	20
TZ-103XT	4 Hy. or 1 Hy.	—	400	—
T-41X	1000 (10 Ma.)	200 CT.	430	130
T-42X	9800 (2 Ma.)	16	855	1.7
TY-44X	1000 (10 Ma.)	16/8/4	180	3.8
TY-47X	2000 CT.(10 Ma.)	16/8/4	260	4

TRANSFORMERS FOR TRANSISTOR POWER SUPPLIES

Type No.	D.C. Out of Rect.	D.C. Max.	Dimensions—Inches			MW
			H	W	D	
TY-68S	250	65	1¼	1¼	1½	1½
TY-69S	300	100	1¾	2¾	1¾	1½
TY-70S	325	150	2	2¾	2¼	1½
TY-71S	375	200	2	2¾	2¼	1½
TY-74S	600	200	2	4½	3	3¾

EPOXY MOLDED TOROIDAL TYPE

Type No.	D.C. Source Volts	D.C. Volts Out Of Rectifier	D.C. Ma.	Dimension—Inches		Wt. Lbs.
				Dia.	Ht.	
TY-78	12.6	250/125	100	1¼	1½	.35
TY-79	12.6	300/150	200	1¾	1	.35
TY-80	12.6	325/162.5	150	1¾	1	.35
TY-81	12.6	375/187.5	200	2	1	.50
TY-82	12.6	450/225	150	2	1	.50
TY-83	12.6	500/250	250	2¾	1¾	.85

‡Static Shield •New item

TY-84	12.6	600/300	200	2¾	1¾	1.00
TY-85	12.6	600/300	350	2¾	2½	2.00
TY-86	12.6	425/212.5	350	2¾	1¾	1.00
TY-87§	12.6	600/300	200	2¾	1¾	1.00
TY-88	28	250/125	80	1¾	¾	.25
TY-89	28	300/150	100	1¾	¾	.35
TY-90	28	325/162.5	200	1¾	1	.35
TY-91	28	375/187.5	200	2	1	.50
TY-92	28	450/225	200	2	1	.50
TY-93	28	500/250	250	2¾	1¾	.85
TY-94	28	600/300	200	2¾	1¾	1.00
TY-99	6.3	300/150	100	1¾	1	.35
TY-100	6.3	325/162.5	150	2	1	.50
TY-101	6.3	375/187.5	200	2¾	1¾	1.00
TY-102	6.3	450/225	150	2¾	1¾	1.00

§ Additional winding 125 V. @ 10 ma. for SSB.

†† MINIATURE AUDIO — "Trijets"

Type No.	Primary Impedance	Secondary Impedance	Max. Level-DBM	Freq. Resp.
T-1X†	600/250/50	50000	0	60-15000
T-2X†	600/250/50	250000	0	100-15000
T-3X	600/250/50	60000 CT.	0	60-15000
T-5X†	30/12/4	50000	0	50-15000
T-11X	15000	50000	10	60-15000
T-12X	15000	60000 CT.	10	60-15000
T-13X	15000 (3 Ma.)	950000 CT.	10	350-70000
T-14X†	200	500000	10	300-3000
T-15X	15000	1 Megohm	10	150-15000
T-20X	15000	600/250/50	10	60-15000
T-21X	3000	50	10	100-15000
T-22X	15000 (3 Ma.)	600/250/50	10	350-7000
T-23X	2000 CT.	600/250/50	10	60-15000
T-24X	10000 CT.	2000 CT.	10	50-20000
T-25X	12000 CT.(2 Ma.)	600 CT. 150	10	50-16000
T-26X	50000 CT.(.5Ma.)	600 CT./150	10	100-15000
T-31X†	600/250/50	600/250/50	10	50-15000
T-32X	1500 CT. (2 Ma.)	600 CT./150	13	50-20000
T-33X†	5000 CT.	5000 CT.	10	60-15000
T-34X	500 CT.	500 CT./125	13	50-20000
T-35X	600 CT.	2000 CT./500	13	50-20000

T-101X 50 henries @ .75 Ma.

T-102X 6 Hy.-3 Ma. or 4 Hy.-6 Ma.

††Low frequency loss will result from DC in windings other than where specified.

**See Case Chart on Triad Page 15

MINIATURES

TRANSISTOR TRANSFORMERS

Type No.	Primary Matching Impedance	Primary Current MA	Secondary Matching Impedance	Maximum Level
TY-23X	50000	.5	500 CT.	100 MW
TY-24X	50000	.5	3000 CT.	200 MW
TY-25X	100000	.5	200 CT.	200 MW
TY-26X	100000	.5	3000 CT.	200 MW
TY-27XT	500 CT.	2	500 CT.	10 MW
TY-28XT	500 CT.	2	200 CT.	10 MW
TY-29X	24 CT.	500	8/4	8W
TY-30X	100 CT.	100	8/4	2W
TY-31X	200 CT.	50	8/4	2W
TY-32X	200 CT.	2	2000 CT.	200 MW
TY-33X	400 CT.	5	16/8/4	200 MW
TY-34X	400 CT.	5	2000 CT.	200 MW
TY-35X	500 CT.	2	150 CT.	100 MW
TY-36X	2000	2	1500 CT.	200 MW
TY-37X	2000 CT.	4	8000 CT.	200 MW
TY-38X	3000 CT.	4	1000 CT.	200 MW
TY-39X	4000 CT.		16/8/4	200 MW
TY-40X	5000	1	200 CT.	100 MW
TY-41X	16000	1	4000	100 MW
TY-42X	20000	.5	8/4	100 MW
TY-43X	20000	.5	800 CT.	100 MW
TY-44X	1000	10	16/8/4	200 MW

Continued on TRIAD Page 2

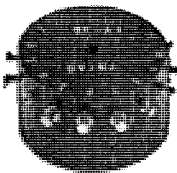
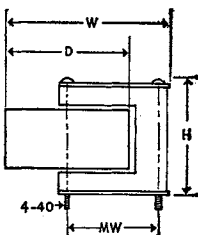

TY-MOLDED

TRIAD DISTRIBUTOR DIVISION



A DIVISION OF LITTON INDUSTRIES



MINIATURES (Continued)

Type No.	Primary Matching Impedance	Primary Current MA	Secondary Matching Impedance	Maximum Level
TY-45X	500 CT.	5	16/8/4	200 MW
TY-46X	100	100	1000 CT.	1 W
TY-47X	2000 CT.	10	16/8/4	200 MW
TY-48X	100 CT.	40	16/8/4	.5 W
TY-49X	500 CT.	12	5000 CT.	1 W
TY-50X	125000	0	2000 CT.	40 MW
TY-51X	2000 CT.	10	200 CT.	100 MW
TY-52X	20000 CT.	1	2000 CT.	200 MW
TY-53X	200 CT.	10	400 CT.	6 W
TY-54X	15000	1.5	200 CT.	200 MW
TY-55X	2000 CT.	2	500 CT.	200 MW
TY-56X	10000	1	2000 CT.	200 MW
TY-57X	250 CT.	10	16/8/4	200 MW
TY-58X	125 CT.	15	8/4	200 MW
TY-59X	5000 CT.	1	50000 CT.	200 MW
TY-60X	200000	0	1000	100 MW
TY-61X	100	100	100 CT.	4 W
TY-62X	10000	2	4	100 MW
TY-63X	48 CT.	275	16/8	8 W
TY-64X	32 CT.	575	16/8/4	10 W
TY-65Z	32 CT.	575	6K/4K/3K	10 W
TY-66A	6 CT.	5A	6K/4K/3K	40 W
TY-67A	6 CT.	5A	16/8/4	40 W

†† JO SERIES — Hermetically Sealed

Type No.	Primary Impedance	Secondary Impedance	Max. Level-DBM	Freq. Resp.	Case
JO-1	600/250/50	50000	0	60-15000	JOA
JO-2	600/250/50	250000	0	100-8000	JOA
JO-3	600/250/50	60000 CT.	0	60-15000	JOA
JO-11	15000	60000	10	50-15000	JOB
JO-12	15000	60000 CT.	10	50-15000	JOB
JO-13	15000-3 Ma.	95000 CT.	10	300-7000	JOB
JO-21	15000	600/250/50	10	50-15000	JOB
JO-22	15000-3 Ma.	600/250/50	10	300-7000	JOB
JO-23	20000 CT.	600/250/50	10	50-15000	JOB
JO-31	600/250/50	600/250/50	10	50-15000	JOB
JO-101	50 h.-2 Ma.				JOB

DC TO AC TRANSISTOR TRANSFORMERS

Type	Primary	Secondary		
TY-75A	12v	115v	60cps	115 watts
TY-76A	12v	115v	60cps	60 watts
TY-46B	28v	115v	400cps	60 watts
TY-46Z	12v	115v	400cps	60 watts

DC TO DC CONVERTER TRANSFORMERS For use in blocking oscillator type power supplies

No. Type	L.	W.	H.	Mtg. Cent-ers	*Typical Operation Input	Output
TY-200X	1 1/8	7/8	1 1/8	1 3/8	3VDC @ 20 Ma.	1050VDC @ 25 μa
TY-201TZ	1/2	3/8	3/8	—	4VDC @ 15 Ma.	500VDC @ 50 μa
TY202X	1 1/8	7/8	1 1/8	1 3/8	4VDC @ 45 Ma.	550VDC @ 80 μa

POWER COMPONENTS HERMETICALLY SEALED

Combined PLATE and FILAMENT Transformers Primary 115V — 50/60 cycle

Type No.	Plate Supply AC Volts	DC Ma.	Filaments	F Dim. (Min.) Inches	Case
HSM-200	120	100	6.3 CT.-1.6A.	1	FA
HSM-201	500 CT.	20	6.3 CT.-2A.	1 1/8	GA
HSM-202	120	20	6.3 CT.-.6A.	1 1/8	EA
HSM-203	600 CT.	50	6.3 CT.-2.5A. 5 -2A.	1 1/8	JB
HSM-205	700 CT.	70	6.3 CT.-3A. 5 -3A.	1 1/8	JA
HSM-207	700 CT.	120	6.3 CT.-5A. 5 -3A.	1 1/8	KA
HSM-208	626 CT.	200	6.3/5.0-3A. 6.3 CT. 5	1 1/8	KA
HSM-241	700 CT.- 70V. bias.tap.	150	6.3 CT.-6A. 6.3-V. -2A. 5 -3A.	1 1/8	LA

•New item

HSM-212	1000/ 800 CT.	150 (ch. in.) 117 (cd. in.)	6.3/5-4A. 6.3 CT.-4A. 6.3 V-4A.	1 1/8	LA
HSM-245	800/ 700 CT. 70 V. bias tap.	200	6.3 CT.-6A. 6.3-V. -4A. 5 -6A.	1 1/8	MA
HSM-216	1000/ 800 CT.	200 (ch. in.) 157 (cd. in.)	6.3/5-4A. 6.3 CT.-5A. 6.3-5A.	1 1/8	MA
HS-247	800/ 700 CT. 70 V. bias tap.	300	6.3 CT.-8A. 6.3-V. -4A. 5 -6A.	1 1/8	GP-15
HSM-218	1000/ 800 CT.	300 (ch. in.) 235 (cd. in.)	6.3/5-6A. 6.3 CT.-6A. 6.3-6A.	1 1/8	GP-15
HSM-219	(115/ 230 pri.) 760/ 1600 CT.	40/230 (ch.input)		Spcl.	GP-15

All types electrostatically shielded
GP-15 dims. 4 3/4" x 5 7/8" x 6 5/8" high. Wt. approx. 22 lbs.
Mtg. centers 3 3/4" x 4 7/8".

Combined PLATE and FILAMENT Transformers

Primary 115V—400 cycle to operate 380 to 1500 cycles

Type No.	Plate Supply AC Volts	DC Ma.	Filaments	Insur. Test Volt.	F Dim. (Min.) Inches	Case
HS-401	500 CT.	40	6.3 CT.-1A. 6.3-1A	1500	1	EB
HS-400	125	25	6.3 CT.-8A.	1500	3/32	AH
HS-404	500 CT.	120	6.3 CT.-3A. 6.3/5.0-3A.	1500	1 1/8	FA
HS-405	600 CT.	70	6.3 CT.-2A. 6.3-2A. *6.3-2A.	1500	1 1/8	GA
HS-407	600 CT.	120	6.3 CT.-3.5A. 6.3-3.5A. *6.3/5-3A.	1500	1 1/8	JB
HS-409	700 CT.	150	6.3 CT.-4A. *6.3/5-3A.	1500	1 1/8	HA
HS-413	450 CT.	200	6.3 CT.-6A. 6.3 -6A. *6.3/5-4A.	1500	1 1/8	JA
HS-415	800/ 600 CT.	200	6.3 CT.-6A. 6.3-6A. *6.3/5-6A.	2500	1 1/8	KB
HS-417	800/ 600 CT.	300	6.3 CT.-6A. 6.3-6A. *6.3/5-6A.	2500	1 1/8	LA

* Tapped for 5 volt rectifier use. All types electrostatically shielded.

SOLID STATE LOW-VOLTAGE TRANSFORMER

Primary 10/115/125 volts — 50/60 cycles

Type No.	Secondary AC Volts	RMS Amps	Rectifier Circuit CT. Full Wave	Bridge FW	Case
•HSM-248	35 CT.	3	14.5v	29v	•KA

AUDIO INTERSTAGE Transformers

Type No.	Primary Imped.	Turn Ratio	Freq. Resp.	Power Output	Shieldg	Case
HS-25	15000	1:2.72 overall	20-20000	75 MW	P-1	GP-4
HS-35	15000	1:2.72 overall	20-20000	26 MW	P-1	GP-2
HS-27	20000/ 5000	1:1.72 overall	20-20000	130 MW	P-1	GP-4
HS-29	20000/ 5000	1:2 overall	20-20000	20 MW	P-5	GP-4
HSM-31	20000/ 5000	1:1 or 2:1	20-20000	3 W		FA
HS-32	15000 (6 Ma.)	1:2 overall	20-15000	200 MW	P-1	GP-5



HS Series

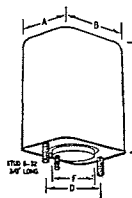

JO Series

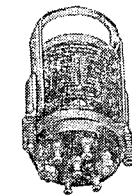

JO Series

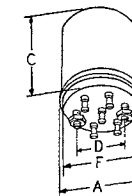

TRIAD DISTRIBUTOR DIVISION



A DIVISION OF LITTON INDUSTRIES

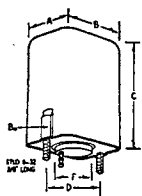

GP 1, 2, 3

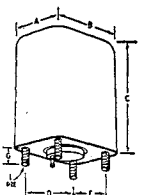

MIL-T-27A CASE

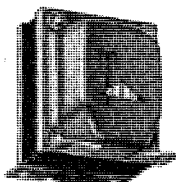

Case A

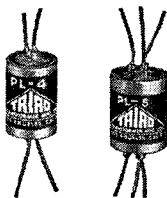

PL-4

PL-5



PL-6

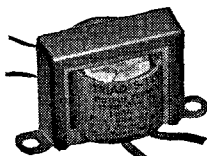

Case X

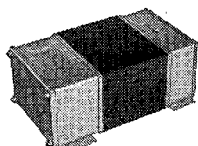

Case SC

POWER OUTPUT to Line and VC. Hermetically Sealed

Type No.	Primary Impedance	Secondary Impedance	Max. Level-Watts	Freq. Resp.	** Case
HS-71	10000 (10 Ma.)	600/150	2	150-15000	AH-2
HS-73	5000 (40 Ma.)	500/250/16/8/4	5	70-15000	AJ-2
HS-75	1000 CT. (50 Ma. bal.)	500/250/16/8/4	10	100-25000	EB
HS-77	9000 CT. (120 Ma. bal.)	500/250/16/8/4	25	70-20000	GA

LOW LEVEL AUDIO

AUDIO INPUT TRANSFORMERS Hermetically Sealed

Type No.	Primary Imped.	Turn Ratio	Freq. Resp.	Power Output MW	Insulation Class	** Case
HS-1	600*/250*/150/62.5	1:11.3	20-20000	10	P-5	GP-4
HS-11	Same as above	1:14	20-20000	10	P-1	GP-2
HS-3	600*/250*/150/62.5	1:14 overall	20-20000	10	P-5	GP-5
HS-4	Same as above				P-3	GP-4
HS-14	Same as above				P-1	GP-3
HS-15	600*/250*/150/62.5 (10 Ma.)	1:8 overall	30-20000	100	P-3	GP-5
HS-5	30	1:65.7	40-12000	1	P-5	GP-4

*Balanced center tap.

OUTPUT, MIXING, MATCHING, BRIDGING

Type No.	Primary Imped.	Secondary Impedance	Freq. Resp.	Power Output MW	Insulation Class	** Case
HS-50	15000	600*/250*/150/62.5	20-20000	400	P-3	GP-4
HS-60	15000	600*/350*/150/62.5	20-20000	20	P-1	GP-2
HS-61	15000 (5 Ma.)	600*/250*/150/62.5	40-15000	200	P-1	GP-5
HS-52	20000 CT./5000	600*/250*/150/62.5	20-20000	400	P-1	GP-4
HS-54	20000 CT./5000	600*/250*/150/62.5	20-20000	30	P-5	GP-4
HS-56V	600*/250*/150*62.5	600*/250*/150/62.5	10-30000	100	P-3	GP-4
HS-66	600*/250*/150*62.5	600*/250*/150/62.5	10-30000	100	P-1	GP-3
HS-58	600*/250*/150*62.5	600*/250*/150/62.5	20-20000	50	P-3H	GP-5

* Balanced center tap.

POWER COMPONENTS

Type No.	Primary Volts	Secondary Volts	Secondary Amperes	Insulation Test Voltage	** Case
HSM-223	115	6.3	0.6	1500	AJ-2
HSM-225	105-115-125	6.3 CT.	2	1500	EA
HSM-226	105-115-125	6.3 CT.	3.6	1500	FA
HSM-224	105-115-125	6.3 CT.	5.5	2500	HB
HSM-234	105-115-125	±6.3 CT. 6.3	10	2500	KA
HSM-227	105-115-125	±6.3 CT. 6.3	3	2500	GA
HSM-229	105-115-125	6.3 CT.	8	2500	JB
HSM-233	105-115-125	12.6 CT.	.8	1500	EA
HSM-237	105-115-125	12.6 CT.	2	2000	FA
HSM-230	105-115-125	24 CT.	0.8	1500	FA
HSM-239	105-115-125	24 CT.	1.5	2500	GA
HSM-240	115/230	±12.6 CT. ±12.6	1.5	2500	GA
HSM-236	105-115-125	±12.6 CT. 12.6	2	2500	JB
HSM-228	105-115-125	±6.3 CT. 6.3	6	2500	JA
HSM-231	105-115-125	6.3 CT. 5 CT.	5	2500	JB
HSM-235	105-115-125	2.5 CT. 10 CT.	10	7500	MA
HSM-238	105-115-125	±26 CT. ±26	2	2500	JA

† Series or parallel connections.

** See case chart Triad Page 15.

FILAMENT Transformers, 380/1500 cycle

Type No.	Primary Volts	Secondary Volts	Secondary Amperes	Insulation Test Voltage	** Case
HS-436	115	6.3 CT.	1	1500	AH
HS-425	105-115-125	6.3 CT.	2	1500	AJ-2
HS-427	105-115-125	6.3 CT.	5	2500	EA
HS-445	105-115-125	24 CT.	3	2500	EA
HS-438	105-115-125	24 CT.	1.5	1500	EA
HS-433	105-115-125	*6.3 CT. *6.3	5	2500	FA
HS-435	105-115-125	*6.3 CT. *6.3	3.5	2000	FA
HS-441	105-115-125	*5 CT. *5	10	2000	HA
HS-443	105-115-125	*12.6 CT. *12.6	0.8	1500	AJ-2
HS-442△	57.5-99.7-115-120 Single phase.	*12.6 CT. *12.6	2	1500	EA
HS-444△	57.5-99.7-115-120*26 CT.	*26 CT. *26 CT.	2	2000	FA

△ Two Units can be used, 115 volt 3 phase to 26 volt 2 phase, Scott-connected. * Series or parallel connection. † 5 volt tap for filament type rectifiers.

UNIVERSAL RECTIFIER

POWER SUPPLY TRANSFORMERS

Primaries 115 Volts, 50/60 Cycles

Type No.	DC Range	MIL Case
HSM-249	6V.-.065A. to 53V.-.02A.	AH
HSM-250	6V.-.22A. to 53V.-.07A.	AJ
HMS-251	6V.-1.2A. to 53V.-.4A.	FA
HSM-252	6V.-3A. to 53V.-1A.	HA
HSM-253	6V.-7.5A. to 53V.-2.5A.	KA
HSM-254	6V.-18A. to 53V.-6A.	OA

HIGH FIDELITY OUTPUT

HIGH LEVEL OUTPUT — Hermetically Sealed

Type No.	Primary Impedance	Secondary Impedance	Freq. Resp.	Max. Level Watts	F.D.I. Min. In.	** Case
HSM-79	20000 CT. (20 Ma.) or 5000 (40 Ma.)	16/8/4	40-20000	5	1 1/8	FA
HSM-80	20000 CT. (20 Ma.) or 5000 (40 Ma.)	600/250 CT. or 150/62.5	40-20000	5	1 1/8	FA
HSM-81	8000 CT. Split primary.	16/8/4	7-50000	15	1 1/8	JB
HSM-82	8000 CT. Split primary.	600/250/125	7-50000	15	1 1/8	JB
HSM-182	8000/2000 CT. Split primary.	600/250/125	7-50000	15	1 1/8	JB
HSM-84	5000 CT.	16/8/4	15-30000	20	1 1/8	JB
HSM-184	8000	16/8/4	10-50000	25	1 1/8	KB
HSM-189	10000/2500 CT. Split primary.	16/8/4	7-50000	25	1 1/8	KB
HSM-190	10000/2500 CT. Split primary.	500/250/125	7-50000	25	1 1/8	KB
HSM-187	6600 CT. or 1650 CT. Split primary.	500/250/125	7-50000	25	1 1/8	KB

(Continued on next page.)

TRIAD DISTRIBUTOR DIVISION



A DIVISION OF LITTON INDUSTRIES



HIGH FIDELITY OUTPUT (cont.)

HSM-94	4500 CT.	16/8/4	7-50000	55 1/2%	LA
--------	----------	--------	---------	---------	----

HIGH LEVEL OUTPUT

Type No.	Primary Impedance	Secondary Impedance	Output Watts
S-34X	4000 CT.	32/16/8	7.5
S-31A	8000 CT.	16/8/4	15
S-32A	8000 CT.	500/250/125	15
†S-142A	8000 CT.	16/8/4	15
S-35A	5000 CT.	16/8/4	20
S-36A	5000 CT.	500/250/125	20
†S-146A	6600 CT.	16/8/4	25
S-149A	3300 CT.	16/8/4	50
SR-45Z*	4000/2000/1000/500	16/8/4	10
S-46A	2000/1000/500/250	16/8/4	20
†SX-201	3300 ohms CT.	4-8-16 ohms	10-15
†SX-202	4500 ohms CT.	4-8-16 ohms	10-15
SX-203	5000 ohms	4-8-16 ohms	5-7
SX-204	5000 ohms CT.	4-8-16 ohms	10-15
SX-205	6600 ohms CT.	4-8-16 ohms	10-15
†SX-206	6600 ohms CT.	4-8-16 ohms	10-15
†SX-207	8000 ohms CT.	4-8-16 ohms	10-15
SX-208	8000 ohms CT.	4-8-16 ohms	10-15

† Williamson type circuit. Proper taps on primary for screen operation, leads out both end bells.
* Replaces S-45Z.

LINE POWER

ISOLATION Transformers, 50/60 cycles

(See Triad page 6 for 380/1500 cycle isolation transformers)

Type No.	V. A. Output	Input Volts	Output Volts
• N-48X	15	115	115
• N-49X	35	115	57.5/115*
N-51X	35	115	115
N-68X	50	230/115	115
N-53M	85	115	115
N-54M	150	115	115
N-73A	150	115	115/230
N-74A	150	115	57.5/115
N-67A	150	230/115	115
N-55M	250	115	115
N-66A	250	230/115	115
N-57M	500	115	115
N-59M	1000	115	115
†N-52M	350	95 to 130 (in 5V steps)	115
†N-56M	150	95 to 130 (in 5V. steps)	115
† With switch and meter for primary voltage control. Detachable cord. * Split Winding.			
N-469A	50	440/220	115
N-470A	150	440/220	115
N-471A	300	440/220	115

CONSTANT VOLTAGE TRANSFORMERS

Type No.	Rating V. A.	Input Volts	Output Volts
• K-48U	24	95-130	24 CT.
	24	95-130	24 CT.
K-100	30	95-130	117
K-101	60	95-130	117
K-102	120	95-130	117
K-103	250	95-130	117
K-104	500	95-130	117
K-105	750	95-130	117
• K-106	1000	95-130	117

• New Item.

PULSE TRANSFORMERS BLOCKING OSCILLATOR TYPE

Type No.	Pulse Voltage per Winding	Pulse Duration—us	Load Impedance—Ohms
PL-4	100-100	.54 to .66	500*
PL-5	100-100-100	.36 to .54	2000
PL-6	100-100-100	.36 to .54	2000*

* As blocking oscillator in Triad circuit. Can be used with lower impedances and higher peak power at lower duty cycle.

Note: Last letter of Type No. denotes case style.

FILTER REACTORS

Type No.	Current DC Ma.	Inductance *Henries	Resistance Ohms	Insulation Test Voltage
HSM-301	20	30	1000	1500
HSM-302	20	14	560	1500
HS-331	40	4	375	1500
HS-303	50	12	385	1500
HS-333	70	3	225	1500
HSM-305	70	15	300	2500
HS-335	120	3	150	1500
HSM-307	120	15	185	2500
HSM-309	150	9	115	2500
HS-339	200	3	105	2000
HSM-315	200	10	100	2500
HS-341	300	2	48	2000
HSM-319	300	10	85	2500

Minimum Inductance—20%

STEPDOWN Autoformers, 50/60 cycles

Type No.	V. A. Output	Input Volts	Output Volts
N-1X	50	230	115
N-3M	85	230	115
N-4M	150	230	115
N-5M	250	230	115
N-7M	600	230	115
N-9M	1250	230	115
N-11M	2000	230	115
N-34X	150	95/105/115/125/135	115
†N-35M	250	95 to 130 (in 5V. steps)	115
†N-50M	500	95 to 130 (in 5V. steps)	115

† M case with switch for primary voltage control and detachable cord.

HIGH SPEED FERRITE TOROIDAL CORE LOW POWER

Type No.	Turns Ratio	Pulse Width μ Sec.	Rise Time μ Sec.	Repetition Rate	Suggested Load Ohms	Volts
PL-80E	1-1	.07	.03	1-2 Mc	200	15
PL-81E	2-1	.07	.03	1-2 Mc	200	20
PL-81H						
PL-81P						
PL-82H	3-1	.08	.03	1-2 Mc	100	15
PL-82P						
PL-83E	4-1	.08	.03	1-2 Mc	100	15
PL-83H						
PL-83P						
PL-84E	5-1	.08	.03	1-2 Mc	100	15
PL-84H						

The letter "H" indicates Hermetically Sealed, the letter "P" indicates Miniature Plug-in and the letter "E" indicates Epoxy Molded.

LOW SPEED SILICON CORE LOW POWER

Type No.	Pulse Voltage per Winding	Pulse Duration—μ Sec.	Load Impedance—Ohms
PL-124H	300-300-300	.6 to 5	150
PL-140E	100-400-100	.6 to 5	175
PL-140H			
PL-140M			
PL-139E	100-100	.3 to 1.5	250
PL-139H			
PL-139M			
PL-146E	300-300	.6 to 5	250
PL-146H			
PL-146M			

Letter "M" indicates MIL type case. For pulse types only.

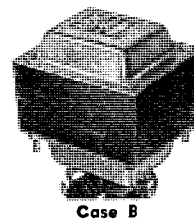

Case B

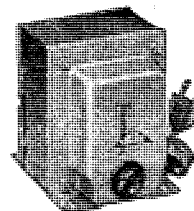

Case M

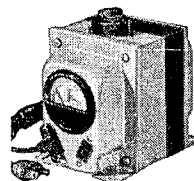

Case M with Meter

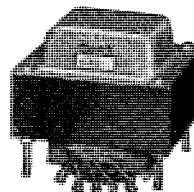

Case C

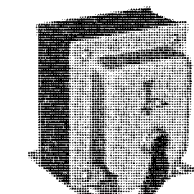

Case AC

TRIAD DISTRIBUTOR DIVISION



A DIVISION OF LITTON INDUSTRIES



Instrument POWER SUPPLY Transformers

For PREAMPLIFIERS, VTVM, etc.
Primary 115 volts — 60 cycles

Type No.	Plate Supply		Filament Windings Volts and Amperes
	AC Volts	DC Ma.	
R-68A	800 CT.	30	5V.-2A, 6.3V-1.2A, 6.3V-1.2A.
R-2C	135	15	6.3V.-9A.
R-23B	250 CT.	22	6.3.-8A. 15.5/12.6V.-6A.
R-3A	500 CT.	20	6.3V CT.-2A.
•R-53Z	500 CT.	25	6.3V-1A.
R-29A	230 CT.	40	6.3V.CT.-1.5A.
R-30X	135	50	6.3V.-1.5A.
R-54X	115	15	6.3V.-6A.
R-56A	130	20	0/15/22.5/30V.-6A.
R-73B	135	200	6.3V CT.-5.5A.

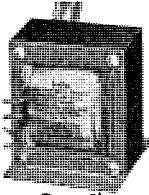

Case U

For CATHODE RAY Tubes
Primary 115 volts — 60 cycles

Type No.	Plate Supply		Filament Windings Volts and Amperes
	AC Volts	DC Ma.	
R-41C	440-0-440-1250.	125/5	*6.3V.-.6A. †2.5V.-1.75A. 5V.-3A.
R-45C	400-0-400-800.	30/5	*6.3V.-.6A. 6.3 CT.-3A. †5V.-2A
R-43C	1600	3	*6.3/5/2.5V.-1A. †6.3/5/2.5V.-3A.

* Static shielded and insulated for full plate voltage.
† Insulated for full plate voltage.

SELENIUM RECTIFIER Transformers Primary 60 cycles

These transformers are for use with Selenium rectifiers.
Rectifiers not included.

Type No.	Primary Volts	Secondary AC Volts	Secondary Amperes RMS	Half	Full
				Wave DC	Wave DC
F-47U	115	17-18	3	6-7	13-14
F-48U	115	17-18	6	6-7	13-14
F-49U	115	36 36	3 3	13	26
F-60U	115	6.5-13-19.5-26	3 (int.)	9	18
F-61U	115	24-27-30-33-36	3	13	26
F-67U	110-120	24-27-30-33-36	8	13	26
F-63U	115	8-9 8-9	2 2		6-7
F-64U	115	7-8-9	7		6-7
F-62U	105-115-125	9-9-9-9	10 ea. wdg.		6-7 ea. wdg.
F-68U	115	9 CT. 9 9 9	3.5 3.5 3.5 3.5		6-7 ea. wdg.
F-65U	110-120	140-150-160	.75	60	115
F-66U	110-120	140-150-160	2.5	60	115
•F-74U	115	14-28-42-56 14-28		2 series conn. 4 parallel conn.	
•F-75U	115	14-28-42-56 14-28		4 series conn. 8 parallel conn.	
F-79U	115	24-26-28-30	15	11.4	22.8
F-80U	tapped for mult. sec.	12 to 18 or 24 to 36CT	40		13
F-84AC	230-115	24CT or 12CT	10 20		8.5
F-90X	115 tapped	40CT-20CT-10	100ma	15	30
F-91X	115 tapped	40CT-20CT-10	300ma	15	30
F-92A	115 tapped	40CT-20CT-10	1 amp	15	30
R-93A	115	6.3CT (voltage doubler circuit) 150-160-170 (500ma)	6	65	120
F-93X	115 tapped	40CT-20CT-10	750ma	15	30
F-94X	115 tapped	40CT-20CT-10	35ma	15	30

• New item.

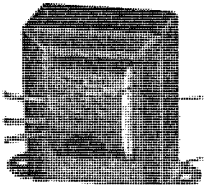

Case Z

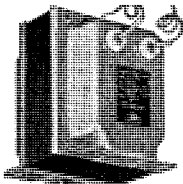

Case A1

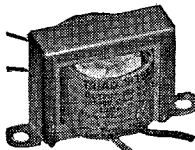

Case X

For REGULATED POWER SUPPLIES
Primary 115 volts — 60 cycles

Type No.	Plate Supply		Filament Windings Volts and Amperes	
	AC Volts	DC Ma. Choke Input		
R-70A	880 CT.	75	6.3V.-.6A. 6.3V.-.3A.	6.3V.-.9A. 6.3V.-.3A.
R-26A	880-720 CT.	200	6.3 CT.-8A. 6.3V.-1A.	6.3V.-3A. 5V.-3A.
R-28A	1250 CT.	300	6.3 CT.-8A. 6.3V.-3A.	6.3V.-3A. 5V.-6A.
R-46A	1250 CT. 130 (Bias winding)	350	5V.-4A.	6.3V.-4A. 6.3V.-1A. 6.3V.-1A.
R-46A will supply 550 V. D.C. using 2 5R4G rectifier tubes, choke input. Will also supply 130 V. for bias using Selenium rectifier. Sufficient filament windings to regulate screen voltages.				
R-27A	1500 CT.	400	5V.-6A.	6.3V.-3A. 6.3V.-8A.

UNIVERSAL

Isolation, Autoformer, Voltage Control 50/60CPSS

Type No.	V.A. (Isolation)	V.A. (Autoformer)
N-64AC	500	1000
N-62AC	1000	2000
N-60SC	2000	4000

SOLID STATE RECTIFIER POWER TRANSFORMERS

Primary 117 volts — 50/60 cycles

Type No.	Secondary No. 1		Secondary No. 2		Secondary No. 3		Mounting Centers
	Volts	MADC	Volts @ A	Volts @ A	Volts @ A	Volts @ A	
R-82B	35-0-35	3.5 Amp.	—	—	—	—	3 x3¼
R200A	200-0-200	400	6.3	3	6.3	3	2¾x3¾
R201A	150-0-150	600	6.3	2.5	6.3	2.5	2¾x3¾
R202A	100-0-100	800	6.3	2	6.3	2	2¾x2¾
R-203A	50-0-50	1600	6.3	1.5	6.3	1.5	2¾x2¾
R-204A	40-0-40	2000	6.3	1.5	6.3	1.5	2¾x2¾
R-205A	30-0-30	2500	6.3	1.5	6.3	1.5	2¾x2¾
R-206B	27-0-27	1.9 Amp.	—	—	—	—	2½x3½
R-208A	40-0-40	1.2 Amp.	—	—	—	—	2¼x3¾

FILAMENT Transformers, Single Secondary

Primary 115 volts — 50/60 cycles

Type No.	Secondary Volts	Secondary Amperes	Test Volts
F-1X	2.5 CT.	3	1500
*F-72Z	2.5 CT.	5	7500
F-6X	2.5 CT.	6	2500
*F-3X	2.5 CT.	10	3000
F-5U	2.5 CT.	10	7500
*F-71U	2.5 CT.	10	10000
F-7X	5 CT.	3	1500
F-8X	5 CT.	6	1500
F-12X	5 CT.	8	2500
F-9A	5.2 CT.	13	1500
*F-10U	5 CT.	14	10000
F-9U	5.2 CT.	13	1500
*F-15U	5 CT.	15	3000
F-11U	5.2 CT.	24	1500
F-13X	6.3	.6	1500
*F-14X	6.3 CT.	1.2	2500
F-52X	6.3	1.2	5000
*F-51X	6.3/5	2	5000
F-53X	6.3	4	5000
F-16X	6.3 CT.	3	2500
*F-43X	6.3	4	1500
F-18X	6.3 CT.	6	1500
F-18A	6.3 CT.	6	1500
F-19X†	6.3/6 CT.	6	2000
F-21A	6.3 CT.	10	1500
F20U†	6.3/6 CT.	11	3000
*F-17U	6.3 CT.	15	Pri. 1500 Sec. 10000
F-22A	6.3 CT.	20	2000
F-24U†	7.5/6.3 CT.	8	3000
F-28U†	7.5/6.3 CT.	25	3000
F-23U	10 CT.	7	1500
F-29U†	12/11/10 CT.	11	3000
F-25X	12.6 CT.	1.5	1500

* 60 cycles. † Tapped primary to produce lower voltages.
(Continued on next page.)

TRIAD DISTRIBUTOR DIVISION



A DIVISION OF LITTON INDUSTRIES



*F-44X	12.6 CT.	1	1500
*F-26X	12.6 CT.	2.5	1500
*F-45X	24 CT.	1	1500
*F-46X	24	1	1500
*F-41X	25.2 CT.	2	1500
*F-40X	26.8 CT.	1	1500
*F-55X	26.8	1.7	1500
*F-50X	Filament line transformer Pri. 6.3V/5V Sec. 6.3/5V 2A		5000
F-54X	35 CT.	1.5	1500
F-85U	5 or 7.5 CT.	20	1500
	5 or 7.5 CT.	20	1500

* 60 cycles.

CHOKES

SWINGING FILTER REACTORS				
Type No.	Inductance Henries	Current Ma.	Resistance Ohms	Test Volts RMS
C-31A	25/5	20/200	150	2500
C-33A	25/5	30/300	105	3000
C-32AL	20/4	35/350	105	5000
C-35A	20/4	40/400	65	3000
C-39A	25/5	50/500	65	3000
C-38AL	25/5	50/500	65	5000

SMOOTHING FILTER REACTORS				
Type No.	Inductance Henries	Current Ma.	Resistance Ohms	Test Volts RMS
C-30X	50	15	3500	1500
C-2X	2	15	70	1500
C-1X	15	20	1000	1500
C-3X	10	50	500	1500
C-4X	4	50	360	1500
C-6X	5	65	330	1500
C-5X	12	75	390	1500
C-8X	7	75	240	1500
C-7X	10	90	270	1500
C-9X	4	90	100	1500
C-11X	6	110	160	1500
C-10X	9	125	250	1500
C-12X	6	160	165	1500
C-12A	6	160	165	1500
C-13X	3	160	75	1500
C-14X	6	200	150	1500
C-14A	6	200	150	1500
C-16A	10	200	150	2500
C-21X	1.5	225	65	1500
C-15X	4	250	100	1500
C-15A	4	250	100	1500
C-23X	1.2	260	45	1500
C-24X	1	240	50	1500
C-27X	.7	290	25	1500
C-36X	.5	300	30	1500
C-17X	1.5	300	40	1500
C-18A	8	300	90	2500
C-19A	10	300	105	3000
C-25A	2.6	310	60	1500
C-42AL	8	350	105	5000
C-34X	.6	350	35	1500
C-28X	1	350	35	1500
C-29X	1.5	375	50	1500
C-50X	2	400	40	2500
C-20A	6	400	60	3000
C-22A	10	500	65	3000
C-45AL	10	500	65	5000
C-40X	.32	600	10	1500
C-47U	.3-.075	1A-2A	3-.75	1500
C-48U	.08-.02	2.5A-5A	.57-.143	1500
C-49U	.032-.008	5A-10A	.19-.05	1500
C-80U	.024-.006	20A-40A	.1/.025	1500
C-56U	.035	2.0A	.75	1500
C-57U	.025	4.0A	.55	1500
C-58U	.01	8.0A	.15	1500
C-59U	.01	12.5A	.10	1500
C-60U	.005	22.5A	.06	1500

ISOLATION Transformers

Primary 115V—400 cycle to operate 380 to 1500 cycles

Type No.	Secondary Volts	Amp.	V. A.	F Dim. (Min.)	Inches	Case
HS-470	115	.35	40	1		EA
HS-471	115	.7	80	1		FA
HS-472	115	1.4	160	1		GA
HS-474	115	2.6	300	1		JA
HS-475	115	4.4	500	1		KA

60 cycle — hermetically sealed					
Type No.	secondary volts	amp.	V.A. (Min.)	F dim. inches	Case
HSM-270	105-115-125	.4	50	1	JB
HSM-271	105-115-125	1	125	1	KA
HSM-272	105-115-125	2	250	1 1/4	NB

All isolation transformers electrostatically shielded.

FILAMENT Transformers, Multiple Secondary

Primary 115 volts — 60 cycles

Type No.	Secondary Volts and Amperes	Test Volts RMS
F-27U	10 CT.-10A. 2.5 CT.-10A.	1500 7500
F-30A	5 CT.-3A. 6.3 CT.-8A.	1500
F-32A	6.3 CT.-3A. 6.3 CT.-3A.	1500
F-34A	6.3 CT.-1.75A. 6.3V.-1.75A. 6.3V.-1.75A.	1500
F-36A	6.3 CT.-3.5A. 6.3V.-3.5A. 6.3V.-3.5A.	1500
F-38A	6.3 CT.-5A. 6.3V.-1A. 5V.-4A. 6.3V.-5A. 5 CT.-2A.	1500
F-42A	12.6 CT.-2.5A. 12.6-2.5A.	1500
F-83A	12.6 CT. 12.6 CT.	5 5

AUDIO TRANSFORMERS

Low Level High Fidelity

Type No.	Application	Frequency Response	Primary Impedance	Turn Ratio
A-9J	line or mike to grid	30-15000	600/250/50	12
A-10J	line to grid	30-15000	600/150 split wdgs.	10.5
A-11J	line or mike to grid 60-80DB shielding	30-15000	600/250/50	10
A-12J	same as A-11J	30-15000	600 CT./150 split windings	10
A-13J	line to transistor or line to line (70 db Shldg)	30-15000	600/300/200 CT./110/50 split windings	1
A-40J	par. fed 6J5 or 6SN7 plate to P.P. grids	30-15000	15000	2.76
A-50J	pp plates to voice coil	30-15000	10000 CT.	35.3
A-52J	line or transistor to line or transistor	30-15000	500/CT./125 20 MA. D.C. Split Winding	2
A-55J	par. fed 6J5 or 6SN7 to line	30-15000	15000	5
A-56J	line or transistor to Voice Coil	30-15000	500 CT./125 20 MA. D.C. Split Winding	5.6
A-61J	line to 2 lines or transistors	60-15000	600/150 split wdgs.	1.41:1:1
A-65J	par. fed 6J5 or 6SN7 to line	30-15000	15000 CT.	5
A-66J	same as A-65J—5 ma DC in primary	40-15000	15000	5
A-67J	line to line	30-15000	600 CT./150 split windings	1
A-68J	pp plate to line 4 ma DC in primary	30-15000	15000 CT.	5
A-69J	pp plates or bridging to line 3 MA. D.C. in Primary	30-15000	25,000 CT./6250 Split Winding	7.1
A-70J	line or transistor to line or transistor	30-15000	500 CT./125 15 MA. D.C. Split Winding	2.24
A-77J	Audio choke — dual winding	250 henries - 5 ma DC 62.5 henries - 10 ma DC		
A-57J	line or transistor to line	30-15000	600/250/50	1:1
A-79J	Transistor inter-stage 10ma in primary	20-15000	1000	2.2

Line or Microphone to Grid

Type No.	Application	Frequency Response	Primary Impedance	Turn Ratio
A-1X	Line or single button mike to grid.	100-15000	100	31.4
A-3X	Line or D.B. mike to grid.	200-10000	400 CT.	22.1
A-4X	Line to grid.	100-20000	500/200/67.5 CT.	12
A-5X	Single button mike to p.p. grids—Hi-gain.	100-15000	100	84
A-6X	Speaker V.C. to grid	150-20000	8/3.2	79
A-7J	Voice coil to grid	150-10000	3.2	124

* New item.

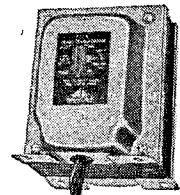

Case A

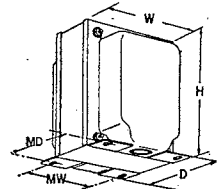

Case A

Triad J Series offers flexibility enabling your amplifiers to exceed broadcast standards. Although economy in construction has cut costs, these transformers approach and closely approximate performance characteristics found in more costly hermetically sealed parts. Single hole mounting provides for rotation for maximum reduction of hum... alloy shielding gives you 40-60 db hum reduction (60-80 db in Types A-11J & A-12J)... you can obtain wide frequency ranges... flexible leads facilitate ease in mounting... input units are electrostatically and magnetically shielded... light weight and encased in Triad's satin smooth baked gray enamel cases, 1 3/8" diameter, 1 3/4" above chassis... legible circuit diagrams are permanently affixed to every case.



TRIAD DISTRIBUTOR DIVISION

A DIVISION OF LITTON INDUSTRIES



AUDIO OUTPUT TRANSFORMERS

Line to Voice Coil

Type No.	Primary Impedance	Output Imped.	Output Watts	Freq. Resp.
S-23X	50 (autoformer).	3.2	1	100-8000
S-26X	500/50 (autoformer).	3.2	4	100-8000
S-65X	500	8/4	5	100-10000
S-66X	500 (autoformer).	16/8/4	3	100-10000
S-76Z	250/125/62.5/31	16/8/4	10	40-15000
S-77U	500 CT./125 split wdgs.	32/16/8/4/2	30	40-15000

POWER

Combined PLATE and FILAMENT Transformers Primary 115 volts — 60 cycles

Type No.	Plate Supply		Rect. Fil.		Other Fil.	
	AC Volts	DC Ma.	Volts	Amp.	Volts	Amp.
R-22A	380/320 CT.	70	6.3	.6	6.3 CT.	3
R-22B	380/320 CT.	70	6.3	.6	6.3 CT.	3
R-4A	500 CT.	40			6.3 CT.	2
R-4B	500 CT.	40			6.3 CT.	2
R-5A	600 CT.	65			6.3 CT.	2.7
R-5B	600 CT.	65			6.3 CT.	2.7
R-6A	480 CT.	50	5	2	6.3 CT.	2
R-6B	480 CT.	50	5	2	6.3 CT.	2
R-7A	600 CT.	50	5	2	6.3 CT.	2
R-7B	600 CT.	50	5	2	6.3 CT.	2
R-8A	500 CT.	75	5	2	6.3 CT.	2.5
R-8B	500 CT.	75	5	2	6.3 CT.	2.5
R-9A	600 CT.	75	5	2	6.3 CT.	3
R-9B	600 CT.	75	5	2	6.3 CT.	3
R-10A	525 CT.	90	5	2	6.3 CT.	5

R-10B	525 CT.	90	5	2	6.3 CT.	5
R-11A	700 CT.	90	5	2	6.3 CT.	3.5
R-11B	700 CT.	90	5	2	6.3 CT.	3.5
• R-98B	650 CT. 40 Tap.	100	5	3	6.3 CT.	3
R-12A	550 CT.	110	5	2	6.3 CT.	5
R-12B	550 CT.	110	5	2	6.3 CT.	5
R-14A	700 CT.	125	5	3	6.3 CT.	4.5
R-14B	700 CT.	125	5	3	6.3 CT.	4.5
R-16A	700 CT.	160	5	3	6.3 CT.	5
R-16B	700 CT.	160	5	3	6.3 CT.	5
R-17A	750 CT. 80 Tap	160	5	3	6.3 CT. 2.5 CT.	5 5
R-18A	750 CT.	175	5	3	6.3 CT.	8
R-18B	750 CT.	175	5	3	6.3 CT.	8
• R-99B	600 CT. 40 Tap.	200			6.3 CT.	4
R-19A	750 CT. 80 Tap	200	5	3	6.3 CT. 2.5 CT.	6 10
R-20A	700 CT.	200	5	3	6.3 CT.	8
R-20B	700 CT.	200	5	3	6.3 CT.	8
R-72A	800 CT.	140	5	3	6.3 CT.	4
R-21A	800 CT.	200	5	3	6.3 CT.	6
R-21B	800 CT.	200	5	3	6.3 CT.	6
R-24A	800 CT.	300	5	6	6.3 CT.	6
R-24B	800 CT.	300	5	6	6.3 CT.	6
R-25A	800 CT.	500	5	6	6.3 6.3 CT.	3 7
R-58A	875 CT.	185	5	3	6.3 6.3 CT.	4 3
• R-59A	1200 CT.	200	5	3	6.3 6.3 CT.	3 3
R-71A	900 CT.	250	5 CT.	4	6.3 CT. 6.3	2 4

• New item.

Combined PLATE and FILAMENT Transformers "100" Series

Never have the outstanding features of Triad Combined Plate and Filament Power Transformers been available at such realistic costs. No quality or performance requirement has been overlooked... specify Triad and be certain. Shielding, impregnation, chatter freedom... to Triad's demanding quality control standards.

PRIMARY 115 VOLTS 60 CYCLES

Type No.	Plate Supply		Rect. Filaments		Other Filaments		Case Dim.			Mtg. Dim.		Wt. Lbs.
	AC Volts	DC Ma.	Volts	Amp.	Volts	Amp.	H	W	D	MW	MD	
R-104A	500 C.T.	40			6.3 V.C.T.	2	2 ³ / ₈	2 ³ / ₈	2 ¹ / ₄	1 ³ / ₄	1 ¹ / ₂	1.55
R-104B	500 C.T.	40			6.3 V.C.T.	2	1 ⁵ / ₈	2 ³ / ₈	2 ¹ / ₄	2 ³ / ₈	1 ³ / ₄	1.55
R-105A	600 C.T.	65			6.3 V.C.T.	2.7	3 ¹ / ₈	2 ⁵ / ₈	2 ¹ / ₂	2	1 ³ / ₄	2
R-105B	600 C.T.	65			6.3 V.C.T.	2.7	1 ³ / ₄	3 ¹ / ₈	2 ⁵ / ₈	2 ¹ / ₂	2	2
R-106A	480 C.T.	50	5	2	6.3 V.C.T.	2	3 ¹ / ₈	2 ⁵ / ₈	2 ³ / ₈	2	1 ⁵ / ₈	2.05
R-106B	480 C.T.	50	5	2	6.3 V.C.T.	2	1 ⁵ / ₈	3 ¹ / ₈	2 ⁵ / ₈	2 ¹ / ₂	2	2.05
R-107A	600 C.T.	50	5	2	6.3 V.C.T.	2	3 ¹ / ₈	2 ⁵ / ₈	2 ¹ / ₂	2	1 ³ / ₄	2.35
R-107B	600 C.T.	50	5	2	6.3 V.C.T.	2	1 ³ / ₄	3 ¹ / ₈	2 ⁵ / ₈	2 ¹ / ₂	2	2.35
R-108A	500 C.T.	75	5	2	6.3 V.C.T.	2.5	3 ¹ / ₈	2 ⁵ / ₈	2 ⁵ / ₈	2	1 ⁷ / ₈	2.4
R-108B	500 C.T.	75	5	2	6.3 V.C.T.	2.5	1 ⁷ / ₈	3 ¹ / ₈	2 ⁵ / ₈	2 ¹ / ₂	2	2.4
R-109A	600 C.T.	75	5	2	6.3 V.C.T.	3	3 ¹ / ₂	3	2 ⁷ / ₈	2 ¹ / ₄	1 ³ / ₄	2.9
R-109B	600 C.T.	75	5	2	6.3 V.C.T.	3	1 ³ / ₄	3 ¹ / ₈	2 ⁷ / ₈	2 ¹ / ₄	2 ¹ / ₄	2.9
R-110A	525 C.T.	90	5	2	6.3 V.C.T.	5	3 ¹ / ₂	3	3 ¹ / ₄	2 ¹ / ₄	2	3.25
R-110B	525 C.T.	90	5	2	6.3 V.C.T.	5	2	3 ¹ / ₈	2 ⁷ / ₈	2 ¹ / ₄	2 ¹ / ₄	3.25
R-111A	700 C.T.	90	5	3	6.3 V.C.T.	3.5	3 ¹ / ₂	3	3 ¹ / ₄	2 ¹ / ₄	2	3.55
R-111B	700 C.T.	90	5	3	6.3 V.C.T.	3.5	2	3 ¹ / ₈	2 ⁷ / ₈	2 ¹ / ₄	2 ¹ / ₄	3.55
R-112A	550 C.T.	110	5	2	6.3 V.C.T.	5	3 ¹ / ₂	3	3 ³ / ₈	2 ¹ / ₄	2 ¹ / ₈	3.7
R-112B	550 C.T.	110	5	2	6.3 V.C.T.	5	2 ¹ / ₈	3 ¹ / ₈	2 ⁷ / ₈	2 ¹ / ₈	2 ¹ / ₄	3.7
R-113A	650 C.T.	40	5	2	6.3 V.C.T.	2	3 ¹ / ₈	2 ⁵ / ₈	2 ³ / ₄	2	1 ³ / ₄	2.3
R-113B	650 C.T.	40	5	2	6.3 V.C.T.	2	2	3	2 ¹ / ₂	2 ¹ / ₂	2	2.3
R-114A	700 C.T.	125	5	3	6.3 V.C.T.	4.5	3 ⁷ / ₈	3 ¹ / ₄	3 ¹ / ₄	2 ¹ / ₂	2 ³ / ₈	4.7
R-114B	700 C.T.	125	5	3	6.3 V.C.T.	4.5	2 ¹ / ₂	3 ³ / ₈	3 ¹ / ₈	3 ³ / ₈	2 ¹ / ₂	4.7
R-115A	680 C.T.	70	5	2	6.3 V.C.T.	2.5	3 ⁵ / ₈	3	3 ³ / ₈	2 ¹ / ₄	2 ¹ / ₈	3.5
R-115B	680 C.T.	70	5	2	6.3 V.C.T.	2.5	2	3 ¹ / ₈	2 ⁷ / ₈	2 ¹ / ₈	2 ¹ / ₄	3.5
R-116A	700 C.T.	160	5	3	6.3 V.C.T.	5	3 ⁷ / ₈	3 ¹ / ₄	3 ⁵ / ₈	2 ¹ / ₂	2 ⁵ / ₈	5.65
R-116B	700 C.T.	160	5	3	6.3 V.C.T.	5	2 ⁵ / ₈	3 ³ / ₈	3 ¹ / ₈	3 ¹ / ₈	2 ¹ / ₂	5.65
R-118A	750 C.T.	175	5	3	6.3 V.C.T.	8	4 ¹ / ₄	3 ⁵ / ₈	4	2 ³ / ₄	2 ⁷ / ₈	7.45
R-118B	750 C.T.	175	5	3	6.3 V.C.T.	8	2 ⁷ / ₈	4 ¹ / ₈	3 ¹ / ₂	3 ¹ / ₈	2 ³ / ₄	7.45
R-120A	700 C.T.	200	5	3	6.3 V.C.T.	8	4 ¹ / ₄	3 ⁵ / ₈	4 ¹ / ₈	2 ³ / ₄	2 ⁷ / ₈	8.25
R-120B	700 C.T.	200	5	3	6.3 V.C.T.	8	3	4 ¹ / ₈	3 ¹ / ₂	3 ¹ / ₈	2 ³ / ₄	8.25
R-121A	800 C.T.	200	5	3	6.3 V.C.T.	6	4 ¹ / ₄	3 ⁵ / ₈	4 ³ / ₈	2 ³ / ₄	3 ¹ / ₄	8.25
R-121B	800 C.T.	200	5	3	6.3 V.C.T.	6	3 ¹ / ₄	4 ¹ / ₈	3 ¹ / ₂	3 ¹ / ₈	2 ³ / ₄	8.25

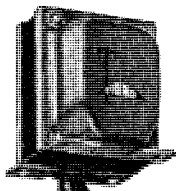

Case A

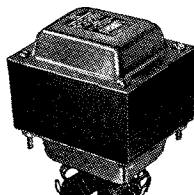

Case B

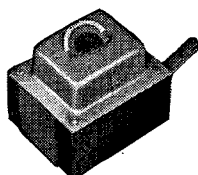

Case BS

TRIAD DISTRIBUTOR DIVISION



A DIVISION OF LITTON INDUSTRIES



PLATE POWER Transformers

Primary 115 volts — 50/60 cycles

Type No.	Secondary Volts		Sec. D.C. Ma.		Rect. Fil.
	AC	DC	CCS	ICAS	
P-1A	440/220 CT.	180/90	160	190	5V-3A
P-3A	600/300 CT.	250/125	300	360	5V-4A
P-5A°	1100 CT.	400	250	300	5V-4A
P-7A°	1235 CT.	500	250	300	5V-4A
P-9A	1235 CT.	500	500	600	5V-6A
P-11A°	1455 CT.	600	250	300	
P-213AL*†	1780 CT.	750	250	300	
SP-14A	1780 CT.	750/600	250	300	
P-215AL*†	2340 CT.	1000	250	300	
P-216AL*†	2430 CT.	1000	500	600	
P-217AL*†	2880 CT.	1250	250	300	
P218AL*†	2880 CT.	1250	500	600	
P-220AL*†	3300 CT.	1500	350	420	
PR-21AL	3300 CT.	1500	500	600	

† Plate leads out side of case for 866 rectifiers.

‡ Tapped Pri. to produce the lower D.C. voltage.

°Pri. is 230/115V.

*60 cycle only.

POWER TRANSFORMERS

Combined Plate and Filament

Electrostatically shielded. Primary 115 volts 60 cycles.

Type No.	Plate Supply		Filaments —	
	AC Volts	DC Ma.	Volts	and Amperes
R-37BC	735 V.C.T.	275	5V.—6A.	6.3V.—8.5A. 6.3V./5V.—2A.*
R-38A	750 V.C.T.	225	5V.—3A.	6.3V.—10A.* 6.3V.—1.2A.* 6.3V.—2.5A.
R-40BC	780/440 V.C.T.	300	5V.—3A. 5V.—3A. 5V.—2A.	6.3V.—8.5A. 6.3V.—3.5A.
R-49BS	650 V.C.T.	240	5V.—3A.	6.3V.—9A. 6.3V.—0.9A. 6.3V.—1.2A.*
R-49BC				
R-50A	790/650 V.C.T.	310	5V.—3A. 5V.—3A. 5V.—2A.	6.3V.—5A. 6.3V.—5A. 6.3V.—2.6A.
R-50BC				
R-51BC	505 V.C.T.	320	5V.—6A.	6.3V.—5A. 6.3V.—5A. 6.3V.—1.2A.*
R-60BC	460 V.C.T.	300	5V.—6A.	6.3V.—10A. 6.3V.—1.2A.* 6.3V.—2.5A.
R-61BC	560 V.C.T.	275	5V.—6A.	6.3V.—6A. 6.3V.—6A. 6.3V.—1.2A.*
R-62BC	680 V.C.T.	290	5V.—6A.	6.3V.—10A. 6.3V.—1.5A. 6.3V.—1.2A.*
R-64BC	520 V.C.T.	270	5V.—3A.	6.3V.—10A.
R-65BC	550 V.C.T.	270	5V.—3A.	6.3V.—10A.
R-66BC	580 V.C.T.	270	5V.—3A.	6.3V.—10A.
R-67BC	600 V.C.T.	250	5V.—3A.	6.3V.—9A.
R-69BC	550 V.C.T.	270	5V.—3A.	6.3V.—10A.
R-74BC	680 V.C.T.	190	6.3V.—7.8A. 6.3V.—1.2A. (damper wdg)	5V.—3A.

* Less than 100 m.m.f.d. capacity to ground and insulated for high voltage damper tube.

Height of transformers in BC cases is measured from chassis line to top of case. Copper shading ring on all BC cases to reduce external magnetic field.

Note: Last letter of Type No. denotes case style.

UNIVERSAL RECTIFIER POWERS

Type No.	Secondary No. 1 AC Volts	Secondary DC Amps		Secondary No. 2 AC Volts	DC Amps
		Full Wave CT	Bridge		
■ F-200A	13 or 18 @ .9 ADC	—	—	13 or 18 @ .9 ADC	—
■ F-202U	11.0 to 29.5	2.0	1.25	—	—
■ F-203U	12.0 to 30.0	4.0	2.0	—	—
■ F-204U	11.5 to 29.0	8.0	4.0	—	—
■ F-205U	12.0 to 29.5	12.0	6.0	—	—

■ New item.

AUDIO

Triad Replacement Output Transformers furnish a wide range of size and mounting characteristics... specifically engineered for mounting in precise location in chassis. Climatite treated... manufactured to exacting quality standards of more costly types... progressively designed for advanced circuitry and audio tubes... total complete coverage over impedance and wattage ranges... Triad units provide finest response in minimum space... and outlive all others.

REPLACEMENT OUTPUT TRANSFORMERS

Single Tube To Standard Voice Coil 3-4 Ohms

Type No.	Primary Impedance	D.C. Ma	Audio Watt
S-20X	2000	50	2-3
S-20Z	2000	50	2-3
S-2X	2000	55	3-5
S-12X	2500	50	2-3
S-12Z	2500	50	2-3
S-1X	2500	60	3-5
S-50X	2500	60	4-6
S-16X	3000 5% Tap	50	2-3
S-30X	3000	60	3-5
S-67X	3200	60	4-6
S-4X	3000	70	5-8
S-14Z	4000	50	2-3
S-41X	4000	50	3-5
S-41Z	4000	50	3-5
S-6X	5000	35	2-3
S-6Z	5000	35	2-3
S-3X	5000	40	3-5
S-5X	5000	50	5-8
S-5Z	5000	50	5-8
S-48X	6500	35	2-3
S-48Z	6500	35	2-3
S-49X	6500	35	3-5
S-7X	7500	30	3-5
S-9X	7500	50	5-8
S-9Z	7500	50	5-8
S-8X	8000	30	2-3
S-8Z	8000	30	2-3
S18X	8000	45	4-6
S-18Z	8000	45	4-6
S-11X	10000	30	2-3
S-11Z	10000	30	2-3
§-17X	10000	30	3-5
S-10X	10000	45	4-6
S-40X	14000	5.5	¼
S-38X	16000	15	2-3
S-38Z	16000	15	2-3
S-37X	25000	4.0	¼
S-13X	25000	10	2-3
S-13Z	25000	10	2-3

REPLACEMENT PUSH-PULL OUTPUT TRANSFORMERS

Push-Pull Tubes To Voice Coil 3-4 Ohms

Type No.	Impedance	D.C. MA. Each Side	Audio Watts
S-39X	12000 CT.	30	3-4
S-64X	6000 CT.	40	4-6
S-15X	10000 CT.	35	7-10
S-19Z	10000 CT.	50	10-14
S-68Z	3000/3800 CT.	90	15-18
S-69Z	5000 CT.	60	15-18
S-21A	8000 CT.	55	15-18
S-21Z	8000 CT.	55	15-18

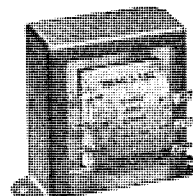

Case Z

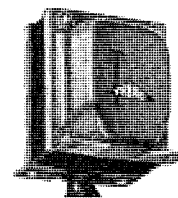

Case A

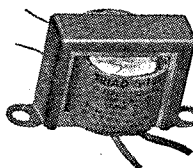

Case X



TRIAD DISTRIBUTOR DIVISION

A DIVISION OF LITTON INDUSTRIES



LOW VOLTAGE, LOW CURRENT Transformers

All 117 v., 50/60 cycle pri

Type No.	Secondary Volts	Secondary Amps.	Test Volts
•F-113X	12 volts	150 ma.	1500
•F-114X	12 volts	700 ma.	1500
•F-115X	24 v. CT.	85 ma.	1500
•F-116X	24 v. CT.	200 ma.	1500
•F-117X	24 v. CT.	400 ma.	1500
•F-118X	24 v. CT.	700 ma.	1500
•F-119X	26.8 v. CT.	150 ma.	1500
•F-120X	26.8 v. CT.	500 ma.	1500

• New item.

AUDIO

LOW LEVEL OUTPUT Transformers

Type No.	Application	Freq. Resp.	Pri. Imped.	Second. Imped.
A-51X	Tube to line.	300-3000	7000	50
A-53X	Single or p.p. tubes to line.	70-7000	18000 CT.	600/250/50
S-58X	Line to line.	300-3000	600/150	600/150

—Split windings—

SPLATTER Chokes

Type No.	Inductance Henries	Current Ma.	Res. Ohms	Wt. Lbs.
C-26X	Tapped to 1.5	100	95	1 1/4
C-43X	Tapped .05 to 1	300	40	2

UNIVERSAL OUTPUT Transformers

Single Or Push-Pull Tubes To Voice Coil

Type No.	Application	Impedance	DC Audio MA	Watts
S-62X	Single or P.p. plates	2000-10000	30	2
S-52X	Single or p.p. plates	4000-24000	30	4
S-51X	Single or p.p. plates	4000-14000	35	5
S-63X	Single or p.p. plates	1500- 7000	50	6
S-54X	Single	1500- 5000	70	8
S-53X	Single or p.p. plates	4000-14000	40	8
S-55X	P.p. plates	4000-14000	40	10
S-55Z	P.p. plates	4000-14000	40	10
S-56Z	Single	1500- 6000	85	12
S-59Z	P.p. plates	1500- 4000	65	15
S-57Z	P.p. plates	4000-14000	55	15
S-61Z	P.p. plates	4000-10000	60	20

PLUG-IN INPUT Transformers

Type No.	Application	Pri. Imped.	Second Imped.	Freq. Resp.	Shld'g
A-202P	Same as above.	200/50 CT. Δ	36,000	20-20000	90 db.
HS-273P	Same as above	200/50 CT. Δ	80,000	30-30000	70 db.
A-210P	Stereo Isolation	1:1 ratio	30,000	20-20000	45 db.

Δ Split Winding

INTERSTAGE Transformers

Plate to Grid

Type No.	Application	Freq. Resp.	Pri. Imped.	Second Imped.	Ratio
A-31X	Plate to single or p.p. grids	300-300u	10000	90000CT	1 : 3
A-33X	Plate to single or p.p. grids	70-7000	10000	90000CT	1 : 3
A-42Z	Multi-ratio single or p.p. plates to single or p.p. grids.	70-7000 CT.	15000	135000CT. or 33750	1 : 1.5 1 : 3 1 : 6
A-35A	Plate to single or p.p. grids	50-10000	10000	90000CT	1 : 3
A-40J	Parallel-fed 6J5 or 6SN7. Plate to p.p. grid 45 db. shielding.	30-15000	15000	115000CT	1 : 2.76

MODULATION Transformers

Tube to RF Load

Type No.	Primary	Freq. Resp.	Secondary Impedance	Ma.	Aud. Wtts.
TY-65Z	32 CT. (575 Ma.) (Transistor use)	70-15000	3000-4000-6000	100	10
M-4Z	5000 (Auto-former).	300-3000	6750 4	100 (total)	10
M-1X	10000 CT. for 19, 1J6, 6N7, 6A6, etc.	300-3000	5000-8000-10000	50	5
M-3X	10000 CT. for 5N7, 6A6, 6F6's, etc.	300-3000	3000-5000-8000	100	20
TY-66A	6 CT. (5A) (Transistor use)	300-3000	3000-4000-6000	200	40
†M-7AL	4250 CT. for 807's	300-3000	3000-5000-8000	200	60
†M-12AL	Multi-match	300-3000	4000 to 20000	300	125

DRIVER Transformers

Type No.	Driver Tubes	Output Tubes	Frequency Response	Ratio Primary 1/2 Sec.	Primary D.C. Ma.
A-81X	30, 1H4, etc.	19, 30's, 1J6, etc.	200-20,000	2.66:1	15
A-83X	6F6, 42, 45, etc.	6L6, 6F6, 6V6, 807, etc.	70-7000	1.33:1	40
A-85X	6F6, 42, 45, etc.	6L6, 6F6, 6V6, 807, etc.	50-10000	2.66:1	40
A-89A	P.p. plates to class B or AB grids— Universal 15 watt.	Any class B or AB tubes. 100-500 watts output	50-10000	3.1 or 1.8:1	100 per side
TY-61X	Transistor use		70-10000	1:0.5	100
TY-158X	Transistor use, dual secondaries		20-20,000	1.5:1:1	50
TY-159X	Transistor use, dual secondaries		20-20,000	3:1:1	50
TY-160X	Transistor use, dual secondaries		20-20,000	6:1:1	50

†Plate leads out side

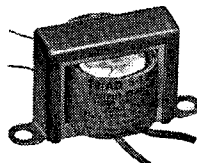

Case X



Case J



Case P

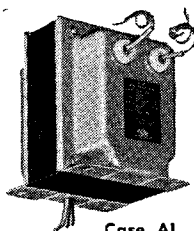

Case AL

TRIAD DISTRIBUTOR DIVISION



A DIVISION OF LITTON INDUSTRIES



OUTPUT Transformers Tube to Voice Coil and Line

Type No.	Tubes	Pri. Imped.	Sec. Imped.	DC Pri.	Audio Watts
S-27A	2A3, 6A3, 6B4, 6L6, 6U6, 6Y6, 12A5, 25B6, 35B5, 50A5.	2500	500/16/8/4	80	8
S-28X	2A5, 6AC5, 6B5, 6F6, 6K6, 7B5, 14A5, 25AC5.	7500	500/16/8/4	40	5
S-29X	6AQ5, 6AS5, 6V6, 7C5, 25A6, 25B5, 25L6, 25N6, 35A5, 35L6.	5000	500/16/8/4	45	5
S-22A	P.p. 2A3, 6B4, 6A5, 6L6, etc.	5000 CT.	500/16/8/4	100 (bal.)	15
S-24A	P.p. 6V6, 7C5, 6K6, 6F6, etc.	8000 CT.	500/16/8/4	80 (bal.)	15
S-60A	P.p. 6L6, 5881, 6600 CT.	500/250/807, etc.	500/250/16/8/4	120 (bal.)	35

70.7 volt Line to Voice Coil

Type No.	Primary Impedance	Sec. Imped.	Output Watts	Freq. Resp.
S-70Z	Autoformer 16000/8000/4000/2000/1000.	8/4	5	40-15000
S-71Z	Autoformer 4000/2000/1000/500.	16/8/4	10	40-20000
S-25Z	Autoformer 4000/2000/1000/500.	8/4	10	30-20000
SR-45Z	Autoformer 4000/2000/1000/500.	16/8/4	10	20-20000
SR-74K	Weatherproof autoformer 4000/2000/1000/500.	16/8/4	10	20-20000
S-72Z	Autoformer 2000/1000/500/250.	16/8/4	20	40-20000
•S-43Z		16/8/4	30-20 10-5	35-20000
•S-44Z		16/8/4	50-40 25-15	35-20000

• New item.

70.7 volt Line to Voice Coil (Cont.)

Type No.	Primary Impedance	Sec. Imped.	Output Watts	Freq. Resp.
•S-44Z		16/8/4	50-40 25-15	35-20000
S-46A	Autoformer 2000/1000/500/250.	16/8/4	20	20-20000
S-75K	Weatherproof autoformer 2000/1000/500/250.	16/8/4	20	20-20000
S-78Z	Isolation 4000/2000/1000/500.	16/8/4	10	40-20000
S-79Z	Isolation 2000/1000/500/250.	16/8/4	20	40-20000
S-47Z	10K/5K/2.5K/1250/625	16/8/4	8	20-20000
S-73X	Isolation 16K/8K/4K/2K/1K	16/8/4	5	40-15000

25 VOLT LINE TRANSFORMERS

Type No.	Primary Matching Impedance	Secondary Load Impedance	Output Watts
S-131X	1250/625/312	8/4	2
S-132X	1000/500/250/125	16/8/4	5
S-133Z	500/250/125/62.5	16/8/4	10

MATCHING TRANSFORMERS FOR 25 OR 70.7 VOLT LINE

S-129Z	70.7V line to 25V line or, 25V line to 70.7V line	30	20-15000
S-130Z	70.7V line to 25V line or, 25V line to 70.7V line	10	20-15000

Special TRANSCEIVER Transformers (Voice Frequencies)

Type No.	Application	Primary Impedance	Secondary Impedance
A-21X	S.B. mike or plate to grid (2 primaries)	100 10000	100000
A-23X	Tube to line and hi-impedance phones.	10000	50 and 2000

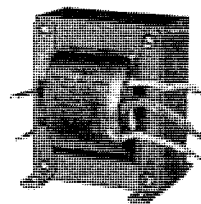

Case U

INSTRUMENTATION GEOFORMERS

LOW FREQUENCY TRANSISTOR TRANSFORMERS

Type No.	Impedance Ohms		Turns Ratio	Min. pri. Ind. @ 100MV-60 cy. With No Un-balanced D.C. Current	D. C. Resistance (Ohms)		Frequency Response in Cycles Primary Signal of 1 Volt Unbalanced D.C. Secondary Current of						Shielding	Case Mtg.	Wt.			
	Pri.	Sec.			Pri.	Sec.	1 Ma.		2 Ma.		5 Ma.							
							-3DB	-1DB	-3DB	-1DB	-3DB	-1DB				-3DB	-1DB	
G-18	1000 or 250	125 or 31	2:83:1	60.	500	44		5 to 2000	8 to 700	5 to 2000	8 to 700	6 to 2000	9 to 700	7 to 2000	10 to 700	P1-H	GP-1F	3.2 oz.
G-19	1000 or 250	1000 or 250	1:1	65.	540	230		12 to 700	15 to 380	12 to 700	15 to 380	12 to 700	15 to 380	20 to 700	40 to 380	P1-H	GP-2L	5 1/4 oz.
G-30	1000 CT.	2500 CT.	1:1.58	20.	350	1800		20 to 8000	40 to 4200	22 to 8000	45 to 4200	40 to 8000	75 to 4200	70 to 8000	160 to 4200	P1	GP-1F	3.2 oz.

CHOPPER INPUT TRANSFORMERS

Triad Chopper Input Transformers provide exceedingly close balance between the two halves of the primary winding... minimum noise in microvolt ranges of input signals is assured with Triad's special core treatment techniques. For demanding transistor and tube applications, Triad's special design capabilities have an outstanding record. For special applications, consult Triad.

Type No.	Turns Ratio	Minimum Primary Inductance @ 1V-60	Maximum Primary Volts @ 60	Primary Matching Impedance In Ohms	Secondary Matching Impedance In Ohms	D.C. Resistance		Stray Fields Shield	Case and Mounting	Weight
						Primary In Ohms	Secondary In Ohms			
G-20‡	1:8	120 h.	25	10,000 CT or 2500	640,000 CT	370	21,000	P5-H	GP-4T	11 1/2 oz.
G-21‡ G-21TS‡	4:1	1200 h.	84	20,000 CT	12,500 CT	4000	1300	P1-H P5-H	GP-2L GP-4T	5 1/4 oz. 11 1/2 oz.
G-22‡	1:4	1000 h.	90	50,000 CT	800,000 CT	2200	19,000	P5-H	GP-5W	1 lb.
G-23‡	6.32:1	1000 h.	75	40,000 CT	1000 CT	4400	160	P1-H	GP-2L	5 1/4 oz.
G-24‡	1:1	400 h. Low capacity coupling less than .02 µF between windings.	19.5	40,000 CT	40,000 CT	1625	1625	P5	GP-5S	1 lb.
G-25‡ G-25TS‡	2:1	800 h.	70	40,000 CT or 10,000 CT	10,000 CT	3200	2200	P1-H P5-H	GP-2L GP-4T	5 1/4 oz. 11 1/2 oz.

‡Static Shield

TRIAD DISTRIBUTOR DIVISION

TOROIDS



A DIVISION OF LITTON INDUSTRIES



Triad toroids may be ordered with standard leads in strong plastic coating, or epoxy molded encapsulated per Specification MIL-T-27A; TF5RX20ZZ. To specify molded toroids with gold-plated fixed terminals, an "A" should be added to the full type number; for example, EM-001A.



A

TOROIDS



EA SERIES

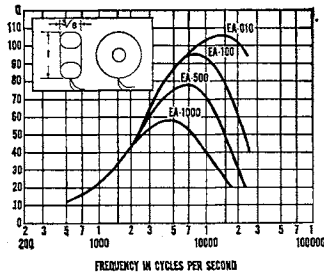

EC SERIES

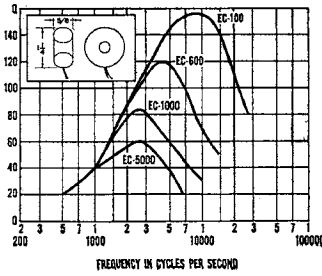

EK SERIES

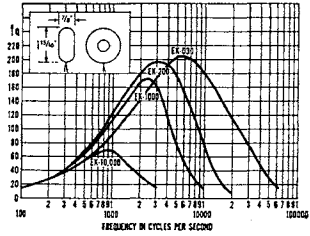

Type No.	Ind.	Res-Ohms Average	D.C.-Ma. for 5% Ind. drop
EA-001	1 mh	.40	270
EA-002	2 mh	.58	192
EA-003	3 mh	.73	157
EA-004	4 mh	.85	135
EA-005	5 mh	1.10	121
EA-007	7 mh	1.35	102
EA-010	10 mh	2.10	86
EA-015	15 mh	3.10	70
EA-020	20 mh	4.25	60
EA-025	25 mh	4.80	54
EA-030	30 mh	6.70	50
EA-040	40 mh	9.50	43
EA-050	50 mh	11.00	38
EA-070	70 mh	16.00	32
EA-100	100 mh	23.00	27
EA-150	150 mh	37.00	22
EA-200	200 mh	42.00	19
EA-250	250 mh	60.00	17
EA-300	300 mh	70.00	16
EA-400	400 mh	95.00	14
EA-500	500 mh	115.00	12
EA-600	600 mh	150.00	11
EA-700	700 mh	160.00	10
EA-1000	1000 mh	260.00	8.6

Type No.	Ind.	Res-Ohms Average	D.C.-Ma. for 5% Ind. drop
EC-001	1 mh	.40	520
EC-002	2 mh	.56	368
EC-003	3 mh	.70	300
EC-004	4 mh	.82	260
EC-005	5 mh	.92	233
EC-007	7 mh	1.05	195
EC-010	10 mh	1.30	165
EC-015	15 mh	1.60	134
EC-020	20 mh	1.85	116
EC-030	30 mh	2.85	95
EC-040	40 mh	4.20	82
EC-050	50 mh	5.50	74
EC-070	70 mh	8.30	74
EC-100	100 mh	13.00	52
EC-200	200 mh	23.00	37
EC-250	250 mh	33.00	33
EC-300	300 mh	35.00	30
EC-400	400 mh	42.00	26
EC-500	500 mh	72.50	23
EC-600	600 mh	80.00	21
EC-700	700 mh	68.00	19.5
EC-1000	1000 mh	134.00	16.5
EC-1500	1500 mh	200.00	13.5
EC-2000	2000 mh	220.00	11.6
EC-3000	3000 mh	370.00	9.5
EC-4000	4000 mh	550.00	6.2
EC-5000	5000 mh	780.00	7.4
EC-7000	7000 mh	700.00	6.2
EC-10000	10000 mh	1100.00	5.2

Type No.	Ind.	Res-Ohms Average	D.C.-Ma. for 5% Ind. drop
EK-010	10 mh	.82	262
EK-020	20 mh	1.10	184
EK-030	30 mh	1.40	150
EK-040	40 mh	1.90	130
EK-050	50 mh	2.40	116
EK-060	60 mh	2.60	106
EK-080	80 mh	3.10	92
EK-100	100 mh	4.40	82
EK-120	120 mh	4.80	75
EK-150	150 mh	6.20	67
EK-200	200 mh	7.50	58
EK-250	250 mh	9.00	52
EK-300	300 mh	12.00	47
EK-400	400 mh	14.00	41
EK-500	500 mh	19.00	37
EK-700	700 mh	27.00	31
EK-1000	1000 mh	45.00	26
EK-1500	1500 mh	67.00	21
EK-2000	2000 mh	100.00	18.4
EK-2500	2500 mh	108	16.5
EK-3000	3000 mh	116	15
EK-4000	4000 mh	150	13
EK-5000	5000 mh	200	11.6
EK-7000	7000 mh	300	9.8
EK-10000	10000 mh	350	8.2
EK-20000	20000 mh	800	5.8
EK-30000	30000 mh	1250	4.1
EK-40000	40000 mh	2000	4.1

Type No.	Ind.	Res-Ohms Average	D.C.-Ma. for 5% Ind. drop
EM-001	1 mh	1.25	150
EM-002	2 mh	1.70	108
EM-003	3 mh	2.25	87
EM-004	4 mh	2.60	76
EM-005	5 mh	3.10	68
EM-007	7 mh	4.5	57
EM-010	10 mh	6.5	48
EM-015	15 mh	10.00	39
EM-020	20 mh	11.5	34
EM-025	25 mh	16.5	30
EM-030	30 mh	18	27.6
EM-040	40 mh	27	24
EM-050	50 mh	30	22
EM-060	60 mh	40	19.5
EM-070	70 mh	43	18
EM-100	100 mh	66	15
EM-150	150 mh	100	12.5
EM-200	200 mh	115	11
EM-250	250 mh	155	9.6
EM-300	300 mh	180	8.8
EM-400	400 mh	265	7.6
EM-500	500 mh	295	7
EM-700	700 mh	400	5.8
EM-1000	1000 mh	650	4.8

EM SERIES

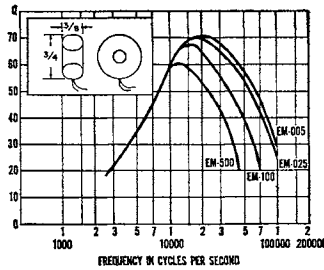

ET SERIES

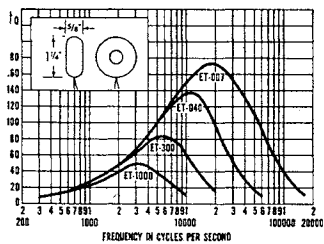

Type No.	Ind.	Res-Ohms Approx.	D.C.-Ma. for 5% Ind. drop
ET-001	1 mh	.20	680
ET-002	2 mh	.50	480
ET-003	3 mh	.68	396
ET-004	4 mh	.81	342
ET-005	5 mh	1.10	306
ET-007	7 mh	1.50	260
ET-010	10 mh	2	217
ET-015	15 mh	2.85	177
ET-020	20 mh	4.0	153
ET-025	25 mh	4.8	137
ET-030	30 mh	6.5	125
ET-040	40 mh	9.2	108
ET-050	50 mh	10.3	97
ET-060	60 mh	14.5	88
ET-070	70 mh	15.0	82
ET-100	100 mh	24.0	68
ET-150	150 mh	35.0	56
ET-200	200 mh	44.5	48
ET-250	250 mh	64	43
ET-300	300 mh	70	40
ET-400	400 mh	94	34
ET-500	500 mh	108	31
ET-700	700 mh	173	26
ET-1000	1000 mh	230	22

■Discontinued item, available until stock depleted.

TRIAD DISTRIBUTOR DIVISION



A DIVISION OF LITTON INDUSTRIES



RED SPEC TRANSISTOR TRANSFORMERS

Type No.	Application Type	MIL-T-27A Designation	Primary Impedance	D.C. Res. Pri. Ohms	Max. Unbal. Pri. D.C. Ma.	Secondary Impedance	Max. Power MW
SP-4	Input	TF5RX16ZZ	20000 c.t.	5300	0	1000 c.t.	10
SP-5	Input	TF5RX16ZZ	50000 c.t.	3800	0	1000 c.t.	25
SP-7	Input	TF5RX16ZZ	200000	5300	0	1000	10
SP-11	Interstage	TF5RX13ZZ	25000/20,000	1700	.5	1000/800	40
SP-13	Interstage	TF5RX13ZZ	25000 c.t./20,000 c.t.	1700	.5	1000 c.t./800 c.t.	40
SP-15	Interstage	TF5RX13ZZ	10000 c.t.	1050	1	1500 c.t.	50
SP-20	Driver	TF5RX13ZZ	10000 c.t.	1050	1	1200 c.t.	50
SP-21	Driver	TF5RX13ZZ	10000 c.t.	1050	1	2000 c.t.	50
SP-22	Driver	TF5SX13ZZ	10000	1050	1	2000 c.t./500†	50
SP-29	Driver	TF5RX13ZZ	10000 c.t.	1050	1	500 c.t.	50
*SP-32	Output	TF5RX17ZZ	500	60	3	50	50
SP-33	Output	TF5RX17ZZ	1000	145	3	50	50
SP-34	Output	TF5RX17ZZ	600	70	3	3.2	50
SP-35	Output	TF5RX13ZZ	1200	131	2	3.2	50
SP-42	Output	TF5RX17ZZ	150 c.t.	18	10	12	50
SP-47	Output	TF5RX13ZZ	1500 c.t.	179	3	12	50
SP-48	Output	TF5RX13ZZ	7500 c.t.	796	1	12	50
SP-49	Output	TF5RX17ZZ	300 c.t.	41	7	600	50
SP-50	Output	TF5RX17ZZ	500 c.t.	67	3	600	50
SP-51	Output	TF5RX17ZZ	900 c.t.	104	4	600	50
SP-52	Output	TF5RX13ZZ	1500 c.t.	168	3	600	50
SP-63	Output	TF5RX13ZZ	1200 c.t.	125	3	3.2	50
SP-64	Output	TF5RX13ZZ	1600 c.t.	186	2.5	3.2	50
SP-65	Output	TF5RX13ZZ	8000 c.t.	790	1	3.2	50
SP-66	Output Isolation	TF5RX13ZZ	10000 c.t.	1000	1	10000 c.t.	50
SP-67	Output Isolation	TF5RX17ZZ	600 c.t.	73	3	600 CT.	50
SP-68	Output Isolation	TF5SX13ZZ	10000	1000	1	10000 c.t./2500†	50
SP-69	Output Isolation	TF5SX17ZZ	600	72	3	600 c.t./150†	50
SP-70	Output Isolation	TF5RX17ZZ	600	72	3	600	50
SP-106	Choke	TF5RX20ZZ	6 hy.	1700	2		
SP-107	Choke	TF5RX20ZZ	1.25 hy.	180	2		
SP-108	Choke	TF5RX20ZZ	3.5 hy.	1100	2		
SP-117	Choke	TF5RX20ZZ	.5HY	110	2		
SP-118	Choke	TF5RX20ZZ	.3 hy.	42	4		
SP-128	Choke	TF5RX20ZZ	.1HY	15	5		
SP-310	Magnetic shielding case						

CT For Center Tap. †Split secondary.

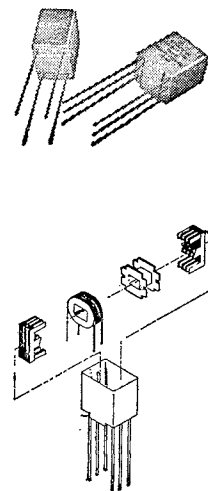

Sub-miniature Encapsulated TOROIDAL INDUCTORS

Triad sub-miniature toroidal inductors, designed for quick, easy printed-circuit board mounting, are now stocked for immediate delivery in a range of standard ratings from 50 micro-henries to 500 milli-henries. Many uses, especially in airborne telemetering applications incorporating Triad's sub-miniature filters FL-384 through FL-388. Case size of units is 1/4 inch diameter by 1/4 inch high. Providing an optimum combination of high Q and extremely small-size, this series is ideal for printed board, transistor or vacuum tube application.

Triad sub-miniature inductors are toroidally wound on permalloy powdered cores. Encapsulated in high temperature epoxy resin. Weldable or solderable leads of gold plated nickel alloy. Highly resistant to severe acceleration, shock or vibration. Manufactured to MIL-T-27A, Grade 5 Class S (MIL type TF5SX20ZZ).

NOTE: Ma. DC maximum is for approximately 5% drop in inductance. Those figures marked * will give less than 5% inductance drop but should not be exceeded under operating conditions. Inductance tolerance of EX-P05A through EX-P50A is ±5%; EX-001A through EX-500A is ±2%.

Cat. No.	Inductance (0 DC)	DCR (ohms) ±25%	Maximum Ma. DC
EX-P05A	50 μh	1.2	75*
EX-P10A	100 μh	1.4	75*
EX-P20A	200 μh	2.0	75*
EX-P30A	300 μh	2.3	75*
EX-P50A	500 μh	3.0	75*
EX-001A	1 mh	4.3	75*
EX-002A	2 mh	8	60*
EX-003A	3 mh	6.5	60
EX-005A	5 mh	11	47
EX-010A	10 mh	15.6	33
EX-020A	20 mh	35	23
EX-030A	30 mh	55	19
EX-050A	50 mh	62	14
EX-100A	100 mh	130	10
EX-200A	200 mh	139	6
EX-300A	300 mh	206	5
EX-400A	400 mh	310	4.5

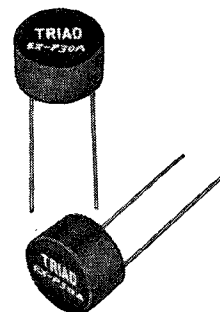

Prices subject to change without notice. Net prices shown for 1-9 quantity. For 1 to 249 pieces, see your stocking Triad Distributor for quantity discount schedule. For 250 or more pieces, contact your Triad Representative or call the factory.



TRIAD DISTRIBUTOR DIVISION

A DIVISION OF LITTON INDUSTRIES



PRICE INDEX BY TYPE NUMBER

Triad No.	Sugg'd Resale Price	Triad No.	Sugg'd Resale Price	Triad No.	Sugg'd Resale Price	Triad No.	Sugg'd Resale Price	Triad No.	Sugg'd Resale Price	Triad No.	Sugg'd Resale Price	Triad No.	Sugg'd Resale Price	Triad No.	Sugg'd Resale Price
A-1X	2.97	A-300X	5.55	D-56	8.07	D-157	10.35	D-611	7.93	EC-040A	6.33	EK-40000	8.44	ET-500A	7.70
A-3X	4.32	A-301X	5.13	D-57	9.15	D-158	4.88	D-612	7.80	EC-050	4.08	EK-40000A	11.74	ET-700	5.10
A-4X	4.15	A-302X	5.33	D-58	6.63	D-159	7.90	D-613	7.77	EC-050A	6.38	EM-001	3.92	ET-700A	7.70
A-5X	4.28	A-304X	5.95	D-59	7.35	D-160	8.55	D-614	8.34	EC-070	4.13	EM-001A	5.60	ET-1000	5.13
A-6X	3.25	A-305X	6.17	D-60R	6.43	D-161	7.50	D-615	6.68	EC-070A	6.63	EM-002	3.93	ET-1000A	7.75
A-7J	4.95	A-200P	15.00	D-61	5.55	D-162	7.80	D-616	7.82	EC-100	4.18	EM-002A	3.93	EX-P05A	8.10
A-9J	10.00	A-202P	20.85	D-62	5.82	D-163	6.62	D-617	8.40	EC-100A	6.92	EM-003	3.95	EX-P10A	8.10
A-10J	9.43	A-210P	10.86	D-63	6.40	D-164	7.28	D-618	10.20	EC-200	4.27	EM-003A	5.63	EX-P20A	8.10
A-11J	9.64	C-1X	2.35	D-64	7.50	D-165	7.41	D-619	8.00	EC-200A	6.72	EM-004	3.98	EX-P30A	8.10
A-12J	9.95	C-2X	2.07	D-65	9.25	D-166	6.45	D-620	6.50	EC-250	4.33	EM-004A	5.67	EX-P50A	8.10
A-13J	9.35	C-3X	2.75	D-66	9.60	D-167	9.92	D-621	7.80	EC-250A	6.80	EM-005	4.03	EX-001A	8.10
A-21X	3.53	C-4X	2.30	D-67	9.98	D-168	5.35	D-622	8.70	EC-300	4.40	EM-005A	5.73	EX-002A	8.10
A-23X	2.85	C-5X	3.28	D-68	10.15	D-169	8.40	D-623	8.40	EC-300A	6.95	EM-007	4.08	EX-003A	8.50
A-31X	3.90	C-6X	2.73	D-69	7.28	D-170	7.83	D-624	8.80	EC-400	4.50	EM-007A	5.75	EX-005A	8.50
A-33X	4.85	C-7X	3.48	D-70	8.40	D-171	7.33	D-625	6.82	EC-400A	6.93	EM-010	4.15	EX-010A	8.72
A-35A	6.18	C-8X	3.38	D-71	7.20	D-172	8.49	D-626	7.20	EC-500	4.60	EM-010A	5.80	EX-020A	8.72
A-39A	8.65	C-9X	2.90	D-72	8.27	D-173	8.73	D-627	7.90	EC-500A	6.93	EM-015	4.23	EX-030A	9.27
A-40J	9.82	C-10X	4.13	D-73R	8.57	D-174	8.75	D-628	7.68	EC-600	4.67	EM-015A	5.88	EX-050A	9.27
A-41J	9.24	C-11X	3.62	D-74	7.14	D-175	7.13	D-629	3.57	EC-600A	7.00	EM-020	4.30	EX-100A	9.89
A-42Z	5.13	C-12A	6.00	D-75	8.40	D-176	2.85	D-630	7.68	EC-700	4.75	EM-020A	5.95	EX-200A	10.55
A-50J	6.55	C-12X	4.32	D-76R	9.02	D-177	7.50	D-631	7.86	EC-700A	7.08	EM-025	4.38	EX-300A	10.77
A-51X	3.33	C-13X	4.55	D-77R	9.47	D-178	8.43	D-632	7.86	EC-1000	4.85	EM-025A	6.00	EX-400A	10.99
A-52J	6.80	C-14A	6.48	D-78	7.48	D-179	6.88	D-638	7.72	EC-1000A	7.25	EM-030	4.45	F-1X	3.55
A-53X	4.08	C-14X	4.75	D-79	7.57	D-180	7.88	D-639	7.00	EC-1500	4.90	EM-030A	6.17	F-3X	4.98
A-54X	2.73	C-15A	6.27	D-80	7.95	D-181	7.80	EA-001	3.28	EC-1500A	7.57	EM-040	4.50	F-5U	6.38
A-55J	9.47	C-15X	4.58	D-81	7.27	D-182	7.48	EA-001A	5.70	EC-2000	5.00	EM-040A	6.20	F-6X	4.62
A-57J	9.12	C-16A	8.25	D-82	9.32	D-183	7.50	EA-002	3.32	EC-2000A	7.65	EM-050	4.53	F-7X	4.00
A-58J	7.73	C-17X	3.77	D-83R	5.95	D-184	8.22	EA-002A	5.73	EC-3000	5.10	EM-050A	6.22	F-8X	5.22
A-61J	9.52	C-18A	9.80	D-84	9.35	D-185	8.70	EA-003	3.33	EC-3000A	7.97	EM-060	4.55	F-9A	9.97
A-64J	6.30	C-19A	12.30	D-85	9.44	D-186	7.80	EA-003A	5.75	EC-4000	5.18	EM-060A	6.25	F-9U	9.62
A-65J	9.69	C-20A	13.65	D-86	9.77	D-187	7.65	EA-004	3.35	EC-4000A	8.00	EM-070	4.60	F-10U	10.07
A-66J	8.65	C-21X	3.15	D-87	8.18	D-188R	7.88	EA-004A	5.77	EC-5000	5.25	EM-070A	6.27	F-11U	10.79
A-67J	9.77	C-22A	22.50	D-88	7.40	D-189	9.05	EA-005	3.37	EC-5000A	8.32	EM-100	4.65	F-12X	6.05
A-68J	9.07	C-23X	3.67	D-89R	9.55	D-190 Kit	7.95	EA-005A	5.78	EC-7000	5.35	EM-100A	6.33	F-13X	2.67
A-69J	8.34	C-24X	2.68	D-90	8.45	D-191	7.48	EA-007	3.37	EC-7000A	8.18	EM-150	4.73	F-14X	3.17
A-70J	6.45	C-25A	6.10	D-91	6.99	D-192	6.98	EA-007A	5.78	EC-10000	5.42	EM-150A	6.40	F-14Z	3.55
A-75J	5.85	C-26X	3.55	D-92	8.15	D-193	9.32	EA-010	3.38	EC-10000A	9.60	EM-200	4.83	F-15U	9.32
A-77J	8.39	C-27X	2.50	D-93R	8.30	D-194	7.20	EA-010A	5.80	EK-010	5.70	EM-200A	6.47	F-16X	3.98
A-78J	8.42	C-28X	3.57	D-94R	7.95	D-195	6.50	EA-015	3.40	EK-010A	8.90	EM-250	4.88	F-17U	12.94
A-79J	8.32	C-29X	3.80	D-95	7.20	D-196	6.57	EA-015A	5.90	EK-020	5.79	EM-250A	6.57	F-18A	7.05
A-81X	3.23	C-30X	3.00	D-96	9.57	D-197	6.33	EA-020	3.42	EK-020A	8.92	EM-300	4.93	F-18X	5.88
A-83X	3.75	C-31A	8.13	D-97R	10.30	D-198	9.45	EA-020A	5.92	EK-030	5.77	EM-300A	6.97	F-19X	6.15
A-85X	4.12	C-32AL	13.00	D-98R	10.57	D-199	7.35	EA-025	3.47	EK-030A	8.95	EM-400	4.98	F-20U	9.82
A-89A	8.55	C-33A	12.22	D-99	7.97	D-200	6.68	EA-025A	6.08	EK-040	5.82	EM-400A	6.72	F-21A	9.00
A-91A	8.45	C-34X	2.68	D-100	7.47	D-201	7.50	EA-030	3.47	EK-040A	9.00	EM-500	5.03	F-22A	12.50
A-95X	3.08	C-35A	13.98	D-101	7.90	D-202	7.43	EA-030A	6.08	EK-050	5.87	EM-500A	6.73	F-23U	7.77
A-96X	3.67	C-36X	2.42	D-102	7.65	D-203	7.58	EA-040	3.50	EK-050A	9.00	EM-700	5.10	F-24U	8.44
A-97K	4.28	C-38AL	24.73	D-103	8.80	D-204	7.92	EA-040A	6.12	EK-060	5.93	EM-700A	6.83	F-25X	3.75
A-97X	3.05	C-39A	23.34	D-104	6.30	D-205	8.00	EA-050	3.50	EK-060A	9.09	EM-1000	5.15	F-26X	4.15
A-97Y	4.70	C-40X	3.15	D-105	7.67	D-206	7.65	EA-050A	6.12	EK-080	5.98	EM-1000A	6.92	F-27U	13.82
A-97Z	3.38	C-42AL	12.62	D-106	7.33	D-207	7.92	EA-070	3.57	EK-080A	9.24	ET-001	4.47	F-28U	18.07
A-98K	5.10	C-43X	4.77	D-107	8.44	D-208	6.88	EA-070A	6.18	EK-100	5.92	ET-001A	6.83	F-29U	12.51
A-98X	2.68	C-45AL	30.74	D-108	10.20	D-209	9.32	EA-100	3.62	EK-100A	9.45	ET-002	4.50	F-30A	9.97
A-99X	4.65	C-47U	7.60	D-109	6.90	D-210	6.67	EA-100A	6.23	EK-120	6.13	ET-002A	6.92	F-32A	7.02
A-101U	6.00	C-48U	9.55	D-110	8.28	D-211	7.77	EA-150	3.75	EK-120A	9.40	ET-003	4.52	F-34A	8.67
A-102X	4.07	C-49U	14.69	D-111	8.10	D-212	7.85	EA-150A	6.50	EK-150	6.20	ET-003A	6.93	F-36A	11.39
A-103X	3.93	C-50X	6.53	D-112	8.62	D-213	7.86	EA-200	3.80	EK-150A	9.55	ET-004	4.53	F-38A	11.94
A-104X	4.73	C-56U	3.90	D-113	8.57	D-214	7.57	EA-200A	6.55	EK-200	6.27	ET-004A	6.97	F-40X	3.38
A-105X	3.93	C-57U	6.05	D-114	9.35	D-215	8.34	EA-250	3.83	EK-200A	9.55	ET-005	4.57	F-41X	4.82
A-107X	5.68	C-58U	8.53	D-115R	7.17	D-216	8.94	EA-250A	6.58	EK-250	6.40	ET-005A	7.00	F-42A	7.40
A-108X	4.52	C-59U	9.63	D-116	10.94	D-217	7.33	EA-300	3.88	EK-250A	9.74	ET-007	4.60	F-43X	4.38
A-109X	4.82	C-60U	17.12	D-117	7.02	D-218	8.94	EA-300A	6.63	EK-300	6.57	ET-007A	7.03	F-44X	3.73
A-110X	4.08	C-80U	36.97	D-118R	8.40	D-219	6.67	EA-400	3.97	EK-300A	9.85	ET-010	4.62	F-45X	3.77
A-111X	3.98	CE-1	9.92	D-119	8.18	D-220	6.87	EA-400A	6.78	EK-400	6.70	ET-010A	7.08	F-46X	3.87
A-112X	4.43	CE-4	11.50	D-120	7.30	D-221	8.50	EA-500	4.08	EK-400A	10.00	ET-015	4.63	F-47U	8.07
A-113X	4.27	CE-5	10.85	D-121	7.72	D-222	9.02	EA-500A	6.83	EK-500	6.77	ET-015A	7.10	F-48U	9.97
A-113Z	3.43	CL-1	.60	D-122	7.30	D-223	11.10	EA-6000	4.17	EK-500A	10.07	ET-020	4.65	F-49U	16.39
A-114X	4.90	D-2	6.90	D-123	7.88	D-224	10.35	EA-600A	6.92	EK-700	6.85	ET-020A	7.17	F-50X	5.35
A-115X	4.35	D-11	10.22	D-124	6.67	D-225	9.40	EA-700	4.25	EK-700A	10.17	ET-025	4.70	F-51X	5.68
A-115Z	3.40	D-14R	7.80	D-125	7.62	D-226	9.00	EA-700A	7.00	EK-1000	7.15	ET-025A	7.20	F-52X	4.15
A-116X	3.82	D-19	9.01	D-126	9.87	D-227	8.40	EA-1000	4.35	EK-1000A	10.24	ET-030	4.73	F-53X	5.48
A-117X	4.08	DA-20	4.75	D-127	7.44	D-228	8.32	EA-1000A	7.10	EK-1500	7.05	ET-030A	7.25	F-54X	4.87
A-118X	4.53	D-22	7.80	D-128	2.53	D-229	7.73	EC-001	3.60	EK-1500A	10.37	ET-040	4.80	F-55X	5.15
A-119X	5.20	D-27	7.82	D-129	6.82	D-230	8.33	EC-001A	5.72	EK-2000	7.08	ET-040A	7.37	F-60U	7.10
A-120X	3.05	D-28	6.57	D-130R	6.47	D-231	6.00	EC-002	3.63	EK-2000A	10.44	ET-050	4.85	F-61U	10.17
A-120Z	2.83	D-33	7.14	D-131	9.58	D-232	5.23	EC-002A	5.68	EK-2500	7.15	ET-050A	7.43	F-62U	25.24
A-122X	2.72	DA-36	3.77	D-132	7.77	D-233	5.12	EC-003	3.67	EK-2500A	10.54	ET-060	4.90	F-63U	7.05
A-122Z	2.72	DA-37	2.49	D-133	9.										

TRIAD DISTRIBUTOR DIVISION



A DIVISION OF LITTON INDUSTRIES



PRICE INDEX BY TYPE NUMBER

Triad No.	Sugg'd Resale Price	Triad No.	Sugg'd Resale Price	Triad No.	Sugg'd Resale Price	Triad No.	Sugg'd Resale Price	Triad No.	Sugg'd Resale Price	Triad No.	Sugg'd Resale Price	Triad No.	Sugg'd Resale Price		
F-92A	7.73	G-65	17.40	HSM-186	30.02	HS-474	31.77	N-55M	22.67	R-6A	8.03	R-81BS	32.09	S-10X	2.87
F-93X	5.48	G-72	21.20	HSM-187	44.43	HS-475	35.92	N-56M	39.17	R-6B	7.95	R-82B	13.93	S-11X	2.45
F-94X	3.72	G-80	31.32	HSM-189	43.14	JAF-1	16.25	N-57M	52.33	R-7A	8.22	R-83A	18.59	S-11Z	2.45
F-102X	6.33	G-84	21.20	HSM-190	45.19	JAF-2	15.33	N-59M	56.95	R-7B	8.13	R-84K	6.15	S-12X	2.37
F-104U	8.65	G-85	21.20	HSM-193	45.04	JAF-3	16.25	N-60SC	119.17	R-8A	8.65	R-85A	15.99	S-12Z	2.38
F-105Z	4.17	G-101	26.22	HSM-200	18.20	JAF-5	16.25	N-62AC	54.30	R-8B	8.57	R-86BA	12.48	S-13X	2.48
F-106Z	5.05	G-101TS	32.67	HSM-201	23.09	JAF-11	16.25	N-64AC	30.22	R-9A	10.15	R-87BC	16.62	S-13Z	2.58
F-107Z	7.50	G-135	24.02	HSM-202	17.79	JAF-12	16.25	N-66A	17.95	R-9B	10.05	R-88A	17.92	S-14Z	2.47
F-108U	9.97	G-150	19.60	HSM-203	26.34	JAF-13	16.25	N-67A	11.55	R-10A	10.09	R-89BC	17.60	S-15X	3.27
F-109U	17.89	G-183	29.41	HSM-205	33.87	JAF-14	16.25	N68X	5.88	R-10B	10.00	R-90BC	18.10	S-16X	2.28
F-113X	3.12	G-201	19.60	HSM-207	36.24	JAF-15	14.57	N-73A	11.28	R11A	10.77	R-91HA	17.82	S-17X	2.43
F-114X	4.30	G-202	26.21	HSM-208	44.49	JAF-21	16.25	N-74A	11.67	R-11B	10.70	R-92A	18.15	S-18X	2.33
F-115X	3.85	G-235	24.17	HSM-212	47.43	JAF-22	16.25	N-469A	7.35	R-12A	9.64	R-93A	16.17	S-18Z	2.35
F-116X	4.12	G-250	22.19	HSM-216	54.64	JAF-23	16.25	N-470A	10.62	R-12B	9.64	R-94H	26.11	S-19Z	4.22
F-117X	4.42	G-255	23.10	HSM-218	78.78	JAF-24	16.25	N-471A	16.92	R-14A	12.67	R-104A	6.00	S-20X	2.40
F-118X	3.87	G-266	26.61	HSM-219	72.53	JAF-25	16.25	NW-1	.60	R-14B	12.67	R-104B	6.02	S-20Z	2.40
F-119X	4.12	G-274	26.17	HSM-223	11.62	JAF-26	16.25	NW-2	.72	R-16A	13.87	R-105A	6.90	S-21A	4.72
F-120X	3.85	G-283	24.92	HSM-224	19.94	JAF-31	16.25	NW-3	.78	R-16B	13.87	R-105B	6.90	S-21Z	4.05
F-200A	7.22	G-284	24.57	HSM-225	22.47	JAF-32	16.25	NW-4	.78	R-17A	15.27	R-106A	7.28	S-22A	7.13
F-202U	7.23	G-285	20.00	HSM-226	19.00	JAF-33	16.49	NW-5	.78	R-18A	16.13	R-106B	7.33	S23X	2.37
F-203U	8.89	G-286	25.15	HSM-227	22.42	JAF-34	16.25	NW-6	.72	R-18B	15.92	R-107A	7.60	S-24A	6.77
F-204U	13.10	G-301	20.82	HSM-228	26.66	JAF-35	16.25	NW-7	.60	R-19A	16.45	R-107B	7.60	S-25Z	3.98
F-205U	16.67	G-306	21.40	HSM-229	24.25	JAF-101	16.25	NW-10	.60	R-20A	15.95	R-108A	7.82	S-26X	2.50
FL-381	43.90	G-309	63.89	HSM-230	17.35	JAF-102	16.25	NW-14	.78	R-20B	15.64	R-108B	7.73	S-27A	6.05
FL-384	62.25	G-310	49.87	HSM-231	25.39	JO-1	12.84	NW-18	.60	R-21A	17.28	R-109A	7.38	S-28X	4.72
FL-385	61.42	G-313	21.77	HSM-232	33.14	JO-2	12.84	NW-19	.60	R-21B	17.00	R-109B	7.38	S-29X	4.77
FL-386	61.42	G-315	21.57	HSM-233	18.97	JO-3	12.84	NW-21	.67	R-22A	7.90	R-110A	8.65	S-30X	2.67
FL-387	61.42	G-335	20.00	HSM-234	37.61	JO-5	12.84	NW-22	.82	R-22B	7.80	R-110B	8.65	S-31A	8.67
FL-388	63.62	G-336	19.74	HSM-235	50.43	JO-11	12.84	NW-23	.72	R-23B	6.45	R-111A	8.95	S-32A	8.82
FL-389	41.39	G-350	18.91	HSM-236	23.15	JO-12	12.84	NW-24	.72	R-24A	19.65	R-111B	8.95	S-34X	4.73
FL-404	39.00	G-355	18.72	HSM-237	16.49	JO-13	12.84	NW-25	.67	R-24B	19.65	R-112A	9.15	S-35A	10.27
FL-405	39.00	G-388	16.34	HSM-238	30.19	JO-21	12.84	P-1A	9.10	R-25A	34.01	R-112B	9.15	S-36A	9.32
FL-406	39.00	G-391	18.91	HSM-239	18.67	JO-22	12.84	P-3A	11.02	R-26A	22.29	R-113A	7.57	S-37X	4.43
FL-407	39.00	G-394	14.02	HSM-240	21.77	JO-23	12.84	P-5A	14.47	R-27A	41.21	R-113B	7.57	S-38X	2.15
FL-408	39.00	G-401	19.60	HSM-241	44.83	JO-31	12.84	P-7A	15.40	R-28A	30.09	R-114A	9.95	S-38Z	2.15
FL-409	39.00	G-435	23.89	HSM-245	53.51	JO-101	12.84	P-9A	27.87	R-29A	5.92	R-114B	9.95	S-39X	2.40
FL-410	39.00	G-435TS	25.85	HS-247	70.53	JZ-1	10.83	P-11A	13.98	R-30X	5.45	R-115A	8.50	S-40X	3.48
FL-411	39.00	G-437	23.52	HSM-248	29.18	JZ-5	10.83	P-14A	21.50	R-35A	19.09	R-115B	8.50	S-41X	2.30
FL-412	39.00	G-455	23.07	HSM-249	15.25	JZ-7	10.83	P-15AL	25.22	R-37BC	25.57	R-116A	11.07	S-41Z	2.05
FL-413	39.00	G-500	34.44	HSM-250	17.60	JZ-13	10.83	P-17AL	25.22	R-38A	23.59	R-116B	11.07	S-42A	15.19
FL-414	39.00	G-501	32.84	HSM-251	24.27	JZ-15	10.83	P-18AL	49.48	R-38BC	20.45	R-118A	13.00	S-43Z	4.20
FL-415	42.00	G-502	35.84	HSM-252	31.16	JZ-25	10.83	P-20AL	48.62	R-39A	18.05	R-118B	13.00	S-44Z	5.40
FL-416	42.00	GF-600	36.84	HSM-253	47.06	K-20 Kit	6.98	PR-21AL	50.67	R-39BC	18.90	R-120A	12.75	SR-45Z	6.40
FL-417	42.00	GF-601	47.87	HSM-254	67.46	K-100	25.00	P-213AL	19.50	R-40BC	26.07	R-120B	12.75	S-46A	9.67
FL-418	42.00	GF-602	33.25	HSM-270	26.04	K-101	28.25	P-215AL	21.65	R-41C	15.97	R-121A	14.85	S-47Z	4.03
FL-419	42.00	HC-115	29.25	HSM-271	33.87	K-102	37.70	P-216AL	43.32	F-42BC	14.49	R-121B	14.85	S-48X	2.00
FL-429	42.00	HC-300	38.10	HSM-272	48.19	K-103	55.60	P-217AL	24.67	R-43C	12.49	R-122A	17.15	S-48Z	2.00
FL-421	42.00	HS-1	25.27	HS-273P	19.65	K-104	87.00	P-218AL	48.30	R-45C	14.99	R-123HA	16.47	S-49X	2.12
G-2	33.61	HS-3	31.92	HSM-301	21.10	K-105	102.95	P-220AL	43.33	R-46A	28.51	R-124BC	13.84	S-50X	2.27
G-2H3	23.65	HS-4	28.40	HSM-302	12.44	K-106	144.65	PL-4	10.35	R-49BC	22.90	R-125BC	16.15	S-51X	3.57
G-4	33.44	HS-5	22.00	HS-303	14.49	KA-1	2.50	PL-5	12.13	R-49BS	21.27	R-126A	15.44	S-52X	4.38
G-7	31.77	HS-8	28.58	HSM-305	16.95	KA-2	2.50	PL-6	12.13	R-50A	26.06	R-127A	16.14	S-53X	4.10
G-7	31.69	HS-11	19.05	HSM-307	22.65	KA-3	3.25	PL-10	1.78	R-50BC	24.60	R-128BC	17.34	S-54X	4.52
G-8	39.22	HS-14	25.59	HSM-309	21.82	M-1X	3.48	PL-80E	10.94	R-51BC	22.19	R-129BC	19.00	S-55X	5.45
G-10	39.99	HS-15	31.92	HSM-315	23.59	M-3X	5.77	PL-80H	12.14	R-52BC	17.15	R-131A	24.25	S-55Z	5.45
G-12	27.84	HS-23	22.87	HSM-319	33.87	M-4Z	4.17	PL-81E	11.47	TR-53Z	3.55	R-132BC	15.55	S-56Z	5.27
G-14	19.60	HS-25	26.22	HS-331	9.37	M-5Z	4.11	PL-81H	12.25	R-54X	2.72	R-133A	17.15	S-57Z	5.93
G-17	30.84	HS-27	24.72	HS-333	10.67	M-6X	4.77	PL-81P	11.67	R-56A	6.55	R-134A	16.40	S-58X	3.18
G-18	23.49	HS-29	25.92	HS-335	14.20	M-7AL	11.22	PL-82E	11.39	R-58A	18.39	R-135BC	18.14	S-59Z	5.72
G-18TS	24.40	HSM-31	27.33	HS-339	16.50	M-8AL	14.77	PL-82H	12.69	R-59A	18.87	R-136BC	15.84	S-60A	10.24
G-19	25.11	HS-32	26.84	HS-341	17.75	M-12AL	22.15	PL-82P	12.02	R-60BC	20.39	R-138A	15.74	S-61Z	5.93
G-19TS	24.53	HS-35	19.51	HS-347	17.50	M-15A	9.05	PL-83E	12.17	R-61BC	22.29	R-200A	16.20	S-62X	4.17
G-20	37.51	HS-50	25.29	HS-400	15.34	M-16AL	11.34	PL-83H	12.92	R-62BC	28.42	R-201A	15.82	S-63X	3.52
G-21	31.69	HS-52	26.27	HS-401	23.17	MB-20	.72	PL-83P	12.27	R-63BC	16.15	R-202A	15.07	S-64X	2.80
G-21TS	38.67	HS-54	25.71	HS-402	15.96	MK-1	3.58	PL-84E	11.82	R-64BC	18.19	R-203A	14.15	S-65X	2.57
G-22	38.12	HS-56V	30.19	HS-404	26.47	MK-2	3.58	PL-84H	13.07	R-64BC	18.19	R-204A	14.87	S-66X	2.85
G-22H	25.85	HS-58	36.64	HS-405	28.56	MK-3	4.42	PL-84P	12.42	R-65BC	17.24	R-205A	14.27	S-67X	2.77
G-23	31.22	HS-60	19.32	HS-407	34.32	MK-4	4.42	PL-124E	11.39	R-66BC	18.59	R-206B	10.48	S-68Z	3.78
G-24	33.34	HS-61	20.64	HS-409	30.87	N-1X	4.10	PL-124H	12.77	R-67BC	16.15	R-208A	8.42	S-69Z	5.35
G-25	31.11	HS-66	25.71	HS-413	34.82	N-3M	8.90	PL-139E	9.80	R-68A	9.77	R-300A	19.00	S-70Z	3.63
G-25TS	38.22	HS-71	14.10	HS-415	47.21	N-4M	10.20	PL-139H	10.88	R-69BC	17.37	R-675A	19.00	S-71Z	5.10
G-30	18.00	HS-73	16.75	HS-417	49.44	N-5M	13.30	PL-139M	11.75	R-70A	11.97	S-1X	2.70	S-72Z	4.20
G-31	25.69	HS-77	21.20	HS-425	16.34	N-7M	22.72	PL-140E	11.39	R-71A	18.94	S-2X	2.45	S-73X	4.00
G-32	32.74	HSM-79	22.89	HS-427	21.19	N-9M	50.10	PL-140H	12.77	R-72A	12.20	S-3X	2.60	SR-74K	6.45
G-33	30.79	HSM-80	24.45	HS-433	23.34	N-11M	56.55	PL-140M	13.85	R-73B	8.64	S-4X	2.98	S-76Z	5.23
G-36</															



A DIVISION OF LITTON INDUSTRIES



TRIAD DISTRIBUTOR DIVISION

PRICE INDEX BY TYPE NUMBER

Triad No.	Sugg'd Resale Price	Triad No.	Sugg'd Resale Price	Triad No.	Sugg'd Resale Price	Triad No.	Sugg'd Resale Price	Triad No.	Sugg'd Resale Price	Triad No.	Sugg'd Resale Price	Triad No.	Sugg'd Resale Price	Triad No.	Sugg'd Resale Price
S-144A	15.24	SP-106	7.07	T-42X	3.90	TY-51X	4.50	TY-92	15.50	WLC-10	1.59	Y-22	8.42	Y-70-1	9.49
S-146A	15.78	SP-107	5.98	T-101X	4.02	TY-52X	5.63	TY-93	24.77	WLC-11	2.05	Y-22-1	9.09	Y-72-1	10.09
S-148A	15.35	SP-108	6.22	T-102X	2.77	TY-53X	4.20	TY-94	22.64	WLC-12	1.38	Y-22-3	9.07	Y-81-3	11.62
S-149A	18.35	SP-117	6.28	TY-1XT	3.82	TY-54X	5.22	TY-99	15.10	WLC-17	1.41	Y-24	9.74	Y-83-1	9.92
S-152A	19.77	SP-118	6.02	TY-2Z	4.13	TY-55X	5.22	TY-100	23.95	WLC-21	1.33	Y-24-3	7.00	Y-82-1	9.59
S-154A	21.57	SP-128	5.93	TY-3XT	3.73	TY-56X	3.77	TY-101	19.39	WLC-23	1.33	Y-25	5.83	YC-1	.82
S-156A	16.50	SP-310	.84	TY-4XT	3.18	TY-57X	4.07	TY-102	19.75	WLC-25	1.52	Y-25-1	6.45	YC-110	1.17
S-158A	25.54	SX-201	7.44	TY-16XT	1.67	TY-58X	3.78	TY-158	4.88	WLC-26	1.62	Y-25-3	6.33	YC-111	1.17
SP-4	10.50	SX-202	7.41	TY-17XT	2.32	TY-59X	6.73	TY-159X	4.93	WLC-29	1.85	Y-26-2	8.67	YC-112	1.17
SP-5	9.95	SX-203	7.26	TY-23X	5.57	TY-60X	6.32	TY-160X	5.47	WLC-30	1.68	Y-28	7.97	YC-300-1	22.50
SP-7	9.52	SX-204	7.44	TY-24X	5.42	TY-61X	3.49	TY-200X	7.57	WLC-31	1.88	Y-28-3	8.37	YC-310-2	18.33
SP-11	8.27	SX-205	7.50	TY-25X	6.17	TY-62X	4.32	TY-201TZ	5.32	Y-12	6.52	Y-30G	8.94	YC-311-2	19.51
SP-13	9.07	SX-206	7.59	TY-26X	9.17	TY-63X	4.83	TY-202X	5.77	Y-12-1	7.68	Y-31G	9.24	YC-312-2	19.28
SP-15	8.99	SX-207	7.62	TY-27XT	4.22	TY-64X	4.95	TY-462	16.64	Y-12-3	7.23	Y-40	8.32	YT-101	8.91
SP-20	8.72	SX-208	7.50	TY-28XT	4.67	TY-65Z	4.52	TY-468	13.35	Y-17	7.77	Y-40-3	8.80	YT-102-2	9.09
SP-21	8.77	T-1X	4.35	TY-29X	4.95	TY-66A	10.22	TZ-1	6.05	Y-17-1	6.05	Y-41	7.63	YT-103-1	10.00
SP-22	9.10	T-1X	5.30	TY-29X	4.95	TY-67A	9.89	TZ-2XT	6.38	Y-17-2	8.65	Y-41-2	9.37	YT-106-2	9.80
SP-29	8.49	T-2X	5.27	TY-30X	3.32	TY-68S	7.52	TZ-5	8.07	Y-17-3	8.54	Y-41-3	8.87	YT-107-2	9.80
SP-32	6.87	T-3X	5.27	TY-31X	3.25	TY-69S	9.49	TZ-7	4.75	Y-19	8.03	Y-42-2	8.73	13125	4.90
SP-33	7.10	T-5X	4.32	TY-32X	3.77	TY-70S	10.10	TZ-13	6.37	Y-19-1	6.82	Y-44	8.75	13500-1	6.60
SP-34	6.55	T-11X	4.57	TY-33X	3.72	TY-71S	10.20	TZ-15	4.62	Y-19-3	8.22	Y-44-1	9.39	13500-2	8.20
SP-35	6.65	T-12X	5.32	TY-34X	3.60	TY-74S	8.94	TZ-17XT	5.07	Y-20	7.78	Y-45	9.15	13510	6.60
SP-42	7.28	T-13X	5.08	TY-35X	3.17	TY-75A	16.54	TZ-24XT	5.80	Y-20-2	8.90	Y-45-2	9.90	13510-2	8.20
SP-47	7.70	T-14X	4.00	TY-36X	3.57	TY-76A	10.67	TZ-25	5.25	Y-20-3	8.20	Y-46	5.95	13511	14.25
SP-48	7.78	T-15X	4.12	TY-37X	4.47	TY-77X	14.72	TZ-26	4.65	Y-21	8.50	Y-46-3	7.57	13540	6.60
SP-49	7.48	T-20X	4.35	TY-38X	4.30	TY-79	14.72	TZ-28	4.08	Y-21-1	8.90	Y-47	5.98	13541	6.60
SP-50	7.62	T-21X	4.17	TY-39X	5.15	TY-80	15.94	VR-30Z	4.15	Y-21-3	7.05	Y-48	6.40	13542	6.60
SP-51	7.67	T-22X	4.00	TY-40X	4.18	TY-81	15.19	V-31	4.47	Y-48-3	4.72	Y-48-3	7.48	13543	6.60
SP-52	7.98	T-23X	4.68	TY-41X	5.13	TY-82	14.72	V-31K	6.96	Y-49	4.87	Y-49	7.68	13544	6.60
SP-53	7.23	T-24X	3.98	TY-42X	4.97	TY-83	21.17	WC-13	1.32	Y-60R	3.53	Y-60R	9.29	13545	6.60
SP-54	7.27	T-25X	4.03	TY-43X	4.88	TY-84	21.57	WLC-3	1.33	Y-60-1	5.23	Y-60-1	9.29	13546	6.60
SP-55	7.50	T-26X	3.73	TY-44X	4.08	TY-85	22.94	WLC-4	1.32	Y-60-2	5.93	Y-62	11.49	13600	9.20
SP-56	7.50	T-31X	4.20	TY-45X	4.12	TY-86	21.80	WLC-5	1.33	Y-62	9.19	Y-62	8.59	13600-2	11.50
SP-66	8.48	T-32X	3.35	TY-46X	3.03	TY-87	22.50	WLC-6	1.32	Y-64	5.50	Y-64-1	9.15	13750	3.92
SP-67	7.55	T-33X	4.90	TY-47X	4.55	TY-88	13.02	WLC-7	1.35	Y-64-2	6.65	Y-64-2	9.35	13800	1.40
SP-68	8.90	T-34X	3.38	TY-48X	4.02	TY-89	12.82	WLC-8	1.80	Y-66-1	8.34	Y-66-1	9.29	13801	1.40
SP-69	8.50	T-35X	3.98	TY-49X	3.98	TY-90	16.10	WLC-8A	1.80	V-23K	8.34	Y-70	8.94		
SP-70	6.95	T-41X	4.62	TY-50X	7.13	TY-91	15.37	WLC-9	1.88	V-23Z	5.67				

† New item.

■ Discontinued item. Available until supply is exhausted

TRIAD CASES

GB	HA	HB	JA	JB	KA	KB	LA	LB	MA	MB	NA	NB	AH	AJ	EA	EB	FA	FB	GA		
A	2 3/8	2 5/8	3 1/8	3 3/8	3 5/8	3 7/8	A	3 1/8	3 3/8	4	4	4 5/8	4 7/8	A	1 3/8	1 5/8	1 7/8	1 9/8	2 1/8	2 3/8	2 5/8
B	2 3/4	3 1/8	3 3/8	3 5/8	3 7/8	3 9/8	B	4 3/8	4 5/8	4 7/8	4 9/8	5 1/8	5 3/8	B	1 3/8	1 5/8	1 7/8	1 9/8	2 1/8	2 3/8	2 5/8
C	2 1/2	4 1/4	3 3/8	4 7/8	3 7/8	5 1/4	C	5 3/8	4 1/2	6	4 7/8	6 1/8	5 1/2	C	1 3/4	2 3/8	2 3/4	2 7/8	3 1/8	2 1/2	3 1/8
D	2 1/8	2 1/4	2 1/4	2 5/8	2 5/8	3	D	3 3/8	3 5/8	3 7/8	3 9/8	4 3/8	4 5/8	D	1 1/4	1 3/8	1 3/8	1 3/8	1 7/8	1 7/8	2 1/8
E	1 3/4	1 5/8	1 5/8	2 1/8	2 1/8	2 1/8	E	2 1/8	2 1/8	3	3	3 3/8	3 5/8	E	1 3/8	1 1/4	1 1/4	1 1/4	1 3/8	1 3/8	1 3/4
G	3/8	3/8	3/8	3/8	3/8	1/2	G	1/2	1/2	5/8	5/8	5/8	5/8	G	3/8	3/8	3/8	3/8	3/8	3/8	3/8
I	6-32	8-32	8-32	8-32	8-32	10-32	I	10-32	10-32	1/4-20	1/4-20	1/4-20	1/4-20	I	6-32	6-32	6-32	6-32	6-32	6-32	6-32
Wt. (avg.) lbs.	1 3/4	2 1/2	2 1/4	4 1/2	4	7 3/4	Wt. (avg.) lbs.	9 1/4	8 1/2	13 1/2	12 1/2	18	16	Wt. (avg.) lbs.	4 oz.	9 oz.	1	15 oz.	1 3/4	1 1/2	2

	AF	AG	AH-2	AJ-2	JZ†
A	3/4	1	1-5/16	1-5/8	9/16 dia.
B	3/4	1	1-5/16	1-5/8	Round
†*Bw	1-3/64	1-3/32	1-11/32		
C	1-1/8	1-3/8	1-3/4	2-3/8	25/32
D	*27/32	*1-1/32	*1-11/32	*1-5/8	
F	5/8	3/4	7/8	7/8	
I	4/40	6/32	6/32	6/32	
Unit	1-1/4	2-1/2	5-1/4	11	.5
Wt.	oz.	oz.	oz.	oz.	oz.

	GP-1	GP-2	GP-3	GP-4	GP-5
A	7/8	1 1/8	1 1/4	1 3/8	1 5/8
B	1 1/8	1 1/4	1 1/2	1 3/4	2
Bw	1 1/8	1 1/8	1 1/8		
C	1 1/8	2 1/4	2 3/8	2 1/2	2 3/4
D	1 3/8	1 3/8	1 3/8	1 1/2	1 1/2
F	3/4	3/4	1 1/8	1 1/8	1 1/8
Wt.	3 oz.	5 1/2 oz.	8 oz.	12 oz.	17 oz.

	JOA	JOB
A	1 1/8 dia.	1 1/8 dia.
B	Round	Round
C	1 1/32	1 1/32
D	3/8	3/8
F	7/8	7/8
Unit Wt.	2 oz.	2 1/2 oz.

* Not in conformance with MIL-T-27A.
† Not in conformance with MIL-T-27

SHIELDING

- P-1—One nickel alloy high permeability shield — 45db. reduction in pickup.
- P-3—Two nickel alloy shields interleaved with one heavy copper shading ring — 70db. reduction in pickup.
- P-5—Three nickel alloy shields interleaved with two heavy copper shading rings— 95 db. reduction in pickup.

Prices subject to change without notice. Net prices shown for 1-9 quantity. For 1 to 249 pieces, see your stocking Triad Distributor for quantity discount schedule. For 250 or more pieces, contact your Triad Representative or call the factory.



NEW TRANSFORMERS & FILTERS

AUDIO TRANSFORMERS

DO-T200* SERIES, ULTRAMINIATURE PLUG-IN TRANSISTORS TRANSFORMERS

Manufactured and successfully tested to complete environmental requirements of MIL-T-27B. Most Ruggedized MIL Structure. Grade 4, Metal Encased. MIL type TF4RX13YY, TF4RX16YY. Immediate Delivery From Stock. Full Conformance to MIL Mounting Requirements. Solderable and Weldable Leads. Hermetically Sealed. Straight Pin Terminals. Excellent Response. High Efficiency. Low Distortion. Leads are 7/8" long, .016 Dumet wire, gold plated, and may be either welded or soldered. They are uninsulated and are spaced on a 1/4" radius circle. In pulse coupling impedance matching applications (when measured with a 30 microsecond input pulse voltage wave), typical values for these transformers are: 5% or less droop, zero overshoot, and less than 10% backswing. Also see below and pages 3 & 4 for other DO-T family constructions.

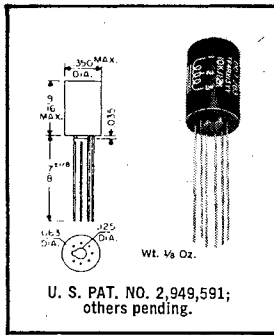

Type No.	Pri. Imp.	D.C. ma.± in Pri.	Sec. Imp.	Application	Suggested Net Price
DO-T255	1000 CT 1200 CT	3 3	50 60	Output or matching	\$6.90
DO-T275	10,000 CT 12,000 CT	1	1500 CT 1800 CT	Interstage	7.80
DO-T277	10,000 CT 12,000 CT	1	2000 split 2400 split	Interstage	8.70
DO-T278	10,000 12,500	1	2000 CT 2500 CT	Driver	8.70
DO-T283	10,000 CT 12,000 CT	1	10,000 CT 12,000 CT	Isolation or Interstage (Ratio 1:1) also pulse appl.	8.70
DO-T288	20,000 CT 30,000 CT	.5 .5	800 CT 1200 CT	Interstage	8.70
DO-T297	200,000 CT	0	1000 CT	Input and Chopper	10.80
DO-T200SH	Drawn Hipermalloy shield provides 15 to 20 db shielding through side of case				.75

±DCma shown is for single ended usage. For push pull, DCma can be any balanced value taken by .5W transistors. Where windings are listed as split, 1/4 of the listed impedance is available by paralleling the winding.

DO-T*, DI-T* TRANSFORMERS

Designed, manufactured and successfully tested to complete MIL-T-27B specifications. See page 4 for size and weight and complete DO-T, DI-T line. Also above and page 3 for other DO-T family constructions. These units can be used for pulse coupling impedance matching applications. All U.S. Pat. No. 2,949,591; others pending.

Type No.	Pri. Imp.	D.C. ma.± in Pri.	Sec. Imp.	Typical Application	Suggested Net Price
DO-T53	400 CT 500 CT	8 6	4K CT 5K CT	Input or driver	\$7.80
DO-T54	40K CT 50K CT	.25 .25	4K CT 5K CT	Interstage or isol.	8.70
DI-T53	400 CT 500 CT	8 6	4K CT 5K CT	Input or driver	7.80

±DCma shown is for single ended usage. For push pull, DCma can be any balanced value taken by .5W transistors.

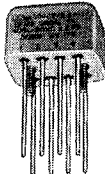

SUBMINIATURE TRANSFORMERS

Designed, manufactured and successfully tested to complete MIL-T-27B specifications. See page 7 for size and weight of FH units, also listings of other FH & H hermetic audio units. These units have straight pin terminals for welding or printed circuit use. Response ±2 db from 300 to 20KC. Level +17 dbm; 50 mw.

Type No.	Application	MIL Type	Pri. Imp. Ohms	Sec. Imp. Ohms	Unbal. DC ma Price	Sugg. Net Price
FHA-5	Transistor Input	TF4RX17YY	500/125 split	5K/1250 split	12	\$8.10
FHA-10	Transistor Intrstg or Isol	TF4RX13YY	5000/1250 split	5K/1250 split	4	8.10

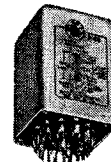

ULTRA-COMPACT "A" LINE TRANSFORMERS

Newly added to the line of high quality industrial type transformers. See page 11 for complete listing of Ultra-Compact transformers. Application: "2 wire to 4 wire" hybrid circuit. Two transformers in one case for hybrid circuit use. Frequency response: 40-20KC ±2 db. Level: +10dbm, 10 mw. Includes 60 db minimum circuit isolation.

Type No.	Pri. Imp. Ohms	Unbal. DC	Sec. Imp. Ohms	Suggested Net Price
A-48	500/600	0	500/600 } 2 wdgds. plus winding for balance loading	\$18.00

400 CYCLE POWER TRANSFORMERS

UNIVERSAL TRANSISTOR SUPPLY TRANSFORMERS

Designed, manufactured and successfully tested to complete MIL-T-27B specifications. Units are in drawn MIL metal cases. The MET-495 (MIL type TF4SX02A) is in a MIL AJ case: 1 1/2" x 1 1/2" x 2 3/4" h, wt. 2 1/2 lbs. The MET-445 (MIL type TF4SX02AH) is in a MIL AH case: 1 1/2" x 1 1/2" x 1 3/4" h, wt. 3/8 lbs. For full line of MET type universal transistor supply transformers see page 5.

MET-495 Pri. 115 Volts, 400 Hz Nom. Sec. V, 16.5 to 81
MET-445 115 Volts, 400 Hz Nom. Sec. V, 8.25 to 40.5

TYPE NO.	MIL DC RANGE	INDUST. DC RANGE	Suggested Net Each
MET-495	12V-.6A to 106V-.2A	12V-.76A to 106V-.24A	\$15.00
MET-445	6V-.6A to 53V-.2A	6V-.75A to 53V-.24A	13.50

ISOLATION TRANSFORMERS

Units designed, manufactured and successfully tested to complete MIL-T-27B specifications. These units are metal encased to MIL Grade 4, Class S, Life X. ELECTROSTATICALLY SHIELDED. See page 5 for complete line of MET type transformers.

Type No.	MET-400	MET-405
Primary	105/115/125 380-1000 Hz	105/115/125 380-1000 Hz
Secondary	1) 115VCT-.06A 2) 115VCT-.06A	1) 115VCT-.2A 2) 115VCT-.2A
Series Con.	230V-.06A	230VCT-.2A
Parallel Con.	115V-.12A	115VCT-.4A
MIL Type	TF4SX03AH	TF4SX01EA
Base	1 1/2" x 1 1/2"	1 1/2" x 1 1/2"
Height	1 3/4"	2 3/4"
Weight	3/8 lbs.	1 lb.
Suggested Net Price	\$13.50	\$14.70

MOLDED ISOLATION & SUPPLY TRANSFORMERS

Designed, manufactured and successfully tested to complete MIL-T-27B specifications. These units are vacuum molded to MIL Grade 5. Units are ELECTROSTATICALLY SHIELDED. See page 5 for Metal Cased lines of transistor supply transformers.

Type No.	H-149	H-148
Application	Isolation	
Primary	28V 380-1000Hz	105/115V 400Hz
Secondary	1) 6.3V-.08A 2) 6.3V-.08A	115VCT-.02A
Series Con.	12.6V-.08A	
Parallel Con.	6.3V-.16A	
MIL Type	TF5SX03ZZ	TF5SX03ZZ
Base	3/4" x 7/8"	3/4" x 1"
Height	3/4"	2 3/4"
Weight	.04 lbs.	.05 lbs.
Suggested Net Price	\$7.50	\$10.80

SEE OTHER FILTERS ON PAGES 3 & 9

ELECTRIC WAVE FILTERS

NEW STANDARD FILTERS

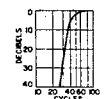
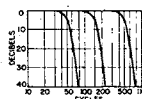

Base 1 1/2" x 1 1/4"
LMI-150 1 5/8" h, wt. 6 oz.
LMI-50 2 1/2" h, wt. 9 oz.
LMI-500
HML-40 2 1/2" h, wt. 9 oz.

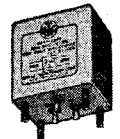

All UTC filters are designed, manufactured and successfully tested to MIL-F 18327C environmental requirements. The LMI-50 & LMI-150 are Low Pass Interstage Filters with source and load impedance of 10,000 ohms. Cutoff frequencies: LMI-50 at 50 Hz; LMI-150 at 150 Hz. The LMI-500 is a Low Pass Filter with a source and load impedance of 500/600 ohms, cutoff frequency is 500 Hz. HML-40 is a High Pass Filter with a source and load impedance of 500/600 ohms, cutoff frequency is 40 Hz. Suggested net prices are: LMI-50 — \$39.00; LMI-150 — \$31.50; LMI-500 — \$39.00; HML-40 — \$42.00. MIL designations: LMI-50 & LMI-150, FR6RX11YY1; LMI-500, FR6RX11YY1; HML-40, FR6RX33YY1.

BROAD BAND FILTER

The FBH-1 — Flat package Broad Band Pass Filter has a source and load of 10K ohms. Units are within 3 db from 1 kHz to 2 kHz, and have an attenuation of at least 36 db at frequencies below 500 cps and above 4 kHz. FP-C Case. MIL type FR6RX22YY1. Suggested net price: \$54.00.

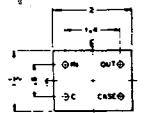
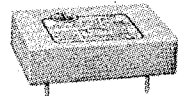
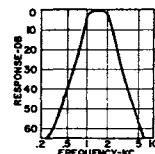

FP-C CASE
Height 1/2", wt. 2.2 oz.

LOW FREQUENCY FILTER

(BAND PASS & BAND REJECT)

The LBP-10 Low Frequency Band Pass Filter has a 10 Hz center frequency. The filter has 4 terminals so that it can be used as a band pass filter with a 10K ohm load or with a high impedance load, and in addition as a band reject filter. As a Band Pass Filter, the unit is within 3 db at 9.6 and 10.4 Hz. Attenuation at 5 & 20 Hz is at least 30 db with the 10K ohm output load and 35 db with the 3.3 Megohm load. As a Band Reject Filter, the unit attenuates 10 Hz by a minimum of 30 db and varies less than 3 db from DC to 7 Hz, and from 14 Hz to 36 kHz. This filter is MIL type FR6RX22FB1. Suggested net price: \$60.00. For size and weight see FB Page 15.

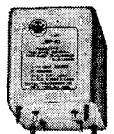
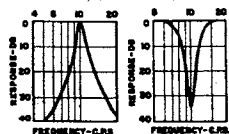

UNITED TRANSFORMER COMPANY DIVISION OF TRW INC.

UTC PAGE 2. *UTC Trade Mark. All Product Lines or Type Designations are UTC Trade Marks. Specify by Trade Mark to assure UTC high quality and reliability. © 1968 United Transformer Co., Div. of TRW INC.

NEW



TRANSFORMERS, FILTERS, MAGAMPS, HIGH Q COILS

NEW UTC "FLATS"™ ELECTRIC WAVE FILTERS

For other Filters see pages 2 & 9

Designed, Manufactured and Successfully Tested to Complete

MIL-F-18327C Specifications

These filters meet today's need for flat component configurations, have excellent attenuation characteristics and are ruggedized to Grade 4, MIL-F-18372C. Straight pin terminals and flat construction make these units ideally suited for printed circuit applications. These filters are hermetically sealed in flat metal cases shielded to reduce hum pickup. FP-A case: 2 x 2 x 1/2" h., 2.5 oz. FP-B case: 2 x 1 1/2 x 3/8" h., 2 oz. Suggested stock price: \$42.00 each net.

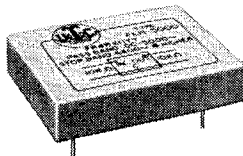

FHH-200: Flat package high pass filter, source and load 10K ohms. Units are within 1 db up to 300 Hz 3 db \pm 1 db at 200 Hz, and have an attenuation of at least 40 db at frequencies below 140 Hz. FP-A case. Mil Type: FR6RX33YY1.

FLH-600: Flat package low pass filter, source and load 10K ohms. Units are within 1 db from DC to 450 Hz, 3 db \pm 1 db at 600 Hz, and have an attenuation of at least 40 db at frequencies above 800 Hz. FP-A case. Mil Type: FR6RX11YY1.

FLH-5000: Flat package low pass filter, source and load 10K ohms. Units are within 1 db from DC to 4.2 kHz, 3 db \pm 1 db at 5 kHz, and have an attenuation of at least 43 db at frequencies above 6400 Hz. FP-B case. Mil Type: FR6RX11YY1.

FLL-3500: Flat package low pass filter, source and load 600 ohms. Units are within 1 db from DC to 3 kHz, 3 db \pm 1 db at 3500 Hz, and have an attenuation of at least 40 db at frequencies above 4500 Hz. FP-A case. Mil Type: FR6RX33YY1.

FLL-18000: Flat package low pass filter, source and load 600 ohms. Units are within 1 db from DC to 15 kHz, 3 db \pm 1 db at 18 kHz, and have an attenuation of at least 43 db at frequencies above 23 kHz. FP-A case. Mil Type: FR6RX11YY1.

FLL-50000: Flat package low pass filter, source and load 600 ohms. Units are within 1 db from DC to 42 kHz, 3 db \pm 1 db at 50 kHz, and have an attenuation of at least 43 db above 64 kHz. FP-B case. Mil Type: FR6RX11YY1.

NEW LINE OF SOLID STATE "MAS"™ PUSH-PULL MAGNETIC AMPLIFIERS

For other Magamps see page 8.

The "MAS" magamps operate on an input of 115 V 400 Hz with an output of ± 7.5 V DC, 1000 ohm load and have 2 isolated control inputs. These magnetic amplifiers afford a power gain of approximately 30,000. The power input and output are also completely and individually isolated. The "MAS" magamps are manufactured to MIL-T-27B standards. Units are housed in a hermetically sealed steel case with plug-in octal compressed glass terminals. The "MAS" magamps are 3 inches high with a 1 1/2 inch diameter and weighs approximately 1/2 pound.

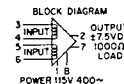
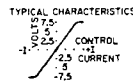

The "MAS" magamps have many advantages over other active circuit elements such as tubes, transistors: • Long life and years of maintenance free operation due to magnetic characteristics and solid state elements. • Reliability can withstand high shock, vibration, radiation, and moisture. • Reliability — can withstand 10 times overloads and operate into short without damage.

Possible applications include: • Control Amplifier • Photocell • SCR Controls • Strain Gauge Amplifier • Meter Preamps • Thermocouple • Differential Amplifier • Signal mixing, summing, integration • Hydraulic Servo Valve Driver • Servo Motor • Linear Amplifications of Transducer Signals.

Type Number	Winding Number	Input Resistance Ohms	Trans-resistance Ohms	Nominal DC amps 5V DC Output 1000 Ω Load	Suggested Price Net
MAS-400	1	45	2.5 x 10 ⁴	200	\$135.00
	2	45	2.5 x 10 ⁴	200	
MAS-410	1	500	8.0 x 10 ⁴	60	135.00
	2	500	8.0 x 10 ⁴	60	
MAS-420	1	1000	12.5 x 10 ⁴	40	135.00
	2	100	4.0 x 10 ⁴	125	

NEW, LLP-10 & LLP-15, STANDARD LOW FREQUENCY LOW PASS FILTER

For other Filters see pages 2 & 9.

Designed, Manufactured and Successfully Tested to Complete MIL-F-18327C

The LLP-10 low frequency low pass filter has a loss of less than 3 db at 10 Hz and attenuation of more than 40 db at 20 Hz. The LLP-15 low frequency low pass filter has a loss of less than 3 db at 15 Hz and attenuation of more than 40 db at 30 Hz. Both filters have a source and load impedance of 100K ohms. Both are MIL Type FR6RX11FA1. Dim: 2 1/2 x 2 3/4 x 3 3/8" h., 1 1/2 lbs. Suggested Net Price: \$60.00 net.

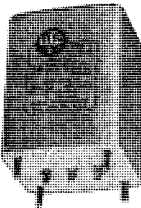

NEW "PIL"™ AUDIO TRANSFORMERS

For other PIL'S see page 4.

Designed, Manufactured and Successfully Tested to Complete MIL-T-27B Specifications.

These units are the smallest audio transformers available. The DO-T type structure incorporated overcomes inherently poor electrical characteristics usually found in miniature audio transformers. These ultraminiature PIL transformers are engineered to provide top electrical performance. All units are subjected to a 500 volt dielectric strength test, instead of the usual 100 volts, for higher safety margins and reliability.

Units are designed to a field-proven, ruggedized construction with a completely rigid cylindrical bobbin eliminating wire movement and stress. The turns are circular, effecting uniform wire lay and eliminating corner stress. The leads are rigidly anchored to the coil wire terminal board fashion, eliminating the use of tape, and brought out through strain relief. The units are terminated in weldable and solderable, insulated Gold plated Dumet leads. Dim: 3/8" dia. x 3/8" h., 1/20 oz.

All units are metal encased to Grade 4. Units made to Class S are available on special order. U. S. Patent No. 2,949,591.



Type No.	MIL Type	Pri Imp	Unbal D.C. ma In Pri	Sec Imp	Pri DCR	Max Mw Level	± 3 db Fre Range @ 1 Mw	Suggested Net Price
PIL-50	TF4RX17YY	500 CT	3	500 CT	40	100	800 cps-250KC	\$7.20
PIL-70	TF4RX13YY	10K CT	1	500 CT	530	100	800 cps-250KC	7.50
PIL-75	TF4RX13YY	10K CT	1	2K CT	530	100	800 cps-250KC	7.50

NEW "FE," FI,* FO"™ MINIATURE INDUCTORS

For other High Q Coils see pages 1 & 10.

Designed, Manufactured and Successfully Tested to Complete MIL-T-27B Specifications.

FE, FI, FO miniature inductors are ideal for transistor and printed circuit applications, having both pin terminals and a molded flat construction. These units are symmetrical toroids providing maximum Q in minimum size. The FE and FI inductors are adjusted at 1 V, 1 kHz. The FO units are adjusted at 1 V, 400 Hz. All units are adjusted to a tolerance of $\pm 1\%$. The ma DC Max shown is for approximately 5% drop in inductance. The temperature stability is unequalled from -55°C to $+100^{\circ}\text{C}$. For AC level limitations, a general rule of thumb would be to consider the maximum AC current approximately equal to the maximum DC current rating. However, for specific applications, contact UTC with exact level, frequency, and Q requirements to determine suitability of part in application. All FE, FI, FO inductors are equally well suited for vacuum tube application. All units Mil Type: TF5RX20ZZ.



DIMENSIONS:

FE: 1 1/2" sq. x 1/2" h., wt. 0.7 oz.
FI: 1 1/2" sq. x 3/8" h., wt. 1.5 oz.
FO: 1 1/2" sq. x 1/2" h., wt. 0.5 oz.

Type No.	Ind. Hy. (0 DC)	ma DC Max.	DCR Max.	Suggested Price Net
FE-01	.0100	70	2.5	\$ 8.70
FE-02	.0200	50	5.1	9.00
FE-05	.0500	30	12	9.60
FE-1	.100	22	22	10.20
FE-5	.500	10	122	10.80
FE-1	1.00	7	250	11.40
FE-2	2.00	5	500	12.00
FI-04	.0400	50	4.3	10.80
FI-1	.100	30	11	11.10
FI-25	.250	20	27	11.40
FI-.5	.500	14	60	11.70
FI-1	1.00	10	110	12.00
FI-4	4.00	5	430	12.90
FO-1	.100	60	4.2	15.00
FO-5	.500	25	23	15.00
FO-1	1.00	18	43	15.60
FO-2	2.00	12	92	16.20
FO-5	5.00	8	240	16.80
FO-10	10.0	6	440	18.00

PRECISION SCOTT-T REFERENCE TRANSFORMER NEW SCR-10™

Designed, Manufactured and Successfully Tested to Complete MIL-T-27B Specifications

Used in the precise conversion of three wire synchro information to equivalent resolver information. Two outputs 90° apart are obtained, which can be utilized in analog and digital computer application or coordinate transformation applications. Mil type TF4SX09AJ.

Special custom built units with other electrical values are available to your requirements
Input 90V 60/400 Hz 3 Phase high impedance suitable for synchro output.
Output 1) 3V @ .25 MA 2 Phase Output.
2) 3V @ .25 MA 2 Phase Output.

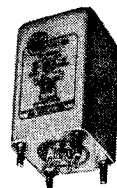

UNITED TRANSFORMER COMPANY DIVISION OF TRW INC.

UTC PAGE 3. *UTC Trade Mark. All Product Lines or Type Designations are UTC Trade Marks. Specify by Trade Mark to assure UTC high quality and reliability. © 1968 United Transformer Co., Div. of TRW INC.

TRANSISTOR TRANSFORMERS

Designed, Manufactured and Successfully Tested to Complete MIL-T-27B Specifications.



DO-T* AND DI-T*

ALSO SEE PAGES 1 & 2 FOR NEW DO-T FAMILY UNITS

NEW

TRANSISTOR TRANSFORMERS

DI-T200* SERIES TRANSISTOR TRANSFORMERS

(ALSO SEE PAGE 2 FOR DO-T200)

These revolutionary transistor transformers embody the same rugged reliable construction afforded by the unique winding techniques and physical construction found in the DO-T & DI-T transformers. DI-T200 series differ by having straight pin, 1" long, .017 d. Dumet wire, gold plated leads. To MIL-T-27B, size 3/16 x 3/8", wt. 1/15 oz. U.S. Pat. No. 2,949,591



Revolutionary transistor transformers hermetically sealed to MIL-T-27B specs. Plastic insulated solderable leads, firmly anchored to withstand 10 pound pull. Ideal for printed circuits. DO-T: 3/16" dia. x 1 3/8" long, wt., 1/10 oz. DI-T: 3/16" dia. x 1 1/4" long, wt., 1/15 oz. these compact units provide frequency response, high efficiency and low distortion. U.S. Pat. No. 2,949,591

(ALSO SEE PAGE 2)

DO-T Type	DI-T Type	Application	Pri. Imped., Ohms	Sec. Imped., Ohms	Suggested Net Each
DO-T1	DI-T1	a	20K/30K, 0.5 ma	800/1200	\$6.00
DO-T2	DI-T2	b	500/600, 3 ma	50/60	5.40
DO-T3	DI-T3	b	1K/1.2K, 3 ma	50/60	5.40
DO-T4	DI-T4	b	600, 3 ma	3.2	5.40
DO-T5	DI-T5	b	1.2K, 2 ma	3.2	5.40
DO-T6	DI-T6	b	10K, 1 ma	3.2	6.00
DO-T7	DI-T7	c	200K	1K	9.90
DO-T8	DI-T8	d*	3.5 hys. @ 2 ma	2.5 hys.±±	4.80
DO-T9	DI-T9	e	10K/12K, 1 ma	500/600 CT	6.60
DO-T10	DI-T10	f	10K/12.5K, 1 ma	1.2K-1.5K CT	6.60
DO-T11	DI-T11	f	10K/12.5K, 1 ma	2K/2.5K CT	6.60
DO-T12	DI-T12	b	150/200 CT, 10 ma	12/16	5.70
DO-T13	DI-T13	b	300/400 CT, 7 ma	12/16	5.70
DO-T14	DI-T14	b	600/800 CT, 5 ma	12/16	6.00
DO-T15	DI-T15	b	800/1070 CT, 4 ma	12/16	6.00
DO-T16	DI-T16	b	1K/1330 CT, 3.5 ma	12/16	6.00
DO-T17	DI-T17	b	1.5K/2K CT, 3 ma	12/16	6.00
DO-T18	DI-T18	b	7.5K/10K CT, 1 ma	12/16	6.30
DO-T19	DI-T19	b	300 CT, 7 ma	600	6.00
DO-T20	DI-T20	b	500 CT, 5.5 ma	600	6.00
DO-T21	DI-T21	b	900 CT, 4 ma	600	6.00
DO-T22	DI-T22	b	1500 CT, 3 ma	600	6.00
DO-T23	DI-T23	a	20K/30K CT, .5 ma	0.8K/1.2K CT	6.90
DO-T24	DI-T24	c	200K CT	1K CT	9.90
DO-T25	DI-T25	a	10K/12K CT, 1 ma	1.5K/1.8K CT	7.20
DO-T26	DI-T26	dt	6 hys. @ 2 ma	4.5 hys.±±	5.70
DO-T27	DI-T27	d±	1.25 hys. @ 2 ma	0.9 hys.±±	4.80
DO-T28	DI-T28	d\$	0.3 hy. @ 4 ma	0.1 hy.±±	4.80
DO-T29	DI-T29	b	120/150 CT, 10 ma	3.2/4	5.70
DO-T30	DI-T30	b	320/400 CT, 7 ma	3.2/4	6.00
DO-T31	DI-T31	b	640/800 CT, 5 ma	3.2/4	6.00
DO-T32	DI-T32	b	800/1K CT, 4 ma	3.2/4	6.00
DO-T33	DI-T33	b	1060/1330 CT, 3.5 ma	3.2/4	6.00
DO-T34	DI-T34	b	1.6K/2K CT, 3 ma	3.2/4	6.00
DO-T35	DI-T35	b	8K/10K CT, 1 ma	3.2/4	6.30
DO-T36	DI-T36	a	10K/12K CT, 1 ma	10K/12K CT	7.50
DO-T37	DI-T37	a	2K/2.5K CT, 3 ma	8K/10K Split	7.80
DO-T38	DI-T38	a	10K/12K CT, 1 ma	2K/2.4 Split	7.80
DO-T39	DI-T39	a	20K/30K CT, .5 ma	1K/1.5K Split	7.80
DO-T40	DI-T40	a	40K/50K CT, .25 ma	400/500 Split	8.40
DO-T41	DI-T41	a	400/500 CT, 8/6 ma	400/500 Split	7.50
DO-T42	DI-T42	a	400/500 CT, 8/6 ma	120/150 Split	7.50
DO-T43	DI-T43	a	400/500 CT, 8/6 ma	40/50 Split	7.50
DO-T44	DI-T44	a	80/100 CT, 12/10 ma	32/40 Split	7.80
DO-T45	DI-T45	a	1K/1.25K CT, 3.5 ma	16K/20K Split	7.80
DO-T46	DI-T46	c	100K CT	500 CT	9.60
DO-T47	DI-T47	a	9K/10K, 1 ma	9K/10K CT	8.10
DO-T48	DI-T48	a	8K/10K, 1 ma	1.2K/1.5K CT	7.80
DO-T49	DI-T49	d\$§	Series—20 hys @ 1 ma, 5100Ω Parallel—5 hys @ 2 ma, 1275Ω Series—.075 hys @ 10 ma, 10.5Ω Parallel—.018 hys @ 20 ma, 2.6Ω		7.80
DO-T50	DI-T50	d\$§			5.70
DO-T51	DI-T51	a	2K/2.5K CT, 3 ma	2K/2.5 K split	7.80
DO-T52	DI-T52	a	4K/5K CT, 2 ma	8K/10K CT	7.80
DO-T400	DI-T400	h	28V, 380-1 kHz	6.3 V, 60 ma	6.60
DO-T410	DI-T410	h	28V, 380-1 kHz	Two 6.3 V, 30 ma	7.80
DO-T420	DI-T420	h	28V, 380-1 kHz	28 V, 10 ma	7.80
DO-TSH	DI-TSH		High mu shield and cover; 25 db		.90

*630 ohms. 12100 ohms. ±100 ohms. 525 ohms.
 ±DI-T primary impedance. §§2 Wdgs.
 a—Interstage; b—Output; c—Input; d—Inductor; e—Driver or Output; f—Driver; g—matching; h—Power Unit.

Type No.	Application	Pri. Imped., Ohms	Sec. Imped., Ohms	Suggested Net Each
DI-T225	Interstage	80 CT 100 CT	32 Split 40 Split	\$8.40
DI-T230	Output or Matching	300 CT	600 Split	7.20
DI-T235	Interstage	400 CT 500 CT	40 Split 50 Split	8.40
DI-T240	Interstage or Output (Ratio 2:1:1)	400 CT 500 CT	400 Split 500 Split	8.40
DI-T245	Output or Matching	500 CT 600 CT	50 CT 60 CT	6.90
DI-T250	Output or Mixing	500 CT	600 CT	7.20
DI-T255	Output or Matching	1,000 CT 1,200 CT	50 CT 60 CT	6.90
DI-T260	Output	1,500 CT	600 CT	7.20
DI-T265	Isolation or Interstage	2,000 CT 2,500 CT	8,000 Split 10,000 Split	8.70
DI-T270	Output or Driver	10,000 CT 12,000 CT	500 CT 600 CT	7.80
DI-T273	Output or Driver	10,000 CT 12,500 CT	1,200 CT 1,500 CT	7.80
DI-T276	Interstage or Driver	10,000 CT 12,000 CT	2,000 CT 2,400 CT	7.80
DI-T278	Interstage or Driver	10,000 CT 12,500 CT	2,000 Split 2,500 Split	8.70
DI-T283	Isolation or Interstage	10,000 CT 12,000 CT	10,000 CT 12,000 CT	8.40
DI-T288	Interstage or Driver	20,000 CT 30,000 CT	800 CT 1,200 CT	8.10
DI-T204	Split Inductor (2 wdgs)	Series: 1 hy @ 4 ma DC, 25Ω Parallel: .025 hy @ 8 ma DC, 6Ω		6.00
DI-T201	Split Inductor (2 wdgs)	Series: 9 hy @ 2 ma DC, 105Ω Parallel: 2 hy @ 4 ma DC, 26Ω		6.00
DI-T212	Split Inductor (2 wdgs)	Series: 2.5 hy @ 2 ma DC, 630Ω Parallel: 6 hy @ 4 ma DC, 157Ω		6.00
DI-T216	Split Inductor (2 wdgs)	Series: 4.5 hy @ 2 ma DC, 2300Ω Parallel: 1.1 hy @ 4 ma DC, 575Ω		6.90
DI-T200SH	Drawn Hipermalloy shield provides 15 to 20 db shielding through side of case			.75

NEW PIL* ULTRAMINIATURE AUDIO INDUCTORS

The new PIL series constitutes the smallest audio inductors available. These units are metal encased, ruggedized manufactured and guaranteed to MIL-T-27B. They are MIL Type TF4RX-20YY. Physical construction is that of the PIP (DO-T, DI-T) units shown on this page.

Type No.	Con-Ind. Hys.	Min IV, 1Kc	DC	DCR
PIL-5	Series .12	0	43	
	Parallel .03	0	10.7	
	Series .10	10		
	Parallel .025	10		
PIL-8	Series .32	0	115	
	Parallel .08	0	28	
	Series .16	10		
	Parallel .06	10		
PIL-12	Series .8	0	300	
	Parallel .2	0	75	
	Series .4	5		
	Parallel .15	5		

PIL units shown: Suggested net each: \$6.00

For New PIL Transformers See Fig. 3.

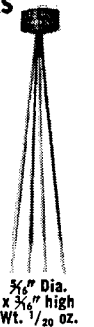

PIP* SERIES TRANSISTOR PULSE TRANSFORMERS

UTC's PIP series of subminiature transistor type pulse transformers is designed to give a maximum of component density in equipments, their configuration being especially compatible with transistors. The design is based on the UTC DO-T and DI-T series to impart exceptional reliability. PIP-1 through PIP-9 have a ratio of 4:4:1, PIP-10 through PIP-12 have a ratio of 5:3:1. All units are checked and adjusted in a transistor test circuit to give the required pulse width.

Hermetically sealed, manufactured & guaranteed to MIL-T-20138B by full environmental testing... all units, completely METAL CASED, MIL type TP6RX4410CZ. See UTC page 8 for other miniature pulse transformers.

All Units Individually Adjusted to Parameters Shown in Table

U.S. Pat. No. 2,949,591

5/16" Dia. x 3/16" high Weight 1/20 oz.



Type No.	APPROX. DCR, OHMS				BLOCKING OSCILLATOR PULSE					COUPLING CIRCUIT CHARACTERISTICS						Suggested Net Each	
	1-Brn 2-Rd	3-Orn 4-Yel	5-Grn 6-Blu		Width μSec.	Rise Time	% Over Shoot	Drop %	% Back Swing	P Width μSec.	Volt	Rise Time	% Over Shoot	Drop %	Back Swing		Imp. in, out,
PIP-1	.18	.20	.07	.05	.02	.02	0	0	37	.05	9	.018	0	0	12	50	\$6.00
PIP-2	.47	.56	.17	.1	.025	0	0	25	.1	8	.02	0	0	5	50	6.00	
PIP-3	1.01	1.25	.37	.2	.030	2	0	15	.2	7	.035	0	0	5	100	6.00	
PIP-4	1.5	1.85	.54	.5	.05	0	0	15	.5	7	.06	0	0	0	100	6.00	
PIP-5	2.45	3.1	.9	1	.08	0	0	14	1	6.8	.15	0	0	5	100	6.00	
PIP-6	3.0	3.7	1.1	2	.10	0	0	15	2	6.6	.18	0	2	10	100	6.00	
PIP-7	4.9	6.05	1.8	3	.20	0	0	14	3	6.8	.20	0	2	10	100	6.00	
PIP-8	8.0	9.7	2.9	5	.30	0	0	3	5	7.9	.22	0	13	25	200	6.00	
PIP-9	13.1	15.9	4.7	10	.35	0	5	12	10	6.5	.4	0	15	20	200	6.00	
PIP-10	.55	.41	.15	.1	.01	0	0	20	0	8	.01	0	0	5	140/50	6.00	
PIP-11	2.9	2.2	.82	1	.02	4	4	6	1	6.6	.05	0	6	12	280/100	6.00	
PIP-12	9.4	7.1	2.6	5	.05	0	12	12	5	8	.09	2	12	25	560/200	6.00	
PIP-100	Transistor pulse transformer kit, consisting of PIP-1 thru PIP-9 in plastic case.																
PIP-SH	Drawn Hipermalloy shield and cover for PIP's provides 20 to 30 db shielding.																

UNITED TRANSFORMER COMPANY DIVISION OF TRW INC.

UTC PAGE 4.

*UTC Trade Mark All Product Lines or Type Designations are UTC Trade Marks. Specify by Trade Mark to assure UTC high quality and reliability. © 1968 United Transformer Co., Div. of TRW Inc.



SECTION 5600

TRANSISTOR TRANSFORMERS

Designed, Manufactured and Successfully Tested to Complete MIL-T-27B Specifications.

TRANSISTOR SUPPLY TRANSFORMERS

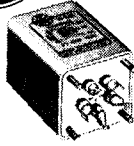

Primary 115V. 50/60 Hz (tapped on H-143 thru H-146 for dual secondary voltages). DC ratings are approximate, based on silicon bridge rectifier (except H-141, H-142 also shown F.W.C.T.). Choke input DCV is based on 10% voltage drop in choke. Condenser value, C, is in 1000 mfd. H-141, H-142, H-147 listing under "Secs in parallel" is single winding. All units MIL type TF4RX02.

Type No.	Sec. V Rms	Sec. A Rms	Choke DCV	Sec. in Parallel		Sec. in Series		MIL Case (Pg. 15)	Sugg. Net Each
				Input DCA	Cond. DVC	Input DCA	Cond. DVC		
H-141	20 CT	.3	16.5	.3	26	.2	2	EB	\$10.80
H-142	20 CT	.6	16.5	.43	12	.3	5	EA	13.50
				.6	26	.4	4		
H-143	17/21.5	1.5	14/17.5	.85	13	.6	1	HA	19.80
				3	18.5/25	2	1		
H-144	17/21.5	1.5	14/17.5	8	18.5/25	5	2	LA	33.00
				4	28/35	4	43/56		
H-145	17/21.5	4	14/17.5	18	18.5/25	12	6	RC-175	51.00
				9	28/35	9	43/56		
H-146	34/43	4.5	28/35	9	43/56	6	4	UTC Pg. 12	51.00
				3	56/70	4.5	85/110		
H-147	10	20	8.2	20	10	13	12	KA	30.00

ALSO SEE PAGE 2 FOR NEW MOLDED ISOLATION & TRANSISTOR SUPPLY TRANSFORMERS

UNIVERSAL TRANSISTOR SUPPLY TRANSFORMERS

Low Voltage DC Supply Telephone Supply Bias Supply Battery Chargers Plating Rectifiers

UTC universal transistor supply transformers are high reliability units in drawn MIL cases. Primary tapes can modify nom. AC voltages by -6%, +6%, and +12%. The capacitor following the rectifier affects the DC voltage.

PRIMARY 115 VOLTS, 50/60 Hz
NOMINAL SEC. VOLTS, 8.25 to 40.5

Type No.	MIL DC Range	Indust. DC Range	MIL Case (Pg. 15)	Sugg. Net Each
H-915	6V-.065A to 53V-.02A	6V-.085A to 53V-.025A	AH	\$13.50
H-925	6V-.22A to 53V-.07A	6V-.28A to 53V-.085A	AJ	14.10
H-935	6V-1.2A to 53V-4A	6V-1.52A to 53V-48A	FA	15.60
H-94	6V-3A to 53V-1A	6V-3.8A to 53V-1.2A	HA	22.50
H-95	6V-7.5A to 53V-2.5A	6V-9A to 53V-3A	KA	30.00
H-96	6V-18A to 53V-6A	6V-23A to 53V-7.5A	OA	54.00

PRIMARY 115 VOLTS, 50/60 Hz
NOMINAL SEC. VOLTS, 16.5 TO 81

H-965	12V-1.5A to 106V-.5A	12V-1.9A to 106V-.6A	HA	\$22.50
-------	----------------------	----------------------	----	---------

NEW 400 Hz MET* TYPES
PRIMARY 115 VOLTS, 400 Hz
NOMINAL SEC., 8.25-40.5 VOLTS

MET 455	6V-1.2A to 53V-.4A	6V-1.52A to 53V-.48A	AJ	\$15.00
MET 465	6V-3A to 53V-4A	6V-3.8A to 53V-1.2A	FA	15.60
MET 475	6V-7.5A to 53V-2.5A	6V-9A to 53V-3A	HA	21.00

ALSO SEE PAGE 2 FOR NEW 400 Hz UNIVERSAL TRANSISTOR SUPPLY TRANSFORMERS



Primary 105/115 Volts 380-1000 Hz. Sec: 6.3 VCT 2500V RMS Test
MOLDED 400 Hz TYPE TF55X01ZZ

Type No.	Sec. Amp.	L In.	W In.	H In.	Wt. Lbs.	Sugg. Net Each
H-101	3.5	1 7/8	1 7/8	2	.3	\$15.60
H-102	5.5	1 3/4	2	2 1/4	.44	16.50
H-103	10	2 3/4	2 1/2	2 1/2	.8	21.00
H-104	25	2 7/8	2 1/2	3 1/2	1.5	24.00
H-118	.3	Subouncers mold see pg. 13				9.90

TRANSISTOR INVERTER TRANSFORMERS

High reliability (layer insulated) types providing high efficiency in small size. Units are in drawn MIL cases. Circuit details supplied with transformer. With 6 V. input instead of 12 V., output voltage is halved, current rating remains the same.

FOR 12/14 OR 24/48 VOLT BATTERY

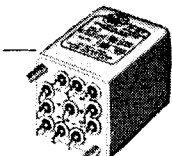

Type No.	DC output, when used in circuit shown	MIL Sugg. Case Net (Pg. 15) Each
H-97	250V-.60 ma	AH \$16.50
H-98	375V-.100 ma	AJ 17.40
H-99	425V-.175 ma	FA 22.20
H-100	550V-.200 ma	GB 22.20

IMMEDIATE DELIVERY ON ALL ITEMS FROM STOCK

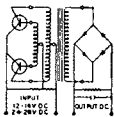

NEW MET* 400-Hz SERIES

Type No.	MIL Type	Sec. Amps. Volt (MIL)	Amps. (Indust.)	Sec. Test V. RMS	MIL Case (Pg. 15)	Sugg. Net Each
MET-410#	TF4SX01YY 400 cy. pri.	6.3	.6	.75	500	RC-25 \$ 7.80
MET-420	TF4SX01AH 3800-1000 cy.±	6.3CT	2	2.5	1500	AH (Pg. 17) 12.00
MET-430†	TF4SX01FA 400 cycles±	12.6CT	2	2.5	1500	FA 19.50
MET-435	TF4SX01FA 380-1000 cy.±	6.3CT	10	12	2500	FA 15.00
MET-440	TR4SX01GB 380-1000 cy.±	6.3CT	6	7	2500	GB 15.00

†Two MET-430's, Scott-connected, provide 26v., 2-phase from 115 v., 3-phase 400 Hz input. Replaces former No. H-139.
‡105/115/125 v. primary.
#57.5/99.7/115 v. primary.
#Replaces former No. H-140.

ALSO SEE PAGE 2 FOR NEW 400 Hz ISOLATION TRANSFORMERS

HERMETIC SEALED TRANSISTOR/FILAMENT SUPPLY TRANSFORMER

Primary: 105/115/210/220 volts, 50/60 Hz, except H-130, H-137, H-138, H-104 (115v.) and H-131 (115/220v.) Suited to 400/100 Hz. H-128: 6 1/2 x 5 1/2 x 7 3/4" h. (wt. 34 lbs.) H-129: 6 1/2 x 5 1/2 x 7 3/4" h. (wt. 28 lbs.)

METAL CASED TF4 TYPE

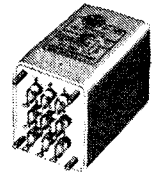

MIL T-27B RATINGS IN REGULAR TYPE, INDUSTRIAL RATINGS IN BOLD TYPE

Type No.	MIL Type	Sec. Volts	Amps. (MIL)	Amps. (Indust.)	Sec. Test V. RMS	MIL Case Pg. 15	Sugg. Net Each
H-119	TF4RX01AH	6.3CT	.3	.38	1500	AH	\$ 9.00
H-120	TF4RX01GB	2.5	10	12	4000	GB	15.00
H-121	TF4RX01JB	2.5	10	12	10000	JB	19.50
H-122	TF4RX01KB	2.5	20	26	10000	KB	24.00
H-123	TF4RX01NB	2.5	5	7.5	10000	NB	41.70
		2.5	5	7.5	10		
H-124	TF4RX01FB	5	3	3	2000	FB	14.10
H-125	TF4RX01KB	5	10	12	10000	KB	24.00
H-126	TF4RX01LA	5	20	25	10000	LA	31.50
H-127	TF4RX01NA	5	20	30	21000	NA	54.00
Term. Opp. Mtg.							
H-128	TF4RX01YY	5	60	75	21000		87.00
Term. Opp. Mtg.							
H-129	TF4RX01YY	5	10	12	21000		99.00
Term. Opp. Mtg.							
		5	10	12			
		5	20	24			
H-130	TF4RX01AJ	6.3CT	.6	.75	1500	AJ	9.90
H-131	TF4RX01FB	6.3CT	2	2.5	2500	FB	13.50
H-132	TF4RX01JA	6.3CT	6	7	2500	JA	21.00
		6.3CT	6	7			
H-133	TF4RX01HB	6.3CT	7	8	2500	HB	16.50
H-134	TF4RX01HA	6.3CT	10	12	2500	HA	19.50
H-135	TF4RX01JB	10 CT	10	13	2500	JB	22.50
H-136	TF4RX01LA	14, 12, 11 CT	10	14	2500	LA	31.50
H-137	TF4RX01EB	6.3	.6	.75	1500	EB	13.50
H-138	TF4RX01GA	6.3	.6	.75	1500	GA	21.00
		12.6	2	2.5			

UNITED TRANSFORMER COMPANY DIVISION OF TRW INC.

UTC PAGE 5.

UTC Trade Mark. All Product Lines of Type Designations are UTC Trade Marks. Specify by Trade Mark to assure UTC high quality and reliability. © 1968 United Transformer Co., Div. of TRW INC.



TRANSISTOR TRANSFORMERS
(Commercial Types)
& M-S Transformers & Inductors

TRANSISTOR TRANSFORMERS (Commercial Type).

NEW CAT★ TRANSISTOR IMPEDANCE TYPES

All units in RC-50 case. (See page 12) Frequency range ± 2 db, 50-15,000 Hz. Power level 1 watt except CAT-15, 5 watts.

UTC Type	Application	Imped. Ohms	Primary Unbal. ma DC	Secondary Imped., Ohms	Sugg. Net Each
CAT-15	Output	48/12 spl.	750*	16 spl./8/4	\$8.85
CAT-20	lstg./outp.	500/125 spl.	20	16/4 split	8.10
CAT-25	Isol./outp.	500/125 spl.	20	500/125 spl.	8.70
CAT-30	Input/1stg.	500/125 spl.	20	2K/500 split	8.40
CAT-40	lstg./outp.	10K/2.5K spl.	8	2K/500 split	8.40

*Balance. ★Trade mark.

CHANNEL FRAME FILAMENT/TRANSISTOR TRANSFORMERS
Pri. 115 V, 50/60 Hz—Test Volts RMS: 1500

Type No.	Secondary	W	D	H	M	Lbs.	Sugg. Net Each
FT-1	2.5 VCT-3A	2 7/8	1 5/8	1 11/16	2 3/8	3/4	\$4.50
FT-2	6.3 VCT-1.2A	2 7/8	1 5/8	1 11/16	2 3/8	3/4	4.50
FT-3	2.5 VCT-6A	3 1/8	1 7/8	2	2 13/16	1	5.10
FT-4	5.3 VCT-3A	3 1/8	1 7/8	2	2 13/16	1	5.10
FT-5	2.5 VCT-10A	3 3/4	2 1/8	2 3/8	3 1/8	1 1/2	5.70
FT-6	5 VCT-3A	3 3/4	2 1/8	2 3/8	3 1/8	1 1/2	5.70
FT-7	7.5 VCT-3A	3 3/4	2 1/8	2 3/8	3 1/8	1 1/2	5.70
FT-8	6.3 VCT-8A	4	2 1/2	2 3/8	3 1/8	2 1/2	6.30
FT-10	24 VCT-2A or 12V-4A	4	2 5/8	2 11/16	3 1/8	2 1/2	6.90
FT-11	24 VCT-1A or 12 V-2A	3 3/4	2 1/8	2 3/8	3 1/8	1 1/2	6.00
FT-12	36 VCT-1.3A or 18 V-2.6A	4	2 5/8	2 5/8	3 3/8	2 1/2	6.90

Taps on pri. of FT-13, FT-14 & FT-15 to modify sec. nominal V, -6% +6%, +12%

FT-13	26 VCT-.04A	2 1/8	1 3/8	1 1/2	1 3/4	1/4	\$5.70
FT-14	26 VCT-.25A	2 1/8	1 5/8	1 11/16	2 3/8	3/4	5.70
FT-15	48VCT-1A	4	2 1/2	2 3/8	3 3/8	2 1/2	7.80
FT-16*	11 VCT-2.5A or 5.5 V-.5A	3 3/4	2 1/8	2 3/8	3 1/8	1 1/2	7.80

* For 120 V input, use 6% tap

TRANSISTOR/FILAMENT TRANSFORMERS

Pri. 115 x 50/60 Hz; Bridge Rectifier
S-77, S-78 & S-79 Tapped For Dual Secondary Voltages

UTC Type	DCV	DCA	Case No.	Sugg. Net Ea.
S-75	5.2/14	1.2/4	G-1	\$ 6.60
S-76	10/26	4/14	G-4	9.90
S-77	14/56	3/1	G-5	11.40
S-78	28/110	9/3	G-10	33.00
S-79	32/120	3/1	G-7	18.00

CIRCUIT DEVELOPMENT TRANSFORMERS FOR TRANSISTORS

The UTC Laboratory circuit development transformers aid the designer in selecting optimum impedances for best power and distortion results from his transistor circuit.

LAB* UNIT

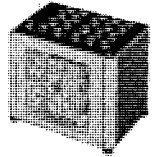

LAB-5		LAB-5 & LAB-10	
20 Hz to 20 kHz Up to 50mw Continuous		units in LS-1 case 3 1/2x2 1/2x3 1/4"; 3 lbs.	
Pri Imp. Ω	Sec. Imp. Ω	Pri. Imp. Ω	Sec. Imp. Ω
125	125	5 3/8x5 3/4x4 1/2"	15 lbs.
200 split	200 split	Terminal board as shown above	
500 split	500 split		
2000 split	2000 split		

Suggested Net Each: \$48.00

LAB-10	
20 Hz to 20 kHz Up to 1W Continuous	
Pri. Imp. Ω	Sec. Imp. Ω
1900 Ω to 14,400 Ω	20:1 or 10:1
925 Ω to 7600 Ω	10:1 or 5:1

Suggested Net Each: \$30.00

LAB-20	
20 Hz to 20 kHz Up to 50W Continuous	
Pri. Imp. Ω	Sec. Imp. Ω
1900 Ω to 14,400 Ω	20:1 or 10:1
925 Ω to 7600 Ω	10:1 or 5:1

Suggested Net Each: \$60.00

TRANSISTOR/FILAMENT SUPPLY TRANSFORMERS

Primary 115 volts 50/60 cycles

Type No.	Sec. V RMS	Sec. A RMS	in Parallel		in Series		Case No.	Sugg. Net Ea.				
			Choke in C in	DCV DCA	Choke in C in	DCV DCA						
CG-30	17/21.5	1.5	14/17.5	3	18.5/25	2	28/35	1.5	43/56	1	RC-112	\$18.90
CG-31	34/43	4.5	28/35	9	43/56	6	56/70	4.5	85/110	3	RC-175	42.00
CG-32	6.3VCT	1.2									RC-62	10.50

FILAMENT/TRANSISTOR SUPPLY TRANSFORMERS

Primary 105, 115, 210, 220, 230 volts, 50/60 Hz, except CG-34 . . . 105, 115, 220, 230. These transformers may be used on 25 to 43 Hz if 220 volt primary is used on 110 volts. Secondary voltage is simultaneously reduced to half.

Type No.	Sec. Volts C.T.	Sec. Amp.	Working Voltage	Sec. Test Volts RMS	Case No. See Page 12	Sugg. Net Each
CG-33	6.3	4	500	2000	RC-75	\$10.50
CG-34	2.5	10	2500	6000	RC-112	12.60
CG-35	6.3	6	500	2000	RC-87	12.00
CG-36	6.3/6.3	5/5	500	2000	RC-100	15.60
CG-120	2.5	10	5000	11000	RC-125	18.00
CG-121	5	25	5000	11000	RC-150	22.50
CG-122	7.5/6.3	10	1500	4000	RC-125	18.00
CG-124	10	10	1500	4000	RC-150	18.00
CG-125	14/12/11	10	1500	4000	RC-150	21.00
CG-126	14/11/10	10	1500	4000	RC-152	30.00

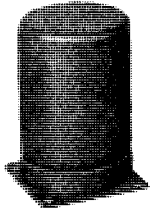

RC CASE See page 12

MILITARY STANDARD TRANSFORMERS AND INDUCTORS

Designed, Manufactured and Successfully Tested to Complete MIL-T-27B Specifications

FILAMENT, POWER, PLATE TRANSFORMERS

Primary 105/115/125 v., 54/66 Hz. Current ratings are for high voltage secondary DC, choke input filter. For condenser input, reduce by 70%. All units are MIL grade 4, ruggedized; equally usable where grade 1 is specified. Electrostatically shielded.

UTC Type	MS No.	MIL Type TF4RX-	Secondary Rating	MIL Case (Pg. 15)	Sugg. Net Ea.
N-583A	90016-2	01EB002	2.5 v.-3 a.; 1000 WV	EB	\$13.50
N-584A	90017-2	01GB003	2.5 v.-10 a.; 1000 WV	GB	15.00
N-585A	90018-2	01FB004	5 v.-3 a.; 1000 WV	FB	13.50
N-586A	90019-2	01HB005	5 v.-10 a.; 1000 WV	HB	18.00
N-587A	90020-2	01FB006	6.3 v.-2 a.; 1000 WV	FB	13.50
N-588A	90021-2	01GB007	6.3 v.-5 a.; 1000 WV	GB	15.00
N-589A	90022-2	01JB008	6.3 v.-10 a.; 1000 WV	JB	19.50
N-590A	90023-2	01KB009	6.3 v.-20 a.; 1000 WV	KB	24.00
N-591A	90024-2	01JB012	2.5 v.-10 a.; 6300 WV	JB	19.50
N-592A	90025-2	01KB013	5 v.-10 a.; 6300 WV	KB	22.50
N-593A	90026-2	03HA001	200-100-0-100-200, 70 ma; 6.3/5 v.-2 a.; 6.3 v.-3 a.	HA	22.20
N-594A	90027-2	03JB002	325-0-325, 70 ma; 6.3/5 v.-2 a.; 6.3 v.-4 a.	JB	24.00
N-595A	90028-2	03KB006	325-0-325, 150 ma; 5 v.-3 a.; 6.3 v.-5 a.	KB	26.40
N-596A	90029-2	03LB003	400-0-400, 175 ma; 5 v.-3 a.; 6.3 v.-8 a.	LB	33.00
N-597A	90030-2	03MB004	450-0-450, 250 ma; 5 v.-3 a.; 6.3 v.-8 a.	MB	39.00
N-598A	90031-2	02KB001	350-0-350, 250 ma	KB	21.00
N-599A	90032-2	02LB002	550-0-550, 250 ma	LB	28.50
N-600A	90036-2	02NB003	800-0-800, 250 ma	NB	37.50

AUDIO TRANSFORMERS

Frequency response 300-10,000 Hz ± 2 db. Split 600-ohm units provides for 600 ohms CT and 1500 ohms. Electrostatic shielding provided on W-784, W-785 and W-786. No. W-783 has center-tapped secondary for 90K CT or 22.5K CT. All units in AJ case (Pg. 15). Wt., 0.6 lb.

UTC Type	MS No.	MIL Type TF4RX- #	Pri. Ohms	Pri. DC ma.	Sec. Ohms	Sugg. Net Ea.
W-783	90000-A	15AJ001	a	10K CT	10	90K spl. \$16.50
W-784	90001-A	16AJ002	b	600 spl.	4/8/16 15.90
W-785	90002-A	10AJ001	c	600 spl.	135K CT 15.30
W-786	90003-A	16AJ001	d	600 spl.	600 spl. 15.30
W-787	90004-A	13AJ001	e	7.6K/4.8K	40	600 spl. 13.95
W-788	90005-A	13AJ002	f	7.6K/4.8K	40	4/8/16 14.25
W-789	90006-A	13AJ003	g†	15K CT	10	600 spl. 13.95
W-790	90007-A	13AJ004	g*	24K CT	20†	600 spl. 14.25
W-791	90008-A	13AJ005	g**	60K CT	20†	600 spl. 13.95

Use: a—PP plates to pp grids, 15 dbm level. b—Line to VC, 2 watts. c—Line to pp grids, 15 dbm. d—Line to line, 15 dbm. e—Plate to line, 2 watts. f—Plate to VC, 2 watts. g—PP plates to line. †Balanced. ‡2 watts. *† watt. **0.5 watt.

INDUCTORS

Two windings for series or parallel connection. Inductance shown for series connection. All but Z-847 are standard MIL case types. Rated 3500 WVDC, unless otherwise noted.

UTC Type	MS No.	MIL Type	Induct. Hy.	DC ma	DCR Ohms	MIL Case Pg. 15	Sugg. Net Each
Z-848*	90009-2	04FA001	16	80	645	FA	\$12.60
Z-849*	90010-2	04GA002	25	80	670	GA	15.60
Z-850*	90011-2	04HA003	40	80	1020	HA	22.50
Z-851†	90013-2	04HA005	16	125	330	HA	18.00
Z-852†	90014-2	04JB006	25	125	460	JB	25.50
Z-853	90037-2	04KA007	40	125	535	KA	31.50
Z-854	75000-2	04LA009	16	200	180	LA	33.00
Z-855	75001-2	04MA010	25	200	210	MA	37.50
Z-856	75002-2	04NA012	16	315	105	NA	45.30
Z-857	75003-2	04Y013	25	315	150	YY	75.00

*1000 WVDC. †2000 WVDC. ‡TF4RX-. **TF4RX.

UNITED® TRANSFORMER COMPANY DIVISION OF TRW INC.

UTC PAGE 6.

*UTC Trade Mark. All Product Lines or Type Designations are UTC Trade Marks. Specify by Trade Mark to assure UTC high quality and reliability. © 1968 United Transformer Co., Div. of TRW INC.

HERMETIC COMPONENTS

Designed, Manufactured and Successfully Tested to Complete MIL-T-27B Specifications.



HERMETIC AUDIO UNITS

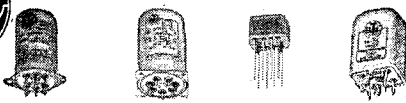

These extremely compact units are proved to specifications of MIL-T-27B. Response & level ratings: RC-25: Similar to Oncuers for case (1 1/4" x 1/4" x 1 1/4" h. 1.5 oz.). RC-50: Similar to ultra compact units for case (1 5/8" x 1 5/8" x 2 3/4" h. 8 oz.). SM: Similar to SSO units for case (1 1/4" x 1 1/2" x 2 1/2" h. 0.8 oz.). FH: 2 1/2" x 2 1/2" x 1/4" h. .8 oz.

ALSO SEE PAGE 2 FOR NEW HERMETIC AUDIO UNITS

Table with columns: UTC Type, Application, Pri. Imped., Sec. Imped., #, Sugg. Price. Lists various audio unit types and their specifications.

*Has 75 db shielding. †6000 ohms. †1500 ohms. \$5. watts. ††10 watts. #Case: a-RC-25. b-RC-50. c-RC-62. d-SM. e-FH. f-RC-37. (See above & pg.12)

HERMETIC SEALED FILTER INDUCTORS TUBE and TRANSISTOR TYPE

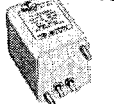

METAL CASED MF4 TYPE H-70 thru H-79, H-164 thru H-173



MOLDED MIL TYPE TF55X04ZZ H-105 thru H-109 & H-300

The multiple ratings for the "H" series of filter chokes suit these units for the complete gamut of military and industrial applications. Transistor supply units are swinging type to enhance regulation. H-79 terminals opposite mounting. †Relates to ripple voltage, in input filter circuits only.

Table with columns: Type No., Ind. Hys., ITA @ DC, Res. Ohms, Max. DCV Ch. Input, Test V. RMS, Mil. Case Pgs., Sugg. Price. Lists various filter inductor types and their specifications.

Table with columns: Type No., Inductance @ DC MA, D.C.R. Ohms, L, W, H, Wgt. Lbs., Sugg. Price. Lists various inductor types and their specifications.

HERMETIC SEALED POWER and PLATE TRANSFORMERS

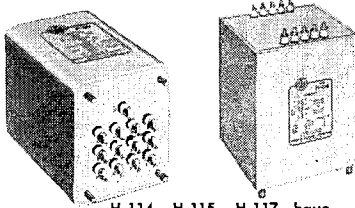

H-114, H-115, H-117 have terminals opposite mounting.

Power transformers: primary 115V, 60 Hz suited to 50* 1000 Hz service. Plate transformers: primary 105/115/210/220 volts, 50/60 Hz. "L" ratings are choke input... "C" ratings are condenser input. H-80 thru H-197 MIL type TF4RX03, H-110 thru H-117 MIL type TF4RX02. The tapped high voltage winding provides either of two secondary voltages for greatest versatility. The power transformer listings indicate DC voltages and permissible currents for both choke and condenser input filters, as well as for military and industrial applications.

"W" suffix units designed for full wave center tap and full wave bridge application. Center tap of secondary may be disconnected from ground.

MIL-T-27B Ratings in Regular Type, Industrial Ratings in Bold Type

Large table with columns: MIL Type No., HV Sec. C, T, DC Volts, Approx. DC Volts, Fil. Wdg., DC C, Approx. DC Volts, Fil. Wdg., MIL Case Pg. 15, Sugg. Net Each. Lists various transformer types and their ratings.

*For 50 Hz, secondary current ratings reduced by 10%. **DC ratings for bridge rectifier circuits. †6x5x6 1/2", ††6x6x6 1/2", †††11x11x14 1/2" # New full wave bridge rectifier types

IMMEDIATE DELIVERY ON ALL STOCK ITEMS UTC TRANSFORMER COMPANY



HERMETIC COMPONENTS

SECTION 5600

Designed, Manufactured and Successfully Tested to Complete MIL-T-27B Specifications.

MAT* MAGNETIC AMPLIFIERS FOR SERVO MOTOR APPLICATIONS

For NEW Magamps see page 3.

VACUUM TUBE TYPE

The MAT 1-4 Magnetic Amplifiers are exceptionally stable units designed for the control of 2 phase, 115V., 400 Hz servo motors. They are compact... hermetically sealed... magnetically shielded... and meet MIL-T-27B and MIL-E-5400 Specifications. The output is sinusoidal, amplitude variable, and phase reversible. Control is provided by a dual triode such as 12AU7 operating with a plate voltage of 115 volts, 400 Hz, or higher. The signal to the triode grids can be polarity reversible DC or phase reversible 400 Hz with or without suppressed carrier modulation. These units eliminate DC power requirements as well as temperature sensitive dry disc rectifiers. The high input impedance provides minimum loading on sensing elements and high power gain. Ringing at low load level has been reduced to a minimum through high internal damping factors. The power output figures are conservative... power gain of the Magnetic Structure is approximately 40... response time approximately 7.5 milliseconds. The maximum null voltage is 3 volts RMS. For single phase supply voltage the load capacitor should effect 90° phase shift with motor load... for 3 phase, 30° phase shift.

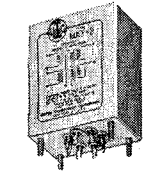

or phase reversible 400 Hz with or without suppressed carrier modulation. These units eliminate DC power requirements as well as temperature sensitive dry disc rectifiers. The high input impedance provides minimum loading on sensing elements and high power gain. Ringing at low load level has been reduced to a minimum through high internal damping factors. The power output figures are conservative... power gain of the Magnetic Structure is approximately 40... response time approximately 7.5 milliseconds. The maximum null voltage is 3 volts RMS. For single phase supply voltage the load capacitor should effect 90° phase shift with motor load... for 3 phase, 30° phase shift.

Type No.	MAT-1	MAT-2	MAT-3	MAT-4
230 Volt Supply				
Power output	4 W.	8 W.	11 W.	18 W.
RL, ohms	3300	1600	1200	720
CL, mfd., approx.	.2	.3	.5	.7
115 Volt Supply				
Power output	2 W.	4 W.	6 W.	9 W.
RL, ohms	6500	3300	2200	1450
CL, mfd.	.13	.2	.3	.45
Reson. Freq.	40 Hz	35 Hz	35 Hz	20 Hz
Log-Decr.	.18	.23	.03	.65
Cont. Wdg. Res.	6200 ohms	8450 ohms	4750 ohms	5650 ohms
Case, Length, in.	1 1/4	1 1/2	1 3/4	1 3/4
Width, in.	1 1/8	2 1/8	2 1/2	3 1/8
Height, in.	2 3/8	2 3/4	2 3/8	3 3/8
Mtg. Dim., in.	3 1/8 x 1 1/2	1 x 1 1/8	1 1/8 x 1 7/8	1 1/2 x 2 1/2
Studs, stainless	4-40	6-32	8-32	8-32
Cutout, in.	1	1	1	1
Unit Weight, lbs.	.67	1.1	1.7	2.75
Sugg. Net Each	\$27.00	\$30.00	\$36.00	\$39.00

MAT-5 115V.-400 Hz to 460 VCT; provides 230V. 48 ma DC or 460V. 24 ma DC. RC-37 Case (UTC pg. 12). MIL Type TF45Y02YY. Suggested Net Each \$10.80

MAT-6 Input... 10,000 ohms pri... 1:15 C.T. ratio... phase shift under 1°. ... RC-25 case (UTC pg. 7). MIL-type TF4RX10YY. Suggested Net Each \$9.00

TRANSISTOR TYPE

UTC transistor MAT units are identical to their vacuum tube counterparts, but designed for low impedance control. The input transformer may be chosen by impedance ratio rather than precise rated impedance.

Type No.	MAT-7	MAT-8	MAT-9	MAT-10	MAT-60
Power output	4 W.	8 W.	11 W.	18 W.	50 W.
RL, ohms	3300	1600	1200	720	260
CL, mfd approx.	.2	.3	.5	.7	.7
Cont. Wind. Res.	38Ω	52Ω	30Ω	36Ω	50Ω
Case Length, in.	2 3/8	2 1/2	2 3/4	2 3/2	MIL MB
Width, in.	1 1/8	2 1/4	2 1/2	2 3/2	
Height, in.	1 1/2	1 1/2	2	2 1/4	
Mtg. Dim., in.	1 3/8 x 1 7/8	1 1/8 x 2	1 1/8 x 2 1/8	2 3/8 x 2 3/8	60 cycle type
Studs, stainless	4-40	6-32	8-32	8-32	
Cutout, in.	1	1	1	1	
Weights, lbs.	.65	1.1	1.7	2.75	
Sugg. Net Each	\$25.80	\$28.80	\$34.50	\$37.50	\$54.00

MAT-11 115V.-400 Hz to two 28 Volt 2A windings for 56 VCT-2A or 28V.-4A RC-37 (UTC pg. 12) case. MIL type TF45Y02YY. Suggested Net Each \$10.05

MAT-65 115V.-60 Hz to 8.5 VCT @ 500 ma & 63 VCT @ 300 ma. FA case (pg. 15). MIL type TF45X02FA. Sugg. Net Each \$12.60

ULTRASHIELDED POWER-LINE ISOLATION TRANSFORMERS

Simulates battery operation for critical circuits requiring extreme isolation from power line.

Designed to give the ultimate in isolation, for line-powered equipment, which formerly could only be obtained from battery power. The effective capacity coupling between primary and secondary windings is less than 0.1 MMFD.

For this purpose shields are individually terminated to allow maximum flexibility. Input and output terminals are brought out on opposite sides of a special housing in order to maintain the excellent isolation between line and load.

MIL-T-27B Ratings in Regular Type Industrial Ratings in Bold Type Primary 115 V 50/60 Hz

Type No.	Power Watts	Power Case Size	Sugg. Net Ea.
HIT-1	50	4 1/2 x 4 1/2 x 3 1/2"	\$33.00
HIT-15	120	5 1/2 x 5 x 3 1/2"	\$39.00
HIT-2	160	5 1/2 x 5 1/2 x 4 1/2"	48.00
HIT-3	400	8 x 6 1/2 x 5 1/2"	69.00
HIT-4	1000	9 x 7 1/2 x 7 1/2"	120.00
HIT-450†	80	4 1/2 x 4 1/2 x 3 1/2"	33.00

†Primary 115v. 400 Hz. Secondary 115 volts.

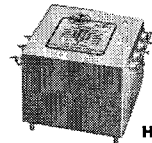

PRECISION MINIATURE WIDE APPLICATION PULSE TRANSFORMERS

UTC miniature, wound core, pulse transformers are individually precision adjusted in standard test circuits to close tolerances. They are high reliability units, hermetically sealed by vacuum molding and suited for service from -70° C. to +130° C. Wound core structure provides excellent temperature stability (un-

like ferrite). Designs are high inductance type to provide minimum of droop and assure true pulse width. H-45 thru H-57 ratio 1:1:1. H-60 thru H-69 ratio 4:4:1. Others ratio 5:3:1.

See PIP pulse units on UTC page 4.

ALL UNITS INDIVIDUALLY ADJUSTED TO PARAMETERS SHOWN IN TABLES

Type No.	APPROX. DCR, OHMS			BLOCKING OSCILLATOR PULSE				COUPLING CIRCUIT CHARACTERISTICS				Sugg. Net Each				
	1-2	3-4	5-6	Width μSec.	Rise Time	Over Shoot %	Droop %	Back Swing %	P Width μSec.	Volts Out	Rise Time		Over Shoot %	Droop %	Back in, out	
H-60	.124	.14	.05	.05	.016	0	0	30	.05	9.3	.012	0	0	20	50	6.60
H-61	.41	.48	.19	.1	.016	0	0	30	.1	8.2	.021	0	0	15	50	6.60
H-62	.78	.94	.33	.2	.022	0	0	18	.2	7.4	.034	0	5	12	100	6.60
H-63	1.86	2.26	.70	.5	.027	2	10	20	.5	7.5	.045	0	20	25	100	6.60
H-64	3.73	4.4	1.33	1	.033	0	12	25	1	7.7	.078	0	15	23	100	6.60
H-65	6.2	7.3	2.22	2	.066	0	15	25	2	6.6	.14	0	10	20	100	7.50
H-66	10.2	12	3.6	3	.087	0	18	30	3	6.8	.17	0	10	20	100	7.50
H-67	14.5	17.5	5.14	5	.097	0	23	28	5	7.9	.2	0	18	28	200	7.50
H-68	42.3	52.1	14.8	10	.14	0	15	28	10	6.5	.4	0	15	30	200	7.50
H-611	.426	.32	.132	.1	.018	8	0	12	.1	8.2	.02	0	0	30	140/50	-7.20
H-641	5	3.6	1.4	1	.04	0	10	10	1	7	.07	0	20	30	280/100	7.20
H-671	21	16	6	5	.08	0	14	12	5	8	.2	0	25	30	560/200	7.50
H-69	Transistor pulse transformer kit, consists of H-60 thru H-68 in plastic case.											60.00				

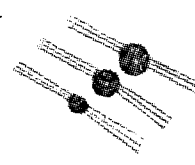

Size & weight of these units same as H-45.

VACUUM TUBE PULSE TRANSFORMERS

Type No.	APPROX. DCR, OHMS			BLOCKING OSCILLATOR PULSE				COUPLING CIRCUIT CHARACTERISTICS				DIMENSIONS			Sugg. Net Each				
	1-2	3-4	5-6	Width μSec.	Rise Time	Over Shoot %	Droop %	Back Swing %	P Width μSec.	Volts Out	Rise Time	Over Shoot %	Droop %	Back Swing		Imp. in, out	L in.	W in.	Wt. Grams
H-45	3	3.5	4	.05	.022	0	20	10	.05	17	.01	20	0	35	250	3/8	3/8	1	\$ 7.35
H-46	5.5	6.5	7	.10	.024	0	25	10	10	19	.01	30	10	50	250	3/8	3/8	1	7.35
H-47	3.7	4.0	4	.20	.026	0	25	8	20	18	.01	30	15	6.5	500	3/8	3/8	4	6.60
H-48	5.5	5.8	6	.50	.03	0	20	5	.50	20	.01	30	20	6.5	500	3/8	3/8	4	6.60
H-49	8	8.5	9	1	.04	0	20	10	1	24	.02	15	15	6.5	500	3/8	3/8	4	6.60
H-50	20	21	22	2	.05	0	20	10	2	27	.05	10	15	35	500	3/8	3/8	4	6.60
H-51	28	31	33	3	.10	1	20	8	3	26	.07	10	10	35	500	3/8	3/8	4	6.60
H-52	36	41	44	5	.13	1	25	8	5	23	.15	10	10	45	1000	3/8	3/8	4	6.60
H-53	37	44	49	7	.28	0	25	8	7	24	.20	10	10	50	1000	3/8	3/8	6	6.60
H-54	50	58	67	10	.30	0	20	8	10	24	.25	10	10	50	1000	3/8	3/8	6	6.90
H-55	78	96	112	16	.75	0	20	10	16	23	.40	5	15	20	1000	3/8	3/8	6	6.90
H-56	93	116	138	20	1.25	0	25	10	20	23	.6	5	10	10	1000	3/8	3/8	6	6.90
H-57	104	135	165	25	2.0	0	30	10	25	24	1.5	5	10	10	1000	3/8	3/8	6	6.90
H-461	9.6	6.4	2.5	.1	.025	0	0	8	.1	19	.02	3	5	20	700/250	3/8	3/8	1	7.50
H-501	30	20	7	2	.08	0	12	5	2	27	.06	12	15	35	1400/500	3/8	3/8	4	6.60
H-531	66	47	17	7	.32	0	12	3	7	24	.23	12	10	40	2800/1000	3/8	3/8	6	6.60
H-561	180	142	53	20	1.75	0	13	5	20	23	.7	5	10	10	2800/1000	3/8	3/8	6	6.90
H-58	Pulse transformer kit. Consisting of H-45 thru H-57 in a partitioned plastic case.											88.20							

UNITED TRANSFORMER COMPANY DIVISION OF TRW INC.

UTC PAGE 8. *UTC Trade Mark. All Product Lines or Type Designations are UTC Trade Marks. Specify by Trade Mark to assure UTC high quality and reliability. © 1968 United Transformer Co., Div. of TRW INC.



ELECTRIC WAVE FILTERS

Designed, Manufactured and Successfully Tested to Complete MIL-F-18327C Specifications.

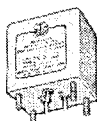

BM & LM Series

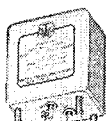

HM Series

SPECIAL FREQUENCY FILTERS	
BMI, BML, BPH, BPM, BTI, HMI, HML, HPM, LMI, LML, LPM	\$48.00
MNF, MWF, TMN, TMW	\$60.00
TGR	\$90.00
TGT	\$54.00

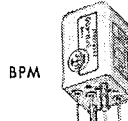

BPM



MINIFILTERS*



HPM & LPM

INTERSTAGE AND LINE FILTERS

Available in stock frequencies listed below (numerical part of type number is cutoff frequency in Hz). Compact shielded cases hermetically sealed to MIL-F-18327C specs. BMI, BML, BAAL cases: 1 1/2" x 1 1/2" x 1 1/2" h.; wt., 6 oz. HMI, HML, LML cases: 1 1/2" x 1 1/2" x 2 1/2" h.; wt., 9 oz. The BMI filters are band pass interstage units designed to operate between a vacuum tube plate (or 10,000 ohms) and a grid. They provide a gain of 2 at center frequency. BTI units are same as BMI, but 10,000 ohms output. BML band pass filters, similarly, work into a grid, but have an input impedance of 500/600 ohms. They provide a gain of 9. HMI filters are high pass interstage units. LMI filters are low pass interstage units. HML filters are high pass with input and output impedance of 500/600 ohms. LML filters are low pass filters with input and output impedance of 500/600 ohms. LLP low frequency low pass filter, loss of less than 40 db at 20 Hz. Source & load 100K ohms.

UTC Type	Sugg. Net Ea.	UTC Type	Sugg. Net Ea.	UTC Type	Sugg. Net Ea.
BMI-30	\$36.00	BML-1000	\$30.00	LMI-800	\$31.50
BMI-50	30.00	BTI-60	36.00	LMI-1000	31.50
BMI-60	30.00	BTI-100	36.00	LMI-1500	31.50
BMI-90	30.00	BTI-120	36.00	LMI-2000	31.50
BMI-100	30.00	HMI-50	31.50	LMI-2500	31.50
BMI-120	30.00	HMI-100	31.50	LMI-3000	31.50
BMI-150	30.00	HMI-200	31.50	LMI-4000	31.50
BMI-200	30.00	HMI-300	31.50	LMI-5000	31.50
BMI-240	30.00	HMI-400	31.50	LMI-10000	31.50
BMI-300	30.00	HMI-500	31.50	LML-1000	31.50
BMI-400	30.00	HMI-800	31.50	LML-1500	31.50
BMI-500	30.00	HMI-1000	31.50	LML-2000	31.50
BMI-750	30.00	HMI-2000	31.50	LML-2500	31.50
BMI-800	30.00	HMI-3000	31.50	LML-3000	31.50
BMI-1000	30.00	HML-200	39.00	LML-4000	31.50
BMI-1500	30.00	HML-300	39.00	LML-8000	31.50
BMI-2000	30.00	HML-500	39.00	LML-10000	31.50
BMI-3000	30.00	HML-1000	39.00	LML-12000	31.50
BMI-4000	30.00	LMI-100	31.50		
BMI-5000	30.00	LMI-200	31.50		
BMI-10000	30.00	LMI-400	31.50		
BML-400	30.00	LMI-500	31.50		

For NEW Filters See Pages 2 & 3.

These units provide almost the same characteristics as the standard interstage units listed to the left, although extremely miniaturized. Hermetically sealed to MIL-F-18327C specs. B type case: 3/4" x 3/4" x 1 1/8" h.; wt., 1 oz. H and L cases: 1" x 1" x 1 3/8" h.; wt., 2 1/4 oz. Cutoff frequencies in Hz indicated by type number. BPM units (BAND PASS) have 2:1 gain. Attenuation is approximately 2 db ±3% from center frequency, and 35 db per octave as shown. Input 10,000 ohms, output to grid, tapped for 10,000 ohms to provide for transistor circuits. For tube circuits continuity is on grid side, for transistor use continuity is on input side. BPH units (BAND PASS) attenuation less than 3 db ±5% from center frequency, and 40 db per octave. Source and load 500 ohms. HPM units (HIGH PASS) are down less than 6 db at cutoff frequency, and more than 30 db at .67 cutoff frequency, 40 db at 6 cutoff frequency. Input and output 10,000 ohms. LPM units (LOW PASS) are down less than 6 db at cutoff frequency, and more than 30 db at 1.5 cutoff frequency, 40 db at 1.65 cutoff frequency. Input and output 10,000 ohms.

UTC Type	Sugg. Ea.	UTC Type	Sugg. Ea.	UTC Type	Sugg. Ea.
BPH-50000	\$27.00	BPM-2500	\$27.00	HPM-1500	\$30.00
BPH-100000	27.00	BPM-3000	27.00	HPM-4000	30.00
BPM-400	27.00	BPM-3200	27.00	LPM-200	30.00
BPM-440	27.00			LPM-300	30.00
BPM-500	27.00	BPM-4000	27.00	LPM-500	30.00
BPM-600	27.00	BPM-4800	27.00	LPM-1000	30.00
BPM-750	27.00	BPM-5000	27.00	LPM-1500	30.00
BPM-800	27.00	BPM-6000	27.00	LPM-2000	30.00
BPM-1000	27.00	BPM-6400	27.00	LPM-3000	30.00
BPM-1200	27.00	BPM-8000	27.00	LPM-5000	30.00
BPM-1500	27.00	BPM-10000	27.00	LPM-6000	30.00
BPM-1600	27.00	BPM-20000	27.00	LPM-8000	30.00
BPM-1800	27.00	HPM-500	30.00	LPM-10000	30.00
BPM-2000	27.00	HPM-1000	30.00	LPM-15000	30.00

NEW 400-CYCLE 115 V. LINE FILTERS

Intended for use on 115 v., 400 cps line to eliminate harmonic distortion.



UTC No. PLF-25 — Gives 150 v. output into 500 ohm load with ±1 db, 375-425 Hz. Will attenuate 800 Hz by 30 db; 1200 Hz and higher by at least 50 db. MIL type, FR4RX11NB1. Meets MIL-F-18327C. Size 4 1/2" w x 5 1/2" d. x 5 1/2" h. Weight, 10 lbs. Suggester Net Each.....\$66.00

UTC No. PLP-13 — Eliminates harmonic distortion, rejects 60 and 120 Hz, and gives zero phase shift at 400 Hz. Operating into 1000 ohm load, provides 115 v. output at 400 Hz, within ±1 db, 375-425 Hz. Attenuates 800 Hz by 15 db; 1200 Hz by 45 db; above 1200 Hz by at least 35 db; 120 Hz by 20 db; and, 60 Hz by 30 db. MIL type FR4RX22-LB1; meets MIL-F-18327C specifications. Size, 3 1/4" w x 4 1/2" d. x 4 1/2" h. Weight, 6 1/2 lbs. Suggested Net Each.....\$66.00

TELEGRAPH TONE CHANNEL FILTERS

UTC band pass filters for multiplex transmitting and receiving provide maximum stability in miniature sizes. Stock filters cover all standard transmit and receive bands. All units employ 7 terminal header matching subminiature 7 pin socket.

TGR (receiving) & TGT (transmitting) filters are

TGT CASE
1 1/2 x 1 1/2 x 2 1/2
Mtg 1 1/8 x 1 1/8"
Screws6-32
Weight8 oz.



TGR CASE
1 1/2 x 1 1/2 x 4 1/4
Mtg 1 1/8 x 1 1/8"
Screws6-32
Weight15 oz.

UTC Type	Sugg. Net Ea.	Center Frequency (Hz)	UTC Type	Sugg. Net Ea.
TGT-425	\$42.00	425	TGR-425	\$72.00
TGT-595	42.00	595	TGR-595	72.00
TGT-765	42.00	765	TGR-765	72.00
TGT-935	42.00	935	TGR-935	72.00
TGT-1105	36.00	1105	TGR-1105	63.00
TGT-1275	36.00	1275	TGR-1275	63.00
TGT-1445	36.00	1445	TGR-1445	63.00
TGT-1615	36.00	1615	TGR-1615	63.00
TGT-1785	33.00	1785	TGR-1785	60.00
TGT-1955	33.00	1955	TGR-1955	60.00
TGT-2125	33.00	2125	TGR-2125	60.00
TGT-2295	33.00	2295	TGR-2295	60.00
TGT-2465	30.00	2465	TGR-2465	57.00
TGT-2635	30.00	2635	TGR-2635	57.00
TGT-2805	30.00	2805	TGR-2805	57.00
TGT-2975	30.00	2975	TGR-2975	57.00
TGT-3145	30.00	3145	TGR-3145	57.00
TGT-3315	30.00	3315	TGR-3315	57.00

IMMEDIATE DELIVERY ON ALL ITEMS

TELEMETERING BAND PASS FILTERS

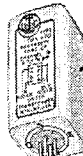

TMN-4 thru
TMN-1.7
1 1/2 x 1 1/2 x 2"
Weight 3.5 oz.
TMN-2.3 thru
TMW-70
3/32 x 3/32 x 1 3/8"
Weight 1.2 oz.

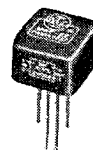

MNF-5.4 thru
MNF-5.4
1 1/2" Sq. x
1/2" high
Weight 1 oz.
MNF-7.35 thru
MWF-70
3/32" Sq. x
1/2" high
Weight 1/30z.

Both TMN and TMW types are designed for 100 K input and output impedance and have an insertion loss of less than 3 db. Four pin hermetic header matches small Winchester socket.

TMN filters are down less than 3 db at ± 7.5% of center frequency. They are down more than 18 db at ± 25% of center frequency. Attenuation is greater than 40 db beyond 1.75 Fc and .58 Fc. TMW filters are down less than 3 db at ± 15% of center frequency. They are down more than 20 db at ± 50% of center frequency. Attenuation is greater than 40 db beyond 2.5 Fc and .4 Fc. MNF and MWF (Minifilter) provide same performance as filters described above but are extremely miniaturized. Slanted toward use with transistors. Pin terminals ideally suited for printed circuits.

UTC Type	Sugg. Net Ea.	Center Frequency kHz	Band Width ±	UTC Type	Sugg. Net Ea.
TMN-.4	\$39.00	.4	7 1/2%	MNF-.4	\$39.00
TMN-.56	39.00	.56	7 1/2%	MNF-.56	39.00
TMN-.73	39.00	.73	7 1/2%	MNF-.73	39.00
TMN-.96	39.00	.96	7 1/2%	MNF-.96	39.00
TMN-1.3	39.00	1.3	7 1/2%	MNF-1.3	39.00
TMN-1.7	39.00	1.7	7 1/2%	MNF-1.7	39.00
TMN-2.3	39.00	2.3	7 1/2%	MNF-2.3	39.00
TMN-3.0	39.00	3.0	7 1/2%	MNF-3.0	39.00
TMN-3.9	39.00	3.9	7 1/2%	MNF-3.9	39.00
TMN-5.4	39.00	5.4	7 1/2%	MNF-5.4	39.00
TMN-7.35	39.00	7.35	7 1/2%	MNF-7.35	39.00
TMN-10.5	42.00	10.5	7 1/2%	MNF-10.5	42.00
TMN-14.5	42.00	14.5	7 1/2%	MNF-14.5	42.00
TMN-22	42.00	22	7 1/2%	MNF-22	42.00
TMN-30	42.00	30	7 1/2%	MNF-30	42.00
TMN-40	42.00	40	7 1/2%	MNF-40	42.00
TMN-52.5	42.00	52.5	7 1/2%	MNF-52.5	42.00
TMN-70	42.00	70	7 1/2%	MNF-70	42.00
TMW-22	42.00	22	15%	MWF-22	42.00
TMW-30	42.00	30	15%	MWF-30	42.00
TMW-40	42.00	40	15%	MWF-40	42.00
TMW-52.5	42.00	52.5	15%	MWF-52.5	42.00
TMW-70	42.00	70	15%	MWF-70	42.00

HIGH Q PRECISION INDUCTANCE DECADE

Invaluable instruments for design and experimental work with tuned circuits, wave filters, and equalizers. The low hum pickup toroid coils employ a new permalloy dust core which, combined with special winding methods, provides very high Q, excellent voltage and temperature stability, and high self resonance frequency. The inductance values are laboratory adjusted to better than 1% precision, with calibration noted on base.

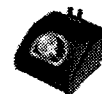

DI CASE
Length4 1/2"
Width4 3/8"
Height2 3/8"
Weight2 lbs.

Type No.	Induct. Henries	Optimum Range	Max. Q	Max. ACma	Ins. Test Volts RMS	Sugg. Net Ea.
DI-1	10 x .01	2-60 KC	200	500	500	\$42.00
DI-2	10 x .1	.25-20 KC	200	150	500	54.00
DI-3	10 x 1	.25-10 KC	200	50	500	57.00
DI-4	10 x 10	2-1.5 KC	100	15	500	72.00



HIGH Q COILS & INDUCTORS

Designed, Manufactured and Successfully Tested to Complete MIL-T-27B Specifications.

MINIDUCTORS *

For NEW Inductors See pages 1 & 3.

All these ultracompact high Q units are grade 5, hermetically sealed to (MIL-T-27B). All give extra temperature stability rated at 1%, -55° C to +100° C.

MM-Ultraminiature epoxy molded toroidal inductors with pin terminals for printed circuit application. Maximum Q at 30 kHz. 3/16 dia. x 1/4" h.; wt. .07 oz.

MH-Ultraminiature epoxy molded toroidal inductors similar to MM except maximum Q at 100 kHz. Size & wt. as MM.

ML-Ultraminiature hermetically sealed inductors with epoxy board and pin terminals for printed circuit application. Maximum Q at 800 Hz to 2 kHz, depending on inductance. 3/16 x 3/16 x 3/16; wt. 2 oz.

MO-Miniature epoxy molded inductors with pin terminals for printed circuit application. Maximum Q at 600 Hz to 1500 Hz depending on inductance. 3/16 x 1/4 x 1/4; wt. 1 oz.

MW-Miniature epoxy molded toroidal inductors with pin terminals for printed circuit application. Maximum Q at 5 to 10 kHz: 3/16 dia. x 1/4; wt. .25 oz.



Table with columns: UTC Type, Induct. Hys., Sugg. Net Ea., UTC Type, Induct. Hys., Sugg. Net Ea., UTC Type, Induct. Hys., Sugg. Net Ea., UTC Type, Induct. Hys., Sugg. Net Ea.

HIGH Q TOROID INDUCTORS

Favorites for over fifteen years, UTC HQ Toroids are only excelled by the preferred new "M" series. As typical Q curves show, HQ coils are available for application from 100 Hz to 100 KHz. Adjusted to 1%, the inductance is virtually independent of frequency, temperature, and vibration. Voltage stability is excellent, and shielding case assures 80 db coupling attenuation. Hermetically to MIL-T-27B. All units MIL type TF4RX-20YY.



HQA and HQC CASE Diameter 1 1/16" Height 1 1/8" Mounting 1 1/8" Screws 6-32 Cutout 3/8 x 1 1/8" Weight 5 oz.

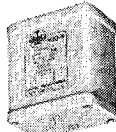

HQB CASE Length 2 5/8" Width 1 5/8" Height 2 5/8" Mounting 1 1/4 x 2 1/4" Screws 6-32 Cutout 3/8 x 1 1/8" Weight 14 oz.



HQC CASE Length 1 1/16" Width 1 1/8" Height 1 1/8" Mounting 3/4" Screws 4-40 Cutout 5/8 x 1 1/2" Weight 1.5 oz.

Table with columns: Type No., Inductance (O DC), DC ma Max., Sugg. Net Ea. Each, Type No., Inductance (O DC), DC ma Max., Sugg. Net Ea. Each, Type No., Inductance (O DC), DC ma Max., Sugg. Net Ea. Each.

HERMETIC "M" TYPE TOROIDS

UTC permalloy dust toroids provide highest Q factor with miniaturized dimensions. Lab adjusted to 1% tolerance and sealed to MIL-T-27B specs. Magnetic case plus toroid provide 80 db shielding.

Table with columns: Type, Induct. Hys., Sugg. Net Ea., Type, Induct. Hys., Sugg. Net Ea., Type, Induct. Hys., Sugg. Net Ea., Type, Induct. Hys., Sugg. Net Ea.



TQA units are similar to MQA but enter tapped for oscillator application, etc. Net each: TQA-1 thru TQA-15, \$1.50 more than MQA's; TQA-16, 14.70; TQA-17, 15.90; TQA-18, 17.40; TQA-19, 21.00; TQA-20, 23.40.

Table with columns: UTC Type, Induct. Hys., Sugg. Net Ea., UTC Type, Induct. Hys., Sugg. Net Ea., UTC Type, Induct. Hys., Sugg. Net Ea., UTC Type, Induct. Hys., Sugg. Net Ea.

VARIDUCTORS

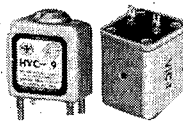

These variable inductors are ideal for use in tuned circuits, equalizers, oscillators, etc. TYPE HVC—Gives highest Q and stability; adjustable -70% to +200% of mean value. Hermetically sealed to MIL-T-27B.

HVV Types: For precise matching; vernier inductance variation ±10% of nominal value. Offer high Q over a wide frequency range and high temperature stability.

HVC & HVV (*VIC is not a MIL item)

Size: HVC, TVC and HVV types, 1 1/8" lg. x 3/8" w. x 1 1/4" h.; weight 2 oz. VIC type, 1 1/8" lg. x 1 1/4" w. x 1 1/4" h.; weight 5/2 oz. TVC type inductors are identical to HVC units, but provide taps at 30% and 50% of total turns—ideal for oscillator circuits, etc. HVC & TVC: U. S. Pat. No. 2,879,489. HVV: U. S. Pat. No. 3,267,400.

Table with columns: UTC Type, Mean Hys., DC ma, Sugg. Net Ea., UTC Type, Mean Hys., DC ma, Sugg. Net Ea., UTC Type, Mean Hys., DC ma, Sugg. Net Ea., UTC Type, Mean Hys., DC ma, Sugg. Net Ea.

LOW FREQUENCY HIGH Q COILS

MLQ TYPES

All these units of MIL type TF4RX20YY induct value to 2% tolerance at 1v., 60 Hz. Exceptional Q and stability; inductance swing less than 3.5% from -55°C to +85°C. The case, sealed hermetically to MIL-T-27B is 1 1/8" dia. 2 1/2" h. Transformer, parallel, series or center-tapped connections are permitted due to dual windings to 4 terminals. Mounting 1 1/4" sq. with a 6-32 screw. Cutout 1 1/2" dia wt. 1 lb.

Table with columns: Type No., Hys. (O DC) Parallel, Sugg. Net Ea., Type No., Hys. (O DC) Parallel, Sugg. Net Ea., Type No., Hys. (O DC) Parallel, Sugg. Net Ea., Type No., Hys. (O DC) Parallel, Sugg. Net Ea.

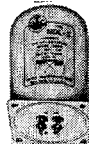

MQM TYPES

Designed for high Q at low frequencies. Structure provides exceptional stability, adjusted to 2% at 1v., 60 Hz. Inductance variation less than 2% from -55°C to +130°C. Made to MIL-T-27B, MIL type TF4SX20YY. Size 1 1/8" d x 1 1/8" h., cutout: 1" d., wt. 5 oz.

Table with columns: Type No., Series Hy (O DC), Parallel Hy (O DC), Series DCR ±20%, Sugg. Net Ea.



HI-FI & BROADCASTING COMPONENTS

ULTRACOMPACT* HI-FI AUDIOS

Small light weight, wide range units. Level +15 dbm except where otherwise noted. Top and bottom mounting. Die cast case, 1 1/2" x 1 1/2" x 2" h. Weight, 1/2 lb.

ALSO SEE PAGE 2 FOR NEW A-48 UNIT

Table with columns: UTC Type, Application, Primary Impedance, Sec. Imped., #, Sugg. Net Ea. Lists various audio components like A-10 to A-44.



LINEAR STANDARD* TRANSFORMERS

Guaranteed frequency response of ±1 db 20-20,000 Hz, ±1 db 7-50,000 Hz on high level units, make these ideal transformers for uniform frequency response and low distortion.

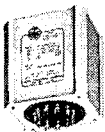

LOW LEVEL TRANSFORMERS

Type LS-1 case, 2 5/8" x 3 3/8" x 3 1/4" h. Suffix X indicates multiple alloy shield. Weight, 3 lbs.

Table with columns: UTC Type, Application, Pri. Imp., Sec. Imp., Level, Sugg. Net Ea. Lists low level transformer models like LS-10, LS-10X, etc.

HIGH LEVEL TRANSFORMERS

Table with columns: UTC Type, Application, Pri. Imp., #, Level Watts, Sugg. Net Ea. Lists high level transformer models like LS-33, LS-34, etc.

HIPERMALLOY* TRANSFORMERS

Hipermalloy audio and power transformers are specifically designed for portable and compact service. High fidelity though light in weight and dependable.

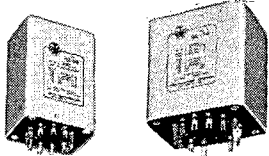

Table with columns: TYPE H-2 CASE, TYPE H-1 CASE. Lists dimensions and weights for different transformer types.

LOW IMPEDANCE TO GRID AND MIXING TRANSFORMERS Units Housed in Type H-1 Case

Table with columns: UTC Type, Application, Primary Imped., Sec. Imped., Level dbm, Sugg. Net Ea. Lists low impedance transformer models like HA-100, HA-100X, etc.

*High electrostatic shielding.

INTERSTAGE AUDIO TRANSFORMERS Units Housed in Type H-1 Case, except HA-107: in H-2 Case

Table with columns: UTC Type, Application, Primary Imped., Sec. Imped., Level Mw., Sugg. Net Ea. Lists interstage transformer models like HA-104, HA-105, etc.

Continued on next column

Continued from bottom of previous column PLATE TO LINE TRANSFORMERS Units Housed in Type H-1 Case

Table with columns: UTC Type, Application, Prim. Imped., Sec. Imped., Level mw, Sugg. Net Ea. Lists plate to line transformer models like HA-113, HA-114, HA-1133.

OUTPUT TRANSFORMERS Units Housed in Type H-2 Case

Table with columns: UTC Type, Application, Prim. Imped., Sec. Imped., Level Watts, Sugg. Net Ea. Lists output transformer models like HA-134, HA-135, HA-136.

POWER TRANSFORMERS

Table with columns: UTC Type, Application, Pri. Volt, Hi-Volt, Fil. Wind, Sugg. Net Ea. Lists power transformer models like HP-122, HP-123.

UNITED TRANSFORMER COMPANY DIVISION OF TRW INC.

UTC PAGE 11. *UTC Trade Mark. All Product Lines or Type Designations are UTC Trade Marks. Specify by Trade Mark to assure UTC high quality and reliability. ©1968 United Transformer Co., Div. of TRW INC.



COMMERCIAL GRADE COMPONENTS

DIMENSIONS, COMMERCIAL GRADE "RC" CASE

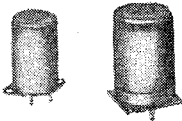

Performance insured during constant usage due to the ruggedness of this vacuum impregnated component with special sealing compound. Case, finished in light gray enamel, is ready for mounting on chassis. (All audio components linear).

Case No.	Base Dim. (Sq.)	Mounting Dim. (Sq.)	Ht., +1/8, -1/16	Cutout Dia.	Unit Wt. (Lbs.)
RC-37	1 3/8	1 1/8	1 5/8	1 1/4	.35
RC-50	1 3/8	1 3/8	2 1/4	1 1/2	1/2
RC-62	1 13/16	1 1/2	2 1/2	1 1/2	1
RC-75	2 3/16	1 3/8	2 7/8	1 7/8	1 1/2
RC-87	2 3/16	2 3/8	3 1/4	2	2 1/2
RC-100	3	2 3/8	3 3/4	2 5/8	3 1/2
RC-112	3 1/16	2 1/16	4 1/8	2 7/8	5
RC-125	3 3/4	3	4 1/2	3	6 1/2
RC-150	4 1/2	3 3/8	5 1/2	3 3/4	11
RC-152	5 1/8	4 1/8	5 1/2	4	15 1/2
RC-175	5 3/4	4 7/8	7	4	22

AUDIO UNITS

UTC Type	Use †	Pri. Imped., Ohms	Level	Case RC-	Sugg. Net Ea.
CG-131	a	15K	+28 dbm	50	\$13.50
CG-132	b	15K	+30 dbm	62	13.50
CG-133	c	30K CT	+32 dbm	75	13.50
CG-134	d	50, 200, 500	+30 dbm	50	11.40
CG-135	e	50, 200, 500	+30 dbm	50	12.90
CG-235	f	50, 200, 500	+28 dbm	75	21.00
CG-136	g	15K, 50, 200	+30 dbm	62	18.00
CG-137	h	50, 200, 500	+28 dbm	50	10.80
CG-140	i	15K	+30 dbm	50	9.90
CG-141	j	30K CT	+32 dbm	50	9.60
CG-233	k	30K CT	+35 dbm	87	15.00
CG-333	k	30K CT	+35 dbm	87	15.00
CG-433	k	5K CT	10 w.	100	12.00
CG-15	l	8K CT	20 w.	100	13.50
CG-16	l	3K/5K CT	20 w.	100	14.70
CG-19	l	6K/10K CT	20 w.	100	14.40
CG-710	l	14K/20K CT	20 w.	100	18.00
CG-2L6	l	9K CT	30 w.	125	16.50
CG-20	m	5K CT, 43% screen taps	25 w.	125	18.00
CG-21	m	3.3K CT, 40% screen taps	50 w.	150	24.00
CVP-1	n	3K/5K/6K/8K/10K/14K CT	12 w.	100	16.80
CVP-2	n	"	30 w.	125	18.90
CVP-3	n	"	60 w.	150	27.00
CVP-4	n	"	125 w.	152	33.00
CVP-5	n	"	300 w.	175	48.00
CVL-1	p	500	15 w.	87	12.00
CVL-2	p	500	40 w.	125	18.00
CVL-3	p	500	75 w.	150	21.00
CVM-0	q	Any Class B	12 w.	100	14.10
CVM-1	q	"	30 w.	125	18.00
CVM-2	q	"	60 w.	150	22.50
CVM-3	q	"	125 w.	152	30.00
CVM-4	q	"	300 w.	175	54.00
CVM-5	q	"	600 w.	†	168.00
CG-51AX	r	15K	5 w.	87	15.00
CG-53AX	r	3K/10K/CT	20 w.	112	15.00
CG-59AX	r	50, 200, 500	20 w.	112	15.00

† 7" x 12" x 9"; Wt., 60 lbs. †a—Pl. to grid. b—Pl. to 2 grids. c—2 pl. to 2 grids. d—Input, humbucking. e—P-p input, humbucking. f—Input, mag. shielded. g—Dual input, humbucking. h—Mixing. i—Pl. to line. j—P-p to line. k—Driver. l—Output. m—Feedback output. n—Universal output. p—Universal matching. q—Universal modulator. r—Universal driver.

SWINGING INPUT AND FILTER INDUCTORS

UTC Type	Induct. Henries	DC ma	DC Res. Ohms	Test Volts	Case No.	Sugg. Net Ea.
CG-40	10	200	110	1750	RC-112	\$10.20
CG-44	30	100	400	1750	RC-100	8.10
CG-45	250	15	5000	1750	RC-87	7.50
CG-48C	75	50	2200	1750	RC-87	9.00
CG-100	12	150	110	2500	RC-125	10.50
CG-102	12	250	100	3000	RC-150	15.60
CG-104	10	350	90	5000	RC-152	18.90
CG-108	10	500	52	7000	RC-175	30.00
CG-15	10	1000	40	9000	11 1/2 x 4 3/4 x 6 7/8 H. Wt., 40 lbs.	75.00
CG-101	25/5	150	110	2500	RC-125	10.50
CG-103	25/5	250	100	3000	RC-150	15.60
CG-105	25/5	350	90	5000	RC-152	18.90
CG-109	25/5	500	52	7000	RC-175	30.00
CG-111§	100/10mh	2.5a.	.6	1500	RC-87	11.40
(2 wdgs)‡	25/2.5mh	.5a.	.15			
CG-112§	40/10mh	6 a.	.24	1500	RC-112	12.60
(2 wdgs)‡	10/2.5mh	12 a.	.06			
CG-113§	7/1.75mh	17.5a.	.036	1500	RC-125	14.70
(2 wdgs)‡	1.8/45mh	35 a.	.009			
CG-1C	25/5	1000	40	9000	11 1/2 x 4 3/4 x 6 7/8 H. Wt., 40 lbs.	75.00

§ Split winding in series. †Wt., 40 lbs. ‡ Split winding in parallel.

END CASTING UNITS

See note on "W" suffix units under plate transformers.

PLATE TRANSFORMERS

Primaries for 105, 115, 220, 230 volts; 50/60 Hz. For reduced power, secondary can be cut in half, using 220 v. primary on 110 volts; may be used on 25 to 43 Hz in this case. "W" suffix units designed for full wave center tap and full wave bridge application. Center tap may be disconnected from ground.

UTC Type	High Voltage	DC Volts	Case No.	Sugg. Net Ea.
CG-300	625-515-0-515-625	500/400	RC-150	\$21.00
CG-300W	625-515-0-515-625	1000/800	RC-150	22.50
CG-301	580-530-300-0-300-530-580	475/425/250	RC-152	33.00
CG-301W	580-530-300-0-300-530-580	950/850/500	RC-152	36.00
CG-302	950-750-0-750-950	760/610	RC-175	39.00
CG-302W	950-750-0-750-950	1520/1220	RC-175	42.00
CG-303	1500-1235-400-0-400-1235-1500	1250/1000	RC-175	43.50
CG-303W	1500-1235-400-0-400-1235-1500	2500/2000	RC-175	48.00

POWER AND BIAS TRANSFORMERS

Primary 115 volts, 50/60 Hz. DCma is for choke input; reduce 70% for condenser input. Filament 1 is 5 volts, 3 amps., and Filament 2 is 5 volts, 2 amps., except as otherwise noted.

UTC Type	High Voltage	DC ma	Filament 3	Filament 4	Case No.	Sugg. Net Ea.
CG-422	435-365-0-365-435	125	6.3 VCT-3A	2.5 VCT-5A	RC-150	\$27.00
CG-428	500-0-500	250	6.3 VCT-4A	6.3 VCT-3A, tapped 2.5 VCT-3A	RC-152	31.50
CG-429*	600-525-0-525-600	250	7.5 VCT-3A, tapped 6.3 VCT-4A		RC-152	31.50
CG-431†	500-400-0-400-500	500	6.3 VCT-5A	6.3 VCT-3A	RC-175	42.60
CG-315	Tapped for any DC voltage from 15 to 100 volts within 6%—250 MA				RC-125	16.50
CG-316	Tapped for any DC voltage from 75 to 400 volts within 6%—250 MA				RC-152	27.00

*Filament 2 is 6.3 VCT-3A. †Filament 1 is 5V-6A.

UCT Type	High Volt	DC Volt	L	W	H	Wt. Lbs.	Sugg. Net Ea.
CG-304	1500-1235-0-1235-1500	1.25K	1K 14 5/8	8 1/2	10 3/8	100	\$198.00
CG-304W†	1500-1235-0-1235-1500	2.5K	2K 14 5/8	8 1/2	10 3/8	100	219.00
CG-305	2400-1750-0-1750-2400	2K 1.5K	10 1/2	4 3/4	6 7/8	50	75.00
CG-305W†	2400-1750-0-1750-2400	4K	3K 10 1/2	4 3/4	6 7/8	50	81.00
CG-306	as above	2K 1.5K	13 7/8	8 1/2	10 3/8	100	174.00
CG-306W†	as above	4K	3K 13 7/8	8 1/2	10 3/8	100	186.00
CG-307	3500-3000-2400-0-2400-3000-3500	3K 2.5K	13 5/8	8 1/2	10 3/8	90	183.00
CG-308	as CG-307	3K 2.5K	15 1/8	8 1/2	10 3/8	125	225.00
CG-309	as CG-307	3K 2.5K	21	10	13 1/4	253	450.00
CG-310	4600-4050-3500-0-3500-4050-4600	4K 3.5K	17 1/4	10	13 1/4	150	420.00
CG-311	1500-1235-0-1235-1500	1.25K	1K 10 1/2	4 3/4	6 7/8	50	75.00
CG-311W†	1500-1235-0-1235-1500	2.5K	2K 10 1/2	4 3/4	6 7/8	50	78.60
CG-312	1800-1500-0-1500-1800	1.5K 1.25K	10 1/2	4 3/4	6 7/8	38	81.00

† Full Wave Bridge Rectifier types.

VARIPOWER * AUTOFORMERS

Simultaneous control of filament, plate and line voltage. Filament voltage control within 2 1/2%. Output voltage from 0 to 130 volts, 50/60 Hz. Taps at 25, 55, 75, 95, 100, 105, 110, 115, 120, 125, and 130 volts.

UTC Type	Watts Output	Case No.	Sugg. Net Ea.	UTC Type	Watts Output	Case No.	Sugg. Net Ea.
CVA-1	150	RC-112	\$13.50	CVA-4	1000	RC-152	\$27.00
CVA-2	250	RC-125	18.00	CVA-5	2000	RC-175	42.60
CVA-3	500	RC-150	22.50				

UNITED TRANSFORMER COMPANY DIVISION OF TRW INC.



MINIATURE, OUNCER, SUBOUNCER & SUB-SUBOUNCER UNITS

SUBOUNCER* & SUB-SUBOUNCER* AUDIO TRANSFORMERS
TRANSISTOR & TUBE TYPES HERMETICALLY SEALED

Designed, Manufactured and Successfully Tested to complete MIL - T - 27B Specifications.

UTC SSO-#P and SO-#P units are ideal miniaturized components having high efficiency and wide frequency response. Special nickel iron core materials and winding methods provide exceptional performance and reliability.

These units are vacuum molded to MIL Grade 5. They employ 50 mil deeply anchored pin terminals ideally suited for printed circuit and transistor application. Terminals are strong enough to support these light weight units.

The UTC SML-70 is an ultra miniature transformer providing high shielding, extremely low insertion loss with wide band response, 200 Hz to 20 kHz. These units are provided with pin terminals (.025 dia.) strong enough to support the unit and are ideal for printed circuits.

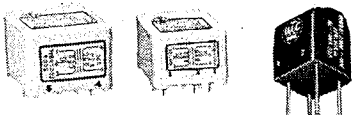

SO-#P UNIT	SSO-#P UNIT	SML-70
Dim. 1/4" x 1/2" x 1/8"	Dim. 3/4" x 1/2" x 1/8"	1/2" x 3/4" x 1/8"
Pin Length 1/2"	Pin Length 1/2"	Wt. .2 oz.
Wt.05 lb.	Wt.04 lb.	

PRINTED CIRCUIT AUDIO UNIT — HIPERMALLOY SHIELD CASE

Type No.	Application	Pri. Imp. ohms	Sec. Imp. ohms	Sugg. Net Ea.
SML-70	Input or Chopper Service	200K	1K	\$8.40

MIL TYPE: TF5RX16ZZ.

PRINTED CIRCUIT MOLDED TYPES TO MIL GRADE 5

Type No.	Application	Pri. Imp. ohms	Sec. Imp. ohms	Sugg. Net Ea.
SO-2P	Interstage/3:1	10K	90K	\$6.90
SO-3P*	Plate to Line	10K	200	6.90
		25K	500	
SO-5P	Inductor: 40 hy at 1 ma, 2675 ohms, series; 4 hy at 4 ma, 670 ohms, parallel;			6.90
SO-7P*	Transistor	20K	800	6.60
	Interstage	30K	1200	
SO-8P	Transistor to PP Sec.	10K	2000 CT	7.50
SO-9P	PP Transistor to V.C.	500 CT	3.2	7.50
SO-14P	Transistor	80 CT	32 Split	7.80
	Interstage	100 CT	40 Split	
SO-15P	Tr. output	600 CT	600 Split	7.80
SO-17P	Inductor: 16 hy at 2 ma, 1.1K ohms, series; 4 hy at 4 ma, 275 ohms, parallel;			6.90
SO-18P	Tr. output	50K CT	600 Split	7.80

MIL TYPES: TF5RX13ZZ: SO-3P, SO-7P, SO-8P, SO-18P; TF5RX15ZZ: SO-2P; TF5RX17ZZ: SO-9P, SO-14P, SO-15P, SO-17P; TF5RX20ZZ: SO-5P.

SSO-3P	Plate to line	10K	200	\$7.20
		25K		
SSO-5P	Inductor: 100 hy at 0 ma, 4.4K ohms, series; 25 hy at 0 ma, 1.1K ohms, parallel			6.90
SSO-8P	Transistor topp sec.	10K	2000 CT	7.20
SSO-14P	Transistor	10K CT	200 CT	7.50
	Interstage	25K CT	500 CT	
SSO-15P	Transistor	20K CT	800 CT	7.50
	Interstage	30K CT	1200 CT	
SSO-19P	Output matching	500 CT	600 CT	7.20
SSO-20P	Output	1.5K CT	600 CT	7.20
SSO-21P	Crystal/Chopper	200K CT	1000 CT	8.10
SSO-22P	Interstage	10K CT	1500 CT	7.20
		12K CT	1800 CT	
SSO-23P	Inductor: 8 hy at 2 ma, 600 ohms, series; 2 hy at 4 ma, 150 ohms, parallel			6.90
SSO-24P	Inductor: 3.5 hy at 2 ma, 160 ohms, series; 0.9 hy at 4 ma, 40 ohms, parallel			6.90
SSO-25P	Transistor	10K CT	10K/1	8.10
	Interstage		2.5K spl.	
SSO-27P	Tr. Output	4K CT 2.5 ma	600 spl.	8.10

MIL TYPES: TF5RX13ZZ: SSO-3P, SSO-8P, SSO-14P, SSO-15P, SSO-20P, SSO-22P, SSO-25P, SSO-27P; TF5RX16ZZ: SSO-21P; TF5RX17ZZ: SSO-19P; TF5RX20ZZ: SSO-5P, SSO-23P, SSO-24P.

SUB-SUBOUNCERS* AND SUBOUNCERS*

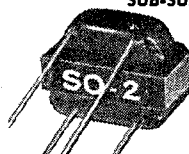

Lead mounted (channel available as separate item) miniature nickel iron core units for transistor or vacuum tube circuits. Plastic mounted leads. SSO Sub-Subouncers: Approx. 2 db, 140-1000 Hz; +20 VU except inputs +7 VU. (1/16" x 3/4" x 3/8"; wt., .02 lb.) SO Subouncers: Approx. 2 db, 100-10,000 Hz; +24 VU except inputs +10 VU. (1/32" x 3/4" x 7/8"; wt., .03 lbs.)

UTC SUGG. Applica- Net Ea. tion	Pri. Imp., Ohms	Sec. Imp., Ohms	UTC SUGG. Net Ea.
1 \$4.50 Input	50/200	62.5K/250K	1 \$3.60
2 4.80 Interstage	10K, 25 ma	90/60	2 3.30
3 4.20 Pl. to line	10K/25K, 1.5 ma	200/500	3 3.30
4 3.90 Output	30K, 1 ma	50	4 3.30
5 3.90 Inductor:	50 hys. @ 1 ma	4400 ohms#	5# 3.00
6 4.20 Output	100K, .5 ma	60	6 3.90
7 3.30 Tr. intrstg.	20K/30K†	80/1200	7 3.00
8 3.90 Tr. intrstg.	10K, 1 ma	2K CT	8 3.60
9 3.00 Tr. to V.C.	10K, 2 ma	16
.....	Tr. to V.C.	500 CT	3.2
10 3.00 Tr. to V.C.	10K, 2 ma	3.2
.....	Tr. to V.C.	2K/4K CT	8/16
11 3.00 Tr. Output	500/600S	50/60
.....	Transist. Int.	400/500 CT	400/500 Split
12 3.00 Tr. Output	1K, 2K††	120/150 Split	11 4.20
.....	Transist. Int.	400/500 CT	1K
13 4.50 Input	200K	40/50 Split	13 4.20
.....	Transist. Int.	10K/25K CT	200/500 CT
14 4.20 Tr. intrstg.	80/100 CT	32/40 Split	14 4.20
.....	Tr. intrstg.	20K/30K CT	.8K/1.2K CT
15 4.20 Tr. output	600 CT, 5 ma	600 Split	15 4.20
.....	Tr. output	1.2K/1.5K††	3.2/4
16 3.00 Tr. intrstg.	2.5K CT, 4 ma	2500 Split	16 4.20
.....	Output	10K/12.5K**	500/600 CT
17 3.30 Inductor: 16 hy at 2ma, 1.1K ohms, series; 4 hy at 4 ma, 275 ohms, parallel;	10K/12.5K CT	3.2/4	17 3.30
.....	Output	50K CT	600 Split
18 3.30 Matching	500 CT	600 CT	18 5.25
.....	Output	1.5K CT	600 CT
20 3.30 Output	200K CT	1K CT
21 4.80 Chopper	10K/12K CT	1.5K/1.8K CT
22 3.90 Tr. intrstg.	10K/12K CT	1.5K/1.8K CT
23 3.00 Inductor: 4 hys @ 5 ma, 650 ohms		
24 3.00 Inductor: 1.5 hys. @ 5 ma, 160 ohms		
25 5.10 Transist. Int.	10K/12K CT	10K/12 CT
26 5.10 Transist. Int.	40K/50K CT	400/500 Split
27 5.10 Tr. output	4K CT, 2.5 ma	600 Split
CH .30 Mounting channel for any of above			CH .30

†0.5 ma. †Resis., 2675 ohms. †3.5 ma. **2 ma. ††3 ma. #DC resis.

OUNCER* AUDIO UNITS

Standard and Plug-in Types



UTC ouncer components provide wide range ±1 db, 30 to 20,000 Hz (except Nos. O-14 and O-15). O unit case: 7/8" Dia x 1 1/2" H, Wt: 1 oz. (except O-16; heavy shielding case 1 1/2" Dia x 1 1/2" H, Wt: 3 oz.) P unit case: 1 1/2" Dia x 1 1/2" H, Wt: 2 oz. (except P-16; heavy shielding case 1 3/8" Dia x 2 3/4" H, Wt: 4 oz.)

UTC No.	Sugg. Net Ea.	Applica- tion	Pri. Imped., Ohms	Sec. Imped., Ohms	UTC No.	Sugg. Net Ea.
O-1	\$7.80	Input	50, 200, 500	50K	P-1	\$9.00
O-2	7.80	P-p input	50, 200, 500	50K CT	P-2	9.00
O-3	7.50	Input	7.5/30	50K	P-3	8.40
O-4	6.60	Pl. to grid	15K	60K
O-5	6.60	Pl. to grid	15K, 2 ma	60K
O-6	7.50	Pl. to p-p	15K	95K CT	P-6	8.40
O-7	7.50	Pl. to p-p	15K, 2 ma	95K CT	P-7	8.40
O-8	7.80	Pl. to line	15K	50, 200, 500	P-8	9.00
O-9	7.80	Pl. to line	15K, 2 ma	50, 200, 500	P-9	9.00
O-10	8.40	P-p to line	30K CT	50, 200, 500	P-10	9.00
O-11	7.80	Cryst. out.	50K	50, 200, 500	P-11	9.00
O-12	7.80	Mixing	50, 200, 500	50, 200, 500	P-12	9.00
O-13	6.30	Inductor	300 Hys-0 ma; 6000 ohms
O-14	7.50	50:1 input	200	500K
O-15	7.50	10:1 P/G	15K	1 meg.	P-15	9.00
O-16	10.20	Shid. input	250 CT	50K	P-16	11.40
O-17	1.50	Hipermalloy shield, 25 db, for Ouncers
O-18	7.80	Tr. intrstg.	10K split	2K split
O-19	7.80	Tr. intrstg.	10K split	4K split
O-20	6.30	Tr. to line	1.5K CT	500 split
O-21	5.40	Tr. to V.C.	2K/4K CT	8/16
O-22	5.40	Tr. to V.C.	500/400 CT	4/3.2
O-23	5.10	Inductor	7 Hys-3 ma; 230 ohms
O-24	5.10	Inductor	1.6 Hys-3 ma; 25 ohms
O-25	8.10	Transist.	600/150 split	2K/500 split
O-26	8.10	Transist. Int.	10K CT 4 ma.	10K CT
O-27	8.40	Transist. Int.	10K CT 4 ma.	500/125 split
O-28	8.40	Transist. Int.	50K CT, 2 ma.	500/125 split
O-29	8.70	Transist. Int.	100K CT 1 ma.	500/125 split
O-30	8.10	Transist. Int.	500/125 split	500/125 split
O-31	8.10	Transist. Int.	500/125 split	150/37.5 split
O-32	8.10	Transist. Int.	500/125 split	50/12.5 split
O-33	8.10	Transist. Int.	100/25 split	40/10 split
O-34	5.10	Split	Series: 60 Mhy-80 ma; 4 ohms
O-35	5.10	Split	Inductor Parallel: 15 Mhy-160 ma; 1 ohm
O-36	5.10	Split	Inductor Parallel: 25 Hy-40 ma; 15 ohms
O-37	8.10	Tr. to line	4K/1K spl., 4 ma	650/150 split
O-38	5.10	Spkr. match	0, 4, 8, 16 ODC
O-BR	.21	Mounting U-bracket for ouncers



AMATEUR & PUBLIC ADDRESS TRANSFORMERS "S" SERIES

DIMENSIONS, SPECIAL SERIES TRANSFORMERS

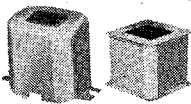

UTC Special Series transformers are specifically designed for amateur and popular-priced PA service. These units are finished in a rich, commercial type medium gray enamel. A recessed terminal strip is provided, permitting above chassis or bread-board wiring in addition to standard chassis type.

G-CASE SIZES

Case	Height, In.	Width, In.	Depth, In.	Wt., Lbs.
G-1	1 7/8	2 1/16	1 3/4	1
G-2	2 3/4	3 3/8	1 15/16	1 1/2
G-3	2 1/2	3 3/4	2 3/32	2
G-4	2 15/16	4 1/8	2 3/8	3
G-5	3 3/4	3 1/8	4 1/2	4 1/2
G-7	4 5/8	4 5/8	5 1/2	8
G-8	4 5/8	5 3/8	5 3/8	12
G-9	5 7/8	5 3/8	6 3/4	21
G-10	5 7/8	6 1/8	6 5/8	24
G-11	5 7/8	6 1/2	7 3/8	31
G-12	10 1/4	7 3/8	9 1/4	52

INPUT AND DRIVER TRANSFORMERS

Type UTC	Application	Ratio Pri. to Sec.	Level	Case	Sugg. Net Ea.
S-1	Plate to grid	1:3 1/2	+30 dbm	G-2	\$ 5.40
S-2	Plate to p-p grids	1:4 †	+30 dbm	G-2	6.60
S-3	Pl. to 1 or 2 grids	1:4 †	+25 dbm	G-1	4.80
S-5	Line to grid, humbkg.	1:16	+30 dbm	G-2	5.70
S-6	Line to grid, compact	1:16	+25 dbm	G-1	4.80
S-8	Driver p-p to p-p	2.66:1, 5:1 †	5 w.	G-3	7.20
S-9	Driver p-p to p-p	2.66:1, 3.6:1 5:1 †	20 w.	G-4	9.60
S-10	Driver p-p to p-p	2.25:1 †	5 w.	G-3	7.20

†Center tapped.

MATCHING, OUTPUT AND MODULATION UNITS

UTC Type	Application	Pri. Imped., Ohms	Level, Watts	Case	Sugg. Net Ea.	
S-11	Pl. to line	15K	.25	G-2	\$ 5.70	
S-12	Line to V.C.	.5K/2K/4K	b	15	G-2	6.00
S-13	Line to V.C.	.5K/2K/4K	b	30	G-4	9.00
S-14	Output	2.5K/4K/7K/10K	c	10	G-2	7.20
S-15	PP output	4K/5K/10K CT	c	12	G-2	7.80
S-16	PP output	3K/6K/9/10K CT	c	30	G-4	9.30
S-17	PP output	3.8K/4.5/5K CT	c	55	G-5	13.20
S-18	Univ. modul.	Any Class B	d	12	G-3	8.40
S-19	Univ. modul.	Any Class B	d	30	G-4	9.90
S-20	Univ. modul.	Any Class B	d	55	G-5	16.50
S-21	Univ. modul.	Any Class B	d	110	G-7	22.50
S-22	Univ. modul.	Any Class B	d	250	G-9	36.00

†Secondary Impedance: a-200/500 ohms. b-2, 4, 8, 15 ohms. c-2, 8, 15, 500 ohms. d-Any Class C.

FILTER, SWINGING AND AUDIO INDUCTORS

Type	Henries	ma DC	Ohms	Insul.	Case	Sugg. Net Ea.
S-23	300	5	5000	1500 v.	G-2	\$ 4.80
S-24	500	3	6000	1500 v.	G-2	5.40
S-25	30	30	800	1500 v.	G-2	4.20
S-26	12	60	250	1500 v.	G-2	4.20
S-27	25	75	350	1500 v.	G-4	5.40
S-28	20	100	350	1500 v.	G-4	6.90
S-29	6	175	90	1500 v.	G-4	5.40
S-30	4/20	175	90	1500 v.	G-4	5.40
S-31	6	225	100	2700 v.	G-5	7.50
S-32	4/20	225	100	2700 v.	G-5	7.50
S-33	8	300	100	4000 v.	G-7	9.90
S-34	4/20	300	100	4000 v.	G-7	10.50
S-35	8	400	60	5000 v.	G-8	12.90
S-36	4/20	400	60	5000 v.	G-8	12.90
S-37	8	550	60	6000 v.	G-8	16.50
S-38	4/20	550	60	6000 v.	G-8	16.50
S-80	50/10 Mhy	1.75A	.5	500 v.	G-1	4.50
S-81	100/8 Mhy	2.5A	.6	1500 v.	G-3	6.60
(2Wdgs)	25/2 Mhy	5A	.15			

§Audio. †P.P. Audio C. T. ‡Swinging.

Information on components in this box listed on UTC page 15.

REPLACEMENT TYPE COMPONENTS

The shells and brackets of these vacuum sealed components are finished in shiny black enamel. A minimum number covers any replacement requirement.

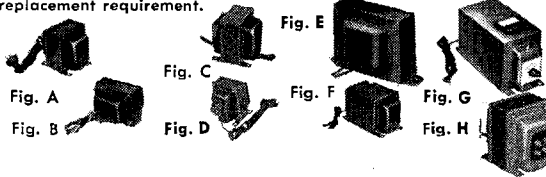

FILAMENT TRANSFORMERS

Primary Tapped 105, 115 Volts, 50-60 Hz.

UTC Type	Secondary Volts	Secondary Current	Insulation	Case No.	Sugg. Net Ea.
S-53	2.5 VCT	10 Amp	1500 V	G-3	\$ 6.90
S-54	5 VCT	4 Amp	2500 V	G-3	6.30
S-55	6.3 VCT	3 Amp	1500 V	G-3	6.00
S-57	2.5 VCT	10 Amp	10000 V	G-5	9.90
S-58	2.5 VCT	20 Amp	10000 V	G-5	10.50
S-59	5 to 5.25 VCT	13 Amp	5000 V	G-5	9.90
S-60	5 to 5.25 VCT	22 Amp	10000 V	G-7	15.00
S-61	7.5 VCT tapped	10 Amp	3000 V	G-5	12.00
S-62	6.3 VCT				
S-62	10 VCT	10 Amp	3000 V	G-5	10.20
S-63	14 VCT tapped	10 Amp	5000 V	G-7	15.00
S-63	12 VCT & 11 VCT				

Type	Filament 1	Filament 2	Filament 3	Case	Sugg. Net Ea.
S-64	2.5 VCT-5A	2.5 VCT-5A	5 VCT-6A	G-5	\$12.00
S-67	5 VCT-6A	6.3 VCT-5A		G-5	11.40
S-68	5 VCT-3A	6.3 VCT-4A	7.5 VCT-5A	G-5	11.70
S-70	6.3 VCT-5A	6.3 VCT-5A		G-5	11.40
S-71	2.5 VCT 6A	2.5 VCT-6A	2.5 VCT-12A	G-7	16.50
S-72	5 VCT-3A	5 VCT-3A	5 VCT-6A	G-5	13.50

§Insulation 10,000 v. †Insulation 5000 v. ‡Insulation 3000 v.

COMBINED PLATE AND FILAMENT TRANSFORMERS

Primary 115 V., 50-60 Hz

UTC Type	DC Voltage	Rect. Fil.	Filament No. 1	Filament No. 2	Case No.	Sugg. Net Ea.
S-39	490-400-0-400-490	400/310	5V-3A	2.5 VCT-6A	6.3 VCT-4A	G-7 \$18.00
S-40	525-425-0-425-525	400/310	5V-3A	6.3 VCT-3A	6.3 VCT-3A	G-7 19.50
S-41	600-0-600-200 ma	475	5 V-3A	7.5 V tapped 6.3 V-3A	6.3 VCT-2A	G-7 19.50
S-42	600-525-0-300 ma	480/400	5 V-6A	7.5 V tapped 6.3 V-3A	6.3 VCT-3A	G-7 21.00

PLATE AND BIAS TRANSFORMERS

Primary 115 V. 50/60 Hz.

UTC Type	2.5 VCT-12A High Voltage	DC Voltages †	DC ma	Case	Sugg. Net Ea.
S-44	575-525-0-525-575	470/430	500	G-9	\$27.00
S-45	900-750-0-750-900	750/620	200	G-8	22.50
S-46	1000-750-0-750-1000	625/600	300	G-9	25.50
S-47	1500-1250-1000-0	1275/1050/825	300	G-10	36.00
S-48	1500-1250-1000-0	1300/1075/850	500	G-11	42.00
S-49	2100-1800-1500-0	1815/1540/1275	300	G-11	39.00
S-50	3000-2500-0-2500-3000	2625/2175	300	G-12	66.00
S-51	Any bias voltage from 15 to 100	± 6%	200	G-5	13.20
S-52	Any bias voltage from 75 to 400	± 6%	200	G-7	18.00

†Based on two section filter for 200 ma. and 300 ma. units. Single section filter for 500 ma. units, both choke input.

**IMMEDIATE DELIVERY
ON ALL UTC STOCK ITEMS
AND SPECIAL CUSTOM BUILT UNITS TO YOUR SPECS.**

UNITED TRANSFORMER COMPANY DIVISION OF TRW INC.

UTC PAGE 14.

*UTC Trade Mark. All Product Lines or Type Designations are UTC Trade Marks. Specify by Trade Mark to assure UTC high quality and reliability. © 1968 United Transformer Co., Div. of TRW INC.



TRANSFORMERS FOR INDUSTRY WIDE APPLICATIONS

DOUBLE SHELL POWER TRANSFORMERS (FIG. B SEE PG. 14)
Rectifier filament 5 volts, 3 amps except R-101, 2 amps.

UTC Type	High V.	DC ma	Amplifier Filament	Overall Height	Wt. Lbs.	Sugg. Net Ea.
R-101	275-0-275	50	6.3 v. CT-2.7A	3"	2 1/2	\$ 8.70
R-102	350-0-350	70	6.3 v. CT-3A	3 5/8"	3 1/2	10.20
R-103	350-0-350	90	6.3 v. CT-3.5A	3 11/16"	4 1/2	10.35
R-104	350-0-350	120	6.3 v. CT-5A	3 7/8"	5 1/2	11.10
R-105	385-0-385	160	6.3 v. CT-5A	4 3/8"	7	12.00

VERTICAL SHELL POWER TRANSFORMERS (FIG. C SEE PG. 14)

Rectifier filaments 5 volts, 3 amps., except R-110, 2 amps.

UTC Type	High V.	DC ma	Amplifier Filament	Overall Height	Wt. Lbs.	Sugg. Net Ea.
R-110	300-0-300	50	6.3 v. CT-2.7A	3 1/4"	2 1/2	\$ 8.70
R-111	350-0-350	70	6.3 v. CT-3A	3 1/4"	3 1/2	10.20
R-112	350-0-350	120	6.3 v. CT-5A	4"	5 1/2	11.10
R-113	400-0-400	200	6.3 v. CT-6A	4 5/8"	8	14.10

CHANNEL FRAME FILTER INDUCTORS (FIG. E SEE PG. 14)

Inductance Shown is at Rated D.C. ma.—Test Volts RMS: 1500

Type No.	Induct. Hys.	Current	Resist. Ohms	Dimensions, in.			Wt. Lbs.	Sugg. Net Ea.
				W	D	H		
R-55	6	40 ma	300	2 3/8	1 3/8	1 3/8	2	1/2 \$ 1.80
R-14	8	40 ma	250	2 7/8	1 1/2	1 1/2	2 3/8	3/4 2.25
R-15	12	30 ma	450	2 7/8	1 1/2	1 1/2	2 3/8	3/4 2.25
R-16	15	30 ma	630	2 7/8	1 1/2	1 1/2	2 3/8	3/4 2.25
R-17	20	40 ma	850	3 1/8	1 5/8	2	2 1/2	1 2.70
R-18	8	80 ma	250	3 3/4	1 5/8	2	2 1/2	1 2.85
R-19	14	100 ma	450	3 3/4	1 7/8	2 1/4	3 1/8	1 1/2 3.45
R-20	5	200 ma	90	4 1/8	2 1/4	2 3/8	3 3/8	2 1/2 3.90
R-21	15/3	200 ma	90	4 1/8	2 1/4	2 3/8	3 3/8	2 1/2 3.90
R-220	100/8	Mhy. 2.5A	.6	3 3/4	2	2 3/8	3 1/8	1 1/2 4.20
	25/2	Mhy. 5A	.16					

PHOTOFASH TRANSFORMERS STANDARD 982

Can be used for either standard (Anglo type) or trigger (Sylvania type) multiple flash tubes. Circuit details included with transformer.

PF-1 Primary for 115 volts, 50/60 Hz. Secondaries for power supply delivering 2200 volts DC to condenser up to 100 Mfd. Compound sealed in G-3 (Pg. 14) case 2 1/8 x 2 3/4 (3 3/4 including flanges) x 2 1/2 inches high. Weight 2 lbs. Suggested net each: \$8.40

PF-3 Trigger Transformer 15 KV peak. 7/8 O.D. x 3 long. Weight 2 oz. Suggested net each: \$6.00



TRANSISTOR TYPE

These are miniaturized light weight units for transistor type photoflash supply.

PF-5 Primary for 115 volts, 50/60 Hz or for 4 1/2 V. battery switched by PF-6 inverter transformer. Output delivers 400 V. DC when used in voltage doubler circuit to charge photoflash capacitor (typically 40 watt-sec.). G-1 case (Pg. 14) Suggested net each: \$8.40

PF-6 Inverter transformer transforms 4 1/2 V. DC from battery to input for PF-5 stepup transformer. Ouncer case (Pg. 14) Suggested net each: \$5.10

PF-7 Trigger transformer. Shorting .25 mfd. capacitor (charged to approx. 225 V. DC) across terminals 1-2 produces 6 KV pulse at terminal 3 for triggering flash tube. 7/8" Dia. x 1 1/8"; Wt. 1/2 oz. Suggested net each: \$3.60

MIL-T-27B CASE SIZES

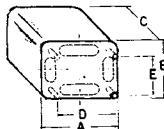

MIL Case	Size, Inches: Dimension					Mtg. Studs
	A	B	C	D	E	
AF	3/4	3/4	1 1/8	Diag.	3/8	4-40 x 3/8
AG	1	1	1 3/8	Diag.	3/4	4-40 x 3/8
AH	1 1/8	1 1/8	1 3/4	Diag.	1 1/4	6-32 x 3/8
AJ	1 3/8	1 3/8	2 3/8	1 3/8	1 3/8	6-32 x 3/8
EA	1 1/2	1 1/2	2 3/4	1 3/8	1 1/4	6-32 x 3/8
EB	1 1/2	1 1/2	2 3/4	1 3/8	1 1/4	6-32 x 3/8
FA	2 1/8	2 1/8	3 1/8	1 1/2	1 3/8	6-32 x 3/8
FB	2 3/8	2 3/8	3 1/2	1 1/2	1 3/8	6-32 x 3/8
GA	2 3/4	2 3/4	3 3/4	1 3/4	1 3/4	6-32 x 3/8
GB	2 3/4	2 3/4	3 3/4	1 3/4	1 3/4	6-32 x 3/8
HA	3 1/8	2 3/8	4 1/4	2 1/8	1 3/4	8-32 x 3/8
HB	3 1/8	2 3/8	3 3/4	2 1/8	1 3/4	8-32 x 3/8
JA	3 3/8	3 3/8	4 7/8	2 5/8	2 1/8	8-32 x 3/8
JB	3 3/8	3 3/8	3 7/8	2 5/8	2 1/8	8-32 x 3/8
KA	3 1/2	3 3/8	5 1/4	3	2 3/8	10-32 x 1/2
KB	3 1/2	3 3/8	4 3/8	3	2 3/8	10-32 x 1/2
LA	4 1/8	3 1/2	5 1/4	3 3/8	2 1/4	10-32 x 1/2
LB	4 1/8	3 1/2	4 1/2	3 3/8	2 1/4	10-32 x 1/2
MA	4 1/2	4	6	3 1/2	3	1/4-20 x 5/8
MB	4 1/2	4	4 1/2	3 1/2	3	1/4-20 x 5/8
NA	5 1/8	4 1/2	6 1/4	4 1/8	3 3/8	1/4-20 x 5/8
NB	5 1/8	4 1/2	5 1/2	4 1/8	3 3/8	1/4-20 x 5/8
OA	5 1/2	4 1/2	6 3/4	3 3/4	3	1/4-20 x 5/8

STEP-DOWN AUTO-TRANSFORMERS (FIG. A SEE PG. 14)

With 6-ft. cord and female receptacle, except R-64; 220/240 to 110/120 v., 50/60 Hz.

UTC Type	Rating	L.	Size, Inches W.	H.	Wt. Lbs.	Sugg. Net Ea.
R-41	85 watt capacity	3 3/8	2 5/8	3 1/8	4	\$ 7.20
R-42	125 watt capacity	3 1/2	3	3 1/2	5	8.70
R-43	175 watt capacity	3 3/4	3 1/4	3 7/8	5 1/2	9.00
R-44	250 watt capacity	4 3/8	3 1/4	3 7/8	6 1/2	12.00
R-45	500 watt capacity	4 3/8	3 1/4	4 3/8	12	13.50
R-46	1200 watt capacity	6 7/8	3 7/8	4 3/8	18	24.00
R-64	2500 watts, no card	10 1/2	4 3/4	6 3/4	30	57.00

ISOLATION TRANSFORMERS (FIG. F SEE PG. 14)

Ideal for isolating line noise. AC-DC sets, etc. Excellent electrostatic shielding 1500 volt breakdown test. Six foot cord and female receptacle, except R-77.

Primary 110-120 volts 50/60 Hz—Secondary 110-120 volts Except R-97 220 volt Primary—120 volt Sec.

Type No.	Rating Watts	L	W	H	Mtg. Dim.	Wgt. Lbs.	Sugg. Net Ea.
R-72	40	3 1/8	2 5/8	3 1/8	2x1 7/8	4	\$ 7.20
R-73	100	3 3/4	3 1/4	3 7/8	2 1/2x2 3/8	6	11.40
R-74	250	4 7/8	3 7/8	4 3/8	3x3 1/2	12	18.00
R-75	600	7 3/8	3 7/8	4 3/8	3x5 7/8	20	24.00
R-76	1200	8 1/2	4 1/2	6 1/8	3 5/8x6 5/8	30	57.00
R-77	2500	12	7	9	6x11	70	111.00
R-97	250	4 7/8	3 7/8	4 3/8	3x3 1/2	12	15.00

LINE VOLTAGE ADJUSTERS WITH METER (FIG. G. SEE PG. 14)

The perfect answer to abnormal or fluctuating line voltage. Adjust switch so that meter reads at red line and you know that your equipment is working at correct voltage. These units combine a tapped auto-transformer with a switch and meter in a compact, rugged assembly. The nine-tap switch provides for line voltage of 60 to 140 volts on 115 volt output models and 160 to 240 volts on 230 volt output model. All units are designed for 50/60 Hz service and come complete with 6 foot input cord and plug and outlet receptacle.

Type No.	Primary Voltages	Sec. Volts	Watts Ratings	L	W	H	Wgt. Lbs.	Sugg. Net Ea.
R-78	†	115	150	7	4	4 3/4	6	\$19.50
R-79	†	115	300	7	4	4 3/4	9	21.00
R-80	†	115	600	10 1/4	4	4 3/4	13	24.00
R-81	†	115	1200	10 1/4	4	4 3/4	21	33.00
R-86	†	230	1200	10 1/4	4	4 3/4	21	33.00
†	60, 70, 80, 90, 100, 110, 120, 130, 140							
‡	160, 170, 180, 190, 200, 210, 220, 230, 240							

EXPORT VOLTAGE ADAPTER (FIG. D SEE PG. 14)

Complete with cord and plug and special locking switch providing for line voltages of 105, 115, 125, 135, 150, 210, 230, 250 volts; 42 to 60 Hz. Output voltage 115.

Type No.	Rating Watts	L	W	H	Mtg. Dim.	Wgt. Lbs.	Sugg. Net Ea.
R-47	85	4 3/8	3	3 1/2	2 1/4x2 1/4	4 1/2	\$12.00
R-48	150	4 3/4	3 1/4	4	2 1/2x2 1/2	5 1/2	12.60

TV VOLTAGE REGULATOR (FIG. D SEE PG. 14)

Complete with cord, plug, and special locking switch. Permits operation of 115 volt 50/60 Hz TV sets on line voltages of 85, 90, 95, 100, 105, 110, 120, 125 V.

Type No.	Rating Watts	L	W	H	Mtg. Dim.	Wgt. Lbs.	Sugg. Net Ea.
R-49	350	5	3 1/4	4	2 1/2x2 3/4	5	\$12.90

SIGNALING AND CONTROL TRANSFORMERS (FIG. H SEE PG. 14)

Primary 110-220 volts, 50/60 Hz — Secondary 4/8/12/16/20/24 volts

High power transformers suitable for operating relays, sirens horns, gongs, etc. from 115 V. 50/60 Hz line. These units have four secondary terminals providing 4, 8, 12, 16, 20 and 24 volt output. The volt ampere rating is based on the 24 volt secondary tap with corresponding reduction at the lower voltages. Underwriters' approved primary leads are employed, and screw-type binding posts.

Type No.	Rating Watts	L	W	H	Mtg. Dim.	Wgt. Lbs.	Sugg. Net Ea.
SC-3	50	3	3 1/8	3 1/8	1 3/4x2 1/4	3	\$8.40
SC-4	100	3 1/4	3 1/8	4	2 1/8x2 1/2	5	9.90
SC-5	250	4	4 3/8	4 3/4	3 3/8x3	10	14.40

INDUSTRIAL DISCOUNTS

Applicable to any UTC products listed in this catalog.

	1-24	25-99	100-249	250-499
Net Price		Net —15%	Net —20%	Net —26%

Amperex Industrial, Communication,

TUBE TYPE	TUBE TYPE	TUBE TYPE	TUBE TYPE	TUBE TYPE	TUBE TYPE	TUBE TYPE
OA2	5HG8/LCF86	6GM8/ECC86	17EW8/HCC85	200NB/900V	5727/2D21W	6960
OB2	5R4GY	6GV8/ECL85	17Z3	356	5759	6961
OE3	5R4GYB	6GW8/ECL86	18GB5/LL500	367	5762	6977
OG3	5U8	6HAS/EC900	18GV8	300PC	5771	6979
1A3/DA90	5U9/LCF201	6HG8/ECF86	19AU4	310PC	5822A	7025
1AB6	5X9/LCF200	6HU6/EM87	19AU4GTA	400PC	5823	7034
1AC6	5Z4G/GZ30	6HU8/ELL80	19BR5	404A	5842	7035
1AH5	6AB8	6J6/ECC91	19D8	417A	5842(JAN)	7035(JAN)
1AJ4	6AF9	6JA	19FL8	500N	5847(JAN)	7038
1AN5	6AJ8/ECH81	6JWB/ECF802	19X3	501N	5847(JAN)	7062
1B3GT	6AK5/EF95	6JX8/ECH84	19Y3	501R	5861/EC55	7090
1B2G	6AK5W	6K6	20AQ3/LY88	502N	5866	7091
1CP1	6AK8	6LFG	21A6	504R	5866A	7092
1CP31/DH3-91	6AL3/EY88	6LN8/LCF80	25E5	505N	5867A	7119
1G3GT/1B3GT	6AL5/EA91	6LX8/LCF802	25L6GT	506N	5867A	7136
1L4/DF92	6AL5W	6N3	27GB5/PL500	507N	5868	7189
1M3/DM70	6AM5	6N8	30A5	575A	5869	7189A
1N3/DM71	6AM6	6Q4/EC80	30AE3	632B	5870	7189MP
1R5/DK91	6AQ4	6R3/EY81	31A3	651	5894	7203
1S2A/DY87	6AQ5/EL90	6R4/EC81	35L6GT	652	5894(JAN)	7204
1S5/DAF91	6AQ5/EL90MP	6S2	38A3	653B	5894A	7237
1T4/DF91	6AQ5A	6S2A	40KG6	655	5895B/8737	7291
1U4	6AQ5AMP	6S4A	42EC4	673	5895	7292
1U5/DAF92	6AQ8/ECC85	6SN7GTB	45A5	725A	5911	7308
1X2B	6AT6/EBC90	6U3	45B5/UL84	805	5913	7308(JAN)
2D21	6AU4GTA	6U8	45B5/UL84MP	807	5920	7316
2D21W	6AU6/EF94	6U8A	50BM8/UCL82	810	5923	7320/E84L
2ER5/XC95	6AU6A	6U9/ECF201	50BM8/UCL82MP	811A	5924	7325
2FY5/XC97	6AV6/EBC91	6V4/EZ80	50C5	812A	5924A	7336
2GK5	6AX4GT	6V9/ECH200	52AVP	813	6007	7377
2HA5	6AX4GTB	6W4GT	53AVP	828	6008	7378
2J42	6BA6/EF93	6X2	53CG	829B	6075	7459
2J55	6BD7A	6X4/EZ90	53UVV	832A	6076	7527
3AMP1/DG7-32	6BE6/EK90	6X9/ECF200	54AVP	833A	6076/QY5-3000A	7534
3A4/DL93	6BE7	6Y9/EFL200	54UVP	833A(JAN)	6077	7580
3A5/DCC90	6BL8/ECF80	7AN7	55N3	838	6078	7580W/4CX250R
3AU6	6BM8/ECL82	7AU7	56AVP	845	6079	7609
3BH2	6BN5	7C24	56AVP/03	849	6083	7609(JAN)
3BU8	6BQ5/EL84	7D8	56AVP/05	857B	6084	7643
3B28	6BQ5/EL84MP	7ES8	56CVP	857B(JAN)	6085	7645
3BK2/DN7-78	6BR5/EM80	7HG8/PCF86	56P17/2	866AX	6146	7650
3BK7/DP7-78	6BT4	8BQ5/XL84	56P17/3	869B	6146A	7693
3BK11/DB7-78	6BX6/EF80	8CW5/XL86	56TVP	869B(JAN)	6146B/8298A	7694
3BK31/DH7-78	6BY7	8GJ7/PC801	56TVP	869BL	6155	7697
3BYP2/DN7-11	6BZ6	8MB6	56UVP	872AX	6156	7699
3BYP7/DP7-11	6C4/EC90	8MG6	57AVP	880	6159	7709
3BYP11/DB7-11	6CA4/EZ81	8MY6	58AVP	892	6159B	7710
3BYP31/DH7-11	6CA7/EL34	8U9/PCF201	58CG	892R	6189/12AU7WA	7714
3BZ6	6CA7/EL34MP	8X9/PCF200	58CV	912NB3/900V	6201	7721/D3A
3C4/DL96	6CB6A	9A8/PCF80	58UVP	912NB4/900V	6211	7722/E280F
3CB6	6CD7/EM34	9AB4	60AVP	967	6211A	7735A
3EH7/XF183	6CG7	9AK8	75C1	1164	6218	7737
3EJ7/XF184	6CH6	9AQ8/PCC85	75N	1561	6227	7737(JAN)
3ER5	6CJ5	9ED4	75NB3	1805	6252	7753
3GK5	6CJ6	9GV8/XCL85	76NB3	1838	6252(JAN)	7788
3HA5/LC900	6CK5	9U8/PCF82	9U8A	1849	6267/EF86	7788(JAN)
3NP4/MW6-2	6CK6	9U8A	9V9/PCH200	1875	6268	7800
3Q4/DL95	6CM4/EC86	9V9/PCH200	10CW5/LL86	1908	6279	7804
3S4/DL92	6CM5	10DX8/LCL84	10DL6	1913	6339	7805
3V4/OL94	6CN6	10L06	11AF9	1941A	6354	7806
3-400Z	6CG6	11AF9	11Y9/LFL200	2050	6360	7807
4-65A	6CS6/EH90	12AC5	12AC5	2050A	6360(JAN)	7843
4-125A	6CT7	12AJ7	12AT6/HBC90	3200	6360A	7844
4-250A	6CU7	12AT7/ECC81	12AT7/ECC81	3533A	6370	7854
4-400A	6CV7	12AU6/HF94	12AU7/ECC82	3538	6375	7899
4B32	6CW5/EL86	12AU7A	12AV6/HBC91	3545	6463	7900
4BL8/XCF80	6CW7	12AX4GTA	12AX4GTA	3554	6508	7983
4C35	6DA5/EM81	12AX4GTB	12AX4GTB	4065	6508	7986/5866A
4CX250B	6DA6/EF89	12AX7A/ECC83	12B6	4152	6618	8008AX
4CX250F	6DC8/EBF89	12B6	12BL6	4654	6681/12AX7A	8032
4X250FG/8621	6DE6	12BS7A	12DS7	4699	6686	8042
4CX250R	6DJ8/ECC88	12ST	12S7	5544	6687	8078
4CX350A	6DL4/EC88	12SN7GTA	12X4/HZ90	5545	6688	8108/EC157
4CX350F	6DLS/EL95	12X4/HZ90	13GB5/XL500	5551A	6688A	8116
4EH7	6DLSMP/EL95MP	14GW8	14K7	5552A	6688(JAN)	8117A
4EJ7	6DR8	14K7	14L7	5553B	6689	8118
4ES8/XCC189	6DS8	15A6	15A6	5555	6693	8119/TBL2/400
4GK5	6DT6	15CW5/PL84	15DQ8/PCL84	5557/FG17	6756	8120/TBL2/500
4HA5/PC900	6DX8/ECL84	16A5	16A5	5559	6759	8163
4X150A	6EA8	16A8/PCL82	16A8/PCL82	5560/FG95	6779	8177
4X150D	6EC4	16AQ3/XY88	16AQ3/XY88	5586	6786	8179
4X150D/7035(JAN)	6ED4	16GK6	16GK6	5604	6800A	8223/E288CC
4X500A	6EH7/EF183	16Y9/PF1200	16Y9/PF1200	5632/C3J	6801	8233
5A4Q	6EJ7/EF184	17C8	17C8	5651	6816	8233(JAN)
5AR4/GZ34	6ER5/EC95			5654/6AK5W	6883	8254
5BHP2	6ES6			5658	6883B/8032A	8254
5BHP7	6ES8/ECC189			5666	6884	8255/E88C
5BHP31	6ET6			5667	6907	8268
5C22	6EU7			5678	6907(JAN)	8268
5EJP31/D13-26GH	6FG6/EM84			5684/C3JA	6922	8270
5ELP2/D13-21GP	6FY5/EC97			5685/C6JA	6922(JAN)	8278/EL503
5ELP7/D13-21GM	6GB5/EL500			5718	6923	8298A
5ELP11/D13-21BE	6GH8A			5726/6AL5W	6939	
5ELP31/D13-21GH	6GJ7/ECF801					
5GJ7/LCF801	6GK5					
	6GK6					

AMPEREX ELECTRONIC CORPORATION

Amperex®

TOMORROW'S THINKING IN TODAY'S PRODUCTS

AUTOMATIC

AMPERITE

REGULATOR

BALLAST TUBE FOR AUTOMATIC REGULATION OF CURRENT AND VOLTAGE



AUTOMATIC REGULATION WHAT IT IS

The AMPERITE Ballast-Regulating Tube is an automatic "rheostat" designed to keep the current in a circuit at a definite value, for example, 0.5 amp.

Should the supply voltage increase, the Amperite will automatically increase in resistance enough to take up the increase in supply voltage — keeping the voltage on the load constant. It consists of an iron wire hermetically sealed in a bulb containing hydrogen or helium — the two gases with the highest heat conductivity. Its regulating action is based on the high temperature co-efficient of resistance of the iron wire and the rapid cooling of hydrogen or helium gas.

Being a constant current device, the AMPERITE Ballast-Regulating Tube can be used only to regulate a constant load—fixed wattage. Thermostatic relays can sometimes be included in these regulators to reduce initial surge.

We strongly recommend that you send us your specifications on special problems, and let us recommend the BALLAST TUBE you need.

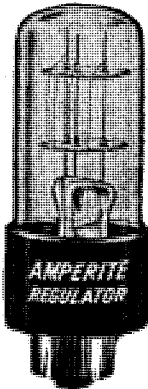

STANDARD



MINIATURE

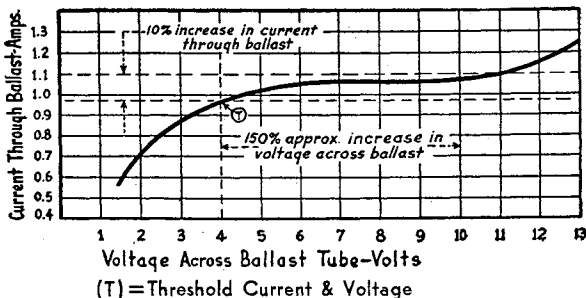

Characteristic curve of a typical Amperite. Approximate curve of any other Amperite can be obtained by multiplying or dividing the current or voltage scale by any number.

Types of Amperite Ballast Tubes Net \$1.80
70V Neon Lamp Net \$1.80

3A20	5-11	6-8B	**7HTF2	9A10	12-4
3H-25	5H3	6A10	**7HTF3	10-3	12A10
3-38A	5H4	6-11	**7HTF4	10-4A	12-11
50A	5H10	6-12	7H4	10-4B	13-4
	5H11	6-13	7H4B	10-4C	15-4
	6-3	6A15	7H7	10-4D	16-4
		6-36	7H11	10A10	17-3
		6H4	**8TF2	10A12	20-3
		**6HTF4	8-3B	10-25	20-4
		6	8-4	11-3	22-4
			8A10	11-4	34-2
			9-4	11A10	41-7E
			4A	11-11	55-1
					55-4

ON LAMP
\$1.80

GENERAL ADVANTAGES:

- Light, compact • No moving parts • Rugged; will withstand vibration of 10G. minimum
- Hermetically sealed; not affected by altitude or humidity changes • Can be changed as easily as a radio tube • Operates equally well on A.C. or D.C. • Inexpensive

CAPACITIES AVAILABLE

Current values of 60 ma. to 5 amps; threshold voltage 0.4 to 40 V. Maximum dissipation 50w per tube (ST19 bulb). Any number of AMPERITES with the same voltage range can be operated in parallel. AMPERITES should not be used in series.

AGEING

AMPERITE Ballast Tubes may change approximately up to 3% in current if aged for 4 to 8 hours, at maximum voltage. They will change very little thereafter.

LIFE EXPECTANCY

- Average life if operated as recommended **2000 Hours**
 If operated continuously at maximum voltage **1000 Hours**
 If operated continuously at 80% maximum voltage **5000 Hours**
 If filament is operated below glow point **5000 Hours up**

In operation, the Amperite filament starts to glow at one point; as the voltage is increased, the glow spreads over the entire filament. Like incandescent lamps, turning Amperite on and off reduces its life, especially if operating near its maximum voltage.

TIME LAG CHARACTERISTICS

Time lag encountered in an Amperite Ballast Tube depends upon the wattage consumed by the ballast and the size of the bulb. Where the wattage is small for the size of the bulb, the action can be made practically instantaneous — less than 1 second. In such cases the bulb will remain at practically ambient temperature. When the wattage is high enough to heat the bulb to a temperature uncomfortable to the hand (160°F) the lag might be as much as several minutes for final readings— but normally reaches within 90% of final readings within a few seconds.

AMPERITE NUMBERING SYSTEM

In general, the AMPERITE number approximately denotes the current—voltage threshold value. For example:

Amperite Number	3-4	3H4	10-7	12-11	12H11
Threshold Current	0.3	0.35	1.0	1.2	1.25
Threshold Voltage	4.0	4.0	7.0	11.0	11.0

We strongly recommend that you send us your specifications on special problems, and let us recommend the BALLAST TUBE you need.

AUTOMATIC

AMPERITE

REGULATOR

BALLAST TUBE FOR AUTOMATIC REGULATION OF CURRENT AND VOLTAGE



AMBIENT EFFECTS

Ambient temperature variation of -50° to $+70^{\circ}$ C will change the current value of an Amperite approximately 2% on regulating portion of curve as shown directly below. Being hermetically sealed the Amperite is not affected by altitude or humidity changes.

We strongly recommend that you send us your specifications on special problems, and let us recommend the BALLAST TUBE you need.

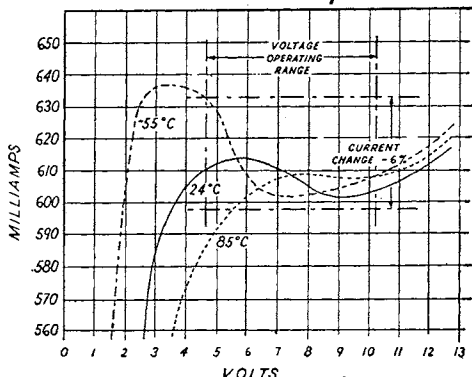

Amperite Ballast-Type 6-4 current voltage characteristic under ambient conditions of -55° , 24° , and 85° C. The percentage change with ambient is approximately the same with all type Amperite ballasts.

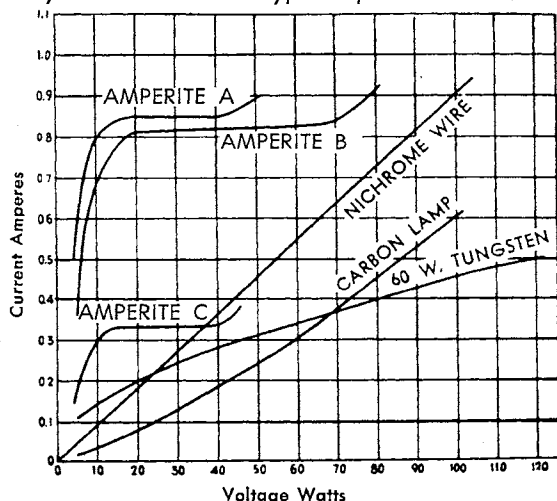

This diagram illustrates far superior regulating characteristics of the Amperite Ballast-Regulating Tube. **STANDARD SIZES available for various wattage consumption . . . For good regulation, a bulb should not be required to dissipate more than 50% of maximum wattage.**

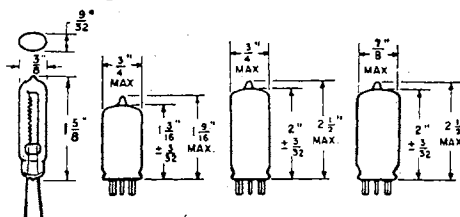

SIZE	SUB. MIN. L	T5 1/2 S	T5 1/2 L	T6 1/2 L	T9	T-12	ST-16	ST-19
MAX. WATTS	2 W.	3	5	5	12	25	30	50
WT. PER TUBE	2 GMS.	7 GMS.	8 GMS.	8 GMS.	1 OZ.	2 1/4 OZ.	2 1/2 OZ.	2 3/4 OZ.

BATTERY CHARGING AND DISCHARGING

Amperite Ballast Tubes are very successfully used for keeping the current constant in charging and discharging batteries. Any number of Amperites of the same voltage range can be placed in parallel to obtain proper current. The current can be kept to $\pm 1\%$. Advise voltage variation and currents desired.

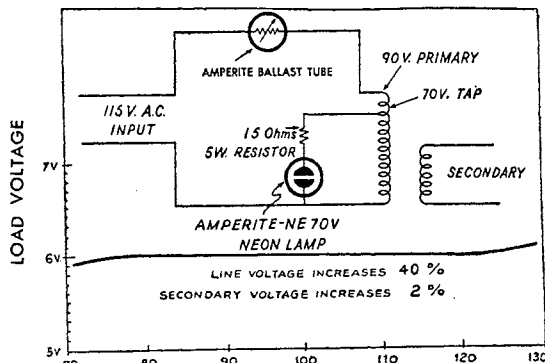

LINE VOLTAGE

A light, compact, and inexpensive method of obtaining close regulation is to use an Amperite Ballast Tube with an Amperite Neon Lamp — type NE70V. Base octal-base wiring-prongs 2-5. One NE70V is used for all loads up to 100W.

POWER SUPPLIES

We strongly recommend, for any particular application, to fill in and return one of our special problem sheets (ASP 343) and permit us to recommend the most suitable AMPERITE.

POWER SUPPLY	Dry Cells	6 Volts	12 Volts	26 Volts	115 Volts
Supply Variation	2.2-3.0V	5.5-7.5V	11.4-13.8V	22.0-30.0V	105-125V
Desired on Load	1.8-2.0V	3.9-4.1V	6.1- 6.4V	12.4-12.8V	90- 95V
Required on AMPERITE	0.4-1.0V	1.6-3.4V	5.3- 7.4V	9.6-19.2V	15- 30V
Current Variation	.29-.32a	.29-.32a	.29-.32a	.29-.32a	.29-.32a

The above chart shows the maximum load voltage for the given supply to obtain $\pm 2\%$ current regulation on load. Better regulation is obtainable by increasing the voltage across the AMPERITE. Up to a point, the higher the percentage of the supply voltage taken up by the AMPERITE, the better the regulation.

Radio tube filament loads — have low cold resistance which causes a high initial surge. For such loads we recommend a bleeder of 20 to 50% prox. of load and the corresponding AMPERITE. e.g.

FILAMENT LOAD	USE AMPERITE	TOTAL CURRENT
0.3a	4HTF4	0.45a
0.6a	8-4	0.8a
0.7a	9H4	0.95a

On Radio tube filament loads the bleeder will also improve the regulation.

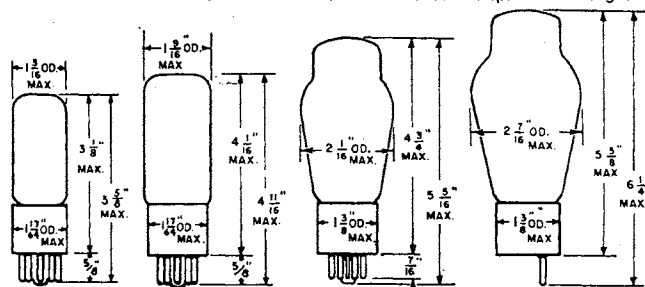



ENTERTAINMENT RECEIVING TUBES

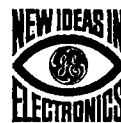

Type	Suggested List Price†	Type	Suggested List Price†	Type	Suggested List Price†	Type	Suggested List Price†	Type	Suggested List Price†	Type	Suggested List Price†
OZ4	\$2.80	3EH7	\$2.55	5HA7	\$3.05	6BF5	\$3.35	6CU8	\$4.60	6FY5	\$2.75
OZ4A	2.80	3EJ7	2.55	5HB7	3.40	6BF6	2.25	6CW4	4.90	6FY7	3.20
1A7GT	5.40	3E5	3.70	5HG8	3.70	6BF11	4.90	6CW5/EL86	2.75	6G11	4.40
1AD2	3.10	3F55	4.30	5HZ6	(Use 5GX6)	6BG6GA	6.15	6CX8	4.45	6GB5/EL500	3.80
1AY2	2.60	3GK5	3.85	5J6	3.25	6BH6	2.95	6CY5	3.60	6GC5	4.20
1B3GT	—	3GS8/3BU8	4.00	5JK6	3.85	6BH8	4.20	6CY7	3.05	6GE5	3.85
(Use 1G3GT/1B3GT)	—	3HA5	—	5JL6	3.85	6BH11	4.30	6CZ5	4.40	6GF5	3.45
1BC2	2.90	(Use 3HM5/3HA5)	—	5KD8	—	6BJ3	2.80	6D10	4.25	6GF7A	4.85
1BC2	2.80	3HM5/3HA5	3.85	(Use 6U8A/6K08/5KD8)	—	6BJ6	2.90	6DA4A/6DM4A	3.30	6GH8A	3.20
1BH2	3.05	3HQ5	4.20			6BJ7	2.95	6DB5	5.00	6GJ5A	5.60
1DN5	4.40	3Q4	3.35	5KE8	5.75	6BJ8	3.60	6DC6	3.85	6GJ7/ECF801	3.10
1G3GT/1B3GT	3.05	3S4	3.40	5KZ8	2.55	6BK4B	7.55	6DE4/6CQ4	3.20	6GK5/6FQ5A	4.15
1H2	3.95	3V4	2.95	5LJ8	4.10	6BK5	3.45	6DE6	2.70	6GK6	3.15
1K3/1J3	3.05	4AU6	2.95	5T8	4.20	6BK7B	3.70	6DE7	3.85	6GL7	5.75
1L4	3.25	4AV6	2.25	5U4GB/5AS4A	2.25	6BL7GA	4.60	6DG6GT	3.85	6GM5	3.05
1L6	12.55	4BC5	—	5U8	3.45	6L8/ECF80	2.70	6DK6	2.35	6GM6	2.95
1LH4	7.60	(Use 4CE5/4BC5)	—	5U9/LCF201	2.95	6BM8/ECL82	2.90	6DM4A	—	6GM8/ECC86	4.35
1N2A	4.40	4BC8	4.00	5V3/5AU4	3.80	6BN4A	3.70	(Use 6DA4A/6DM4A)	—	6GN8/6EB8	4.70
1R5	3.60	4BL8/XCF80	2.40	5V4GA	3.85	6BN6/6KS6	3.30	6DN6	7.00	6GQ7	3.75
1SA/DY87	2.55	4BN6	4.05	5V6GT	3.70	6BN8	3.30	6DN7	3.65	6GT5	5.40
1S5	3.40	4BQ7A/4BZ7	4.45	5X8	4.15	6BN11	4.50	6DQ5	7.85	6GU5	4.10
1T4	3.40	4BS8	4.25	5Y3GT	1.95	6BQ5/EL84	2.95	6DQ6B/6GW6	4.20	6GU7	3.40
1U4	3.30	4BU8	—	5Z3	4.45	6BQ6GA/6CU6	4.10	6DR7	4.30	6GV5	4.10
1U5	2.90	(Use 4GS8/4BU8)	—	6AB4	2.70	6BQ6GTB	4.10	6DS4	4.90	6GW6	—
1V2	2.15	4BZ6	2.35	6AC7	5.75	6BQ7A/6BZ7	3.85	6DS5	3.65	(Use 6DQ6B/6GW6)	—
1X2A/1X2B	3.10	4BZ7	—	6AC10	4.10	6BR8A/6FV8A	4.00	6DT5	3.55	6GW8/ECL86	3.05
2AF4	4.10	(Use 4BQ7A/4BZ7)	—	6AD10	6.90	6BS3A	—	6DT6A	2.25	6GX6 (Use 6GY6/6GX6)	—
2AF4B/2DZ4	4.10	4CB6	2.40	6AF3	3.10	(Use 6AY3B/6BS3A)	—	6DT8	3.75	6GX7	3.70
2AH2	3.40	4CE5/4BC5	3.05	6AF4	4.10	6BS8	4.15	6DV4	6.45	6GY5	4.60
2AS2	3.00	4CS6	3.05	6AF4A/6DZ4	4.10	6B8U	3.70			6GY6/6GX6	2.90
2AV2	2.55	4CY5	2.70	6AF9	3.50	6BV8	3.00	6DW4B	—	6GY8	3.90
2BN4A	3.10	4DE6	2.95	6AF11	5.20	6BW4	2.75	(Use 6CJ3/6DW4B/6CL3)	—	6GZ5	2.70
2CW4	4.90	4DK6	2.95	6AG5	3.10	6BW8	3.30	6DX8/ECL84	2.95	6H6	4.90
2CY5	3.60	4DT6	2.30	6AG7	6.50	6BW11	4.40	6DZ4	—	6HA5	—
2DS4	4.90	4EH7	3.55	6AG9	5.65	6BX7GT	5.60	(Use 6AF4A/6DZ4)	—	(Use 6HM5/6HA5)	—
2DV4	6.45	4EJ7	3.55	6AG11	4.10	6BY5GA	4.80	6DZ7	8.70	6HA6	—
2DZ4	—	4ES8	5.50	6AH4GT	3.25	6BY6	3.00	6E5	5.65	(Use 6HB6/6HA6)	—
(Use 2AF4B/2DZ4)	—	4EW6	2.90	6AH6	4.90	6BY8	2.70	6EA4	—	6HB5	4.60
2EN5	3.20	4GK5	3.85	6AK5/EF95	4.50	6BZ3	2.95			6HB6/6HA6	4.45
2ER5	3.70	4GM6	2.15	6AK6	2.55	6BZ6	2.40			6HB7	3.65
2FH5	3.70	4GS8/4BU8	4.10	6AL3	2.60	6BZ7	—	6EA7	—	6HE5	3.70
2FQ5A	—	4GZ5	3.55	6AL5	1.90	(Use 6BQ7A/6BZ7)	—	(Use 6EM7/6EA7)	—	6HF5	7.30
(Use 2GK5/2FQ5A)	—	4HA5	2.30	6AL7GT	6.90	6BZ8	—	6EA8	3.30	6HF8	4.20
2FS5	4.85	4HA7/4HC7	3.05	6AL11	4.10	(Use 6BC8/6BZ8)	—	6EB8	—	6HG5	—
2GK5/2FQ5A	3.85	4HM6	3.10	6AM4	5.55	6C4	1.95	(Use 6GN8/6EB8)	—	(Use 6AQ5A/6HG5)	—
2GU5	4.50	4HQ5	4.20	6AM8A	3.45	6C5	5.35	6EF4	(Use 6EJ4A)	6HG8/ECF86	3.70
2HA5	3.85	4HS8	3.35	6AN4	6.15	6C9	5.50	6EH4A	8.20	6HJ8	3.10
2HK5	3.85	4HT6	2.55	6AN8A	3.95	6C10	3.70	6EH5	3.15	6HK5	3.90
2HQ5	3.85	4JC6	3.85	6AQ5A/6HG5	2.45	6CA4	2.40	6EH7/EF183	3.85	6HL8	3.05
3A2	5.50	4JD6	3.85	6AQ6	3.25	6CA5	3.00	6EH8	3.50	6HM5/6HA5	3.85
3A3A/3AW3/3B2	3.20	4LJ8	4.10	6AQ7GT	4.30	6CA7/EL34	5.35	6EJ4A	8.50	6HM6	2.95
3AF4B/3DZ4	4.10	5AM8	4.45	6AQ8/ECC85	3.00	6CB5A	9.40	6EJ7/EF184	3.55	6HQ5	4.45
3AL5	2.15	5AN8	4.75	6AR5	2.45	6CB6A/6CF6	2.35	6EM5	3.35	6HR5	2.55
3AT2	3.05	5AQ5	2.70	6AR8	4.85	6CD3	—	6EM7/6EA7	2.90	6HS5	7.75
3AU6	2.40	5AR4/GZ34	4.25	6AR11	4.50	(Use 6CG3/6CE3/6CD3)	—	6EQ7	4.95	6HS6	3.70
3AV6	2.95	5AS4A	—	6AS5	2.95	6C06GA	5.50	6ER5	3.80	6HS8	3.85
3AW2	3.20	(Use 5U4GB/5AS4A)	—	6AS8	4.20	6CE3	—	6ES5	2.85	6HZ6	2.90
3AW3	—	5AS8	4.40	6AS11	5.10	(Use 6CG3/6CE3/6CD3)	—	6ES8/ECC189	5.45	6HZ8	5.50
(Use 3A3A/3AW3/3B2)	—	5AT8	4.00	6AT6	2.05	6CE5/6BC5	2.95	6EU7	2.95	6J5	4.10
3B2	—	5AU4	—	6AT8A	4.45			6EU8	3.70	6J6A	2.90
(Use 3A3A/3AW3/3B2)	—	(Use 5V3/5AU4)	—	6AU4GA	3.70	6CF6	—	6EV5	2.80	6J10 (Use 6Z10/6J10)	—
3BC5	—	5AV8	4.05	6AU5GT	4.90	(Use 6CB6A/6CF6)	—	6EV7	3.25	6J7	5.20
(Use 3CE5/3BC5)	—	5B8	5.50	6AU6A	2.10	6CC3/6CE3/6CD3	3.40	6EW6	2.55	6J11	4.80
3BE6	2.70	5BC3	3.40	6AU8A	4.60	6CG7	—	6EW7	6.00	6JB6A	5.85
3BL2	3.55	6AV5GA	5.20	6AV5GA	5.20	(Use 6FQ7/6CG7)	—	6EX6	7.50	6JCG	3.95
3BN2	3.45	6AV6	1.75	6AV6	1.75	6CG8A	3.25	6EY6	3.60	6JCH	3.30
3BN4	3.40	6AV11	4.40	6AV11	4.40	6CH8	5.65	6EZ5	4.05	6JD6	3.55
3BN6	3.80	6AW8A	3.85	6AX3	2.55	6CJ3/6DW4B/6CL3	3.50	6EZ8	3.55	6JE6B	8.50
3BS2	3.25	6AX3	2.55	6AX4GTB	2.75	6CK3	2.80	6F5	5.50	6JE8	3.70
3BU8	—	6AX5GT	3.55			6CK4	3.55	6F6	5.80	6JF6	6.20
(Use 3GS8/3BU8)	—	6AX8	3.45	6AX5GT	3.70	6CL3	—	6F6GT	5.80	6JG6A	6.50
3BY6	3.00	6AY3B/6BS3A	3.45	6AU5GT	4.90	(Use 6CJ3/6DW4B/6DL3)	—	6FD6	3.55	6JH6	2.70
3BZ6	2.35	6AY11	4.50	6AU6A	2.10	6CQ4	—	6FD7	5.30	6JH8	4.30
3CA3	3.20	6AZ8	5.55	6AU8A	4.60	(Use 6DE4/6CQ4)	—	6FG5	5.35	6JH8	4.05
3CB6/3CF6	2.30	6B10	3.65	6AV5GA	5.20	6CL6	3.80	6FG6/EM84	3.30	6JM6	4.10
3CE5/3BC5	2.70	6B8A/EF93	2.10	6AV6	1.75	6CL8A	3.90	6FG7	3.70	6JN6	3.85
3CF6	—	6BA7	5.90	6AV11	4.40	6CM6	3.55	6FH5	3.45	6JN8	3.65
(Use 3CB6/3CF6)	—	6BA7	5.90	6AW8A	3.85	6CM7	2.95	6FH8	4.05	6JS6B	7.30
3CN3A	3.20	6BA8A	4.60	6AX3	2.55	6CM8	4.05	6FJ7	3.75	6JT6A	4.95
		6BA11	4.10	6AX4GTB	2.75	6CN7	4.20	6FM7	3.25	6JT8	4.05
3CS6	2.90	6BC4	5.50					6FM8	2.80	6JU8A	3.50
3CX3	3.45	6BC5	—	6AX5GT	3.55	6CQ4	—	6FQ5A	—	6JVB	4.40
3CY5	3.75	(Use 6CE5/6BC5)	—	6AX8	3.45	(Use 6DE4/6CQ4)	—	(Use 6GK5/6FQ5A)	—	6JWB/ECF802	3.10
3DG4	4.30	6BC7	3.60	6AY11	4.50	6CQ8	3.45	6FQ7/6CG7	2.30	6JZ6	4.60
3DK6	2.55	6BC8/6BZ8	3.75	6AZ8	5.55	6CS6	2.70	6F55	4.10	6JZ8	3.55
3DT6	2.60	6BD6	2.30	6B10	3.65	6CS7	3.05	6FV6	4.20	6K6GT	2.75
3DZ4	—	6BD11	5.55	6BA6/EF93	2.10	6CJ3/6DW4B/6CL3	3.50	6FV8A	—	6K7	5.00
(Use 3AF4B/3DZ4)	—	6BE3	2.80	6BA7	5.90	6CK3	2.80	(Use 6BR8A/6FV8A)	—	6K11/6Q11	3.65
3EA5	3.55	6BE6	2.55	6BA8A	4.60			6FW5	3.85	6KA8	4.45

† Manufacturer's suggested list price; subject to change without notice.



ENTERTAINMENT RECEIVING TUBES



Type	Suggested List Price†	Type	Suggested List Price†	Type	Suggested List Price†	Type	Suggested List Price†	Type	Suggested List Price†	Type	Suggested List Price†	Type	Suggested List Price†	Type	Suggested List Price†
6KD6	\$7.70	8B10	\$3.35	12AY3A/12BS3A	\$2.65	12SG7	\$4.70	19E7Z	\$4.50	6267	\$2.85	6707	\$2.85	6707	\$2.85
6KD8	—	8BA11	4.00	12AZ7A	2.95	12S7	4.30	19GQ7	3.80	6931	3.40	6931	3.40	6931	3.40
(Use 6U8A/6KD8/5KD8)	—	8BM11	4.25	12B4A	3.20	12SK7	4.45	19HV8	3.75	6973	4.60	6973	4.60	6973	4.60
6KE8	5.65	8BN11	4.35	12BA6	1.80	12SL7GT	4.15	19JN8/19CL8A	3.20	7025	—	7025	—	7025	—
6KM6	8.20	8BQ5	2.95	12BA7	5.90	12SN7GTA	3.10	19K8	3.10	(Use 12AX7A/7025)	—	(Use 12AX7A/7025)	—	(Use 12AX7A/7025)	—
6KM8	3.45	8BQ11	4.30	12BD6	2.30	12SQ7	4.45	19T8	4.45	7027A	6.75	7027A	6.75	7027A	6.75
6KR8	4.25	8BU11	4.55	12BE3	3.05	12T10	4.25	20AQ3/LY88	3.30	7189A	3.10	7189A	3.10	7189A	3.10
6KS6	—	8CG7 (Use 8FQ7/8CG7)	—	12BE6	2.30	12V6GT	4.45	20E27	3.45	7199	4.90	7199	4.90	7199	4.90
(Use 6BN6/6KS6)	—	8CM7	2.70	12BF6	2.30	12W6GT	4.45	21GY5	4.60	7247	3.20	7247	3.20	7247	3.20
		8CN7	3.05	12BF11	4.35	12X4	2.25	21HB5A	4.75	7355	3.65	7355	3.65	7355	3.65
6KT6	3.30	8CS7	3.25	12BH7A	3.15	13CW4	5.05	21JV6	4.60	7408	3.20	7408	3.20	7408	3.20
6KT8	4.70	8CW5	2.55	12BK5	3.75	13DE7	4.00	21JZ6	4.85	7581A/KT66	4.55	7581A/KT66	4.55	7581A/KT66	4.55
6KU8	4.80	8CX8	4.40	12BL6	3.40	13DR7	4.45	21KA6	4.45	7591A	2.80	7591A	2.80	7591A	2.80
6KV8	5.85	8EB8 (Use 8GN8/8EB8)	—	12BN6	3.65	13EM7/15EA7	5.35	21LG6	7.65	7695	4.40	7695	4.40	7695	4.40
6KY8A	7.25	8EM5	3.40	12BQ6GA/12CU6	4.20	13FD7	5.05	21LR8	4.75	7868	4.45	7868	4.45	7868	4.45
6KZ8	3.70	8ET7	4.15	12BQ6GTB	4.20			21LU8	4.75	8136	2.55	8136	2.55	8136	2.55
6L6	8.80	8FQ7/8CG7	2.30	12BR7	3.05			22BH3A	3.10	8417	5.65	8417	5.65	8417	5.65
6L6GC	4.75	8GJ7	2.90	12BS3A	—	13FM7	—	22BW3	3.05	8425A/6AU6A	2.55	8425A/6AU6A	2.55	8425A/6AU6A	2.55
6LB6	8.15	8GN8/8EB8	4.15	(Use 12AY3A/12BS3A)	—	(Use 15FM7/13FM7)	—	22DE4	3.70	8426A/12AU6	2.80	8426A/12AU6	2.80	8426A/12AU6	2.80
6LB8	4.70	8JU8A	3.35	12BT3	2.85	13GB5	3.80	22JF6	6.80	DY87 (Use 1S2A/DY87)	—	DY87 (Use 1S2A/DY87)	—	DY87 (Use 1S2A/DY87)	—
						13GF7A	4.65			ECC81	—	ECC81	—	ECC81	—
6LC6 (Use 6LH6A)	—	8JV8	4.00	12BV7	—	13J10	—	22JG6A	5.90	(Use 12AT7/ECC81)	—	(Use 12AT7/ECC81)	—	(Use 12AT7/ECC81)	—
6LC8	4.20	8KA8	4.25	(Use 12BY7A/12BV7/12DQ7)	—	(Use 13Z10/13J10)	—	22JU6	5.75	ECC82	—	ECC82	—	ECC82	—
6LE8	5.55	8LC8	4.25	12BQ7	3.30	13V10	4.10	23Z9	4.75	(Use 12AU7A/ECC82)	—	(Use 12AU7A/ECC82)	—	(Use 12AU7A/ECC82)	—
6LF8	3.85	8LT8	2.70	12BW4	—	13Z10/13J10	5.05	24BF11	5.20	ECC83	—	ECC83	—	ECC83	—
6LH6A	7.70	9A8/8A8/PCF80	2.65	12BY7A/12BV7/12DQ7	—	14BL11	5.60	24JZ8	4.50	(Use 12AX7/ECC83)	—	(Use 12AX7/ECC83)	—	(Use 12AX7/ECC83)	—
6LJ6	6.75	9AU7	2.95	12BZ7	4.15	14BR11	5.25	25AV5GA	5.65	ECC85	—	ECC85	—	ECC85	—
6LJ8	4.10	9BJ11	4.80	12C5	—	14GT8	3.50	25AX4GT	3.05	ECC85	—	ECC85	—	ECC85	—
6LM8	4.45	9BR7	3.15	(Use 12CU5/12C5)	—	14JG8	3.10	25BK5	3.40	(Use 6AQ8/ECC85)	—	(Use 6AQ8/ECC85)	—	(Use 6AQ8/ECC85)	—
6LN8	2.40	9CL8	2.95	12CA5	3.10	15AF11	5.75	25BQ6GA/25CU6	4.35	ECC86	—	ECC86	—	ECC86	—
6LQ8	5.05	9GV8	3.40			15BD11	4.30	25BQ6GTB	4.35	(Use 6GM8/ECC86)	—	(Use 6GM8/ECC86)	—	(Use 6GM8/ECC86)	—
										ECC189	—	ECC189	—	ECC189	—
6LT8	2.70	9KC6	4.35	12CN5	3.25	15CW5/PL84	2.45	25C5	2.95	(Use 6ES8/ECC189)	—	(Use 6ES8/ECC189)	—	(Use 6ES8/ECC189)	—
6L8	4.75	9KZ8	2.95	12CR6	2.95	15DQ8	3.55	25CA5	3.60	ECF80	—	ECF80	—	ECF80	—
6LX8/LCF802	2.60	9U8A	3.10	12CT8	4.95	15EA7	—	25CD6GB	5.75	(Use 6BL8/ECF80)	—	(Use 6BL8/ECF80)	—	(Use 6BL8/ECF80)	—
6LY8	3.90	10AL11	4.55	12CU5/12C5	3.05	(Use 13EM7/15EA7)	—	25CG3	3.40	ECF86	—	ECF86	—	ECF86	—
6M11	5.00	10BQ5	2.55	12CU6	—	15FM7/13FM7	3.00	25CU6	—	(Use 6HG8/ECF86)	—	(Use 6HG8/ECF86)	—	(Use 6HG8/ECF86)	—
6MD8	4.85	10C8	5.15	(Use 12BQ6GA/12CU6)	—	15F77	3.90	(Use 25BQ6GA/25CU6)	—	ECF200	—	ECF200	—	ECF200	—
6ME8	4.20	10CW5	2.55	12CX6	2.75	15KY8A	5.05	25DK4	2.20	(Use 6X9/ECF200)	—	(Use 6X9/ECF200)	—	(Use 6X9/ECF200)	—
6N7	5.05	10DE7	3.95	12CX6	2.75	15LE8	7.65	25DN6	5.95	ECF801	—	ECF801	—	ECF801	—
6Q11 (Use 6K11/6Q11)	—	10DX8/LCL84	2.75	12DA	3.05	16A8	3.45	25EC6	6.15	(Use 6GJ7/ECF801)	—	(Use 6GJ7/ECF801)	—	(Use 6GJ7/ECF801)	—
6S4A	2.55	10EG7	4.40	12DB5	2.60	16AK9	5.90	25EH5	3.25	ECF802	—	ECF802	—	ECF802	—
										(Use 6JW8/ECF802)	—	(Use 6JW8/ECF802)	—	(Use 6JW8/ECF802)	—
6SA7	4.85	10EM7	4.90	12DQ6B/12GW6	4.25	16AQ3/XY88	2.70	25FS5A	3.85	ECL82	—	ECL82	—	ECL82	—
6SC7	4.60	10EW7	4.40	12DQ7	—	16BQ11	4.35	25L6GT/25W6GT	3.40	(Use 6BM8/ECL82)	—	(Use 6BM8/ECL82)	—	(Use 6BM8/ECL82)	—
6SF5	4.00	10GFWA	4.35	(Use 12BY7A/12BV7/12DQ7)	—	16BX11	5.10	25W4GT	3.70	ECL84	—	ECL84	—	ECL84	—
6SG7	4.90	10GK6	3.05	12DS7	5.40	16GK6	3.05	25W6GT	—	(Use 6DX8/ECL84)	—	(Use 6DX8/ECL84)	—	(Use 6DX8/ECL84)	—
6SH7	5.35	10GN8	4.00			16GY5	4.85	(Use 25L6GT/25W6GT)	—	ECL86	—	ECL86	—	ECL86	—
6SJ7	4.10	10HF8	4.65	12DT5	3.10	16KA6	4.45	25Z6GT	3.85	(Use 6GW8/ECL86)	—	(Use 6GW8/ECL86)	—	(Use 6GW8/ECL86)	—
6SK7	4.45	10JA8	—	12DT8	3.55	17AB10	—	27	5.10	EF93 (Use 6BA6/EF93)	—	EF93 (Use 6BA6/EF93)	—	EF93 (Use 6BA6/EF93)	—
6SL7GT	3.55	(Use 10LZ8/10JA8)	—	12DT8	3.55	(Use 17X10/17AB10)	—	27GB5/PL500	3.70	EF95 (Use 6AK5/EF95)	—	EF95 (Use 6AK5/EF95)	—	EF95 (Use 6AK5/EF95)	—
6SN7GTB	2.80	10JT8	4.05	12DV7	3.55	17AX3	2.60	29GK6	3.60	EF183	—	EF183	—	EF183	—
6SQ7	4.00	10JY8	3.65	12DY8	7.95	17AX4GTA	3.35	30AG11	5.05	(Use 6EH7/EF183)	—	(Use 6EH7/EF183)	—	(Use 6EH7/EF183)	—
										EF184	—	EF184	—	EF184	—
6T8A	3.45	10KR8	4.25	12DZ6	—	17AY3A/17BS3A	2.70	31AL10	5.00	(Use 6EJ7/EF184)	—	(Use 6EJ7/EF184)	—	(Use 6EJ7/EF184)	—
6T9	4.05	10KU8	4.85	(Use 12EK6/12DZ6/12EA6)	—	17BE3	2.90	31JS6A	7.30	EL34 (Use 6C47/EL34)	—	EL34 (Use 6C47/EL34)	—	EL34 (Use 6C47/EL34)	—
6T10	4.25	10LE8	5.90	12EA6	—	17BF11	4.55	32ET5A	2.40	EL84 (Use 6BQ5/EL84)	—	EL84 (Use 6BQ5/EL84)	—	EL84 (Use 6BQ5/EL84)	—
6U8A/6KD8/5KD8	3.10	10LW8	4.25	(Use 12EK6/12DZ6/12EA6)	—	17BS3A	—	32HQ7	6.20	EL86 (Use 6CW5/EL86)	—	EL86 (Use 6CW5/EL86)	—	EL86 (Use 6CW5/EL86)	—
6U9	2.90	10LZ8/10JA8	3.90	12ED5	2.70	(Use 17AY3A/17BS3A)	—	33GT7	6.95	EL500	—	EL500	—	EL500	—
6U10	3.65	11AR11	4.10	12ED5	2.70	17BZ3	2.90	33GY7A	6.05	(Use 6GB5/EL500)	—	(Use 6GB5/EL500)	—	(Use 6GB5/EL500)	—
6V3A	4.55	11BQ11	5.90	12EG6	3.45	17C5/17CU5	2.70	33JV6	4.60	EM84	—	EM84	—	EM84	—
6V4/EZ80	1.50	11CA11	5.65	12EK6/12DZ6/12EA6	3.60	17CU5	7.15	34CE3	3.90	(Use 6FG6/EM84)	—	(Use 6FG6/EM84)	—	(Use 6FG6/EM84)	—
6V6	6.35	11CY7	3.60			(Use 17C5/17CU5)	—	34GD5	2.95	EZ80 (Use 6V4/EZ80)	—	EZ80 (Use 6V4/EZ80)	—	EZ80 (Use 6V4/EZ80)	—
								35B5	3.20	GZ34 (Use 5AR4/GZ34)	—	GZ34 (Use 5AR4/GZ34)	—	GZ34 (Use 5AR4/GZ34)	—
6V6GTA	2.70	11FY7	3.70	12EQ7	2.75	17D4/17DM4A	3.40	35C5	2.40	HCC85	—	HCC85	—	HCC85	—
6W4GTA	2.55	11HM7	4.30	12EZ6	3.55	17DE4	3.65	35DZ8	4.00	(Use 17EW8/HCC85)	—	(Use 17EW8/HCC85)	—	(Use 17EW8/HCC85)	—
6W6GT	3.30	11JE8	3.85	12F8	3.25	17DM4A	—	35EH5	3.40	KT66	—	KT66	—	KT66	—
6X4	1.80	11KV8	5.90	12FK6	2.55	(Use 17D4/17DM4A)	—	35GL6	2.90	(Use 7581A/KT66)	—	(Use 7581A/KT66)	—	(Use 7581A/KT66)	—
6X5GT	2.40	11LQ8	5.90	12FM6	2.60	17DQ6B/17GW6	4.25	35L6GT	3.60	LCF201	—	LCF201	—	LCF201	—
6X8A	3.30	11LT8	3.25	12FQ8	5.20	17EW8/HCC85	2.75			(Use 5U9/LCF201)	—	(Use 5U9/LCF201)	—	(Use 5U9/LCF201)	—
6X9/ECF200	2.95	11Y9	3.10	12FX5	2.70	17G5E	4.35	35W4	1.40	LCL84	—	LCL84	—	LCL84	—
6Y6GT	3.55	12AB5	3.45	12FX8A	3.85	17GE5	4.35	35Y4	4.50	(Use 10DX8/LCL84)	—	(Use 10DX8/LCL84)	—	(Use 10DX8/LCL84)	—
6Y9	2.95	12AC6	2.10	12GA6	2.70	17GJ5	5.50	35Z5GT	2.40	LY88	—	LY88	—	LY88	—
6Z10/6J10	5.00	12AD6	2.80	12GC6	3.95	17GT5	4.90	36AM3A	2.55	(Use 20AQ3/LY88)	—	(Use 20AQ3/LY88)	—	(Use 20AQ3/LY88)	—
								38H7	6.65	PCF80	—	PCF80	—	PCF80	—
7A4	7.05	12AE6A	3.10	12GE5	4.10	17GW6	—			(Use 9A8/8A8/PCF80)	—	(Use 9A8/8A8/PCF80)	—	(Use 9A8/8A8/PCF80)	—
7A7	7.15	12AE10	4.65	12GN7A	3.90	(Use 17DQ6B/17GW6)	—	38HK7	6.55	PCF86	—	PCF86	—	PCF86	—
7AU7	2.70	12AF3	3.85	12GT5	5.35	17H3	2.75	40KD6	8.05	(Use 7HG8/PCF86)	—	(Use 7HG8/PCF86)	—	(Use 7HG8/PCF86)	—
7B5	8.35	12AF6	3.15	12GW6	—	17JB6A	5.50	42KN6	7.20	UL84 (Use 45B5/UL84)	—	UL84 (Use 45B5/UL84)	—	UL84 (Use 45B5/UL84)	—
7B6	5.25	12AL5	2.30	(Use 12DQ6B/12GW6)	—	17JM6	4.20	45B5/UL84	2.80	XCF80	—</				

Industrial Receiving and Communication Tubes



TYPE	DESCRIPTION	GENERAL						MAXIMUM RATINGS				TYPICAL OPERATING CONDITIONS																		
		Base Connections	Dimensions In Inches		Cathode		Max. Freq. for Full Ratings, mc.	DC Plate Volts	Plate Dissipation Watts	Screen Grid No. 2, Volts	Screen Dissipation Watts	Class and Type of Service	Plate Input Watts	Voltages			Currents			GM, μ uhos	Triode μ Factor	Drive Watts	Load for Rated Output Ohms	RMS Power Output Watts						
			Length	Diameter	Volts	Current Amps.								Type	Plate	Screen Grid No. 2	Control Grid No. 1	Plate, ma	Screen Grid No. 2, ma						Control Grid No. 1, ma					
6DJ8	Twin Triode	9DE	2 $\frac{3}{16}$	$\frac{7}{8}$	6.3	0.365	—	130	1.8	—	—	—	Class A Amplifier	—	90	—	—	1.3	15	—	—	12,500	33	—	—	—				
6J4 σ	High-Frequency Triode	7BQ	2 $\frac{1}{8}$	$\frac{3}{4}$	6.3	0.4	CU	150†	2.25†	—	—	—	Class A Amplifier	2.25	150	—	—	R _k =100	15†	—	—	12,000	55	—	—	—				
6SK7WA θ (R) See 6137(R)																														
6X4WA θ (R) σ See 6202(R)																														
12AT θ WB θ (R) σ See 6201																														
12AY7 σ	Twin Triode	9A	2 $\frac{3}{16}$	$\frac{7}{8}$	6.3	0.3	CU	300†	1.58†	—	—	—	Class A Amplifier (per section)	0.75†	250	—	—	4.0	3.0	—	—	1,750	44	—	—	—				
28D7	Double Beam Power Amplifier	8BS	3 $\frac{1}{2}$	1 $\frac{1}{8}$	28.0	0.4	CU	100†	3.08†	67.5†	0.5†	—	Class A Amplifier (per section)	0.35†	28	28	—	—	3.5	12.5†	1.0†	—	3,400	—	—	4,000	0.100			
407A σ	Medium-Mu Twin Triode	407A	1 $\frac{3}{4}$	$\frac{7}{8}$	40	0.05	CU	330†	1.35†	—	—	—	Class A Amplifier	—	150	—	—	—	8.2	—	—	5,500	35	—	—	—				
408A σ	Sharp-Cutoff Pentode	7BD	1 $\frac{3}{4}$	$\frac{3}{4}$	2.0	0.05	CU	180†	1.7†	180†	0.5†	—	Class A Amplifier	—	120	120	—	—	R _k =200	7.0	2.2	—	5,000	—	—	—				
83	Full-Wave Mercury-Vapor Rectifier	4C	5 $\frac{3}{8}$	2 $\frac{1}{8}$	5.0	3.0	CF	Tube voltage drop =15 volts				Max. DC output current=225 ma; max. peak inverse voltage=1,550 volts; max. rms supply voltage per plate=450 volts; max. peak current per plate=1,000 ma																		
502A	Thyratron	6BS	2 $\frac{1}{8}$	1 $\frac{3}{16}$	6.3	0.6	CU	Anode voltage drop=8 volts				Controlled Rectifier Max. DC cathode current=100 ma; max. peak inverse voltage=1,300 volts; max. peak cathode current=1.0 ampere																		
807	Beam Power Amplifier	5AW	5 $\frac{3}{4}$	2 $\frac{1}{8}$	6.3	0.9	CU	60	400†	25†	400†	—	—	AB ₁ T CCS	24	400	400†	-45	60†	—	0	6,000	8	0	3,000	15				
									400†	30†	400†	—	—	AB ₁ T ICAS	24	400	400†	-45	60†	—	0	6,000	8	0	3,000	15				
									—	—	—	—	—	AB ₁ (2) CCS	57.2*	400	300	-30	56†	—	2†	—	—	—	0	6,800 ρ	36			
									600†	25†	300†	3.5†	—	AB ₁ (2) CCS	70.5*	500	300	-32	44†	—	1†	—	—	—	0	8,200 ρ	46			
									—	—	—	—	—	AB ₁ (2) CCS	83.3*	600	300	-34	141*	-16*	—	—	—	—	—	0	10,000 ρ	56		
									750†	30†	300†	3.5†	—	AB ₁ (2) ICAS	105*	750	300	-35	36†	—	0.6†	—	—	—	0	12,000 ρ	72			
									—	—	—	—	—	AB ₂ (2) CCS	96*	400	300	-28	72†	—	2.0†	0.2	—	—	—	0.2	3,700 ρ	55		
									600†	25†	300†	3.5†	—	AB ₂ (2) CCS	120*	500	300	-30	240*	-20*	—	—	—	—	—	0.2	4,600 ρ	75		
									—	—	—	—	—	AB ₂ (2) CCS	120*	600	300	-32	48†	—	0.7†	0.2	—	—	—	0.1	6,900 ρ	80		
									750†	30†	300†	3.5†	—	AB ₂ (2) ICAS	180*	750	300	-35	200*	-18*	—	—	—	—	—	0.2	7,300 ρ	120		
									—	—	—	—	—	B-P CCS	30	400	300	-40	75	5	0	—	—	—	—	—	0.4	—	9*	
									600†	25†	300†	2.5†	—	B-P CCS	35	500	300	-40	70	4	0	—	—	—	—	—	0.3	—	11*	
									—	—	—	—	—	B-P CCS	37.5	600	300	-40	62.5	4	0	—	—	—	—	—	0.2	—	12.5*	
									750†	30†	300†	2.5†	—	B-P ICAS	45	750	300	-40	60	3	0	—	—	—	—	—	0.2	—	15*	
—	—	—	—	—	C-P CCS	26	325	250	-75	80	6	3.5	—	—	—	—	—	0.3	—	17*										
475†	16.5†	300†	2.5†	—	C-P CCS	32	400	250	-75	80	6	3.5	—	—	—	—	—	0.3	—	22*										
—	—	—	—	—	C-P CCS	39.4	475	250	-85	83	8	4	—	—	—	—	—	0.4	—	28*										
600†	25†	300†	2.5†	—	C-P ICAS	60	600	300	-85	100	8	4	—	—	—	—	—	0.4	—	44*										
—	—	—	—	—	C-T CCS	40	400	250	-45	100	8	4	—	—	—	—	—	0.3	—	25*										
600†	25†	300†	3.5†	—	C-T CCS	50	500	250	-45	100	8	4	—	—	—	—	—	0.3	—	32*										
—	—	—	—	—	C-T CCS	60	600	250	-45	100	8	4	—	—	—	—	—	0.3	—	40*										
750†	30†	300†	3.5†	—	C-T ICAS	75	750	250	-45	100	8	4	—	—	—	—	—	0.3	—	54*										
GL-811-A	High-Perveance High-Mu Zero-Bias Triode	3G	6 $\frac{1}{32}$	2 $\frac{1}{8}$	6.3	4.0	TF	30	1,250	45	—	—	—	B(2) CCS	262*	750	—	0	32†	—	—	—	160	9.7	5,100 ρ	178				
									—	—	—	—	—	B(2) CCS	350*	1,000	—	0	44†	—	—	—	—	—	—	160	7.5	7,400 ρ	248	
									—	—	—	—	—	B(2) CCS	325*	1,250	—	0	50†	—	—	—	—	—	—	160	3.8	12,400 ρ	235	
									1,500	65	—	—	—	B(2) ICAS	448*	1,250	—	0	54†	—	—	—	—	—	—	—	160	6	9,200 ρ	310
									—	—	—	—	—	B(2) ICAS	470*	1,500	—	-4.5	32†	—	—	—	—	—	—	—	160	4.4	12,400 ρ	340
									1,000	30	—	—	—	C-P CCS	115	1,000	—	-55	115	—	45*	—	—	—	—	—	160	6.1*	—	88*
									1,250	45	—	—	—	C-P ICAS	175	1,250	—	-120	140	—	45*	—	—	—	—	—	160	10*	—	135*
1,250	45	—	—	—	C-T CCS	175	1,250	—	-50	140	—	45*	—	—	—	—	—	160	5.7*	—	135*									
1,500	65	—	—	—	C-T ICAS	260	1,500	—	-70	173	—	40*	—	—	—	—	—	160	7.1*	—	200*									
1,750†	45†	—	—	—	C-T ω CCS	204	1,750†	—	-70	130	—	46*	—	—	—	—	—	160	12*	—	175*									
1,125†	45†	—	—	—	C-T β CCS	175	1,125†	—	-35	125	—	25*	—	—	—	—	—	160	3*	—	135*									
GL-812-A	High-Perveance Medium-Mu Triode	3G	6 $\frac{1}{32}$	2 $\frac{1}{8}$	6.3	4.0	TF	30	1,250	45	—	—	—	B(2) CCS	325*	1,250	—	-40	22†	—	—	—	29	3.5	12,200 ρ	235				
									1,500	65	—	—	—	B(2) ICAS	465*	1,500	—	-48	28†	—	—	—	—	—	—	29	5	13,200 ρ	340	
									1,000	30	—	—	—	C-P CCS	115	1,000	—	-110	115	—	33*	—	—	—	—	29	6.6*	—	85*	
									1,250	45	—	—	—	C-P ICAS	175	1,250	—	-115	140	—	35*	—	—	—	—	—	29	7.6*	—	130*
									1,250	45	—	—	—	C-T CCS	175	1,250	—	-90	140	—	30*	—	—	—	—	—	29	5.4*	—	130*
1,500	65	—	—	—	C-T ICAS	260	1,500	—	-120	173	—	30*	—	—	—	—	—	29	6.5*	—	190*									
1,750†	45†	—	—	—	C-T ω CCS	236	1,740†	—	-100	150	—	29*	—	—	—	—	—	29	12*	—	200*									
GL-816	Half-Wave, Mercury-Vapor Rectifier	4P	4 $\frac{1}{16}$	1 $\frac{1}{8}$	2.5	2.0	CF	max. peak plate current=0.5 ampere; max. average plate current=0.125 ampere Tube voltage drop=15 volts; max. peak inverse voltage=7,500 volts;																						
GL-866-A	Half-Wave, Mercury-Vapor Rectifier	866-A	6 $\frac{1}{16}$	2 $\frac{1}{8}$	2.5	5.0	CF	Tube voltage drop=15 volts For 10,000 peak inverse volts, max. peak current=1.0 amp.; max. average current=0.25 amp. For 5,000 peak inverse volts, max. peak current=1.0 amp.; max. average current=0.25 amp. For 2,500 peak inverse volts, max. peak current=2.0 amp.; max. average current=0.5 amp.																						
GL-872A/872	Half-Wave, Mercury-Vapor Rectifier	872-A	8 $\frac{1}{2}$	2 $\frac{3}{8}$	5.0	7.5	CF	Tube voltage drop=15 volts For 10,000 peak inverse volts, max. peak current=5.0 amp.; max. average current=1.25 amp. For 5,000 peak inverse volts, max. peak current=5.0 amp.; max. average current=1.25 amp.																						

Industrial Receiving and Communication Tubes



TYPE	DESCRIPTION	GENERAL					MAXIMUM RATINGS					TYPICAL OPERATING CONDITIONS																					
		Base Connections	Dimensions In Inches		Cathode		Max. Freq. for Full Ratings, mc.	DC Plate Volts	Plate Dissipation Watts	Screen Grid No. 2, Volts	Screen Dissipation Watts	Class and Type of Service	Plate Input Watts	Voltages			Currents			GM, μ amhos	Triode μ Factor	Drive Watts	Load for Rated Output Ohms	RMS Power Output Watts									
Length	Diameter	Volts	Current Amps.	Type	Screen Grid No. 1	Plate, ma								Screen Grid No. 2, ma	Control Grid No. 1, ma	Plate, ma	Screen Grid No. 2, ma	Control Grid No. 1, ma	Control Grid No. 1, ma						Control Grid No. 1, ma								
2050	Thyratron	6BS	4 $\frac{1}{8}$	1 $\frac{1}{8}$	6.3	0.6	CU	Anode voltage drop=8 volts					Controlled Rectifier	Max. DC cathode current=100 ma; max. peak inverse voltage=1,300 volts; max. peak cathode current=1.0 ampere																			
2050A	Thyratron	6BS	3 $\frac{1}{8}$	1 $\frac{1}{8}$	6.3	0.6	CU	Anode voltage drop=8 volts					(Same as 2050)																				
5636 θ ^(R)	Dual-Control Pentode	8DC	1.375	0.400	6.3	0.15	CU	165	0.65	155	0.7	Gated Amplifier	.53	100	100	R \dot{k} =	5.3	3.6	—	3,200	G ₃ tied to cathode	E _{g3} =-1.0 volts		—									
5642 α	Half-Wave, High-Voltage Rectifier	5642	2.380	0.400	1.25	0.2	CF	—	—	—	—	TV Flyback Rectifier	Voltage drop=30 volts at 4.0 ma DC; max. DC output current=0.25 ma; max. peak inverse voltage=10,000 volts; max. peak current=5.0 ma																				
5651 σ	Glow-Discharge Diode Voltage Reference	5B0	2 $\frac{3}{8}$	3/4	—	—	—	—	—	—	—	Max. anode supply voltage=150 volts; max. DC operating current=3.5 ma; max. ionization voltage=115 volts. Min. DC operating current=1.5 ma; max. operating voltage=92 volts. Regulation (1.5 to 3.5 ma)=3.0 volts, max.	—																				
5654 θ ^(R) σ	Sharp-Cutoff RF Pentode	7BD	1 $\frac{3}{8}$	3/4	6.3	0.175	CU	200	1.65	155	0.55	Class A Amplifier	.9	120	120	R \dot{k} =	7.5	2.5	—	5,000	—	—	—	—									
5663 σ	Thyratron	6CE	1 $\frac{1}{2}$	3/4	6.3	0.15	CU	—	—	—	—	Controlled Rectifier	Anode voltage drop=11 volts; max. DC cathode current=20 ma; max. peak inverse voltage=500 volts; max. peak cathode current=60 ma																				
5670 θ ^(R) σ	High-Frequency Twin Triode	8CJ	1 $\frac{3}{8}$	7/8	6.3	0.35	CU	330	1.35	—	—	Class A Amplifier AB ₁ (1)	1.2	150	—	R \dot{k} =	8.2	—	—	5,500	35	—	—	—									
													3.8	300	—	R \dot{k} =	9.8†	—	—	—	—	—	—	27,000	1.0								
																R \dot{k} =	800 ϵ	—	—	—	—	—	—	—	—								
5686 θ ^(R) σ	Beam Power Amplifier	9G	2 $\frac{3}{8}$	7/8	6.3	0.35	CU	160	275	7.5	275	3.0	Class A Amplifier C-T CCS	6.7	250	250	-12.5	27†	3†	—	3,100	—	—	—	9,000	2.7							
																-50	30	6.5	2.0*	—	—	—	—	0.1*	—	5*							
																10.0	250	250	2.0*	—	—	—	—	0.15*	—	6.5*							
5687 θ σ	Medium-Mu Twin Triode	9H	2 $\frac{3}{8}$	7/8	12.6	0.45	CU	300†	4.2†	—	—	Class A Amplifier (per section)	4.1	180	—	-7.0	23.0	—	—	8,500	17	—	—	—	—	—							
																3.0	250	—	-12.5	12.0	—	—	—	—	—	—	—						
																—	—	—	—	5,400	16	—	—	—	—	—							
5687WA θ ^(R) σ	See 5687 θ																																
5691	High-Mu Twin Triode	8BD	2 $\frac{7}{8}$	1 $\frac{1}{2}$	6.3	0.6	CU	275	1.0	—	—	Class A Amplifier (per section)	.58	250	—	-2.0	2.3	—	—	1,600	70	—	—	—	—	—							
5692	Medium-Mu Twin Triode	8BD	2 $\frac{7}{8}$	1 $\frac{1}{2}$	6.3	0.6	CU	275	1.75	—	—	Class A Amplifier (per section)	1.6	250	—	-9.0	6.5	—	—	2,200	20	—	—	—	—	—							
5693	Sharp-Cutoff Pentode	8N	2 $\frac{5}{8}$	1 $\frac{3}{8}$	6.3	0.3	CU	300	2.0	125	0.3	Class A Amplifier	.75	250	100	-3.0	3.0	0.85	—	1,650	—	—	—	—	—	—							
5718 θ α	Medium-Mu Triode	8DK	1.375	0.400	6.3	0.15	CU	165	0.9	—	—	Class A Amplifier UHF Oscillator	.85	100	—	R \dot{k} =	8.5	—	—	5,800	27	—	—	—	—	0.9*							
																150	—	—	—	—	—	—	—	—	—	—							
5719 θ α	High-Mu Triode	8DK	1.375	0.400	6.3	0.15	CU	165	0.1	—	—	Class A Amplifier	.073	100	—	R \dot{k} =	0.73	—	—	1,700	70	—	—	—	—	—							
																1500	—	—	—	—	—	—	—	—	—	—							
5725 ^(R) σ	Dual-Control RF Pentode	7CM	1 $\frac{3}{8}$	3/4	6.3	0.175	CU	200	1.65	155	0.55	Class A Amplifier	.62	120	120	-2.0	5.2	3.5	—	3,200	E _g =0 volts	—	—	—	—	—							
5726 ^(R) σ	Twin Diode	6BT	1 $\frac{3}{8}$	3/4	6.3	0.30	CU	—	—	—	—	Half Wave Rectifier	Tube voltage drop per section=10 volts at 60 ma DC; max. DC output current per plate=10 ma; max. peak inverse voltage=360 volts; rms supply voltage per plate=117 volts; max. peak current per plate=60 ma																				
5727 ^(R) σ	Thyratron	7BN	2 $\frac{1}{8}$	3/4	6.3	0.6	CU	—	—	—	—	Controlled Rectifier	Anode voltage drop=8 volts; max. DC cathode current=100 ma; max. peak inverse voltage=1,300 volts; max. peak cathode current=500 ma																				
5749 ^(R) σ	Remote-Cutoff RF Pentode	7BK	2 $\frac{1}{8}$	3/4	6.3	0.3	CU	330	3.1	300	1.1	Class A Amplifier	2.75	250	100	R \dot{k} =	11.0	4.2	—	4,400	—	—	—	—	—	—							
																68	10.8	4.4	—	4,300	—	—	—	—	—	—							
																88	—	—	—	—	—	—	—	—	—	—							
5750 θ ^(R) σ	Pentagrod Converter	7CH	2 $\frac{1}{8}$	3/4	6.3	0.3	CU	330	1.1	110	1.0	Converter	.65	250	100	-1.5	2.6	7.5	osc.	I _{g1} =0.5 ma; R _{g1} =20,000 ohms	—	—	—	—	—	—							
5751 θ ^(R) σ	High-Mu Twin Triode	9A	2 $\frac{3}{8}$	7/8	12.6	0.175	CU	330	0.8	—	—	Class A Amplifier (per section)	.25	250	—	-3.0	1.0	—	—	1,200	70	—	—	—	—	—							
																.08	100	—	-1.0	0.8	—	—	—	—	—	—							
																30-Amp.	250	8.0	250	1.5	C-P CCS	10	250	250	-39	40	5.6	1*	7,000	—	0.05*	—	6.4*
																30-Amp.	300	12.0	250	1.5	C-P ICAS	15	300	250	-42.5	50	6	2.4*	7,000	—	0.15*	—	10*
																30-Amp.	300	12.0	250	2.0	C-T CCS	15	300	250	-28.5	50	6.6	1.6*	—	—	0.1*	—	10.3*
																30-Amp.	350	13.5	250	2.0	C-T ICAS	17	350	250	-28.5	48.5	6.2	1.6*	—	—	0.1*	—	12*
																50-Amp.	300	12.0	250	2.0	C-T CCS	15	300	250	-60	50	5	3*	—	—	0.35*	—	7*
																175-Dbl.	300	12.0	250	2.0	Doubler-CCS	12	300	250	-75	40	4	1*	—	—	0.6*	—	2.1*
																175-Trip.	300	12.0	250	2.0	Tripler-CCS	8.5	300	235	-100	35	5	1*	—	—	0.6*	—	1.3*
5814-A θ ^(R) σ	Medium-Mu Twin Triode	9A	2 $\frac{3}{8}$	7/8	12.6	0.175	CU	330	3.0	—	—	Class A Amplifier (per section)	2.7	250	—	-8.5	10.5	—	—	2,200	17	—	—	—	—	—							
																1.2	100	—	0.0	11.8	—	—	—	—	—	—							
																—	—	—	—	3,100	19.5	—	—	—	—	—							
5823	Gas Triode	4CK	1 $\frac{7}{8}$	3/4	—	—	—	—	—	—	—	Peak cathode current=100 ma max; d-c cathode current=25 ma max; starter voltage drop=61 volts; anode drop=62 volts	—																				
5824	Beam Power Amplifier	7AC	4 $\frac{1}{8}$	1 $\frac{1}{8}$	25.0	0.3	CU	200†	12.5†	135†	2.0†	Class A Amplifier	9.4	135	135	-22.0	61†	2.5†	—	5,000	—	—	—	—	1,700	4.3							
																—	-69*	-14.5*	—	—	—	—	—	—	—	—							
5840 θ α	Sharp-Cutoff RF Pentode	8DL	1.375	0.400	6.3	0.15	CU	165	0.8	155	0.35	Class A Amplifier	.75	100	100	R \dot{k} =	7.5	2.4	—	5,000	—	—	—	—	—	—							
5844 σ	Medium-Mu Twin Triode	7BF	2 $\frac{1}{8}$	3/4	6.3	0.3	CU	200	1.0	—	—	Class A Amplifier (per section)	.75	100	—	R \dot{k} =	4.8	—	—	3,700	28	—	—	—	—	—							
																470	—	—	—	—	—	—	—	—	—	—							
5879 σ	Sharp-Cutoff AF Pentode	9AD	2 $\frac{3}{8}$	7/8	6.3	0.15	CU	300†	1.25†	250†	0.25†	Class A Amplifier (pentode con.)	.45	250	100	-3.0	1.8	0.4	—	1,000	—	—	—	—	—	—							
																1.4	1.250	—	-8.0	5.5	—	—	—	—	—	—							
																—	—	—	—	1,530	21	—	—	—	—	—							

Industrial Receiving and Communication Tubes



TYPE	DESCRIPTION	GENERAL					MAXIMUM RATINGS				TYPICAL OPERATING CONDITIONS													
		Base Connections	Dimensions in inches		Cathode		Max. Freq. for Full Ratings, mc.	DC Plate Volts	Plate Dissipation Watts	Screen Grid No. 2, Volts	Screen Dissipation Watts	Class and Type of Service	Plate Input Watts				Currents			GM, μ mbos	Triode μ Factor	Drive Watts	Load for Rated Output Ohms	RMS Power Output Watts
			Length	Diameter	Volts	Current Amps.							Type	Plate	Screen	Control	Control	Plate, ma	Screen					
5881	Beam Power Amplifier	7AC	3 1/2	1 1/4	6.3	0.3	CU	360	23	270	3.0	Class A Amplifier (single tube)	13.3	350	250	-18	53	2.5	5,200			4,200	11.3	
												Class A Amplifier (2 tubes, push-pull)	18.8	250	250	-14	65	8.5	6,100			2,500	6.7	
												Class AB ₁ (2 tubes, push-pull)	30	250	250	-16.0	75	4.3				5,000	14.5	
													36.2	270	270	-17.5	80	7.6				5,000	17.5	
													32	360	270	-22.5	120	10				6,600	26.5	
5886	Electrometer Pentode	5886	1 1/2	0.400	1.25	0.01		45		45		Electrometer		12	4.5	-2.0	6.0	3.6		14				
5896 ϕ a	High-Frequency Twin Diode	8DJ	1.375	0.400	6.3	0.3	CU					Full-Wave Rectifier	Tube voltage drop (per section)=4.5 volts at 18 ma DC; max. DC output per plate=10 ma; max. peak inverse voltage=460 volts; rms supply voltage per plate=150 volts; max. peak current per plate=60 ma											
5899 ϕ a	Semi-Remote-Cutoff RF Pentode	8DL	1.375	0.400	6.3	0.15	CU	165	0.75	155	0.35	Class A Amplifier	.72	100	100	R _k =120	7.2	2.0		4,500				
5902 ϕ a	Beam Power Amplifier	8DL	1.750	0.400	6.3	0.45	CU	165	3.7	155	0.4	Class A Amplifier	3.3	110	110	R _k =270	30	2.2		4,200			3,000	1.0
5963 σ	Medium-Mu Twin Triode	9A	2 3/4	7/8	12.6	0.15	CU	250	2.5			Class A Amplifier (per section)	.58	67.5		0	8.5			3,200	21			
5964 σ	High-Mu Twin Triode	7BF	2 1/2	3/4	6.3	0.45	CU	250	1.5			Class A Amplifier (per section)	.95	100		R _k =50	9.5			6,000	39			
5965 σ	Twin Triode	9A	2 3/4	7/8	12.6	0.225	CU	330	2.4			Class A Amplifier (per section)	1.28	150		R _k =220	8.5			6,700	47			
5965A σ	Twin Triode	9A	2 3/4	7/8	6.3	0.45	CU		4.4			Freq. Halfer (per section)	1.25	150		-5.5	10.5	0.15	I _c =140 ma				7,200	7,200
5998A	Low-Mu Twin Triode	8BD	4 1/4	1 1/4	6.3	2.4	CU	275	156			Class A Amplifier	11	110		R _k =105	100			5,500	5.4			
6005 θ (R) σ	Beam Power Amplifier	7BZ	2 1/2	3/4	6.3	0.45	CU	275	11	275	2.2	Class A Amplifier (single tube)	11	250	250	-12.5	45	4.5		4,100			5,000	4.5
6012	Thyratron	6CO	3 7/8	1 1/8	6.3	2.6	CU					Controlled Rectifier	Tube voltage drop=10 volts; max. peak inverse voltage=1,300 volts; max. peak current=5 amp.; max. average current=0.5 amp.; max peak forward voltage=650 volts.											
6021 θ (R)	Medium-Mu Twin Triode	8DG	1.375	0.400	6.3	0.3	CU	165	0.7			Class A (per section)	.65	100		R _k =150	6.5			5,400	35			
6046	Beam Power Amplifier	7AC	3 3/4	1 1/2	25.0	0.3	CU	200	10	125	1.5	Class A Amplifier	9.2	200	125	R _k =180	46	2.2		8,000			4,000	3.8
	Relay Energizer											Relay Energizer	5.5	110	110	-7.5	49	4.0		8,000			2,000	2.1
6072A θ (R) σ	Twin Triode	9A	2 3/4	7/8	12.6	0.175	CU	330	1.6			Class A (per section)	.75	250		-4.0	3.0			1,750	44			
6080 θ	Low-Mu Twin Triode Power Amplifier	8BD	4 1/4	1 3/4	6.3	2.5	CU	250	13			DC Amplifier (per section)	17	135		R _k =250	125			7,000	2			
6087 θ (R)	See 6087/5Y3WGTB θ (R)																							
6087 θ (R)	Full-Wave, High-Vacuum Rectifier	5L	3 3/4	1 1/2	5.0	2.0	CU					Full-Wave Rectifier	Tube voltage drop per section=50 volts at 125 ma DC; max. DC output current=125 ma; max. peak inverse voltage=1,400 volts; rms supply voltage per plate=350 volts; max. peak current per plate=375 ma											
6111 θ (R)	Medium-Mu Twin Triode	8DG	1.375	0.400	6.3	0.3	CU	165	0.95			Class A Amplifier (per section)	.85	100		R _k =220	8.5			5,000	20			
6112 θ (R)	High-Mu Twin Triode	8DG	1.375	0.400	6.3	0.3	CU	165	0.3			Class A Amplifier (per section)	.26	150		R _k =820	1.75			2,500	70			
												Relay Energizer	.08	100		R _k =1,500	0.8			1,800	70			
6134	Sharp-Cutoff RF Pentode	8N	2 1/2	1 1/4	6.3	0.45	CU	330	3.3	330	0.45	Class A Amplifier	3.0	300	150	R _k =160	10	2.5		9,000				
6135 θ (R) σ	Medium-Mu Triode	6BG	2 1/2	3/4	6.3	0.175	CU	330	3.8			Class A Amplifier	2.6	250		-8.5	10.5			2,200	17			
6136 σ	Sharp-Cutoff RF Pentode	7BK	2 1/2	3/4	6.3	0.3	CU	330	3.3	165	0.7	Class A Amplifier	1.2	100		0	11.8			3,100	19.5			
												Class A Amplifier	.5	100	100	R _k =68	10.6	4.3		5,200				
												Class A Amplifier				R _k =150	5.0	2.1		3,900				
6137 θ (R)	Remote-Cutoff RF Pentode	8N	2 1/2	1 1/4	6.3	0.3	CU	330	3.3	140	0.44	Class A Amplifier	2.3	250	100	-3	9.2	2.6		2,000				
												Class A Amplifier	1.3	100	100	-1	13.0	4.0		2,350				
6146	Beam Power Amplifier	7CK	3 3/4	1 3/2	6.3	1.25	CU	400	20	400		AB ₁ (2) CCS	31.3	250	250	-50	120			7,000	4.5	0	5,000	10
												AB ₁ (2) CCS	40	400	400	-100	40					0	8,000	22
												AB ₁ (2) CAS	40	400	400	-100	40					0	8,000	22
												AB ₁ (2) CCS	91	400	190	-40	63	2.5	0			0	4,000	55

Industrial Receiving and Communication Tubes

GENERAL ELECTRIC

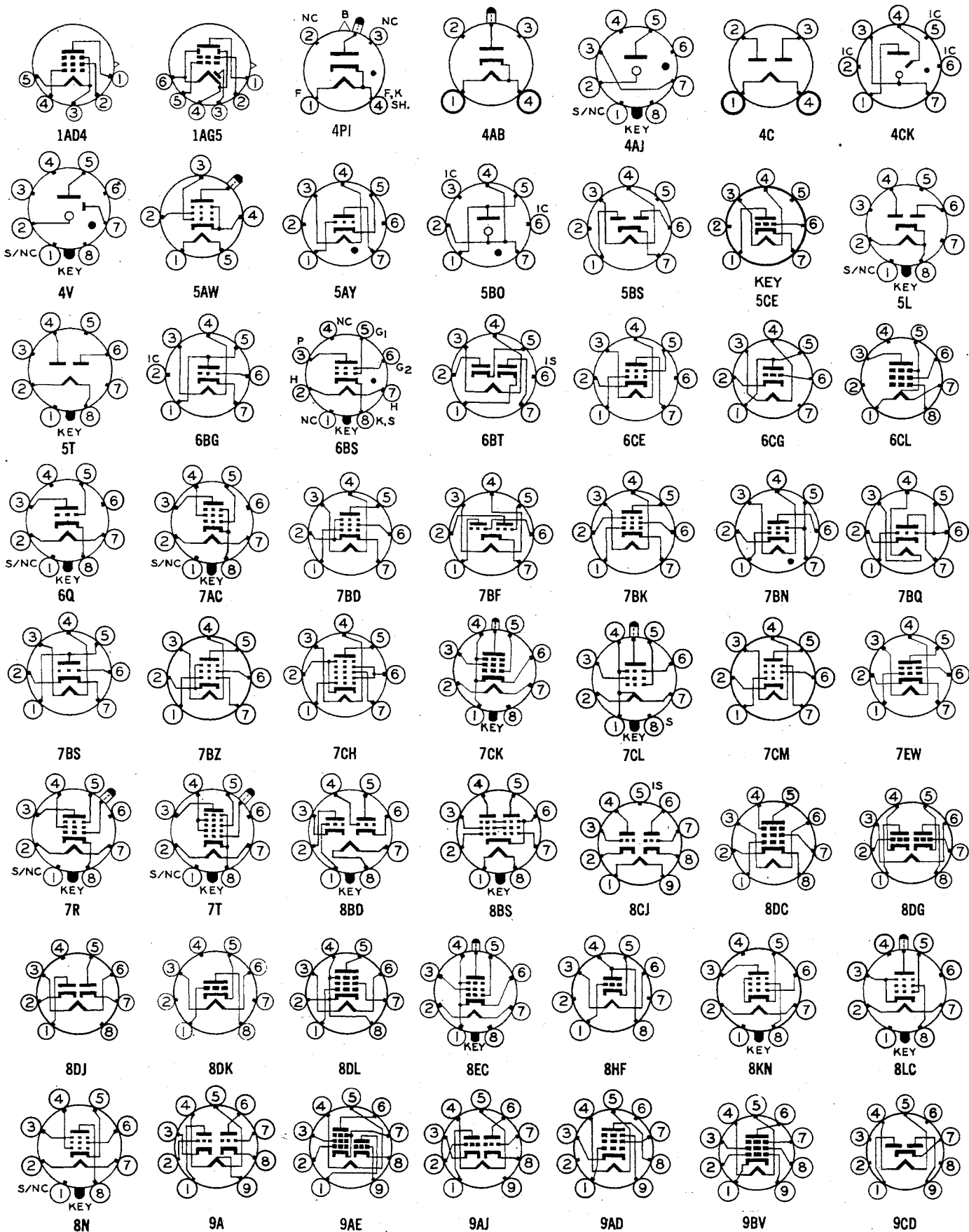

Industrial Receiving and Communication Tubes

GENERAL ELECTRIC

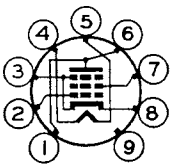

9CE

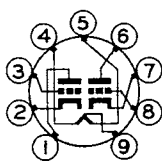

9CZ

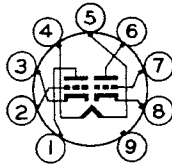

9DE

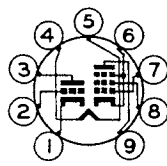

9DX

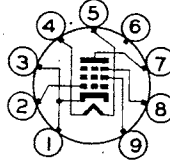

9EQ

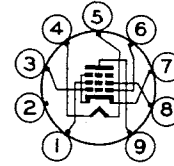

9EU

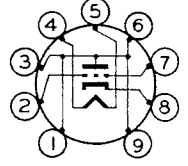

9FR

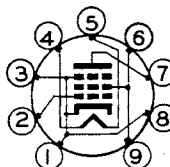

9G

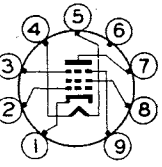

9GT

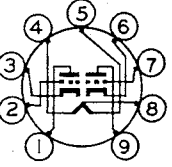

9H

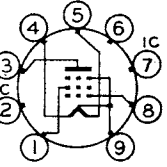

9JL

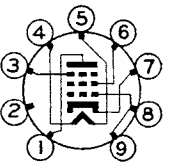

9K

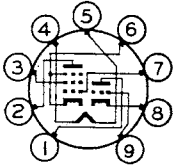

9JT

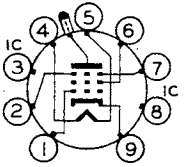

9KH

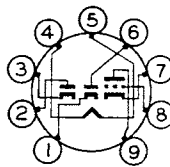

9KR

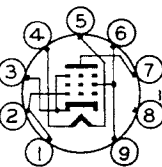

9LE

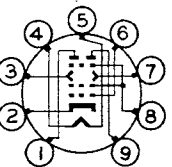

9NF

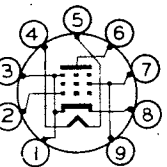

9MS

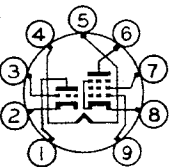

9PJ

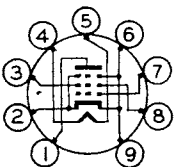

9PL

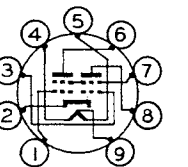

9PW

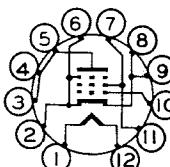

12EU

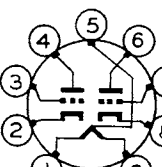

407-A

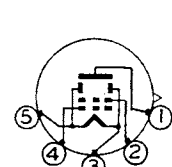

512-AX

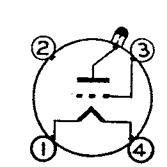

809

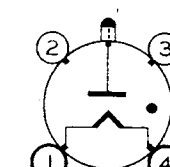

4P

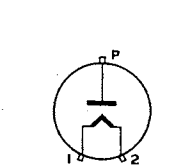

5642

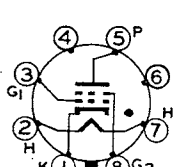

6CO

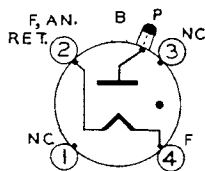

4AT

18 VALUE-ANALYZED benefits of G-E 5-Star Tubes . . .

- Controlled inside diameter on bulbs reduces vibrational output and microphonics.
- Highly efficient getter performs throughout tube life and guides flash to avoid inter-element leakage.
- A getter flash shield improves initial leakage characteristics.
- Two double mica spacers, with additional anti-leakage slots, brace internal parts, provide superior inter-element insulation and improve vibration characteristics. 12 or 16 contact points give firmer fit between bulb and mount.
- Short, sturdy cages increase rigidity of tube structure.
- Plate ears are embossed for added strength and improved mica fit.
- U-bolt construction through top and bottom micas firmly secures the cage assembly.
- Smooth grid legs prevent a "sawing" action on the mica, reducing grid vibration and microphonic noise.
- Critical grids are plated with gold or silver to minimize grid emission.
- Passive cathode alloys assure reliability and long life in low-duty cycle circuits where interface tends to develop.
- Outside diameter and density of cathode coating are statistically controlled.
- Low thermo-conductivity cathode tab reduces heat loss.
- Cataphoretic coating of all heater bends after forming insures complete heater-cathode insulation.
- Folded heater design proved most reliable under shock, vibration and heater cycling conditions. Heater is temperature-controlled to further improve reliability and lengthen life.
- Rhenium-tungsten heater material increases tensile strength, reduces brittleness, and allows larger-diameter heater wire.
- Lead-glass stems help ward off glass electrolysis.
- Pins are annealed to prevent glass strain at socket insertion.
- Stem design minimizes welds—fewer points of possible failure—less change of short-causing particles from weld splash.

Broadcast, Industrial & Special Purpose Power Tubes

GENERAL ELECTRIC

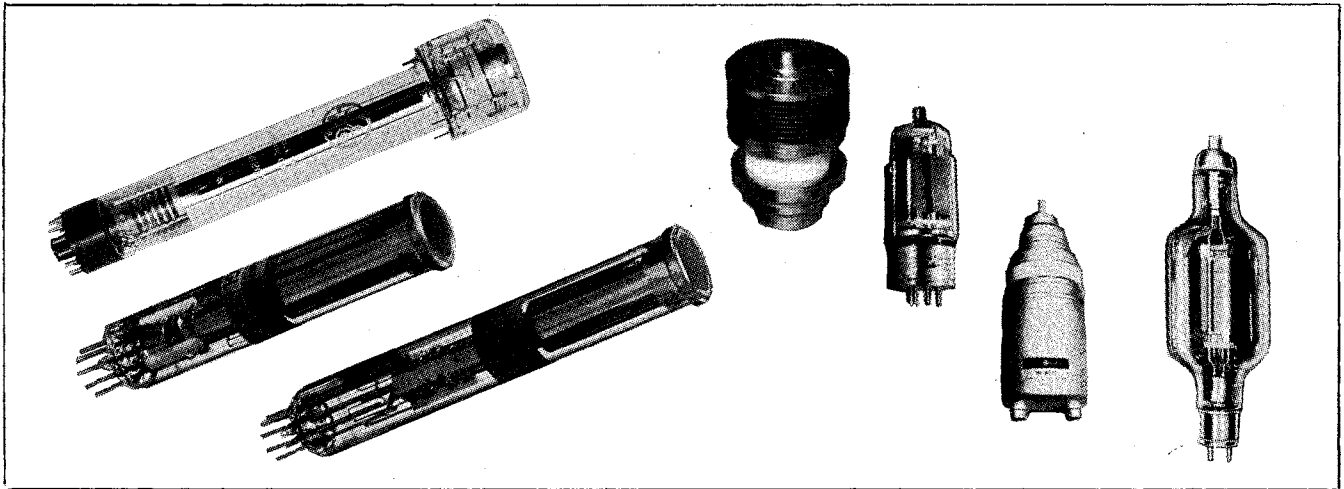

LONG LIFE IMAGE ORTHICONS

Type	Target	Field Mesh	Signal-Noise (4.5 mc)	Amplitude Response @ 400 TV Lines	Typical Lens Aperture vs. Scene Illumination		Application	
					Color	Monochrome	Primary	Other
27899	Electronic Glass	No	65:1	65%	—	f:16 @ 80 - 100 ft-c	Studio, VTR	Color remote
27888		Yes	65:1	65%	f:8 @ 200 ft-c	f:16 @ 80 - 100 ft-c	Color remote	Monochrome VTR
27866	Semiconductor	Yes	50:1	70%	f:5.6 @ 50 ft-c	f:22 @ 50 - 100 ft-c	Color studio	Monochrome X-ray
7629A	MgO	No	50:1	65%	—	f:16 @ 25 - 50 ft-c	Monochrome Remote	X-ray

STANDARD IMAGE ORTHICONS

4401	Glass	No	50:1	60%	—	f:16 @ 50 ft-c	Studio, remote	X-ray
5820A 5820A/R	Glass (Ruggedized)	No	50:1	60%	—	f:16 @ 100 ft-c	Studio, VTR	Remote
7293A 7293A/R	Glass (Ruggedized)	Yes	50:1	60%	—	f:16 @ 100 ft-c	Monochrome studio	Color studio
8093A 8093A/R	Glass (Ruggedized)	Yes	60:1	60%	—	f:16 @ 120 ft-c	Studio color, VTR	Monochrome

SPECIAL PURPOSE IMAGE ORTHICONS

Type	Target	Field Mesh	Photo Cathode	Resolution Sensitivity*	Applications
25395 27805	MgO Ruggedized 25395	No	S-1	500 @ 7.6×10^{-5} 200 @ 1.0×10^{-5}	Near IR sensitive, infrared detection aerial mapping, star tracking, missile tracking
7538 7409	MgO Ruggedized 7538	No	S-10	500 @ 1.5×10^{-5} 100 @ 4×10^{-7}	Low light level surveillance, electro optical telescope systems, airborne and tank fire control
7967 27806	MgO Ruggedized 7967	No	S-20	500 @ 5×10^{-6} 100 @ 1.5×10^{-7}	Extremely low light level surveillance, underwater TV systems, astronomical systems
7969 27807	MgO Ruggedized 7969	No	UV	500 @ 1.5×10^{-5} 100 @ 4×10^{-7}	Near UV sensitive medical biological studies, missile detection
27809	MgO	No	S-10		Similar to 7538 except fiber optic faceplate. Fibre optic systems. Can be coupled to image intensifier
27810 27822	MgO Ruggedized 27810	No	S-20		Similar to 7967 except fiber optic faceplate. Fiber optic systems, radiation scintillator studies. Can be coupled to image intensifier
27814	MgO	Yes	S-20	500 @ 5×10^{-6} 100 @ 2.7×10^{-7}	Improved Corner resolution, electro-optical telescope systems
7198A	Glass	No	S-10		General Purpose surveillance, fire control

* Resolution sensitivity is defined as television lines per target inch @ specified photocathode illumination in foot-candles.

BROADCAST AND INDUSTRIAL VIDICONS

Type	Application	Maximum Dimensions		Heater Current @ 6.3 V Amperes	Amplitude Response @ 400 TV Lines		Sensitivity	OPERATING PARAMETERS			
		Dia. Inches	Length Inches		Focus Coil Field Strength @ 40 Gauss	@ 60 Gauss		Faceplate Illumination ft-c	Target Volts	Dark Current Micro-amperes	Signal Output Micro-amperes
7038 7038V	Film Color Film	1.135	6.50	.6	30%	40%	Average Min. Lag	15 100	30 - 50 10 - 30	.02 .004	.4 .3
8134V	Color Film	1.135	6.35	.09	30%	35%	Average Max.	1.0 .1	30 - 50 40 - 60	.03 .1	.27 .1
7735A	Live	1.135	6.50	.6	30%	40%	Average Max.	1.0 .1	20 - 40 35 - 70	.02 .2	.2 .2
7735B	Live	1.135	6.50	.6	35%	45%	Average Max.	1.0 .1	20 - 40 35 - 70	.02 .2	.2 .2

SECTION 5700

Special Purpose Power Tubes
Broadcast, Industrial &



BROADCAST AND INDUSTRIAL VIDICONS (Continued)

Type	Application	Maximum Dimensions		Heater Current @ 6.3 V Amperes	Amplitude Response @ 400 TV Lines Focus Coil Field Strength @ 40 Gauss		Sensitivity	OPERATING PARAMETERS			
		Dia. Inches	Length Inches		30%	40%		Faceplate Illumination ft-c	Target Volts	Dark Current Micro- amperes	Signal Output Micro- amperes
7226	Live	1.135	5.25	.15	30%	40%	Average Max.	1.0 .2	30 - 50 40 - 100	.02 .2	.2 .2
8484	Live	1.135	5.50	.6	30%	40%	Average Max.	1.0 .2	30 - 50 40 - 100	.02 .2	.2 .2
7262A	Live	1.135	5.25	.09	30%	40%	Average Max.	1.0 .1	20 - 40 35 - 70	.02 .2	.2 .2
7263A	Ruggedized 7262A	1.135	5.25	.09	30%	40%	Average Max.	1.0 .1	20 - 40 35 - 70	.02 .2	.2 .2
8507 F507A	Live	1.135	6.50	.6	50%	70%	Average Max.	1.0 .1	20 - 40 35 - 70	.02 .2	.2 .2
8541	Live	1.135	6.50	.09	50%	70%	Average Max.	1.0 .0	20 - 40 35 - 70	.02 .2	.2 .2
8572 8572V	Film Color Film	1.135	6.50	.6	50%	70%	Average Min. Lag	15 100	30 - 50 10 - 30	.02 .004	.4 .3
8604	Film	1.135	6.50	.09	50%	70%	Average Min. Lag	15 100	30 - 50 10 - 30	.02 .004	.4 .3

TRANSMITTING TUBES

TYPE	DESCRIPTION	DIMENSIONS IN INCHES		CATHODE			MAXIMUM RATINGS					CLASS AND TYPE OF SERVICE	TYPICAL OPERATING CONDITIONS									
		Length	Diameter	Volts	Amps.	Type	Max. Freq. for Full Input, Mc.	Plate Dissipation Watts	Plate Volts	Plate Input Watts	Screen Grid No. 2 Volts		Plate Volts	Plate Current, ma	Screen Grid No. 2 Volts	Screen Grid No. 2 Current, ma	Grid No. 1 Volts	μ Factor	GM μ/amhos	Approx. Drive Power, Watts	Approx. Output Power, Watts	
GL-2H21θ	Phasitron type. For use as phase modulator. Max. frequency 500 KC.	4 ¹ / ₁₆	1 ⁵ / ₁₆	6.3	0.3	CU						DC Plate Volts=300; Deflector volts=100; RF output volts=4.										
GL-4-400A	Forced-air cooled power tetrode.	6 ³ / ₁₆	3 ³ / ₁₆	5.0	14.5	TF	110	400 270 400	4,000 3,200 4,000	— — —	600 600 600	AB ₂ (2) C-P C-T	3,000 2,500 3,000	700 500 350	500 500 500	40 28 46	-80 -220 -220	5.1 — —	4,000 — —	4.5 3.5 6.1	1,375 510 800	
GL-4-1000A	Forced-air cooled beam power tetrode.	9 ⁹ / ₁₆	5 ¹ / ₁₆	7.5	21	TF	110	1,000	6,000	—	1,000	C-T C-P	6,000 5,000	700 600	500 500	140 130	-200 -200	7.2 —	10,000 15	11 11	3,440 2,440	
GL-4D21/ 4-125A	Air-cooled beam power tetrode.	5 ¹ / ₁₆	2 ⁷ / ₁₆	5.0	6.5	TF	120 120	85 125	2,500 3,000	— —	400 400	C-P C-T	2,500 3,000	152 167	350 350	30 30	-210 -150	6.2 —	2,450 —	3.3 2.5	300 375	
GL-4X150A	Air-cooled beam power tetrode.	2 ¹ / ₃₂	1.635	6.0	2.6	CU	— 500 500	150 100 150	1,250 1,000 1,250	— — —	400 300 300	AB ₂ (2) C-P C-T	1,250 1,000 1,250	475 200	300 250 280	65 20	-44 -150 -115	5.0 — —	12,000 — —	0.15 2 30	425 140 140	
GL-7C29θ	Forced-air cooled triode.	5 ³ / ₁₆	2 ¹ / ₂	10.5	28	TF	110	500	3,000	1,200	—	C-T	2,800	330	—	—	-250	29	—	—	600	
GL-7D21θ	Thoriated-tungsten filament. Forced-air cooled tetrode.	7 ¹ / ₂	3.015	6.3	30	TF	110	1,200	4,000	3,000	750	C-T	3,750	670	600	100	-102	8.0	—	60	1,575	
GL-810	High-perveance triode; jumbo 4-pin base. Medium grid and plate caps.	8 ³ / ₁₆	2 ¹ / ₄	10	4.5	TF	— 30 30	175 125 175	2,750 2,000 2,500	510 500 750	— — —	B(2)■ C-P■ C-T■	2,250 2,000 2,000	450 250 300	— — —	-60 -350 -180	— 36 —	— — —	13 35 19	725 380 575		
GL-813	Beam power amplifier; giant 7-pin bayonet base; medium cap.	7 ¹ / ₂	2 ³ / ₁₆	10	5.0	TF	— 30 30	125 100 125	2,500 2,000 2,250	450 400 500	— — —	AB ₂ (2)■ C-P■ C-T■	2,500 2,000 2,250	290 200 220	750 400 350	— — —	-95 -175 -155	— — —	— 4.3 4.0	0 300 375	490 300 375	
GL-829-B	Twin beam power ampli- fier; septar 7-pin base; wire plate terminals.	4 ⁹ / ₁₆	2 ³ / ₁₆	6.3 12.6	2.25 1.125	CU	— 200 200	30 28 40	750 600 750	100 90 120	— — —	AB ₂ (2)■ C-P■ C-T■	600 600 750	110 150 160	200 200 200	— — —	-18 -60 -50	9.0	8,500	0 0.5 0.4	44 70 99	
GL-832-A	Twin beam power ampli- fier; septar 7-pin base; wire plate terminals.	3 ⁹ / ₁₆	2 ³ / ₁₆	6.3 12.6	1.6 0.8	CU	200 200	15 20	600 750	36 50	— — —	C-P■ C-T■	600 750	60 65	200 200	— — —	-70 -50	6.5	3,500	0.21 0.24	26 35	
GL-833-A	High perveance triode; forced-air cooled; special post terminals.	8 ¹ / ₁₆	4 ¹ / ₃₂	10	10	TF	— 20 20	450 350 450	4,000 4,000 4,000	1,800 1,800 2,000	— — —	B(2)■ C-P■ C-T■	4,000 4,000 4,000	900 450 500	— — —	-100 -325 -225	— 35 —	— — —	48 32 35	2,700 1,500 1,600		
GL-838	Air-cooled triode; jumbo 4-pin base.	7 ⁷ / ₁₆	2 ³ / ₁₆	10	3.25	TF	30	100	1,250	220	—	C-T	1,250	150	—	—	-90	—	—	6.0	130	
GL-862-Aθ	Water-cooled triode. Dissipation 50 to 100 KW.	60	3 ³ / ₁₆	33	207	TF	1.6	100,000	20,000	00,000	—	C-P	12,000	5,000	—	—	-800	45	—	2,000	45,000	
GL-880θ	Water-cooled triode; for broadcast and RF heating; special terminals.	11 ¹ / ₂	7	12.6	320	PT	— 25 25	15,000 12,000 20,000	10,500 10,500 10,500	40,000 36,000 60,000	— — —	B(2) C-P C-T	10,000 10,000 10,000	7,000 3,600 6,000	— — —	-450 -1200 -1000	20	—	540 1,100 1,500	46,000 27,000 40,000		
GL-889-Aθ	Water-cooled triode; for broadcast and RF heating; special terminals.	10 ¹ / ₁₆	3 ³ / ₁₆	11.0	125	PT	— 50 50	5,000 3,000 5,000	8,500 6,000 8,500	12,000 6,000 16,000	— — —	B(2) C-P C-T	7,500 6,000 7,500	3,200 1,000 2,000	— — —	-300 -900 -800	21	—	150 140 400	15,000 4,000 10,000		
GL-892	Water-cooled triode; two-section filament; special connections.	20 ⁷ / ₈	6 ¹ / ₁₆	11.0 per sec.	60	PT	— 1.6 1.6	7,500 6,000 10,000	15,000 10,000 15,000	20,000 10,000 30,000	— — —	B(2) C-P C-T	12,500 10,000 12,000	2,800 780 1,550	— — —	-170 -1,600 -1,600	50	—	160 460 565	22,000 6,000 14,000		
GL-5513θ	Forced-air cooled triode; thoriated- tungsten filament.	7 ¹ / ₂	3.015	6.3	32.0	TF	220	1,200	3,000	3,300	—	Class B,TV	2,000	680	—	—	-20	—	223	1,125		

Broadcast, Industrial & Special Purpose Power Tubes



TRANSMITTING TUBES (Continued)

TYPE	DESCRIPTION	DIMENSIONS IN INCHES		CATHODE			MAXIMUM RATINGS					CLASS AND TYPE OF SERVICE	TYPICAL OPERATING CONDITIONS								
		Length	Diameter	Volts	Amps.	Type	Max. Freq. for Full Input, mc.	Plate Dissipation Watts	Plate Volts	Plate Input Watts	Screen Grid No. 2 Volts		Plate Volts	Plate Current, ma	Screen Grid No. 2 Volts	Screen Grid No. 2 Current, ma	Grid No. 1 Volts	μ Factor	GM μmhos	Approx. Drive Power, Watts	Approx. Output Power, Watts
GL-5518/	Forced-air cooled triode tungsten filament.	12 $\frac{3}{4}$	5.530	6.3	235	PT	110	4,000	7,000	12,000	—	C-T	6,600	1,300	—	—	-520	21	—	180	6,500
GL-5549	Forced-air cooled triode. Dissipation 4.0 KW.	11	5 $\frac{1}{2}$	12.6	57	TF	50	4,000	8,500	10,000	—	C-T	8,000	1,250	—	—	-800	23	—	230	7,500
GL-5556	Air-cooled triode; small 4-pin bayonet base.	4 $\frac{1}{2}$	1 $\frac{1}{8}$	4.5	1.1	TF	6	10	350	14	—	C-T	350	35	—	—	-80	—	—	0.25	6
GL-5593/	Phasitron type for use as phase modulator.	4 $\frac{1}{16}$	1 $\frac{1}{8}$	6.3	0.3	CU	Max. frequency for full rating=250 MC.; Anode volts=300; Deflector volts=100; RF output volts=4.														
GL-5675	Medium-μμ "pencil type" triode; for service up to 3,000 MC.	2.252	0.816	6.3	0.135	CU	—	9	300	9	—	C-T oscillator at 1,700 MC.	120	25	—	—	-8	20	—	—	0.475
GL-5736	Forced-air cooled triode. Special connections.	7 $\frac{3}{8}$	3 $\frac{3}{8}$	6.0	60	TF	60	2,500 2,500 1,650	3,000 5,000 3,500	4,200 5,000 4,000	—	B C-T C-P	3,000 5,000 3,500	2,800 1,000 1,140	—	—	-160 -850 -600	—	—	140 250 270	4,350 4,100 3,200
GL-5762/ 7C24	Forced-air cooled triode; special terminal connections.	7 $\frac{1}{8}$	4 $\frac{1}{16}$	12.6	29	TF	30	3,000 2,000 3,000	6,200 5,000 6,200	8,700 5,000 8,700	—	B C-P C-T-F	4,700 4,700 6,000	2,800 960 1,250	—	—	-200 -400 -550	—	—	195 720 1,225	8,800 4,200 7,000
GL-5894	Air-cooled twin tetrode. Max. ratings up to 250 MC.	4 $\frac{1}{16}$	1 $\frac{1}{16}$	6.3 12.6	1.8 0.9	CU	250	40	750	120	300	B C-T C-P	600 600 600	200 200 150	300 250 250	26 16 20	-25 -80 -80	8.2	—	0.2 3.0 0.8	86 90 71
GL-6039/	Water-cooled triode; Replaces GL-9C24 with filament change.	8 $\frac{1}{32}$	3.9	5.0	78	TF	220	7,000	6,000	13,500	—	Class B, TV	5,000	2,100	—	—	-300	21	—	1,060	4,900
GL-6161/	Forced-air cooled triode; special terminal connections.	3 $\frac{1}{2}$	1.76	6.3	3.4	CU	900 900	250 250	1,600 1,600	560 400	—	B-T C-T-F C-M	1,600 ^b 1,650 ^b 1,675 ^b	350 250 250	—	—	-100 ^a -150 ^a -175 ^a	—	—	75 ^c 80 ^c 100 ^c	230 ^d 180 ^d 140 ^d
GL-6251/	Water-cooled metal and ceramic tetrode.	13 $\frac{1}{4}$	5 $\frac{1}{2}$	5.5	19.0	TF	220	25,000	7,000	50,000	700	Class B, TV	6,800	7,500	600	50	-20	20	—	2,300	25,000
GL-6907	Twin tetrode for use up to 600 MC. Standard 7-pin base.	3 $\frac{3}{8}$	1.8	12.6	0.65	CU	400 600	20 14 20	600 500 600	—	250 300 250	B C-P C-T	500 400 400	70 80 100	250 300 250	16 6 5	-26 -50 -50	8	2,500	—	23.5 13 20
GL-6942/	Forced-air cooled metal and ceramic tetrode.	8 $\frac{3}{4}$	3 $\frac{1}{2}$	5.7	24	CV	1,000 1,000	1,500 1,500	4,000 4,000	2,500 2,500	—	Class B, TV C-T	3,500 4,000	520 420	500 500	35 11	-40 -110	—	—	100 65	1,000 1,000
GL-7007/	Forced-air cooled metal and ceramic tetrode. Special connections.	11.63	6.4	5.0	180	CU	220 220	8,000 12,000	5,000 7,500	10,000 20,000	2,000 2,000	C-P C-T	4,800 7,000	1,800 2,600	800 1,000	160 200	-300 -300	10	—	100 80	6,000 12,000
7034/4X150A See 4X150A																					
GL-7085/ 356	Water and forced-air cooled triode for broadcast and industrial heating. Replaces GL-880.	11 $\frac{1}{4}$	7	7.5	170	TF	— 25 25	22,500 22,500 15,000	12,500 12,500 10,000	45,000 33,000 40,000	—	B(2) B-P C-P	12,500 12,500 10,000	6,400 2,400 3,800	—	—	-600 -625 -840	20	—	430 1,070 1,010	55,000 12,000 29,000
							25	22,500	12,500	60,000	—	C-T	10,000	4,500	—	—	-1,150	—	—	960	32,000
							2	22,500	15,000	67,500	—	C-T	10,000	5,600	—	—	-1,300	—	—	1,440	38,000
											—		12,500	4,700	—	—	-1,400	—	—	850	42,000
											—		15,000	4,400	—	—	-1,500	—	—	770	51,000
GL-7289	High transconductance triode, forced-air cooled with integral radiator.	2 $\frac{3}{4}$	1 $\frac{1}{4}$	6.3	1.0							Otherwise same as GL-2C39-B									
GL-8000	High-perveance triode; jumbo 4-pin base; skirted medium and cap, medium side cap.	8 $\frac{3}{4}$	2 $\frac{1}{4}$	10.0	4.5	TF	30 30	175 125 175	2,750 2,000 2,500	510 500 750	—	B C-P C-T	2,250 2,000 2,500	450 250 300	—	—	-130 -370 -240	16.5	—	7.9 20 18	725 380 575
GL-8005	Maximum ratings up to 150 MC.	5	1 $\frac{1}{16}$	16.0	38	PT	150	750	2,500	1,250	—	C-P	—	—	—	—	—	20	—	—	—
GL-8020	High-perveance triode; jumbo 4-pin base; medium cap.	6 $\frac{1}{16}$	2 $\frac{1}{8}$	10	3.25	TF	60 60	85 75 85	1,500 1,250 1,500	250 240 300	—	B C-P C-T	1,500 1,250 1,500	330 190 200	—	—	-67.5 -195 -130	20	—	5.5 9 7.5	330 170 220

See Ceramic Section pgs. 0-0 for types 2C39B.
See Ceramic Section pgs. 0-0 for GL-6299 - GL-6897.
Outline diagrams for GL-7644 and GL-7784 are on page 12.

Outline diagrams for GL-16897 and GL-7289 are on page 4.
Basing diagram for GL-7085/356 is on page 9.
Footnotes are on page 14.

FOOTNOTES FOR TRANSMITTING TUBE LISTINGS

A Cathode to grid volts.
A₁(1) Single tube class A audio power amplifier.
AB₂(2) Push-pull class AB₂ audio power amplifier.
AB₃(2) Push-pull class AB₃ audio power amplifier.
B Referred to grid terminal.
B(2) push-pull class B audio power amplifier.
B-P Single tube class B RF telephone service.
C Driver power output.
C-P Single tube class C plate-modulated telephony service.
C-T Single tube class C telegraphy or FM service.
C-T (Pulsed) Single tube class C RF pulsed oscillator.
CF Coated filament (directly heated).

CV Thoriated tungsten cathode (indirectly heated)
CU Coated indirectly heated cathode (unipotential).
D Useful power output.
C-G-T Single tube class C grid-modulated video service.
PT Pure tungsten filament (directly heated).
TF Thoriated-tungsten filament (directly heated).
/ Broadcast tube type.
■ Intermittent Commercial and Amateur Service rating.
^a Cathode to grid volts.
^b Referred to grid terminal.
^c Driver power output.
^d Useful power output.

Broadcast, Industrial & Special Purpose Power Tubes

GENERAL ELECTRIC

BROADCAST, INDUSTRIAL & SPECIAL PURPOSE POWER TUBES—HIGH VACUUM RECTIFIERS

TYPE	DESCRIPTION	DIMENSIONS IN INCHES		CATHODE		MAXIMUM ANODE RATINGS			TYPICAL OPERATION*			
		Length	Diameter	Volts	Amps.	Peak Inverse Volts	Peak Amperes	Average Current Amperes	Peak Inverse Volts	A.C. Anode Volts	D.C. Output Volts	D.C. Output Current Amperes
GL-2B22	UHF lighthouse type diode, 8-pin octal base.	1 $\frac{3}{8}$	1.312	6.3	0.75	300	0.7	0.02	150	100	50	0.005
GL-2B23	Magnetically-controlled diode. Six-pin octal base.	3 $\frac{3}{8}$	1 $\frac{3}{8}$	6.3	0.3			0.03			150	0.030
GL-3B24-W	Small size, high peak—Inverse voltage diode, shock and vibration resistant.	4 $\frac{7}{8}$	1 $\frac{1}{2}$	2.5 5.0	3.0 3.0	20,000 20,000	0.15 0.3	0.03 0.06	20,000 20,000			0.03 0.06
GL-836	Heater-cathode type. Small 4-pin bayonet base. Medium cap.	6 $\frac{1}{8}$	2 $\frac{1}{8}$	2.5	5	5,000	1	0.25	5,000†	3,400†	1,550†	0.5†
GL-1616	Coated-filament type. Small 4-pin bayonet base. Medium cap.	6 $\frac{1}{8}$	2 $\frac{1}{8}$	2.5	5	6,000	0.8	0.13	5,500†	3,800†	1,730†	0.26†
GL-5973	Thoriated tungsten filament. Two-pin base. Medium cap.	19 $\frac{1}{2}$	6 $\frac{1}{8}$	16.0	19.1	75,000 40,000	5.0 5.0	1.0 1.25	75,000 40,000			1.0 1.25
GL-8020	Tungsten-filament type. Small 4-pin bayonet base.	8	2 $\frac{3}{8}$	5.0	6.0	40,000	0.75	0.1	40,000	28,000		0.1

BROADCAST, INDUSTRIAL & SPECIAL PURPOSE POWER TUBES—GAS-FILLED RECTIFIERS

TYPE	DESCRIPTION	Time Voltage Drop	MAX. ANODE RATING — FOR 60 CPS SUPPLY				DIMENSIONS IN INCHES		CATHODE		OPERATING CONDITIONS#				
			Temp. Range Condensed Mercury, °C.	Peak Inverse Volts	Peak Amperes	Average Amperes	Fault Amperes	Length	Diameter	Volts	Amps.	Peak Inverse Volts	Max. A.C. Plate-to-Plate Supply Volts	Approx. D.C. Output Volts to Filter	D.C. Output Amperes
GL-3B28	Small 4-pin, bayonet base. Medium cap—ceramic-insulated, Xenon-filled.	10	-75 to +90	5,000 10,000	2 1	0.5 0.25	20 20	6	2 $\frac{1}{8}$	2.5	10.0	5,000 10,000	3,400 7,000	1,550 3,200	1.0 0.5
FG-32	See GL-5558/FG-32														
FG-104	See GL-5561/FG-104														
FG-280	All-metal tube for use in low-voltage applications. Flexible leads.	15	40 to 80	1,000	40	6.4	200	10 $\frac{3}{4}$	2 $\frac{1}{4}$	5.0	10.0	2,000	1,400	645	12.8
GL-575-A	Jumbo 4-pin, bayonet base. Medium cap.	10	20 to 50	15,000	10	2.5	100	11 $\frac{1}{8}$	3 $\frac{3}{8}$	5.0	10.0	15,000	10,600	4,800	5
GL-673	Same as GL-575-A except for super-jumbo 4-pin, bayonet base.	Same as GL-575-A						11 $\frac{1}{8}$	3 $\frac{3}{8}$						
GL-857-B	Special terminal connections. Skirted large cap.	15	30 to 40 25 to 60	22,000 10,000	40 40	10 10	400 400	19 $\frac{7}{8}$ ^a	7 $\frac{1}{8}$	5.0	30.0	22,000 10,000	15,400 7,000	7,000 3,200	20 20
GL-866-A	Small 4-pin, bayonet base. Medium cap—ceramic-insulated.	15	20 to 60	10,000	1	0.25	20	6 $\frac{1}{8}$	2 $\frac{1}{8}$	2.5	5.0	10,000	7,000	3,200	0.5
GL-869-B	4-pin base. Skirted large cap.	15	30 to 40	20,000	10	2.5	100	14 $\frac{3}{8}$	5 $\frac{1}{8}$	5.0	19.0	20,000	14,000	6,400	5
GL-870-A	Heavy-duty heater-cathode type. Flexible leads.	16	35 to 40 35 to 50	16,000 7,500	450 450	75 75	4,500 4,500	26 ^a	5 $\frac{1}{2}$	5.0	65.0	16,000 7,500	9,060 4,260	4,150 1,950	150
GL-872-A	Jumbo 4-pin base. Medium cap—ceramic-insulated.	10	20 to 60 20 to 70	10,000 5,000	5 5	1.25 1.25	50 50	8 $\frac{1}{2}$	2 $\frac{3}{8}$	5.0	7.5	10,000 5,000	7,000 3,400	3,200 1,550	2.5 2.5
GL-5558/FG-32	Small 4-pin, bayonet base. Medium cap.	15	30 to 60 30 to 80	5,000 2,000	15 15	2.5 2.5	200 200	7 —	3 —	5.0 —	4.5 —	5,000 2,000	3,400 1,400	1,550 645	5 5
GL-5561/FG-104	Super-jumbo 4-pin, bayonet base. Maximum averaging time 15 sec. for welder-control service.	15 15	40 to 80 25 to 50	3,000 10,000	40 16	6.4 4.0	400 160	11 $\frac{1}{4}$	3 $\frac{1}{8}$	5.0	10.0	3,000	2,000	910	12.8
GL-8008	Same as GL-872-A except for super-jumbo 4-pin, bayonet base.	Same as GL-872-A						8 $\frac{1}{4}$	2 $\frac{3}{8}$						

THYRATRON TUBES

TYPE	DESCRIPTION	Dimensions Inches (Max.)		Cathode		Approx. Tube Drop Volts	MAXIMUM RATINGS						Critical Grid Volts at Anode Volts
		Length	Diam.	Volts	Amps.		Temperature Range of Condensed Mercury, °C.	Peak Forward Anode Volts	Peak Inverse Anode Volts	Peak Cathode Amperes	Average Cathode Amperes	Fault Amperes	
2D21	Negative-control, heater-cathode type. Miniature 7-pin base.	2 $\frac{1}{8}$	$\frac{3}{4}$	6.3	0.6	8	-75 to +90*	650	1,300	0.5	0.1	10	4.2 @ 450
3C23	Gas and mercury-filled. Negative-control, filament type. Small 4-pin bayonet base, medium cap.	6 $\frac{1}{8}$	2 $\frac{1}{8}$	2.5	7	15	-40 to +80 -40 to +100	1,250 200	1,250 200	6 6	1.5 1.5	120 120	-5.5 @ 1,000 -2.5 @ 100
6D4	Relay tube or relaxation oscillator. Miniature 7-pin base.	2 $\frac{1}{8}$	$\frac{3}{4}$	6.3	.25	16	-55 to +90*	350	350	0.11	.025	—	—
FG-81-A	Mercury vapor type for relay control. Medium 4-pin bayonet base, medium cap.	6 $\frac{1}{8}$	2 $\frac{1}{8}$	2.5	5	16	-55 to +85	500	500	2.0	0.5	40	-7.5 @ 500
FG-97	Mercury vapor, double-grid type. Medium 4-pin bayonet base, medium cap top and side.	6 $\frac{3}{8}$	2 $\frac{1}{8}$	2.5	5	16	+40 to +80	1,000	1,000	2.0	0.5	40	-13 @ 1,000
FG-98A	Mercury vapor, double-grid type. Medium 4-pin bayonet base, medium cap top and side.	6 $\frac{3}{8}$	2 $\frac{1}{8}$	2.5	5	16	-55 to +85	500	500	2.0	0.5	40	-16 @ 500
FG-105	Negative-control, heater-cathode type. Super-jumbo 4-pin bayonet base, large cap top and side.	11 $\frac{1}{4}$	2 $\frac{1}{2}$ R	5.0	10	16	-40 to +80	2,500	2,500	40	6.4	400	-9 @ 1,000
FG-154	Negative-control, heater-cathode type. Uses low grid power. Medium 4-pin bayonet base, medium cap.	8	3	5.0	7	16	-20 to +50*	500	500	10	2.5	80	-9 @ 500
FG-172	Negative-control, heater-cathode type. Metal envelope with flexible leads and threaded terminal. †Welder Control Ratings.	10 $\frac{3}{4}$	2 $\frac{5}{8}$ R	5.0 5.5†	10 11†	16 16	+40 to +80 +30 to +95	2,000 750	2,000 750	40 77	6.4 2.5	400 400	-9 @ 1,000

Broadcast, Industrial &
Special Purpose Power TubesGENERAL  ELECTRIC

THYRATRON TUBES (Continued)

TYPE	DESCRIPTION	Dimensions Inches (Max.)		Cathode		Approx. Tube Drop Volts	MAXIMUM RATINGS						Critical Grid Volts at Anode Volts
		Length	Diam.	Volts	Amps.		Temperature Range of Condensed Mercury, °C.	Peak Forward Anode Volts	Peak Inverse Anode Volts	Peak Cathode Amperes	Average Cathode Amperes	Fault Amperes	
393-A	Negative-control, filament type, mercury vapor and gas-filled. Octal base, small cap.	6¾	2¼	2.5	7	15	-40 to +80	1,250	1,250	6.0	1.5	—	-5.5 @ 1,000
414	Negative-control, mercury vapor, heater-cathode type. Bracket mounted, flexible leads.	15¼	3½	5	19	20	+40 to +80	3,000	3,000	100	5.0	1,500	-10 @ 1,000
502-A	Negative-control, heater-cathode type. Metal envelope, octal base.	2½	1¾	6.3	0.6	11	-55 to +90*	650	1,300	1.0	0.1	10	-3.5 @ 1,000
672-A	Negative-control, heater-cathode type. Ignitor firing applications. Super-jumbo 4-pin bayonet base, medium cap.	8¾	2¾	5	5	12	+40 to +80	2,500	2,500	40	3.2	150	-10 @ 1,000
678	Negative-control, filament type. Relay control application. Jumbo 4-pin bayonet base, medium cap.	10¾	2¾	5	7.5	15	+25 to +50	10,000	15,000	6.0	1.6	50	-15 @ 1,000
884	Negative-control, heater-cathode type. Relaxation oscillator and relay control. Small 5-pin base.	4¾	1¾	6.3	0.6	16	-75 to +90*	350	350	0.3	0.075	—	-25 @ 250
2050-A	Negative-control, heater-cathode type. Octal 8-pin base.	4¾	1¾	6.3	0.6	8	-75 to +90*	650	1,300	1.0	0.1	10	-3 @ 650
5544	Negative-control, inert gas, filament type. Quick-heating cathode. Super-jumbo 4-pin base, medium cap.	7½	2¾	2.5	12	16	-55 to +70*	1,500	1,500	40	3.2	560	-8 @ 1,000
5557	Negative-control, mercury vapor, filament type. Medium 4-pin bayonet base, medium cap.	6¾	2¾	2.5	5	16	+40 to +80	2,500	5,000	2	0.5	40	-7 @ 1,000
5559	Negative-control, heater-cathode type. Small 4-pin bayonet base, medium cap.	7¼	3	5.0	4.5	16	+40 to +80	1,000	1,000	15	2.5	200	-6.5 @ 1,000
5560	Negative-control, heater-cathode type. Ignitor firing applications. Small 4-pin bayonet base, two medium caps.	7¾	2¼	5.0	4.5	16	+40 to +80	1,000	1,000	15	2.5	200	-9 @ 1,000
5563-A	Negative-control, filament type. Jumbo 4-pin bayonet base, medium cap.	10½	2¾	5.0	10	15	+25 to +50 +25 to +55 +25 to +50 +25 to +55	20,000 15,000 20,000 15,000	20,000 15,000 20,000 15,000	6.4 10 11.5 11.5	1.6 1.8 2.5 2.5	70 70 70 70	-2.5 @ 500
5632/C3J	Negative-control, filament type. Small 4-pin bayonet base, medium cap.	6	1¾	2.5	9	10	-55 to +75*	900	1,250	30	2.5	300	-4.5 @ 750
5663	Negative-control, inert-gas-filled. For relay and grid-control rectifier applications. Seven-pin miniature.	1½	¾	6.3	0.15	11	-55 to +90*	500	500	0.06	0.02	1.0	-2.5 @ 500
5665/C16J	Negative-control, xenon, filament type. Base bracket and flexible leads.	10½	2¾	2.5	31	11	-55 to +75*	1,000	1,250	160	16	1,000	-2.2 @ 500 -4.0 @ 1,000
5696A	Negative-control, inert-gas-filled cathode type. seven-pin miniature.	1¾	¾	6.3	0.15	10	-55 to +90	500	500	0.125	0.028	2.0	—
5720	Positive-control, heater-cathode type. Medium 4-pin bayonet base, medium cap.	7½	3	5.0	4.5	—	+35 to +80	1,000	1,000	15	2.5	200	+9.5 @ 1,000
5727	Negative-control, inert-gas-filled cathode type. Seven-pin miniature.	1¾	¾	6.3	0.6	8	-75 to +90*	650	1,300	0.5	0.1	10	-3.5 @ 450
5728	Negative/positive-control, heater-cathode type. Small 4-pin bayonet base, medium cap.	7	3	5.0	4.5	16	+40 to +80	1,000	1,000	15	2.5	200	+4 @ 100 0 @ 1,000
5830	Negative-control, heater-cathode type for high voltage and current applications.	17¾	5¼	5.0	20	16	+40 to +65	10,000	10,000	75	12.5	1,500	-6 @ 10,000
5855	Negative-control, filament type. High commutation factor for motor control. Lugs for connections.	11¼	3¾	2.5	34	16	-55 to +70*	1,500	1,500	160	18	2,000	-3 @ 1,000
6011/710	Negative-control, mercury vapor and gas-filled type. Medium 4-pin bayonet base, large cap.	6¼	1¾	2.5	9	15	-40 to +80	1,000	1,250	30	2.5	250	-5 @ 1,000
6012	Negative-control, heater-cathode type. Octal, 6-pin base.	4¼	1½	6.3	2.5	10	-75 to +90*	650	1,300	5	0.5	20	-10 @ 650
6014/C1K	Negative-control, filament, xenon type. Small 4-pin bayonet base.	4¼	1¾	2.5	6.3	8	-55 to +75*	1,000	1,250	8	1	77	-2 @ 500
6807	Negative-control, gas type. Super-jumbo bayonet base.	9	2¾	2.5	21	16	-55 to +70*	1,500	1,500	80	6.4	1,120	-6 @ 1,000
6808	Same as GL-6807 with flexible leads and bracket mount.	9	2¾	2.5	21	16	-55 to +70*	1,500	1,500	80	6.4	1,120	-6 @ 1,000
6809	Same as GL-6807 with spade lugs for panel mounting.	9	2¾	2.5	21	16	-55 to +70*	1,500	1,500	80	6.4	1,120	-6 @ 1,000
6858/760	Negative-control, filament type. Four-pin bayonet base. Medium cap.	9½	2¾	2.5	21	12	-40 to +80	1,500	1,500	77	6.4	770	-4 @ 500 -5.5 @ 1,250
6859/760-P	Negative-control, filament type. Bracket-type base for panel mounting. Medium cap.	9½	2¾	2.5	21	12	-40 to +80	1,500	1,500	77	6.4	770	-4 @ 500 -5.5 @ 1,250
7518/710-L	Negative-control, gas and mercury type. Spade lugs for panel mounting. Medium cap.	6¼	1¾	2.5	9	15	-40 to +80	1,000	1,250	30	2.5	250	-5 @ 1,000
7725	Negative-control, gas and mercury type. Quick-heating filament. Four-pin bayonet base. Medium cap.	6¼	1¾	2.5	9	15	-40 to +80	3,500	3,500	30	2.5	250	-5 @ 1,000 -9 @ 3,500
7726	Same as GL-7725 except spade lugs for panel mounting.	6¼	1¾	2.5	9	15	-40 to +80	3,400	3,500	30	2.5	250	-5 @ 1,000 -9 @ 3,500

Miniature types are in bold face.

* Temperature rating expressed in ambient temperature range over which the tube will operate.

Ignitrons

GENERAL  ELECTRIC

Ignitrons are gas-discharge tubes employing a mercury pool as the cathode. The mercury pool cathode provides extremely high emission capability. Initiation of conduction in the ignitron is accomplished by means of a starting electrode called the ignitor. The ignitor is a small rod of highly refractory material which dips into the mercury pool. The passage of ignition current through the ignitor causes a cathode spot to form at the junction of the ignitor and mercury pool. Ionization from the cathode spot spreads throughout the volume of the ignitron and when the anode is positive electrons flow to it. By control of the point in the A-C cycle at which the ignitor is fired the duration of current flow through the ignitron is controlled. The ignitron,

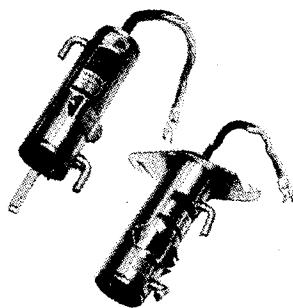

therefore, is ideally suited for high current rectification and control service. The following charts present summarized rating information for General Electric ignitrons. All ratings are based on 25-60 CPS operation. For convenience to the user the ignitron types are grouped by typical application service. Many types are rated for more than one service and therefore appear in two or more rating charts. More detailed ratings are available upon request for all of the G.E. ignitrons listed. The ignitron has long been recognized as a long life, highly reliable device. As the industry's leading ignitron manufacturer General Electric is pleased to present the information contained in this booklet and invites your inquiry for additional application assistance if required.

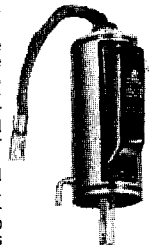

IGNITRONS — RESISTANCE WELDING CONTROL SERVICE

TYPE	SIZE	MECHANICAL DATA			MAXIMUM ELECTRICAL RATINGS*				
		Maximum Dimensions - Inches		Mounting	Supply Volts RMS	Maximum Demand KVA	Corresponding Average Anode Current Amperes	Maximum Average Anode Current Amperes	Corresponding Demand KVA
		Rigid Length	Diameter						
GL-5550	A	9 $\frac{1}{16}$	2 $\frac{3}{4}$	Clamp	250-600	300	12.1	22.4	100
GL-5551A/GL-5551A-PC	B	13	2 $\frac{3}{4}$	Conventional	250-600	600	30.2	56	200
GL-5552A/GL-5552A-PC	C	14	4 $\frac{1}{4}$	Conventional	250-600	1200	75.6	140	400
GL-5553B/GL-5553B-PC	D	19 $\frac{1}{2}$	5 $\frac{5}{8}$	Conventional	250-600	2400	192	355	800
GL-5554 ⁽²⁾	—	17	4 $\frac{1}{8}$	Conventional	2400	1200	75	113	600
GL-5555 ⁽²⁾	—	17 $\frac{1}{16}$	5 $\frac{1}{4}$	Conventional	2400	2400	135	207	1105
GL-5564 ⁽²⁾	—	27 $\frac{1}{16}$	9 $\frac{1}{8}$	Special	2400	4800	270	414	2210
GL-6512 ⁽²⁾	Integral Thermostat Version of GL-5554. Same Ratings Apply.								
GL-6513 ⁽²⁾	Integral Thermostat Version of GL-5555. Same Ratings Apply.								
GL-6515 ⁽²⁾	Integral Thermostat Version of GL-5564. Same Ratings Apply.								
GL-7151	E	23 $\frac{1}{4}$	9 $\frac{1}{8}$	Special	250-600	4800 ⁽¹⁾	486	900	1600
GL-7669/GL-7669-PC	B	9 $\frac{7}{8}$	2 $\frac{3}{4}$	Coaxial	250-600	600	30.2	56	200
GL-7671/GL-7671-PC	C	11 $\frac{7}{8}$	4 $\frac{1}{4}$	Coaxial	250-600	1200	75.6	140	400
GL-7673/GL-7673-PC	D	19 $\frac{1}{2}$	5 $\frac{5}{8}$	Coaxial	250-600	2400	192	355	800
GL-7681/GL-7681-PC	Jumbo C	17 $\frac{1}{2}$	4 $\frac{1}{4}$	Conventional	250-600	1800	135	220	600
GL-7998/GL-7998-PC	Jumbo C	14 $\frac{1}{4}$	4	Coaxial	250-600	1800	135	220	600
GL-8205	E	23	9 $\frac{1}{8}$	Coaxial	250-600	4800 ⁽¹⁾	486	900	1600
GL-37250/GL-37250-PC	B-2000	13	2 $\frac{3}{4}$	Conventional	250-600	1000	43.2	75	200
GL-37251/GL-37251-PC	B-2000	13	2 $\frac{3}{4}$	Coaxial	250-600	1000	43.2	75	200
GL-37252/GL-37252-PC	C-4000	14 $\frac{1}{4}$	4 $\frac{1}{4}$	Conventional	250-600	2000	108	150	380
GL-37253/GL-37253-PC	C-4000	14 $\frac{1}{4}$	4 $\frac{5}{8}$	Coaxial	250-600	2000	108	150	380
GL-37254/GL-37254-PC	D-6000	19 $\frac{1}{2}$	5 $\frac{5}{8}$	Conventional	250-600	3000	224	400	1000
GL-37255/GL-37255-PC	D-6000	19 $\frac{1}{2}$	5 $\frac{5}{8}$	Coaxial	250-600	3000	224	400	1000

Warranty for all types listed above is H-12 except for those marked ⁽²⁾, see footnote below.

PC Indicates plastic coated version.

* All ratings based on use of liquid cooling.

⁽¹⁾ Maximum demand current below 500 volts should not exceed 9600 amperes RMS.

⁽²⁾ Have H-24 warranty.

IGNITRONS — FREQUENCY-CHANGER WELDING CONTROL SERVICE

TYPE	SIZE	MECHANICAL DATA			MAXIMUM ELECTRICAL RATINGS*				
		Maximum Dimensions - Inches		Mounting	Peak Inverse Voltage Volts	Maximum Peak Anode Current Amperes	Corresponding Average Anode Current Amperes	Maximum Average Anode Current Amperes	Corresponding Peak Anode Current Amperes
		Rigid Length	Diameter						
GL-5551A GL-5551A-PC	B	13	2 $\frac{3}{4}$	Conventional	1200 1500	600 480	5 4	22.5 18	135 108
GL-5553B GL-5553B-PC	D	19 $\frac{1}{2}$	5 $\frac{5}{8}$	Conventional	1200 1500	3000 2400	40 32	140 112	840 672
GL-5822A GL-5822A-PC	C	14 $\frac{1}{4}$	4 $\frac{1}{4}$	Conventional	1200 1500	1500 1200	20 16	70 56	420 336
GL-7669 GL-7669-PC	B	9 $\frac{7}{8}$	3 $\frac{1}{4}$	Coaxial	1200 1500	600 480	5 4	22.5 18	135 108
GL-7672 GL-7672-PC	C	11 $\frac{7}{8}$	4 $\frac{5}{8}$	Coaxial	1200 1500	1500 1200	20 16	70 56	420 336
GL-7673 GL-7673-PC	D	19 $\frac{1}{2}$	5 $\frac{5}{8}$	Coaxial	1200 1500	3000 2400	40 32	140 112	840 672
GL-7681 GL-7681-PC	Jumbo C	17 $\frac{1}{2}$	4 $\frac{1}{4}$	Conventional	1200 1500	2250 1800	30 24	105 84	630 502
GL-7998 GL-7998-PC	Jumbo C	16	4	Coaxial	1200 1500	2250 1800	30 24	105 84	630 502

Warranty for all types listed above is H-12.

PC Indicates plastic coated version.

* All ratings based on use of liquid cooling.

Ignitrons

GENERAL  ELECTRIC

IGNITRONS — PULSE WELDING CONTROL SERVICE

TYPE	SIZE	MECHANICAL DATA			MAXIMUM ELECTRICAL RATINGS*						
		Maximum Dimensions - Inches		Mounting	Peak Inverse Voltage Volts	Initial Peak Inverse Voltage Volts	Peak Anode Current Amperes	Average Anode Current Amperes	Averaging Time Seconds	Anode Current Repetition Rate - Pulses Per Second	Anode Current Pulse Width Microseconds
		Rigid Length	Diameter								
GL-7670	B	9 $\frac{7}{8}$	2 $\frac{3}{4}$	Coaxial	2500	1250	2000	10	2	60	1000
GL-7673	C	19 $\frac{1}{2}$	5 $\frac{7}{8}$	Coaxial	2500	1250	4000	20	2	60	1200
GL-8360	B	9 $\frac{7}{8}$	2 $\frac{3}{4}$	Coaxial	2500	1250	2000	10	2	60	1000

Warranty for all types listed above is H-12.

* All ratings based on use of liquid cooling.

IGNITRONS — POWER RECTIFIER SERVICE

TYPE	DESCRIPTION	MECHANICAL DATA			MAXIMUM ELECTRICAL RATINGS*				Warranty
		Max. Dimensions Inches		Mounting	Peak Anode Voltage Volts		Anode Current Amperes		
		Rigid Length	Diameter		Forward	Inverse	Peak	Average	
GL-5554	For continuous-duty power rectifier service at 100 amperes at 900 volts peak forward and inverse. Has auxiliary anode and two ignitrons.	17	4 $\frac{1}{8}$	Conventional	900 2,100	900 2,100	900 600	100 75	H-24, G-12
GL-5555	For continuous-duty power rectifier service at 200 amperes at 900 volts peak forward and inverse. Has auxiliary anode and two ignitrons.	17 $\frac{1}{8}$	5 $\frac{3}{8}$	Conventional	900 2,100	900 2,100	1,800 1,200	200 150	H-24, G-12
GL-5564	For continuous-duty power rectifier service at 400 amperes at 900 volts peak forward and inverse. Has auxiliary anode and two ignitrons.	27 $\frac{1}{8}$	9 $\frac{1}{8}$	Special	750	750	3,600	400	H-24, G-12
GL-5630	For high voltage power-rectifier and inverter service. Also used as capacitor discharge or DC short-circuiting switch.	22 $\frac{3}{8}$	5 $\frac{3}{8}$	Conventional	20,000	20,000	200	50	G-12
GL-5779	Small glass air-cooled type for demonstrating the operating principles of ignitrons and ignitrons.	8 $\frac{3}{4}$	2 $\frac{1}{2}$	Conventional	350	350	30	10	G-12
GL-5788	Similar to GL-5555. Features reliable operation at higher water temperatures and phase-retard operation; has larger diameter ignitor terminals.	19 $\frac{1}{4}$	5 $\frac{3}{8}$	Conventional	2,100	2,100	1,200	150	H-24, G-12
GL-6228	For high voltage power-rectifier and inverter service. Also used in capacitor discharge and DC short-circuiting switch service.	42	9	Special	20,000	20,000	900	150	H-36, G-12
GL-6504	Double-grid type with three ignitrons for locomotive rectifier service. Twelve tubes will supply DC power for 4000 HP locomotive.	30 $\frac{1}{4}$	9	Coaxial	4,000	4,000	2,000	350	G-12
GL-6509	Similar to GL-5555. For auxiliary power in rectifier locomotives. Has three ignitrons.	7 $\frac{1}{8}$	5 $\frac{3}{8}$	Conventional	900 2,100	900 2,100	1,800 1,200	200 150	G-12
GL-6512	Integral thermostat version of GL-5554. Same ratings apply.								H-24, G-12
GL-6513	Integral thermostat version of GL-5555. Same ratings apply.								H-24, G-12
GL-6514	Integral thermostat version of GL-5788. Same ratings apply.								H-24, G-12
GL-6515	Integral thermostat version of GL-5564. Same ratings apply.								H-24, G-12
GL-6878	Double-grid type for locomotive rectifier service. Features coaxial cathode connection to reduce magnetic field effects.	30 $\frac{1}{4}$	13 $\frac{1}{8}$	Coaxial	100	4,000	2,500	675	G-12
GL-6958	Double-grid type for industrial power rectifier and inverter service. Especially suited for phase retard operation. Features coaxial cathode connection to reduce magnetic field effects.	29 $\frac{3}{8}$	9	Special	4,000	4,000	2,000	275	G-12
GL-7042	Integral thermostat version of GL-6958. Same ratings apply.								G-12
GL-7736	Similar to GL-5564. Features reliable operation at high voltage and with phase-retard operation.	27 $\frac{3}{8}$	9 $\frac{1}{8}$	Special	900 2,100	900 2,100	3,600 2,400	400 300	G-12
GL-8420	Forced-air-cooled type for locomotive electronic contactor service. Features coaxial cathode connection to reduce magnetic field effects; integral thermostat control.	22 $\frac{1}{8}$	10 $\frac{1}{8}$	Coaxial	1,000	1,000	2,500	200	G-12
GL-8465	For motor control service. Has auxiliary anode and two ignitrons.	17 $\frac{1}{8}$	5 $\frac{3}{8}$	Conventional	900 2,100	900 2,100	1,800 1,200	200 150	H-24, G-12
GL-8466	Integral thermostat version of GL-8465. Same ratings apply.								H-24, G-12
GL-35438	Double-grid motor control ignitron. Features cathode connection to reduce magnetic field effects.	30 $\frac{1}{4}$	13 $\frac{1}{8}$	Special	4,000	4,000	2,500	675	G-12

* All ratings are based on use of liquid cooling except GL-5779 and GL-8420 whose ratings are based on use of forced air cooling.

Ignitrons



IGNITRONS — CAPACITOR DISCHARGE SERVICE

TYPE	MECHANICAL DATA			MAXIMUM ELECTRICAL RATINGS					Cooling
	Maximum Dimensions - Inches		Mounting	Peak Anode Voltage Volts		Peak Anode Current Amperes	Typical Discharge Rate Pulses Per Minute	Ionization Time-Micro- seconds	
	Rigid Length	Diameter		Forward	Inverse				
GL-5630	22 $\frac{3}{4}$	5 $\frac{3}{4}$	Conventional	35,000	35,000	20,000	2	0.8	Liquid
GL-6228	42	9	Special	50,000	50,000	30,000	2	0.8	Liquid
GL-7171	8 $\frac{3}{4}$	2 $\frac{5}{8}$	Clamp	15,000	15,000	35,000	2	0.5	Air
GL-7703	7 $\frac{5}{8}$	2 $\frac{1}{4}$	Clamp	20,000	20,000	100,000	2	0.5	Liquid or Air
GL-37207	20	5 $\frac{3}{4}$	Conventional	25,000	25,000	300,000	500	0.5	Liquid
GL-37228	7 $\frac{5}{8}$	2 $\frac{1}{4}$	Clamp	20,000	20,000	100,000	2	0.5	Liquid or Air
GL-37248	7 $\frac{5}{8}$	2 $\frac{1}{4}$	Clamp	50,000	50,000	25,000	2	0.7	Liquid or Air
GL-37267A	10 $\frac{1}{4}$	6 $\frac{1}{2}$	Coaxial	20,000	20,000	300,000	500	0.7	Liquid

For above types, warranty is normally K-1000, however warranty information for specific applications will be supplied upon request.

IGNITRON ACCESSORIES

THERMOSTAT KITS

Kit includes thermostat and spring-loaded fastener in a captive assembly for connection to mounting pad located on ignitron water jacket.

Single-pole contacts perform control functions as shown in chart below.

Kit No.	Function	Contacts	Temperature		Termination
			Open (°F)	Close (°F)	
N15272AA	Water control	NO	86	96	36-inch leads with spade terminals
N15273AA	Over-temperature protection	NC	125	105	36-inch leads with spade terminals
N15286AA	Water control	NO	86	96	Terminal block
N15287AA	Over-temperature protection	NC	125	105	Terminal block

COOLING CLAMP

Suitable for use with GL-5550, GL-7171 and GL-7703 to accomplish cathode connection and liquid cooling: Cat. No. L 6922259-G5

IGNITOR TERMINAL CONNECTING LEADS

Insulated leads for connection to 0.250-inch diameter ignitor terminals
 Cat. No. N 22006LC 7 $\frac{3}{4}$ inches long
 Cat. No. N 22007LC 13 $\frac{1}{2}$ inches long

QUICK-CHANGE WATER CONNECTORS

Ignitron installation time is reduced through the use of slotted anode and cathode terminals... provided as a regular feature on all standard G-E welding ignitrons... and the use of the quick-change brass water hose connectors shown in table.

Fitting No.	Description	Use with G-E Ignitron Type
B1HK	Socket	GL-5551-A, GL-5552-A, GL-5822-A, GL-7669, GL-7670, GL-7671, GL-7672, GL-7681, GL-7998, GL-8360, GL-37250, GL-37251, GL-37252, GL-37253
B1K11	Plug	
B2HK	Socket	GL-5553-B, GL-5554, GL-5555, GL-6512, GL-6513, GL-7673, GL-37254, GL-37255
B2K16	Plug	

CONDENSED WARRANTY INFORMATION

G-12—
 (Rectifier service only.) Warranted for full replacement within one year of service. Expires 18 months from date of sale to ultimate user or two years from date of shipment by G.E.

H-12—
 Warranted for one year with prorated adjustment after 15 days of service. Expires 18 months from date of sale to ultimate user, 12 months from date of initial installation, or 2 years from date of shipment by G.E.

H-24—
 Warranted for two years with prorated adjustment after 15 days of service. Expires 36 months from date of sale to ultimate user, 24 months from date of initial installation, or 3 $\frac{1}{2}$ years from date of shipment by G.E.

K-1000—
 Warranted for 1000 operations or six months of service with prorated adjustment for the difference between elapsed number of operations and 1000. Expires nine months from date of sale to ultimate user, six months from date of initial installation, or twelve months from date of shipment by G.E.

PLANAR TUBES — CERAMIC • GLASS LIGHTHOUSE

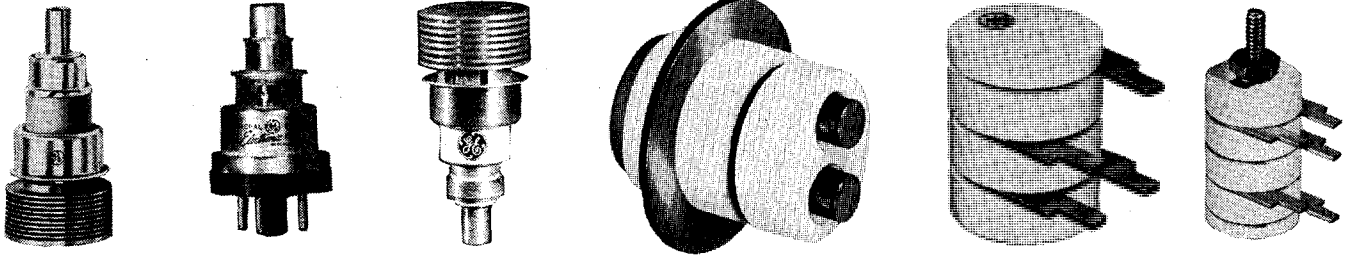
GENERAL  ELECTRIC

GENERAL, MAXIMUM RATINGS							CHARACTERISTIC AND TYPICAL OPERATION													
TYPE	GENERAL DESCRIPTION	Out-line Dwg.	Heater		Max. Plate Volts And Watts	Max. Grid Current ma	Max. Freq. MC ⁽⁸⁾	Plate Volts	Neg. Grid Volts	Plate Milli-amperes	Grid Milli-amperes	μ	Rp, Ohms	Gm, μ Mhos	Gain in db	R.F. Power Output	Freq. MC			
			Volts	Amps																
2B22	Metal-glass diode—"lighthouse" type, intended for detector service.	A	6.3	0.75	300 ⁽¹⁾	—	1,500	Signal detector									Tube voltage drop: 6.0 volts at $I_b=20$ milliamperes. Maximum DC cathode current=20 milliamperes; maximum peak cathode current=700 milliamperes.			
2C39-A	Metal-ceramic triode—intended for UHF power amplifier, oscillator, or frequency multiplier service.	B	6.3	1.03	1,000 ⁽²⁾ 100 ⁽³⁾	50	2,500	Avg. char. Class C Oscillator Class C Oscillator	600 ⁽⁷⁾ 900 800	-22 90 -20	70 90 80	27 32	100 — —	2,500 — —	— — —	27W 12W	500 2,500			
2C39-B	Metal-ceramic triode—intended for UHF power amplifier, oscillator, or frequency multiplier service.	B	6.3 ⁽²⁾	1.03	1,000 ⁽²⁾ 100 ⁽³⁾	50	2,500	Avg. char. Class-C oscillator Class-C oscillator	600 ⁽⁴⁾ 900 900	22 40	75 90 90	27 30	95 — —	24,800 — —	— — —	17W 40W	2,500 500			
2C39-WA	Military version of 2C39B when subject to considerable vibration and shock. Interchangeable with 2C39B.	Same as 2C39B																		
2C40	Metal-glass triode—"lighthouse" type, intended for UHF oscillator or amplifier service.	C	6.3	0.75	500 6.5	8.0	3,370	Avg. char. Radio-frequency oscillator	250 250	R _k =200 5.0	17 20	0.5	36 —	4,850 —	— —	75MW	3,370			
2C40-A	Metal-glass triode—"lighthouse" type, intended for UHF oscillator service, either CW or pulse.	C	6.3	0.75	500 6.5 1,400 ⁽⁵⁾ 4.0 ⁽⁶⁾	1,000 ⁽⁶⁾	3,370	Avg. char. Radio-frequency oscillator Plate-pulsed oscillator D.F.=.001	250 250 1,400	R _k =200 5.0 —	17 20 1,000	0.5 —	35 —	5,100 —	— —	75MW 300W	3,370 3,000			
2C42	Lighthouse triode. For use as plate-pulsed oscillator up to 1300 mc.	D	6.3	0.9	3,000 25	—	—	C-T Oscillator At 3370 mc.	250	-5	20	—	36 —	4,850 —	— —	— —				
2C43	Metal-glass triode—"lighthouse" type, intended for UHF CW	D	6.3	0.9	500 12 3,500 ⁽⁵⁾	—	1,500 3,370 ⁽⁶⁾	Avg. char. Push-pull radio-frequency oscillator— values for two tubes Plate-pulsed oscillator D.F.=.001	250 470 3,000	R _k =100 R _g =1,000 R _g =100	21 38 2,500	— —	50 —	8,100 —	— —	9.0W 1.75KW	350 3,370			
2C46	Lighthouse triode. For use in cavity as stable oscillator between 1,000 and 1,200 mc.	D	6.3	0.75	500 12	—	—	C-T UHF Oscillator	150	—	8	—	60	3,500	—	—				
3CX100A5	Metal-ceramic triode—intended for UHF oscillator or amplifier service, either CW or pulse.	E	6.0 ⁽²⁾	1.0	1,000 ⁽²⁾ 100 ⁽³⁾	50	2,500 3,000 ⁽⁴⁾	Avg. char. Class-C amplifier Plate-pulsed oscillator D.F.=.0025	600 900 3,500	⁽⁷⁾ 40 —	70 90 3,000	100 30 1,800	— —	25,000 —	— —	40W 1.6W	500 3,000			
6299	Metal-ceramic triode—intended for low-noise UHF amplifier service.	F	6.3	0.3	200 2.0	0	3,000	Avg. char. Class-A radio-frequency amplifier— grounded-grid	175 ⁽¹⁰⁾ 0 ⁽¹⁰⁾ 0 ⁽¹⁰⁾	⁽⁹⁾ 0 0	10 10 10	— 110 —	7,300 9600	15,000 —	17.5 11	— —	450 3,000			
6442	Metal-ceramic triode—intended for UHF oscillator or amplifier service, either CW or pulse.	G	6.3 ⁽²⁾	0.9	350 8.0 ⁽³⁾ 3,000 ⁽⁵⁾ 7.5 ⁽⁴⁾	1,250 ⁽⁴⁾	2,500 5,000 ⁽⁴⁾	Avg. char. Class-C amplifier Plate-pulsed oscillator — D.F.=.001	350 250 3,000	4.25 — 75	35 23 2,500	6.0 1,250	50 —	16,500 —	— —	2.8W 0.5KW	1,000 5,000			
6771	Metal-ceramic triode—intended for UHF oscillator or amplifier service, either CW or pulse.	G	6.3 ⁽²⁾	0.575	300 6.25 ⁽³⁾ 1,750 ⁽⁵⁾	700 ⁽⁶⁾	4,000 5,000 ⁽⁶⁾	Avg. char. Radio-frequency oscillator	250 275	1.6 —	25 25	—	90 —	23,000 —	— —	300MW	4,000			
6897	Metal-ceramic triode—intended for UHF CW oscillator or amplifier service.	B	6.3 ⁽²⁾	1.03	1,000 ⁽²⁾ 100 ⁽³⁾	50	2,500	Avg. char. Class-C oscillator	600 900 500	⁽⁴⁾ 22 40	75 90 90	90 27 30	24,800 — —	— — —	17W 40W	2,500 500				
7077	Metal-ceramic triode—intended for low-noise UHF amplifier service.	H	6.3	0.24	250 1.1	—	3,000	Avg. char. Grounded-grid amplifier	250 ⁽¹¹⁾ 250 ⁽¹¹⁾	R _k =82 R _k =82	6.5 6.5	—	90 —	9,000 10,000	14.5 —	450				
7266	Metal-ceramic diode—intended for instrument-probe service.	I	6.3	0.215	600 ⁽¹⁾	—	3,000	Instrument detector	Tube voltage drop: 1.0 volts at $I_b=1.0$ milliamperes. Maximum DC cathode current=2.2 milliamperes; maximum peak cathode current=11 milliamperes.											
7289	Metal-ceramic triode—intended for UHF oscillator or amplifier service, either CW or pulse.	E	6.0 ⁽²⁾	1.0	1,000 ⁽²⁾ 100 ⁽³⁾ 3,500 ⁽⁵⁾ 27 ⁽⁶⁾	1,800 ⁽⁴⁾	2,500 3,000 ⁽⁴⁾	Avg. char. Class-C amplifier Plate-pulsed oscillator — D.F.=.0025	600 ⁽⁷⁾ 900 3,500	40 —	70 90 3,000	30 1,800	100 —	25,000 —	— —	40W 1.6KW	500 3,000			
7296	Metal-ceramic triode—intended for VHF oscillator or amplifier service.	J	6.3	0.4	330 5.5	10	500	Avg. char.	200	R _k =68	17	—	90	5,450	16,500	—	—			
7391	Metal-ceramic triode—intended for UHF oscillator service.	F	6.3	0.38	200 2.25	3.0	6,000	Avg. char. Class-C oscillator	175 150 150	1.5 — —	10 12 12	— 3.0 3.0	62 — —	11,000 — —	— — —	65MW 500MW	5,400 500			
7462	Metal-ceramic triode—intended for low-noise VHF amplifier service.	K	6.3	0.24	250 1.1	—	500	Avg. char.	150	⁽¹²⁾	7.2	—	94	10,500	—	—				
7486	Metal-ceramic triode—intended for UHF oscillator or amplifier service.	H	6.3	0.24	250 1.0	2.2	3,000	Avg. char. UHF oscillator service Class-C amplifier	150 150 150	R _k =82 R _g =1,000 R _g =3,000	7.5 8.0 5.0	2.0 1.0	90 — —	10,500 — —	— — —	300MW 300MW	1,200 450			
7588	Metal-ceramic triode—intended for VHF amplifier service.	J	6.3	0.4	300 5.5	—	500	Avg. char.	200	⁽¹³⁾	24	—	175	3,900	45,000	—	—			

PLANAR TUBES — CERAMIC • GLASS LIGHTHOUSE



GENERAL, MAXIMUM RATINGS								CHARACTERISTIC AND TYPICAL OPERATION										
TYPE	GENERAL DESCRIPTION	Out-line Dwg.	Heater		Max. Plate Volts And Watts	Max. Grid Current ma	Max. Freq. MC (8)	Plate Volts	Neg. Grid Volts	Plate Milli-am-peres	Grid Milli-am-peres	Rp, Ohms	Gm, μ Mhos	Gain in db	R.F. Power Output	Freq. MC		
			Volts	Amps														
7625	Metal-ceramic triode—intended for low-level audio-frequency amplifier service.	K	6.3	0.215	275 0.85	—	—	Avg. char.	150	Rk=1,000	0.95	—	80	57,000	1,400	—	—	
7644	Metal-ceramic triode—intended for low-noise UHF amplifier service.	F	6.3	0.3	200 2.0	—	3,000	Avg. char. Class-A radio-frequency amplifier—grounded-grid	175 300 (14) 300 (14)	(9) 0 0	10 10 10	— — —	110 — —	7,300 — —	15,000 — —	— 11 17.5	— — 3,000 450	
7720	Metal-ceramic triode—intended for VHF oscillator service.	K	6.3	0.24	250 1.0	2.2	500	Avg. char. Class-C oscillator	150 150	Rk=82 Rg=7,000	7.5 4.0	— 0.5	90 —	— —	10,500 —	— 100MW	— 450	
7768	Metal-ceramic triode—intended for UHF amplifier service.	L	6.3	0.4	330 5.5	—	3,000	Avg. char.	200	(13)	24	—	225	4,500	50,000	—	—	
7784	Metal-ceramic triode—intended for low-noise UHF amplifier service.	M	6.3	0.3	200 2.0	—	3,000	Avg. char. Class-A radio-frequency amplifier—grounded-grid	175 (10) (10)	(9) 0 0	10 10 10	— — —	110 — —	7,300 — —	15,000 — —	— 17.5 11	— — 450 3000	
7815	Metal-ceramic triode—intended for UHF pulsed oscillator or amplifier service.	N	6.0 (2)	—	3,500	5.0	3,000	Plate-pulsed oscillator—D.F.=.003	3,500	—	3,000	3.0	—	—	—	—	2KW	2,500
7815R	Metal-ceramic triode—intended for UHF pulsed oscillator or amplifier service.	O	6.0 (2)	1.0	3,500 (5) 10 (6, 15)	5.0	3,000	Plate-pulsed oscillator—D.F.=.003	3,500	—	3,000	3.0	—	—	—	—	2KW	2,500
7841	Metal-ceramic diode—intended for detector service.	I	6.3	0.215	350 (1)	—	3,000	Signal detector	Tube voltage drop: 2.6 volts at Ib=5.0 milliamperes. Maximum DC current=55 milliamperes; maximum peak current=22 milliamperes									
7910	Metal-ceramic triode—intended for UHF plated-pulsed oscillator or amplifier service.	P	6.3	0.275	1,200 (5) 1.5 (6)	200 (6)	7,500	Avg. char. Plate-pulsed oscillator—D.F.=.001	125 1,000	Rk=82 —	11.5 600	200 —	75 —	— —	16,000 —	— 100W	— 5,900	
7911	Metal-ceramic triode—intended for UHF plate-pulsed oscillator or amplifier service.	Q	6.3	0.55	3,000 (5) 6.5 (6)	1,000 (6)	6,000	Avg. char. Plate-pulsed oscillator—D.F.=.001	200 3,000	Rk=100 —	23 2,500	300 —	58 —	2,300 —	25,000 —	— 2.2KW	— 4,100	
7913	Metal-ceramic triode—intended for UHF oscillator or amplifier service.	L	6.3	0.4	330 5.5	10	3,000	Avg. char. Class-C oscillator	200 300	Rk=47 Rg=1,500	25 25	5.0 —	100 —	2,500 —	40,000 —	— 4.0W	— 400	
8081	Metal-ceramic triode—intended for low-level audio-frequency amplifier service.	R	6.3	0.215	275 0.85	—	—	Avg. char.	150	Rk=1,000	0.95	—	80	57,000	1,400	—	—	
8082	Metal-ceramic triode—intended for UHF oscillator service.	R	6.3	0.24	250 1.0	2.2	500	Avg. char. UHF oscillator	150 150	Rk=82 Rg=7,000	7.5 4.0	— 0.5	90 —	— —	10,500 —	— 100MW	— 450	
8083	Metal-ceramic triode—intended for low-noise VHF amplifier service.	R	6.3	0.24	250 1.1	—	500	Avg. char.	150	(12)	7.2	—	94	9,000	10,500	—	—	

NOTES

- (1) Peak inverse voltage.
- (2) This is the bogey value at which average characteristics are determined. For some classes of operation a lower value may be recommended.
- (3) These are the highest values listed for any class of CW operation; lower values may be indicated for some classes of CW operation. Refer to complete data sheets.
- (4) Adjusted for Ib=75 milliamperes.
- (5) for this information.
- (6) Peak voltage rating for pulse service.
- (7) Pulse service.
- (8) Adjusted for Ib=70 milliamperes.

- (9) The frequency listed is one at which significant application data are available or expected, and does not necessarily represent an absolute frequency limit.
- (10) Adjusted for Ib=10 milliamperes.
- (11) Adjusted for Ib=10 milliamperes; range must be variable from 75 to 200 volts.
- (12) Bypassed resistor (18k) in plate-supply lead.
- (13) With Rk=910 and Eg=+6.0 volts.
- (14) With Rk=270 and Eg=+6.0 volts.
- (15) Bypassed resistor (17.5k) in plate-supply lead.
- (16) Plate dissipation of 100 watts is permissible with forced-air cooling.

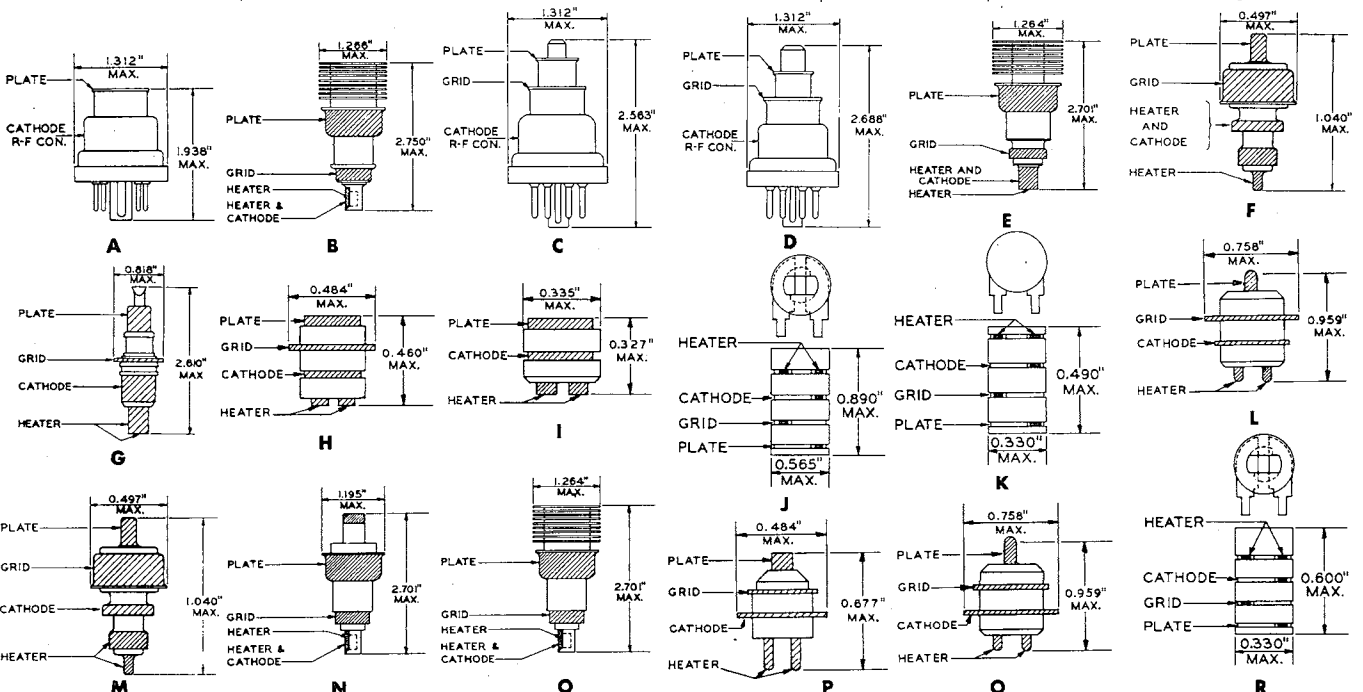

Special Devices — Photo Conductive Cells

GENERAL  ELECTRIC

Reliable, hermetically sealed, or plastic encapsulated, cadmium sulfide and cadmium selenide photoconductive cells are available in a wide assortment of package sizes and electrical characteristics.

Photo-cell-lamp combinations consist of a photoconductive cell and an illumination source enclosed in a light tight, metal package available in an assortment of electrical characteristics.

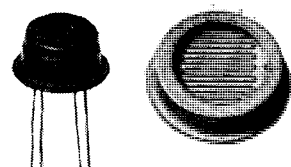
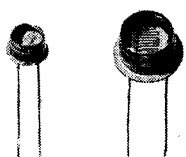

TYPE	Outline Drawing	Enclosures	Sensitive Material	Peak Spectral Response	MAXIMUM RATINGS			Resistance at 2 Footcandles—Ohms	Resistance at 20 Footcandles—Ohms	Dark Current (Maximum)	RESPONSE TIME	
					Ambient Temperature	Power Dissipation	Voltage				Turn-on Time ⁽¹⁾ Sec.	Turn-off Time ⁽²⁾ Sec.
A33P1	B	Plastic	CdS	5500A	-40 to +65C	50 MW ⁽¹⁰⁾	30	6,300	1,070	100µA ⁽⁴⁾	0.88	0.21
A35	A	Metal-Glass	CdS	5500A	-40 to +65C	75 MW ⁽³⁾	50	12,000	2,900	100µA ⁽⁴⁾	1.0	0.28
A36M1	A	Metal-Glass	CdS	5500A	-40 to +65C	75 MW ⁽³⁾	60	30,000	3,800	60µA ⁽⁴⁾	0.089	0.005
B46	C	Metal-Glass	CdS	6100A	-40 to +80C	250 MW ⁽⁶⁾	60	1,250	260	80µA ⁽⁴⁾	0.75	0.57
B425	C	Metal-Glass	CdS	6100A	-40 to +65C	250 MW ⁽³⁾ 500 MW ⁽⁷⁾	250	9,100	1,400	80µA ⁽⁴⁾	0.56	0.09
B425P1	D	Plastic	CdS	6100A	-40 to +65C	200 MW ⁽³⁾	250	9,100	1,400	80µA ⁽⁴⁾	0.56	0.09
C425P1	D	Plastic	CdSe	7300A	-40 to +65C	50 MW ⁽¹⁰⁾	250	15,000	1,800	50µA ⁽⁴⁾	0.016	0.021
B430	C	Metal-Glass	CdS	6100A	-40 to +65C	250 MW ⁽³⁾ 500 MW ⁽⁷⁾	300	15,000	2,500	100µA ⁽⁴⁾	0.32	0.08
B1035M1	F	Metal-Glass	CdS	6100A	-40 to +65C	600 MW ⁽³⁾ 1.0 W ⁽⁸⁾	350	12,000	1,570	400µA ⁽⁹⁾	0.23	0.1
B1035M2	F	Metal-Glass	CdS	6100A	-40 to +65C	600 MW ⁽³⁾ 1.0 W ⁽⁸⁾	350	5,500	970	400µA ⁽⁹⁾	0.23	0.1
B1035M3	F	Metal-Glass	CdS	6100A	-40 to +65C	600 MW ⁽³⁾ 1.0 W ⁽⁸⁾	350	2,750	580	1500µA ⁽⁹⁾	0.23	0.1

NOTES

- (1) The time required for current through the cell to reach 90% of its steady value upon switching from darkness to a light level of 5 footcandles.
- (2) The time required for current through the cell to decrease to 10% of its steady value upon switching from a light level of 5 footcandles to darkness.
- (3) This dissipation is allowable at ambient temperatures from -40 to +40C. From +40 to +65C, the allowable dissipation decreases linearly, reaching zero at +65C.
- (4) Measures approximately 30 seconds after removal of illumination of two footcandles produced by a tungsten-filament source operated at a color temperature of 2854 Kelvin and at rated cell voltage.
- (5) This dissipation is allowable at ambient temperatures from -40 to +40C. From +40 to +80C, the allowable dissipation decreases linearly, reaching 37 milliwatts at +80C, and going to zero above +80C.

- (6) Measured approximately 20 seconds after removal of illumination of two footcandles produced by a tungsten-filament source operated at a color temperature of 2854 Kelvin; d-c polarizing voltage 12 volts.
- (7) Allowable dissipation may reach 500 milliwatts with external heat-conducting bracket.
- (8) For a maximum of 20 minutes at 12-hour intervals.
- (9) Measured approximately 30 seconds after removal of illumination of one footcandle produced by a tungsten-filament source operated at a color temperature of 2854 Kelvin; d-c polarizing voltage 50 volts.
- (10) This dissipation is allowable at ambient temperatures from -40 to +30C. From +30 to +65C, the allowable dissipation decreases linearly, reaching zero at +65C.

A33 - A35 - A36M1

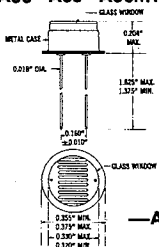

A33P1

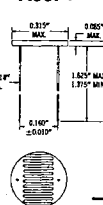

OUTLINE DRAWINGS

B46 - B425 - B430

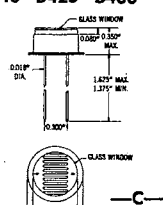

B425P1 - C425P1

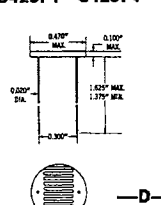

B1035M1 - M2 - M3

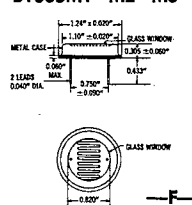

Photoconductive Cell — Lamp Combinations

TYPE	Outline Drawing	Sensitive Material	MAXIMUM RATINGS				Cell Resistance At 20% Of Maximum Lamp Voltage—Ohms	Cell Resistance At 90% Of Maximum Lamp Voltage—Ohms	Dark Current (Maximum)	
			PHOTOCONDUCTIVE CELL			LAMP				
			Ambient Temperature	Power Dissipation	Voltage	Voltage				Current ⁽¹⁾
PL5B1	A	CdS	-40 to +65C	100 MW ⁽²⁾	250	5.0	60 MA	40,000	260	80µA ⁽⁴⁾
PL5C1	A	CdSe	-40 to +65C	100 MW ⁽²⁾	200	5.0	60 MA	20,000	260	15µA ⁽⁶⁾
PL5B2	A	CdS	-40 to +65C	100 MW ⁽²⁾	60	5.0	60 MA	3,400	60	400µA ⁽³⁾
Y-1248*	A	CdS	-40 to +65C	100 MW ⁽²⁾	60	28	40 MA	2,000	30	100µA ⁽³⁾
Y-1260*	A	CdS	-40 to +65C	100 MW ⁽²⁾	250	28	40 MA	5,000	130	80µA ⁽⁴⁾

NOTES

- (1) Current of a bogey lamp at rated voltage.
- (2) This dissipation is allowable at ambient temperatures from -40 to +30C. From +30 to +65C, the allowable dissipation decreases linearly, reaching zero at +65 C.
- (3) Measured approximately 5 minutes after removal of illumination; d-c polarizing voltage 60 volts.

- (4) Measured approximately 5 minutes after removal of illumination; d-c polarizing voltage 250 volts.
 - (6) Measured approximately 5 minutes after removal of illumination; d-c polarizing voltage 200 volts.
- * Publication of these data does not obligate the General Electric Company to manufacture a device with these characteristics.

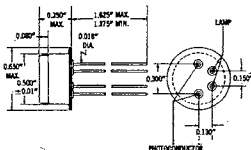

OUTLINE DRAWINGS

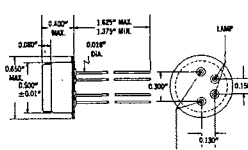

Special Devices — Reed Switches



In a relatively short period of years, the dry reed switch has begun to play an important role in performing the switching function for a wide variety of electronic/electro-mechanical equipment. Major application, now in general use, range from telephone switchgear, appliances, and data processing units to logic circuitry for industrial controls.

The General Electric reed switch capsule consists of a pair of low reluctance, magnetically actuated, flat metal reeds, hermetically sealed in an atmosphere of dry inert gas. The reeds are of equal length and are supported as cantilevers, overlapping at the center of the glass cylinder where they are separated by a small air gap, thus forming a normally open Single Pole, Single Throw (SPST) switch.

Type ⁽¹⁾	Former Designation	MAXIMUM CONTACT RATING			SENSITIVITY		Maximum Initial Contact Resistance In Milliohms	Breakdown Voltage Minimum, 60 cps rms	Life Expectancy in Millions of Cycles ⁽²⁾	MAXIMUM DIMENSIONS IN INCHES			Contacts And Leads
		Resistive Load	Maximum Current	Maximum Voltage	Pull-In Ampere-Turns	Drop-Out Ampere-Turns				Glass Dia. (A)	Glass Length (B)	Overall Length (C)	
MINIATURE — INERT-GAS FILLED													
DR100	IDR04	4VA	0.25A	250	43±11 ⁽³⁾	18±8 ⁽³⁾	150	300	20 ⁽⁴⁾	0.108	0.84	2.03	⁽⁵⁾
DR121	Y-1292	10VA	0.25A	250	43±11 ⁽³⁾	28±8 ⁽³⁾	150	300	20 ⁽⁴⁾	0.108	0.84	2.55	⁽⁶⁾
DR123	Y-1513	10VA	0.25A	250	35±11 ⁽³⁾	15±10 ⁽³⁾	150	300	20 ⁽⁴⁾	0.108	0.84	2.55	⁽⁶⁾
DR125	Y-1454	4VA	0.25A	250	35±13 ⁽³⁾	18±10 ⁽³⁾	150	300	20 ⁽⁴⁾	0.108	0.84	2.03	⁽⁵⁾
DR145		10VA	0.25A	250	28±10	6 Min.	150	300	20 ⁽⁴⁾	0.108	0.84	2.55	⁽⁶⁾
2" — INERT-GAS FILLED													
DR101	2DR15	15VA	1.0A	250	90±15 ⁽⁷⁾	34±8 ⁽⁷⁾	50	500	20 ⁽⁸⁾	0.215	2.10	3.21	⁽⁹⁾
DR104	2DR15-3	15VA	1.0A	125	40±10 ⁽⁷⁾	23±7 ⁽⁷⁾	50	350	20 ⁽⁸⁾	0.215	2.10	3.21	⁽⁹⁾
DR113	2DR50	50VA	3.0A	250	90±15 ⁽⁷⁾	45±10 ⁽⁷⁾	50	500	20 ⁽¹⁵⁾	0.215	2.10	3.21	⁽¹⁶⁾
2" — VACUUM													
DRV120	2VR15	—	3.0A ⁽¹⁶⁾	5000 ⁽¹⁶⁾	113±20 ⁽¹⁷⁾	52±10 ⁽¹⁷⁾	50	7000	—	See Drawing			
FORM C													
DR138		5VA	0.25A	250	90±20	32±15	50	350	20	See Drawing			

NOTES

- (1) All switches use single-pole, single-throw, normally open, Form A contact arrangements. With the exception of type DRV120, which is a vacuum switch, all switches are filled with inert gas at an internal pressure 1/2 atmosphere
- (2) Some degradation or improvement in performance may be expected at operating conditions other than those specified.
- (3) Sensitivity measured using a 6300 turn coil of #41 wire wound on a 0.8" long bobbin approximately 0.17" in diameter.
- (4) Full load, 25 volts d-c, 60 operations per second at H.V.A.
- (5) Diffused gold contacts with gold-plated leads.
- (6) Rhodium-plated contacts with gold-plated leads.
- (7) Sensitivity measured using a 10,000 turn coil of #39 wire wound on a 2.0" long bobbin approximately 0.25" in diameter.
- (8) Full load, 50 volts d-c, 60 operations per second.
- (9) Diffused gold contacts with both leads tinned.
- (12) Sensitivity measured using a 10,000 turn coil of #36 wire wound on a 1.750" long bobbin approximately 0.330" in diameter.
- (13) Nominal center-to-center of bent leads.
- (14) Diffused gold contacts with both leads tinned and bent at 90° angle.
- (15) Full load, 125 volts d-c, 60 operations per second.
- (16) The voltage rating is a "hold-off" value, and the current rating is a measure of the current the contacts will carry but not switch. Maximum permissible switching currents are to be determined.
- (17) Sensitivity measured using a 5,700 turn coil of #36 wire wound on a 2.0" long bobbin having an oval cross-section of approximately 0.5" x 0.28".
- (18) Rhodium-plated contacts with both leads tinned.

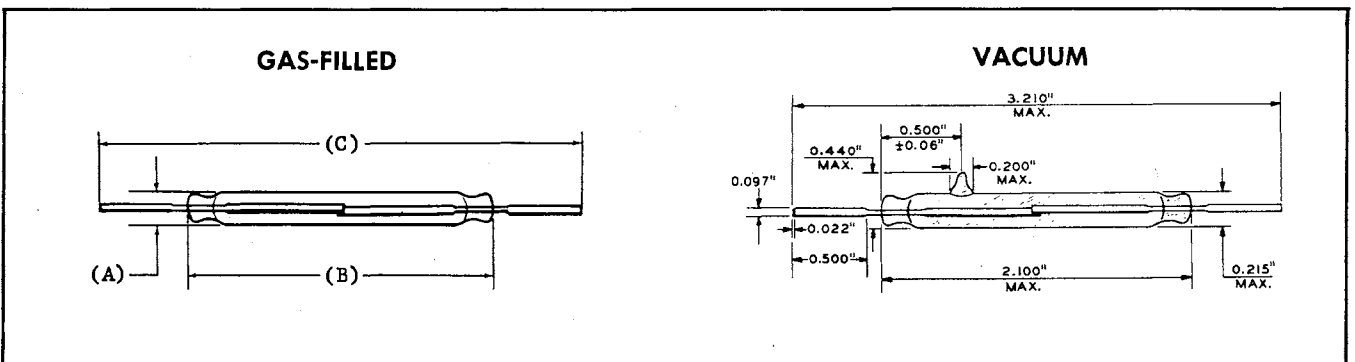
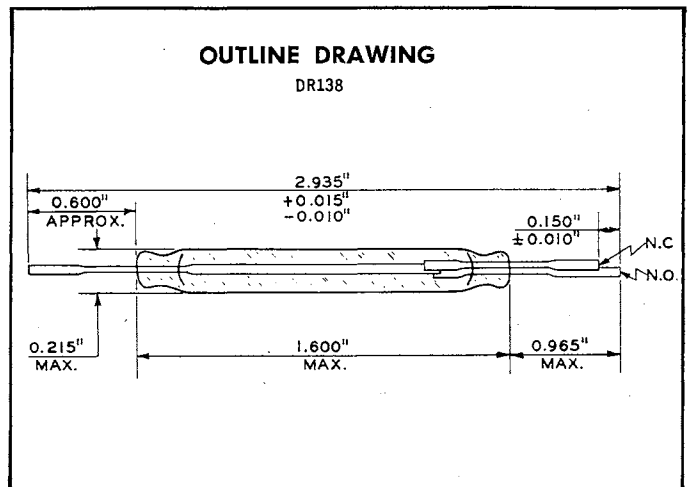

Special Devices—Tungar Bulbs

GENERAL  ELECTRIC

The Tungar bulb developed by General Electric in 1916—and used for rectification of a-c to d-c is well known wherever battery charging or similar applications require d-c power.

CATALOG NUMBER	12X825 206501†	20X672	16X897	45X674	99X44	189048 (RTMA) Type 4828	189049 (RTMA) Type 4826	217283 (RTMA) Type 5821	76X13	99X45
TYPE	Argon Half-wave	Mercury Argon Half-wave	Mercury Argon Full-wave	Mercury Argon Full-wave	Mercury Argon Half-wave	Argon Half-wave	Argon Half-wave	Argon Half-wave	Mercury Argon Half-wave	Mercury Argon Half-wave
MAXIMUM RATINGS — ABSOLUTE VALUES										
Maximum peak inverse anode voltage	275	90	1000	1000	105	300	375	225	275	110
Maximum anode current:										
Average amperes — in phase operation	2	5	2	6	10	6	6	15	20	20
Peak amperes — in phase operation	12	30	12	36	36	36	36	90	120	120
Maximum d-c output, average volts	75	20	250	250	25	60	90	60	75	25
Maximum temperature measured at tube base ..	100 C	130 C	90 C	90 C	160 C	100 C	100 C	100 C	160 C	160 C
GENERAL DESIGN										
Number of electrodes	2	2	3	3	2	2	2	2	2	2
Catalog Number of socket	278768	3778926	5556072G1	5556072G1	217967	217967	217967	217967	217967	217967
Cathode, thoriated tungsten filament*:										
Maximum volts	2.1	2.1	2.625	2.625	2.31	2.31	2.31	2.625	2.73	2.73
Minimum volts	1.9	1.9	2.375	2.375	2.09	2.09	2.09	2.375	2.47	2.47
Filament current — Amperes (approx.)	12	12	10	18	17.5	17	17	25	32	32
Pre-heating time — Seconds	0 ¹	0 ²	300 ³	300 ³	0 ²	0 ¹	0 ¹	15 ⁴	180 ³	15 ³
Anode voltage drop (Arc Drop):										
Maximum volts	9.5	9	20	18	10.5	10	11	9	15	10
Design standard, volts	7.5	6	9	9	6	7	7.5	7.5	6.5	7.5
Critical anode voltage (pick-up):										
Hot	15	6	20	20	6	15	16	16	6	6
Cold	15	11	24	20	11	15	16	16	12	12
Type of cooling	Radiation	Radiation	Radiation	Radiation	Radiation	Radiation	Radiation	Radiation	Radiation	Radiation
Mouting position	Any	Vertical— Base Down	Vertical— Base Down	Vertical— Base Down	Vertical— Base Down	Any	Any	Any	Vertical— Base Down	Vertical— Base Down
DIMENSIONS AND WEIGHTS										
Net weight in ounces	2	3	3	4½	4	4	4	5½	6½	6½
Standard carton quantity	12	12	12	12	12	12	12	12	12	12
Shipping weight in pounds per carton	8	8	8	7½	7½	7½	7½	26	26	26
Maximum length in inches	4¼	4⅝	6	7½	7	7	7	8¾	9½	9½
Maximum diameter in inches	2⅜	2⅜	2⅜	3⅜	3⅜	3⅜	3⅜	3⅜	3⅜	3⅜

NOTES

- * Except for Cat. Nos. 16X897 and 45X674 which have coated filaments.
† Cat. No. 206501 is identical to Cat. No. 12X825 except that it is fitted with an adapter to take a clip anode lead and fits a standard Edison socket.
- ¹ Under normal ambient temperature conditions, this tube will deliver 90 percent of full output within three seconds after the simultaneous application of anode and filament voltages. Longer tube life can be obtained by applying anode voltage 1 to 3 seconds later than the filament voltage.
- ² Under normal ambient temperature conditions, this tube will deliver 80 percent of full output within three seconds after the simultaneous application of anode

and filament voltages. Longer tube life can be obtained by applying anode voltage 1 to 3 seconds later than the filament voltage.

³ The preheating time listed must be respected and filament excitation must be continuous if guarantees are to apply. When first installed in a new location, this tube should be operated for 10 minutes with filament voltage only.

⁴ Full output can be obtained as soon as power is applied to the anode after preheating time. The recommended tube preheating time must be respected and filament excitation must be continuous if guarantees are to apply.

Electrons Industrial Components

TYPE	OTHER DESIGNATIONS	DESCRIPTION	MAX. CONTINUOUS AVERAGE DC ANODE CURRENT (AMPS)	OSCILLOGRAPH PEAK ANODE CURRENT CONTINUOUSLY RECURRING (AMPS)	MAX. INSTANTANEOUS PEAK FORWARD VOLTAGE	MAX. INSTANTANEOUS PEAK INVERSE VOLTAGE
RECTIFIERS Xenon-Filled						
EL 1C	3B22	Full Wave, A4-10 Base, Single End.	1.0	4.0		725
EL 3B	6013	Half Wave A4-10 Base, Anode Cap.	2.5	20		920
EL 3C	4B24	Full Wave, A4-81 Base, Single End.	2.5	10		725
EL 3C/L	6982	Full Wave, Lug Type Base, Single End.	2.5	10		725
EL 6B	5892	Half Wave, A4-81 Base, Anode Cap.	6.4	77		920
EL 6B/L	6983	Half Wave, Lug Type Base, Anode Cap.	6.4	77		920
EL 6C		Full Wave, A4-81 Base, Single End.	6.4	25.6		725
EL 6F	6015	Half Wave, Panel Mounted, Flexible Leads	6.4	77		920
EL 16F		Half Wave, Panel Mounted, Flexible Leads	16.0	96		620
THYRATRONS						
EL C1B	3C31	A4-10 Base, Anode Cap. Xenon	1.0	8.0	525	700
EL C1B/A	5664	A4-10 Base, Anode Cap. Xenon	1.0	8.0	750	1250
EL C1K	6014	A4-10 Base, Single End. Xenon	1.0	8.0	1000	1250
EL C1K/B	7319	A4-10 Base, Single End. Xenon	1.0	8.0	2000	2000
EL C3J	5632	A4-10 Base, Anode Cap. Xenon	2.5	30	900	1250
EL C3J/A	5684	A4-10 Base, Anode Cap. Xenon	2.5	30	1000	1250
EL C3J/L	7216	Lug Type Base, Anode Cap. Xenon	2.5	30	900	1250
EL C3J/AL	7556	Lug Type Base, Anode Cap. Xenon	2.5	30	1000	1250
EL C4H-1		A4-81 Base, Anode Cap. Xenon	4.0	50	1700	1700
EL C4H-2		Panel Mounted, Anode Cap. Xenon	4.0	50	1700	1700
EL C4H-3		Lug Type Base, Anode Cap. Xenon	4.0	50	1700	1700
EL C4H-4		Panel Mounted, Flexible Leads. Xenon	4.0	50	1700	1700
EL C4H-5		Lug Type Base, Flexible Lead. Xenon	4.0	50	1700	1700
EL C6C	6987	#4310 Base, Anode Cap. Xenon	6.4	77	2000	4000
EL C6H-1		A4-81 Base, Anode Cap. Xenon	6.4	80	1700	1700
EL C6H-2		Panel Mounted, Anode Cap. Xenon	6.4	80	1700	1700
EL C6H-3		Lug Type Base, Anode Cap. Xenon	6.4	80	1700	1700
EL C6H-4		Panel Mounted, Flexible Leads. Xenon	6.4	80	1700	1700
EL C6H-5		Lug Type Base, Flexible Lead. Xenon	6.4	80	1700	1700
EL C6J	5C21	A4-81 Base, Anode Cap. Xenon	6.4	77	750	1250
EL C6J/A	5685	A4-81 Base, Anode Cap. Xenon	6.4	77	1000	1250
EL C6J/F	6860	Panel Mounted, Anode Cap. Xenon	6.4	77	1000	1250
EL C6J/L	6988	Lug Type Base, Anode Cap. Xenon	6.4	77	750	1250
EL C6J/K	6864	A4-81 Base, Anode Cap. Xenon	6.4	77	1000	1250
EL C6J/KF	6871	Panel Mounted, Flexible Leads. Xenon	6.4	77	1000	1250
EL C6J/KL	6989	Lug Type Base, Anode Cap. Xenon	6.4	77	1000	1250
EL C16J	5665	Panel Mounted, Flexible Leads. Xenon	16.0	160	1000	1250
EL C16H		Panel Mounted, Flexible Leads. Xenon	16.0	160	1700	1700
EL 6011/710	7307A	A4-10 Base, Anode Cap. Mercury Gas	2.5	30	1700	1700
EL 7518/710L	7509A	Lug Type Base, Anode Cap. Mercury Gas	2.5	30	1700	1700
GAS GAP SURGE ARRESTERS (G₂SA)						
TYPE		DESCRIPTION	APPLICATION AC LINE VOLTS			
EL RP-100		G ₂ SA w/indicator. Mounts in 30 amp cartridge fuse clip. Max. supply 1 KVA.	120			
EL RP-101		G ₂ SA w/indicator. Mounts in 30 amp cartridge fuse clip. Max. supply 2 KVA.	120			
EL RP-600		G ₂ SA w/indicator. Mounts in 30 amp cartridge fuse clip. Use only in series with varistor.	600			
EL P-1000		Complete 3 ϕ system protector in conduit connected box. Max. supply 2 KVA.	120			
EL P-1001		Complete 3 ϕ system protector in conduit connected box w/series varistors 100 KVA.	120			
EL 2140		A4-10 Base 3 Electrode	120			
EL 2175		A4-10 Base 3 Electrode	480			

ELECTRONS COMPANY

A Unit of General Signal Corporation

HEINTZ AND KAUFMAN

SINCE LTD 1927

Type	Resale Price	Type	Resale Price	Type	Resale Price	Type	Resale Price	Type	Resale Price
0A2	1.30	2J39	155.00	5BP1	32.00	26A7GT	6.15	437A	58.70
0A2WA	3.30	2J40	155.00	5BT1	49.00	26C6	3.05	468	35.00
0A3	1.54	2J41	207.00	5C22	36.00	26D6	3.05	502A	Use 2050A
0B2	1.35	2J42	119.00	5C24	52.50	26E6WG	28.10	543	49.00
0B2WA	2.30	2J48	100.00	5CP7A	31.00	26Z5W	3.25	545	88.00
0B3	2.30	2J49	150.00	5CP11A	31.00	28D7	4.75	549	58.80
0C3	1.45	2J50	160.00	5D21	38.03	28D7W	9.90	554	88.00
0C3W	5.90	2J51A	425.00	5DEP1	32.00	35T	31.00	558	53.00
0D3	1.39	2J55	204.00	5FP7	25.00	35TG	30.00	561	79.00
0D3W	5.90	2J56	198.00	5FP14	25.00	53	11.40	572B	20.00
0G3	2.30	2K25	41.00	5FP15A	35.00	72	6.50	575A	18.00
1A4	2.75	2K26	64.00	5J26	495.00	83	1.89	576A	26.00
1A4H	2.22	2K28	85.00	5J21	42.50	100R	16.00	577	20.75
1AJ5	3.50	2K39	350.00	5JP1A	60.00	100TH	23.25	577W	53.00
1B22	42.50	2K41	375.00	5JP2	42.50	100TL	23.25	578	17.00
1B23	19.50	2K45	86.00	5LP1	38.00	120	32.00	582	37.00
1B24A	32.00	2K48	97.00	5MP1	38.00	T-160L	22.50	583	15.00
1B26	55.00	2K50	470.00	5RAWGA	7.90	203	15.00	589	88.00
1B29	14.00	2SM15	12.00	5RAWGB	12.70	203WA	46.00	593	46.00
1B32	18.00	2X2A	3.25	5RAWGY	6.15	206	9.90	596	34.50
1B35	8.50	3A4	1.25	5RP1A	135.00	211	17.20	631-P1	7.30
1B35A	8.80	3A5	2.03	5UP1	23.80	211D	26.70	673	23.60
1B36	40.00	3ACP7A	39.45	5WP15	83.00	211W	44.00	701A	23.50
1B37	8.00	3ACP11	38.75	5Y3WGTA	3.75	213A	13.20	703A	10.00
1B37A	9.25	3ADP1	60.00	5Y3WGTB	5.75	217C	24.00	705A	21.00
1B38	80.00	3AQP1	30.00	5YP1	54.00	221B	Use 371B	705WA	57.00
1B40	16.00	3B4	2.94	6AC7W	4.44	242C	53.00	707B	34.00
1B41	66.00	3B22	9.98	6AG5WA	Use 6186/6AG5WA	249B	17.00	713A	8.00
1B44	41.00	3B24W	9.00	6AH6WA	6.40	249C	12.50	715A	20.00
1B45	52.00	3B24WA	9.85	6AJ5	3.40	250R	40.00	715B	28.50
1B46	16.00	3B24WB	10.50	6AK4	2.22	250TH	39.80	715C	43.80
1B51	20.20	3B25	Use 3B28	6AK5W	2.25	250TL	39.80	717A	7.90
1B53	25.00	3B28	6.85	6AL5W	1.33	254W	Use HK254W	719A	123.00
1B58A	79.00	3B29	10.00	6AN5	4.14	272A	30.00	721B	44.40
1B59	19.00	3B29W	16.00	6AN5WA	9.20	274A	8.35	722A	16.90
1B63A	22.50	3BP1A	30.00	6AN6	3.40	274B	9.00	723A/B	43.50
1P30	5.25	3C22	89.70	6AR6	5.25	275A	17.00	724A	13.50
1P39	2.75	3C23	8.25	6AS6	3.33	279A	640.00	724B	14.00
1P40	3.90	3C24	16.00	6AS7G	4.93	300B	23.00	725A	205.00
1P41	4.75	3C27	81.20	6AU6WA	2.65	307A	7.80	726A	43.00
1Q22	38.00	3C45	19.75	6AU6WB	2.70	310A	12.00	726B	49.00
1Q23	42.00	3C45W	41.00	6B4G	9.15	311CH	43.00	726C	72.00
1Z2	9.88	3CX100A5	26.00	6BA5	5.90	311CT	46.00	801A	11.90
2AC15	11.00	3D21WA	23.20	6BA6W	Use 5749/6BA6W	311T	46.00	803	42.50
2AP1A	19.40	3D21WB	93.00	6BE6W	Use 5750/6BE6W	313C	4.52	805	25.50
2AS15	10.50	3DP1	28.00	6BF7	2.00	313CA	5.67	807	3.10
2AS15A	10.50	3DP1A	32.00	6BF7W	4.12	313CB	6.30	808	12.25
2B22	27.25	3JP1	26.50	6BL6	84.00	313CC	4.97	809	11.00
2B23	57.20	3JP2	30.00	6BM6	84.00	316A	10.75	810	25.50
2B24	5.75	3JP12	32.00	6BM6A	84.00	323A	Use 323B	811A	6.50
2BP1	29.75	3KP1	28.90	6C21	90.00	323B	8.40	811AW	9.75
2C26	6.50	3MP1	27.00	6D4	2.83	328A	7.75	812A	6.50
2C26A	7.00	3RP1	18.30	6H6WGT	6.00	329A	7.50	812AW	8.80
2C36	69.00	3RP1A	30.20	6J4	3.75	336A	14.00	812HD	16.50
2C37	69.00	3RP7A	31.60	6J4WA	4.20	337A	9.50	813	24.25
2C39A	19.90	3WP1	38.40	6J6WA	4.85	339A	48.00	814	21.40
2C39B	27.50	4-65A	25.00	6L6WGA	Use 5932/6L6WGA	346C	6.23	815	25.00
2C39WA	19.95	4-125A	35.50	6L6WGB	3.75	348A	8.20	816	4.00
2C40	27.50	4-250A	42.00	6Q5G	6.00	349A	13.20	826	39.00
2C40A	33.00	4-400A	47.00	6SA7WGT	7.90	350A	14.75	829B	19.75
2C42	25.00	4B23	19.00	6SG7Y	3.15	350B	15.72	830B	15.50
2C43	26.50	4B24	11.50	6SK7WA	2.95	353A	6.08	832A	16.50
2C44	18.00	4B26	7.00	6SL7WGT	3.12	355A	24.00	836	13.80
2C46	28.20	4B28	7.00	6SN7WGT	2.35	368AS	9.00	836A	17.50
2C50	9.66	4B31	21.70	6SN7WGTA	4.75	371B	12.71	837	15.50
2C51	3.25	4B32	9.90	6SU7GT	3.75	374A	13.00	838	20.00
2C52	4.80	4B35	5.50	6SU7WGT	Use 6188	376C	13.26	838W	47.00
2C53	11.80	4C22/HF100	29.80	6X4W	1.58	393A	9.75	843	4.00
2D21	1.22	4C27	22.00	6X4WA	2.85	394A	9.95	845	27.00
2D21W	2.75	4C28	22.00	7AK7	8.00	404A	9.40	845W	47.00
2E22	8.25	4C35	36.00	7BP7	40.00	407A	5.80	851	625.00
2E26	3.95	4C35A	36.70	7C29	208.50	408A	4.90	852	26.20
2E27	2.22	4CX250B	35.60	10KP7A	64.45	409A/6AS6	5.55	860	74.00
2J25	244.00	4CX250R	44.00	10SP4	72.00	412A	11.15	861	137.50
2J26	124.00	4D21	35.50	12AT7WA	Use 6201/12AT7WA	413B	9.94	864	3.75
2J27	124.00	4D32	72.00	12AU7WA	Use 6189/12AU7WA	415A	5.60	865	7.75
2J28	244.00	4E27	42.00	12AY7	2.40	416B	72.00	866A	2.60
2J31	110.00	4J52A	385.00	12E1	11.25	417A	8.00	866JR	3.75
2J32	110.00	4MP1	69.00	12SX7GT	2.40	418A	25.00	868	4.50
2J33	110.00	4PR60B	107.00	12SY7	2.65	420A	16.50	872A	9.85
2J34	110.00	4X150D	29.00	15E	15.00	421A	23.00	873	17.17
2J36	110.00	4X250B	33.70	16ADP7	87.00	422A	23.00	874	3.50
2J36A	140.00	4X250F	38.00	25T	26.50	423A/6140	11.00	876	5.25
2J37	125.00	5A6	6.50	25TG	19.00	429A	17.00	878	17.00
2J38	155.00	5ADP7	48.00	26A6	3.65	430B	5.40	917	8.10

HEINTZ & KAUFMAN Ltd. • Sold World Wide Since 1927

INDUSTRIAL, SPECIAL PURPOSE AND MICROWAVE TUBES

Type	Resale Price	Type	Resale Price	Type	Resale Price	Type	Resale Price	Type	Resale Price
918	4.65	5687	3.00	5931	6.60	6245	7.50	7722/E280F	8.00
922	3.75	5687WA	4.50	5932/6L6WGA	7.75	6247	10.22	7735A	165.65
923	3.88	5691	8.75	5933/807W	11.45	6247WA	17.77	7737	6.90
927	4.15	5692	7.80	5933WA	16.25	6252	25.00	7788	9.75
928	11.30	5693	6.49	5939	32.00	6268	39.75	8000	31.50
929	2.40	5696	1.85	5939A	35.35	6278	40.90	8002	510.00
930	3.90	5702	3.88	5948/1754	180.00	6279	44.40	8002R	425.00
934	5.25	5702WA	5.95	5949/1907	110.00	6303	78.00	8008	9.50
935	12.60	5702WB	8.10	5956	64.00	6303A	94.00	8008XE	14.00
949A	240.00	5703WA	6.08	5957	64.00	6310	140.00	8012	18.50
954	3.90	5703WB	8.20	5960	31.50	6312	170.00	8013	12.00
955	5.90	5704	4.75	5962	8.20	6314	195.00	8013A	17.00
956	9.90	5718	3.65	5963	1.29	6326A	510.00	8014A	50.00
957	7.90	5719	2.50	5964	1.52	6327	23.50	8020	16.00
958A	11.90	5719A	2.75	5965	1.88	6336	16.80	8020W	18.95
959	11.90	5721	100.00	5977	5.25	6336A	18.00	8025	15.55
966	8.50	5722	9.50	5977A	5.38	6336B	33.33	8093A/L	1666.66
967	Use FG 17	5725/6AS6W	3.05	5979/BS1	40.00	6339	35.00	8165	2700
972A	15.00	5725/6AS6W/6187	3.15	5980/BS2	15.60	6350	1.85	8252	107.00
973	21.90	5726/6AL5W	1.35	5981/5650	218.00	6360	4.75	8298A	Use 6146B
1236C	13.00	5726/6AL5W/6097	1.38	5992	6.10	6390	125.00	8370	95.00
1258	39.17	5727/2D21W	2.44	5993	11.25	6390A	135.00	8480	O.R.
1274	4.50	5736	195.00	5998	11.50	6414	3.60	8484	185.00
1603	7.20	5744	2.75	6005/6AQ5W	3.15	6418	3.20	8485	255.00
1611	2.95	5744WA	6.66	6005/6AQW/6095	3.25	6442	38.00	8507	200.00
1612	5.77	5749/6BA6W	2.10	6014/C1K	11.80	6478	17.77	8673	1666.66
1613	3.30	5750/6BE6W	3.45	6021	3.00	6481	O.R.	8674	1666.66
1614	4.93	5751	2.50	6021A	3.45	6503	97.00	8748	1777.77
1616	9.85	5751WA	2.40	6028	4.90	6510/4J52A	345.00	8749	1777.77
1619	5.00	5755/420A	8.65	6032	140.00	6528	21.55	8775	1666.66
1620	7.55	5763	2.33	6038	11.25	6533	12.00	9001	5.31
1621	3.85	5767	80.00	6044	25.00	6543	615.50	9002	3.52
1622	5.35	5768	80.00	6045	5.95	6550	4.95	9003	5.33
1624	7.50	5780	895.00	6072	3.50	6688	7.85	9004	2.94
1625	3.60	5783	3.65	6073/OA2	3.00	6689	4.00	9005	7.80
1626	3.38	5783WA	5.85	6074/OB2	3.45	6763	4.00	9006	2.60
1629	1.85	5783WB	7.80	6080	4.95	6788	10.85	C1A	13.50
1630	2.90	5784	4.35	6080WA	9.95	6814	4.90	C1K	11.80
1631	3.15	5784WA	8.90	6080WB	20.00	6832	18.50	C3P14	27.50
1635	3.80	5784WB	13.33	6082	5.25	6855	16.75	C3R14	28.50
1636	4.50	5787	4.80	6084	3.65	6856	20.80	C6J/5C21	28.10
1641	8.50	5787WA	4.86	6085	5.00	6857	22.50	C6M	16.00
1654	5.60	5789	895.00	6088	3.05	6858	28.10	CV11	18.88
2033	4.95	5796	19.15	6094	21.21	6859	31.80	F124A	1200.00
2050	2.35	5814	2.00	6095	3.25	6864	33.00	FP265	60.00
2050A	2.05	5814A	2.25	6096	2.30	6888	4.00	G10/241E	30.00
2050W	6.35	5814WA	2.28	6097	1.38	6895	19.25	GC10/4B	13.50
2051	2.27	5820A/L	1666.66	6098/6AR6WA	12.20	6901	14.70	GC10B	12.50
2399	17.72	5823	1.70	6099	5.50	6922	4.70	GC10B/L	13.50
4415E	1666.66	5829	4.15	6100/6C4WA	2.50	6939	10.90	GC10B/S	13.70
4492	1444.44	5829WA	6.66	6101/6J6WA	5.35	6871	34.50	GC10D	15.65
4536	1888.88	5836	85.00	6106	6.44	6940	85.00	GC12/4B	15.60
5517	3.25	5837	85.00	6110	7.55	6977	2.50	GR10 Series	O.R.
5557/FG17	9.25	5840	5.05	6111	3.50	7006	1388.00	GR12 Series	O.R.
5558/FG32	17.50	5840A	5.35	6111A	3.60	7008	1010.00	GS10C/S	15.45
5559/FG57	24.50	5842/417A	7.25	6112	4.00	7025	1.30	GS10D	17.25
5581	4.00	5845	9.50	6112A	4.25	7034	23.00	GS10H	11.25
5583	5.70	5846	67.75	6116	60.00	7035	29.00	GS12D	18.25
5608A	11.40	5847/404A	8.75	6117	85.00	7038	170.00	HF100	34.00
5632	15.05	5851	9.00	6130	19.75	7077	39.05	HF200	37.50
5636	6.00	5852	6.10	6134/6AC7WA	5.95	7159	87.00	HF300	41.50
5639A	4.55	5863	60.00	6136/6AU6WA	2.60	7203	35.60	HK24	25.00
5641	4.85	5864	48.40	6140/423A	11.00	7226	298.00	HK24G/3C24	18.00
5642	5.90	5875	2.50	6146	4.80	7241	59.00	HK54	34.80
5642	3.85	5876	7.50	6146B/8298A	5.10	7242	65.00	HK72/RK72	6.00
5643	5.25	5876A	6.90	6155	36.00	7289	26.00	HK220/72	9.00
5646	12.35	5881	3.50	6156	42.00	7293A/L	1666.66	HK253	47.00
5647	7.50	5886	5.00	6159	4.80	7293B	1666.66	HK254W	39.80
5650	Use 5981-5650	5894	24.00	6161	117.00	7295B	1333.33	KU17	59.50
5651	1.78	5896	3.05	6163	36.66	7295B/L	1666.66	KU23	39.90
5651WA	3.50	5899	5.05	6186/6AG5WA	3.75	7295C	1777.77	KU610	25.00
5653	3.00	5902	4.44	6187	3.15	7308	5.20	KY21A	29.50
5654/6AK5W	2.25	5902A	4.66	6188/6SU7WGT	7.20	7310	57.00	PL177A	29.00
5654/6AK5W/6096	2.30	5903	6.75	6189/12AU7WA	3.45	7325	185.00	R1130B/1B59	22.22
5656	15.90	5904	6.50	6197	2.20	7327	10.65	RX21A	21.70
5663	2.10	5905	7.25	6198A	Use 7325	7336	510.00	SR554	82.00
5670	2.11	5906	7.45	6201/12AT7WA	2.50	7360	3.75	SG339	82.00
5670WA	2.30	5906A	7.69	6202/6X4WA	2.69	7389C	1777.77	SGR-1	39.50
5672	2.25	5908	9.00	6205	5.25	7402	90.00	SS501	26.50
5676	3.00	5910	2.50	6211	1.85	7410	15.00	UH50	35.00
5678	2.25	5915	1.60	6216	4.15	7513C	1666.66	UXCV11	22.50
5679	6.60	5916	9.00	6227	3.50	7513/L	1666.66	V70D	32.00
5680	190.00	5922	38.38	6229	310.00	7522	17.80	VT158	278.60
5685/C6JA	31.00	5927	74.40	6236	115.00	7580W	Use 4CX150R	X13	315.00
5686	3.30	5930	4.75	6236A	125.00	7629A	1654.54	X80	78.00





Electron Tubes

For

Entertainment and Industry

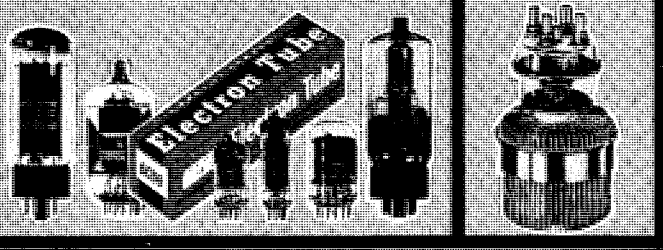

IEC SERVICE RANGE

A large selection of the most popular receiving tubes for the U.S. service dealer renewal market.

TUBE TYPE	TUBE TYPE	TUBE TYPE	TUBE TYPE	TUBE TYPE
1AD2	6AL11	6EM7	6JN6	12CU5/
1B3GT/	6AN8A	6ER5	6JS6A	12C5
1G3GT	6AQ5A/	6EW6	6J78	12DQ6B/
1K3/1J3	6HG5	6F67	6JU8A	12W6
1V2	6AQ8	6FH5	6K6GT	
1X2B/	6AT6	6FQ7/	6KA8	
1X2A	6AT8	6CG7	6K28	
2AF4B/	6AU4GTA	6CC5	6K08/	
2D24	6AU6A	6G7FA	6U8A	
2AV2	6AU8	6CG8A	6K8	
3A3/3B2	6AV6	6CL8A	6L60B	
3AL5	6AW8A	6GM7	6L6GC	
3AT2	6AX4GTB	6CQ8	6LM8	
3BN6	6AY3B	6CS6	6SA4	
3BY6	6B10	6CS6	6SN7GTB	
3BZ6	6BA6	6CZ5	6T8A	
3CA3	6BG6GA	6CY5	6T10	
3CB6/	6BH6	6DA6	6U8A/	
3CF6	6BJ8	6DE6	6KD8	
3D7A	6BK4B	6DJ8	6V6GTA	
3GK5	6BK7B	6DK9	6W6GT	
3GS8/	6BL7GT	6DQ6B/	6X8A	
3BU8	6BL8	6GW6	7AU7	
3HQ5	6BM8	6DT6A	7G57	
4AU6	6BN6	6GH8A/	8AW8A	
4BL8	6BN8	6E8A	8B10	
4BQ7A/	6BQ5	6G17	8BQ5	
4BZ7	6BQ6GTB/	6CK5/	8CG7/	
4DT6A	6CU6	6FO5A	8FQ7	
4EH7	6BQ7A/	6GK6	8JV8	
4EJ7	6BR8A	6GM6	9A9/8A8	
4HA5	6BS8	6GU7	10CW5	
4HQ5	6BZ7/	6GX6	10DE7	
5AM8	6BQ7A	6H26	12AD6	
5AN8	6C4	6H8	12AL5	
5AQ5	6C6A/	6HG8	12AT6	
5BK7A	6CF6	6HM5/	12A7	
5GS7	6CD6GA	6HA5	12A7A	
5U4GB	6DW4B	6HQ5	12AV7	
5U8	6DX8	6HS8	12AX4GTB	
5V3A	6E8B/	6HZ6	12AX7A	
6AF4A/	6GH8A	6J6A	12A7Z	
6D24	6EB8	6JC6	12BA6	
6AK5	6EH7	6JD6	12BES	
6AL3	6EJ7	6JE6A	12BH7A	
6AL5	6EM5	6JH6	12BY7A	
		6JM6		



IEC MULLARD RECEIVING TUBES

Universally recognized and preferred for Hi Fidelity • Stereo • Foreign Replacement

TUBE TYPE	CROSS REF.	TUBE TYPE	CROSS REF.	TUBE TYPE	CROSS REF.
DAF96	1AH5	EF80	6BX6	LFL200	11Y9
DK91	1R5	EF85	6BY7	LL86	10CW5
DL98	3B4	EF86	6267	LY88	20AQ3
DM70	1M3	EF89	6DA6	PABC80	9AK8
DY87	1S2A	EF91	6AM6	PC900	4HA5
EABC80	6AK8	EF92	6CQ6	PCC85	9AQ8
EB91	6AL5	EF93	6BA6	PCC88	7DJ8
EBC33		EF94	6AU6	PCF80	9A8
EBC41	6CV7	EF95	6AK5	PCF82	9U8
EBC81	6BD7A	EF183	6EH7	PCF200	8X9
EBC90	6AT6	EF184	6EJ7	PCF201	8U9
EBF80	6N8	EL34	6CA7	PCF801	8GJ7
EBF89	6DC8	EL37		PCH200	9V9
EC88	6DL4	EL84	6BQ5	PCL82	16A8
EC92	6AB4	EL86	6CQ5	PCL84	15DQ8
EC97	6H45	EL90	6AQ5	PCL85	18G8
EC900	6M8	EL95	6DL5	PCL86	14G8
ECC81	12A7	EL500	6B85	PL36	255
ECC82	12AU7	EM34	6CD7	PL84	15CW5
ECC83	12AX7	EM81	6DA5	PL500	27G85
ECC85	6AQ8	EM84	6FG6	PY81	17Z3
ECC86	6GM8	EM87	6HU6	PY88	30AE3
ECC88	6DJ8	EY88	6AL3	UCC85	
ECC189	6E58	EZ80	6V4	UCH81	19D8
ECF80	6BL8	EZ81	6CA4	UCL82	50BM8
ECF82	6U8	EZ90	6X4	UL84	45B5
ECF86	6HG8	GZ34	5AR4	UY85	38A3
ECF200	6X9	HCC85	17E8	XC80	48L8
ECF201	6U9	LC900	3HA5	XC801	4GJ7
ECF201	6GJ7	LCF80	6LN8	XL84	88Q5
ECH81	6AJ8	LCF86	5HG8	XL86	8CW5
ECH200	6V9	LCF200	5X9	XL500	13G85
ECL80	6AB8	LCF201	5U9	XY88	16AQ3
ECL82	6BM8	LCF801	5EJ7	7025A	
ECL85	6CV8	LCF802	6LX8	7189A	
ECL86	6GW8	LF183	4EH7	7247	12DW7
EF40		LF184	4EJ7		



10M TUBE SERIES

A selected series of individually laboratory tested tubes ideally suited for today's advanced electronic equipment.

- TUBE-TO-TUBE UNIFORMITY • LONG LIFE
- SECTION-TO-SECTION UNIFORMITY

TUBE TYPE	SUGG. RESALE PRICE	TUBE TYPE	SUGG. RESALE PRICE
6AB8/ECL80	\$2.75	12AX7A	\$2.20
6AJ8/ECH81	2.65	12DW7/7247	2.55
6AK5/EF95	3.25	15CW5/PL84	2.50
6AK8/EABC80	2.80	6267/EF86	2.50
6AL5/EB91	1.95	7025	2.35
6AQ5/EL90	2.15	7247/12DW7	2.55
6AQ5A	2.15	EABC80/6AK8	2.80
6AQ8/ECC85	2.40	EB91/6AL5	1.95
6AT6/ECB90	2.00	EB90/6AT6	2.00
6AU6/EF94	2.05	EB91/6AV6	1.95
6AU6A	2.05	EBF89/6DC8	2.65
6AV6/EB91	1.95	EC90/6C4	2.85
6BA6/EF93	2.00	EC95/6E85	2.40
6BE6/EK90	2.10	EC97/6FY5	2.35
6BL8/ECF80	3.05	ECC81/12AT7	2.55
6BQ5/EL84	2.15	ECC82/12AU7	2.20
6BQ5A	2.15	ECC83/12AX7	2.20
6C4/EC90	2.85	ECC85/6AQ8	2.40
6DA6/EF89	2.55	ECC88/6DJ8	3.10
6DC8/EBF89	2.65	EC91/6J6	2.55
6DJ8/ECC88	3.10	ECC189/6E58	3.50
6DL5/EL95	2.55	ECF80/6BL8	3.05
6DX8/ECL84	2.85	ECF86/6HG8	3.10
6EJ7/EF183	2.60	ECH81/6AJ8	2.65
6EJ7/EF184	2.60	ECH80/6AB8	2.75
6ER5/EC95	2.40	ECL84/6DX8	2.85
6F86/EC91	3.50	EF86/6E27	2.50
6EU7	2.35	EF89/6DA6	2.55
6FY5/EC97	2.35	EF93/6BA6	2.00
6GK5	2.40	EF94/6AU6	2.05
6HG8/ECF86	3.10	EF95/6AK5	3.25
6J6/ECC91	2.55	EF183/6EJ7	2.60
6J6A	2.55	EF184/6EJ7	2.60
6T8A	2.80	EK90/6BE6	2.10
6H8B/PCF86	2.65	EL84/6BQ5	2.15
9A8/PCF80	3.25	EL90/6A05	2.15
12A7/ECC81	2.55	EL95/6DL5	2.55
12AU7/ECC82	2.20	HBC91/12AV6	1.95
12AU7A	2.20	PCF80/9A8	3.25
12AV6/HBC91	1.95	PCF86/8HG8	2.65
12AX7/ECC83	2.20	PL84/15CW5	2.50



IEC MATCHED PAIRS

For the most complete range for optimum performance. Laboratory Balanced

TUBE TYPE	CROSS REF.	TUBE TYPE	CROSS REF.	TUBE TYPE	CROSS REF.
ECL82MP	6BM8MP	EL90MP	6AQ5MP	UL84MP	45B5MP
ECL86MP	6GW8MP	EL95MP	6DL5MP	7189MP	
EL34MP	6CA7MP	KT68MP		KT SERIES	
EL37MP		KT77MP		TUBE TYPE	
EL84MP	6BQ5MP	KT88MP		KT66	
EL86MP	6CW5MP	UCL82MP	50B8MP	KT77	
				KT88	



IEC SPECIAL PURPOSE TUBES

An extensive range of over 700 dependable Tubes for virtually every industrial application.

TUBE TYPE	CROSS REF.	SUGG. RESALE PRICE	TUBE TYPE	CROSS REF.	SUGG. RESALE PRICE	TUBE TYPE	CROSS REF.	SUGG. RESALE PRICE	TUBE TYPE	CROSS REF.	SUGG. RESALE PRICE
AW17-20		\$135.00	EL360		\$ 4.75	M8196/		QOV03-10	6360		\$ 4.95
DH3-91	1CP1/		EN91	2D21	1.28	6AS6W	5725	QOV06-40A	5894		\$ 5.50
	1CP31	17.70	J99-2.5	7028	142.00	M8204/		QV05-10	2E26		4.35
DM160	6977	2.50	K59-20D		115.00	2D21W	5727	QV05-25	2E26		3.25
E55L	8233	13.25	M8079	6058	4.20	M8212/		QV06-20	6146		4.35
E80CC	6085	3.30	M8080/			6AL5W	6097/5726	QV06-20B	6883		4.45
E80CF	7643	4.95	6C4WA		7.25	M8224		QY5-3000A	6076		305.00
E80F	6084	3.30	M8081/	6100		M8248		RG1-240A			12.50
E80L	6227	3.05	6J6WA	6101	5.35	ME1400		RG3-250A			15.65
E81L	6686	4.10	M8082	6516	5.75	ME1401/		RR3-250	3B28		16.50
E83F	6689	3.85	M8083	6064	4.75	4065	5800	TD03-10/			
E88CC	6922	4.87	M8096	6062	7.60	ME1402/		EC55	5861		37.50
E90CC	5920	3.20	M8100/			4066	5802	TD03-10E			45.00
E90F		3.75	6AK5W	6096/5654	2.45	ME1403/		XG1-2500	5559		23.00
E91H	6687	2.75	M8136/			4068/		XH3-045	3C45		50.10
E92CC		2.00	12AU7WA	6189	3.70	58A9	5886	XR1-6400A	6807		71.85
E180CC	7062	2.25	M8137	6057	6.50	ME1404/		Z300T	1267		7.95
E180F	6688	6.80	6065		5.85	4069		Z502S			11.00
E182CC	7119	2.95	M8161	6065	3.25	OCF71	7632	Z510M/			
E186F	7737	7.20	M8162	12AT7WA	7.95	ORP10		ZM1020	6844		9.80
E188CC	7308	5.20	M8163			ORP90		Z803U	6779		5.75
E810F	7788	9.75	M8190/			QVQ02-6	6939	Z900T	5823		3.45
EA76	6489	4.70	85A3	5783WA	14.00						



INTERNATIONAL ELECTRONICS SALES CORP.



Number	Suggested Resale Price	Number	Suggested Resale Price	Number	Suggested Resale Price	Number	Suggested Resale Price
OA2	\$1.30	5FP7A	\$32.95	814	\$23.50	6101/6J6WA	\$5.35
OA2WA	3.30	5JP1AM	75.00	816	3.20	6136	2.70
OA3	1.54	5JP2AM	75.00	826	28.00	6146A	4.30
OB2	1.35	5LP1A	40.00	836	11.10	6146B	5.20
OB2WA	2.35	5MP1AM	40.00	838	20.00	6159	4.80
OB3	2.30	5NP1	35.00	866A	2.65	6186	3.75
OC3	1.45	5R4GY	2.03	866JR	3.75	6186/6AG5WA	3.75
OD3	1.40	5RP1A	169.70	872A	9.85	6189/12AU7A	3.45
OD3W	6.20	5RP11AM	169.70	873	19.50	6197	2.48
OG3	2.30	5SP7AM	160.00	918	4.65	6201/12AT7WA	2.50
2AC15	11.00	5UP7	29.05	1612	5.77	6205	5.35
2AP1	19.50	5Y3WGTA	3.75	1613	3.30	6211	1.95
2AP1A	19.50	5Y3WGTA	5.75	1620	7.55	6293	5.95
2AS15	10.50	5YP1	55.00	1621	3.85	6336A	18.00
2AS15A	10.50	5ZP16	83.00	1622	5.35	6414	3.65
2B23	75.00	6AC7W	5.70	1629	1.85	6528	21.55
2BP1	20.60	6AC7WA	5.70	1631	3.25	6626/0A2WA	3.30
2C26A	7.50	6AH6WA	7.50	1635	3.80	6660/6BA6	1.01
2C50	9.90	6AJ5	3.75	5557/FG17	9.50	6661/6BH6	1.34
2C51	3.65	6AK5W	2.35	5558/FG32	17.50		
2C52	4.80	6AL5W	1.33	5559/FG57	24.50	6662/6BJ6	1.29
2C53	9.00	6AS7G	4.93	5651	1.78	6663/6AL5W	.92
2D21	1.22	6AU6WA	2.70	5651WA	3.75	6664/6AB4	1.12
2D21W	2.90	6AU6WB	2.70	5654	2.35	6676/6CB6A	1.06
2E22	8.40	6C21	90.00	5654/6AK5W	2.35	6677/6CL6	1.85
2SM15	12.00	6J4WA	5.50	5654/6AK5W/6090	5.10	6678/6U8A	1.62
2X2A	3.25	6J6WA	4.95	5670	2.11	6679/12AT7	1.50
3ABP1	125.00	6L6WGB	4.10	5670WA	2.30	6680/12AU7A	1.22
3ACP1A	37.00	6Q5G	6.00	5685/6GJA	27.00	6681/12AX7	1.26
3ACP2	39.45	6SN7WGTA	4.90	5687	3.15	6887	1.40
3ACP7	39.45	6X4W	1.60	5691	8.75	6922/E88CC	4.75
3ACP11	39.45	10QP7	75.00	5692	8.25	7054	1.54
3AP1	44.15	12AKP7	55.00	5693	6.60	7057	1.95
3BP1	29.80	12AT7WA	2.53	5725	3.05	7059	1.48
3B4WA	5.85	12DP7A	67.95	5726	2.10		
3B24W	9.00	12SP7D	46.80	5726/6AL5W/6097	1.40	7061	1.29
3B24WA	9.90	25T	26.50	5727	2.90	7370	10.26
3B28	7.50	35T	31.00	5727/2D21W	2.90	7730	1.93
3B29	10.30	35TG	31.00	5749	2.20	7898	1.34
3C23	11.98	100R	16.20	5749/6BA6W	2.20		
3C24	16.00	100TH	23.50	5750	3.45	8008	9.90
3C45	19.00	100TL	23.50	5751	2.55	8013A	17.05
3DP1A	45.70	152TH	93.00	5751WA	2.85	8020	16.00
3FP7A	35.00	249B	18.00	5763	2.53	8020W	19.50
3GP1A	29.50	249C	14.60	5814A	2.30	9001	5.40
3JP1	30.75	250R	36.00	5814WA	2.30	9002	4.20
3JP7	30.75	250TH	38.50	5823	1.70	9003	5.40
4-65	25.70	250TL	38.50	5842/417A	7.25	9004	4.60
4-125A	35.50	254W	30.00	5847/404A	9.40	9005	8.05
4B24	11.80	274A	8.35	5881	3.10	9006	2.70
4B26	7.00	274B	9.00	5963	1.34	C1K	11.80
4B31	32.83	300B	10.80	4964	1.55	C6J/5C21	28.10
4D21	36.00	310A	7.70	5965	1.90	FG17/5557	9.50
4PR60B	107.00	407A	5.90	6005	3.70	FG57/5559	24.50
5ADP7	40.20	408A	4.95	6005/6AQ5W	3.75	FG154	108.00
5BCP1/T55P1	77.60	715A	20.00	6073	3.00	HF100	34.00
5BDP7	98.00	715B	28.50	6073/OA2	3.00	HF200	58.00
5BP1	39.45	715C	70.00	6074	3.45	HF300	46.50
5CBP1	63.00	719A	260.00	6074/OB2	3.45	KU23	47.00
5CP1A	35.90	807	3.15	6080	5.00	LK24G/3C24	16.00
5CP1B	49.80	811A	6.50	6080WA	9.95	LK54	36.00
5D21	45.00	812A	6.50	6082	5.60	LK72	6.00
				6099	15.35	R1130B/1B59	22.90

PRICES AND DELIVERY FOR TUBES NOT LISTED ARE AVAILABLE UPON REQUEST FROM RUSSELL INDUSTRIES



PICTURE TUBES

COLOR and BLACK and WHITE

TUBE TYPE	TUBE TYPE	TUBE TYPE	TUBE TYPE	TUBE TYPE
23EKP4	23FMP4 Use 23HFP4A	23HGP4	23UP4 Use 23BQP4	24CP4B
23ENP4	23FRP4	23HLP4 Use 23GSP4	23WP4 Use 23FP4A	24DP4 Use 24AEP4
23EQP4	23FSP4	23HQP4 Use 23HGP4	23XP4 Use 23YP4	24DP4A Use 24AEP4
23ESP4 Use 23HFP4A	23FVP4 Use 23HFP4A	23HRP4 Use 23HWP4A	23YP4	24QP4 Use 24CP4B
23ETP4	23FVP4A Use 23HFP4A	23HUP4A	23ZP4 Use 23BLP4	24TP4 Use 24CP4B
23EWP4 Use 23EQP4	23GP4 Use 23CP4	23HWP4 Use 23HWP4A	24ADP4 Use 24CP4B	24VP4 Use 24CP4B
23EWP4A Use 23EQP4	23GBP4 Use 23HFP4A	23HWP4A	24AEP4	24VP4A Use 24CP4B
23EYP4	23GEP4 Use 23FBP4	23HXP4 Use 23HFP4A	24AHP4	24XP4 Use 24CP4B
23EZP4	23GJP4 Use 23GJP4A	23JEP4	24AJP4 Use 24ATP4	24YP4 Use 24AEP4
23FP4A	23GJP4A	23JP4	24ALP4 Use 24AHP4	24ZP4 Use 24AEP4
23FBP4	23GSP4	23KP4 Use 23FP4A	24ANP4 Use 24AEP4	27EP4 Use 27RP4A
23FCP4 Use 23GJP4A	23GTP4 Use 23ETP4	23KP4A Use 23FP4A	24ATP4	27GP4 Use 27RP4A
23FDP4 Use 23GJP4A	23GWP4 Use 23GJP4A	23MP4 Use 23FP4A	24AUP4	27LP4 Use 27RP4A
23FEP4 Use 23ENP4	23GXP4 Use 23GSP4	23MP4A Use 23FP4A	24AVP4 Use 24BEP4	27NP4 Use 27RP4A
23FHP4 Use 23GJP4A	23HP4 Use 23CP4	23NP4	24BAP4	27RP4 Use 27RP4A
23FJP4 Use 23ETP4	23HFP4 Use 23HFP4A	23ORB4	24BEP4	27RP4A
23FLP4 Use 23EKP4	23HFP4A	23TP4 Use 23YP4	24CP4A Use 24CP4B	310AVB4 Use 12CNP4

NOTES

Where replacement type is indicated consult RCA Interchangeability Guide for Replacement information.

NOTE 1: For replacement purposes of these types electrical and/or mechanical modifications may be required. **NOTE 2:** 21AP4 — "RCA receivers with 21AP4 may be converted to 21ZP4 with conversion kit (RCA Part No. 12B202)."

NOTE 3: Pin No. 6 (Focusing Electrode) of the RCA replacement must be connected to Pin No. 11 at the socket. The original tube did not require an external voltage for focus.

RCA HI-LITE "RARE EARTH" COLOR TELEVISION PICTURE TUBES

NOTICE: RCA Hi-Lite "Rare Earth" Color Television Picture Tubes contain all new parts and materials.

H-15LP22 H-15NP22 H-19GVP22 H-19GWP22 H-21GUP22 H-21GVP22 H-22JP22 H-25XP22 H-25YP22

RCA COLORAMA PICTURE TUBES

NOTICE: RCA Colorama Picture Tubes contain used materials which, prior to re-use, are carefully inspected to meet our high quality standards. Sulfide types are marked with *; all others are "Rare Earth" types.

15GP22* C-19EYP22 C-19HNP22 C-21FBP22* C-21GVP22/21FJP22A C-23EGP22A* C-25XP22/25AP22A
 C-15LP22 C-19GVP22/19EXP22 C-21AXP22A* C-21FJP22* C-22JP22 C-25AP22A C-25YP22/25BP22A
 C-15NP-22 C-19GWP22/19EYP22 C-21CYP22A* C-21GUP22/21FBP22A C-22UP22 C-25BP22A C-25AJP22

COLOR PICTURE TUBE INTERCHANGEABILITY GUIDE

TYPE TO BE REPLACED	REPLACE BY RCA TYPE	NOTES	TYPE TO BE REPLACED	REPLACE BY RCA TYPE	NOTES	TYPE TO BE REPLACED	REPLACE BY RCA TYPE	NOTES	TYPE TO BE REPLACED	REPLACE BY RCA TYPE	NOTES
15GP22	15GP22	Direct	21CYP22	{C-21CYP22A C-21FBP22	Direct Note 1	22JP22	{H-22JP22 C-22JP22	Direct Direct	25GP22	{C-25AP22A H-25XP22	Direct Note 1
15LP22	{H-15LP22 C-15LP22	Direct Direct	21CYP22A	{H-21GUP22 C-21GUP22/ 22FBP22A	Note 1 Note 1	22LP22	{C-22JP22	Direct	25GP22A	{C-25XP22/ 25AP22A	Note 1
15NP22	{H-15NP22 C-15NP22	Direct Direct	21FBP22	{C-21FBP22 H-21GUP22	Direct Note 1	22UP22	C-22UP22	Direct	25RP22	{C-25BP22A H-25YP22 C-25YP22/ 25BP22A	Direct Note 1 Note 1
19EXP22	{H-19GVP22 C-19GVP22/ 19EXP22	Note 1 Note 1	21FBP22A	{C-21FBP22 H-21GUP22 C-21GUP22/ 21FBP22A	Direct Note 1 Note 1	23EGP22	{C-23EGP22A C-25AP22A	Direct Note 2	25SP22	{C-25AP22A H-25XP22 C-25XP22/ 25AP22A	Direct Note 1 Note 1
19EYP22	{C-19EYP22 H-19GWP22	Direct Note 1	21FJP22	{C-21FJP22 H-21GVP22	Direct Note 1	23EGP22A	{H-25XP22 C-25XP22/ 25AP22A	Note 2 Note 2	25XP22	{C-25AP22A H-25XP22 C-25XP22/ 25AP22A	Direct Direct Direct
19FMP22	{H-19GWP22 C-19GWP22/ 19EYP22	Note 1 Note 1	21FJP22A	{C-21FJP22 H-21GVP22 C-21GVP22/ 21FJP22A	Direct Note 1 Note 1	25AP22	{C-25AP22A H-25XP22 C-25XP22/ 25AP22A	Direct Note 1 Note 1	25YP22	{C-25AP22A H-25XP22 C-25XP22/ 25AP22A	Direct Note 1 Note 1
19FXP22	{H-19GWP22 C-19GWP22/ 19EYP22	Note 1 Note 1	21FKP22	{C-21FJP22 H-21GVP22 C-21GVP22/ 21FJP22A	Direct Note 1 Note 1	25AP22A	{C-25AP22A H-25XP22 C-25XP22/ 25AP22A	Direct Direct Direct	25ZP22	{C-25BP22A H-25YP22 C-25YP22/ 25BP22A	Direct Direct Direct
19GVP22	{H-19GVP22 C-19GVP22/ 19EXP22	Direct Direct	21GFP22	{C-21FJP22 H-21GVP22 C-21GVP22/ 21FJP22A	Direct Note 1 Note 1	25ABP22	{C-25AP22A H-25XP22 C-25XP22/ 25AP22A	Direct Direct Direct	25Y22	{C-25BP22A H-25YP22 C-25YP22/ 25BP22A	Direct Direct Direct
19GWP22	{H-19GWP22 C-19EYP22 C-19GWP22/ 19EYP22	Direct Direct Direct	21GRP22	{H-22JP22 C-22JP22	Note 2 Note 2	25AJP22	C-25AJP22	Direct	25Y22A	{C-25BP22A H-25YP22 C-25YP22/ 25BP22A	Direct Note 1 Note 1
19GXP22	{H-19GVP22 C-19GVP22/ 19EXP22	Note 1 Note 1	21GWP22	{H-22JP22 C-22JP22	Note 2 Note 2	25AJP22A	C-25AJP22	Direct	25Y22B	{C-25BP22A H-25YP22 C-25YP22/ 25BP22A	Direct Note 1 Note 1
19GYP22	{H-19GVP22 C-19GVP22/ 19EXP22	Note 1 Note 1	21GUP22	{H-21GUP22 C-21FBP22 C-21GUP22/ 21FBP22A	Direct Direct Direct	25BP22	{C-25BP22A H-25YP22 C-25YP22/ 25BP22A	Direct Note 1 Note 1	25Y22C	{C-25AP22A H-25XP22 C-25XP22/ 25AP22A	Direct Note 1 Note 1
19HBP22	{H-19GWP22 C-19EYP22 C-19GWP22/ 19EYP22	Direct Direct Direct	21GUP22A	{H-21GUP22 C-21FBP22 C-21GUP22/ 21FBP22A	Direct Direct Direct	25BP22A	{C-25BP22A H-25YP22 C-25YP22/ 25BP22A	Direct Note 1 Note 1	25Y22D	{C-25AP22A H-25XP22 C-25XP22/ 25AP22A	Direct Note 1 Note 1
19HNP22	C-19HNP22	Direct	21GUP22A	{H-21GUP22 C-21FBP22 C-21GUP22/ 21FBP22A	Direct Direct Direct	25CP22	{C-25AP22A H-25XP22 C-25XP22/ 25AP22A	Direct Note 1 Note 1	25Y22E	{C-25BP22A H-25YP22 C-25YP22/ 25BP22A	Direct Note 1 Note 1
21AXP22	{C-21AXP22A C-21CYP22A	Direct Note 1	21GVP22	{H-21GVP22 C-21FJP22 C-21GVP22/ 21FJP22A	Direct Direct Direct	25CP22A	{C-25AP22A H-25XP22 C-25XP22/ 25AP22A	Direct Note 1 Note 1	25Y22F	{C-25BP22A H-25YP22 C-25YP22/ 25BP22A	Direct Note 1 Note 1
21AXP22A	{C-21AXP22A C-21FBP22	Direct Note 1	21GVP22A	{H-21GVP22 C-21FJP22 C-21GVP22/ 21FJP22A	Direct Direct Direct	25FP22	{C-25BP22A H-25YP22 C-25YP22/ 25BP22A	Direct Note 1 Note 1	25Y22G	{C-25BP22A H-25YP22 C-25YP22/ 25BP22A	Direct Note 1 Note 1
21AXP22A/21AXP22	{H-21GUP22 C-21GUP22/ 21FBP22A	Note 1 Note 1	21GVP22A	{H-21GVP22 C-21FJP22 C-21GVP22/ 21FJP22A	Direct Direct Direct	25FP22A	{C-25BP22A H-25YP22 C-25YP22/ 25BP22A	Direct Note 1 Note 1	490EB22A	{H-19GVP22 C-19GVP22/ 19EXP22	Note 1 Note 1
21AXP22A/21AXP22	{H-21GUP22 C-21GUP22/ 21FBP22A	Note 1 Note 1	21GVP22A	{H-21GVP22 C-21FJP22 C-21GVP22/ 21FJP22A	Direct Direct Direct	25FP22A	{C-25BP22A H-25YP22 C-25YP22/ 25BP22A	Direct Note 1 Note 1	490FB22		
21AXP22A/21AXP22	{H-21GUP22 C-21GUP22/ 21FBP22A	Note 1 Note 1	21GVP22A	{H-21GVP22 C-21FJP22 C-21GVP22/ 21FJP22A	Direct Direct Direct	25FP22A	{C-25BP22A H-25YP22 C-25YP22/ 25BP22A	Direct Note 1 Note 1	490GB22		
21AXP22A/21AXP22	{H-21GUP22 C-21GUP22/ 21FBP22A	Note 1 Note 1	21GVP22A	{H-21GVP22 C-21FJP22 C-21GVP22/ 21FJP22A	Direct Direct Direct	25FP22A	{C-25BP22A H-25YP22 C-25YP22/ 25BP22A	Direct Note 1 Note 1	490HB22		
21AXP22A/21AXP22	{H-21GUP22 C-21GUP22/ 21FBP22A	Note 1 Note 1	21GVP22A	{H-21GVP22 C-21FJP22 C-21GVP22/ 21FJP22A	Direct Direct Direct	25FP22A	{C-25BP22A H-25YP22 C-25YP22/ 25BP22A	Direct Note 1 Note 1	490JB22		
21AXP22A/21AXP22	{H-21GUP22 C-21GUP22/ 21FBP22A	Note 1 Note 1	21GVP22A	{H-21GVP22 C-21FJP22 C-21GVP22/ 21FJP22A	Direct Direct Direct	25FP22A	{C-25BP22A H-25YP22 C-25YP22/ 25BP22A	Direct Note 1 Note 1	490LB22		
21AXP22A/21AXP22	{H-21GUP22 C-21GUP22/ 21FBP22A	Note 1 Note 1	21GVP22A	{H-21GVP22 C-21FJP22 C-21GVP22/ 21FJP22A	Direct Direct Direct	25FP22A	{C-25BP22A H-25YP22 C-25YP22/ 25BP22A	Direct Note 1 Note 1	490MB22		

Note 1 — Replacement information is packed with the tube.

Note 2 — Mounting hardware may have to be modified to accept substitution. In some small cabinet receivers substitution may not be feasible.



ELECTRON TUBES ENTERTAINMENT RECEIVING TYPES

*Optional List

PRICE SCHEDULE — AUGUST 1968

RCA Type	List Price*	RCA Type	List Price*	RCA Type	List Price*	RCA Type	List Price*	RCA Type	List Price*	RCA Type	List Price*
0Z4	\$3.25	3KT6	3.40	5V6GT	3.70	6BM8/ECL82	2.90	6DW5	3.85	6HM6	2.95
0Z4A	3.25	3Q4	3.35	5X8	4.15	6BN4A	4.00	6DX8/ECL84	2.90	6HQ5	4.50
1A3	6.65	3Q5GT	5.85	5Y3GT	2.25	6BN6	3.70	6DZ4	4.10	6HR5	2.55
1A5GT	4.00	3S4	3.40	5Y4GA	2.45	6BN8	3.70	6E5	5.65	6HR6	3.70
1AD2	3.10	3V4	3.40	5Y4GT	3.40	6BN11	4.50	6EA5 use 6CY5		6HS5	7.75
1AY2	2.60	4AU6	3.40	5Z3	4.45	6BQ5/EL84	3.25	6EA7	5.20	6HS6	3.70
1B3GT use		4AV6	2.95	5Z4 use		6BQ6GTB/6CU6	4.45	6EA8	3.55	6HS8	4.30
1G3GT/1B3GT		4BC8	4.00	5Y3GT		6BQ7A	4.15	6EB8	5.05	6HZ6	3.00
1BC2	3.25	4BL8/XCF80	2.40	6A7	8.00	6BR8A	4.30	6EH4A	8.20	6J5	4.10
1BH2	3.05	4BN6	4.05	6A8	7.10	6BS3A	3.70	6EH5	3.55	6J5GT	4.10
1G3GT/1B3GT	3.40	4BQ7A	4.90	6BA4	3.25	6BS8	4.45	6EH7/EF183	3.85	6J6A	3.25
1K3/1J3	3.40	4BS8	4.25	6AC7	5.75	6BU8	4.15	6EH8	3.50	6J7	5.20
1L6	12.55	4BU8/4GS8	4.45	6AC10	4.10	6BV8	3.00	6EJ4A	8.50	6J10 use	
1N5GT	4.90	4BZ6	2.95	6AD10	6.90	6BV11	4.80	6EJ7/EF184	3.55	6Z10/6J10	
1R5	4.00	4BZ7	4.90	6AF3	3.10	6BW4	2.75	6EM5	3.70	6J11	4.80
1S2A/DY87	2.55	4CB6	2.85	6AF4	4.10	6BW8	3.35	6EM7	5.20	6J18A	5.85
1S4	4.10	4CS6	3.40	6AF4A	4.10	6BW11	4.40	6EQ7	2.95	6J18	3.95
1S5	3.40	4DE6	2.95	6AF6G	6.30	6BX7GT	5.90	6ER5	3.80	6J28	3.05
1T4	3.85	4DK6	3.40	6AF9	3.55	6BY5GA	4.80	6ES5	2.85	6J28	3.55
1U4	3.85	4DT6A	2.95	6AF11	5.20	6BY6	3.40	6ES8/ECC189	5.45	6J28	8.50
1U5	3.40	4EH7/LF183	3.55	6AG5	3.40	6BY8	2.70	6ET7	4.00	6J28	3.70
1V2	2.55	4EJ7/LF184	3.55	6AG7	6.50	6BZ6	2.70	6EU7	3.25	6J28	6.20
1X2A use		4ES8/XCC189	5.50	6AG9	5.65	6BZ7	4.15	6EU8	3.70	6J28	6.50
1X2B/1X2A		4EW6	2.90	6AG11	4.15	6BZ8	4.20	6EV5	3.10	6J28	2.95
2A3	9.90	4GK5	3.90	6AH4GT	3.25	6C4	2.25	6EV7	3.25	6J28	4.75
2AF4B/2DZ4	4.10	4GM6	2.20	6AH6	5.20	6C5	5.35	6EW6	2.70	6J28	3.85
2AH2	3.40	4GS8 use		6AH9	4.75	6C6	7.85	6EW7	6.00	6J28	4.05
2AS2	3.00	4BU8/4GS8		6AK5/EF95	4.75	6C9	5.50	6EZ5	4.45	6J28	4.15
2AV2	2.85	4CX7	3.60	6AL3/EY88	2.60	6C10	3.70	6EZ8	3.55	6J28	3.85
2BJ2	4.20	4HA5/PC900	2.35	6AL5	2.25	6CA4	2.95	6F5	5.50	6J28	3.65
2BN4A	3.55	4HA7	3.05	6AL7GT	6.95	6CA5	3.00	6F6	5.80	6J28	3.15
2CN3A	3.25	4HC7	3.05	6AL11	4.60	6CA7/EL34	5.35	6F6GT	5.80	6J28	6.00
2CW4	4.90	4HM6	3.10	6AM4	5.55	6CB5A	9.35	6F8G	8.45	6J28	7.30
2CY5	4.00	4HQ5	4.60	6AM8A	3.70	6CB6A/6CF6	2.85	6FA7	2.95	6J28	4.95
2DS4	4.90	4HS8	3.35	6AN4	6.15	6CD6GA	5.80	6FD7	5.30	6J28	4.00
2DV4	6.45	4HT6	2.55	6AN8A	4.30	6CE5 use		6FE5	3.40	6J28	6.35
2DZ4 use		4JC6A	4.30	6AQ5A	2.95	6BC5/6CE5		6FG6 use		6J28	3.85
2FA4B/2DZ4		4JD6	4.30	6AQ6	3.25	6CF6 use		EM84/6FG6		6J28	4.40
2EG4	4.90	4JH6	3.40	6AQ7GT	4.30	6CB6A/6CF6		6FG7	4.15	6J28	3.10
2EN5	3.20	4KE8	6.05	6AQ8/ECC85	3.00	6CG3/6CD3	3.40	6FH5	3.85	6J28	4.65
2ER5	3.70	4LJ8	4.10	6AR5	2.45	6CG7 use		6FH8	4.05	6J28	3.55
2FH5	3.70	5AM8	4.90	6AR8	4.85	6FQ7/6CG7		6FJ7	3.75	6J28	2.95
2FQ5A use 2GK5		5AN8	5.20	6AR11	4.50	6CG8A	3.55	6FM7	3.25	6J28	5.90
2FS5	4.85	5AQ5	2.95	6AS5	3.25	6CH8	5.60	6FM8	2.85	6J28	7.70
2GK5	4.20	5AR4/GZ34	4.25	6AS8	4.45	6CJ3	3.60	6FQ5A	3.85	6J28	3.65
2GU5	4.50	5AS4A	3.45	6AS11	5.10	6CK3	3.40	6FQ7/6CG7	2.35	6J28	4.50
2HA5	3.85	5AS8	4.40	6AT6	2.40	6CK4	3.55	6FS5	4.10	6J28	4.50
2HQ5	3.85	5AT8	4.45	6AT8A	5.20	6CL3	3.50	6FV6	4.45	6J28	7.70
3A2	5.50	5AU4 use		6AU4GTA	4.00	6CL6	4.15	6FV8A	4.30	6J28	6.35
3A3A/3B2	3.20	5V3A/5AU4		6AU5GT	5.20	6CL8A	4.15	6FW5	3.85	6J28	4.40
3AF4A/3DZ4	4.10	5AV8	4.05	6AU6A	2.40	6CM3	4.90	6FY5/EC97	2.75	6J28	8.80
3AL5	2.70	5AZ4	5.30	6AU8A	4.90	6CM6	3.85	6FY7	3.20	6J28	4.75
3AT2	3.05	5B8	5.50	6AV5GA	5.20	6CM7	3.25	6G11	4.40	6J28	6.95
3AU6	2.95	5BC3A	3.40	6AV6	1.95	6CM8	4.05	6GB5/EL500	3.80	6J28	8.15
3AV6	2.95	5BE8	3.10	6AV11	4.40	6CN7	4.45	6GC5	4.45	6J28	4.25
3AW2	3.20	5BK7A	4.15	6AW8A	3.85	6CQ4	3.55	6GE5	3.85	6J28	7.20
3AW3 use		5BQ7A	4.30	6AX3	2.60	6CQ8	3.70	6GF5	3.50	6J28	4.90
3A3A/3B2		5BR8	4.90	6AX4GTB	2.95	6CR6	2.95	6GF7A	4.85	6J28	4.80
3B2 use		5BT8	3.10	6AX5GT	3.85	6CS6	2.95	6GH8A	3.20	6J28	5.85
3A3A/3B2		5BW8	3.20	6AX8	3.50	6CS7	3.40	6GJ5A	5.60	6J28	4.80
3BA6	2.35	5CG8	3.70	6AY3B	3.40	6CU5	3.55	6GJ7/ECF801	3.10	6J28	7.25
3BC5/3CES	2.95	5CL8A	4.45	6AY11	4.50	6CU6 use		6GK5	4.15	6J28	8.80
3BN4A	3.40	5CQ8	4.10	6AZ8	5.50	6BQ6GTB/6CU6		6GK6	3.40	6J28	4.75
3BN6	4.30	5CZ5	4.45	6B8	6.85	6C8	4.60	6GL7	5.80	6J28	6.95
3BU8/3GS8	4.45	5DJ4	3.55	6B10	3.65	6CW4	4.90	6GM5	3.05	6J28	8.15
3BY6	3.00	5EA8	4.60	6BA3	3.05	6CWS/EL86	2.75	6GM6	3.25	6J28	4.70
3BZ6	2.95	5ES8/YCC189	5.50	6BA6/EF93	2.40	6CX8	4.75	6GN8	4.60	6J28	4.20
3CA3	3.20	5EU8	4.00	6BA7	5.85	6CY5	4.00	6GQ7	3.75	6J28	6.20
3CB6/3CF6	2.95	5EW6	3.40	6BA8A	4.65	6CY7	3.05	6GT5A	5.40	6J28	4.15
3CE5 use		5FG7	3.55	6BA11	4.30	6CZ5	4.75	6GU5	4.10	6J28	7.70
3BC5/3CE5		5FV8	3.25	6BC4	5.50	6D10	4.25	6GU7	3.70	6J28	7.55
3CF6 use		5GH8A	4.60	6BC5/6CE5	3.25	6DA4	3.70	6GV5	4.15	6J28	4.45
3CB6/3CF6		5GJ7	2.95	6BC7	3.60	6DB5	5.00	6GV8/ECL85	4.60	6J28	4.10
3CN3A	3.20	5GM6	3.25	6BC8	4.15	6DC6	3.85	6GW6/6DQ6B	4.20	6J28	8.50
3CS6	3.70	5GX6	2.45	6BD6	2.35	6DC8/EBF89	3.05	6GW8/ECL86	3.05	6J28	5.05
3CU3	3.75	5GX7	3.60	6BD11	5.55	6DE4	3.55	6GX6	2.90	6J28	2.70
3CY5	3.90	5HA7	3.05	6BE3/6BZ3	3.40	6DE6	2.95	6GX7	3.60	6J28	4.75
3DG4	4.75	5HB7	3.40	6BE6	2.85	6DE7	4.15	6GY5	4.60	6J28	2.60
3DK6	2.95	5HG8/LCF86	3.70	6BF5	3.35	6DG6GT	3.85	6GY6	2.90	6J28	3.90
3DT6A	2.95	5HZ6	3.25	6BF6	2.85	6DK6	2.95	6GY8	3.90	6J28	5.00
3DZ4 use		5J6	3.70	6BF11	4.90	6DL5/EL95	2.95	6H6	4.90	6J28	4.85
3FA4B/3DZ4		5JK6	3.85	6BC6G	6.10	6DM4A	3.35	6HA5 use		6J28	4.60
3EA5	3.55	5JL6	3.85	6BH3A	2.80	6DN6	7.00	6HM5/6HA5		6J28	4.75
3EH7/XF183	2.55	5KD8	2.50	6BH6	3.25	6DN7	4.00	6HB5	4.60	6J28	4.20
3EJ7/XF184	2.55	5KE8	5.80	6BH8	4.60	6DQ5	7.85	6HB6	4.45	6J28	4.30
3ER5	4.45	5KZ8	2.55	6BH11	4.30	6DQ6 use		6HB7	4.00	6J28	3.35
3FH5	3.25	5LJ8	4.10	6BJ3	2.80	6GW6/6DQ6B		6HE5	3.70	6J28	5.05
3FS5	4.30	5LJ8	4.45	6BJ6	3.25	6DR7	4.60	6HF5	7.30	6J28	5.20
3GK5	4.20	5T8	2.55	6BJ7	2.95	6DS4	4.90	6HF8	4.60	6J28	5.90
3GS8 use		5U4G	2.55	6BJ8	4.00	6DS5	3.65	6HG5	2.95	6J28	2.75
3BU8/3GS8		5U4GB	2.55	6BK4B	7.55	6DT5	3.55	6HG8/ECF86	3.70	6J28	4.15
3HM5/3HA5	3.85	5U8	3.85	6BK5	3.50	6DT6A	2.70	6HJ8	3.10	6J28	5.90
3HQ5	4.75	5U9/LCF201	2.95	6BK7B	4.00	6DT8	3.75	6HK5	3.90	6J28	4.40
3JC6A	4.00	5V3A	4.15	6BL7GTA	5.05	6DV4	6.45	6HL8	3.05	6J28	5.95
		5V3A/5AU4	3.80	6BL8/ECF80	2.70	6DW4B	3.50	6HM5/6HA5	3.85	6J28	4.90
		5V4GA	4.30							6J28	4.90

RCA**ELECTRON TUBES
ENTERTAINMENT RECEIVING TYPES**

*Optional List

PRICE SCHEDULE — AUGUST 1968

RCA Type	List Price*	RCA Type	List Price*	RCA Type	List Price*	RCA Type	List Price*	RCA Type	List Price*	RCA Type	List Price*
6SF5	4.45	8JV8	4.30	12AY3A	2.65	12JB6A	6.20	17CT3	2.95	25CD6GB	5.75
6SF7	6.30	8KA8	4.25	12AY7	5.20	12JN6	3.90	17CU5/17C5	2.70	25CU6 use	
6SG7	4.90	8LC8	4.25	12AZ7A	3.25	12JN8	3.70	17D4	3.70	25BQ6GTB/25CU6	
6SH7	5.35	8LT8	2.70	12B4A	3.20	12JQ6	3.70	17DE4	3.65	25DN6	5.95
6SJ7	4.15	9A8/PCF80	2.65	12BA6	2.10	12JT6A	4.95	17DM4A	3.70	25EC6	6.15
6SK7	4.45	9AU7	2.95	12BA7	5.90	12K5	3.45	17DQ6B use		25EH5	3.25
6SK7GT	5.50	9B11	4.80	12BD6	2.35	12K7GT	6.60	17GW6/17DQ6B		25F5A	3.85
6SL7GT	4.00	9BR7	3.15	12BE6	3.05	12KL8	2.45	17EWS/HCC85	2.75	25L6GT	3.70
6SN7GTB	3.10	9EA8	3.05	12BE6	2.55	12L6GT	3.55	17GE5	4.35	25WAGT	3.70
6SQ7	4.45	9GV8/XCL85	3.40	12BF6	2.35	12MD8	4.85	17G5A	5.50	25Z6GT	3.85
6SR7	4.90	9KC6	4.35	12BF11	4.35	12R5	3.35	17GT5A	4.90	27GB5/PL500	3.70
6T4	5.15	9KX6	4.35	12BH7A	3.15	12S7	5.90	17GVS	4.20	31J5A	7.30
6T8A	3.70	9KZ8	2.95	12BK5	3.75	12SC7	5.20	17GW6/17DQ6B	4.60	32ET5A	2.40
6T9	4.05	9U8A	3.10	12BL6	3.70	12SF5	3.85	17JB6A	5.50	33GT7	6.95
6T10	4.25	10AL11	4.55	12BN6	3.65	12SF7	6.20	17JG6A	6.30	33GY7A	6.05
6U5	7.40	10BQ5	2.55	12BQ6GTB/12CU6	4.45	12SG7	5.40	17JM6A	4.20	33JV6	4.65
6U8A/6KD8	3.10	10C8	5.15	12BR7	3.05	12SH7	4.70	17JN6	3.90	34GD5A	2.95
6U9/ECF201	2.90	10CW5/LL86	2.55	12BS3A	3.70	12SJT	4.30	17JT6A	4.95	35B5	3.20
6U10	3.65	10DE7	4.45	12BT3	2.85	12SK7	4.45	17JZ8	3.55	35C5	2.70
6V3A	4.55	10DR7	4.45	12B7	3.30	12SK7GT	4.45	17KV6	7.30	35EH5	3.40
6V6	6.35	10DX8/LCL84	2.75	12BV11	4.80	12SL7GT	4.15	17LD8 use		35GL6	2.90
6V6GTA	3.25	10EG7	4.35	12BW4	3.35	12SN7GTA	3.40	15KY8A		35L6GT	3.85
6W4GT	2.95	10EM7	4.90	12BY7A	3.20	12SQ7	4.45	17X10	4.50	35W4	1.65
6W6GT	3.70	10EW7	4.90	12BZ6	2.40	12T10	4.25	18FW6A	2.45	35Y4	4.50
6X4	2.10	10GF7A	4.75	12BZ7	4.15	12V6GT	4.45	18FX6A	2.95	35Z4GT	2.55
6X5GT	2.95	10GK6	3.05	12C5 use		12W6GT	4.45	18FY6A	2.95	35Z6GT	2.70
6X8A	3.40	10GN8	4.45	12CA5	3.40	12X4	2.25	18GD6A	2.95	36AM3B	2.55
6X9/ECF200	2.90	10HF8	4.90	12CL3	3.50	13CW4	5.05	19AU4GTA	4.00	38E7	6.65
6Y6GA/6Y6G	4.45	10JA8	4.15	12CN5	3.25	13DE7	4.00	19BG6GA	6.65	38HK7	6.55
6Y9	2.95	10JT8	4.05	12CR6	2.95	13DR7	4.75	19CL8A	3.70	40KD6	8.10
6Z4 use 84/6Z4		10Y8	3.65	12CU5/12C5	3.40	13EM7/15EA7	5.35	19EA8	4.45	42	4.85
6Z10/6J10	5.00	10KR8	4.25	12CU6 use		13FD7	5.05	19EZ8	4.50	42KN6	7.20
7A7	7.15	10KU8	4.85	12C6GTB/12CU6	2.75	13FM7	3.00	19GQ7	3.80	43	7.20
7AU7	2.70	10LB8	4.70	12CX6	2.75	13GB5/XL500	3.70	19HR6	2.45	50A5	5.85
7C5	3.35	10LE8	5.90	12D4	3.05	13GF7A	4.70	19HS6	2.40	50B5	2.95
7C7	3.40	10LW8	4.25	12DB5	2.60	13J10 use		19HV8	3.75	50C5	2.55
7EY6	3.35	10LZ8	2.95	12DK6	2.30	13Z10/13J10	4.10	19I6	3.70	50DC4	2.40
7F7	7.50	11AR11	4.10	12DQ6B use		13V10	5.05	19JN8	3.20	50EH5	2.70
7F8	8.25	11BQ11	4.10	12DG6	3.25	13Z10/13J10	5.60	19K8	3.10	50FE5	4.45
7HG8/PCF86	2.75	11BT11	5.90	12DQ6B use		14B11	5.60	19T8	4.90	50FK5	2.20
7N7	7.10	11CY7	3.60	12DQ7	3.25	14BR11	5.30	19X8	4.10	50HC6	2.40
7V7	4.65	11FY7	3.40	12D57	5.40	14GT8	3.45	20AQ3/LY88	3.25	50HK6	2.15
8AR11	4.35	11HM7	4.75	12DT5	3.10	14JG8	3.10	20EZ7	3.40	50L6GT	3.55
8AU8	3.85	11JE8	3.85	12DT8	4.00	15AF11	4.75	21G55	4.65	50X6	5.85
8AW8A	4.30	11KV8	5.90	12DW7	3.05	15BD11	5.30	21HB5A	4.75	50Y6GT	4.35
8B10	3.35	11LQ8	5.90	12DY8	7.95	15CW5/PL84	2.45	21JV6	4.65	50Y7GT	4.25
8BA8A	3.45	11Y9/LFL200	3.70	12DZ6	3.60	15DQ8	3.40	21JZ6	4.85	53HK7	8.35
8BA11	4.00	12AB5	3.85	12ED5	2.70	15FM7	3.40	21KA6	4.45	60FX5	2.95
8BH8	3.35	12AC6	2.10	12EK6	3.55	15FY7	3.90	21LR8	4.75	80	4.80
8BM11	4.25	12AD6	3.10	12EQ7	2.75	15KY8A	5.80	21L8	4.75	84/6Z4	5.20
8BN8	3.70	12AE6A	3.10	12F8	3.25	15LE8	7.65	22BH3A	3.10	117L7/M7GT	9.55
8BQ5	3.25	12AE10	4.65	12FK6	2.55	16A8	3.40	22BW3	3.05	117N7GT	12.85
8BQ11	4.30	12AF3	3.85	12FM6	2.60	16AQ3/XY88	2.70	22DE4	3.70	117Z3	4.50
8BU11	4.55	12AF6	3.15	12FQ8	5.20	16GK6	3.05	22JF6	6.85	5879	4.75
8CG7 use		12AL5	2.30	12FV7	3.40	16GY5	4.85	22JG6A	6.20	6973	4.60
8FQ7/8CG7		12AL8	6.15	12FX5	3.25	17AX3	2.60	22JR6	6.20	7025	3.10
8CM7	2.70	12AL11	4.20	12FX8A	3.85	17AX4GTA	3.70	22JU6	6.25	7027A	6.75
8CN7	3.05	12AQ5	3.10	12GC6	3.95	17AY3A	3.25	22KM6	8.20	7189	3.40
8CS7	3.55	12AT6	2.40	12GE5	4.10	17BE3/17BZ3	2.90	23Z9	4.70	7199	4.90
8CW5/XL86	2.55	12AT7/ECC81	2.85	12GJ5A	4.90	17BF11	4.55	22BF11	5.20	7247	3.20
8CX8	4.40	12AU6	2.55	12GN7A	4.45	17BH3	2.85	24J6A	8.50	7355	3.65
8EB8	4.10	12AU7A/ECC82	2.55	12GT5	5.35	17BQ6GTB	5.20	24J28	4.50	7408	3.35
8EM5	3.70	12AV5GA	5.05	12GW6/12DQ6B	4.25	17BS3A	3.35	24LQ6/24J6C	8.50	7543	3.25
8ET7	4.15	12AV6	1.95	12H6	4.45	17BZ3 use		25AV5GA	5.65	7581A	4.55
8FQ7/8CG7	2.35	12AV7	3.60	12HE7	6.80	17BE3/17BZ3		25AX4GT	3.05	7591A	2.80
8GJ7/PCF801	2.90	12AW6	3.55	12HG7	4.45	17C5 use		25BK5	3.40	7695	4.40
8GN8	4.15	12AX3	3.00	12HL7	4.45	17CU5/17C5		25BQ6GTB/25CU6	4.40	7868	4.75
8GU7	3.20	12AX4GTB	2.70	12J5GT	4.80	17C9	7.15	25C5	2.95	8417	5.65
8JU8A	3.35	12AX7A/ECC83	2.70	12J8	4.35	17CK3	2.95	25CA5	3.60	EM84/6FG6	3.35

INDUSTRIAL TUBES FOR DEALER SERVICE

0A2	\$1.85	6AS7G	6.95	930	6.20	5726/6AL5W	2.20	6336A	26.70	6939	15.95
0A2WA	4.05	6DJ8/ECC88	2.65	991	1.45	5749/6BA6W	3.10	6350	2.60	6977	3.50
0A3	2.20	6J4	5.65	1612	8.10	5750	4.85	6360A	6.30	7054	2.20
0A3A	2.20	6X4W	2.25	1614	6.95	5751	3.60	6386	10.85	7056	1.30
0A4G	2.65	12A6	4.75	1619	8.75	5763	3.45	6417	4.70	7057	2.75
0B2	1.95	12AT7WA	3.55	1620	10.60	5783	5.90	6550	6.45	7058	1.80
0B2WA	2.85	12AT7WB	3.55	1625	6.80	5814A	3.30	6550V1		7059	2.10
0C3	2.10	12SW7	2.10	1629	2.90	5823	2.45	(Matched Pair)	14.80	7061	1.85
0C3A	2.10	12SX7GT	3.55	1635	5.90	5824	4.20	6660/6BA6	1.45	7167	2.00
0D3	2.05	12SY7	3.75	2050	3.35	5881	4.35	6661/6BH6	1.90	7258	2.60
0D3A	2.05	83	2.65	2050A	2.85	5915	2.30	6662/6BJ6	1.85	7308	6.00
1L4	3.10	807	4.45	2076/5R4GYB	2.95	5963	1.95	6663/6AL5	1.30	7360	5.30
1P40	5.90	811A	9.10	5581	6.20	5964	2.20	6664/6AB4	1.60	7551	4.75
2D21	1.85	812A	8.45	5642	4.95	5965	2.70	6669/6AQ5A	1.50	7558	4.90
2E24	8.20	816	4.80	5651A	2.50	6005	4.55	6676/6CB6A	1.50	7717/6CY5	1.95
2E26	4.65	866A	4.40	5654	3.40	6080	7.50	6677/6CL6	2.60	7724/14GT8	2.10
2X2A	4.95	868	8.00	5654/6AK5W	3.40	6136	3.80	6678/6U8A	2.30	7898	1.90
3A5	2.85	884	3.20	5670	3.45	6146A	5.05	6679/12AT7	2.10	7905	5.40
3AQP1	40.20	918	8.00	5672	3.20	6146B/8298A	6.05	6680/12AU7A	1.75	8077/7054	2.10
5CP1A	43.40	920	12.35	5686	4.75	6159B	5.90	6681/12AX7A	1.80	8156	5.45
5R4GYB	2.85	922	4.40	5687	4.80	6197	3.25	6883	5.00	9001	7.55
5UP1	29.45	925	6.40	5725	4.45	6201	3.55	6883B/8032A/8552	6.20	9002	5.80
6AK6	2.90	927	7.55	5725/6AS6W	4.45	6202	3.80	6922/E88CC	6.85	9003	7.55
6AS6	4.85	929	4.30								



ELECTRON TUBES FOR INDUSTRY AND COMMUNICATIONS

RESALE PRICE SCHEDULE • SEPTEMBER 2, 1968

POWER/MICROWAVE/PHOTOSENSITIVE/CAMERA/DISPLAY/INDUSTRIAL RECEIVING

RCA Type	Dist. Resale Price Optional	RCA Type	Dist. Resale Price Optional	RCA Type	Dist. Resale Price Optional	RCA Type	Dist. Resale Price Optional
RCA POWER TUBES				TETRODES			
RCA VACUUM POWER TUBES FOR CW APPLICATIONS				(Mercury-Vapor Types)—			
2C39A	\$20.75	8171/4CX10000D	\$575.00	For Control Service			
2C39A/V1	20.75	8226	80.05	3D22A	\$37.00	920	\$10.55
2C39WA	20.75	8239/3X3000F1	215.00	105	59.00	921	5.15
2C40	30.80	8281/4CX15000A	695.00	632B	33.00	923	5.00
2C43	26.95	8437	2,890.00	672A	39.85	927	6.45
2E24	7.00	8438/4-400A	48.00	5560	33.00	930	5.30
2E26	3.95	8462	45.50	RCA MICROWAVE TUBES			
2K26	68.00	8501	1,150.00	RCA MAGNETRONS			
4-125A/4D21	36.00	8596	105.00	For Pulsed-Oscillator Service			
4-250A/5D22	46.50	RCA VACUUM POWER TUBES FOR RF-PULSE APPLICATIONS				SINGLE AND TWIN-UNIT TYPES — Vacuum Tubes	
4E27A/5-125B	45.00	2041	P	6521	725.00	1P39	3.45
4X500A	128.50	2054	P	6521/R	725.00	1P42	16.20
9C25	2,195.00	4612	P	8684	2,335.00	917	9.55
807	3.80	4616	P	RCA KLYSTRONS			
810	28.00	4621	125.00	2K26			
811A	7.75	5946	145.00	8568	P	919	10.15
812A	7.20	6949	P	2K26	68.00	922	3.75
813	23.75	6950	P	RCA TRAVELING-WAVE TUBES			
827R	615.00	6952	P	4012	P	934	5.65
828	33.80	7651	260.00	4013	P	935	15.35
829B	19.40	7835	P	4015	P	2022	5.50
832A	16.30	8184	2,335.00	4017	P	5652	8.60
833A	67.90	8587	P	4019	P	5653	5.35
837	14.70	RCA HARD-TUBE MODULATORS				6570	10.55
845	32.20	3E29	21.10	4020	P	7043	6.60
891R	430.00	6293	4.90	4021	P	RCA MULTIPLIER PHOTOTUBES	
892	325.00	RCA VACUUM POWER TUBES FOR SPECIAL APPLICATIONS				1P21	55.30
892R	425.00	4600A	345.00	4041	P	1P22	17.25
1624	10.25	4614	325.00	4053	P	1P28	21.80
1625	5.80	RCA RECTIFIERS VACUUM TYPES — Half-Wave Types				1P28A	27.30
4604	9.00	2X2A	4.20	4054	P	931A	12.10
4624	295.00	3B28 (Gas Type)	8.10	6861	995.00	931VA	12.75
4626	605.00	579B	20.50	7642	1,265.00	2020	85.00
4628	1,225.00	836	14.75	8379	1,525.00	2031	16.90
4629	380.00	1616	16.25	RCA PENCIL TUBES			
4630	2,670.00	5825	28.50	4028A	32.35	2055	15.90
4631	95.00	8013A	19.55	4037A	27.55	2060	50.40
4632	1,090.00	8020	23.50	4055	32.90	2061	60.90
4634	460.00	MERCURY-VAPOR TYPES — Half-Wave Types (except as noted)				2062	53.20
4635	2,500.00	575A	20.60	4058	17.60	2063	105.00
4636	525.00	604/7014 (Full-Wave)	11.80	4062A	32.90	2064B	120.00
4637	105.00	615/7018	10.05	4065	31.50	2065	165.00
4638	700.00	673	20.60	5675	6.90	2067	170.00
4640	3,165.00	816	4.10	5876A	6.90	2068	115.00
5556	54.25	857B	225.00	5893	18.45	4438	115.00
5671	2,110.00	866A	3.75	6173	15.20	4439	115.00
5713	700.00	869B	123.50	6263A	13.55	4440	115.00
5762	230.00	872A	10.70	6264A	14.35	4441	170.00
5770	1,780.00	5558	17.50	6562/5794A	P	4441	170.00
5771	700.00	5561	59.00	7533	7.75	4441A	350.00
5786	310.00	6894	25.90	7552	46.45	4459	495.00
6076	305.00	6895	25.90	7553	55.80	4460	235.00
6146A	4.30	8008	11.50	7554	39.20	4461	280.00
6146B/8298A	5.15	RCA IGNITRONS				4463	235.00
6146W	6.60	5550	49.00	4464	250.00	4465	290.00
6155	36.00	5551A	65.00	4471	17.95	4472	24.60
6159B	5.05	5552A	99.00	4472	24.60	4473	93.85
6159W	9.00	RCA THYRATRONS TRIODES (Mercury-Vapor Types)— For Control Service				4516	185.00
6161	135.00	3C23	11.98	4517	85.60	4518	105.00
6166	825.00	627	27.50	4521	675.00	4522	1,025.00
6166A/7007	975.00	676	63.80	4522	125.00	4523	135.00
6181	1,280.00	677	63.80	4523	205.00	4524	135.00
6448	5,675.00	710/6011	12.00	4525	205.00	4526	750.00
6524	23.95	714/7021	10.00	4526	750.00	4527	125.00
6806	6,975.00	760/6858	28.10	4527	125.00	4528	135.00
6816	51.80	5557	9.50	4528	205.00	4529	135.00
6850	22.40	5559	23.00	4529	205.00	4530	135.00
6883	4.25	5563A	53.90	4530	205.00	4531	135.00
6883B/8032A/8552	5.30	TRIODES (Gas Types)— For Control Service				4532	135.00
6884	39.20	6130/3C45	25.75	4533	135.00	4534	135.00
6897	33.60	C1K/6014	11.80	4534	135.00	4535	135.00
7034/4X150A	23.15	C3J/5632	12.70	4535	135.00	4536	135.00
7094	38.15	C3JA/5684	13.10	4536	135.00	4537	135.00
7203/4CX250B	35.60	C3J/L	14.20	4537	135.00	4538	135.00
7213	415.00	C6J/5C21	28.10	4538	135.00	4539	135.00
7214	440.00	C6JA/5685	29.00	4539	135.00	4540	135.00
7271	35.00	C16J/5665	52.50	4540	135.00	4541	135.00
7457	63.90	RCA PHOTOSENSITIVE TUBES & DEVICES				4541	135.00
7650	240.00	PHOTOCONDUCTIVE CELLS				4542	135.00
7842	63.90	SQ2502	1.90	4543	135.00	4544	135.00
7843	33.60	SQ2503	1.32	4544	135.00	4545	135.00
8000	26.25	SQ2508	1.90	4545	135.00	4546	135.00
8005	19.10	SQ2519	1.90	4546	135.00	4547	135.00
8032	4.90	SQ2520	1.08	4547	135.00	4548	135.00
8072	19.70	SQ2521	1.49	4548	135.00	4549	135.00
8121	30.10	SQ2522	1.54	4549	135.00	4550	135.00
8122	35.00	SQ2526	1.54	4550	135.00	4551	135.00
8165/4-65A	27.00	SQ2527	1.54	4551	135.00	4552	135.00
8166/4-1000A	132.00	SQ2529	1.65	4552	135.00	4553	135.00
8167/4CX-300A	54.00	SQ2530	1.32	4553	135.00	4554	135.00
8168/4CX-1000A	200.00	SQ2534	1.65	4554	135.00	4555	135.00
8170/4CX5000A	495.00	SQ2535	1.13	4555	135.00	4556	135.00
		SQ2536	1.13	4556	135.00	4557	135.00
		SQ2543	2.06	4557	135.00	4558	135.00
		SQ2544	1.90	4558	135.00	4559	135.00
		SQ2544V1	1.90	4559	135.00	4560	135.00
		SQ2545	1.90	4560	135.00	4561	135.00
		SQ2545V1	1.90	4561	135.00	4562	135.00
		SQ2546	1.90	4562	135.00	4563	135.00
		SQ2554	1.13	4563	135.00	4564	135.00
		SQ2555	1.17	4564	135.00	4565	135.00
		SQ2556	1.44	4565	135.00	4566	135.00
		SQ2557	1.40	4566	135.00	4567	135.00
		SQ2558	1.57	4567	135.00	4568	135.00
		4403	1.21	4568	135.00	4569	135.00
		4404	1.32	4569	135.00	4570	135.00
		4448	1.32	4570	135.00	4571	135.00
		4453	1.28	4571	135.00	4572	135.00
		7163	1.21	4572	135.00	4573	135.00
		RCA PHOTOTUBES SINGLE AND TWIN-UNIT TYPES — Gas Types				4574	135.00
		1P29	8.45	4575	135.00	4576	135.00
		1P37	6.85	4576	135.00	4577	135.00
		1P40	5.05	4577	135.00	4578	135.00
		868	6.15	4578	135.00	4579	135.00
		918	6.85	4579	135.00	4580	135.00
			6.85	4580	135.00	4581	135.00

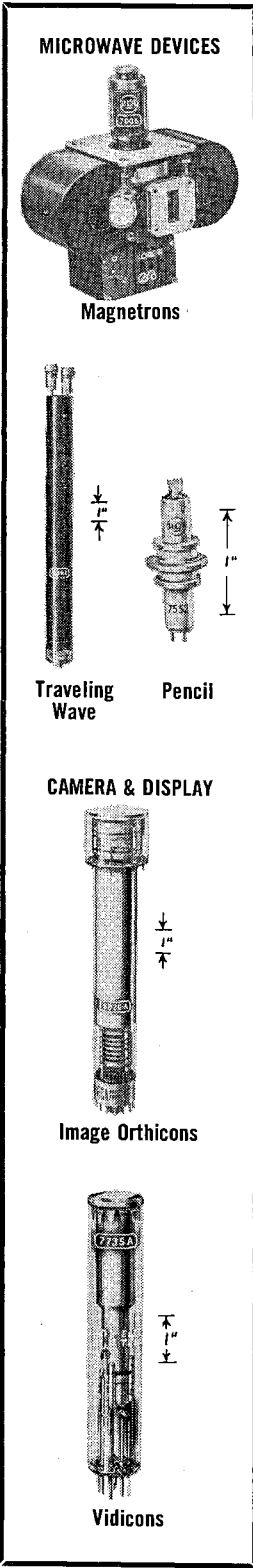



ELECTRON TUBES FOR INDUSTRY AND COMMUNICATIONS

RESALE PRICE SCHEDULE • SEPTEMBER 2, 1968

POWER/MICROWAVE/PHOTOSENSITIVE/CAMERA/DISPLAY/INDUSTRIAL RECEIVING

RCA Type	Dist. Resale Price Optional	RCA Type	Dist. Resale Price Optional	RCA Type	Dist. Resale Price Optional	RCA Type	Dist. Resale Price Optional
RCA CAMERA & DISPLAY TUBES		MONITOR KINESCOPIES		OC3A		Triodes	
RCA IMAGE ORTHICONS		7CP4	\$71.75	0D3	\$1.50	Subminiature:	
4470	\$8,775.00	7TP4	73.15	0D3A	1.44	5718	\$3.65
4492	1,650.00	8HP4	52.50	6AS7G	4.93	5719	3.15
4536	2,165.00	8NP4	36.95	991	1.01	Miniature:	
5-20A	995.00	8QP4	50.65	5651A	1.78	6D4	2.70
5820A/L	1,800.00	10SP4	99.35	5651WA	6.60	6J4	4.02
7198A	1,335.00	17DWP4	25.65	5783	4.19	407A	5.90
7295B	1,440.00	21EYP4	31.85	6073	3.00	5842/417A	7.35
7295C	1,975.00	PROJECTION KINESCOPIES		6073/0A2	3.35	6664/6AB4	1.12
7389B	1,440.00	5AZP4	135.00	6074	3.45	9002	4.14
7389C	1,975.00	7NP4	1,085.00	6074/0B2	3.70	Nuvistor:	
7629A	1,700.00	7WP4	1,110.00	6080	5.33	7586	3.35
7967	3,500.00	4486	1,095.00	6080WA	10.80	7587	5.20
8673	1,800.00	FLYING-SPOT CATHODE-RAY TUBES		6082	5.60	7895	3.35
8673/S	1,800.00	5AUP24	150.00	6336A	19.04	8056	5.00
8674	1,800.00	5WP15	95.90	6626/0A2WA	3.35	8058	14.95
8674/S	1,800.00	5ZP16	89.00	Pentodes		8203	3.80
8685	1,440.00	DISPLAY STORAGE TUBES		6AH6WA	7.60	8393	3.45
8748	1,975.00	Direct-View Types		7258	1.82	8627	14.15
8749	1,975.00	4412	3,415.00	8156	3.89	8628	5.00
8775	1,800.00	4454	1,030.00	Subminiature:		Acorn:	
RCA MONOSCOPIES		6866	1,280.00	5636	6.10	6F4	14.40
2F21	300.00	7183A	1,025.00	5639	5.25	955	7.05
1699	P	7268B	P	5672	2.27	Twin Diodes	
RCA VIDICONS		7315	925.00	5678	2.30	5726	1.55
2048	720.00	7539	1,635.00	5840	5.35	5896	3.80
4427	585.00	RADECHON		5899	5.55	6663/6AL5	.92
4478	64.40	Single Beam, Barrier-Grid Type		Miniature:		6887	1.40
4482	705.00	1858	430.00	1L4	1.50	7055	1.00
4493	1,055.00	6499	360.00	3A4	1.25	TWIN TRIODES	
4494	1,055.00	RCA IMAGE-CONVERTER TUBES		6AK6	1.40	3A5	2.03
4495	1,055.00	4449A	1,750.00	6AN5	4.20	6DJ8/ECC88	1.89
4500	430.00	6381	P	6AS6	3.43	6J6WA	5.35
4503	470.00	6914	P	6AU6WB	2.70	12AT7WA	2.53
4542	375.00	6914A	P	26A6	3.70	12AT7WB	2.53
7038	175.00	6929	P	408A	4.95	1635	4.20
7262A	215.00	RECEIVING TYPE TUBES FOR INDUSTRY AND COMMUNICATIONS		5654	2.41	5670	2.45
7263A	370.00	Beam Deflection		5725	3.15	5687	4.05
7735	120.00	7360	3.77	5725/6AS6W	3.12	5691	8.75
7735A	150.00	Beam Power		5749	2.20	5692	8.25
7735B	175.00	3B4WA	5.85	5847/404A	9.55	5751	2.55
8051	605.00	Subminiature:		6136	2.70	5814A	2.35
8134	275.00	5902	4.80	6186	3.85	5844	2.40
8134/V	370.00	5902	4.80	6186/6AG5WA	3.85	5963	1.36
8480	760.00	Miniature:		6197	2.30	5964	1.55
8480/V1	1,140.00	5686	3.37	6660/6BA6	1.01	5965	1.92
8507A	215.00	5763	2.45	6661/6BH6	1.34	6021	3.50
8521	605.00	6005	3.23	6662/6BJ6	1.29	6072	5.35
8567	910.00	6417	3.33	6676/6CB6A	1.06	6101	3.90
8572	215.00	6669/6AQ5A	1.06	6677/6CL6	1.85	6111	3.70
8573	275.00	7061	1.29	6688A	6.80	6112	4.15
RCA CATHODE-RAY TUBES OSCILLOGRAPH TYPES		7061	1.29	6939	11.37	6189	3.70
1EP1	26.25	7905	3.85	7054	1.54	6201	2.95
1EP11	27.45	Other Air-Cooled Types:		7056	.92	6211	2.15
2AP1A	18.55	12A6	3.36	8077/7054	1.50	6350	1.85
2BP1	19.70	26A7GT	7.70	9001	5.38	6386	7.75
3AP1A	26.60	1614	4.93	9003	5.38	6679/12AT7	1.50
3AQP1	34.35	1619	6.23	Acorn:		6680/12AU7A	1.22
3BP1A	33.90	1622	5.35	959	13.85	6681/12AX7A	1.26
3JP1	32.65	5824	3.60	Other Air-Cooled Types:		6922/E88CC	4.87
3JP7	27.65	5881	3.10	6AC7W	5.45	7044	2.70
3KP1	28.60	5881	3.10	6AG7Y	2.80	7057	1.95
3RP1	18.30	6550V1 (Match Pair)	9.25	6SJ7Y	2.15	7058	1.26
3RP1A	27.00	Diodes		1613	3.30	7308	5.20
3RP7A	31.60	9005	8.05	1620	7.55	7898	1.34
3WP1	35.90	9006	2.70	1621	3.85	TWIN DIODE TRIODES AND TRIODE PENTODES	
3WP11	37.80	Glow-Discharge		5693	6.60	12SW7	1.49
5ABP1	47.60	0A4G	1.86	Power Rectifiers		26C6	3.05
5ABP31	47.60	1C21	4.15	5R4GYB	2.03	6678/6U8A	1.62
5ADP1	47.60	5823	1.72	6X4W	1.60	7059	1.48
5ADP31	47.60	Voltage Regulators		83	1.89	7060	1.75
5BP1A	38.85	0A2	1.32	2076/5R4GYB	2.11	7724/14GT8	1.48
5CP1A	37.10	0A2WA	3.35	5642 (Pulsed)	3.53	MISCELLANEOUS TYPES	
5FP7A	39.20	0A3	1.54	6202	2.69	2K26	68.00
5UP1	21.10	0A3A	1.54	Tetradodes		12SY7	2.67
5UP7	25.70	0B2	1.37	105	59.00	26D6	3.05
5UP31	21.80	0B2WA	2.40	6360A	4.95	1612	5.77
7MP7	54.05	0C2	1.50	7167	1.41	1699	2.04
7VP1	30.80	0C3	1.50	7171/6CY5	1.39	1946	16.15
7VP31	30.80	Thyratrons		Gas:		1947	47.00
902A	21.00	0A2	1.32	2D21	1.29	1949	23.75
4489	21.00	0A2WA	3.35	884	2.28	5734	22.05
4490	36.05	0A3	1.54	2050	2.37	5750	3.45
4491	40.60	0A3A	1.54	2050A	2.03	5915	1.62
4-99	32.85	0B2	1.37	5663	2.20	6550	4.59
4510	35.70	0B2WA	2.40	5696	1.95	6977	2.48
VIEW-FINDER KINESCOPIES		0C2	1.50	5727	2.90		
5FP4A	36.05	0C3	1.50	6012	7.65		

PHOTOSENSITIVE

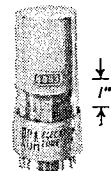

Multiplier



Phototubes



Photocells

POWER TUBES

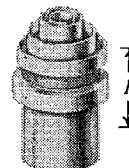

Small

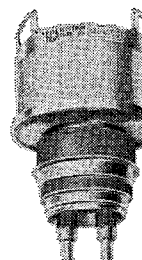

Large

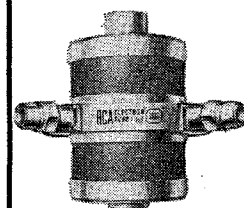

Super

P—Price and Delivery on Request

SYLVANIA INDUSTRIAL PRODUCTS

Type	Sugg. User Price	Type	Sugg. User Price	Type	Sugg. User Price	Type	Sugg. User Price	Type	Sugg. User Price
RECEIVING TUBES									
*OA2	\$ 1.32	6AN5	\$ 4.20	869B†	\$155.00	GB-5751	\$ 2.55	*6676/6CB6A	\$ 1.06
GB-OA2WA	3.35	*6AN5WA	10.80	872A	9.90	*5763	2.45	*6677/6CL6	1.85
OA3	1.54	6AS6	3.43	889RA (See		5796	17.25	*6678/6UBA	1.62
*OA4G	1.86	6AS7G	4.93	5667/889RA)		GB-5814A	2.35	*6679/12AT7	1.50
OA5	6.96	6AS7GA	4.93	921	5.20	*5823	1.72	*6680/12AU7	1.22
*OB2	1.37	*6AU6WB	2.70	922	3.80	*5840	5.35	*6681/12AX7	1.26
*OB2WA	2.40	*6BF7W	4.20	923	4.70	5845	9.95	6688	6.80
GB-OB2WA	2.40	GB-6BQ7A	2.20	927	6.00	5855	85.00	*6788	10.85
*OB3	2.35	*6C4W	1.55	929	3.45	5879	1.95	6802	11.43
*OC3	1.50	*6C4WA	3.15	930	4.95	5881	3.10	6807	32.25
*OD3	1.44	GB-6CY5	1.85	931A	12.30	5894	25.00	*6832	20.65
C1K/6014	11.80	*6D4	2.85	1000T	169.00	*5896	3.80	6879	13.37
VG1A	32.60	6DJ8	1.90	1051A	65.00	*5899	5.55	*6883A	4.30
1P39	3.15	GB-6DJ8	2.70	1052A	99.00	*5902	4.80	6897	32.15
1P40	4.80	6J4	4.02	1061	65.00	*5903	7.45	6909	11.43
2-01C	18.00	*6J4WA	5.60	R1111	12.70	*5904	7.90	6910	13.37
2C39A	20.75	GB-6J4WA	5.60	R1111M	26.00	*5905	8.40	6922	4.87
2C39B	32.15	C6J/A/5685	29.00	1218A	5.00	*5906	8.40	6939	11.37
2C39WA	29.00	*6J6WA	5.35	GB-1219/5670	3.70	*5907	8.40	*6943	11.10
2C40	29.30	*6SJ7WGT	2.70	GB-1220/5654	3.05	*5908	9.80	*6944	11.10
2C43	26.95	*6SL7WGT	3.15	1229	5.35	5916	9.80	*6945	11.10
2C51	3.65	GB-6SL7WGT	3.15	GB-1252/6U8A	2.00	*5931	6.80	*6946	10.85
2D21W	1.25	*6SN7WGT	2.35	1319	125.00	GB-5931	6.80	*6947	11.35
2D21W (See		GB-6SN7WGT	2.35	1616	15.10	*5932	11.30	*6948	11.35
5727/2D21W)		*6SN7WGTA	4.90	1624	9.45	GB-5932	6973 (Receiving		
2E24	6.45	*6V6GT	1.45	2050	2.37	*5933	12.35	Type)	X
2E26	4.00	*6X4W	1.60	2050A	2.03	GB-5933	12.35	6977	2.50
*2J42	102.00	*6X4WA	2.85	5530H	425.00	*5933WA	16.50	7025 (Receiving	
2X2A	3.95	GB-6X4WA	2.85	5531	795.00	5934	22.00	Type)	X
3-400Z (See		*6X5WGT	1.55	5541	670.00	*5963	1.34	7034/4X150A	25.00
8163/3-400Z)		GB-6X5WGT	1.55	5552A	99.00	5964	1.54	7038	175.00
3A5	2.03	*7AK7	8.15	5553B	245.00	5965	1.95	7044	2.70
3B28	7.00	GB-7AK7	8.15	5557†	9.50	5966	42.00	*7054	1.54
3C23	11.98	*7F8W	7.05	5558	17.50	*5977	6.55	*7055	1.00
3CPN10A5 (See		*12AT7WA	2.55	5559†	23.00	*5987	11.10	*7056	.92
7815/3CPN10A5)		*12AT7WB	2.55	5575/100	225.00	6005	3.23	*7057	1.95
3GX100A5 (See		12AY7	2.45	5576/200	245.00	GB-6005	3.23	*7058	1.26
7289/3CX100A5)		C16J/5665	52.50	5604	570.00	6011/710	12.00	*7059	1.48
3CX2500A3	200.00	RX21A	25.75	5606	288.00	6012	7.65	*7060	1.75
3CX2500F3	210.00	25T	28.50	5632 (See C3J/5632)		6014 (See C1K/6014)		7155	13.37
3CX3000A1	210.00	*28D7	4.95	*5636A	6.10	*6021	3.50	*7167	1.45
3CX3000F1	220.00	FG-95 (See		*5639	5.25	*6028	4.95	7199 (Receiving	
3E29	21.50	5560/FG95)		*5641	7.55	6072	3.90	Type)	X
C3J/5632	12.70	100 (See 5575/100)		5642	3.55	*6080	5.33	7203/4CX250B	35.75
C3J/A/5684	13.10	100TH	23.50	*5643	9.05	GB-6080	5.33	7204/4CX250F	39.00
4-65A (See		102A	174.00	*5644	9.90	*6080WA	10.80	*7258	2.75
8165/4-65A)		200 (See 5576/200)		*5647	8.65	GB-6101	5.35	7289/3CX100A5	30.75
4-125A	36.00	250TH	38.50	5651	1.90	*6110	8.05	7325	185.00
4-250A	46.50	304TH	75.00	5651WA	3.75	*6111	3.70	7551	3.40
4-400A (See		304TL	75.00	5654	2.45	*6112	4.10	7735A	170.00
843B/4-400A)		GB-407A	5.90	GB-5654	2.45	*6135	2.40	7738	2.80
4-1000A (See		GB-408A	4.95	5658	595.00	GB-6135	2.40	*7759	7.35
8166/4-1000A)		450TL	85.00	5665 (See C16J/5665)		GB-6136	2.70	*7760	15.25
4CX250B (See		481B	10.90	5667 (889RA)†	370.00	*6146A	4.35	*7761	7.40
7203/4CX250B)		575A†	21.00	5668	350.00	6146B/8298A	5.20	*7762	7.40
4CX250F (See		579B	20.50	5669	515.00	*6159A	4.80	7815/	
7204/4CX250F)		592/3-200A3	46.00	*5670	2.45	GB-6186	3.85	3CPN10A5	30.75
4CX250K (See		604	11.80	GB-5670	2.45	*6186/6AG5WA	3.85	*7887	6.70
8245/4CX250K)		604L	13.00	5684 (See		6189	3.70	*7888	5.25
4CX300A (See		615	10.05	C3J/A/5684)		GB-6189	3.70	7962	7.50
8167/4CX300A)		627	27.50	5685 (See		*6197	2.30	7963	7.50
4CX1000A (See		632B	33.00	C6J/A/5685)		GB-6201	2.55	7984	5.35
8168/4CX1000A)		635	13.00	GB-5687	4.00	*6205	5.90	8008	11.80
4CX5000A (See		635L	13.50	*5687WA	5.66	*6206	7.25	8035 (CT-4251)	11.10
8170/4CX5000A)		652 (See 5551A/652)		*5692	8.25	6211	1.95	*8064	7.50
4E27A/5-125B	45.00	672A	39.85	5693	6.60	*6216	4.15	8070	7.50
4PR60B (See		673	21.00	5696	1.95	6257	330.00	8071	7.50
8252/4PR60B)		678	50.75	*5718	3.65	6350	1.85	8077/7054	1.50
4W20,000A (See		710 (See 6011/710)		*5719	3.15	*6352	9.85	8161/3X2500A3	
8173/4W20,000A)		760	28.10	5722	8.35	*6360	4.95	(See 3CX2500A3)	
4X150A (See		760L	29.40	5725	3.15	6421-F	545.00	8163/3-400Z	34.00
7034/4X150A)		807†	3.40	GB-5725	3.15	6425-F	675.00	8165/4-65A	27.00
4X250B	35.75	810	28.60	5726	1.55	6476A	14.95	8166/4-1000A	132.00
4X500A	127.50	811A	7.15	GB-5726	1.55	6483	3.09	8167/4CX300A	54.00
5R4GYB	2.03	813	24.25	GB-5727	2.90	6485	2.05	8168/	
*5Y3WGTA	4.05	815	35.75	*5727/2D21W	2.90	6550	4.95	4CX1000A	181.00
GB-5Y3WGTA	4.05	816	3.60	5736	164.75	*6660/6BA6	1.01	8170/	
6AD4	3.40	828	34.50	5749	2.20	*6661/6BH6	1.34	4CX5000A	495.00
*6AH6WA	7.60	829B	19.85	GB-5749	2.20	*6662/6BJ6	1.29	8173/	
*6AJ5	3.85	832A	16.65	5750	3.45	*6663/6AL5	.92	4W20,000A	2,030.00
6AK6	1.40	833A†	16.15	GB-5750	3.45	6664/6AB4	1.12		
		866A	3.25	*5751	2.55	*6669/6AQ5A	1.06		

SYLVANIA INDUSTRIAL PRODUCTS

Type	Sugg. User Price	Type	Sugg. User Price	Type	Sugg. User Price	Type	Sugg. User Price	Type	Sugg. User Price
8210	\$10.75	*5AHP4A	\$49.50	7UP25	\$60.85	1N461	\$.42	MICROWAVE DIODES	
8233	13.25	*5AHP7	★	8CP1	65.60	1N461A	.42	1N21C	\$1.02
8238/3X3000A1		*5AHP7A	49.50	8CP2	65.60	1N462A	.44	1N21D	2.10
(See 3CX3000A1)		5AHP14	★	8CP7	65.60	1N463A	.54	1N21E	3.50
8239/3X3000F1		5AHP14A	49.50	8CP11	65.60	1N464A	.53	1N21F	7.15
(See 3CX3000F1)		5AHP19	★	8DP4	42.35	1N482A	.69	1N21WE	4.35
8245/4CX250K	64.00	5AHP19A	49.50	8FP4	60.55	1N483B	.70	1N21G	11.90
8251/3X2500F3		5AMP1	★	8HP4	50.35	1N484A	.70	1N23C	1.02
(See 3X2500F3)		*5AMP1A	70.05	8NP4	50.35	1N485A	.90	1N23D	2.10
8252/4PR60B	107.00	5AMP2	★	8KP4	50.35	1N486A	.90	1N23E	3.50
8298A (See		*5AMP2A	70.05	8LP4	54.30	1N487A	1.41	1N23F	7.15
6146B/8298A)		5AMP7	★	8QP4	62.00	1N488A	1.78	1N23WE	4.35
8334	5.00	*5AMP7A	70.05	*10AKP7	79.70	1N541	.26	1N23G	11.90
8353	11.10	5AMP11	★	10ANP4	132.00	1N625	.43	1N25	3.53
8438/4-400A	48.00	*5AMP11A	70.05	*10ANP7	132.00	1N626	.45	1N25A	8.48
8484	175.00	5AMP31A	70.05	10ANP16	132.00	1N627	.60	1N25B	11.75
8507	215.00	5AQP1	★	10ANP19	132.00	1N628	.72	1N26	6.50
9001	5.40	5AQP1A	57.30	10ANP25	132.00	1N629	.81	1N26A	7.75
70780	.65	5AQP2	★	10KP7	★	1N662	.92	1N26B	27.25
7460-0008	1.20	5AQP2A	57.30	*10KP7A	71.30	1N663	1.20	1N26C	31.15
INDUSTRIAL and MILITARY CATHODE RAY TUBES		*5AQP7	★	10KP7B	76.00	1N695	.30	1N53	23.20
2AP1A	\$33.00	5AQP7A	57.30	10NP11	162.30	1N816	.52	1N53A	25.70
2BP1	33.00	5AQP11	★	10SP4	78.15	1N914	.45	1N53B	29.65
2BP11	33.00	5AQP11A	57.30	10VP7	97.60	1N916	.75	1N53C	46.80
*3ACP1A	45.60	5AUP24	165.20	10VP15	97.60	1N995	.60	1N53D	55.00
*3ACP2A	45.60	5BCP1	81.00	*10WP7	71.10	1N3064	.67	1N76	2.05
*3ACP7A	45.60	5BCP4	81.00	10WP7A	78.25	1N3182	.64	1N76A	2.60
*3ACP11A	45.60	*5BCP7	81.00	10WP14	71.10	1N4092	.34	1N78B	7.00
3ACP12A	45.60	5BCP11	81.00	10WPI4A	78.25	1N4093	.68	1N78C	14.00
3ACP16A	45.60	5BNP16	47.85	10WP19	71.10	*1N4148	.35	1N78D	22.00
*3ADP1	66.30	*5BP1A	36.95	10WP19A	78.25	1N4149	.45	1N78E	31.50
3ADP2	66.30	5BRP1	60.50	12ABP7	★	1N4150	2.25	1N78F	56.00
3ADP7	66.30	5BRP4	60.50	*12ABP7A	71.70	1N4151	.80	1N415C	1.02
3ADP11	66.30	5BRP7	60.50	12ABP14	★	1N4152	.72	1N415D	2.10
3ASP1	53.10	5BRP11	60.50	12ABP14A	71.70	1N4154	.42	1N415E	3.50
3ASP2	53.10	*5CP1A	44.35	12ABP19	★	1N4446	.40	1N415F	7.15
3ASP7	53.10	*5CP1B	46.00	12ABP19A	71.70	1N4447	.50	1N415G	11.90
3ASP11	53.10	*5CP7A	44.35	12AXP1	180.00	1N4448	.80	1N416C	1.02
3BEP1	68.00	5CP11A	44.35	12AXP4	180.00	1N4449	.50	1N416D	2.10
*3BGP1	66.10	*5CP12	44.35	12AXP7	180.00	*1N4454	.67	1N416E	3.50
3BGP2	66.10	*5CVP1	203.00	*12DP7A	101.00	1N4531	.45	1N416F	7.15
3BGP7	66.10	*5CVP7	203.00	*12DP7C	108.70	1N4532	.65	1N416G	11.90
3BGP11	66.10	*5CVP19	203.00	12SP7	X	1N4533	.85	1N830	2.95
3BMP1	58.50	5DEP1	34.45	12SP7B	X	1N4534	1.00	1N830A	3.85
3BMP2	58.50	5DEP2	34.45	*12SP7D	82.00	1N4536	.45	1N831	6.85
3BMP7	58.50	5DEP7	34.45	17DWP4	29.90	*1N4938	2.00	1N831A	10.90
3BMP11	58.50	5DEP11	34.45	21EYP4	33.30	1N5282	2.25	1N831B	15.00
3BMP12	58.50	5DKP4	37.20	SC-2854	49.50	RECTIFIERS			
*3BP1A	41.05	5DKP11	37.20	KLYSTRONS		1N645	\$1.40	1N832	10.90
*3FP7A	45.90	5DKP15	37.20	SK-220A	\$165.00	1N832B	15.00	1N832C	22.50
*3JP1	41.90	5DKP16	37.20	SK-220B-F	155.00	1N832C	22.50	1N1132	15.00
*3JP2	41.90	5DLP4	43.85	SK-221A	170.00	1N646	1.65	1N1610	32.90
*3JP7	41.90	5FP4A	39.30	SK-221B-K	160.00	1N647	1.70	1N1611	4.30
*3JP12	41.90	*5FP7A	39.30	SK-221H	210.00	1N648	1.80	1N1611A	9.15
*3KP1	35.85	5FP11A	39.30	SK-222B-G	160.00	1N649	2.25	1N1611B	18.00
3KP4	35.85	*5FP14A	39.30	K-4014	195.00	1N2069	.65	1N2102	13.35
3KP7	35.85	5QP4A	61.10	DIODES		1N2070	.71	1N2510	18.20
3KP11	35.85	*5UP1	31.65	1N34A	\$.30	1N2071	.87	1N2926	17.15
3KP16	35.85	5UP7	31.65	1N35	1.58	1N2482	.65	1N2926A	23.30
3MP1	29.90	5UP11	31.65	1N38A (Order 1N38B)	.49	1N2483	.69	1N3143	5.60
*3RP1	27.05	5WP11	137.75	1N48	.30	1N2484	.71	1N3655	4.00
3RP1A	34.45	5WP15	137.75	1N55A	.40	1N4001	.45	1N3655A	9.00
*3SP1	51.90	5ZP15	116.60	1N58A	.55	1N4002	.49	1N3655B	16.00
3SP2	51.90	5ZP16	116.60	1N60	.30	1N4003	.60	1N3745	6.60
3SP11	51.90	5ZP24	116.60	1N64	.30	1N4004	.67	1N3746	13.80
*3WP1	40.85	7ABP7	★	1N72 (Order 1N82A)	.30	1N4005	.81	1N3747	19.75
3WP2	40.85	*7ABP7A	64.00	1N82	.60	1N4006	1.12	1N3778	6.70
3WP11	40.85	7ABP14	★	1N82A	.82	1N4007	1.80	1N4379	11.25
*4MP1	76.85	7ABP14A	64.00	1N90	.33	1N4383	.48	1N4600	20.00
5ABP1	51.40	7ABP19	★	1N99	.50	1N4384	.58	1N4601	24.00
5ABP1A	53.80	7AEP1	79.35	1N100	.32	1N4385	.78	1N4602	36.00
5ABP4	51.40	7AEP2	79.35	1N126A	.30	1N4385	1.20	1N4603	15.00
5ABP4A	53.80	*7AEP7	79.35	1N191	.35	1N4586	2.70	1N4604	25.00
5ABP7	51.40	7AEP11	79.35	1N198A	.35	Types listed in Bold Face are Sylvania Gold Brand Tubes.			
5ABP7A	53.80	7AQP4	86.40	1N251	.72	• Tubes are "Communication Quality" types.			
5ABP11	51.40	7AQP7	86.40	1N252	.65	* Indicates Military Type Approval.			
5ABP11A	53.80	7AQP19	86.40	*1N270	.32	† These tubes may be of foreign manufacture and, in many cases, manufactured by the foreign affiliate of Sylvania Electric Products Inc.			
5ABP31A	53.80	7AQP19A	86.40	1N276	.31	X, Price quoted upon request.			
*5ADP1	51.40	7AQP25	86.40	1N277	.34	★ Order "A" version.			
5ADP1A	53.80	7AUP4	86.40	1N279	.29	Prices are subject to change without notice.			
*5ADP2	51.40	7AUP7	86.40	1N281	.31	SYLVANIA			
5ADP2A	53.80	7BP2A	56.75	1N283	.51	A DIVISION OF			
*5ADP7	51.40	7BP7A	56.75	1N294	.34	GENERAL TELEPHONE & ELECTRONICS			
5ADP7A	53.80	7MP7	71.30	1N295	.35	New Capabilities In: Electronic Tubes • Semiconductors •			
5ADP11	51.40	7MP14	71.30	1N456A	.42	Microwave Devices • Special Components • Display Devices			
5ADP11A	53.80	7JP1/7VP1	51.30	1N457A	.45				
5ADP31A	53.80	7JP7	51.30	1N458A	.48				
		7UP7	60.85	1N459A	.51				

Types listed in Bold Face are Sylvania Gold Brand Tubes.

• Tubes are "Communication Quality" types.

* Indicates Military Type Approval.

† These tubes may be of foreign manufacture and, in many cases, manufactured by the foreign affiliate of Sylvania Electric Products Inc.

X, Price quoted upon request.

★ Order "A" version.

Prices are subject to change without notice.

SYLVANIA

A DIVISION OF
GENERAL TELEPHONE & ELECTRONICS

New Capabilities In: Electronic Tubes • Semiconductors •
Microwave Devices • Special Components • Display Devices



UNITED ELECTRONICS

MANUFACTURERS OF QUALITY ELECTRON TUBES • POWER • TRANSMITTING • SPECIAL PURPOSE

"ASSURANCE OF RELIABILITY"

PRICES SUBJECT TO CHANGE OR WITHDRAWAL WITHOUT NOTICE.

TUBE TYPE	DESCRIPTION	NET PRICE	TUBE TYPE	DESCRIPTION	NET PRICE
2C53	Hi Mu Triode (M)	\$ 6.85	576A	Clipper Diode Rectifier (M)	\$ 16.95
3B24WA	Vacuum Rectifier Diode	7.50	577W	Vacuum Rectifier (M)	35.00
3B24WB	Vacuum Rectifier Diode (M)	7.95	578	Vacuum Rectifier (M)	18.95
3B28	Rectifier, Gas, Half-Wave (M)	4.25	582	Vacuum Rectifier	25.00
3B29W	Clipper Diode H.V. Rectifier (M)	9.95	583	Clipper Diode (M)	7.95
3C23	Thyratron, Gas & Mercury	4.95	589	Diode, External Anode (M)	60.00
3C24	High Frequency Triode (M)	12.00	593	Vacuum Rectifier (M)	30.00
4B32	Rectifier, Gas, Half-Wave (M)	7.50	596	Rectifier, Full-Wave (M)	25.00
4C22/HF100	Power Triode (M)	30.00	673	Mercury Rectifier	13.50
4PR60	Pulse Tetrode	75.00	705WA	Vacuum Rectifier (M)	35.00
5C24	Power Triode	32.50	715C	Pulse Amplifier Tetrode	45.00
CV-11	Power Triode	12.50	805	Power Triode (M)	18.00
UXCV-11	Power Triode	12.50	809	Power Triode (M)	6.75
FG17	Thyratron, Mercury	5.25	810	Power Triode (M)	18.00
HV-18/HF-200	Power Triode	35.00	811A	Power Triode	4.25
FV20	Power Triode	35.00	812A	Power Triode	4.25
KU23/HF300	Power Triode	26.00	812HD	Power Triode	9.75
35T	Power Triode (M)	30.00	830	Power Triode	20.00
V70D	Power Triode	20.00	830B	Power Triode	13.95
X80/G303	Clipper Diode Rectifier	50.00	836A	Rectifier, Half-Wave H.V.	8.75
UE100	Power Triode	20.00	838W	Power Triode	35.00
100TH	Power Triode Hi Mu (M)	17.50	845W	Power Triode (M)	35.00
120	Power Triode (M)	20.00	851	Power Triode	495.00
203WA	Power Triode (M)	30.00	860	Power Tetrode	50.00
211W	Power Triode (M)	35.00	861	Power Tetrode	125.00
217C	Vacuum Rectifier	35.00	866A	Rectifier, Mercury H.W.	1.95
242C	Power Triode	35.00	872A	Rectifier, Mercury Vapor	6.25
250TH	Power Triode Hi Mu (M)	30.00	873	Thyratron Triode, Mercury Vapor	9.65
250TL	Power Triode Low Mu (M)	30.00	949A	Power Triode	160.00
FP265	Power Triode	40.00	966	Rectifier, Mercury Vapor	4.50
311CH	Power Triode	28.00	972A	Rectifier, Mercury Vapor	6.25
311CT	Power Triode	30.00	973	Thyratron	9.65
311T	Power Triode	30.00	1641	Rectifier, Full-Wave H.V.	4.95
323B	Rectifier	4.95	6303	Clipper Diode Rectifier (M)	50.00
371B	Rectifier (M)	12.50	6303A	Clipper Diode Rectifier (M)	60.00
2-450A	High Vacuum Diode	95.00	6339	Diode, External Anode (M)	60.00
468/HF201A	Power Triode	35.00	S6339	Diode, External Anode	60.00
543	Vacuum Rectifier	35.00	6901	Thyratron, Gas Mercury	9.95
545	Rectifier, External Anode (M)	60.00	7159	Diode, External Anode	60.00
549	Rectifier	40.00	7310	Vacuum Rectifier	40.00
554	Diode, External Anode	60.00	7402	Clipper Diode Rectifier (M)	65.00
SR554	Diode, External Anode	60.00	7410	Thyratron	9.95
558	Clipper Diode Rectifier	35.00	8008	Rectifier, Mercury Vapor	6.75
561	Clipper Diode Rectifier	55.00	8008XE	Rectifier, Xenon	8.25
572B	Power Triode	9.95	8020	Vacuum Rectifier	12.50
575A	Mercury Rectifier (M)	13.50	8020W	Vacuum Rectifier (M)	15.00

(M) THESE ITEMS CAN BE SUPPLIED TO EXISTING CURRENT MILITARY SPECIFICATIONS, WITH A CERTIFICATE OF COMPLIANCE. (NO GOVERNMENT SOURCE INSPECTION) TUBES CAN BE BRANDED JAN.

United Electronics Company

DIRECT INTERCHANGEABILITY LIST



This Interchangeability Index has been prepared to assist you in finding exact replacement for electronic tubes in the Industrial, Transmitting and Special Purpose fields.

This listing is believed to be accurate to the date of issue. However, no responsibility is assumed by Westinghouse for its completeness or for its use, nor for any infringement of patents or other rights of third parties which may result from its use.

KEY TO ABBREVIATIONS

CR — Cathode Ray
 CS — Camera or Storage
 Glow — Glow Tube (Cold Cath.)
 GA — Vacuum Gauge
 Ig — Ignitron
 IR — Industrial Receiving

N — Neutron Detector
 Photo — Phototube
 Rect — Rectifier
 Thyr — Thyatron
 Trans. — Transmitting
 VR — Voltage Regulator or Reference
 HCDD — Hollow Cathode Discharge Device

INDEX OF COMMONLY USED MANUFACTURERS PREFIXES

A Radio Corporation of America
 AH Marconi Wireless Telegraph Co.
 AX Amperex Electronic Corp.
 BL Bomac Laboratories
 BR Standard Telephone & Cables Inc.
 BT British Thomson-Houston Co.
 CE Continental Electric Co.
 CK Raytheon Manufacturing Co.
 DET Marconi Wireless Telegraph Co.
 DR General Electronics Inc.
 EE Electronic Enterprises Inc.
 EL Electrons Inc.
 F International Telephone & Telegraph
 FG General Electric Co.
 G General Motors Laboratories Inc.
 GL General Electric Co.
 HD C B S Hytron Co.

HV United Electronics Co.
 HV Japanese Manufacture
 HY C B S Hytron Co.
 KD Ferranti Ltd.
 KI Westinghouse Electric Corp.
 KU Westinghouse Electric Corp.
 KU Kuthe Laboratories Inc.
 KX Westinghouse Electric Corp.
 M Mullard Electric Products Ltd.
 ML Machlett Laboratories Inc.
 MT English Electric Valve Co.
 NL National Electronics Inc.
 NU National Union Electric Corp.
 PL Penta Laboratories Inc.
 N. V. Philips Gloeilampenfabrieken
 QK Raytheon Manufacturing Co.
 R Radio Corporation of America

RK Raytheon Manufacturing Co.
 SN Sylvania Electric Products Inc.
 T Taylor Tubes Inc.
 TT Taylor Tubes Inc.
 UE United Electronics Co.
 UX United Electronics Co.
 V Varian Associates Inc.
 VA Varian Associates Inc.
 WE Western Electric Co.
 WL Westinghouse Electric Corp.
 WT Weltronic Co.
 WTT Weltronic Co.
 WX Westinghouse Electric Corp.
 X Varian Associates Inc.
 XG Mullard Electric Products Ltd.
 Z General Electric Co.
 ZP General Electric Co.

TUBE TYPE MARKED	CLASS OF TUBE	EQUIVALENT WESTINGHOUSE TYPE
SBS	Ig	WL-555IA
SCS	Ig	WL-5552A
SDR	Ig	WL-5555
SDS	Ig	WL-5553B
TGRA	Rect	WL-575A
TGRB	Rect	WL-872A
TGRG	Thyr	WL-5563A
TVTA	Trans	WL-892
TVTB	Trans	WL-833A
TVTCT	Trans	WL-889A
TVTG	Trans	WL-5606
TVTP	Trans	WL-5771
WL-OAZ	VR	WL-OA2
OA2	VR	WL-OA2
WL-OA3	VR	WL-OA3
OA3	VR	WL-OA3
OA3/VR75	VR	WL-OA3
WL-OC2	VR	WL-OC2
OC2	VR	WL-OC2
WL-OC3	VR	WL-OC3
OC3	VR	WL-OC3
OC3/VR105	VR	WL-OC3
WL-OD3	VR	WL-OD3
OD3	VR	WL-OD3
OD3/VR150	VR	WL-OD3
OG3	VR	WL-5651
AC-IC	Rect	WL-3B22
CT1-2500	Thyr	WL-5559
EL-1C	Rect	WL-3B22
EL-C1B	Thyr	WL-5664
EL-C1BA	Thyr	WL-5664
EL-C1J	Thyr	WL-6014
GL-C1J	Thyr	WL-6014
EL-C1JA	Thyr	WL-6014
EL-C1K	Thyr	WL-6014
GXU1	Rect	WL-3B28
TQ1-2	Thyr	WL-3C23
XG1-2500	Thyr	WL-5559
XR1-3200	Thyr	WL-22994
XR1-6400	Thyr	WL-C6H-1
1G50	Thyr	WL-2050
1P32	Photo	WL-927
WL-1P39	Photo	WL-1P39
1P39	Photo	WL-1P39
GL-1P40	Photo	WL-1P40
WL-1P40	Photo	WL-1P40
1P40	Photo	WL-1P40
1R21	Ig	WL-5550
B2A	Thyr	WL-2050
BTL2-1	Trans	WL-5762
D2M9	IR	WL-6663
DQ2	Rect	WL-866A
DX2	Rect	WL-3B28
H2-10	Rect	WL-2X2A
M-2K-2.5	Rect	WL-7018
M-2K-215	Rect	WL-7018
P2-12	Trans	WL-832A
P2-40	Trans	WL-829B
P2-40B	Trans	WL-829B
QB2/250	Trans	WL-813
QQEO2/5	Trans	WL-6939
QQVO2/6	Trans	WL-6939
QY2-100	Trans	WL-813
TQ2	Thyr	WL-5557
TX2/3	Thyr	WL-2294
TX2/6	Thyr	WL-C6H-1
XGQ2-6400	Thyr	WL-105

TUBE TYPE MARKED	CLASS OF TUBE	EQUIVALENT WESTINGHOUSE TYPE
2B21	Rect	WL-2X2A
2B29	Trans	WL-829B
2B32	Trans	WL-832A
2B94	Trans	WL-5894
2C4	Thyr	WL-5696
ML-2C39	Trans	WL-2C39A
2C39	Trans	WL-2C39A
WL-2C39A	Trans	WL-2C39A
2C39A	Trans	WL-2C39A
GL-2C39B	Trans	WL-2C39B
ML-2C39B	Trans	WL-2C39B
WL-2C39B	Trans	WL-2C39B
2C39B	Trans	WL-2C39B
GL-2D2I	Thyr	WL-2D2I
PL-2D2I	Thyr	WL-2D2I
WL-2D2I	Thyr	WL-2D2I
2D2I	Thyr	WL-2D2I
2D21W	Thyr	WL-5727
GL-2E24	Trans	WL-2E24
WL-2E24	Trans	WL-2E24
2E24	Trans	WL-2E24
GL-2E26	Trans	WL-2E26
WL-2E26	Trans	WL-2E26
2E26	Trans	WL-2E26
2G57	Thyr	WL-5557
2H28	Rect	WL-3B28
2H66	Rect	WL-866A
2V/400A	Rect	WL-866A
2XM600A	Rect	WL-866A
2X2/879	Rect	WL-2X2A
GL-2X2A	Rect	WL-2X2A
WL-2X2A	Rect	WL-2X2A
2X2A	Rect	WL-2X2A
EM-2.5	Rect	WL-7018
EL-C3J	Thyr	WL-5632
C3J	Thyr	WL-5632
C3J/5632	Thyr	WL-5632
EL-C3JA	Thyr	WL-7306A
EL-C3JAL	Thyr	WL-7556A
EL-3C	Rect	WL-4824
EL-3C/L	Rect	WL-7015
QB3/300	Trans	WL-4D21
QE03/10	Trans	WL-5763
QQEO3/12	Trans	WL-6360
QQVO3-10	Trans	WL-6360
QY03-12	Trans	WL-5763
QY3-125	Trans	WL-4D21
RG3-250A	Rect	WL-866A
RR3-250	Rect	WL-3B28
T-3C	Rect	WL-4824
GL-3C23	Thyr	WL-3C23
WL-3C23	Thyr	WL-3C23
3C23	Thyr	WL-3C23
3C31	Thyr	WL-5664
3E21	Trans	WL-829B
3E29	Trans	WL-829B
3G15	Thyr	WL-5664
3G501A	Thyr	WL-C6H-1
3H150J	Trans	WL-2C39B
3V390A	Thyr	WL-5559
3X100A5	Trans	WL-2C39A
3X100A11	Trans	WL-2C39B
GL-3X2500A3	Trans	WL-8161
WL-3X2500A3	Trans	WL-8161
3X2500A3	Trans	WL-8161
WL-3X2500F3	Trans	WL-8251
3X2500F3	Trans	WL-8251

TUBE TYPE MARKED	CLASS OF TUBE	EQUIVALENT WESTINGHOUSE TYPE
QB-3.5-750	Trans	WL-5D22
AX-4-125A	Trans	WL-4D21
AX-4-125A/6155	Trans	WL-4D21
AX-4-250A	Trans	WL-5D22
AX-4-250A/6156	Trans	WL-5D22
BPM04	IR	WL-6669
DCG4-1000G	Rect	WL-866A
DCX4-1000	Rect	WL-3B28
DQ4	Rect	WL-872A
EL-C4H-1	Thyr	WL-6856
C4H-1	Thyr	WL-6856
EL-C4H-2	Thyr	WL-6857
C4H-2	Thyr	WL-6857
EL-C4J	Thyr	WL-6856
C4J	Thyr	WL-6856
EL-C4J/F	Thyr	WL-6857
C4J/F	Thyr	WL-6857
GL-KC4	Rect	WL-5575
PM04	IR	WL-6660
QQEO4/20	Trans	WL-832A
QQVO4-20	Trans	WL-815
QY04-15	Trans	WL-832A
QY4-250	Trans	WL-5D22
TY4-350	Trans	WL-833A
4-125A	Trans	WL-4D21
4-125A/4D21	Trans	WL-4D21
4-250A	Trans	WL-5D22
4-250A/5D22	Trans	WL-5D22
GL-4-400A	Trans	WL-4-400A
WL-4-400A	Trans	WL-4-400A
4-400A	Trans	WL-4-400A
GL-4-1000A	Trans	WL-4-4000A
WL-41000A	Trans	WL-4-1000A
4-1000A	Trans	WL-4-1000A
4B13	Trans	WL-813
4CX250B	Trans	WL-4CX250B
4G23	Thyr	WL-3C23
4G63	Thyr	WL-5563A
4G/280K	Thyr	WL-5727
4H72	Rect	WL-872A
4H88	Rect	WL-8008
4T100	Trans	WL-813
4T150A/1	Trans	WL-813
4X250B	Trans	WL-4CX250B
4Y25	Trans	WL-807
BT5	Thyr	WL-5559
DCG5/5000GB	Rect	WL-872A
DCG5/5000GS	Rect	WL-8008
G5D	Rect	WL-872A
PM05	IR	WL-5654
QE05/40	Trans	WL-6146A
QE05/40H	Trans	WL-6159
QV05/25	Trans	WL-807
XG5-500	Thyr	WL-5557
5B/250A	Trans	WL-807
5CEP11	C R	5CEP11
5C21	Thyr	WL-5C21
5C/100A	Trans	WL-813
5DEP1	C R	5DEP1
PL-5D22	Trans	WL-5D22
WL-5D22	Trans	WL-5D22
5D22	Trans	WL-5D22
5FP7	C R	5FP7A
5FP7A	C R	5FP7A
5F22A	Trans	WL-5D22
5H69A	Rect	WL-869B
5R4-GY	Rect	WL-5R4-GYB

Direct Interchangeability List

continued



TUBE TYPE MARKED	CLASS OF TUBE	EQUIVALENT WESTINGHOUSE TYPE	TUBE TYPE MARKED	CLASS OF TUBE	EQUIVALENT WESTINGHOUSE TYPE	TUBE TYPE MARKED	CLASS OF TUBE	EQUIVALENT WESTINGHOUSE TYPE
5R4-GYA	Rect	WL-5R4-GYB	AR-14	Ig	WL-5551A	RKR-72	Rect	WL-481B
5R4-GYB	Rect	WL-5R4-GYB	P-14	Thyr	WL-5557	VR-75	V R	WL-OA3
5S1	Trans	WL-807	AR-14T	Ig	WL-5551A	VT75(Br)	I R	WL-5881
5T33	Trans	WL-833A	AR-14TP	Ig	WL-5551APC	VR-75ST	V R	WL-OA3
5UP1	C R	5UP1	AR-14TWS	Ig	WL-5551APC	BT77	Thyr	WL-C6H-1
5ZP16	C R	5ZP16	G15F	Photo	WL-927	D77	I R	WL-6663
EL-C6J	Thyr	WL-5C21	EL-C16J	Thyr	WL-5665	KT77	I R	WL-5881
C6J	Thyr	WL-5C21	GS-16SO	Photo	WL-1P40	QD77	I R	WL-5726
C6J/5C21	Thyr	WL-5C21	QQV16/40A	Trans	WL-5894	CC81E	I R	WL-6201
EL-C6J/A	Thyr	WL-C6H-1	TT16	Trans	WK-4D21	ECC81	I R	WL-6679
C6J/A	Thyr	WL-C6H-1	TT16D	Trans	WL-4D21	E81CC	I R	WL-6201
C6J/A5685	Thyr	WL-C6H-1	DET17	Trans	WL-810	FG-81A	Thyr	WL-31A
EL-C6J/F	Thyr	WL-C6H-2	EE-17	Thyr	WL-5557	WL-81A	Thyr	WL-31A
C6J/F	Thyr	WL-C6H-2	FG-17	Thyr	WL-5557	EBF82	I R	WL-6678
EL-C6J/K	Thyr	WL-C6H-1	HT-17	Thyr	WL-5557	ECC82	I R	WL-6680
C6J/K	Thyr	WL-C6H-1	MT17	Thyr	WL-5557	ECC83	I R	WL-6681
EL-C6J/KF	Thyr	WL-C6H-2	RL-17	Thyr	WL-5557	ECC84	I R	WL-6386
C6J/KF	Thyr	WL-C6H-2	TT-17	Thyr	WL-5557	84A3	Photo	WL-923
EL-C6J/L	Thyr	WL-7321	WE-17	Thyr	WL-5557	85A2	V R	WL-5651
C6J/L	Thyr	WL-7321	WL-17	Thyr	WL-5557	E88CC	I R	WL-6922
EL-C6H-1	Thyr	WL-C6H-1	17	Thyr	WL-5557	KT88	I R	WL-6550
WL-C6H-1	Thyr	WL-C6H-1	P17A	Trans	WL-807	VT88(Br)	Trans	WL-832A
C6H-1	Thyr	WL-C6H-1	CE-20	Photo	WL-927	E90F	I R	WL-6661
EL-C6H-2	Thyr	WL-C6H-2	NU-20	Photo	WL-927	EL90	I R	WL-6669
WL-C6H-2	Thyr	WL-C6H-2	20A3	Thyr	WL-5727	BT-91	Thyr	WL-2299A
C6H-2	Thyr	WL-C6H-2	KD21	I R	WL-OA3	E91AA	I R	WL-6663
DD6	Thyr	WL-6663	PL21	Thyr	WL-2D21	E91N	Thyr	WL-2D21
DD6G	I R	WL-6663	RL-21	Thyr	WL-2D21	EAA91	I R	WL-6663
DO6	I R	WL-869B	Z1A6	Thyr	WL-81A	EB91	I R	WL-6663
EL-6C	Rect	WL-670	CE-23	Photo	WL-923	EN91	Thyr	WL-2D21
EL-6C/L	Rect	WL-7017	NU-23	Photo	WL-923	EC92	I R	WL-6664
T-6C	Rect	WL-670	BK24	Ig	WL-5552A	EN92	Thyr	WL-5696
QEO6/50	Rect	WL-807	KD24	V R	WL-OC3	EF93	I R	WL-6660
QEO6/40	Trans	WL-5894	BK24A	Ig	WL-5552A	EF94	I R	WL-6136
QQVO6/40	Trans	WL-5894	BK24B	Ig	WL-5552A	EF95	I R	WL-5654
QQVO6/40A	Trans	WL-5894	ATS25	Trans	WL-807	QV95/25	Trans	WL-807
QVO6/20	Trans	WL-6146A	G25/3000	Rect	WL-866A	E99F	I R	WL-6664
6AB4	I R	WL-6664	KD25	V R	WL-OD3	ML-100	Rect	WL-5575
6AK5	I R	WL-5654	NU-25	Photo	WL-927	TXM100	Thyr	WL-2D21
6AK5W	I R	WL-5654	ATS25A	Trans	WL-807	VT100	Trans	WL-102A
6AK5W/5654	I R	WL-5654	CE-25C	Photo	WL-927	VT100A	Trans	WL-807
6AL5	I R	WL-6663	CV26	Trans	WL-813	ML-102A	Rect	WL-807
6AQ5	I R	WL-6669	BT27	Thyr	WL-105	WL-102A	Thyr	WL-105
6AS6	I R	WL-6AS6	D27	I R	WL-6663	X-103	Trans	WL-4D21
6AS7G	I R	WL-6AS7GA	CE29	Photo	WL-1P39	FG-104	Rect	WL-5561
6AS7GA	I R	WL-6AS7GA	CE-30	Photo	WL-1P40	WL-104	Rect	WL-5561
6AU6	I R	WL-6136	NU-30	Photo	WL-930	WTT-104	Rect	WL-575A
6AU6W	I R	WL-6136	CE-30C	Photo	WL-930	AX-105	Thyr	WL-105
6AU6WA	I R	WL-6136	CE-30Q	Thyr	WL-5557	FG-105	Thyr	WL-105
6B32	I R	WL-6663	CV32(Br)	Rect	WL-866A	ML-105	Thyr	WL-105
6BA6	I R	WL-6660	ECC32	I R	WL-5692	PL-105	Thyr	WL-105
6BH6	I R	WL-6661	EN32	Thyr	WL-2050	RL-105	Thyr	WL-105
6BJ6	I R	WL-6662	FG-32	Rect	WL-5558	VR-105	V R	WL-OC3
6CL6	I R	WL-6677	WL-32	Rect	WL-5558	WL-105	Thyr	WL-105
6D2	I R	WL-6663	FG-33	Thyr	WL-5720	WTT-105	Trans	WL-892
6F31	I R	WL-6660	BK34	Ig	WL-5553B	105	Thyr	WL-105
6F33	I R	WL-6AS6	REL34	Trans	WL-2C40	VR-105MT	V R	WL-OC3
6G10	Thyr	WL-105	VT34	Trans	WL-207	PL-106	Thyr	WL-6858
6G45	Thyr	WL-C6H-1	BK34A	Ig	WL-5553B	WTT-106	Thyr	WL-7307A
6L6	I R	WL-5881	BK34B	Ig	WL-5553B	STV108/30	V R	WL-OB2
6L6G	I R	WL-5881	ECC35	I R	WL-5691	WTT-108	Thyr	WL-3C23
6L6GA	I R	WL-5881	TE-35	I R	WL-5654	108C1	V R	WL-OB2
6L6GB	I R	WL-5881	EL37	I R	WL-5881	WTT-111	Thyr	WL-5559
6L6GC	I R	WL-5881	RK-39	Trans	WL-807	WTT-112	Thyr	WL-632C
6L6W	I R	WL-5881	VT39A	Rect	WL-869B	VT115A	I R	WL-5881
6L6WA	I R	WL-5881	FG-41	Thyr	WL-5830	VT116	I R	WL-5693
6L6WB	I R	WL-5881	WL-41	Thyr	WL-5830	WTT-117	Thyr	WL-5557
6L41	Trans	WL-5763	BK42	Ig	WL-5551A	X-117	Thyr	WL-5D22
6SJ7	I R	WL-5693	CE-42	Photo	WL-922	VT118	Trans	WL-832A
6SL7-GT	I R	WL-5691	EB42	Rect	WL-857B	WTT-118	Thyr	WL-105
6SL7-WGT	I R	WL-5691	VT42	Rect	WL-872A	VT119	Rect	WL-2X2A
6SN7-GT	I R	WL-5692	BK42A	Ig	WL-5551A	WTT-119	Thyr	WL-172
6SN7-GTA	I R	WL-5692	VT42A	Rect	WL-872A	CV124	Trans	WL-807
6U8	I R	WL-6678	BK42B	Ig	WL-5551A	T-125	Trans	WL-810
6U8A	I R	WL-6678	L-FTX44-5	Thyr	WL-5665	E-125A	Trans	WL-4D21
QQVO7-40	Trans	WL-829B	TX44-5	Thyr	WL-5665	WTT-127	Trans	WL-833A
7ABP7	C R	7ABP7A	BK46	Ig	WL-5555	BR-132	Trans	WL-5762
7ABP7A	C R	7ABP7A	VT46	Rect	WL-866A	WTT-134	Thyr	WL-5665
7C24	Trans	WL-5762	VT46A	Rect	WL-866A	VT139	V R	WL-OD3
7F25A	Trans	WL-4-1000A	GS-47X	Photo	WL-927	B142	Trans	WL-833A
7H57	Rect	WL-857B	HD51	V R	WL-OA2	KX142	Rect	WL-2X2A
8F66R	Trans	WL-7007	TSS1	I R	WL-5654	C143	Trans	WL-813
8NP4	C R	8NP4	51A	Photo	WL-927	C144	Trans	WL-829B
8T92	Trans	WL-892	R-51A	Photo	WL-927	VT144	Trans	WL-813
8T92R	Trans	WL-892R	VT53	Rect	WL-872A	WTT-149	Thyr	WL-172
D2M9	I R	WL-6663	TE-54	I R	WL-5687	QS150-40	V R	WL-OD3
TT10	Trans	WL-813	FG-57	Thyr	WL-5559	SM150-30	V R	WL-OA2
10E/9	Trans	WL-832A	MT-57	Thyr	WL-5559	STV150/30	V R	WL-OA2
10E/587	Trans	WL-807	PL-57	Thyr	WL-5559	VR-150	V R	WL-OD3
10E/11-141	Trans	WL-807	RL-57	Thyr	WL-5559	VR-150-30	V R	WL-OD3
10WP7A	C R	10WP7A	TG-57	Thyr	WL-5559	VR-150MT	V R	WL-OA2
GU12	Rect	WL-866A	WL-57	Thyr	WL-5559	VR-150ST	V R	WL-OD3
12AT7	I R	WL-6679	VT60(Br)	Trans	WL-807	150C1	V R	WL-OA2
12AT7W	I R	WL-6201	VT60A(Br)	Trans	WL-807	150C2	V R	WL-OA2
12AT7WA	I R	WL-6201	DP61	I R	WL-5654	150C3	I R	WL-OD3
12AU7	I R	WL-6680	HY-61	Trans	WL-807	150C4	V R	WLOA2
12AU7W	I R	WL-6189	HY-61/807	Trans	WL-807	B152	I R	WL-6679
12AU7WA	I R	WL-6189	R-61A	Photo	WL-930	D152	I R	WL-6663
12AX7	I R	WL-6681	61A3	Photo	WL-930	Q160-1	Trans Ig	WL-4D21
DG13-32	C R	5UP1	B65	I R	WL-5692	BK168B	Ig	WL-5822A
MF13-1	C R	5FP7A	BK66	Ig	WL-5550	FG-172	Thyr	WL-172
13D2	I R	WL-5692	EL71	I R	WL-5902	WL-172	Thyr	WL-172

Direct Interchangeability List

continued



TUBE TYPE MARKED	CLASS OF TUBE	EQUIVALENT WESTINGHOUSE TYPE	TUBE TYPE MARKED	CLASS OF TUBE	EQUIVALENT WESTINGHOUSE TYPE	TUBE TYPE MARKED	CLASS OF TUBE	EQUIVALENT WESTINGHOUSE TYPE
172	Thyr	WL-172	CE-232	Rect	WL-5558	WL-579A	Rect	WL-579B
C178	Trans	WL-589A	FG-235A	Ig	WL-5552A	WL-579B	Rect	WL-579B
C180	Trans	WL-832A	FG-238B	Ig	WL-5555	579B	Rect	WL-579B
G180-2M	V R	WL-OD3	CE-245	Rect	WL-7016	CV597	Rect	WL-2X2A
VT187	Rect	WL-575A	VT-245	Thyr	WL-2050	NL-600	Rect	WL-3B22
ECC189	I R	WL-6922	WT-246	Thyr	WL-2050	NL-604	Rect	WL-7014
EF190	I R	WL-6676	G250/3000	Rect	WL-866A	NL-604L	Rect	WL-7015
BR191	Trans	WL-5762	GRG250/3000	Thyr	WL-5557	NL-606	Rect	WL-7016
ML-199	Rect	WL-8094	RG250/3000	Rect	WL-866A	WT-606	Thyr	WL-2D21
ML-200	Rect	WL-5576	E-250A	Trans	WL-5D22	NL-606L	Rect	WL-7017
VT200	V R	WL-OC3	K251	Rect	WL-866A	KU-610	Glow	KU-610
AH201	Rect	WL-866A	VT252	Photo	WL-923	ACC612	Thyr	WL-C6H-1
VT202	I R	WL-9002	HF-255	Rect	WL-869B	R-612G	Rect	WL-2X2A
A-206	Rect	WL-579B	PL-255	Thyr	WL-414	WL-613	Rect	WL-613
GL-207	Trans	WL-207	255A	Rect	WL-869B	613	Rect	WL-613
ML-207	Trans	WL-207	255B	Rect	WL-869B	NL-615	Rect	WL-7018
RX-207	Rect	WL-670	FG-258A	Ig	WL-55535	WL-616	Rect	WL-5575
UE-207	Trans	WL-207	FG-258B	Ig	WL-5553B	KU-618	Thyr	KU-618
WL-207	Trans	WL-207	VT259	Trans	WL-829B	WL-624	Thyr	WL-624
207	Trans	WL-207	FG-259B	Ig	WL-5554	CV627	Trans	WL-810
WT-210-0001	Thyr	WL-2D21	VT260	V R	WL-OA3	GL-627	Thyr	WL-627
WT-210-0004	Thyr	WL-205-	WT-262	Rect	WL-866A	KU-627	Thyr	WL-627
WT-210-0008	Rect	WL-866A	WT-269	V R	WL-OC3	WL-627	Thyr	WL-627
WT-210-0011	V R	WL-OC3	FG-271	Ig	WL-5551A	627	Thyr	WL-627
WT-210-0015	Thyr	WL-5557	WE-272	Thyr	WL-5557	CV628	Trans	WL-811A
WT-210-0017	Thyr	WL-6856	WT-272	Thyr	WL-5557	WL-629	Thyr	WL-629
WT-210-0018	V R	WL-OD3	WT-272A	Thyr	WL-5557	629	Thyr	WL-629
WT-210-0027	Rect	WL-872A	WE-274B	Rect	WL-5R4-GYB	WL-630	Thyr	WL-2050
WT-210-0038	Thyr	WL-172	WT-280	Thyr	WL-C6H-1	WT-630	Thyr	WL-2050
WT-210-0043	Thyr	WL-5796	VT286	Trans	WL-832A	WL-630A	Thyr	WL-2050
WT-210-0044	Rect	WL-575A	VT287	Trans	WL-815	WL-631	Thyr	WL-5559
WT-210-0045	Trans	WL-892	WT-294	V R	WL-OD3	WT-631	Thyr	WL-5559
WT-210-0047	Thyr	WL-3C23	CE-303	Thyr	WL-566A	CV632	Trans	WL-829B
WT-210-0051	V R	WL-OA2	CE-306	Thyr	WL-C6H-1	NL-632B	Thyr	WL-632C
WT-210-0054	Thyr	WL-5830	F-307A	Trans	WL-207	WL-632B	Thyr	WL-632C
WT-210-0056	Thyr	WL-5559	CE-308	Thyr	WL-C6H-1	KU-634	Thyr	WL-677
WT-210-0057	Thyr	WL-632C	ML-308	Trans	WL-5668	CV635	Trans	WL-833A
WT-210-0058	Thyr	KU-676	ML-308R	Trans	WL-5669	NL-635	Rect	WL-7019
WT-210-0059	Thyr	WL-677	B309	I R	WL-6679	WT-635	Thyr	WL-C6H-1
WT-210-0062	Thyr	WL-5557	CE-309	Thyr	WL-5557	NL-635L	Rect	WL-7020
WT-210-0063	Thyr	WL-5685	CE-311	Thyr	WL-3C23	NL-635P	Rect	WL-6930
WT-210-0066	Thyr	WL-5665	WL-319A	Rect	WL-872A	CV642	Rect	WL-872A
WT-210-0069	Thyr	WL-5557	WE-319A	Rect	WL-872A	KX-642	Glow	KX-642
WT-210-0070	Ig	WL-5550	CE-320	Thyr	WL-7307A	CV644	Rect	WL-575A
WT-210-0071	Ig	WL-5551A	320A	Thyr	WL-7307A	WL-651	Ig	WL-5552A
WT-210-0072	Ig	WL-5552A	B329	I R	WL-6680	WL-652	Ig	WL-5551A
WT-210-0073	Ig	WL-5553B	B339	I R	WL-6681	WL-653	Ig	WL-5555
WT-210-0074	Thyr	WL-105	F-353A	Rect	WL-872A	WL-653A	Ig	WL-5555
WT-210-0075	Ig	WL-5822A	F-357A	Rect	WL-857B	WL-653B	Ig	WL-5555
WT-210-0077	Thyr	WL-5727	F-357B	Rect	WL-8575	DF654	I R	WL-5678
WT-210-0078	Thyr	WL-172	F-363A	Trans	WL-892	WL-655	Ig	WL-5553B
WT-210-0079	Thyr	WL-105	F-366A	Rect	WL-866A	WL-656	Ig	WL-5552A
WT-210-0086	Trans	WL-833A	WE-366A	Rect	WL-866A	WL-657	Ig	WL-5551A
WT-210-0093	Trans	WL-5668	F-369B	Rect	WL-869B	WL-658	Ig	WL-5553B
WT-210-0100	Thyr	WL-672A	WT-373	Rect	WL-7018	CV664	I R	WL-9002
WT-210-0106	Thyr	WL-7306A	F-375A	Rect	WL-575A	K1-664	Rect	WL-4B24
WT-210-0116	Thyr	WL-632C	WT-382	Rect	WL-872A	WL-670	Rect	WL-670
WT-210-0120	Thyr	KU-610	Q400-1	Trans	WL-5D22	WL-672	Thyr	WL-672A
WT-210-0134	Thyr	WL-678	WE-403A	I R	WL-5654	GL-672	Thyr	WL-672A
WT-210-0141	Thyr	WL-5796	WE-409A	I R	WL-6AS6	672	Thyr	WL-672A
WT-210-0147	Ig	WL-5552A	GL-414	Thyr	WL-414	GL-672A	Thyr	WL-672A
WT-210-0149	Ig	WL-5551A	WL-414	Thyr	WL-414	WL-672A	Thyr	WL-672A
WT-210-0152	Ig	WL-5553B	GL-415	Ig	WL-5550	672A	Thyr	WL-672A
WT-210-0156	Ig	WL-5551A	GL426	Rect	WL-7018	GL-673	Rect	WL-673
WT-210-0157	Ig	WL-5552A	WT-439	Thyr	WL-172	ML-673	Rect	WL-673
WT-210-0158	Ig	WL-5551A	440	Rect	WL-7018	ML-673	Rect	WL-673
WT-210-0159	Ig	WL-5552A	444	Rect	WL-3822	673	Rect	WL-673
WT-210-0162	Thyr	WL-7509A	GL452	Trans	WL-892	KU-676	Thyr	KU-676
WT-210-0165	Ig	WL-5553B	WL-456	Rect	WL-456	676	Thyr	KU-676
WT-210-0170	Ig	WL-5822A	GL-473	Trans	WL-5736	WL-677	Thyr	WL-677
WT-210-0179	Thyr	WL-C6H-1	ML-473	Trans	WL-5736	677	Thyr	WL-677
WT-210-0183	Thyr	WL-7556A	WL-473	Trans	WL-5736	GL-678	Thyr	WL-678
WT-210-0188	Thyr	WL-6014	X-474	Trans	WL-2C39A	WL-678	Thyr	WL-678
WT-210-0234	Thyr	WL-5665	WL-481	Rect	WL-481B	678	Thyr	WL-678
WT-210-0245	Thyr	WL-C6H-2	WL-481A	Rect	WL-481B	WL-679	Ig	WL-5554
WT-210-0246	Ig	WL-7681	WL-481B	Rect	WL-481B	WL-681	Ig	WL-5550
WT-210-0249	Ig	WL-5551APC	GL-490	Rect	WL-7016	WL-682	Ig	WL-5550
WT-210-0252	Ig	WL-5552APC	CV491	I R	WL-6189	CV685	V R	WL-OD3
WT-210-0274	Ig	WL-7669	495	Rect	WL-7016	CV686	V R	WL-OC3
WT-210-0275	Ig	WL-7671	GL-506	Ig	WL-6228	WL-686	Ig	WL-5550
WT-210-0283	Ig	WL-7670	GL-509	Trans	WL-889A	WL-689	Ig	WL-6228
WT-210-0285	Ig	WL-7671PC	GL-509R	Trans	WL-5667	CV691	Rect	WL-575A
WT-210-0290	Ig	WL-7669PC	GL-510	Rect	WL-857B	WT-699	Ig	WL-5550
WT-210-0306	Ig	WL-5553B	GL-512	Rect	WL-575A	NL-710	Thyr	WL-7307A
AH213	Rect	WL-869B	GL-512A	Rect	WL-575A	NL-710L	Thyr	WL-7509A
CE-213	Rect	WL-7018	VH-550A	Rect	WL-866A	NL-715	Thyr	WL-5557
CE-213A	Rect	WL-7018	VX-550A	Rect	WL-3828	CV717	Rect	WL-5R4GYA
CV216	V R	WL-OD3	P552/1E	Trans	WL-4D21	D717	I R	WL-6663
VT216	Rect	WL-816	QM559	I R	WL-5726	T717	I R	WL-5557
VR216A	Rect	WL-866A	WT-568	Rect	WL-7018	CV724	Rect	WL-816
AH217	Rect	WL-872A	CK-569AX	I R	WL-5678	N727	I R	WL-6669
VT217	Trans	WL-811A	CK-571AX	I R	WL-5886	W727	I R	WL-6660
CE-220	Rect	WL-481B	GL-572	Trans	WL-2C39A	ML-728	Thyr	WL-5557
CE-221	Rect	WL-670	ZP-572	Trans	WL-2C39A	DC728A	Thyr	WL-627
CE-222	Rect	WL-3B22	DR-575A	Rect	WL-575A	XC728A	Thyr	WL-627
AX-224	Rect	WL-3B28	EE-575A	Rect	WL-575A	NL-730	Thyr	WL-22994
CE-224	Rect	WL-4B24	F-575A	Rect	WL-575A	731A	I R	WL-5654
Z-225	Rect	WL-866A	GL-575A	Rect	WL-575A	EF734	I R	WL-6205
VT229	I R	WL-5691	ML-575A	Rect	WL-575A	NL-734	Thyr	WL-22994
ECC-230	I R	WL-6080	WL-575A	Rect	WL-575A	NL-740	Thyr	WL-6856
230N	Rect	WL-5558	575A	Rect	WL-575A	NL-740L	Thyr	WL-7022
VT231	I R	WL-5692	WL-579	Rect	WL-579B	NL-740P	Thyr	WL-6857

Direct Interchangeability List

continued



TUBE TYPE MARKED	CLASS OF TUBE	EQUIVALENT WESTINGHOUSE TYPE	TUBE TYPE MARKED	CLASS OF TUBE	EQUIVALENT WESTINGHOUSE TYPE	TUBE TYPE MARKED	CLASS OF TUBE	EQUIVALENT WESTINGHOUSE TYPE
WL-741	Photo	WL-923	866	Rect	WL-866A	WL-920	Photo	WL-920
WL-759	Glow	WL-759	C866A	Rect	WL-866A	TX-920	Thyr	WL-5559
NL-760	Thyr	WL-C6H-1	CE-866A	Rect	WL-866A	920	Photo	WL-920
NL-760L	Thyr	WL-7023	EE-866A	Rect	WL-866A	UL-905	Thyr	WL-5559
NL-760P	Thyr	WL-6859	GL-866A	Rect	WL-866A	GL-922	Photo	WL-922
NL-761	Thyr	WL-C6H-1	HF-866A	Rect	WL-866A	WL-922	Photo	WL-922
NL-762	G A	WL-762	ML-866A	Rect	WL-866A	922	Photo	WL-922
WL-765	G A	WL-765	NU-866A	Rect	WL-866A	GL-923	Photo	WL-923
WL-765A	G A	WL-765A	RCA-866A	Rect	WL-866A	WL-923	Photo	WL-923
XB767A	Thyr	WL-2050	RK-866A	Rect	WL-866A	923	Photo	WL-923
CV788	Trans	WL-832A	T-866A	Rect	WL-866A	GL-927	Photo	WL-927
CV797	Thyr	WL-2D21	UE-866A	Rect	WL-866A	WL-927	Photo	WL-927
ECC801S	S P	WL-6201	WL-866A	Rect	WL-866A	927	Photo	WL-927
DR-807	Trans	WL-807	866A	Rect	WL-866A	GL-929	Photo	WL-1P39
GL-707	Trans	WL-807	HY-866JR	Rect	WL-816	WL-929	Photo	WL-1P39
GL-807	Trans	WL-807	NU-866JR	Rect	WL-816	929	Photo	WL-1P39
807	Trans	WL-807	866JR	Rect	WL-816	GL-930	Photo	WL-930
DR-810	Trans	WL-810	UV-869	Rect	WL-869B	WL-930	Photo	WL-930
GL-810	Trans	WL-810	869	Rect	WL-869B	930	Photo	WL-930
ML-810	Trans	WL-810	UV-869A	Rect	WL-869B	931	Photo	WL-931A
T-810	Trans	WL-810	869A	Rect	WL-869B	GL-931A	Photo	WL-931A
UE-810	Trans	WL-810	CE-869B	Rect	WL-869B	WL-931A	Photo	WL-931A
WL-810	Trans	WL-810	DR-869B	Rect	WL-869B	931A	Photo	WL-931A
810	Trans	WL-810	EE-869B	Rect	WL-869B	UE-966	Rect	WL-866A
DR-811	Trans	WL-811A	F-869B	Rect	WL-869B	UE-966A	Rect	WL-866A
GL-811	Trans	WL-811A	GL-869B	Rect	WL-869B	BM-966B	Rect	WL-866A
NU-811	Trans	WL-811A	ML-869B	Rect	WL-869B	HV-966B	Rect	WL-866A
WL-811	Trans	WL-811A	WL-869B	Rect	WL-869B	NU-967	Thyr	WL-5557
811	Trans	WL-811A	869B	Rect	WL-869B	UE-967	Thyr	WL-5557
GL-811A	Trans	WL-811A	WL869BL	Rect	WL-869BL	UE-972	Rect	WL-872A
WL-811A	Trans	WL-811A	869BL	Rect	WL-869BL	UE-972A	Rect	WL-872A
811A	Trans	WL-811A	872	Rect	WL-872A	UE-975A	Rect	WL-575A
DR-812	Trans	WL-812A	DR-872A	Rect	WL-872A	SN976	I R	WL-5902
GL-812	Trans	WL-812A	EE-872A	Rect	WL-872A	SN976D	I R	WL-5902
NU-812	Trans	WL-812A	F-872A	Rect	WL-872A	RG1000/3000	Rect	WL-872A
WL-812	Trans	WL-812A	GL-872A	Rect	WL-872A	Stel-1000-2.5-15	Thyr	WL-5559
812	Trans	WL-812A	ML-872A	Rect	WL-872A	RS-1007	Trans	WL-4D21
GL-812A	Trans	WL-812A	RK-872A	Rect	WL-872A	WT-1009	Ig	WL-7681
WL-812A	Trans	WL-812A	UE-872A	Rect	WL-872A	NL-1009A	Ig	WL-7681
812A	Trans	WL-812A	WL-872A	Rect	WL-872A	NL-1009AP	Ig	WL-7681PC
DR-813	Trans	WL-813	872A	Rect	WL-872A	NL-1011A	Ig	WL-23011
GL-813	Trans	WL-813	T-875A	Rect	WL-575A	NL-1011AP	Ig	WL-23011PC
ML-813	Trans	WL-813	879	Rect	WL-2X2A	NL-1012A	Ig	WL-23012
RK-813	Trans	WL-813	GL-880	Trans	WL-5658	NL-1012AP	Ig	WL-23012PC
T-813	Trans	WL-813	ML-880	Trans	WL-5658	NL-1013A	Ig	WL-23013
UE-813	Trans	WL-813	UE-880	Trans	WL-5658	NL-1016	Ig	WL-23016
WL-813	Trans	WL-813	WL-880	Trans	WL-5658	NL-1022	Ig	WL-5822A
813	Trans	WL-813	880	Trans	WL-5658	WT-1022	Ig	WL-5822A
GL-815	Trans	WL-815	889	Trans	WL-889A	NL-1022A	Ig	WL-5822A
WL-815	Trans	WL-815	F-889A	Trans	WL-889A	D1031A	Trans	WL-8045
815	Trans	WL-815	GL-889A	Trans	WL-889A	NL-1036	Ig	WL-7171
DR-816	Rect	WL-816	ML-889A	Trans	WL-889A	B-1038	C R	10WP7A
GL-816	Rect	WL-816	UE-889A	Trans	WL-889A	NL-1051	Ig	WL-5551A
WL-816	Rect	WL-816	WL-889A	Trans	WL-889A	NL-1051A	Ig	WL-5551A
816	Rect	WL-816	889A	Trans	WL-889A	WT-1051A	Ig	WL-5551A
CV822	Rect	WL-4B24	889R	Trans	WL-5667	NL-1051P	Ig	WL-5551APC
GL-829	Trans	WL-829B	F-889RA	Trans	WL-5667	WT-1051P	Ig	WL-5551APC
NU-829	Trans	WL-829B	GL-889RA	Trans	WL-5667	NL-1052	Ig	WL-5552A
RK-829	Trans	WL-829B	ML-889RA	Trans	WL-5667	NL-1052A	Ig	WL-5552A
829A	Trans	WL-829B	UE-889RA	Trans	WL-5667	WT-1052A	Ig	WL-5552A
GL-829B	Trans	WL-829B	WL-889RA	Trans	WL-5667	NL-1052P	Ig	WL-5552APC
ML-829B	Trans	WL-829B	889RA	Trans	WL-5667	WT-1052P	Ig	WL-5552APC
RK-829B	Trans	WL-829B	F-891	Trans	WL-891	NL-1053	Ig	WL-5553B
WL-829B	Trans	WL-829B	GL-891	Trans	WL-891	WT-1053A	Ig	WL-5553B
829B	Trans	WL-829B	ML-891	Trans	WL-891	WT-1053P	Ig	WL-5553BPC
T830B	Photo	WL-930	UE-891	Trans	WL-891	CV1060	Trans	WL-807
GL-832	Trans	WL-832A	WL-891	Trans	WL-891	NL-1061	Ig	WL-7669
NU-832	Trans	WL-832A	891	Trans	WL-891	NL-1061P	Ig	WL-7669PC
832	Trans	WL-832A	F-891R	Trans	WL-891R	NL-1062	Ig	WL-7671
DR-832A	Trans	WL-832A	GL-891R	Trans	WL-891R	NL-1066	Ig	WL-7670
GL832A	Trans	WL-832A	ML-891R	Trans	WL-891R	NL-1071	Ig	WL-23014
ML-832A	Trans	WL-832A	UE-891R	Trans	WL-891R	NL-1071P	Ig	WL-23014PC
RK-832A	Trans	WL-832A	WL-891R	Trans	WL-891R	NL-1072	Ig	WL-23015
WL-832A	Trans	WL-832A	891R	Trans	WL-891R	NL-1072P	Ig	WL-23015PC
832A	Trans	WL-832A	F-892	Trans	WL-892	NL-1073	Ig	WL-23017
WL-833	Trans	WL-833A	GL-892	Trans	WL-892	CV1075	I R	WL-5881
833	Trans	WL-833A	ML-892	Trans	WL-892	NL-1079	Ig	WL-23018
DR-833A	Trans	WL-833A	UE-892	Trans	WL-892	CV1088	Trans	WL-832A
GL-833A	Trans	WL-833A	WL-892	Trans	WL-892	CK-1090	Glow	WL-5823
ML-833A	Trans	WL-833A	892	Trans	WL-892	C-1108	Trans	WL-4D21
RK-833A	Trans	WL-833A	DR-892R	Trans	WL-892R	CV1144	Thyr	WL-5557
WL-833A	Trans	WL-833A	F-892R	Trans	WL-892R	K-1195P7	C R	7ABP7A
833A	Trans	WL-833A	GL-892R	Trans	WL-892R	QS-1206	V R	WL-OC3
CV850	I R	WL-6654	ML-892R	Trans	WL-892R	QS-1207	V R	WL-0A2
S-856	V R	WL-0A2	UE-892R	Trans	WL-892R	1220	I R	WL-5654
857	Rect	WL-857B	WL-892R	Trans	WL-892R	1295	Thyr	WL-632C
F-857A	Rect	WL-857B	892R	Trans	WL-892R	Stel-1300-01-05	Thyr	WL-2D21
GL-857A	Rect	WL-857B	GL-895	Trans	WL-895	K-1304P7	C R	7ABP7A
857A	Rect	WL-857B	ML-895	Trans	WL-895	CV1364	Trans	WL-807
DR-857B	Rect	WL-857B	WL-895	Trans	WL-895	CV1374	Trans	WL-807
F-857B	Rect	WL-857B	895	Trans	WL-895	1381HQ	I R	WL-5654
GL-857B	Rect	WL-857B	GL-895R	Trans	WL-895R	CV1474	Photo	WL-927
ML-857B	Rect	WL-857B	ML-895R	Trans	WL-895R	Z1494	I R	WL-5654
WL-857B	Rect	WL-857B	WL-895R	Trans	WL-895R	Z1498	I R	WL-6189
857B	Rect	WL-857B	895R	Trans	WL-895R	ME-1504	Thyr	WL-5559
S-859	V R	WL-OC2	Z900T	Glow	WL-5823	CV1572	Trans	WL-807
F-863	Trans	WL-892	EAA901	I R	WL-6663	GL-1614	I R	WL-5881
RCA863	Trans	WL-892	S901C	V R	WL-5651	RK-1614	I R	WL-5881
F-863A	Trans	WL-892	EAA901S	I R	WL-6663	1614	I R	WL-5881
C866	Rect	WL-866A	CV904	Trans	WL-892R	1657	Thyr	WL-2050
UX-866	Rect	WL-866A	EF905	I R	WL-5654	1665	Thyr	WL-2050
			UL-905	Thyr	WL-5559	1672	Thyr	WL-172

Direct Interchangeability List

continued



TUBE TYPE MARKED	CLASS OF TUBE	EQUIVALENT WESTINGHOUSE TYPE	TUBE TYPE MARKED	CLASS OF TUBE	EQUIVALENT WESTINGHOUSE TYPE	TUBE TYPE MARKED	CLASS OF TUBE	EQUIVALENT WESTINGHOUSE TYPE
HF-1701	Thyr	WL-5557	A-4051G	Trans	WL-807	GL-5552	Ig	WL-5552A
CV1730	I R	WL-5881	A-4051J	Trans	WL-807	NL-5552	Ig	WL-5552A
CV1832	Rect	WL-OA2	CV4054	I R	WL-5654	PL-5552	Ig	WL-5552A
ZV-1798	V R	WL-5973	4078F	Rect	WL-8698	WL-5552	Ig	WL-5552A
CV1833	V R	WL-OB2	4078Z	Rect	WL-8698B	WT-5552	Ig	WL-5552A
A-1834	I R	WL-6080	WX-4113	G A	WL-22618	5552	Ig	WL-5552A
CV1835	Rect	WL-3B28	4260	Thyr	WL-5557	AJ-5552A	Ig	WL-5552A
E-1870	Trans	WL-4D2I	426I	Thr	WL-5557	GL-5552A	Ig	WL-5552A
1971	Trans	WL-207	A4273B	I R	WL-5692	NL-5552A	Ig	WL-5552A
2014	I R	WL-6197	WX-4424	G A	WL-22614	PL-5552A	Ig	WL-5552A
CV2020	I R	WL-5654	WX-4433	Rect	WL-22800	VJ-5552A	Ig	WL-5552A
GL-2050	Thyr	WL-2050A	WX-4433A	Rect	WL-22800	WL-5552A	Ig	WL-5552A
RK-2050	Thyr	WL-2050A	WX-4436	HCDD	WL-22602	5552A	Ig	WL-5552A
WL-2050	Thyr	WL-2050A	WX-4451	G A	WL-22620	WL-5552APC	Ig	WL-5552APC
2050	Thyr	WL-2050A	A446I	I R	WL-6660	AX-5553	Ig	WL-5553B
GL-2050A	Thyr	WL-2050A	A4475	I R	WL-6AS7GA	GL-5553	Ig	WL-5553B
WL-2050A	Thyr	WL-2050A	WX-4484	HCDD	WL-22603	WL-5553	Ig	WL-5553B
2050A	Thyr	WL-2050A	WX-4492	Rect	WL-22801	5553	Ig	WL-5553B
RK-2051	Thyr	WL-2050	A-4522A	I R	WL-6681	GL-5553A	Ig	WL-5553B
2051	Thyr	WL-2050	A4524A	I R	WL-6681	5553A	Ig	WL-5553B
CV2129	Trans	WL-5763	A-4535	I R	WL-6080	AJ-5553B	Ig	WL-5553B
CV2130	Trans	WL-4D2I	A-4535A	I R	WL-6080	GL-5553B	Ig	WL-5553B
CV2131	Trans	WL-5D22	A-4541H	Trans	WL-5763	WL-5553B	Ig	WL-5553B
CV2210	Thyr	WL-22994	WX-4580	HCDD	WL-22604	VJ-5553B	Ig	WL-5553B
CV2215	Thyr	WL-C6H-J	WX-4586	Rect	WL-22802	WL-5553B	Ig	WL-5553B
A-2251A	Trans	WL-5667	WL-4620	HCDD	WL-22605	5553B	Ig	WL-5553B
A2251B	Trans	WL-5667	WX-4650	HCDD	WL-22606	WL-5553BPC	Ig	WL-5553BPC
QA2404	I R	WL-6663	WX-4651	HCDD	WL-22607	AX-5554	Ig	WL-5554
QA2408	I R	WL-5692	WX-4659	HCDD	WL-22608	GL-5554	Ig	WL-5554
Stel-2500-6-40	Thyr	WL-105	WX-4663	HCDD	WL-22609	WL-5554	Ig	WL-5554
CV2522	I R	WL-5725	WX-4664	HCDD	WL-22610	5554	Ig	WL-5554
CV2523	I R	WL-6AS7GA	WX-4680	HCDD	WL-22804	AX-5555	Ig	WL-5555
CV2565	Thyr	WL-2050	WX-4688	HCDD	WL-22809	GL-5555	Ig	WL-5555
CV2573	V R	WL-5651	WX-4689	HCDD	WL-22811	WL-5555	Ig	WL-5555
CV2575	I R	WL-5670	WX-4715A	Trans	WL-22803	5555	Ig	WL-5555
CV2578	I R	WL-5687	WX-4743	HCDD	WL-22663	WL-5555A	Ig	WL-5555A
CV2650	I R	WL-12AY7	WX-4748	HCDD	WL-22811	5555A	Ig	WL-5555A
CV2661	Trans	WL-812A	WX-4836	N	WL-22792	AX-5557	Thyr	WL-5557
CV2663	Trans	WL-815	WX-4930	HCDD	WL-22812	GL-5557	Thyr	WL-5557
CV2666	Trans	WL-829B	WX-4931A	HCDD	WL-22822	WL-5557	Thyr	WL-5557
CV2679	Rect	WL-816	WX-4932	HCDD	WL-22813	5557	Thyr	WL-5557
CV2685	Trans	WL-5658	WX-4933	HCDD	WL-22815	GL-5558	Rect	WL-5558
CV2686	Trans	WL-889A	WX-4934	HCDD	WL-22805	NL-5558	Rect	WL-5558
CV2688	Trans	WL-891R	WX-4936	HCDD	WL-22816	WL-5558	Rect	WL-5558
CV2694	Photo	WL-IP40	WX-4937	HCDD	WL-22817	5558	Rect	WL-5558
CV2695	Photo	WL-931A	WX-4972	HCDD	WL-22818	AX-5559	Thyr	WL-5559
CV2696	Photo	WL-931A	ASG5017	Thyr	WL-5557	GL-5559	Thyr	WL-5559
CV2723	Rect	WL-869B	PA-5021	Rect	WL-866A	NL-5559	Thyr	WL-5559
CV2753	Thyr	WL-7306A	TH5021B	Rect	WL-866A	WL-5559	Thyr	WL-5559
CV2754	Thyr	C6H-I	ASG5023	Thyr	WL-3C23	5559	Thyr	WL-5559
CV2790	Thyr	WL-6014	CV5027	Thyr	WL-5559	5560	Thyr	WL-632B
CV2957	Thyr	WL-5557	TH5031B	Rect	WL-872A	GL-5561	Rect	WL-5561
CV2963	Trans	WL-4D2I	CV5043	Trans	WL-811A	WL-5561	Rect	WL-5561
CV2964	Trans	WL-5D22	WX-5059	N	WL-22791	5561	Rect	WL-5561
CV2984	I R	WL-6080	WX-5073	HCDD	WL-22819	ML-5575	Rect	WL-5575
CV-2990	I R	WL-6136	ASG512I	Thyr	WL-2D21	WL-5575	Rect	WL-5575
3069	Rect	WL-866A	WX-5382	HCDD	WL-22820	ML-5576	Rect	WL-5576
3070	Rect	WL-872A	WX-5399	HCDD	WL-22821	WL-5576	Rect	WL-5576
3071	Rect	WL-869B	WX-5434	HCDD	WL-22838	5591	I R	WL-5654
WX-3072	Rect	WL-670	WX-5463	HCDD	WL-22823	AX-5604	Trans	WL-5604
3072	Rect	WL-857B	WX-5464	HCDD	WL-22824	ML-5604	Trans	WL-5604
WX-3141	Thyr	WL-676	WX-5471	HCDD	WL-22825	WL-5604	Trans	WL-5604
WX-3172	Thyr	WL-672A	WX-5472	HCDD	WL-22826	5604	Trans	WL-5604
WX-3187	Thyr	WL-414	WX-5485	HCDD	WL-22827	ML-5606	Trans	WL-5606
WX-3194	Ig	WL-5550	WX-5486	HCDD	WL-22828	WL-5606	Trans	WL-5606
XRI-3200	Thyr	WL-22994	WX-5487	HCDD	WL-22829	5606	Trans	WL-5606
WX-3230	Thyr	WL-678	WX-5488	HCDD	WL-22830	ML-5606A	Trans	WL-5606A
CV3508	I R	WL-620I	WX-5489	HCDD	WL-22831	WL-5606A	Trans	WL-5606A
CV3512	Thyr	WL-5696	WX-5490	HCDD	WL-22832	5606A	Trans	WL-5606A
CV3523	Trans	WL-6146A	WL-5513	Trans	WL-5513	ML-5619	Trans	WL-5619
3546PW	Photo	WL-927	5513	Trans	WL-5513	WL-5619	Trans	WL-5619
3572	Trans	WL-829B	WL5530	Trans	WL-5530	5619	Trans	WL-5619
CV3599	I R	WL-12AY7	5530	Trans	WL-5530	GL-5625	Rect	WL-5575
CV3650	Trans	WL-807	ASG-5544	Thyr	WL-22994	5625	Rect	WL-5575
CV3679	I R	WL-5693	GL-5544	Thyr	WL-22994	GL-5632	Thyr	WL-7307A
CV3699	Thyr	WL-5796	5544	Thyr	WL-22994	5632	Thyr	WL-7307A
CV3706	Trans	WL-832A	ASG-5545	Thyr	WL-C6H-I	5640	I R	WL-5902
CV3714	Rect	WL-2X2A	GL-5545	Thyr	WL-C6H-I	5648	Trans	WL-2C39B
CV3748	C R	SCEPII	5545	Thyr	WL-C6H-I	GL-5651	V R	WL-5651
WX-3751	Rect	WL-866A	AX-5550	Ig	WL-5550	WL-5651	V R	WL-5651
CV3798	V R	WL-OA3	GL-5550/415	Ig	WL-5550	5651	V R	WL-5651
CV3815	Rect	WL-3B22	NL-5550	Ig	WL-5550	CK-5654	V R	WL-5654
3874A	Trans	WL-813	WL-5550	Ig	WL-5550	GL-5654	I R	WL-5654
CV3880	Trans	WL-4-1000A	WT-5550	Ig	WL-5550	WL-5654	I R	WL-5654
3885A	Rect	WL-3B28	5550	Ig	WL-5550	5654	S P	WL-5654
CV3900	I R	WL-5963	AJ-5551	Ig	WL-5551A	ML-5658	Trans	WL-5658
CV3908	I R	WL-6661	AX-5551	Ig	WL-5551A	WL-5658	Trans	WL-5658
CV3930	I R	WL-5718	GL-5551	Ig	WL-5551A	5658	Trans	WL-5658
CV3942	I R	WL-5692	NL-5551	Ig	WL-5551A	WL-5684	Thyr	WL-5684
CV3974	I R	WL-6AS7GA	PL-5551	Ig	WL-5551A	5664	Thyr	WL-5664
WX-3989	C S	WL-7383	VJ-5551	Ig	WL-5551A	GL-5665	Thyr	WL-5665
CV3990	Trans	WL-2E26	WL-5551	Ig	WL-5551A	WL-5665	Thyr	WL-5665
CV4003	I R	WL-6189	WT-5551	Ig	WL-5551A	5655	Thyr	WL-5665
CV4010	I R	WL-5654	5551	Ig	WL-5551A	F-5667	Trans	WL-5667
CV4011	I R	WL5725	AJ-5551A	Ig	WL-5551A	ML-5667	Trans	WL-5667
CV4016	I R	WL-5814A	AX-5551A	Ig	WL-5551A	WL-5667	Trans	WL-5667
CV4017	I R	WL-5751	GL-5551A	Ig	WL-5551A	5667	Trans	WL-5667
CV4018	Rect	WL-866A	PL-5551A	Ig	WL-5551A	F-5668	Trans	WL-5668
CV4018	Thyr	WL-5727	WL-5551A	Ig	WL-5551A	ML-5668	Trans	WL-5668
CV4032	I R	WL-5814A	5551A	Ig	WL-5551A	WL-5668	Trans	WL-5668
CV4050	I R	WL-5654	WL-5551APC	Ig	WL-5551APC	5668	Trans	WL-5668
A-4051	Trans	WL-807	AX-5552	Ig	WL-5552A	F-5669	Trans	WL-5669

Direct Interchangeability List

continued



TUBE TYPE MARKED	CLASS OF TUBE	EQUIVALENT WESTINGHOUSE TYPE	TUBE TYPE MARKED	CLASS OF TUBE	EQUIVALENT WESTINGHOUSE TYPE	TUBE TYPE MARKED	CLASS OF TUBE	EQUIVALENT WESTINGHOUSE TYPE
ML-5669	Trans	WL-5669	5932	I R	WL-5881	6347	Ig	WL-5552A
WL-5669	Trans	WL-5669	5933	Trans	WL-807	6348	Ig	WL-5553A
5669	Trans	WL-5669	WL-5934	Rect	WL-5934	WL-6376	N	WL-6376A
CK-5678	I R	WL-5678	WL-5936	Trans	WL-5936	WL-6376A	N	WL-6376A
WL-5678	I R	WL-5678	GL-5963	I R	WL-5963	WL-6377	N	WL-6377
5678	I R	WL-5678	WL-5963	I R	WL-5963	WL-6379	Trans	WL-6379
WL-5682	Trans	WL-5682	5963	I R	WL-5963	6379	Trans	WL-6379
5682	Trans	WL-5682	GL-5964	I R	WL-5964	F-6399	Trans	WL-6399
5683	Thyr	WL-6014	WL-5964	I R	WL-5964	WL-6399	Trans	WL-6399
WL-5684	Thyr	WL-7306A	5964	I R	WL-5964	6399	Trans	WL-6399
NL-5684NE	Thyr	WL-5684NE	GL-5965	I R	WL-5965	XRI-6400	Thyr	WL-C6H-I
WL-5684NE	Thyr	WL-5684NE	WL-5965	I R	WL-5965	XRI-6400A	Thyr	WL-C6H-I
5684NE	Thyr	WL-5684NE	5965	I R	WL-5965	ML-6420	Trans	WL-6420
AX-5685	Thyr	WL-5685	WL-5966	G A	WL-5966	WL-6420	Trans	WL-6420
WL-5685	Thyr	WL-5685	GL-5973	Rect	WL-5973	6420	Trans	WL-6420
5685	Thyr	WL-5685	WL-5973	Rect	WL-5973	WL-6421	Trans	WL-6421
GL-5687	I R	WL-5687	5973	Rect	WL-5973	WL-6421	Trans	WL-6421
WL-5687	I R	WL-5687	WL-5986	Trans	WL-5986A	6421	Trans	WL-6421
5687	I R	WL-5687	WL-5986A	Trans	WL-5986A	ML-6421F	Trans	WL-6421F
GL-5691	I R	WL-5691	6005	I R	WL-6669	WL-6421F	Trans	WL-6421F
WL-5691	I R	WL-5691	GL-6011	Thyr	WL-7307A	6421F	Trans	WL-6421F
5691	I R	WL-5691	PL-6011	Thyr	WL-7307A	ML-6422	Trans	WL-6422
GL-5692	I R	WL-5692	TH-6011	Thyr	WL-5557	WL-6422	Trans	WL-6422
WL-5692	I R	WL-5692	WL-6011	Thyr	WL-7307A	6422	Trans	WL-6422
5692	I R	WL-5692	6011	Thyr	WL-7307A	ML-6423	Trans	WL-6423
GL-5693	I R	WL-5693	WL-6012	Thyr	WL-6012	WL-6423	Trans	WL-6423
WL-5693	I R	WL-5693	6012	Thyr	WL-6012	6423	Trans	WL-6423
5693	I R	WL-5693	GL-6014	Thyr	WL-6914	ML-6423F	Trans	WL-6423F
GL-5696	Thyr	WL-5696	WL-6014	Thyr	WL-6014	WL-6423F	Trans	WL-6423F
WL-5696	Thyr	WL-5696	6014	Thyr	WL-6014	6423F	Trans	WL-6423F
5696	Thyr	WL-5696	GL-6021	I R	WL-6021	ML-6424	Trans	WL-6424
GL-5720	Thyr	WL-5720	WL-6021	I R	WL-6021	WL-6424	Trans	WL-6424
NL-5720	Thyr	WL-5720	6021	I R	WL-6021	6424	Trans	WL-6424
WL-5720	Thyr	WL-5720	R6025	C R	IOFPA	ML-6425	Trans	WL-6425
5720	Thyr	WL-5720	TH-6031	Thyr	WL-5559	WL-6425	Trans	WL-6425
5725	I R	WL-6AS6	6057	I R	WL-5751	6425	Trans	WL-6425
5726	I R	WL-6663	6058	I R	WL-6663	ML-6425F	Trans	WL-6425F
GL-5727	Thyr	WL-5727	6060	I R	WL-6679	WL-6425F	Trans	WL-6425F
WL-5727	Thyr	WL-5727	6062	Trans	WL-5763	6425F	Trans	WL-6425F
5727	Thyr	WL-5727	6067	I R	WL-5814A	ML-6426	Trans	WL-6426
GL-5736	Trans	WL-5736	GL-6072	I R	WL-6072	WL-6426	Trans	WL-6426
ML-5736	Trans	WL-5736	WL-6072	I R	WL-6072	6426	Trans	WL-6426
WL-5736	Trans	WL-5736	6072	I R	WL-6072	ML-6427	Trans	WL-6427
5736	Trans	WL-5736	6073	V R	WL-0A2WA	WL-6427	Trans	WL-6427
GL-5749	I R	WL-6660	6074	V R	WL-0B2WA	6427	Trans	WL-6427
5749	I R	WL-6660	WL-6080	I R	WL-6080	GL-6511	Rect	WL-575A
GL-5751	I R	WL-5751	6080	I R	WL-6080	6511	Rect	WL-575A
WL-5751	I R	WL-5751	6096	I R	WL-5654	6520	I R	WL-6080
5751	I R	WL-5751	6097	I R	WL-6663	WL-6550	I R	WL-6550
WL-5762	Trans	WL-5762	6113	I R	WL-5691	6550	I R	WL-6550
5762	Trans	WL-5762	TH-6120	Thyr	WL-105	WL-6567	Trans	WL-6567
GL-5763	Trans	WL-5763	GL-6136	I R	WL-6136	6567	Trans	WL-6567
WL-5763	Trans	WL-5763	WL-6136	I R	WL-6136	6582	I R	WL-5654
5763	Trans	WL-5763	6136	I R	WL-6136	WL-6623	Trans	WL-6623
GL-5771	Trans	WL-5771	GL-6146	Trans	WL-6146A	6623	Trans	WL-6623
ML-5771	Trans	WL-5771	R6146	Rect	WL-8008	6626	V R	WL-0A2WA
WL-5771	Trans	WL-5771	WL-6146	Trans	WL-6146A	6627	V R	WL-0B2WA
5771	Trans	WL-5771	6146	Trans	WL-6146A	GL-6660	I R	WL-6660
CK5783	V R	WL-5651	WL-6146A	Trans	WL-6146A	WL-6660	I R	WL-6660
WL-5796	Thyr	WL-5796	6146A	Trans	WL-6146A	6660	I R	WL-6660
CK-5814	I R	WL-5814A	6155	Trans	WL-4D21	GL-6661	I R	WL-6661
5814	I R	WL-5814A	6156	Trans	WL-5D22	WL-6661	I R	WL-6661
GL-5814A	I R	WL-5814A	GL-6159	Trans	WL-6159	6661	I R	WL-6661
WL-5814A	I R	WL-5814A	WL-6159	Trans	WL-6159	GL-6662	I R	WL-6662
5814A	I R	WL-5814A	6159	Trans	WL-6159	WL-6662	I R	WL-6662
GL-5822	Ig	WL-5822A	WL-6166A	Trans	WL-7007	6662	I R	WL-6662
NL-5822	Ig	WL-5822A	6166A	Trans	WL-7007	GL-6663	I R	WL-6663
WL-5822	Ig	WL-5822A	R6175B	Rect	WL-5R4-GYB	WL-6663	I R	WL-6663
5822	Ig	WL-5822A	6180	S P	WL-5692	6663	I R	WL-6663
GL-5822A	Ig	WL-5822A	6187	S P	WL-6AS6	GL-6664	I R	WL-6664
NL-5822A	Ig	WL-5822A	GL-6189	S P	WL-6189	WL-6664	I R	WL-6664
WL-5822A	Ig	WL-5822A	WL-6189	S P	WL-6189	6664	I R	WL-6664
5822A	Ig	WL-5822A	6189	S P	WL-6189	GL-6669	I R	WL-6669
WL-5823	Glow	WL-5823	WL-6197	S P	WL-6197	WL-6669	I R	WL-6669
5823	Glow	WL-5823	6197	S P	WL-6197	6669	I R	WL-6669
GL-5830	Thyr	WL-5830	GL-6198	C S	See 6198A	GL-6676	I R	WL-6676
WL-5830	Thyr	WL-5830	WL-6198	C S	See 6198A	WL-6676	I R	WL-6676
5830	Thyr	WL-5830	6198	C S	See 6198A	6676	I R	WL-6676
WL-5859	Rect	WL-5859	GI-6198A	C S	See 6198A	GL-6677	I R	WL-6677
WL-5860	Rect	WL-5859	ML-6198A	C S	See 6198A	WL-6677	I R	WL-6677
WL-5877	Thyr	WL-22994	WL-6198A	C S	See 6198A	6677	I R	WL-6677
WL-5878	Thyr	WL-C6H-I	6198A	C S	See 6198A	GL-6678	I R	WL-6678
GL-5879	I R	WL-5879	R6200	Thyr	WL-7038	WL-6678	I R	WL-6678
WL-5879	I R	WL-5879	GL-6201	I R	WL-2021	6678	I R	WL-6678
5879	I R	WL-5879	6201	I R	WL-6201	GL-6679	I R	WL-6679
GL-5881	I R	WL-5881	TH-6220	Thyr	WL-C6H-I	WL-6679	I R	WL-6679
WL-5881	I R	WL-58815881	GL-6228	Ig	WL-6228	6679	I R	WL-6679
5881	I R	WL-5881	WL-6228	Ig	WL-6228	GL-6680	I R	WL-6680
CK-5886	I R	WL-5886	6228	Ig	WL-6228	WL-6680	I R	WL-6680
WL-5886	I R	WL-5886	TH-6230	Thyr	WL-3C23	6680	I R	WL-6680
5886	I R	WL-5886	6265	I R	WL-6661	GL-6681	I R	WL-6681
WL-5891	Trans	WL-5891	WL-6293	Trans	WL-6293	WL-6681	I R	WL-6681
ML-5894	Trans	WL-5894	6293	Trans	WL-6293	6681	I R	WL-6681
WL-5894	Trans	WL-5894	WL-6307	N	WL-6307	AX-6693	Rect	WL-673
5894	Trans	WL-5894	TS-6336	I R	WL-6336A	6693	Rect	WL-673
GL-5902	I R	WL-5902	6336	I R	WL-6336A	WL-6696	Trans	WL-6696
WL-5902	I R	WL-5902	TS-6336A	I R	WL-6336A	6696	Trans	WL-6696
5902	I R	WL-5902	WL-6336A	I R	WL-6336A	WL-6697	Trans	WL-6697
5902A	I R	WL-5902	6336A	I R	WL-6336A	6697	Trans	WL-6697
F-5918A	Trans	WL-5919A	AJ-6346	Ig	WL-5551A	GL-6807	Thyr	WL-6807
WL-5918A	Trans	WL-5918A	6346	Ig	WL-5551A	WL-6807	Thyr	WL-6807
5918A	Trans	WL-5918A	AJ-6347	Ig	WL-5552A	6807	Thyr	WL-6807

Direct Interchangeability List

continued



TUBE TYPE MARKED	CLASS OF TUBE	EQUIVALENT WESTINGHOUSE TYPE	TUBE TYPE MARKED	CLASS OF TUBE	EQUIVALENT WESTINGHOUSE TYPE	TUBE TYPE MARKED	CLASS OF TUBE	EQUIVALENT WESTINGHOUSE TYPE
GL-6808	Thyr	WL-6808	WL-7321	Thyr	WL-7321	AX-9903	Trans	WL-5894
WL-6808	Thyr	WL-6808	F-7328	Trans	WL-7328A	WL-22602	HCDD	WL-22602
6808	Thyr	WL-6808	WL-7328	Trans	WL-7328A	WL-22603	HCDD	WL-22603
GL-6829	I R	WL-5965	7328	Trans	WL-7328A	WL-22604	HCDD	WL-22604
6829	I R	WL-5965	WL-7328A	Trans	WL-7328A	WL-22605	HCDD	WL-22605
GL-6856	Thyr	WL-6856	WL-7353	N	WL-7353	WL-22606	HCDD	WL-22606
WL-6856	Thyr	WL-6856	WL-7363	Thyr	WL-7363	WL-22607	HCDD	WL-22607
6856	Thyr	WL-6856	WL-7383	C S	WL-7383	WL-22608	HCDD	WL-22608
GL-6857	Thyr	WL-6857	7386	Thyr	WL-C6H-1	WL-22609	HCDD	WL-22609
WL-6857	Thyr	WL-6857	VH7400	Rect	WL-872A	WL-22610	HCDD	WL-22610
6857	Thyr	WL-6857	WL-7413	Trans	WL-7413	WL-22611	HCDD	WL-22611
GL-6858	Thyr	WL-6858	WL-7463	Trans	WL-7463	WL-22612	G A	WL-22612
WL-6858	Thyr	WL-6858	WL-7464	Trans	WL-7464	WL-22613	G A	WL-22613
6858	Thyr	WL-6858	C7473D	C R	5FP7A	WL-22614	G A	WL-22614
GL-6859	Thyr	WL-6859	ML-7482	Trans	WL-7482	WL-22618	G A	WL-22618
WL-6859	Thyr	WL-6859	WL-7482	Trans	WL-7482	WL-22619	G A	WL-22619
6859	Thyr	WL-6859	7482	Trans	WL-7482	WL-22620	G A	WL-22620
GL-6860	Thyr	WL-6860	WL-7509	Thyr	WL-7509A	WL-22627	G A	WL-22627
WL-6860	Thyr	WL-6860	WL-7509A	Thyr	WL-7509A	WL-22637	G A	WL-22637
6860	Thyr	WL-6860	GL-7518	Thry	WL-7509A	WL-22640	G A	WL-22640
6864	Thyr	WL-C6H-1	WL-7540	Trans	WL-7540	WL-22643	G A	WL-22643
6871	Thyr	WL-C6H-2	7543	I R	WL-6136	WL-22663	HCDD	WL-22663
GL-6883	Trans	WL-8032	WL-7556	Thyr	WL-7556A	WL-22754	G A	WL-22754
WL-6883	Trans	WL-8032	WL-7556A	Thyr	WL-7556A	WL-22759	Trans	WL-22759
WL-6893	Trans	WL-6893	ML-7560	Trans	WL-7560	WL-22789	Trans	WL-22789
6893	Trans	WL-6893	WL-7560	Trans	WL-7560	WL-22791	N	WL-22791
6900	Trans	WL-5687	7560	Trans	WL-7560	WL-22792	N	WL-22792
WL-6922	I R	WL-6922	WL-7560V	Trans	WL-7560V	WL-22793	N	WL-22793
6922	I R	WL-6922	WL-7565	Trans	WL-7565	WL-22800	Rect	WL-22800
6928	I R	WL-6669	GL-7581	I R	WL-5881	WL-22801	Rect	WL-22801
WL-6937	I R	WL-6937A	7581	I R	WL-5881	WL-22802	Rect	WL-22802
WL-6938	N	WL-6938	AX-7585	Ig	WL-5552A	WL-22803	Trans	WL-22803
WL-6939	N	WL-6939	7585	Ig	WL-5552A	WL-22804	HCDD	WL-22804
6939	N	WL-6939	WL-7604	Trans	WL-7604	WL-22805	HCDD	WL-22805
WL-6941	Trans	WL-6941A	WL-7606	N	WL-7606	WL-22806	HCDD	WL-22806
WL-6941A	Trans	WL-6941A	WL-7657	N	WL-7657	WL-22809	HCDD	WL-22809
6968	N	WL-5654	WL-7658	Rect	WL-7658	WL-22810	HCDD	WL-22810
WL-6971	N	WL-6971A	WL-7659	Rect	WL-7659	WL-22811	HCDD	WL-22811
WL-6971A	I R	WL-6971A	WL-7676	G A	WL-7676	WL-22812	HCDD	WL-22812
6982	N	WL-7015	WL-7685	Trans	WL-7685	WL-22813	HCDD	WL-22813
6984	N	WL-6856	WL-7691	Trans	WL-7691	WL-22814	HCDD	WL-22814
6985	Rect	WL-6857	WL-7703	Ig	WL-7703	WL-22815	HCDD	WL-22815
6988	Thyr	WL-7321	7703	Ig	WL-7703	WL-22816	HCDD	WL-22816
WL-6998	Thyr	WL-6998	7725	Thyr	WL-7307A	WL-22817	HCDD	WL-22817
NL-7014	Thyr	WL-7014	7726	Thyr	WL-7509A	WL-22818	HCDD	WL-22818
WL-7014	N	WL-7014	7735	C S	WL-7735A	WL-22819	HCDD	WL-22819
7014	Rect	WL-7014	WL-7735A	C S	WL-7735A	WL-22820	HCDD	WL-22820
NL-7015	Rect	WL-7015	7735A	C S	WL-7735A	WL-22821	HCDD	WL-22821
WL-7015	Rect	WL-7015	WL-7740	Ig	WL-7740	WL-22822	HCDD	WL-22822
7015	Rect	WL-7015	WL-7741	N	WL-7741	WL-22823	HCDD	WL-22823
NL-7016	Rect	WL-7016	WL-7748	Trans	WL-7748	WL-22824	HCDD	WL-22824
WL-7016	Rect	WL-7016	WL-7750	Trans	WL-7750	WL-22825	HCDD	WL-22825
7016	Rect	WL-7016	7752	I R	WL-6A56	WL-22826	HCDD	WL-22826
NL-7017	Rect	WL-7017	WL-7903	G A	WL-7903	WL-22827	HCDD	WL-22827
WL-7017	Rect	WL-7017	WL-7904	G A	WL-7904	WL-22828	HCDD	WL-22828
7017	Rect	WL-7017	WL-7982	Trans	WL-7982	WL-22829	HCDD	WL-22829
NL-7018	Rect	WL-7018	DR-8008	Rect	WL-8008	WL-22830	HCDD	WL-22830
WL-7018	Rect	WL-7018	EE-8008	Rect	WL-8008	WL-22831	HCDD	WL-22831
7018	Rect	WL-7018	GL-8006	Rect	WL-8008	WL-22832	HCDD	WL-22832
NL-7019	Rect	WL-7019	ML-8008	Rect	WL-8008	WL-22833	HCDD	WL-22833
WL-7019	Rect	WL-7019	UE-8008	Rect	WL-8008	WL-22834	HCDD	WL-22834
7019	Rect	WL-7019	WL-8008	Rect	WL-8008	WL-21835	HCDD	WL-21835
NL-7020	Rect	WL-7020	8008	Rect	WL-8008	WL-22836	HCDD	WL-22836
TH-7020	Ig	WL-5551A	8018	Trans	WL-807	WL-22837	HCDD	WL-22837
WL-7020	Rect	WL-7020	8024	Trans	WL-832A	WL-22838	HCDD	WL-22838
7020	Rect	WL-7020	WL-8032	Trans	WL-8032	WL-22839	HCDD	WL-22839
TH-7021	Ig	WL-5551A	WL-8043	Thyr	WL-8043	WL-22840	HCDD	WL-22840
NL-7023	Thyr	WL-7023	WL-8044	Trans	WL-8044	WL-22841	HCDD	WL-22841
WL-7023	Thyr	WL-7023	WL-8057	G A	WL-8057	WL-22842	HCDD	WL-22842
7023	Thyr	WL-7023	WL-8073	N	WL-8073	WL-22843	HCDD	WL-22843
TH-7030	Ig	WL-5552A	WL-8074	N	WL-0874	WL-22844	HCDD	WL-22844
TH-7031	Ig	WL-5552A	WL-8075	N	WL-8075	WL-22845	HCDD	WL-22845
WL-7038	C S	WL-7038	M8079	I R	WL-6663	WL-22846	HCDD	WL-22846
7038	C S	WL-7038	WL-8094	Rect	WL-8094	WL-22847	HCDD	WL-22847
TH-7040	Ig	WL-5553B	M8100	I R	WL-5654	WL-22848	HCDD	WL-22848
TH7041	Ig	WL-5553B	M8101	I R	WL-6660	WL-22849	HCDD	WL-22849
WL-7087	N	WL-7087	WL-8105	N	WL-8105	WL-22850	HCDD	WL-22850
WL-7087A	N	WL-7087A	M8136	I R	WL-6189	WL-22851	HCDD	WL-22851
7136	Rect	WL-575A	M8137	I R	WL-5751	WL-22856	HCDD	WL-22856
GL-7171	Ig	WL-7171	WL-8137	N	WL-8137	WL-22857	HCDD	WL-22857
WL-7171	Ig	WL-7171	8161	Trans	WL-8161	WL-22858	HCDD	WL-22858
7171	Ig	WL-7171	M8162	I R	WL-6201	WL-22859	HCDD	WL-22859
WL-7186	N	WL-7186	8166	Trans	WL-4-1000A	WL-22860	HCDD	WL-22860
WL-7187	N	WL-7187	8170	Trans	WL-4CX5000A	WL-22862	Trans	WL-23185
WL-7188	N	WL-7188	M8178	Thyr	WL-5727	WL-22863	HCDD	WL-22863
WL-7203	Trans	WL-4CX250B	M8196	I R	WL-6A56	WL-22864	HCDD	WL-22864
7203	Trans	WL-4CX250B	M8204	Thyr	WL-5727	WL-22867	HCDD	WL-22867
WL-7215	Trans	WL-7215	M8212	I R	WL-6663	WL-22868	G A	WL-22868
7216	Thyr	WL-7556A	M8214	I R	WL-6681	WL-22869	G A	WL-22869
WL-7243	N	WL-7243	WL-8214	N	WL-8214	WL-22870	HCDD	WL-22870
WL-7255	Trans	WL-7255	M8223	V R	WL-0A2	WL-22871	HCDD	WL-22871
WL-7268	C S	WL-7268A	M8245	I R	WL-6669	WL-22872	HCDD	WL-22872
7268	C S	WL-7268A	8251	Trans	WL-8251	WL-22873	HCDD	WL-22873
WL-7269	Thyr	8043	8298	Trans	WL-8298	WL-22874	HCDD	WL-22874
WL-7290	C S	WL-7290	WL-8298A	Trans	WL-8298A	WL-22875	HCDD	WL-22875
WL-7297	Thyr	WL-23052	8298A	Trans	WL-8298A	WL-22876	HCDD	WL-22876
WL-7299	Thyr	WL-C6H-2	WL-8306	Ig	WL-8306	WL-22877	HCDD	WL-22877
WL-7306	Thyr	WL-7306A	8348	Trans	WL-4-400A	WL-22878	HCDD	WL-22878
WL-7306A	Thyr	WL-7306A	WL-8461	Trans	WL-8461	WL-22879	HCDD	WL-22879
WL-7307	Thyr	WL-7307A	GL-9002	I R	WL-9002	WL-22880	HCDD	WL-22880
WL-7307A	Thyr	WL-7307A	WL-9002	I R	WL-9002	WL-22881	HCDD	WL-22881
7316	I R	WL-6189	9002	I R	WL-9002	WL-22882	HCDD	WL-22882
WL-7317	N	WL-7317						



Direct Interchangeability List

continued

TUBE TYPE MARKED	CLASS OF TUBE	EQUIVALENT WESTINGHOUSE TYPE	TUBE TYPE MARKED	CLASS OF TUBE	EQUIVALENT WESTINGHOUSE TYPE	TUBE TYPE MARKED	CLASS OF TUBE	EQUIVALENT WESTINGHOUSE TYPE
WL-22883	HCDD	WL-22883	WL-22952	HCDD	WL-22952	WL-23015	Ig	WL-23015
WL-22884	HCDD	WL-22884	WL-22953	HCDD	WL-22953	WL-23015PC	Ig	WL-23015PC
WL-22885	HCDD	WL-22885	WL-22954	HCDD	WL-22954	WL-23016	Ig	WL-23016
WL-22886	HCDD	WL-22886	WL-22955	HCDD	WL-22955	WL-23017	Ig	WL-23017
WL-22887	HCDD	WL-22887	WL-22956	HCDD	WL-22956	WL-23018	Ig	WL-23018
WL-22888	HCDD	WL-22888	WL-22957	HCDD	WL-22957	WL-23027	Ig	WL-23027
WL-22889	HCDD	WL-22889	WL-22958	HCDD	WL-22958	WL-23028	HCDD	WL-23028
WL-22890	HCDD	WL-22890	WL-22959	HCDD	WL-22959	WL-23029	HCDD	WL-23029
WL-22891	HCDD	WL-22891	WL-22960	HCDD	WL-22960	WL-23034	Rect	WL-23034
WL-22892	HCDD	WL-22892	WL-22961	HCDD	WL-22961	WL-23035	HCDD	WL-23035
WL-22893	HCDD	WL-22893	WL-22962	HCDD	WL-22962	WL-23036	HCDD	WL-23036
WL-22894	HCDD	WL-22894	WL-22963	HCDD	WL-22963	WL-23041	HCDD	WL-23041
WL-22895	HCDD	WL-22895	WL-22964	HCDD	WL-22964	WL-23042	HCDD	WL-23042
WL-22896	HCDD	WL-22896	WL-22965	HCDD	WL-22965	WL-23046	HCDD	WL-23046
WL-22897	HCDD	WL-22897	WL-22966	HCDD	WL-22966	WL-23049	HCDD	WL-23049
WL-22898	HCDD	WL-22898	WL-22967	HCDD	WL-22967	WL-23059	HCDD	WL-23059
WL-22899	HCDD	WL-22899	WL-22968	HCDD	WL-22968	WL-23060	HCDD	WL-23060
WL-22900	HCDD	WL-22900	WL-22969	HCDD	WL-22969	WL-23063	Trans	WL-23063
WL-22901	HCDD	WL-22901	WL-22970	HCDD	WL-22970	WL-23095	Rect	WL-23095
WL-22902	HCDD	WL-22902	WL-22971	HCDD	WL-22971	WL-23102	Rect	WL-23102
WL-22903	HCDD	WL-22903	WL-22972	HCDD	WL-22972	WX-30008	HCDD	WL-22806
WL-22904	HCDD	WL-22904	WL-22973	HCDD	WL-22973	WX-30009	HCDD	WL-22833
WL-22905	HCDD	WL-22905	WL-22974	HCDD	WL-22974	WX-30010	HCDD	WL-22834
WL-22906	HCDD	WL-22906	WL-22975	HCDD	WL-22975	WX-30011	HCDD	WL-22835
WL-22907	HCDD	WL-22907	WL-22976	HCDD	WL-22976	WX-30024	HCDD	WL-22837
WL-22908	HCDD	WL-22908	WL-22977	HCDD	WL-22977	WX-30040	HCDD	WL-22843
WL-22909	HCDD	WL-22909	WL-22978	HCDD	WL-22978	WX-30041	HCDD	WL-22842
WL-22910	HCDD	WL-22910	WL-22979	HCDD	WL-22979	WX-30042	HCDD	WL-22836
WL-22911	HCDD	WL-22911	WL-22980	HCDD	WL-22980	WX-30043	HCDD	WL-22841
WL-22912	HCDD	WL-22912	WL-22981	HCDD	WL-22981	WX-30044	HCDD	WL-22840
WL-22913	HCDD	WL-22913	WL-22982	HCDD	WL-22982	WX-30052	HCDD	WL-22814
WL-22914	HCDD	WL-22914	WL-22983	HCDD	WL-22983	WX-30053	HCDD	WL-22844
WL-22915	HCDD	WL-22915	WL-22984	HCDD	WL-22984	WX-30054	HCDD	WL-22839
WL-22916	HCDD	WL-22916	WL-22985	HCDD	WL-22985	WX-30103	HCDD	WL-22845
WL-22917	HCDD	WL-22917	WL-22986	HCDD	WL-22986	WX-30104	HCDD	WL-22846
WL-22923	G A	WL-22923	WL-22987	HCDD	WL-22987	WX-30105	HCDD	WL-22867
WL-22925	HCDD	WL-22925	WL-22988	HCDD	WL-22988	WX-30106	HCDD	WL-22847
WL-22926	HCDD	WL-22926	WL-22989	HCDD	WL-22989	WX-30108	HCDD	WL-22848
WL-22927	HCDD	WL-22927	WL-22990	HCDD	WL-22990	WX-30143	HCDD	WL-22850
WL-22928	HCDD	WL-22928	WL-22991	HCDD	WL-22991	WX-30144	HCDD	WL-22849
WL-22929	HCDD	WL-22929	WL-22992	HCDD	WL-22992	WX-30145	HCDD	WL-22851
WL-22930	HCDD	WL-22930	WL-22997	HCDD	WL-22997	WX-30146	HCDD	WL-22857
WL-22931	HCDD	WL-22931	WL-22998	HCDD	WL-22998	WX-30147	HCDD	WL-22860
WL-22932	HCDD	WL-22932	WL-23007	HCDD	WL-23007	WX-30148	HCDD	WL-22859
WL-22933	HCDD	WL-22933	WL-23008	HCDD	WL-23008	WX-30213	HCDD	WL-23014
WL-22934	HCDD	WL-22934	WL-23009	HCDD	WL-23009	82170	Ig	10WP7A
WL-22935	HCDD	WL-22935	WL-23010	HCDD	WL-23010	175771	IR	WL-5814A
WL-22936	HCDD	WL-22936	WL-23011	HCDD	WL-23011	823623	IR	WL-6189
WL-22937	HCDD	WL-22937	WL-23011PC	Ig	WL-23011PC	845712	IR	WL-6681
WL-22938	HCDD	WL-22938	WL-23012	Ig	WL-23012	845722	IR	WL-6AS7GA
WL-22939	HCDD	WL-22939	WL-23012PC	Ig	WL-23012PC	845723	IR	WL-5881
WL-22940	HCDD	WL-22940	WL-23013	Ig	WL-23013	845724	IR	WL-5654
WL-22941	HCDD	WL-22941	WL-23013PC	Ig	WL-23013PC	845926	IR	WL-5654
WL-22942	HCDD	WL-22942	WL-23014	Ig	WL-23014		Trans	WL-5763
WL-22951	HCDD	WL-22951	WL-23014PC	Ig	WL-23014PC			

Inclusion of a tube type in this book does not necessarily imply availability of that type from Westinghouse. Although every effort has been made to ensure accuracy of these data, no liability is assumed for their use.

WESTINGHOUSE INDUSTRIAL AND POWER TUBES



KEY TO ABBREVIATIONS

A	Anode	IC	Internal Connection (Do NOT Use)	PK	Peak
Å	Angstrom Units	ITV	Industrial & Closed Circuit TV	PN	Pentode
AMP	Ampere (s)	K	Cathode	RAD	Radius
AVG	Average	KV	Kilovolt (s)	REFL	Reflector
CO	Cut-off	KVA	Kilovolt-Ampere (s)	RES	Resonator
COLL	Collector	KW	Kilowatt (s)	RP	Plate Resistance
COOL	Type of Cooling	LUM	Luminous	SEC	Second (s)
DIAM	Diameter	Ma	Milliamper (s)	SENS	Sensitivity
DISS	Dissipation	MAX	Maximum	T	Triode
DWG	Drawing	Mc	Megacycle (s)	Trig	Trigger Electrode
FREQ	Frequency	MIN	Minute	TV	Television Broadcasting
G	Grid	Min	Miniature	TYP	Typical
G1	Grid One	mmHG	Millimeters of Mercury	V	Volt (s)
G2	Grid Two	NC	No Connection	µA	Microampere (s)
G3	Grid Three	nv	Neutrons/cm ² /Second	µMHOS	Micromhos
GC	Gigacycle (s)	OAL	Overall Length	µSEC	Microsecond (s)
H	Heater	PC	Photocathode	°C	Degrees Centigrade

GUIDE TO BASE DRAWINGS

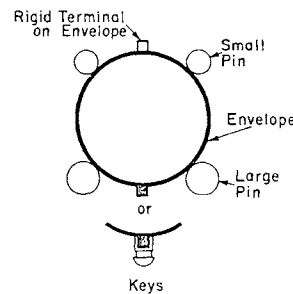

HIGH VACUUM AMPLIFIERS

TUBE TYPE	CODL	CATHODE		RATINGS (1)			PERFORMANCE						MECHANICAL			
		VOLTS	AMPS.	ANODE KV	INPUT KW	DISS. KW	FREQ. MHz ⁽³⁾	ANODE KV	GRID VOLTS	ANODE AMPS.	DRIVE WATTS	OUT KW	(4) gm or µ	MAX. OAL (2) INCH	MAX. DIAM. (2) INCH	BASE DWG.
WL-2C39A	F	6.3	1	1	125W	100W	2500	800V	-20(6)	80mA	6	27(5)	100	2 3/4	1 1/4	2AN
WL-2C39B	F	6.3	1	1	125W	100W	2500	800V	-20(6)	80mA	6	27(5)	100	2 3/4	1 1/4	2AN
WL-2E24	A	6.3	0.65	600V	40W	13.5W	125	600V	-50	66mA	0.21	27W	3200	3 3/32	1 3/16	7CL
WL-2E26	A	6.3	0.8	600V	40W	13.5W	125	600V	-45	66mA	0.17	27W	3500	3 3/32	1 3/16	7CK
WL-4CX250B	F	6	2.6	2	0.5	0.25	500	2	-90	0.25	1	0.4	12000	2 1/2	1 3/8	4V1
WL-4CX5000A	F	7.5	75	7.5	22.5	5	30	7.5	-350	2.8	150	16	—	9 1/8	4 13/16	VC2
WL-4D21	A	5	6.5	3	0.5	125W	120	3	-150	0.167	2.5	0.375	2450	5 11/16	2 3/4	5BK
WL-4-400A	A	5	14.5	4	1.4	0.4	110	4	-220	0.35	12	1.1	4000	6 3/8	3 1/8	5BK
WL-4-1000A	F	7.5	21	6	4.2	1	110	6	-200	0.7	200	3.4	10000	9 5/8	5 1/4	5BK
WL-5D22	F	5	14.5	4	1.4	0.25	110	4	-225	0.312	10	1	4000	6 3/8	3 1/8	5BK
WL-207	W	22	52	15	30	10	1.6	12	-1660	1.67	235	15	20	20 1/4	4 1/8	VF2
WL-807	A	6.3	0.9	600V	60W	25W	60	600V	-45	100mA	0.2	40W	6000	5 3/4	2 1/8	5AW
WL-810	A	10	4.5	2	0.5	125W	30	2	-160	0.25	12	0.375	36	8 3/4	2 1/8	2N
WL-811A	A	6.3	4	1.5	260W	65W	30	1.5	-70	0.173	7.1	0.2	160	6 3/32	2 1/8	3G
WL-812A	A	6.3	4	1.5	260W	65W	30	1.5	-120	0.173	6.5	0.19	29	6 13/32	2 1/8	3G
WL-813	A	10	5	2	0.36	100W	30	2	-120	0.18	1.9	0.275	3750	7 1/2	2 1/8	5BA
WL-815	A	12.6(8)	0.8	500V	75W	25W	150	500V	-45	0.15	0.18	56W	4000	4 7/8	2 3/8	8BY
WL-829B(7)	A	12.6(8)	1.125	750V	45W	15W	200	750V	-50	0.12	0.45	65W	8500	4 5/8	2 3/8	7BP
WL-832A(7)	A	12.6(8)	0.80	750V	18W	7.5W	200	750V	-65	48mA	0.19	26W	3500	3 3/8	2 3/8	7BP
WL-833A	F	10	10	4	1.8	0.4	20	4	-200	0.45	26	1.44	35	8 13/16	4 13/32	VP2
WL889A	W	11	120	8.5	16	5	50	7.5	-800	2	400	10	21	10 11/16	3 5/8	VP6
WL-891	W	22(9)	60	12	18	6	1.6	10	-2000	1.4	310	10	8.5	20 7/8	4 1/4	VP3
WL-891R	F	22(9)	60	10	15	4	1.6	10	-2000	1.4	310	10	8.5	22	12	VP3
WL-892	W	22(9)	60	15	30	10	1.6	12	-1600	1.64	500	14	50	20 7/8	4 1/4	VP3
WL-892R	F	22(9)	60	12.5	18	4	1.6	10	-1300	1.4	495	10	50	22	12	VP3
WL-895	W	19(10)	139	17	140	40	6	17	-1000	7.5	1700	100	37	23 3/8	6 3/4	VP4
WL-895R	F	19(10)	139	17	110	20	6	17	-1800	6	2200	84	37	24 1/2	17	VP5
WL-5513	F	6.3	30	4	3.6	1.2	220	3750	-150	0.94	64	2370	49	6 7/8	3	VC1
WL-5530	F	5	55	5	8.75	3	110	4	-300	1.25	130	3.2	26	7 23/32	5 3/32	3V4
WL-5604	F	11	176	12.5	32.5	10	25	12	-1170	2.5	470	22.5	20	13 3/4	8 1/8	VP6
WL-5606	W	22	60	14	25	10	1.6	12	-1100	1.8	—	15.5	50	16	4 1/8	VP7
WL-5606A	W	22	60	15	30	10	1.6	12	-1600	1.52	570	14.6	36	16	4 1/8	VP7
WL-5619	W	11	176	12.5	32.5	20	25	12	-1170	2.5	470	22.5	20	13	5 1/4	VP6
WL-5658	W	12	290	12.5	60	20	15	12	-870	4.5	800	40	20	11 1/2	7	VP8
WL-5666	W	11	120	10	20	12.5	22.5	9	-750	2	340	12.2	21	10 3/4	3 5/8	VP6
WL-5667	F	11	120	10	20	7.5	22.5	9	-750	2	340	12.2	21	11 3/4	11	VP6
WL-5668	W	22	60	14	28	20	5	12	-700	2	—	17	50	16	4 1/8	VP7
WL-5669	F	22	60	14	26	10	5	12	-700	2	—	17	50	17 1/8	8 1/8	VP7
WL-5682	W	16.5	325	16	300	120	30	15	-1400	18.4	7200	215	30	23 1/4	8 3/32	VC3

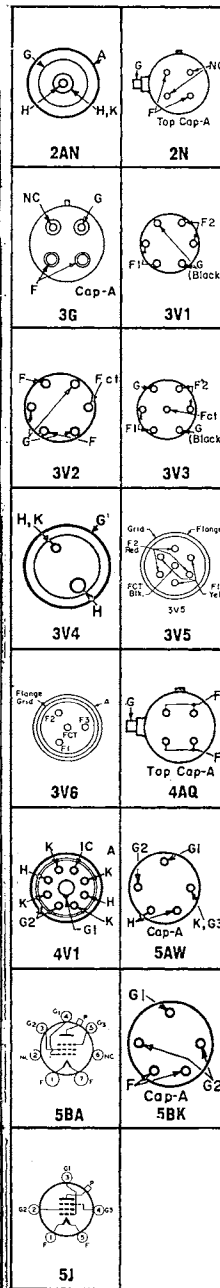



High Vacuum Amplifiers

continued

TUBE TYPE	COOL	CATHODE		RATINGS (1)			PERFORMANCE						MECHANICAL			
		VOLTS	AMPS.	ANODE KV	INPUT KW	DISS. KW	FREQ. MHz ⁽²⁾	ANODE KV	GRID VOLTS	ANODE AMPS.	DRIVE WATTS	OUT KW	(4) gm or μ	MAX. OAL (2) INCH	MAX. DIAM. (2) INCH	BASE DWG.
WL-5736	F	6	60	3.5	3.5	2.5	110	3.5	-300	1	85	2.55	22	7 $\frac{1}{4}$	3 $\frac{3}{16}$	VP9
WL-5762	F	12.6	29	6.2	8.7	3	30	6	-550	1.25	225	6	29	7 $\frac{1}{8}$	4 $\frac{1}{16}$	VF3
WL-5763	A	6	0.75	300V	15W	12W	50	300V	-60	50mA	0.35	7W	7000	2 $\frac{5}{8}$	$\frac{7}{8}$	9K
WL-5771	W	7.5	170	15	67.5	22.5	1.6	15	-990	4.5	1160	53	20	11 $\frac{1}{16}$	7	VP8
WL-5891	F	11	95	15	100	25	10	15	-1500	6.1	1785	73.5	36	24 $\frac{1}{2}$	11 $\frac{11}{16}$	VP5
WL-5894(7)	A	12.6	0.9	750V	60W	20W	250	600V	-80	200mA	3	90W	—	4 $\frac{5}{16}$	1 $\frac{15}{16}$	VPO
WL-5918A	W	11	285	17.5	300	70	22	17.5	-1000	13.8	3600	180	37	23 $\frac{3}{8}$	7 $\frac{1}{8}$	3V1
WL-5936	W	20	143	18	180	70	15	17	-1400	10	4500	136	37	23 $\frac{3}{8}$	8 $\frac{1}{8}$	VP5
WL-5966A	W	11	285	17.5	300	70	22	17.5	-1000	13.8	3600	180	37	24	8 $\frac{3}{32}$	VF4
WL-6146A	A	6.3	1.25	600V	67.5W	20W	60	600V	-58	112mA	0.2	52W	7000	3 $\frac{13}{16}$	1 $\frac{23}{32}$	7CK
WL-6146B	A	6.3	1.25	600V	90W	27W	60	600V	-70	0.15	0.3	63W	7000	3 $\frac{13}{16}$	1 $\frac{23}{32}$	7CK
WL-6159	A	26.5	0.30	600V	67.5W	20W	60	600V	-58	112mA	0.2	52W	7000	3 $\frac{13}{16}$	1 $\frac{23}{32}$	7CK
WL-6360	A	12.6(8)	0.41	300V	22.5W	10W	200	300V	-40	75mA	0.1	14.5W	3300	3 $\frac{1}{16}$	$\frac{7}{8}$	9HL
WL-6379(11)	W	11	285	17.5	150	70	Note 11	14.7	-3100	1.2 Min. 20 Max.	0	150	5	23 $\frac{3}{8}$	6 $\frac{3}{4}$	3V1
WL-6399	W	11	29	6.2	9	6	30	6	-800	1.4	210	6	25	8 $\frac{1}{2}$	2 $\frac{15}{16}$	3V2
WL-6420	W	7.0	85	10	20	12.5	30	9	-750	2	240	13.2	20	13 $\frac{3}{4}$	4 $\frac{1}{16}$	VC5
WL-6421	F	7	85	10	20	10	30	9	-750	2	240	13.2	20	17 $\frac{7}{8}$	4 $\frac{17}{32}$	VC6
WL-6421F	F	7	85	10	20	7.5	30	9	-750	2	240	13.2	20	14 $\frac{1}{2}$	8 $\frac{1}{8}$	VC5
WL-6422	W	7	85	12.5	30	20	30	12	-400	2.1	200	18.2	90	15 $\frac{1}{2}$	4 $\frac{1}{16}$	VC6
WL-6423	F	7	85	12.5	30	12.5	30	12	-400	2.1	200	18.2	90	15 $\frac{1}{4}$	5	VC6
WL-6423F	F	7	85	12.5	30	10	30	12	-400	2.1	200	18.2	90	16	8 $\frac{1}{8}$	VC5
WL-6424	W	7	120	12.5	40	20	30	12	-1000	3.3	430	30.6	20	15 $\frac{1}{2}$	4 $\frac{1}{16}$	VC6
WL-6425	F	7	120	12.5	40	12.5	30	12	-1000	3.3	430	30.6	20	15 $\frac{1}{4}$	5	VC6
WL-6425F	F	7	120	12.5	40	11	30	12	-1000	3.3	430	30.6	20	16	8 $\frac{1}{8}$	VC5
WL-6426	W	8	200	12.5	80	40	30	7.5	-850	5.3	7500	33	20	15 $\frac{5}{8}$	4 $\frac{3}{4}$	VC6
WL-6427	F	8	200	12.5	80	20	30	7.5	-850	5.3	7500	33	20	16 $\frac{1}{4}$	5 $\frac{1}{4}$	VC6
WL-6567	W	6	70	12	24	15	50	12	-800	1.94	445	19.3	33	11 $\frac{1}{4}$	3 $\frac{3}{4}$	VC7
WL-6623	F	6	60	5	5	2.5	30	5	-850	1	250	4.1	22	6 $\frac{1}{16}$	4 $\frac{1}{16}$	VF5
WL-6696	W	13	205	16	120	60	30	15	-1600	7	600	80	20	19 $\frac{3}{8}$	6 $\frac{1}{8}$	VC6
WL-6697	F	13	205	16	120	35	30	15	-1600	7	600	80	20	19 $\frac{3}{8}$	6 $\frac{1}{8}$	VC6
WL-6893	A	12.6	0.4	600V	40W	13.5W	125	600V	-45	66mA	0.17	27W	3500	3 $\frac{21}{32}$	1 $\frac{1}{16}$	7CK
WL-6939	A	6.3	0.6	250	12W	6W	500	180V	-20	55mA	1.2	5W	10500	2 $\frac{5}{8}$	$\frac{7}{8}$	9HL
WL-7120(11)	W	7	85	10	20	12.5	Note 11	10	-2350	0.6 Min. 4.2 Max.	0	21	4.4	13 $\frac{3}{8}$	4 $\frac{1}{16}$	VC6
WL-7121(11)	F	7	85	10	20	10	Note 11	10	-2350	0.6 Min. 4.2 Max.	0	21	4.4	13 $\frac{3}{8}$	4 $\frac{1}{2}$	VC6
WL-7203	F	6	2.3	2	—	250W	500	2	-90	0.25	1	0.4	—	2 $\frac{15}{32}$	1 $\frac{5}{8}$	4V1
WL-7215	W	6	60	9.2	18	9	30	9	-1400	2	337	13.6	22	8 $\frac{1}{2}$	3 $\frac{5}{8}$	VP9
WL-7255	W	6	60	9.2	18	9	30	9	-1400	2	337	13.6	22	9 $\frac{1}{2}$	3 $\frac{5}{8}$	VF5
WL-7328A(11)	F	7	245	10	50	20	Note 11	10	-2200	0.5 Min. 8.5 Max.	0	49.5	6	14 $\frac{1}{2}$	10 $\frac{1}{16}$	3V3
WL-7463	F	6	70	12	24	12	60	12	-800	1.94	445	19.3	33	9 $\frac{13}{16}$	11	VC7
WL-7464(11)	W	6	60	8	18	8	Note 11	7.5	-1200	0.3 Min. 2.68 Max.	0	10.8	6	9 $\frac{1}{2}$	3 $\frac{5}{8}$	VP9
WL-7482	V	14.5	450	20	600	200	30	20	-1000	29	6000	440	45	26	11 $\frac{3}{8}$	VC6
WL-7482V	V	14.5	450	20	600	200	30	20	-1000	29	6000	440	45	27 $\frac{1}{2}$	11 $\frac{3}{8}$	VC6
WL-7540(11)	W	5	250	15	70	35	Note 11	12.5	-2800	1 Min. 8 Max.	0	59	5	16	7 $\frac{1}{4}$	VF6
WL-7560	W	14.5	450	20	600	175	30	20	-1000	29	6000	440	45	29 $\frac{1}{2}$	10	VC6
WL-7560V	W	14.5	450	20	600	175	30	20	-1000	29	6000	440	45	36 $\frac{1}{2}$	10	VC6

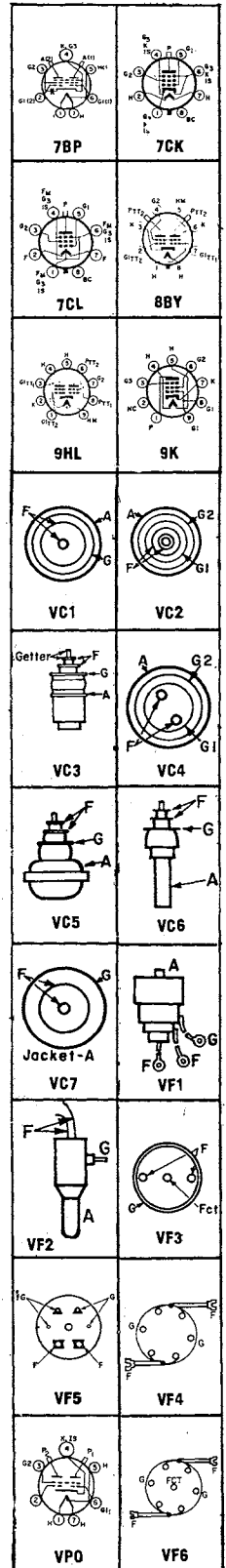

High Vacuum Amplifiers

continued



TUBE TYPE	COOL	CATHODE		RATINGS (1)			PERFORMANCE						MECHANICAL			
		VOLTS	AMPS.	ANODE KV	INPUT KW	DISS. KW	FREQ. MHz ⁽³⁾	ANODE KV	GRID VOLTS	ANODE AMPS.	DRIVE WATTS	OUT KW	(4) gm or μ	MAX. OAL (2) INCH	MAX. DIAM. (2) INCH	BASE DWG.
WL-7565(11)	F	6	60	5	5	2.5	Note 11	7	-1140	0.5 Min. 2.2 Max.	0	7.7	6	6 $\frac{1}{16}$	4 $\frac{1}{16}$	VF5
WL-7604(12)	F	5	8	4	1.5	0.6	60	3.5	-210	0.285	65	755	20	5 $\frac{1}{16}$	2 $\frac{1}{16}$	3V4
WL-7685(12)	F	5	8	4	1.5	0.6	60	4	-550	0.12 Min. 0.64 Max.	0	1550	6.5	5 $\frac{1}{16}$	2 $\frac{1}{16}$	3V4
WL-7748	W	8	150	12.5	80	35	30	12.5	-1300	4.25	970	46.5	20	15	7 $\frac{1}{4}$	3V3
WL-7982(11)	W	7	265	10	75	35	Note 11	10	-2200	0.5 Min. 9.3 Max.	61	65	5.5	15	6 $\frac{3}{8}$	3V3
WL-8032	A	13.5	0.585	600V	67.5W	20W	60	600V	-58	112mA	0.2	52W	7000	3 $\frac{1}{16}$	1 $\frac{23}{32}$	7CK
WL-8161/ 3CX2500A3	F	7.5	51.5	6	12	2.5	75	6	-500	2	136	10	22.5	9	4 $\frac{1}{8}$	VC1
WL-9251/ 3CX2500F3	F	7.5	51.5	6	12	2.5	30	6	-500	2	136	10	22.5	9	4 $\frac{1}{8}$	VF1
WL-8298	A	6.75	1.165	600V	67.5W	20W	60	600V	-58	112mA	0.2	52W	7000	3 $\frac{1}{16}$	1 $\frac{23}{32}$	7CK
WL-8298A	A	6.75	1.165	600V	90W	27W	60	600V	-70	0.15	0.3	63W	7000	3 $\frac{1}{16}$	1 $\frac{23}{32}$	7CK
WL-22759	W	6	60	9.2	18	9	30	9	-1400	2	337	13.6	22	9 $\frac{1}{2}$	3 $\frac{3}{8}$	VF5
WL-22789	W	6	60	9.3	21	9	30	9	-1400	2	337	13.6	22	9 $\frac{1}{2}$	3 $\frac{3}{8}$	VF5
WL-22803	W	13.5	550	22	600	200	15	20	-1400	30	8800	485	35	33 $\frac{1}{8}$	9 $\frac{1}{2}$	3V5
WL-22862	W	12.6	285	18	270	90	2	16	-1800	13.2	3250	150	22	24	8 $\frac{3}{2}$	VF4
WL-22924	V	12.6	285	18	270	100	2	16	-1800	13.2	3250	150	22	25	10	VF4
WL-23063	W	13.5(10)	375	25	1000	375	15	16	-1900 -2200	46 52.5	17KW 18KW	550 770	22	40	15	3V6
WL-23165	W	11(10)	95	15	150	90	10	15	-1500	6.1	1785	73.5	36	23 $\frac{7}{8}$	8 $\frac{1}{4}$	VP5

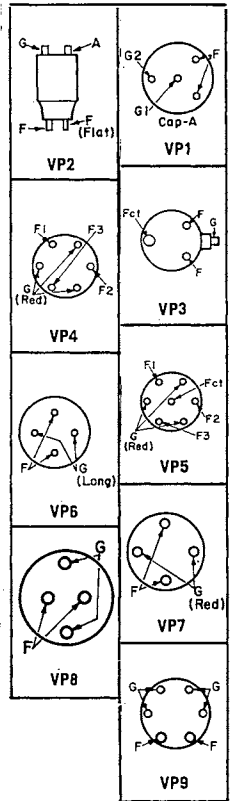

Notes

1. Ratings and Performance are based on CCS Class C Telegraphy service unless otherwise shown.
2. Excluding flying leads and protruding side terminals, pipes or handles.
3. Highest frequency for full input.
4. For triodes, amplification factor (μ) is shown; for tetrodes, beam tubes and pentodes, transconductance (gm) in micromhos is listed.
5. Watts output at 500 megahertz.
6. Milliwatts output at 3000 megahertz.
7. Twin unit tube, Ratings are each unit, Performance for both units.
8. Parallel heater connection requires half heater voltage and twice heater current.
9. For d-c and single phase a-c. For 2 phase a-c voltage per phase will be half listed value and current per phase will be listed current value.
10. Listed values of filament voltage and current are per phase for 3 phase operation.
11. Designed for audio and ultra-sonic service, Ratings are single tube Class AB and Performance is for 2 tubes Class AB.
12. Ratings and Performance are for Class AB r-f amplifier service.

COOLING CODE = A — RADIATION W — WATER
 F — FORCED AIR V — VAPOR

GAS AND MERCURY VAPOR RECTIFIERS

TUBE TYPE	CATHODE		RATINGS				COOL	MECHANICAL		
	VOLTS	AMPS.	INVERSE VOLTS	PEAK AMP.	AVG. AMP.	DROP VOLTS (2)		MAX. (1) OAL	MAX. DIAM.	BASE DWG.
WL-3B22	2.5	6	725	4.0	1.0	8	air	6"	1 $\frac{1}{32}$ "	4C
WL-3B28	2.5	5	10000	1.0	0.25	10	air	6 $\frac{3}{32}$ "	2 $\frac{1}{16}$ "	4P
WL-4B24	2.5	11.5	725	10.0	2.5	8	air	7 $\frac{1}{2}$ "	2 $\frac{3}{16}$ "	4BS
WL-575A	5.0	10	15000	6.0	1.5	10	air	11 $\frac{1}{16}$ "	3 $\frac{3}{16}$ "	4PS
WL-670	2.5	17	725	25.6	6.3	8	air	8"	2"	4BS
WL-673	5.0	10	15000	10.0	2.5	10	air	11 $\frac{1}{16}$ "	3 $\frac{1}{8}$ "	2P
WL-816	2.5	2	7500	0.5	0.125	15	air	4 $\frac{1}{16}$ "	1 $\frac{1}{16}$ "	4P
WL-857B(3)	5.0	30	22000	40.0	10.0	15	air	19 $\frac{7}{8}$ "	7 $\frac{1}{8}$ "	2FL
WL-866A	2.5	5	10000	1.0	0.25	15	air	6 $\frac{1}{16}$ "	2 $\frac{1}{16}$ "	4P
WL-869B	5.0	19	20000	10.0	2.5	15	air	14 $\frac{7}{8}$ "	5 $\frac{1}{8}$ "	2LP
WL-869BL(3)	5.0	19	20000	10.0	2.5	15	air	14 $\frac{7}{8}$ "	5 $\frac{1}{8}$ "	2LF
WL-872A	5.0	7.5	10000	5.0	1.25	15	air	8 $\frac{1}{2}$ "	2 $\frac{1}{16}$ "	4AT

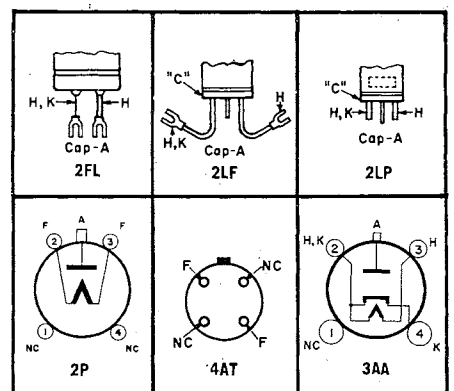

GAS AND MERCURY VAPOR RECTIFIERS

TUBE TYPE	CATHODE		RATINGS				MECHANICAL				
	VOLTS	AMPS.	INVERSE VOLTS	PEAK AMP.	AVG. AMP.	DROP VOLTS (2)	COOL.	MAX. (1) OAL	MAX. DIAM.	BASE DWG.	
WL-5558	5.0	4.5	5000	15.0	2.5	15	air	7"	3"	3W	
WL-5561	5.0	10	3000	40.0	6.4	15	air	11 $\frac{1}{4}$ "	3 $\frac{3}{16}$ "	3AA	
WL-6894	5.0	10	20000	11.5	2.5	25(4)	air	10 $\frac{1}{32}$ "	2 $\frac{5}{8}$ "	4AT	
WL-6895	5.0	10	20000	11.5	2.5	25(4)	air	10 $\frac{1}{32}$ "	2 $\frac{5}{8}$ "	2P	
WL-6930(3)	2.5	18	1000	77	6.4	9	air	8 $\frac{5}{8}$ "	2 $\frac{1}{4}$ " (5)	2P	
WL-7014(6)	2.5	11.5	900	10.0	2.5	10	air	7 $\frac{1}{2}$ "	2 $\frac{1}{16}$ "	4BS	
WL-7015(7)	2.5	11.5	900	10.0	2.5	10	air	7 $\frac{1}{2}$ "	2 $\frac{1}{16}$ "	4BS	
WL-7016(6)	2.5	17	900	25.6	6.4	10	air	8"	2 $\frac{1}{16}$ "	4BS	
WL-7017(7)	2.5	17	900	25.6	6.4	10	air	8 $\frac{5}{8}$ "	2 $\frac{1}{16}$ "	4BS	
WL-7018	2.5	7	2000	10.0	2.5	12	air	6 $\frac{1}{8}$ "	2 $\frac{1}{16}$ "	4P	
WL-7019	2.5	18	1000	77.0	6.4	9	air	9 $\frac{1}{2}$ "	2 $\frac{1}{16}$ "	2P	
WL-7020(8)	2.5	18	1000	77.0	6.4	9	air	9 $\frac{1}{2}$ "	2 $\frac{3}{16}$ "	2P	
WL-7659(3)	5.0	16.25	22000	40.0	10.0	15	air	17 $\frac{5}{8}$ "	7 $\frac{1}{2}$ "	2FL	
WL-8008	5.0	7.5	10000	5.0	1.25	15	air	8 $\frac{3}{4}$ "	2 $\frac{5}{16}$ "	2P	
WL-23029(3)	5.0	30	22000	40.0	10.0	15	air	19 $\frac{1}{8}$ "	7 $\frac{1}{8}$ "	2FL	

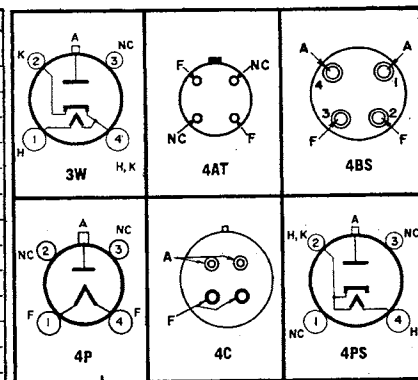
**Notes**

1. Excluding flying leads.
2. Average value at rated current.
3. Flying leads.
4. Max. value at rated peak current.
5. Excluding mounting bracket.
6. Twin units, ratings are per unit.
7. Lug-based, twin units, ratings are per unit.
8. Lug-based.

HIGH VACUUM RECTIFIERS

TUBE TYPE	NOTE	CATHODE		RATINGS				MECHANICAL		
		VOLTS	AMPS	INVERSE KV	PEAK MA	AVG. MA	DROP (3) VOLTS	MAX. OAL	MAX. DIAM.	BASE DWG.
WL-2X2A	(1)	2.5	1.75	12.5	60	7.5	240	4 $\frac{1}{32}$ "	1 $\frac{1}{16}$ "	4AB
WL-5R4-GYB	(1)	5	2	3100	715	150	123	4 $\frac{1}{4}$ "	1 $\frac{1}{16}$ "	5T
WL-102A	(1)	20.0	19	75	750	120	—	16 $\frac{1}{16}$ "	5 $\frac{1}{8}$ "	2B
WL-399	(2)	10.0	11.5	140	—	50	—	9 $\frac{3}{32}$ "	3 $\frac{3}{16}$ "	2B
WL-456	(1)	11.0	20	140	500	60	1760	19"	5 $\frac{1}{8}$ "	2B
WL-481B	(1)	2.5	5	25	150	30	80 (5)	4 $\frac{7}{8}$ "	1 $\frac{1}{16}$ "	4P
WL-579B	(1)	2.5	6	20	270	25	510	7 $\frac{1}{16}$ "	2 $\frac{1}{16}$ "	2P
WL-613	(1)	11.0	10	140	200	20	1040	19"	5 $\frac{1}{8}$ "	2SB
WL-836	(1)	2.5	5	5	1000	250	1800	6 $\frac{1}{16}$ "	2 $\frac{1}{16}$ "	2W
WL-5575	(1)	20.0	24	150	1000	160	525	25 $\frac{1}{4}$ "	6 $\frac{1}{8}$ "	2B
WL-5576	(1)	20.0	32	150	2500	400	1000	25 $\frac{1}{4}$ "	6 $\frac{1}{8}$ "	2B
WL-5859/5860	(2)	10.0	11.5	140	—	100	—	7 $\frac{7}{8}$ "	2 $\frac{1}{16}$ "	2B
WL-5934	(1)	2.5	6	20	270	25	520	6 $\frac{7}{8}$ "	2 $\frac{1}{16}$ "	4P
WL-5973	(1)	16.0	19.1	75	5000	1000	950	19 $\frac{1}{2}$ "	6 $\frac{1}{8}$ "	2B
WL-7658	(6)	4.0	6.8	125	750	150	900	8"	2 $\frac{1}{16}$ "	2B
WL-8094	(1)	12.0	23	110	10000	650	2500	25 $\frac{1}{4}$ "	6 $\frac{1}{8}$ "	2B
WL-22800	(7)	7	250	50	60A	20A	850	14 $\frac{1}{2}$ "	10 $\frac{1}{16}$ "	2V2
WL-22801	(7)	5	125	30	30A	10A	950	11"	6 $\frac{3}{32}$ "	2V3
WL-22802	(8)	7	250	50	60A	20A	850	15"	8 $\frac{1}{8}$ "	2V2
WL-23095(9)	(8)	9	132	30	—	3.5A	Note 9	12 $\frac{3}{16}$ "	4 $\frac{3}{8}$ "	2V3
WL-23102/102A	(1)	20	19	75	750	120	1800	16 $\frac{1}{8}$ "	5 $\frac{1}{8}$ "	2B
WL-23178(9)	(8)	16	32	15	—	2A	Note 9	9 $\frac{1}{2}$ "	4 $\frac{1}{2}$ "	2V4

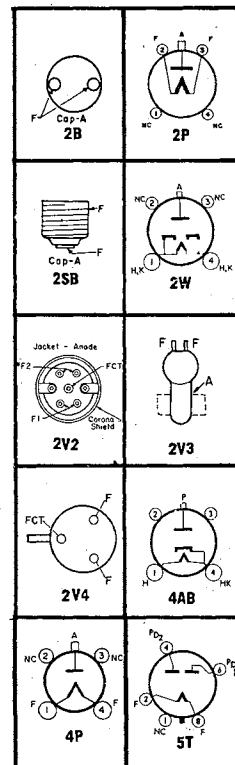
**Notes**

1. Air cooled.
2. Oil cooled for X-ray applications.
3. At bogey filament conditions and peak current.
4. Excluding leads.
5. Measured at 30 ma.
6. Oil cooled.
7. Forced air cooled.
8. Water cooled.
9. Control diode.

THYRATRONS



TUBE TYPE	CATHODE		FILL	RATINGS			MECHANICAL		
	VOLTS	AMPS		ANODE VOLTS	PEAK AMPS	AVG. AMPS	MAX. OAL	MAX. DIAM.	BASE DWG.
WL-2D21	6.3	0.6	gas	1300	0.5	0.1	2 1/8"	3/4"	7BN
WL-3C23	2.5	7.0	Hg.	1250	6.0	1.0	6 1/8"	2 1/16"	3G
WL-5C21	2.5	21	gas	1250	77	6.4	9 1/2"	2 3/32"	4AV
WL-C6H-1	2.5	21	gas	1700	80	6.4	8 3/4"	2 3/32"	4AV
WL-C6H-2	2.5	21	gas	1700	80	6.4	8"	2 3/32"	4AV(F)
WL-81A	2.5	5.0	gas	500	2.0	0.5	6 5/8"	2 1/16"	3G
WL-105	5.0	10	Hg.	2500	40	6.4	11 1/4"	2 3/16"	105
WL-172	5.0	10	Hg.	2000	40	6.4	18 7/8"	2 1/4"	3FL
WL-414	5.0	20	Hg.	2000	100	12.5	15 1/16"	3 3/8"	3FL
KU-610	2.5	6.5	gas	500	0.4	0.1	6 1/2"	2 1/16"	610
WL-624	5.0	10	Hg.	2500	80	6.4	11 1/8"	3 5/16"	4CE
WL-627	2.5	5	Hg.	5000	2.5	0.64	6 5/8"	2 1/16"	4AV
WL-629	2.5	2.6	gas	350	0.2	0.04	4 1/4"	1 1/16"	5A
WL-632C	5.0	5	Hg.	1500	30	2.5	8 3/4"	1 3/4"R	4CD
WL-672A	5.0	5	Hg.	2500	40	3.2	8 3/8"	2 5/16"	4CE
WL-676	5.0	10	Hg.	2500	40	6.4	11 3/4"	3 13/16"	4PB
WL-677	5.0	10	Hg.	10000	15	4.0	11 1/16"	3 13/16"	4PB
WL-678	5.0	7.5	Hg.	15000	6.0	1.6	11 3/16"	2 9/16"	3N
WL-2050	6.3	0.6	gas	1300	1.0	0.1	4 1/8"	1 1/16"	6BS
WL-2050A	6.3	0.6	gas	1300	1.0	0.1	3 3/4"	1 3/32"	6BS
WL-5557	2.5	5	Hg.	5000	2.0	0.5	6 1/8"	2 1/16"	3G
WL-5559	5.0	4.5	Hg.	1000	15	2.5	7 1/4"	3"	4BL
WL-5563A	5	10	Hg.	15000	10	1.8	10 1/2"	2 9/8"	3N
WL-5632	2.5	9	gas	1250	30	2.5	6"	1 9/8"	4CF
WL-5664	2.5	6.3	gas	1250	8.0	1.0	4 3/4"	1 1/16"	3G
WL-5665	2.5	31	gas	1250	160	16.0	11 1/4"	2 1/16"	3BF(F)
WL-5684NE*	2.5	9	gas	1250	30	2.5	5 11/16"	1 9/16"	4CF
WL-5685	2.5	21	gas	1250	77	6.4	9 1/2"	2 1/8"	4AV
WL-5696	6.3	0.15	gas	500	0.1	0.025	1 3/4"	3/4"	7BN
WL-5720	5.0	4.5	Hg.	1000	15	2.5	7 1/2"	3"	4BL
WL-5727	6.3	0.60	gas	1300	0.5	0.1	2 1/8"	3/4"	7BN
WL-5796	2.5	8.5	gas	1500	20	1.6	5 1/4"	1 9/16"	4CF
WL-5830	5.0	20	Hg.	10000	75	12.5	17 11/16"	5 1/16"	4BL
WL-6012	6.3	2.6	gas	1300	5.0	0.5	3 7/8"	1 23/32"	6CO
WL-6014	2.5	6.3	gas	1250	8.0	1.0	4 1/4"	1 9/16"	4D
WL-6807	2.5	21	gas	1500	80	6.4	9"	2 5/8"	4AV
WL-6808	2.5	21	gas	1500	80	6.4	8 5/16"	2 5/8"	4AV(F)
WL-6856	2.5	16	gas & Hg.	1500	50	2.5	9 1/2"	2 1/16"	4PB
WL-6857	2.5	16	gas & Hg.	1500	30	4.0	8 5/8"	2 1/16"	4PB(F)
WL-6858	2.5	21	gas & Hg.	1500	77	6.4	9 1/2"	2 9/16"	4AV
WL-6859	2.5	21	gas & Hg.	1500	77	6.4	8 3/4"	2 9/16"	4AV(F)
WL-6860	2.5	21	gas	1250	77	6.4	8 3/4"	2 3/32"	4AV(F)
WL-7022	2.5	16	gas & Hg.	1500	50	2.5	9 1/2"	2 1/16"	4PB(L)
WL-7023	2.5	21	gas & Hg.	1500	77	6.4	10"	2 1/16"	4PB(L)
WL-7297	2.5	10.8	gas	1500	40	3.2	6 3/8"	2 3/16"	4PL(L)
WL-7306A	2.5	9	gas	1250	30	2.5	5 11/16"	1 9/16"	4CF
WL-7307A	2.5	9	gas & Hg.	1500	30	2.5	6 1/4"	1 9/16"	4CF
WL-7321	2.5	21	gas	1250	77	6.4	10"	2 9/16"	4AV(L)
WL-7363	2.5	8.5	gas	1500	20	1.6	5"	1 9/16"	4CF
WL-7509A	2.5	9	gas & Hg.	1500	30	2.5	7"	2 3/16"	4PL(L)
WL-7556A	2.5	9	gas	1250	30	2.5	7"	2 3/16"	4PL(L)
WL-8043	5	6	Hg.	21000	50	2.5	11 3/16"	2 9/16"	3N
WL-22994/5877	2.5	10.8	gas	1500	40	3.2	7 7/8"	2 1/32"	4AV
WL-23052/7297	2.5	10.8	gas	1500	40	3.2	7 3/8"	2 3/32"	4PL(L)

*Life Indicating Tube.

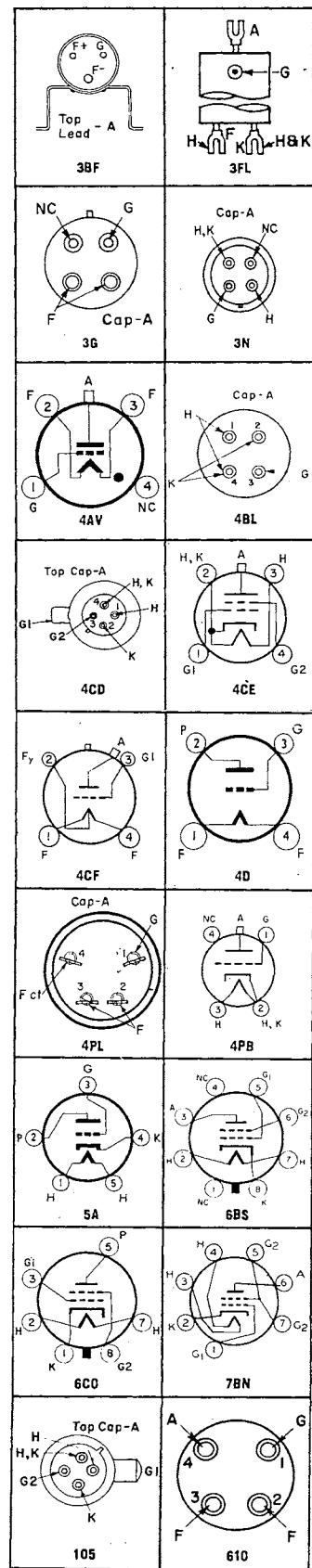



IGNITRONS

Ignitrons are gas-discharge, pool-type cathode tubes in which current conduction is initiated for each conducting cycle by means of an electrode called an ignitor. The ignitor is a small conical refractory element projecting into the mercury. When a relatively small current is conducted through the ignitor to the mercury, ionization of some mercury molecules in this area takes place. Ignitrons are of the half-wave type and current is conducted only when the anode is positive with respect to the cathode and the ignitor is fired. Control of the average conducted current is accomplished by phase control of the point in the input cycle at which the ignitor is fired. During the non-conducting cycle, ionization in these single-anode tubes is very low; the resulting reduction of shielding necessary to

prevent arc-backs lowers the arc voltage and permits operation at lower supply voltages. Ignitrons therefore have some of the control characteristics of thyratrons and, having a mercury-pool cathode, are capable of conducting very large currents. Water cooling of metal envelopes is used on most types to further increase current carrying capacity in a compact tube. Provision is made on some of the tube shells to connect thermostats for tube protection and water saving. Ignitrons are used in resistance welders, frequency-changer resistance welders, power rectifiers, high current switches in controlled fusion equipment, heat control devices for air-frame testing, and any circuit requiring precise control of large amounts of alternating or direct current.

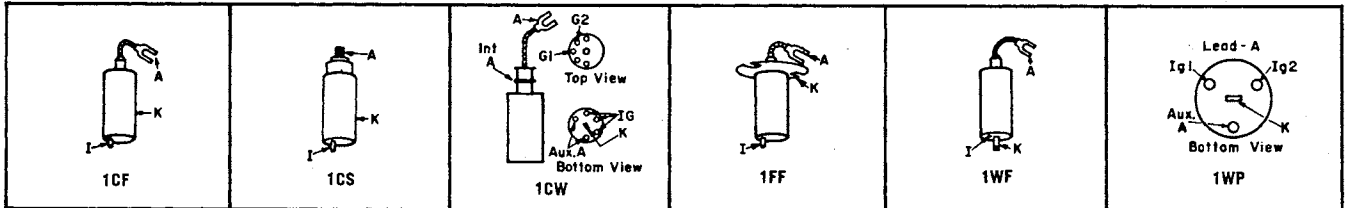

A.C. WELDER CONTROL IGNITRONS

TUBE TYPE (NOTE 2)	SIZE	MAXIMUM RATINGS								MAX. DIMENSIONS (NOTE 1)		COOLING	BASE DWG.
		RMS LINE VOLTS	DEMAND KVA	CORRES. CURRENT DC AMP.	DEMAND RMS AMP. 500 V. 1-30 CPS	CURRENT DC AMP.	CORRES. DEMAND KVA	MAX. AVG. TIME IN SEC. @ 250 V	@ 500 V	LENGTH	DIAM.		
WL-5550	A	250-600	300	12.1	600	22.4	100	22	11	9 7/8"	2 3/4"	Clamp	1 CF
WL-5551A WL-5551A (PC)	B	250-600	600	30.2	1200	56	200	18	9	13"	2 3/4"	Water	1 WF
WL-5552A WL-5552A (PC)	C	250-600	1200	75.6	2400	140	400	14	7.1	14"	4 1/4"	Water	1 WF
WL-5553B WL-553B (PC)	D	250-600	2400	192	4800	355	800	11.2	5.6	19 1/2"	5 5/8"	Water	1 WF
WL-5554/679	C	2400	1200	75	500 (Note 3)	113	600	1.5 (Note 3)	—	17"	4 3/8"	Water	1 WP
WL-5555/653B WL-5555A	D	2400	2400	135	1000 (Note 3)	207	1105	1.7 (Note 3)	—	20"	5 3/4"	Water	1 WP
WL-7669 WL-7669 (PC)	B Coax	250-600	600	30.2	1200	56	200	18	9	13"	3 1/4"	Water	1 FF
WL-7671 WL-7671 (PC)	C Coax	250-600	1200	75.6	2400	140	400	14	7.1	14 1/4"	4 5/8"	Water	1 FF
WL-7681	C 1/2	250-600	1800	113.5	3600	210	600	9.5	7.1	17 1/2"	4 1/4"	Water	1 WF

FREQUENCY CHANGER WELDING CONTROL IGNITRONS

TUBE TYPE (NOTE 2)	SIZE	PEAK INVERSE VOLTS	RATED CURRENTS				MAX. AVG. TIME SECONDS	MAX. DIMENSIONS (NOTE 1)		COOLING	BASE DWG.
			MAX. PEAK AMP.	CORRES. AVG. AMP.	MAX. AVG. AMP.	CORRES. PEAK AMP.		LENGTH	DIAMETER		
WL-5551A WL-5551A (PC)	B	1200 1500	600 480	5 4	22.5 18	135 108	10 10	13"	2 3/4"	Water	1 WF
WL-5553B WL-5553B (PC)	D	1200 1500	3000 2400	40 32	140 112	840 672	6.25 6.25	19 1/2"	5 5/8"	Water	1 WF
WL-5822A	C	1200 1500	1500 1200	20 16	70 56	420 336	6.25 6.25	14"	4 1/4"	Water	1 WF
WL-7669 WL-7669 (PC)	B Coax	1200 1500	600 480	5 4	22.5 18	135 108	10 10	13"	3 1/4"	Water	1 FF
WL-7670	—	2500	2000	10	—	—	2	12"	2 3/4"	Water	1 FF
WL-7681	C 1/2	1200 1500	2250 1800	30 24	105 84	630 502	6.25 6.25	17 1/2"	4 1/4"	Water	1 WF



POWER RECTIFIER IGNITRONS

TUBE TYPE	SIZE	PEAK INVERSE VOLTS	MAXIMUM CURRENT RATINGS		MAXIMUM DIMENSIONS (NOTE 1)		COOLING	BASE DWG.
			PEAK AMP.	CONT. AVG. AMP.	LENGTH	DIAMETER		
WL-5554/679	C	900 2100	900 600	100 75	17"	4 $\frac{1}{8}$ "	Water	1 WP
WL-5555A WL-5555/653B	D	900 2100	1800 1200	200 150	20"	5 $\frac{3}{4}$ "	Water	1 WP
WL-6228	—	20000	900	150	42"	9"	Water	1 CW

CONTINUOUS DUTY A.C. CONTROL IGNITRONS (NOTE 4)

TUBE TYPE (NOTE 2)	SIZE	MAXIMUM RATINGS								MAX. DIMENSIONS (NOTE 1)		COOLING	BASE DWG.
		RMS LINE VOLTS	DEMAND KVA	CORRES. CURRENT DC AMP.	CONTIN- UOUS RMS AMP. 2 TUBES	CURRENT DC AMP.	CORRES. DEMAND KVA	MAX. AVG. TIME IN SEC.		LENGTH	DIAM.		
								@ 250 V	@ 500 V				
WL-23011 WL-23011 (PC)	B	250-600	600	30.2	124	56	200	18	9	13"	2 $\frac{3}{4}$ "	Water	1 WF
WL-23012 WL-23012 (PC)	C	250-600	1200	75.6	311	140	400	14	7.1	14"	4 $\frac{1}{4}$ "	Water	1 WF
WL-23013 WL-23013 (PC)	D	250-600	2400	192	788	355	800	11.2	5.6	19 $\frac{1}{2}$ "	5 $\frac{5}{8}$ "	Water	1 WF
WL-23014 WL-23014 (PC)	B Coax	250-600	600	30.2	124	56	200	18	9	13"	3 $\frac{1}{4}$ "	Water	1 FF
WL-23015 WL-23015 (PC)	C Coax	250-600	1200	75.6	311	140	400	14	7.1	14 $\frac{1}{4}$ "	4 $\frac{5}{8}$ "	Water	1 FF
WL-23016	C $\frac{1}{2}$	250-600	1800	113.5	466	210	600	9.5	7.1	17 $\frac{1}{2}$ "	4 $\frac{1}{4}$ "	Water	1 WF
WL-23017	D Coax	250-600	2400	192	788	355	800	11.2	5.6	17 $\frac{1}{2}$ "	5 $\frac{5}{8}$ "	Water	1 FF
WL-23018	C $\frac{1}{2}$ Coax	250-600	1800	113.5	466	210	600	9.5	7.1	15"	5 $\frac{3}{8}$ "	Water	1 FF

CAPACITOR DISCHARGE & CROWBAR IGNITRONS

TUBE TYPE	MAXIMUM RATINGS					MAX. DIMENSIONS (NOTE 1)		COOLING	BASE DWG.
	HOLD-OFF KV	PEAK AMP.	DISCHARGE COULOMBS	REP. RATE PULSES/MIN.	AVERAGE CURRENT AMP.	LENGTH	DIAMETER		
WL-7171	10	35,000	18.6	2	0.6	8 $\frac{7}{16}$ "	2 $\frac{5}{32}$ "	Clamp	1 CS
WL-7703	20	100,000	—	2	—	7"	2 $\frac{7}{32}$ "	Clamp	1 CS
WL-7740	20	35,000	18.6	2	0.6	8 $\frac{7}{8}$ "	2 $\frac{5}{32}$ "	Clamp	1 CS
WL-8306	15	35,000	18.6	2	0.6	8 $\frac{7}{8}$ "	2 $\frac{5}{32}$ "	Clamp	1 CS

PULSE MODULATOR IGNITRONS (NOTE (5))

TUBE TYPE	MAXIMUM RATINGS			AVG. AMP.	PULSE		BASE DWG.
	FORWARD KV	INVERSE KV	PEAK AMP.		LENGTH μ SEC.	REP. RATE PPS	
WL-6228	40	0.5	3300	3.8	3.2	360	1 CW

NOTES

- Excluding flying leads, water pipes, and on coaxial tubes the mounting flange.
- Suffix PC indicates plastic-coated tube.
- At 2400 volts.
- These tubes use heavy duty ignitrons designed for continuous duty.
- Consult Industrial and Transmitting Tube Development Department for pulse modulator applications. The parameters listed represent a specific application only and substantial increases can be made in some areas.



VACUUM MEASURING TUBES

Vacuum measuring tubes are designed to become part of an evacuated system. With suitable circuitry, the pressure in that system may be accurately determined. The Bayard-Alpert ionization gauge is used for measurement of very low pressures. The Schulz-Phelps ionization gauge measures pressures up to one half torr. The Pirani and thermocouple gauges

are less accurate and measure only the higher pressures, but, their associated circuitry is much simpler.

These tubes are used in electron tube and semiconductor device processing control, vacuum deposition, research and rocket altimeter applications.

Ionization Gauges

TUBE TYPE	TUBE CLASS	RANGE TORR	ELECTRICAL				MECHANICAL				
			FILAMENT		COLL VOLTS	GRID VOLTS	TUBULATION		MAX. OAL (1)	MAX. DIAM.	BASE DWG.
			VOLTS	AMPS.			SIZE	MAT'L.			
WL-5966	Bayard-Alpert (2)	10 ⁻³ to 10 ⁻¹⁰	7	2.5	-30	150	1/2"	Nonex	11 1/2"	3 3/8"	4VF
WL-6794	Bayard-Alpert (2)	10 ⁻³ to 10 ⁻¹⁰	6	2.5	-30	.50	1/2"	Pyrex	8 3/8"	2 1/2"	7VP
WL-7676	Schulz-Phelps	5x10 ⁻¹ to 10 ⁻⁵	2	2.25	-60	60	1/2"	Nonex	7 1/4"	1 13/16"	8VP
WL-7903	Schulz-Phelps	5x10 ⁻¹ to 10 ⁻⁵	1.3	2.4	-60	60	1/2"	Pyrex	7 1/4"	1 13/16"	9VP
WL-7904	Bayard-Alpert (2)	10 ⁻³ to 10 ⁻⁹	4	1.5	-30	150	1/2"	Pyrex	7 1/4"	1 13/16"	9PV
WL-8057	Bayard-Alpert (3)	10 ⁻³ to 10 ⁻⁹	7	2.5	-30	150	3/4"	Nonex	5 1/4"	4 9/16"	5VP
WL-22612	Bayard-Alpert (2)	10 ⁻³ to 10 ⁻⁹	7	2.5	-30	150	1/2"	Pyrex	11 1/2"	3 3/8"	4VF
WL-22613	Bayard-Alpert (2)	10 ⁻³ to 10 ⁻⁹	7	2.5	-30	150	3/4"	Pyrex	11 1/2"	3 3/4"	4VF
WL-22614	Bayard-Alpert (2)	10 ⁻³ to 10 ⁻⁹	7	2.5	-30	150	1"	Pyrex	11 1/2"	3 3/8"	4VF
WL-22618	Bayard-Alpert (2)	10 ⁻³ to 10 ⁻⁹	7	2.5	-30	150	1/2"	Pyrex	5 3/8"	5 5/16"	4VF
WL-22619	Bayard-Alpert (2)	10 ⁻³ to 10 ⁻⁹	7	2.5	-30	150	3/4"	Pyrex	5 3/8"	5 5/16"	4VF
WL-22620	Bayard-Alpert (2)	10 ⁻³ to 10 ⁻⁹	7	2.5	-30	150	1"	Pyrex	5 3/8"	5 5/16"	4VF
WL-22627	Bayard-Alpert (2)	10 ⁻³ to 10 ⁻¹⁰	7	2.5	-30	150	3/4"	Pyrex	8"	2 1/8"	7VP
WL-22637	Bayard-Alpert (3)	10 ⁻³ to 10 ⁻⁹	7	2.5	-30	150	3/4"	Pyrex	6 3/8"	5 5/16"	5VP
WL-22640	Bayard-Alpert (3)	10 ⁻³ to 10 ⁻⁹	7	2.5	-30	150	3/4"	Kovar	6 3/8"	5 5/16"	5VP
WL-22643	Bayard-Alpert (3)	10 ⁻³ to 10 ⁻⁹	7	2.5	-30	150	3/4"	Pyrex	8"	2 1/8"	7VP
WL-22754	Bayard-Alpert (4)	10 ⁻³ to 10 ⁻⁹	2.5	2.5	-30	150	3/4"	Nonex	5 1/4"	4 9/16"	5VP
WL-22868	Bayard-Alpert (4)	10 ⁻³ to 10 ⁻⁹	2.5	2.5	-30	150	3/4"	Pyrex	5 1/4"	4 9/16"	5VP
WL-22869	Bayard-Alpert (4)	10 ⁻³ to 10 ⁻⁹	2.5	2.5	-30	150	3/4"	Kovar	5 1/4"	4 9/16"	5VP
WL-22923	Schulz-Phelps	5x10 ⁻¹ to 10 ⁻⁵	2	2.25	-60	60	1/2"	Kovar	7 1/4"	1 13/16"	9VP
WL-22947	Bayard-Alpert (4)	10 ⁻³ to 10 ⁻⁹	2.5	2.5	-30	150	3/4"	Nonex	5 1/4"	4 9/16"	4VP
WL-22948	Bayard-Alpert (4)	10 ⁻³ to 10 ⁻⁹	2.5	2.5	-30	150	3/4"	Pyrex	5 1/4"	4 9/16"	4VP
WL-22949	Bayard-Alpert (4)	10 ⁻³ to 10 ⁻⁹	2.5	2.5	-30	150	3/4"	Kovar	5 1/4"	4 9/16"	4VP

Notes

1. Excluding flexible leads. Length and diameter describe space to contain tube.
2. Grid outgassed by electron bombardment.
3. Grid outgassed by a-c current conduction.
4. Non-burn-out filament and grid outgassed by a-c current conduction.

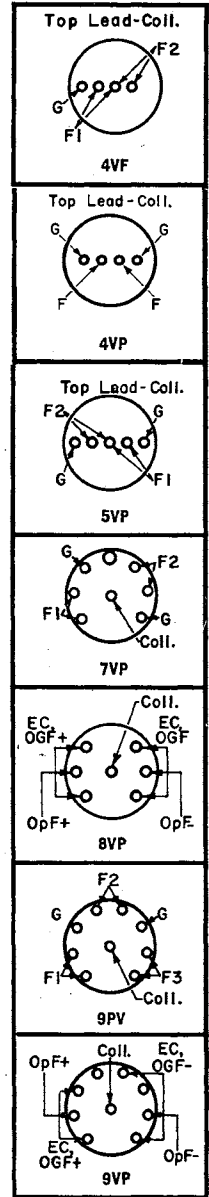

Pirani Tubes

TUBE TYPE	FILAMENT		TUBULATION		RANGE TORR	MAX. OAL	MAX. DIAM.	BASE DWG.
	MAT'L.	AMPS.	SIZE	GLASS				
WL-762	Platinum	0 to 0.3	3/8"	Nonex	1 to 5x10 ⁻⁴	7 15/16"	1 1/16"	4A
WL-765	Platinum	0 to 0.3	5/8"	Nonex	1 to 5x10 ⁻⁴	6 3/4"	1 1/16"	4A
WL-765A	Platinum	0 to 0.3	None	None	1 to 5x10 ⁻⁴	5 1/4"	1 1/16"	4A

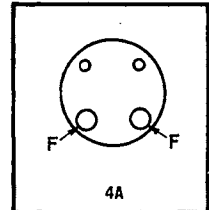

Hollow Cathode Discharge Devices For Atomic Absorption Spectroscopy

Gas Fill	Window	
	Quartz 1"	Pyrex 1½"
Argon	Q-A-B	P-A-A
Neon	Q-N-B	P-N-A



Single-Element Hollow-Cathode Devices (See Note)

Tube Type	Window, Gas Fill & Size	Element	Analytical Lines				Max. mA	Tube Type	Window, Gas Fill & Size	Element	Analytical Lines				Max. mA
			Å	Å	Å	Å					Å	Å	Å	Å	
WL-22603	P-N-A	Copper	3247	3274	—	20	WL-22932	Q-N-B	Bismuth	2231	3068	—	12		
WL-22610	P-N-A	Calcium	4227	—	—	20	WL-22933	Q-N-B	Cadmium	2288	3261	—	12		
WL-22806	Q-A-B	Silver	3281	3383	—	20	WL-22934	Q-N-B	Chromium	3579	4254	—	25		
WL-22809	P-N-A	Aluminum	3092	3962	—	20	WL-22935	Q-N-B	Gold	2428	2676	—	15		
WL-22810	Q-N-B	Iron	2483	3720	—	20	WL-22936	Q-N-B	Manganese	2795	2801	—	25		
WL-22811	Q-N-B	Zinc	2139	3076	—	18	WL-22937	Q-N-B	Molybdenum	3133	3170	—	30		
WL-22818	Q-N-B	Samarium	3951	4760	—	20	WL-22938	Q-N-B	Selenium	1960	2040	—	15		
WL-22819	Q-N-B	Nickel	2320	3415	—	20	WL-22939	Q-N-B	Silicon	2516	—	—	20		
WL-22823	P-N-A	Cesium	4556	8521	—	25	WL-22940	Q-N-B	Tellurium	2143	2386	—	15		
WL-22824	P-N-A	Rubidium	7800	—	—	30	WL-22941	Q-N-B	Tin	2863	—	—	15		
WL-22826	Q-N-B	Uranium	5027	5915	—	25	WL-22942	Q-N-B	Rhenium	3460	3465	—	25		
WL-22827	Q-N-B	Dysprosium	4046	4187	—	15	WL-22968	Q-N-B	Magnesium	2025	2852	—	20		
WL-22828	Q-N-B	Erbium	4008	—	—	15	WL-22969	Q-N-B	Palladium	2448	2476	3404	25		
WL-22829	Q-N-B	Holmium	4054	5983	—	15	WL-22973	Q-N-B	Vanadium	3184	3855	—	30		
WL-22830	P-N-A	Lithium-6	6708	—	—	30	WL-22977	Q-N-B	Cerium	—	—	—	20		
WL-22831	P-N-A	Lithium-7	6708	—	—	30	WL-22979	Q-N-B	Neodymium	4925	—	—	20		
WL-22833	Q-N-B	Gallium	2874	4172	—	15	WL-22981	Q-N-B	Praseodymium	4951	5133	—	20		
WL-22834	P-N-A	Barium	5536	—	—	25	WL-22983	Q-A-B	Ytterbium	3988	—	—	20		
WL-22835	P-N-A	Strontium	4607	—	—	25	WL-22985	Q-N-B	Gadolinium	3684	—	—	20		
WL-22836	Q-N-B	Arsenic	1937	1972	—	20	WL-22987	Q-N-B	Yttrium	4077	4102	—	15		
WL-22837	Q-N-B	Iron (High Purity)	2843	3720	—	20	WL-22989	Q-N-B	Phosphorus	—	—	—	20		
WL-22844	Q-N-B	Tungsten	4009	4294	—	30	WL-22991	Q-N-B	Titanium	3643	3998	—	25		
WL-22845	Q-N-B	Europium	4594	4627	—	20	WL-22996	Q-N-B	Indium	3040	—	—	20		
WL-22847	Q-A-B	Mercury	2537	—	—	15	WL-22997	Q-N-B	Rhodium	3435	3692	—	25		
WL-22848	Q-N-B	Terbium	4319	4338	—	25	WL-23007	Q-N-B	Thulium	4094	4105	—	20		
WL-22851	Q-A-B	Platinum	2659	—	—	25	WL-23009	Q-N-B	Lutetium	3081	3282	—	20		
WL-22858	Q-N-B	Niobium	4059	4080	—	25	WL-23027	Q-N-B	Thorium	—	—	—	20		
WL-22859	Q-A-B	Tantalum	3311	—	—	30	WL-23049	Q-N-B	Lanthanum	3574	3928	4015	15		
WL-22860	Q-A-B	Zirconium	3519	3601	—	25	WL-23060	P-N-A	Lithium-Nat.	6708	—	—	30		
WL-22863	P-N-A	Potassium	4044	7665	—	25	WL-23138	Q-A-B	Ruthenium	3499	3728	—	25		
WL-22864	P-A-A	Sodium	3302	5890	—	25	WL-23135	Q-N-B	Sulphur	—	—	—	20		
WL-22916	Q-A-B	Boron	2497	—	—	20	WL-23144	Q-A-B	Osmium	—	—	—	20		
WL-22927	Q-N-B	Lead	2170	2833	—	15	WL-23145	Q-N-B	Iridium	2850	—	—	25		
WL-22928	Q-N-B	Cobalt	2407	3454	3527	25	WL-23160	Q-A-B	Germanium	2651	—	—	20		
WL-22931	Q-N-B	Antimony	2176	2311	—	25	WL-23180	Q-N-B	Hafnium	2866	3072	—	18		
							WL-23181	Q-N-B	Scandium	3907	3912	—	20		

Multi-Element Hollow-Cathode Devices (See Note)

Tube Type	Window, Gas Fill & Size	Elements	Max. mA	Tube Type	Window, Gas Fill & Size	Elements	Max. mA
WL-22930	Q-N-B	Ca Mg Al	20	WL-23135	Q-N-B	Cu Zn Mo	15
WL-23034	P-N-A	Ba Ca Sr	25	WL-23141	Q-N-B	Cu Zn Mo Co	15
WL-23035	Q-N-B	Ca Mg Al Li	18	WL-23146	Q-N-B	Cu Zn Pb Cd	12
WL-23106	Q-N-B	Fe Cu Mn	20	WL-23147	Q-N-B	As Sb Bi	15
WL-23108	Q-N-B	Cr Fe Mn Ni	30	WL-23148	Q-N-B	As Se Te	15
WL-23109	Q-N-B	Cu Zn Pb Sn	12	WL-23171	Q-N-B	Pb Zn Ag	12
WL-23116	Q-N-B	As Ni	20	WL-23173	P-N-A	Na K	25
WL-23117	Q-N-B	Au Ni	15	WL-23174	Q-N-B	Cr Co Ni	25
WL-23118	Q-N-B	In P	20	WL-23176	Q-N-B	Cr Co Cu Fe Mn Ni	30
WL-23119	Q-N-B	Cu Ga	15	WL-23177	Q-N-B	Mo Cu Fe	25
WL-23130	Q-N-B	Se Ni	15	WL-23179	Q-N-B	Fe Cu Ni Pb Zn	15
WL-23131	Q-N-B	Cu Mn	20	WL-23190	Q-N-B	Cu Co	20
WL-23132	Q-N-B	Cu Pb Zn Ag	15	WL-23207	Q-N-B	Ca Zn	15
WL-23133	Q-N-B	Ba Ca Sr Mg	25	WL-23208	Q-N-B	Cr Cu	20
WL-23134	Q-N-B	Cu Zn Fe Mn	15	WL-23211	Q-N-B	Au Cu Fe Ni	20
				WL-23216	Q-N-B	Ag Zn Pb Cd	12

NOTE: This is not a complete listing. Only preferred types are listed. Preferred types have window and fill combinations, for each element, suitable for most applications and are stocked for immediate shipment. For a complete listing refer to data sheets ET-1532 and ET-1553.

Industrial & Military Cathode Ray Tubes

Tube Type	Bulb				Electrical					Max. OAL
	Note	Face Rad.	Base Dwg.	Defl. Angle	Anode KV	Focus Volts	Grid 2 Volts	Grid 1 Volts (1)	Line Width	
3JP1	3	8"	14J	ES	4	400 to 690	2000	-45 to -75	—	10.188"
WL-5038	3	Flat	12E	ES	2	340 to 640	—	-75	0.023"	15.12"
5CEP11	2	Flat	12Q	42°	10	2070 to 2370	300	-40 to -65	0.0015"	13.5"
5DEP1	3	20"	12E	ES	2	340 to 640	—	-90 max.	0.023"	15.125"
5DKP16	2	24"	5AN	53°	8	Mag.	250	-30 to -75	0.006"	11.5"
5FP7A	3	24"	5AN	53°	5	Mag.	250	-25 to -70	0.010"	11.5"
5UP1	3	20"	12E	ES	2	340 to 640	—	-90 max.	0.023"	15.125"
5ZP16	2	Flat	12C	40°	27	5544 to 7056	200	-42 to -98	0.0045"	14.75"
WL-5078	3	Flat	12E	ES	1.5	150 to 450	—	-90	0.020"	9.44"
7ABP7A	2	24"	12M	50°	7	0 to 250	300	-33 to -77	0.012"	13.5"
8NP4	5	27"	12M	90°	16	0 to 400	300	-33 to -77	0.012"	9.94"
10WP7A	2	42"	12M	50°	10	0 to 600	300	-35 to -75	0.015"	17.312"

Notes: 1. For cutoff.

- Aluminized screen, round faceplate.
- Round faceplate.
- Aluminized screen, round faceplate, 0.9" diameter neck, 6.3 volt — 300 mA heater.
- Aluminized screen, rectangular faceplate.

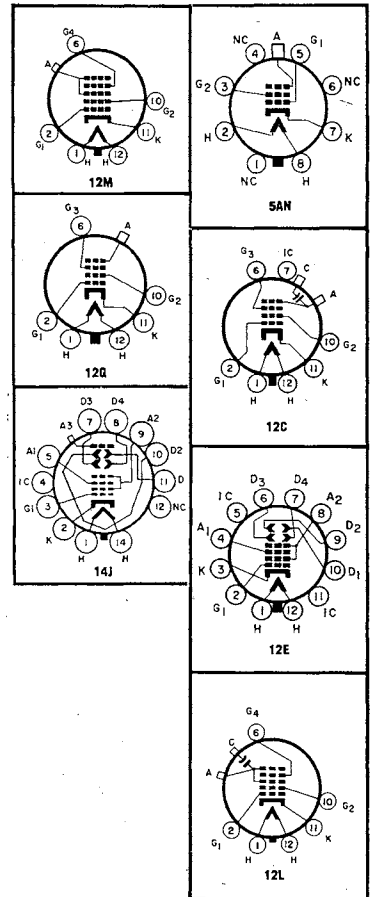

Zenith Tubes...

life-tested for greater dependability!

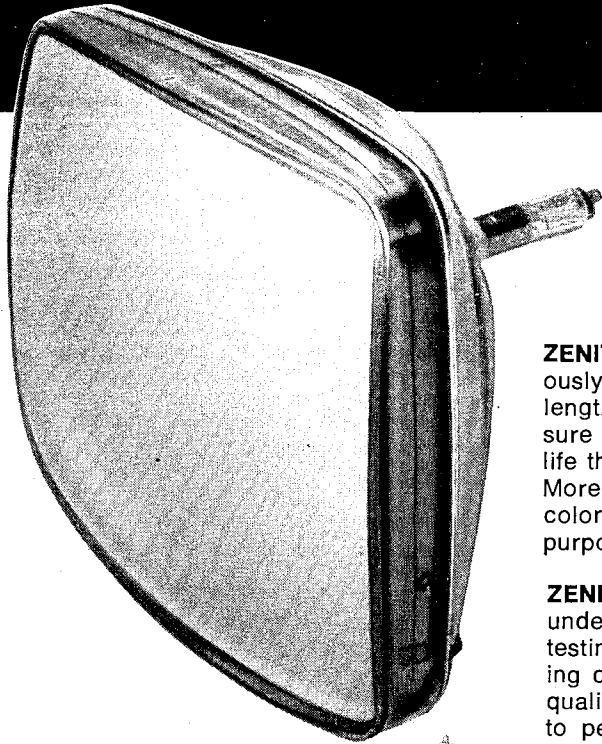

ZENITH TV PICTURE TUBES are rigorously tested at elevated line voltages for lengthy periods. Just one reason you can be sure of Zenith's great reliability and long life that better satisfies your customers. More than 200 Zenith quality tubes—for color TV, black-and-white TV, or special purposes—are in the complete line.

ZENITH "ROYAL CREST" CIRCUIT TUBES undergo over 1½ million hours of life-testing every month. Under actual operating conditions, they must meet the same quality standards as Zenith original parts—to perform with unrivaled dependability. Choose from a full line of more than 900 top-quality Zenith tubes.

Order all genuine Zenith replacement parts and accessories from your Zenith distributor

Exciting Surprises
for You—
and Your Family!
Fun for all!
Get the details
at your Zenith
Distributor's
Parts Department.

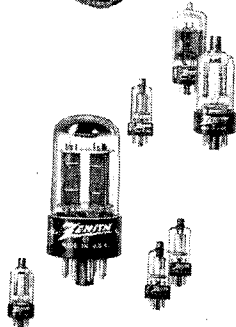

Zenith B&W replacement picture tubes are made only from new parts and materials except for the glass envelope in some tubes which, prior to reuse, is inspected and tested to the same high standard as a new envelope. Some color picture tubes contain used material which, prior to reuse, is carefully inspected to meet Zenith's high quality standards.

BEST YEAR YET TO SELL THE BEST



ZENITH

® The quality goes in
before the name goes on

CABLE PRODUCTS[®]



AMPHENOL

RG COAXIAL CABLE

Military Number RG/U	AMPHENOL Number	Armour O.D.	Jacket O.D.	Type	Shields		Dielectric O.D. & Type	Center Conductor	V.P. %	Cap. Mmfd. /Ft.	Max. Oper. Volts Rms.	Imp. Nom. Ohms	1000 Lbs./ Ft.	Connector Series
					Outer	Inner								
8	21-005	—	.405	I	—	C	.288P	7/21C	65.9	29.5	5000	52	105	N, C, HN, UHF
8A	21-290	—	.405	IIa	—	C	.288P	7/21C	65.9	29.5	5000	52	105	N, C, HN, UHF
9B	21-332	—	.420	IIa	S	S	.280P	7/21S	65.9	30	5000	50	127	N, C, HN, UHF
11	21-007	—	.405	I	—	C	.285P	7/26TC	65.9	20.5	5000	75	92	N, C, HN, UHF
55B	21-802	—	.206	IIIa	TC	TC	.116P	20S	65.9	28.5	1900	53.5	34	TNC, BNC, BN, C, UHF
58	21-024	—	.195	I	—	—	.116P	20C	65.9	28.5	1900	53.5	27	TNC, BNC, BN, C, UHF, N, PLUG-IN
58A	21-199	—	.195	I	—	TC	.116P	10/.0071 TC	65.9	30	1900	50	27	TNC, BNC, BN, C, UHF, N, PLUG-IN
58C	21-316	—	.195	IIa	—	TC	.116P	10/.0071 TC	65.9	30	1900	50	27	TNC, BNC, BN, C, UHF, N, PLUG-IN
59	21-025	—	.242	I	—	C	.146P	.023CW	65.9	21.5	2300	73	37	TNC, BNC, BN, C, UHF, N, PLUG-IN
59B	21-794	—	.242	IIa	—	C	.146P	22CW	65.9	21	2300	75	35	TNC, BNC, BN, C, UHF, N, PLUG-IN
62	21-026	—	.242	I	—	C	.146SSP	22CW	84	13.5	750	93	36	TNC, BNC, BN, C, UHF, N, PLUG-IN
62B	21-771	—	.242	IIa	—	C	.146SSP	7/32CW	84	13.5	750	93	30	TNC, BNC, BN, C, UHF, N, PLUG-IN
71B	21-804	—	.250 Max.	IIIa	—	C	.146SSP	22CW	85	13.5	750	93	43	TNC, BNC, BN, C, UHF, N, PLUG-IN
108A	21-327	—	.235	IIa	—	TC	.079 (each P)	Two 7/28TC	68	23.5	1000	78	29	TWIN
142B	421-176	—	.195	IX	S	S	.1167	.039SCW	69.5	28.5	1900	50	42	C, N

RG SUBMINIATURE CABLE

AMPHENOL line of subminiature coaxial cables were created for use in any miniaturized electronic application. Teflon dielectric subminiature

cable is able to withstand continuous operating temperatures up to 250°C. Teflon jacket is weatherproof, chemically inert, insoluble in liquids and gases.

The polyethylene dielectric miniature coaxial cable is intended for use where extremely high temperature is not a consideration.

Military Number RG/U	AMPHENOL Number	Armour O.D.	Jacket O.D.	Jacket Type	Shields		Dielectric O.D. & Type	Center Conductor	V.P. %	Cap. Mmfd. /Ft.	Max. Oper. Volts Rms.	Nom. Imp. Ohms	Lbs./ 1000 Ft.	Connector Series
					Outer	Inner								
174	21-598	—	.100	I	—	TC	.060P	7/34CW	65.9	30.0	1500	50	7.5	Subminax
178B	421-094	—	.075 Max.	IX	—	S	.034T	7/38SCW	69.5	28.5	1000	50	6	Subminax
179B	421-096	—	.105 Max.	IX	—	S	.063T	7/38SCW	69.5	19.5	1200	75	11	BNC, Subminax
180B	421-098	—	.145 Max.	IX	—	S	.102	7/38SCW	69.5	15.0	1500	95	20	BNC, Subminax, TNC
187A	421-079	—	.110 Max.	VII	—	S	.060	7/38SCW	69.5	19.5	1200	75	11.3	BNC, Subminax
188A	421-077	—	.110 Max.	VII	—	S	.060T	7/.0067 SCW	69.5	29.0	1200	50	11.1	BNC, Subminax
195A	421-075	—	.155 Max.	VII	—	S	.102T	7/38SCW	69.5	15.0	1500	95	21.1	BNC, Subminax, TNC
196A	421-073	—	.080 Max.	VII	—	S	.034T	7/38SCW	69.5	28.5	1000	50	5.9	Subminax

Cable Jacket Types: (I) Black Polyvinyl Chloride, (V) Fiberglass Braid, (VII) Teflon (Polytetrafluoroethylene), (IX) Teflon (Fluorinated Ethylene Propylene).

CABLE PRODUCTS



AMPHENOL

RG COAXIAL CABLE

Military Number RG/U	AMPHENOL Number	Armour O.D.	Jacket O.D.	Type	Shields		O.O. & Type Dielectric	Conductor Center	V.P. %	Cap. Mmfd. /Ft.	Max. Oper. Volts Rms.	Nom. Imp. Ohms	Lbs./ 1000 Ft.	Connector Series
					Outer	Inner								
213	21-779	—	.405	IIa	—	C	.285P	7/.0296C	65.9	29.5	5000	50	103	N, C, HN, UHF
223	21-788	—	.216	IIa	S	S	.185P	.0556N	65.9	29.0	2700	50	84	N, C
225	421-135	—	.430	V	S	S	.285T	7/.0312S	69.5	29.5	5000	50	174	N.C, HN, UHF

CATV CABLE

AMPHENOL Polyfoam® Communications and TV Cables are designed to satisfy the need for a low attenuation, low capacitance RF cable for the communications field.

All cables illustrated are available in 1000 foot continuous lengths.

Note: * Add the following suffixes to the Amphenol Number for sweep testing:
 —101 (sweep tested from 50 MC to 90 MC and 170 MC to 220 MC).
 —202 (sweep tested from 10 MC to 250 MC).

Type RG/U	Number AMPHENOL	O.D. Jacket	Type Jacket	Shield	Dielectric O.O. & Type	Center Conductor	V.P. %	Nom. Cap. Mmfd/ft	Max. Oper. Volts RMS	Nom. Imp. Ohms	Lbs./ 1000 ft.	Connector Series
8	621-111*	.405	I	C	.285 FP	7/19C	80	17.3	1000	75	32	BNC, TNC, UHF
59	621-186*	.242	P	C	.146 FP	20CW	80	24.5	1500	50	104	UHF

TRIAxIAL CABLES

AMPHENOL Triaxial Cables satisfy the need for a high degree of shielding in a flexible transmission line. This is

achieved by adding a high coverage braid over the cable jacket and then applying a second or outer jacket. This cable can be used to carry two separate signals.

58A	21-204*	.285 I	TC	.195 TC	.116 P TC	19/.0071	65.9	29.5	1900	50	60	Triax
-----	---------	--------	----	---------	-----------	----------	------	------	------	----	----	-------

LOW NOISE CABLES

AMPHENOL Low Noise Cable fulfills the need for cable which will remain electrically neutral under conditions of shock

and vibration. The reduction of inherent noise is achieved on these cables by the application of a semi-conductive coating over the dielectric.

59	21-541	.242	I	C	.146CCP	7/32TC	65.9	21.5	2300	73	35	BNC, BN, C, UHF
----	--------	------	---	---	---------	--------	------	------	------	----	----	-----------------

HIGH VOLTAGE CABLE AND WIRE

AMPHENOL High Voltage Cable and Wire satisfies a multitude of high voltage applications — wherever flexibility and

temperature extremes may be a factor. High voltage wire operates up to 50,000 volts D.C. — coaxial cables up to 35,000 volts D.C.

AMPHENOL Number	Jacket O.D.	Jacket Type	Shield	Dielectric O.O. & Type	Center Conductor	V.P. %	Cap. Mmfd/ ft.	Max. Oper. Volts RMS	Nom. Imp. Ohms	Dielectric Strength	Lbs./1000 ft.	Connector Series
14-047-02	.120	Red Vinyl	—	.080 P	1/30TC	—	—	—	—	10,000V AC 50,000V DC	7.75	—
14-047-10	.120	Black Vinyl	—	.080 P	7/30TC	—	—	—	—	10,000V AC 50,000V DC	7.75	—

TWIN-LEAD TRANSMISSION LINES

AMPHENOL Marine Core® Twin-Lead has the lowest signal loss of any twin-lead wet or dry. It has a tough, brown virgin polyethylene jacket protecting double self-sealing cores of Polyfoam.

Amphenol Number	Imp.	Conductors	Description
214-056	300	7/28C	Flat Type, standard for TV and FM antenna lead-in.
214-100	300	7/28C	Flat Type, heavy duty.
214-318	300	7/28C	Flat Type, clear polyethylene for indoor applications.

Amphenol Number	Imp.	Conductors	Description
214-271	300	7/28C	AIR CORE Tubular Twin-Lead, same above except this is capable of handling 500 watts of RF power.
214-103	300	7/28C	MARINE CORE Twin-Lead, outstanding for applications under adverse conditions such as moisture, salt spray and industrial contamination.
214-298	—	7/28C	4-Conductor-Rotor Cable, 28 volt rating, one conductor tinned for identification.

BC/U* 100 PER CENT SHIELDED CABLE

AMPHENOL BC/U bonded cable is a high reliability, low loss, 100% shielding, especially designed lightweight cable for applications wherever efficiency and performance is a factor, i.e., CCTV, MATV, CATV communications. Meets or exceeds all requirements of MIL-C-17.

Amphenol Number	Designation	Center Conductor	Dielectric	Shield	Jacket	Weight Lbs/1000	Impedance Nom.	Cap. Nom.	V.P. Nom.	Max. Oper. Voltage	Dielec. Strength	Frequency (mc)	6	13
21-1050	BC 59/U	22 AWG Copperweld Wire	.146" Polyethylene	.181" Bonded Aluminum	.242 Polyethylene	22.75	75 ohms	20.5 mmf/ft	67%	2,300 VRMS	7,000 VRMS	Attenuation (db/100 ft.) nom.	2.35	4.8
621-010	BC 6/U	18 AWG Bare Copper	.185" Polyfoam®	.215" Bonded Aluminum	.275 Polyethylene	32.00	75 ohms	17.2 mmf/ft	79%	1,500 VRMS	2,000 VRMS	Attenuation (db/100 ft.) nom.	1.75	3.8

ALPHA WIRE MFG.

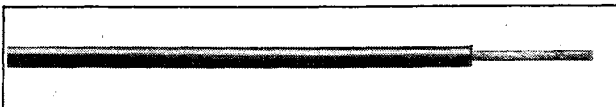

MIL-W-76B-PLASTIC WIRE

TYPE MW-UNCOVERED PLASTIC

DESCRIPTION: Solid or extra flexible stranded tinned copper, color coded medium wall polyvinylchloride insulation. The stranded conductor has an extra tight lay to prevent springing open when stripped.

CHARACTERISTICS: Temperature rating -40°C to +80°C. Voltage rating 1000 volts. Resistant to acids, alkalis, oil, flame, moisture and fungus.

STRANDED

ALPHA NO.	TYPE DESIGNATION	CONDUCTOR SIZE	STRAND	NOM. WALL THICKNESS	NOMINAL O.D.	* STOCK COLORS
1550	MW-C 24(7)U	24	7/32	.016"	.059"	1-30 AS LISTED BELOW
1551	MW-C 22(7)U	22	7/30	.016"	.064"	
1553	MW-C 20(10)U	20	10/30	.016"	.073"	
1555	MW-C 18(16)U	18	16/30	.016"	.084"	
1557	MW-C 16(26)U	16	26/30	.016"	.095"	
1559	MW-C 14(41)U	14	41/30	.016"	.110"	
1560	MW-C 12(65)U	12	65/30	.016"	.125"	

SOLID

ALPHA NO.	TYPE DESIGNATION	CONDUCTOR SIZE	STRAND	NOM. WALL THICKNESS	NOMINAL O.D.	* STOCK COLORS
1561/24	MW-C 24(1)U	24	1	.016"	.055"	1-30 AS LISTED BELOW
1561	MW-C 22(1)U	22	1	.016"	.060"	
1563	MW-C 20(1)U	20	1	.016"	.066"	
1565	MW-C 18(1)U	18	1	.016"	.074"	
1567	MW-C 16(1)U	16	1	.016"	.083"	

STANDARD SPOOL PUT-UP: 100 FT., 500 FT., 1000 FT.
ALSO AVAILABLE TO ORDER CUT, STRIPPED AND TINNED

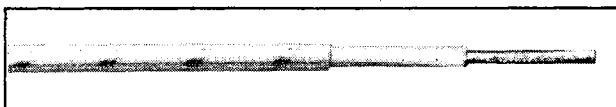

MIL-W-76B-PLASTIC WIRE

TYPE MW-GLASS BRAID

DESCRIPTION: Extra flexible stranded tinned copper, white medium wall polyvinylchloride insulation, color coded flame retardant lacquered glass braid overall. The stranded conductor has an extra tight lay to prevent springing open when stripped.

CHARACTERISTICS: Temperature rating -40°C to +80°C. Voltage rating 1000 volts. Resistant to acids, alkalis, oil, flame, moisture and fungus.

ALPHA NO.	TYPE DESIGNATION	CONDUCTOR SIZE	STRAND	NOM. WALL THICKNESS	NOMINAL O.D.	* STOCK COLORS
1590	MW-C 22(7)B	22	7/30	.016"	.080"	1-19 as listed below
1591	MW-C 20(10)B	20	10/30	.016"	.090"	1-19 as listed below
1592	MW-C 18(16)B	18	16/30	.016"	.100"	1-19 as listed below
1593	MW-C 16(26)B	16	26/30	.016"	.115"	1-19 as listed below
1594	MW-C 14(41)B	14	41/30	.016"	.125"	1 & 11-19 as listed below
1595	MW-C 12(65)B	12	65/30	.016"	.140"	1 & 11-19 as listed below

STANDARD SPOOL PUT-UP: 100 FT., 500 FT., 1000 FT.
ALSO AVAILABLE TO ORDER CUT, STRIPPED AND TINNED

*Other solid colors and striped combinations available to order.

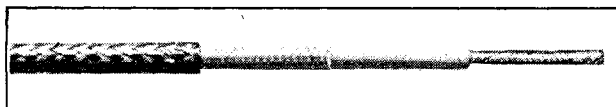

MIL-W-76B-PLASTIC WIRE

TYPE MW-GLASS BRAID-SHIELDED

DESCRIPTION: Extra flexible stranded tinned copper, white medium wall polyvinylchloride insulation, white flame retardant lacquered glass braid with tinned copper shield overall, 80% coverage. The stranded conductor has an extra tight lay to prevent springing open when stripped.

CHARACTERISTICS: Temperature rating -40°C to +80°C. Voltage rating 1000 volts. Resistant to acids, alkalis, oil, flame, moisture and fungus.

ALPHA NO.	TYPE DESIGNATION	CONDUCTOR SIZE	STRAND	NOM. WALL THICKNESS	NOMINAL O.D.	* STOCK COLOR
1194/24	MW-C 24(7)BS	24	7/32	.016"	.090"	White
1194/22+	MW-C 22(7)BS	22	7/30	.016"	.095"	White
1194+	MW-C 20(10)BS	20	10/30	.016"	.108"	White
1196+	MW-C 18(16)BS	18	16/30	.016"	.124"	White
1197+	MW-C 16(26)BS	16	26/30	.016"	.133"	White
1198+	MW-C 14(41)BS	14	41/30	.016"	.144"	White
1199+	MW-C 12(65)BS	12	65/30	.016"	.168"	White

STANDARD SPOOL PUT-UP: 100 FT., 500 FT., 1000 FT.
ALSO AVAILABLE TO ORDER CUT, STRIPPED AND TINNED

*Other solid colors and striped combinations available to order.
1194/22 to 1199 formerly 1361 to 1365



MIL-W-76B-PLASTIC WIRE

TYPE MW-SHIELDED

DESCRIPTION: Extra flexible stranded tinned copper, color coded medium wall polyvinylchloride insulation, braided tinned copper shield overall, 80% coverage. Stranded conductor has an extra tight lay to prevent springing open when stripped.

CHARACTERISTICS: Temperature rating -40°C to +80°C. Voltage rating 1000 volts. Resistant to acids, alkalis, oil, flame, moisture and fungus.

ALPHA NO.	TYPE DESIGNATION	CONDUCTOR SIZE	STRAND	NOM. WALL THICKNESS	NOMINAL O.D.	* STOCK COLORS
1350	MW-C 24(7)S	24	7/32	.016"	.075"	White
1351	MW-C 22(7)S	22	7/30	.016"	.085"	White
1352	MW-C 20(10)S	20	10/30	.016"	.095"	White
1353	MW-C 18(16)S	18	16/30	.016"	.105"	White
1354	MW-C 16(26)S	16	26/30	.016"	.115"	White
1355	MW-C 14(41)S	14	41/30	.016"	.130"	White
1356	MW-C 12(65)S	12	65/30	.016"	.145"	White

STANDARD SPOOL PUT-UP: 100 FT., 500 FT., 1000 FT.
ALSO AVAILABLE TO ORDER CUT, STRIPPED AND TINNED

*Other solid colors and striped combinations available to order.



MIL-W-76B-PLASTIC WIRE

TYPE MW-NYLON JACKET

DESCRIPTION: Extra flexible stranded tinned copper, color coded medium wall polyvinylchloride insulation, clear nylon (polyamide) jacket overall. Stranded conductor has an extra tight lay to prevent springing open when stripped.

CHARACTERISTICS: Temperature rating -40°C to +90°C. Voltage rating 1000 volts. Resistant to acids, alkalis, oil, flame, moisture and fungus.

ALPHA NO.	TYPE DESIGNATION	CONDUCTOR SIZE	STRAND	NOM. WALL THICKNESS	NOM. JKT. THICK.	NOM. O.D.	* STOCK COLORS
1503	MW-C 24(7)J	24	7/32	.016"	.002"	.065"	1-19 as listed below
1504	MW-C 22(7)J	22	7/30	.016"	.003"	.072"	1-19 as listed below
1505	MW-C 20(10)J	20	10/30	.016"	.003"	.079"	1-19 as listed below
1506	MW-C 18(16)J	18	16/30	.016"	.003"	.090"	1-19 as listed below
1507	MW-C 16(26)J	16	26/30	.016"	.004"	.103"	1-19 as listed below
1508	MW-C 14(41)J	14	41/30	.016"	.004"	.118"	1-6 as listed below
1509	MW-C 12(65)J	12	65/30	.016"	.005"	.135"	1-3 as listed below

STANDARD SPOOL PUT-UP: 100 FT., 500 FT., 1000 FT.
ALSO AVAILABLE TO ORDER CUT, STRIPPED AND TINNED

*Other solid colors and striped combinations available to order.

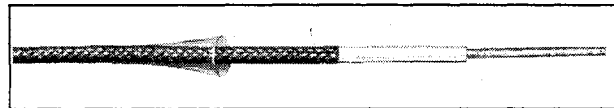

MIL-W-76B-PLASTIC WIRE

TYPE MW-SHIELDED-NYLON JACKET

DESCRIPTION: Stranded tinned copper, white medium wall polyvinylchloride insulation, braided tinned copper shield, 80% minimum coverage, clear nylon (polyamide) jacket overall.

CHARACTERISTICS: Temperature rating -40° to +90°C. Voltage rating 1000 volts. Resistant to acids, alkalis, oil, flame, moisture and fungus.

ALPHA NO.	TYPE DESIGNATION	CONDUCTOR SIZE	STRAND	NOM. WALL THICKNESS	NOMINAL JACKET	NOMINAL O.D.
1370	MW-C 24(7)SJ	24	7/32	.016"	.005"	.091"
1371	MW-C 22(7)SJ	22	7/30	.016"	.005"	.100"
1372	MW-C 20(7)SJ	20	7/28	.016"	.005"	.105"
1373	MW-C 18(19)SJ	18	19/30	.016"	.005"	.115"
1374	MW-C 16(19)SJ	16	19/29	.016"	.005"	.125"
1375	MW-C 14(19)SJ	14	19/27	.016"	.005"	.138"
1376	MW-C 12(19)SJ	12	19/25	.016"	.005"	.156"

STANDARD SPOOL PUT-UP: 100 FT., 500 FT., 1000 FT.
ALSO AVAILABLE TO ORDER CUT, STRIPPED AND TINNED

*** STOCK COLORS**

- | | | | | |
|--------------|--------------------|-----------------|-----------------------|-----------------------|
| 1—White | 7—Brown | 13—White/Green | 19—White/Violet | 25—White/Black/Orange |
| 2—Black | 8—Orange | 14—White/Yellow | 20—White/Black/Red | 26—White/Black/Gray |
| 3—Red | 9—Gray (slate) | 15—White/Blue | 21—White/Black/Green | 27—White/Black/Violet |
| 4—Green | 10—Violet (purple) | 16—White/Brown | 22—White/Black/Yellow | 28—Tan |
| 5—Yellow | 11—White/Black | 17—White/Orange | 23—White/Black/Blue | 29—Pink |
| 6—Light Blue | 12—White/Red | 18—White/Gray | 24—White/Black/Brown | 30—Dark Blue |
- *Other striped color combinations available to order.

SECTION 6000

COLOR CODED PLASTIC INSULATION

STRANDED CONDUCTOR

CLEAR NYLON JACKET

COLOR CODED PLASTIC INSULATION

STRANDED CONDUCTOR

Mil-W-16878D Plastic Wire

TYPE B — UNCOVERED PLASTIC

Regular Tinned Copper Conductor

DESCRIPTION: Stranded tinned copper, color coded .010" polyvinylchloride insulation.
CHARACTERISTICS: Temperature rating -55°C to +105°C. Voltage rating 600 volts. Resistant to acids, alkalis, oil, flame, moisture, solvents, and fungus.

ALPHA NO.	TYPE DESIGNATION	CONDUCTOR SIZE	STRAND	NOM. WALL THICKNESS	NOM. O.D.
1850	B-32	32	7/40	.010"	.028"
1851	B-30	30	7/38	.010"	.032"
1852	B-28	28	7/36	.010"	.034"
1853	B-26	26	7/34	.010"	.038"
1854	B-24	24	7/32	.010"	.043"
1854/19	B-24	24	19/36	.010"	.043"
1855	B-22	22	7/30	.010"	.050"
1855/19	B-22	22	19/34	.010"	.050"
1856	B-20	20	7/28	.010"	.058"
1856/19	B-20	20	19/32	.010"	.058"
1857	B-18	18	7/26	.010"	.068"
1857/19	B-18	18	19/30	.010"	.068"
1858/19	B-16	16	19/29	.010"	.077"
1859/19	B-14	14	19/27	.010"	.091"

* STOCK COLORS

- 1—White
 - 2—Black
 - 3—Red
 - 4—Green
 - 5—Yellow
 - 6—Light Blue
 - 7—Brown
 - 8—Orange
 - 9—Grey (slate)
 - 10—Violet (purple)
 - 11—White/Black
 - 12—White/Red
 - 13—White/Green
 - 14—White/Yellow
 - 15—White/Blue
 - 16—White/Brown
 - 17—White/Orange
 - 18—White/Gray
 - 19—White/Violet
- Other striped color combinations to order.

TYPE B — NYLON JACKET

Regular Tinned Copper Conductor

DESCRIPTION: Stranded tinned copper, color coded .010" polyvinylchloride insulation, clear nylon (polyamide) jacket overall.
CHARACTERISTICS: Temperature rating -55°C to +115°C. Voltage rating 600 volts. Resistant to acids, alkalis, oil, flame, moisture, solvents, and fungus.

ALPHA NO.	TYPE DESIGNATION	CONDUCTOR SIZE	STRAND	NOM. WALL THICKNESS	NOM. JKT. THICKNESS	NOM. O.D.
1860	B-32	32	7/40	.010"	.003"	.035"
1861	B-30	30	7/38	.010"	.003"	.039"
1862	B-28	28	7/36	.010"	.003"	.041"
1863	B-26	26	7/34	.010"	.003"	.044"
1864	B-24	24	7/32	.010"	.003"	.049"
1864/19	B-24	24	19/36	.010"	.003"	.049"
1865	B-22	22	7/30	.010"	.003"	.056"
1865/19	B-22	22	19/34	.010"	.003"	.056"
1866	B-20	20	7/28	.010"	.003"	.064"
1866/19	B-20	20	19/32	.010"	.003"	.064"
1867	B-18	18	7/26	.010"	.003"	.074"
1867/19	B-18	18	19/30	.010"	.003"	.074"
1868/19	B-16	16	19/29	.010"	.003"	.085"
1869/19	B-14	14	19/27	.010"	.004"	.099"

STANDARD SPOOL PUT-UP: 100 FT., 500 FT., 1000 FT.
 ALSO AVAILABLE TO ORDER CUT, STRIPPED, MARKED AND TINNED.

Mil-W-16878D Multi-Conductor Cable

STRANDED CONDUCTOR

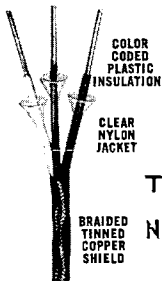

TYPE B — NYLON SHIELDED-PLASTIC JACKET

DESCRIPTION:

Each conductor stranded tinned copper, .010" polyvinylchloride insulation, color coded, clear nylon (polyamide) jacket, conductors cabled, braided tinned copper shield 90% coverage, white polyvinylchloride jacket overall.

CHARACTERISTICS:

Temperature rating -55°C to +105°C
 Voltage rating 600 volts, resistant to acids, alkalis, oil, flame, moisture, fungus, solvents.

ALPHA NO.	NO. OF COND.	CONDUCTOR SIZE	STRAND	NOM. WALL THICKNESS	NOM. NYLON THICKNESS	NOM. OVERALL JACKET	NOM. O.D.
3200	1	26	7/34	.010"	.003"	.010"	.087"
3201	2	26	7/34	.010"	.003"	.014"	.138"
3202	3	26	7/34	.010"	.003"	.014"	.142"
3203	4	26	7/34	.010"	.003"	.016"	.162"
3210	1	24	19/36	.010"	.003"	.010"	.092"
3211	2	24	19/36	.010"	.003"	.016"	.152"
3212	3	24	19/36	.010"	.003"	.016"	.161"
3213	4	24	19/36	.010"	.003"	.017"	.162"
3220	1	22	19/34	.010"	.003"	.010"	.100"
3221	2	22	19/34	.010"	.003"	.016"	.168"
3222	3	22	19/34	.010"	.003"	.017"	.178"
3223	4	22	19/34	.010"	.003"	.019"	.174"
3230	1	20	19/32	.010"	.003"	.010"	.106"
3231	2	20	19/32	.010"	.003"	.019"	.186"
3232	3	20	19/32	.010"	.003"	.019"	.196"
3233	4	20	19/32	.010"	.003"	.021"	.193"
3240	1	18	19/30	.010"	.003"	.012"	.120"
3241	2	18	19/30	.010"	.003"	.021"	.210"
3242	3	18	19/30	.010"	.003"	.022"	.227"
3243	4	18	19/30	.010"	.003"	.023"	.218"
3245	1	16	19/29	.010"	.003"	.016"	.137"
3246	2	16	19/29	.010"	.003"	.023"	.236"
3247	3	16	19/29	.010"	.003"	.023"	.240"
3248	4	16	19/29	.010"	.003"	.025"	.274"

STANDARD SPOOL PUT-UP: 100 FT., 500 FT., 1000 FT.

COLOR CODE OF CONDUCTORS
 1—White, 2—Black, 3—Red, 4—Green



ALPHA WIRE MFG.

Sold Nationally to Electronic Parts Distributors by; Loral Distributor Products, a Division of Loral Corporation

Mil-W-16878D Plastic Wire

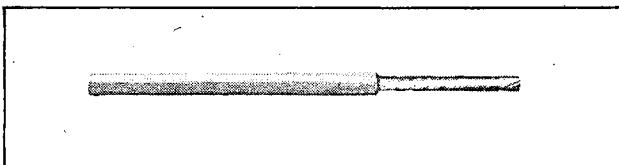

TYPE C — UNCOVERED PLASTIC

DESCRIPTION: Stranded tinned copper, color coded .016" polyvinylchloride insulation.
CHARACTERISTICS: Temperature rating —55°C to +105°C. Voltage rating 1000 volts. Resistant to acids, alkalis, oil, flame, moisture, solvents and fungus.

ALPHA NO.	TYPE DESIGNATION	CONDUCTOR SIZE	CONDUCTOR STRAND	NOM. WALL THICKNESS	NOMINAL O.D.	* STOCK COLORS
1830	C-24	24	7/32	.016"	.058"	1-19 as listed below
1831	C-22	22	7/30	.016"	.064"	1-19 as listed below
1832	C-20	20	7/28	.016"	.072"	1-19 as listed below
1833	C-18	18	7/26	.016"	.082"	1-19 as listed below
1834	C-16	16	19/29	.016"	.091"	1 & 11-19 as listed below
1835	C-14	14	19/27	.016"	.105"	1 & 11-19 as listed below
1836	C-12	12	19/25	.016"	.124"	1 & 11-19 as listed below

STANDARD SPOOL PUT-UP: 100 FT., 500 FT., 1000 FT.
 ALSO AVAILABLE TO ORDER CUT, STRIPPED, MARKED AND TINNED

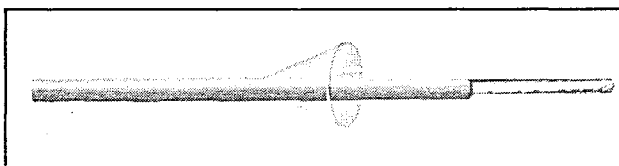

TYPE C — NYLON JACKET

DESCRIPTION: Stranded tinned copper, color coded .016" polyvinylchloride insulation, clear nylon (polyamide) jacket overall.
CHARACTERISTICS: Temperature rating —55°C to +115°C. Voltage rating 1000 volts. Resistant to acids, alkalis, oil, flame, moisture, solvents and fungus.

ALPHA NO.	TYPE DESIGNATION	CONDUCTOR SIZE	CONDUCTOR STRAND	NOM. WALL THICKNESS	NOM. JKT. THICK.	NOMINAL O.D.	* STOCK COLORS
1840	C-24	24	7/32	.016"	.002"	.065"	1-19 as listed below
1841	C-22	22	7/30	.016"	.003"	.072"	1-19 as listed below
1842	C-20	20	7/28	.016"	.003"	.079"	1-19 as listed below
1843	C-18	18	7/26	.016"	.003"	.090"	1-19 as listed below
1844	C-16	16	19/29	.016"	.004"	.099"	1 & 11-19 as listed below
1845	C-14	14	19/27	.016"	.004"	.114"	1 & 11-19 as listed below
1846	C-12	12	19/25	.016"	.005"	.135"	1 & 11-19 as listed below

- *STOCK COLORS
- | | | | |
|----------|--------------------|-----------------|-----------------|
| 1—White | 6—Light Blue | 11—White/Black | 16—White/Brown |
| 2—Black | 7—Brown | 12—White/Red | 17—White/Orange |
| 3—Red | 8—Orange | 13—White/Green | 18—White/Gray |
| 4—Green | 9—Gray (slate) | 14—White/Yellow | 19—White/Violet |
| 5—Yellow | 10—Violet (purple) | 15—White/Blue | |
- Other solid colors and striped combinations available to order.

STANDARD SPOOL PUT-UP: 100 FT., 500 FT., 1000 FT.
 ALSO AVAILABLE TO ORDER CUT, MARKED AND STRIPPED

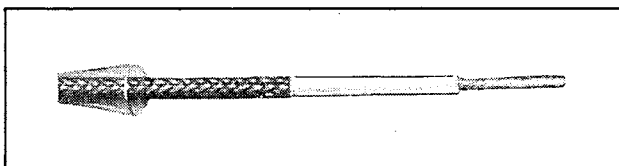

TYPE C — SHIELDED — NYLON JACKET

DESCRIPTION: Stranded tinned copper, white .016" polyvinylchloride insulation, braided tinned copper shield, 90% coverage, clear nylon (polyamide) jacket overall (which can be striped to order for color identification).
CHARACTERISTICS: Temperature rating —55°C to +115°C. Voltage rating 1000 volts. Resistant to acids, alkalis, oil, flame, moisture, solvents and fungus.

ALPHA NO.	TYPE DESIGNATION	CONDUCTOR SIZE	CONDUCTOR STRAND	NOM. WALL THICKNESS	NOMINAL JKT. THICKNESS	NOMINAL O.D.
1470	C-24	24	7/32	.016"	.005"	.091"
1471	C-22	22	7/30	.016"	.005"	.098"
1472	C-20	20	7/28	.016"	.005"	.105"
1473	C-18	18	19/30	.016"	.005"	.115"
1474	C-16	16	19/29	.016"	.005"	.125"
1475	C-14	14	19/27	.016"	.005"	.142"
1476	C-12	12	19/25	.016"	.005"	.156"

STANDARD SPOOL PUT-UP: 100 FT., 500 FT., 1000 FT.
 ALSO AVAILABLE TO ORDER CUT, STRIPPED, MARKED AND TINNED

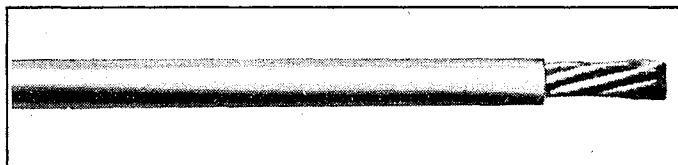

TYPE D — UNCOVERED PLASTIC

DESCRIPTION: Stranded tinned copper, color coded polyvinylchloride insulation.
CHARACTERISTICS: Temperature rating —55°C to +105°C. Voltage rating 3000 volts. Resistant to acids, alkalis, oil, flame, moisture, solvents and fungus.

ALPHA NO.	TYPE DESIGNATION	CONDUCTOR SIZE	CONDUCTOR STRAND	NOM. WALL THICKNESS	NOM. O.D.	*STOCK COLORS
1870	D-24	24	7/32	.029"	.082"	Wh., Blk., Red
1871	D-22	22	7/30	.029"	.088"	Wh., Blk., Red
1872	D-20	20	7/28	.029"	.096"	Wh., Blk., Red
1873	D-18	18	7/26	.029"	.105"	Wh., Blk., Red
1874	D-16	16	19/29	.029"	.115"	Wh., Blk., Red
1875	D-14	14	19/27	.029"	.129"	Wh., Blk., Red
1876	D-12	12	19/25	.034"	.158"	Wh., Blk., Red
1877	D-10	10	37/26	.037"	.185"	White
1878	D- 8	8	133/29	.040"	.247"	White
1879	D- 6	6	133/27	.040"	.290"	White
1879/4	D- 4	4	133/25	.045"	.355"	White
1879/2	D- 2	2	665/30	.045"	.425"	White
1879/1	D- 1	1	817/30	.050"	.480"	White
1879/0	D- 0	0	1045/30	.052"	.530"	White

STANDARD SPOOL PUT-UP: 100 FT., 500 FT., 1000 FT.
 ALSO AVAILABLE TO ORDER CUT, STRIPPED, MARKED AND TINNED

NEW

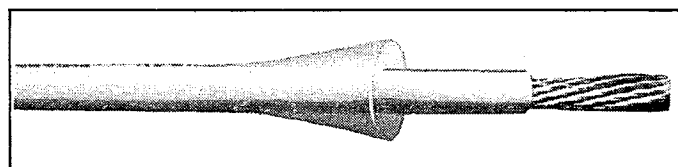

TYPE D — NYLON JACKET

DESCRIPTION: Stranded tinned copper, color coded polyvinylchloride insulation. Sizes 24-6, clear nylon (polyamide) jacket overall, sizes 4-0, white nylon braid overall.

CHARACTERISTICS: Temperature rating —55°C to +115°C. Voltage rating 3000 volts. Resistant to acids, alkalis, oil, flame, moisture, solvents and fungus.

CLEAR NYLON JACKET

ALPHA NO.	TYPE DESIGNATION	CONDUCTOR SIZE	CONDUCTOR STRAND	NOM. WALL THICKNESS	NOM. JKT. THICKNESS	NOMINAL O.D.	*STOCK COLORS
1880	D-24	24	7/32	.029"	.004"	.090"	Wh., Blk., Red
1881	D-22	22	7/30	.029"	.004"	.096"	Wh., Blk., Red
1882	D-20	20	7/28	.029"	.004"	.104"	Wh., Blk., Red
1883	D-18	18	7/26	.029"	.004"	.114"	Wh., Blk., Red
1884	D-16	16	19/29	.029"	.005"	.125"	Wh., Blk., Red
1885	D-14	14	19/27	.029"	.005"	.139"	Wh., Blk., Red
1886	D-12	12	19/25	.034"	.005"	.168"	Wh., Blk., Red
1887	D-10	10	37/26	.037"	.006"	.197"	White
1888	D- 8	8	133/29	.040"	.009"	.265"	White
1889	D- 6	6	133/27	.040"	.010"	.310"	White

WHITE NYLON BRAID

1889/4	D- 4	4	133/25	.045"	.010"	.375"	White
1889/2	D- 2	2	665/30	.045"	.011"	.447"	White
1889/1	D- 1	1	817/30	.050"	.011"	.502"	White
1889/0	D- 0	0	1045/30	.052"	.011"	.552"	White

STANDARD SPOOL PUT-UP: 100 FT., 500 FT., 1000 FT.
 ALSO AVAILABLE TO ORDER CUT, STRIPPED, MARKED AND TINNED

NEW

PRICES

Alpha No.	Sugg. Resale per 1000'	Alpha No.	Sugg. Resale per 1000'
1830	11.29	1472	76.56
1831	12.37	1473	90.42
1832	14.85	1474	111.21
1833	18.15	1475	148.17
1834	23.92	1476	224.40
1835	35.47	1870	21.61
1836	61.38	1871	22.77
1840	15.97	1872	25.90
1841	16.50	1873	32.01
1842	19.80	1874	47.85
1843	23.10	1875	57.09
1844	29.70	1876	89.26
1845	41.25	1877	135.30
1846	71.88	1878	353.92
1470	63.52	1879	462.00
1471	68.97	1879/4	627.00
		1879/2	973.50
		1879/1	1,221.00
		1879/0	1,518.00
		1880	33.16
		1881	35.47
		1882	38.61
		1883	44.55
		1884	65.01
		1885	80.19
		1886	126.23
		1887	196.35
		1888	429.00
		1889	577.50
		1889/4	709.50
		1889/2	1,122.00
		1889/1	1,353.00
		1889/0	1,633.50



ALPHA WIRE MFG.

Sold Nationally to Electronic Parts Distributors by; Loral Distributor Products, a Division of Loral Corporation

Mil-W-16878D Shielded Teflon Cables

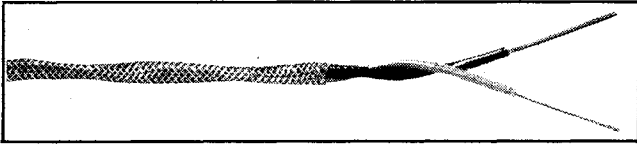

NO OUTER COVERING OVER SHIELD

DESCRIPTION: Each conductor stranded silver plated copper, Type E extruded TFE .010" insulation, braided silver plated copper shield over conductor(s), 90% coverage.
CHARACTERISTICS: Temperature rating -65°C to +200°C. Voltage rating 600 volts. Resistant to acids, alkalis, oil, flame, moisture, solvents and fungus.

ALPHA NO.	NO. OF COND.	CONDUCTOR SIZE	STRAND	NOM. O.D.	NOM. CAP. IN MMF SHIELD TO COND.	COND. TO COND.
2809	1	24	19/36	.069"	45	—
2809/2	2	24	19/36	.112"	35	25
2809/3	3	24	19/36	.120"	35	20
2809/4	4	24	19/36	.132"	35	20
2812	1	22	19/34	.075"	55	—
2812/2	2	22	19/34	.124"	45	25
2812/3	3	22	19/34	.132"	35	25
2812/4	4	22	19/34	.146"	35	25
2815	1	20	19/32	.083"	55	—
2815/2	2	20	19/32	.142"	95	25
2815/3	3	20	19/32	.151"	85	25
2815/4	4	20	19/32	.168"	140	30
2818	1	18	19/30	.093"	70	—
2818/2	2	18	19/30	.162"	60	35
2818/3	3	18	19/30	.172"	60	35
2818/4	4	18	19/30	.192"	55	35
2807	1	16	19/29	.103"	107	—
2807/2	2	16	19/29	.184"	67	35

STANDARD SPOOL PUT-UP: 100 FT., 500 FT., 1000 FT.
 ■ NEW
 COLOR CODE OF CONDUCTORS
 1—White 2—Black 3—Red 4—Green

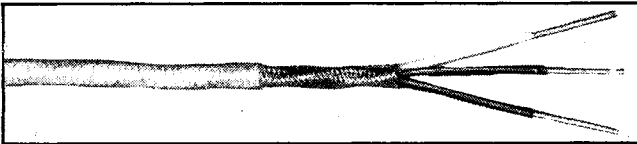

TEFLON IMPREGNATED BRAID OVER SHIELD

DESCRIPTION: Each conductor stranded silver plated copper, Type E extruded .010" TFE Teflon insulation, color coded, cabled, braided silver plated copper shield, 90% coverage, braided white fused Teflon impregnated, fiber-glass braid overall.
CHARACTERISTICS: Temperature rating -65°C to +200°C. Voltage rating 600 volts. Resistant to acids, alkalis, oil, flame, moisture, solvents and fungus.

ALPHA NO.	NO. OF COND.	CONDUCTOR SIZE	STRAND	NOM. O.D.	NOM. CAP. IN MMF SHIELD TO COND.	COND. TO COND.
2811	1	24	19/36	.081"	45	—
2811/2	2	24	19/36	.126"	35	25
2811/3	3	24	19/36	.133"	35	20
2811/4	4	24	19/36	.144"	35	20
2814	1	22	19/34	.088"	55	—
2814/2	2	22	19/34	.137"	45	25
2814/3	3	22	19/34	.144"	35	25
2814/4	4	22	19/34	.158"	35	25
2817	1	20	19/32	.097"	55	—
2817/2	2	20	19/32	.154"	95	25
2817/3	3	20	19/32	.163"	85	25
2817/4	4	20	19/32	.180"	140	30
2819	1	18	19/30	.106"	70	—
2819/2	2	18	19/30	.174"	60	35
2819/3	3	18	19/30	.185"	60	35
2819/4	4	18	19/30	.205"	55	35
2820	1	16	19/29	.117"	107	—
2820/2	2	16	19/29	.196"	67	35

STANDARD SPOOL PUT-UP: 100 FT., 500 FT., 1000 FT.
 ■ NEW
 COLOR CODE OF CONDUCTORS
 1—White 2—Black 3—Red 4—Green

Alpha No.	Sugg. Retail per 500'	2815	185.62	2807/2	558.75	2817/2	247.96
2809	146.25	2815/2	427.50	2811	133.87	2817/3	380.98
2809/2	299.25	2815/3	573.75	2811/2	197.71	2817/4	475.69
2809/3	438.75	2815/4	720.00	2811/3	301.53	2819	217.56
2809/4	517.50	2818	222.75	2811/4	385.48	2819/2	345.33
2812	157.50	2818/2	517.50	2814	140.29	2819/3	462.69
2812/2	335.25	2818/3	652.50	2814/2	218.32	2819/4	676.81
2812/3	468.75	2818/4	832.50	2814/4	428.43	2820	238.12
2812/4	585.00	2807	270.00	2817	152.88	2820/4	433.13
2814/3	337.81						

Sold Nationally to Electronic Parts Distributors by; Loral Distributor Products, a Division of Loral Corporation

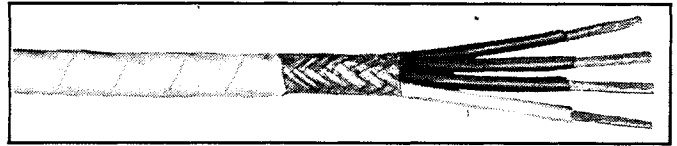

TEFLON TAPE WRAP JACKET OVER SHIELD

DESCRIPTION: Each conductor stranded silver plated copper, Type E extruded .010" TFE Teflon insulation, color coded, cabled, braided silver plated copper shield 90% coverage, sintered wrapped white Teflon tape jacketed overall.
CHARACTERISTICS: Temperature rating -65°C to +200°C. Voltage rating 600 volts. Resistant to acids, alkalis, oil, flame, moisture, solvents and fungus.

ALPHA NO.	NO. OF COND.	CONDUCTOR SIZE	STRAND	NOM. JKT. THICKNESS	NOM. O.D. AT HIGH POINT	NOM. CAP. IN MMF SHIELD TO COND.	COND. TO COND.
2821	1	24	19/36	.010"	.095"	45	—
2821/2	2	24	19/36	.010"	.140"	35	25
2821/3	3	24	19/36	.010"	.147"	35	20
2821/4	4	24	19/36	.014"	.159"	35	20
2824	1	22	19/34	.010"	.102"	55	—
2824/2	2	22	19/34	.014"	.154"	45	25
2824/3	3	22	19/34	.014"	.162"	35	25
2824/4	4	22	19/34	.014"	.176"	35	25
2827	1	20	19/32	.010"	.110"	55	—
2827/2	2	20	19/32	.014"	.170"	95	25
2827/3	3	20	19/32	.014"	.175"	85	25
2827/4	4	20	19/32	.018"	.213"	140	30
2829	1	18	19/30	.010"	.120"	70	—
2829/2	2	18	19/30	.014"	.190"	60	35
2829/3	3	18	19/30	.018"	.219"	60	35
2829/4	4	18	19/30	.018"	.237"	55	35
2826	1	16	19/29	.010"	.130"	107	—
2826/2	2	16	19/29	.018"	.230"	67	25

STANDARD SPOOL PUT-UP: 100 FT., 500 FT., 1000 FT.
 ■ NEW
 COLOR CODE OF CONDUCTORS
 1—White, 2—Black, 3—Red, 4—Green

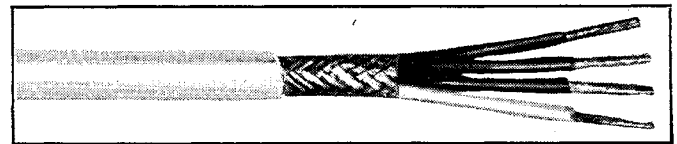

TEFLON FEP EXTRUDED JACKET OVER SHIELD

DESCRIPTION: Each conductor stranded silver plated copper, Type E extruded TFE insulation color coded, cabled, braided silver plated copper shield 90% coverage, extruded FEP white Teflon jacket overall.
CHARACTERISTICS: Temperature rating -65°C to +200°C. Voltage rating 600 volts. Resistant to acids, alkalis, oil, flame, moisture, solvents and fungus. Extruded FEP Teflon jacket is tough and abrasion resistant.

ALPHA NO.	NO. OF COND.	CONDUCTOR SIZE	STRAND	NOM. WALL THICKNESS	NOM. JKT. THICKNESS	NOM. O.D.	NOM. CAP. IN MMF SHIELD TO COND.	COND. TO COND.
2831	1	24	19/36	.010"	.010"	.085"	45	—
2831/2	2	24	19/36	.010"	.010"	.130"	35	25
2831/3	3	24	19/36	.010"	.010"	.135"	35	20
2834	1	22	19/34	.010"	.010"	.091"	55	—
2834/2	2	22	19/34	.010"	.014"	.150"	45	25
2834/3	3	22	19/34	.010"	.014"	.158"	35	25
2837	1	20	19/32	.010"	.010"	.100"	55	—
2837/2	2	20	19/32	.010"	.014"	.168"	95	25
2837/3	3	20	19/32	.010"	.014"	.178"	85	25
2839	1	18	19/30	.010"	.010"	.110"	70	—
2839/2	2	18	19/30	.010"	.014"	.188"	60	35
2839/3	3	18	19/30	.010"	.018"	.207"	60	35
2836	1	16	19/29	.010"	.010"	.123"	107	—
2836/2	2	16	19/29	.010"	.018"	.220"	67	35

STANDARD SPOOL PUT-UP: 100 FT., 500 FT., 1000 FT.
 ■ NEW
 COLOR CODE OF CONDUCTORS
 1—White, 2—Black, 3—Red

Alpha No.	Sugg. Retail per 500'	2827	414.00	2826	697.50	2837	371.25
2821	315.00	2827/2	772.50	2826/2	1,237.50	2837/2	668.25
2821/2	527.25	2827/3	1,014.75	2831	283.50	2837/3	918.00
2821/3	776.25	2827/4	1,293.75	2831/2	477.00	2839	447.75
2821/4	585.00	2829	495.00	2831/3	704.25	2839/2	897.75
2824	348.75	2829/2	937.75	2834	320.62	2839/3	1,118.25
2824/2	648.00	2829/3	1,192.50	2834/2	585.00	2836	652.50
2824/3	855.00	2829/4	1,400.62	2834/3	771.75	2826/2	1,102.50
2824/4	1,113.75						

SECTION 6000

Mil-W-16878D Teflon[†] Wire

TYPE E — EXTRUDED (600 VOLTS)

DESCRIPTION: Single conductor stranded silver plated copper, TFE extruded Teflon insulation.
 CHARACTERISTICS: Temperature rating: -65°C to +200°C. Voltage rating: 600 volts. Resistant to acid, alkalis, oil, flame, moisture, solvents and fungus.

ALPHA NO.	TYPE DESIGNATION	CONDUCTOR SIZE	STRAND	NOM. WALL THICKNESS	NOM. O.D.	*STOCK COLORS
2850	E-32	32	7/40	.010"	.029"	1-19 as listed
2851	E-30	30	7/38	.010"	.032"	1-19 as listed
2852	E-28	28	7/36	.010"	.036"	1-19 as listed
2853	E-26	26	7/34	.010"	.040"	1-19 as listed
2854	E-24	24	19/36	.010"	.045"	1-19 as listed
■ 2854/7	E-24	24	7/32	.010"	.044"	1-19 as listed
2855	E-22	22	19/34	.010"	.051"	1-19 as listed
■ 2855/7	E-22	22	7/30	.010"	.050"	1-19 as listed
2856	E-20	20	19/32	.010"	.059"	1-19 as listed
■ 2856/7	E-20	20	7/28	.010"	.058"	1-19 as listed
2857	E-18	18	19/30	.010"	.070"	1-19 as listed
2858	E-16	16	19/29	.010"	.077"	1-19 as listed
2859	E-14	14	19/27	.012"	.094"	1-6 6 11-19
2859/12	E-12	12	19/25	.012"	.113"	1 & 11-19
2859/10	E-10	10	37/26	.012"	.134"	1 & 11-19

TYPE EE — EXTRUDED (1000 VOLTS)

DESCRIPTION: Single conductor stranded silver plated copper, extruded TFE Teflon insulation.
 CHARACTERISTICS: Temperature rating: -65°C to +200°C. Voltage rating: 1000 volts. Resistant to acid, alkalis, oil, flame, moisture, solvents and fungus.

ALPHA NO.	TYPE DESIGNATION	CONDUCTOR SIZE	STRAND	NOM. WALL THICKNESS	NOM. O.D.	*STOCK COLORS
2874	EE-24	24	19/36	.014"	.055"	1-19
2875	EE-22	22	19/34	.014"	.062"	1-19
2876	EE-20	20	19/32	.014"	.070"	1-19
2877	EE-18	18	19/30	.014"	.080"	1-19
2878	EE-16	16	19/29	.014"	.089"	1 & 11-19
2879	EE-14	14	19/27	.017"	.106"	1 & 11-19
2879/12	EE-12	12	19/25	.017"	.124"	1 & 11-19
2879/10	EE-10	10	37/26	.017"	.145"	1 & 11-19
2879/8	EE-8	8	133/29	.020"	.210"	White only

* STOCK COLORS:

- | | | | | |
|---------|--------------|--------------------|-----------------|-----------------|
| 1—White | 5—Yellow | 9—Gray (slate) | 13—White/Green | 17—White/Orange |
| 2—Black | 6—Light Blue | 10—Violet (purple) | 14—White/Yellow | 18—White/Gray |
| 3—Red | 7—Brown | 11—White/Black | 15—White/Blue | 19—White/Violet |
| 4—Green | 8—Orange | 12—White/Red | 16—White/Brown | |

†Other solid colors and striped combinations available to order.

† T.M. DuPont

STANDARD SPOOL PUT-UP: 100 FT., 500 FT., 1000 FT. ALSO AVAILABLE TO ORDER CUT, MARKED AND STRIPPED. ■ NEW

Mil-W-5086A

UNSHIELDED AIRCRAFT WIRE FOR ELECTRICAL SYSTEMS

DESCRIPTION

MIL-W-5086A—Type I — AN-22 thru AN-12 — Single conductor stranded tinned copper, white polyvinylchloride insulation, clear nylon, (polyamide) jacket overall.

MIL-W-5086A—Type II — AN-22 thru AN-12 — Single conductor stranded tinned copper, white polyvinylchloride insulation, white glass braid, clear nylon (polyamide) jacket overall.

MIL-W-5086A—Type II — AN-10 thru AN-0000 — Single conductor stranded tinned copper, white polyvinylchloride insulation, white glass braid, flame retardant nylon lacquered nylon braid overall.

CHARACTERISTICS: Temperature rating: -55°C. to +105°C. Voltage rating: 600 volts. Resists effects of water, oil, aircraft fuels, hydraulic fluid, skydral, ethyleneglycol, alcohol, dilute acids, alkalis, fungus and abrasion.

UNSHIELDED (MIL-W-5086A) TYPE I

ALPHA NO.	MIL TYPE DESIGNATION	CONDUCTOR SIZE	STRAND	NOMINAL O.D.	NOM. WGT LBS. PER M/FT.
1381	AN-22	22	19/34	.068"	4.0
1382	AN-20	20	19/32	.078"	5.7
1383	AN-18	18	19/30	.088"	8.3
1384	AN-16	16	19/29	.098"	18.4
1385	AN-14	14	19/27	.117"	15.9
1386	AN-12	12	19/25	.137"	23.7

UNSHIELDED (MIL-W-5086A) TYPE II

ALPHA NO.	MIL TYPE DESIGNATION	CONDUCTOR SIZE	STRAND	NOMINAL O.D.	NOM. WGT LBS. PER M/FT.
1341	AN-22	22	19/34	.075"	4.6
1342	AN-20	20	19/32	.085"	6.3
1343	AN-18	18	19/30	.095"	8.9
1344	AN-16	16	19/29	.105"	10.9
1345	AN-14	14	19/27	.125"	16.3
1346	AN-12	12	19/25	.143"	24.2
1387	AN-10	10	49/27	.189"	39.2
1388	AN-8	8	133/29	.240"	66.2
1389	AN-6	6	133/27	.293"	102.8
1389/4	AN-4	4	133/25	.355"	158.2
1389/2	AN-2	2	665/30	.425"	244.1
■ 1389/1	AN-1	1	817/30	.470"	300.0
1389/0	AN-0	0	1045/30	.525"	381.0
1389/00	AN-00	00	1330/30	.590"	485.0
■ 1389/000	AN-000	000	1661/30	.645"	609.0
■ 1389/0000	AN-0000	0000	2104/30	.715"	755.0

STANDARD SPOOL PUT-UP: 100 FT., 500 FT., 1000 FT. ALSO AVAILABLE TO ORDER CUT, MARKED AND STRIPPED. ■ NEW

Alpha No.	Sugg. Resale per 1000'	Alpha No.	Sugg. Resale per 1000'	Alpha No.	Sugg. Resale per 1000'	Alpha No.	Sugg. Resale per 1000'
2850	78.00	2855	108.15	2859	282.00	2877	180.00
2851	75.90	2855/7	99.00	2859/12	420.00	2878	243.00
2852	81.00	2856	138.75	2859/10	705.00	2879	330.00
2853	84.60	2856/7	123.00	2874	103.35	2879/12	495.00
2854	96.74	2857	158.10	2875	120.75	2879/10	840.00
2854/7	84.15	2858	210.90	2876	153.60	2879/8	1725.00

Alpha No.	Sugg. Resale per 1000'	Alpha No.	Sugg. Resale per 1000'	Alpha No.	Sugg. Resale per 1000'	Alpha No.	Sugg. Resale per 1000'
1381	25.90	1341	34.15	1387	156.75	1389/0	1,468.50
1382	30.19	1342	40.26	1388	297.00	1389/00	1,848.00
1383	37.29	1343	48.67	1389	429.00	1389/000	2,524.50
1384	40.92	1344	55.77	1389/4	618.75	1389/0000	3,217.50
1385	56.92	1345	77.38	1389/2	924.00		
1386	83.32	1346	106.42	1389/1	1,122.00		

Sold Nationally to Electronic Parts Distributors by: Lorai Distributor Products, a Division of Lorai Corporation

Alpha RG Cable Types

POLYETHYLENE DIELECTRIC

All Illustrations — Actual Size

ALPHA PART NO.	RG CABLE TYPE	INNER CONDUCTOR			DIELECTRIC		SHIELDS			JACKET		ARMOR (.0126 ALUM. WIRE)	OPR VOLTS RMS	LBS. PER M/FT.	NOM. IMPED. OHMS	NOM. CAP MMF/ FT.
		MAT.	STRAND	NOM. O.D.	MAT.	O.D.	Inner	Outer	O.D.	MAT	O.D.					
9006A	6A/U	CW	1	.0285	PE	.189	SC	C	.264	NCV	.336		2700	74	75	20
9008	8/U	C	7/.0285	.086	PE	.295	C	—	.340	V	.415		5000	105	52	29.5
9008A	8A/U	C	7/.0285	.086	PE	.295	C	—	.340	NCV	.415		5000	99	52	29.5
9009B	9B/U	SC	7/.0285	.086	PE	.285	SC	SC	.355	NCV	.430		5000	126	50	30
9010A	10A/U	C	7/.0285	.086	PE	.295	C	—	.340	NCV	.415	.475	5000	125	52	29.5
9011	11/U	TC	7/.0159	.048	PE	.295	C	—	.340	V	.415		5000	94	75	20.5
9011A	11A/U	TC	7/.0159	.048	PE	.292	C	—	.340	NCV	.412		5000	89	75	20.5
9012A	12A/U	TC	7/.0159	.048	PE	.292	C	—	.340	NCV	.412	.475	5000	113	75	20.5
9014A	14A/U	C	1	.102	PE	.383	C	C	.463	NCV	.558		7000	201	52	29.5
9017A	17A/U	C	1	.188	PE	.695	C	—	.760	NCV	.885		11000	462	52	29.5
9019A	19A/U	C	1	.250	PE	.925	C	—	.990	NCV	1.135		14000	720	52	29.5
9022B	22B/U	C	Two 7/.0152	.047	PE	.291	TC	TC	.355	NCV	.430		1000	124	95	16
9055	55/U	C	1	.032	PE	.121	TC	TC	.176	NP	.206		1900	31	53.5	28.5
9055B	55B/U	SC	1	.032	PE	.121	TC	TC	.176	BP	.206		1900	32	53.5	28.5
9058	58/U	C	1	.032	PE	.121	TC	—	.150	V	.200		1900	24	53.5	28.5
9058A	58A/U	TC	19/.0071	.0375	PE	.120	TC	—	.150	V	.199		1900	25	50	29.5
9058C	58C/U	TC	19/.0071	.0375	PE	.120	TC	—	.150	NCV	.199		1900	25	50	29.5
9059	59/U	CW	1	.0253	PE	.150	C	—	.191	V	.250		2300	36	73	21
9059B	59B/U	CW	1	.023	PE	.150	C	—	.191	NCV	.246		2300	36	75	20.5
9062	62/U	CW	1	.025	SSP	.151	C	—	.191	V	.250		750	34	93	13.5
9062A	62A/U	CW	1	.025	SSP	.151	C	—	.191	NCV	.249		750	34	93	13.5
9063B	63B/U	CW	1	.0253	SSP	.295	C	—	.340	NCV	.415		1000	78	125	10
9071B	71B/U	CW	1	.025	SSP	.151	C	TC	.208	BP	.250		750	42	93	13.5
9174	174/U	CW	7/.0063	.019	PE	.060	TC	—	.088	V	.105		1500	7	50	30
9212	212/U	SC	1	.056	PE	.189	SC	SC	.265	NCV	.336		3000	85	50	29.5
9213	213/U	C	7/.0296	.090	PE	.292	C	—	.340	NCV	.412		5000	100	50	30.5
9214	214/U	SC	7/.0296	.090	PE	.292	SC	SC	.360	NCV	.432		5000	129	50	30.5
9215	215/U	C	7/.0296	.090	PE	.292	C	—	.340	NCV	.412	.475	5000	122	50	30.5
9217	217/U	C	1	.106	PE	.380	C	C	.463	NCV	.555		7000	202	50	30
9218	218/U	C	1	.195	PE	.690	C	—	.760	NCV	.880		11000	457	50	30
9219	219/U	C	1	.195	PE	.690	C	—	.760	NCV	.880	.945	11000	507	50	30
9223	223/U	SC	1	.036	PE	.120	SC	SC	.176	NCV	.216		1900	36	50	30

ALL TYPES LISTED CONFORM TO LATEST REVISION MIL-C-17.

C—Bare Copper
TC—Tinned Copper
SC—Silver Covered Copper
CW—Copper Covered SteelPE—Solid Polyethylene
SSP—Semi Solid Polyethylene
BP—Black Polyethylene—Type IIIANP—Natural Polyethylene—Type III
V—Polyvinylchloride—Type I
NCV—Non-Contaminating Polyvinylchloride—Type IIAALL DIMENSIONS ARE MAXIMUM
EXCEPT WHERE INDICATED

alpha

ALPHA WIRE MFG.

Sold Nationally to Electronic Parts Distributors by; Loral Distributor Products, a Division of Loral Corporation

Flat Ribbon Cable

MULTI-CONDUCTOR — PLASTIC INSULATION
CONDUCTORS PER MIL-W-16878D, Type C

DESCRIPTION: Each conductor stranded tinned copper, color coded .016" polyvinylchloride insulation, conductors banded together to form flat ribbon cable.

CHARACTERISTICS: Temperature rating -55°C to +105°C. Voltage rating 1000 volts. Resistant to acids, alkalis, oil, flame, moisture, solvents, and fungus.

APPLICATIONS: Saves time, weight, and space on circuit connections, interconnecting assemblies and systems, wiring harnesses for racks, sliding drawer and drop panels. Conductors fully color coded and easily separated for neat terminations.

ALPHA NO.	NO. OF COND.	CONDUCTOR SIZE	CONDUCTOR STRAND	NOM. WALL THICKNESS	NOMINAL O.D.
3504	4	22	7/30	.016"	.065" x .260"
3508	8	22	7/30	.016"	.065" x .520"
3512	12	22	7/30	.016"	.065" x .780"
3516	16	22	7/30	.016"	.065" x 1.040"
3520	20	22	7/30	.016"	.065" x 1.300"

STANDARD SPOOL PUT-UP: 100 FT., 500 FT., 1000 FT.

COLOR CODE OF CONDUCTORS

- | | |
|--------------------|--------------------|
| 1—White | 11—White/Black |
| 2—Black | 12—White/Red |
| 3—Red | 13—White/Green |
| 4—Green | 14—White/Yellow |
| 5—Yellow | 15—White/Blue |
| 6—Light Blue | 16—White/Brown |
| 7—Brown | 17—White/Orange |
| 8—Orange | 18—White/Gray |
| 9—Gray (slate) | 19—White/Violet |
| 10—Violet (purple) | 20—White/Black/Red |

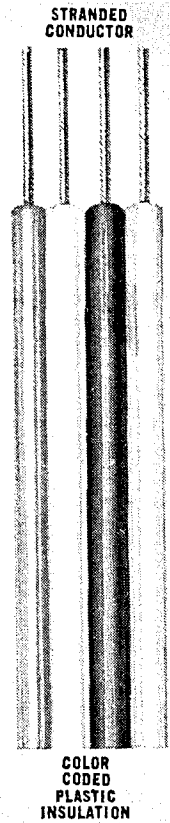

Shielded Control Cable

GENERAL PURPOSE MULTI-CONDUCTOR
PLASTIC JACKETED CABLE

DESCRIPTION: Each conductor, stranded tinned copper, color coded, polyethylene insulation, cabled with fillers where necessary, rayon wrap, braided tinned copper shield, chrome gray polyvinylchloride jacket overall.

CHARACTERISTICS: Suggested Operating Temperature: -20°C to +60°C. Suggested Operating Voltage: 600 Volts.

ALPHA NO.	NO. OF COND.	CONDUCTOR SIZE	CONDUCTOR STRAND	NOM. WALL THICKNESS	NOM. JKT. THICKNESS	NOM. O.D.
1712	2	20	26/34	.014"	.030"	.230"
1713	3	20	26/34	.014"	.035"	.250"
1715	4	20	26/34	.014"	.035"	.260"
1716	5	20	26/34	.014"	.035"	.275"
1717	6	20	26/34	.014"	.035"	.300"
1719	8	20	26/34	.014"	.035"	.330"
1721	10	20	26/34	.014"	.035"	.375"
1723	12	20	26/34	.014"	.035"	.380"
1726	15	20	26/34	.014"	.035"	.410"
1728	20	20	26/34	.014"	.035"	.455"

STANDARD SPOOL PUT-UP: 100 FT., 250 FT., 500 FT., 1000 FT.

COLOR CODE OF CONDUCTORS

- | | | | | |
|---------|----------|----------------|-----------------|-----------------|
| 1—Black | 5—Yellow | 9—Slate | 13—White/Green | 17—White/Purple |
| 2—White | 6—Blue | 10—Purple | 14—White/Yellow | 18—White/Slate |
| 3—Red | 7—Brown | 11—White/Black | 15—White/Blue | 19—Black/Red |
| 4—Green | 8—Orange | 12—White/Red | 16—White/Brown | 20—Black/Yellow |

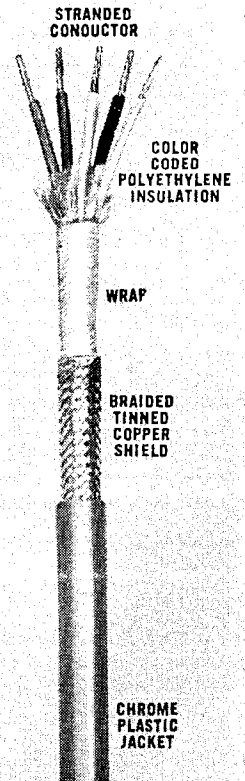

Alpha No.	Sugg. Resale 1000'	Alpha No.	PRICES		Sugg. Resale 1000'	Alpha No.	Sugg. Resale 1000'
3504	143.95	3520	675.21	1716	150.88	1723	771.75
3508	240.34	1712	111.51	1717	307.12	1726	1,197.00
3512	396.58	1713	111.99	1719	396.90	1728	1,559.25
3516	544.95	1715	130.57	1721	488.25		

Sold Nationally to Electronic Parts Distributors by: Loral Distributor Products, a Division of Loral Corporation

Shielded Microphone Cable

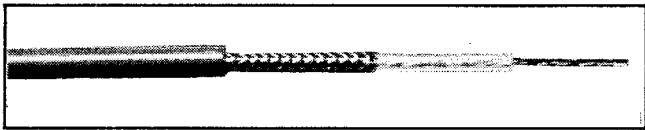

PLASTIC JACKET

DESCRIPTION: 1702-1706: Single conductor, stranded tinned copper, white polyethylene insulation, braided or spiral wrapped tinned copper shield, gray polyvinylchloride jacket overall.

1709-1712: Each conductor stranded tinned copper, color coded polyethylene insulation, cabled with fillers, textile wrap, braided or spiral wrapped tinned copper shield, gray polyvinylchloride jacket overall.

APPLICATIONS: 1702-1706: All high impedance microphones, lapel, ribbon, velocity, crystal contact, hi-fi interconnecting cables.

1709-1712: All low impedance microphones—carbon, condenser, dynamic.

CHARACTERISTICS: Suggested operating temperature: -20°C to +60°C.

ALPHA NO.	NO. OF COND.	CONDUCTOR SIZE	CONDUCTOR STRAND	NOM. WALL THICKNESS	*CAPACITY NOM./FT.	SUC. WORK. VOLTAGE	TYPE OF SHIELD	NOM. JKT THICKNESS	NOM. O.D.
1702	1	26	3/34† 4/34†	.016"	38 mmf.	1000	Spiral Wrapped	.020"	.110"
1703	1	24	10/34	.020"	35 mmf.	3500	Braided	.030"	.145"
1704	1	24	10/34	.040"	23 mmf.	5000	Braided	.030"	.190"
1705	1	24	10/34	.016"	45 mmf.	1000	Spiral Wrapped	.020"	.110"
1706	1	20	26/34	.030"	36 mmf.	4000	Braided	.030"	.175"
1709	2	24	10/34	.016"	38 mmf.	1000	Spiral Wrapped	.030"	.190"
1710	2	22	16/34	.025"	31 mmf.	1000	Braided	.025"	.230"
1712	2	20	26/34	.014"	45 mmf.	600	Braided	.030"	.245"

STANDARD SPOOL PUT-UP: 100 FT., 250 FT., 500 FT., 1000 FT.

* Between one conductor and remaining conductors connected to shield.

† Three strands of tinned copper and four strands of tinned copperweld.

COLOR CODE OF CONDUCTORS
1—White 2—Black

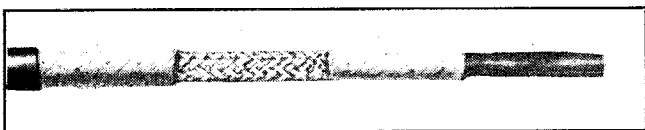

RUBBER AND NEOPRENE JACKETS

DESCRIPTION: Each conductor stranded tinned copper, color coded rubber insulation, cotton wrap, braided tinned copper shield, cotton wrap, tough black rubber or neoprene jacket overall.

APPLICATIONS: 1248-1449: All high impedance microphone, broadcast and heavy duty studio use, communication and audio systems.

1250-1450/16: All low impedance microphone, broadcast and heavy duty studio use. Can also be used for control circuits, video and audio interconnection cable, and as electronic power cables.

CHARACTERISTICS: Suggested operating temperature: -20°C to +60°C.

Rubber jacketed cable suited for standard duty indoor use.

Neoprene jacketed cable suited for heavy duty outdoor use and direct burial. Will resist oil, acid, sunlight, ageing and abrasion.

ALPHA NO.	NO. OF COND.	CONDUCTOR SIZE	CONDUCTOR STRAND	NOM. WALL THICKNESS	NOM. JKT THICKNESS	TYPE OF JKT	*NOM. CAP. MME./FT.	NOM. O.D.
1248†	1	20	26/34	.025"	.030"	Rubber	97	.190"
1249	1	20	26/34	.040"	.035"	Rubber	60	.230"
1249/18	1	18	41/34	.040"	.035"	Rubber	69	.240"
1449	1	18	41/34	.040"	.035"	Neoprene	69	.240"
1250	2	20	26/34	.020"	.035"	Rubber	68	.270"
1250/18	2	18	41/34	.020"	.035"	Rubber	78	.295"
1450	2	18	41/34	.020"	.035"	Neoprene	78	.295"
1450/16	2	16	65/34	.025"	.035"	Neoprene	82	.335"

STANDARD SPOOL PUT-UP: 100 FT., 250 FT., 500 FT., 1000 FT.

* Between one conductor and remaining conductors (if any) connected to shield.

† Mylar wrap under tinned copper shield.

COLOR CODE OF CONDUCTORS
1—Black 2—White

PRICES

Alpha No.	Sugg. Resale per 500'	Alpha No.	Sugg. Resale per 500'	Alpha No.	Sugg. Resale per 250'	Alpha No.	Sugg. Resale per 250'
1702	43.15	1706	81.90	1248	122.22	1250	129.31
1703	44.89	1709	99.85	1249	124.59	1250/18	214.20
1704	62.22	1710	85.68	1249/18	176.40	1450	254.10
1705	48.82	1712	111.51	1449	191.40	1450/16	455.40

Sold Nationally to Electronic Parts Distributors by; Loral Distributor Products, a Division of Loral Corporation

Low Capacitance Shielded Microphone Cable

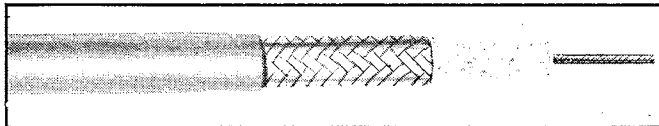

CELLULAR FOAM POLYETHYLENE INSULATION — PLASTIC JACKET

DESCRIPTION: Single conductor, stranded tinned copper, white foam polyethylene insulation, braided tinned copper shield, chrome gray polyvinylchloride jacket.

Two conductors, stranded tinned copper, color coded foam polyethylene insulation, 1 white and 1 black, cabled with fillers, textile wrap, braided tinned copper shield, chrome gray polyvinylchloride jacket.

CHARACTERISTICS: Suggested operating temperature: -20°C to +60°C. Low loss foam polyethylene provides lower capacitance and attenuation than standard solid polyethylene microphone cables, thereby increasing the effective length of usable cable without loss of signal.

ALPHA NO.	NO. OF COND.	CONDUCTOR SIZE	CONDUCTOR STRAND	NOM. WALL THICKNESS	*CAPACITY NOM./FT.	NOM. JKT THICKNESS	NOM. O.D.
2310	1	26	3/34† 4/34†	.016"	30 mmf	.020"	.115"
2311	1	24	10/34	.035"	20 mmf	.030"	.180"
2312	1	24	10/34	.055"	15 mmf	.030"	.225"
2323	2	22	16/34	.035"	11 mmf	.030"	.300"

STANDARD SPOOL PUT-UP: 100 FT., 250 FT., 500 FT., 1000 FT.

* Between one conductor and remaining conductors connected to shield.

† Three strands of tinned copper and four strands of tinned copperweld.

COLOR CODE OF CONDUCTORS
1—White 2—Black

E-Z-Strip Lamp Cord

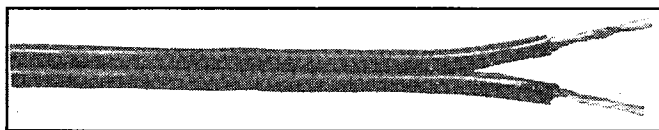

U.L. APPROVED

DESCRIPTION: Conductors parallel, stranded extra flexible bare copper, rubber or polyvinylchloride jacket overall. Slit in jacket to permit "E-Z" separation.

APPLICATIONS: For line cord on radios, lamps, electric clocks, food mixers and other small instruments and appliances.

CHARACTERISTICS: Suggested operating temperature: -20°C to +60°C. Suggested operating voltage: 300 volts.

ALPHA NO.	NO. OF COND.	CONDUCTOR SIZE	CONDUCTOR STRAND	INSUL. TYPE	NOM. WALL THICKNESS	U/L TYPE	NOMINAL O.D.	STOCK COLORS
1967	2	18	41/34	Rubber	.032"	SP-1(POSJ)	.220" x .120"	Brown, Black, White
1977	2	18	41/34	Plastic	.032"	SPT-1(POT)	.215" x .115"	Brn., Blk., Wh., Gray, Tan
1978	2	18	41/34	Plastic	.045"	SPT-2(POT)	.285" x .150"	Brown
1979	2	18	41/34	Plastic	.032"	SPT-1(POT)	.215" x .115"	Clear
1982	2	16	65/34	Plastic	.045"	SPT-2(POT)	.300" x .160"	Brown

STANDARD SPOOL PUT-UP: 100 FT., 250 FT., 500 FT., 1000 FT.

PRICES

Alpha No.	Sugg. Resale per 500'	Alpha No.	Sugg. Resale per 500'	Alpha No.	Sugg. Resale per 250'	Alpha No.	Sugg. Resale per 250'
2310	63.31	2312	103.00	1967	54.34	1978	70.87
2311	77.80	2323	170.10	1977	46.47	1979	52.77
						1982	83.47



Shielded Plastic Jacketed Cable

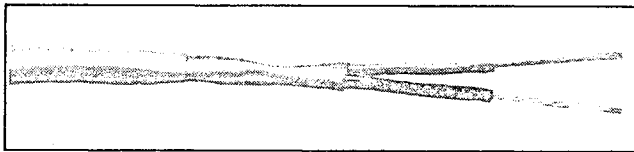

SPIRAL WRAPPED COPPER SHIELD

DESCRIPTION: Each conductor stranded or solid tinned copper, color coded polyvinylchloride insulation, conductors twisted, spiral wrapped copper shield, gray polyvinylchloride jacket overall. Nominal jacket thickness .020".

CHARACTERISTICS: Use of spiral shield makes pigtailing off extremely simple and fast. Excellent for production line work. Provides close to 100% shielded coverage for audio and RF frequencies. Suggested operating temperature: 20°C to -60°C.

ALPHA NO.	NO. OF COND.	CONDUCTOR SIZE	CONDUCTOR STRAND	NOM. WALL THICKNESS	NOM. O.D.	SUGG. WORKING VOLTAGE
2255	2	22	Solid	.016"	.170"	350V
2254/1	1	22	7/30	.016"	.115"	350V
2254	2	22	7/30	.016"	.175"	350V
2254/3	3	22	7/30	.016"	.190"	350V
2254/4	4	22	7/30	.016"	.200"	350V
2254/6	6	22	7/30	.016"	.235"	350V
2256/1	1	20	10/30	.016"	.130"	350V
2256	2	20	10/30	.016"	.195"	350V
2256/3	3	20	10/30	.016"	.210"	350V
2256/4	4	20	10/30	.016"	.225"	350V
2256/6	6	20	10/30	.016"	.265"	350V
2258/1	1	18	16/30	.016"	.135"	350V
2258	2	18	16/30	.016"	.230"	350V
2258/3	3	18	16/30	.016"	.235"	350V
2258/4	4	18	16/30	.016"	.245"	350V
2260	2	16	26/30	.016"	.240"	350V
2260/3	3	16	26/30	.016"	.245"	350V
2265	2	14	41/30	.020"	.285"	450V
2265/3	3	14	41/30	.020"	.290"	450V
2268	2	12	65/30	.020"	.325"	450V
2268/3	3	12	65/30	.020"	.330"	450V

STANDARD SPOOL PUT-UP: 100 FT., 250 FT., 500 FT., 1000 FT.
 COLOR CODE OF CONDUCTORS
 1—Black 2—Red 3—White 4—Green 5—Yellow 6—Blue

Alpha No.	Sugg. Resale per 500'	PRICES					
2255	46.47	2256/1	46.30	2258/1	53.71	2260/3	181.12
2254/1	41.11	2256	56.86	2258	68.67	2265	179.55
2254	54.18	2256/3	77.34	2258/3	92.61	2265/3	316.57
2254/3	73.87	2256/4	155.14	2258/4	179.55	2268	330.75
2254/4	115.77	2256/6	211.05	2260	98.44	2268/3	504.00
2254/6	173.25						

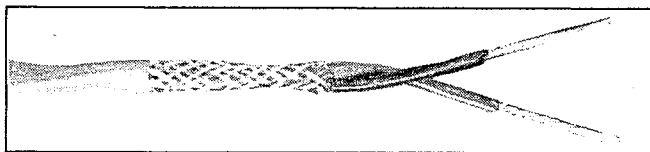

BRAIDED COPPER SHIELD

DESCRIPTION: Each conductor tinned copper, color coded polyvinylchloride insulation, conductors twisted, braided copper shield, gray polyvinylchloride jacket overall. Suitable for outdoor installations.

CHARACTERISTICS: A conventional type of braided shield providing approximately 75% coverage is particularly desirable where flexibility is required. The copper shield allows ease of pigtail soldering. Shield construction provides additional cable strength. Operating temperature: -20°C to +60°C. Nominal jacket thickness .020".

APPLICATIONS: For public address and sound systems, ideal for recording studios, amateur radio transmitters, shielded power or electronic circuits, wherever an economical shielded cable is required.

STRANDED

ALPHA NO.	NO. OF COND.	CONDUCTOR SIZE	CONDUCTOR STRAND	NOM. WALL THICKNESS	NOM. O.D.	SUGG. WORKING VOLTAGE
1735	1	22	7/30	.016"	.125"	350V
1736	2	22	7/30	.016"	.185"	350V
1737	3	22	7/30	.016"	.200"	350V
1738	4	22	7/30	.016"	.210"	350V
1740	1	20	10/30	.016"	.135"	350V
1741	2	20	10/30	.016"	.200"	350V
1742	3	20	10/30	.016"	.220"	350V
1743	4	20	10/30	.016"	.230"	350V
1745	1	18	16/30	.016"	.145"	350V
1746	2	18	16/30	.016"	.235"	350V
1747	3	18	16/30	.016"	.245"	350V
1747/4	4	18	16/30	.016"	.255"	350V
1748	2	16	26/30	.016"	.250"	350V
1749	3	16	26/30	.016"	.255"	350V
1750	2	14	41/30	.020"	.290"	450V
1751	3	14	41/30	.020"	.295"	450V
1760	2	12	65/30	.020"	.335"	450V
1761	3	12	65/30	.020"	.340"	450V

SOLID

ALPHA NO.	NO. OF COND.	CONDUCTOR SIZE	CONDUCTOR STRAND	NOM. WALL THICKNESS	NOM. O.D.	SUGG. WORKING VOLTAGE
1775*	2	22	1	.016"	.175"	350V
1779	2	20	1	.016"	.210"	350V
1783	2	18	1	.016"	.220"	350V

*With 22 AWG solid tinned copper ground wire under braided copper shield.
 STANDARD SPOOL PUT-UP: 100 FT., 250 FT., 500 FT., 1000 FT.
 COLOR CODE OF CONDUCTORS 1—Black 2—Red 3—White 4—Green

Alpha No.	Sugg. Resale per 500'	PRICES					
1735	61.59	1742	111.82	1747/4	223.65	1760	337.84
1736	67.41	1743	166.95	1748	164.59	1761	456.75
1737	91.83	1745	83.64	1749	228.37	1775	56.86
1738	120.01	1746	113.08	1750	223.65	1779	93.55
1740	68.04	1747	164.74	1751	311.85	1783	113.36
1741	87.25						



ALPHA WIRE MFG.

Sold Nationally to Electronic Parts Distributors by; Lorai Distributor Products, a Division of Lorai Corporation

Unshielded Audio Cable

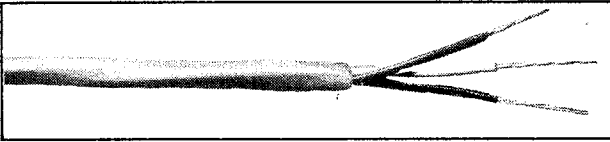

MULTI-CONDUCTOR — PLASTIC JACKET

DESCRIPTION: Each conductor stranded tinned copper, color coded polyvinylchloride insulation, conductors twisted, gray polyvinylchloride jacket overall. Suitable for outdoor installations.

APPLICATIONS: Unbalanced intercom systems. Low voltage relay control cable. P.A. systems. Electronic computer cable. Interconnecting cables. Remote control circuits. Telephones. Telemetering connecting cable. "Baby Sitter" intercom.

CHARACTERISTICS: Suggested Operating Temperature: -20°C to +60°C.

200 VOLTS STRANDED CONDUCTORS

ALPHA NO.	NO. OF COND.	CONDUCTOR SIZE	CONDUCTOR STRAND	NOM. WALL THICKNESS	NOM. JKT. THICKNESS	NOM. O.D.
1172	2	22	7/30	.010"	.020"	.140"
1173	3	22	7/30	.010"	.020"	.145"
1174	4	22	7/30	.010"	.020"	.170"
1175	5	22	7/30	.010"	.020"	.175"
1176	6	22	7/30	.010"	.020"	.185"
1177	7	22	7/30	.010"	.020"	.190"
1178	8	22	7/30	.010"	.020"	.200"
1179	9	22	7/30	.010"	.020"	.225"
1180	10	22	7/30	.010"	.020"	.235"
1181	12	22	7/30	.010"	.020"	.255"
1181/15	15	22	7/30	.010"	.020"	.280"
1181/20	20	22	7/30	.010"	.020"	.310"
1181/25	25	22	7/30	.010"	.020"	.340"
1181/30	30	22	7/30	.010"	.020"	.365"
1181/40	40	22	7/30	.010"	.025"	.425"
1181/50	50	22	7/30	.010"	.035"	.500"
1181/60	60	22	7/30	.010"	.035"	.530"

STANDARD SPOOL PUT-UP: 100 FT., 250 FT., 500 FT., 1000 FT.

300 VOLTS STRANDED CONDUCTORS

ALPHA NO.	NO.	CONDUCTOR SIZE	CONDUCTOR STRAND	NOM. WALL THICKNESS	NOM. JKT. THICKNESS	NOM. O.D.
1897	2	18	16/30	.016"	.020"	.200"
1898	3	18	16/30	.016"	.020"	.210"
1898/4	4	18	16/30	.016"	.020"	.240"
1898/6	6	18	16/30	.016"	.020"	.290"
1898/8	8	18	16/30	.016"	.025"	.315"
1898/10	10	18	16/30	.016"	.025"	.370"
1898/12	12	18	16/30	.016"	.025"	.385"

STANDARD SPOOL PUT-UP: 100 FT., 250 FT., 500 FT., 1000 FT.

300 VOLTS SOLID CONDUCTORS

ALPHA NO.	CONDUCTOR NO.	CONDUCTOR SIZE	NOM. WALL THICKNESS	NOM. JKT. THICKNESS	NOM. O.D.
1797	2	18	.016"	.020"	.190"
1798	3	18	.016"	.020"	.200"
1798/4	4	18	.016"	.020"	.220"
1798/5	5	18	.016"	.020"	.235"
1798/6	6	18	.016"	.020"	.265"

STANDARD SPOOL PUT-UP: 100 FT., 250 FT., 500 FT., 1000 FT.

COLOR CODE OF CONDUCTORS

1—Black	21—White, Brown	41—White/Green/Red
2—Red	22—White/Orange	42—White/Green/Green
3—White	23—White/Gray	43—White/Green/Blue
4—Green	24—White/Violet	44—White/Green/Brown
5—Orange	25—White/Black/Red	45—White/Green/Purple
6—Blue	26—White, Black/Green	46—White/Blue/Black
7—Brown	27—White/Black/Yellow	47—White/Blue/Red
8—Yellow	28—White, Black/Blue	48—White/Blue/Green
9—Purple	29—White/Black/Brown	49—White/Blue/Blue
10—Slate	30—White/Black/Orange	50—White/Blue/Brown
11—Pink	31—White/Black/Slate	51—White/Blue/Purple
12—Tan	32—White/Black/Purple	52—White/Brown/Black
13—Red/Green	33—White/Black/Black	53—White/Brown/Red
14—Red/Yellow	34—White/Red/Black	54—White/Brown/Green
15—Red/Black	35—White/Red/Red	55—White/Brown/Blue
16—White/Black	36—White/Red/Green	56—White/Brown/Brown
17—White/Red	37—White/Red/Blue	57—White/Brown/Purple
18—White/Green	38—White/Red/Brown	58—White/Purple/Red
19—White/Yellow	39—White/Red/Purple	59—White/Purple/Green
20—White/Blue	40—White/Green/Black	60—White/Purple/Blue

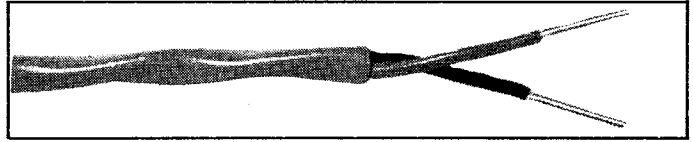

MULTI-CONDUCTOR — PLASTIC JACKET

DESCRIPTION: Each conductor tinned copper, color coded polyvinylchloride insulation, conductors twisted, gray polyvinylchloride jacket overall. Suitable for outdoor installations.

APPLICATIONS: Intercoms. Interconnecting cables. Remote control circuits. Telephones. Telemetering connecting cable. "Baby Sitter" intercom.

CHARACTERISTICS: Suggested Operating Temperature: -20°C to +60°C

SOLID

ALPHA NO.	NO. OF COND.	CONDUCTOR SIZE	CONDUCTOR STRAND	NOM. WALL THICKNESS	NOMINAL JACKET	NOMINAL O.D.	SUGG. OPER. VOLTAGE
1793	2	22	1	.010"	.020"	.130"	200 V
1794	3	22	1	.010"	.020"	.140"	200 V
1794/4	4	22	1	.010"	.020"	.160"	200 V
1795	2	20	1	.016"	.020"	.170"	350 V
1796	3	20	1	.016"	.020"	.180"	350 V
1796/4	4	20	1	.016"	.020"	.200"	350 V
1797	2	18	1	.016"	.020"	.190"	350 V
1798	3	18	1	.016"	.020"	.200"	350 V
1798/4	4	18	1	.016"	.020"	.220"	350 V
1799	2	16	1	.016"	.020"	.215"	350 V
1799/3	3	16	1	.016"	.020"	.230"	350 V
1799/4	4	16	1	.016"	.020"	.250"	350 V

STANDARD SPOOL PUT-UP: 100 FT., 250 FT., 500 FT., 1000 FT.

COLOR CODE OF CONDUCTORS: 1—Black 2—Red 3—White 4—Green

STRANDED

1893	2	22	7/30	.010"	.020"	.135"	200 V
1894	3	22	7/30	.010"	.020"	.145"	200 V
1894/4	4	22	7/30	.010"	.020"	.170"	200 V
1895	2	20	10/30	.016"	.020"	.180"	350 V
1896	3	20	10/30	.016"	.020"	.190"	350 V
1896/4	4	20	10/30	.016"	.020"	.215"	350 V
1897	2	18	16/30	.016"	.020"	.200"	350 V
1898	3	18	16/30	.016"	.020"	.210"	350 V
1898/4	4	18	16/30	.016"	.020"	.240"	350 V
1899	2	16	26/30	.016"	.020"	.225"	350 V
1899/3	3	16	26/30	.016"	.020"	.245"	350 V
1899/4	4	16	26/30	.016"	.020"	.270"	350 V
1891	2	14	41/30	.016"	.020"	.260"	350 V
1891/3	3	14	41/30	.016"	.020"	.280"	350 V
1892	2	12	65/30	.016"	.020"	.300"	350 V
1892/3	3	12	65/30	.016"	.020"	.320"	350 V

STANDARD SPOOL PUT-UP: 100 FT., 250 FT., 500 FT., 1000 FT.

COLOR CODE OF CONDUCTORS: 1—Black 2—Red 3—White 4—Green

PRICES

Alpha No.	Sugg. Resale per 500'	Alpha No.	Sugg. Resale per 500'	Alpha No.	Sugg. Resale per 500'	Alpha No.	Sugg. Resale per 500'
1172	27.09	1181/50	1,291.50	1793	26.46	1899	88.20
1173	34.65	1181/60	1,559.25	1794	39.54	1899/3	152.46
1174	45.67	1897	60.48	1794/4	59.53	1899/4	211.05
1175	57.49	1898	100.80	1795	49.45	1891	154.35
1176	79.06	1898/4	139.23	1796	70.87	1891/3	208.84
1177	93.24	1898/6	211.05	1796/4	86.31	1892	19.80
1178	101.59	1898/8	283.50	1797	55.44	1892/3	330.75
1179	114.03	1898/10	359.10	1798	79.69	1894/4	66.78
1180	124.42	1898/12	422.10	1798/4	102.22	1895	42.37
1181	135.45	1797	55.44	1799	103.63	1896	77.97
1181/15	307.12	1798	79.69	1799/3	125.05	1896/4	94.18
1181/20	417.37	1798/4	102.22	1799/4	173.25	1897	60.48
1181/25	543.37	1798/5	137.97	1893	26.46	1898	100.80
1181/30	661.50	1798/6	163.80	1894	47.41	1898/4	139.23
1181/40	1,039.50						



ALPHA WIRE MFG.

Sold Nationally to Electronic Parts Distributors by; Loral Distributor Products, a Division of Loral Corporation

Unshielded Intercom Cable

PAIRED CONDUCTORS — PLASTIC JACKET

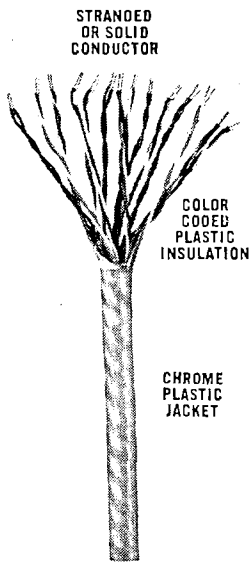

DESCRIPTION:

Each conductor tinned copper, color coded polyvinylchloride insulation, conductors twisted into pairs, gray polyvinylchloride jacket overall. Suitable for outdoor installatior.s.

APPLICATIONS:

Balanced intercom systems. Annunciators. Telephones. Nurses call systems. Control circuit cable. Electronic computer cable. Multiple speaker cable. Signal systems. Alarm systems.

CHARACTERISTICS:

Suggested operating temperature: -20°C to +60°C. Suggested operating voltage: 200 volts.

SOLID CONDUCTORS

ALPHA NO.	NO. OF PAIRS	NO. OF COND.	COND. SIZE	COND. STRAND	NOM. WALL THICKNESS	NOM. JKT. THICKNESS	NOM. O.D.
1300	1	2	22 Solid	1	.010"	.020"	.130"
1302	2	4	22 Solid	1	.010"	.020"	.195"
1304	3	6	22 Solid	1	.010"	.020"	.220"
1307	6	12	22 Solid	1	.010"	.020"	.275"
1307/7	7	14	22 Solid	1	.010"	.020"	.285"
1307/9	9	18	22 Solid	1	.010"	.020"	.310"
1308/11	11	22	22 Solid	1	.010"	.020"	.340"
1309	13	26	22 Solid	1	.010"	.025"	.380"
1309/15	15	30	22 Solid	1	.010"	.025"	.400"
1310	16	32	22 Solid	1	.010"	.025"	.420"
1313	27	54	22 Solid	1	.010"	.035"	.510"
1313/31	31	62	22 Solid	1	.010"	.035"	.555"
1313/41	41	82	22 Solid	1	.010"	.035"	.630"
1314	51	102	22 Solid	1	.010"	.045"	.735"

STRANDED CONDUCTORS

1316	1	2	22	7/30	.010"	.020"	.145"
1317	2	4	22	7/30	.010"	.020"	.210"
1318	3	6	22	7/30	.010"	.020"	.225"
1319	4	8	22	7/30	.010"	.020"	.240"
1320	5	10	22	7/30	.010"	.020"	.265"
1322	6	12	22	7/30	.010"	.020"	.290"
1323	9	18	22	7/30	.010"	.020"	.355"
1324	11	22	22	7/30	.010"	.020"	.365"
1327	15	30	22	7/30	.010"	.025"	.450"
1327/19	19	38	22	7/30	.010"	.025"	.480"
1328	23	46	22	7/30	.010"	.030"	.530"
1329	27	54	22	7/30	.010"	.035"	.570"
1329/31	31	62	22	7/30	.010"	.040"	.635"
1329/41	41	82	22	7/30	.010"	.040"	.710"
1330	51	102	22	7/30	.010"	.045"	.800"

STANDARD SPOOL PUT-UP: 50 FT., 100 FT., 250 FT., 500 FT., 1000 FT.

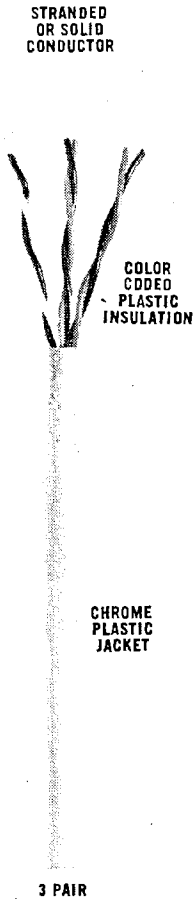

PAIR NO.	COLOR COMBINATION
1	Black paired with Red
2	Black paired with White
3	Black paired with Green
4	Black paired with Blue
5	Black paired with Brown
6	Black paired with Yellow
7	Black paired with Orange
8	Red paired with Green
9	Red paired with White
10	Red paired with Blue
11	Red paired with Yellow
12	Red paired with Brown
13	Red paired with Orange
14	Green paired with Blue
15	Green paired with White
16	Green paired with Brown
17	Green paired with Orange

PAIR NO.	COLOR COMBINATION
18	Green paired with Yellow
19	White paired with Blue
20	White paired with Brown
21	White paired with Orange
22	White paired with Yellow
23	Blue paired with Brown
24	Blue paired with Orange
25	Blue paired with Yellow
26	Brown paired with Orange
27	Brown paired with Yellow
28	Purple paired with Red
29	Purple paired with White
30	Purple paired with Green
31	Purple paired with Blue
32	Purple paired with Brown
33	Purple paired with Yellow
34	Purple paired with Orange

PAIR NO.	COLOR COMBINATION
35	Purple paired with Slate
36	Purple paired with Black
37	Slate paired with Red
38	Slate paired with White
39	Slate paired with Green
40	Slate paired with Blue
41	Slate paired with Brown
42	Slate paired with Yellow
43	Slate paired with Orange
44	Slate paired with Black
45	White/Black paired w. Red
46	White/Black paired w. Green
47	White/Black paired w. Blue
48	White/Black paired w. Brown
49	White/Black paired w. Yellow
50	White/Black paired w. Orange
51	White/Black paired w. Purple

Alpha No.	Sugg. Resale 1000'	PRICES				Alpha No.	Sugg. Resale 1000'
1300	21.27	1309	198.45	1316	38.11	1324	283.50
1302	39.37	1309/15	237.82	1317	76.86	1327	307.12
1304	54.34	1310	308.70	1318	100.80	1327/19	496.12
1307	96.07	1313	417.37	1319	113.40	1328	544.95
1307/7	123.48	1313/31	894.60	1320	120.49	1329	1,275.75
1307/9	141.75	1313/41	275.75	1322	127.57	1329/31	1,779.75
1308/11	173.25	1314	622.25	1323	195.30	1329/41	2,063.25
						1330	



Sold Nationally to Electronic Parts Distributors by: Lorai Distributor Products, a Division of Lorai Corporation

Unshielded Audio Cable

MULTI-CONDUCTOR — OUTER COTTON BRAID

DESCRIPTION: Each conductor stranded tinned copper, color coded polyvinylchloride insulation, conductors twisted, brown cotton braid overall.

CHARACTERISTICS: Suggested operating temperature: -40°C to +80°C. Suggested operating voltage: 600 volts.

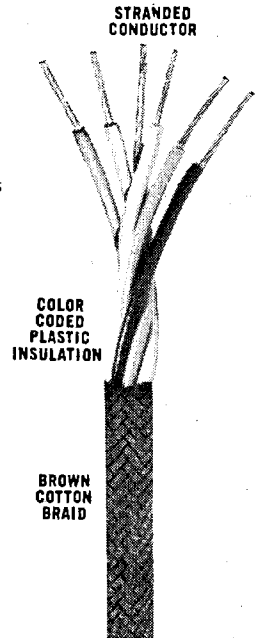

ALPHA NO.	NO. OF COND.	CONDUCTOR SIZE	STRAND	NOM. WALL THICKNESS	NOMINAL O.D.
1182	2	20	10/30	.016"	.170"
1183	3	20	10/30	.016"	.180"
1184	4	20	10/30	.016"	.200"
1185	5	20	10/30	.016"	.220"
1186	6	20	10/30	.016"	.240"
1187	7	20	10/30	.016"	.240"
1188	8	20	10/30	.016"	.265"
1189	9	20	10/30	.016"	.285"
1190	10	20	10/30	.016"	.310"
1192	12	20	10/30	.016"	.322"
1192/15	15	20	10/30	.016"	.360"
1192/20	20	20	10/30	.016"	.405"
1192/25	25	20	10/30	.016"	.450"
1192/30	30	20	10/30	.016"	.485"

COLOR CODE OF CONDUCTORS

- 1—Black
- 2—Red
- 3—White
- 4—Green
- 5—Orange
- 6—Blue
- 7—Brown
- 8—Yellow
- 9—Purple
- 10—Slate
- 11—Pink
- 12—Tan
- 13—White/Black
- 14—White/Red
- 15—White/Green
- 16—White/Orange
- 17—White/Blue
- 18—White/Brown
- 19—White/Yellow
- 20—White/Purple
- 21—White/Gray
- 22—White/Black/Red
- 23—White/Black/Green
- 24—White/Black/Blue
- 25—White/Black/Brown
- 26—White/Black/Orange
- 27—White/Black/Gray
- 28—White/Black/Violet
- 29—White/Black/Gray
- 30—Dark Blue

STANDARD SPOOL PUT-UP:

1182-1192/20; 100 FT., 500 FT., 1000 FT.
1192/25-1192/30; 100 FT., 250 FT., 500 FT.

MULTI-CONDUCTOR — NO OUTER JACKET

DESCRIPTION: Each conductor tinned copper, color coded polyvinylchloride insulation, conductors twisted.

APPLICATIONS: Intercoms. Interconnecting cables. Remote control circuits. Telephones. Telemetering connecting cable. "Baby Sitter" intercom.

CHARACTERISTICS: Suggested Operating Temperature: -20°C to +60°C. Suggested Operating Voltage: 350 Volts.

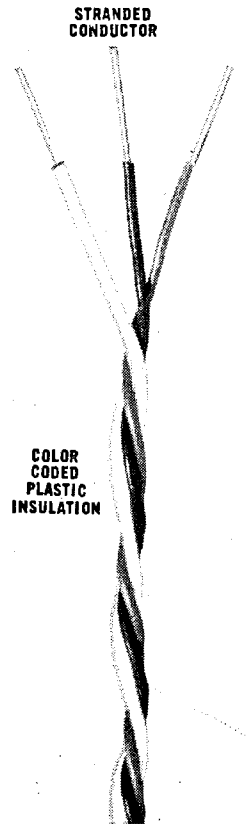

SOLID

ALPHA NO.	NO. OF COND.	CONDUCTOR SIZE	STRAND	NOM. WALL THICKNESS	NOM. O.D.
1900	2	22	1	.016"	.100"
1901	3	22	1	.016"	.115"
1903	2	20	1	.016"	.120"
1904	3	20	1	.016"	.135"
1906	2	18	1	.016"	.145"
1907	3	18	1	.016"	.155"
1909	2	16	1	.016"	.175"
1910	3	16	1	.016"	.190"
1912	2	19*	1	.016"	.130"
1913	3	19*	1	.016"	.135"

STRANDED

ALPHA NO.	NO. OF COND.	CONDUCTOR SIZE	STRAND	NOM. WALL THICKNESS	NOM. O.D.
1915	2	22	7/30	.016"	.125"
1916	3	22	7/30	.016"	.140"
1918	2	20	10/30	.016"	.145"
1919	3	20	10/30	.016"	.160"
1921	2	18	16/30	.016"	.165"
1922	3	18	16/30	.016"	.180"
1924	2	16	26/30	.016"	.190"
1925	3	16	26/30	.016"	.210"
1927	2	14	41/30	.016"	.220"
1928	3	14	41/30	.016"	.240"

STANDARD SPOOL PUT-UP: 100 FT., 250 FT., 500 FT., 1000 FT.

*Bare Untinned Copper Conductor.

COLOR CODE OF CONDUCTORS: 1—Brown 2—Tan 3—Gray



Alpha No.	Sugg. Resale 1000'	Alpha No.	Sugg. Resale 1000'
1182	61.42	1912	381.15
1183	86.47	1919	41.58
1184	108.04	1906	40.63
1185	139.23	1907	60.48
1186	174.82	1909	73.24
1187	193.72	1910	107.58
1188	227.59	1912	22.36
1189	277.20	1913	36.22
1190	311.85	1915	28.66
		1916	41.74
		1918	38.74
		1919	57.49
		1921	46.93
		1922	69.30
		1924	57.33
		1925	85.36
		1927	99.22
		1928	157.50

Sold Nationally to Electronic Parts Distributors by; Loral Distributor Products, a Division of Loral Corporation

Shielded Audio & Data Cable

INDIVIDUALLY SHIELDED MULTIPLE PAIRS — PLASTIC JACKET

DESCRIPTION: Each conductor, tinned copper, color coded, high density polyethylene, conductors twisted into pairs. 22 gauge tinned copper drain wire. Mylar-supported aluminum foil shield, aluminum facing inward. Chrome Grey PVC jacket overall.

NEW

CHARACTERISTICS: Mutual conductance between conductors of a pair, 25 pf/ft. Capacitance of a single conductor to shield, 45 pf/ft.

APPLICATIONS: For audio, R.F. and pulse applications requiring superior circuit isolation.

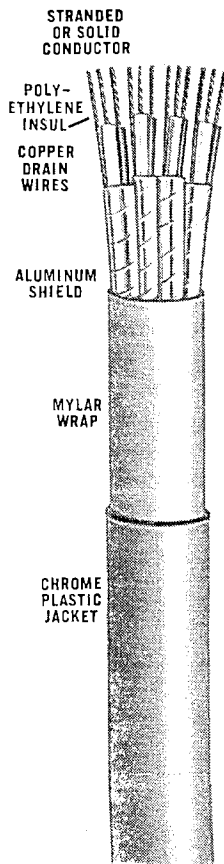

#22 — SOLID

#22 — STRANDED

ALPHA NO.	NO. OF PAIRS	NO. OF COND.	COND. STRAND	NOM. WALL THICK. (Inches)	NOM. JKT. THICK. (Inches)	NOM. O.D. (Inches)	ALPHA NO.	NO. OF PAIRS	NO. OF COND.	COND. STRAND	NOM. WALL THICK. (Inches)	NOM. JKT. THICK. (Inches)	NOM. O.D. (Inches)
6000	3	6	1	.010	.025	.235	6010	3	6	7/30	.010	.025	.252
6002	6	12	1	.010	.030	.318	6012	6	12	7/30	.010	.030	.342
6004	9	18	1	.010	.030	.371	6014	9	18	7/30	.010	.035	.410
6006	11	22	1	.010	.035	.414	6016	11	22	7/30	.010	.040	.457
6008	15	30	1	.010	.040	.485	6018	15	30	7/30	.010	.040	.523
							6020	19	38	7/30	.010	.050	.570
							6022	27	54	7/30	.010	.055	.687

STANDARD SPOOL PUT-UP: 100 FT., 500 FT., 1000 FT.

PAIR NO. COLOR COMBINATION OF PAIRS

- 1—Black paired with Red
- 2—Black paired with White
- 3—Black paired with Green
- 4—Black paired with Blue
- 5—Black paired with Brown
- 6—Black paired with Yellow
- 7—Black paired with Orange
- 8—Red paired with Green
- 9—Red paired with White
- 10—Red paired with Blue
- 11—Red paired with Yellow
- 12—Red paired with Brown
- 13—Red paired with Orange
- 14—Green paired with Blue
- 15—Green paired with White
- 16—Green paired with Brown
- 17—Green paired with Orange
- 18—Green paired with Yellow
- 19—White paired with Blue
- 20—White paired with Brown
- 21—White paired with Orange
- 22—White paired with Yellow
- 23—Blue paired with Brown
- 24—Blue paired with Orange
- 25—Blue paired with Yellow
- 26—Brown paired with Orange
- 27—Brown paired with Yellow

Shielded Plastic Jacketed Cable

MYLAR SUPPORTED ALUMINUM FOIL SHIELD

DESCRIPTION: Each conductor stranded tinned copper, color coded polyethylene insulation, conductors cabled, wrapped mylar supported aluminum foil shield, 100% coverage with drain wire laid parallel, aluminum foil facing outward to provide maximum ground, gray pvc jacket overall.

CHARACTERISTICS: Operating temperature: -20°C to +60°C. Operating voltage: 400 volts. Light weight, reduces cable diameter, and provides 100% shield coverage.

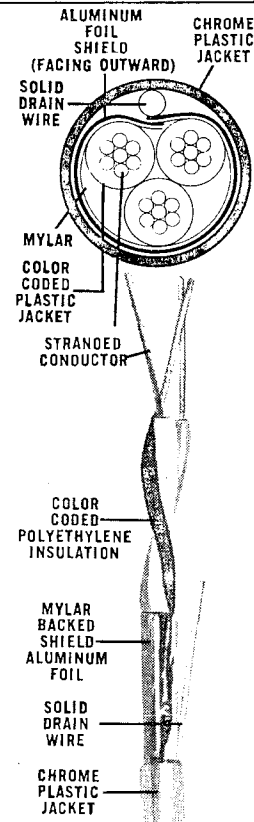

ALPHA NO.	NO. OF COND.	CONDUCTOR SIZE	STRAND	NOM. WALL THICKNESS	NOM. JKT. THICKNESS	NOM. O.D.
2402	2	22	7/30	.016"	.020"	.195"
2403	3	22	7/30	.016"	.020"	.210"
2404	4	22	7/30	.016"	.020"	.225"
2412	2	20	10/30	.016"	.020"	.210"
2413	3	20	10/30	.016"	.020"	.225"
2414	4	20	10/30	.016"	.020"	.240"
2422	2	18	16/30	.016"	.020"	.230"
2423	3	18	16/30	.016"	.020"	.245"
2424	4	18	16/30	.016"	.020"	.265"
2432	2	16	26/30	.016"	.020"	.255"
2433	3	16	26/30	.016"	.020"	.275"
2442	2	14	41/30	.016"	.020"	.290"
2443	3	14	41/30	.016"	.020"	.310"

STANDARD SPOOL PUT-UP: 100 FT., 500 FT., 1000 FT.

COLOR CODE OF CONDUCTORS: 1—Black 2—Red 3—White 4—Green



Alpha No.	Sugg. Resale 1000'	Alpha No.	Sugg. Resale 1000'
6000	126.00	6014	378.00
6002	224.44	6016	441.00
6004	318.15	6018	585.90
6006	378.00	6020	809.55
6010	135.45	6022	1,081.21
6012	255.15	2402	40.63
		2403	51.03
		2404	89.62
		2412	50.08
		2413	63.79
		2414	109.30
		2422	59.07
		2423	80.49
		2424	126.31
		2432	117.34
		2433	155.46
		2442	163.80
		2443	223.81

Sold Nationally to Electronic Parts Distributors by: Loral Distributor Products, a Division of Loral Corporation

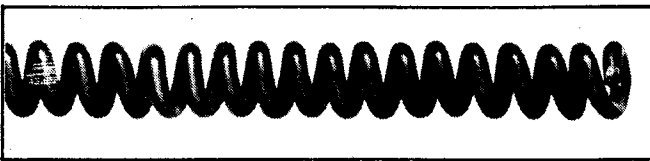

RETRACTILE COIL CORDS

POWER CORDS—NEOPRENE JACKET U.L. APPROVED

RETRACTED LENGTHS 2 & 4 FEET—EXTENDED LENGTHS 12 & 25 FEET

DESCRIPTION: Long-lasting service is assured with this quality multi-conductor power cord. Each conductor is stranded copper, with rubber insulation, and a rugged weather and oil resistant neoprene jacket overall.

APPLICATION: Used on electric tools, portable drills, soldering wires, electrical appliances, household appliances, etc., to eliminate loose hanging wires and to prevent wires from tangling and twisting.

CHARACTERISTICS: Suggested operating temperature: 20 C to -60 C.

1 FT. LEADS	ALPHA NO.	NO. OF CONDS.	CONDUCTOR SIZE	U.L. TYPE	AMP. RATING	VOLT. RATING	NOM. COIL O.D.	NOM. O.D. CORD	COLOR CODE OF CONDUCTORS
660 2	660 4	2	18 41 34	SVO	7	300	7 8"	.260"	1-Black 2-White
760 2	760 4	3	18 41 34	SVO	7	300	1 1/2"	.275"	1-Black 2-White 3-Red
661 2	661 4	2	18 41 34	SJO	7	300	1-3 16"	.320"	1-Black 2-White
662 2	662 4	3	18 41 34	SJO	7	300	1-3 8"	.350"	1-Black 2-White 3-Red
663 2	663 4	4*	18 41 34	SJO	5.6	300	1-7 16"	.385"	1-Black 2-White 3-Red 4-Green
762 2	762 4	3	18 41 34	SO	7	600	1-5 8"	.405"	1-Black 2-White 3-Red
763 2	763 4	4*	18 41 34	SO	5.6	600	1-5 8"	.435"	1-Black 2-White 3-Red 4-Green
664 2	664 4	2	16 65 34	SJO	10	300	1-3 8"	.360"	1-Black 2-White
665 2	665 4	3	16 65 34	SJO	10	300	1-7 16"	.390"	1-Black 2-White 3-Red
666 2	666 4	4*	16 65 34	SJO	8	300	1-1 1/2"	.425"	1-Black 2-White 3-Red 4-Green
670 2	670 4	3	16 41 30	SO	10	600	1-13 16"	.470"	1-Black 2-White 3-Red
671 2	671 4	4*	16 41 30	SO	8	600	1-7 8"	.500"	1-Black 2-White 3-Red 4-Green
672 2	672 4	2	14 41 30	SO	15	600	2-1 8"	.540"	1-Black 2-White
673 2	673 4	3	14 41 30	SO	15	600	2-1 8"	.560"	1-Black 2-White 3-Red
674 2	674 4	4*	14 41 30	SO	12	600	2-1 1/4"	.605"	1-Black 2-White 3-Red 4-Green
675 2	675 4	2	12 65 30	SO	20	600	2-1 1/4"	.605"	1-Black 2-White
676 2	676 4	3	12 65 30	SO	20	600	2-3 8"	.635"	1-Black 2-White 3-Red
677 2	677 4	4*	12 65 30	SO	16	600	2-3 8"	.678"	1-Black 2-White 3-Red 4-Green

COLOR CODE OF CONDUCTORS
1-Black 2-White 3-Green 4-Red

*If all four conductors normally carry current, amp rating is as shown. If one lead is used as a ground, amp rating is the same as 2 and 3 conductor cords.
†A 12" retracted length with a 12" straight lead on each end for easy stripping and termination. Cord extends to approximately 6 feet.

RETRACTILE TEST LEAD WIRE

RETRACTED LENGTH 12"—EXTENDED LENGTH 6 FEET

DESCRIPTION: A high grade quality rubber insulation for maximum flex life extruded over a single conductor of extra flexible tinned copper which gives long life to this retractile test lead wire. Available in a 12" retracted length with a 6" straight lead on each end, the cord extends to approximately 6 feet.

ALPHA NO.	CONDUCTOR SIZE	CONDUCTOR STRAND	AMP. RATED	VOLT. RATING	NOM. COIL O.D.	NOM. O.D. CORD	COLOR CODE
650	20	41 36	4	3,000	1/4"	.165"	Black-Red

COLOR CODE RED SPECIFY BLACK OR RED

RETRACTILE POWER CORD SETS U.L. APPROVED

RETRACTED LENGTH 18"—EXTENDED LENGTH 7 1/2 FEET

DESCRIPTION: Coiled power cord with a sturdy molded male plug on one end. On the other end we have removed a portion of the neoprene jacket, exposed the conductors and stripped them for easy termination. Operating voltage, 300 volts.

APPLICATION: Same as power cords, but with a plug on one end.

ALPHA NO.	NO. OF CONDS.	CONDUCTOR SIZE	CONDUCTOR STRAND	U.L. TYPE	AMP. RATING	VOLT. RATING	NOM. COIL O.D.	NOM. O.D. CORD	COLOR CODE OF CONDUCTORS
654	2	18	41 34	SVO	7	300	7 8"	.260"	1-Black 2-White
655	2	18	41 34	SJO	7	300	1-3 16"	.320"	1-Black 2-White
656	3	18	41 34	SJO	7	300	1-3 8"	.350"	1-Black 2-White 3-Red
657	2	16	65 34	SJO	10	300	1-3 8"	.360"	1-Black 2-White
658	3	16	65 34	SJO	10	300	1-7 16"	.390"	1-Black 2-White 3-Red

COLOR CODE OF CONDUCTORS
1-Black 2-White 3-Green

RETRACTILE COIL CORDS

RETRACTILE COMMUNICATION COIL CORDS

RETRACTED LENGTHS 2 & 4 FEET—EXTENDED LENGTHS 12 & 25 FEET

DESCRIPTION: Multi-conductor communication cord manufactured with extra flexible #23 AWG-21 36 tinned soft cadmium copper for maximum flex life. Insulated with rubber for communication circuits of maximum 120 working volts. The overall jacket is a specially compounded cured neoprene jacket giving long life to the retractile cord.

APPLICATION: Used in communication equipment, such as telephone car carriers, mobile radio equipment, ham operations, head sets, citizen band units and radio transmitter to receiver head sets, communication cords eliminate hazards and inconveniences caused by tangled straight cords.

ALPHA NO.	NO. OF CONDS.	CONDUCTOR SIZE	CONDUCTOR STRAND	AMP. RATING	VOLT. RATING	NOM. COIL O.D.	NOM. O.D. CORD	COLOR CODE OF CONDUCTORS
680 2	680 4	2	23	21 36	1	120	3 4"	.215"
681 2	681 4	3	23	21 36	1	120	13 16"	.220"
682 2	682 4	4	23	21 36	1	120	15 16"	.250"
683 2	683 4	5	23	21 36	1	120	1-1 16"	.285"
684 2	684 4	6	23	21 36	1	120	1-1 8"	.305"
685 2	685 4	7	23	21 36	1	120	1-1 4"	.320"

RETRACTILE COMMUNICATION CORDS (SHIELDED)

RETRACTED LENGTHS 2 & 4 FEET—EXTENDED LENGTHS 12 & 25 FEET

DESCRIPTION: Same as above, except that shielded conductors are individually shielded with a cadmium copper shield to eliminate external electrical interference. Shield can be pigtailed for direct soldering connections.

APPLICATION: When shielded communication cords are needed.

ALPHA NO.	NO. OF CONDS.	CONDUCTOR SIZE	CONDUCTOR STRAND	VOLTAGE RATING	SHIELDING	NOM. COIL O.D.	NOM. O.D. CORD	COLOR CODE OF CONDUCTORS
690 2	690 4	1	24	41 40	75	Shielded	1/4"	.160" White
692 2	692 4	2	1-23 1-24	21 36 41 40	120 75	Unshielded Shielded	1/4"	.240" Black White
694 2	694 4	3	2-23 1-24	21 36 41 40	120 75	Unshielded Shielded	1/4"	.240" Black & Red White
696 2	696 4	4	2-23 2-24	21 36 41 40	120 75	Unshielded Individually Shielded	1"	.270" Red & Black White & Green

RETRACTILE COMMUNICATION CORDS

PREPARED FOR EASY INSTALLATION AND REPLACEMENT

RETRACTED LENGTH 12"—EXTENDED LENGTH 6 FEET

DESCRIPTION: Same as communication cords except each end is prepared as indicated.

ALPHA NO.	NO. OF CONDS.	AWG	NOM. COIL O.D.	NOM. O.D. CORD	PREPARATION
686	3	23-21 36	13 16"	.220"	1 end: total length 1 1/2". Conductors stripped and tinned. Other end: total length 1 1/2" jacket removed.
687	4	23-21/36	15 16"	.250"	1 end: total length 1". Conductors stripped and tinned. Other end: total length 1 1/2" jacket removed.
688	5	23-21/36	1-1 16"	.285"	1 end: total length 4 1/4". Conductors stripped and tinned. Other end: total length 4 1/4" conductors stripped and tinned.

MINIATURE RETRACTILE COMMUNICATIONS CORDS

RETRACTED LENGTH 2 FEET—EXTENDED LENGTH 10 FEET

DESCRIPTION: A small diameter plastic cord with stranded tinned copper conductors for maximum flexibility, insulated and jacketed with polyvinylchloride. Each cord is available in a 2 ft. retracted length with a 6" straight lead on each end and extends to approximately 10 feet.

APPLICATION: For low voltage power and communication equipment where miniaturization is required due to space and weight limitations.

ALPHA NO.	NO. OF CONDS.	CONDUCTOR SIZE	CONDUCTOR STRAND	AMP. RATING	VOLT. RATING	NOM. COIL O.D.	NOM. O.D. CORD	COLOR CODE OF CONDUCTORS
651	2	28	19 40	0.5	100	1/2"	.135"	1-Black 2-White
652	4	28	19 40	0.5	100	1/2"	.150"	1-Black 2-White 3-Green 4-Red

For 3 conductor, use 4 conductor with one lead unused

Alpha No.	Sugg. Resale 1000'	Alpha No.	Prices	Alpha No.	Prices
660/2	4.89	664/4	12.45	675/4	38.43
660/4	8.82	664/1	3.78	676/2	25.59
660/1	2.71	665/2	8.67	676/4	48.04
760/2	7.48	665/4	16.38	677/2	28.35
760/4	13.39	665/1	4.41	677/4	53.55
661/2	5.35	666/2	10.71	654	4.41
661/4	9.76	666/4	19.84	655	5.35
661/1	2.80	670/2	11.97	656	8.35
662/2	6.85	670/4	22.36	657	5.98
662/4	12.76	671/2	13.23	658	8.82
662/1	3.78	671/4	24.88	650	1.26
663/2	8.04	672/2	13.15	680/2	4.33
663/4	15.12	672/4	24.73	680/4	7.72
762/2	12.45	673/2	14.80	681/2	5.35
762/4	22.99	673/4	28.03	681/4	9.13
763/2	13.71	674/2	17.71	682/2	6.06
763/4	25.83	674/4	32.29	682/4	10.56
664/2	6.69	675/2	20.79	683/2	8.25
				683/4	14.17
				684/2	9.76
				684/4	17.95
				685/2	10.87
				685/4	20.16
				690/2	6.69
				690/4	11.82
				692/2	9.06
				692/4	16.54
				694/2	12.84
				694/4	24.10
				696/2	14.49
				696/4	27.40
				686	3.63
				687	5.98
				688	6.78
				651	4.29
				652	5.04



Sold Nationally to Electronic Parts Distributors by; Loral Distributor Products, a Division of Loral Corporation

Tinned Copper Tubular Braid To MIL Spec QQ-B-575



DESCRIPTION: A woven tinned copper braid which is manufactured completely round as outlined in Mil Spec QQ-B-575. Each strand of the braid is soft drawn tinned copper wire. The braid is self-supporting and maintains its round configuration. The percentage of shielding coverage is 95% or more when placed over a mandrel of an equivalent diameter to the inside braid diameter.

ALPHA NO.	NOM. I.D. WHEN ROUNDED	BRAID CONSTRUCTION			APPROX. AWG. EQUIV.	NOM. CIRCULAR MILLS	*CURRENT CARRYING CAPACITY (Amps)	PUT-UP CODE
		AWG OF INDIV. ENDS	CARRIERS	TOTAL NO. OF INDIV. ENDS				
2160	1/32"	36	24	24	22	600	7.0	1-3
2162	1/16"	36	24	48	19	1200	11.0	1-3
2163	3/64"	36	24	72	18	1800	16.0	1-3
2164	1/8"	36	24	96	16	2400	19.0	1-3
2166	3/16"	36	24	120	15	3000	25.0	1-3
2167	5/32"	36	24	240	12	6000	40.0	1-3
2168	1/4"	36	24	168	14	4200	32.0	1-3
2170	13/64"	34	24	192	11	7630	46.0	1-2
2171	1/4"	36	24	384	10	9600	53.0	1-2
2171/1	5/32"	30	24	120	9	12060	60.0	1-2
2172	3/8"	36	48	384	10	9600	53.0	1-2
2173	7/16"	30	24	240	6	24120	90.0	1-2
2174	1/2"	36	48	528	9	13200	62.0	1-2
2175	3/8"	30	48	480	3	48240	145.0	1-2
2175/1	21/32"	30	48	768	1	77180	190.0	1-2
2176	25/32"	36	48	864	7	21600	88.0	1-2

PUT-UP CODE: 1—50 Ft. 2—100 Ft. 3—250 Ft.

EXTRA LARGE TINNED COPPER TUBULAR BRAID

DESCRIPTION: These tubular braids manufactured to standards of QQ-B-575 although these sizes are not listed in the specification.

ALPHA NO.	NOM. I.D. WHEN ROUNDED	BRAID CONSTRUCTION			APPROX. AWG. EQUIV.	NOM. CIRCULAR MILLS	*CURRENT CARRYING CAPACITY (Amps)	PUT-UP CODE
		AWG OF INDIV. ENDS	CARRIERS	TOTAL NO. OF INDIV. ENDS				
2177	7/8"	30	48	336	5	33700	100.0	1 & 2
2178	1"	30	48	384	4	38600	120.0	1 & 2
2179	1 1/8"	30	48	432	4	43330	130.0	1 & 2
2180	1 1/4"	30	48	480	3	48150	145.0	1 & 2
2181	1 3/8"	30	48	528	3	53000	150.0	1 & 2
2182	1 1/2"	30	48	576	2	57775	165.0	1 & 2

PUT-UP CODE: 1—50 Ft. 2—100 Ft.

SILVER PLATED TUBULAR BRAID CONSTRUCTION TO MIL SPEC QQ-B-575

DESCRIPTION: A woven silver plated copper braid which is manufactured completely round as outlined in Mil Spec QQ-B-575. Each strand of the braid is soft drawn silver plated copper wire. The braid is self-supporting and maintains its round configuration. The percentage of shielding coverage is 95% or more when placed over a mandrel of an equivalent diameter to the inside braid diameter.

ALPHA NO.	NOM. I.D. WHEN ROUNDED	BRAID CONSTRUCTION			APPROX. AWG. EQUIV.	NOM. CIRCULAR MILLS	*CURRENT CARRYING CAPACITY (Amps)	PUT-UP CODE
		AWG OF INDIV. ENDS	CARRIERS	TOTAL NO. OF INDIV. ENDS				
2190	1/32"	36	24	24	22	600	7.0	1-3
2191	1/16"	36	24	48	19	1200	11.0	1-3
2192	3/64"	36	24	72	18	1800	16.0	1-3
2193	1/8"	36	24	96	16	2400	19.0	1-3
2194	3/16"	36	24	120	15	3000	25.0	1-3
2195	5/32"	36	24	240	12	6000	40.0	1-3
2196	11/64"	36	24	168	14	4200	32.0	1-3
2197	13/64"	34	24	192	11	7640	46.0	1 & 2
2198	1/4"	36	24	384	10	9600	53.0	1 & 2

PUT-UP CODE: 1—50 Ft. 2—100 Ft. 3—250 Ft.

* Values shown are for bare cable in free air at 30°C (86°F) and intended as a reference guide only. Actual values will depend on permissible temperature rise, permissible voltage drop and other conditions of service.

PRICES

Alpha No.	Sugg. Resale per 250'	Alpha No.	Sugg. Resale per 100'	Alpha No.	Sugg. Resale per 100'	Alpha No.	Sugg. Resale per 100'
2160	8.25	2170	22.70	2176	59.40	2191	12.87
2162	16.09	2171	29.86	2177	79.53	2192	16.92
2163	18.57	2171/1	31.18	2178	89.76	2193	23.10
2164	25.99	2172	30.36	2179	94.05	2194	24.75
2166	27.06	2173	50.32	2180	105.60	2195	47.02
2167	49.50	2174	43.56	2181	122.59	2196	35.14
2168	35.07	2175	75.90	2182	131.83		
		2175/1	119.46			Alpha No.	Sugg. Resale per 100'
				Alpha No.	Sugg. Resale per 100'	2197	66.00
				2190	7.26	2198	88.32

Sold Nationally to Electronic Parts Distributors by: Loral Distributor Products, a Division of Loral Corporation



U.L. Approved Hook-Up Wire

DESCRIPTION: Stranded tinned copper, color coded polyvinylchloride insulation.
CHARACTERISTICS: Temperature rating (-10°C to +80°C, 300 V) (-10°C to +105°C, 600 V). Resistant to acids, alkalis, oil, flame, moisture and fungus.

300 VOLT 80°C - STYLE No. 1007

ALPHA NO.	CONDUCTOR SIZE	CONDUCTOR STRAND	NOM. O.D.
3050	24	7/32	.057"
3051	22	7/30	.065"
3053	20	10/30	.071"
3055	18	16/30	.080"
3057	16	26/30	.095"

*** STOCK COLORS: 1-19**

- | | | |
|--------------|--------------------|-----------------|
| 1—White | 7—Brown | 13—White Green |
| 2—Black | 8—Orange | 14—White Yellow |
| 3—Red | 9—Gray (slate) | 15—White Blue |
| 4—Green | 10—Violet (purple) | 16—White Brown |
| 5—Yellow | 11—White Black | 17—White Orange |
| 6—Light Blue | 12—White Red | 18—White Gray |
| | | 19—White Violet |

*Other striped color combinations to order

600 VOLT* 105°C - STYLE No. 1015

ALPHA NO.	CONDUCTOR SIZE	CONDUCTOR STRAND	NOM. O.D.
3071	22	7/30	.095"
3073	20	10/30	.102"
3075	18	16/30	.112"
3077	16	26/30	.125"
3079	14	41/30	.142"

*** STOCK COLORS: 1-10**

STANDARD SPOOL PUT-UP: 100 FT., 500 FT., 1000 FT.

STRANDED CONDUCTOR

COLOR CODED PLASTIC INSULATION

STRANDED CONDUCTOR

COLOR CODED PLASTIC INSULATION

STRANDED CONDUCTOR

SILICONE RUBBER INSULATION

WHITE GLASS BRAID

U.L. Semi-Rigid Business Machine Wire

DESCRIPTION: Stranded tinned copper, color coded semi-rigid polyvinylchloride insulation.

CHARACTERISTICS: Temperature rating -10°C to +80°C, 300 volts in business machine or electronic computers only.

APPLICATIONS: Internal wiring of computers, electric bookkeeping, accounting machines, and other office and control equipment.

300 VOLT 80°C — STYLE No. 1061

ALPHA NO.	CONDUCTOR SIZE	CONDUCTOR STRAND	NOM. WALL THICKNESS	NOM. O.D.
3250	24	7/32	.009"	.042"
3251	22	7/30	.009"	.048"
3252	20	7/28	.009"	.056"

STOCK COLORS

- | | |
|----------|-----------|
| 1—White | 6—Blue |
| 2—Black | 7—Brown |
| 3—Red | 8—Orange |
| 4—Green | 9—Gray |
| 5—Yellow | 10—Violet |

*Other striped color combinations available to order.

STANDARD SPOOL PUT-UP: 100 FT., 500 FT., 1000 FT. 5000 FT.

U.L. Silicone Rubber Appliance and Fixture Wire

NEW

300 VOLT 80°C — STYLE No. 1061

DESCRIPTION: Stranded tinned copper conductor, silicone rubber insulation, impregnated white fiberglass braid overall.

CHARACTERISTICS: Resistant to abrasion, oil, moisture, and fungus.

APPLICATIONS: For wiring all types of lighting fixtures and other high wattage devices.

MAXIMUM OPERATING TEMPERATURE +200°C (392°F)

ALPHA NO.	N.E.C. TYPE DESIGNATION	CONDUCTOR SIZE	CONDUCTOR STRAND	INSULATION WALL (64ths)	VOLTAGE RATING (Volts)	NOM. O.D. (Inches)	NET WT. LBS. PER M/FT.
6124	SF-2	18	7/26	2	600	.13	12
6125	SF-2	16	7/24	2	600	.14	16
6126	SF-2	14	7/22	2	600	.16	22
6127	—	12	19/25	2	600	.18	32
6128	—	10	41/26	3	600	.24	52

MAXIMUM OPERATING TEMPERATURE +150°C (302°F)

6129	—	22*	7/30	1	300	.08	5
6130	—	22*	7/30	2	600	.11	8
6131	—	20*	10/30	1	300	.09	7
6132	—	20*	10/30	2	600	.12	9
6133	SFF-1	18	16/30	1	300	.10	9
6134	SFF-2	18	16/30	2	600	.13	12
6135	SFF-2	16	26/30	2	600	.14	16
6136	SFF-2	14	41/30	2	600	.16	22
6137	—	12	41/28	2	600	.18	32

* Listed by U/L for radio hookup wire. **STANDARD SPOOL PUT-UP: 100 FT., 500 FT., 1000 FT.**

Alpha No.	Sugg. Resale per 1000'	PRICES				Alpha No.	Sugg. Resale per 1000'
3050	8.46	3075	20.04	6125	316.80	6134	257.40
3051	10.56	3077	26.56	6126	396.00	6135	321.75
3053	11.13	3079	37.45	6127	485.10	6136	396.00
3055	15.21	3250	12.37	6128	990.00	6137	470.25
3057	23.82	3251	13.62				
3071	12.78	3252	16.26				
3073	14.89	6124	247.50				



ALPHLEX® ZIPPER TUBING

DESCRIPTION Alphlex Zipper Tubing is the all purpose modern way to harness, cover and protect cables. Just zip to close — and zip to reopen. If you wish, it may be permanently sealed with PB-200 Special Compound Liquid Sealer. Alphlex Zipper Tubing is strong, flexible, durable, and offers new freedom in design, production and repair.

APPLICATIONS To shield, to harness wire, to custom-cable to any length, to enclose, to encase, to identify (such as cable markers), to protect, to replace worn jackets.

HOW TO ORDER
Select the type of Zipper Tubing desired from the chart and the required Inside Diameter. When ordering, request as follows: For example, ZIP-31 Tubing in 1/4" Inside Diameter order — ZIP-31 — 1/4".



TYPES OF ZIPPER TUBING						
TYPE	MATERIAL	WALL THICKNESS (Inches)	OPER. TEMP.	APPLICATIONS	STOCK COLORS	STANDARD PUT-UPS
ZIP-31	Polyvinylchloride made from MIL-I-631 D, GRADE C Materials	.020	-20° C to 105° C	All Purpose Type	Clear Black Yellow	25' 50' 100' 25' 50' 100' 25' 50' 100'
ZIP-31M	Polyvinylchloride made from MIL-I-631 D, GRADE C Materials	.040	-20° C to 105° C	Heavy Duty Constructions	Clear Black	100' 100'
ZIP-44	Polyvinylchloride made from MIL-I-7444 B Materials	.020	-67° C to 70° C	Extreme Flexibility, Low Temperature & Aircraft industry	Clear Black	100' 100'
ZIP-50	Polyvinylchloride "sandwich" of aluminum foil laminated between two sheets of polyvinyl	.040	-20° C to 105° C	100% RF shielding	Silver-Grey	100'

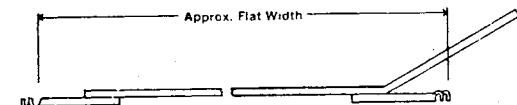

ZIPPER SPECIFICATIONS FOR ALL TYPES OF ALPHLEX ZIPPER TUBING

Material	Polyvinylchloride	Cold Brittleness	-85° C
Track Thickness (when closed)	.095"	Fungus-proof	will not support fungus
Dielectric Strength, V/mil	759	Flammability	self-extinguishing
Tensile Strength-P.S.I.	3810	Lateral Pull Strength (unsealed)	42.7 pounds/inch
Ultimate Elongation	255%	Lateral Pull Strength (permanently sealed)	59.8 pounds/inch
Operating Temperature, Upper Limit	106° C	Standard Colors	Black, Clear, Yellow

Contrasting color combinations of zipper and body are available to order. The zipper portion can be supplied in any of the following colors: Black, Yellow, Clear, Blue, White, Brown, Purple, Red, Orange, Green, Slate.

STANDARD SIZES FOR ALL ZIPPER TUBING	
Zipper Tubing Inside Diameter	Approx. Flat Width (From track to track — excluding flap)
1/4"	1 1/4"
3/8"	1 3/8"
1/2"	2"
5/8"	2 1/2"
3/4"	2 3/4"
7/8"	3 1/8"
1"	3 1/2"
1 1/4"	4 1/4"
1 1/2"	4 3/4"
1 3/4"	5 1/4"
2"	6 1/4"

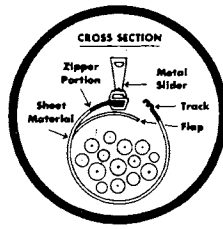

Because of small Inside Diameter, these sizes cannot be closed by using the slider. The tracks must be closed by manual pressure.

PRICES

Alpha No.		Sugg. Resale per 100'
ZIP-31—1/4"		36.00
ZIP-31—3/8"		37.00
ZIP-31—1/2"		37.50
ZIP-31—5/8"		38.00
ZIP-31—3/4"		38.50
ZIP-31—7/8"		39.50
ZIP-31—1"		40.00
ZIP-31—1 1/8"		41.50
ZIP-31—1 1/4"		42.00
ZIP-31—1 1/2"		43.50
ZIP-31—1 3/4"		45.00
ZIP-31—2"		46.00

Alpha No.		Sugg. Resale
LC-113—White	1/2 lb.	4.73
LC-113—Black	1/2 lb.	5.51
LC-114—White	1/2 lb.	4.73
LC-114—Black	1/2 lb.	5.51
LC-115—White	1/2 lb.	4.73

Alpha No.		Sugg. Resale
LC-115—Black	1/2 lb.	5.51
LC-132—White	500 yd.	8.45
LC-132—Black	500 yd.	9.14
LC-134—White	500 yd.	5.41
LC-134—Black	500 yd.	6.09

Alpha No.		Sugg. Resale
LC-136—White	500 yd.	8.45
LC-136—Black	500 yd.	9.14
LC-140—White	500 yd.	8.45
LC-140—Black	500 yd.	9.14
LC-143—White	500 yd.	8.45

Alpha No.		Sugg. Resale per 1000'
PVC-105/24		13.00
PVC-105/22		13.10
PVC-105/20		13.50
PVC-105/18		13.80
PVC-105/17		14.00
PVC-105/16		14.60
PVC-105/15		14.90

Alpha No.		Sugg. Resale per 500'
PVC-105/14		9.95
PVC-105/13		10.20
PVC-105/12		10.70
PVC-105/11		11.05
PVC-105/10		11.55
PVC-105/9		15.70
PVC-105/8		16.95
PVC-105/7		18.10
PVC-105/6		19.55
PVC-105/5		21.15
PVC-105/4		13.75
PVC-105/3		14.70

Alpha No.		Sugg. Resale per 100'
PVC-105/2		6.91
PVC-105/1		7.42
PVC-105/0		7.98
PVC-105/3/8		9.42
PVC-105/3/4		10.81
PVC-105/7/8		11.58
PVC-105/1/2		12.77
PVC-105/1/4		17.00
PVC-105/5/8		18.38

Alpha No.		Sugg. Resale per 50'
PVC-105/3/4		12.67
PVC-105/7/8		14.25
PVC-105/1		15.92
PVC-105/1 1/8		20.88
PVC-105/1 1/4		22.07
PVC-105/1 3/8		23.59
PVC-105/1 1/2		28.60
PVC-105/1 3/4		35.66
PVC-105/2		49.00
PVC-105/2 1/4		58.26
PVC-105/2 1/2		69.07

ALPHLEX® ELECTRONIC LACING CORDS AND TAPES

MIL-T-713A NYLON TWISTED CORD

ALPHA NO.	CLASS	TYPE	BREAKING STRENGTH	FINISH	NOMINAL DIAMETER	STOCK COLORS	YARDS PER POUND	STANDARD PUT-UP
LC-113	I	P Twine	70 lbs.	MW	.050"	Wh., Bik.	560	8 oz. spls.
LC-114	II	P Twine	48 lbs.	MW	.035"	Wh., Bik.	750	8 oz. spls.
LC-115	III	P Twine	32 lbs.	MW	.030"	Wh., Bik.	1180	8 oz. spls.

MIL-T-713A NYLON FLAT BRAIDED TAPE

ALPHA NO.	CLASS	TYPE	BREAKING STRENGTH	NOMINAL WIDTH	NOMINAL THICKNESS	FINISH	STOCK COLORS	STANDARD PUT-UP
LC-136	II	P Tape	50 lbs.	.090" (3/32")	.014"	MW	Wh., Bik.	500 yd. spls.

NYLON FLAT BRAIDED TAPE

ALPHA NO.	WIDTH	THICKNESS	TENSILE STRENGTH	FINISH	STOCK COLORS	STANDARD PUT-UP
LC-132	3/32"	.014"	50 lbs.	GE	Wh., Bik.	500 yd. tubes
LC-134	1/16"	.010"	30 lbs.	MW	Wh., Bik.	500 yd. spls.
LC-136	3/32"	.014"	50 lbs.	MW	Wh., Bik.	500 yd. spls.
LC-140	3/32"	.014"	50 lbs.	SR	Wh., Bik.	500 yd. spls.
LC-143	3/32"	.014"	50 lbs.	AM	Wh., Bik.	500 yd. spls.

DACRON FLAT BRAIDED TAPE

ALPHA NO.	WIDTH	THICKNESS	TENSILE STRENGTH	FINISH	STOCK COLORS	STANDARD PUT-UP
LC-158	3/32"	.014"	50 lbs.	GE	Wh., Bik.	500 yd. tubes
LC-162	3/32"	.014"	50 lbs.	MW	Wh., Bik.	500 yd. spls.

Other materials, finishes and sizes available to order.

Sold Nationally to Electronic Parts Distributors by: Loral Distributor Products, a Division of Loral Corporation

Alphlex® Polyvinylchloride Plastic Tubing (PVC-105)

CONFORMS TO MIL-I-631D †

DESCRIPTION: The superior mechanical, thermal, and electrical properties of Alphlex PVC-105, coupled with its economical cost have led to an ever increasing use of this all-purpose insulating material. Another major advantage of Alphlex PVC-105 is its high degree of flexibility, which is maintained even under severe environmental conditions.

Rated for temperatures as high as 105°C, PVC-105 has a high dielectric strength that remains unaffected by increasing temperature throughout its range. PVC-105 maintains a high resistance to the agents of heat, oil, chemical corrosion and fungi with no loss in tensile strength, or flexibility. Other features include an exceptional resistance to abrasion and indefinite shelf life.

Alphlex PVC-105 is compounded with first quality, non-migratory resinous type plasticizers. Carefully selected stabilizers and modifiers added in the manufacturing process, counteract chemical and environmental degradation. Under adverse conditions Alphlex PVC-105 retains its flexibility which permits it to cling to and protect irregular shapes. An unusually simple to handle insulating material, PVC-105 "snakes" well under all environmental conditions.

APPLICATIONS: Designed and manufactured for general electronic, aircraft and electrical applications involving temperatures as high as 105°C. Especially useful to protect wires and cables subject to abrasion or where a flexible tubing with a high degree of resistivity to oil, chemicals or solvents is necessary.

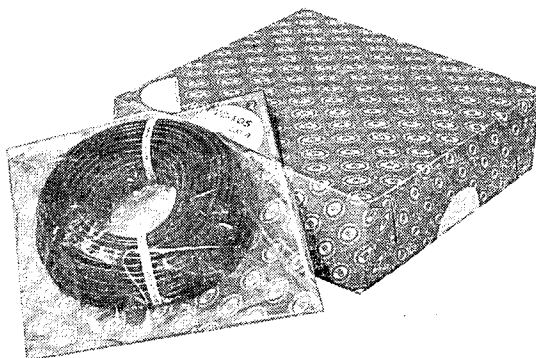

DIMENSIONS CHART

ALPHLEX NUMBER	SIZE	NOM. INSIDE DIA. (Inch.)	NOM. WALL THICKNESS (Inch.)	*STOCK COLORS	STANDARD PUT-UPS
PVC-105/24	24	.022	.013	1-6	100', 500', 1000' Spools
PVC-105/22	22	.027	.012	1-6	100', 500', 1000' Spools
PVC-105/20	20	.034	.016	1-6	100', 500', 1000' Spools
PVC-105/19	19	.038	.016	1-6	100', 500', 1000' Spools
PVC-105/18	18	.042	.016	1-6	100', 500', 1000' Spools
PVC-105/17	17	.047	.016	1-6	100', 500', 1000' Spools
PVC-105/16	16	.053	.016	1-6	100', 500', 1000' Spools
PVC-105/15	15	.059	.016	1-6	100', 500', 1000' Spools
PVC-105/14	14	.066	.016	1-6	100', 500', — Spools
PVC-105/13	13	.076	.016	1-6	100', 500', — Spools
PVC-105/12	12	.085	.016	1-6	100', 500', — Spools
PVC-105/11	11	.095	.016	1-6	100', 500', — Spools
PVC-105/10	10	.106	.016	1-6	100', 500', — Spools
PVC-105/9	9	.118	.020	1-6	100', 500', — Spools
PVC-105/8	8	.133	.020	1-6	100', 500', — Spools
PVC-105/7	7	.148	.020	1-6	100', 500', — Spools
PVC-105/6	6	.166	.020	1-6	100', 500', — Spools
PVC-105/5	5	.186	.020	1-6	100', 500', — Spools
PVC-105/4	4	.208	.020	1-6	100', 250', — Coils
PVC-105/3	3	.234	.020	1-6	100', 250', — Coils

ALPHLEX NUMBER	SIZE	NOM. INSIDE DIA. (Inch.)	NOM. WALL THICKNESS (Inch.)	*STOCK COLORS	STANDARD PUT-UPS
PVC-105/2	2	.263	.020	1-6	100', 250' Coils
PVC-105/1	1	.294	.020	1,2,3	100', 250' Coils
PVC-105/0	0	.330	.020	1,2,3	100', 250' Coils
PVC-105/5/16"	5/16"	.312	.025	1,2,3	100', 250' Coils
PVC-105/3/8"	3/8"	.375	.025	1,2,3	100', 250' Coils
PVC-105/7/16"	7/16"	.438	.025	1,2,3	25', 100', — Coils
PVC-105/1/2"	1/2"	.500	.025	1,2,3	25', 100', — Coils
PVC-105/5/8"	5/8"	.562	.030	1,2,3	25', 100', — Coils
PVC-105/3/4"	3/4"	.625	.030	1,2,3	25', 100', — Coils
PVC-105/3/4"	3/4"	.750	.035	1,2,3	25', 50', — Coils
PVC-105/7/8"	7/8"	.875	.035	1,2,3	25', 50', — Coils
PVC-105/1"	1"	1.000	.035	1,2,3	25', 50', — Coils
PVC-105/1 1/8"	1 1/8"	1.125	.035	1,2	25', 50', — Coils
PVC-105/1 1/4"	1 1/4"	1.250	.040	1,2	25', 50', — Coils
PVC-105/1 3/8"	1 3/8"	1.375	.040	1,2	25', 50', — Coils
PVC-105/1 1/2"	1 1/2"	1.500	.045	1,2	25', 50', — Coils
PVC-105/1 3/4"	1 3/4"	1.750	.055	1,2	25', 50', — Coils
PVC-105/2"	2"	2.000	.060	1,2	25', 50', — Coils
PVC-105/2 1/4"	2 1/4"	2.250	.065	1,2	25', 50', — Coils
PVC-105/2 1/2"	2 1/2"	2.500	.070	1,2	25', 50', — Coils

* STOCK COLORS 1—Clear 2—Black 3—White 4—Yellow 5—Red 6—Green

† MIL-I-631D, Type F, Form U, Grade C, Class I, Category 1

ALPHA WIRE

alpha

Sold Nationally to Electronic Parts Distributors by; Loral Distributor Products, a Division of Loral Corporation

Alphlex® Teflon Extruded Tubing

CONFORMS TO MIL-I-22129B

DESCRIPTION: Alphlex Teflon Tubing is unmatched by any other type of tubing for use in electrical applications at high frequencies and temperatures. Teflon is rated for continuous operation at 250°C, and retains an exceptional toughness and its flexibility throughout its temperature range.

Alphlex Teflon Tubing has the further advantage of a high degree of resistance to flexural fatigue and repetitive stresses; coefficient of friction lower than that of any other known solid; and a dielectric constant and power factor lower than that of any other known solid. This tubing will not crack or become brittle during aging.

Because of its resistance to soldering iron temperature, Alphlex Teflon Tubing will not shrink back during the soldering process. Alphlex Teflon Tubing will not melt and flow as do conventional thermoplastic materials. At high frequencies, its dielectric strength is many times that of other insulating materials.

Alphlex Teflon Tubing is chemically inert, has zero moisture absorption and its insulation resistance properties are unaffected by heat aging or temperature use up to 250°C.

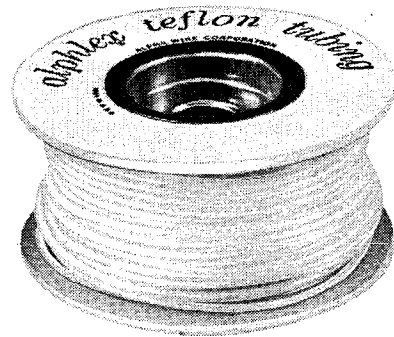

APPLICATIONS: A thin flexible insulation, Alphlex Teflon Tubing permits a miniaturization and compactness of design never before possible. Invaluable in any application where a high heat resistant, flexible, non-flammable, chemical solvent and corrosion-resistant material is required.

ALPHLEX® THIN WALL TEFLON TUBING (TFT-200)

ALPHLEX NUMBER	SIZE	NOM. INSIDE DIA. (Inch.)	NOM. WALL THICKNESS (Inch.)	STOCK COLORS	STANDARD PUT-UPS
TFT-200/30	30	.012	.009	Nat., Yel., Blk., Red	100' Spools
TFT-200/28	28	.015	.009	Nat., Yel., Blk., Red	100' Spools
TFT-200/26	26	.018	.010	Nat., Yel., Blk., Red	100' Spools
TFT-200/24	24	.022	.010	Nat., Yel., Blk., Red	100' Spools
TFT-200/22	22	.027	.010	Nat., Yel., Blk., Red	100' Spools
TFT-200/20	20	.034	.012	Nat., Yel., Blk., Red	100' Spools
TFT-200/19	19	.038	.012	Nat., Yel., Blk., Red	100' Spools
TFT-200/18	18	.042	.012	Nat., Yel., Blk., Red	100' Spools
TFT-200/17	17	.047	.012	Nat., Yel., Blk., Red	100' Spools
TFT-200/16	16	.053	.012	Nat., Yel., Blk., Red	100' Spools
TFT-200/15	15	.059	.012	Nat., Yel., Blk., Red	100' Spools
TFT-200/14	14	.066	.012	Nat., Yel., Blk., Red	100' Spools
TFT-200/13	13	.076	.012	Nat., Yel., Blk., Red	100' Spools

ALPHLEX NUMBER	SIZE	NOM. INSIDE DIA. (Inch.)	NOM. WALL THICKNESS (Inch.)	STOCK COLORS	STANDARD PUT-UPS
TFT-200/12	12	.085	.012	Nat., Yel., Blk., Red	100' Spools
TFT-200/11	11	.095	.012	Nat., Yel., Blk., Red	100' Spools
TFT-200/10	10	.106	.012	Nat., Yel., Blk., Red	100' Spools
TFT-200/9	9	.118	.015	Nat., Yel., Blk., Red	100' Coils*
TFT-200/8	8	.133	.015	Nat., Yel., Blk., Red	100' Coils*
TFT-200/7	7	.148	.015	Natural Only	100' Coils*
TFT-200/6	6	.166	.015	Natural Only	100' Coils*
TFT-200/5	5	.186	.015	Natural Only	100' Coils*
TFT-200/4	4	.208	.015	Natural Only	100' Coils*
TFT-200/3	3	.234	.015	Natural Only	100' Coils*
TFT-200/2	2	.263	.015	Natural Only	100' Coils*
TFT-200/1	1	.294	.015	Natural Only	100' Coils*
TFT-200/0	0	.330	.015	Natural Only	100' Coils*

* RANDOM LENGTHS PACKED IN 100' COILS

ALPHLEX® STANDARD WALL TEFLON TUBING (TFT-250)

Similar in characteristics to TFT-200 (Thin Wall Tubing), but for use in application where additional dielectric values and mechanical strength are necessary.

ALPHLEX NUMBER	SIZE	NOM. INSIDE DIA. (Inch.)	NOM. WALL THICKNESS (Inch.)	STOCK COLORS	STANDARD PUT-UPS
TFT-250/24	24	.022	.012	Natural Only	100' Spools
TFT-250/22	22	.027	.012	Natural Only	100' Spools
TFT-250/20	20	.034	.016	Natural Only	100' Spools
TFT-250/19	19	.038	.016	Natural Only	100' Spools
TFT-250/18	18	.042	.016	Natural Only	100' Spools
TFT-250/17	17	.047	.016	Natural Only	100' Spools
TFT-250/16	16	.053	.016	Natural Only	100' Spools
TFT-250/15	15	.059	.016	Natural Only	100' Spools
TFT-250/14	14	.066	.016	Natural Only	100' Spools
TFT-250/13	13	.076	.016	Natural Only	100' Spools
TFT-250/12	12	.085	.016	Natural Only	100' Spools
TFT-250/11	11	.095	.016	Natural Only	100' Spools

ALPHLEX NUMBER	SIZE	NOM. INSIDE DIA. (Inch.)	NOM. WALL THICKNESS (Inch.)	STOCK COLORS	STANDARD PUT-UPS
TFT-250/10	10	.106	.016	Natural Only	100' Spools
TFT-250/9	9	.118	.020	Natural Only	100' Coils*
TFT-250/8	8	.133	.020	Natural Only	100' Coils*
TFT-250/7	7	.148	.020	Natural Only	100' Coils*
TFT-250/6	6	.166	.020	Natural Only	100' Coils*
TFT-250/5	5	.186	.020	Natural Only	100' Coils*
TFT-250/4	4	.208	.020	Natural Only	100' Coils*
TFT-250/3	3	.234	.020	Natural Only	100' Coils*
TFT-250/2	2	.263	.020	Natural Only	100' Coils*
TFT-250/1	1	.294	.020	Natural Only	100' Coils*
TFT-250/0	0	.330	.020	Natural Only	100' Coils*

* RANDOM LENGTHS PACKED IN 100' COILS

Alpha No.	Sugg. Resale per 100'	Alpha No.	Sugg. Resale per 100'	Alpha No.	Sugg. Resale per 100'
TFT-200/30	9.00	TFT-200/12	18.48	TFT-250/24	10.01
TFT-200/28	8.00	TFT-200/11	20.45	TFT-250/22	11.23
TFT-200/26	7.70	TFT-200/10	22.04	TFT-250/20	15.19
TFT-200/24	7.70	TFT-200/9	24.95	TFT-250/19	16.31
TFT-200/22	9.50	TFT-200/8	27.52	TFT-250/18	18.70
TFT-200/20	12.00	TFT-200/7	29.45	TFT-250/17	20.39
TFT-200/19	12.50	TFT-200/6	31.82	TFT-250/16	21.78
TFT-200/18	12.98	TFT-200/5	34.85	TFT-250/15	22.26
TFT-200/17	14.18	TFT-200/4	38.10	TFT-250/14	24.03
TFT-200/16	14.53	TFT-200/3	41.74	TFT-250/13	25.33
TFT-200/15	14.58	TFT-200/2	48.13	TFT-250/12	27.41
TFT-200/14	16.04	TFT-200/1	52.71	TFT-250/11	30.43
TFT-200/13	17.17	TFT-200/0	59.14	TFT-250/10	33.02
				TFT-250/9	45.86
				TFT-250/8	45.43
				TFT-250/7	49.56
				TFT-250/6	53.55
				TFT-250/5	58.99
				TFT-250/4	64.09
				TFT-250/3	70.89
				TFT-250/2	73.14
				TFT-250/1	81.26
				TFT-250/0	91.38



Sold Nationally to Electronic Parts Distributors by: Loral Distributor Products, a Division of Loral Corporation

Irradiated Polyolefin Tubing

NEW ALL-PURPOSE SHRINKABLE TUBING — FIT-221

- SHRINKS 50% (2:1 RATIO) WITH ONLY 5% LONGITUDINAL SHRINKAGE
- FEWER SIZES COVERING MORE APPLICATIONS
- AVAILABLE TO MEET U.L. SPECIFICATIONS
- MEETS MIL-1-23053A (WEP)
- AMS SPECIFICATIONS 3636A (COLOR), 3637 (CLEAR)



DESCRIPTION: Alphlex FIT-221 Shrinkable Tubing, when heated, forms a tight-mechanical bond, even over irregularly shaped materials. FIT-221 is available in a range of colors and in clear.

FIT-221 is an all-purpose polyolefin extruded tubing that is simple to use and provides a tight mechanical bond. FIT-221 is an irradiated, thermally stable, modified polyolefin base product. FIT-221 Clear may be used so that jacketed, printed components or cable data is clearly visible and inspection of insulated components, cables or terminations is simplified.

The tubing is supplied in an expanded form and easily slips over the object to be covered. When a temperature of approximately 275°F (135°C) is applied, it immediately returns to its predetermined size (approximately one-half smaller) and forms a permanent tight-fitting mechanical bond. FIT-221 Tubing will not cold-flow or melt but retains form stability

throughout its temperature range. No radioactivity exists in or on the material and it will not emit radiation. Longitudinal shrinkage is 5% maximum when completely recovered.

Controlled shrinkage to the correct predetermined size takes place within seven seconds at 225°F to 255°F. Shrinkage will begin at 235°F, but at a somewhat slower rate. When using an oven, temperature may range from 235°F to 300°F. Prolonged exposure to these temperatures will not affect the physical or electrical properties of FIT-221 Shrinkable Tubing. FIT-221 Clear Tubing remains transparent over its entire operating range of -55°C to 135°C.

FLAMMABILITY: Although FIT-221 Clear is a high temperature material, it is flammable and will burn. However, when the tubing is shrunk over non-flammable or flame-resistant components, such as connectors, terminals and wire, the entire assembly will not support combustion.

All Types of FIT Tubing are available from stock and may be cut and/or marked to your specifications.

DIMENSIONS CHART

ALPHLEX NO. FIT-221	EQUIVALENT TO FIT-275/270	SIZE	MIN. I.D. BEFORE SHRINKAGE (Inches)	RECOVERED I.D. AFTER SHRINKAGE (Inches)	RECOVERED NOM. WALL THICKNESS (Inches)	STANDARD PACKAGE* 4' LENGTHS		STANDARD PACKAGE* 6" LENGTHS	
						TOT. FTG.	NO. OF LGTHS.	TOT. FTG.	NO. OF LGTHS.
FIT-221-3/4"	FIT-275-24	3/4	.046	.023	.016	100'	25	20'	40
FIT-221-1/16"	FIT-275-22, 20	1/16	.063	.031	.017	100'	25	18'	36
FIT-221-3/32"	FIT-275-18, 16	3/32	.093	.046	.020	100'	25	16'	32
FIT-221-1/8"	FIT-275-14	1/8	.125	.062	.020	100'	25	14'	28
FIT-221-3/16"	FIT-275-12, 10	3/16	.187	.093	.020	100'	25	12'	24
FIT-221-1/4"	FIT-275-8	1/4	.250	.125	.025	100'	25	10'	20
FIT-221-3/8"	FIT-275-6, 4	3/8	.375	.187	.025	100'	25	8'	16
FIT-221-1/2"	FIT-275-2, 3/16"	1/2	.500	.250	.025	20'	5	7'	14
FIT-221-3/4"	FIT-275-3/8", 7/16"	3/4	.750	.375	.030	20'	5	6'	12
FIT-221-1"	FIT-275-1/2", 5/8"	1	1.000	.500	.035	20'	5	4'	8
FIT-221-1 1/2"	FIT-275-3/4", 7/8"	1 1/2	1.500	.750	.040	20'	5	2.5'	5
FIT-221-2"	FIT-275-1", 1 1/4"	2	2.000	1.000	.045	20'	5	1.5'	3
FIT-221-3"	FIT-275-1 1/2", 1 3/4"	3	3.000	1.500	.050	8'	2	1'	2
FIT-221-4"	FIT-275-2"	4	4.000	2.000	.055	8'	2	.5'	1

STOCK COLORS — Black White, Red, Yellow, Blue, and Clear

*STANDARD PACKAGE FIT-221 Tubing is available ONLY in the specified packages. When ordering, indicate package desired (6 inches or 4 foot).

For Details On Alpha's Complete Line Of Shrinkable Tubing — Write For Alpha Catalog.



ALPHA WIRE MFG.

Sold Nationally to Electronic Parts Distributors by: Loral Distributor Products, a Division of Loral Corporation



Irradiated Polyvinylchloride Tubing FIT-105

All Types of FIT Tubing are available from stock and may be cut and/or marked to your specifications.

HIGHLY FLEXIBLE — IDEAL FOR CABLE JACKETING

Conforms to MIL-1-631D, Type F, Form U, Grade C, Class 1, Cat. 1

SHRINKAGE RATIO 2:1 (50% Shrinkage)

DESCRIPTION: Alphlex FIT-105 is an easy-to-use modified polyvinylchloride that provides a snug, extremely flexible insulation.

Because of its flexibility, strength and its ability to shrink 50% on application of heat, FIT-105 is ideally suited for insulating components and cables with a wide variation in shape and diameter.

Because of the 50% expanded diameter of FIT-105 Tubing, it is an extremely useful cable jacketing material. Cable cores may be pulled through FIT-105 Tubing with comparative ease and shrunk down to form a jacket with all the qualities of the finest extruded plastic jackets.

The tubing is supplied in expanded form and in continuous lengths. When a temperature of approximately 347°F (175°C) is applied, Alphlex FIT-105 Tubing immediately returns to its predetermined size (approximately 50% smaller), and forms a permanent, tight-fitting mechanical bond. FIT-105 Tubing will not cold-flow or melt but retains form stability within its temperature range. No radioactivity exists in or on the material and it will not emit radiation. Longitudinal shrinkage is less than 10%.

Controlled shrinkage to the correct predetermined size takes place within seven seconds at 325°F, or above. When using an oven, temperature may range from 325°F to 350°F.

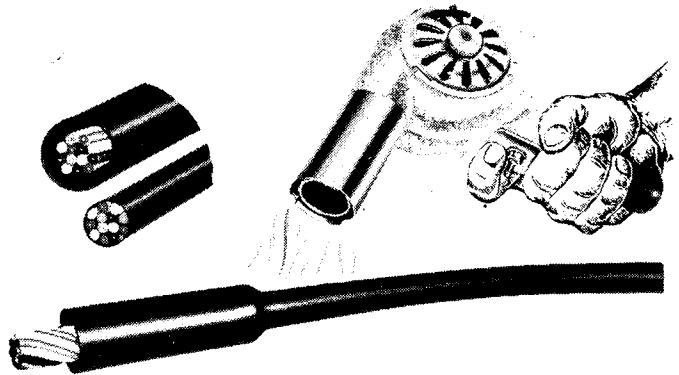

DIMENSIONS CHART

ALPHLEX NO. (BLACK ONLY)	SIZE (Inches)	MINIMUM I.D. BEFORE SHRINKING (Inches)	RECOVERED I.D. AFTER SHRINKING (Inches)	NOMINAL WALL THICKNESS (Inches)	STANDARD PUT-UP (Feet)
FIT-105- $\frac{3}{64}$	$\frac{3}{64}$.046	.023	.020	25, 100, 500
FIT-105- $\frac{1}{16}$	$\frac{1}{16}$.062	.031	.020	25, 100, 500
FIT-105- $\frac{3}{32}$	$\frac{3}{32}$.093	.046	.020	25, 100, 200
FIT-105- $\frac{1}{8}$	$\frac{1}{8}$.125	.062	.025	25, 100, 200
FIT-105- $\frac{3}{16}$	$\frac{3}{16}$.187	.093	.025	25, 100, 200
FIT-105- $\frac{1}{4}$	$\frac{1}{4}$.250	.125	.025	25, 100, 200
FIT-105- $\frac{3}{8}$	$\frac{3}{8}$.375	.187	.030	25, 100, 200
FIT-105- $\frac{1}{2}$	$\frac{1}{2}$.500	.250	.030	25, 100
FIT-105- $\frac{3}{4}$	$\frac{3}{4}$.775	.375	.035	25, 100
FIT-105-1	1	1.000	.500	.040	25, 100
FIT-105-1 $\frac{1}{2}$	1 $\frac{1}{2}$	1.500	.750	.045	25, 100
FIT-105-2	2	2.000	1.000	.050	10, 25, 50

STOCK COLOR — BLACK

LONG LENGTHS — MAXIMUM THREE LENGTHS PER PUT-UP.

Alpha No.	Footage	Sugg. Resale	PRICES			Alpha No.	Footage	Sugg. Resale
FIT-105- $\frac{3}{64}$	500	31.75	FIT-105- $\frac{3}{16}$	200	26.30	FIT-105- $\frac{3}{4}$	25	8.61
FIT-105- $\frac{1}{16}$	100	9.15	FIT-105- $\frac{1}{8}$	100	13.90	FIT-105-1	100	40.00
FIT-105- $\frac{3}{32}$	25	2.95	FIT-105- $\frac{3}{16}$	25	4.35	FIT-105-1	25	12.20
FIT-105- $\frac{1}{8}$	500	33.25	FIT-105- $\frac{1}{4}$	200	33.00	FIT-105-1 $\frac{1}{2}$	100	65.75
FIT-105- $\frac{3}{16}$	100	9.50	FIT-105- $\frac{1}{4}$	100	17.25	FIT-105-1 $\frac{1}{2}$	25	19.73
FIT-105- $\frac{1}{8}$	25	3.06	FIT-105- $\frac{3}{8}$	25	5.33	FIT-105-2	50	56.60
FIT-105- $\frac{3}{32}$	200	20.30	FIT-105- $\frac{3}{8}$	200	36.50	FIT-105-2	25	28.80
FIT-105- $\frac{1}{16}$	100	10.90	FIT-105- $\frac{1}{2}$	100	19.00	FIT-105-2	10	11.57
FIT-105- $\frac{3}{32}$	25	3.48	FIT-105- $\frac{1}{2}$	25	5.84			
FIT-105- $\frac{1}{8}$	200	21.50	FIT-105- $\frac{3}{4}$	100	20.75			
FIT-105- $\frac{3}{16}$	100	11.50	FIT-105- $\frac{3}{4}$	25	6.58			
FIT-105- $\frac{1}{8}$	25	3.65	FIT-105-1	100	27.75			

alpha

Sold Nationally to Electronic Parts Distributors by; Loral Distributor Products, a Division of Loral Corporation

BELDEN • PRICE LIST

Trade Number Length in ft.	Suggested Trade Price Each	Trade Number Length in ft.	Suggested Trade Price Each	Trade Number Length in ft.	Suggested Trade Price Each	Trade Number Length in ft.	Suggested Trade Price Each
8000-50	1.32	8081	3.23	8215-100	12.25	8245-1000 (RG-55/U)	76.40
8000-75	1.91	8082	3.56	8215-500	53.10	8254-100 (RG-62/U)	6.45
8000-100	2.40	8083	4.14	8215-1000	106.20	8254-500 (RG-62/U)	24.00
8000-1000	21.90	8084	5.13	8216-100 (RG-174/U)	3.75	8254-1000 (RG-62/U)	48.00
8002-50	.96	8085	6.18	8216-500 (RG-174/U)	13.80	8255-500 (RG-62B/U)	27.60
8002-100	1.65	8086	8.04	8216-1000 (RG-174/U)	27.60	8255-1000 (RG-62B/U)	55.20
8008-100	4.50	8150-98	.98	8217-100 } TBO (Use	5.70	8257-500 (RG-71/U)	39.75
8008-150	6.40	8151-98	.98	8217-500 } 8221)	22.05	8257-1000 (RG-71/U)	79.50
8008-500	19.80	8152-98	.98	8217-1000 }	44.10	8258-500 (RG-71B/U)	38.20
8009-100	2.85	8153-98	.98	8218-100	5.25	8258-1000 (RG-71B/U)	76.40
8009-150	3.90	8154-98	.98	8218-500	19.35	8259-25 (RG-58A/U)	2.06
8009-500	11.55	8155-98	.98	8218-1000	38.70	8259-50 (RG-58A/U)	3.15
8011-100	3.85	8156-98	.98	8219-100	6.00	8259-100 (RG-58A/U)	5.85
8012-100	2.55	8157-98	.98	8219-500	23.25	8259-500 (RG-58A/U)	21.30
8012-1000	21.45	8158-98	.98	8219-1000	46.50	8259-1000 (RG-58A/U)	42.60
8013-100	1.73	8159-98	.98	8221-100	6.30	8261-100 (RG-11A/U)	13.00
8013-1000	14.50	8160-98	.98	8221-500	21.30	8261-500 (RG-11A/U)	55.15
8014-25	.62	8161-98	.98	8221-1000	42.60	8261-1000 (RG-11A/U)	110.30
8014-500	3.60	8162-98	.98	8222-100	1.80	8262-500 (RG-58C/U)	23.25
8018-50	1.20	8163-98	.98	8222-500	8.10	8262-1000 (RG-58C/U)	46.50
8018-500	9.75	8164-98	.98	8225-25	.78	8263-500 (RG-59B/U)	25.65
8019-100	1.20	8165-98	.98	8225-50	1.20	8263-1000 (RG-59B/U)	51.30
8019-1000	9.00	8166-98	.98	8225-75	1.56	8264-500 (RG-5A/U)	135.45
8020-100	.93	8167-98	.98	8225-100	1.97	8264-1000 (RG-5A/U)	270.90
8020-1000	6.40	8168-98	.98	8225-250	4.85	8265-100 (RG-178B/U)	13.90
8021-100	.78	8169-98	.98	8225-500	9.15	8265-500 (RG-178B/U)	136.50M'
8021-1000	4.65	8170-98	.98	8225-1000	17.70	8266-100 (RG-180B/U)	38.25
8022-100	.77	8171-98	.98	8225-T1000	17.70	8266-500 (RG-180B/U)	342.00M'
8022-1000	3.96	8172-98	.98	8226-25	.78	8267-500 (RG-213/U)	60.75
8023-100	.75	8173-98	.98	8226-50	1.20	8267-1000 (RG-213/U)	121.50
8023-1000	3.55	8174-98	.98	8226-100	1.56	8268-500 (RG-214/U)	211.50
8024-100	.72	8175	1.50	8227-500	53.25	8268-1000 (RG-214/U)	423.00
8024-1000	3.30	8176	per pkg.	*8228-100	6.30	8269-100 (RG-188A/U)	28.35
8025-100	.72	8177	.39	*8228-500	20.70	8269-500 (RG-188A/U)	257.25M'
8025-1000	3.00	8178	per pkg.	*8228-1000	41.40	8270-100 (RG-196A/U)	19.20
8040	.95	8179	1.29	8230-25	.89	8270-500 (RG-196A/U)	160.50M'
8041	1.01	8178	per pkg.	8230-50	1.34	8275-50	2.70
8042	1.10	8179	1.32	8230-75	1.77	8275-75	3.80
8043	1.16	8180	per pkg.	8230-100	2.22	8275-100	4.65
8044	1.31	8181	1.35	8230-250	5.50	8275-250	11.05
8045	1.67	8180	per pkg.	8230-500	10.65	8275-500	22.00
8046	2.25	8181	2.40	8230-1000	20.35	8275-1000	43.20
8047	1.26	8190	per pkg.	8230-T1000	20.35	8279-100	9.45
8048	1.26	8191	2.40	8232-500	45.75	8279-250	22.05
8049	1.29	8191	per pkg.	8232-1000	91.50	8279-500	40.95
8050	1.29	8191	.98	8232-2000	183.00	8280§ (Cut to customer's specified length Maximum 1500')	799.50M'
8051	1.29	8191	.98	8233-500	88.95	8281-500	82.90
8052	1.32	8196	2.95	8233-1000	177.90	8281-1000	165.75
8053	1.38	8197	11.25	8233-2000	355.80	8282§ (Cut to customer's specified length Maximum 2000')	354.75M'
8054	1.47	8198	30.40	8235-100	5.35	8283§ (Cut to customer's specified length Maximum 1000')	2895.00M'
8055	1.64	8199	67.60	8235-500	24.30	8284§ (Cut to customer's specified length Maximum 1000')	981.00M'
8056	1.83	8201-100	4.50	8237-50 (RG-8/U)	7.35	8285-50	2.85
8057	1.95	8201-500	18.60	8237-100 (RG-8/U)	13.75	8285-75	3.85
8058	2.28	8201-1000	37.20	8237-250 (RG-8/U)	29.10	8285-100	4.90
8059	1.29	8205-100	3.10	8237-500 (RG-8/U)	55.20	8285-250	11.65
8060	1.29	8205-500	11.40	8237-1000 (RG-8/U)	110.40	8285-500	22.50
8061	1.32	8205-1000	22.80	8238-100 (RG-11/U)	11.85	8285-1000	45.00
8062	1.35	8208-100	7.90	8238-250 (RG-11/U)	27.60	8286§ (Cut to customer's specified length Maximum 1000')	825.00M'
8063	1.37	8208-500	34.80	8238-500 (RG-11/U)	47.55	8290-50	5.95
8064	1.41	8208-1000	69.60	8238-1000 (RG-11/U)	95.10	8290-75	8.05
8065	1.49	8210-100	7.80	8239-500 (RG-54A/U)	39.40	8290-100	10.15
8066	1.61	8210-250	18.15	8239-1000 (RG-54A/U)	78.80	8290-250	23.95
8067	1.79	8211-500	23.65	8240-25 (RG-58/U)	1.82	8290-500	47.90
8068	1.94	8211-1000	47.30	8240-50 (RG-58/U)	2.85	8299-25	3.75
8069	2.19	8211-2000	94.60	8240-100 (RG-58/U)	4.95	(25 per box)	
8070	2.63	8212-500	23.65	8240-250 (RG-58/U)	10.70		
8071	3.11	8212-1000	47.30	8240-500 (RG-58/U)	18.30		
8072	3.83	8212-2000	94.60	8240-1000 (RG-58/U)	36.60		
8073	2.16	8213-500	62.25	8241-25 (RG-59/U)	2.04		
8074	2.25	8213-1000	124.50	8241-50 (RG-59/U)	3.25		
8075	2.37	8213-2000	249.00	8241-100 (RG-59/U)	5.75		
8076	2.37	8214-50	8.25	8241-250 (RG-59/U)	12.90		
8077	2.37	8214-100	15.30	8241-500 (RG-59/U)	19.95		
8078	2.45	8214-250	30.75	8241-1000 (RG-59/U)	39.90		
8079	2.61	8214-500	61.50	8242-100 (RG-9/U)	35.85		
8080	2.87	8214-1000	123.00	8242-1000 (RG-9/U)	330.75		
				8243-500 (RG-9B/U)	211.50		
				8243-1000 (RG-9B/U)	423.00		
				8245-500 (RG-55/U)	38.20		

BELDEN • PRICE LIST

Trade Number Length in ft.	Suggested Trade Price Each	Trade Number Length in ft.	Suggested Trade Price Each	Trade Number Length in ft.	Suggested Trade Price Each	Trade Number Length in ft.	Suggested Trade Price Each
8300-25 † Solid Color	2.20	8330-500 †•Solid Color	150.00M	8416-50	3.40	8443-500	12.15
8300-100 †•Solid Color	5.55	8330-1000†•Solid Color	148.50M	8416-100	5.95	8443-1000	24.30
8300-500 †•Solid Color	48.75M	8330-1000†•Striped ▲	157.50M	8416-250	13.65	8444-25	1.41
8300-1000†•Solid Color	48.00M	8390-25	10.50	8417-15	1.05	8444-100	4.15
8300-1000†•Striped▲	57.00M	8390-100•	39.60	8417-25	1.41	8444-250	8.50
8301-25 † Solid Color	2.20	8390-500•	396.00M	8417-50	2.27	8444-500	16.95
8301-100 †•Solid Color	5.70	8391-25	13.05	8417-100	4.30	8444-1000	33.90
8301-500 †•Solid Color	51.75M	8391-100•	48.60	8417-250	9.30	8445-25	1.60
8301-1000†•Solid Color	51.00M	8391-500•	486.00M	8418-100	25.50	8445-100	4.80
8301-1000†•Striped▲	60.00M	8392-25	15.75	8418-250	61.80	8445-250	10.15
8302-25 † Solid Color	2.20	8392-100•	58.20	8419-10	.98	8445-500	20.25
8302-100 †•Solid Color	5.85	8392-500•	582.00M	8419-25	1.71	8445-1000	40.50
8302-500 †•Solid Color	53.65M	8393-25	10.50	8419-250	12.25	8446-15	1.60
8302-1000†•Solid Color	52.90M	8393-100•	42.00	8420-15	1.80	8446-100	7.15
8302-1000†•Striped▲	61.90M	8393-500•	420.00M	8420-25	2.67	8446-250	15.55
8303-25 † Solid Color	2.55	8401-15	1.26	8420-50	4.00	8446-500	31.05
8303-100 †•Solid Color	7.20	8401-25	1.65	8420-100	7.45	8446-1000	62.10
8303-500 †•Solid Color	62.25M	8401-50	2.91	8420-250	17.50	8447-100	7.95
8304-25 † Solid Color	2.50	8401-100	5.35	8420-500	34.95	8447-250	17.55
8304-100 †•Solid Color	6.45	8401-250	11.35	8421-15	1.29	8447-500	35.10
8304-500 †•Solid Color	58.50M	8401-500	22.65	8421-25	1.71	8447-1000	70.20
8304-1000†•Solid Color	57.75M	8401-1000	45.30	8421-50	3.10	8448-15	1.74
8304-1000†•Striped▲	66.75M	8402-100	12.15	8421-100	5.05	8448-100	8.55
8305-25 † Solid Color	2.70	8402-250	28.35	8421-250	11.20	8448-250	19.20
8305-100 †•Solid Color	7.80	8402-500	56.70	8422-15	1.62	8448-500	38.40
8305-500 †•Solid Color	67.50M	8403-15	2.10	8422-25	2.43	8448-1000	76.80
8305-1000†•Solid Color	66.75M	8403-50	5.60	8422-50	4.50	8449-15	1.91
8305-1000†•Striped▲	75.75M	8403-100	10.35	8422-100	7.85	8449-100	9.25
8306-25 † Solid Color	2.85	8403-250	23.25	8422-250	17.40	8449-250	21.00
8306-100 †•Solid Color	8.10	8403-500	46.50	8422-500	34.80	8449-500	42.00
8306-500 †•Solid Color	75.00M	8403-1000	93.00	8422-1000	69.60	8449-1000	84.00
8306-1000†•Solid Color	74.25M	8404-15	2.43	8423-15	2.52	8450-100	3.85
8306-1000†•Striped▲	83.25M	8404-100	11.40	8423-50	6.65	8450-250	7.20
8307-25 † Solid Color	3.15	8404-250	26.25	8423-100	12.55	8450-500	14.20
8307-100 †•Solid Color	9.60	8404-500	52.50	8423-250	29.20	8450-1000	28.35
8307-500 †•Solid Color	90.00M	8404-1000	105.00	8423-500	58.35	8451-100	4.38
8307-1000†•Solid Color	89.25M	8405-250	31.00	8423-1000	116.70	8451-250	8.95
8307-1000†•Striped▲	98.25M	8405-500	62.00	8424-15	2.85	8451-500	17.85
8308-25 † Solid Color	3.15	8405-1000	124.00	8424-50	7.50	8451-1000	35.70
8308-100 †•Solid Color	9.45	8406-100	13.05	8424-100	14.10	8452-25	2.10
8308-500 †•Solid Color	87.00M	8406-250	30.55	8424-250	33.25	8452-50	3.57
8309-25 † Solid Color	3.75	8406-500	61.10	8424-500	66.45	8452-100	6.25
8309-100 †•Solid Color	11.55	8407-100	25.50	8424-1000	132.90	8452-250	14.20
8309-500 †•Solid Color	109.50M	8407-250	61.50	8425-100	16.95	8452-500	28.35
8309-1000†•Solid Color	108.75M	8408-100	20.85	8425-250	41.25	8452-1000	56.70
8309-1000†•Striped▲	117.75M	8408-250	48.75	8426-100	20.65	8453-50	4.40
8310-25 † Solid Color	4.95	8408-500	97.50	8426-250	51.00	8453-100	8.25
8310-100 †•Solid Color	14.10	8409	1.14	8427-100	22.20	8453-500	40.50
8310-500 †•Solid Color	135.00M	8410-25	3.00	8427-250	54.45	8454-50	5.05
8310-1000†•Solid Color	134.25M	8410-50	5.25	8428-100	14.65	8454-100	9.55
8310-1000†•Striped▲	143.25M	8410-100	9.75	8428-500	68.25	8454-500	43.80
8323-25 † Solid Color	3.00	8410-250	22.65	8428-1000	136.50	8454-1000	87.60
8323-100 †•Solid Color	8.85	8410-500	45.30	8429-10	.92	8455-100	9.70
8323-500 †•Solid Color	79.50M	8411-15	1.02	8429-25	1.47	8455-250	24.15
8325-25 † Solid Color	3.10	8411-25	1.41	8429-250	10.05	8456-100	9.40
8325-100 †•Solid Color	9.00	8411-50	2.25	8430-10	.62	8456-500	42.90
8325-500 †•Solid Color	81.00M	8411-100	4.20	8430-25	.87	8456-1000	85.80
8326-25 † Solid Color	3.25	8411-250	8.95	8430-250	5.20	8457-100	10.05
8326-100 †•Solid Color	9.75	8411-500	17.90	8431-10	.81	8457-500	46.50
8326-500 †•Solid Color	90.75M	8411-1000	35.80	8431-15	1.05	8457-1000	93.00
8326-1000†•Solid Color	90.00M	8412-25	3.10	8431-25	1.38	8458-100	17.40
8326-1000†•Striped▲	99.00M	8412-50	5.80	8431-100	4.38	8458-500	78.00
8327-25 † Solid Color	3.75	8412-100	10.75	8431-500	19.80	8458-1000	156.00
8327-100 †•Solid Color	10.95	8412-250	24.70	8434-100	6.10	8459-100	26.40
8327-500 †•Solid Color	102.00M	8412-500	49.45	8434-500	27.60	8459-500	122.25
8327-1000†•Solid Color	101.25M	8412-1000	98.85	8434-1000	55.20	8459-1000	244.50
8327-1000†•Striped▲	110.25M	8413-15	2.01	8437-500	22.65	8460-100	3.45
8328-25 † Solid Color	3.75	8413-25	2.95	8437-1000	45.30	8460-500	13.35
8328-100 †•Solid Color	10.80	8413-50	5.50	8441-100	5.85	8460-1000	26.70
8328-500 †•Solid Color	100.50M	8413-100	10.15	8441-500	25.90	8461-100	4.40
8329-25 † Solid Color	4.35	8413-250	23.50	8441-1000	51.75	8461-500	17.85
8329-100 †•Solid Color	13.80	8413-500	46.95	8442-500	10.05	8461-1000	35.70
8329-500 †•Solid Color	129.00M	8415-1	1.50	8442-1000	20.10	8462-25 †	1.38
8329-1000†•Solid Color	128.25M	8415-50	1.37	8443-25	1.20	8462-100 †	4.15
8329-1000†•Striped▲	137.25M	8416-15	1.46	8443-100	3.10	8462-250 †	9.55
8330-25 † Solid Color	5.25	8416-25	1.86	8443-250	6.10	8463-50	2.51
8330-100 †•Solid Color	15.75						

BELDEN • PRICE LIST

Trade Number Length in ft.	Suggested Trade Price Each	Trade Number Length in ft.	Suggested Trade Price Each	Trade Number Length in ft.	Suggested Trade Price Each	Trade Number Length in ft.	Suggested Trade Price Each
8463-75	3.48	8491	1.86	8516-1000†	Striped ¶ 21.10	8537-100 †	Solid Color 2.16
8463-100	4.65	8492-1000	21.00	8517-100 †	Solid Color 2.24	8537-1000†	Solid Color 14.95
8463-500	21.40	8494	1.80	8517-1000†	Solid Color 17.20	8537-100 †	Striped ¶ 2.28
8464-50	2.15	8495	1.41			8537-1000†	Striped ¶ 16.10
8464-75	2.91	8497-1	1.56	8517-100 †	Striped ¶ 2.36		
8464-100	3.72	8497-50	1.43	8517-1000†	Striped ¶ 18.35	8538-100 †	Solid Color 1.28
8464-500	16.35	8499	1.05	8518-100 †	Solid Color 2.18	8538-500 †	Solid Color 3.85
8464-1000	32.70	8500-100 †	Solid Color 2.27	8518-1000†	Solid Color 16.50	8538-1000†	Solid Color 6.90
						8538-100 †	Striped ¶ 1.40
8465-100	8.80	8500-500 †	Solid Color 9.40	8519-100 †	Solid Color 1.92	8538-500 †	Striped ¶ 4.45
8465-250	20.05	8500-1000†	Solid Color 17.55	8519-1000†	Solid Color 14.40	8538-1000†	Striped ¶ 8.05
8465-500	40.05	8500-100 †	Striped ¶ 2.39	8520-100 †	Solid Color 4.00	8541-100	2.64
8465-1000	80.10	8500-1000†	Striped ¶ 18.70	8520-500 †	Solid Color 18.00	8541-1000	19.00
8466-100	21.90	8501-100 †	Solid Color 1.86	8520-1000†	Solid Color 33.75	8542-100	2.81
8466-250	53.65	8501-500 †	Solid Color 7.30	8520-100 †	Striped ¶ 4.12	8542-1000	20.65
8466-500	107.25	8501-1000†	Solid Color 13.95	8520-500 †	Striped ¶ 18.60	8543-100	3.30
8466-1000	214.50	8501-100 †	Striped ¶ 1.98	8520-1000†	Striped ¶ 34.90	8543-1000	25.05
8467-100	11.70	8501-1000†	Striped ¶ 15.10	8521-100 †	Solid Color 2.81	8544-100	3.85
8467-250	26.80	8502-100 †	Solid Color 1.71	8521-500 †	Solid Color 11.20	8544-1000	30.45
8467-500	53.65	8502-500 †	Solid Color 6.00	8521-1000†	Solid Color 21.90	8545-100	4.95
8467-1000	107.25	8502-1000†	Solid Color 11.10	8521-100 †	Striped ¶ 2.93	8545-500	22.30
8468-100	29.70	8502-100 †	Striped ¶ 1.83	8521-500 †	Striped ¶ 11.80	8545-1000	42.90
8468-500	140.25	8502-1000†	Striped ¶ 12.25	8521-1000†	Striped ¶ 23.05	8546-100	6.60
8468-1000	280.50	8503-100 †	Solid Color 1.52	8522-25 †	Solid Color .84	8546-500	28.90
8469-100	15.70	8503-500 †	Solid Color 5.55	8522-100 †	Solid Color 2.10	8546-1000	57.75
8469-250	36.75	8503-1000†	Solid Color 9.90	8522-500 †	Solid Color 8.10	8547-100	114.00
8469-500	73.50	8503-100 †	Striped ¶ 1.64	8522-1000†	Solid Color 15.60	8548-100	96.60
8469-1000	147.00	8503-500 †	Striped ¶ 6.15	8522-100 †	Striped ¶ 2.22	8549-100	66.75
8470-500	17.85	8503-1000†	Striped ¶ 11.05	8522-500 †	Striped ¶ 8.70	8550-100	45.45
8470-1000	35.70	8504-100 †	Solid Color 1.40	8522-1000†	Striped ¶ 16.75	8550-500	217.50
8471-500	22.30	8504-500 †	Solid Color 4.80	8523-25 †	Solid Color .72	8551-100	34.50
8471-1000	44.55	8504-1000†	Solid Color 9.10	8523-100 †	Solid Color 1.67	8551-500	166.50
8472-25	2.85	8504-100 †	Striped ¶ 1.52	8523-500 †	Solid Color 6.10	8552-100	26.40
8472-100	9.90	8504-500 †	Striped ¶ 5.40	8523-1000†	Solid Color 11.35	8552-500	125.40
8472-250	23.55	8504-1000†	Striped ¶ 10.25	8523-100 †	Striped ¶ 1.79	8553-100	13.20
8473-500	36.75	8505-100 †	Solid Color 1.40	8523-500 †	Striped ¶ 6.70	8553-500	59.40
8473-1000	73.50	8505-500 †	Solid Color 5.25	8523-1000†	Striped ¶ 12.50	8553-1000	118.50
8474-100	11.55	8505-1000†	Solid Color 9.75	8524-25 †	Solid Color .66	8554-100	7.65
8474-250	27.75	8505-100 †	Striped ¶ 1.52	8524-100 †	Solid Color 1.47	8554-500	33.00
8475-100	6.45	8505-1000†	Striped ¶ 10.90	8524-500 †	Solid Color 5.40	8554-1000	66.00
8475-500	29.10	8507-100 †	Solid Color 1.92	8524-1000†	Solid Color 10.05	8555-100	6.00
8476-100	9.60	8507-1000†	Solid Color 13.80	8524-100 †	Striped ¶ 1.59	8555-500	26.50
8476-500	42.00	8507-100 †	Striped ¶ 2.04	8524-500 †	Striped ¶ 6.00	8555-1000	51.00
8477-500	49.50	8507-1000†	Striped ¶ 14.95	8524-1000†	Striped ¶ 11.20	8556-100	4.95
8477-1000	99.00	8508-100 †	Solid Color 1.79	8525-100 †	Solid Color 1.34	8556-1000	39.60
8478-100	7.15	8508-1000†	Solid Color 11.35	8525-500 †	Solid Color 4.60	8557-100	4.30
8478-250	17.05	8508-100 †	Striped ¶ 1.91	8525-1000†	Solid Color 8.55	8557-1000	34.50
8478-1000	68.10	8508-1000†	Striped ¶ 12.50	8525-100 †	Striped ¶ 1.46	8558-100	3.85
8479-100	13.20	8509-100 †	Solid Color 1.73	8525-500 †	Striped ¶ 5.20	8558-1000	28.90
8479-250	32.10	8509-1000†	Solid Color 10.80	8525-1000†	Striped ¶ 9.70	8559-100	3.50
8481-100	1.95	8509-100 †	Striped ¶ 1.85	8527-100 †	Solid Color 5.70	8559-1000	24.75
8481-500	6.25	8509-1000†	Striped ¶ 11.95	8527-500 †	Solid Color 24.75	8561-100 †	8.10
8481-1000	12.45	8510-100 †	Solid Color 2.82	8527-1000†	Solid Color 47.25	8561-1000†	68.10
8482-100	2.45	8510-1000†	Solid Color 23.25	8528-100 †	Solid Color 1.86	8562-100 †	4.85
8482-500	8.80	8510-100 †	Striped ¶ 2.94	8528-500 †	Solid Color 7.00	8562-1000†	41.25
8482-1000	17.55	8510-1000†	Striped ¶ 24.40	8528-1000†	Solid Color 13.30	8563-100 †	4.40
8483-100	3.15	8511-100 †	Solid Color 2.40	8529-25 †	Solid Color .66	8563-1000†	36.00
8483-500	12.45	8511-1000†	Solid Color 18.30	8529-100 †	Solid Color 1.47	8564-100 †	3.50
8483-1000	24.90	8511-100 †	Striped ¶ 2.52	8529-500 †	Solid Color 5.20	8564-1000†	29.55
8484-100	4.05	8511-1000†	Striped ¶ 19.45	8529-1000†	Solid Color 9.75	8565-100 †	2.93
8484-500	17.10	8512-100 †	Solid Color 1.95	8529-100 †	Striped ¶ 1.59	8565-1000†	24.00
8484-1000	34.20	8512-1000†	Solid Color 14.70	8529-500 †	Striped ¶ 5.80	8566-100 †	2.36
8485-100	4.85	8512-100 †	Striped ¶ 2.07	8529-1000†	Striped ¶ 10.90	8566-1000†	19.90
8485-500	21.10	8512-1000†	Striped ¶ 15.85	8530-25 †	Solid Color .62	8567-100 †	1.50
8485-1000	42.15	8513-100 †	Solid Color 1.85	8530-100 †	Solid Color 1.23	8567-1000†	9.90
8486-500	11.35	8513-1000†	Solid Color 13.30	8530-500 †	Solid Color 4.05	8568-100 †	1.22
8486-1000	22.65	8513-100 †	Striped ¶ 1.97	8530-1000†	Solid Color 7.80	8568-1000†	7.65
8487-500	15.40	8513-1000†	Striped ¶ 14.45	8530-100 †	Striped ¶ 1.35	8569-100 †	1.19
8487-1000	30.75	8514-100 †	Solid Color 1.74	8530-500 †	Striped ¶ 4.65	8569-1000†	7.05
8488-100	5.70	8514-1000†	Solid Color 12.10	8530-1000†	Striped ¶ 8.95	8570-100 †	1.11
8488-500	25.50	8514-100 †	Striped ¶ 1.86	8531-100 †	Solid Color 2.33	8570-1000†	6.60
8488-1000	51.00	8514-1000†	Striped ¶ 13.25	8531-500 †	Solid Color 9.60	8571-100 †	1.11
8489-100	7.15	8515-100 †	Solid Color 1.86	8531-1000†	Solid Color 18.60	8571-1000†	6.55
8489-250	15.75	8515-1000†	Solid Color 13.30	8535-100 †	Solid Color 3.20	8574-1000†	14.85
8489-500	31.50	8516-100 †	Solid Color 2.67	8535-1000†	Solid Color 22.75	8575-1000†	12.15
8489-1000	63.00	8516-1000†	Solid Color 20.95	8536-100 †	Solid Color 2.28	8576-1000†	11.35
8490	1.62	8516-100 †	Striped ¶ 2.79	8536-1000†	Solid Color 17.35	8577-1000†	11.05

BELDEN • PRICE LIST

Trade Number Length in ft.	Suggested Trade Price Each	Trade Number Length in ft.	Suggested Trade Price Each	Trade Number Length in ft.	Suggested Trade Price Each	Trade Number Length in ft.	Suggested Trade Price Each
8578-1000†	10.50	8652-50	1.98	8691-100	21.75	8742-1000	45.45
8580-100 †	34.50	8652-250	8.25	8691-500	99.00	8743-100	8.40
8580-500 †	150.00	8653-10	.80	8691-1000	198.00	8743-250	19.45
		8653-50	2.15	8692-100	31.50	8743-500	38.85
8581-100 †	27.15						
8581-500 †	125.40	8653-250	9.10	8692-500	150.00	8743-1000	77.70
8582-100 †	11.55	8654-10	.83	8692-1000	300.00	8744-100	12.00
8582-1000†	105.60	8654-50	2.31	8700-25	1.80	8744-250	28.15
		8654-250	9.90	8700-50	2.95	8744-500	56.25
8583-100 †	7.60						
8583-1000†	69.30	8655-10	2.97	8700-100	5.25	8744-1000	112.50
8584-100 †	5.70	8655-50	13.20	8700-250	12.15	8745-100	20.65
8584-1000†	44.55	8655-250	62.70	8701-100	2.45	8745-250	47.65
		8656-10	4.65	8701-500	8.55	8745-500	95.25
8585-100 †	3.30						
8585-1000†	25.50	8656-50	20.65	8701-1000	17.10	8745-1000	190.50
8586-100 †	2.81	8656-250	99.00	8718-500	69.00	8746S (Cut to customer's specified length maximum 1500')	349.50M'
8586-1000†	19.80	8657-10	6.30	8718-1000	138.00		10.45
		8657-50	28.05	8719-500	33.60	8747-100	10.45
8589-100	36.30						
8589-500	171.60	8658-10	8.25	8719-1000	67.20	8747-250	24.00
8590-100	23.95	8658-50	37.95	8720-500	52.50	8747-500	48.00
8590-500	112.20	8659-10	12.40	8720-1000	105.00	8747-1000	96.00
		8659-50	57.75	8722-500	30.75	8748-100	14.70
8591-100 †	11.55						
8591-1000†	103.95	8660-10	.75	8722-1000	61.50	8748-250	35.25
8597-100 †	1.35	8660-50	2.25	8723-100	5.85	8748-500	70.50
8597-1000†	8.50	8660-250	10.20	8723-500	25.90	8748-1000	141.00
		8661-10	1.05	8723-1000	51.75	8749-100	25.50
8598-100 †	1.37						
8598-1000†	9.30	8661-50	3.65	8724-250	13.00	8749-250	60.75
8599-100 †	1.62	8661-250•	16.80	8724-500	25.95	8749-500	121.50
8599-1000†	11.70	8662-10	2.45	8724-1000	51.90	8749-1000	243.00
		8662-50	10.75	8725-500	117.75		
8601	1.14						
8602	1.73	8662-250•	52.00	8725-1000	235.50	8750S (Cut to customer's specified length maximum 1500')	462.00M'
8603	1.76	8663-10	1.13	8726-100	18.15		
8604	2.70	8663-50	3.80	8726-500	83.25	8751S (Cut to customer's specified length maximum 1500')	943.50M'
		8663-250	17.85	8726-1000	166.50		
8605	1.47						
8618-500	43.90	8664-10	.90	8727-100	37.20	8752S (Cut to customer's specified length maximum 1500')	907.50M'
8618-1000	87.75	8664-50	2.64	8727-500	186.00		14.85
8619-500	157.50	8664-250	11.55	8727-1000	372.00	8753-100	14.85
		8668-10	1.07	8728-500	38.25		
8619-1000	315.00						
8620-100	11.55	8668-50	3.06	8728-1000	76.50	8753-250	35.65
8620-500	53.65	8668-250	13.35	8729-500	42.75	8753-500	71.25
8620-1000	107.25	8669-10	1.80	8729-1000	85.50	8753-1000	142.50
		8669-50	7.60	8730-500	32.65	8754-100	16.80
8621-100	19.65						
8621-500	87.75	8669-250•	36.30	8730-1000	65.25	8754-250	40.50
8621-1000	175.50	8670-10	3.65	8731-500	18.70	8754-500	81.00
8622-100	33.00	8670-50	16.50	8731-1000	37.35	8754-1000	162.00
		8670-250•	79.20	8732-100	6.55	8755-500	123.75
8622-500	153.00						
8622-1000	306.00	8671-10	2.73	8732-500	27.60	8755-1000	247.50
8623-100	46.50	8671-50	12.40	8732-1000	55.20	8756-500	145.50
8623-500	222.75	8671-250•	61.05	8733-100	6.55	8756-1000	291.00
		8672-10	1.98	8733-500	27.60	8757-500	28.90
8623-1000	445.50						
8624-100	56.10	8672-50	8.80	8733-1000	55.20	8757-1000	57.75
8624-500	264.00	8672-250•	39.60	8734-100	5.05	8758-100	4.70
8624-1000	528.00	8673-100	9.60	8734-500	21.00	8758-500	19.05
		8673-500	46.80	8734-1000	42.00	8758-1000	38.10
8627-100	19.80						
8627-500	90.75	8674-10	.68	8735-15	1.28	8759-100	5.05
8627-1000	181.50	8674-50	1.64	8735-50	3.25	8759-500	21.00
8628-100	34.65	8674-250	7.45	8735-100	5.70	8759-1000	42.00
		8675-100	7.45	8735-500	24.30	8760-250	12.60
8628-500	160.90					8760-500	24.00
8628-1000	321.75	8675-500	34.80	8735-1000	48.60	8760-1000	48.00
8629-100	56.10	8676-10	.62	8737-100	4.05	8761-500	15.60
8629-500	272.25	8676-50	1.13	8737-250	8.95	8761-1000	31.20
		8676-250	5.25	8737-500	17.85	8762-100	4.80
8629-1000	544.50						
8640-250	7.00	8677-100	5.65	8737-1000	35.70	8762-250	10.00
8640-500	13.15	8677-500	26.55	8738-1000	32.40	8762-500	19.90
8641-100	3.75	8678-100	14.55	8739-100	3.85	8762-1000	39.75
		8678-500	69.30	8739-500	16.20	8763-500	24.30
8641-500	15.00					8763-1000	48.60
8641-1000	30.00	8679-100	24.00	8739-1000	32.40	8764-100	27.25
8642-250	19.65	8680-100	21.45	8740-100	2.40	8764-250	66.40
8642-500	36.45	8681-100	13.80	8740-250	4.80		
		8682-100	6.75	8740-500	8.55		
8643-25	2.15						
8643-50	3.55	8683-100	4.80	8740-1000	17.10	8764-500	132.75
8643-100	6.30	8684-100	3.40	8741-100	4.05	8764-1000	265.50
8643-250	14.85	8685-100	2.60	8741-250	8.85	8765-100	32.25
		8688-100	12.00	8741-500	16.20	8765-250	78.40
8649-100	2.43						
8649-500	8.75	8689-100	6.15	8741-1000	32.40		
8649-1000	17.55	8690-100	11.10	8742-100	5.35		
8652-10	.77	8690-500	50.25	8742-250	12.00		
		8690-1000	100.50	8742-500	22.75		

BELDEN • PRICE LIST

Trade Number Length in ft.	Suggested Trade Price Each	Trade Number Length in ft.	Suggested Trade Price Each	Trade Number Length in ft.	Suggested Trade Price Each	Trade Number Length in ft.	Suggested Trade Price Each
8765-500	156.75	8783-100	6.45	8870-100	34.80	8916-100 †	4.05
8765-1000	313.50	8783-500	28.90	8871-25	40.50	8916-500 †	16.65
8766-100	43.50	8784-500	57.75	8871-100	162.00	8917-100 †	3.10
8766-250	105.00	8786-100	7.65	8873-1	.48	8917-500 †	12.30
8766-500	210.00	8786-500	34.50	8873-100	.31	8918-100 †	2.28
8766-1000	420.00	8787-500	69.00	8874	.68	8918-1000†	17.20
8767-100	9.90	8788-500	39.90	8875	.45	8919-100 †	1.86
8767-250	22.65	8789-500	27.90	8878	3.45 pr	8919-1000†	13.80
8767-500	45.30	8789-1000	55.80	8879	1.49 pr	8920-100 †	1.62
8767-1000	90.60	8790-100	6.25	8880-100 †	8.40	8920-1000†	10.95
8768-100	19.50	8790-250	13.35	8880-1000†	76.50	8933-100 †	5.20
8768-250	46.15	8790-500	26.70	8881-100 †	6.55	8933-500 †	22.20
8768-500	92.25	8790-1000	53.40	8881-1000†	58.50	8934-100 †	3.41
8768-1000	184.50	8791-100	7.65	8882-100 †	4.05	8934-500 †	14.25
8769-100	69.30	8791-500	34.05	8882-1000†	36.45	8935-100 †	2.76
8769-250	165.00	8791-1000	68.10	8883-100 †	3.41	8935-1000†	21.25
8769-500	330.00	8794-500	12.15	8883-1000†	28.20	8936-100 †	2.16
8769-1000	660.00	8794-1000	24.30	8884-100 †	5.55	8936-1000†	16.65
8770-500	30.40	8795-500	10.05	8884-1000†	48.00	8937-100 †	1.95
8770-1000	60.75	8795-1000	20.10	8885-15	1.13	8937-1000†	14.05
8771-250	9.85	8800	.83	8885-25	1.50	8950-100	4.30
8771-500	19.65	8816	6.72	8885-100	4.50	8950-1000	34.80
8771-1000	39.30	8817	.71	8885-500	21.00	8951-100	2.85
8772-500	24.75	8822	6.60	8886-100 †	3.90	8951-1000	23.55
8772-1000	49.50	8823	7.35	8886-1000†	34.05	8952-100 †	2.28
8773§ (Cut to customer's specified length maximum 1000')	999.00M'	8824	5.76	8887-100 †	3.25	8952-1000†	17.85
8774-100	33.00	8825	10.10	8887-1000†	27.60	8953-100 †	1.95
8774-250	78.40	8826	9.40	8888-25 †	1.29	8953-1000†	14.65
8774-500	156.75	8827	10.90	8888-100. †	3.41	8954-100 †	1.71
8774-1000	313.50	8850-100	9.90	8888-250 †	7.30	8954-1000†	12.15
8775-100	38.70	8851-100	8.10	8889-1	.45	8955-100	1.58
8775-250	93.40	8852-100	6.60	8889-100	.31	8955-1000	11.10
8775-500	186.75	8852-500	28.90	8890-25 †	.98	8956-100	4.45
8775-1000	373.50	8853-100	5.80	8890-100 †	2.45	8956-1000	40.50
8776-100	51.45	8853-1000	50.25	8890-500 †	10.20	8957-100	3.25
8776-250	124.50	8854-100	5.10	8892-100	5.55	8957-1000	29.25
8776-500	249.00	8854-1000	44.55	8892-500	22.65	8958-100 †	2.76
8776-1000	498.00	8855-100	4.95	8892-1000	45.30	8958-1000†	22.65
8777-100	11.40	8855-1000	41.25	8893-100	4.90	8959-100 †	2.43
8777-250	27.00	8858-100	10.35	8893-500	19.90	8959-1000†	19.50
8777-500	54.00	8858-1000	95.55	8893-1000	39.75	8960-100 †	2.28
8777-1000	108.00	8859-100	8.40	8894-100	7.00	8960-1000†	16.20
8778-100	22.50	8859-1000	75.30	8894-1000	61.50	8963-100	30.75
8778-250	55.30	8860-100	7.00	8895-1	.45	8963-500	147.75
8778-500	110.55	8860-1000	62.40	8895-100	.23	8964-100	24.45
8778-1000	221.10	8861-100	5.85	8896-100	4.90	8964-500	117.75
8779-500	36.00	8861-1000	50.25	8896-500	21.90	8965-100	9.25
8779-1000	72.00	8862-100	5.20	8896-1000	43.80	8965-1000	92.25
8780-100	7.65	8862-1000	46.95	8897-500	15.75	8966-100	7.00
8780-500	34.45	8863-100	4.65	8897-1000	31.50	8966-1000	69.75
8780-1000	68.85	8863-1000	41.25	8898-10 †	1.14	8967-100	4.30
8781-100	1.79	8866-25	1.95	8898-25 †	2.10	8967-1000	42.75
8781-500	5.25	8866-100	5.55	8898-100 †	5.40	8968-100	4.20
8781-1000	10.50	8866-500	23.40	8898-500 †	22.65	8968-1000	39.75
8782-25	.74	8868-25	1.19	8899-10 †	.81	8969-100 †	3.00
8782-50	1.11	8868-100	2.93	8899-14	.89	8969-1000†	26.70
8782-100	1.65	8868-500	11.35	8899-25 †	1.23	8970-100 †	2.67
8782-500	5.50	8869-25	1.02	8899-100 †	3.90	8970-1000†	21.90
8782-1000	10.95	8869-100	2.43	8899-500 †	14.05	8971-100 †	2.28
		8869-500	9.10	8899-1000†	28.10	8971-1000†	18.25

* New Item † Specify Color

ALL SPOOLS ARE ONE PIECE EXACT LENGTH. (EXCEPT SPOOLS WITH (*) FOOTNOTE)

• Spools may contain more than one piece, minimum length of any one piece is 25 ft.

When priced per M ft. length may vary ±10% from length shown; all other lengths are exact.

§ Cut to Customer's Specified Length subject to available stock lengths—minimum length 25'; 25' to 199', plus 25', minus 0; 200' or over, plus 50', minus 0.

▲ (Teflon Hook-up Wire) Prices apply to any striped color combination in quantities of 1000' or more. Minimum order 1000' per stripe color combination on 500' and 1000' spools only. Striping adders do not apply to braided tracers—Write for prices on non-stock tracer colors.

¶ (Vinyl Hook-up Wire) Prices apply to standard stock colors as listed in our current catalog and to non-stock striped colors over stock solid colors in quantities of 10,000' or more. Non-stock striped colors over stock solid colors in quantities of 1000' to 9999', add pro-rata set-up charge of \$4.50 per color combination. Minimum order 1000' per special stripe combination. Special stripe colors in any quantity will be subject to 2 piece put-up and plus or minus 10% per spool.

Prices Subject to Change Without Notice

COMPLETE CORDS

Reference
Bulletin C68P-1T
February 12, 1968

Trade Number	Single Lot Price Each	Trade Number	Single Lot Price Each	Trade Number	Single Lot Price Each	Trade Number	Single Lot Price Each
1706B	2.02	1714S	2.78	1725B	2.42	1735S	2.26
1706S	2.18	1715B	3.10	1725S	2.58	1775B	3.55
1709B	1.63	1715S	3.26	1734B	1.81	1775S	3.71
1709S	1.79	1724B	2.10	1734S	1.97	1780B	1.57
1714B	2.62	1724S	2.26	1735B	2.10	1780S	1.73

BELDEN • PRICE LIST

Trade Number	Single Lot Price Each	Trade Number	Single Lot Price Each	Trade Number	Single Lot Price Each	Trade Number	Single Lot Price Each
1782B	2.43	17238B	.74	17419S	1.25	17724C	1.01
1782S	2.59	17238S	.88	*17420B	1.11	17725B	.77
1785B	2.72	17239B	.64	17422B	1.38	17726C	1.10
1785S	2.88	17239S	.78	17422S	1.57	17727B †	.74
17106B †	.26	17249S	1.23	17425S	1.89	17727S □	.88
17106S †	.35	17258S	1.06	*17430B	1.59	17728B †	.74
17109B †	.30	17259S	.90	17447S	1.62	17728S □	.88
17109S †	.45	17260S	.82	17448S	1.92	17729B	.93
17112S †	.51	17270C	1.39	17449S	2.61	17730B	1.01
17116B	.27	17271C	1.58	17460S	1.30	17730S	1.17
17116S	.43	17272C	1.14	17461S	1.49	17756S	.93
17126B	.30	17273C	1.28	17462S	1.60	17806B	.37
17126S	.43	17274C	1.65	17475S	3.90	17806S	.46
17129S	.53	*17275C †	1.84	17476S	6.64	17826B	.45
17139B	.34	17288C	1.28	17477S	12.00	17826S	.56
17139S	.48	17290C	1.38	17491S	2.32	17836S	1.04
17140S	1.25	17291C	1.14	17492S	4.26	17852S	.46
17141S	1.25	17308B	.58	17493S	7.76	17856B	.48
17156S †	.46	17308S	.72	17494S	2.72	17856S	.61
17159S †	.53	17310B	.66	17495S	5.36	17857S	.66
17162S	.66	17310S	.82	17497S	9.60	17866B	.51
17165S †	.74	17328B	.69	17555S	3.12	17866S	.62
17177S	.85	17328S	.85	17556S	5.52	17870B	.64
17186B	.34	17330B	.82	17565S	6.40	17870S	.77
17186S	.48	17330S	.96	17566S	11.68	17876S	.77
17194S	2.61	17359B	.91	17629B	2.02	17886S	1.17
17195S	4.43	17361S	1.07	17629S	2.30	17887S	1.22
17205B †	.42	17370S	1.26	17635S	3.40	17888S	1.38
17205S ■	.56	17375S	2.91	17656S	2.26	17922	.32
17206B	.50	17405B	.62	17659S	2.78	17923S	.58
17206S	.66	17405S	.77	17662S	3.39	17925S	2.88
17220B †	1.25	17406B	.66	*17664S	8.00	17931S	.72
17220C †	1.20	17406S	.82	*17665S	14.08	17932S	2.48
17221C †	1.49	17407B	.72	17675S	8.08	17933S	3.60
17222C †	1.01	17407S	.86	17676S	14.32	17940S	16.75
17223C †	1.10	17408B	.78	17694S	5.70	17943S	27.84
*17230C †	1.35	17408S	.94	17695S	10.02	17945S	28.80
*17231C †	1.47	17409B	.86	17697S	18.32	17950S	4.56
17236B	.62	*17410B	1.04	17706B	.62	17995S	6.08
17236S	.76	17412B	1.14	17706S	.72	17996S	8.64
17237B	.54	17412S	1.30	17707B	.67	17998S	8.16
17237S	.69	17419B	1.07	17723C	1.01	17999S	11.04

* New Item † Specify Color ■ Black Only ‡ Gray Only □ Black/White Only

Reference Bulletin P68P-IT
March 11, 1968

PORTABLE CORDAGE

Trade Number & Standard Pkg. In Ft. 2S-250=2-250 Spis. 4S-250=4-250 Spis. C=Coil	Suggested Trade Net Per M Feet 250 to 999	Trade Number & Standard Pkg. In Ft. 2S-250=2-250 Spis. 4S-250=4-250 Spis. C=Coil	Suggested Trade Net Per M Feet 250 to 999	Trade Number & Standard Pkg. In Ft. 2S-250=2-250 Spis. 4S-250=4-250 Spis. C=Coil	Suggested Trade Net Per M Feet 250 to 999	Trade Number & Standard Pkg. In Ft. 2S-250=2-250 Spis. 4S-250=4-250 Spis. C=Coil	Suggested Trade Net Per M Feet 250 to 999
18100 C-250	382.40	18123 2S-250 †	41.12	18205 C-250	609.60	*18216 C-200	503.60
18101 C-250	276.16	18124 2S-250	167.44	18206 C-250	445.60	*18217 C-50	384.00
18102 C-250	193.60	18125 2S-250	119.20	18207 C-250	350.40	*18217 C-200	384.00
18103 2S-250	123.52	18126 2S-250 †	52.00	18208 C-250	217.20	18227 2S-250	89.76
18104 2S-250	105.76	18127 2S-250	63.20	18209 C-250	190.80	18228 2S-250	102.72
18105 C-250	478.40	18128 2S-250	87.68	*18210 C-50	859.20	18229 2S-250	108.48
18106 C-250	363.20	18129 2S-250	87.68	*18210 C-200	859.20	18230 2S-250	152.16
18107 C-250 †	270.08	18130 2S-250	124.96	*18211 C-50	1211.20	18314 2S-250	140.16
18108 C-250	170.80	18140 2S-250	61.28	*18211 C-200	1211.20	18316 2S-250	98.88
18109 C-250	146.08	18141 2S-250 †	80.48	*18213 C-25	1657.60	18318 2S-250	87.68
18110 2S-250	108.80	18142 2S-250 †	108.00	*18213 C-100	1657.60	18326 2S-250	74.32
18111 2S-250	79.52	18200 C-250	472.80	*18214 C-25	1165.60	18328 2S-250	59.04
18115 4S-250 †	37.28	18201 C-250	366.96	*18214 C-100	1165.60	18336 2S-250	87.84
18120 2S-250 †	60.56	18202 C-250	254.40	*18215 C-50	699.20	18338 2S-250	73.28
18121 2S-250 †	46.08	18203 2S-250	159.68	*18215 C-200	699.20		
18122 4S-250 †	31.84	18204 2S-250	138.96	*18216 C-50	503.60		

* New Item † Specify Color
Shipped only in standard packages as listed. Production quantities of special wires quoted on request.

Reference Bulletin HST-67P-IT REV.
July 17, 1967

Prices Subject to Change Without Notice

HEAT SHRINKABLE TUBING

Trade No.	Suggested Trade Price 4' Per Piece	Trade No.	Suggested Trade Price 6' Per Piece	Trade No.	Suggested Trade Price 6" Per Pkg.	Trade No.	Suggested Trade Price Per Spool
68002	.56	68041	4.15	68231	2.60	68534	16.41
68012	.59	68051	5.00	68241	2.90	68535	35.40
68022	.68	68061	6.25	68251	3.40	68543	4.80
68032	.72	68071	7.15	68261	4.50	68544	17.85
68042	.88	68081	8.30	68271	5.00	68545	39.10
68052	1.11	68091	5.00	68281	5.70	68553	5.53
68062	1.23	68101	8.00			68554	18.70
68072	1.40	68111	6.65	68205	Per Spool	68555	43.35
68082	1.87	68121	10.00	68215	36.55	68563	8.38
68092	2.62	68131	20.00	68235	7.31	68564	22.53
68102	3.93			68245	19.04	68573	6.93
68112	5.42	68202	.43	68255	23.12	68574	24.65
68122	8.60	68212	.46	68265	28.90	68583	8.76
68132	12.53	68232	.49	68275	16.07	68584	32.94
		68242	.56	68513	3.27	68593	9.35
		68252	.65	68514	10.75	68594	35.70
		68262	.77	68515	10.75	68603	15.30
		68272	.90	68523	12.84	68604	58.65
		68282	1.11	68524	12.84	68613	22.10
		68292	1.56	68525	28.26	68614	86.70
				68533	4.46		

BELDEN · PRICE LIST — TEFLON WIRES

Trade Number and Length in Ft.	Old Trade Number	Suggested Trade Price Ea.	Trade Number and Length in Ft.	Old Trade Number	Suggested Trade Price Ea.	Trade Number and Length in Ft.	Old Trade Number	Suggested Trade Price Ea.
83000-25†	8300	\$1.43	*83047-1000†▲	—	28.35M'	*83317-500●	—	487.50M'
83000-100†●	8300	3.60	*83048-100†●	—	4.75	*83317-1000●	—	487.50M'
83000-500†▲	8300	25.05M'	*83048-1000†▲	—	33.00M'	*83318-100●	—	63.00
83000-1000†●▲	8300	23.55M'	*83049-100†●	—	4.65	*83318-500●	—	517.50M'
83001-25†	8301	1.50	*83049-1000†●▲	—	32.40M'	*83318-1000●	—	517.50M'
83001-100†●	8301	3.75	*83050-100†●	—	4.80	*83319-100●	—	75.45
83001-500†▲	8301	26.40M'	*83050-1000†●▲	—	34.90M'	*83319-500●	—	622.50M'
83001-1000†●▲	8301	24.90M'	*83240-100● (RG-140/U)	—	66.00	*83319-1000●	—	622.50M'
83002-25†	8302	1.65	*83240-500● (RG-140/U)	—	619.50M'	*83320-100●	—	85.50
83002-100†●	8302	4.15	*83240-1000● (RG-140/U)	—	612.75M'	*83320-500●	—	705.00M'
83002-500†▲	8302	29.85M'	*83241-100● (RG-141A/U)	—	48.75	*83320-1000●	—	705.00M'
83002-1000†●▲	8302	28.35M'	*83241-500● (RG-141A/U)	—	456.00M'	*83321-100●	—	101.55
83003-25†	8303	1.88	*83241-1000● (RG-141A/U)	—	450.00M'	*83321-500●	—	840.00M'
83003-100†●	8303	5.20	*83242-100● (RG-142B/U)	—	60.00	*83321-1000●	—	840.00M'
83003-500†▲	8303	38.25M'	*83242-500● (RG-142B/U)	—	570.00M'	*83322-100●	—	135.00
83004-25†	8304	1.73	*83242-1000● (RG-142B/U)	—	564.00M'	*83322-500●	—	1110.00M'
83004-100†●	8304	4.35	*83243-100● (RG-143A/U)	—	177.00	*83322-1000●	—	1110.00M'
83004-500†▲	8304	31.50M'	*83243-500● (RG-143A/U)	—	1717.50M'	*83330-100●	—	65.50
83004-1000†●▲	8304	30.00M'	*83243-1000● (RG-143A/U)	—	1705.50M'	*83330-500●	—	540.00M'
83005-25†	8305	1.88	*83264-100● (RG-179B/U)	—	24.00	*83330-1000●	—	540.00M'
83005-100†●	8305	5.20	*83264-500● (RG-179B/U)	—	208.50M'	*83331-100●	—	70.50
83005-500†▲	8305	38.25M'	*83264-1000● (RG-179B/U)	—	204.00M'	*83331-500●	—	577.50M'
83005-1000†●▲	8305	36.75M'	83265-100● (RG-178B/U)	8265	13.90	*83331-1000●	—	577.50M'
83006-25†	8306	2.03	83265-500● (RG-178B/U)	8265	120.00M'	*83332-100●	—	75.00
83006-100†●	8306	5.70	83266-100● (RG-180B/U)	8266	31.50	*83332-500●	—	615.00M'
83006-500†▲	8306	43.00M'	83266-500● (RG-180B/U)	8266	291.00M'	*83332-1000●	—	615.00M'
83006-1000†●▲	8306	41.50M'	*83267-100● (RG-187A/U)	—	22.50	*83333-100●	—	84.75
83007-25†	8307	2.35	*83267-500● (RG-187A/U)	—	204.00M'	*83333-500●	—	697.50M'
83007-100†●	8307	6.90	*83267-1000● (RG-187A/U)	—	195.00M'	*83333-1000●	—	697.50M'
83007-500†▲	8307	51.00M'	83269-100● (RG-188A/U)	8269	22.50	*83334-100●	—	93.00
83007-1000†●▲	8307	49.50M'	83269-500● (RG-188A/U)	8269	204.00M'	*83334-500●	—	765.00M'
83008-25†	8308	2.18	83270-100● (RG-196A/U)	8270	16.80	*83334-1000●	—	765.00M'
83008-100†●	8308	6.30	83370-500● (RG-196A/U)	8270	142.50M'	*83335-100●	—	108.75
83008-500†▲	8308	47.70M'	*83281-100● (RG-302/U)	—	54.00	*83335-500●	—	900.00M'
83009-25†	8309	2.95	*83281-500● (RG-302/U)	—	510.00M'	*83335-1000●	—	900.00M'
83009-100†●	8309	9.30	*83281-1000● (RG-302/U)	—	504.00M'	*83336-100●	—	126.75
83009-500†▲	8309	72.75M'	*83282-100● (RG-303/U)	—	43.50	*83336-500●	—	1050.00M'
83009-1000†●▲	8309	71.25M'	*83282-500● (RG-303/U)	—	417.00M'	*83336-1000●	—	1050.00M'
83010-25†	8310	3.45	*83282-1000● (RG-303/U)	—	411.75M'	*83337-100●	—	163.50
83010-100†●	8310	11.55	*83283-100● (RG-304/U)	—	172.50	*83337-500●	—	1350.00M'
83010-500†▲	8310	91.05M'	*83283-500● (RG-304/U)	—	1522.50M'	*83337-1000●	—	1350.00M'
83010-1000†●▲	8310	89.55M'	*83283-1000● (RG-304/U)	—	1512.00M'	*83345-100●	—	77.55
83023-25†	8323	2.35	*83284-100● (RG-316/U)	—	22.50	*83345-500●	—	639.00M'
83023-100†●	8323	6.90	*83284-500● (RG-316/U)	—	199.50M'	*83345-1000●	—	639.00M'
83023-500†▲	8323	52.80M'	*83301-100●	—	195.00M'	*83346-100●	—	82.50
83025-25†	8325	2.40	*83301-500●	—	27.60	*83346-500●	—	682.50M'
83025-100†●	8325	7.20	*83301-1000●	—	223.50M'	*83346-1000●	—	682.50M'
83025-500†▲	8325	55.05M'	*83302-100●	—	28.65	*83347-100●	—	91.50
83026-25†	8326	2.55	*83302-500●	—	232.50M'	*83347-500●	—	757.50M'
83026-100†●	8326	7.90	*83302-1000●	—	232.50M'	*83347-1000●	—	757.50M'
83026-500†▲	8326	60.90M'	*83303-100●	—	33.30	*83348-100●	—	99.75
83026-1000†●▲	8326	59.40M'	*83303-500●	—	271.50M'	*83348-500●	—	825.00M'
83027-25†	8327	2.95	*83303-1000●	—	271.50M'	*83348-1000●	—	825.00M'
83027-100†●	8327	9.30	*83304-100●	—	37.20	*83349-100●	—	117.75
83027-500†▲	8327	72.40M'	*83304-500●	—	300.00M'	*83349-500●	—	975.00M'
83027-1000†●▲	8327	70.90M'	*83304-1000●	—	300.00M'	*83349-1000●	—	975.00M'
83028-25†	8328	2.80	*83305-100●	—	40.50	*83350-100●	—	138.75
83028-100†●	8328	8.70	*83305-500●	—	330.00M'	*83350-500●	—	1147.50M'
83028-500†▲	8328	67.50M'	*83305-1000●	—	330.00M'	*83350-1000●	—	1147.50M'
83029-25†	8329	3.75	*83306-100●	—	45.45	*83351-100●	—	149.25
83029-100†●	8329	12.60	*83306-500●	—	372.00M'	*83351-500●	—	1237.50M'
83029-500†▲	8329	99.75M'	*83306-1000●	—	372.00M'	*83351-1000●	—	1237.50M'
83029-1000†●▲	8329	98.25M'	*83307-100●	—	53.85	*83352-100●	—	204.00
83030-25†	8330	4.05	*83307-500●	—	442.50M'	*83352-500●	—	1695.00M'
83030-100†●	8330	14.05	*83307-1000●	—	442.50M'	*83390-25	8390	8.85
83030-500†▲	8330	112.00M'	*83308-100●	—	73.20	83390-100●	8390	33.00
83030-1000†●▲	8330	111.50M'	*83308-500●	—	600.00M'	83390-500●	8390	322.50M'
*83041-100†●	—	3.45	*83308-1000●	—	600.00M'	83391-25	8391	11.05
*83041-1000†●▲	—	23.25M'	*83315-100●	—	51.90	83391-100●	8391	42.00
*83043-100†●	—	3.55	*83315-500●	—	426.00M'	83391-500●	8391	411.00M'
*83043-1000†●▲	—	23.40M'	*83315-1000●	—	426.00M'	83392-25	8392	13.20
*83045-100†●	—	3.70	*83316-100●	—	54.75	83392-100●	8392	51.00
*83045-1000†●▲	—	24.60M'	*83316-500●	—	450.00M'	83392-500●	8392	498.00M'
*83046-100†●	—	4.00	*83316-1000●	—	450.00M'	83393-25	8393	10.50
*83046-1000†●▲	—	26.70M'	*83317-100●	—	59.25	83393-100●	8393	43.50
*83047-100†●	—	4.15				83393-500●	8393	420.00M'

* New Item † Specify Color ■ Trademark of Du Pont
 ● Spools may contain more than one piece, minimum length of any one piece is 25 feet. When priced per M feet, length may vary ±10% from length shown; all other lengths are exact.
 ▲ STRIPING ADDERS FOR TYPES E, EE, and ET: 1, 2 or 3 stripes. Minimum order 1,000 feet per stripe combination.
 1,000' to 4,999' add \$10.50/M' 5,000' to 24,999' add \$7.50/M' 25,000' to 49,999' add \$6.00/M' 50,000' and Over add \$4.50/M'
 AGGREGATION: Sizes, types and colors may be aggregated per order for striping adder quantity price. Prices Subject To Change Without Notice.

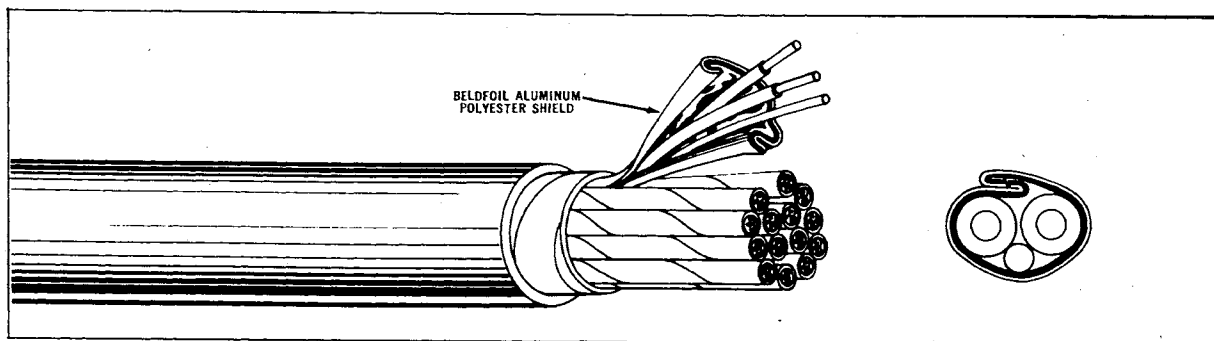

The Beldfoil ISO-Shield Story

Much of today's miniaturized, high-gain electronic equipment calls for small diameter cables that are lightweight, flexible and has total electrostatic shielding.

Wire braid and serve type shields have a practical range up to 97 percent maximum coverage. While they provide sufficient electrostatic shielding for many applications, they do not furnish the full-coverage shielding required by many high-gain electronic systems.

Beldfoil ISO-Shield provides 100 percent coverage and adds greater effectiveness to all major shielding functions: excluding external signals, confining the transmitted signal and minimizing crosstalk.

Beldfoil ISO-Shield uses a thin layer of aluminum bonded to a polyester film. The aluminum provides the necessary electrostatic shielding while the polyester film adds a bonus insulation and increased mechanical strength. The 100% shielding is accomplished by an exclusive

method of folding back both edges of the tape in such a way as to provide metal-to-metal contact between adjacent wraps, thus providing the same shielding effect as a continuous aluminum tube. As a direct result of using this thin layer of aluminum-polyester shielding, Beldfoil ISO-Shield is lightweight, flexible and small in diameter. Depending on the cable type the polyester film may be used to increase the dielectric strength between the conductors and the shield, or to provide insulation between adjacent shields.

Applications for Beldfoil ISO-Shield range from a single conductor audio and sound cable to complex multi-conductor multi-shield cables. They include cables for data processing systems, telemetering equipment, strain gauge applications, hi-fi systems, instrumentation, TV cameras and receivers, microphones and communications equipment plus many special constructions for both military and commercial use.

INDEX	Page
Aircraft Wire	29
Aluminum TV Grounding Wire.....	17
Amateur Transmission Twin Lead.....	16, 17
Antenna Rotor Cables.....	16, 17
Antenna Wire	15, 36
Audio Cables	3-11
Automotive Wire and Terminals.....	33-36
BELDSOL	14
Bonding and Shielding Cables.....	30
Broadcast Audio Cables.....	3, 4
Bus Bar Wire.....	30
Cathode Ray Tube Cables.....	23
CELLULINE	16
Cheater Cords	17
Citizens Band Antenna Cable.....	21
Coaxial Cables	21-23
Coiled Cords	13
Coin Operated Phonograph Cables.....	6
Community TV Antenna System Cables.....	21-23
Control Cables	11
Cords:	
Cheater Cords	17
Cordlites	46
Cord Reels	47
Extension Cords	42, 44, 46
Heater Appliance Cords.....	8, 39, 40
Power Supply Cords	40-43, 45
Range and Dryer Cords.....	46
Retractable Cords	13
Data Process Cables	8
Enamel Wire	14
Grid Wire	30

INDEX	Page
Grounding Wire	17
Heat Shrinkable Tubing.....	31, 32
Hi-Fi Connector Cable	18
High Voltage Cables.....	23
Hook-up Wire	24-30
Ignition Cable	24-30
Instrumentation Cable	3-8, 12, 19, 20, 53
Intercom Cables	3-11
Language Lab Cable	18
Lead-In Wire	15, 16
Litz Wire	14
Magnet Wire	14
Marine Wire	36
Microphone Cables	12, 13
Military Specifications:	
MIL-C-17	21-23, 37
MIL-W-76, Type LW, MW & HW.....	26-29
MIL-W-16878, Type B, C & D.....	24-26
MIL-W-16878, Type E & EE.....	26, 37, 54
MIL-W-5086	29
MIL-W-7078	29
JAN-C-17	21, 22
Multiple Conductor Cables.....	4-11
Multiple Set Antenna Cable.....	22
Parallel Lamp Cordage, SP-1 & SPT-1.....	18, 49
PERMOHM	15, 16
Phonograph Cable	6, 7
POLYETHERMALEZE	14
Portable Cordage	18, 48-50
Primary Wire:	
Aircraft	29
Automotive & Marine.....	33-36

INDEX	Page
Public Address Cables.....	3, 4, 6-8
Quads & Multiple Quads.....	5, 6
Retractable (Coiled) Mike Cables.....	13
Retractable (Coiled) Power Supply & Control Cables	13
Retractable (Coiled) Telephone Cords.....	13
RG/U Transmission Line Cables.....	21-23, 53
Rotor Cables	17
Shielded Intercom System Cables.....	3-9
Shielded Power Supply Cordage	12, 13
Shielding	30
Shrink Tubing	31-32
Sound System Cables.....	3-11
Spark Plug Wire.....	33, 34
Stereo Cables	18
SJ & SV Cord.....	18, 48, 49
SP-1 & SPT-1	18, 49
Strain Gauge Cables.....	5
Teflon Hook-up Wire.....	26, 37, 52
Teflon Cables	37
Telephone Cables	9-11, 13
Test Prod Wire	18
TV Camera Cables.....	19, 20
TV Grounding Wire	17
TV Power Supply Cord.....	17
TV Twin Lead.....	16
UL Type Cordage.....	18, 48-50
UL Type Lead Wire.....	30
Video Cable	20
WELDOHM	16

shielded sound and broadcast audio cables

Belden**COMMUNICATIONS CABLE**

Belden offers a complete line of Communications Cables to provide customers with the best all-around cable for every application requirement. Cables are available in a wide range of sizes, dimensions, shielding constructions and types of insulation. All Communications Cables are designed to protect the desired signal by eliminating or minimizing the interference of hum, noise and crosstalk.

SHIELDING: Because it affords such excellent protection, Beldfoil ISO-Shield is now being specified for many critical applications such as instrumentation systems, tracking station equipment, computer and data processing systems, audio, sound, strain gauge and control cables.

No other type of shield on the market surpasses Beldfoil Shield for full coverage and protection against radiation and penetration at audio and radio frequencies. Beldfoil's unique polyester-aluminum shielding provides 100% coverage.

Braided Copper Shields have high tensile strength and are very effective at audio and radio frequencies in flexing applications. Served Copper Shields usually provide more coverage than Braided Copper Shields; they're also easier to terminate. Both Braided and Served Copper Shields are recommended at audio frequencies.







INSULATIONS: Belden's Communications Cables are available in a variety of insulation materials, each having its own advantages depending upon the size requirements, environmental and electrical conditions dictated by the application.

Vinyl insulation resists flame, most solvents, oil, ozone and sunlight. It has a higher dielectric constant and capacitance than polyethylene. Therefore it is recommended for audio frequency applications. It is easy to strip.

Polyethylene insulation is lightweight and resists ozone. It has a low dielectric constant for low capacitance and provides low electrical loss and is recommended for audio and radio frequency applications. Like vinyl, polyethylene is easy to strip.

Polypropylene insulation provides excellent heat and abrasion resistance. It has a low dielectric constant with equally low capacitance. It is less flexible than polyethylene. Because it has excellent dielectric strength and mechanical ruggedness, polypropylene insulations are widely used for miniaturization applications. Even with low overall diameters, they permit very low loss. Recommended for audio and radio frequencies.

TWO CONDUCTOR SHIELDED CABLES

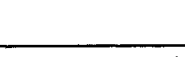
Description	Trade Number	AWG & (Stranding)	Insulation Thickness (Inch)	Jacket Thickness (Inch)	Nom. O.D. (Inch)	Cond. Color Coding	Percent Shield Coverage	Nom. *Cap. (mmf/ft)	Nom. **Cap. (mmf/ft)	Suggested Working Voltage	Standard Spool Lengths in ft
 With JACKET	8640	26 (Solid)	.002	.020	.089	Red, Clear	100	80	140	100	250, 500
 BELDFOIL®	Solid Copper, BELDSOL® (solderable—no stripping required) insulated BELDFOIL aluminum-polyester shield, 30 AWG solid tinned Copperweld ▲ ground drain wire, WHITE vinyl jacket. Maximum operating temperature 105° C. Ideal for Instrumentation and Audio Console Work where Subminiaturization is Required.										
 BELDFOIL® Miniature Broadcast Audio Cable	8450*	22 (Solid)	.006	.018	.118	Blk, Red	100	40	76	200	100, 250, 500, 1000
	8451*	22 (7x30)	.008	.020	.135	Blk, Red	100	34	67	200	100, 250, 500, 1000
 Broadcast Audio Cable	8437	22 (Solid)	.015	.025	.200	Blk, Red	88	48	85	200	500, 1000
	8441	22 (16x34)	.015	.025	.210	Blk, Red	88	49	86	200	100, 500, 1000
 BELDFOIL®	8641*	24 (7x32)	.014	.025	.160	Blk, Clear	100	22	42	350	100, 500, 1000
	8761*	22 (7x30)	.014	.025	.167	Blk, Clear	100	24	47	350	500, 1000
	8762*	20 (7x28)	.014	.028	.196	Blk, Clear	100	27	49	350	100, 250, 500, 1000
	8760*	18 (16x30)	.018	.028	.222	Blk, Clear	100	24	44	450	250, 500, 1000
 BELDFOIL®	8719	16 (19x29)	.025	.030	.274	Blk, Clear	100	24	47	600	500, 1000
	8720	14 (19x27)	.032	.035	.340	Blk, Clear	100	24	47	750	500, 1000
	*8718	12 (19x25)	.037	.040	.400	Blk, Clear	100	25	49	1000	500, 1000
 BELDFOIL®	Tinned copper polyethylene insulated, BELDFOIL aluminum-polyester shield, stranded tinned copper ground drain wire, (24 AWG for 8641, 22 AWG for 8761, and 20 AWG for 8760 and 8762, 18 AWG for 8719, 16 AWG for 8720, 14 AWG for 8718), chrome vinyl jacket.										
	8739	22 (Solid)	.015	.025	.160	Blk, Red	94.0	38	66	350	100, 500, 1000
	8737	22 (7x30)	.015	.025	.170	Blk, Red	89.3	40	70	350	100, 250, 500, 1000
	8759	20 (7x28)	.015	.025	.195	Blk, Red	81.0	47	79	350	100, 500, 1000
	8790	18 (7x26)	.020	.028	.231	Red, Wht	76.5	53	92	450	100, 250, 500, 1000
	8780	16 (19x29)	.023	.030	.266	Blk, Wht	84.1	57	98	450	100, 500, 1000
 BELDFOIL®	Tinned copper, vinyl insulated, tinned copper spiral wrapped shield, chrome vinyl jacket.										
	8208	18 (16x30)	.020	.025	.255	Red, Wht	69	46	77	200	100, 500, 1000
Tinned copper, rubber insulated, braided tinned copper shield, chrome vinyl jacket.											

*New Item

*Capacitance between conductors.



**Capacitance between 1 conductor and other conductor connected to shield.

▲Trademark of Copperweld Steel Co.

•Belden U.S.
Patent 3,032,604.

For underground burial recommendations of all types of vinyl, polyethylene, Hypalon and neoprene jacketed cables, please write for Bulletin #6 Electronic Wire Section.

Beldenshielded instrumentation, strain gauge
and communication cables**TWO CONDUCTOR SHIELDED CABLES (Cont'd)**

Description	Trade Number	AWG & (Stranding)	Insulation Thickness (Inch)	Jacket Thickness (Inch)	Nom. O.D. (Inch)	Cond. Color Coding	Percent Shield Coverage	Nom. *Cap. (mmf/ft)	Nom. **Cap. (mmf/ft)	Suggested Working Voltage	Standard Spool Lengths in ft.
 High Temperature	8390 TEFLON	22 (19x34)	.015	.015	.180	Blk, Wht	90	23	40	1000	25, 100, 500
	Stranded tinned copper, FEP teflon [®] insulated, cabled tinned copper braid shield, white FEP teflon jacket. +200° C maximum, -70° C minimum operating temperature. Ideal where chemical resistance is needed and/or extremely high or low temperatures are required.										
 Without JACKET	* 8393	20 (7x28)	.020	.030	.245	Blk, Red	100	22	42	1000	25, 100, 500
	Tinned copper FEP Teflon insulated, noise reducing tape, 20AWG (10x30) nickel coated copper drain wire, special Beldfoil shield, Silicone rubber jacket. +150° C maximum, -70° C minimum operating temperature. Jacket working voltage, 1000V DC, shield to ground.										
 Without JACKET	8738	22 (Solid)	.015	—	.130	Blk, Red	72.8	35	61	350	1000
	8758	20 (7x28)	.015	—	.165	Blk, Red	63.8	42	72	350	100, 500, 1000
	8789	18 (7x26)	.020	—	.204	Blk, Wht	74	50	89	450	500, 1000
	8779	16 (19x29)	.023	—	.225	Blk, Wht	83	63	112	600	500, 1000
Tinned copper, vinyl insulated, braided tinned copper shield.											

INSTRUMENTATION CABLES

Instrumentation cable provides the vital communications link between sensing devices and read-out equipment. Because of the many and diverse conditions of environment and stress under which instrumentation cables must transmit information — in usable form, without distortion or change — cable characteristics should always be carefully matched with the specific requirements of the particular application.



The scientific, medical and industrial uses of instrumentation cable are vast and ever growing. Some of the

common uses for instrumentation cable are such things as measuring pressure, speed, resistance and temperature.

Belden manufactures a wide variety of precision instrumentation wire using several types of insulating materials for conductors and shields to meet a wide variety of electrical, physical and thermal requirements.

Many Belden Instrumentation Cables are unique in the field and have been engineered for specific application problems.

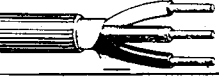
THREE CONDUCTOR SHIELDED

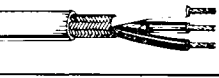
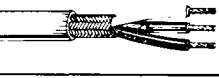
Description	Trade Number	AWG & (Stranding)	Insulation Thickness (Inch)	Jacket Thickness (Inch)	Nom. O.D. (Inch)	Cond. Color Coding	Percent Shield Coverage	Nom. *Cap. (mmf/ft)	Nom. **Cap. (mmf/ft)	Suggested Working Voltage	Standard Spool Lengths in ft.
 Without JACKET	8731	22 (Solid)	.015	.025	.178	Blk, Red, Wht	76.2	36	63	350	500, 1000
	8791	18 (7x26)	.020	.028	.236	Blk, Red, Wht	78.2	47	84	450	100, 500, 1000
Tinned copper, vinyl insulated, conductors cabled, tinned copper spiral wrapped shield, chrome vinyl jacket.											
 BELDFOIL [®]	* 8618	16 (19x29)	.025	.030	.300	Blk, Red, Wht	100	26	50	600	500, 1000
	8771	22 (7x30)	.014	.025	.175	Blk, Red, Clear	100	23	41	350	250, 500, 1000
	8772	20 (7x28)	.014	.028	.200	Blk, Red, Clear	100	27	51	350	500, 1000
	8770	18 (16x30)	.018	.028	.236	Blk, Red, Clear	100	24	48	450	500, 1000
Tinned copper, polyethylene insulated, conductors cabled, BELDFOIL [™] aluminum-polyester shield, stranded tinned copper ground drain wire (22 AWG for 8771, 20 AWG for 8770 and 8772, and 18 AWG for 8618), chrome vinyl jacket.											
 High Temperature	8735	22 (7x30)	.015	.025	.199	Blk, Red, Wht	70	34	60	350	15, 50, 100, 500, 1000
	Tinned copper, vinyl insulated, conductors cabled, tinned copper braid shield, chrome vinyl jacket.										
 High Temperature	8391 TEFLON	22 (19x34)	.015	.015	.190	Blk, Red, Wht	90	20	35	1000	25, 100, 500
	Stranded tinned copper, FEP teflon [®] insulated, cabled tinned copper braid shield, white FEP teflon jacket. +200° C maximum, -70° C minimum operating temperature. Ideal where chemical resistance is needed and/or extremely high or low temperatures are required.										
 Without JACKET	* 8643	30 (7x38)	.005	.010	.086	Blk, Red, Wht	95	25	43	200	25, 50, 100, 250
	Tinned copper, polypropylene insulated conductors cabled around textile strength member, tinned copper braid shield, chrome vinyl jacket. 105° C max. operating temperature.										

*New Item

*Capacitance between conductors.

**Capacitance between 1 conductor and other conductor connected to shield.







[®]Trademark of DuPont.

*Belden U.S. Patent 3,032,604.

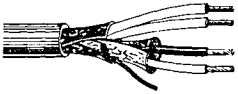
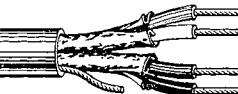
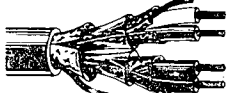
shielded instrumentation, strain gauge and communication cables

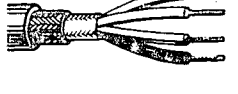
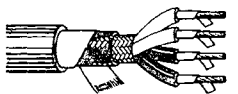
Belden

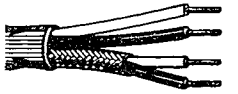
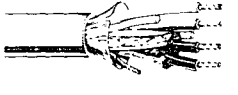
STRAIN GAUGE QUAD CABLES

Description	Trade Number	No. of Cond.	AWG & (Stranding)	Insulation Thickness (Inch)	Jacket Thickness (Inch)	Nom. O.D. (Inch)	Cond. Color Coding	Per- cent Shield Coverage	Nom. *Cap. (mmf/ ft)	Nom. **Cap. (mmf/ ft)	Sug- gested Working Voltage	Standard Spool Lengths in ft
 BELDFOIL®	8434	4	25 (7x33) 3 copper 4 copper-weld	.013	.020	.179	Red, Blk, Grn, Clear	100	25	40	400	100, 500, 1000
			Tinned copper, polyethylene insulated, black and red conductors under BELDFOIL aluminum-polyester shield, stranded ground wire, green and clear conductors under over-all BELDFOIL aluminum-polyester shield, chrome vinyl jacket. Pairs cabled on common axis to reduce diameter. ⊖									
 BELDFOIL®	8723	4	22 (7x30) copper	.008	.019	.165	Red, Blk, Grn, Wht	100	35	62	400	100, 500, 1000
			Tinned copper, polypropylene insulated, black and red under a BELDFOIL aluminum-polyester shield, Green and white under a BELDFOIL aluminum-polyester shield, stranded tinned copper drain wire, chrome vinyl jacket. Pairs cabled on common axis to reduce diameter. ⊖									
 BELDFOIL®	*8728	4	22 (7x30)	.008	.021	.188	Red, Blk, Grn, Wht	100	35	62	400	500, 1000
			Tinned copper, polypropylene insulated, cabled in pairs each pair BELDFOIL aluminum-polyester shielded with stranded copper drain wire, polyester film over each shield, overall BELDFOIL aluminum-polyester shield and stranded tinned copper drain wire, chrome vinyl jacket. Pairs cabled on common axis to reduce diameter. ⊖									
 BELDFOIL®	8729	4	22 (19x34)	.015	.050	.265	Clear, Blk, Red, Grn	100	22	42	600	500, 1000
			Tinned copper, polyethylene insulated, cabled BELDFOIL aluminum-polyester shield. 18 AWG stranded tinned copperweld ground drain wire, white vinyl jacket.									
 BELDFOIL®	8404	4	20 (26x34)	.015	.033	.255	Red, Blk, Grn, Clear	87	25	45	600	15, 100, 250, 500, 1000
			Tinned copper, polyethylene insulated, cabled, rayon braid, tinned copper braid shield, chrome vinyl jacket.									
 BELDFOIL®	8407	4	16 (65x34)	.032	.043	.422	Red, Blk, Grn, Wht	84	37	65	600	100, 250
			Tinned copper, separator, rubber insulated, cabled, rayon braid, tinned copper braid shield, cotton wrap, black neoprene jacket.									
 BELDFOIL®	8424	4	20 (26x34)	.020	.040	.295	Red, Blk, Grn, Wht	83.5	55	95	600	15, 50, 100, 250, 500, 1000
			Tinned copper, cotton wrap, rubber insulated, rayon braid, tinned copper braid shield, cotton wrap, black rubber jacket.									
 TEFLON	8392	4	22 (19x34)	.015	.015	.205	Red, Blk, Grn, Wht	90	20	35	1000	25, 100, 500
			Stranded tinned copper, FEP teflon [®] insulated, cabled tinned copper braid shield, white FEP teflon jacket. HIGH TEMPERATURE +200° C maximum, -70° C minimum operating temperature. Ideal where chemical resistance is needed and/or extremely high or low temperatures are required.									
 BELDFOIL®	8724	2 shielded 2 unshielded	22 (7x30) 22 (7x30)	.008 .008	.019	.165	Red, Blk, Grn, Wht	100	34	67	200	250, 500, 1000
	8722	2 shielded 2 unshielded	20 (7x28) 20 (7x28)	.015 .015	.028	.260	Red, Blk, Grn, Wht	100	60	99	350	500, 1000
			Tinned copper, 8722 vinyl insulated, 8724 polypropylene insulated, BELDFOIL aluminum-polyester shield over 2 conductors, stranded tinned copper ground drain wire (22 AWG for 8722 and 24 AWG for 8724), chrome vinyl jacket. Pairs cabled on common axis to reduce diameter. ⊖									
 BELDFOIL®	8732	2 shielded 2 unshielded	22 (7x30) 22 (7x30)	.015 .015	.030	.188x .296	Blk, Clear Blk, Clear	62	21	37	350	100, 500, 1000
			Tinned copper, polyethylene insulated, tinned copper braid shield over 1 pair, chrome vinyl jacket.									
 BELDFOIL®	*8730	2 shielded 2 unshielded	22 (7x30) 22 (7x30)	.008 .008	.030	.250	Red, Blk, Grn, Wht	100	34	67	200	500, 1000
			Tinned copper, polypropylene insulated, BELDFOIL aluminum-polyester shield over 1 pair with stranded tinned copper drain wire, chrome vinyl jacket. Pairs cabled on separate axes for reduced magnetic coupling.									

*New Item

*Capacitance between conductors.

**Capacitance between 1 conductor and other conductor connected to shield.

⊖Request information before planning high and low level circuits in same cable.

•Belden U.S. Patent 3,032,604.

■Trademark of DuPont





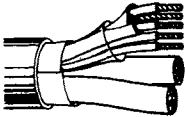
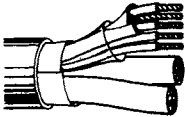

Belden

multi-purpose and special communication cables

MULTIPLE QUADS AUDIO AND COMMUNICATION CABLES

Description	Trade Number	No. of Cond.	AWG & (Stranding)	Cond. Color Coding	Insulation Thickness (Inch)	Jacket Thickness (Inch)	Nom. O.D. (Inch)	Percent Shield Coverage	Suggested Working Voltage	Nom. Cap. (mmf ft)	Nom. Cap. (mmf ft)	Standard Spool Lengths in ft.
	8726*	12 3 (QUADS)	22 (7x30)	Red, Blk, Grn, Wht	.008	.035	.330	100	200	34	67	100, 500, 1000
	<i>Cabled around common axis-request information before planning high and low level circuits in same cable</i>											
	8727*	28 (7 QUADS)	22 (7x30)	Red, Blk, Grn, Wht	.008	.040	.450	100	200	34	67	100, 500, 1000
	<i>Cabled around common axis-request information before planning high and low level circuits in same cable</i>											
BELDFOIL®												
<i>22 AWG tinned copper, polypropylene insulation, cabled in quads, BELDFOIL shield over black and red conductors, 24 AWG stranded tinned copper drain wire. Each quad is 8724 (on page 9) except for tape shield folding and a clear polyester tape instead of a vinyl jacket. Shields color coded, overall chrome vinyl jacket.</i>												

SPECIAL AUDIO AND COMMUNICATION CABLES

	8734	3 Conductors 1 shielded	22 (7x30)	Wht	.015	.025	.194	82	350	—	79	100, 500, 1000	
		2 unshielded	22 (7x30)	Blk, Red	.015	<i>Tinned copper, vinyl insulated, tinned copper braid shield over 1 conductor, 3 conductors cabled, chrome vinyl jacket.</i>							
	8763*	3 Conductors 2 shielded	20 (7x28)	Blk, Red	.014	.028	.210	100	350	26	48	500, 1000	
		1 unshielded	20 (7x28)	Clear	.014	<i>Tinned copper, polyethylene insulated, BELDFOIL aluminum-polyester shield over 2 conductors, #20 stranded tinned copper ground drain wire, chrome vinyl jacket.</i>							
	8733*	3 Conductors shielded	22 (7x30)	Blk, Red, Clear	.014	.030	.205	100	350	—	51	100, 500, 1000	
		<i>Tinned copper, polyethylene insulated, each conductor separately BELDFOIL aluminum-polyester shielded. Ground wire for each conductor is tinned cadmium bronze ribbon under BELDFOIL chrome vinyl jacket.</i>											
	8788*	5 Conductors 3 shielded	22 (7x30)	Blk, Red, Grn, Yel, Blue	.015	.028	.236	100	350	—	125	500	
		2 unshielded	<i>Tinned copper, vinyl insulated 3 conductors each separately BELDFOIL shielded, ground drain wire for each conductor is tinned cadmium bronze ribbon under BELDFOIL 2 conductors unshielded, cabled around a vinyl filler, chrome vinyl jacket.</i>										
	8783	3 Conductors 3 unshielded	1-20 (10x30) 2-16 (26x30)	Blue, Grn, Org	.020 .020	.025	.250	—	450	—	—	100, 500	
		<i>Tinned copper, vinyl insulated, conductors cabled, chrome vinyl jacket.</i>											
	8786*	6 Conductors 2 unshielded	22 (7x30)	Blu, Wht	.015	.028	.256	100	350	—	—	100, 500	
		4 shielded	24 (7x32)	Blk, Grn, Red, Yel	.015	<i>Tinned copper, vinyl insulated, 4 conductors twisted under BELDFOIL aluminum-polyester shield, 2 conductors unshielded, 22 AWG drain wire, chrome vinyl jacket.</i>							
	8787*	10 Conductors 4 shielded	24 (7x32)	Gry, Wht, Blu, Grn	.012	.030	.290	100	350	—	—	500	
		4 shielded 2 unshielded	24 (7x32) 22 (7x30)	Red, Brn, Yel, Org Wht, Blu	.012 .015	<i>Tinned copper, 22 AWG conductors vinyl insulated, 24 AWG conductors polyethylene insulated, cabled in 2 quads, each with transparent polyester tape wrap, 24 AWG tinned copper ground wire. Red BELDFOIL shield over one quad, green BELDFOIL shield over the other quad; plus 2 unshielded conductors, chrome vinyl jacket.</i>							

*Capacitance between conductors.

**Capacitance between 1 conductor and other conductor connected to shield.

•Belden U.S. Patent 3,032,604.

BELDEN PAGE 6

special audio and communication cable
audio cable selection guide



SPECIAL AUDIO AND COMMUNICATION CABLES

Description	Trade Number	No. of Cond.	AWG & (Stranding)	Cond. Color Coding	Insulation Thickness (Inch)	Jacket Thickness (Inch)	Nom. O.D. (Inch)	Percent Shield Coverage	Suggested Working Voltage	Nom. Cap. (mmf./ft)	Nom. **Cap. (mmf./ft)	Standard Spool Lengths in ft
	8784	10 un-shielded	2-16 (26x30) 1-20 (10x30) 7-22 (7x30)	Blk, Wht Gray Red, Grn, Org, Yel, Blu, Purple Brown	.016 .018 .013	.040	.295	—	300	—	—	500
<i>Tinned copper, vinyl insulated, conductors cabled, chromo vinyl jacket.</i>												
	8640	2	26 (Solid) 1 Pair	Red, Clear	.002	.020	.089	100	100	80	140	250, 500
	8642	6	26 (Solid) 3 Pair	Red, Clear	.002	.025	.140	100	100	80	140	250, 500

Solid copper, BELDSOL[®] (solderable—no stripping required), BELDFOIL aluminum-polyester shield on each pair, red, brown, orange textile marker and isolating polyester tape for each pair on 8642, Copperweld ground drain wire, WHITE vinyl jacket.

Ideal for instrumentation and audio console work where subminiaturization is required.
105° C maximum operating temperature.

*Capacitance between conductors.
**Capacitance between 1 conductor and other conductor connected to shield.

AUDIO CABLE SELECTION GUIDE

The length of cable run for a given wire size can be doubled if twice the power loss can be tolerated in the cable.

The next smaller size can be used when twice the power loss can be tolerated in the cable and the length of cable run remains the same.

To use this chart for constant voltage systems, determine the load impedance using Step 1 below. If this impedance does not appear on the chart, use Step 2 to determine the maximum length of cable run for each wire size.

The choice of appropriate audio cables for runs of varying distances depends on many factors such as amplifier voltage output and power level as well as load impedances and the percent of power loss which can be tolerated. For this reason it is not practical to provide a general chart showing the recommended wire size for all conditions. The chart shows the maximum recommended cable runs for various wire sizes selected for commonly encountered load impedances.

Wire Size (AWG)	Load Impedance (Ohms)					
	1 OHM	2 OHM	5 OHM	10 OHM	25 OHM	500 OHM
14	88	176	352	1045	2610	5220
16	55	110	220	630	1574	3150
18	35	70	140	410	1020	2050
20	22	44	88	262	655	1310
22	13	26	52	164	410	820
24	8	16	32	105	262	525

STEP ONE	$Z \text{ (Load Impedance)} = \frac{E^2 \text{ (Voltage} \times \text{Voltage)}}{P \text{ (Watts)}}$
STEP TWO	$\text{Ft. (Max.)} = \frac{\text{Ft. (chart)} \times Z \text{ (Load Impedance)}}{Z \text{ (chart)}}$
FOR EXAMPLE	<p>Find maximum length of run for #20 AWG pair in a 70 volt, 25 watt system.</p> <p>1. $Z = \frac{70 \times 70}{25} = 196 \text{ Ohms}$ 2. $\text{Ft. (max.)} = \frac{262 \times 196}{100} = 513 \text{ feet}$</p>

Belden

miniature coaxial and shielded paired instrumentation and sound cables

COLOR CODING FOR PAIRED CABLES

Pair Number	Color Combination	Pair Number	Color Combination	Pair Number	Color Combination
1	Black paired with Red	10	Red paired with Blue	19	White paired with Blue
2	Black paired with White	11	Red paired with Yellow	20	White paired with Yellow
3	Black paired with Green	12	Red paired with Brown	21	White paired with Brown
4	Black paired with Blue	13	Red paired with Orange	22	White paired with Orange
5	Black paired with Yellow	14	Green paired with White	23	Blue paired with Yellow
6	Black paired with Brown	15	Green paired with Blue	24	Blue paired with Brown
7	Black paired with Orange	16	Green paired with Yellow	25	Blue paired with Orange
8	Red paired with White	17	Green paired with Brown	26	Brown paired with Yellow
9	Red paired with Green	18	Green paired with Orange	27	Brown paired with Orange

MULTIPLE PAIR INDIVIDUALLY SHIELDED AUDIO AND SOUND CABLES

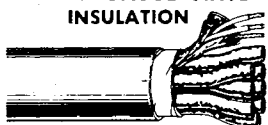
Description	Trade Number	No. of Pairs	Stranding	Insulation Thickness (Inch)	Jacket Thickness (Inch)	Nom. O.D. (Inch)	Nom. *Cap. (mmf ft)	Nom. **Cap. (mmf ft)	Standard Spool Lengths in ft
 22 GAUGE VINYL INSULATION	8767*	3	Solid	.013	.030	.270	40	77	100, 250, 500, 1000
	8768*	6	Solid	.013	.037	.394	40	77	100, 250, 500, 1000
	8764*	9	Solid	.013	.040	.440	40	77	100, 250, 500, 1000
	8765*	11	Solid	.013	.040	.485	40	77	100, 250, 500, 1000
	8766*	15	Solid	.013	.045	.540	40	77	100, 250, 500, 1000

BELDFOIL

#22 tinned copper, vinyl insulated, cabled in pairs, each pair and its ground wire under BELDFOIL[®] aluminum-polyester shield, over-all chrome vinyl jacket. 300 Volts suggested working voltage.

Vinyl insulation is used for ease of stripping and soldering. Recommended for audio frequency applications requiring excellent circuit isolation. Maximum operating temperature 80°C.

Insulation resistance between shields.....100 megohms/M'
Capacitance between adjacent shields.....115 mmf/ft
Voltage breakdown between adjacent shields.....1500 volts
Working voltage between adjacent shields.....50 volts

MULTIPLE PAIR INDIVIDUALLY SHIELDED AUDIO AND DATA CABLES

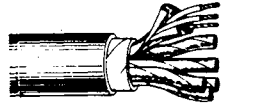
Description	Trade Number	No. of Pairs	Stranding	Insulation Thickness (Inch)	Jacket Thickness (Inch)	Nom. O.D. (Inch)	Nom. *Cap. (mmf ft)	Nom. **Cap. (mmf ft)	Standard Spool Lengths in ft
 22 GAUGE POLYPROPYLENE INSULATION	8777*	3	(7x30)	.010	.030	.270	30	55	100, 250, 500, 1000
	8778*	6	(7x30)	.010	.037	.394	30	55	100, 250, 500, 1000
	8774*	9	(7x30)	.010	.040	.440	30	55	100, 250, 500, 1000
	8775*	11	(7x30)	.010	.040	.485	30	55	100, 250, 500, 1000
	8776*	15	(7x30)	.010	.045	.540	30	55	100, 250, 500, 1000
	8769*	19	(7x30)	.010	.055	.620	30	55	100, 250, 500, 1000
	8773*	27	(7x30)	.010	.070	.760	30	55	§Cut to customer's specified length. Maximum length 1000

BELDFOIL

#22 gauge tinned copper, polypropylene insulated, cabled in pairs, each pair and its ground wire under BELDFOIL[®] aluminum-polyester shield, over-all chrome vinyl jacket. 300 volts suggested working voltage.

Recommended for audio, pulse, and radio frequency applications requiring superior circuit isolation. Polypropylene insulation is used for excellent high frequency properties and mechanical toughness. Maximum operating temperature 105°C.

Insulation resistance between shields.....100 megohms/M'
Capacitance between adjacent shields.....115 mmf/ft
Voltage breakdown between adjacent shields.....1500 volts
Working voltage between adjacent shields.....50 volts

SPECIAL INSTRUMENTATION CABLES

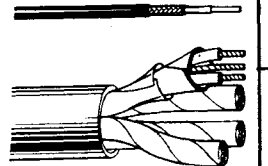
Description	Trade Number	AWG & (Stranding)	Insulation Thickness (Inch)	Jacket Thickness (Inch)	Nom. O.D. (Inch)	Cond. Color Coding	Percent Shield Coverage	Nom. *Cap. (mmf ft)	Nom. **Cap. (mmf ft)	Suggested Working Voltage	Standard Spool Lengths in ft
 BELDFOIL	8700	28 (Solid) Coaxial	.005	.008	.054	Black	80	48	—	100	25,50,100,250
	Solid tinned copper, polypropylene insulation, copper braid, black vinyl jacket. May be steam sterilized for medical research.										
	8725†	4 pairs 20 (7x28)	.015	.030	.360	Red, Blk Grn, Wht Wht/Red Wht/Blk Wht/Grn Wht/Yel	100	27	49	400	500 1000

Tinned copper conductors, polypropylene insulated, four groups of two conductors with #22 AWG drain wire. Each group individually BELDFOIL[®] shielded with polyester tape wrap, chrome vinyl jacket. 105°C Maximum operating temperature.

*Capacitance between conductors.

**Capacitance between 1 conductor and other conductor connected to shield.

•Belden U.S. Patent 3,032,604.

§Minimum length 25' 25' to 199', plus 25', minus 0. 200' or over, plus 50', minus 0.

†Cabled around common axis—request information before planning high and low level circuits in same cable.

○Color code is Western Regional Strain Gauge Committee.

unshielded paired sound cables

Belden**MULTIPLE PAIR UNSHIELDED SOUND CABLES**

TYPICAL APPLICATIONS: Balanced line sound systems.

Made with 80°C vinyl plastic compounds for high dielectric strength and the best physical properties, such as free stripping, small

diameter, and tear resistance. It also resists the effects of water, sun, oil, grease, and ozone. The conductors are paired with a short-lay twist for conductor balance, providing a quiet circuit, free from cross talk.

1 to 27 Pairs	Trade Number	No. of Pairs	AWG & Stranding	Insulation Thickness (Inch)	Jacket Thickness (Inch)	Nom. O. D. (Inch)	Suggested Working Voltage	Standard Spool Lengths in ft
ALL CONSTRUCTIONS: Tinned copper, vinyl insulated cabled in pairs, chrome vinyl jacket.	8740	1	22 Solid	.015	.025	.150	200	100, 250, 500, 1000
	8741	2	22 Solid	.015	.028	.201	200	100, 250, 500, 1000
	8742	3	22 Solid	.015	.030	.240	200	100, 250, 500, 1000
	8690	3	18 (16x30)	.018	.037	.362	400	100, 500, 1000
	8757	4	22 Solid	.015	.030	.255	200	500, 1000
	8743	6	22 Solid	.010	.035	.305	200	100, 250, 500, 1000
	8747	6	22 (7x30)	.010	.035	.340	200	100, 250, 500, 1000
	8691	6	18 (16x30)	.018	.045	.550	400	100, 500, 1000
	8744	9	22 Solid	.010	.037	.354	200	100, 250, 500, 1000
	8748	9	22 (7x30)	.010	.037	.389	200	100, 250, 500, 1000
	8692	9	18 (16x30)	.018	.055	.638	400	100, 500, 1000
	8753	11	22 Solid	.010	.037	.384	200	100, 250, 500, 1000
	8754	13	22 Solid	.010	.037	.409	200	100, 250, 500, 1000
	8745	15	22 Solid	.010	.040	.420	200	100, 250, 500, 1000
	8749	15	22 (7x30)	.010	.040	.425	200	100, 250, 500, 1000
	8755	19	22 Solid	.010	.040	.480	200	500, 1000
	8756	23	22 Solid	.010	.040	.510	200	500, 1000
	8746	27	22 Solid	.010	.045	.550	200	§Cut to customer's specified length. Maximum length 1500'
	8750	27	22 (7x30)	.010	.045	.595	200	§Cut to customer's specified length. Maximum length 1500'

For color coding please refer to page 12

38 AND 51 PAIR CABLE

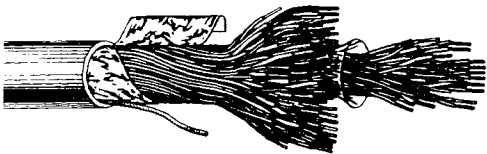
Description	Trade Number	No. of Pairs	Conductors	Insulation Thickness (Inch)	Jacket Thickness (Inch)	Nom. O. D. (Inch)	Standard Spool Lengths in ft
	8752	38	Solid Tinned Copper	.008	.045	.600	§Cut to customer's specified length. Maximum length 1500'
	8751	51	Solid Tinned Copper	.010	.050	.725	

§22 tinned copper, 8751 vinyl insulated, 8752 polypropylene insulated, cabled in pairs, BELDFOIL® aluminum-polyester shield over cabled pairs, #22 (7x30) stranded drain wire, chrome vinyl jacket. 200 Volts suggested working voltage. Color coding available on request.





§Minimum length 25'.
25' to 199', plus 25', minus 0.
200' or over, plus 50', minus 0.

For color coding information on 8751 and 8752 write for Technical Data

Belden

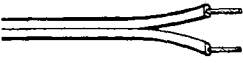

two and three conductor unshielded cables

TWO CONDUCTOR UNSHIELDED CABLES

Description	Trade Number	AWG & (Stranding)	Insulation Thickness (Inch)	Jacket Thickness (Inch)	Conductor Color Coding	Available Jacket Colors	Nominal O.D. (Inch)	Suggested Working Voltage	Standard Spool Lengths in ft
 Copper, vinyl insulated, PARALLEL	8781	22 (Solid)	.016	—	1 cond. tinned	Chrome	.060x .120	100	100, 500, 1000
	8782	24 (7x32)	.017	—	1 cond. tinned	Chrome, Sand, White, Clear	.058x .115	300	25, 50, 100, 500, 1000
	8649	20 (7x28)	.020	—	1 cond. tinned	Chrome, Clear	.073x .146	300	100, 500, 1000
Without JACKET  Copper, vinyl insulated, TWISTED.	8481	22 (Solid) bare	.015	—	Brn, Tan	—	.112	350	100, 500, 1000
	8482	19 (Solid) bare	.015	—	Brn, Tan	—	.130	350	100, 500, 1000
	8492	19 (Solid)	.025	—	Brown or White 1 cond. tinned	—	.170	600	1000
	8460	18 (7x26) tinned	.020	—	Blk, Wht	—	.175	450	100, 500, 1000
	8470	16 (19x29) tinned	.023	—	Blk, Wht	—	.195	600	500, 1000
With JACKET  SOLID  STRANDED Copper, vinyl insulated, CABLED, vinyl jacket	8740	22 (Solid) tinned	.015	.025	Blk, Red	Chrome	.150	200	100, 250, 500, 1000
	8442	22 (7x30) tinned	.015	.025	Blk, Red	Chrome	.165	350	500, 1000
	8205	20 (10x30) tinned	.018	.025	Blk, Red	Chrome	.190	350	100, 500, 1000
	8486	19 (Solid) bare	.015	.025	Brn, Tan	Chrome	.162	350	500, 1000
	8461	18 (7x26) tinned	.020	.028	Blk, Wht	Chrome	.226	450	100, 500, 1000
	8471	16 (19x29) tinned	.023	.030	Blk, Wht	Chrome	.256	600	500, 1000
	8473	14 (19x27) tinned	.031	.035	Blk, Wht	Chrome	.332	600	500, 1000
*8477	12 (19x25) tinned	.031	.040	Blk, Wht	Chrome	.384	600	500, 1000	

For additional 2 conductor cables see PORTABLE CORDAGE on pages 22, 52, 53 and 54. DUPLEX PRIMARY WIRE on page 40.

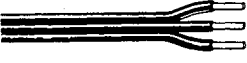
THREE CONDUCTOR UNSHIELDED CABLES

Description	Trade Number	AWG & (Stranding)	Insulation Thickness (Inch)	Jacket Thickness (Inch)	Conductor Color Coding	Nominal O.D. (Inch)	Suggested Working Voltage	Standard Spool Lengths in ft
 Copper, vinyl insulated, PARALLEL	8701	22 (Solid)	.016	—	Chrome 1 cond. tinned	.060x .190	100	100, 500, 1000
	8475	16 (19x29) bare	.023	—	Wht, Brn, Red	.102x .295	300	100, 500
Without JACKET  Bare copper, vinyl insulated, CABLED	8483	19 (Solid)	.015	—	Brn, Gray, Tan	.132	350	100, 500, 1000
With JACKET  Copper, vinyl insulated, CABLED, chrome vinyl jacket.	8443	22 (7x30) tinned	.010	.025	Blk, Grn, Red	.150	200	25, 100, 250, 500, 1000
	8487	19 (Solid) bare	.015	.025	Brn, Gray, Tan	.180	350	500, 1000



*New Item.

For additional 3 conductor cables see PORTABLE CORDAGE on pages 22, 52, and 53.

multiple unshielded cables
and telephone cables

Belden

MULTIPLE CONDUCTOR CONTROL AND AUDIO CABLES (NOT PAIRED)

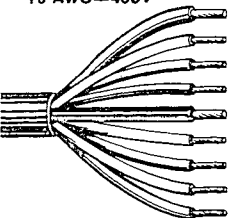
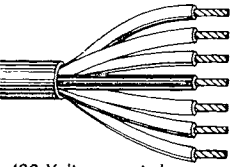
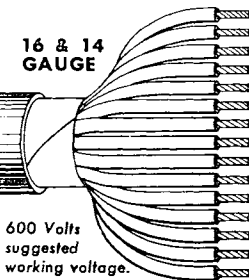
Description and Gauge	Trade Number	No. of Cond.	AWG & (Stranding)	Insulation Thickness (Inch)	Jacket Thickness (Inch)	Nom. O.D. (Inch)	Color Code or Chart No.	Standard Spool Lengths in ft.
 Telephone Cable Bare copper, polyethylene insulated, cabled, rose gray vinyl jacket.	8795	2	22 (Solid)	.016	.022	.160	Red, Grn	500, 1000
	8794	3	22 (Solid)	.016	.022	.168	Red, Grn, Yel	500, 1000
All Constructions: Tinned copper, vinyl plastic insulated, cabled, chrome vinyl jacket. 22 GAUGE  COMBINATION GAUGES Suggested working voltage 22 AWG—200V 18 AWG—400V 	8443	3	22 (7x30)	.010	.025	.150	1	25, 100, 250, 500, 1000
	8444	4	22 (7x30)	.010	.025	.168	1	25, 100, 250, 500, 1000
	8445	5	22 (7x30)	.010	.025	.180	1	25, 100, 250, 500, 1000
	8456	10	22 (7x30)	.010	.030	.260	1	100, 500, 1000
	8457	12	22 (7x30)	.010	.030	.260	1	100, 500, 1000
	8458	15	22 (7x30)	.010	.040	.320	2	100, 500, 1000
	8459	25	22 (7x30)	.010	.040	.370	2	100, 500, 1000
	8446	6	4-22 (7x30) 2-18 (16x30)	.010 .018	.025	.222	1	15, 100, 250, 500, 1000
	8447	7	5-22 (7x30) 2-18 (16x30)	.010 .018	.028	.246	1	100, 250, 500, 1000
	8448	8	6-22 (7x30) 2-18 (16x30)	.010 .018	.028	.250	1	15, 100, 250, 500, 1000
18 GAUGE  400 Volts suggested working voltage.	*8489	4	18 (16x30)	.018	.030	.250	1	100, 250, 500, 1000
	8465	5	18 (16x30)	.018	.037	.286	1	100, 250, 500, 1000
	8467	7	18 (16x30)	.018	.037	.324	1	100, 250, 500, 1000
	8469	9	18 (16x30)	.018	.037	.379	1	100, 250, 500, 1000
	8466	12	18 (16x30)	.018	.040	.412	2	100, 250, 500, 1000
	8468	15	18 (16x30)	.018	.045	.490	2	100, 500, 1000
	*8619	19	18 (16x30)	.018	.045	.505	2	500, 1000
16 & 14 GAUGE  600 Volts suggested working voltage.	8620	4	16 (19x29)	.030	.045	.375	2	100, 500, 1000
	8621	7	16 (19x29)	.030	.045	.455	2	100, 500, 1000
	8622	12	16 (19x29)	.030	.060	.600	2	100, 500, 1000
	8623	15	16 (19x29)	.030	.060	.650	2	100, 500, 1000
	8624	19	16 (19x29)	.030	.065	.715	2	100, 500, 1000
	8627	4	14 (19x27)	.045	.045	.495	2	100, 500, 1000
	8628	7	14 (19x27)	.045	.060	.630	2	100, 500, 1000
8629	12	14 (19x27)	.045	.065	.770	2	100, 500, 1000	

COLOR CODE
Chart No. 1

*New Item.

Conductor	Color
1st	Black
2nd	Red
3rd	Green
4th	White
5th	Brown
6th	Blue
7th	Orange
8th	Yellow
9th	Purple
10th	Gray
11th	Pink
12th	Tan

18 Gauge conductors in cables 8446 through 8449 are Black and Red.

IPCEA COLOR CODE

(Insulated Power Cable Engineers Association)

Chart No. 2

Conductor	Color	Conductor	Color	Conductor	Color
1st	Black	9th	Green/Black	17th	White/Red
2nd	White	10th	Orange/Black	18th	Orange/Red
3rd	Red	11th	Blue/Black	19th	Blue/Red
4th	Green	12th	Black/White	20th	Red/Green
5th	Orange	13th	Red/White	21st	Orange/Green
6th	Blue	14th	Green/White	22nd	Blk/Wht/Red
7th	White/Black	15th	Blue/White	23rd	Wht/Blk/Red
8th	Red/Black	16th	Black/Red	24th	Red/Blk/Wht
				25th	Grn/Blk/Wht

Belden

microphone
and shielded power supply cables

MICROPHONE CABLES

Belden Microphone Cables are designed for flexible service at audio frequencies. They are used not only for microphones, but also for home entertainment equipment, instruments, tape recorders and shielded power supplies.

Shielded single conductor cables are used in high impedance systems, while multiple conductor cables are used in

low impedance applications.



All cables are precision-engineered and manufactured to transmit clear signals and to cancel out hum pick-up and crosstalk interference. They are designed to withstand the flexing and normal abuse of studio, laboratory and home usage.

RUBBER, HYPALON AND NEOPRENE MICROPHONE AND SHIELDED POWER SUPPLY CABLES

Description	Trade Number	No. of Cond.	AWG (Stranding)	Insulation Thickness (Inch)	Jacket Thickness (Inch)	Nom. O.D. (Inch)	Percent Shield Coverage	Suggested Working Voltage	Impedance (Ohms)	Nom. *Cap. (mmf/ft)	Nom. **Cap. (mmf/ft)	Standard Spool Lengths in ft	
 SINGLE CONDUCTOR	8410	1	25 (7x33)	.063	.025	.245	80	3000 DC	52	—	33	25, 50, 100, 250, 500	
	3 strands copper, 4 strands Copperweld tinned, cellulose yarn braid, rubber insulated, rayon braid, tinned copper braid shield, cellulose yarn wrap, black rubber jacket.												
 MINIATURE	8413	2	24 (45x40)	.019	.025	.190	100	300	—	38	71	15, 25, 50, 100, 250, 500	
	8406	3	24 (45x40)	.019	.025	.223	100	300	—	43	76	100, 250, 500	
Tinned cadmium bronze, cotton serve, rubber insulated, cabled with fillers, conductive textile serve, tinned copper braid shield, cotton serve, black rubber jacket.													
 MULTIPLE CONDUCTOR	8412	2	20 (26x34)	.020	.043	.268	84	600	—	42	68	25, 50, 100, 250, 500, 1000	
	*8402	2	20 (26x34)	.020	.040	.268	84	600	—	42	68	100, 250, 500	
	Brown Hypalon jacket.—Heavy Duty.												
	8428	2	18 (41x34)	.022	.038	.295	91	600	—	47	80	100, 500, 1000	
	Black neoprene jacket.—Heavy Duty												
	*8408	2	16 (65x34)	.032	.040	.385	84	600	—	32	56	100, 250, 500	
	Brown Hypalon jacket.—Heavy Duty												
	8423	3	20 (26x34)	.020	.040	.277	84	600	—	50	85	15, 50, 100, 250, 500, 1000	
8424	4	20 (26x34)	.020	.040	.295	83.5	600	—	55	95	15, 50, 100, 250, 500, 1000		
8407	4	16 (65x34)	.032	.043	.422	84	600	—	37	65	100, 250		
Black neoprene jacket.—Heavy Duty													
8425	5	20 (26x34)	.020	.040	.323	76	600	—	44	80	100, 250		
8426	6	20 (26x34)	.020	.040	.349	90	600	—	40	78	100, 250		
8427	7	20 (26x34)	.020	.043	.360	90	600	—	40	75	100, 250		
8418	8	20 (26x34)	.020	.043	.386	92	600	—	42	75	100, 250		

Tinned copper, cotton wrap, rubber insulated, rayon braid, tinned copper braid shield, cotton wrap, black rubber jacket.

VINYL MICROPHONE AND SHIELDED POWER SUPPLY CABLES

 SINGLE CONDUCTOR	8411	1	25 (7x33)	.020	.020	.144	72	3500	52	—	37	15, 25, 50, 100, 250, 500, 1000
	8401A	1	25 (7x33)	.043	.025	.200	74	5000	57	—	25	15, 25, 50, 100, 250, 500, 1000
3 strands copper, 4 strands Copperweld, tinned, cellulose yarn braid, polyethylene insulated, tinned copper braid shield, chrome vinyl jacket. See 8421 page 22 for spiral wrapped shield version of these cables. Recommended for Hi-Fi use.												
 MINIATURE	8420	2	24 (45x40)	.015	.020	.185	77	500	—	22	40	15, 25, 50, 100, 250, 500
	Tinned cadmium bronze, cotton wrap, polyethylene insulated, cabled with fillers, rayon braid, tinned copper braid shield, chrome vinyl jacket.											
 MULTIPLE CONDUCTOR	8422	2	22 (16x34)	.023	.023	.231	87	1000	—	18	32	15, 25, 50, 100, 250, 500, 1000
	8403	3	20 (26x34)	.015	.033	.244	89	600	—	25	45	15, 50, 100, 250, 500, 1000
	8404	4	20 (26x34)	.015	.033	.255	87	600	—	25	45	15, 100, 250, 500, 1000
	8405	5	20 (26x34)	.015	.035	.275	83	600	—	25	45	250, 500, 1000

Tinned copper, polyethylene insulated, cabled, rayon braid, tinned copper braid shield, chrome vinyl jacket.

RUBBER—HYPALON—NEOPRENE—PLASTIC

See page 17 for conductor color coding

▲See 8421 Page 22 for spiral wrapped shield version of 8401—Recommended for Hi-Fi use.

*Capacitance between conductors.

**Capacitance between 1 conductor and remaining conductors (if any) connected to shield.

PLASTIC CABLES RECOMMENDED FOR: Lower capacitance, lower loss, greater ozone and oil resistance, lighter weight, smaller diameter.
 RUBBER CABLES RECOMMENDED FOR: Greater abrasion and impact resistance, and extra limpness so cable will lie flat on stage or studio floor.
 NEOPRENE AND HYPALON CABLES RECOMMENDED FOR: Outside use, cold weather applications. Resistant to effects of sun, oil, and ozone.

retractile (coiled) cables and cords

Belden**COILED CORDS**

Retractile cords keep telephone and microphone cables from tangling and cluttering desk tops, communications consoles and the front seats of motor vehicles. Belden manufactures a full line of high quality retractile coiled cord products for a wide number of applications.

Belden retractile cables and cords are used for telephone equipment; ham and citizen band radios; hand and

desktop microphones; language lab equipment; musical instruments; mobile controls and mobile communications equipment and for a variety of assorted industrial applications.

The specially designed conductors and shields of Belden retractile cords are constructed to withstand rugged use and to minimize replacement frequency.

RETRACTILE (COILED) MICROPHONE CABLES

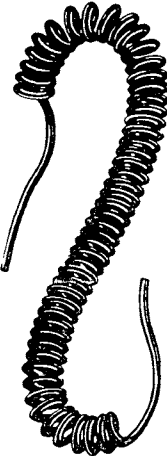
Description	Trade Number	No. of Cond.	AWG & (Stranding)	Insulation Thickness (Inch)	Jacket Thickness (Inch)	Nom. O.D. (Inch)	Nom. Coil O.D. (Inch)	Percent Shield Coverage	Nom. Cap. (mmf/cord)	Retracted Length (Inch)	Practical Extended Length (Feet)	Standard Put-Up
	8409	4 unshielded	28 (7x36)	.005	.050	.165	7/8	No shield	—	12	6	1
		<i>Tinned copper, nylon insulated, neoprene jacket.</i>										
	8415	4 unshielded	23 (21x36)	.020	.055	.250	7/8	No shield	—	11 1/2	6	1, 50
		<i>5 strands TCW, 16 strands TC rubber insulated, paper tape, neoprene jacket.</i>										
	8499	1 shielded	24 (45x40)	.019	.043	.160	1 1/8	80	285	7 1/2	4	1
		<i>Tinned cadmium bronze, rubber insulated, spiral TC shield, cotton wrap, neoprene jacket.</i>										
	*8605	1 shielded	24 (19x36)	.021	.042	.160	1 1/8	87	550	21 1/2	12	1
	<i>Tinned copper, polypropylene insulated, spiraled TC shield, Gray PVC jacket.</i>											
8497	3 1 shielded 2 unshielded	23 (21x36)	.020	.046	.250	7/8	100	480	11 1/2	6	1, 50	
	<i>5 strands, TCW, 16 strands TC, rubber insulated double BELDFOIL® aluminum polyester shield with drain wire same as conductors, paper tape, neoprene jacket.</i>											
8491	4 2 individually shielded 2 unshielded	23 (21x36)	.020	.050	.300	1 1/8	100	480	12	6	1	
	<i>5 strands, TCW, 16 strands TC, rubber insulated, double BELDFOIL® aluminum polyester shield with drain wire same as conductors, paper tape, neoprene jacket.</i>											
8490	5 unshielded	23 (21x36)	.020	.045	.265	7/8	No shield	—	11 1/2	6	1	
	<i>5 strands TCW, 16 strands TC, rubber insulated, paper tape, neoprene jacket.</i>											

NEOPRENE RETRACTILE (COILED) POWER CONTROL CABLES

Longer lengths are available on request.

Trade Number	No. of Cond.	Type	AWG & (Stranding)	Insulation Thickness (Inch)	Jacket Thickness (Inch)	Nom. O.D. (Inch)	Nom. Coil O.D. (Inch)	Percent Shield Coverage	Nom. Cap. (mmf/cord)	Retracted Length (Inch)	Practical Extended Length (Feet)	Standard Put-Up
8601	2	SVO	18 (41x34)	.016	.045	.270	1	12	6	1		
8602	3	SJO	18 (41x34)	.031	.045	.360	1 3/8	12	6	1		
8603	3	SJO	16 (65x34)	.031	.045	.370	1 1/2	12	6	1		
8604	3	SJO	16 (65x34)	.031	.045	.370	1 1/2	22	12	1		

Bare copper, paper wrap, rubber insulation, cabled with fillers, paper tape wrap, black neoprene jacket. 6" straight portion each end. Jacket removed 1 1/2" each end.

VINYL RETRACTILE (COILED) TELEPHONE CORDS

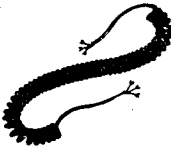
Description	Trade Number	No. of Cond.	AWG & (Stranding)	Insulation Thickness (Inch)	Jacket Thickness (Inch)	Nom. O.D. (Inch)	Nom. Coil O.D. (Inch)	Percent Shield Coverage	Nom. Cap. (mmf/cord)	Retracted Length (Inch)	Practical Extended Length (Feet)	Standard Put-Up
	8495	3	23 (21x36)	.020	.041	.220	7/8	10	4 1/2	1		
	8494	4	23 (21x36)	.020	.043	.245	7/8	10	4 1/2	1		

Bare cadmium bronze, vinyl insulated, cabled, paper wrapped, black vinyl jacket. 8494 one end stripped 7 3/4" spade terminals attached and hook strain relief clamped over jacket. Other and stripped 6 1/4" and spade terminals attached. 8495 one end stripped 2 3/4", spade terminals attached and hook strain relief clamped over jacket. Other end stripped 3 3/4" and spade terminals attached.

CONDUCTOR COLOR CODING

Color coding of individual conductors for cables on this page and microphone cables on page 16.

(1) White, (2) Black, (3) Red, (4) Green, (5) Blue, (6) Brown, (7) Yellow, (8) Orange.

*New Item

***Capacitance of shielded conductor.

Belden

hook-up wire kits, antenna wire, magnet wire and litz wire

KITS—HOOK-UP WIRE ON RACKS

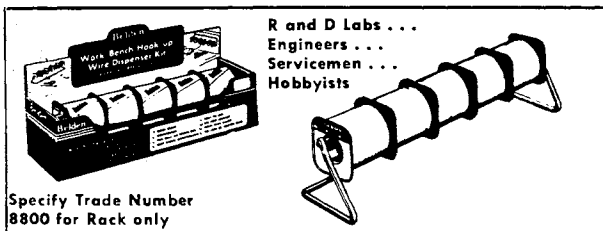

R and D Labs...
Engineers...
Servicemen...
Hobbyists

Specify Trade Number
8800 for Rack only

Trade Number	No. of Spools	Spool Lengths	Type of Wire	Colors in Kit
*8816	8	25'	18 Stranded vinyl (8522-25)	1, 2, 3, 4, 5, 6, 9, 10
8822	10	25'	20 solid, vinyl (8529-25)	1, 2, 3, 4, 5, 6, 7, 8, 9, 10
8823	5	100'	20 solid, vinyl (8529-100)	2, 5, 6, 9, 10
8824	8	25'	20 stranded, vinyl (8523-25)	1, 2, 3, 4, 5, 6, 9, 10
8825	5	100'	20 stranded, vinyl (8507-100)	9, 14, 15, 16, 17
8826	5	100'	22 stranded, vinyl (8508-100)	9, 14, 15, 16, 17
8827	5	100'	22 stranded, vinyl-nylon (8518-100)	2, 5, 6, 9, 10

See column below for color coding.

STOCK COLORS

First color in stripe combination is body color and second or third colors are stripes. (EXAMPLE: White/Black/Red.)

1. Brown	6 Light Blue	10 Black	14 White/Black
2 Red	7 Violet (purple)	11 Tan	15 White/Red
3 Orange	8 Gray (slate)	12 Pink	16 White/Green
4 Yellow	9 White	13 Dark Blue	17 White/Yellow
5 Green			

ANTENNA WIRE



Stranded bare copperweld

Trade Number	AWG & (Stranding)	Nom. O.D. (Inch)	Standard Spool Lengths in ft.
8002	16(7x24)	.060	50, 100
8000	14(7x22)	.076	50, 75, 100, 1000



Copper, Belden Heavy Poly-Thermaleze insulated.

Trade Number	AWG & (Stranding)	Nom. O.D. (Inch)	Standard Spool Lengths in ft.
8009	14(Solid)	.067	100, 150, 500
8008	12(Solid)	.084	100, 150, 500

RADIO ANTENNA WIRE



Tinned copperweld, weather-resistant brown polyethylene insulation.

Trade Number	AWG & (Stranding)	Insulation Thickness (Inch)	Nom. O.D. (Inch)	Standard Spool Lengths in ft.
8201	20(7x28)	.121	.278	100, 500, 1000

INDOOR ANTENNA WIRE



Tinned copper, chrome vinyl insulated.

Trade Number	AWG & (Stranding)	Insulation Thickness (Inch)	Nom. O.D. (Inch)	Standard Spool Lengths in ft.
8014	25(13x36)	.010	.044	25, 500

*New Item Licensed under U. S. Pat. 3,022,200 and patent pending



SINGLE BELDSOL® Solderable

BELDSOL Magnet Wire is a dual film insulated Magnet Wire that combines the excellent dielectric characteristics of Polyurethane and the known toughness and solvent resistance offered by an overcoat of nylon. This wire is rated by IEEE tests for 130°C usage and will solder without insulation removal at 750°F. Complies with Mil-W-583 specification.

Size	¼ Pound Spool		½ Pound Spool		Turns per Linear Inch	Turns per Square Inch
	Trade Number	Approx. Length (Feet)	Trade Number	Approx. Length (Feet)		
14			8047	40	15.2	231
16			8048	63	19.1	365
18			8049	100	23.9	571
20			8050	160	29.9	894
22			8051	254	37.5	1410
24			8052	404	46.9	2200
26			8053	645	59.0	3480
28	8040	510	8054	1020	73.8	5450
30	8041	807	8055	1615	91.7	8410
32	8042	1257	8056	2515	114.0	13000
34	8043	2030	8057	4060	144.0	20700
36	8044	3200	8058	6400	180.0	32400
38	8045	5070			225.0	50600
40	8046	8050			290.0	84100

BELDEN HEAVY POLY-THERMALEZE High Temperature

BELDEN POLY-THERMALEZE is a dual polyester film insulated Magnet Wire rated for 155°C usage and has exceptional ability to resist solvents and abuse in difficult windings. Complies with Mil-W-583 specification.

Size	½ Pound Spool		1 Pound Spool		Turns per Linear Inch	Turns per Square Inch
	Trade Number	Approx. Length (Feet)	Trade Number	Approx. Length (Feet)		
14	8059	40	8073	80	14.9	222
16	8060	63	8074	126	18.6	346
18	8061	100	8075	199	23.2	538
20	8062	157	8076	315	28.9	835
22	8063	250	8077	501	36.0	1296
24	8064	396	8078	793	44.7	1998
26	8065	630	8079	1260	55.7	3102
28	8066	995	8080	1990	69.4	4816
30	8067	1570	8081	3140	86.2	7430
32	8068	2440	8082	4880	106.0	11236
34	8069	3930	8083	7860	133.0	17689
36	8070	6200	8084	12400	167.0	27889
38	8071	9700	8085	19400	225.0	50600
40	8072	16050	8086	32100	290.0	84100

38 AWG & 40 AWG Single Polyester, Blue Color

LITZ WIRE

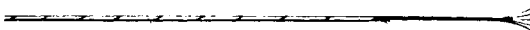

Copper, Celenamel® insulated, nylon wrap.

Trade Number	Stranding	Nom. O.D. (Inch)	Standard Spool Lengths in ft.
8817	5x44	.008	100

transmission line cables

Belden

Presenting Belden's

COLOR TWINS

Now, there's a Belden quality TV antenna wire just right for color and UHF TV reception in both congested and uncongested areas.

With today's strong emphasis on quality UHF and color TV programming and equipment, the importance of the transmission line connecting the outdoor antenna and TV receiver is critical. Until recently, there's been a big quality gap — a missing link — between the best engi-

neered color TV sets and the finest TV antennas.

Belden's Color Twins were specially engineered to provide color and black/white, UHF and VHF TV reception in congested close-in areas and uncongested fringe areas.

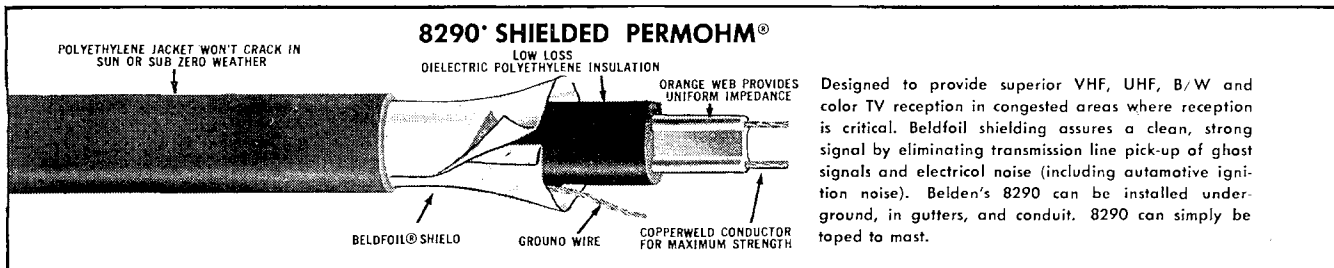

Designed to provide superior VHF, UHF, B/W and color TV reception in congested areas where reception is critical. Beldfoil shielding assures a clean, strong signal by eliminating transmission line pick-up of ghost signals and electrical noise (including automotive ignition noise). Belden's 8290 can be installed underground, in gutters, and conduit. 8290 can simply be taped to mast.

AWG & Stranding	Color	Nominal O.D. (Inch)	Nominal Velocity of Propagation	Nominal Capacitance (mmf/ft)	Nominal Attenuation per 100'		Std. Pkg. Length in ft.
					mc	db	
22 (7x30)	Brown	.305X .515	69.8%	7.8	57	1.7	50, 75, 100 coils have terminals attached
					85	2.1	
					177	3.2	
					213	3.5	available in counter dispenser
					473	5.4	
					671	6.6	
					887	7.7	250, 500 spool

Copperweld, 2 conductors, orange polyethylene insulation and web between conductors, cellular polyethylene oval insulation, Beldfoil[®] shield, stranded tinned drain wire, polyethylene jacket.

• Patent No. 2,782,251 and Patent Pending

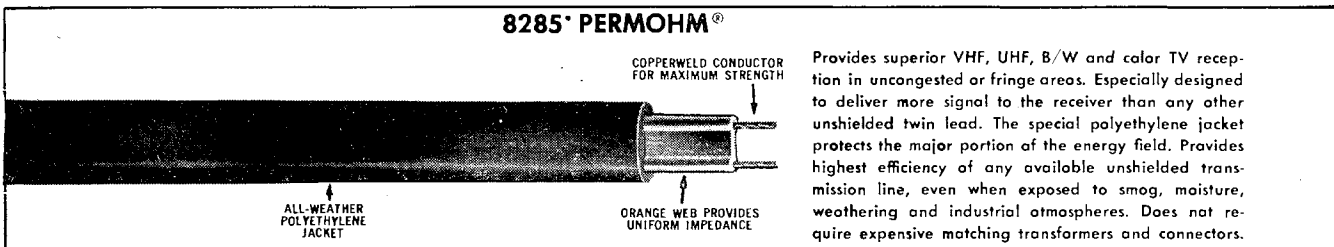

Provides superior VHF, UHF, B/W and color TV reception in uncongested or fringe areas. Especially designed to deliver more signal to the receiver than any other unshielded twin lead. The special polyethylene jacket protects the major portion of the energy field. Provides highest efficiency of any available unshielded transmission line, even when exposed to smog, moisture, weathering and industrial atmospheres. Does not require expensive matching transformers and connectors.

AWG & (Stranding)	Color	Nom. O.D. (Inch)	Nom. Velocity of Propagation	Nom. Capacitance (mmf ft)	Nom. Attenuation per 100'		Standard Package Lengths in ft.
					mc	db	
22 (7x30)	Brown	.255 x .468	73.3%	5.3	100	1.4	50, 75, 100 coils have terminals attached
					300	2.8	
					500	3.8	
					700	4.8	available in counter dispenser
					900	5.6	
							1000 spool

Copperweld, 2 conductors parallel, orange polyethylene insulation and web between conductors, cellular polyethylene oval jacket.

• Patent No. 2,782,251

TERMINALS

FOR 8290 SHIELDED PERMOHM AND 8285 PERMOHM

These terminals now offer an easy termination method for 8290 Shielded PermoHM and 8285 PermoHM for the antenna and TV set termination with

any simple crimping tool. They are the same terminals used on the 50, 75 and 100 ft. coils of 8290 and 8285.





Description	Trade Number	Screw Size	Length (Inch)	Width of Face (Inch)	Thickness of Stock (Inch)
	8190-98	Size 10	1	27/64	.030
	8191-98	Size 6	49/64	9/32	.030

Now available for the TV Serviceman and Dealer in individual "98 packets"

Belden

transmission line cables

TWIN LEAD WIRES (Cont'd)

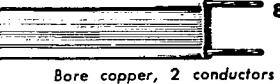
Description & Trade Number	AWG & (Stranding)	Color	Nom. O.D. (Inch)	Nom. Velocity of Propagation	Nom. Capacitance (mmf/ft.)	Nom. Attenuation per 100'		Standard Package Lengths in ft.
						mc	db	
 <p>Celluline® 8275</p> <p>Bore copperweld; 2 conductors parallel, polyethylene jacket with inert gas filled unicellular polyethylene core.</p>	20 (7x28)	Brown	.300 x .400	80%	4.6	100	1.05	50, 75, 100 coils in counter dispenser 250, 500 1000 spools
						200	1.64	
						300	2.12	
						400	2.5	
						500	2.98	
 <p>8235</p> <p>Bare copper, 2 conductors parallel, polyethylene insulated.</p>	18 (7x26)	Brown	.185 x .520	77%	5.0	100	.85	100 coil 500 spool
						200	1.35	
						300	1.80	
						400	2.20	
						500	2.60	
 <p>Weldohm® 8230</p> <p>Bare copperweld; 2 conductors parallel, polyethylene insulated.</p>	20 (7x28)	Brown	.072 x .400	80%	4.4	100	1.1	25, 50, 75, 100 pancake coils in a sleeve 250, 500 1000 spools T-1000 (tote-m pak)
						200	1.7	
						300	2.2	
						400	2.7	
						500	3.1	
 <p>8225</p> <p>Bare copper, 2 conductors parallel, polyethylene insulated.</p>	20 (7x28)	Brown	.058 x .400	80%	4.4	100	1.1	25, 50, 75, 100 pancake coils in a sleeve 250, 500 1000 spools T-1000 (tote-m pak)
						200	1.7	
						300	2.2	
						400	2.7	
						500	3.1	
 <p>8226</p> <p>Bare copper, 2 conductors parallel, polyethylene insulated.</p>	20 (7x28)	Ivory, Clear	.058 x .400	80%	4.4	Same as 8225		25, 50, 75, 100 pancake coils in a sleeve
						700	3.7	
						900	4.5	

CELLULINE maintains uniform electrical characteristics by eliminating all possible moisture between conductors. Installation is easier because no end-sealing is necessary. Losses are lower because of its lower dielectric constant (1.5).

The thick outer wall of brown polyethylene protects the cable from abrasion and sun damage; the round shape offers less wind resistance. The result is a longer lasting, more efficient line. Recommended for black and white VHF and local UHF reception.

Amateur transmitting and receiving twin lead—1 KW(RF) rated.

WELDOHM is 1 1/2 times STRONGER and has 2 1/2 times more FLEX LIFE than equivalent twin lead with all copper conductors, without changing the RF electrical characteristics. Tests prove its superior resistance to the pulling, whipping, and twisting that is so important to a long lasting installation.

Brown polyethylene for the best weathering.

For indoor use only

*Belden U.S. Patent No. 2,814,666

BELDEN MERCHANDISERS

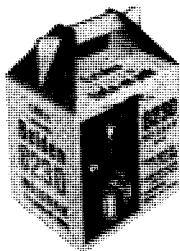

NEW! TOTE-M PAK*

A great new on the job convenience item for TV servicemen and installation crews! Disposable tote-m pak shipping carton has a built-in carrying handle for easy, on-the-job handling. Contains 1,000 ft. spool which feeds wire out through special opening (spool never has to be removed or handled).tote-m pak features convenient reminder footage chart.

8230 (Weldohm) and 8225 available in 1,000' spools only.

* Belden Trademark

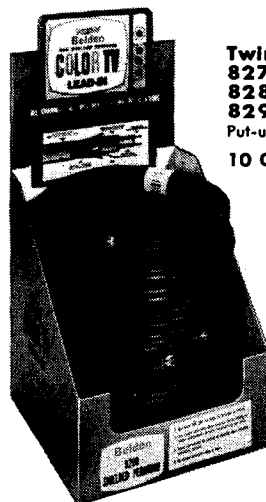

Twin Lead Coils
8275 (Celluline)
8285 (Permohm)
8290 (Shielded Permohm)
 Put-ups 50', 75', 100'
10 Coils per box

WITH TERMINALS

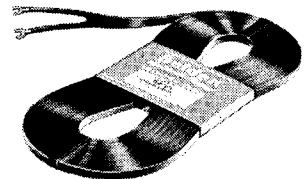

Twin Lead—10 Pancake Coils Per Box

8225
8226
8230 (Weldohm)
 Put-ups 25', 50', 75', 100'
Antenna Rotor Cables
8464 (4 conductor, flat)
 Put-ups 50', 75', 100'
8463 (5 conductor, flat)
 Put-ups 50', 75', 100'

transmission line cables
and antenna rotor cables



Belden

ALUMINUM GROUND WIRE

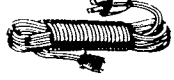

Packaged in counter dispensers of 10-50' connected coils, or spools of 500 ft. Wire on spools is marked every 100' for easy measuring.

Description	Trade Number	Nom. O.D. (Inch)	Standard Package Lengths in ft
 8 AWG solid, soft annealed aluminum	8018	.128	500' in 10'-50' connected coils 500' spools

TV AND CHEATER CORDS

Description	Trade Number	Length in ft.	Standard Package
CHEATER CORDS			
	8874	6	1 in polyethylene bag with description. SP-1 brown rubber parallel cord with male plug and TV connector.
	8895	6	1 in polyethylene bag with description. 100 bulk hanked.
	8889	9	SPT-1 brown rubber parallel cord with male plug and TV connector.
	8873	6	1 in polyethylene bag with description. 100 bulk hanked.
Polarized			SPT-1 brown plastic parallel cord with Polarized male plug and TV connector.
CHEATER EXTENSION CORD			
	8875	6	1 in polyethylene bag with description. SPT-1 red plastic parallel cord with male and female TV connectors.
Additional Cords Listed on Pages 42-51			

72 OHM TRANSMISSION LINE CABLES

Description	Trade Number	AWG & (Stranding)	Nom. O.D. (Inch)	Nom. Velocity of Propagation	Nom. Capacitance (mmf ft)	Nom. Attenuation per 100'		Standard Spool Lengths in ft
						mc	db	
 72 OHM LINE	8222	20 (7x28)	.075 x .128	70%	20.3	100 200 300 400	7.7 11.0 13.6 15.9	100, 500
			<i>Bare copper, 2 conductors parallel, brown polyethylene insulated.</i>					
 72 OHM 1 KW (RF) RATED	8210	13 (7x21)	.166 x .278	67%	21.0	100 200 300 400 500 700 900	3.8 6.0 7.8 9.3 11.0 13.7 16.0	100, 250
			<i>Bare copper, 2 conductors parallel, brown polyethylene insulated.</i>					

SHIELDED 100 OHM TRANSMISSION LINE

Description	Trade Number	AWG & (Stranding)	Nom. O.D. (Inch)	Nom. Velocity of Propagation	Percent Shield Coverage	Nom. Capacitance (mmf ft)	Nom. Attenuation per 100'		Standard Spool Lengths in ft
							mc	db	
 SHIELDED 100 OHM TRANSMISSION LINE	8227	20 (7x28)	.325	62%	83	15.5	100 200 300 400	4.1 6.4 8.4 10.2	500

One conductor tinned, one bare copper, polyethylene insulated, cabled, polyethylene jacket, tinned copper braid shield, black vinyl jacket. This shielded transmission line offers low-loss signal transmission which remains unaffected by outside signals or noise fields. Recommended for RF applications requiring a cross-talk free, balanced operation.

ANTENNA ROTOR CABLE

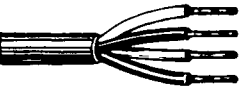

Description	Trade Number	No. of Cond.	AWG & (Stranding)	Cond. Coding	Insulation Thickness (Inch)	Jacket Thickness (Inch)	Nom. O.D. (Inch)	Suggested Working Voltage	Standard Package Lengths in ft
	8464	4	20 (7x28)	1 cond. tinned and insulation ribbed	—	—	.070 x .390	200	50, 75, 100 pancake coils 500, 1000 spools
			<i>Bare copper, parallel, chrome vinyl insulated.</i>						
	8463	5	20 (7x28)	1 cond. tinned	—	—	.070 x .375	200	50, 75, 100 pancake coils 500 spools
			<i>Bare copper, parallel, brown polyethylene insulated.</i>						
	8484	4	20 (7x28) bare copper	Blk, Grn, Red, Wht	.010	.020	.180	200	100, 500, 1000 spools
	*8489	4	18 (16x30) tinned copper	Blk, Wht, Red, Grn	.018	.030	.250	400	100, 250, 500 1000, spools
	8485	5	20 (7x28) bare copper	Blk, Grn, Red, Wht, Yel	.010	.020	.190	200	100, 500, 1000 spools
	8488	8	22 (7x30) bare copper	Blk, Blu, Brn, Grn, Org, Red, Wht, Yel	.010	.020	.205	200	100, 500, 1000 spools

Vinyl insulated, cabled, chrome vinyl jacket.
★ New Item

Belden

phonograph, hi-fi and stereo cables, language lab cable, portable cordage and test prod wire

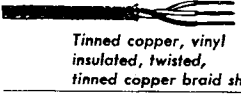
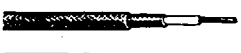
HI-FI AND STEREO CABLES

Description	Trade Number	No. of Cond.	AWG & (Stranding)	Insulation Thickness (Inch)	Jacket Thickness (Inch)	Nom. O.D. (Inch)	Cond. Color Coding	Nom. Cap. between condrs. (mmf/ft)	Nom. Cap. to other cond. & shield (mmf/ft)	Standard Spool Lengths in ft
 Phono Pick-Up Arm Cables	8430	2	32 (7x40)	.009	—	.050	Blk, Red	21	—	10, 25, 250
		4		Tinned copper, vinyl insulated, twisted pair. Use two 8430s for maximum channel isolation, one for each channel.						
 Tinned copper, vinyl insulated, twisted, tinned copper braid shield.	8429	2	32 (7x40)	.009	—	.057	Blk, Red	22	38	10, 25, 250
	8419	3	32 (7x40)	.009	—	.067	Blk, Red, Wht	30	50	10, 25, 250
		4		Use two 8429s for maximum channel isolation, one for each channel.						
 Hi-Fi Connecting Cable	8431	1	24 (16x36)	.015	—	.095	—	96	—	10, 15, 25 100, 500
				Tinned copper, rubber insulated, tinned copper braid shield, brown cotton braid.						
 Hi-Fi Connecting Cable	8421	1	25 (7x33)	.050	.025	.180	—	18	—	15, 25, 50, 100, 250
				3 strands tinned copper and 4 tinned Copperweld, cellular polyethylene insulated, tinned copper spiral wrapped shield, chrome vinyl jacket.						
 BELDFOIL [®] Miniature Audio Connecting Cable totally shielded	8417	1	25 (7x33)	.020	.026	.140	—	25	—	15, 25, 50, 100, 250
				3 strands tinned copper and 4 tinned Copperweld, cellular polyethylene insulated, double BELDFOIL aluminum-polyester shield, inner shield folded 26 AWG stranded tinned copper, ground drain wire, chrome vinyl jacket.						



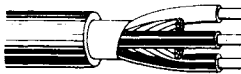

LANGUAGE LAB CABLE

 Dual Channel Audio Cable for head set, stereo and language labs	8416	2	25 (7x33)	.018	.020	.106 x .213	1 Clear 1 Red	35 each channel	—	15, 25, 50, 100, 250
				3 strands tinned copper and 4 tinned Copperweld, polyethylene insulated, individual tinned copper spiral wrapped shield, chrome vinyl jacket, polarity rib on red conductor.						

RUBBER-VINYL MULTI-CONDUCTOR PORTABLE CORDAGE

Description	Trade Number	U.L. Type	Insulation	No. of Conductors	AWG & (Stranding)	Insulation Thickness (Inch)	Conductor Coding	Jacket Thickness (Inch)	Nominal O.D. (Inch)	Color	Standard Spool Lengths in ft
	8462	SP-1	Rubber	2	18 (41x34) Tinned	.031	Polarity Ribbed	—	.123 x .223	Brown or Ivory	25, 100, 250
	8888	SPT-1	Vinyl	2	18 (41x34)	.031	Polarity Ribbed	—	.110 x .207	Brn, Ivory, or Gray	25, 100, 250
				Two conductors, stranded copper, parallel, insulated with one conductor polarity ribbed.							
 Stranded copper, rubber insulated, cabled with fillers, rubber jacket.	8452	SV	Rubber	2	18 (41x34)	.016	Blk, Wht	.031	.245	Black	25, 50, 100, 250, 500, 1000
	8478	SJ	Rubber	2	18 (41x34)	.031	Blk, Wht	.031	.298	Black	100, 250, 1000
	8472	SJ	Rubber	2	16 (65x34)	.031	Blk, Wht	.031	.325	Black	25, 100, 250
	8474	—	Rubber	2	14 (41x30)	.031	Blk, Wht	.035	.360	Black	100, 250
	8453	SV	Rubber	3	18 (41x34) Tinned	.016	Blk, Wht, Green	.031	.265	Black	50, 100, 500
	*8479	—	Rubber	3	14 (41x30)	.031	Blk, Wht, Green	.035	.380	Black	100, 250
	8454	—	Rubber	4	18 (41x34) Tinned	.016	Blk, Wht, Brn, Red	.031	.265	Black	50, 100, 500, 1000
	8455	—	Rubber	5	3—20 (26x34) 2—18 (41x34) Tinned	.015 .015	Brn, Grn, White Blk, Red	.031	.280	Black	100, 250

TEST PROD WIRE

Description	Trade Number	AWG & (Stranding)	Insulation Thickness (Inch)	Nom. O.D. (Inch)	Breakdown Voltage	Suggested Working Voltage	Standard Package	Standard Spool Lengths in ft.	
 Tinned copper, separator, rubber insulated, red or black.	8899	18 (65x36)	.045	.144	20,000	5,000	—	10, 14*, 25**, 100**, 500**, 1000	
			*7' of red and 7' of black. **Also available in blue, white, gray, green or yellow.						
	8897	18 (65x36)	.045	.144	20,000	5,000	—	500, 1000	
			Manufactured per MIL-W-13169						
 Miniature	8898	18 (65x36)	.088	.230	29,000	10,000	—	10, 25, 100, 500	
	8890	24 (45x40)	.019	.066	10,000	1,000	—	25, 100, 500	
 With Prods	8878	20 (42x36)	.063	.173	20,000	5,000	1 pair Red and Black	—	
			Stranded tinned copper rubber insulated with 4" long solderless threaded plastic "phone tip" test prod 3/8" diameter on one end and 1" long solderless threaded plastic "phone tip" test prod 3/8" diameter on the other end. 5 ft. in length retracts to 8 inches. Is recommended for use with multimeters.						
 Without Prods	8879	20 (42x36)	.063	.173	20,000	5,000	1 pair Red and Black	—	
			Tinned copper, rubber insulated, 5 ft. in length retracts to 8 inches.						

*New Item

†For intermittent duty only

©U.L. Type rating only: 300V-60°C

®Belden U.S. Patent 3,032,604.

All breakdown voltages and suggested working voltages are AC RMS values.

TV CAMERA CABLES

Belden TV Broadcast and Closed Circuit TV Camera Cables assure reliable circuit isolation thereby reducing a-c hum and minimizing crosstalk between circuits. They are made to withstand rugged service and to maintain high conductor insulation resistance regardless of ambient temperature changes.

Major uses for these cables are for controlling, powering and transmitting sound and picture information for

monochrome and color TV cameras as well as for remote control, monitor and cue line systems.

Belden TV Camera Cables are engineered to be lightweight, flexible and easy to terminate. They are manufactured and tested in accordance with Belden's own rigid and time-proven quality control standards in order to assure outstanding reliability, performance and service life.



Designed to meet the critical electrical and physical requirements necessary for color television broadcast applications.

Trade Number **8283**

82 Conductor TV Color Camera Cable

4-14 AWG (19x27) tinned copper, vinyl plastic insulated, color coded.
3-16 AWG (26x30) tinned copper, vinyl plastic insulated, color coded.

BELDFOIL[®] aluminum-polyester wrapped shield around the above 7 conductors cabled with stranded tinned copper drain wire.

8 coaxial cables. Nom. impedance 53.5 ohms, color coded.

67-22 AWG (7x30) tinned copper, vinyl plastic insulated, color coded, 7 under conductive textile shield with stranded ground wire.
Tinned copper braid shield.
Chrome vinyl plastic jacket. 1.22" Nom. O.D.
§Cut to customer's specified length.
Maximum length 1000'.



Trade Number **8280**

28 Conductor TV Camera Cable

4-18 AWG (16x30) tinned copper, vinyl insulated, color coded.
21-22 AWG (7x30) tinned copper, vinyl insulated, cabled in 3 groups of 7, color coded.
3 coaxial cables. Nom. impedance 51 ohms, color coded.

Tinned copper braid shield.
Chrome vinyl jacket. .750" Nom. O.D.
§Cut to customer's specified length.
Maximum length 1500'.

A smaller, lighter weight cable designed to make long runs easier. For black and white (Monochrome) systems.

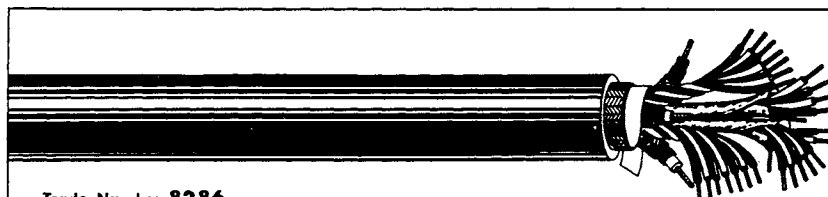

Trade Number **8286**

28 Conductor Hypalon & TV Camera Cable

4-18 AWG (16x30) tinned copper, vinyl insulated, color coded.
BELDFOIL aluminum-polyester wrapped shield around 4 conductors with stranded drain wire, polyester tape over this shielded group.
21-22 AWG (7x30) tinned copper, vinyl insulated, cabled in 3 groups of 7, color coded, one group of 7 has a BELDFOIL aluminum-polyester wrapped shield overall with a stranded drain wire, polyester tape over this shielded group.

3 coaxial cables. Nom. impedance 75 ohms.
Tinned copper braid shield.
Black Hypalon jacket. .730" O.D.
§Cut to customer's specified length.
Maximum length 1000'.

A 75 ohm cable designed to remain flexible in cold weather. Recommended for transistorized TV cameras.

§Minimum length 25'. 25' to 199', plus 25' minus 0. 200' or over, plus 50', minus 0.
®DuPont trademark.

Belden

tv camera cable and 75 ohm video cables

TV CAMERA CABLES

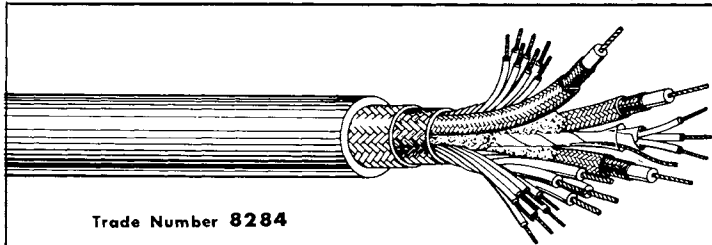

Trade Number **8284**

24 Conductor TV Camera Cable

17-22 AWG (7x30) tinned copper, vinyl insulated, color coded.
 3 under BELDFOIL shield with stranded drain wire.
 4-16 AWG (26x30) tinned copper, vinyl insulated, color coded.
 3 coaxial cables. Nom. impedance 53.5 ohms, color coded.

Designed specifically for color TV transmission. This cable incorporates circuit isolation assuring the reduction in AC hum level and cross talk essential for color TV broadcasting.

Tinned copper braid shield. Heavy cotton braid.
 Chrome vinyl plastic jacket. .800" Nom. O.D.
 §Cut to customer's specified length. Maximum length 1000'.



Trade Number **8282**

13 Conductor TV Eye Cable

8-22 AWG (7x30) tinned copper vinyl insulated, color coded.
 1-22 AWG (7x30) polyethylene insulated conductor.
 2-18 AWG (16x30) tinned copper conductor vinyl insulated.
 Black and Red.

1-RG-58A/U cable 50-ohm coax.
 1-72-ohm coax, stranded conductor, polyester tape wrapped.
 Chrome vinyl jacket. .470" Nom. O.D.
 §Cut to customer's specified length. Maximum length 2000'.



Especially engineered for TV Eye Cameras. Recommended for remote control, monitor and cue line applications.

§Minimum length 25'. 25' to 199', plus 25' minus 0. 200' or over, plus 50', minus 0.

75 OHM PRECISION VIDEO CABLE

TYPICAL APPLICATIONS: Video signal transmission in Color and Monochrome TV studios. Provides high quality carrier of video signal with superior picture definition and eliminates problems of periodicity. Cable is manufactured with rigid

control of concentricity and all dimensional tolerances. The black polyethylene jacket is inherently a non-contaminating, non-migratory compound. 100% SWEEP TESTED.

Description	Trade Number	AWG & (Stranding) Material	Nom. O.D. (Inch)	Percent Shield Coverage	Nom. Impedance (Ohms)	Nom. Velocity of Propagation	Nom. Cap. (mmf/ft)	Nom. Attenuation per 100		Standard Spool Lengths in ft.
								kc or mc	db	
	8281	20 (Solid) bare copper Conductor, polyethylene insulated, tinned copper double braid shield, black polyethylene jacket.	.304	96.4	75	66%	21.	10 KC 100 KC 1 MC 10 MC 100 MC	.06 .08 .25 .78 2.70	500, 1000
 Miniature	8279	23 (7x31) Tinned compacted conductor, polyethylene insulated, tinned copper braid shield, black polyethylene jacket. Fit RG59/U connectors.	.220	96	75	66%	21.	10 KC 100 KC 1 MC 10 MC 100 MC	.14 .15 .35 1.30 4.90	100, 250 500

Compacted conductor combines impedance uniformity of solid conductor and "nick-resistance" of stranded conductor.



For Use on 8281 Only











8299 Adapter for use with PL-259 connector. 25 in a box.



RG/U transmission line cables

Belden

COAXIAL CABLES***

Description	Trade Number	RG No.	AWG & (Stranding) Material	Insulation	No. of Shields & Material	Jacket	Nom. O.D. (Inch)	Nom. Imp. (Ohms)	Nom. Vel. of Prop.	Nom. Cap. (mmf/ft.)	Nom. Attenuation per 100' mc db		Standard Spool Lengths in ft.
	8264	5A/U JAN-C-17A	16 (Solid) silver coated copper	Polyethylene	2 silver-coated copper	Gray non-contaminating vinyl	.328	50	66%	30.8	100 200 400	2.40 3.50 5.25	500 1000
	8215	6A/U Type	21 (Solid) bare Copperweld	Polyethylene	2 bare copper	Black polyethylene	.332	75	66%	20.5	50 100 200 300 400	2.0 2.9 4.3 5.4 6.5	100, 500, 1000
			100% SWEEP TESTED										
	8237	8/U JAN-C-17A	13 (7x21) bare copper	Polyethylene	1 bare copper	Black vinyl	.405	52	66%	29.5	100 200 400	2.10 3.30 4.50	50, 100, 250, 500 1000
	8214	8/U Type	11 (7x19) bare copper	Cellular Polyethylene	1 bare copper	Black vinyl	.403	50	78%	26	50 100 200 300 400	1.20 1.80 2.60 3.30 3.80	50, 100 250 500 1000
	8242	9/U JAN-C-17A	13 (7x21) silver coated copper	Polyethylene	2 inner-silver-coated outer-bare copper	Gray non-contaminating vinyl	.420	51	66%	30.0	100 200 400	2.10 3.30 4.50	100 1000
	8243†	9B/U MIL-C-17D	13 (7x21) silver coated copper	Polyethylene	2 silver coated copper	Black non-contaminating vinyl	.420	50	66%	30.8	100 200 400	2.10 3.30 4.50	500 1000
	8238	11/U JAN-C-17A	18 (7x26) tinned copper	Polyethylene	1 bare copper	Black vinyl	.405	75	66%	20.5	100 200 400	1.90 2.85 4.35	100 250, 500 1000
	8213	11/U Type	14 (Solid) bare copper	Cellular Polyethylene	1 bare copper	Black polyethylene	.405	75	78%	17.3	50 100 200 300 400	1.0 1.5 2.3 2.9 3.4	500, 1000, 2000
			100% SWEEP TESTED										
	8261†	11A/U MIL-C-17D	18 (7x26) tinned copper	Polyethylene	1 bare copper	Black non-contaminating vinyl	.405	75	66%	20.5	100 200 400	1.90 2.85 4.35	100 500 1000
	8239	54A/U JAN-C-17A	18 (7x.0152) bare copper	Polyethylene	1 tinned copper	Clear polyethylene	.245	58	66%	26.5	100 200 400	3.10 4.40 6.70	500 1000
	8245	55/U JAN-C-17A	20 (Solid) bare copper	Polyethylene	2 tinned copper	Clear polyethylene	.201	53.5	66%	28.5	100 200 400	4.10 6.20 9.50	500 1000
	8240	58/U JAN-C-17A	20 (Solid) bare copper	Polyethylene	1 tinned copper	Black vinyl	.195	53.5	66%	28.5	100 200 400	4.10 6.20 9.50	25, 50, 100 250, 500 1000
	8219	58/AU Type	20 (19x32) tinned copper	Cellular Polyethylene	1 tinned copper	Black vinyl	.195	50	78%	26	50 100 200 300 400	3.6 4.8 7.6 8.5 10.1	100 500 1000









† Manufactured to current Government specifications and subsequent revisions.

***RG/U cables combine low capacitance and low attenuation. The virgin polyethylene insulation assures constant electrical characteristics regardless of changes in frequency or temperature. Note: Max. rating of polyethylene is 80°C (176°F).

Belden

RG/U transmission line cables

COAXIAL CABLES (Cont'd)

Description	Trade Number	RG No.	AWG & (Stranding) Material	Insulation	No. of Shields & Material	Jacket	Nom. O.D. (Inch)	Nom. Imp. (Ohms)	Nom. Vel. of Prop.	Nom. Cap. (mmf/ft.)	Nom. Attenuation per 100' mc db	Standard Spool Lengths in ft.	
	8259	58A/U JAN-C-17A	20 (19x.0071) tinned copper	Polyethylene	1 tinned copper	Black vinyl	.195	50	66%	30.8	100 200 400	5.30 8.20 12.60	25,50 100, 250 1000
	8262 ‡	58C/U MIL-C-17D	20 (19x.0071) tinned copper	Polyethylene	1 tinned copper	Black non-contaminating vinyl	.195	50	66%	30.8	100 200 400	5.30 8.20 12.60	500 1000
	8241	59/U JAN-C-17A	22 (Solid) bare Copperweld	Polyethylene	1 bare copper	Black vinyl	.242	73	66%	21.0	100 200 400	3.75 5.60 8.30	25, 50, 100, 250, 500, 1000
	8211	59/U Type 100% SWEEP TESTED	22 (Solid) bare Copperweld	Cellular Polyethylene	1 bare copper	Black Polyethylene	.242	75	78%	16.3	50 100 200 300 400	2.4 3.4 4.8 5.8 6.7	500, 1000, 2000
	8212	59/U Type 100% SWEEP TESTED	20 (Solid) bare Copperweld	Cellular Polyethylene	1 bare copper	Black Polyethylene	.242	75	78%	17.3	50 100 200 300 400	2.3 3.2 4.5 5.5 6.3	500, 1000, 2000
	*8221	59/U Type 100% SWEEP TESTED	22 (Solid) bare Copperweld	Cellular Polyethylene	1 bare copper	Gray, White, Black vinyl	.242	75	78%	16.3	50 100 200 300 400	2.4 3.4 4.8 5.8 6.7	100, 500, 1000
	8263 ‡	59B/U MIL-C-17D	.023 (Solid) bare Copperweld	Polyethylene	1 bare copper	Black non-contaminating vinyl	.242	75	66%	20.5	100 200 400	3.75 5.60 8.30	500 1000
	8254	62/U JAN-C-17A	22 (Solid) bare Copperweld	Semi-solid Polyethylene	1 bare copper	Black vinyl	.242	93	84%	13.5	100 200 400	3.10 4.40 6.30	100 500 1000
	8255	62B/U MIL-C-17D	24 (7x32) bare Copperweld	Semi-solid Polyethylene	1 bare copper	Black non-contaminating vinyl	.242	93	84%	13.5	100 200 400	3.10 4.40 6.30	500 1000
	8257	71/U JAN-C-17A	22 (Solid) bare Copperweld	Semi-solid Polyethylene	2 tinned copper	Clear Polyethylene	.245	93	84%	13.5	100 200 400	3.10 4.40 6.30	500 1000
	8258 ‡	71B/U MIL-C-17D	22 (Solid) bare Copperweld	Semi-solid Polyethylene	2 tinned copper	Black polyethylene	.245	93	84%	13.5	100 200 400	3.10 4.40 6.30	500 1000
	8216	174/U MIL-C-17D	26 (7x34) bare Copperweld	Polyethylene	1 tinned copper	Black vinyl	.100	50	66%	30.8	100 200 400	8.8 13.0 20.0	100 500 1000
	8265 ‡	178B/U MIL-C-17D	30 (7x38) Silver coated Copperweld	TFE TEFLON	1 Silver coated copper	Brown FEP TEFLON ■	.072	50	69.5%	29	400	29.0 Max.	100 500
	8266 ‡	180B/U MIL-C-17D	30 (7x38) Silver coated Copperweld	TFE TEFLON	1 Silver coated copper	Brown FEP TEFLON	.142	95	69.5%	15	400	17.0 Max.	100 500
	8269 ‡	188A/U MIL-C-17D	26 (7x.0067) Silver coated Copperweld	TFE TEFLON	1 Silver coated copper	White TFE TEFLON	.106	50	69.5%	29	400	20.0 Max.	100 500

★New Item

■Trademark of DuPont

‡ Manufactured to current Government specifications and subsequent revisions.





REQUEST QUOTATIONS ON PRODUCTION QUANTITIES OF RG/U CABLES NOT LISTED.

BELDEN PAGE 22

RG/U transmission line and High Voltage cables

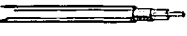
Belden

COAXIAL CABLES (Cont'd)

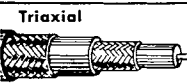
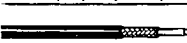
Description	Trade Number	RG No.	AWG & (Stranding) Material	Insulation	No. of Shields & Material	Jacket	Nom. O.D. (Inch)	Nom. Imp. (Ohms)	Nom. Vel. of Prop.	Nom. Cap. (mmf ft.)	Nom. Attenuation per 100' mc db	Standard Spool Lengths in ft.
	8270 †	196A/U MIL-C-17D	30 (7x38) Silver coated Copperweld	TFE TEFLON [■]	1 Silver coated copper	White TFE TEFLON [■]	.076	50	69.5%	29	400 29.0 Max.	100 500
	8267 ‡	213/U MIL-C-17D	13 (7x21) bare copper	Polyethylene	1 bare copper	Black non-contaminating vinyl	.405	50	66%	30.8	100 200 400 2.10 3.30 4.50	500 1000
	8268	214/U MIL-C-17D	13 (7x.0296) Silver coated copper	Polyethylene	2 Silver coated copper	Black non-contaminating vinyl	.425	50	66%	30.8	100 200 400 2.10 3.30 4.50	500 1000
	8218	—	27 (7x35) bare Copperweld	Polyethylene	1 tinned copper	Black vinyl	.150	75	66%	20.5	100 200 400 5.7 8.4 12.5	100 500 1000
 Triaxial Conductor, cellular polyethylene insulated, bare copper braid shield, polyethylene insulated, bare copper braid shield, black polyethylene jacket.	8232	59/U Type Double Shield 100% SWEEP TESTED	20 (Solid) bare Copperweld	Cellular Polyethylene	2 bare copper	Black Polyethylene	.315	75	78%	17.3	50 100 200 300 400 2.3 3.2 4.5 5.5 6.3	500,1000, 2000
	8233	11/U Type Double Shield 100% SWEEP TESTED	14 (Solid) bare copper	Cellular Polyethylene	2 bare copper	Black Polyethylene	.475	75	78%	17.3	50 100 200 300 400 1.0 1.5 2.3 2.9 3.4	500,1000, 2000
	8700 *	—	28 (Solid) tinned copper	Polypropylene	1 bare copper	Black vinyl	.054	32	66%	48	400 5.5	25, 50, 100, 250

■ Trademark of DuPont • 80 Percent shield coverage suggested working voltage 100

‡ Manufactured to current Government specifications and subsequent revisions.

REQUEST QUOTATIONS ON PRODUCTION QUANTITIES OF RG/U CABLES NOT LISTED.

HIGH VOLTAGE CABLES

Belden High Voltage Cables are designed for use by public utilities and laboratories in testing high voltage equipment and apparatus. Through their use, potentially dangerous conditions can be detected both before installation and at intervals during service.

Belden High Voltage Test Cables are engineered to achieve the best possible performance at continual rated voltages. Their special design incorporates the use of

conductive polyethylene over the center conductor, bonded to the polyethylene dielectric material. This provides uniform voltage stress distribution around the center conductor and results in an increased elimination of degradation due to internal corona.



For special cables up to 600 KVDC ratings, please ask for individual quotation.

HIGH VOLTAGE CATHODE-RAY TUBE LEAD

Description	Trade Number	AWG & (Stranding)	Insulation Thickness (Inch)	Jacket Thickness (Inch)	Nom. O.D. (Inch)	Jacket Color	Break-down Voltage	Suggested Working Voltage	Standard Spool Lengths in ft.
	8866	18 (41x34)	.057	.015	.208	Red	110,000	40,000	25, 100, 500
	8868	22 (7x30)	.045	.015	.150	Red	50,000	25,000	25, 100, 500
	8869	22 (7x30)	.030	.015	.120	Black	35,000	17,000	25, 100, 500

Tinned copper, conductive polyethylene, polyethylene insulated, vinyl jacket.

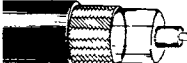
HIGH VOLTAGE CABLE

Description	Trade Number	AWG & (Stranding)	Insulation Thickness (Inch)	Jacket Thickness (Inch)	Nom. O.D. (Inch)	Jacket Color	Break-down Voltage	Suggested Working Voltage	Standard Spool Lengths in ft.
	8870	22 (Solid) Copperweld Solid Copperweld, conductive polyethylene, polyethylene insulation, tinned copper braid equipotential sheath, black polyethylene jacket.	.142	.020	.440	Black	160,000 D.C.	80,000 D.C.	100
	8871 *	16 (Braided) Tinned copper braid (CMA equivalent to 16 AWG) over solid polyethylene rod, black conductive polyethylene, clear polyethylene insulation, tinned copper braid, black polyethylene jacket.	.270	.025	.830	Black	400,000 D.C.	200,000 D.C.	25, 100

* New Item

Conductive polyethylene over inner conductor combined with a copper wire braid over the dielectric provides uniform distribution of voltage stress. Very high-voltage DC cable applied from 200 KVDC to 600 KVDC is available from Belden on special order. Consult Belden Engineering Department for AC or pulse applications.

Belden

 mil-w-16878 vinyl plastic

MILITARY SPECIFICATIONS PERTAINING TO BELDEN HOOK-UP WIRE

Belden's outstanding line of Hook-Up Wire represents a broad selection of quality products that meets the Military Specifications indicated on this and on the following pages.

Basically, from the customer's point of view, Military Specifications can be a helpful guide in determining specific information about cable construction, electrical limits and test data as an aid in comparing and selecting wiring products to meet the needs of specific applications.

The following Military Specifications cover the Belden Hook-Up Wire Products to be found in this catalog:

MIL-W-16878—Wire, Electrical, Insulated, High Temperature.

Covers insulated wire for the internal wiring of meters, panels, and electrical and electronic equipment at temperatures ranging from 105°C to 200°C. The many types available in different voltages and thermal ratings are listed on the following pages to meet your individual requirements.

MIL-W-76—Wire and Cable, Hook-Up, Electrical, Insulated.

Covers single conductor, plastic-insulated Hook-Up wire for the internal wiring of electrical and electronic equipment. The many types available in different voltages and outer covering are listed on the following pages to meet your individual requirements.

TYPE B—MIL-W-16878—VINYL—600V-105°C

Trade Number	Type Designation	AWG & (Stranding)	Insulation Thickness (Inch)	Nom. O.D. (Inch)	Stock Colors on Standard Spools		
					100'	500'	1000'
8599	B-32	32 (7x40)	.010	.029	1 thru 10	—	1 thru 10
8598	B-30	30 (7x38)	.010	.032	1 thru 10	—	1 thru 10
8597	B-28	28 (7x36)	.010	.035	1 thru 10	—	1 thru 10
8505	B-26	26 (7x34)	.010	.039	1 thru 10 14 thru 22	1 thru 10 —	1 thru 10 14 thru 22
8509	B-24	24 (19x36)	.010	.045	9, 14 thru 22	—	9, 14 thru 22
8504	B-24	24 (7x32)	.010	.044	1 thru 10 14 thru 22	1 thru 10 14 thru 22	1 thru 10 14 thru 22
8508	B-22	22 (19x34)	.010	.051	9, 14 thru 22	—	9, 14 thru 22
8503	B-22	22 (7x30)	.010	.050	1 thru 10 14 thru 22	1 thru 10 14 thru 22	1 thru 10 14 thru 22
8507	B-20	20 (19x32)	.010	.059	9, 14 thru 22	—	9, 14 thru 22
8502	B-20	20 (7x28)	.010	.058	1 thru 10 14 thru 22	1 thru 10 —	1 thru 10 14 thru 22
8501	B-18	18 (7x26)	.010	.068	1 thru 10 14 thru 22	1 thru 10 —	1 thru 10 14 thru 22
8500	B-16	16 (19x29)	.010	.077	1 thru 10 14 thru 22	1 thru 10 —	1 thru 10 14 thru 22

Tinned copper, vinyl insulated.

First color in stripe combination is body color and second or third colors are stripes. (EXAMPLE: White/Black/Red.)

TYPE B—MIL-W-16878—VINYL-NYLON JACKET—600V-115°C

Trade Number	Type Designation	AWG & (Stranding)	Insulation Thickness (Inch)	Nom. O.D. (Inch)	Stock Colors on Standard Spools	
					100'	1000'
8515	B-26	26 (7x34)	.010	.045	1 thru 10	1 thru 10
8519	B-24	24 (19x36)	.010	.051	1 thru 10	1 thru 10
8514	B-24	24 (7x32)	.010	.050	1 thru 10 14 thru 22	1 thru 10 14 thru 22
8518	B-22	22 (19x34)	.010	.057	1 thru 10	1 thru 10
8513	B-22	22 (7x30)	.010	.056	1 thru 10 14 thru 22	1 thru 10 14 thru 22
8517	B-20	20 (19x32)	.010	.065	1 thru 10 14 thru 22	1 thru 10 14 thru 22
8512	B-20	20 (7x28)	.010	.064	1 thru 10 14 thru 22	1 thru 10 14 thru 22
8516	B-18	18 (19x30)	.010	.075	9, 14 thru 22	9, 14 thru 22
8511	B-18	18 (7x26)	.010	.074	1 thru 10 14 thru 22	1 thru 10 14 thru 22
8510	B-16	16 (19x29)	.010	.083	1 thru 10 14 thru 22	1 thru 10 14 thru 22

Tinned copper, vinyl insulated, nylon jacket overall.

Manufactured to current Government specifications and subsequent revisions.

First color in stripe combination is body color and second or third colors are stripes. (EXAMPLE: White/Black/Red.)

STOCK COLORS

1 Brown	6 Light Blue	11 Tan	16 White/Green	21 White/Gray	26 White/Black/Blue
2 Red	7 Violet (purple)	12 Pink	17 White/Yellow	22 White/Violet	27 White/Black/Brown
3 Orange	8 Gray (slate)	13 Dark Blue	18 White/Blue	23 White/Black/Red	28 White/Black/Orange
4 Yellow	9 White	14 White/Black	19 White/Brown	24 White/Black/Green	29 White/Black/Gray
5 Green	10 Black	15 White/Red	20 White/Orange	25 White/Black/Yellow	30 White/Black/Violet

mil-w-16878 vinyl plastic

Belden**TYPE C—MIL-W-16878—VINYL—1000V-105°C**

Tinned copper, vinyl insulated.

Trade Number	Type Designation	AWG & (Stranding)	Insulation Thickness (Inch)	Nom. O.D. (Inch)	Temperature Rating	Stock Colors on Standard Spools	
						100'	1000'
8955	C-24	24 (7x32)	.018	.058	105C	9	9
8954	C-22	22 (7x30)	.018	.064	105C	1 thru 10	1 thru 10
8953	C-20	20 (7x28)	.018	.072	105C	1 thru 10	1 thru 10
8952	C-18	18 (7x26)	.018	.082	105C	1 thru 10	1 thru 10
8951	C-16	16 (19x29)	.018	.091	105C	9	9
8950	C-14	14 (19x27)	.018	.105	105C	9	9

TYPE C—MIL-W-16878—VINYL-NYLON—1000V-115°C

Tinned copper, vinyl insulated, nylon jacket overall.

8960	C-22	22 (7x30)	.018	.070	115C	1 thru 10	1 thru 10
8959	C-20	20 (7x28)	.018	.078	115C	1 thru 10	1 thru 10
8958	C-18	18 (7x26)	.018	.089	115C	1 thru 10	1 thru 10
8957	C-16	16 (19x29)	.018	.098	115C	9	9
8956	C-14	14 (19x27)	.018	.114	115C	9	9

TYPE D—MIL-W-16878—VINYL—3000V-105°C

Tinned copper, vinyl insulated.

Trade Number	Type Designation	AWG & (Stranding)	Insulation Thickness (Inch)	Nom. O.D. (Inch)	Stock Colors on Standard Spools		
					100'	500'	1000'
8971	D-22	22 (7x30)	.030	.090	1 thru 10	—	1 thru 10
8970	D-20	20 (7x28)	.030	.098	1 thru 10	—	1 thru 10
8969	D-18	18 (7x26)	.030	.108	1 thru 10	—	1 thru 10
8968	D-16	16 (19x29)	.030	.117	9	—	9
8967	D-14	14 (19x27)	.030	.131	9	—	9
8966	D-12	12 (19x25)	.035	.160	9	—	9
8965	D-10	10 (37x26)	.035	.178	9	—	9
8964	D-8	8 (133x29)	.040	.245	9	9	—
8963	D-6	6 (133x27)	.040	.290	9	9	—

First color in stripe combination is body color and second or third colors are stripes. (EXAMPLE: White/Black/Red.)

STOCK COLORS

1 Brown	6 Light Blue	11 Tan	16 White/Green	21 White/Gray	26 White/Black/Blue
2 Red	7 Violet (purple)	12 Pink	17 White/Yellow	22 White/Violet	27 White/Black/Brown
3 Orange	8 Gray (slate)	13 Dark Blue	18 White/Blue	23 White/Black/Red	28 White/Black/Orange
4 Yellow	9 White	14 White/Black	19 White/Brown	24 White/Black/Green	29 White/Black/Gray
5 Green	10 Black	15 White/Red	20 White/Orange	25 White/Black/Yellow	30 White/Black/Violet

Beldenmil-w-16878 teflon
and mil-w-76 vinyl plastic**TYPE E—MIL-W-16878 TEFLON 600V-200°C**Concentrically stranded silver coated copper conductor,
extruded TFE Teflon insulated.

Trade Number	Type Designation	AWG & (Stranding)	Insulation Thickness (Inch)	Nom. O. D. (Inch)	Stock Colors	Standard Spool Lengths in ft.
8300	E-30	30 (7x38)	.010	.033	1 thru 10	25, 100, 500, 1000
8301	E-28	28 (7x36)	.010	.036	1 thru 10	25, 100, 500, 1000
8302	E-26	26 (7x34)	.010	.041	1 thru 10	25, 100, 500, 1000
8303	E-24	24 (19x36)	.010	.046	1 thru 10	25, 100, 500
8304	E-24	24 (7x32)	.010	.045	1 thru 10	25, 100, 500, 1000
8305	E-22	22 (7x30)	.010	.051	1 thru 10	25, 100, 500, 1000
8306	E-22	22 (19x34)	.010	.052	1 thru 10	25, 100, 500, 1000
8307	E-20	20 (19x32)	.010	.060	1 thru 10	25, 100, 500, 1000
8308	E-20	20 (7x28)	.010	.059	1 thru 10	25, 100, 500
8309	E-18	18 (19x30)	.010	.071	1 thru 10	25, 100, 500, 1000
8310	E-16	16 (19x29)	.010	.080	1 thru 10	25, 100, 500, 1000

Color striping available on 1000' minimum per item each color on 500' and 1000' spools.

TYPE EE—MIL-W-16878 TEFLON 1000V-200°CConcentrically stranded silver coated copper conductor,
extruded TFE Teflon insulated.

Trade Number	Type Designation	AWG & (Stranding)	Insulation Thickness (Inch)	Nom. O. D. (Inch)	Stock Colors	Standard Spool Lengths in ft.
8323	EE-24	24 (19x36)	.014	.053	1 thru 10	25, 100, 500
8325	EE-22	22 (7x30)	.014	.058	1 thru 10	25, 100, 500
8326	EE-22	22 (19x34)	.014	.060	1 thru 10	25, 100, 500, 1000
8327	EE-20	20 (19x32)	.014	.068	1 thru 10	25, 100, 500, 1000
8328	EE-20	20 (7x28)	.014	.066	1 thru 10	25, 100, 500
8329	EE-18	18 (19x30)	.014	.079	1 thru 10	25, 100, 500, 1000
8330	EE-16	16 (19x29)	.014	.086	1 thru 10	25, 100, 500, 1000

Color striping available on 1000' minimum per item each color on 500' and 1000' spools.

MIL-W-76

Covers single conductor, plastic-insulated Hook-Up wire for the internal wiring of electrical and electronic equipment. The many types available in different voltages and

outer covering are listed on the following pages to meet your individual requirements.

TYPE MW—MIL-W-76—VINYL—1000V-80°C

Tinned copper, vinyl insulated, medium wall. The extruded vinyl insulation is flame and ozone-resistant and is inert to most chemicals, oils, and solvents.

Trade Number	Type Designation	AWG & (Stranding)	Insulation Thickness (Inch)	Nom. O. D. (Inch)	Stock Colors on Standard Spools			
					25'	100'	500'	1000'
8525	MW-C 24 (7) U	24 (7x32)	.017	.058	—	1 thru 22	1 thru 22	1 thru 22
8538	MW-C 24 (1) U	24 (Solid)	.017	.054	—	1 thru 22	1 thru 22	1 thru 22
8524	MW-C 22 (7) U	22 (7x30)	.017	.064	1 thru 13	1 thru 30	1 thru 30	1 thru 30
8530	MW-C 22 (1) U	22 (Solid)	.017	.059	1 thru 13	1 thru 30	1 thru 30	1 thru 30
8523	MW-C 20 (10) U	20 (10x30)	.017	.070	1 thru 13	1 thru 30	1 thru 30	1 thru 30
8529	MW-C 20 (1) U	20 (Solid)	.017	.066	1 thru 13	1 thru 22	1 thru 22	1 thru 22
8522	MW-C 18 (16) U	18 (16x30)	.017	.080	1 thru 13	1 thru 30	1 thru 30	1 thru 30
8528	MW-C 18 (1) U	18 (Solid)	.017	.074	—	1 thru 13	1 thru 13	1 thru 13
8521	MW-C 16 (26) U	16 (26x30)	.019	.098	—	1 thru 22	1 thru 22	1 thru 22
8531	MW-C 16 (1) U	16 (Solid)	.017	.085	—	1 thru 10	1 thru 10	1 thru 10
8520	MW-C 14 (41) U	14 (41x30)	.020	.111	—	1 thru 22	1 thru 22	1 thru 22
8527	MW-C 12 (65) U	12 (65x30)	.020	.130	—	1 thru 10	1 thru 10	1 thru 10

First color in stripe combination is body color and second or third colors are stripes. (EXAMPLE: White/Black/Red.)

Manufactured to current Government specifications and subsequent revisions.

STOCK COLORS

1 Brown	6 Light Blue	11 Tan	16 White/Green	21 White/Gray	26 White/Black/Blue
2 Red	7 Violet (purple)	12 Pink	17 White/Yellow	22 White/Violet	27 White/Black/Brown
3 Orange	8 Gray (slate)	13 Dark Blue	18 White/Blue	23 White/Black/Red	28 White/Black/Orange
4 Yellow	9 White	14 White/Black	19 White/Brown	24 White/Black/Green	29 White/Black/Gray
5 Green	10 Black	15 White/Red	20 White/Orange	25 White/Black/Yellow	30 White/Black/Violet

mil-w-76 vinyl plastic

Belden**TYPE MW—MIL-W-76—VINYL-NYLON—1000V-90°C**

Tinned copper, vinyl insulated. Medium wall, clear nylon jacket overall.

Trade Number	Type Designation	AWG & (Stranding)	Insulation Thickness (Inch)	Nom. O.D. (Inch)	Stock Colors on Standard Spools			
					25'	100'	500'	1000'
8537	MW-C 22 (7) J	22 (7x30)	.017	.069	—	1 thru 10 14 thru 22	—	1 thru 10 14 thru 22
8536	MW-C 20 (10) J	20 (10x30)	.017	.076	—	1 thru 10	—	1 thru 10
8535	MW-C 18 (16) J	18 (16x30)	.017	.086	—	1 thru 10	—	1 thru 10

TYPE MW—MIL-W-76—SHIELDED WITH NYLON JACKET—1000V-80°C

Tinned copper, vinyl insulated. Medium wall, tinned copper shield, nylon jacket.

Trade Number	Type Designation	AWG & (Stranding)	Insulation Thickness (Inch)	Nom. O.D. (Inch)	Stock Colors on Standard Spools		
					100'	500'	1000'
8893	MW-C22(7)SJ	22 (7x30)	.017	.096	9	9	9
8896	MW-C20(10)SJ	20 (10x30)	.017	.105	9	9	9
8892	MW-C18(16)SJ	18 (16x30)	.017	.114	9	9	9
8894	MW-C16(26)SJ	16 (26x30)	.019	.132	9	—	9

TYPE MW—MIL-W-76—SHIELDED WITHOUT NYLON JACKET—1000V-80°C

Tinned copper, vinyl insulated. Medium wall, tinned copper shield overall.

8887	MW-C24(7)S	24 (7x32)	.017	.082	1 thru 10	—	1 thru 10
8883	MW-C22(7)S	22 (7x30)	.017	.088	1 thru 10	—	1 thru 10
8886	MW-C20(10)S	20 (10x30)	.017	.096	1 thru 10	—	1 thru 10
8882	MW-C18(16)S	18 (16x30)	.017	.105	1 thru 10	—	1 thru 10
8884	MW-C16(26)S	16 (26x30)	.019	.122	1 thru 10	—	1 thru 10
8881	MW-C14(41)S	14 (41x30)	.020	.135	9, 10	—	9, 10
8880	MW-C12(65)S	12 (65x30)	.020	.154	9, 10	—	9, 10

TYPE MW—MIL-W-76—GLASS BRAID-SHIELDED—1000V-80°C

Tinned copper, vinyl insulated. Medium wall, locquered glass braid, tinned copper shield overall.

Trade Number	Type Designation	AWG & (Stranding)	Insulation Thickness (Inch)	Nom. O.D. (Inch)	Stock Colors on Standard Spools	
					100	1000
8863	MW-C22(7)BS	22 (7x30)	.017	.102	9	9
8862	MW-C20(10)BS	20 (10x30)	.017	.110	9	9
8861	MW-C18(16)BS	18 (16x30)	.017	.119	9	9
8860	MW-C16(26)BS	16 (26x30)	.019	.136	9	9
8859	MW-C14(41)BS	14 (41x30)	.020	.149	9	9
8858	MW-C12(65)BS	12 (65x30)	.020	.168	9	9

For miniature shielded hook-up wire see 8700 on page 27

Manufactured to current Government specifications and subsequent revisions.

STOCK COLORS

1 Brown	6 Light Blue	11 Tan	16 White/Green	21 White/Gray	26 White/Black/Blue
2 Red	7 Violet (purple)	12 Pink	17 White/Yellow	22 White/Violet	27 White/Black/Brown
3 Orange	8 Gray (slate)	13 Dark Blue	18 White/Blue	23 White/Black/Red	28 White/Black/Orange
4 Yellow	9 White	14 White/Black	19 White/Brown	24 White/Black/Green	29 White/Black/Gray
5 Green	10 Black	15 White/Red	20 White/Orange	25 White/Black/Yellow	30 White/Black/Violet

BELDEN PAGE 27

Belden

 mil-w-76 vinyl plastic

TYPE MW—MIL-W-76—VINYL-GLASS BRAID (OVERALL)—1000V—80°C



Tinned copper, vinyl insulated. Medium wall, lacquered glass braid overall.

Trade Number	Type Designation	AWG & (Stranding)	Insulation Thickness (Inch)	Nom. O.D. (Inch)	Voltage Rating	Stock Colors on Standard Spools		
						100	500	1000
8566	MW-C 22(7) B	22 (7x30)	.017	.078	1000V	1 thru 10	—	1 thru 10
8565	MW-C 20(10) B	20 (10x30)	.017	.086	1000V	1 thru 10	—	1 thru 10
8564	MW-C 18(16) B	18 (16x30)	.017	.095	1000V	1 thru 10 124 thru 132	—	1 thru 10 124 thru 132
8563	MW-C 16(26) B	16 (26x30)	.019	.112	1000V	1 thru 10 124 thru 132	—	1 thru 10 124 thru 132
8562	MW-C 14(41) B	14 (41x30)	.020	.125	1000V	9, 124 thru 132	—	9, 124 thru 132
8561	MW-C 12(65) B	12 (65x30)	.020	.144	1000V	9, 125, 132	—	9, 125, 132

TYPE HW—MIL-W-76—VINYL-GLASS BRAID (OVERALL)—600V—80°C



Tinned copper, vinyl insulated. Heavy wall, lacquered glass braid, overall.

8591	HW-C 10(105) B	10 (105x30)	.048	.238	600V	9, 125, 132	—	9, 125, 132
8590	HW-C 8(133) B	8 (133x29)	.048	.279	600V	9	9	—
8589	HW-C 6(133) B	6 (133x27)	.048	.328	600V	9	9	—

TYPE LW—MIL-W-76—VINYL—300V—80°C



Tinned copper, vinyl insulated. Light wall.

Trade Number	Type Designation	AWG & (Stranding)	Insulation Type	Insulation Thickness (Inch)	Nom. O.D. (Inch)	Temperature Rating	Stock Colors on Standard Spools	
							100	1000
8571	LW-C 28(7) U	28 (7x36)	Vinyl	.011	.037	80C	1 thru 10	1 thru 10
8570	LW-C 26(7) U	26 (7x34)	Vinyl	.011	.041	80C	1 thru 10	1 thru 10
8569	LW-C 24(7) U	24 (7x32)	Vinyl	.011	.046	80C	1 thru 10	1 thru 10
8568	LW-C 22(7) U	22 (7x30)	Vinyl	.012	.054	80C	1 thru 10	1 thru 10
8567	LW-C 20(10) U	20 (10x30)	Vinyl	.012	.060	80C	1 thru 10	1 thru 10

TYPE LW—MIL-W-76—VINYL-NYLON—300V—90°C



Tinned copper, vinyl insulated. Light wall, clear nylon jacket overall

8578	LW-C 28(7) J	28 (7x36)	Vinyl-Nylon	.011	.042	90C	—	1 thru 10
8577	LW-C 26(7) J	26 (7x34)	Vinyl-Nylon	.011	.046	90C	—	1 thru 10
8576	LW-C 24(7) J	24 (7x32)	Vinyl-Nylon	.011	.051	90C	—	1 thru 10
8575	LW-C 22(7) J	22 (7x30)	Vinyl-Nylon	.012	.059	90C	—	1 thru 10
8574	LW-C 20(10) J	20 (10x30)	Vinyl-Nylon	.012	.065	90C	—	1 thru 10

Manufactured to current Government specifications and subsequent revisions.

First color in stripe combination is body color and second or third colors are stripes. (EXAMPLE: White/Black/Red.)

STOCK COLORS

1 Brown	6 Light Blue	124 White/Brown	129 White/Blue
2 Red	7 Violet (purple)	125 White/Red	130 White/Violet
3 Orange	8 Gray (slate)	126 White/Orange	131 White/Gray
4 Yellow	9 White	127 White/Yellow	132 White/Black
5 Green	10 Black	128 White/Green	

mil-w-76 vinyl plastic
mil-w-5086 & mil-w-7078 aircraft wire

Belden

TYPE HW—MIL-W-76—VINYL—Gauges 16-22, 2500V—80°C, Gauges 6-14 600V—80°C



Tinned copper, vinyl insulated. Heavy wall.

Trade Number	Type Designation	AWG & (Stranding)	Insulation Thickness (Inch)	Nom. O.D. (Inch)	Stock Colors on Standard Spools			Stock Colors
					100'	500'	1000'	
8586	HW-C 18(16) U	18(16x30)	.034	.115	1 thru 10	—	1 thru 10	1 Brown 2 Red 3 Orange 4 Yellow 5 Green 6 Light Blue 7 Violet (purple) 8 Gray (slate) 9 White 10 Black
8585	HW-C 16(19) U	16(26x30)	.034	.128	2, 9, 10	—	2, 9, 10	
8584	HW-C 14(19) U	14(41x30)	.048	.171	2, 9, 10	—	2, 9, 10	
8583	HW-C 12(19) U	12(65x30)	.048	.191	2, 9, 10	—	2, 9, 10	
8582	HW-C 10(37) U	10(105x30)	.048	.220	2, 9, 10	—	2, 9, 10	
8581	HW-C 8(127) U	8(133x29)	.048	.261	2, 9, 10	2, 9, 10	—	
8580	HW-C 6(127) U	6(133x27)	.048	.310	2, 9, 10	2, 9, 10	—	

MIL-W-5086—TYPES 1 & 2—600V—105°C



Trade Number	MIL Type Designation	AWG & (Stranding)	Nom. O.D. (Inch)	Spec. Type	Stock Colors on Standard Spools			Stock Color
					100'	500'	1000'	
8541	AN-22	22(19x34)	.068	No. 1	9	—	9	White only (9) Additional Description MIL-W-5086A-Type I AN-22 thru AN-12. Stranded tinned copper, white vinyl, clear nylon jacket.
8542	AN-20	20(19x32)	.078	No. 1	9	—	9	
8543	AN-18	18(19x30)	.088	No. 1	9	—	9	
8544	AN-16	16(19x29)	.098	No. 1	9	—	9	
8545	AN-14	14(19x27)	.117	No. 1	9	9	9	
8546	AN-12	12(19x25)	.137	No. 1	9	9	9	
8559	AN-22	22(19x34)	.075	No. 2	9	—	9	MIL-W-5086A-Type II AN-22 thru AN-12 Stranded tinned copper, white vinyl insulation, saturated glass braid, clear nylon jacket.
8558	AN-20	20(19x32)	.085	No. 2	9	—	9	
8557	AN-18	18(19x30)	.095	No. 2	9	—	9	
8556	AN-16	16(19x29)	.105	No. 2	9	—	9	
8555	AN-14	14(19x27)	.125	No. 2	9	9	9	
8554	AN-12	12(19x25)	.143	No. 2	9	9	9	
8553	AN-10	10(49x27)	.190	No. 2	9	9	9	MIL-W-5086A-Type II AN-12 thru AN-00 Stranded tinned copper, white vinyl insulation, saturated glass braid, nylon braid, nylon lacquer.
8552	AN-8	8(133x29)	.240	No. 2	9	9	—	
8551	AN-6	6(133x27)	.293	No. 2	9	9	—	
8550	AN-4	4(133x25)	.355	No. 2	9	9	—	
8549	AN-2	2(665x30)	.425	No. 2	9	—	—	
8548	AN-0	0(1045x30)	.525	No. 2	9	—	—	
8547	AN-00	00(1330x30)	.590	No. 2	9	—	—	

MIL-C-7078—TYPE 1—600V—105°C

(MIL-W-5086 Type 1 Conductor Braided Tinned Copper Shield)

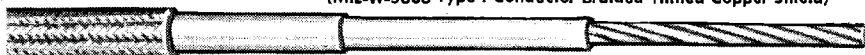

Trade Number	MIL Type Designation	AWG & (Stranding)	Nom. O.D. (Inch)	Spec. Type	Stock Colors on Standard Spools			Stock Color
					100	500	1000	
8855	AN-22	22(19x34)	.092	No. 1	9	—	9	White only (9) Additional Description Stranded tinned copper, white vinyl insulation, nylon jacket, braided tinned copper shield.
8854	AN-20	20(19x32)	.102	No. 1	9	—	9	
8853	AN-18	18(19x30)	.112	No. 1	9	—	9	
8852	AN-16	16(19x29)	.122	No. 1	9	9	—	
8851	AN-14	14(19x27)	.141	No. 1	9	—	—	
8850	AN-12	12(19x25)	.156	No. 1	9	—	—	

Manufactured to current Government specifications and subsequent revisions.

Belden

hook-up and lead wires—grid wire,
shielding and bonding cable—bus bar wire

UL TYPE HOOK-UP AND LEAD WIRES

UL-600V-90°C (CSA-TYPE TRB)

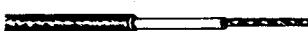
 Tinned copper, vinyl insulated, cotton braid, lacquered

Trade Number	AWG & (Stranding)	Insulation Thickness (Inch)	Nom. O.D. (Inch)	Stock Colors	Standard Spool Lengths in ft
8937	22 (7x30)	.016	.091	1, 2, 3, 4, 5, 9, 10, 13	100, 1000
8936	20 (10x30)	.017	.098	1, 2, 3, 4, 5, 9, 10, 13	100, 1000
8935	18 (16x30)	.017	.113	1, 2, 3, 4, 5, 9, 10, 13	100, 1000
8934	16 (26x30)	.017	.126	1, 2, 3, 4, 5, 9, 10, 13	100, 500
8933	14 (41x30)	.031	.177	1, 2, 3, 4, 5, 9, 10, 13	100, 500

UL rated 600V for electronic circuits only—300V for other applications.

For color coding see Page 30.

UL-600V-105°C (CSA-600V-TYPE TEW)

 Tinned copper, vinyl insulated.

Trade Number	AWG & (Stranding)	Insulation Thickness (Inch)	Nom. O.D. (Inch)	Stock Colors	Standard Spool Lengths in ft.
8920	22 (7x30)	.031	.095	1, 2, 3, 4, 5, 9, 10, 13	100, 1000
8919	20 (10x30)	.031	.102	1, 2, 3, 4, 5, 9, 10, 13	100, 1000
8918	18 (16x30)	.031	.112	1, 2, 3, 4, 5, 9, 10, 13	100, 1000
8917	16 (26x30)	.031	.126	1, 2, 3, 4, 5, 9, 10, 13	100, 500
8916	14 (41x30)	.031	.141	1, 2, 3, 4, 5, 9, 10, 13	100, 500

UL rated 2500 volts peak for electronic circuits.

For color coding see Page 30.

GRID WIRE

Description	Trade Number	AWG & Stranding	Insulation Thickness (Inch)	Nom. O.D. (Inch)	Suggested Working (Voltage)	Breakdown Voltage	Nom. Cap. (mmf ft)	Standard Spool Lengths in ft
	8885	20 (10x30)	.015	.117	300	4000	80	15, 25, 100, 500

Tinned copper, rubber insulated, cellulose acetate braid, lacquered, tinned copper braid shield.

SHIELDING AND BONDING CABLES

Cables conforming to QQB575 can be manufactured on a special order basis. Braided tinned copper. Standard Spool: 10, 50, 250 feet.[Ⓞ]

Trade Number	Stranding	Approx. CMA	Recommended Current (Amps.)	Oval Max. I.D. (Inch)	Flat Width (Inch)
8676	16x36	400	5.5	1/2	3/4
8674	24x36	600	7.5	3/4	1/2
*8652	96x40	920	10.0	1/2	3/2
*8653	48x36	1200	12.0	3/2	7/4
*8654	72x36	1800	16.0	3/4	1/2
*8664	96x36	2400	20.0	1/2	3/2
8660	96x34	3800	27.0	3/2	3/2
8668	120x34	4700	30.0	3/16	3/16
8663	168x34	6700	38.0	3/16	3/16
8661	192x34	7600	42.0	1/2	3/16

Trade Number	Stranding	Approx. CMA	Recommended Current (Amps.)	Oval Max. I.D. (Inch)	Flat Width (Inch)
8669	336x34	13300	61.5	3/2	1 1/16
8672	528x36	13200	61.0	—	3/16
8671	864x36	21600	84.0	—	1 1/16
8662	576x34	22900	88.0	—	1 1/2
*8655	360x30	36000	120.0	—	3/2
8670	480x30	48000	145.0	—	3/4
*8656	576x30	57600	165.0	—	7/8
*8657	768x30	76800	195.0	—	1 1/16
*8658	1056x30	105600	235.0	—	1 3/8
*8659	1680x30	168000	320.0	—	1 1/2

[Ⓞ]8657, 8658, 8659 Available only in 10' & 50' put-ups.

For additional sizes, see current BRAIDED AND STRANDED COPPER CABLE CATALOG.

BUS BAR WIRE

Made in accordance with Federal Spec QQ-W-343. Solid tinned copper. Standard Spool: 100, 1000 feet.[Ⓞ]

Trade Number	AWG	Nom. O.D. (Inch)	Circular Mil. Area
8025	30	.010	100.0
8024	28	.012	159.0
8023	26	.016	253.0
8022	24	.020	404.0
8021	22	.025	640.0

*New Item

Trade Number	AWG	Nom. O.D. (Inch)	Circular Mil. Area
8020	20	.032	1020.0
8019	18	.040	1620.0
8013	16	.050	2580.0
8012	14	.064	4110.0
8011	12	.080	6530.0

[Ⓞ]8011 Available in 100' spool only.

heat shrinkable tubing

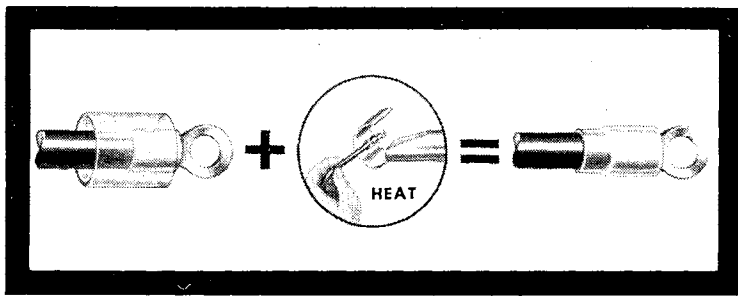
Belden

Belden provides a complete line of heat shrinkable tubing in order to meet the many, diverse application requirements of the electronics industry. Belden Heat Shrinkable Tubing is available from stock in a full range of colors, sizes and lengths in three basic types—all conveniently packaged for easy handling and use. All Belden HST products are manufactured to exact specifications in order to assure dependable production-line uniformity of diameters, shrink-down and electrical properties.

HST 1: BELDEN IRRADIATED POLYOLEFIN HEAT SHRINKABLE TUBING

Belden HST-1 meets all industry standards and size specifications. It is thermally stabilized and homogeneous in nature. HST-1 is essentially free from flaws, defects, pin holes, bubbles, seams, cracks or inclusions. When heated to 275°F, it shrinks to 50% of its original diameter, and

when fully shrunk, its longitudinal change is less than 3% of its original length. It is solvent and fungus resistant and has a maximum water absorption of only 0.1%. Belden HST-1 meets or exceeds MIL-I-23053 (WEPS) Revision A.

(Size inches)	Trade No.	Put-up Length	Stock Colors*	Minimum Expanded I.D. (inch)	Maximum Recovered I.D. (inch)	Nom. Wall Recovered (inch)	No. of Lengths in Std. Pkg.	Total Ft. per Std. Pkg.
3/4	68001	6'	10, 368	.046	.023	.016	25	12½
	68002	4'	10, 368				10	40
1/2	68011	6'	10, 368	.063	.031	.017	25	12½
	68012	4'	10, 368				10	40
3/8	68021	6'	10, 368	.093	.046	.020	25	12½
	68022	4'	2, 4, 6, 9, 10, 368				25	100
1/4	68031	6'	10, 368	.125	.062	.020	25	12½
	68032	4'	2, 4, 6, 9, 10, 368				25	100
3/16	68041	6'	10, 368	.187	.093	.020	25	12½
	68042	4'	2, 4, 6, 9, 10, 368				25	100
1/4	68051	6'	10, 368	.250	.125	.025	25	12½
	68052	4'	2, 4, 6, 9, 10, 368				25	100
3/8	68061	6'	10, 368	.375	.187	.025	25	12½
	68062	4'	2, 4, 6, 9, 10, 368				25	100
1/2	68071	6'	10, 368	.500	.250	.025	25	12½
	68072	4'	2, 4, 6, 9, 10, 368				25	100
3/4	68081	6'	10, 368	.750	.375	.030	25	12½
	68082	4'	2, 4, 6, 9, 10, 368				25	100
1	68091	6'	10, 368	1.000	.500	.035	10	5
	68092	4'	10, 368				10	40
1½	68101	6'	10, 368	1.500	.750	.040	10	5
	68102	4'	10, 368				10	40
2	68111	6'	10, 368	2.000	1.000	.045	5	2½
	68112	4'	10, 368				5	20
3	68121	6'	10, 368	3.000	1.500	.050	5	2½
	68122	4'	10, 368				5	20
4	68131	6'	10, 368	4.000	2.000	.055	5	2½
	68132	4'	10, 368				5	20

HST 2: BELDEN IRRADIATED POLYOLEFIN HEAT SHRINKABLE TUBING

Belden HST-2 combines flexibility with abrasion resistance. It is flame retardant and offers excellent dielectric and mechanical strength. It is essentially free from flaws, defects, pin holes, bubbles, seams, cracks or inclusions. When heated, it shrinks to 50% of its original diameter

and, when fully shrunk, its longitudinal change is less than 10% of its original length. It is impervious to solvents and resists water absorption. It is recommended for most commercial uses that do not require the more costly inspection of military specifications.

Size (inches)	Trade No.	Put-up Length	Stock Colors	Minimum Expanded I.D. (inch)	Maximum Recovered I.D. (inch)	Nom. Wall Recovered (inch)	No. of Lengths in Std. Pkg.	Total Ft. per Std. Pkg.
3/4	68202	4'	10	.046	.023	.020	10	40
	68205	500'	10				1	500
1/2	68212	4'	10	.062	.031	.020	10	40
	68215	500'	10				1	500

*All colors are flame-retardant except clear (368).

Continued on next page

COLOR CODE IDENTIFICATION

2. Red 4. Yellow 6. Light Blue 9. White 10. Black 368. Clear

BELDEN PAGE 31

Belden

heat shrinkable tubing

HST 2: BELDEN IRRADIATED POLYOLEFIN HEAT SHRINKABLE TUBING (Cont'd.)

Size (inches)	Trade No.	Put-up Length	Stock Colors	Minimum Expanded I.D. (inch)	Maximum Recovered I.D. (inch)	Nom. Wall Recovered (inch)	No. of Lengths in Std. Pkg.	Total Ft. per Std. Pkg.
¼	68231	6"	10	.125	.062	.025	25	12½
	68232	4'	10				25	100
	68235	200'	10				1	200
⅜	68241	6"	10	.187	.093	.025	25	12½
	68242	4'	10				25	100
	68245	200'	10				1	200
¼	68251	6"	10	.250	.125	.025	25	12½
	68252	4'	10				25	100
	68255	200'	10				1	200
⅜	68261	6"	10	.375	.187	.030	25	12½
	68262	4'	10				25	100
	68265	200'	10				1	200
½	68271	6"	10	.500	.250	.030	25	12½
	68272	4'	10				25	100
¾	68281	6"	10	.750	.375	.035	25	12½
	68282	4'	10				25	100
1	68292	4'	10	1.000	.500	.040	10	40

HST 3: BELDEN VINYL HEAT SHRINKABLE TUBING

Belden HST-3 Polyvinylchloride Heat Shrinkable Tubing has an extra thin wall for excellent conformability. It is flame retardant and offers outstanding physical and electrical properties. When heated, it shrinks to 50% of its original diameter and when fully shrunk, its longitudinal

change is less than 15% of its original length. All colors (except black) are translucent which permits the enclosed object to remain visible. HST-3 is especially recommended for use in areas where space is critical or where flexibility is a requirement.

Size (inches)	Trade No.	Put-up Length	Stock Colors	Minimum Expanded I.D. (inch)	Maximum Recovered I.D. (inch)	Nom. Wall Recovered (inch)	No. of Spools Std. Pkg.	Total Ft. per Std. Pkg.
¼	68513	25'	2, 6, 10, 368	.135	.075	.014	2	50
	68514	100'					2	200
	68515	250'					2	500
⅜	68523	25'	2, 6, 10, 368	.200	.110	.014	2	50
	68524	100'					2	200
	68525	250'					2	500
¼	68533	25'	2, 6, 10, 368	.270	.150	.020	2	50
	68534	100'					2	200
	68535	250'					1	250
⅜	68543	25'	2, 6, 10, 368	.395	.225	.020	5	125
	68544	100'					2	200
	68545	250'					2	500
½	68553	25'	2, 6, 10, 368	.520	.300	.020	5	125
	68554	100'					2	200
	68555	250'					2	500
¾	68563	25'	2, 6, 10, 368	.645	.375	.020	4	100
	68564	100'					2	200
¾	68573	25'	2, 6, 10, 368	.770	.450	.020	2	50
	68574	100'					2	200
¾	68583	25'	2, 6, 10, 368	.895	.525	.020	2	50
	68584	100'					2	200
1	68593	25'	2, 6, 10, 368	1.02	.600	.020	2	50
	68594	100'					2	200
1½	68603	25'	2, 6, 10, 368	1.52	.90	.030	2	50
	68604	100'					2	200
2	68613	25'	2, 6, 10, 368	2.02	1.20	.030	2	50
	68614	100'					1	100

COLOR CODE IDENTIFICATION

2. Red 6. Light Blue 10. Black 368. Clear

merchandisers and crimping tool

Belden

BELDEN MERCHANDISERS

Belden offers a full line of mobile communications terminals in a wide range of sizes and configurations to suit every wiring need and to meet the requirements of many specialized applications. Belden terminals are manufactured in accordance with the highest quality control standards and packaged for extra handling convenience.

Primary wire terminals are made from electrolytic copper, electro-tinned for corrosion resistance. Insulated terminals have tough vinyl sleeves which can be crimped

without cutting or breaking.

The Belden 98 Packet self-service, counter-top Merchandiser displays a complete selection of the most popular terminals and assures fast turnover with minimal handling and restocking costs. Belden's fine selection of complementary terminal accessories, kits and application tools complete the line to assure full product coverage and customer satisfaction.

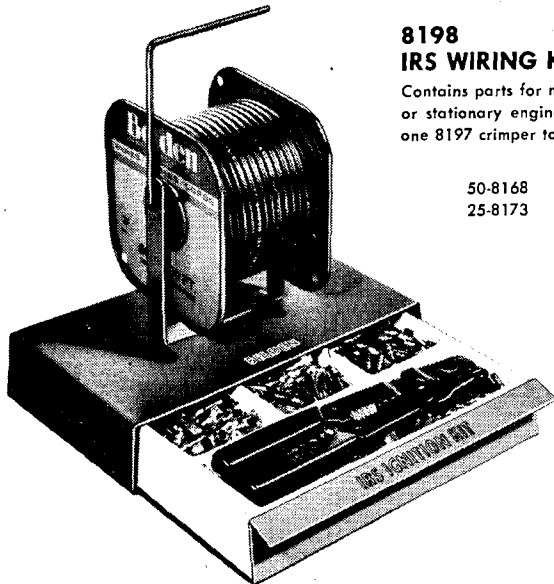

**8198
IRS WIRING KIT (Ignition Radiation Suppression)**

Contains parts for making up ignition leads or sets for cars, trucks, boats or stationary engines. Includes 100' 8688 IRS cable, 400 terminals and one 8197 crimper tool. IRS application information on page 38.

Contents:

50-8168	25-8174	50-8171	100' 8688
25-8173	50-8170	200-8172	1-8197



**8196
STRIP-IT TOOL**

Fast, efficient way to strip wire and cable. Easy to use in tight spots. Rugged tool steel blades cut as well as strip. Adjusts for all wire sizes. Blister packaged for easy display and quick sales.



**8199
THE 98 PACKET®**

No. 8199 Assortment holds 75 individual plastic packets containing 25 different types of the most popular primary and ignition terminals to cover your mobile communications requirements. Rack stands on counter or hangs on wall. Weighs just 7 lbs. complete. Dimensions: 18" high, 12" wide, 8" deep.

BELDEN TERMINALS

Packaged in sturdy plastic tubes for fast turnover, easy handling, stocking and reordering. To cover your mobile communications requirements.

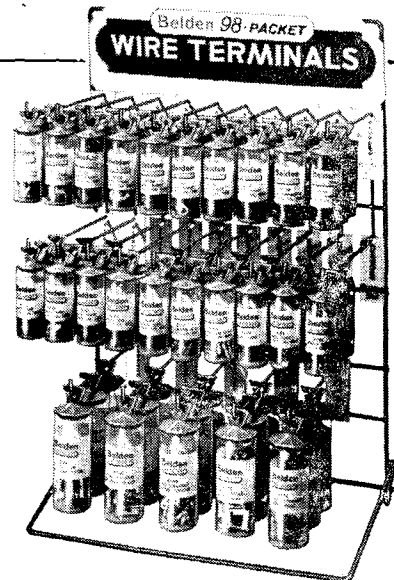

**8197
ALL PURPOSE TERMINAL CRIMPING AND
CABLE STRIPPING TOOL**

Precision machined to permanently swage all types of Primary, Spark Plug, and Snap Terminals shown. Rugged construction made from heat-treated alloy steel with blue plastic handle grips.









Belden

IRS (Ignition Radiation Suppression) wire, spark plug protectors and terminals



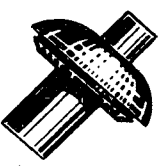

IRS SPARK PLUG WIRE

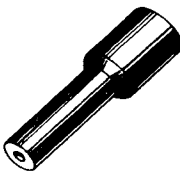
Illustrations and colors	Trade Number	Standard Package	Description	Application
 Ignition Radiation Suppression	8688	100' Spool	IRS IGNITION CABLE 7 MM ● Duoprene G elastomer conductor ● Conductor extruded over a glass cord for strength ● Maximum dielectric rubber ● Glass Fiber Braid ● Over-all Sheath of Black Hypalon	Belden's resistance cable for original equipment replacement on all model passenger cars and trucks where Ignition Radiation Suppression is required. 8198 IRS Wiring Kit shown on page 37.

SPARK PLUG PROTECTORS

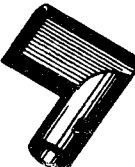
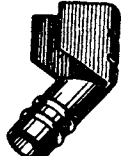
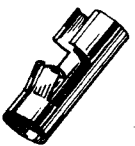
						
Hypalon one third size ★8175 Universal Spark Plug Protector Std. Pkg. 10	Neoprene one half size ★8177 7 MM Angle Distributor Nipple Std. Pkg. 10	Neoprene one half size ★8176 7 MM Red Plastic Distributor Nipple Std. Pkg. 10	Neoprene one half size ★8178 Buick Spark Plug Protector Std. Pkg. 8	Hypalon one half size ★8179 Corvoir Spark Plug Protector Std. Pkg. 6	Hypalon one half size ★8180 Plymouth, Valiant Spark Plug Protector Std. Pkg. 6	Silicone Rubber one half size ★8181 High Heat Spark Plug Protector Std. Pkg. 8









SPARK PLUG WIRE TERMINALS

						
actual size 8171-98 7 MM Snap Solderless Use on all condrs.**	actual size 8170-98 7 MM Angle Solderless Use on all condrs.**	actual size 8174-98 7 MM 115° Solderless Use on all condrs.**	actual size 8168-98 7 MM Straight Distributor Clip Use on all condrs.**	actual size 8173-98 7 MM Angle Distributor Clip Use on all condrs.**	actual size 8169-98 7 MM Brass Distributor Clip Use on copper condr. only	actual size 8172-98 Staple Use only on IRS condr.

** Requires 8172 staple when used with IRS (Ignition Radiation Suppression) conductor

STUD CHART WITH HOLE SIZES

For quick selection of Terminal screw size, match screw shank to corresponding circle in chart below.

STANDARD STUD SIZE								
Screw Dia. (")	#6 .138	#8 .164	#10 .190	#12 .216	1/4" .250	5/16" .312	3/8" .375	1/2" .500

*New Item

TERMINALS

Type (Actual Size)	Trade Number and Description	AWG	Size	Length	Width of Face	Thickness of Stock
	8155-98 Solderless, insulated	14-16-18	Screw Size 10	$2\frac{7}{32}$ "	$2\frac{3}{64}$ "	.032"
	8151-98 Solderless, Insulated	14-16-18	Screw Size 10	$2\frac{7}{32}$ "	$2\frac{3}{64}$ "	.032"
	8154-98 Heavy-Duty Solderless, Insulated	10-12	Screw Size 10	$2\frac{9}{32}$ "	$\frac{3}{8}$ "	.040"
	8162-98 Solderless, Insulated	14-16-18	Screw Size 10	$2\frac{7}{32}$ "	$2\frac{3}{64}$ "	.032"
	8157-98 Solderless, Insulated	14-16-18	Screw Size 8	$2\frac{3}{32}$ "	$\frac{1}{4}$ "	.032"
	8156-98 Solderless, Insulated	14-16-18	Screw Size 6	$4\frac{3}{64}$ "	$\frac{1}{4}$ "	.032"
	8153-98 Solderless, Insulated	14-16-18	Screw Size $\frac{1}{4}$ "	$3\frac{1}{32}$ "	$1\frac{5}{32}$ "	.032"
	8152-98 Heavy-Duty Solderless, Insulated	10-12	Screw Size $\frac{3}{8}$ "	$1\frac{5}{64}$ "	$1\frac{9}{32}$ "	.040"
	8160-98 Male Slide Terminal, Insulated, mates with 8161	14-18	$\frac{1}{4}$ " Blade Terminal	$2\frac{1}{32}$ "	.250"	.032"
	8161-98 Female Slide Terminal, Insulated, mates with 8160	14-18	$\frac{1}{4}$ " Blade Receptacle	$2\frac{1}{32}$ "	.255"	.020"
	8163-98 Male Slide Terminal, Uninsulated, mates with 8164	14-18	$\frac{1}{4}$ " Blade Terminal	$2\frac{5}{32}$ "	.250"	.032"
	8164-98 Female Slide Terminal, Uninsulated, mates with 8163	14-18	$\frac{1}{4}$ " Blade Receptacle	$2\frac{5}{32}$ "	.255"	.020"
	8190-98 Spade Terminal. Removable insulation clamp for large twin-lead.	20-22	Screw Size 10	1"	.422"	.030"
	8191-98 Flanged Spade Terminal. Removable insulation clamp for large twin-lead.	20-22	Screw Size 6	$4\frac{5}{64}$ "	.281"	.030"
	8165-98 Snap Terminal (15 Amp), Uninsulated Use with one 14 AWG or two 16 AWG	—	—	$3\frac{5}{64}$ "	.188 dia.	—
	8166-98 Snap Terminal, Uninsulated Use with one 12 AWG or two 16 AWG	—	—	$3\frac{5}{64}$ "	.188 dia.	—
	8158-98 Parallel Connector, Insulated	14-18	—	$\frac{3}{4}$ "	—	.035"
	8159-98 Butt Connector, Insulated	10-12	—	$1\frac{1}{8}$ "	—	.035"
	8150-98 Butt Connector, Insulated (Nylon)	14-16	—	$1\frac{3}{64}$ "	—	.032"
	8167-98 Two Wire Connector Use with 8165 or 8166	—	—	—	—	—

CIRCUIT CONNECTORS one half size

Belden

 primary, antenna and ignition wire

PRIMARY WIRE—MARINE AND AUTO

 <p>S.A.E. TYPE G.P.T. Bare copper, vinyl insulated.</p>	Trade Number	AWG & (Stranding)	Insulation Thickness (Inch)	Nom. O.D. (Inch)	Color	Standard Spool
	8685	16 (19x29)	.023	.102	Black	100
	8684	14 (19x27)	.023	.117	Green	100
	8683	12 (19x25)	.026	.142	Red	100
	8682	10 (19x23)	.031	.175	White	100
	8681	8 (19x21)	.037	.219	Chrome	100
	8680	6 (37x21)	.043	.290	Chrome	100
	8679	4 (61x22)	.061	.350	Chrome	100

MARINE RADIO ANTENNA WIRE

 <p>WEATHER-RESISTANT Tinned Copperweld polyethylene insulated.</p>	Trade No.	AWG & (Stranding)	Insulation Thickness (Inch)	Nom. O.D. (Inch)	Standard Spool
	8201	20 (7x28)	.121	.278	100, 500, 1000

3 & 4 CONDUCTOR PARALLEL BONDED PRIMARY WIRE

 <p>Bare copper, vinyl insulated.</p>	Trade Number	AWG & (Stranding)	Insulation Thickness (Inch)	Nom. O.D. (Inch)	Color Coding	Standard Spool
	8475	16-3 19x29	.023	.102x .295	Wht/Brn/ Red	10, 500
	8476	16-4 19x29	.023	.102x .400	Wht/Brn/ Yel/Grn	100, 500

Conforms to SAE and Outboard Industries Association Color Coding for boat trailers.

DUPLEX PRIMARY WIRE

 <p>Tinned copper, vinyl insulated, conductors parallel, chrome vinyl jacket.</p>	Trade Number	AWG & (Stranding)	Insulation Thickness (Inch)	Jacket Thickness (Inch)	Nom. O.D. (Inch)	Color Coding	Standard Spool
	8677	16 (19x29)	.032	.022	.164x .276	Brn, Red	100, 500
	8675	14 (19x27)	.037	.022	.189x .326	Brn, Red	100, 500
	8673	12 (19x25)	.040	.022	.213x .384	Brn, Red	100, 500
	8678	10 (19x23)	.040	.025	.243x .436	Brn, Red	100, 500

7 MM IGNITION WIRE



 <p>Tinned copper clad steel wire conductor, rubber insulated, Hypalon Jacket</p>	Trade Number	AWG & (Stranding)	Insulation Thickness (Inch)	Nom. O.D. (Inch)	Color	Standard Spool
	8689	20 (7x28)	.120	.278	Blk.	100

teflon wire | Belden

Teflon is a fluorinated thermoplastic with outstanding thermal physical and electrical properties. However, because the basic resin and processing costs are relatively high, Teflon is generally restricted to applications requiring its special characteristics.

Belden Teflon wire products are highly recommended for miniature cable applications, because of their superior thermal and electrical properties. Teflon is especially suit-





able for internal wiring soldering applications where insulation melt back is a specific problem. Belden Teflon wiring products are outstanding in their resistance to oil, oxidation, heat, sunlight, flame and their ability to remain flexible at low temperatures. They all have excellent resistance to ozone, water, alcohol, gasoline, acids, alkalis, aromatic carbon and solvents.

Description	Trade Number	AWG & (Stranding)	Insulation Thickness (Inch)	Jacket Thickness (Inch)	Nom. O.D. (Inch)	Cond. Color Coding	Percent Shield Coverage	Nom. Cap. (mmf ft)	Nom. Cap. (mmf ft)	Suggested Working Voltage	Standard Spool Lengths in ft
 High Temperature	8390 (2 cond.)	22 (19x34)	.015	.015	.180	Blk, Wht	90	23	40	1000	25, 100, 500
	8391 (3 cond.)	22 (19x34)	.015	.015	.190	Blk, Red Wht	90	20	35	1000	25, 100, 500
	8392 (4 cond.)	22 (19x34)	.015	.015	.205	Red, Blk, Grn, Wht	90	20	35	1000	25, 100, 500
Stranded tinned copper, FEP teflon [®] insulated, cabled, tinned copper braid shield, white FEP teflon jacket. HIGH TEMPERATURE +200° C maximum, -70° C minimum operating temperature. Ideal where chemical resistance is needed and/or extremely high or low temperatures are required.											
 *8393 (2 cond.)	20 (7x28)	.020	.030	.245	Blk, Red	100	22	42	1000	25, 100, 500	
	Tinned copper, FEP Teflon insulated, noise reducing tape, 20 AWG (10x30) nickel coated copper drain wire, special Beldfoil shield, Silicone rubber jacket. +150° C maximum -70° C minimum operating temperature. Jacket working voltage 1000V DC, shield to ground.										

*Capacitance between conductors.

**Capacitance between one conductor and other conductor connected to shield.

RG/U CABLES

Description	Trade Number	RG No.	AWG & (Stranding) Material	Insulation	No. of Shields & Material	Jacket	Nom. O.D. (Inch)	Nom. Imp. (Ohms)	Nom. Vel. of Prop.	Nom. Cap. (mmf ft)	Nom. Attenuation per 100 mc db	Standard Spool Lengths in ft.
	8265	178B/U MIL-C-17D	30 (7x38) Silver coated Copperweld	TFE TEFLON	1 Silver coated copper	Brown FEP TEFLON	.072	50	69.5	29	400 29.0 Max.	100 500
	8266	180B/U MIL-C-17D	30 (7x38) Silver coated Copperweld	TFE TEFLON	1 Silver coated copper	Brown FEP TEFLON	.142	95	69.5	15	400 17.0 Max.	100 500
	8269	188A/U MIL-C-17D	26 (7x.0067) Silver coated Copperweld	TFE TEFLON	1 Silver coated copper	White TFE TEFLON	.106	50	69.5	29	400 20.0 Max.	100 500
	8270	196A/U MIL-C-17D	30 (7x38) Silver coated Copperweld	TFE TEFLON	1 Silver coated copper	White TFE TEFLON	.076	50	69.5	29	400 29.0 Max.	100 500

Manufactured to current Government specifications and subsequent revisions.

TYPE E—MIL-W-16878 TEFLON—600V—200°C

TYPE EE—MIL-W-16878 TEFLON—1000V—200°C



Stock Colors 1 thru 10

Concentrically stranded silver coated copper conductor, extruded TFE Teflon insulated

Stock Colors 1 thru 10

Trade Number	Type Designation	AWG & (Stranding)	Nom. O.D. (Inch)	Insulation Thickness (Inch)	Standard Spool Lengths in ft.
8300	E-30	30 (7x38)	.033	.010	25, 100, 500, 1000
8301	E-28	28 (7x36)	.036	.010	25, 100, 500, 1000
8302	E-26	26 (7x34)	.041	.010	25, 100, 500, 1000
8303	E-24	24 (19x36)	.046	.010	25, 100, 500
8304	E-24	24 (7x32)	.045	.010	25, 100, 500, 1000
8305	E-22	22 (7x30)	.051	.010	25, 100, 500, 1000
8306	E-22	22 (19x34)	.052	.010	25, 100, 500, 1000
8307	E-20	20 (19x32)	.060	.010	25, 100, 500, 1000
8308	E-20	20 (7x28)	.059	.010	25, 100, 500
8309	E-18	18 (19x30)	.071	.010	25, 100, 500, 1000
8310	E-16	16 (19x29)	.080	.010	25, 100, 500, 1000

Trade Number	Type Designation	AWG & (Stranding)	Nom. O.D. (Inch)	Insulation Thickness (Inch)	Standard Spool Lengths in ft.
8323	EE-24	24 (19x36)	.053	.014	25, 100, 500
8325	EE-22	22 (7x30)	.058	.014	25, 100, 500
8326	EE-22	22 (19x34)	.060	.014	25, 100, 500, 1000
8327	EE-20	20 (19x32)	.068	.014	25, 100, 500, 1000
8328	EE-20	20 (7x28)	.066	.014	25, 100, 500
8329	EE-18	18 (19x30)	.079	.014	25, 100, 500, 1000
8330	EE-16	16 (19x29)	.086	.014	25, 100, 500, 1000

Stock Colors

- 1. Brown
- 2. Red
- 3. Orange
- 4. Yellow
- 5. Green
- 6. Light Blue
- 7. Violet (purple)
- 8. Gray (slate)
- 9. White
- 10. Black

Color striping available on 1,000 ft. minimum per item each color on 500' and 1000' spools.

Manufactured to current Government specifications and subsequent revisions. 41

*New Item

Trade mark of DuPont

Belden cords

HPD HEATER CORDS WITHOUT APPLIANCE PLUG

Information and Application

HPD Cordage (Asbestos cotton braid) is recommended for irons and other appliances where flexibility of the cord is extremely important.

Glazed cotton HPD should be used for maximum resistance to abrasion.

All Belden Iron Cords use a fiber glass tie on the stripped conductors for ruggedness and to insure the smallest diameter for easy installation.

17729 has a special terminal finish. The braid is stripped 2 1/4" with a fiber glass tie, and the eyelets are for a #6 screw.

All cords have UL Green Flag Label.

These cords are offered in a wide variety of:

1. Lengths
2. Gauges
3. Colors
4. Cotton Types
5. End Finishes—
Stripped
Terminals
Eyelets

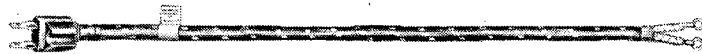

MOLDED VINYL CORD HOLDER PLUG BRAID STRIPPED 1 1/4" WITH FIBER GLASS TIE, RING TERMINALS FOR #8 SCREW

Trade Number	Length of Cord (ft.)	AWG (Stranding)	Nom. O.D. (Inches)	Rating	Type of Cotton	Colors
17706	6	18 (41 x 34)	.265	10A-125V	Glazed	Black, Spiral White Tracer
17727	7	16 (65 x 34)	.285	15A-125V	Glazed	Black, Spiral White Tracer or Brown, crossed White Tracer

THE INDUSTRY'S MOST POPULAR IRON CORD



MOLDED VINYL CORD-HOLDER PLUG BRAID STRIPPED 1 1/4" WITH FIBER GLASS TIE, EYELETS FOR #8 SCREW

Trade Number	Length of Cord (ft.)	AWG (Stranding)	Nom. O.D. (Inches)	Rating	Type of Cotton	Colors
17707	7	18 (41 x 34)	.265	10A-125V	Soft	Black, Spiral White Tracer
17725	7	16 (65 x 34)	.285	15A-125V	Glazed	Black, Spiral White Tracer
17729	8	16 (65 x 34)	.285	15A-125V	Glazed	Black, Spiral White Tracer
17730	10	16 (65 x 34)	.285	15A-125V	Glazed	Black, Spiral White Tracer



MOLDED VINYL CORD-HOLDER PLUG BRAID STRIPPED 1 1/2", TIED WITH FIBER GLASS TIE, CONDUCTORS STRIPPED AND TWISTED 3/8"

Trade Number	Length of Cord (ft.)	AWG (Stranding)	Nom. O.D. (Inches)	Rating	Type of Cotton	Colors
17728	7	16 (65 x 34)	.285	15A-125V	Glazed	Black, Spiral White Tracer or Brown, crossed White Tracer

HPD HEATER CORDS WITH PROTECTOR SLEEVE AND STRAIN RELIEF



Fits G.E. Irons with model numbers F-33, F-34, F-44 and F-50. UL Green Flag Label.

Trade Number	Length of Cord (ft.)	AWG (Stranding)	Nom. O.D. (Inches)	Rating	Type of Cotton	Colors
17723	7	18 (41 x 34)	.265	10A-125V	Glazed	Black, White Spiral Tracer



Fits G.E. Irons with model numbers F-60, F-61, F-70 and F-71. UL Green Flag Label.

Trade Number	Length of Cord (ft.)	AWG (Stranding)	Nom. O.D. (Inches)	Rating	Type of Cotton	Colors
17724	7	18 (41 x 34)	.265	10A-125V	Glazed	Black, White Spiral Tracer



Fits G.E. Irons with model numbers F-23, F-26, F-30, F-35 and F-40. UL Green Flag Label.

Trade Number	Length of Cord (ft.)	AWG (Stranding)	Nom. O.D. (Inches)	Rating	Type of Cotton	Colors
17726	7	16 (65 x 34)	.285	15A-125V	Glazed	Black, Spiral White Tracer

COFFEEMAKER AND FRY PAN CORD SETS

Information and Application

Fits all standard coffeemakers. The miniature appliance plug is slotted so that it also fits many fry pans. The 2 ft. length cord is particularly convenient for the kitchen counter space. Both cords made to original equipment specifications with 3-leaf bronze contacts and 17 AWG conductor. UL Blue Flag Label.

17856 is recommended where just a coffeemaker cord is required. Miniature appliance plug is not slotted. UL Blue Flag Label.

CONVENIENCE AND SAFETY. Dangling cords can be messy, troublesome and unsafe. Retractable cords stay neat, allow free movement of the appliance and prevent accidents. Neoprene jackets meet UL requirements and retain full memory through thousands of stretching cycles.

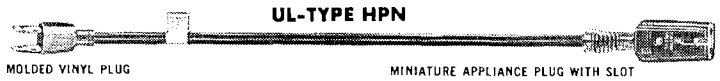

Trade Number	Length of Cord (ft.)	AWG (Stranding)	Nom. O.D. (Inches)	UL Type of Cordage	Color
17852	2	17 (52 x 34)	.160 x .308	HPN	Black
17866	6	17 (52 x 34)	.160 x .308	HPN	Black
17856	6	18 (41 x 34)	.154 x .286	HPN	Black



Trade Number	Retracted Length (in.)	Practical Extended Length (ft.)	AWG (Stranding)	Nom. O.D. (Inches)	UL Type of Cordage	Color
17886	9	4	18 (41 x 34)	.165 x .335	HPN	Black

STANDARD APPLIANCE PLUG CORD SETS



Trade Number	Length of Cord (ft.)	AWG (Stranding)	Nom. O.D. (Inches)	UL Type of Cordage	Colors
17857	6	18 (41 x 34)	.154 x .286	HPN	Black
17756	6	18 (41 x 34)	.265	HPD	Black, Spiral White Tracer

For all kitchen appliances such as waffle irons, grills, battle warmers, etc. using 1/16" spacing between contacts. UL Blue Flag Label.



Trade Number	Retracted Length (in.)	Practical Extended Length (ft.)	AWG (Stranding)	Nom. O.D. (Inches)	UL Type of Cordage	Color
17887	9	4	18 (41 x 34)	.165 x .335	HPN	Black

ROASTER CORD SETS

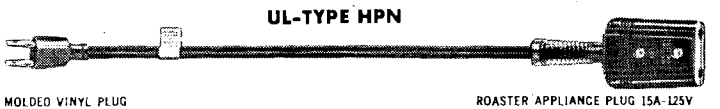

Trade Number	Length of Cord (ft.)	AWG (Stranding)	Nom. O.D. (Inches)	UL Type of Cordage	Color
17876	6	16 (65 x 34)	.166 x .318	HPN	Black

Fits all standard roasters, broilers and big fry pans with 1/16" spacing between contacts. 16 AWG cord is used to carry the heavy load and 3-leaf bronze contacts insure a trouble free connection. UL Blue Flag Label.



Trade Number	Retracted Length (in.)	Practical Extended Length (ft.)	AWG (Stranding)	Nom. O.D. (Inches)	UL Type of Cordage	Color
17888	9	4	16 (65 x 34)	.180 x .365	HPN	Black

Belden cords

HPN HEATER CORDS WITHOUT APPLIANCE PLUG

Information and Application

For soldering irons and appliances where cord is attached directly to the appliance. Ring type terminals for easy attachment. UL Green Flag Label.

UL-TYPE HPN



MOLDED VINYL PLUG CONDUCTORS SPLIT 1" TERMINALS FOR #8 SCREW

Trade Number	Retracted Length (in.)	Practical Extended Length (ft.)	AWG (Stranding)	Nom. O.D. (Inches)	UL Type of Cordage	Rating	Color
17836	9	4	18 (41 x 34)	.165 x .335	HPN Neoprene	10A-125 V	Black



MOLDED VINYL PLUG CONDUCTORS SPLIT 1-1/16" TERMINALS FOR #8 SCREW

Trade Number	Length of Cord (ft.)	AWG (Stranding)	Nom. O.D. (Inches)	UL Type of Cordage	Rating	Color
17826	6	16 (65 x 34)	.152 x .300	HPN Neoprene	15A-125V	Black

For appliances such as toasters, waffle irons, battle warmers and kitchen stove timers where the cord is permanently attached to appliance.

UL Green Flag Label.



MOLDED VINYL PLUG CONDUCTORS SPLIT 1" STRIPPED AND TWISTED 1/2"

Trade Number	Length of Cord (ft.)	AWG (Stranding)	Nom. O.D. (Inches)	UL Type of Cordage	Rating	Color
17806	6	18 (41 x 34)	.140 x .276	HPN Neoprene	10A-125V	Black

HPN HEATER EXTENSION CORD

Eight foot 16 AWG Neoprene Extension Cord. For all appliances such as irons, toasters, mixers, etc., where additional cordage is needed. UL Blue Flag Label.



MOLDED VINYL PLUG MOLDED VINYL CONNECTOR FOR BLADE PRONGS

Trade Number	Length of Cord (ft.)	AWG (Stranding)	Nom. O.D. (Inches)	UL Type of Cordage	Rating	Color
17870	8	16 (65 x 34)	.152 x .300	HPN Neoprene	10A-125V	Black

MIXER CORDS - FAN CORD

UL-TYPE SPT-2 VINYL

Fits latest hand held food mixer models such as Dormeyer, G.E., Hamilton Beach, Sunbeam and Westinghouse. UL Blue Flag Label.



MOLDED VINYL PLUG MOLDED VINYL PLUG ROUND PIN CONNECTOR

Trade Number	Length of Cord (ft.)	AWG (Stranding)	Nom. O.D. (Inches)	UL Type of Cordage	Color
17186	6	18 (41 x 34)	.144 x .277	SPT-2 Vinyl	White



MOLDED VINYL PLUG CONDUCTORS SPLIT 1 1/2" STRIPPED AND TWISTED 1/2"

Trade Number	Length of Cord (ft.)	AWG (Stranding)	Nom. O.D. (Inches)	UL Type of Cordage	Colors
17116	6	18 (41 x 34)	.144 x .277	SPT-2 Vinyl	White
17139	9	18 (41 x 34)	.144 x .277	SPT-2 Vinyl	Brown

Fit older models of many nationally advertised hand held food mixers. Also BVI, Cory, Dormeyer, G.E., Hamilton Beach, Oster and Westinghouse can openers. Also fit knife sharpeners, electric juicers, home hair dryers, desk or window or suitcase fans, portable humidifiers, toy transformers and small business machines. UL Green Flag Label.

TWO CONDUCTOR POWER SUPPLY CORDS

PARALLEL LAMP CORDS



Information and Application

For Lamps, Radios, Desk Fans and Small Appliances. Long life plastic resists cracking and aging. Popular lengths and colors. UL Green Flag Label.

Trade Number	Length of Cord (ft.)	AWG (Stranding)	Nom. O.D. (Inches)	UL Type of Cordage	Colors
17106	6	18 (41 x 34)	.110 x .207	SPT-1 Vinyl	Brown, Gray or Ivory
17109	9	18 (41 x 34)	.110 x .207	SPT-1 Vinyl	Brown, Gray
17112	12	18 (41 x 34)	.110 x .207	SPT-1 Vinyl	Brown, Gray
17126	6	18 (41 x 34)	.110 x .213	SP-1 Rubber	Brown
17129	9	18 (41 x 34)	.110 x .213	SP-1 Rubber	Brown

UL-TYPE SVT VINYL AND SV RUBBER

For Food Mixers, Blenders and Small Appliances. UL Green Flag Label.



Trade Number	Length of Cord (ft.)	AWG (Stranding)	Nom. O.D. (Inches)	UL Type of Cordage	Colors
17205	6	18 (41 x 34)	.243	SVT Vinyl	Black, Gray
17206	6	18 (41 x 34)	.245	SV Rubber	Gray

UL-TYPE SJ RUBBER

For Mixers, Blenders, Washing Machines and Appliances using fractional horse power motors that do not require a three conductor grounding cord. UL Green Flag Label.



Trade Number	Length of Cord (ft.)	AWG (Stranding)	Nom. O.D. (Inches)	UL Type of Cordage	Color
17308	8	18 (16 x 30)	.298	SJ Rubber	Black
17310	10	18 (16 x 30)	.298	SJ Rubber	Black
17328	8	16 (26 x 30)	.323	SJ Rubber	Black
17330	10	16 (26 x 30)	.323	SJ Rubber	Black

Retractable (coiled)

CONVENIENCE AND SAFETY. Dangling cords can be messy, troublesome and unsafe. Retractable cords stay neat, allow free movement of the appliance or tool, and prevent accidents. Rubber insulation and neoprene jackets meet UL requirements and retain full retracting memory through thousands of stretching cycles. UL Green Flag Label.

UL-TYPE SVO NEOPRENE (RETRACTILE)



Trade Number	Retracted Length (in.)	Practical Extended Length (ft.)	AWG (Stranding)	Nom. O.D. (Inches)	UL Type of Cordage	Color
17249	12	6	18 (41 x 34)	.270	SVO Neoprene	Black

BUSINESS MACHINE CORDS

UL-TYPE SJT AND SVT VINYL

17359 fits Burroughs, Monroe and Victor 10 key Adding machines as well as late Friden models and the Burroughs Sensimatic Bookkeeping Machine and Penton Tape Recorder (Triumph model). 17260 fits Revere Projectors and many business machines. UL Blue Flag Label.

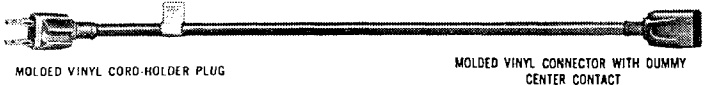

Trade Number	Length of Cord (ft.)	AWG (Stranding)	Nom. O.D. (Inches)	UL Type of Cordage	Color
17359	10	18 (16 x 30)	.298	SJT Vinyl	Gray
17260	8	18 (41 x 34)	.243	SVT Vinyl	Gray

UL-TYPE SJ RUBBER

Fits R. C. Allen Adding Machine and Mimeograph models 100 and 92. Fits following 16MM Motion Picture Projectors: All RCA senior models, all Victor Kalart models, Bell and Howell models 185 through 399. Can also be used as an extension cord where a round connector is required. UL Blue Flag Label.



Trade Number	Length of Cord (ft.)	AWG (Stranding)	Nom. O.D. (Inches)	UL Type of Cordage	Color
17370	10	16 (26 x 30)	.323	SJ Rubber	Black

Belden

 cords

TWO CONDUCTOR EXTENSION CORDS

Information and Application

This new idea in convenience adds an 8' extension cord and you still have an outlet to plug in another cord. UL Blue Flag Label.



Trade Number	Length of Cord (ft.)	AWG (Stranding)	Nom. O.D. (Inches)	UL Type of Cordage	Color
17177	6	18 (41 x 34)	.144 x .277	SPT-2	Brown

CUBE TAP EXTENSION CORD SETS



Manufactured in Brown, Black and Ivory in all popular lengths. The molded three way connector is particularly sturdy and will last long in steady service. UL Blue Flag Label.

Trade Number	Length of Cord (ft.)	AWG (Stranding)	Nom. O.D. (Inches)	UL Type of Cordage	Colors
17156	6	18 (41 x 34)	.110 x .207	SPT-1 Vinyl	Brown, Ivory
17159	9	18 (41 x 34)	.110 x .207	SPT-1 Vinyl	Brown, Ivory
17162	12	18 (41 x 34)	.110 x .207	SPT-1 Vinyl	Brown, Ivory
17165	15	18 (41 x 34)	.110 x .207	SPT-1 Vinyl	Brown, Ivory

UL-TYPE SV AND SJ RUBBER



The molded plugs and connectors give long service life. The CORD-HOLDER plug provides easier storage. It can also be used as cord shortener. For longer extension cords of this type, see Lawnmower and Vacuum Cleaner cords. UL Blue Flag Label.

Trade Number	Length of Cord (ft.)	AWG (Stranding)	Nom. O.D. (Inches)	UL Type of Cordage	Colors
17259	9	18 (41 x 34)	.245	SV Rubber	Gray
17361	10	16 (26 x 30)	.323	SJ Rubber	Black

UL-TYPE SJ AND S RUBBER



For use where a round connector is required. Also used as a power supply cord for some appliances. For longer extensions where a heavier duty type cord is needed for added insulation and abrasion protection use 17555 or 17556. UL Blue Flag Label.

Trade Number	Length of Cord (ft.)	AWG (Stranding)	Nom. O.D. (Inches)	UL Type of Cordage	Color
17370	10	16 (26 x 30)	.323	SJ Rubber	Black
17555	25	16 (65 x 34)	.401	S Rubber	Black
17556	50	16 (65 x 34)	.401	S Rubber	Black

EXTENSION CORDS WITH DUPLEX CONNECTORS

UL-TYPE SJO AND SO NEOPRENE

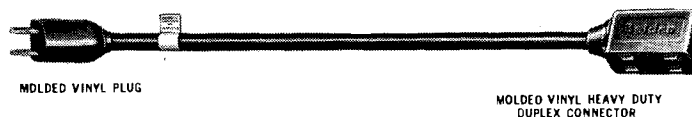

These extension cords with the duplex connector are designed to withstand the punishment of shop, garage and factory use.

These cords are ideal for sound and broadcast studios. The entire cord is oil, grease and ozone resistant. UL Blue Flag Label.

Trade Number	Length of Cord (ft.)	AWG (Stranding)	Nom. O.D. (Inches)	UL Type of Cordage	Color
17375	25	16 (26 x 30)	.323	SJO Neoprene	Black
17565	25	14 (41 x 30)	.528	SO Neoprene	Black
17566	50	14 (41 x 30)	.528	SO Neoprene	Black

THREE CONDUCTOR POWER SUPPLY CORDS

UL-TYPE SJ RUBBER, SJT VINYL AND SJO NEOPRENE

Information and Application



MOLDED VINYL GROUNDING PLUG

OUTER JACKET STRIPPED 2" CONDUCTORS STRIPPED AND TWISTED 3/4"

For all tools such as sanders, saws, grinders and polishers requiring grounding. Three conductor Cord now listed by UL as mandatory for drills 1/8" and larger. UL Green Flag Label.

Trade Number	Length of Cord (ft.)	AWG (Stranding)	Nom. O.D. (Inches)	UL Type of Cordage	Colors
17406	6	18 (16 x 30)	.328	SJ Rubber	Black
17405	6	18 (16 x 30)	.328	SJT Vinyl	Gray
17408	8	18 (16 x 30)	.328	SJ Rubber	Black
17407	8	18 (16 x 30)	.328	SJT Vinyl	Gray
17409	8	18 (16 x 30)	.328	SJO Neoprene	Black
17412	12	18 (41 x 34)	.328	SJ Rubber	Black
17419	9	16 (65 x 34)	.353	SJ Rubber	Black
17422	12	16 (65 x 34)	.353	SJ Rubber	Black
17425	15	16 (65 x 34)	.353	SJ Rubber	Black

UL-TYPE SV RUBBER AND SVT VINYL

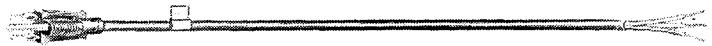

MOLDED VINYL GROUNDING PLUG

OUTER JACKET STRIPPED 1 1/2" CONDUCTORS STRIPPED AND TWISTED 3/4"

Three conductor SV and SVT cords now recognized as a UL Standard for some small tools, business machines and instruments which previously required a three conductor SJ Cord. UL Green Flag Label.

Trade Number	Length of Cord (ft.)	AWG (Stranding)	Nom. O.D. (Inches)	UL Type of Cordage	Colors
17236	6	18 (41 x 34)	.265	SV Rubber	Black
17238	8	18 (41 x 34)	.265	SV Rubber	Black
17237	6	18 (41 x 34)	.253	SVT Vinyl	Gray
17239	8	18 (41 x 34)	.253	SVT Vinyl	Gray

UL TYPE S RUBBER



MOLDED VINYL GROUNDING PLUG

OUTER JACKET STRIPPED 2" CONDUCTORS STRIPPED AND TWISTED 3/4"

For heavy duty power tools and equipment. UL Green Flag Label.

Trade Number	Length of Cord (ft.)	AWG (Stranding)	Nom. O.D. (Inches)	UL Type of Cordage	Color
17629	9	14 (41 x 30)	.558	S Rubber	Black
17635	15	14 (41 x 30)	.558	S Rubber	Black

UL-TYPE SJO NEOPRENE (RETRACTILE)

Retractile (coiled)



MOLDED VINYL GROUNDING PLUG

OUTER JACKET STRIPPED 1 1/2". CONDUCTORS STRIPPED 1/2" AND TINNED

CONVENIENCE AND SAFETY. Dangling cords can be messy, troublesome and unsafe. Retractable cords stay neat, allow free movement of the appliance or tool, and prevent accidents. Rubber insulation and neoprene jackets meet UL requirements and retain full retracting memory through thousands of stretching cycles. UL Green Flag Label.

Trade Number	Retracted Length (in.)	Practical Extended Length (ft.)	AWG (Stranding)	Nom. O.D. (Inches)	UL Type of Cordage	Color
17447	12	6	18 (41 x 34)	.360	SJO Neoprene	Black
17448	12	6	16 (65 x 34)	.370	SJO Neoprene	Black
17449	24	12	16 (65 x 34)	.370	SJO Neoprene	Black

THREE CONDUCTOR PROJECTOR AND BUSINESS MACHINE CORD

UL-TYPE SVT VINYL



MOLDED VINYL GROUNDING PLUG

MOLDED VINYL 3-CONTACT CONNECTOR

Can be used for Revere and Eastman Kodak projectors, Friden, Victor, Hewlett-Packard, Marchant business machines, and DuKane audio equipment. UL Blue Flag Label.

Trade Number	Length of Cord (ft.)	AWG (Stranding)	Nom. O.D. (Inches)	UL Type of Cordage	Color
17258	8	18 (41 x 34)	.253	SVT Vinyl	Gray

Belden cords

THREE CONDUCTOR EXTENSION CORDS

Information and Application

This new idea in convenience adds an 8' extension cord and you still have an outlet to plug in another cord. UL Blue Flag Label.

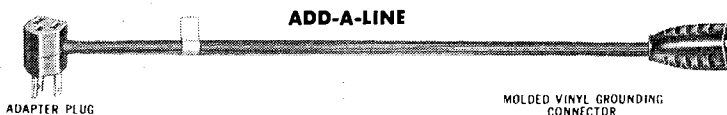

Trade Number	Length of Cord (ft.)	AWG (Stranding)	Nom. O.D. (inches)	UL Type of Cordage	Color
17462	8	18 (16 x 30)	.328	SJT Vinyl	Black

UL-TYPE SJT AND ST VINYL



YELLOW CORDAGE stands out against green or brown backgrounds and thus reduces hazard of accidental cutting.

These extension cord sets are for lawnmowers and hedge clippers using three conductor power supply cordage. UL Blue Flag Label.

Trade Number	Length of Cord (ft.)	AWG (Stranding)	Nom. O.D. (inches)	UL Type of Cordage	Color
17491	25	18 (16 x 30)	.328	SJT Vinyl	Yellow
17492	50	18 (16 x 30)	.328	SJT Vinyl	Yellow
17493	100	18 (16 x 30)	.328	SJT Vinyl	Yellow
17494	25	16 (26 x 30)	.353	SJT Vinyl	Yellow
17495	50	16 (26 x 30)	.353	SJT Vinyl	Yellow
17497	100	16 (26 x 30)	.353	SJT Vinyl	Yellow
17694	25	14 (41 x 30)	.558	ST Vinyl	Yellow
17695	50	14 (41 x 30)	.558	ST Vinyl	Yellow
17697	100	14 (41 x 30)	.558	ST Vinyl	Yellow

UL-TYPE SPT-2 VINYL



FLAT YELLOW 3 conductor extension cords for most light duty purposes. Particularly popular with the marine trade. UL Blue Flag Label.

Trade Number	Length of Cord (ft.)	AWG (Stranding)	Nom. O.D. (inches)	UL Type of Cordage	Color
17194	25	16 (65 x 34)	.152 x .460	SPT-2	Yellow
17195	50	16 (65 x 34)	.152 x .460	SPT-2	Yellow

UL-TYPE SJ RUBBER



Power Supply Cord for business, mowing machines and electrical equipment that have a built in receptacle with blades and grounding pin for cord attachment. These can also be used as extension cords for equipment requiring grounding. UL Blue Flag Label.

Trade Number	Length of Cord (ft.)	AWG (Stranding)	Nom. O.D. (inches)	UL Type of Cordage	Color
17460	10	18 (16 x 30)	.328	SJ Rubber	Black
17461	10	16 (26 x 30)	.353	SJ Rubber	Black

UL-TYPE SJO AND SO NEOPRENE



These three conductor extension cords are for use with power tools and other appliances requiring grounding. These extension cords with the rugged Belden duplex connectors will give years of safe, reliable service. UL Blue Flag Label.

Trade Number	Length of Cord (ft.)	AWG (Stranding)	Nom. O.D. (inches)	UL Type of Cordage	Color
17475	25	16 (26 x 30)	.353	SJO Neoprene	Black
17476	50	16 (26 x 30)	.353	SJO Neoprene	Black
17477	100	16 (26 x 30)	.353	SJO Neoprene	Black
17675	25	14 (41 x 30)	.558	SO Neoprene	Black
17676	50	14 (41 x 30)	.558	SO Neoprene	Black

cords

Belden

VACUUM CLEANER AND FLOOR POLISHER CORDS

Information and Application

For all Standard Home Vacuum Cleaners and Floor Polishers not requiring a Plug-in type connector. UL Green Flag Label.
The CORD-HOLDER plug is a proven convenience for storing cleaner and cord.

Color Shades Match Exactly Original Equipment Manufacturer's Specifications.

WITHOUT CONNECTOR



MOLDED VINYL CORD- HOLDER PLUG

JACKET STRIPPED 1/2", CONDUCTORS STRIPPED AND TWISTED 3/8"

Trade Number	Length of Cord (ft.)	AWG (Stranding)	Nom. O.D. (inches)	UL Type of Cordage	Color
17220	20	18 (41 x 34)	.245	SV Rubber	Black, Brown, Gray
17222	20	18 (41 x 34)	.243	SVT Vinyl	Black, Brown, Gray, Red, Green

WITH CONNECTORS



MOLDED VINYL CORD- HOLDER PLUG

MOLDED STRAIN RELIEF FOR ATTACHMENT

MOLDED VINYL CONNECTOR FOR BLADE PRONGS

Fits Kirby Cleaners requiring connector as illustrated. Note: Strain relief for hooking cord to the hook of Kirby Sweeper handle. UL Blue Flag Label.

Trade Number	Length of Cord (ft.)	AWG (Stranding)	Nom. O.D. (inches)	UL Type of Cordage	Color
17270	20	18 (41 x 34)	.245	SV Rubber	Gray
17272	20	18 (41 x 34)	.243	SVT Vinyl	Gray
17274	32	18 (41 x 34)	.243	SVT Vinyl	Gray



MOLDED VINYL CORD- HOLDER PLUG

MOLDED STRAIN RELIEF FOR ATTACHMENT

MOLDED VINYL CONNECTOR FOR BLADE PRONGS

Fits Kirby Cleaners requiring connector as illustrated but may be used on other cleaners. UL Blue Flag Label.

Trade Number	Length of Cord (ft.)	AWG (Stranding)	Nom. O.D. (inches)	UL Type of Cordage	Color
17271	20	18 (41 x 34)	.245	SV Rubber	Gray
17273	20	18 (41 x 34)	.243	SVT Vinyl	Gray



MOLDED VINYL CORD-HOLDER PLUG

MOLDED VINYL CONNECTOR FOR ROUND PINS

For Vacuum Cleaners with round pin connectors such as Apex and Electrolux models without the reeling device. UL Blue Flag Label.

Trade Number	Length of Cord (ft.)	AWG (Stranding)	Nom. O.D. (inches)	UL Type of Cordage	Color
17288	18	18 (41 x 34)	.245	SV Rubber	Gray
17290	20	18 (41 x 34)	.245	SV Rubber	Gray
17291	20	18 (41 x 34)	.243	SVT Vinyl	Gray

WITH STRAIN RELIEF

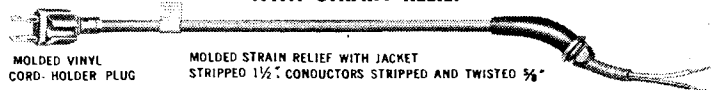

MOLDED VINYL CORD- HOLDER PLUG

MOLDED STRAIN RELIEF WITH JACKET STRIPPED 1/2" CONDUCTORS STRIPPED AND TWISTED 3/8"

For several Hoover and Sunbeam Models requiring a molded strain relief as illustrated. UL Green Flag Label.

Color Shades Match Exactly Original Equipment Manufacturer's Specifications.

Trade Number	Length of Cord (ft.)	AWG (Stranding)	Nom. O.D. (inches)	UL Type of Cordage	Color
17221	20	18 (41 x 34)	.245	SV Rubber	Blue, Brown, White
17223	20	18 (41 x 34)	.243	SVT Vinyl	Blue, Brown, White, Red, Green

Belden

range dryer, air conditioner cords and cordlites

RANGE—DRYER AND AIR CONDITIONER CORDS

FLAT UL-TYPE SRDT VINYL RANGE CORDS



3-PRONG MOLDED VINYL, RIGHT-ANGLE PLUG 3 CONDUCTOR FLAT SRDT CORDAGE -BLACK UL GREEN FLAG LABEL CONDUCTORS SPLIT 2 1/4" TERMINALS FOR 1/4" STUD, STRAIN RELIEF CLAMP

Trade Number	Length of Cord (ft.)	Rating	AWG
1706	3	50A-250V	2-#6 & 1-#8
1714	4	50A-250V	2-#6 & 1-#8
1715	5	50A-250V	2-#6 & 1-#8
1775	6	50A-250V	2-#6 & 1-#8
1709	3	35A-250V	2-#8 & 1-#10
1724	4	35A-250V	2-#8 & 1-#10
1725	5	35A-250V	2-#8 & 1-#10
1785	6	35A-250V	2-#8 & 1-#10

UL-TYPE S AIR CONDITIONER EXTENSION CORD SETS



MOLDED VINYL 3 PRONG GROUNDING PLUG MOLDED RUBBER GROUNDING CONNECTOR

Trade Number	Length of Cord (ft.)	AWG (Stranding)	Nom. OD (inches)	UL Type of Cordage	Rating at 125V (amps.)	Color
17656	6	14 (41 x 30)	.558	S Rubber	15	Gray
17659	9	14 (41 x 30)	.558	S Rubber	15	Gray
17662	12	14 (41 x 30)	.558	S Rubber	15	Gray

Three popular lengths of extension cords for all makes of air conditioners. UL rated 15A - 125V. Note that UL recognizes round jacketed cordage ONLY for this application. UL Blue Flag Label.

FLAT UL-TYPE SRDT VINYL DRYER CORDS



3-PRONG MOLDED VINYL, RIGHT-ANGLE PLUG 3 CONDUCTOR FLAT SRDT CORDAGE -BLACK UL GREEN FLAG LABEL CONDUCTORS SPLIT 2 1/4" TERMINALS FOR 1/4" STUD, STRAIN RELIEF CLAMP

Trade Number	Length of Cord (ft.)	Rating	AWG
1780	3	30A-250V	10
1734	4	30A-250V	10
1735	5	30A-250V	10
1782	6	30A-250V	10



MOLDED VINYL 3 PRONG GROUNDING PLUG CONDUCTORS SPLIT 1 1/2" STRIPPED 1/4" MIDDLE CONDUCTOR STRIPPED 3/8" TO SHOW GREEN INSULATION

Trade Number	Length of Cord (ft.)	AWG (Stranding)	Nom. OD (inches)	UL Type of Cordage	Rating	Color
17140	6	14 (41 x 30)	.229 x .637	SPT-3 Vinyl	15A-125V	Gray
17141	6	14 (41 x 30)	.229 x .637	SPT-3 Vinyl	15A-250V	Gray

17140 is rated 15A—125V. 17141 is rated 15A—250V. For room air conditioners and domestic automatic washers. UL Green Flag Label.

CORDLITES®

TWO CONDUCTOR UL-TYPE SJT VINYL CORDLITES

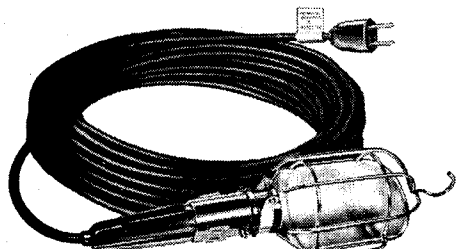

Vinyl Cordlites UL Blue Flag Label

Trade Number	Length of Cord (ft.)	AWG & No. of Conductors	Nom. OD (inches)	UL Type of Cordage	Color
17925	25	18-2	.298	SJT Vinyl	Black
17950	50	18-2	.298	SJT Vinyl	Black

These Cordlites are oil and ozone resistant. The handle has a feed through switch and two tool tops. 17923 lamp guard included.

TWO AND THREE CONDUCTOR UL-TYPE SJO NEOPRENE CORDLITES

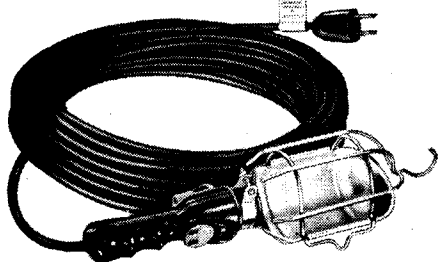

Neoprene Cordlites UL Blue Flag Label

Trade Number	Length of Cord (ft.)	AWG & No. of Conductors	Nom. OD (inches)	UL Type of Cordage	Color
17995	25	18-2	.298	SJO Neoprene	Black
17996	50	18-2	.298	SJO Neoprene	Black
17998	25	18-3	.328	SJO Neoprene	Black
17999	50	18-3	.328	SJO Neoprene	Black

These Cordlites are oil and ozone resistant. The tool tops on the 3 conductor cords are of the 3-contact 15A - 125V grounding type. 17923 lamp guard included.

cord-reels and accessories

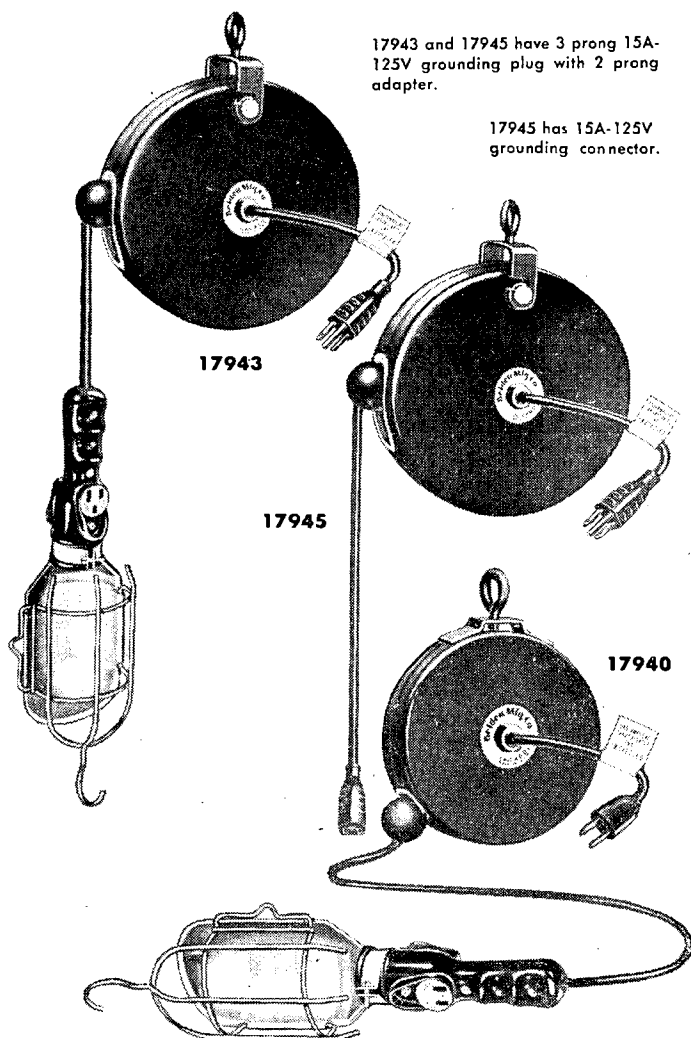
Belden**CORD-REELS**

17943 and 17945 have 3 prong 15A-125V grounding plug with 2 prong adapter.

17945 has 15A-125V grounding connector.

HEAVY DUTY CORDLITE REEL

8 $\frac{3}{4}$ " Diameter by 2 $\frac{1}{2}$ " wide, individually packaged with 17923 Lamp Guard in a Display Carton. Phenolic handle with grounding tool tap.

Trade Number	Length of Cord (ft.)	AWG & No. of Conductors	Nom. OD (Inches)	UL Type of Cordage
17943	30	18-3	.328	SJO Neoprene

HEAVY DUTY EXTENSION REEL

8 $\frac{3}{4}$ " Diameter by 2 $\frac{1}{2}$ " wide, individually packaged. For use where additional length of three way cordage is needed with a reeling device feature.

Trade Number	Length of Cord (ft.)	AWG & No. of Conductors	Nom. OD (Inches)	UL Type of Cordage
17945	25	16-3	.353	SJO Neoprene

COMPACT CORDLITE REEL

6 $\frac{1}{2}$ " Diameter by 1 $\frac{3}{4}$ " wide, individually packaged with 17923 Lamp Guard in a Display Carton. Phenolic handle with tool tap.

Trade Number	Length of Cord (ft.)	AWG & No. of Conductors	Nom. OD (Inches)	UL Type of Cordage
17940	20	18-2	.245	SVO Neoprene

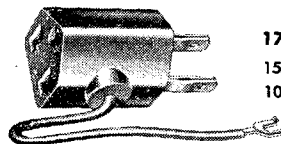
TWO PRONG 3-WIRE ADAPTER

17922
15A-125V ground plug
10 to a package. U.L. Listed.

ACCESSORIES**CORDLITE® LAMP GUARD**

Swing open type for easy replacement of bulb.
10 to a package **17923**

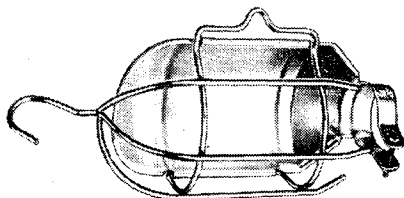
**CORDLITE SWITCH SOCKET**

Push thru switch with contacts for double tool tap. Will fit most Cordlite handles.
5 to a package **17931**

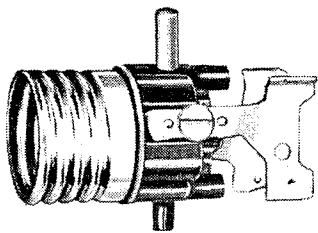
**CORDLITE HANDLES**

Hi-impact fiber reinforced phenolic handles with protective barrier around the switch buttons. One tool tap. Switch and socket are included.

17932 is for 2 conductor cordage

17933 is for 3 conductor cordage

Belden

portable cordage

LISTED BY UNDERWRITERS' LABORATORIES, INC.

Description	Trade Number & Standard Pkg. In Ft.		Size AWG & Stranding	Nom. O.D. (inches)	Weight Std. Pkg. in (lbs.)	Colors
	25	250 Spls.				

S-2 CONDUCTOR—RUBBER JACKET 600V-60°C

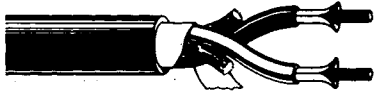
	18104	2S-250	18 (41 x 34)	.386	43	Black
	18103	2S-250	16 (65 x 34)	.401	48	Black
	18102	C-250	14 (41 x 30)	.528	36	Black
	18101	C-250	12 (65 x 30)	.599	46	Black
	18100	C-250	10 (105 x 30)	.643	56	Black

S-3 CONDUCTOR—RUBBER JACKET 600V-60°C

 18107—Lateral separator wrap under jacket	18109	C-250	18 (41 x 34)	.401	22	Black
	18108	C-250	16 (65 x 34)	.426	27	Black
	18107	C-250	14 (41 x 30)	.558	45	Black, Nickel Gray
	18106	C-250	12 (65 x 30)	.634	57	Black
	18105	C-250	10 (105 x 30)	.689	74	Black

SO-2 CONDUCTOR—NEOPRENE JACKET 600V-60°C

	18204	2S-250	18 (41 x 34)	.386	46	Black
	18203	2S-250	16 (65 x 34)	.401	51	Black
	18202	C-250	14 (41 x 30)	.528	39	Black
	18201	C-250	12 (65 x 30)	.599	50	Black
	18200	C-250	10 (105 x 30)	.643	60	Black

SO-3 CONDUCTOR—NEOPRENE JACKET 600V-60°C

 18207—Lateral separator wrap under jacket	18209	C-250	18 (41 x 34)	.401	23	Black
	18208	C-250	16 (65 x 34)	.426	28	Black
	18207	C-250	14 (41 x 30)	.558	48	Black
	18206	C-250	12 (65 x 30)	.634	60	Black
	18205	C-250	10 (105 x 30)	.689	77	Black
	★ 18210	C-50	8 (132 x 29)	.872	30	Black
	★ 18210	C-200	8 (132 x 29)	.872	89	Black
	★ 18211	C-50	6 (133 x 27)	.961	38	Black
	★ 18211	C-200	6 (133 x 27)	.961	120	Black

SO-4 CONDUCTOR—NEOPRENE JACKET 600V-60°C

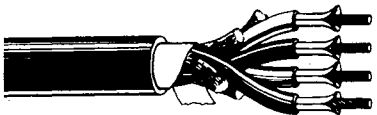
	★ 18217	C-50	14 (41 x 30)	.603	16	Black
	★ 18217	C-200	14 (41 x 30)	.603	50	Black
	★ 18216	C-50	12 (65 x 30)	.690	22	Black
	★ 18216	C-200	12 (65 x 30)	.690	66	Black
	★ 18215	C-50	10 (105 x 30)	.770	27	Black
	★ 18215	C-200	10 (105 x 30)	.770	85	Black
	★ 18214	C-25	8 (132 x 29)	.970	22	Black
	★ 18214	C-100	8 (132 x 29)	.970	67	Black
	★ 18213	C-25	6 (133 x 27)	1.090	27	Black
★ 18213	C-100	6 (133 x 27)	1.090	88	Black	

SJ-2 CONDUCTOR—RUBBER JACKET 300V-60°C

	18127	2S-250	18 (16 x 30) Flex	.298	26	Black
	18111	2S-250	18 (41 x 34) X flex.	.298	26	Black
	18128	2S-250	16 (26 x 30) Flex	.323	32	Black
	18110	2S-250	16 (65 x 34) X flex.	.323	33	Black

*New Item

Continuous lengths will be supplied on at least 85% of each shipment.

When 2 lengths are supplied, 50 ft. will be minimum.

Shipped only in standard packages as listed above









See current carrying capacity tables on page 54

BELDEN PAGE 48

portable cordage

Belden

LISTED BY UNDERWRITERS' LABORATORIES, INC.

Description	Trade Number & Standard Pkg. in Ft. 25 250 2 250 Spls. 45 250 4 250 Spls. C Coil	Size AWG & Stranding	Nom. O.D. (inches)	Weight Std. Pkg. in (lbs.)	Colors	
SJ-3 CONDUCTOR—RUBBER JACKET 300V-60°C						
	18129	25-250	18 (16 x 30) Flex	.328	35	Black
	18125	25-250	18 (41 x 34) X flex.	.328	35	Black
	18130	25-250	16 (26 x 30) Flex	.353	42	Black
	18124	25-250	16 (65 x 34) X flex.	.353	43	Black
SJO-2 CONDUCTOR—NEOPRENE JACKET 300V-60°C						
	18227	25-250	18 (16 x 30) Flex	.298	27	Black
	18228	25-250	16 (26 x 30) Flex	.323	35	Black
SJO-3 CONDUCTOR—NEOPRENE JACKET 300V-60°C						
	18229	25-250	18 (16 x 30) Flex	.328	36	Black
	18230	25-250	16 (26 x 30) Flex	.353	42	Black
SJT-2 CONDUCTOR—PLASTIC JACKET 300V-60°C						
	18141	25-250	18 (41 x 34) X flex.	.298	26	Black, Red
	18142	25-250	16 (65 x 34) X flex.	.323	32	
SV-2 CONDUCTOR—RUBBER JACKET 300V-60°C						
	18120	25-250	18 (41 x 34)	.245	20	Black, Nickel Gray
SVT-2 CONDUCTOR—PLASTIC JACKET 300V-60°C						
	18140	25-250	18 (41 x 34)	.243	19	Black
SPT-1, SPT-2 PLASTIC PARALLEL LAMP CORD 300V-60°C						
	18122	45-250	18 SPT-1 (41 x 34)	.110 x .207	24	Black, Brown, Silver Gray, White
	18123	25-250	18 SPT-2 (41 x 34)	.144 x .277	17	
	18126	25-250	16 SPT-2 (65 x 34)	.155 x .299	21	Black, Brown, Silver Gray
SP-1, SP-2 RUBBER PARALLEL LAMP CORD 300V-60°C						
	18115	45-250	18 SP-1 (41 x 34)	.110 x .213	25	Black, Brown
	18121	25-250	18 SP-2 (41 x 34)	.140 x .276	17	Black, Brown

Continuous lengths will be supplied on at least 85% of each shipment.
When 2 lengths are supplied, 50 ft. will be minimum.

Shipped only in standard packages as listed above

See current carrying capacity tables on page 54

BELDEN PAGE 49

Belden

portable cordage

LISTED BY UNDERWRITERS' LABORATORIES, INC.

Description	Trade Number & Standard Pkg. In Fl. 25 250 2 250 Spls. 45 250 4 250 Spls. C Coil	Size AWG & Stranding	Nom. O.D. (inches)	Weight Std. Pkg. in (lbs.)	Colors
-------------	--	-------------------------	-----------------------	----------------------------------	--------

HPN-2 CONDUCTOR—NEOPRENE HEATER CORD 300V-90°C

	18328	2S-250	18 (41 x 34)	.140 x .276	18	Black
	18326	2S-250	16 (65 x 34)	.152 x .300	23	Black

HPD-2 CONDUCTOR—GLAZED COTTON HEATER CORD 300V-90°C

	18318	2S-250	18 (41 x 34)	.265	18	Black, 1 White Tracer
	18316	2S-250	16 (65 x 34)	.285	22	
	18314	2S-250	14 (104 x 34)	.320	35	

HPD-2 CONDUCTOR—SOFT COTTON HEATER CORD 300V-90°C

	18338	2S-250	18 (41 x 34)	.265	18	Black, 2 White Tracers
	18336	2S-250	16 (65 x 34)	.285	22	

Continuous lengths will be supplied on at least 85% of each shipment.

When 2 lengths are supplied, 50 ft. will be minimum. Shipped only in standard packages as listed above

SUGGESTED AWG SIZE FOR LONG POWER SUPPLY CORDS*

Cord Length**	Current (amperes)**																								
	1	2	3	4	5	6	7	8	9	10	11	12	13	14	15	16	17	18	19	20	21	22	23	24	25
25	18	18	18	18	18	18	18	16	16	16	14	14	14	14	14	12	12	12	12	12	10	10	10	10	10
50	18	18	18	18	18	18	18	16	16	16	14	14	14	14	14	12	12	12	12	12	10	10	10	10	10
75	18	18	18	18	18	18	18	16	16	16	14	14	14	14	14	12	12	12	12	12	10	10	10	10	10
100	18	18	18	18	18	18	18	16	16	16	14	14	14	14	14	12	12	12	12	12	10	10	10	10	10
125	18	18	18	18	18	18	16	16	16	16	14	14	14	14	14	12	12	12	12	12	10	10	10	10	10
150	18	18	18	18	18	16	16	16	14	14	14	14	14	14	12	12	12	12	12	12	10	10	10	10	10

*Rubber and plastic cords, but not including heater cords. Based on a line voltage of 115 and maximum voltage drop (loss) of 10 volts when cord carries rated current.

**To determine correct AWG, refer to cord length in table, and current nearest the current rating on the name plate of the appliance.

CURRENT CARRYING CAPACITY OF FLEXIBLE CORDAGE (amperes)*

AWG	Tinsel Cords	Rubber and Plastic Cords	Heater Cords
27	0.5	—	—
18	—	7	10
17	—	—	12
16	—	10	15
15	—	—	17
14	—	15	20
12	—	20	30
10	—	25	—
8	—	35	—
6	—	45	—
4	—	60	—

*Underwriters' Laboratories Inc. and National Electrical Code Standard for 2 and 3 conductor cords. For cords with 4 to 6 conductors, the current rating is 80% of the values shown.

cabLe finder

Belden

INDICATES SOLID CONDUCTORS, ALL OTHERS STRANDED CONDUCTORS

No. of Conductors	2 Cond.		3 Cond.		4 Cond.		5 Cond.		6 Cond.		7 Cond.		8 Cond.		
	Belden No.	Page No.	Belden No.	Page No.	Belden No.	Page No.	Belden No.	Page No.	Belden No.	Page No.	Belden No.	Page No.	Belden No.	Page No.	
25 AWG or Smaller <i>Shielded</i>	8430	22													
	8429	22	8419	22											
	8416	22	8643	4 & 8											
	8640	7 & 11			8434	9			8642	11					
24 AWG <i>Shielded</i>	8782	14													
	8413	16	8406	16											
	8420	16													
	8641	7													
22 AWG <i>Shielded</i>	8481	14	8443	14 & 15	8741	13	8445	15	8742	13	8447*	15	8757	13	
	8740	13 & 14	8794	15	8444	15			8446*	15			8488	21	
	8442	14	8701	14	8494	17							8448*	15	
	8781	14													
	8795	15													
	8390	8 & 41	8391	8 & 41	8392	9 & 41									
	8422	16	8735	8	8732	9									
	8437	7	8734	10											
	8441	7													
	8738	8													
	8739	7	8731	8											
	8737	7													
	8450	7	8771	8	8723	9	8788	10	8767	12					
	8451	7	8733	10	8729	9			8777	12					
	8761	7			8724	9			8786	10					
				8728	5 & 9										
				8730	5 & 9										
20 AWG <i>Shielded</i>	8649	14	8783	10											
	8205	14			8464	20 & 21	8455*	22							
					8484	21	8485	21							
	8412	16	8423	16	8424	9 & 16	8425	16	8426	16	8427	16	8418	16	
	8758	8	8403	16	8404	9 & 16	8405	16							
	8402	6 & 16													
	8759	7													
	8762	7	8772	8	8722	9							8725	12	
	8393	5, 8 & 41	8763	10											
18 AWG <i>Shielded</i>	8462	22	8453	22	8454	22	8465	15	8690	13	8467	15			
	8888	22			8489	4, 15, 21									
	8452	22	8483†	14											
	8478	22	8487†	14											
	8460	14													
	8461	14													
	8482†	14													
	8492†	14													
	8486†	14													
	8428	16													
	8208	7													
	8789	8													
	8790	7	8791	8											
	8760	7	8770	8											
16 AWG <i>Shielded</i>	8470	14	8475	14 & 40	8476	40					8621	15			
	8471	14			8620	15									
	8472	22													
	8677	40													
	8779	8			8407	9 & 16									
	8409	6 & 16													
8780	7														
8719	7	8618	5 & 8												
14 AWG <i>Shielded</i>	8473	14	8479	4 & 22	8627	15					8628	15			
	8474	22													
	8675	40													
	8720	7													
12 AWG	8477	3 & 14													
	8718	5 & 7													

*2 Conductors are 18 AWG †19 AWG ‡Not all pairs are shielded, or conductors are more than one size.

HOW TO USE THE CABLE FINDER CHART

Match the desired "Number of Conductors" column with the required "Conductor Size" to find the applicable Belden Trade Number and its catalog page.

For cables with more than 8 conductors, see Multiple pair and unpaired unshielded cables on page 13 & 15, Multiple pair individually shielded on pages 9, 10 & 12. For cables combining shielded and unshielded conductors, see Special Audio and Communication cables on pages 10 & 11.



teflon wire

Belden

Teflon[®] is a fluorinated thermoplastic with outstanding thermal physical and electrical properties. However, because the basic resin and processing costs are relatively high, Teflon is generally restricted to applications requiring its special characteristics.

Belden Teflon wire products are highly recommended for miniature cable applications, because of their superior

thermal and electrical properties. Teflon is especially suitable for internal wiring soldering applications where insulation melt back is a specific problem. Belden Teflon wiring products are outstanding in their resistance to oil, oxidation, heat, sunlight, flame and their ability to remain flexible at low temperatures. They all have excellent resistance to ozone, water, alcohol, gasoline, acids, alkalis, aromatic carbon and solvents.

teflon hook-up wire

TYPE E—MIL-W-16878 TEFLON—600V—200°C



Stock Colors 1 thru 10

Concentrically stranded silver coated copper conductor, extruded TFE Teflon insulated

Trade Number	Type Designation	AWG & (Stranding)	Nom. O.D. (Inch)	Insulation Thickness (Inch)	Standard Spool Lengths in ft.
83000	E-30	30 (7x38)	.033	.010	25, 100, 500, 1000
83001	E-28	28 (7x36)	.036	.010	25, 100, 500, 1000
83002	E-26	26 (7x34)	.041	.010	25, 100, 500, 1000
83003	E-24	24 (19x36)	.046	.010	25, 100, 500
83004	E-24	24 (7x32)	.045	.010	25, 100, 500, 1000
83005	E-22	22 (7x30)	.051	.010	25, 100, 500, 1000
83006	E-22	22 (19x34)	.052	.010	25, 100, 500, 1000
83007	E-20	20 (19x32)	.060	.010	25, 100, 500, 1000
83008	E-20	20 (7x28)	.059	.010	25, 100, 500
83009	E-18	18 (19x30)	.071	.010	25, 100, 500, 1000
83010	E-16	16 (19x29)	.080	.010	25, 100, 500, 1000

TYPE EE—MIL-W-16878 TEFLON—1000V—200°C



Stock Colors 1 thru 10

Concentrically stranded silver coated copper conductor, extruded TFE Teflon insulated

Trade Number	Type Designation	AWG & (Stranding)	Nom. O.D. (Inch)	Insulation Thickness (Inch)	Standard Spool Lengths in ft.
83023	EE-24	24 (19x36)	.053	.014	25, 100, 500
83025	EE-22	22 (7x30)	.058	.014	25, 100, 500
83026	EE-22	22 (19x34)	.060	.014	25, 100, 500, 1000
83027	EE-20	20 (19x32)	.068	.014	25, 100, 500, 1000
83028	EE-20	20 (7x28)	.066	.014	25, 100, 500
83029	EE-18	18 (19x30)	.079	.014	25, 100, 500, 1000
83030	EE-16	16 (19x29)	.086	.014	25, 100, 500, 1000

Stock Colors

- | | | | | |
|----------|-----------|---------------|--------------------|-----------|
| 1. Brown | 3. Orange | 5. Green | 7. Violet (purple) | 9. White |
| 2. Red | 4. Yellow | 6. Light Blue | 8. Gray (slate) | 10. Black |

Color striping available on 1,000 ft. minimum per item
each color on 500' and 1000' spools.

Manufactured to current Government specifications and subsequent revisions.

NEW miniature teflon hook-up wire

TYPE ET—MIL-W-16878 TEFLON—250V—200°C



Stock Colors 1 thru 10

Concentrically stranded silver coated copper conductor, extruded TFE Teflon insulated

Trade Number	Type Designation	AWG (Stranding)	Nom. O.D. (Inch)	Insulation Thickness (Inch)	Standard Spool Lengths in Ft.
★83041	ET-32	32 (7x40)	.021	.006	100, 1000
★83043	ET-30	30 (7x38)	.024	.006	100, 1000
★83045	ET-28	28 (7x36)	.027	.006	100, 1000
★83046	ET-26	26 (7x34)	.031	.006	100, 1000
★83047	ET-24	24 (7x32)	.036	.006	100, 1000
★83048	ET-24	24 (19x36)	.037	.006	100, 1000
★83049	ET-22	22 (7x30)	.042	.006	100, 1000
★83050	ET-22	22 (19x34)	.044	.006	100, 1000

★New Item. ■ Trade mark of DuPont

Color striping available on 1000 foot minimum per item
each color on 1000 foot spools

Manufactured to current Government specifications and subsequent revisions.

Stock Colors

- | | | | | |
|----------|-----------|---------------|--------------------|-----------|
| 1. Brown | 3. Orange | 5. Green | 7. Violet (purple) | 9. White |
| 2. Red | 4. Yellow | 6. Light Blue | 8. Gray (slate) | 10. Black |



RG/U transmission line cables

Belden

RG/U CABLES

Trade Number	RG No.	AWG (Stranding) Material	Insulation	No. of Shields & Material	Jacket	Nom. O.D. (Inch)	Nom. Imp. (Ohms)	Nom. Vel. of Prop.	Nom. Cap. (mmf ft.)	Nom. Attenuation Per 100' mc db		Standard Spool Lengths in Ft.
★83240	140/U MIL-C-17D	22 (Solid) Silver Coated Copperweld▲	TFE Teflon	1 Silver Coated Copper	Brown Fiberglass	.233	75	69.5	19.5	400	8.0 Max.	100, 500, 1000
★83241	141A/U MIL-C-17D	18 (Solid) Silver Coated Copperweld	TFE Teflon	1 Silver Coated Copper	Brown Fiberglass	.190	50	69.5	29.0	400	9.0 Max.	100, 500, 1000
★83242	142B/U MIL-C-17D	18 (Solid) Silver Coated Copperweld	TFE Teflon	2 Silver Coated Copper	Tinted Brown FEP	.195	50	69.5	29.0	400	9.0 Max.	100, 500, 1000
★83243	143A/U MIL-C-17D	.059 (Solid) Silver Coated Copperweld	TFE Teflon	2 Silver Coated Copper	Brown Fiberglass	.325	50	69.5	29.0	400	6.0 Max.	100, 500, 1000
83265	178B/U MIL-C-17D	30 (7x38) Silver Coated Copperweld	TFE Teflon	1 Silver Coated Copper	Tinted Brown FEP	.070	50	69.5	29.0	400	29.0 Max.	100, 500
★83264	179B/U MIL-C-17D	30 (7x38) Silver Coated Copperweld	TFE Teflon	1 Silver Coated Copper	Tinted Brown FEP	.100	75	69.5	19.5	400	21.0 Max.	100, 500, 1000
83266	180B/U MIL-C-17D	30 (7x38) Silver Coated Copperweld	TFE Teflon	1 Silver Coated Copper	Tinted Brown FEP	.140	95	69.5	15.0	400	17.0 Max.	100, 500
★83267	187A/U MIL-C-17D	30 (7x38) Silver Coated Copperweld	TFE Teflon	1 Silver Coated Copper	White Teflon Tape	.105	75	69.5	19.5	400	21.0 Max.	100, 500, 1000
83269	188A/U MIL-C-17D	26 (7x.0067) Silver Coated Copperweld	TFE Teflon	1 Silver Coated Copper	White Teflon Tape	.102	50	69.5	29.0	400	20.0 Max.	100, 500
83270	196A/U MIL-C-17D	30 (7x38) Silver Coated Copperweld	TFE Teflon	1 Silver Coated Copper	White Teflon Tape	.076	50	69.5	29.0	400	29.0 Max.	100, 500
★83281	302/U MIL-C-17D	22 (Solid) Silver Coated Copperweld	TFE Teflon	1 Silver Coated Copper	Tinted Brown FEP	.202	75	69.5	19.5	400	8.0 Max.	100, 500, 1000
★83282	303/U MIL-C-17D	18 (Solid) Silver Coated Copperweld	TFE Teflon	1 Silver Coated Copper	Tinted Brown FEP	.170	50	69.5	29.0	400	9.0 Max.	100, 500, 1000
★83283	304/U MIL-C-17D	.059 (Solid) Silver Coated Copperweld	TFE Teflon	2 Silver Coated Copper	Tinted Brown FEP	.280	50	69.5	29.0	400	6.0 Max.	100, 500, 1000
★83284	316/U MIL-C-17D	26 (7x.0067) Silver Coated Copperweld	TFE Teflon	1 Silver Coated Copper	Tinted Brown FEP	.098	50	69.5	29.0	400	20.0 Max.	100, 500, 1000

SPECIAL FEP TEFLON INSULATED INSTRUMENTATION CABLES

Description	Trade Number	AWG & (Stranding)	Insulation Thickness (Inch)	Jacket Thickness (Inch)	Nom. O.D. (Inch)	Cond. Color Coding	Percent Shield Coverage	Nom. *Cap. (mmf ft)	Nom. **Cap. (mmf ft)	Suggested Working Voltage	Standard Spool Lengths in ft
 High Temperature (2 cond.)	83390	22 (19x34)	.015	.015	.180	Blk, Wht	90	23	40	1000	25, 100, 500
	83391	22 (19x34)	.015	.015	.190	Blk, Red Wht	90	20	35	1000	25, 100, 500
	83392	22 (19x34)	.015	.015	.205	Red, Blk, Grn, Wht	90	20	35	1000	25, 100, 500
Stranded tinned copper, FEP teflon [■] insulated, cabled, tinned copper braid shield, white FEP teflon jacket. HIGH TEMPERATURE +200° C maximum, -70° C minimum operating temperature. Ideal where chemical resistance is needed and/or extremely high or low temperatures are required.											
 (2 cond.)	83393	20 (7x28)	.020	.030	.245	Blk, Red	100	22	42	1000	25, 100, 500
	Tinned copper, FEP Teflon insulated, noise reducing tape, 20 AWG (10x30) nickel coated copper drain wire, special Beldfoil shield, Silicone rubber jacket. +150° C maximum -70° C minimum operating temperature. Jacket working voltage 1000V DC, shield to ground.										

*Capacitance between conductors.

**Capacitance between one conductor and other conductor connected to shield.

▲ Trademark of Copperweld Steel Co.

★ New Item.

BELDEN PAGE 53

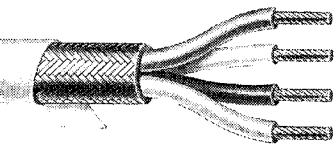

mil-w-16878-Type E shielded teflon cables

Belden

DESCRIPTION: Stranded silver coated copper conductors, type E extruded TFE Teflon insulation, color coded, cabled, braided silver plated copper shield, white TFE Teflon tape wrapped jacket.

MIL-SPEC: MIL-W-16878 Type E
TEMPERATURE RATING: -65°C to 200°C
VOLTAGE: 600Volts (RMS)

TYPE E—TEFLON, SHIELDED, TEFLON JACKETED CABLES

Trade Number	No. of Cond.	AWG & (Stranding)	Insulation Thickness (Inch)	Jacket Thickness (Inch)	Nom. O.D. Inch	Conductor Color Coding	Percent Shield Coverage	Nom. *Cap. (mmf ft.)	Nom. **Cap. (mmf ft.)	Suggested Working Voltage	Standard Spool Lengths in Feet
--------------	--------------	-------------------	-----------------------------	-------------------------	----------------	------------------------	-------------------------	----------------------	-----------------------	---------------------------	--------------------------------

SINGLE CONDUCTOR

★83301	1	30 (7x38)	.010	.010	.074	White	90	30	—	600	100, 500, 1000
★83302	1	28 (7x36)	.010	.010	.078	White	90	35	—	600	100, 500, 1000
★83303	1	26 (7x34)	.010	.010	.082	White	90	40	—	600	100, 500, 1000
★83304	1	24 (19x36)	.010	.010	.088	White	90	51	—	600	100, 500, 1000
★83305	1	22 (19x34)	.010	.010	.094	White	90	60	—	600	100, 500, 1000
★83306	1	20 (19x32)	.010	.010	.103	White	90	67	—	600	100, 500, 1000
★83307	1	18 (19x30)	.010	.010	.113	White	90	75	—	600	100, 500, 1000
★83308	1	16 (19x29)	.011	.012	.123	White	90	89	—	600	100, 500, 1000

TWO CONDUCTOR

★83315	2	30 (7x38)	.010	.010	.106	White, Black	90	15	27	600	100, 500, 1000
★83316	2	28 (7x36)	.010	.010	.112	White, Black	90	18	32	600	100, 500, 1000
★83317	2	26 (7x34)	.010	.010	.120	White, Black	90	20	36	600	100, 500, 1000
★83318	2	24 (19x36)	.010	.010	.132	White, Black	90	22	40	600	100, 500, 1000
★83319	2	22 (19x34)	.010	.010	.144	White, Black	90	26	46	600	100, 500, 1000
★83320	2	20 (19x32)	.010	.012	.162	White, Black	90	28	52	600	100, 500, 1000
★83321	2	18 (19x30)	.010	.012	.188	White, Black	90	30	55	600	100, 500, 1000
★83322	2	16 (19x29)	.011	.012	.200	White, Black	90	33	59	600	100, 500, 1000

THREE CONDUCTOR

★83330	3	30 (7x38)	.010	.010	.111	White, Black, Red	90	14	25	600	100, 500, 1000
★83331	3	28 (7x36)	.010	.010	.117	White, Black, Red	90	17	30	600	100, 500, 1000
★83332	3	26 (7x34)	.010	.010	.126	White, Black, Red	90	19	33	600	100, 500, 1000
★83333	3	24 (19x36)	.010	.010	.136	White, Black, Red	90	22	38	600	100, 500, 1000
★83334	3	22 (19x34)	.010	.012	.156	White, Black, Red	90	24	41	600	100, 500, 1000
★83335	3	20 (19x32)	.010	.012	.175	White, Black, Red	90	27	45	600	100, 500, 1000
★83336	3	18 (19x30)	.010	.012	.196	White, Black, Red	90	28	52	600	100, 500, 1000
★83337	3	16 (19x29)	.011	.012	.218	White, Black, Red	90	30	56	600	100, 500, 1000

FOUR CONDUCTOR

★83345	4	30 (7x38)	.010	.010	.119	White, Black, Red, Green	90	13	24	600	100, 500, 1000
★83346	4	28 (7x36)	.010	.010	.126	White, Black, Red, Green	90	16	28	600	100, 500, 1000
★83347	4	26 (7x34)	.010	.010	.135	White, Black, Red, Green	90	18	32	600	100, 500, 1000
★83348	4	24 (19x36)	.010	.012	.151	White, Black, Red, Green	90	20	36	600	100, 500, 1000
★83349	4	22 (19x34)	.010	.012	.166	White, Black, Red, Green	90	23	40	600	100, 500, 1000
★83350	4	20 (19x32)	.010	.012	.185	White, Black, Red, Green	90	25	44	600	100, 500, 1000
★83351	4	18 (19x30)	.010	.012	.214	White, Black, Red, Green	90	27	50	600	100, 500, 1000
★83352	4	16 (19x29)	.011	.014	.235	White, Black, Red, Green	90	29	54	600	100, 500, 1000

*Capacitance Between Conductors. **Capacitance Between One Conductor and Other Conductor Connected to Shield.
Manufactured to Current Government Specifications and Subsequent Revisions.

★New Item.

Printed in U.S.A.

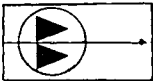

B-105 EXTRUDED PLASTIC TUBING

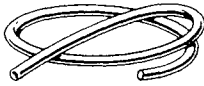

APPROVED FOR 105°C-OPERATION — MEETS MIL-1-631D SPECS — A quality plastic Vinyl tubing designed for electronic and electrical insulation work. Has high dielectric strength, extreme flexibility, non-flammability, abrasion resistance, impervious to oil, water, alkalies, alcohol, solvents, etc., high heat stability and resistance to aging. Meets all A.S.T.M. specifications, Mil. Spec. (Type F, Form U, Grades A and C, Class 2, Category 1).

B&S Gauge Size No.	Birnbach No.	Old Part No.	Nom. I.D.	Nom. Wall
24	B105-24	308	.022	.012
22	B105-22	311	.027	.012
20	B105-20	313	.034	.016
19	B105-19	—	.038	.016
18	B105-18	314	.042	.016
17	B105-17	—	.047	.016
16	B105-16	315	.053	.016
15	B105-15	—	.059	.016
14	B105-14	316	.066	.016
13	B105-13	—	.076	.016
12	B105-12	317	.085	.016
11	B105-11	—	.095	.016
10	B105-10	325	.106	.016
9	B105-9	—	.118	.020
8	B105-8	318	.133	.020
7	B105-7	—	.148	.020
6	B105-6	326	.166	.020
5	B105-5	—	.186	.020
4	B105-4	319	.208	.020
3	B105-3	—	.234	.020

STANDARD COLORS

EVEN NUMBERS — #24, 22, 20, 18, 16 — Clear, Black, Yellow, Red, Green, Brown, Orange, Blue, White, Violet and Gray; #14, 12, 10, 8, 6, 4, 2, 3/4", 5/8", 1/2", 3/8", 1/4" — Clear, Black, Yellow, Red, Green, Brown, Orange, Blue and White.

ODD NUMBERS — #19, 17, 15, 13, 11, 9, 7, 5, 3, 1, 0 — Clear, Black White; #7/8" thru 2 1/2" — Clear, Black, White.

STANDARD PUT-UPS

#24 thru #15	1,000' - 500' - 100' - 50' - 25' spools
#14 thru #8	500' - 100' - 50' - 25' spools
#4 thru 1/2"	250' - 100' - 50' - 25' coils
3/8" thru 7/8"	100' - 50' - 25' coils
1" & larger	50 coils

SIZES #24 THRU #15 AVAILABLE IN 36" LENGTHS

B&S Gauge Size No.	Birnbach No.	Old Part No.	Nom. I.D.	Nom. Wall
2	B105-2	320	.263	.020
1	B105-1	—	.294	.020
0	B105-0	—	.330	.020
5/16"	B105-5/16"	321	.312	.025
3/8"	B105-3/8"	322	.375	.025
7/16"	B105-7/16"	—	.438	.025
1/2"	B105-1/2"	323	.500	.025
9/16"	B105-9/16"	—	.562	.030
5/8"	B105-5/8"	324	.625	.030
3/4"	B105-3/4"	327	.750	.035
7/8"	B105-7/8"	360	.875	.035
1"	B105-1"	361	1.000	.035
1 1/8"	B105-1 1/8"	—	1.125	.040
1 1/4"	B105-1 1/4"	362	1.250	.040
1 3/8"	B105-1 3/8"	—	1.375	.040
1 1/2"	B105-1 1/2"	363	1.500	.045
1 3/4"	B105-1 3/4"	328	1.750	.055
2"	B105-2"	329	2.000	.060
2 1/4"	B105-2 1/4"	364	2.250	.065
2 1/2"	B105-2 1/2"	365	2.500	.070

TABLE OF PHYSICAL & ELECTRICAL PROPERTIES—B-105 TUBING

Tensile Strength—2500 Psi. (Minimum Average)

Flammability—Non-Flammable

Ultimate Elongation—340%

Recommended for Temperatures to—105° C

Cold Bend—40° C

Dielectric Strength .020" Wall—800 V/Mil

Varnish Baking—Good

Water Absorption

Weight Increase (1 Week)—0.1%—Fungi Resistance—Yes

Oil Resistance—Indefinitely flexible when immersed in oil.

Insulation Resistance—over 1,000,000 megohms.

IN STOCK

The Birnbach Line of insulated sleeving and tubing is the basic quality line designed for the rigid performance requirements of the Aircraft, Electrical and Electronic Industries.

Meets or exceeds the required MIL Specifications and ASTM and NEMA standards. We invite your inquiries on special problems and requirements.

B-65 — EXTRUDED PLASTIC TUBING LOW TEMPERATURE — Per MIL-I-7444B to —94° F.

No. B-65 meets Air Force spec. Mil-I-7444 specifically designed for operation at sub-zero temperatures. It is fungus resistant and has excellent dielectric strength.

B&S Gauge Size No.	Birnbach No.	Nom. I.D.	Nom. Wall
24	B65-24	.022	.012
22	B65-22	.027	.012
20	B65-20	.034	.016
19	B65-19	.038	.016
18	B65-18	.042	.016
17	B65-17	.047	.016
16	B65-16	.053	.016
15	B65-15	.059	.016
14	B65-14	.066	.016
13	B65-13	.076	.016
12	B65-12	.085	.016
11	B65-11	.095	.016
10	B65-10	.106	.016
9	B65-9	.118	.020
8	B65-8	.133	.020
7	B65-7	.148	.020
6	B65-6	.166	.020
5	B65-5	.186	.020
4	B65-4	.208	.020
3	B65-3	.234	.020

B&S Gauge Size No.	Birnbach No.	Nom. I.D.	Nom. Wall
2	B65-2	.263	.020
1	B65-1	.294	.020
0	B65-0	.330	.020
5/16"	B65-5/16"	.312	.025
3/8"	B65-3/8"	.375	.025
7/16"	B65-7/16"	.438	.025
1/2"	B65-1/2"	.500	.025
9/16"	B65-9/16"	.562	.030
5/8"	B65-5/8"	.625	.030
3/4"	B65-3/4"	.750	.035
7/8"	B65-7/8"	.875	.035
1"	B65-1"	1.000	.035
1 1/4"	B65-1 1/4"	1.250	.040
1 3/8"	B65-1 3/8"	1.375	.040
1 1/2"	B65-1 1/2"	1.500	.045
1 3/4"	B65-1 3/4"	1.750	.055
2"	B65-2"	2.000	.060
2 1/4"	B65-2 1/4"	2.250	.065
2 1/2"	B65-2 1/2"	2.500	.070

STANDARD COLOR—Clear (Amber)
STANDARD PUT-UPS SAME AS BIRACD 105
EXCEPT OMIT 36" LENGTHS

Applicable Specifications

Air Force Spec. MIL-1-7444

Dielectric Strength

750 v/mil

Temp. Rating

60°C

LowTemp. Flexibility

—65°C

Flame Resistance

Good

Elongation

360%

Tensile Strength

2200 PSI

ALL THE ABOVE TUBING CAN BE ORDERED CUT AND MARKED TO YOUR SPECIFICATIONS

BIRNBACH

COMPANY INC. FOR MORE INFORMATION ON COMPLETE LINES, WRITE FOR NEW CATALOG.

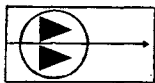

B-130 — VINYL COATED/FIBERGLASS SLEEVING

Per MIL-I-3190B and NEMA Standards to 130° C.



(ASTM, NEMA Grade B-B-1) MEETS MIL-I-3190 SPECS. — Quality Electronic and Electrical Tubing. It is Class B Insulation that combines the best features of the inorganic fiberglass base sleeving with heat resistant, flexible plastic insulation. The plastic compound provides the highest electrical properties, heat stability (130° C.), flexibility and toughness. Meets performance requirements of specs. MIL-I-3190 A, NEMA VSI, ASTM D 372.

Birnbach No.	B&S Ga. Size No.	Old No.	Nom. I.D.	Birnbach No.	B&S Ga. Size No.	Old No.	Nom. I.D.
B130-24	24	289	.022	B130-7	7	—	.148
B130-22	22	290	.027	B130-6	6	302	.166
B130-20	20	291	.037	B130-5	5	—	.186
B130-19	19	—	.038	B130-4	4	305	.208
B130-18	18	293	.042	B130-3	3	—	.234
B130-17	17	—	.047	B130-2	2	306	.263
B130-16	16	294	.053	B130-1	1	—	.294
B130-15	15	—	.059	B130-0	0	303	.330
B130-14	14	295	.066	B130-3/8	3/8	304	.387
B130-13	13	—	.076	B130-1/2	1/2	—	.450
B130-12	12	300	.085	B130-1/2	1/2	299	.512
B130-11	11	—	.095	B130-3/8	3/8	296	.640
B130-10	10	307	.106	B130-1/4	1/4	—	.768
B130-9	9	—	.118	B130-3/8	3/8	—	.893
B130-8	8	301	.133	B130-1	1	—	1.018

SIZES	STANDARD COLORS
#24, 22, 20, 18, 14, 12, 10, 8, 6, 4, 2	Black, Red, White, Yellow, Brown, Orange, Green, Blue, Gray, Purple
3/8", 1/2", 3/4", 1"	Black, Red, White, Yellow, Orange, Green, Blue
#19, 17, 15, 13, 11, 9, 7, 5, 3	Black, Red, Yellow, Green
#1, 0, 3/8"	Black, Yellow
1/4", 3/8", 1", 1 1/4", 1 1/2", 1 3/4", 2", 2 1/4", 2 1/2"	Black

OTHER COLORS AVAILABLE TO ORDER

DIMENSIONAL TOLERANCES OF VINYL COATED FIBERGLASS

Size	Apx. I.D.	N.E.M.A. Tolerances Inches
24	.022	.020-.027
22	.027	.025-.032
20	.034	.032-.039
18	.042	.040-.049
16	.053	.051-.061
14	.066	.064-.072
12	.085	.081-.089
10	.106	.102-.112
8	.133	.129-.141
6	.166	.162-.178
4	.208	.204-.224
3/4, 2	.263	.258-.278
3/4, 0	.3125	.312-.328
3/4	.375	.375-.399
1/2	.500	.500-.524
1/4	.625	.625-.655

PHYSICAL & ELECTRICAL PROPERTIES B130 VINYL COATED FIBERGLASS

Class B
Grade B-1
Dielectric Strength 4000 V.
Temperature Rating 130° C.
Low Temp. Flexibility -30° C.
Non-Flammable
Ins. Resistance Over 1,000,000 MEGS.
Corrosion Resistance Excellent
Oil Resistance Good

COLORS:
Black, Red, White, Yellow, Brown, Orange, Green, Blue, Gray, Purple

STANDARD PUT-UPS

#24 thru #15	1000' - 500' - 250'	100' - 50' - 25' - 30"
#14 thru #6	500' - 250' - 100'	50' - 25' - 30"
#5 thru #2	250' - 100' - 50'	25' - 30"
#1 thru 1/2"	250' - 100' - 50'	25' - 36"
3/8" to 1/4"	100' - 50' - 25'	36"
1" thru 2 1/2"	50' - 25'	

ALL THE ABOVE TUBING CAN BE ORDERED CUT AND MARKED TO YOUR SPECIFICATIONS

B-1200 — FLEXIBLE FIBERGLASS SLEEVING for Hi-Temperature — applications for 1200° F.

HIGH TEMPERATURE FIBERGLASS SLEEVING — Sleeving of tightly braided 100% fiberglass intended for temperatures as high as 1200° F. It provides maximum mechanical strength consistent with the ultimate in flexibility. It is treated to remove all organic matter as well as keeping the glass braid fray resistant. We can provide special construction to 1/4" double wall construction. It can be colored for coding purposes.

Birnbach No.	B & S Gauge Size	I.D. Nom.
B1200-24	24	.022
B1200-22	22	.027
B1200-20	20	.034
B1200-19	19	.038
B1200-18	18	.042
B1200-17	17	.047
B1200-16	16	.053
B1200-15	15	.059
B1200-14	14	.066
B1200-13	13	.076
B1200-12	12	.085
B1200-11	11	.095
B1200-10	10	.106
B1200-9	9	.118
B1200-8	8	.133

Birnbach No.	B & S Gauge Size	I.D. Nom.
B1200-7	7	.148
B1200-6	6	.166
B1200-5	5	.186
B1200-4	4	.208
B1200-3	3	.234
B1200-2	2	.263
B1200-1	1	.294
B1200-0	0	.330
B1200-3/8	3/8	.387
B1200-1/2	1/2	.450
B1200-1/2	1/2	.512
B1200-3/8	3/8	.640
B1200-1/4	1/4	.768
B1200-7/8	7/8	.893
B1200-1"	1"	1.018

STANDARD COLOR: NATURAL
OTHER COLORS AVAILABLE TO ORDER

STANDARD PUT-UPS

SIZES #24 thru #15	1000' - 100'
SIZES #14 thru #2	500' - 100'
SIZES #1 thru 1/2"	250' - 100'
SIZES 3/8" thru 1"	100'

Applicable Specifications	Class	Grade	Dielectric Strength	Temp. Rating	Low Temp. Flexibility	Flame Resistance
---------------------------	-------	-------	---------------------	--------------	-----------------------	------------------

Nema VSI H — Determined by Space Factor 1200° F. — Non-Flam.

BIRNBACH

COMPANY INC. FOR MORE INFORMATION ON COMPLETE LINES, WRITE FOR NEW CATALOG.

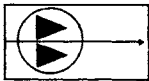

Birflon — TEFLON* SPAGHETTI TUBING

TFE EXTRUDED TUBING

T-500 T-500 Tubing is extruded from DuPont Tetrafluoroethylene Resin. Used in electronic and electrical equipment for connection of components. Its flexibility, ease of handling has established it as the best and most popular insulation sheathing. This high temperature Class C insulation does not melt and flow as the conventional thermo-plastic materials. Birflon T-500 Teflon has unique electrical, chemical and mechanical properties unmatched by any other type tubing for use in applications requiring high frequencies and high temperatures.

Because of Teflon's continuous service temperature of 250° C., which is more than 100° C. above other materials, the soldering technique is simplified since "Teflon" is not harmed by the hot barrel of the soldering iron — therefore, the assembly of aircraft, missile and electronic communication equipment is greatly speeded up. Thin Wall flexible Teflon Tubing can be processed easily into flexible and rigid printed circuits. As a thin, flexible insulation, it permits miniaturization and compactness of design never before possible.

TABLE OF PROPERTIES

Test	ASTM Method	Result
Tensile Strength, 73°F.	D638-52T	1500-3000 Lb./Sq. In.
Elongation, 73°F.	D638-52T	100-200%
Deformation Under Load—122°F.		
1200 Lb./Sq. In., 24 Hrs.	D621-51	4-8%
2000 Lb./Sq. In., 24 Hrs.	D621-51	25%
Hardness Durometer	D676-49T	D50-D65
Heat Distortion Temp, 66 Lb./Sq. In.	D648B-45T	250°F.
Dielectric Strength, .180"	D149-44	400-500 V/MIL
Surface Arc-Resistance	D495-48T	Sec.
Volume Resistivity	D257-52T	10 ¹⁵ Ohm-CM
Surface Resistivity, 100% R.H.	D257-52T	3.6x10 ⁶ Megohms
Dielectric Constant, 60 to 10 ⁴ Cycles	D150-54T	2.00
Power Factor, 60 to 10 ⁴ Cycles	D150-54T	0.0003
Specific Gravity	D792-50	2.1-2.2

SMALL PIECE CUTTING AVAILABLE TO ORDER

STOCK COLORS: Natural, Red, Black, Blue, Brown, Green, Orange, Yellow, Gray, Violet, White.

Nos. T-500-3/8 thru T-500-1/4 available in Natural, Additional Colors. Sizes Made to Order.

Teflon Tubing can be ordered cut to your specifications.

Tracer Colors Available—We Invite Your Inquiries For Your Special Requirements

ADDITIONAL ADVANTAGES OF BIRFLON T-500 TEFLON*

- **ELECTRICAL:** Low power factor, low dielectric constant, high volume and surface resistivity, good dielectric strength (500 to 1000 volts/MIL) constant over wide ranges of temperatures and frequencies. Dielectric constant of 2.0 and dissipation factor of 0.0002 are lowest of any solid dielectric.
- **THERMAL:** No change of electrical properties with temperature (25°C. to 250°C.) or frequency (60 CPS to 100 MC). Class C insulation — capable of continuous service at temperatures to 250°C. Has color stability.
- **TOUGHNESS AND FLEXIBILITY:** Has high impact strength. Is tough and flexible over the broad temperature range of -90°C. to 250°C. Service range -320°F. to 500°F.
- **CHEMICAL INERTNESS:** Completely inert to all chemicals and solvents except molten alkali metals and fluorine at elevated temperatures and pressures. Non-corrosive to all metals.
- **MOISTURE ABSORPTION:** Zero moisture absorption. Completely sun and weather resistant.
- **NON-FLAMMABLE** ● **LOWEST COEFFICIENT OF FRICTION**
- **FUNGI RESISTANCE:** Inert to all fungi growths.
- **SIZES:** Birflon T-500 Teflon Tubing available in sizes to fit B & S gauge wires. Thin wall available from stock, in sizes No. 32 thru 1/4" I.D. Additional sizes and wall thicknesses made to order. Birflon T-500 is made from high molecular weight virgin "Teflon" and meets AMS 3651B, 3653B, 3654, 3655, MIL-C-17B and MIL-I-22129C.

NOTE: When cutting Teflon Tubing, use single edge razor blade for clean unpinched cut.
"Teflon"™ DuPont Trade Name for Tetrafluoroethylene Resin

T-500 - Thin Wall

Birnbach No.	B&S Gauge Size No.	Old No.	Nom. I.D.	Nom. Wall
T500-32	32	8013	.011	.0085
T500-30	30	8014	.012	.009
T500-28	28	8015	.015	.009
T500-26	26	8016	.018	.010
T500-24	24	8000	.022	.010
T500-22	22	8001	.027	.010
T500-20	20	8002	.034	.012
T500-19	19	—	.038	.012
T500-18	18	8003	.042	.012
T500-17	17	—	.047	.012
T500-16	16	8004	.053	.012
T500-15	15	—	.059	.012
T500-14	14	8005	.066	.012
T500-13	13	—	.076	.012
T500-12	12	8006	.085	.012
T500-11	11	—	.095	.012

STANDARD PUT-UPS

SIZES #32 thru 261000' - 500' - 250' - 100'
SIZES #24 thru 1/4"1000' - 500' - 250' - 100' - 50' - 25'

Birnbach No.	B&S Gauge Size No.	Old No.	Nom. I.D.	Nom. Wall
T500-10	10	8007	.106	.012
T500-9	9	—	.118	.015
T500-1/8	1/8	—	.125	.015
T500-8	8	8008	.133	.015
T500-7	7	—	.148	.015
T500-6*	6	8009	.166	.015
T500-5*	5	—	.186	.015
T500-4*	4	8010	.208	.015
T500-3*	3	—	.234	.015
T500-1/4*	1/4	—	.250	.015
T500-2*	2	8011	.263	.015
T500-1*	1	—	.294	.015
T500-3/8*	3/8	—	.312	.015
T500-0*	0	8012	.330	.015
T500-3/8*	3/8	8020	.390	.020
T500-1/2*	1/2	8021	.453	.020
T500-1/2*	1/2	8022	.515	.025
T500-3/4*	3/4	8023	.583	.025
T500-3/4*	3/4	8024	.640	.030
T500-3/4*	3/4	8025	.765	.030
T500-7/8*	7/8	8026	.895	.030
T500-1*	1	8027	1.025	.030
T500-1 1/8*	1 1/8	8028	1.150	.030
T500-1 1/4*	1 1/4	8029	1.275	.030

Tolerance — Nos. 32 thru 0 — ±.003" on Wall
Tolerance — Nos. 3/8" thru 1/4" — .020" on I.D., .006" on Wall

T-550 - Standard Wall

Birnbach No.	B&S Gauge Size No.	Nom. I.D.	Nom. Wall
T550-24	24	.022	.012
T550-22	22	.027	.012
T550-20	20	.034	.016
T550-19	19	.038	.016
T550-18	18	.042	.016
T550-17	17	.047	.016
T550-16	16	.053	.016
T550-15	15	.059	.016
T550-14	14	.066	.016
T550-13	13	.076	.016
T550-12	12	.085	.016
T550-11	11	.095	.016
T550-10	10	.106	.016

STANDARD PUT-UPS

1000' - 500' - 250' - 100' - 50' - 25'

Birnbach No.	B&S Gauge Size No.	Nom. I.D.	Nom. Wall
T550-9	9	.118	.020
T550-1/8	1/8	.125	.020
T550-8	8	.133	.020
T550-7	7	.148	.020
T550-6	6	.166	.020
T550-5	5	.186	.020
T550-4	4	.208	.020
T550-3	3	.234	.020
T550-1/4	1/4	.250	.020
T550-2	2	.263	.020
T550-1	1	.294	.020
T550-3/8	3/8	.312	.020
T550-0	0	.330	.020

SMALL PIECE CUTTING AVAILABLE TO ORDER

STOCK COLORS: Natural, Red, Black, Blue, Brown, Green, Orange, Yellow, Gray, Violet, White.

OTHER COLORS AVAILABLE TO ORDER



COMPANY INC. FOR MORE INFORMATION ON COMPLETE LINES, WRITE FOR NEW CATALOG.



HEAT SHRINKABLE TUBING

HEAT SHRINK

PVC

AND

POLYOLEFIN

TUBING

MAXIMUM CONTINUOUS OPERATING TEMPERATURE	BIRNBACH NUMBER	SIZE	MIN. EXPANDED I.D.	MAX. RECOVERED I.D.	NOM. WALL RECOVERED	
105°C	SK-265					
	VINYL	SK265-1/32"	1/32"	.062	.031	.020
		SK265-3/64"	3/64"	.094	.047	.025
		SK265-1/16"	1/16"	.125	.063	.025
		SK265-3/32"	3/32"	.184	.094	.025
		SK265-1/8"	1/8"	.250	.125	.025
		SK265-3/16"	3/16"	.375	.188	.025
		SK265-1/4"	1/4"	.500	.250	.025
		SK265-3/8"	3/8"	.750	.375	.025
		SK265-1/2"	1/2"	1.00	.500	.030
SK265-3/4"		3/4"	1.50	.750	.035	
SK265-1"	1"	2.00	1.00	.040		

IRRADIATED POLYOLEFIN	BIRNBACH NUMBER	SIZE	MIN. EXPANDED I.D.	MAX. RECOVERED I.D.	NOM. WALL RECOVERED	
135°C	SK-275					
	MIL-I-23053 (wep) Class I	SK275-1/32"	1/32"	.062	.031	.020
		SK275-3/64"	3/64"	.094	.047	.025
		SK275-1/16"	1/16"	.125	.063	.025
		SK275-3/32"	3/32"	.184	.094	.025
		SK275-1/8"	1/8"	.250	.125	.025
		SK275-3/16"	3/16"	.375	.188	.025
		SK275-1/4"	1/4"	.500	.250	.025
		SK275-3/8"	3/8"	.750	.375	.025
		SK275-1/2"	1/2"	1.00	.500	.030
SK275-3/4"		3/4"	1.50	.750	.035	
SK275-1"	1"	2.00	1.00	.040		

SK-265 & SK-275 TUBING PROPERTIES CHART		
	RATING	TEST
TENSILE STRENGTH	2960 PSI	ASTM D-876-59-T
ULTIMATE ELONGATION	200%	ASTM D-876-59-T
BRITTLINESS TEMPERATURE	-34° C.	ASTM D-746-57-T
SPECIFIC GRAVITY	1.34	MIL-I-631 D, 4, 6, 12
WATER ABSORPTION	0.06% 24 Hours	ASTM D-570-57-T Proc. A
DIELECTRIC STRENGTH	1050 Volts/Mil	ASTM D-149-55-T
VOLUME RESISTIVITY	5.2 x 10 ¹⁴ Ohm-cm	ASTM D-257-58 MIL-I-631 D, 4, 6, 13
FUNGUS RESISTIVITY	0-1	MIL-I-631 D 3, 5, 7 and 4, 6, 16
FLAMMABILITY	Self-Extinguishing	ASTM D-876-60-T MIL-I-631 D, 4, 6, 13
FLEXIBILITY AFTER HEAT AGING 200 Hrs. at 100° C. BEND OVER 1/8" MANDREL	GOOD	
CORROSION ON COPPER, BRASS AND ALUMINUM AFTER 14 DAYS at 100° C.	EXCELLENT	MIL-I-7444 B

CHEMICAL RESISTANCE CHART		
FUEL JP-4 MIL-J-5624		EXCELLENT
AVIATION GASOLINE 100/130		EXCELLENT
HYDRAULIC OIL MIL-O-5606		EXCELLENT
HYDROCHLORIC ACID 35%		EXCELLENT
WATER		EXCELLENT
SODIUM CHLORIDE 5%		EXCELLENT
ALKALIS		EXCELLENT

*NOTE: SK265 PVC tubing is unsuitable in contact with organic solvents.
SK265 PVC tubing has a higher resistance to oils than low density Polythiene.

All SK-275 available in 4 foot lengths.

STOCK COLORS: BLACK, WHITE, CLEAR

1/2" Thru 1/8" 500' - 250' - 100' - 50' - 25'
3/32" Thru 1/4" 250' - 100' - 50' - 25'
3/8" Thru 1" 100' - 50' - 25'

HEAT SHRINKABLE TEFLON® TUBING
Birflon Shrink Series, TE Tubing

TEFLON*	Birnbach No.	Nominal Tubing Size	Minimum Expanded ID	Recovered Maximum ID (1)	Dimensions Wall Thickness (2)
250°C	SK-621-22	22*	.055"	.032"	.010"
	SK-621-20	20*	.060"	.039"	.012"
	SK-621-19	19	.065"	.043"	.012"
	SK-621-18	18*	.076"	.049"	.012"
	SK-621-17	17	.085"	.054"	.012"
	SK-621-16	16*	.093"	.061"	.012"
	SK-621-15	15	.110"	.067"	.012"
	SK-621-14	14*	.120"	.072"	.012"
	SK-621-13	13	.140"	.080"	.012"
	SK-621-12	12*	.150"	.089"	.012"
	SK-621-11	11	.170"	.101"	.012"
	SK-621-10	10*	.191"	.112"	.012"
	SK-621-9	9	.205"	.124"	.015"
	SK-621-8	8*	.240"	.141"	.015"
	SK-621-7	7	.270"	.158"	.015"
	SK-621-6	6*	.302"	.178"	.015"
	SK-621-5	5	.320"	.198"	.015"
	SK-621-4	4*	.348"	.224"	.015"
	SK-621-3	3	.360"	.249"	.015"
	SK-621-2	2*	.375"	.278"	.015"
	SK-621-1	1	.385"	.311"	.015"
	SK-621-0	0*	.400"	.347"	.015"
	SK-621-3/8	3/8"	.560"	.399"	.020"
	SK-621-1/2	1/2"	.655"	.462"	.020"
	SK-621-1	1"	.750"	.524"	.020"

Standard Put-up—36" Straight Lengths;

BIRFLON SHRINK SERIES TE TUBING		
HEAT SHRINKABLE TEFLON® TUBING		
Is a Class C material modified from polytetrafluoroethylene. The tubing will shrink when heated to 621 F. (It should be heated until it turns semi-transparent, then the heating process immediately stopped. Overheating can cause splitting, therefore trial and error testing is recommended to establish the proper time and temperature for each application.) Correct procedure will result in a snug-fitting insulating wrap possessing hi-heat resistance, superior chemical resistance, and excellent electrical characteristics. The tubing is available in a full range of colors. Stock colors: black, white, natural.		
* Dupont Polytetrafluoroethelene		
SK621 TEFLON® TUBING		
PROPERTIES CHART	TE SERIES Shrinkable "Teflon"®	

DIELECTRIC STRENGTH (20 Mil Wall)	850 Volts/Mil
DIELECTRIC CONSTANT	2.2
POWER FACTOR	.00
VOLUME RESISTIVITY	10 ¹⁷ Ohms/CM
FUNGUS RESISTANCE	Inert
FLAMMABILITY	Will Not Support Combustion
FUEL and OIL RESISTANCE	Superior
HYDRAULIC FLUID RESISTANCE	Superior
SOLVENT RESISTANCE	Superior
ACID and ALKALI RESISTANCE	Superior
CORROSION RESISTANCE	Excellent
TENSILE STRENGTH	5000-7500 PSI
ULTIMATE ELONGATION	300-500%
WATER ABSORPTION	Nil
LOW TEMPERATURE BRITTLE POINT	-66°F
HARDNESS	98 Shore A
SPECIFIC GRAVITY	2.2

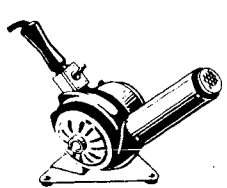

HAG-12 500/750° F Hot Air Gun For PVC Series
HAG-13 750/1000° F Hot Air Gun For TE Series

The quickest and most versatile method for applying heat is the hot air gun noted herein. Also, use of an oven, radiant heat, dipping in hot liquids, or using a soldering iron or the flame of a match.

BIRNBACH

COMPANY INC. FOR MORE INFORMATION ON COMPLETE LINES, WRITE FOR NEW CATALOG.

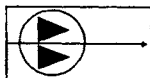

**BUSS BAR, TINNED AND UNTINNED
MAGNET WIRE PER MIL-W-583B**

SOLID TINNED (SOFT DRAWN) SYMBOL TC

Specification MIL-W-3861 Type S, QQ-W-343 Type S, ASTM-B-33

Cat. No.	1/4 lb. SPOOL		1/2 lb. SPOOL		1 lb. SPOOL		Nom. O.D.
	Size B&S	Ft.	Size B&S	Ft.	Size B&S	Ft.	
BST-10	10	8	10	16	10	32	.103"
BST-12	12	12	12	25	12	50	.082"
BST-14	14	20	14	40	14	80	.065"
BST-16	16	32	16	63	16	126	.051"
BST-18	18	50	18	100	18	201	.040"
BST-20	20	80	20	160	20	320	.033"
BST-22	22	127	22	254	22	508	.025"
BST-24	24	201	24	403	24	806	.020"
BST-26	26	320	26	640	26	1280	.016"
BST-28	28	507	28	1015	28	2030	.013"
BST-30	30	805	30	1610	30	3220	.010"
BST-32	32	1282	32	2564	32	5128	.008"
BST-34	34	2037	34	4075	34	8150	.006"
BST-36	36	3221	36	6443	36	12887	.005"
BST-38	38	5132	38	10246	38	20492	.004"
BST-40	40	8143	40	16286	40	32573	.003"

ALL SOLID TINNED COPPER AVAILABLE IN 1000 FT. SPOOLS
BARE COPPER — SOFT DRAWN AVAILABLE FROM STOCK

TINNED COPPER WIRE — SOLID SOFT BRAND

Pure Electrolytic, Copper, annealed, tinned for quick soldering
MIL-W-3861 Type S, ASTM-B-33 specifications, QQ-W-343 Type S

Cat. No.	Size AWG	Area Circular Mills	O.D.
1433/4	4	41,704	.204"
1433/6	6	26,250	.162"
1433	8	16,510	.129"
1402	10	10,380	.103"
1406	12	6,530	.082"
1410	14	4,107	.065"
1414	16	2,583	.051"
1418	18	1,624	.040"
1422	20	1,022	.033"
1434	22	624.4	.025"
1424	24	404.0	.020"
1426	26	254.1	.016"
1428	28	159.8	.013"
1430	30	100.5	.010"
1430/32	32	63.21	.008"
1430/34	34	39.75	.006"
1430/36	36	25.00	.005"
1430/38	38	15.72	.004"

HEAVY FORMVAR (HF) TYPE T2

Single conductor, round bare copper, baked film insulation from a varnish based on a vinyl acetal resin. 105°C.

Has new tough abrasion resisting film. Replaces enamel and fabric insulations for certain applications requiring exceptional abrasion resistance. Stable under heat. High dielectric strength. Infinite resistance to water and moisture. Does not fail after two hours at 105°C. Takes up less winding space.

ALL MAGNET WIRE AVAILABLE IN LARGER PUT-UPS

Cat. No.	1/4 lb. SPOOL		1/2 lb. SPOOL		1 lb. SPOOL		Nom. O.D.
	Size B&S	Ft.	Size B&S	Ft.	Size B&S	Ft.	
BHF-10	10	8	10	16	10	32	.1056"
BHF-12	12	12	12	25	12	50	.0842"
BHF-14	14	20	14	39	14	78	.0673"
BHF-16	16	31	16	62	16	124	.0539"
BHF-18	18	49	18	99	18	198	.0432"
BHF-20	20	78	20	156	20	313	.0346"
BHF-22	22	125	22	250	22	501	.0277"
BHF-24	24	200	24	399	24	798	.0224"
BHF-26	26	300	26	600	26	1200	.0180"
BHF-28	28	500	28	1000	28	1999	.0144"
BHF-30	30	800	30	1600	30	3200	.0116"
BHF-32	32	1225	32	2450	32	4900	.0095"
BHF-34	34	1988	34	3975	34	7950	.0075"
BHF-36	36	3200	36	6400	36	12800	.0060"
BHF-38	38	5050	38	10100	38	20200	.0049"
BHF-40	40	7975	40	15850	40	31700	.0038"
BHF-42	42	12375	42	24750	42	49500	.0032"
BHF-44	44	14500	44	29000	44	58000	.0026"

UNINSULATED COPPER WIRE

SILICON BRONZE AERIAL WIRE

Especially designed for ships, airports, short wave and transmitting antennas where high tensile strength and resistance to the elements are important.

Cat. No.	Size AWG	Strand	Breaking Strength/Lbs.	Nom. O.D.
529	4	7/12	3670	.240"
528	6	7/14	2140	.190"
527	8	7/16	1600	.150"
499	10	7/18	1000	.122"
524	12	7/20	650	.105"
526	14	7/22	420	.075"

#528 & #499 meets MIL-W-13074; #524 meets MIL-W-13276
STANDARD PUT-UPS: 100' — 500' — 1000'

BUS BAR WIRE (Hard Drawn)

QQ-W-343 type S—MIL-W-3861 type S, ASTM-B-33, ASTM-B-246-51 specifications

For hooking up all types of transmitters, especially ultra short wave equipment. All bus wire is made of hard drawn copper, tinned, straightened, and cut in 2 ft. lengths.

STANDARD PACKAGE: 100 pieces

Cat. No.	No.		
2010	10	Round	Tinned
2013	12	Round	Tinned
2015	14	Round	Tinned
2016	16	Round	Tinned
2018	18	Round	Tinned
2020	20	Round	Tinned
2022	22	Round	Tinned

STRANDED TINNED COPPER WIRE

Cat. No.	Size AWG	Strand	Nom. O.D.
495	12	7/20	.102"
1671	14	7/22	.076"
1674	15	7/23	.069"
1628	16	7/24	.062"

#1671 meets H4.4—1940 type W—1
Also available in stranded bare.

JUMPER CABLE
PURE ELECTROLYTIC COPPER, annealed, tinned for quick soldering
MIL-W-3861 Type B, ASTM-B-33 Specifications

Cat. No.	Class	Size AWG	Strand	Nom. O.D.
1622	K	22	7/30	.030"
1620	K	20	10/30	.037"
1618	K	18	16/30	.045"
1616	K	16	26/30	.059"
1614	K	14	41/30	.073"
1612	K	12	65/30	.091"

STANDARD PUT-UPS:
100' — 500' — 1000'

STRANDED BARE COPPER WIRE

Cat. No.	Size AWG	Strand	Nom. O.D.
493	12	7/20	.100"
1670	14	7/22	.075"
1673	15	7/23	.068"
1680	16	7/24	.060"
681	18	7/26	.050"
700	19	7/27	.041"

STANDARD PUT-UPS:
100' — 500' — 1000'

SOLID ENAMEL COPPER WIRE

Cat. No.	Size AWG	Nom. O.D.
497	10	.103"
492	12	.083"
490	14	.066"

STANDARD PUT-UPS:
100' — 250' — 500' — 1000'

BARE COPPER WIRE (Soft Drawn)

QQ—W—341A specifications

Cat. No.	Size AWG	Area Circular Mills	Nom. O.D.
1560	8	16,510	.1285"
1562	10	10,380	.102"
1566	12	6,530	.081"
1570	14	4,107	.064"
1574	16	2,583	.051"

STANDARD PUT-UPS: 100' — 500' — 1000'

PLAIN ENAMEL (PE) TYPE T

Single conductor round bare copper covered with a continuous insulating film of enamel. 105°C.

Cat. No.	1/4 lb. SPOOL		1/2 lb. SPOOL		1 lb. SPOOL		Nom. O.D.
	Size B&S	Ft.	Size B&S	Ft.	Size B&S	Ft.	
BPE-10	10	8	10	16	10	32	.1037"
BPE-12	12	12	12	25	12	50	.0825"
BPE-14	14	20	14	40	14	80	.0657"
BPE-16	16	32	16	63	16	126	.0522"
BPE-18	18	50	18	100	18	201	.0416"
BPE-20	20	80	20	160	20	320	.0332"
BPE-22	22	127	22	254	22	508	.0266"
BPE-24	24	201	24	403	24	806	.0212"
BPE-26	26	320	26	640	26	1280	.0169"
BPE-28	28	507	28	1015	28	2030	.0135"
BPE-30	30	805	30	1610	30	3220	.0108"
BPE-32	32	1282	32	2564	32	5128	.0087"
BPE-34	34	2037	34	4075	34	8150	.0069"
BPE-36	36	3221	36	6443	36	12887	.0055"
BPE-38	38	5132	38	10246	38	20492	.0044"
BPE-40	40	8143	40	16286	40	32573	.0034"
BPE-42	42	12803	42	25605	42	51211	.0028"
BPE-44	44	20455	44	40910	44	81819	.0023"



COMPANY INC. FOR MORE INFORMATION ON COMPLETE LINES, WRITE FOR NEW CATALOG.

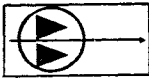

MIL-W-76B PLASTIC WIRE

*** STOCK COLORS**

- 1—White
- 2—Black
- 3—Red
- 4—Green
- 5—Yellow
- 6—Light Blue
- 7—Brown
- 8—Orange
- 9—Gray (state)
- 10—Violet (purple)
- 11—White/Black
- 12—White/Red
- 13—White/Green
- 14—White/Yellow
- 15—White/Blue
- 16—White/Brown
- 17—White/Orange
- 18—White/Gray
- 19—White/Violet
- 20—White/Black/Red
- 21—White/Black/Green
- 22—White/Black/Yellow
- 23—White/Black/Blue
- 24—White/Black/Brown
- 25—White/Black/Orange
- 26—White/Black/Gray
- 27—White/Black/Violet
- 28—Tan
- 29—Pink
- 30—Dark Blue

*Other striped color combinations available to order.

MW	C	22	(7)	j
Type OF WIRE	CONDUCTOR MATERIAL	CONDUCTOR SIZE (AWG)	STRANDING	CONSTRUCTION
LW ... 300 Volt Light Wall	TINNED COPPER	30 thru 20	SOLID 7 STRAND	Symbol None U Jacket J Braid S Shield JS Jacket and Shield BS Braid and Shield SJ Shield & Outer Jacket JSJ Jacket, Shield and Outer Jacket BSJ Braid, Shield and Outer Jacket
MW ... 1,000 Volt Medium Wall	TINNED COPPER	24 thru 12	16 STRAND 26 STRAND 41 STRAND	
HW ... 2500 Volt Heavy Wall	TINNED COPPER	22 thru 12	65 STRAND 105 STRAND 133 STRAND	
HW ... 600 Volt Heavy Wall	TINNED COPPER	10 thru 6		

TYPE MW—UNCOVERED PLASTIC 1,000 V

DESCRIPTION: Solid or extra flexible tinned copper, color coded medium wall polyvinylchloride insulation.

CHARACTERISTICS: Temperature rating —40° to +80°C, Voltage rating 1000 volts. Resistant to acids, alkalis, oil, flame, moisture and fungus.

STRANDED

Cat. No.	Size AWG	Mil-W-76B Type Designation	Conductor Strand	Nom. Wall	Volt Rating	Nom. O.D.
7024	24	MW-C 24(7)U	7/32	015"	1000	059"
7001	22	MW-C 22(7)U	7/30	017"	1000	066"
7003	20	MW-C 20(10)U	10/30	017"	1000	074"
7005	18	MW-C 18(16)U	16/30	017"	1000	085"
7007	16	MW-C 16(26)U	26/30	017"	1000	098"
7009	14	MW-C 14(41)U	41/30	017"	1000	114"
7011	12	MW-C 12(65)U	65/30	017"	1000	132"

SOLID

Cat. No.	Size AWG	Mil-W-76B Type Designation	Conductor Strand	Nom. Wall	Volt Rating	Nom. O.D.
7025	24	MW-C 24(1)U	1	017"	1000	056"
7000	22	MW-C 22(1)U	1	017"	1000	061"
7002	20	MW-C 20(1)U	1	017"	1000	068"
7004	18	MW-C 18(1)U	1	017"	1000	075"
7026	16	MW-C 16(1)U	1	017"	1000	084"

STANDARD PUT-UPS: 100' - 500' - 1000'
STOCK COLORS — 1 thru 30

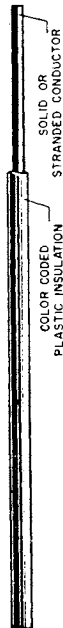

SHIELDED PLASTIC HOOK-UP WIRE

SPECIFICATIONS MIL-W-76B
TEMPERATURE RATING: —40°C TO +80°C
TYPE MW (Medium Wall) — SHIELDED

DESCRIPTION: One conductor stranded tinned copper with WHITE thermoplastic insulation and tinned copper shielded braid overall.

Cat. No.	Size AWG	Mil-W-76B Type Designation	Minimum Strand	Nom. Wall	Volt Rating	Nom. O.D.
7074	24	MW-C 24(7)S	7/32	.015"	1000	.074"
7072	22	MW-C 22(7)S	7/30	.017"	1000	.084"
7070	20	MW-C 20(10)S	10/30	.017"	1000	.094"
7068	18	MW-C 18(16)S	16/30	.017"	1000	.106"
7067	16	MW-C 16(26)S	26/30	.017"	1000	.121"
*7066	14	MW-C 14(41)S	41/30	.017"	1000	.137"
*7065	12	MW-C 12(65)S	65/30	.017"	1000	.155"

STANDARD PUT-UPS: 100' - 500' - 1000'

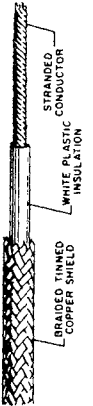

SPECIFICATION MIL-W-76B TYPE MW (Med. Wall)—NYLON JACKET 1000 V (Fungus Proof)

DESCRIPTION: One conductor stranded tinned copper with thermoplastic insulation and extruded nylon jacket overall.

Cat. No.	Size AWG	Mil-W-76B Type Designation	Conductor Strand	Nom. Wall	Volt Rating	Nom. O.D.	Stock Colors
7224	24	MW-C 24(7)J	7/32	.015"	1000	.068"	1-10
7222	22	MW-C 22(7)J	7/30	.017"	1000	.075"	1-10
7220	20	MW-C 20(10)J	10/30	.017"	1000	.087"	1-10
7218	18	MW-C 18(16)J	16/30	.017"	1000	.100"	1-10
7216	16	MW-C 16(26)J	26/30	.017"	1000	.112"	1-10
7214	14	MW-C 14(41)J	41/30	.017"	1000	.122"	1-10
7212	12	MW-C 12(65)J	65/30	.017"	1000	.140"	1-3
7210	10	MW-C 10(105)J	105/30	.017"	1000	.150"	1-3

STANDARD PUT-UPS: 100' - 500' - 1000'



MIL-W-76B-PLASTIC WIRE

Type MW — Glass Braid — Shielded

TINNED COPPER SHIELD OVER LACQUERED BRAID

DESCRIPTION: Extra flexible stranded tinned copper, white medium wall polyvinylchloride insulation, white flame retardant lacquered glass braided with tinned copper shield overall, 80% coverage.

CHARACTERISTICS: Temperature rating —40°C to +80°C, Voltage rating 1000 volts. Resistant to acids, alkalis, oil, flame, moisture and fungus.

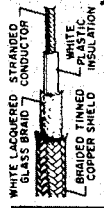

Cat. No.	Size AWG	Type Designation	Strand	Wall Thickness	Nom. O.D.
831	22	MW-C 22(7)BS	7/30	.016"	.095"
832	20	MW-C 20(10)BS	10/30	.016"	.105"
833	18	MW-C 18(16)BS	16/30	.016"	.125"
834	16	MW-C 16(26)BS	26/30	.016"	.135"
835	14	MW-C 14(41)BS	41/30	.016"	.155"
835/12	12	MW-C 12(65)BS	65/30	.016"	.175"
835/10	10	MW-C 10(105)BS	105/30	.025"	.200"

STOCK COLOR: White
STANDARD PUT-UPS: 100' - 500' - 1000'

SPECIFICATION MIL-W-76B TYPE MW (Medium Wall) GLASS BRAID 1000 VOLTS

DESCRIPTION: Extra flexible stranded tinned copper, white medium wall polyvinylchloride insulation, color coded flame retardant lacquered glass braid overall.

CHARACTERISTICS: Temperature rating —40° to +80°C, Voltage rating 1000 volts. Resistant to acids, alkalis, oil, flame, moisture and fungus.

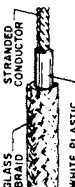

Cat. No.	Size AWG	Mil-W-76B Type Designation	Conductor Strand	Nom. Wall	Volt Rating	Nom. O.D.	Stock Colors As Listed
7022	22	MW-C 22(7)B	7/30	.017"	1000	.079"	1-12
7020	20	MW-C 20(10)B	10/30	.017"	1000	.084"	1-12
7018	18	MW-C 18(16)B	16/30	.017"	1000	.100"	1-12
7016	16	MW-C 16(26)B	26/30	.017"	1000	.116"	1-12
*7014	14	MW-C 14(41)B	41/30	.017"	1000	.129"	1, 11, 12
*7012	12	MW-C 12(65)B	65/30	.017"	1000	.149"	1, 11, 12

STANDARD PUT-UPS: 100' - 500' - 1000'

ALL ITEMS AVAILABLE CUT, STRIPPED AND TINNED

BIRNBACH COMPANY INC. FOR MORE INFORMATION ON COMPLETE LINES, WRITE FOR NEW CATALOG.

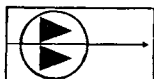

MIL-W-76B PLASTIC WIRE

MIL-W-76B — TYPE MW — SHIELDED — NYLON JACKET

DESCRIPTION: One conductor stranded tinned copper, **WHITE** medium wall polyvinyl chloride insulation, shielded tinned copper braid, minimum 80% coverage, clear nylon (polyamide) jacket overall. Temperature rating —40° to +90°C. Resistant to acids, alkalis, oil, flame, moisture, fungus.

Cat. No.	Size AWG	MIL-W-76B Type Designation	Strand	Nom. Wall	Volt Rating	Nom. O.D.
7074J	24	MW-C 24(7)SJ	7/32	.016"	1000	.087"
7072J	22	MW-C 22(7)SJ	7/30	.017"	1000	.094"
7070J	20	MW-C 20(10)SJ	10/30	.017"	1000	.100"
7068J	18	MW-C 18(16)SJ	16/30	.017"	1000	.110"
7067J	16	MW-C 16(26)SJ	26/30	.017"	1000	.125"
7066J	14	MW-C 14(41)SJ	41/30	.017"	1000	.138"
7065J	12	MW-C 12(65)SJ	65/30	.017"	1000	.160"

Additional colors available to order.
STANDARD PUT-UPS: 100' - 500' - 1000'

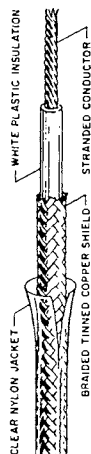

MIL-W-76B — TYPE MW — SHIELDED — VINYL JACKET

DESCRIPTION: One conductor stranded tinned copper, **WHITE** medium wall polyvinyl chloride insulation, shielded tinned copper braid, minimum 80% coverage, black PVC (polyvinylchloride) jacket overall. Temperature rating —40° to +90°C. Resistant to acids, alkalis, oil, flame, moisture, fungus.

Cat. No.	Size AWG	MIL-W-76B Type Designation	Strand	Nom. Wall	Volt Rating	Nom. O.D.
7074VJ	24	MW-C 24(7)SJ	7/32	.015"	1000	.095"
7072VJ	22	MW-C 22(7)SJ	7/30	.017"	1000	.105"
7070VJ	20	MW-C 20(10)SJ	10/30	.017"	1000	.112"
7068VJ	18	MW-C 18(16)SJ	16/30	.017"	1000	.120"
7067VJ	16	MW-C 16(26)SJ	26/30	.017"	1000	.133"
7066VJ	14	MW-C 14(41)SJ	41/30	.017"	1000	.148"
7065VJ	12	MW-C 12(65)SJ	65/30	.017"	1000	.170"

Additional colors available to order.
STANDARD PUT-UPS: 100' - 500' - 1000'

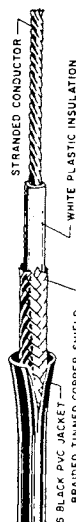

MIL-W-76B TYPE HW (Heavy Wall) 2500 VOLTS (Fungus Proof)

DESCRIPTION: Similar to type MW. One conductor stranded tinned copper with larger wall of primary thermoplastic insulation.

CHARACTERISTICS: Temperature rating —40°C to +80°C. Resistant to acids, alkalis, oil, flame, moisture and fungus.

Cat. No.	Size AWG	MIL-W-76B Type Designation	Conductor Strand	Nom. Wall	Volt Rating	Nom. O.D.	Stock Colors As Listed
7322	22	HW-C 22(7)U	7/30	.033"	2500	.094"	1-10
7320	20	HW-C 20(10)U	10/30	.033"	2500	.102"	1-10
7318	18	HW-C 18(16)U	16/30	.033"	2500	.114"	1-10
7316	16	HW-C 16(26)U	26/30	.033"	2500	.128"	1-10
7314	14	HW-C 14(41)U	41/30	.045"	600	.175"	1-10
7312	12	HW-C 12(65)U	65/30	.045"	600	.188"	1-10
*7013	10	HW-C 10(105)U	105/30	.045"	600	.217"	1-3
*7015	8	HW-C 8(133)U	133/29	.045"	600	.268"	1-3
*7017	6	HW-C 6(133)U	133/27	.045"	600	.315"	1-3

STANDARD PUT-UPS: 100' - 500' - 1000'

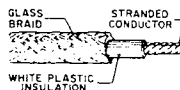
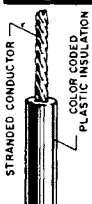

MIL-W-76B — PLASTIC WIRE TYPE HW (Glass Braid)

Cat. No.	Size AWG	Type Designation	Conductor Strand	Nom. Wall	Volt Rating	Nom. O.D.
7010	10	HW-C 10(105)B	105/30	.045"	600	.237"
7008	8	HW-C 8(133)B	133/29	.045"	600	.293"
7006	6	HW-C 6(133)B	133/27	.045"	600	.340"

STOCK COLOR: White. STANDARD PUT-UPS: 100' - 500' - 1000'

MIL-W-76B — TYPE LW (Light Wall) NYLON — 300 VOLTS

DESCRIPTION: Stranded tinned copper, color coded light wall polyvinylchloride insulation, clear nylon (polyamide) jacket overall. Nominal Jacket Thickness, .002".

CHARACTERISTICS: Temperature rating —40°C to +90°C. Voltage rating 300 volts. Resistant to acids, alkalis, oil, flame, moisture and fungus.

Cat. No.	Size AWG	MIL-W-76B Type Designation	Conductor Strand	Nom. O.D.	Standard Colors
7330N	30	LW-C 30(7)J	7/38	.036"	1-10
7328N	28	LW-C 28(7)J	7/36	.039"	1-10
7326N	26	LW-C 26(7)J	7/34	.042"	1-10
7324N	24	LW-C 24(7)J	7/32	.047"	1-19
7324/22N	22	LW-C 22(7)J	7/30	.053"	1-19
7324/20N	20	LW-C 20(7)J	7/28	.065"	1-19

STANDARD PUT-UPS: 100' - 500' - 1000'

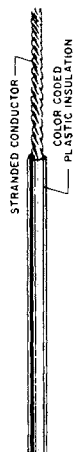

MIL-W-76B — TYPE LW (Light Wall) TYPE LW — LW — VINYL — 300 VOLTS TEMP. RATING —40°C TO 80+°C

DESCRIPTION: One conductor stranded tinned copper with light wall of primary thermoplastic insulation. Nom. Wall .010".

CHARACTERISTICS: Temperature rating —40°C to +80°C. Voltage rating 300 volts. Resistant to acids, alkalis, oil, flame, moisture and fungus.

Cat. No.	Size AWG	MIL-W-76B Type Designation	Conductor Strand	Nom. O.D.	Standard Colors
7330	30	LW-C 30(7)U	7/38	.033"	1-10
7328	28	LW-C 28(7)U	7/36	.035"	1-10
7326	26	LW-C 26(7)U	7/34	.040"	1-10
7324	24	LW-C 24(7)U	7/32	.044"	1-19
7324/22	22	LW-C 22(7)U	7/30	.050"	1-19
7324/20	20	LW-C 20(7)U	7/28	.060"	1-19

STANDARD PUT-UPS: 100' - 500' - 1000'

STOCK COLORS

- | | | | | | | |
|---------|--------------|----------------|--------------------|-----------------|-----------------|-----------------|
| 1—White | 4—Green | 7—Brown | 10—Violet (purple) | 13—White/Green | 16—White/Brown | 19—White/Violet |
| 2—Black | 5—Yellow | 8—Orange | 11—White/Black | 14—White/Yellow | 17—White/Orange | |
| 3—Red | 6—Light Blue | 9—Gray (slate) | 12—White/Red | 15—White/Blue | 18—White/Gray | |

BIRNBACH

COMPANY INC. FOR MORE INFORMATION ON COMPLETE LINES, WRITE FOR NEW CATALOG.

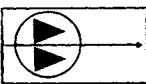
**MIL-W-16878D TEFLON* — HOOK-UP WIRE****MIL-W-16878D — TEFLON† WIRE**Type E—Extruded (600 Volts) —
High Temperature Rating — 90° To + 260°C

Chemically inert, non-flammable, excellent flexibility, easy stripping, high dielectric strength, unaffected by fungus. Exceeds Class H insulation requirements. Unaffected by high or low temperature. Outstanding for its dependability and long life under all operating conditions indoors or outdoors. Teflon permits miniaturization and compactness in electronic designs of sub-miniature components, computers, UHF equip., slip ring assemblies, leads to hermetically sealed and potted components, telemetering equip. and guided missiles. Nom. wall .010" TFE extruded.

DESCRIPTION: Single conductor silver plated copper wire concentrically stranded and insulated with extruded or Teflon insulation.

Cat. No.	Size AWG	Mil Type Designation	Strand	Diam. Over Insulation Max.
8532	32	E-32	7/40	.033"
8530	30	E-30	7/38	.036"
8528	28	E-28	7/36	.039"
8526	26	E-26	7/34	.043"
8524	24	E-24	19/36	.048"
8522	22	E-22	19/34	.054"
8520	20	E-20	19/32	.062"
8518	18	E-18	19/30	.074"
8516	16	E-16	19/29	.087"
8514	14	E-14	19/27	.097"
8512	12	E-12	19/25	.120"
8510	10	E-10	37/26	.139"

*STOCK COLORS: 1 thru 19, as listed.
STANDARD PUT-UPS: 25' - 50' - 100' - 250' - 500' - 1000'

MIL-W-16878D — TEFLON* WIRE

Type EE—Extruded (1000 Volts) MIL-W-16878D

DESCRIPTION: Single conductor silver plated copper wire concentrically stranded and insulated with .016" TFE extruded TEFLON* insulation. Temperature rating —90°C to +260°C 1000 volts.

Cat. No.	Mil Type Designation	Size AWG	Strand	Nom. O.D.
9524	EE-24	24	19/36	.055"
9522	EE-22	22	19/34	.062"
9520	EE-20	20	19/32	.070"
9518	EE-18	18	19/30	.080"
9516	EE-16	16	19/29	.089"
9514	EE-14	14	19/27	.106"
9512	EE-12	12	19/25	.124"
9510	EE-10	10	37/26	.145"
9508	EE-8	8	133/29	.210"

*STOCK COLORS: 1 thru 19, as listed.
STANDARD PUTUPS: 100' - 250' - 500' - 1000'

SHIELDED AND UNSHIELDED TEFLON* CABLES TO MIL-W-16878D

DESCRIPTION: One or more conductors, each conductor silver plated concentrically stranded copper wire, Type E Extruded TFE .010" insulation. When shielded, braided silver plated copper shield over conductor(s), 90% shield coverage. When covered, either a TEFLON* impregnated fiberglass braid or a .010" TEFLON* fused, double reversed tape jacket overall. Temperature —65°C to +260°C. Voltage rating 600V. Fungus, solvent, moisture, flame, acid, alkali and oil resistant.

TEFLON* IMPREGNATED FIBERGLASS BRAID OVER SHIELD

Cat. No.	Conds.	AWG Size	Strand	Nom. O.D.
8706	1	24	19/36	.081"
8706/2	2	24	19/36	.126"
8706/3	3	24	19/36	.133"
8706/4	4	24	19/36	.144"
8706/5	5	24	19/36	.156"
8709	1	22	19/34	.088"
8709/2	2	22	19/34	.137"
8709/3	3	22	19/34	.144"
8709/4	4	22	19/34	.158"
8709/5	5	22	19/34	.172"
8712	1	20	19/32	.093"
8712/2	2	20	19/32	.154"
8712/3	3	20	19/32	.163"
8712/4	4	20	19/32	.180"
8712/5	5	20	19/32	.195"
8715	1	18	19/32	.097"
8715/2	2	18	19/30	.162"
8715/3	3	18	19/30	.172"
8715/4	4	18	19/30	.192"
8715/5	5	18	19/30	.207"

STANDARD PUT-UPS: 250' - 500' - 1000'
CONDUCTOR COLOR CODE: 1—White, 2—Black, 3—Red, 4—Green, 5—Yellow. Special colors and constructions available.

TEFLON* INNERS, NO JACKET SHIELDED BRAID OVERALL

Cat. No.	Conds.	AWG Size	Strand	Nom. O.D.
8704	1	24	19/36	.068"
8704/2	2	24	19/36	.112"
8704/3	3	24	19/36	.120"
8704/4	4	24	19/36	.132"
8704/5	5	24	19/36	.140"
8707	1	22	19/34	.075"
8707/2	2	22	19/34	.124"
8707/3	3	22	19/34	.132"
8707/4	4	22	19/34	.146"
8707/5	5	22	19/34	.154"
8710	1	20	19/32	.082"
8710/2	2	20	19/32	.142"
8710/3	3	20	19/32	.151"
8710/4	4	20	19/32	.168"
8710/5	5	20	19/32	.180"
8713	1	18	19/30	.093"
8713/2	2	18	19/30	.162"
8713/3	3	18	19/30	.172"
8713/4	4	18	19/30	.191"
8713/5	5	18	19/30	.210"

STANDARD PUT-UPS: 250' - 500' - 1000'
CONDUCTOR COLOR CODE: 1—White, 2—Black, 3—Red, 4—Green, 5—Yellow. Special colors and constructions available.

TEFLON* TAPE WRAP JACKET OVER SHIELD

Cat. No.	Conds.	AWG Size	Strand	Nom. O.D.
8521	1	24	19/36	.084"
8521/2	2	24	19/36	.128"
8521/3	3	24	19/36	.135"
8521/4	4	24	19/36	.148"
8521/5	5	24	19/36	.162"
8523	1	22	19/34	.090"
8523/2	2	22	19/34	.140"
8523/3	3	22	19/34	.148"
8523/4	4	22	19/34	.162"
8523/5	5	22	19/34	.183"
8525	1	20	19/32	.099"
8525/2	2	20	19/32	.158"
8525/3	3	20	19/32	.167"
8525/4	4	20	19/32	.184"
8525/5	5	20	19/32	.204"
8527	1	18	19/30	.109"
8527/2	2	18	19/30	.178"
8527/3	3	18	19/30	.189"
8527/4	4	18	19/30	.208"
8527/5	5	18	19/30	.230"

STANDARD PUT-UPS: 250' - 500' - 1000'
CONDUCTOR COLOR CODE: 1—White, 2—Black, 3—Red, 4—Green, 5—Yellow. Special colors and constructions available.

NO SHIELD — TEFLON* IMPREGNATED FIBERGLASS

Cat. No.	Conds.	AWG Size	Strand	Nom. O.D.
8705	1	24	19/36	.044"
8705/2	2	24	19/36	.088"
8705/3	3	24	19/36	.096"
8705/4	4	24	19/36	.108"
8705/5	5	24	19/36	.116"
8708	1	22	19/34	.051"
8708/2	2	22	19/34	.100"
8708/3	3	22	19/34	.108"
8708/4	4	22	19/34	.122"
8708/5	5	22	19/34	.131"
8711	1	20	19/32	.058"
8711/2	2	20	19/32	.118"
8711/3	3	20	19/32	.127"
8711/4	4	20	19/32	.144"
8711/5	5	20	19/32	.156"
8714	1	18	19/30	.069"
8714/2	2	18	19/30	.138"
8714/3	3	18	19/30	.148"
8714/4	4	18	19/30	.167"
8714/5	5	18	19/30	.186"

STANDARD PUT-UPS: 250' - 500' - 1000'
CONDUCTOR COLOR CODE: 1—White, 2—Black, 3—Red, 4—Green, 5—Yellow. Special colors and constructions available.

BIRNBACH

COMPANY INC. FOR MORE INFORMATION ON COMPLETE LINES, WRITE FOR NEW CATALOG.

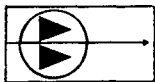

PLASTIC HOOK-UP WIRE — MIL-W-16878D

PLASTIC HOOK-UP WIRE — MIL-W-16878D — Type B — High Temperature Vinyl — 600 Volt

Suitable for general purpose wiring for miniature high temperature hook-ups in aircraft, electronic instruments, devices, etc., where excellent resistance to moisture and solvents may be required.

DESCRIPTION: One conductor stranded tinned copper with rated -55°C to +105°C high temperature thermoplastic light wall insulation. Resistant to acids, alkalis, oil, flame, moisture, solvents, and fungus. Nominal wall: 0.010.

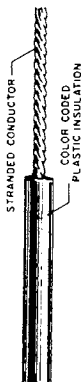

Cat. No.	MIL-W-16878D Type Designation	Size AWG	Conductor Strand	Nom. O.D.
7190	B-32	32	7/40	.029"
7191	B-30	30	7/38	.030"
7192	B-28	28	7/36	.033"
7193	B-26	26	7/34	.037"
7194	B-24	24	7/32	.043"
7194/19	B-24	24	19/36	.043"
7195	B-22	22	7/30	.048"
7195/19	B-22	22	19/34	.048"
7196	B-20	20	7/28	.057"
7196/19	B-20	20	19/32	.057"
7197	B-18	18	7/26	.067"
7197/19	B-18	18	19/30	.067"
7198	B-16	16	19/29	.077"
7199	B-14	14	19/27	.091"

*STOCK COLORS: 1 thru 19, as listed.
STANDARD PUT-UPS: 100' - 500' - 1000'

PLASTIC HOOK-UP WIRE — MIL-W-16878D — Type B — Nylon Jacket — 600 Volt

Suitable for general purpose wiring for miniature high temperature hook-ups in aircraft, electronic instruments, devices, etc., where excellent resistance to moisture and solvents may be required.

DESCRIPTION: Stranded tinned copper, color coded, .010" polyvinylchloride insulation, clear nylon (polyamide) jacket overall.

CHARACTERISTICS: Temperature rating -55°C to +115°C. Voltage rating 600 volts. Resistant to acids, alkalis, oil, flame, moisture, solvents, and fungus.

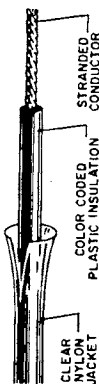

Cat. No.	MIL-W-16878D Type Designation	Size AWG	Conductor Strand	Nom. O.D.
7190N	B-32	32	7/40	.034"
7191N	B-30	30	7/38	.038"
7192N	B-28	28	7/36	.040"
7193N	B-26	26	7/34	.043"
7194N	B-24	24	7/32	.048"
7194N/19	B-24	24	19/36	.048"
7195N	B-22	22	7/30	.055"
7195N/19	B-22	22	19/34	.055"
7196N	B-20	20	7/28	.065"
7196N/19	B-20	20	19/32	.065"
7197N	B-18	18	7/26	.075"
7197N/19	B-18	18	19/30	.075"
7198N	B-16	16	19/29	.085"
7199N	B-14	14	19/27	.099"

STANDARD PUT-UPS: 100' - 500' - 1000'
*STOCK COLORS: 1 thru 19, as listed.

MIL-W-16878D — MULTI-CONDUCTOR CABLE — Type B — Nylon Shielded-Plastic Jacket

DESCRIPTION: Each conductor stranded tinned copper, .010" polyvinylchloride insulation, color coded, clear nylon .003 (polyamide) jacket, conductors cabled, braided tinned copper shield 90% coverage, with polyvinylchloride jacket overall.

CHARACTERISTICS: Temperature rating -55°C to +105°C. Voltage rating 600 volts, resistant to acids, alkalis, oil, flame, moisture, fungus, solvents.

Birnbach No.	No. of Cond.	Conductor Size	Strand	Nom. Overall Jacket	Nom. O.D.
7366-1	1	24	19/36	.010"	.092"
7366-2	2	24	19/36	.016"	.152"
7366-3	3	24	19/36	.016"	.161"
7366-4	4	24	19/36	.017"	.166"
7367-1	1	22	19/34	.010"	.100"
7367-2	2	22	19/34	.016"	.168"
7367-3	3	22	19/34	.017"	.178"
7367-4	4	22	19/34	.019"	.174"
7368-1	1	20	19/32	.010"	.106"
7368-2	2	20	19/32	.019"	.186"
7368-3	3	20	19/32	.019"	.196"
7368-4	4	20	19/32	.021"	.193"
7369-1	1	18	19/30	.012"	.120"
7369-2	2	18	19/30	.021"	.210"
7369-3	3	18	19/30	.022"	.227"
7369-4	4	18	19/30	.023"	.231"
7370-1	1	16	19/29	.016"	.137"
7370-2	2	16	19/29	.023"	.236"
7370-3	3	16	19/29	.024"	.240"
7370-4	4	16	19/29	.025"	.274"

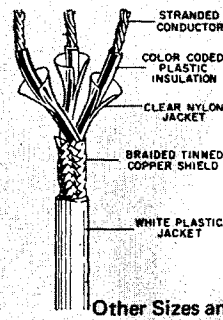

Other Sizes and Colors Available

STANDARD PUT-UP: 100' - 500' - 1000'

COLOR CODE OF CONDUCTORS: 1—White 2—Black 3—Red 4—Green

SPECIAL CONSTRUCTION AVAILABLE AT ANY TIME.

AIRCRAFT PLASTIC HOOK-UP WIRE — MIL-W-5086A and MIL-C-7078A (105°C Rating)

No. 7351

DESCRIPTION: MIL-W-5086A—Type I—AN-22 thru AN-12—Single conductor stranded tinned copper, white polyvinylchloride insulation, clear nylon (polyamide) jacket overall. MIL-W-5086A—Type II—AN-22 thru AN-12—Single conductor stranded tinned copper, white polyvinylchloride insulation, white glass braid, clear nylon (polyamide) jacket overall. MIL-W-5086A—Type III—AN-10 thru AN-00—Single conductor stranded tinned copper, white polyvinylchloride insulation, white glass braid, flame retardant nylon lacquered nylon braid overall. MIL-C-7078A—Type I—Single conductor stranded tinned copper, white polyvinylchloride insulation, clear nylon jacket, braided tinned copper shield overall, 85% coverage.

CHARACTERISTICS: Temperature rating: -55°C. to +105°C. Voltage Rating: 600 volts. Resists effects of water, oil, aircraft fuels, hydraulic fluid, skydrol, ethyleneglycol, alcohol, dilute acids, alkalis, fungus and abrasion.

MIL-W-5086A — UNSHIELDED — 600 Volt Rating

Cat. No.	Size AWG	Mil. Type	Type	Cond. Strand	Nom. O.D.	Cat. No.	Size AWG	Mil. Type	Type Cond.	Conds. Strand	Nom. O.D.
7351	22	AN-22	No. 1	19/34	.100"	7365/2	2	AN-2	No. 2	665/30	.412"
7353	20	AN-20	No. 1	19/32	.080"	7365/0	0	AN-0	No. 2	1045/30	.518"
7355	18	AN-18	No. 1	19/30	.090"	7365/00	00	AN-00	No. 2	1330/30	.588"
7357	16	AN-16	No. 1	19/29	.100"	7351 NB	22	AN-22	No. 2	19/34	.068"
7359	14	AN-14	No. 1	19/27	.125"	7353 NB	20	AN-20	No. 2	19/32	.078"
7361	12	AN-12	No. 1	19/25	.140"	7355 NB	18	AN-18	No. 2	19/30	.088"
7363	8	AN-8	No. 2	133/29	.240"	7357 NB	16	AN-16	No. 2	19/29	.098"
7364	6	AN-6	No. 2	133/27	.297"	7359 NB	14	AN-14	No. 2	19/27	.117"
7365	4	AN-4	No. 2	133/25	.355"	7361 NB	12	AN-12	No. 2	19/25	.137"
						7362 NB	10	AN-10	No. 2	49/27	.189"

MIL-C-7078A — SHIELDED

7371	22	AN-22	No. 1	19/34	.100"	7374	16	AN-16	No. 1	19/29	.139"
7372	20	AN-20	No. 1	19/32	.110"	7375	14	AN-14	No. 1	19/27	.158"
7373	18	AN-18	No. 1	19/30	.124"	7376	12	AN-12	No. 1	19/25	.177"

STANDARD PUT-UPS: 100' - 500' - 1000'

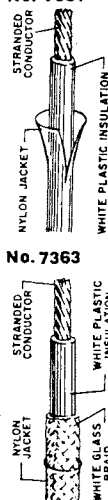

NYLON JACKET No. 7371

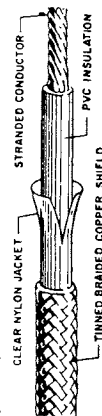

BIRNBACH

COMPANY INC. FOR MORE INFORMATION ON COMPLETE LINES, WRITE FOR NEW CATALOG.

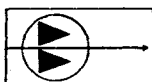

MULTI-CONDUCTOR, INTERCOM & AUDIO CABLES

SPIRAL WRAPPED SHIELDED AUDIO and MULTI-CONDUCTOR CABLE

Plastic Jacketed — with Spiral wrapped copper shield
 Designed for P.A. and sound systems, installations in schools, hospitals, and institutions, recording studios, transmitters, paging and call systems.
DESCRIPTION: Each conductor copper tinned, ¼ plastic insulation, color coded, twisted, spiral wrapped tinned copper shield, gray plastic jacket overall.

Cat. No.	Cond.	Size AWG	Strand	Nom. Insul.	Nom. Jacket	Nom. O.D.
941	2	22	7/30	.017"	.020"	.171"
941/1	1	22	7/30	.017"	.020"	.120"
941/3	3	22	7/30	.017"	.020"	.190"
941/4	4	22	7/30	.017"	.020"	.205"
941/6	6	22	7/30	.017"	.020"	.240"
950	2	22	1	.017"	.020"	.169"
942	2	20	10/30	.017"	.020"	.190"
942/1	1	20	10/30	.017"	.020"	.129"
943	3	20	10/30	.017"	.020"	.208"
944	4	20	10/30	.017"	.020"	.222"
945	6	20	10/30	.017"	.020"	.260"
946	1	18	16/30	.017"	.020"	.139"
947	2	18	16/30	.017"	.020"	.230"
947/3	3	18	16/30	.017"	.020"	.228"
947/4	4	18	16/30	.017"	.020"	.243"
948	2	16	26/30	.017"	.020"	.250"
949	3	16	26/30	.017"	.020"	.249"



CONDUCTOR COLOR CODE: 1-Black, 2-Red, 3-White, 4-Green
STANDARD PUT-UP: 100' - 250' - 500' - 1000'

SHIELDED PLASTIC JACKETED CABLE with ALUMINUM MYLAR* FOIL SHIELD

This cable is extremely light in weight and provides 100% shield coverage at audio and radio frequencies.
DESCRIPTION: Each conductor tinned copper, color coded polyethylene insulation, twisted with #22 7/30 stranded tinned copper drain wire, aluminum Mylar* foil shield, gray polyvinylchloride jacket overall.

Cat. No.	Cond.	Size AWG	Strand	Nom. Insul.	Nom. Jacket	Nom. O.D.
1890	2	22	7/30	.015"	.020"	.165"
1890/3	3	22	7/30	.015"	.020"	.175"
1890/4	4	22	7/30	.015"	.020"	.190"
1891	2	20	10/30	.015"	.020"	.180"
1891/3	3	20	10/30	.015"	.020"	.190"
1891/4	4	20	10/30	.015"	.020"	.200"
1892	2	18	16/30	.017"	.020"	.220"
1892/3	3	18	16/30	.017"	.020"	.230"
1892/4	4	18	16/30	.017"	.020"	.240"

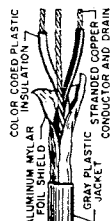

CONDUCTOR COLOR CODE: 1-Black, 2-Red, 3-White, 4-Green
STANDARD PUT-UP: 100' - 500' - 1000'

TWISTED PAIRS — STRANDED CONDUCTORS

DESCRIPTION: Each Conductor #22 7/30 Stranded Tinned Copper, .010" Vinyl plastic insulation, twisted pairs cabled, conductors color coded, tubed gray Vinyl plastic jacket overall.

Cat. No.	Pairs	Cond.	Size AWG	Strand	Nom. O.D.
4731	1	2	22	7/30	.145"
4732	2	4	22	7/30	.210"
4733	3	6	22	7/30	.225"
4734	4	8	22	7/30	.235"
4735	5	10	22	7/30	.245"
4736	6	12	22	7/30	.270"
4739	9	18	22	7/30	.325"
4740	11	22	22	7/30	.365"
4745	15	30	22	7/30	.455"
4745/19	19	38	22	7/30	.480"
4746	23	46	22	7/30	.530"
4747	27	54	22	7/30	.570"
4748	31	62	22	7/30	.635"
4749	41	82	22	7/30	.710"
4750	51	102	22	7/30	.800"

STANDARD PUT-UPS: 50' - 100' - 250' - 1000'

SPECIAL CABLE CONSTRUCTIONS AVAILABLE AT ANY TIME.

SHIELDED BROADCAST AUDIO CABLE

Designed to provide maximum performance on all equipment. Conductors twisted correctly assures quiet, clear operation which eliminates interference and cross talk. Used by Broadcast studios, for P.A. and sound systems, rack wiring, etc.

DESCRIPTION: #938—#22 Solid Tinned Copper Conductor, enameled, heavy cellulose acetate yarn wrap, cotton braid waxed; cabled with #22 AWG solid tinned copper wire laid parallel to twisted pair under tinned copper braid shield; tubed-on Vinyl plastic jacket overall.

#939—#22-7/30 Stranded Tinned Copper, plastic insulation, color coded, twisted, copper braid shield, tubed-on Vinyl plastic jacket overall.

#940—2 Conductors #22 solid plastic insulation, color coded, twisted with #22 AWG solid tinned copper ground wire under tinned copper shield with vinyl plastic jacket overall.

#940/1 same construction as #940 however with tinned copper spiral wrapped shield.

#822 and #824 have solid enameled copper wire, cotton wrap, cotton braid waxed twisted pair, bare copper braid overall.

Cat. No.	Cond.	Size AWG	Strand	Nom. O.D.
938	2	22	Solid	.210"
939	2	22	7/30	.170"
940	2	22	Solid	.160"
940/1	2	22	Solid	.160"
822	2	22	Solid	.125"
824	2	19	Solid	.145"
927	2	20	Solid	.210"
928	2	18	Solid	.220"

STANDARD PUT-UP: 100' - 250' - 500' - 1000'
CONDUCTOR COLOR CODE: Black and Red

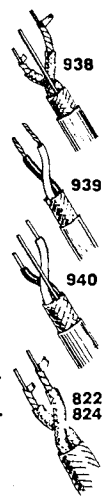

MULTIPLE PAIR INDIVIDUALLY SHIELDED INTERCOM CABLE

Useful where several mikes are operated from a single cable. This series is helpful in reducing the bulk of required cables.

DESCRIPTION: Multi-pairs #22 solid tinned copper, vinyl insulated .013" cabled in pairs. Each pair and ground wire is under aluminum foil mylar shield, overall gray vinyl jacket; Nom. Cap. between Conds. 40 Mmf/ft.; Nom. Cap. between 1 Cond. and others connected to shield — 77Mmf/ft.

Cat. No.	Pairs	Cond.	Nom. Jkt.	Nom. O.D.
4800/3	3	6	.030	.298
4800/6	6	12	.037	.394
4800/9	9	18	.040	.425
4800/11	11	22	.040	.485
4800/15	15	30	.045	.510
4800/19	19	38	.055	.678
4800/27	27	54	.070	.860

4800/19 and 4800/27 is #22 strand 7/30 with .015 wall
STANDARD PUT-UPS: 100' — 250' — 500' — 1000'

MULTI-CONDUCTOR FLEXIBLE CABLE

DESCRIPTION: Each conductor #22 7/30 tinned copper stranded .010" thermoplastic insulation, color coded, conductors twisted, gray vinyl plastic jacket overall. Used for signal, P.A. systems. Electronic computer cable, suitable for outdoor use.

Cat. No.	Cond.	Size AWG	Strand	Nom. Insul.	Nom. Jacket	Nom. O.D.
156	2	22	7/30	.010"	.020"	.140"
157	3	22	7/30	.010"	.020"	.145"
158	4	22	7/30	.010"	.020"	.170"
159	5	22	7/30	.010"	.020"	.175"
160	6	22	7/30	.010"	.020"	.185"
161	7	22	7/30	.010"	.020"	.190"
162	8	22	7/30	.010"	.020"	.200"
163	9	22	7/30	.010"	.020"	.225"
164	10	22	7/30	.010"	.020"	.235"
165	12	22	7/30	.010"	.020"	.255"
165/15	15	22	7/30	.010"	.020"	.280"
165/20	20	22	7/30	.010"	.020"	.310"
165/25	25	22	7/30	.010"	.020"	.340"
165/30	30	22	7/30	.010"	.020"	.365"
165/40	40	22	7/30	.010"	.020"	.425"
165/50	50	22	7/30	.010"	.020"	.500"
165/60	60	22	7/30	.010"	.020"	.530"

STANDARD PUT-UPS: 100' - 250' - 500' - 1000'

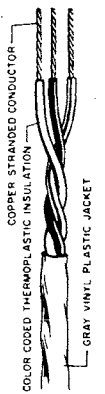

BIRNBACH

COMPANY INC. FOR MORE INFORMATION ON COMPLETE LINES, WRITE FOR NEW CATALOG.

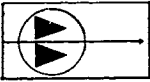

HOOK-UP AND TEST LEAD WIRES

SUBMINIATURE TEFLON* HOOK-UP WIRE

Per MIL-W-16878D Type ET 250 Volts, 250°C Thin Wall .006"

This new exceptionally thin miniature hook-up wire is suitable in miniature slip ring assemblies, as interconnecting wire between wafers in microminiature electronic circuitry, instrument wire, medical wire, subminiature thermo-couple lead wire, strain gauge wire, etc. Provides lighter weight, greater flexibility and hi temperature resistance. Size Nos. 32 thru 20 conform to MIL-W-16878D type ET 250 volts, 250 °C.

Cat. No.	Mil Type Designation	Size AWG	Strand	Nom. O.D.
8550/36	—	36	7/44	.018"
8550/34	—	34	7/42	.020"
8550/32	ET-32	32	7/40	.021"
8550/30	ET-30	30	7/38	.024"
8550/28	ET-28	28	7/36	.027"
8550/26	ET-26	26	7/34	.031"
8550/24	ET-24	24	7/32	.036"
8550/22	ET-22	22	7/30	.042"
8550/20	ET-20	20	7/28	.049"

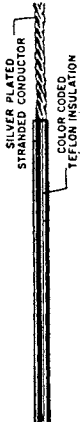

KINKLESS TEST LEAD WIRE

Used with portable test equipment; as tested, leads in analyzers, oscillators, instruments; wherever extreme flexibility and limpness is required. Has excellent dielectric properties.

DESCRIPTION:

No. 61—#20—41/36 extra flexible annealed tinned copper, stranded.

No. 66—#18—65/36 extra flexible annealed tinned copper stranded; paper serve; 3/4" special low capacity rubber, wax finish.

Colors: Red, Black.

Types WS-16/U Black, WS-17/U Red; No. 70 per MIL-W-13169 Specification available same construction as Birnbach #66 except compound per specification.

Cat. No.	Size AWG	Strand	Ins.	Puncture Voltage	Nom. O.D.
61	20	41/36	3/64"	20,000 V	.137"
66	18	65/36	3/64"	22,000 V	.145"
70*	18	65/36	3/64"	22,000 V	.145"

* MILITARY TYPE SPECIFICATION MIL-W-13169B
WS-16/U Black WS-17/U Red
STANDARD PUT-UPS: 100' - 250' - 500' - 1000'

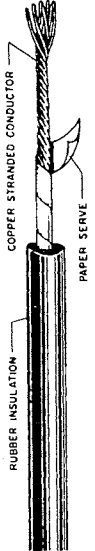

200° C — Birsil Silicone Rubber Hook-Up Lead Wire — 600 Volt

This Birsil Silicone Rubber Hook up lead wire withstands extreme temperature range and flexibility from -104°C. to +400°F. with retention of physical properties and is highly resistant to flex cracking at temperature extremes; fungus resistant; corona resistant; engineered for high-heat and hi-frequency applications; low power factor; acid-alkali-oil resistant; low dielectric constant; insulation approaching mica. Approved by U.L. but consumer must apply for Underwriter's Laboratories approval for individual product.

DESCRIPTION—One conductor, tinned copper strands, silicone rubber insulation, glass braid, lacquered. Color: White.

Cat. No.	Size AWG	Strand	Nom. Ins. Wall	Volt Rating	Breakdown Voltage AC	Nom. O.D.
7622	22	7/30	1/32"	600	11,500	.105"
7620	20	10/30	1/32"	600	18,000	.121"
7618	18	16/30	1/32"	600	21,000	.128"
7616	16	26/30	1/32"	600	20,000	.144"
7614	14	41/30	1/32"	600	15,500	.165"
7612	12	65/30	1/32"	600	14,500	.185"
7610	10	65/28	3/64"	600	20,000	.240"
7608	8	84/27	1/16"	2300	20,000	.320"

Additional sizes and colors available to order.
Types F and FF per MIL-W-16878C available to order.
STANDARD PUT-UPS: 100' - 500' - 1000'

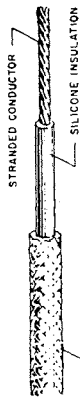

NEW PLASTIC KINKLESS TEST LEAD WIRE

New formulation vinyl compound insulation allows maximum flexibility; rough treatment; extreme variation in climatic conditions; excellent abrasion resistance; greater temperature stability from -80°C to +115°C; fungus resistant; self extinguishing-flame proof; smooth surface. Resists exposure to gasoline and oil. 5000 volts

DESCRIPTION: One conductor tinned copper stranded, special formulation vinyl insulation.

Colors: Black, Red, Yellow, Green, White, Blue.

Cat. No.	Size AWG	Strand	Ins.	Nom. O.D.
1922	22	26/36	.032"	.100"
1920	20	26/34	.032"	.104"
1918	18	65/36	.032"	.112"
1916	16	65/34	.032"	.129"

For portable test equipment; as test leads for instrumentation exceeds the requirements for MIL-I-3930A type JP (PVC). It is superior to synthetic rubber spec MIL-R-6855 Class II Grade 60.

STANDARD PUT-UPS: 100' - 250' - 500' - 1000'

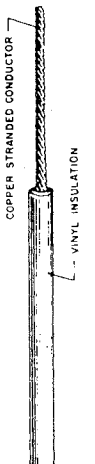

Hi-Voltage and Cathode Ray Cable

Used for 10,000, 20,000, 40,000, 60,000 volt applications as for cathode ray tubes in TV receivers, oscilloscopes and other electronic devices. Has dielectric constant of 2.7 and power factor of .002. Shielded Hi-Voltage type used to shield RF radiation in X-Ray, diathermy, medical equipment, and in transmitters.

DESCRIPTION—One conductor stranded copper tinned rulan (flame retarding type) polyethylene insulation. Available white/red tracer. Temp. Rating: 105°C

Shielded—Same as above with tinned copper braided shield overall.

Cat. No.	Size AWG	Strand	Nom. Ins. Wall	Suggested Working Vol.		Nom. O.D.
				Unshielded	Shielded	
7402	20	10/30	.047"	10,000	.125"	
7412	20	10/30	.068"	20,000	.169"	
7418	18	16/30	.047"	10,000	.135"	
7428	18	16/30	.069"	20,000	.179"	
7448	18	16/30	.095"	40,000	.231"	
7449	18	16/30	.123"	60,000	.285"	

SHIELDED						
7458	18	16/30	.095"	40,000	.256"	

STANDARD PUT-UPS: 100' - 500' - 1000'

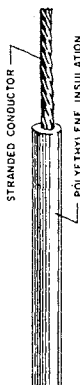

HEAVY DUTY HI-VOLTAGE TYPE

DESCRIPTION:

No. 68—#18—65/36 extra flexible annealed tinned copper, stranded; paper serve; 3/4" special low capacity rubber, wax finish.

Colors: Red, Black.

Used for oscillators, analyzers, TV, therapeutic instruments, etc.; wherever an extremely flexible high voltage lead is indicated.

Cat. No.	Size AWG	Strand	Ins.	Puncture Voltage	Nom. O.D.
68	18	65/36	5/64"	29,000 V	.210"

STANDARD PUT-UPS: 100' - 250' - 500' - 1000'



BIRNBACH

COMPANY INC. FOR MORE INFORMATION ON COMPLETE LINES, WRITE FOR NEW CATALOG.

RETRACTILE HEAVY DUTY AND POWER CORD SETS



RETRACTILE Super Heavy Duty POWER CORDS

GUARANTEED TO RETRACT FOR 4 YEARS MILITARY INDUSTRIAL. AWG SIZES — 12, 14, 16, 3 and 4 COND.

Especially desirable in the maintenance of industrial automation equipment, refrigerated trucks and trailers, mass assembly and production equipment, plane maintenance, control cable for cherry pickers, magnetic cranes, standby power distribution, heavy duty machinery.

Useful whenever and wherever a tougher, more rugged heavy duty power cable is indicated as in foundries, aboard ships, reels on overhead cranes and hoists, tanks, plug-in power for refrigeration and immersion heaters, etc. Usable around salt water, chemicals and many other areas which makes the use of reels undesirable . . . 48" retracted — 25' extended.

THIS IS A NEW CORD and should not be confused with cords of lesser quality.

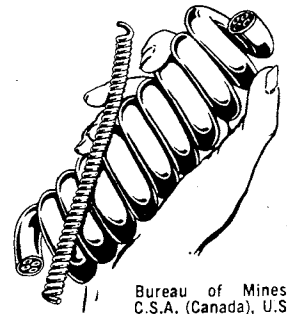

BB Cat. No.	Size Conds.	AWG	Strand.	Nom. JKT. Thkns.	Nom. O.D.
1300	3	16	65/34	7/64"	.505"
1300/4	4	16	65/34	7/64"	.535"
1301	3	14	41/30	7/64"	.620"
1301/4	4	14	41/30	7/64"	.660"
1302	3	12	65/30	8/64"	.715"
1302/4	4	12	65/30	8/64"	.770"

Bureau of Mines, C.S.A. (Canada), U.S. Coast Guard, UL and Army/Navv approved

RETRACTILE (KINKLESS) POWER CORDS RUBBER, NEOPRENE AND PLASTIC — UL AND CSA APPROVED



DESCRIPTION: Multi-conductor power cords, each conductor stranded copper, tough rubber, neoprene or geom plastic jacket overall UL and CSA approved. Available from stock in indicated lengths, can be cut to desired length.

Cat. No.	Retracted Length	Approx. Length Ext.	No. Cond.	Size AWG	Strand	UL Type	Amp. Rating	Volt Rating	Coil Nom. O.D.	Cord. Nom. O.D.
886-2	24"	12'	2	18	41/34	SVO	7	300	7/8"	.250
886	36"	18'	2	18	41/34	SVO	7	300	7/8"	.250
886-4	48"	25'	2	18	41/34	SVO	7	300	7/8"	.250
886/3-2	24"	12'	3	18	41/34	SVO	7	300	1"	.275
886/3-3	36"	18'	3	18	41/34	SVO	7	300	1"	.275
886/3	48"	25'	3	18	41/34	SVO	7	300	1"	.275
887-2	24"	12'	2	18	41/34	SVT	7	300	7/8"	.250
887	36"	18'	2	18	41/34	SVT	7	300	7/8"	.250
887-4	48"	25'	2	18	41/34	SVT	7	300	7/8"	.250
889-2	24"	12'	2	18	41/34	SJO	7	300	1 1/8"	.310
889	36"	18'	2	18	41/34	SJO	7	300	1 1/8"	.310
889-4	48"	25'	2	18	41/34	SJO	7	300	1 1/8"	.310
890-2	24"	12'	2	18	41/34	SJT	7	300	1 1/8"	.310
890	36"	18'	2	18	41/34	SJT	7	300	1 1/8"	.310
890-4	48"	25'	2	18	41/34	SJT	7	300	1 1/8"	.310
889/3-2	24"	12'	3	18	41/34	SJO	7	300	1 3/8"	.330
889/3	36"	18'	3	18	41/34	SJO	7	300	1 3/8"	.330
889/3-4	48"	25'	3	18	41/34	SJO	7	300	1 3/8"	.330
889/4-2	24"	12'	4	18	41/34	SJO	5.6	300	1 3/8"	.360
889/4	36"	18'	4	18	41/34	SJO	5.6	300	1 3/8"	.360
889/4-4	48"	25'	4	18	41/34	SJO	5.6	300	1 3/8"	.360
889/5-2	24"	12'	5	18	41/34	—	5.6	300	1 3/4"	.440
889/5	48"	25'	5	18	41/34	—	5.6	300	1 3/4"	.440
889/7-2	24"	12'	7	18	41/34	—	5.6	300	1 7/8"	.500
889/7	48"	25'	7	18	41/34	—	5.6	300	1 7/8"	.500
891-2	24"	12'	2	16	65/34	SJO	10	300	1 3/8"	.330
891	36"	18'	2	16	65/34	SJO	10	300	1 3/8"	.330
891-4	48"	25'	2	16	65/34	SJO	10	300	1 3/8"	.330
891/3-2	24"	12'	3	16	65/34	SJO	10	300	1 3/8"	.365
891/3	36"	18'	3	16	65/34	SJO	10	300	1 3/8"	.365
891/3-4	48"	25'	3	16	65/34	SJO	10	300	1 3/8"	.365
891/4-2	24"	12'	4	16	65/34	SJO	8	300	1 3/8"	.395
891/4	36"	18'	4	16	65/34	SJO	8	300	1 3/8"	.395
891/4-4	48"	25'	4	16	65/34	SJO	8	300	1 3/8"	.395
891/5-2	24"	12'	5	16	65/34	—	8	600	2"	.540
891/5	48"	25'	5	16	65/34	—	8	600	2"	.540
891/6-2	24"	12'	6	16	65/34	—	8	600	2 1/8"	.550
891/6	48"	25'	6	16	65/34	—	8	600	2 1/8"	.550
891/7-2	24"	12'	7	6/16	#16-65/34	—	#16-8	600	2 1/4"	.600
891/7	48"	25'	7	1/14	#14-41/30	—	#14-12	600	2 1/4"	.600
893-2	24"	12'	2	14	41/30	SO	15	600	2"	.535
893	36"	18'	2	14	41/30	SO	15	600	2"	.535
893-4	48"	25'	2	14	41/30	SO	15	600	2"	.535
893/3-2	24"	12'	3	14	41/30	SO	15	600	2 1/8"	.560
893/3	36"	18'	3	14	41/30	SO	15	600	2 1/8"	.560
893/3-4	48"	25'	3	14	41/30	SO	15	600	2 1/8"	.560
893/4-2	24"	12'	4	14	41/30	SO	12	600	2 1/8"	.605
893/4	36"	18'	4	14	41/30	SO	12	600	2 1/8"	.605
893/4-4	48"	25'	4	14	41/30	SO	12	600	2 1/8"	.605
894-2	24"	12'	2	12	65/30	SO	20	600	2 1/2"	.605
894	36"	18'	2	12	65/30	SO	20	600	2 1/2"	.605
894-4	48"	25'	2	12	65/30	SO	20	600	2 1/2"	.605
894/3-2	24"	12'	3	12	65/30	SO	20	600	2 3/8"	.635
894/3	36"	18'	3	12	65/30	SO	20	600	2 3/8"	.635
894/3-4	48"	25'	3	12	65/30	SO	20	600	2 3/8"	.635
894/4-2	24"	12'	4	12	65/30	SO	16	600	2 1/2"	.665
894/4	36"	18'	4	12	65/30	SO	16	600	2 1/2"	.665
894/4-4	48"	25'	4	12	65/30	SO	16	600	2 1/2"	.665
894/6-2	24"	12'	6	2-12	#12-65/30	—	#12-17	600	2 1/4"	.605
894/6	48"	25'	6	4-18	#18-41/34	—	#18-6	600	2 1/4"	.605
894/7-2	24"	12'	7	2-12	#12-65/30	—	#12-17	600	2 1/4"	.605
894/7	48"	25'	7	4-18	#18-41/34	—	#18-6	600	2 1/4"	.605

CONDUCTOR COLOR CODING: 1-Black, 2-White, 3-Green, 4-Red, 5-Blue, 6-Brown, 7-Yellow

BIRNBACH

COMPANY INC. FOR MORE INFORMATION ON COMPLETE LINES, WRITE FOR NEW CATALOG.

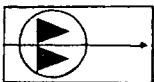

RETRACTILE CORDS

This series of Birnbach Coiled Kinkless Retractable Cords are permanently coiled into a spring-like shape without the use of metal springs or elastic bands. They have inherent "Recovery" properties. These Retractable cords extend approximately six times its retracted length, returning to its original shape and length when released. Always as long as you need them and no longer, they will not kink, tangle, trail, knot or dangle on the floor or bench and cause accidents. Useful wherever cords or cables must change length or position.

RETRACTILE TEST LEAD WIRE

Stretch coiled kinkless test lead wire description. 12" coil—stretches to approx. 6 feet. One conductor #20 stranded copper rubber insulation .165 O.D. Coil O.D. 3/4". 6" straight lead on each end.



Cat. No.	Re-tr. Length	Approx. Extended	Cond.	Size AWG	Strand	Coil O.D.	Nom. O.D.	Pkg. Std.
64	12"	6'	2	23	21/36	3/4"	.200"	6
65	24"	12'	2	23	21/36	3/4"	.200"	6

BIRNBACH MINIATURE RETRACTILE CORD

This small size is suitable where compact equipment is required. 2 ft. retracted, approximately 10 ft. extended Black plastic jacket overall.

Nom. Cond. resistance: .07 OHMS per linear foot (approx. .6 OHMS per retracted ft.)
Maximum working voltage: 100; current capacity 1/2 amp.

Cat. No.	Cond.	Size AWG	Strand	Coil O.D.	Cond. O.D.	Std. Pkg.
875/28	2	28	19/40TC	1/2"	.135	10
877/28	4	28	19/40TC	1/2"	.150	10

CONDUCTOR COLOR CODE: 1-Black, 2-White, 3-Red, 4-Green. For 3 conductors, use 4 cond. and cut one dead.



RETRACTILE COILED COMMUNICATION CORD

Multi-conductors stranded communication cord No. 23 AWG. Tinned copper wire neoprene or Geon plastic jacketed. Long lengths can be cut to exact requirement. Adds product reliability. Useful wherever cords must change length or position. Nom. cond. resistance .022 ohms per linear foot, .185 ohms per retracted foot. Maximum working voltage 120 volts. Current carrying capacity 1 ampere.

Cat. No.	Re-tr. Length	Approx. Extended	Cond.	Size AWG	Strand	Coil O.D.	Nom. O.D.
875-2	24"	12 Ft.	2	23	21/36	3/4"	.200"
875	36"	18 Ft.	2	23	21/36	3/4"	.200"
875-4	48"	25 Ft.	2	23	21/36	3/4"	.200"
876-2	24"	12 Ft.	3	23	21/36	3/4"	.210"
876	36"	18 Ft.	3	23	21/36	3/4"	.210"
876-4	48"	25 Ft.	3	23	21/36	3/4"	.210"
877-2	24"	12 Ft.	4	23	21/36	13/16"	.240"
877	36"	18 Ft.	4	23	21/36	13/16"	.240"
877-4	48"	25 Ft.	4	23	21/36	13/16"	.240"
878-2	24"	12 Ft.	5	23	21/36	1"	.285"
878	36"	18 Ft.	5	23	21/36	1"	.285"
878-4	48"	25 Ft.	5	23	21/36	1"	.285"
878/6-2	24"	12 Ft.	6	23	21/36	1 1/8"	.305"
878/6	36"	18 Ft.	6	23	21/36	1 1/8"	.305"
878/6-4	48"	25 Ft.	6	23	21/36	1 1/8"	.305"
878/7-2	24"	12 Ft.	7	23	21/36	1 1/4"	.320"
878/7	36"	18 Ft.	7	23	21/36	1 1/4"	.320"
878/7-4	48"	25 Ft.	7	23	21/36	1 1/4"	.320"
878/8	48"	25 Ft.	8	23	21/36	1 1/2"	.360"
878/10	48"	25 Ft.	10	23	21/36	1 3/4"	.380"
878/12	48"	25 Ft.	12	23	21/36	1 3/4"	.410"
878/15	48"	25 Ft.	15	23	21/36	1 3/4"	.470"
878/37	48"	25 Ft.	37	23	21/36	2 1/2"	.680"

CONDUCTOR COLOR CODING: 1-Black, 2-White, 3-Red, 4-Green, 5-Blue, 6-Yellow, 7-Brown, 8-Orange, 9-White/Black Tracer, 10-White/Red Tracer, 11-White/Green Tracer, 12-White/Blue Tracer, 13-White/Yellow Tracer, 14-White/Brown Tracer, 15-White/Orange Tracer. Also available in retracted lengths of 12", 24" and 48".



RETRACTILE (KINKLESS) COILED SHIELDED COMMUNICATION CORDS

DESCRIPTION: Single and multi-conductor shielded microphone cable neoprene or geon plastic jacketed. This cable remains neat and compact with no danger of tripping or of the wire becoming entangled in equipment. Also suitable for stereo and additional speaker extensions. Shield can be pigtailed for soldering. No. 24 AWG Str. is 41/40 tinned soft cad. copper. No. 23 has 21/36 tinned soft cad. copper. Spiral wrapped tinned soft copper shielding.

Cat. No.	Retr. Length	Approx. Extended	Cond.	Size AWG	Coil O.D.	Nom. O.D.	Maximum Working Voltage	Capacitance MMF Lin. Ft.	MMF Retr. Ft.	Std. Pkg.
895	48"	25 Ft.	1	No. 24 Shielded	3/8"	.160"	75	56	440	10
895A	12"	6 Ft.	1	No. 24 Shielded	3/8"	.160"	75	56	440	10
895B	6"	3 Ft.	1	No. 24 Shielded	3/8"	.160"	75	56	440	10
896	48"	25 Ft.	2	1-No. 23 1-No. 24 Shielded	7/8"	.200"	#23-120 #24- 75	56	450	10
896A	12"	6 Ft.	2	1-No. 23 1-No. 24 Shielded	7/8"	.200"	#23-120 #24- 75	56	450	10
897	48"	25 Ft.	3	2-No. 23 1-No. 24 Shielded	7/8"	.240"	#23-120 #24- 75	56	450	10
897A	12"	6 Ft.	3	2-No. 23 1-No. 24 Shielded	7/8"	.240"	#23-120 #24- 75	56	450	10
899	48"	25 Ft.	2	2-No. 24 Shielded	7/8"	.210"	75	56	450	10
899A	12"	6 Ft.	2	2-No. 24 Shielded	7/8"	.210"	75	56	450	10
898	48"	25 Ft.	4	2-No. 23 2-No. 24 Shielded	1"	.270"	#23-120 #24- 75	56	460	10
898A	12"	6 Ft.	4	2-No. 23 2-No. 24 Shielded	1"	.270"	#23-120 #24- 75	56	460	10

Additional conductors and sizes available. CONDUCTORS ARE COLOR CODED.



RETRACTILE COMMUNICATION CORDS PREPARED FOR EASY INSTALLATION AND REPLACEMENT

DESCRIPTION: Same as communication cords except each end is prepared as indicated.

Cat. No.	Cond.	Size AWG	Nom. O.D.	Nom. O.D.	Preparation
883	3	23-21/36	3/4"	.220"	1 end: total length 1 1/2". Conductors stripped and tinned. Other end: total length 1 1/2" jacket removed.
884	4	23-21/36	3/4"	.250"	1 end: total length 1". Conductors stripped and tinned. Other end: total length 1 1/2" jacket removed.
885	5	23-21/36	1 1/8"	.285"	1 end: total length 4 1/8". Conductors stripped and tinned. Other end: total length 4 1/8" conductors stripped and tinned.

RETRACTILE POWER CORD SETS

Excellent for portable use. All mobile equipment and office equipment wherever the device application is synonymous with repetitive movement. The "Answer" to most tough hazard problems. 2 and 3 conductors SVO and SJO Retractable Kinkless Neoprene Service Cord Sets with Molded Male Plug one end, other end stripped for application. Adds reliability, compactness and portability.

Cat. No.	Retracted Length	UL Type	Size AWG	Coil O.D.
880	18"	9 Ft.	2	18 SVO 41/34
880/3	18"	9 Ft.	3	18 SVO 41/34
881	18"	9 Ft.	2	18 SJO 41/34
881/3	18"	9 Ft.	3	18 SJO 41/34
882	18"	9 Ft.	2	16 SJO 65/34
882/3	18"	9 Ft.	3	16 SJO 65/34

CONDUCTOR COLOR CODING: 1-Black, 2-White, 3-Green.

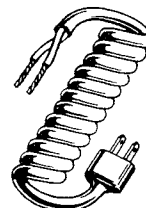

BIRNBACH

COMPANY INC. FOR MORE INFORMATION ON COMPLETE LINES, WRITE FOR NEW CATALOG.

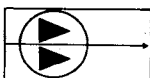

Shielding Braid, Insulated Copper Wire, Braiding

UNINSULATED COPPER WIRE

TINNED COPPER SHIELDING

Used for shielding and bonding on aircraft, marine and auto radio wires and cables. Shields speaker leads, lead-ins, amplifier wires. Extremely flexible, slides over wires and cables.

DESCRIPTION:

No. 853 thru 856/7—Composed of extremely flexible fine soft annealed copper tinned wires closely woven, braided and Rolled Flat.

No. 860—Composed of extremely flexible fine soft annealed copper wires closely woven, braided and Rolled Flat.



TINNED

Cat. No.	Size & No. of Wires	Inside Diam. Flat.	Approx. O.D. Flat.	Approx. AWG Equiv.	Nom. Circ. Mills	Current Carrying Cap./Amps.
853	12x 2/36	1/32"	3/64"	24	400	6.0
854	12x 2/36	1/32"	3/64"	22	600	7.0
855	16x 3/36	1/32"	3/64"	20	1200	11.00
858	24x 5/36	1/16"	3/32"	18	1800	16.00
859	24x 5/36	1/16"	3/32"	15	3000	25.00
863	24x 7/36	1/16"	3/32"	14	4200	32.00
864	48x 4/36	1/16"	3/32"	12	7200	46.00
868	48x 7/36	1/16"	3/32"	10	9600	53.00
865	48x 8/36	1/16"	3/32"	10	9600	53.00
865/1	48x11/36	1/16"	3/32"	7	20,800	85.00
857	48x19/36	1/16"	3/32"	7	20,800	85.00
856	48x19/36	1/16"	3/32"	7	20,800	85.00
856/1	48x19/36	1 1/8"	1 1/8"	7	53,064	85.00
856/2	48x19/36	1 1/8"	1 1/8"	3	125,425	150.00
856/3	48x27/30	1 1/4"	1 1/4"	001	154,368	280.00
856/4	48x32/30	1 1/2"	1 1/2"	000	192,000	310.00
856/6	48x45/30	2 1/2"	2 1/4"	000	216,000	340.00
856/7	48x64/30	3"	3 1/4"	0000	225,000	390.00

BARE

860	24x10/36	1/4"	3/8"	14	4200	32.00
-----	----------	------	------	----	------	-------

STANDARD PUT-UPS:

- #853 thru #856/1 — 50' — 100' — 250' — 500' — 1000'
- #856/2 thru #856/7 — 50' — 100' — 250'
- #860 — 50' — 100' — 250' — 500' — 1000'

TUBULAR BRAID PER MIL SPEC. QQ-B-575

Manufactured completely round as noted in MIL Spec. QQ-B-575, this tinned copper shielded braid has self-supporting characteristics which enables it to maintain its round shape. The shielding coverage percentage is 95% or more. This tubular braid is used in military applications where maximum shielding against electrostatic interference is indicated. In addition, it is used as a protective covering against mechanical abrasion and stresses for the wires, cables and other components.



Cat. No.	Construction			Approx. AWG Equiv.	Nom. Circular Mills	*Current Carrying Capacity Amps	
	Nom. Inside Diam. When Rounded	Total No. of Wires	Carriers				
2250-1/32	1/32"	24	24	36	22	640	7.0
2250-1/16	1/16"	48	24	36	19	1,290	11.0
2250-5/64	5/64"	72	24	36	17	1,900	18.0
2250-7/64	7/64"	96	24	36	16	2,500	22.0
2250-1/8	1/8"	120	24	36	15	3,260	28.0
2250-5/32	5/32"	240	24	36	12	6,200	39.0
2250-11/64	11/64"	168	24	36	14	4,500	32.0
2250-3/16	3/16"	192	24	36	13	5,100	35.0
2250-13/64	13/64"	312	24	36	11	8,200	46.0
2250-1/4	1/4"	384	24	36	10	10,400	53.0
2250-3/8	3/8"	528	48	36	10	10,400	53.0
2250-1/2	1/2"	528	48	36	9	13,200	70.0
2250-9/16	9/16"	528	48	36	7	13,200	70.0
2250-11/16	11/16"	720	48	36	7	19,000	82.0
2250-25/32	25/32"	864	48	36	7	21,750	85.0
2250-13/16	13/16"	864	48	36	7	21,750	85.0
2250-1"	1"	864	48	36	4	38,600	120.0

STANDARD SPOOL PUT-UPS: 50' — 100' — 250', 500' — 1000'

*Values based on copper in free air at 65°F. Additional constructions and variations made to order. Also available in silver plated copper, bare copper and stainless steel.

SILVER PLATED TUBULAR BRAID AVAILABLE

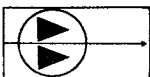

ELECTRONIC LACING CORD/TAPE

To Meet MIL-T-43435 — COMP-P - Type S — MIL-T-713A - Type P*

FLAT BRAIDED LACING TAPE — NYLON

Flat braided Hi-Tenacity Nylon Fiber impregnated with (MW) microcrystalline fungicidal wax. Engineered to stay flat. Distributes stress evenly over a wide area. Resistant to fungus, flame, abrasion, acids. Will not cut or damage insulation. Has strength, toughness and stability.

PUT UP ON 500 YARDS PER TUBE

Cat No.	Class	Width	Thick.	Test lbs.	Yd./Lb.
1035	Natural White	.200"	.014"	150	250
1035B	Black	.200"	.014"	150	250
1036	Natural White	1	.120"	80	550
1036B	Black	1	.120"	80	550
1037	Natural White	2*	.090"	50	750
1037B	Black	2*	.090"	50	750
1038	Natural White	3	.062"	30	1500
1038B	Black	3	.062"	30	1500
1039	Natural White	4	.046"	15	2400
1039B	Black	4	.046"	15	2400



ROUND NYLON LACING CORDS

This nylon lacing cord manufactured to meet Spec. MIL-T-713A Type P, Composition P, Classes 3, 2, 1. Wax finished — compounded with a fungicide to resist mildew.

PUT UP ON 1 LB. TUBES

Cat. No.	Cat. No.	Yds.	Diam.	Breaking Strength Lbs.	
					Natural
Class 1	1070	1070B	600	.039"	70
Class 2	1071	1071B	800	.029"	48
Class 3	1072	1072B	1140	.025"	32
Class 4	1072/1	1072/1B	2400	.020"	20



TEFLON, DACRON AND G.E. FINISH LACING CORDS AVAILABLE.

HarnessRAP

This new spiral wrapping provides a readily flexible and strong protection for groups of conductors. Because of the facility with which it is applied it is particularly useful for temporary or experimental wiring as well as permanent installations. Leads can be brought out at any point to make a "tailor-made" harness, strong, secure, tight-fitting.

Harnessrap retains its elasticity and can be removed as easily as it is applied, then reused again and again.

Because of its flexibility it is especially useful for harnesses that carry wiring around sharp corners or that are subject to repeated flexing or bending.

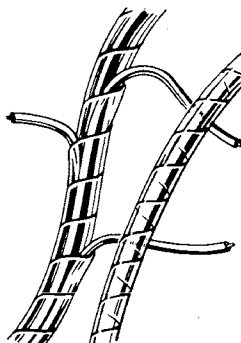

Part No.	Outside Diameter	Wall Thickness
POLYETHYLENE		
BHR-1/8	1/8"	.031
BHR-1/4	1/4"	.032
BHR-3/8	3/8"	.058
BHR-1/2	1/2"	.058
FLAME RETARDANT (RULAN)		
BHRF-1/4	1/4"	.058
BHRF-3/8	3/8"	.058

MADE IN FOUR SIZES

- 1/8" O.D. 1/16" to 1/2" wire groups
- 1/4" O.D. 3/16" to 1 1/2" wire groups
- 3/8" O.D. 1/4" to 2" wire groups
- 1/2" O.D. 3/4" to 4" wire groups

PHYSICAL CHARACTERISTICS

	Standard Polyethylene	Flame Retarded Polyethylene
	Temp. Range	-140°F + 200°F
Flammability	0.94	Self. Ext.
Tensile Strgth.	1700	1500
Water Absorp.		.02
24 hours	.03	2.7
Dielectric Con.	2.3	15
Wgt. thous. ft.	10	

COLORS: Natural (White). Additional colors and sizes available on request.

AVAILABLE IN 25' - 100' - 500' - 2000' Lgths.



COMPANY INC. FOR MORE INFORMATION ON COMPLETE LINES, WRITE FOR NEW CATALOG.

Now,
 the next time
 you need
 just a spool-full
 or so of
Brand Rex
 you can just
 run around the
 corner to your
 nearest
Birnbach
Brand Rex*
 distributor



(he's got a warehouse full.)

If you hadn't heard of a B/BR distributor before, that's because there wasn't one before. Now there is. Nearby. And it means you can buy the full range of Brand-Rex electronic products, in a full range of quantities. If you don't know just where to find your local B/BR man, drop us a line. We'll corner him for you.

BIRNBACH
 COMPANY INC.



*Brand Rex wire marketed by Birnbach

COLUMBIA

DURAFOAM UHF/VHF TELEVISION TRANSMISSION LINE*

MOST WIDELY USED — LARGEST SELLING

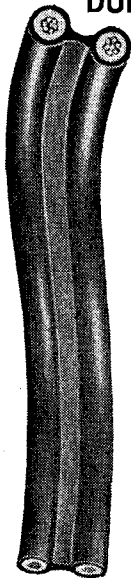

Durafoam quality is so high that we can offer an unconditional 15 year guarantee. Its high reliability construction features two tubes of cellular polyethylene, to assure low signal loss, and a heavy black polyethylene Permaline insulation, to offer the maximum protection against deterioration caused by moisture, chemicals, salts and sunlight.

Durafoam is also extremely easy to install, cutting down the amount of time required for each job.

Cat. No.	
5790L	50 ft.
5790S	65 ft.
5790C	100 ft.
5790D	500 ft.
5790M	1000 ft.

* U. S. Pat. #3,219,752

NEW LOW COST UHF-VHF COLOR TV

FOAM TRANSMISSION LINE
FM-MULTIPLEX 300 OHM

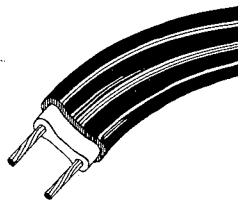

THRIFT-FOAM features a cellular foam polyethylene inner-dielectric which separates two stranded copper conductors. Due to this cellular construction, THRIFT-FOAM has a lower capacitance resulting in lower attenuation losses. An overall jacket of weather-resistant black polyethylene provides durable line protection.

Cat. No. 5740L50 ft. Coil	Cat. No. 5740C100 ft. Coil
Cat. No. 5740S75 ft. Coil	Cat. No. 5740D500 ft. Spool
Cat. No. 5740M1000 ft. Spool	

COLUMBIA SHIELDED PERMAFOAM TELEVISION TRANSMISSION LINE

- Aluminum Mylar Shield for 100% Effective Coverage. Tinned Copper Ground Wire Attaches to Set.
- High Molecular Weight PERMALINE Jacket for Superior Weathering.
- No Standoff Insulators or Matching Transformers Necessary.
- High Strength Copperweld Conductors for Maximum Conductivity.

A New All Channel Transmission Line Designed to prevent line pickup interference.

CABLE SIZE .275 x .455
Nominal velocity of propagation 76.5%
Nominal capacitance 6.8 MMF Ft.
Attenuation DB per 100'



Available in 50 ft. and 100 ft. coils with factory attached terminals for antenna attachment plus 2 terminals for set attachment. Also available in continuous 500 ft. spools and 1,000 ft. reels.

CORD SETS

Complete selection from stock or custom made to your specifications:

- plastic
- rubber
- neoprene
- cheater cords
- heavy duty power cords
- extension cords

"DURA-COLOR"

UHF-VHF 82 CHANNEL
RG-59 TYPE COAXIAL

- Lowest loss RG-59 type cable for color TV
- 100% Shielding and 100% Swept
- Black or White Jacket
- Uses "F" Fittings

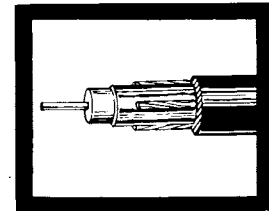

Shield is laminated aluminum high tensile strength Mylar foil totally covering and overlapping a virgin polyethylene dielectric core. Four equally spaced tinned copper drain wires are positioned around the shield; provides extra strength and electrical conductivity.

Cat. No. 5750M1000 ft. Spool	Cat. No. 5750D500 ft. Spool
UHF or VHF KITS — ATTRACTIVELY BOXED	
Cat. No. 5751L50 ft. Kit	Cat. No. 5751S75 ft. Kit
Cat. No. 5751C100 ft. Kit	
Contains BALUN, matching transformer, grounding clamp and 5750 wire.	
Cat. No. 5752L50 ft.	Cat. No. 5752S75 ft.
Cat. No. 5752C100 ft.	

Contains BALUN, 5750 wire, grounding clamp, SPECIAL BAND SEPARATOR WITH 75 OHM INPUT and TWO 300 OHM OUTPUTS ONE UHF, ONE VHF

PERMAFOAM LOW LOSS COAXIAL CABLES

A foam polyethylene dielectric replaces the conventional solid polyethylene thus providing far lower capacity and attenuation. Overall jacket is our PERMALINE high molecular weight polyethylene. This non-contaminating jacket is unaffected by salt air, chemical fumes, damp rot, fungus, acids, alkalis, etc., is immune to the deteriorating effects of sunlight and other ultra violet.

PERMAFOAM 72-75 OHM COAXIAL CABLE

R.G. No.	Nom. Imp.	Attenuation 100 Ft.	Wire 100 MC	Wire Size	Spool O.D. Size	Cat. No.
RG 59 U	73	2.95 DB.	22 Cpwnd.	.240	500 Ft.	5035D
					1000 Ft.	5035M
RG 11 U	75	1.50 DB.	14 Solid	.405	500 Ft.	5025D
					1000 Ft.	5025M

PERMAFOAM 52-53 OHM COAXIAL CABLE

R.G. No.	Nom. Imp.	Attenuation 100 Ft.	Wire 100 MC	Wire Size	Spool O.D. Size	Cat. No.
RG 58 U	53	3.10 DB.	20 Solid	.195	100 Ft.	5045C
					500 Ft.	5045D
					1000 Ft.	5045M
RG 8 U	52	1.50 DB.	7/21	.405	100 Ft.	5015C
					500 Ft.	5015D
					1000 Ft.	5015M
RG 17 U	52	.712 DB.	5 Solid	.870	100 Ft.	5090C
					500 Ft.	5090D
					1000 Ft.	5090M

COLUMBIA STANDARD COAXIAL CABLES

Premium quality standard coaxial cable. Meets all specifications. Black vinyl jacket.

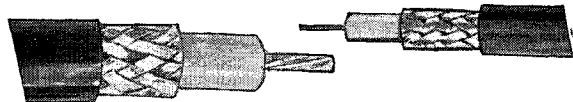

R.G. No.	Nom. Imp.	Mmfd. Ft.	Wire Size	Overall Jacket	Spool Size	Cat. No.
RG 59 U	73.0	21.0	22 C Weld	Black Vinyl .240 O.D.	100 Ft.	1104C
					500 Ft.	1104D
					1000 Ft.	1104M
RG 59 U	73.0	21.0	22 C Weld	Commercial Grade (Foam Dielectric)	100 Ft.	1112C
					500 Ft.	1112D
					1000 Ft.	1112M
RG 59 U	73.0	21.0	22 C Weld	Commercial Grade (Solid Poly-Dielectric)	100 Ft.	1112C
					500 Ft.	1112D
					1000 Ft.	1112M
RG 8 U	52.0	29.5	7/21	Black Vinyl .405 O.D.	100 Ft.	1154C
					500 Ft.	1154D
					1000 Ft.	1154M
RG 11 U	75.0	20.5	7/26	Black Vinyl .405 O.D.	100 Ft.	1160C
					500 Ft.	1160D
					1000 Ft.	1160M
RG 58 U	53.5	28.5	20 Ga.	Black Vinyl .195 O.D.	100 Ft.	1166C
					500 Ft.	1166D
					1000 Ft.	1166M
RG 58 A/U	50.0	29.0	19/.0068	Black Vinyl .159 O.D.	100 Ft.	1178C
					500 Ft.	1178D
					1000 Ft.	1178M

Long Lengths of Any Co-ax Available Upon Request

WRITE TO YOUR LOCAL PARTS DISTRIBUTOR FOR COMPLETELY ILLUSTRATED COLUMBIA WIRE PRODUCTS CO. CATALOG

COLUMBIA

FLEXFOAM ULTRA LOW CAPACITANCE MICROPHONE CABLES — EXCLUSIVE WITH COLUMBIA

Another Columbia first is a complete line of microphone cables with capacity as much as 35% lower than the best regular microphone cables available today. This drastic lowering of capacity has been made possible by the use of foamed polyethylene as the inner dielectric instead of solid polyethylene as normally used. This low capacitance means that lengths of microphone cable can be increased as much as 50%. These cables are also ideal for Hi-Fi and high quality sound work because of the extremely low attenuation, particularly at the higher audio-frequencies. The use of a special flexible vinyl as an outer jacket provides flexibility practically as good as rubber yet has much greater abrasion resistance. Color—Grey.

Also available in high gloss gleaming white jackets.

FLEXFOAM MIKE CABLE WITH BRAIDED SHIELD

	Per Ft.	250 Ft. Spool	Net	500 Ft. Spool
Crystal Size (.190" O.D.)	16 MMF	No. 1399T	11.90	1399D
Lapel Size (.140" O.D.)	19 MMF	No. 1379T	9.02	1379D

FLEXFOAM MIKE CABLE WITH SPIRAL SHIELD

	Per Ft.	250 Ft. Spool	Net	500 Ft. Spool
Crystal Size (.190" O.D.)	16 MMF	No. 1389T	11.07	1389D
Lapel Size (.140" O.D.)	19 MMF	No. 1369T	8.29	1369D
Miniature (.085" O.D.)	35 MMF	No. 1359T	6.11	1359D

TWO CONDUCTOR PLASTIC MICROPHONE CABLE — .230 O.D. T/C BRAID SHIELD

250 Ft. Spool	22 Ga.	16/34 Stranding	1322T
500 Ft. Spool	22 Ga.	16/34 Stranding	1322D
Nominal Capacitance 30 MMF Per Ft. Between 1 Cond. and Remaining Cond. Connected to Shield			

ECONOMY SPIRAL SHIELDED MICROPHONE CABLES

Plastic insulated with wrapped concentric spiral shield for more effective shielding. Cables are more flexible and of smaller size.

CRYSTAL MICROPHONE CABLE .160 O.D.

CAT. NO.		25 Ga. 7 x 33 Str.
1314T	250 Ft. Spool	Nominal Cap. 25 MMF Per Ft.
1314D	500 Ft. Spool	Nominal Cap. 25 MMF Per Ft.

LAPL MICROPHONE CABLE .125 O.D.

		25 Ga. 7 x 33 Str.
1366T	250 Ft. Spool	Nominal Cap. 33 MMF Per Ft.
1366M	250 Ft. Spool	Nominal Cap. 33 MMF Per Ft.

HEAVY DUTY MICROPHONE CABLE

Heavy duty studio type plastic insulated microphone cable that will withstand abrasion and rough usage.

18 Ga. Str. 41 x 34 Tinned Copper Conductors.
Jute Fillers T/C Shield
.295 O.D.

		CAT. NO.
100 Ft. Spool	Color—Black	3302C
500 Ft. Spool	Color—Black	3302D

Nominal Capacitance 75 MMF. Per Ft.

Also available with bright red jackets for easy identification.

COMPLETE LINE OF SHIELDED RUBBER AND NEOPRENE JACKETED MICROPHONE CABLE

COLUMBIA SUPER-FLEX ULTRA FLEXIBLE FOAM COAXIAL CABLES

We believe Super-Flex Coaxial Cables are the finest available today — not only because of their appearance and flexibility, but because they actually out-perform any similar type of coaxial cable in use today. Cables feature High Gloss Non Contaminating Jackets and have a primary insulation of foam Polyethylene to reduce attenuation as much as 25% over regular types of coaxial cables. In addition to the above features Super-Flex Coaxial Cables will not become rigid in severe cold. Can be used with standard connectors. Ideal for citizens band and amateur use. Perfect for master television systems due to the wide range of colors available. Standard stock colors are: Black-White-Silver or Beige. Other colors to special order with a minimum of 5000 ft. of a color.



SUPER-FLEX RG 8/U 52 OHM IMPEDANCE

19/.020 Conductor. Insulation Foam Poly Dielectric

Cat. No.				
1198C	100 Ft.	RG 8/U	Super-Flex	.405 O.D.
1198D	500 Ft.	RG 8/U	Super-Flex	.405 O.D.
1198M	1000 Ft.	RG 8/U	Super-Flex	.405 O.D.

Cap. 22.1 MMFD Per Ft.

Attenuation 1.50 DB Per 100 Ft. at 100 MC.

SUPER-FLEX RG 58 A/U 50 OHM IMPEDANCE

19/.0068 Conductor. Insulation Foam Poly Dielectric

1188C	100 Ft.	RG 58 A/U	Super-Flex	.195 O.D.
1188D	500 Ft.	RG 58 A/U	Super-Flex	.195 O.D.
1188M	1000 Ft.	RG 58 A/U	Super-Flex	.195 O.D.

Cap. 22.9 MMFD Per Ft.

Attenuation 4.25 DB Per 100 Ft. at 100 MC.

SUPER-FLEX RG 59/U 73 OHM IMPEDANCE

22 Solid Copperweld Conductor. Insulation Foam Poly Dielectric

1135C	100 Ft.	RG 59/U	Super-Flex	.242 O.D.
1135D	500 Ft.	RG 59/U	Super-Flex	.242 O.D.
1135M	1000 Ft.	RG 59/U	Super-Flex	.242 O.D.

Cap. 16.6 MMFD Ft.

Attenuation 2.95 DB Per 100 Ft. at 100 MC

Super-Flex RG 59/U is also available with a 7/31 stranded conductor to provide still more flexibility. Center conductor can be used only with Pin Type Fittings such as used to plug into wall plates for Master Television Systems.

MULTI PAIRED INTERCOM CABLES

For use in intercom systems as station to station wiring, the cables listed below will handle most installations. 22 ga. conductors, solid or stranded with an .010 wall of durable color coded plastic. Each pair is individually twisted. Overall jacket is .025 grey vinyl.

Other types of paired cables for indoor or outdoor use can be made to your specifications.



Standard Color Coding

Cat. No.	Cat. No.	No. of Pairs	Type	O.D.
4010C	4010D	2 Pair	22 Ga. Solid	.200
6010C	6010D	2 Pair	22 Ga. Stranded	.205
4014C	4014D	3 Pair	22 Ga. Solid	.225
6014C	6014D	3 Pair	22 Ga. Stranded	.245
4016C	4016D	5 Pair	22 Ga. Solid	.260
6016C	6016D	5 Pair	22 Ga. Stranded	.285
4018C	4018D	7 Pair	22 Ga. Solid	.310
6018C	6018D	7 Pair	22 Ga. Stranded	.345
4022C	4022D	11 Pair	22 Ga. Solid	.365
6022C	6022D	11 Pair	22 Ga. Stranded	.410
4026C	4026D	15 Pair	22 Ga. Solid	.395
6026C	6026D	15 Pair	22 Ga. Stranded	.465
4030C	4030D	27 Pair	22 Ga. Solid	.500
6030C	6030D	27 Pair	22 Ga. Stranded	.570
4038C	4038D	51 Pair	22 Ga. Solid	.750

WRITE TO YOUR LOCAL PARTS DISTRIBUTOR FOR COMPLETELY ILLUSTRATED COLUMBIA WIRE PRODUCTS CO. CATALOG



CONSOLIDATED WIRE AND ASSOCIATED CORPORATIONS

SEND FOR COMPLETE CATALOG

RG TYPE COAXIAL CABLES



Non-Contaminating Low Temp. Black Jacket		Vinyl & Poly. Jackets		Armor O.D.	Jacket O.D.	Vinyl Jacket	Shields		Dielectric O.D.	Center Conductor	V.P. %	Cap. M.mfd. /Ft.	Max. Oper. Volts Rms.	Nom. Imp. Ohms
Number RG-/U	Cat. Number	No. RG/U	Cat. No.				Outer	Inner						
		5	4431		.332	Black	C	C	.185	16	65.9	28.5	3000	52.5
5B	4432				.332	Black	S	S	.185	.053S	65.9	29.5	3000	50
6A	4433				.332	Black	C	S	.185	21CW	65.9	20.	2700	75
		7	4434		.370	Black	-	C	.250**	19	84	12.5	1000	97
		8	4415		.405	Black	-	C	.285	7/21	65.9	29.5	4000	52
8A	4435				.405	Black	-	C	.285	7/.0296	65.9	30.5	4000	52
		9	4436		.420	Grey	C	S	.280	7/21S	65.9	30	4000	51
9A	4437				.420	Grey	S	S	.280	7/21S	65.9	30	4000	51
9B	4438				.425	Black	S	S	.285	7/.0296S	65.9	30.5	4000	50
10A	4439			.475	.405	Black	-	C	.285	7/.0296	65.9	30.5	4000	50
		11	4419		.405	Black	-	C	.285	7/26T	65.9	20.5	4000	75
11A	4440				.405	Black	-	C	.285	7/26T	65.9	20.5	4000	75
12A	4441			.475	.405	Black	-	C	.285	7/26T	65.9	20.5	4000	75
		13	4442		.425	Black	C	C	.285	7/26T	65.9	20.5	4000	75
13A	4443				.425	Black	C	C	.285	7/26T	65.9	20.5	4000	75
14A	4467				.545	Grey	C	C	.370	10	65.9	29.5	5500	52
14A	4468				.545	Black	C	C	.370	.106	65.9	30	5500	52
17A	4482				.870	Black	-	C	.680	.188C	65.9	29.5	11000	52
18A	4483			.945	.870	Black	-	C	.680	.188C	65.9	29.5	11000	52
		21	4444		.322	Grey	S	S	.185	16N	65.9	29	2700	53
21A	4445				.332	Black	S	S	.185	.053N	65.9	30	2700	50
		22	4471		.405	Black	-	T	.285	Two 7/.0152	65.9	16	1000	95
22B	4475				.420	Black	T	T	.285	Two 7/.0152	65.9	16	1000	95
		29	4446		.184	Poly	-	T	.116	20	65.9	28.5	1900	53.5
		54A	4469		.250	Poly	-	T	.178	7/.0152	65.9	26.5	3000	58
		55	4447		.206	Poly	T	T	.116	20	65.9	28.5	1900	53.5
55A	4448				.216	Black	S	S	.116	.035S	65.9	29.5	1900	50
55B	4484				.206	Black	T	T	.116	20S	65.9	28.5	1900	53.5
		58	4405		.195	Black	-	T	.116	20	65.9	28.5	1900	53.5
58A	4449				.195	Black	-	T	.116	19/.0071T	65.9	29.5	1900	50
58B	4474				.195	Black	-	T	.116	20	65.9	28.5	1900	53.5
58C	4450				.195	Black	-	T	.116	19/.0071T	65.9	29.5	1900	50
		59	4401		.242	Black	-	C	.146	22CW	65.9	21	2300	73
		59	4402		.242	Grey	-	C	.146	22CW	65.9	21	2300	73
59A	4451				.242	Black	-	C	.146	.023CW	65.9	20.5	2300	75
59B	4470				.242	Black	-	C	.146	.023CW	65.9	20.5	2300	75
		62	4452		.242	Black	-	C	.146**	22CW	84	13.5	750	93
62A	4453				.242	Black	-	C	.146**	22CW	84	13.5	750	93
62B	4472				.242	Black	-	C	.146	22CW	84	13.5	750	93
		63	4454		.405	Black	-	C	.285**	22CW	84	10	1000	125
63B	4455				.405	Black	-	C	.285**	22CW	84	10	1000	125
65A	4473				.405	Black	-	C	.340	32F	65	44	3000	950
		71	4456		.250	Poly	T	T or C	.146**	22CW	84	13.5	750	93
71A	4466				.245	Black	T	T or C	.146**	22CW	84	13.5	750	93
71B	4485				.250	Black	T	C	.146	22CW	84	13.5	750	93
74A	4486			.615	.545	Black	C	C	.370	10C	65.9	29.5	7000	52
79B	4487			.475	.405	Black	-	C	.285	22CW	84	10	1000	125
		108	4464		.235	Black	-	T	.079 ea.	Two 7/28T	68	23.5	1000	78
108A	4465				.235	Black	-	T	.079 ea.	Two 7/28T	65.9	23.5	1000	78
122	4457				.160	Black	-	T	.096	27/36T	65.9	29.5	1900	50
212	4488				.332	Black	S	S	.185	.0556S	65.9	29.5	3000	50
213	4489				.405	Black	-	C	.285	7X.0296C	65.9	29.5	5000	50
214	4490				.425	Black	S	S	.285	7X.0296C	65.9	29.5	5000	50
215	4497				.475	Black	-	C	.285	7/.029C	65.9	29.5	4000	50
216	4491				.425	Black	C	C	.285	7X26TC	65.9	20.5	5000	75
217	4492				.545	Black	C	C	.370	.106C	65.9	29.5	7000	50
21B	4493				.870	Black	-	C	.680	.195C	65.9	29.5	11000	50
219	4494			.945	.870	Black	-	C	.680	.195C	65.9	29.5	11000	50
222	4495				.332	Black	S	S	.185	.0556N	65.9	29.0	2700	50
223	4496				.216	Black	S	S	.116	.035S	65.9	29.5	1900	50

**Semi-Solid Dielectric N—Nichrome C—Cooper S—Silvered Copper CW—Copperweld T—Tinned Cooper F—Formvar

CONSOLIDATED WIRE AND ASSOCIATED CORPORATIONS



SEND FOR COMPLETE CATALOG

RG TYPE COAXIAL CABLES



MINIATURE COAXIAL CABLE

Number RG/U	Cat. Number	Vinyl & Poly. Jackets		Armor O.D.	Jacket O.D.	Vinyl Jacket	Shields		Dielectric O.D.	Center Conductor	V.P. %	Cap. Mmfd. /Ft.	Max. Oper. Volts Rms.	Nom. Imp. Ohms
		Cat. No.	No. RG/U				Outer	Inner						
		4459	174		.105	Black	—		.060**	7/.0063CW		30		50

**Semi-Solid Dielectric N—Nichrome C—Copper S—Silvered Copper CW—Copperweld T—Tinned Copper F—Formvar

FOAM POLYETHYLENE COAXIAL CABLE

		8	4477		.405	Black	—	C	.285	7/19C	80	24.5	1500	50
11	4476				.405	Black	—	C	.285	14C	80	16.5	3000	75
		58	4498		.195	Black	—	T	.116	20C	80	28.5	1900	53.5
		59	4478		.195	Black	—	C	.107	22CW	80	17	500	72
62	4479				.242	Black	—	C	.146	.023CW	80	14.5	700	93
11	4480				.406	Black	C	C	.285	14C	80	16.5	3000	75
59	4481				.242	Black	C	C	.107	.107	80	17	500	72

**Semi-Solid Dielectric N—Nichrome C—Copper S—Silvered Copper CW—Copperweld T—Tinned Copper F—Formvar

TRIAxIAL CABLE DOUBLE SHIELD DOUBLE JACKET

RG/U Type	Cat. No.	Impedance in Ohms	Jacket Diameter	Vinyl Jacket	Shields		O. D. Dielectric	Inner Conductor	V. P. %	Cap. MMFD./Ft.	Max. Oper. Volts-RMS
					1st	2nd					
Triaxial 58A	4463	50	.285	Black	T	T	.116	19 .0071T	65.9	28.5	1,900
Triaxial 59	4460	73	.242	Black	C	C	.146	22CW	65.9	21.0	2,300
Triaxial 11	4461	75	.460	Black	C	C	.285	7 26T	65.9	20.5	4,000
Triaxial 8	4462	52	.490	Black	C	C	.285	7 21C	65.9	29.5	4,000

**Semi-Solid Dielectric N—Nichrome C—Copper S—Silvered Copper CW—Copperweld T—Tinned Copper F—Formvar

TEFLON COAXIAL CABLE

Number RG/U	Cat. Number	Inner Conductor	Dielectric Material	Nominal Diameter of Dielectric (inch)	Type of Shielding Braids	Protective Covering	Nominal Over-all Diameter (inch)	Nominal Capacitance (mmfd./ft.)	Maximum Operating Voltage (Volts rms)	Nominal Impedance (Ohms)
87A	4701	7/.032 Silver Covered Copper	F-1	.280	Silver Coated Copper Double Braid	V	.425	29.5	5000	50
94	4702	19/.0225 Silver Covered Copper	F-2	.292	Copper Double Braid	V	.445	29.0	7000	50
94A	4703	19/.0254 Silver Plated Copper	F-2	.370	Copper Double Braid	V	.500	27.0	7000	50
115	4704	7/.028 Silver Covered Copper	F-2	.250	Silver Coated Copper Double Braid	V	.375	29.5	5000	50
115A	4705	7/.028 Silver Covered Copper	F-2	.255	Silver Coated Copper Double Braid	V	.415	29.5	4000	50
116	4706	7/.032 Silver Covered Copper	F-1	.280	Silver Coated Copper Double Braid	V with armor	.490	29.5	5000	50
117	4707	.188 Copper	F-1	.620	Copper Single Braid	V	.730	29.0	7000	50
117A	4708	.188 Copper	F-1	.620	Copper Single Braid	V	.730	—	7000	50
118	4709	.188 Copper	F-1	.620	Copper Single Braid	V with armor	.795	29.0	7000	50
118A	4710	.188 Copper	F-1	.620	Copper Single Braid	V with armor	.780	—	7000	50
119	4711	.102 Copper	F-1	.332	Copper Double Braid	V	.465	29.0	6000	50
120	4712	.102 Copper	F-1	.332	Copper Double Braid	V with armor	.525	29.0	6000	50
126	4713	7/.0203 Karma or Equal	F-1	.185	Karma or Equal Single Braid	V	.280	29.0	3000	50
140	4714	.025 Silver Coated Copper Steel	F-1	.146	Silver Coated Copper Single Braid	V	.233	21.0	2300	75
141	4715	.0359 Silver Plated Copper Weld	F-1	.116	Silver Coated Copper Single Braid	V	.190	28.5	1900	50
141A	4716	.039 Silver Covered Copper Steel	F-1	.116	Silver Coated Copper Single Braid	V	.190	28.5	1900	50
142	4717	.0359 Silver Covered Copper Steel	F-1	.116	Silver Coated Copper Double Braid	V	.206	28.5	1900	50
142A	4718	.039 Silver Covered Copper Steel	F-1	.116	Silver Coated Copper Double Braid	V	.206	28.5	1900	50

Continued on following page

F-1—Solid Teflon F-2—Taped Teflon F-3—Air Spaced Teflon

V—High Temperature Lacquer Impregnated Fiberglass Braid with Teflon Tape Between Shield and Jacket

VI—Polyester Fiber Impregnated with High Temperature Lacquer over Wrapped or Extruded Silicone Impregnated Fiberglass

IIA—Low Temperature Black Polyvinylchloride Non-Contaminating

FEP—Fluorinated Ethylene Propylene Copolymer, 200° Teflon

TFE—Tetrafluoride Ethylene Propylene Copolymer, 250°C Teflon



CONSOLIDATED WIRE AND ASSOCIATED CORPORATIONS

SEND FOR COMPLETE CATALOG

TEFLON COAXIAL CABLE



Number RG/U	Cat. Number	Inner Conductor	Dielectric Material	Nominal Diameter of Dielectric (inch)	Type of Shielding Braids	Protective Covering	Nominal Over-all Diameter (inch)	Nominal Capacitance (mmfd./ft.)	Maximum Operating Voltage (Volts rms)	Nominal Impedance (Ohms)
142B	4719	.039 Silver Covered Copper Steel	F-1	.116	Silver Coated Copper Double Braid	FEP	.195	28.5	1900	50
143	4720	.057 Silver Plated Copper Weld	F-1	.185	Silver Coated Copper Double Braid	V	.325	28.5	3000	50
143A	4721	.059 Silver Covered Copper Steel	F-1	.185	Silver Coated Copper Double Braid	V	.325	28.5	3000	50
144	4722	7/.0179 Silver Covered Copper Steel	F-1	.285	Silver Coated Copper Single Braid	V	.410	20.5	5000	75
146	4723	.007 Copper Covered Steel	F-3	.285	Copper Single Braid	V	.375	6.0	1000	190
161	4724	7/38 Silver Plated Cadmium Bronze	F-1	.057	Single Silver Copper	Extruded Black Nylon	.090	20.0	1000	70
165	4725	7/.032 Silver Covered Copper	F-1	.285	Silver Covered Copper Single Braid	V	.410	—	5000	50
166	4726	7/.032 Silver Covered Copper	F-1	.285	Silver Covered Copper Single Braid	V with armor	.460	—	5000	50
178	4727	7/.0039 Silver Plated Copper Weld	F-1	.036	Silver Plated Copper Single Braid	KEL-F	.079	27.9	1000	50
178A	4728	7/.004 Silver Covered Copper Steel	F-1	.034	Silver Plated Copper Single Braid	KEL-F	.075	27.9	1000	50
178B	4729	7/.004 Silver Covered Copper Steel	F-1	.034	Silver Covered Copper Single Braid	FEP	.075	—	1000	50
179A	4730	7/.004 Silver Covered Copper Steel	F-1	.063	Silver Plated Copper Single Braid	KEL-F	.105	20.0	1200	75
179B	4731	7/.004 Silver Covered Copper Steel	F-1	.063	Silver Covered Copper Single Braid	FEP	.105	—	1200	75
180	4732	7/.0039 Silver Plated Copper Weld	F-1	.103	Silver Plated Copper Single Braid	KEL-F	.141	15.3	1500	93
180A	4733	7/.004 Silver Covered Copper Steel	F-1	.102	Silver Plated Copper Single Braid	KEL-F	.145	14.5	1500	95
180B	4734	7/.004 Silver Covered Copper Steel	F-1	.102	Silver Covered Copper Single Braid	FEP	.145	—	1500	95
187	4735	7/.004 Silver Covered Copper Steel	F-1	.060	Silver Covered Copper Single Braid	Teflon	.110	—	1200	75
187A	4736	7/.004 Silver Covered Copper Steel	F-1	.060	Silver Covered Copper Single Braid	TFE	.110	—	1200	75
188	4737	7/.0067 Silver Covered Copper Steel	F-1	.060	Silver Covered Copper Single Braid	Teflon	.110	—	1200	50
188A	4738	7/.0067 Silver Covered Copper Steel	F-1	.060	Silver Covered Copper Single Braid	TFE	.110	—	1200	50
195	4739	7/.004 Silver Covered Copper Steel	F-1	.102	Silver Covered Copper Single Braid	Teflon	.155	—	1500	95
195A	4740	7/.004 Silver Covered Copper Steel	F-1	.102	Silver Covered Copper Single Braid	TFE	.155	—	1500	95
196	4741	7/.004 Silver Covered Copper Steel	F-1	.034	Silver Covered Copper Single Braid	Teflon	.080	—	1000	50
196A	4742	7/.004 Silver Covered Copper Steel	F-1	.034	Silver Covered Copper Single Braid	TFE	.080	—	1000	50
209	4743	19/.037 Silver Covered Copper	F-3	.500	Silver Covered Copper Double Braid	VI	.750	—	3200	50
210	4744	.0253 Silver Covered Copper Steel	F-3	.146	Silver Covered Copper Single Braid	V	.242	14.5	750	93
211	4745	.190 Copper	F-1	.620	Copper Single Braid	V	.730	—	7000	50
211A	4746	.190 Copper	F-1	.620	Copper Single Braid	V	.730	—	7000	50
225	4747	7/.0312 Silver Covered Copper	F-1	.285	Silver Covered Copper Double Braid	V	.430	—	5000	50
226	4748	19/.0254 Silver Covered Copper	F-2	.370	Copper Double Braid	V	.500	—	7000	50
227	4749	7/.0312 Silver Covered Copper	F-1	.285	Silver Covered Copper Double Braid	V with armor	.490	—	5000	50
228	4750	.190 Copper	F-1	.620	Copper Single Braid	V with armor	.795	—	7000	50
228A	4751	.190 Copper	F-1	.620	Copper Single Braid	V with armor	.795	—	7000	50
235	4752	7/.028 Copper	F-2	.255	Silver Covered Copper Double Braid	VI	.490	—	5000	50
280	4753	.1144 Copper	F-2	.327	Silver Covered Copper Double Braid	IIA	.480	27.5	4000	50
281	4754	19/.0378 Silver Covered Copper	F-2	.500	Silver Covered Copper Double Braid	VI	.750	29.5	4000	50
301	4755	7/.0203 Karma	F-1	.185	Karma Single Braid	FEP	.245	29.0	3000	50
302	4756	.025 Silver Covered Copper Steel	F-1	.146	Silver Covered Copper Single Braid	FEP	.206	21.0	2300	75
303	4757	.039 Silver Covered Copper Steel	F-1	.116	Silver Covered Copper Single Braid	FEP	.170	28.5	1900	50
304	4758	.059 Silver Covered Copper Steel	F-1	.185	Silver Covered Copper Double Braid	FEP	.280	28.5	3000	50
316	4759	7/.0067 Silver Covered Copper Steel	F-1	.060	Silver Covered Copper Single Braid	FEP	.102	—	1200	50

F-1—Solid Teflon

F-2—Taped Teflon

F-3—Air Spaced Teflon

V—High Temperature Lacquer Impregnated Fiberglass Braid with Teflon Tape Between Shield and Jacket

VI—Polyester Fiber Impregnated with High Temperature Lacquer over Wrapped or Extruded Silicone Impregnated Fiberglass

IIA—Low Temperature Black Polyvinylchloride Non-Contaminating

FEP—Fluorinated Ethylene Propylene Copolymer, 200° Teflon

TFE—Tetrafluoride Ethylene Propylene Copolymer, 250°C Teflon

CONSOLIDATED WIRE PAGE 5

CONSOLIDATED WIRE AND ASSOCIATED CORPORATIONS



SEND FOR COMPLETE CATALOG

MIL-W-76

TYPE MW-VINYL — 1000V — 80C



Tinned copper, vinyl insulated, medium wall. The polyvinylchloride insulation is flame and ozone resistant and is inert to most chemicals, oils, and solvents.

STRANDED CONDUCTOR

Catalog Number	Type Designation	Size & (Stranding)	Insulation Thickness (Inch)	Nom. O.D. (Inch)	Stock Colors on Standard Spools		
					100'	500'	1000'
9001	MW-C-24-(7)-U	24(7x32)	.017	.058	As Listed	As Listed	As Listed
9002	MW-C-22-(7)-U	22(7x30)	.017	.064	As Listed	As Listed	As Listed
9003	MW-C-20-(10)-U	20(10x30)	.017	.070	As Listed	As Listed	As Listed
9004	MW-C-18-(16)-U	18(16x30)	.017	.080	As Listed	As Listed	As Listed
9005	MW-C-16-(26)-U	16(26x30)	.019	.098	As Listed	As Listed	As Listed
9006	MW-C-14-(41)-U	14(41x30)	.020	.111	As Listed	As Listed	As Listed
9007	MW-C-12-(65)-U	12(65x30)	.020	.130	As Listed	As Listed	As Listed

Stock Colors*

0 Black	92 White/Red
1 Brown	93 White/Orange
2 Red	94 White/Yellow
3 Orange	95 White/Green
4 Yellow	96 White/Blue
5 Green	97 White/Violet
6 Dark Blue	98 White/Gray
7 Violet (Purple)	901 White/Black/Brown
8 Gray (Slate)	902 White/Black/Red
9 White	908 White/Black/Orange
11 Tan	904 White/Black/Yellow
12 Pink	905 White/Black/Green
13 Light Blue	906 White/Black/Blue
90 White/Black	907 White/Black/Violet
91 White/Brown	908 White/Black/Gray

SOLID CONDUCTOR

9010	MW-C-22-(1)-U	22 (Solid)	.017	.059	As Listed	As Listed	As Listed
9011	MW-C-20-(1)-U	20 (Solid)	.017	.066	As Listed	As Listed	As Listed
9012	MW-C-18-(1)-U	18 (Solid)	.017	.074	As Listed	As Listed	As Listed
9013	MW-C-16-(1)-U	16 (Solid)	.017	.085	As Listed	As Listed	As Listed

TYPE MW-SHIELED — 1000V — 80C

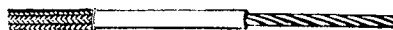

Tinned copper, polyvinylchloride insulation. Medium wall, tinned copper shield overall.

Catalog Number	Type Designation	Size & (Stranding)	Insulation Thickness (Inch)	Nom. O.D. (Inch)	Stock Colors on Standard Spools		
					100'	500'	1000'
9014	MW-C-24-(7)-S	24(7x32)	.017	.082	As Listed	As Listed	As Listed
9015	MW-C-22-(7)-S	22(7x30)	.017	.088	As Listed	As Listed	As Listed
9016	MW-C-20-(10)-S	20(10x30)	.017	.094	As Listed	As Listed	As Listed
9017	MW-C-18-(16)-S	18(16x30)	.017	.104	As Listed	As Listed	As Listed
9018	MW-C-16-(26)-S	16(26x30)	.019	.122	As Listed	As Listed	As Listed
9019	MW-C-14-(41)-S	14(41x30)	.020	.135	0, 2, 9	0, 2, 9	0, 2, 9
9020	MW-C-12-(65)-S	12(65x30)	.020	.154	0, 2, 9	0, 2, 9	0, 2, 9

Stock Colors*

0 Black	5 Green
1 Brown	6 Dark Blue
2 Red	7 Violet (Purple)
3 Orange	8 Gray (Slate)
4 Yellow	9 White

TYPE MW-SHIELED — NYLON JACKET — 1000V — 80C

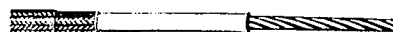

Tinned copper, polyvinylchloride insulation. Medium wall, tinned copper shield, nylon jacket.

Catalog Number	Type Designation	Size & (Stranding)	Insulation Thickness (Inch)	Nom. O.D. (Inch)	Stock Colors on Standard Spools		
					100'	500'	1000'
9021	MW-C-22-(7)-SJ	22(7x30)	.017	.095	9	9	9
9022	MW-C-20-(7)-SJ	20(10x30)	.017	.101	9	9	9
9023	MW-C-18-(16)-SJ	18(16x30)	.017	.112	9	9	9
9024	MW-C-16-(19)-SJ	16(26x30)	.019	.131	9	9	9

Stock Color*

9 Vinyl insulation. White only.

*Stock Color Numbers in Accordance to Military Type Designation and EIA Color Coding.

SEND FOR COMPLETE CATALOG

MIL-W-76**TYPE MW-GLASS BRAID — 1000V — 80C**

Tinned copper, polyvinylchloride insulated. Medium wall, lacquered glass braid overall.

Catalog Number	Type Designation	Size & (Stranding)	Insulation Thickness (Inch)	Nom. O.D. (Inch)	Stock Colors on Standard Spools		
					100'	500'	1000'
9025	MW-C-22(7)-B	22(7x30)	.017	.076	As Listed	As Listed	As Listed
9026	MW-C-20(10)-B	20(10x30)	.017	.084	As Listed	As Listed	As Listed
9027	MW-C-18(16)-B	18(16x30)	.017	.094	As Listed	As Listed	As Listed
9028	MW-C-16(26)-B	16(26x30)	.019	.112	As Listed	As Listed	As Listed
9029	MW-C-14(41)-B	14(41x30)	.020	.125	9,90 ^{thru} 98	9,90 ^{thru} 98	9,90 ^{thru} 98
9030	MW-C-12(65)-B	12(65x30)	.020	.144	9, 90, 92	9, 90, 92	9, 90, 92

Stock Colors*

0 Black	90 White/Black
1 Brown	91 White/Brown
2 Red	92 White/Red
3 Orange	93 White/Orange
4 Yellow	94 White/Yellow
5 Green	95 White/Green
6 Dark Blue	96 White/Blue
7 Violet (Purple)	97 White/Violet
8 Gray (Slate)	98 White/Gray
9 White	

TYPE MW-GLASS BRAID-SHIELDED — 1000V — 80C

Tinned copper, polyvinylchloride insulated. Medium wall, lacquered glass braid, tinned copper shield overall.

Catalog Number	Type Designation	Size & (Stranding)	Insulation Thickness (Inch)	Nom. O.D. (Inch)	Stock Colors on Standard Spools		
					100'	500'	1000'
9031	MW-C-22(7)-BS	22(7x30)	.017	.102	9	9	9
9032	MW-C-20(7)-BS	20(10x30)	.017	.108	9	9	9
9033	MW-C-18(16)-BS	18(16x30)	.017	.118	9	9	9
9034	MW-C-16(19)-BS	16(26x30)	.019	.136	9	9	9
9035	MW-C-14(19)-BS	14(41x30)	.020	.149	9	9	9
9036	MW-C-12(19)-BS	12(65x30)	.020	.168	9	9	9

Stock Color*

9 Vinyl insulation. White only.

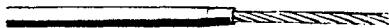
TYPE MW — NYLON JACKET — 1000V — 90C

Tinned copper, polyvinylchloride insulated. Medium wall, clear nylon jacket overall.

Catalog Number	Type Designation	Size & (Stranding)	Insulation Thickness (Inch)	Nom. O.D. (Inch)	Stock Colors on Standard Spools		
					100'	500'	1000'
9037	MW-C-22(7)-J	22(7x30)	.017	.069	As Listed	As Listed	As Listed
9038	MW-C-20(10)-J	20(10x30)	.017	.075	As Listed	As Listed	As Listed
9039	MW-C-18(16)-J	18(16x30)	.017	.086	As Listed	As Listed	As Listed
9040	MW-C-16(26)-J	16(26x30)	.019	.106	As Listed	As Listed	As Listed
9041	MW-C-14(41)-J	14(41x30)	.020	.118	0, 1, 3, 4 5, 9	0, 1, 3, 4 5, 9	0, 1, 3, 4 5, 9
9042	MW-C-12(65)-J	12(65x30)	.020	.139	0, 1, 3, 4 5, 9	0, 1, 3, 4 5, 9	0, 1, 3, 4 5, 9

Stock Colors*

0 Black	90 White/Black
1 Brown	91 White/Brown
2 Red	92 White/Red
3 Orange	93 White/Orange
4 Yellow	94 White/Yellow
5 Green	95 White/Green
6 Dark Blue	96 White/Blue
7 Violet (Purple)	97 White/Violet
8 Gray (Slate)	98 White/Gray
9 White	

*Stock Color Numbers in Accordance to Military Type Designation and EIA Color Coding.

CONSOLIDATED WIRE PAGE 7

SEND FOR COMPLETE CATALOG

MIL-W-76

TYPE HW — VINYL — Gauges 16-22 2500V, Gauges 6-14 600—80C

 Tinned copper, polyvinylchloride insulated. Heavy wall.

Catalog Number	Type Designation	Size & (Stranding)	Insulation Thickness (Inch)	Nom. O.D. (Inch)	Stock Colors on Standard Spools		
					100'	500'	1000'
9100	HW-C-22(7)-U	22(7x30)	.034	.098	As Listed	As Listed	As Listed
9101	HW-C-20(10)-U	20(10x30)	.034	.104	As Listed	As Listed	As Listed
9102	HW-C-18(16)-U	18(16x30)	.034	.114	As Listed	As Listed	As Listed
9103	HW-C-16(26)-U	16(26x30)	.034	.128	0, 2, 9	0, 2, 9	0, 2, 9
9104	HW-C-14(41)-U	14(41x30)	.048	.171	0, 2, 9	0, 2, 9	0, 2, 9
9105	HW-C-12(65)-U	12(65x30)	.048	.191	0, 2, 9	0, 2, 9	0, 2, 9
9106	HW-C-10(105)-U	10(105x30)	.048	.214	0, 2, 9	0, 2, 9	0, 2, 9
9107	HW-C-8(133)-U	8(133x29)	.048	.261	0, 2, 9	0, 2, 9	0, 2, 9
9108	HW-C-6(133)-U	6(133x27)	.048	.296	0, 2, 9	0, 2, 9	0, 2, 9

Stock Colors*

0 Black	5 Green
1 Brown	6 Dark Blue
2 Red	7 Violet (Purple)
3 Orange	8 Gray (Slate)
4 Yellow	9 White

TYPE HW — GLASS BRAID — 600V — 80C



 Tinned copper, polyvinylchloride insulated. Heavy wall, lacquered glass braid.

Catalog Number	Type Designation	Size & (Stranding)	Insulation Thickness (Inch)	Nom. O.D. (Inch)	Stock Colors on Standard Spools		
					100'	500'	1000'
9110	HW-C-10(105)-B	10(105x30)	.048	.232	As Listed	As Listed	As Listed
9111	HW-C-8(133)-B	8(133x29)	.048	.279	As Listed	As Listed	As Listed
9112	HW-C-6(133)-B	6(133x27)	.048	.314	As Listed	As Listed	As Listed

Stock Colors*

9 White
90 White/Black
92 White/Red

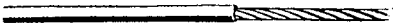
TYPE LW — VINYL — 300V — 80C



 Tinned copper, polyvinylchloride insulated. Light wall.

Catalog Number	Type Designation	Size & (Stranding)	Insulation Thickness (Inch)	Nom. O.D. (Inch)	Stock Colors on Standard Spools		
					100'	500'	1000'
9200	LW-C-30(7)-U	30(7x38)	.011	.034	0 thru 9	0 thru 9	0 thru 9
9201	LW-C-28(7)-U	26(7x36)	.011	.037	As Listed	As Listed	As Listed
9202	LW-C-26(7)-U	26(7x34)	.011	.041	As Listed	As Listed	As Listed
9203	LW-C-24(7)-U	24(7x32)	.011	.046	As Listed	As Listed	As Listed
9204	LW-C-22(7)-U	22(7x30)	.012	.054	As Listed	As Listed	As Listed
9205	LW-C-20(10)-U	20(10x30)	.012	.060	As Listed	As Listed	As Listed

Stock Colors*

0 Black	90 White/Black
1 Brown	91 White/Brown
2 Red	92 White/Red
3 Orange	93 White/Orange
4 Yellow	94 White/Yellow
5 Green	95 White/Green
6 Dark Blue	96 White/Blue
7 Violet (Purple)	97 White/Violet
8 Gray (Slate)	98 White/Gray
9 White	

TYPE LW — NYLON JACKET — 300V — 90C

 Tinned copper, polyvinylchloride insulated. Light wall, clear nylon jacket overall.

Catalog Number	Type Designation	Size & (Stranding)	Insulation Thickness (Inch)	Nom. O.D. (Inch)	Stock Colors on Standard Spools		
					100'	500'	1000'
9210	LW-C-30(7)-J	30(7x38)	.011	.039	0 thru 9	0 thru 9	0 thru 9
9211	LW-C-28(7)-J	28(7x36)	.011	.042	As Listed	As Listed	As Listed
9212	LW-C-26(7)-J	26(7x34)	.011	.046	As Listed	As Listed	As Listed
9213	LW-C-24(7)-J	24(7x32)	.011	.051	As Listed	As Listed	As Listed
9214	LW-C-22(7)-J	22(7x30)	.012	.059	As Listed	As Listed	As Listed
9215	LW-C-20(10)-J	20(10x30)	.012	.065	As Listed	As Listed	As Listed

Stock Colors*

0 Black	90 White/Black
1 Brown	91 White/Brown
2 Red	92 White/Red
3 Orange	93 White/Orange
4 Yellow	94 White/Yellow
5 Green	95 White/Green
6 Dark Blue	96 White/Blue
7 Violet (Purple)	97 White/Violet
8 Gray (Slate)	98 White/Gray
9 White	

*Stock Color Numbers in Accordance to Military Type Designation and EIA Color Coding.

CONSOLIDATED WIRE AND ASSOCIATED CORPORATIONS

SEND FOR COMPLETE CATALOG

MIL-W-16878**TYPE B — VINYL — 600V — 105C**

 Tinned copper, polyvinylchloride insulated.

Catalog Number	Type Designation	Size & (Stranding)	Insulation Thickness (Inch)	Nom. O.D. (Inch)	Stock Colors on Standard Spools		
					100'	500'	1000'
9300	B-32	32(7x40)	.010	.029	0 thru 9	0 thru 9	0 thru 9
9301	B-30	30(7x38)	.010	.032	0 thru 9	0 thru 9	0 thru 9
9302	B-28	28(7x36)	.010	.035	0 thru 9 90 thru 98	0 thru 9 90 thru 98	0 thru 9 90 thru 98
9303	B-26	26(7x34)	.010	.039	0 thru 9 90 thru 98	0 thru 9 90 thru 98	0 thru 9 90 thru 98
9304	B-24	24(19x36)	.010	.045	9,90thru98	9,90thru98	9,90thru98
9305	B-24	24(7x32)	.010	.044	As Listed	As Listed	As Listed
9306	B-22	22(19x34)	.010	.051	9,90thru98	9,90thru98	9,90thru98
9307	B-22	22(7x30)	.010	.050	As Listed	As Listed	As Listed
9308	B-20	20(19x32)	.010	.059	9,90thru98	9,90thru98	9,90thru98
9309	B-20	20(7x28)	.010	.058	As Listed	As Listed	As Listed
9310	B-18	18(19x30)	.010	.069	9,90thru98	9,90thru98	9,90thru98
9311	B-18	18(7x26)	.010	.068	0 thru 9 90 thru 98	0 thru 9 90 thru 98	0 thru 9 90 thru 98
9312	B-16	16(19x29)	.010	.077	0 thru 9 90 thru 98	0 thru 9 90 thru 98	0 thru 9 90 thru 98

Stock Colors*

0 Black	90 White/Black
1 Brown	91 White/Brown
2 Red	92 White/Red
3 Orange	93 White/Orange
4 Yellow	94 White/Yellow
5 Green	95 White/Green
6 Dark Blue	96 White/Blue
7 Violet (Purple)	97 White/Violet
8 Gray (Slate)	98 White/Gray
9 White	
11 Tan	
12 Pink	
13 Light Blue	

TYPE B — VINYL-NYLON JACKET — 600V — 115C

 Tinned copper, polyvinylchloride insulated, nylon jacket overall.

Catalog Number	Type Designation	Size & (Stranding)	Insulation Thickness (Inch)	Nom. O.D. (Inch)	Stock Colors on Standard Spools		
					100'	500'	1000'
9313	B-32	32(7x40)	.010	.035	0 thru 9	0 thru 9	0 thru 9
9314	B-30	30(7x38)	.010	.038	0 thru 9	0 thru 9	0 thru 9
9315	B-28	28(7x36)	.010	.041	As Listed	As Listed	As Listed
9316	B-26	26(7x34)	.010	.045	As Listed	As Listed	As Listed
9317	B-24	24(19x36)	.010	.051	As Listed	As Listed	As Listed
9318	B-24	24(7x32)	.010	.050	As Listed	As Listed	As Listed
9319	B-22	22(19x34)	.010	.057	As Listed	As Listed	As Listed
9320	B-22	22(7x30)	.010	.056	As Listed	As Listed	As Listed
9321	B-20	20(19x32)	.010	.065	As Listed	As Listed	As Listed
9322	B-20	20(7x28)	.010	.064	As Listed	As Listed	As Listed
9323	B-18	18(19x30)	.010	.075	9,90thru98	9,90thru98	9,90thru98
9324	B-18	18(7x26)	.010	.074	As Listed	As Listed	As Listed
9325	B-16	16(19x29)	.010	.083	As Listed	As Listed	As Listed

Stock Colors*

0 Black	90 White/Black
1 Brown	91 White/Brown
2 Red	92 White/Red
3 Orange	93 White/Orange
4 Yellow	94 White/Yellow
5 Green	95 White/Green
6 Dark Blue	96 White/Blue
7 Violet (Purple)	97 White/Violet
8 Gray (Slate)	98 White/Gray
9 White	

*Stock Color Numbers in Accordance to Military Type Designation and EIA Color Coding.

SEND FOR COMPLETE CATALOG

MIL-W-16878

TYPE C VINYL — 1000V — 105C



Tinned copper, polyvinylchloride insulated.

Catalog Number	Type Designation	Size & (Stranding)	Insulation Thickness (Inch)	Nom. O.D. (Inch)	Stock Colors on Standard Spools		
					100'	500'	1000'
9400	C-24	24(7x32)	.018	.060	9,90thru98	9,90thru98	9,90thru98
9401	C-22	22(7x30)	.018	.066	As Listed	As Listed	As Listed
9402	C-20	20(7x28)	.018	.074	As Listed	As Listed	As Listed
9403	C-18	18(7x26)	.018	.084	As Listed	As Listed	As Listed
9404	C-16	16(19x29)	.018	.093	9,90thru98	9,90thru98	9,90thru98
9405	C-14	14(19x27)	.018	.107	9,90thru98	9,90thru98	9,90thru98

Stock Colors*

0 Black	90 White/Black
1 Brown	91 White/Brown
2 Red	92 White/Red
3 Orange	93 White/Orange
4 Yellow	94 White/Yellow
5 Green	95 White/Green
6 Dark Blue	96 White/Blue
7 Violet (Purple)	97 White/Violet
8 Gray (Slate)	98 White/Gray
9 White	

TYPE C — VINYL-NYLON JACKET — 1000V — 115C



Tinned copper, polyvinylchloride insulated, nylon jacket overall.

Catalog Number	Type Designation	Size & (Stranding)	Insulation Thickness (Inch)	Nom. O.D. (Inch)	Stock Colors on Standard Spools		
					100'	500'	1000'
9410	C-24	24(7x32)	.018	.066	9,90thru98	9,90thru98	9,90thru98
9411	C-22	22(7x30)	.018	.072	As Listed	As Listed	As Listed
9412	C-20	20(7x28)	.018	.080	As Listed	As Listed	As Listed
9413	C-18	18(7x26)	.018	.091	As Listed	As Listed	As Listed
9414	C-16	16(19x29)	.018	.100	9,90thru98	9,90thru98	9,90thru98
9415	C-14	14(19x27)	.018	.114	9,90thru98	9,90thru98	9,90thru98

Stock Colors*

0 Black	90 White/Black
1 Brown	91 White/Brown
2 Red	92 White/Red
3 Orange	93 White/Orange
4 Yellow	94 White/Yellow
5 Green	95 White/Green
6 Dark Blue	96 White/Blue
7 Violet (Purple)	97 White/Violet
8 Gray (Slate)	98 White/Gray
9 White	

TYPE D — VINYL — 3000V — 105C



Tinned copper, polyvinylchloride insulated.

Catalog Number	Type Designation	Size & (Stranding)	Insulation Thickness (Inch)	Nom. O.D. (Inch)	Stock Colors on Standard Spools		
					100'	500'	1000'
9500	D-24	24(7x32)	.030	.084	9,90thru98	9,90thru98	9,90thru98
9501	D-22	22(7x30)	.030	.090	As Listed	As Listed	As Listed
9502	D-20	20(7x28)	.030	.098	As Listed	As Listed	As Listed
9503	D-18	18(7x26)	.030	.108	As Listed	As Listed	As Listed
9504	D-16	16(19x29)	.030	.117	9,90thru98	9,90thru98	9,90thru98
9505	D-14	14(19x27)	.030	.131	9,90thru98	9,90thru98	9,90thru98
9506	D-12	12(19x25)	.035	.160	9,90thru98	9,90thru98	9,90thru98
9507	D-10	10(37x26)	.035	.181	9,90thru98	9,90thru98	9,90thru98
9508	D- 8	8(133x29)	.040	.245	9,90thru98	9,90thru98	9,90thru98
9509	D- 6	6(133x27)	.040	.290	9,90thru98	9,90thru98	9,90thru98

Stock Colors*

0 Black	90 White/Black
1 Brown	91 White/Brown
2 Red	92 White/Red
3 Orange	93 White/Orange
4 Yellow	94 White/Yellow
5 Green	95 White/Green
6 Dark Blue	96 White/Blue
7 Violet (Purple)	98 White/Gray
8 Gray (Slate)	
9 White	

*Stock Color Numbers in Accordance to Military Type Designation and EIA Color Coding.



CONSOLIDATED WIRE AND ASSOCIATED CORPORATIONS

SEND FOR COMPLETE CATALOG

MIL-W-5086A AIRCRAFT WIRE & CABLE TYPES 1 & 2 — 600V

UNSHIELDED

Catalog Number	MIL Type Designation	Size & (Stranding)	Nom. O.D.	Spec. Type	Stock Colors on Standard Spools		
					100'	500'	1000'
9700	AN-22	22(19x34)	.068	No. 1	9	9	9
9701	AN-20	20(19x32)	.078	No. 1	9	9	9
9702	AN-18	18(19x30)	.088	No. 1	9	9	9
9703	AN-16	16(19x29)	.098	No. 1	9	9	9
9704	AN-14	14(19x27)	.117	No. 1	9	9	9
9705	AN-12	12(19x25)	.137	No. 1	9	9	9

Stock Color*
White only (9)

Additional Description

MIL-W-5086A-Type I
AN-22 thru AN-12.

Stranded tinned copper, white polyvinylchloride clear nylon jacket insulation.

9706	AN-22	22(19x34)	.075	No. 2	9	9	9
9707	AN-20	20(19x32)	.085	No. 2	9	9	9
9708	AN-18	18(19x30)	.095	No. 2	9	9	9
9709	AN-16	16(19x29)	.105	No. 2	9	9	9
9710	AN-14	14(19x27)	.125	No. 2	9	9	9
9711	AN-12	12(19x25)	.143	No. 2	9	9	9

MIL-W-5086A-Type II
AN-22 thru AN-12

Stranded tinned copper, white polyvinylchloride insulation, saturated glass braid, clear nylon jacket.

9713	AN-10	10(49x27)	.189	No. 2	9	9	9
9714	AN-8	8(133x29)	.240	No. 2	9	9	9
9715	AN-6	6(133x27)	.293	No. 2	9	9	9
9716	AN-4	4(133x25)	.355	No. 2	9	9	9
9717	AN-2	2(665x30)	.425	No. 2	9	9	9
9718	AN-0	0(1045x30)	.525	No. 2	9	9	9
9719	AN-00	00(1330x30)	.590	No. 2	9	9	9

MIL-W-5086A-Type II
AN-10 thru AN-00

Stranded tinned copper, white polyvinylchloride insulation, saturated glass braid, nylon braid, nylon lacquer.

MIL-C-7078A — TYPE 1 — 600 VOLT

(MIL-W-5086A Type I Conductor Braided Tinned Copper Shield)

SHIELDED

Catalog Number	MIL Type Designation	Size & (Stranding)	Nom. O.D.	Spec. Type	Stock Colors on Standard Spools		
					100'	500'	1000'
9720	AN-22	22(10x34)	.092	No. 1	9	9	9
9721	AN-20	20(19x32)	.102	No. 1	9	9	9
9722	AN-18	18(19x30)	.112	No. 1	9	9	9
9723	AN-16	16(19x29)	.122	No. 1	9	9	9
9724	AN-14	14(19x27)	.141	No. 1	9	9	9
9725	AN-12	12(19x25)	.161	No. 1	9	9	9

Stock Color*
White only (9)

Additional Description

Stranded tinned copper, white polyvinylchloride insulation, nylon jacket, braided tinned copper shield.

*Stock Color Numbers in Accordance to Military Type Designation and EIA Color Coding.



MIL-W-16878-D

TYPE E — TFE TEFLON — 600V — 200C



Concentrically stranded silver coated copper conductor, extruded TFE Teflon insulated.

Catalog Number	Type Designation	Size & (Stranding)	Nom. O.D. (Inch)	Stock Colors on Standard Spools		
				100'	500'	1000'
9600	E-32	32(7x40)	.032	As Listed	As Listed	As Listed
9601	E-30	30(7x38)	.032	As Listed	As Listed	As Listed
9602	E-28	28(7x36)	.035	As Listed	As Listed	As Listed
9603	E-26	26(19x38)	.039	As Listed	As Listed	As Listed
9604	E-26	26(7x34)	.039	As Listed	As Listed	As Listed
9605	E-24	24(19x36)	.044	As Listed	As Listed	As Listed
9606	E-24	24(7x32)	.044	As Listed	As Listed	As Listed
9607	E-22	22(19x34)	.050	As Listed	As Listed	As Listed
9608	E-22	22(7x30)	.050	As Listed	As Listed	As Listed
9609	E-20	20(19x32)	.058	As Listed	As Listed	As Listed
9610	E-20	20(7x28)	.058	As Listed	As Listed	As Listed
9611	E-18	18(19x30)	.069	As Listed	As Listed	As Listed
9612	E-18	18(7x26)	.069	As Listed	As Listed	As Listed
9613	E-16	16(19x29)	.080	As Listed	As Listed	As Listed
9614	E-14	14(19x27)	.095	As Listed	As Listed	As Listed
9615	E-12	12(19x25)	.115	As Listed	As Listed	As Listed
9616	E-10	10(37x26)	.131	As Listed	As Listed	As Listed

Stock Colors*

0 Black	5 Green
1 Brown	6 Dark Blue
2 Red	7 Violet (Purple)
3 Orange	8 Gray (Slate)
4 Yellow	9 White

NOTE: Tracer colors available upon customer request. Minimum quantity 500 feet.

TYPE EE — TFE TEFLON — 1000V — 200C

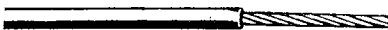

Concentrically stranded silver coated copper conductor, extruded TFE Teflon insulated.

Catalog Number	Type Designation	Size & (Stranding)	Nom. O.D. (Inch)	Stock Colors on Standard Spools		
				100'	500'	1000'
9620	EE-32	32(7x40)	.042	As Listed	As Listed	As Listed
9621	EE-30	30(7x38)	.042	As Listed	As Listed	As Listed
9622	EE-28	28(7x36)	.045	As Listed	As Listed	As Listed
9623	EE-26	26(19x38)	.049	As Listed	As Listed	As Listed
9624	EE-26	26(7x34)	.049	As Listed	As Listed	As Listed
9625	EE-24	24(19x36)	.054	As Listed	As Listed	As Listed
9626	EE-24	24(7x32)	.054	As Listed	As Listed	As Listed
9627	EE-22	22(19x34)	.060	As Listed	As Listed	As Listed
9628	EE-22	22(7x30)	.060	As Listed	As Listed	As Listed
9629	EE-20	20(19x32)	.068	As Listed	As Listed	As Listed
9630	EE-20	20(7x28)	.068	As Listed	As Listed	As Listed
9631	EE-18	18(19x30)	.079	As Listed	As Listed	As Listed
9632	EE-18	18(7x26)	.079	As Listed	As Listed	As Listed
9633	EE-16	16(19x29)	.089	As Listed	As Listed	As Listed
9634	EE-14	14(19x27)	.110	As Listed	As Listed	As Listed
9635	EE-12	12(19x25)	.129	As Listed	As Listed	As Listed
9636	EE-10	10(37x26)	.149	As Listed	As Listed	As Listed

Stock Colors*

0 Black	5 Green
1 Brown	6 Dark Blue
2 Red	7 Violet (Purple)
3 Orange	8 Gray (Slate)
4 Yellow	9 White

NOTE: Tracer colors available upon customer request. Minimum quantity 500 feet.

ROME SYNTHINOL

UL TYPE HOOK-UP AND LEAD WIRES

UL-300V-80C

UL-600V-105C (CSA 600V-90C)

Catalog Number	Size Awg.	Stranding	Nom. Ins. Thckns.	Volts	Max. Dia. Inches
801	22	Solid	1/64	300	.065
811	20	Solid	1/64	300	.071
841	18	Solid	1/64	300	.080
821	22	7 x No. 30	1/64	300	.069
831	20	10 x No. 30	1/64	300	.078
846	18	16 x No. 30	1/64	300	.085
881	20—2 cond. Black & Red	10 x No. 30	.025	300	.170

Catalog Number	Size Awg.	Stranding	Nom. Ins. Thckns.	Volts	Max. Dia. Inches
851	22	Solid	1/32	600	.097
836	20	Solid	1/32	600	.104
861	18	Solid	1/32	600	.112
866	22	7 x No. 30	1/32	600	.102
871	20	10 x No. 30	1/32	600	.110
876	18	16 x No. 30	1/32	600	.119

Colors: Black, Blue, Brown, Green, Orange, Pink, Purple, Red, Slate, White, Yellow
STANDARD SPOOL PUT-UP: 25 FT., 100 FT., 500 FT., 1000 FT.

*Stock Color Numbers in Accordance to Military Type Designation and EIA Color Coding.



SECTION 6000
CONSOLIDATED WIRE AND ASSOCIATED CORPORATIONS

SEND FOR COMPLETE CATALOG

SHIELDED TEFLON CABLES
MIL-W-16878

Each conductor stranded silver plated copper Type E extruded Teflon .010" insulation—90% braided silver copper shield, also supplied with either a Teflon impregnated Fiberglass braid or Teflon fused tape overall jacket.

Temperature rating —65°C to +260°C. Voltage rating 600 volts.



NO OUTER COVERING OVER SHIELD

Catalog Number	No. of Cond.	Size & Stranding	Nom. O.D. (Inch)
9800	1	24(19x36)	.069
9801	2	24(19x36)	.112
9802	3	24(19x36)	.120
9803	4	24(19x36)	.132
9804	1	22(19x34)	.075
9805	2	22(19x34)	.124
9806	3	22(19x34)	.132
9807	4	22(19x34)	.146
9808	1	20(19x32)	.083
9809	2	20(19x32)	.142
9810	3	20(19x32)	.151
9811	4	20(19x32)	.168
9812	1	18(19x30)	.093
9813	2	18(19x30)	.162
9814	3	18(19x30)	.172
9815	4	18(19x30)	.192

STOCK COLORS

Catalog Numbers 9800 thru 9855
Specify color coding when ordering.
Standard spool put up Catalog Numbers 9800 thru 9855: 100 ft., 500 ft., 1000 ft.

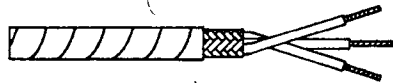

TEFLON TAPE WRAP JACKET OVER SHIELD

Catalog Number	No. of Cond.	Size & Stranding	Nom. O.D. (Inch)
9820	1	24(19x36)	.084
9821	2	24(19x36)	.128
9822	3	24(19x36)	.135
9823	4	24(19x36)	.148
9824	1	22(19x34)	.090
9825	2	22(19x34)	.140
9826	3	22(19x34)	.148
9827	4	22(19x34)	.162
9828	1	20(19x32)	.099
9829	2	20(19x32)	.158
9830	3	20(19x32)	.167
9831	4	20(19x32)	.184
9832	1	18(19x30)	.109
9833	2	18(19x30)	.178
9834	3	18(19x30)	.189
9835	4	18(19x30)	.208

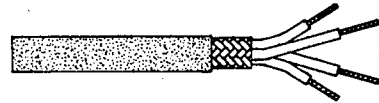

TEFLON IMPREGNATED BRAID OVER SHIELD

Catalog Number	No. of Cond.	Size & Stranding	Nom. O.D. (Inch)
9840	1	24(19x36)	.081
9841	2	24(19x36)	.126
9842	3	24(19x36)	.133
9843	4	24(19x36)	.144
9844	1	22(19x34)	.088
9845	2	22(19x34)	.137
9846	3	22(19x34)	.144
9847	4	22(19x34)	.158
9848	1	20(19x32)	.097
9849	2	20(19x32)	.154
9850	3	20(19x32)	.163
9851	4	20(19x32)	.180
9852	1	18(19x30)	.106
9853	2	18(19x30)	.174
9854	3	18(19x30)	.185
9855	4	18(19x30)	.205

Stock Color Numbers in accordance to Military Type Designation and E.I.A. Color Coding.









CONSOLIDATED WIRE AND ASSOCIATED CORPORATIONS

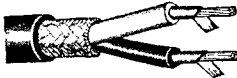

SEND FOR COMPLETE CATALOG

INTERCOMMUNICATING AND SOUND SYSTEM CABLES

STANDARD SPOOL PUT-UP: 10 FT., 25 FT., 50 FT., 100 FT., 500 FT., 1000 FT.

	NO.	TYPE	Size & Stranding	INSULATION THICKNESS (INCHES)	SPECIFICATION AND GENERAL APPLICATION	NOMINAL DIAMETER (INCHES)
 <p>STATION-TO-STATION EXTENSION WIRING SHIELDED</p>	5501	2 Condr.	22 Solid	.015	Tinned copper vinyl plastic insulation, wires twisted together—1 cond. red—1 cond. black—closely woven braided tinned copper shield.	.110
	5506	3 Condr.	22 Solid	.015	Same as 5504—cond. red—1 cond. black—1 cond. blue.	.145
	5521	2 Condr.	20 Solid	.015	Tinned copper vinyl plastic insulation, wires twisted together—1 cond. red—1 cond. black—closely woven braided tinned copper shield.	.155
 <p>EXTENSION WIRING SHIELDED—PLASTIC JACKET</p>	5511	2 Condr.	22 Solid	.015	Tinned copper vinyl plastic insulation, wires twisted together—1 cond. red—1 cond. black—and a spiral tinned copper shield with .020" tubed gray vinyl plastic jacket.	.170
 <p>PAIRED CABLE—SHIELDED PLASTIC JACKET</p>	5516	2 Pair 4 Condr.	22 7x30	.015	Stranded tinned copper vinyl plastic insulation. 2 pair cabled (4 conductors)—1 pair black & white with braided tinned copper shield—1 pair black & brown unshielded—both pair bunched and .020" gray vinyl plastic jacket overall.	.168x.276
 <p>EXTENSION-SPEAKERS SHIELDED FOR LONG RUNS</p>	5526	2 Condr.	20 10x30	.015	Tinned copper vinyl plastic insulation, wires twisted together—1 cond. red—1 cond. black—closely woven tinned copper shield.	.215
	5531	3 Condr.	20 10x30	.015	Same as 5526—1 cond. red—1 cond. black—1 cond. blue.	.230
	5536	2 Condr.	18 16x30	.015	Stranded tinned copper vinyl plastic insulation, wires twisted together. 1 cond. red—1 cond. white, closely woven braided tinned copper shield.	.235
	5568	2 Condr.	22 7x30	.015	Tinned copper vinyl plastic insulation. 2 condrs.—cabled black and red—tinned copper spiral wrapped shield .023" chrome vinyl plastic jacket.	.166
	5569	3 Condr.	22 7x30	.015	Tinned copper vinyl plastic insulation. 3 condrs.—cabled black, red, white—tinned copper spiral shield—chrome vinyl plastic jacket.	.193
 <p>EXPANSION-SPEAKERS SHIELDED—PLASTIC JACKET</p>	5538	2 Condr.	18 16x30	.015	Stranded tinned copper vinyl plastic insulation, wires twisted together. 1 cond. red. 1 cond. white. Spiral tinned copper shield and .020" gray vinyl plastic jacket overall.	.225
	5543	2 Condr.	20 10x30	.015	Same as 5538 1 cond. Red. 1 cond. Black.	.185
	5541	2 Condr.	18 16x30	.015	Stranded tinned copper vinyl plastic insulation, wires twisted together. 1 cond. red—1 cond. white, closely woven braided tinned copper shield and .020" gray vinyl plastic jacket overall.	.260
	5547	2 Condr.	24 7x32	.015	Stranded 1 cond. bare copper—1 cond. tinned copper—2 condrs. parallel gray vinyl plastic insulation. Colors—brown, clear, gray, white.	.058x.115
 <p>HIGH IMPEDANCE LAPEL MICROPHONES</p>	5551	1 Condr.	24 16x34	.020	Stranded tinned copper polyethylene insulation closely woven braided tinned copper shield with .020" gray vinyl jacket.	.125
 <p>INTER COMMUNICATING SOUND SYSTEM</p>	5556	2 Condr.	19 Solid	.015	Bare copper vinyl plastic insulation, wires twisted together—1 cond. brown—1 cond. tan.	.115
	5561	3 Condr.	19 Solid	.015	Same as 5556—1 cond. brown—1 cond. tan—1 cond. gray.	.132
 <p>INTER COMMUNICATING WEATHER-PROOF</p>	5566	2 Condr.	22 Solid	.015	Bare copper .015 rubber insulation with a black cotton braid weatherproof finish. Conductors coded for easy identification. Ideal for exterior or interior communication installations.	.191x.208

TELEPHONE AND COMMUNICATION CABLE DIRECT BURIAL TYPE

FULLY COLOR CODED

SPECIFICATIONS

Solid bare annealed copper 22 Awg. gauge conductors; thin wall, color coded, polyethylene insulation; conductors twisted to form pairs with symmetrically varying lays to minimize cross-talk; cabled (for 6 thru 50 pairs) by stranding pairs in concentric layers, or (for 75 thru 400 pairs) by stranding pairs into concentrically formed units, which are in turn cabled to form the complete assembly; non-hygroscopic binder tape furnishing high dielectric strength between shield and individual conductors; continuous copper shielding tape; high-molecular weight, polyethylene jacket.

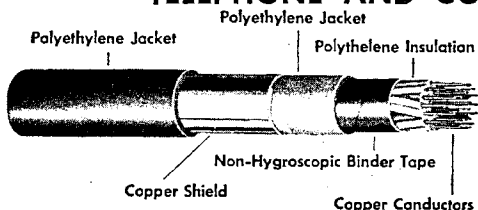

GENERAL APPLICATION AND ADVANTAGE

APPLICATION: Communication and Telephone Cable for use in direct burial installations provides a high quality product similar to that used for aerial and duct systems, but with the addition of protective armoring. This minimizes the possibility of damage to the cable from rodents and insects and, correctly installed, reduces the dangers to the cable from sharp stones and other hazards of underground burial installations.

ADVANTAGE: The lightweight, but rugged construction of direct burial Communication and Telephone Cable permits fast and economical underground installation of communication systems with the assurance of dependable and enduring service. This is made possible through utilization of the same high quality polyethylene compounds that are used in its counterpart for aerial and duct type installations, with the added protection of copper armoring tapes and a durable, high-molecular weight, polyethylene jacket.

NO.	NO. OF PAIRS	NO. OF COND.	COND. SIZE	NOMINAL JACKET THICKNESS, MILS	NOMINAL O. D. (Inches)
				INNER	OUTER
6006	6	12	22 Solid	40	.430
6012	12	24	22 Solid	40	.500
6018	18	36	22 Solid	40	.560
6025	25	50	22 Solid	40	.630
6050	50	100	22 Solid	40	.820
6075	75	150	22 Solid	50	.990
6100	100	200	22 Solid	50	1.20
6150	150	300	22 Solid	50	1.30
6200	200	400	22 Solid	50	1.50
6300	300	600	22 Solid	50	1.80
6400	400	800	22 Solid	50	2.00



CONSOLIDATED WIRE AND ASSOCIATED CORPORATIONS

SEND FOR COMPLETE CATALOG

PAIRED PLASTIC CONDUCTORS

SPECIFICATIONS AND GENERAL APPLICATIONS Tinned copper conductor .010" vinyl plastic insulation. Cabled .202" gray vinyl plastic Jacket overall

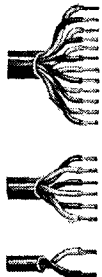

NO.	TYPE	SIZE AND STRANDING	NOMINAL DIAMETER (Inches)
5201	1 Pr. 2 Condr.	22 Solid	.145
5205	2 Pr. 4 Condr.	22 Solid	.190
5211	3 Pr. 6 Condr.	22 Solid	.230
5221	5 Pr. 10 Condr.	22 Solid	.250
5226	6 Pr. 12 Condr.	22 Solid	.265
5231	7 Pr. 14 Condr.	22 Solid	.280
5236	8 Pr. 16 Condr.	22 Solid	.300
5241	9 Pr. 18 Condr.	22 Solid	.320
5251	11 Pr. 22 Condr.	22 Solid	.360
5271	15 Pr. 30 Condr.	22 Solid	.390
5286	27 Pr. 54 Condr.	22 Solid	.510

STANDARD SPOOL PUT-UP: 100 FT., 500 FT., 1000 FT.

MULTIPLE CONDUCTORS FULLY COLOR CODED

SIZE & STRANDING 22 - 7x30 SPECIFICATION AND GENERAL APPLICATION Tinned copper conductor .010" vinyl plastic insulation. Cabled .020" gray vinyl plastic Jacket overall



NO.	TYPE	SIZE AND STRANDING	NOMINAL DIAMETER (Inches)
5400	2 Condr.	22 7x30	.130
5401	3 Condr.	22 7x30	.140
5406	4 Condr.	22 7x30	.158
5411	5 Condr.	22 7x30	.170
5416	6 Condr.	22 7x30	.212
5421	7 Condr.	22 7x30	.230
5426	8 Condr.	22 7x30	.235
5431	9 Condr.	22	.245
5434	12 Condr.	22 7x30	.250

STANDARD SPOOL PUT-UP: 10 FT., 15 FT., 25 FT., 100 FT., 500 FT., 1000 FT.

PHONOGRAPH MULTIPLE CABLE STANDARD SPOOL PUT-UP: 500 FT., 1000 FT.



TYPE No.	SIZE	SPECIAL USE	SPECIFICATIONS	STRANDING	FINISHED O.D. (Inches)
5103	3-22	Same as 5030	3 condrs. No. 22 with 1/4" thermoplastic insulation, all individually color coded. All conductors grouped into cable form with a treated cotton braid overall lacquered.	7 x 30	.125
5123	2-16 1-18	Same as 5030	2 condrs. No. 16 1/4" thermoplastic insulation. 1 condr. No. 18 1/2" thermoplastic insulation, all individually color coded. All conductors grouped into cable form with gray vinyl plastic jacket.	2-26 x 30 1-16 x 30	.215
5135	22 5 condr.	Same as 5030	5 condr. No. 22 with 1/4" thermoplastic insulation; 3 condr. twisted together with a braided tinned copper shield; 2 condr. twisted; all condr. grouped into cable form with a brown cotton braid overall.	5-7 x 30	.225
5124	4-18	Same as 5030	No. 18 solid 4 condr. color coded gray plastic jacket overall.	Solid	.225



MICROPHONE CABLE CONDUCTOR COLOR CHART: 1—Black; 2—White; 3—Red; 4—Green; 5—Yellow; 6—Blue; 7—Brown.

STANDARD SPOOL PUT-UP: 9 FT., 10 FT., 25 FT., 50 FT., 100 FT., 250 FT., 500 FT., 1000 FT.

SHIELDED; Weatherproof rubber jacket for all microphone or weatherproof extension work. (Longer continuous lengths if desired.)

No	TYPE	SIZE	SPECIAL USE	SPECIFICATIONS	STRANDING	FINISHED O.D. (Inches)	NOMINAL CAPACITY per ft. (mmf)
1461	1 conductor	22	Lapel microphone	Tinned copper polyethylene insulation with a closely woven tinned copper shield. Gray vinyl plastic jacket.	16 x 34	.125	34.
1457	1 conductor	22	Crystal, Ribbon and other high impedance microphones	Same as 1461 except heavier polyethylene insulation on conductor.	16 x 34 26 x 34	.200 .175	25. 40.
1458	2 conductor	22	Low impedance microphones	Tinned copper conductors polyethylene insulation conductors; black and white. Cabled with fillers closely woven tinned copper shield. Gray vinyl plastic jacket.	16 x 34	.231	32.
1459	1 conductor	20	Lapel microphone	Tinned Copper Wire, with polyethylene to .087" O.D. with a closely woven tinned copper shielded braid, and a heavy black plastic jacket overall.	26 x 34	.240	33.
1460	1 conductor	20	Crystal microphone	Tinned copper, yarn serve; wall of live rubber; tinned copper braid shield; rubber jacket overall.	26 x 34	.240	68.
1462	2 conductor	20	Carbon microphones	Same as 1460; color coded	00 x 00	.268	
1456	2 conductor	18	Heavy duty studio cable	Same as 1460; color coded	41 x 34	.295	80.
1463	3 conductor	20	Carbon microphones	Same as 1460; color coded	26 x 34	.277	85.
1464	4 conductor	20	Carbon microphones	Same as 1460; color coded	26 x 34	.295	95.
1465	5 conductor	20	Carbon microphones	Same as 1460; color coded	26 x 34	.323	
1466	6 conductor	20	Carbon microphones	Same as 1460; color coded	26 x 34	.350	
1467	7 conductor	20	Carbon microphones	Same as 1460; color coded	26 x 34	.360	
1455	8 conductor	20	Same as 1465	Same as 2460; color coded	26 x 34	.386	

CONSOLIDATED WIRE AND ASSOCIATED CORPORATIONS
SEND FOR COMPLETE CATALOG

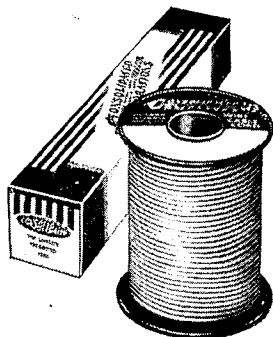

MAGNET WIRE

Popular, profitable specialty wire packaged for easy selling in radio-electrical, department, specialty and hardware stores. Wide variety of sizes and insulations. Keeps stock in perfect order, always saleable. Supplied on Spool as shown and in Heavier Weights for whatever weight desired. Here is a handy and convenient way to stock small quantities of wire. It prevents wire from matting or tangling.

No. 2000 VARIOUS OTHER INSULATIONS

Film	Technical Classification
ENAMEL	oleoresinous
FORMVAR	poly vinyl acetal
SODEREZE	polyurethane
THERMALEZE	epoxide polyester
NYFORM	formvar, nylon sheath
NYLON	
BONDEZE	
GRIZEPE	
LECTRON	acrylic
ISONSEL	terephthalic polyester
ALKANVAR	terephthalic polyester
SYLYKD ENAMELED	
COTTON AND COMBINATIONS	
SILK AND COMBINATIONS	
CELANESE AND COMBINATIONS	
GLASS AND COMBINATIONS	
PAPER AND COMBINATIONS	

PLAIN ENAMEL MAGNET WIRE

Size	¼ lb.	½ lb.	1 lb.
14	\$0.45	\$0.75	\$1.39
15	.45	.80	1.40
16	.50	.84	1.42
17	.50	.87	1.44
18	.50	.89	1.45
19	.55	.92	1.49
20	.55	.94	1.50
21	.55	.95	1.59
22	.55	.97	1.70
23	.58	.99	1.75
24	.60	1.00	1.87
25	.65	1.10	1.95
26	.65	1.10	2.03
27	.70	1.15	2.14
28	.73	1.20	2.25
29	.75	1.25	2.30
30	.80	1.30	2.35
31	.89	1.35	2.45
32	.90	1.40	2.50
33	.95	1.50	2.55
34	1.00	1.70	2.75
35	1.09	1.84	3.14
36	1.29	2.00	3.50
37	1.45	2.25	4.00
38	1.70	2.50	4.50
39	1.87	3.00	5.00
40	2.50	3.75	6.00
41	3.00	5.63	8.48
42	3.48	6.60	12.89
43	4.35	8.25	15.75
44	4.88	9.98	18.45

SINGLE FORMVAR MAGNET WIRE

Size	¼ lb.	½ lb.	1 lb.
14	\$0.66	\$1.12	\$2.07
15	.66	1.20	2.10
16	.75	1.25	2.14
17	.75	1.30	2.15
18	.75	1.34	2.17
19	.83	1.39	2.23
20	.83	1.40	2.25
21	.83	1.42	2.37
22	.83	1.45	2.56
23	.89	1.49	2.62
24	.90	1.50	2.80
25	.97	1.65	2.92
26	.99	1.65	3.05
27	1.05	1.74	3.26
28	1.10	1.80	3.37
29	1.14	1.87	3.46
30	1.20	1.95	3.52
31	1.34	2.02	3.67
32	1.35	2.10	3.75
33	1.42	2.25	3.95
34	1.50	2.55	4.12
35	1.64	2.81	4.70
36	1.92	3.00	5.26
37	2.17	3.37	6.00
38	2.55	3.75	6.76
39	2.80	4.50	7.50
40	3.75	5.64	9.00
41	3.75	6.75	12.60
42	4.28	7.40	13.43
43	5.18	7.88	14.25
44	6.60	11.70	22.58

HEAVY FORMVAR MAGNET WIRE

Size	¼ lb.	½ lb.	1 lb.
14	\$0.73	\$1.24	\$2.27
15	.73	1.34	2.33
16	.84	1.39	2.35
17	.84	1.44	2.37
18	.84	1.47	2.39
19	.92	1.52	2.45
20	.92	1.54	2.51
21	.92	1.55	2.61
22	.92	1.60	2.80
23	.97	1.64	2.87
24	1.00	1.65	3.07
25	1.15	1.97	3.50
26	1.19	1.98	3.64
27	1.25	2.07	3.84
28	1.34	2.15	4.04
29	1.37	2.24	4.14
30	1.44	2.34	4.22
31	1.67	2.52	4.58
32	1.69	2.63	4.67
33	1.77	2.81	4.94
34	1.87	3.19	5.16
35	2.04	3.46	5.88
36	2.39	3.75	6.58
37	2.72	4.20	7.50
38	3.17	4.69	8.45
39	3.50	5.64	9.38
40	4.69	7.04	11.27
41	5.18	7.59	13.65
42	5.78	8.15	14.72
43	6.00	8.63	15.08
44	7.48	11.40	23.33

DOUBLE COTTON COVERED MAGNET WIRE

Size	¼ lb.	½ lb.	1 lb.
14	\$0.55	\$0.95	\$1.87
15	.58	.98	1.90
16	.60	1.00	1.95
17	.60	1.05	2.00
18	.60	1.10	2.05
19	.65	1.15	2.28
20	.65	1.25	2.34
21	.77	1.34	2.50
22	.82	1.39	2.64
23	.88	1.50	2.75
24	.94	1.60	3.00
25	.95	1.65	3.14
26	1.00	1.75	3.39
27	1.15	1.89	3.64
28	1.20	2.14	4.00
29	1.30	2.39	4.50
30	1.32	2.50	4.75
31	1.50	2.75	5.00
32	1.75	3.00	5.64
33	1.89	3.37	6.25
34	2.14	3.89	7.00
35	2.39	4.25	7.50
36	2.75	4.89	8.65
37	2.25	6.25	11.40
38	4.75	8.65	16.50
39	6.00	11.50	20.00
40	8.00	15.00	28.15

BARE COPPER WIRE

Size	¼ lb.	½ lb.	1 lb.
14	\$0.53	\$0.97	\$1.54
15	.57	1.00	1.60
16	.60	1.10	1.83
17	.52	1.12	1.87
18	.63	1.14	1.90
19	.65	1.17	1.95
20	.67	1.20	2.00
21	.68	1.20	2.07
22	.70	1.24	2.14
23	.70	1.27	2.17
24	.70	1.30	2.20
25	.72	1.30	2.20
26	.73	1.34	2.27
27	.75	1.37	2.30
28	.77	1.40	2.40
29	.77	1.42	2.47
30	.77	1.42	2.47
31	.77	1.44	2.53
32	.77	1.44	2.50
33	.78	1.47	2.58
34	.80	1.50	2.77
35	.82	1.55	2.90
36	.84	1.60	3.04
37	.92	1.75	3.22
38	1.00	1.90	3.40
39	1.02	1.97	3.45
40	1.04	2.04	3.50

TINNED COPPER WIRE

Size	¼ lb.	½ lb.	1 lb.
14	\$0.67	\$1.13	\$1.75
15	.73	1.27	1.92
16	.80	1.40	2.00
17	.84	1.44	2.03
18	.87	1.47	2.08
19	.90	1.50	2.12
20	.94	1.53	2.17
21	.95	1.53	2.24
22	.97	1.57	2.30
23	.98	1.58	2.34
24	1.00	1.60	2.37
25	1.00	1.60	2.37
26	1.00	1.60	2.37
27	1.05	1.67	2.64
28	1.10	1.75	2.90
29	1.13	1.84	2.94
30	1.17	1.92	2.97
31	1.20	2.00	3.04
32	1.24	2.09	3.10
33	1.27	2.17	3.19
34	1.30	2.25	3.27
35	1.32	2.30	3.40
36	1.34	2.34	3.54
37	1.36	2.42	3.72
38	1.38	2.50	3.90
39	1.39	2.50	3.95
40	1.40	2.67	4.00

SPECIAL MAGNET WIRES

In addition to the standard listing shown here, we maintain an extensive stock of all other sizes in round, rectangular and square magnet wire.

BARE NICKEL CHROMIUM WIRE

No. 2000

Recommended for electrical heating appliances and other devices where the highest quality in performance is required, whose operating temperatures do not exceed 1850° F. Particularly suited for heavy duty rheostats and controls which require compact resistance.

ON PROTECTA-METAL SPOOLS

Size	1 Oz.	¼ Lb.	1 Lb.
14	\$1.52	\$5.56
15	1.56	5.95
16	1.58	5.73
17	1.63	5.90
18	1.67	5.87
19	1.71	6.02
20	\$0.67	1.76	6.17
21	.71	1.85	6.49
22	.72	1.99	6.79
23	.74	2.08	7.44
24	.76	2.22	8.09
25	.82	2.37	8.74
26	.87	2.53	9.39
27	.89	2.57	9.96

Size	1 Oz.	¼ Lb.	1 Lb.
28	\$0.92	\$2.84	\$10.53
29	1.00	2.98	11.18
30	1.09	3.11	11.83
31	1.14	3.28	12.28
32	1.18	3.43	12.73
33	1.31	3.79	14.73
34	1.44	4.16	16.73
35	1.58	4.55	17.71
36	1.71	4.94	18.69
37	2.22	6.50	23.96
38	2.74	8.05	29.03
39	2.86	8.39	31.62
40	2.98	8.95	34.20

CONSOLIDATED WIRE AND ASSOCIATED CORPORATIONS

SEND FOR COMPLETE CATALOG



MULTIPLE CONDUCTOR COTTON BRAIDED CABLE

FOR SPEAKERS, TESTERS,
BATTERY HOOK-UP, ETC.



SPECIFICATIONS: Tinned flexible copper; colored plastic insulation; bunched individual conductors; heavy brown cotton braid overall; color coded. Size 20; Stranding 10x30; Insulation Thickness $\frac{1}{64}$ "

TYPE NO.	TYPE	FINISHED O.D. (Inches)	TYPE NO.	TYPE	FINISHED O.D. (Inches)
1481	1 cond.	.150	1487	7 cond.	.275
1482	2 cond.	.175	1488	8 cond.	.300
1483	3 cond.	.200	1489	9 cond.	.310
1484	4 cond.	.275	1490	10 cond.	.325
1485	5 cond.	.250	1494	11 cond.	.335
1486	6 cond.	.260	1495	12 cond.	.350

MULTIPLE CONDUCTOR TINNED COPPER SHIELD CABLE



SPECIFICATIONS: Tinned flexible copper, 912E20, Stranding 10x30— $\frac{1}{64}$ " plastic insulation, color coded, Braided tinned copper shield.

TYPE NO.	TYPE	FINISHED O.D. (Inches)
1471	1 conductor	.110
1472	2 conductors	.190
1473	3 conductors	.200
1474	4 conductors	.220
1475	5 conductors	.235
1476	6 conductors	.250
1477	7 conductors	.265

ANALYZER CABLE

SPECIFICATIONS: Extra flexible tinned copper; plastic insulation; color coded; Brown cotton braid overall.

TYPE	SIZE	STRAND-ING	INSULATION THICKNESS (Inches)	FINISHED O.D. (Inches)
1501	8 cond.	2-14	41 x 30	$\frac{1}{64}$
		6-18	16 x 30	
1502	9 cond.	2-14	41 x 30	$\frac{1}{64}$
		7-18	16 x 30	

TEST PROD WIRE



A Specially Constructed High Grade Wire For Use On Laboratory Test Equipment, Bench Analyzers, Etc.

SPECIFICATIONS: Extra flexible tinned copper; cotton wrap; red or black; live rubber insulation.

1001	5,000 volts	20	41 x 36	.043	.140
1006	10,000 volts	18	65 x 36	.088	.230

SHIELDING AND BONDING CABLE DESIGNED FOR SHIELDING INSULATED WIRES AND CABLES . . . BONDING AND MANY OTHER USES

STANDARD SPOOL PUT-UP:
50 FT., 100 FT., 250 FT., 1000 FT.

NO.	APPROX. I. D.	SIZE & NUMBER OF WIRES	APPROX. AWG.	CARRYING CAPACITY IN AMPERES
1386	$\frac{1}{32}$ "	24 x 36	24	7
1387	$\frac{3}{64}$ "	24 x 36	23	7
1388	$\frac{3}{32}$ "	48 x 36	19	12
1389	$\frac{7}{64}$ "	72 x 36	18	14
1390	$\frac{1}{8}$ "	96 x 36	18	15
1391	$\frac{3}{16}$ "	120 x 36	15	23
1392	$\frac{1}{4}$ "	168 x 36	14	30
1393	$\frac{3}{8}$ "	288 x 36	11	50
1394	$\frac{1}{2}$ "	386 x 36	10	55
1395	$\frac{5}{8}$ "	396 x 36	10	61
1396	$\frac{3}{4}$ "	832 x 36	7	80
1397	$\frac{25}{32}$ "	832 x 36	7	80
1398	1"	832 x 36	7	84
1399	$1\frac{3}{8}$ "	912 x 36	7	105



TINNED COPPER BUS BAR WIRE SOLID SOFT DRAWN COPPER AND BRIGHTLY TINNED FOR ALL TYPES OF SOLDERING CONNECTIONS AND OTHER APPLICATIONS

STANDARD SPOOL PUT-UP: 100 FT., 1000 FT.

NO.	NOMINAL DIAMETER	SIZE SOLID	CIRCULAR MIL. AREA
3845	.129"	8	16510
3841	.102"	10	10380
3831	.082"	12	6530
3821	.064"	14	4110
3815	.051"	16	2583
3816	.040"	18	1624
3817	.032"	20	1022
3818	.025"	22	642
3819	.020"	24	404
3846	.016"	26	254.1
3847	.013"	28	159.8
3848	.010"	30	100.5

LEAD COVERED CABLE



FOR FREEDOM FROM INTERFERENCE, CORROSION AND DAMPNES.

SPECIFICATIONS: Tinned copper wire; heavy rubber insulation and cotton braid; heavy lead shield.

1453	2 cond.	18	Solid	$\frac{1}{32}$	240 x .200
1454	3 cond.	18	Solid	$\frac{1}{32}$.420

CONSOLIDATED WIRE AND ASSOCIATED CORPORATIONS



SEND FOR COMPLETE CATALOG

ELECTRICAL CORDAGES UNDERWRITERS APPROVED

SUPPLIED ON ATTRACTIVE TRI-COLOR
LITHOGRAPHED METAL SPOOLS

RUBBER HANDYCORD CENTERSTRIP



PLASTIC HANDYCORD CENTERSTRIP



RUBBER SHEATHED SERVICE CORD UNDERWRITERS APPROVED



SPECIFICATIONS AND APPLICATION

Extra flexible bare copper cotton served. 1/32" rubber insulation color coded conductors cabled with fillers, cotton wrap and black, tough rubber jacket.

For all electronic equipment, household appliances, garden and power tools.

NEOPRENE SHEATHED SERVICE CORD UNDERWRITERS APPROVED



SPECIFICATIONS AND APPLICATION

Same specifications as 4200 Series except black Neoprene jacket.

For all types of equipment exposed to oils, acid and excessive moisture.

HEATER CORD



Colors: Black and White Marker.

STANDARD SPOOL PUT-UP: 25 FT., 50 FT., 100 FT., 250 FT., 500 FT., 1000FF.

NO.	NO. OF COND.	SIZE AWG.	U. L. TYPE	STRAND-ING	NOM. INS. THICKNESS	NOM. O. D.
4072	2	18	SP(P.O.S.J.)	41 x 34	1/64"	.235 x .130
4074	2	16	SP(P.O.S.J.)	65 x 34	1/32"	.300 x .160

Colors: Black, Brown, White, Gray.

STANDARD SPOOL PUT-UP: 25 FT., 50 FT., 100 FT., 250 FT., 500 FT., 1000 FT.

4077	2	18	SPT(P.O.T.)	41 x 34	1/64"	.235 x .130
4079	2	16	SPT(P.O.T.)	65 x 34	1/32"	.300 x .160

Colors: Black, Brown, White, Gray.

STANDARD PUT-UP: 25 FT., 50 FT., 100 FT., 250 FT.

NO.	NO. OF COND.	SIZE AWG.	U. L. TYPE	CURRENT CARRYING CAPACITY	VOLTAGE RATING	NOM. O. D.
4202	2	18	SV	5 Amps.	300	.250"
4207	2	18	SJ	5 Amps.	300	.310"
4212	3	18	SJ	5 Amps.	300	.345"
4214	4	18	SJ	5 Amps.	300	.360"
4217	2	16	SJ	7 Amps.	300	.340"
4222	3	16	SJ	7 Amps.	300	.375"
4224	4	16	SJ	7 Amps.	600	.395"
4227	2	18	S	5 Amps.	600	.390"
4232	3	18	S	5 Amps.	600	.405"
4234	4	18	S	5 Amps.	600	.435"
4237	2	16	S	7 Amps.	600	.410"
4242	3	16	S	7 Amps.	600	.430"
4244	4	16	S	7 Amps.	600	.485"
4247	2	14	S	15 Amps.	600	.540"
4252	3	14	S	15 Amps.	600	.560"
4254	4	14	S	15 Amps.	600	.605"
4257	2	12	S			
4262	3	12	S	20 Amps.	600	.635"
4264	4	12	S	20 Amps.	600	.665"
4267	2	10	S	25 Amps.	600	.640"
4272	3	10	S	25 Amps.	600	.690"
4274	4	10	S	25 Amps.	600	.745"

STANDARD PUT-UP: 25 FT., 50 FT., 100 FT., 250 FT.

4307	2	18	SJO	5 Amps.	300	.310"
4312	3	18	SJO	5 Amps.	300	.345"
4314	4	18	SJO	5 Amps.	300	.360"
4317	2	16	SJO	7 Amps.	300	.340"
4322	3	16	SJO	7 Amps.	300	.375"
4324	4	16	SO	7 Amps.	600	.395"
4327	2	18	SO	5 Amps.	600	.390"
4332	3	18	SO	5 Amps.	600	.405"
4334	4	18	SO	5 Amps.	600	.435"
4337	2	16	SO	7 Amps.	600	.410"
4342	3	16	SO	7 Amps.	600	.430"
4344	4	16	SO	7 Amps.	600	.485"
4347	2	14	SO	15 Amps.	600	.540"
4352	3	14	SO	15 Amps.	600	.560"
4354	4	14	SO	15 Amps.	600	.605"
4357	2	12	SO	20 Amps.	600	.605"
4362	3	12	SO	20 Amps.	600	.635"
4364	4	12	SO	20 Amps.	600	.665"
4367	2	10	SO	25 Amps.	600	.640"
4372	3	10	SO	25 Amps.	600	.690"
4374	4	10	SO	25 Amps.	600	.745"

STANDARD SPOOL PUT-UP: 100 FT., 250 FT.

NO.	NO. OF COND.	SIZE AWG.	U. L. TYPE	STRAND-ING	NOM. INS. THICKNESS	NOM. O. D.
4087	2	16	HPD	65 x 34	1/32"	.275
4092	2	18	HPD	41 x 34	1/32"	.250

CONSOLIDATED WIRE PAGE 18



DABURN ELECTRONICS & CABLE CORP.

WIRE • CABLE • TUBING • MIL/COMM • SWITCHES • ELECTRONIC HARDWARE



DAFLEX 105 PLASTIC TUBING

105°C POLYVINYLCHLORIDE (PVC) MEETS MIL-I-631D SPECS



Specifically compounded vinyl resins for superior all around performance. UL approved for 105°C, conforms to Spec MIL-I-631D Type F, Form U, Grades A and C. Class 1 and 2, Category 1. Resistant to heat, oil, water, chemical corrosion, fungi and aging. Very hi abrasion resistance. Will retain its flexibility. Suitable for covering and protecting wires and cables. Designed for electrical, electronic and aircraft applications. Non-flammable. Meets ASTM—D876, ASTM—D922.

D105 compounded with non-migratory resin type plasticizers. Retains its flexibility, permitting it to cling and protect irregular shapes. D105 snakes well under practically all conditions.

DIMENSIONAL TOLERANCES OF DAFLEX 105

DAFLEX No.	Size	Old Daburn No.	Nom. I.D.	Nom. Wall	Specify Std. Put-Up Spool or Coil	ASTM Tolerance, Inches	Wall Thickness Inches
D105-24	24	808	.022"	.012"	25', 100', 1000'	.020 .027	.012 ± .002
D105-22	22	811	.027"	.012"	25', 100', 1000'	.025 .032	.012 ± .002
D105-20	20	813	.034"	.016"	25', 100', 1000'	.032 .039	.016 ± .003
D105-19	19	—	.038"	.016"	100', 1000'	.044 .036	.016 ± .003
D105-18	18	814	.042"	.016"	25', 100', 1000'	.040 .049	.016 ± .003
D105-17	17	—	.047"	.016"	100', 1000'	.054 .045	.016 ± .003
D105-16	16	815	.053"	.016"	25', 100', 1000'	.051 .061	.016 ± .003
D105-15	15	—	.059"	.016"	100', 500'	.067 .057	.016 ± .003
D105-14	14	816	.066"	.016"	25', 100', 500'	.064 .072	.016 ± .003
D105-13	13	—	.076"	.016"	100', 500'	.080 .072	.016 ± .003
D105-12	12	817	.085"	.016"	25', 100', 500'	.081 .089	.016 ± .003
D105-11	11	—	.095"	.016"	100', 500'	.101 .091	.016 ± .003
D105-10	10	825	.106"	.016"	25', 100', 500'	.102 .112	.016 ± .003
D105-9	9	—	.118"	.020"	100', 500'	.124 .114	.020 ± .003
D105-8	8	818	.135"	.020"	25', 100', 500'	.129 .141	.020 ± .003
D105-7	7	—	.148"	.020"	100', 500'	.158 .144	.020 ± .003
D105-6	6	826	.166"	.020"	25', 100', 250'	.162 .178	.020 ± .003
D105-5	5	—	.186"	.020"	100', 250'	.198 .182	.020 ± .003
D105-4	4	819	.208"	.020"	25', 100', 250'	.204 .224	.020 ± .003
D105-3	3	—	.234"	.020"	100', 250'	.249 .229	.020 ± .003
D105-2	2	820	.263"	.020"	100', 250'	.258 .278	.020 ± .003
D105-1	1	—	.330"	.020"	100', 250'	.311 .289	.020 ± .003
D105-0	0	—	.330"	.020"	100', 250'	.347 .325	.020 ± .003
D105-3/8"	3/8"	821	.312"	.025"	100', 250'	.3125 .334	.025 ± .003
D105-1/2"	1/2"	822	.375"	.025"	100', 250'	.375 .399	.025 ± .003
D105-5/8"	5/8"	—	.438"	.025"	100', 250'	.462 .438	.025 ± .003
D105-3/4"	3/4"	823	.500"	.025"	100', 250'	.500 .524	.025 ± .003
D105-7/8"	7/8"	—	.562"	.030"	50', 100'	.592 .562	.030 ± .003
D105-1"	1"	824	.625"	.030"	50', 100'	.625 .655	.030 ± .005
D105-1 1/8"	1 1/8"	827	.750"	.035"	50', 100'	.750 .786	.035 ± .005
D105-1 1/4"	1 1/4"	860	.875"	.035"	50', 100'	.875 .911	.035 ± .005
D105-1 1/2"	1 1/2"	861	1.000"	.035"	50'	1.000 1.036	.035 ± .005
D105-1 3/4"	1 3/4"	—	1.125"	.040"	50'	1.125 1.161	.035 ± .005
D105-1 7/8"	1 7/8"	862	1.250"	.040"	50'	1.250 1.286	.040 ± .005
D105-1 3/2"	1 3/2"	—	1.375"	.040"	50'	1.375 1.411	.040 ± .005
D105-1 1/2"	1 1/2"	863	1.500"	.045"	50'	1.500 1.536	.045 ± .005
D105-1 3/4"	1 3/4"	863	1.750"	.055"	50'	1.812 1.750	.055 ± .008
D105-2"	2"	829	2.000"	.060"	50'	2.000 2.070	.060 ± .010
D105-2 1/4"	2 1/4"	864	2.250"	.065"	50'	2.250 2.330	.065 ± .010
D105-2 1/2"	2 1/2"	865	2.500"	.070"	50'	2.500 2.590	.070 ± .010

IN STOCK

PROPERTIES OF DAFLEX-105 TUBING

Recommended for Temperatures to 105°C (220°F)

• Low Temperature Flexibility to -30°C

• Dielectric Strength — .020" Wall 800 V/MIL

• Dielectric Constant 6.0

• Tensile Strength — Min. (PSI) 2700

• Ultimate Elongation 300%

• Oil Resistance Excellent

• Fungus Resistance Excellent

• Flammability Self-Extinguishing

• Corrosion and Abrasion Resistance Excellent

COLORS AVAILABLE FROM STOCK

Sizes 24 thru 2: Clear, Black, White, Yellow, Red, Green, Brown, Blue, Orange.

Sizes 3/8" thru 3/4": Clear, Black, Yellow, Red, Green, White

Sizes 7/8" thru 2 1/2": Clear, Black, White.

Additional Colors to Order.

ALL THE ABOVE TUBING CAN BE ORDERED CUT AND MARKED TO YOUR SPECIFICATIONS

DAFLEX AND DAFLON TUBING PLASTIC - FIBERGLASS - TEFLON TUBING COMPARATIVE PROPERTIES CHART

DAFLEX AND DAFLON TUBING	D105	D74	D130	D1200	DTT500 DTT550
Maximum Operating Temperature	105°C	80°C	130°C	1200°F	Continuous Service 250°C
Maximum Low Temperature Flexibility	-20°C	-94°C	-20°C	—	-90°C
Dielectric Strength Dry-V/MIL	1000 @ .015 Wall 900 @ .030 Wall	650 @ .015 Wall 300 @ .030 Wall	4000	Determined by Space Factor	1400 @ .010 Wall 850 @ .020 Wall
Dielectric Constant	6.0	4.5	7.0	—	2.2
Flammability	Self-Extinguishing	Self Extinguishing	Self Extinguishing	Will not burn	Non-flammable
Tensile Strength (PSI)	2700-3300	2200	1500-2000 (coating material only)	—	5000 - 7500
Ultimate Elongation	300 - 400%	375 - 450%	300 - 400%	—	300 - 500%
Minimum Volume Resistance Ohm-CM	10 ¹³	10 ⁹	10 ⁹	—	10 ¹⁷
Fungus Resistance	Excellent	Excellent	Good	Excellent	Completely Inert
Oil Resistance	Excellent	Excellent	Excellent	Excellent	Superior
Abrasion Resistance	Excellent	Fair	Excellent	—	Fair
Chemical Corrosion Resistance	Excellent	Good	Excellent	Excellent	Completely Inert
Applicable Specs	MIL-I-631D ULE-20344 Grade A & C Type F, Form U Class 1 & 2 Category 1 ASTM-D876 ASTM-D922 MIL-T-5438	MIL-I-7444B MIL-I-22076	MIL-I-3190B Class B, Grade B ASTM-D372 NEMA-VS-1 MIL-I-21557 MIL-T-5438 UL E-20344	NEMA VSI	MIL-T-22129C MIL-P-14078A AMS-3651B AMS-3653 AMS-3654 AMS-3655 MIL-C-17D UL E-20344
Gamma Radiation Dosage to 25% Degradation Ergs/Gram	10 ¹⁹	10 ⁹	10 ⁹	—	10 ⁷
Corona Resistance	Excellent	Good	Excellent	—	Good

DABURN

DABURN ELECTRONICS & CABLE CORP.

WIRE • CABLE • TUBING • MIL/COMM • SWITCHES • ELECTRONIC HARDWARE

DAFLON TEFLON® SPAGHETTI TUBING

Daflon 500 and 550 tubing is extruded from Dupont Tetrafluoroethylene resin and is unmatched by any other tubing for use in applications for hi frequencies and hi temperatures. Rated for continuous operation of 250°C it retains its toughness and flexibility thruout. Has high resistance to fatigue and stresses. Will not shrink back during soldering operation. Non-flammable, flexible, it permits miniaturization of design and compactness. Lowest coefficient of friction. Inert to all fungus growth. Conforms to MIL-I-22129C Spec. AMS 3651B, 3653B, 3654, 3655.

TABLE OF PROPERTIES

Test	ASTM Method	Result
Tensile Strength, 73°F.	D638-52T	1500-300 Lb./Sq. In.
Elongation, 73°F.	D638-52T	100-200%
Deformation Under Load—122°F.		
1200 Lb./Sq. In., 24 Hrs.	D621-51	4-8%
2000 Lb./Sq. In., 24 Hrs.	D621-51	25%
Hardness Durometer	D676-49T	D50-D65
Heat Distortion Temp., 6 Lb./Sq. In.	D648B-45T	250°C
Dielectric Strength, .080"	D149-44	400-500 V/MIL
Surface Arc-Resistance	D495-48T	Sec.
Volume Resistivity	D257-52T	10 ¹⁵ Ohm-CM
Surface Resistivity, 100% R.H.	D257-52T	3.6x10 ¹⁴ Megohms
Dielectric Constant, 60 to 10 ⁵ Cycles	D150-54T	2.00
Power Factor, 60 to 10 ⁵ Cycles	D150-54T	0.0003
Specific Gravity	D792-50	2.1-2.2

DAFLON THIN WALL TEFLON® TUBING (DTT-500)

MIL-I-22129C					
DAFLON No.	Size	Nom. I.D.	Nom. Wall Thickness	Specify Std. Spool or Coil	Put-Up
DTT500-32	32	.011"	.0085"	100', 500', 1000'	
DTT500-30	30	.012"	.009"	100', 500', 1000'	
DTT500-28	28	.015"	.009"	100', 500', 1000'	
DTT500-26	26	.018"	.010"	100', 500', 1000'	
DTT500-24	24	.022"	.010"	25', 50', 100', 500', 1000'	
DTT500-22	22	.027"	.010"	25', 50', 100', 500', 1000'	
DTT500-20	20	.034"	.012"	25', 50', 100', 500', 1000'	
DTT500-19	19	.038"	.012"	100', 500', 1000'	
DTT500-18	18	.042"	.012"	25', 50', 100', 500', 1000'	
DTT500-17	17	.047"	.012"	100', 500', 1000'	
DTT500-16	16	.053"	.012"	25', 50', 100', 500', 1000'	
DTT500-15	15	.059"	.012"	100', 500', 1000'	
DTT500-14	14	.066"	.012"	25', 50', 100', 500', 1000'	
DTT500-13	13	.076"	.012"	100', 500', 1000'	
DTT500-12	12	.085"	.012"	25', 50', 100', 500', 1000'	
DTT500-11	11	.095"	.012"	100', 500', 1000'	
DTT500-10	10	.106"	.012"	25', 50', 100', 500', 1000'	
DTT500-9	9	.118"	.015"	100', 500', 1000'	
DTT500-1/8	1/8	.125"	.015"	25', 50', 100', 500', 1000'	
DTT500-8	8	.133"	.015"	25', 50', 100', 500', 1000'	
DTT500-7	7	.148"	.015"	100', 500', 1000'	
DTT500-6	6	.166"	.015"	25', 50', 100', 500', 1000'	
DTT500-5	5	.186"	.015"	100', 500', 1000'	
DTT500-4	4	.208"	.015"	25', 50', 100', 500', 1000'	
DTT500-3	3	.234"	.015"	100', 500', 1000'	
DTT500-1/4	1/4	.250"	.015"	25', 50', 100', 500', 1000'	
DTT500-2	2	.263"	.015"	25', 50', 100', 500', 1000'	
DTT500-1	1	.294"	.015"	100', 500', 1000'	
DTT500-3/8	3/8	.312"	.015"	25', 50', 100', 500', 1000'	
DTT500-0	0	.330"	.015"	25', 50', 100', 500', 1000'	
DTT500-5/8	5/8	.390"	.020"	50', 100**	
DTT500-3/4	3/4	.453"	.020"	50', 100**	
DTT500-1/2	1/2	.515"	.025"	25', 50', 100**	
DTT500-3/8	3/8	.583"	.025"	25', 50', 100**	
DTT500-5/8	5/8	.640"	.030"	25', 50', 100**	
DTT500-3/4	3/4	.765"	.030"	25', 50', 100**	
DTT500-7/8	7/8	.895"	.030"	25', 50', 100**	
DTT500-1"	1"	.825"	.030"	25', 50', 100**	
DTT500-1 1/8"	1 1/8"	1.150"	.030"	25', 50', 100**	
DTT500-1 1/4"	1 1/4"	1.275"	.030"	25', 50', 100**	

*Random Lengths in Coils.

STOCK COLORS AVAILABLE:

Natural, Red, Black, Yellow, Blue, Brown, Green, Orange, Gray, Violet, White.

If No Color Is Specified, Natural Will Be Supplied

SMALL PIECE CUTTING AVAILABLE TO ORDER

STOCK COLORS: Natural, Red, Black, Blue, Brown, Green, Orange, Yellow, Gray, Violet, White.

Nos. DTT500-3/8 thru 1 1/4" available in Natural. Additional Colors, Sizes Made to Order.

Teflon Tubing can be ordered cut to your specifications.

Tracer Colors Available

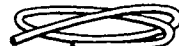

We Invite Your Inquiries For Your Special Requirements

WIRE — CABLE — TUBING DIVISION

PROPERTIES OF DAFLON 500 & 550 TEFLON TUBING

Continuous Service to 250°C

Low Temperature Flexibility -90°C

Color Stability

Dielectric Constant 2.0

Dielectric Strength 500 to 1000 V/MIL

Fungus, Oil, Chemical Corrosion Completely Inert

DAFLON STANDARD WALL TEFLON® TUBING

(DTT-550) MIL-I-22129C Spec.

FOR USE WHERE GREATER MECHANICAL STRENGTH IS INDICATED

DAFLON No.	Nom. Size	Nom. I.D.	Nom. Wall Thickness	Spool or Coil Std. Put-Up
DTT550-24	24	.022"	.012"	100'
DTT550-22	22	.027"	.012"	100'
DTT550-20	20	.034"	.016"	100'
DTT550-19	19	.038"	.016"	100'
DTT550-18	18	.042"	.016"	100'
DTT550-17	17	.047"	.016"	100'
DTT550-16	16	.053"	.016"	100'
DTT550-15	15	.059"	.016"	100'
DTT550-14	14	.066"	.016"	100'
DTT550-13	13	.076"	.016"	100'
DTT550-12	12	.085"	.016"	100'
DTT550-11	11	.095"	.016"	100'
DTT550-10	10	.106"	.016"	100'
DTT550-9	9	.118"	.020"	100**
DTT550-1/8	1/8	.125"	.020"	100'
DTT550-8	8	.133"	.020"	100**
DTT550-7	7	.148"	.020"	100**
DTT550-6	6	.166"	.020"	100**
DTT550-5	5	.186"	.020"	100**
DTT550-4	4	.208"	.020"	100**
DTT550-3	3	.234"	.020"	100**
DTT550 1/4	1/4	.250"	.020"	100'
DTT550-2	2	.263"	.020"	100**
DTT550-1	1	.294"	.020"	100**
DTT550-3/8	3/8	.312"	.020"	100'
DTT550-0	0	.330"	.020"	100**

STOCK COLORS: Natural

Available All Other Colors.

*Random Lengths in Coils.

Made from Hi Molecular Weight Virgin "TEFLON" TFE-Dupont.

DAFLEX VINYL COATED FIBERGLASS TUBING 130°C MEETS MIL-I-3190B SPECS (ASTM, NEMA GRADE B-B-1)

DAFLEX 130, Class B, Grade B-1 is recommended for continuous temperatures up to 130°C. Constructed to provide a tough, flexible, heat resistant tubing. Made from an inorganic fiberglass base sleeving with heat resistant coating, extremely flexible tough plastic insulation. Will not support combustion. Meets MIL-I-3190B, NEMA VSI ASTM D372. MIL-I-21557.



DAFLEX No.	Size	Old Daburn No.	Nom. I.D.	Specify Std. Put-Up Spool or Coil
D130-24	24	889	.022"	100', 1000'
D130-22	22	890	.027"	100', 1000'
D130-20	20	891	.034" 25',	100', 1000'
D130-19	19	—	.038"	100', 1000'
D130-18	18	893	.042" 25',	100', 1000'
D130-17	17	—	.047"	100', 1000'
D130-16	16	894	.053" 25',	100', 1000'
D130-15	15	—	.059"	100', 1000'
D130-14	14	895	.066" 25',	100', 500'
D130-13	13	—	.076"	100', 500'
D130-12	12	800	.085" 25',	100', 500'
D130-11	11	—	.095"	100', 500'
D130-10	10	807	.106" 25',	100', 500'
D130-9	9	—	.118"	100', 500'
D130-8	8	801	.133" 25',	100', 500'

DAFLEX No.	Size	Old Daburn No.	Nom. I.D.	Specify Std. Put-Up Spool or Coil
D130-7	7	—	.148"	100', 250'
D130-6	6	802	.166"	100', 250'
D130-5	5	—	.186"	100', 250'
D130-4	4	805	.208"	100', 250'
D130-3	3	—	.234"	100', 250'
D130-2	2	806	.263"	100', 250'
D130-1	1	—	.294"	100'
D130-0	0	803	.330"	100'
D130-3/8"	3/8"	804	.375"	100'
D130-1/2"	1/2"	—	.438"	100'
D130-5/8"	5/8"	899	.500"	100'
D130-3/4"	3/4"	896	.625"	100'
D130-7/8"	7/8"	—	.750"	100'
D130-1"	1"	—	.875"	100'
D130-1 1/8"	1 1/8"	—	1.018"	100'

DIMENSIONAL TOLERANCES OF VINYL COATED FIBERGLASS

24	.022	.020-.027
22	.027	.025-.032
20	.034	.032-.039
19	.038	.044-.036
18	.042	.040-.049
17	.047	.054-.045
16	.053	.051-.061
15	.059	.067-.057
14	.066	.064-.072
13	.076	.080-.072
12	.085	.081-.089
11	.095	.101-.091
10	.106	.102-.112
9	.118	.124-.114
8	.133	.129-.141
7	.148	.158-.144
6	.166	.162-.178
5	.186	.198-.182
4	.208	.204-.224
3	.234	.249-.229
2	.263	.258-.278
1	.294	.311-.289
0	.330	.347-.325
3/8	.375	.399-.375
1/2	.4375	.462-.438
5/8	.500	.500-.524
3/4	.625	.625-.655
7/8	.750	.786-.750
1"	.875	.911-.078
1"	1.000	1.036-1.000

PROPERTIES OF DAFLEX 130 VINYL COATED FIBERGLASS
 Recommended for Temperatures to 130°C
 Ins. Resistance
 Max. Low Temperature Flexibility
 -20°C
 Over 1,000,000 Megs.
 Dielectric Strength
 4000 V/MIL
 Dielectric Constant
 7.0
 Oil Resistance — Excellent
 Tensile Strength
 Min. (Psi)
 1500
 Ultimate Elongation
 350%
 Non-Flammable
 Will not support Combustion,
 Abrasion, Oil, Chemical
 Corrosion Resistance
 Excellent
 Fungus Resistance
 Good
 Gamma Radiation
 Dosage to 25%
 10¹⁷
 Degradation ERGS/GRAM
 Color Stability even on
 Prolonged Baking at
 Elevated Temperatures

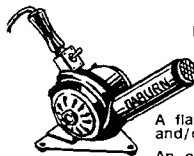

Hot Air Gun FOR DAFLEX SHRINKABLE TUBING
 DABURN No. N61—For SH265, SH275, SH290 & SH160 Series
 N62—For SH400 & SH621 Series
 A flameless heat source; light in weight; portable and/or permanent mounting.
 An oven, hot liquids, radiant heat, open flame or soldering iron may also be used for all types of shrinkable tubing with excellent results.

All the Above Tubing Can Be Ordered Cut to Your Specifications
 Small Pieces Cut to Order
 Your Inquiries Invited
 COLORS AVAILABLE FROM STOCK
 #24 thru #2:
 Black, Red, Green, Yellow, Brown, Blue
 3/8" thru 1": Black
 Additional Colors to Order.



DABURN ELECTRONICS & CABLE CORP.

WIRE • CABLE • TUBING • MIL/COMM • SWITCHES • ELECTRONIC HARDWARE

LOW TEMPERATURE TUBING

DAFLEX 74 EXTRUDED PLASTIC TUBING
LOW TEMPERATURE PER MIL-SPEC MIL-I-7444B MIL-I-22076 TO -34°C



Low temperature applications at sub-zero. Meets Mil spec. Fungus resistant. 750 V/Mil dielectric strength. Tensile strength 2200 psi. Elongation — 360%

DAFLEX No.	Size	Nom. I.D.	Nom. Wall
D74-24	24	.022"	.012"
D74-22	22	.027"	.012"
D74-20	20	.034"	.016"
D74-19	19	.038"	.016"
D74-18	18	.042"	.016"
D74-17	17	.047"	.016"
D74-16	16	.053"	.016"
D74-15	15	.059"	.016"
D74-14	14	.066"	.016"
D74-13	13	.076"	.016"
D74-12	12	.085"	.016"
D74-11	11	.095"	.016"
D74-10	10	.106"	.016"
D74-9	9	.118"	.020"
D74-8	8	.133"	.020"
D74-7	7	.148"	.020"
D74-6	6	.166"	.020"
D74-5	5	.186"	.020"
D74-4	4	.208"	.020"
D74-3	3	.234"	.020"
D74-2	2	.263"	.020"
D74-1	1	.294"	.020"
D74-0	0	.330"	.020"
D74-3/16	3/16	.312"	.025"
D74-1/8	1/8	.375"	.025"
D74-3/16	3/16	.438"	.025"
D74-1/4	1/4	.500"	.025"
D74-5/16	5/16	.562"	.030"
D74-3/8	3/8	.625"	.030"
D74-1/2	1/2	.750"	.035"
D74-7/8	7/8	.875"	.035"
D74-1"	1"	1.000"	.035"
D74-1 1/4"	1 1/4"	1.250"	.040"
D74-1 1/2"	1 1/2"	1.375"	.040"
D74-1 3/4"	1 3/4"	1.500"	.045"
D74-1 7/8"	1 7/8"	1.750"	.055"
D74-2"	2"	2.000"	.060"
D74-2 1/4"	2 1/4"	2.250"	.065"
D74-2 1/2"	2 1/2"	2.500"	.070"

STANDARD COLOR: CLEAR (NATURAL) ADDITIONAL COLORS AVAILABLE TO ORDER. STD. PUT-UP: 100 FT., 500 FT., 1000 FT.

FIBERGLASS SLEEVING

DAFLEX 1200—FOR HIGH TEMPERATURE APPLICATIONS TO 1200°F FLEXIBLE FIBERGLASS SLEEVING



Extremely flexible class H, it is non-flammable and treated for removal of all organic matter. Glass braid is fray resistant. Will provide maximum mechanical strength. Tightly braided. Applicable specs—Nema VSI. Dielectric strength determined by space factor.

DAFLEX No.	Size	Nom. I.D.
D1200-24	24	.022"
D1200-22	22	.027"
D1200-20	20	.034"
D1200-19	19	.038"
D1200-18	18	.042"
D1200-17	17	.047"
D1200-16	16	.053"
D1200-15	15	.059"
D1200-14	14	.066"
D1200-13	13	.076"
D1200-12	12	.085"
D1200-11	11	.095"
D1200-10	10	.106"
D1200-9	9	.118"
D1200-8	8	.133"
D1200-7	7	.148"
D1200-6	6	.166"
D1200-5	5	.186"
D1200-4	4	.208"
D1200-3	3	.234"
D1200-2	2	.263"
D1200-1	1	.294"
D1200-0	0	.330"
D1200-3/8"	3/8"	.387"
D1200-1/2"	1/2"	.450"
D1200-5/8"	5/8"	.512"
D1200-3/4"	3/4"	.640"
D1200-7/8"	7/8"	.768"
D1200-1"	1"	.893"
D1200-1 1/8"	1 1/8"	1.018"

STANDARD COLOR: NATURAL. ADDITIONAL COLORS AVAILABLE TO ORDER. STD. PUT-UP: 100 FT., 500 FT., 1000 FT.

ALL THE ABOVE CAN BE CUT AND MARKED TO YOUR SPECIFICATIONS.

DAFLEX AND DAFLOX COMPARATIVE PROPERTIES CHART SHRINKABLE TUBING

DAFLEX AND DAFLOX HEAT SHRINKABLE TUBING	Shrinkable Irradiated Polyolefin SH-275	Shrinkable Semi-Rigid Polyolefin SH-290	Shrinkable Vinyl (PVC) In Colors SH-265	Shrinkable Teflon* FEP SH-400	Shrinkable Teflon* TFE SH-621	Shrinkable Neoprene* SH-160
Continuous Operating Temperature	135°C 275°F	135°C 275°F	105°C 220°F	200°C 400°F	250°C 480°F	212°F
Shrinkage Temperature	120°C 250°F	120°C 250°F	95°C 200°F	300°F	327°C 621°F	160°F
Shrinkage Ratio Minimum	2:1 (50%)	2:1 (50%)	2:1 (50%)	1 1/4:1	1 1/2:1	3:1 (66 2/3%)
Longitudinal Change	5%	5%	10%	10 - 20%	10 - 20%	50%
Tensile Strength, PSI Minimum	2400	2600	2000	3000	3000	1500
Ultimate Elongation %	400	400	200	20	200	400
Low Temperature Flexibility	-55°C -67°F	-55°C -67°F	-10°C +14°F	-67°C -85°F	-67°C -85°F	-55°C -67°F
Specific Gravity (ASTM D792)	1.30 Color Tubing 1.0 Clear Tubing	1.26 Color 1.0 Clear	1.40	2.16	2.20	1.40
V/MIL. Minimum Dielectric Strength (ASTM D149)	500	500	700	500	500	400
Water Absorption Maximum (MIL-I-23053)	.1%	.1%	1%	.01%	.01%	1.0%
Fungus Resistance (MIL-I-7444)	Excellent	Excellent	Excellent	Excellent	Excellent	Good
Corrosion (MIL-I-23053)	Non-corrosive	Non-corrosive	2.0% Max. Per MIL-I-631	Non-corrosive	Non-corrosive	Good
Flammability (MIL-I-23053)	Self-Ext.†	Self-Ext.†	Self-Ext.	Non-flammable	Non-flammable	Self-Ext.
Resistance to Soldering Iron	Good	Good	Poor	Excellent	Excellent	Poor
Applicable Specs	MIL-I-23053A MIL-I-7444B ASTM-D-792 ASTM-D-149 ASTM-D-638 ASTM-D-150 ASTM-14-53T ASTM-150-54T MIL. STD. 104 L-P 406 UL E-20344	MIL-I-2353A MIL-I-7444B ASTM-D-792 ASTM-D-149 ASTM-D-638 ASTM-D-150 MIL. STD. 104 UL E-20344	MIL-I-2353A MIL-I-631 ASTM-D-792 ASTM-D-149 ASTM-D-638 ASTM-D-150 MIL. STD. 104 UL E-20344	SH-400	MIL-I-20353A MIL-I-22129C MIL-I-7444B ASTM-D-638 ASTM-D-149 ASTM-D-792 ASTM-D-150 MIL. Std. 104 L-P 406	MIL-I-23053B
Temperature Limits	-67 to +275°F	-67 to +275°F	-25 to +221°F	-275 to +400°F	-275 to +500°F	-67 to 212°F

* Dupont. † Clear tubing is not flame retardant.

DABURN

DABURN ELECTRONICS & CABLE CORP.

96 PRINCE ST., N. Y., N. Y. 10012 • 212 226-4079 — 5833

WIRE • CABLE • TUBING • MIL/COMM • SWITCHES • ELECTRONIC HARDWARE

HEAT SHRINKABLE TUBING

SHRINKABLE IRRADIATED POLYOLEFIN TUBING

This series is designed for maximum mechanical strength at stress or points of connection. It is strong and abrasion resistant and is supplied in expanded sizes. It insulates, jackets, splices, encapsulates, weatherproofs components, connectors, cables and irregular shaped objects. When exposed to heat (235°F) the tubing shrinks 50% in diameter, 5% longitudinal contraction. Controlled shrinkage to exact requirement takes place. Meets or exceeds MIL-I-23053A Class 1 and 2. Available with UL approval. AMS 3636, 3637.



CAT. NOS. INDICATE
EXPANDED SIZE
Shrinkage Ratio:
2:1 (50%)

DAFLEX SH-275 All Purpose	DAFLEX SH-290 Semi-Rigid	Equiv. I.D. AWG	Before Shrinkage As Supplied Expand. I.D.	Recover- ed I.D.	Recovered Nom. Wall†	Standard Package
SH-275-1/4"	SH-290-1/4"	22-20	.063"	.031"	.016"	100', 250'
SH-275-3/8"	SH-290-3/8"	18-16	.093"	.046"	.020"	100', 250'
SH-275-1/2"	SH-290-1/2"	14	.125"	.062"	.020"	100', 250'
SH-275-3/4"	SH-290-3/4"	12-10	.187"	.093"	.020"	100', 250'
SH-275-1"	SH-290-1"	8	.250"	.125"	.025"	100', 250'
SH-275-1 1/4"	SH-290-1 1/4"	6	.312"	.156"	.025"	100', 250'
SH-275-1 1/2"	SH-290-1 1/2"	4	.375"	.187"	.025"	100', 250'
SH-275-2"	SH-290-2"	2	.500"	.250"	.025"	100'
SH-275-3/4"	SH-290-3/4"	3/8	.750"	.375"	.030"	100'
SH-275-1"	SH-290-1"	1/2	1.000"	.500"	.035"	100'

STOCK COLOR: Black, White, Red, Clear. Although processed by hi-energy radiation the Daflex SH-275 and SH-290 shrinkable tubings do not at any time become radioactive or possess any residual radioactivity. † Wall thickness will be less if recovery is restricted.

SPECIFICATIONS

All Tests Made on Tubing in Recovered Dimension

Continuous Operating Temperature	135°C
Longitudinal Change	5% Max.
Tensile Strength	1500 PSI Min.
Ultimate Elongation	200% Min.
Special Gravity	1.29 Max.
Low Temperature Flexibility (-54°C)	No Cracking
Shrinkage Ratio	2:1 (50%)
Dielectric Strength	500 V/MIL Min.
Dielectric Constant	2.87 Max.
Corrosive Resistance	Non-Corrosive
Resistance to Soldering Iron	Excellent
Fuel, Oil, Solvent, Acid, Alkali, Hydraulic Fluid Resistance	Excellent

DABURN SHRINKABLE POLYVINYLCHLORIDE ALL PURPOSE
Shrinkage Ratio: 2:1 (50%)

Flexible, shrinks 50% on heat application, less than 10% longitudinal contraction. Suitable for insulating components and cables in varying shapes and diameters. Has a higher resistance to oils than low density polyethylene. Conforms to MIL-I-631D, Type F, Form V, Grade A and C, Class 1 and 2, Cat. 1. Controlled shrinkage on application of heat to predetermined size takes place at temperatures below 200°F (one minute or less). Meets or exceeds MIL-I-23053A, Grade 5.



CAT. NOS. INDICATE
EXPANDED SIZE

DAFLEX SH-265	Equiv. I.D. AWG	Before Shrinkage As Supplied Expanded I.D.	Max. Recovered I.D.	Recovered Nom. Wall†	Standard Package
SH-265-1/4"	22-20	.063"	.031"	.020"	100', 250'
SH-265-3/8"	18-16	.093"	.046"	.025"	100', 250'
SH-265-1/2"	14	.125"	.062"	.025"	100', 250'
SH-265-3/4"	12-10	.187"	.093"	.025"	100', 250'
SH-265-1"	8	.250"	.125"	.025"	100', 250'
SH-265-1 1/4"	6	.312"	.156"	.025"	100', 250'
SH-265-1 1/2"	4	.375"	.187"	.025"	100', 250'
SH-265-2"	2	.500"	.250"	.025"	25', 100'
SH-265-3/4"	3/8	.750"	.375"	.025"	25', 100'
SH-265-1"	1/2	1.000"	.500"	.030"	25', 100'
SH-265-1 1/2"	3/8	1.500"	.750"	.035"	25', 100'
SH-265-2"	1/2	2.000"	1.000"	.040"	25', 100'

COLORS: Black, White, Clear, Red.

PACK ASSORTMENTS

DAFLEX Cat. No.	Lengths Per Pack	Tubing Size
SH-275-PA1	30	1/4" thru 3/8"
SH-275-PA2	16	1/2" thru 3/4"
SH-275-PA3	10	1"

COLORS: Black, White, Clear, Red. Each pack contains an assortment of 6" lengths in mixed sizes and colors (specify).

HEAT SHRINKABLE TEFLON[†] TUBING

DAFLON SH-400 (FEP)

Made with Modified TEFLON* FEP will shrink over inserted objects upon exposure to moderate heat. Heretofore, many joints, parts, components, devices could not be protected because of hi temperature required for shrinkage. FEP TEFLON*, which has a continuous service temperature of 400°F., will shrink at 300°F. Supplied in natural color. Complete shrinkage at 350°F. Now, many heat sensitive products can use the permanent protection of TEFLON.* Will not burn or support flame, long lengths available. Extruded.

DABURN No.	Size	I.D.	Min. Exp. I.D.	Max. I.D.	Recovered Wall Thickness
SH-400-24	24	.023"	.031"	.027"	.008"
SH-400-22	22	.028"	.036"	.032"	.008"
SH-400-20	20	.034"	.045"	.039"	.008"
SH-400-18	18	.042"	.060"	.049"	.008"
SH-400-16	16	.053"	.075"	.061"	.009"
SH-400-14	14	.066"	.092"	.072"	.009"
SH-400-12	12	.085"	.115"	.089"	.009"
SH-400-10	10	.108"	.141"	.114"	.010"
SH-400-9	9	.118"	.158"	.124"	.010"
SH-400-8	8	.136"	.180"	.143"	.010"
SH-400-7	7	.148"	.197"	.158"	.011"
SH-400-6	6	.170"	.225"	.180"	.011"
SH-400-5	5	.186"	.248"	.198"	.011"
SH-400-4	4	.214"	.290"	.226"	.011"
SH-400-3	3	.234"	.310"	.249"	.011"
SH-400-2	2	.268"	.365"	.280"	.012"
SH-400-1	1	.294"	.400"	.311"	.012"
SH-400-0	0	.366"	.440"	.349"	.012"
SH-400-3/8	3/8"	.375"	.500"	.383"	.015"
SH-400-1/2	1/2"	.437"	.580"	.448"	.020"
SH-400-5/8	5/8"	.500"	.666"	.510"	.020"
SH-400-3/4	3/4"	.625"	.830"	.637"	.025"
SH-400-7/8	7/8"	.750"	1.000"	.764"	.030"
SH-400-1"	1"	.875"	1.170"	.891"	.035"
SH-400-1 1/4"	1 1/4"	1.000"	1.330"	1.020"	.035"

STANDARD PACKAGE: 100 Ft. † DUPONT

Daburn No. HG1 — Heat Gun for SH-265, SH-275, SH-290, SH-160 Series.

DAFLON SHRINK SERIES SH-621

TFE TUBING MIL-I-23053A CLASS 6

Made of modified TEFLON[†] polytetrafluoroethylene will shrink when heated to 621°F. Suitable where hi temp protection is required. Extruded. Will not support combustion, dielectric strength (20 Mil Wall) 850 V/M, low temp. brittle point -66°F, superior chemical resistance.

DAFLON No.	Nominal Tubing Size	Minimum Expanded ID	Recovered Dimensions Maximum ID (1)	Wall Thickness (2)
SH-621-26	26	.046"	.022"	.009"
SH-621-24	24*	.050"	.027"	.010"
SH-621-22	22*	.055"	.032"	.010"
SH-621-20	20*	.060"	.039"	.012"
SH-621-19	19	.065"	.043"	.012"
SH-621-18	18*	.076"	.049"	.012"
SH-621-17	17	.085"	.054"	.012"
SH-621-16	16*	.093"	.061"	.012"
SH-621-15	15	.110"	.067"	.012"
SH-621-14	14*	.120"	.072"	.012"
SH-621-13	13	.140"	.080"	.012"
SH-621-12	12*	.150"	.089"	.012"
SH-621-11	11	.170"	.101"	.012"
SH-621-10	10*	.191"	.112"	.012"
SH-621-9	9	.205"	.124"	.015"
SH-621-8	8*	.240"	.141"	.015"
SH-621-7	7	.270"	.158"	.015"
SH-621-6	6*	.302"	.178"	.015"
SH-621-5	5	.320"	.198"	.015"
SH-621-4	4*	.348"	.224"	.015"
SH-621-3	3	.360"	.249"	.015"
SH-621-2	2*	.375"	.278"	.015"
SH-621-1	1	.385"	.311"	.015"
SH-621-0	0*	.400"	.347"	.015"
SH-621-3/8	3/8"*	.560"	.399"	.020"
SH-621-1/2	1/2"*	.655"	.462"	.020"
SH-621-1/2	1/2"*	.750"	.524"	.020"

STANDARD PACKAGE: 100 Feet.

STANDARD PUT-UP: 36" Straight Lengths — One Foot Minimums.

WALL TOLERANCES: 26 thru 22 ± .002; 20 thru 10 ± .003; 9 thru 0 ± .004.

(*) Stock Sizes.

Daburn No. HG2 — Heat Gun for SH-400 and SH-621 Series

DABURN

DABURN ELECTRONICS & CABLE CORP.
WIRE • CABLE • TUBING • MIL/COMM • SWITCHES • ELECTRONIC HARDWARE

TUBULAR BRAID PER MIL SPEC QQ-B-575

Tinned copper shielded braid mfd completely round per Mil Spec QQ-B-575. Maintains its round configuration. Shielding coverage is 95% or more. Used in military applications where maximum shielding is required against electrostatic interference. Useful against mechanical abrasion and stresses for cables — as grounding cable.

DABURN No.	Nom. Inside Diam. When Rounded	Construction Total No. of Wires	Carriers	AWG of Indiv. Wires	Approx. AWG Equiv.	Nom. Circular Mills	*Current Carrying Cap.
2350-1/32	1/32"	24	24	#36	#22	640	7.0 amps.
2350-1/16	1/16"	48	24	#36	#19	1,290	11.0 amps.
2350-5/64	5/64"	72	24	#36	#17	1,900	18.0 amps.
2350-7/64	7/64"	96	24	#36	#16	2,500	22.0 amps.
2350-1/8	1/8"	120	24	#36	#15	3,260	28.0 amps.
2350-5/32	5/32"	240	24	#36	#12	6,200	39.0 amps.
2350-11/64	11/64"	168	24	#36	#14	4,500	32.0 amps.
2350-3/16	3/16"	192	24	#36	#13	5,100	35.0 amps.
2350-13/64	13/64"	312	24	#36	#11	8,200	46.0 amps.
2350-1/4	1/4"	384	24	#36	#10	10,400	53.0 amps.
2350-9/32	9/32"	120	24	#30	#9	12,060	60.0 amps.
2350-3/8	3/8"	384	48	#36	#10	10,400	53.0 amps.
2350-7/16	7/16"	240	24	#30	#6	24,120	90.0 amps.
2350-1/2	1/2"	528	48	#36	#9	13,200	70.0 amps.
2350-9/16	9/16"	528	48	#36	#9	13,200	70.0 amps.
2351-9/16	9/16"	480	48	#30	#3	48,240	145.0 amps.
2350-11/16	11/16"	720	48	#36	#7	19,000	82.0 amps.
2350-25/32	25/32"	864	48	#36	#7	21,750	85.0 amps.
2350-13/16	13/16"	864	48	#36	#7	21,750	85.0 amps.
2350-7/8	7/8"	336	48	#30	#5	33,700	100.0 amps.
2350-1	1"	384	48	#30	#4	38,600	120.0 amps.
2350-1 1/8	1 1/8"	432	48	#30	#4	43,330	130.0 amps.
2350-1 1/4	1 1/4"	480	48	#30	#3	48,150	145.0 amps.
2350-1 3/8	1 3/8"	528	48	#30	#3	53,000	150.0 amps.
2350-1 1/2	1 1/2"	576	48	#30	#2	57,775	165.0 amps.

STANDARD SPOOL PUT-UP: 50 Ft., 100 Ft., 250 Ft.

Larger Spools Available — Advise.

*Values based on copper in free air at 65°F. Additional constructions and variations made to order. Also available in silver plated copper, bare copper and stainless steel.

TINNED COPPER SHIELDING — FLAT BRAID



Soft annealed tinned copper woven braid, rolled flat at time of manufacture. It is extremely flexible. Used as battery grounding, bonding strap for aircraft, vehicles, marine equipment. Eliminates ignition interference and moving parts. Slides over wire and cables.

DABURN No.	Size and No. of Wires	I.D. Flat	O.D. Flat	Approx. AWG Equiv.	Nom. Circular Mills	*Current Carrying Cap.
2355-1/32	12 x 2 x 36	1/32"	3/64"	24	400	6.0
2355-1/16	12 x 2 x 36	3/64"	1/16"	22	600	7.0
2355-3/64	16 x 3 x 36	1/16"	3/64"	20	1,200	11.0
2355-1/8	24 x 5 x 36	1/8"	3/32"	18	1,800	16.0
2355-3/16	24 x 5 x 36	3/16"	1/32"	15	3,000	25.0
2355-1/4	24 x 7 x 36	1/4"	3/32"	14	4,200	32.0
2355-3/8	48 x 4 x 36	3/8"	1/32"	12	7,200	46.0
2355-1/2	48 x 7 x 36	1/2"	1/32"	10	9,600	53.0
2355-3/8	48 x 8 x 36	5/8"	2/32"	10	9,600	53.0
2355-3/4	48 x 11 x 36	3/4"	13/64"	7	20,800	85.0
2355-7/8	48 x 19 x 36	7/8"	21/32"	7	20,800	85.0
2355-1	48 x 19 x 36	1"	1 1/64"	7	20,800	85.0
2355-1 1/8	48 x 19 x 36	1 3/8"	1 1/16"	7	33,700	85.0
2355-1 1/2	48 x 19 x 36	1 1/2"	1 1/8"	3	53,064	150.0
2355-1 3/4	48 x 27 x 30	1 3/4"	1 7/8"	00	125,425	280.0
2355-2	48 x 32 x 30	2"	2 1/4"	000	154,368	310.0
2355-2 1/4	48 x 35 x 30	2 1/4"	2 1/2"	000	168,840	320.0
2355-2 1/2	48 x 45 x 30	2 1/2"	2 3/4"	000	192,000	340.0
2355-3	48 x 64 x 30	3"	3 1/4"	0000	225,000	390.0

STANDARD SPOOL PUT-UP: 50 Ft., 100 Ft., 500 Ft., 1000 Ft.

**ADDITIONAL CONSTRUCTION AND VARIATIONS
MADE TO ORDER.**

HEAT SHRINKABLE NEOPRENE* TUBING

This unique tubing meets or exceeds MIL-T-23053B specs. Shrinks down to under 33% of its supplied inside diameter. Upon exposure to heat of 160°F — will remain elastomeric — with no cracks (longitudinal shrinkage 50%). Will protect components, solder joints, terminals, fittings, harnessing and jacketing of wires, medical equipment, etc. Resistant to abrasion, flame, chemicals. Suitable electrical and mechanical properties. Has continuous range of -67° to +212°F. Tubing is self extinguishing when flame is removed. Variety of intermediate recovered sizes. Available expanded sizes: 1/2", 1", 1 1/2", 2".



COLOR: Black. Tubing must be stored below 100°F.

PROPERTIES:

ELECTRICAL

Dielectric Strength: V/M, 400 Min.
Volume Resistivity: OHM/CM, 1 x 10¹⁴ Min.

CHEMICAL

Solvent Resistance: Excellent
Corrosion: Good.
Water Absorption: 1.0 Max.
Flammability: Self-Extinguishing in 15 Seconds

PHYSICAL

Elongation: 400% Min.
Temperature Range: -67° to +212°F
Tensile Strength: 1500 PSI Min.
Dielectric Strength: 360 V/M Min.
Heat Resistance: 212°F for 96 Hours — No cracking.
Specific Gravity: 1.40 Max.

HARDNESS

Shore A Durometer: 85 ±5.

HEAT SHOCK

302°F for 4 Hours — No cracking, flowing or dripping.

SH160 HEAT SHRINKABLE NEOPRENE* TUBING

COLOR: BLACK

DABURN No.	Size	Before Shrinking As Supplied Expanded I.D.	RECOVERED DIMENSIONS (After Heating)	
			I.D. Maximum	Wall Thickness
SH160-1/2"	1/2"	.500"	.165"	.035" ±.010"
SH160-1"	1"	1.00"	.330"	.048" ±.010"
SH160-1 1/2"	1 1/2"	1.500"	.495"	.057" ±.010"
SH160-2"	2"	2.00"	.660"	.070" ±.010"

STD. PKGE.: 100 ft. (random lengths — 10 ft. minimum). * Neoprene—Dupont.

DABURN

DABURN ELECTRONICS & CABLE CORP.

WIRE • CABLE • TUBING • MIL/COMM • SWITCHES • ELECTRONIC HARDWARE

TINNED COPPER WIRE

Pure Electrolytic, Copper, annealed, tinned for quick soldering—Solid Soft Drawn MIL—W—3861 Type S, ASTM—B—33 Specifications, QQ—W—343 Type S

DABURN No.	Size AWG	Area Circ. Mills	O.D.	DABURN No.	Size AWG	Area Circ. Mills	O.D.
2360/4	4	41,704	.204"	2360/18	18	1,624	.040"
2360/6	6	26,250	.162"	2360/20	20	1,022	.033"
2360/8	8	16,510	.129"	2360/22	22	624.4	.025"
2360/10	10	10,380	.103"	2360/24	24	404.0	.020"
2360/12	12	6,530	.082"	2360/26	26	254.1	.016"
2360/14	14	4,107	.065"	2360/28	28	159.8	.013"
2360/16	16	2,583	.051"	2360/30	30	100.5	.010"

STANDARD PUT-UP: 100 Ft., 1000 Ft. See Magnet Wire Section For Additional Sizes

BARE COPPER WIRE (Soft Drawn)

QQ—W—341A SPECIFICATIONS SOLID

DABURN No.	Size AWG	Area Circular Mills	O.D.
2375/8	8	16,510	.1285"
2375/10	10	10,380	.102"
2375/12	12	6,530	.081"
2375/14	14	4,107	.064"
2375/16	16	2,583	.051"

STANDARD PUT-UP: 100 Ft., 1000 Ft.

SOLID FORMVAR COPPER WIRE

DABURN No.	Size AWG	O.D.
2380/10	10	.103"
2380/12	12	.083"
2380/14	14	.066"

STANDARD PUT-UP: 100 Ft., 150 Ft., 200 Ft., 1000 Ft.

DABURN COPPERWELD WIRE

Bare Copper Welded to Core. 40% Conductivity. Hard Drawn; will not stretch. Used for hi tensile strength.

DABURN No.	Size AWG	Nom. O.D.	DABURN No.	Size AWG	Nom. O.D.
2386/20	20	.033"	2386/12	12	.080"
2386/18	18	.040"	2386/10	10	.102"
2386/16	16	.050"	2386/8	8	.129"
2386/14	14	.064"	2386/6	6	.162"

STANDARD PUT-UP: 500 Ft., 1000 Ft.

DABURN MAGNET WIRE — Per MIL-W-583B Spec.

DESCRIPTION: Plain Enamel—Single conductor round bare copper covered with a continuous insulating film of enamel. 105°C, Type T per MIL-W-583B.

DESCRIPTION: Heavy Formvar—Single conductor round baked copper, baked film insulation from varnish base on a vinyl acetal resin. 105°C, Type T2 per MIL-W-583B.

DESCRIPTION: Single conductor soft drawn annealed copper tinned per Spec MIL-W-3861 Type S, QQ-W-343 Type S, ASTM-B-33.

PLAIN ENAMEL (PE)

DABURN No.	Size	Nom. O.D.
DPE-10	10	.1037"
DPE-12	12	.0825"
DPE-14	14	.0657"
DPE-16	16	.0522"
DPE-18	18	.0416"
DPE-20	20	.0332"
DPE-22	22	.0266"
DPE-24	24	.0212"
DPE-26	26	.0169"
DPE-28	28	.0135"
DPE-30	30	.0108"
DPE-32	32	.0087"
DPE-34	34	.0069"
DPE-36	36	.0055"
DPE-38	38	.0044"
DPE-40	40	.0034"
DPE-42	42	.0028"
DPE-44	44	.0023"

HEAVY FORMVAR (HF)

DABURN No.	Size	Nom. O.D.
DHF-10	10	.1056"
DHF-12	12	.0842"
DHF-14	14	.0673"
DHF-16	16	.0539"
DHF-18	18	.0432"
DHF-20	20	.0346"
DHF-22	22	.0277"
DHF-24	24	.0224"
DHF-26	26	.0180"
DHF-28	28	.0144"
DHF-30	30	.0116"
DHF-32	32	.0095"
DHF-34	34	.0075"
DHF-36	36	.0060"
DHF-38	38	.0049"
DHF-40	40	.0038"
DHF-42	42	.0032"
DHF-44	44	.0026"

TINNED COPPER (TC)

DABURN No.	Size	Nom. O.D.
DTC-10	10	.103"
DTC-12	12	.082"
DTC-14	14	.065"
DTC-16	16	.051"
DTC-18	18	.040"
DTC-20	20	.033"
DTC-22	22	.025"
DTC-24	24	.020"
DTC-26	26	.016"
DTC-28	28	.013"
DTC-30	30	.010"
DTC-32	32	.008"
DTC-34	34	.006"
DTC-36	36	.005"
DTC-38	38	.004"
DTC-40	40	.003"

STANDARD PUT-UP: ¼ lb., ½ lb., 1 lb., 5 lbs., 10 lbs. SIZES: 34, 36. Largest Put-up 5 lbs

SIZES: 38, 40, 42, 44. Largest Put-up 1 lb.

BUS BAR WIRE (Hard Drawn)

QQ—W—343 Type S

For hooking up all types of transmitters, especially ultra short wave equipment. All bus wire is made of hard drawn copper, tinned, straightened, and cut in 2 ft. lengths.

MIL—W—3861 Types S, ASTM—B—33, ASTM—B—246—51 Specifications

DABURN No.	Nom. Circ. Mil Area	Size	Nom. O.D.
2362/10	10,380	10	.103"
2362/12	6,530	12	.082"
2362/14	4,107	14	.065"
2362/16	2,583	16	.051"
2362/18	1,642	18	.040"
2362/20	1,022	20	.033"
2362/22	624	22	.025"

STANDARD PUT-UP: 100 Per Package in two foot lengths.

SILICON BRONZE AERIAL WIRE

Especially designed for ships, airports, short wave and transmitting antennas where high tensile strength and resistance to the elements are important.

DABURN No.	Size AWG	Strand	Breaking Strength	O.D.
2364/4	4	7/12	3670 lbs.	.240"
2364/6	6	7/14	2140 lbs.	.190"
2364/8	8	7/16	1600 lbs.	.150"
2364/10	10	7/18	1000 lbs.	.122"
2364/12	12	7/20	650 lbs.	.100"
2364/14	14	7/22	420 lbs.	.075"

STANDARD PUT-UP: 100 Ft., 500 Ft., 1000 Ft.

2364/10 and 2364/6 meets MIL-W-13074, 2364/12 meets MIL-W-13276 Specs.

COPPERWELD ANTENNA WIRE

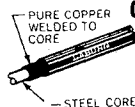

Used where high tensile strength is required as for short wave and transmitting aeriels. Has low R.F. resistance and is ideal for transmitting doublet and directional antennas. Will maintain frequency characteristics because of its stretchless qualities. 40% conductivity.

DABURN No.	Size AWG	Tensile Strength	O.D.
2382/10	10	1130 lbs.	.103"
2382/12	12	720 lbs.	.082"
2382/14	14	400 lbs.	.065"

STANDARD PUT-UP: 100 Ft., 250 Ft., 500 Ft., 1000 Ft., 2500 Ft.

STRANDED BARE COPPER WIRE

DABURN No.	Size AWG	Strand	O.D.
2366/12	12	7/20	.100"
2366/14	14	7/22	.075"
2366/16	16	7/24	.060"
2366/18	18	7/26	.050"
2366/19	19	7/27	.041"

PUT-UP: 100 Ft., 1000 Ft. Spool.



DABURN ELECTRONICS & CABLE CORP.
WIRE • CABLE • TUBING • MIL/COMM • SWITCHES • ELECTRONIC HARDWARE

PER MIL-W-76B PLASTIC HOOK-UP WIRE

300 VOLTS — TYPE LW (Light Wall)
SPEC. MIL-W-76B

CONDUCTOR COLOR CODE PER MIL-W-76B SPEC.

0-Black 1-Brown 2-Red 3-Orange 4-Yellow 5-Green 6-Blue 7-Violet 8-Gray 9-White

DESCRIPTION: One conductor stranded tinned copper with light wall of primary thermoplastic insulation. Nom. Wall .010".

TEMPERATURE RATING: —40°C to +80°C.

LW — UNCOVERED

DABURN Cat. No.	Size AWG	MIL-W-76B Type Designation	Conductor Strand	Nom. O.D.
2585/30	30	LW-C 30(7)U	7/38	.033"
2585/28	28	LW-C 28(7)U	7/36	.035"
2585/26	26	LW-C 26(7)U	7/34	.040"
2585/24	24	LW-C 24(7)U	7/32	.044"
2585/22	22	LW-C 22(7)U	7/30	.050"
2585/20	20	LW-C 20(7)U	7/28	.060"

1000 VOLTS (Medium Wall)
SPEC. MIL-W-76B TYPE MW
(FUNGUS PROOF)

1000 VOLT

TEMP. RATING: —40°C to +80°C.

STRANDED

DABURN Cat. No.	Spool	Size AWG	MIL-W-76B Type Designation	Conductor Strand	Nom. Wall	Nom. O.D.
2555/24	1000'	24	MW-C 24(7)U	7/32	.015"	.059"
*2555/22	1000'	22	MW-C 22(7)U	7/30	.017"	.065"
*2555/20	1000'	20	MW-C 20(10)U	10/30	.017"	.074"
*2555/18	1000'	18	MW-C 18(16)U	16/30	.017"	.085"
2555/16	1000'	16	MW-C 16(26)U	26/30	.017"	.096"
2555/14	1000'	14	MW-C 14(41)U	41/30	.017"	.110"
2555/12	1000'	12	MW-C 12(65)U	65/30	.017"	.130"

SOLID

2560/24	1000'	24	MW-C 24(1)U	1	.015"	.056"
2560/22	1000'	22	MW-C 22(1)U	1	.017"	.060"
2560/20	1000'	20	MW-C 20(1)U	1	.017"	.066"
2560/18	1000'	18	MW-C 18(1)U	1	.017"	.074"

STD. PUT-UP: 100 Ft., 500 Ft., 1000 Ft.

STOCK COLORS: White, Yellow, Lt. Blue, Black, Violet (purple), Blue, Brown, Lt. Green, Pink, Red, Green, Tan, Orange, Gray (slate).

TRACER COLORS AVAILABLE: White/Black, White/Brown, White/Red, White/Orange, White/Yellow, White/Green, White/Blue, White/Purple, White/Gray.

Additional spiral tracer combination available, to order, for all numbers.

GLASS BRAID — TYPE HW (Heavy Wall)

TEMPERATURE RATING: —40°C to +80°C. NOM WALL: .045"

DABURN Cat. No.	Spool	Size AWG	MIL-W-76B Type Designation	Conductor Strand	Nom. O.D.
2575/10	100'-1000'	10	HW-C 10(105)B	105/30	.237"
2575/8	100'-1000'	8	HW-C 8(133)B	133/29	.293"
2575/6	100'-1000'	6	HW-C 6(133)B	133/27	.340"

STOCK COLORS: White, Black. ALSO multi-conductors can be formed to order twisted, shielded with or without plastic jacket overall.

2500 VOLTS (Fungus Proof) — TYPE HW (Heavy Wall)
SPEC MIL-W-76B

600 VOLTS: Sizes 14 through 6 — (Supersedes Jan-C-76 Type SRHV).

TEMP. RATING: —40°C to 80°C. NOM. WALL SIZE: 22 through 16 .033; Size 14 through 6 .045

DESCRIPTION: Similar to type MW. One conductor stranded tinned copper with larger walls of primary thermoplastic insulation to take 2500 V RMS.

DABURN No.	Size AWG	MIL-W-76B Type Designation	Conductor Strand	Nom. O.D.
2580/22	22	HW-C 22(7)U	7/30	.092"
2580/20	20	HW-C 20(10)U	10/30	.100"
2580/18	18	HW-C 18(16)U	16/30	.112"
2580/16	16	HW-C 16(26)U	26/30	.126"
2580/14	14	HW-C 14(41)U	41/30	.170"

STOCK COLORS: White, Black, Brown, Red, Orange, Yellow, Green, Blue, Purple, Gray, Additional sizes, colors available to order.

TEMPERATURE RATING: —40°C to +90°C.
Nominal Nylon Jacket Thickness, .002".

LW — NYLON JACKET

DABURN Cat. No.	AWG Size	MIL-W-76B Type Designation	Conductor Strand	Nom. O.D.
2590/30	30	LW-C 30(7)J	7/38	.036"
2590/28	28	LW-C 28(7)J	7/36	.039"
2590/26	26	LW-C 26(7)J	7/34	.042"
2590/24	24	LW-C 24(7)J	7/32	.047"
2590/22	22	LW-C 22(7)J	7/30	.053"
2590/20	20	LW-C 20(7)J	7/28	.065"

1000 VOLT — NYLON JACKET (Medium Wall)
SPEC. MIL-W-76B TYPE MW
(Fungus Proof)

DESCRIPTION: One conductor stranded tinned copper with thermoplastic insulation and extruded nylon jacket overall.

TEMPERATURE RATING: —40°C to +90°C.

DABURN Cat. No.	Size AWG	MIL-W-76B Type Designation	Conductor Strand	Nom. Wall	Nom. O.D.
2565/24	24	MW-C 24(16)J	16/36	.015"	.068"
2565/22	22	MW-C 22(7)J	7/30	.017"	.075"
2565/20	20	MW-C 20(10)J	10/30	.017"	.087"
2565/18	18	MW-C 18(16)J	16/30	.017"	.100"
2565/16	16	MW-C 16(26)J	26/30	.017"	.122"
2565/14	14	MW-C 14(41)J	41/30	.017"	.122"
2565/12	12	MW-C 12(65)J	65/30	.017"	.140"
2565/10	10	MW-C 10(105)J	105/30	.045"	.240"

STD. PUT-UP: 100 Ft.-1000 Ft.

NYLON JACKET THICKNESS: #24 .002; 22, 20, 18 .003; 16, 14 .004; 12 .005; 10 .007.

STOCK COLORS: White, Orange, Purple, Black, Yellow, Gray, Brown, Green, Red, Blue, White/Black, White/Brown, White/Red, White/Orange, White/Yellow, White/Green, White/Blue, White/Purple, White/Gray,

Nos. 2565/12 and /10 available solid colors only.

1000 VOLTS GLASS BRAID (Medium Wall) TYPE MW
SPEC. MIL-W-76B

DESCRIPTION: One conductor stranded tinned copper with thermoplastic insulation and lacquered glass braid overall.

TEMPERATURE RATING: —40°C to +80°C. NOM. WALL: .017"

DABURN Cat. No.	Spool	Size AWG	MIL-W-76B Type Designation	Conductor Strand	Nom. O.D.
2570/22	100'-1000'	22	MW-C 22(7)B	7/30	.079"
2570/20	100'-1000'	20	MW-C 20(10)B	10/30	.084"
2570/18	100'-1000'	18	MW-C 18(16)B	16/30	.100"
2570/16	100'-1000'	16	MW-C 16(26)B	26/30	.116"
*2570/14	100'-1000'	14	MW-C 14(41)B	41/30	.129"
*2570/12	100'-1000'	12	MW-C 12(65)B	65/30	.149"

STOCK COLORS: White, Black, Brown, Red, Orange, Yellow, Green, Blue, Purple, Gray, White/Brown, White/Black, White/Orange, White/Yellow, White/Green, White/Blue, White/Red, White/Gray, White/Purple, White/Black/Red, White/Black/Yellow, White/Black/Blue, White/Black/Green, White/Black/Orange, White/Black/Brown, White/Black/Gray.

*Nos. 2570/14 and /12, available stock in solid colors.



No. DABURN	AWG Size	Type Designation Mil-W-76B	Strand Conductor	O.D. Nom.
2580/12	12	HW-C 12(65)U	65/30	.186"
2580/10	10	HW-C 10(105)U	105/30	.210"
2580/8	8	HW-C 8(133)U	133/29	.260"
2580/6	6	HW-C 6(133)U	133/27	.305"

STD. PUT-UP: 100-1000 Ft.

DABURN

DABURN ELECTRONICS & CABLE CORP.
WIRE • CABLE • TUBING • MIL/COMM • SWITCHES • ELECTRONIC HARDWARE

SHIELDED PLASTIC HOOK-UP WIRE

1000 VOLT — TYPE MW (Medium Wall) SHIELDED — SPEC. MIL-W-76B
TEMPERATURE RATING —40°C TO +80°C

DESCRIPTION: One conductor stranded tinned copper with thermoplastic insulation and tinned copper shielded braid overall.

DABURN Cat. No.	Size AWG	MIL-W-76B Type Designation	Strand	Nom. Wall	Nom. O.D.
2592/24	24	MW-C24(7)S	7/32	.015"	.074"
2593	24	MW-C24(16)S	16/36	.015"	.075"
2592/22	22	MW-C22(7)S	7/30	.017"	.084"
2592/20	20	MW-C20(10)S	10/30	.017"	.094"

STOCK COLORS: (Underneath Shield) Black, White, Red, Yellow, Brown, Green, Blue, Gray. Nos. 2592/14 and /12, available from stock in Black, White or Red.
STANDARD PUT-UP: 100 Ft., 500 Ft., 1000 Ft.

DABURN Cat. No.	Size AWG	MIL-W-76B Type Designation	Strand	Nom. Wall	Nom. O.D.
2592/18	18	MW-C18(16)S	16/30	.017"	.106"
2592/16	16	MW-C16(26)S	26/30	.017"	.121"
2592/14	14	MW-C14(41)S	41/30	.017"	.137"
2592/12	12	MW-C12(65)S	65/30	.017"	.155"

Also multiconductors can be formed to order twisted shielded, with or without plastic jacket overall.

SHIELDED PLASTIC HOOK-UP WIRE

TYPE MW — SHIELDED — VINYL JACKET — 1000 V
SPEC. MIL-W-76B

DESCRIPTION: One conductor stranded tinned copper, white medium wall polyvinyl chloride insulation, shielded tinned copper braid, minimum 80% coverage, PVC (polyvinylchloride) jacket overall. Resistant to acids, alkalis, oil, flame, moisture, fungus.

TEMPERATURE RATING: —40°C to +90°C.

DABURN Cat. No.	Size AWG	MIL-W-76A Type Designation	Min. Strand	Nom. Wall	Nom. O.D.
2597/24	24	MW-C24(7)SJ	7/32	.015"	.095"
2597/22	22	MW-C22(7)SJ	7/30	.017"	.105"
2597/20	20	MW-C20(7)SJ	7/28	.017"	.112"
2597/18	18	MW-C18(19)SJ	19/30	.017"	.120"
2597/16	16	MW-C16(19)SJ	19/29	.017"	.133"
2597/14	14	MW-C14(19)SJ	19/27	.017"	.148"
2597/12	12	MW-C12(19)SJ	19/25	.017"	.170"

Additional colors available to order.
STANDARD PUT-UP: 100 Ft., 500 Ft., 1000 Ft.

TYPE MW — SHIELDED — NYLON JACKET — 1000 V
SPEC. MIL-W-76B

DESCRIPTION: One conductor stranded tinned copper, white medium wall polyvinyl chloride insulation, shielded tinned copper braid, minimum 80% coverage, clear nylon (polyamide) jacket overall. Resistant to acids, alkalis, oil, flame, moisture, fungus.

TEMPERATURE RATING: —40°C to +90°C.

DABURN Cat. No.	Size AWG	MIL-W-76A Type Designation	Min. Strand	Nom. Wall	Nom. O.D.
2595/24	24	MW-C24(7)SJ	7/32	.015"	.091"
2595/22	22	MW-C22(7)SJ	7/30	.017"	.100"
2595/20	20	MW-C20(7)SJ	7/28	.017"	.105"
2595/18	18	MW-C18(19)SJ	19/30	.017"	.115"
2595/16	16	MW-C16(19)SJ	19/29	.017"	.125"
2595/14	14	MW-C14(19)SJ	19/29	.017"	.138"
2595/12	12	MW-C12(19)SJ	19/25	.017"	.160"

Additional colors available to order.
STANDARD PUT-UP: 100 Ft., 500 Ft., 1000 Ft.

MIL-W-16878D — SHIELDED PLASTIC HOOK-UP WIRE

1000 VOLTS — TYPE C — SHIELDED
SPEC. MIL-W-16878D

DESCRIPTION: Stranded tinned copper, .016" wall white polyvinylchloride insulation, braided tinned copper shield overall temp. rating —55°C to +105°C 1000 volts.

DABURN Cat. No.	Size AWG	Min. Strand	Nom. Wall	Nom. O.D.
2530/24	24	7/32	.016"	.075"
2530/22	22	7/30	.016"	.085"
2530/20	20	7/28	.016"	.095"
2530/18	18	7/26	.016"	.105"
2530/16	16	19/26	.016"	.115"
2530/14	14	19/27	.016"	.140"
2530/12	12	19/25	.016"	.152"

STD. PUT-UP: 1000 Ft.

1000 VOLTS — TYPE C
SHIELDED WITH VINYL JACKET — SPEC. MIL-W-16878D

DESCRIPTION: Stranded tinned copper, .016" wall white with polyvinylchloride insulation braided tinned copper shield with polyvinylchloride jacket overall. Resistant to acids, alkalis, flame, fungus, solvents, moisture.

TEMPERATURE RATING: —55°C to +105°C.

DABURN No.	Size AWG	Min. Strand	Nom. Wall	Nom. O.D.
2535/24	24	7/32	.016"	.094"
2535/22	22	7/30	.016"	.104"
2535/20	20	7/28	.016"	.112"
2535/18	18	7/26	.016"	.120"
2535/16	16	19/29	.016"	.133"
2535/14	14	19/27	.016"	.150"
2535/12	12	19/25	.016"	.165"

STD. PUT-UP: 1000 Ft.

1000 VOLTS — TYPE C
SHIELDED NYLON JACKET

SPEC. MIL-W-16878D

DESCRIPTION: Stranded tinned copper .016" wall polyvinylchloride insulation, braided tinned copper shield, 90% coverage, clear nylon (polyamide) jacket overall. Nylon nominal jacket thickness .005".

TEMPERATURE RATING: —55°C to +115°C.

DABURN No.	Size AWG	Min. Strand	Nom. Wall	Nom. O.D.
2533/24	24	7/32	.016"	.090"
2533/22	22	7/30	.016"	.096"
2533/20	20	7/28	.016"	.105"
2533/18	18	7/26	.016"	.115"
2533/16	16	19/29	.016"	.125"
2533/14	14	19/27	.016"	.145"
2533/12	12	19/25	.016"	.157"

STD. PUT-UP: 1000 Ft.

MULTI-CONDUCTOR CABLE TYPE B
NYLON SHIELDED-PLASTIC JACKET
PER MIL-W-16878D — 600 V

DESCRIPTION: One or more conductors stranded tinned copper, PVC insulation, color coded, clear nylon (polyamide) jacket, cabled conductors, 90% coverage braided tinned copper, white polyvinylchloride jacket overall.

TEMPERATURE RATING: —55°C to +105°C. Voltage rating 600 volts. Resistant to acids, alkalis, flame, fungus, oil, moisture, solvents.

DABURN Cat. No.	No. of Cond.	Size	Strand	Nom. Wall	Nom. Nylon Wall	Nom. Overall Jacket	Nom. O.D.
2540	1	26	7/34	.010"	.003"	.010"	.087"
2540/2	2	26	7/34	.010"	.003"	.014"	.138"
2540/3	3	26	7/34	.010"	.003"	.014"	.142"
2540/4	4	26	7/34	.010"	.003"	.016"	.162"
2541	1	24	19/36	.010"	.003"	.010"	.092"
2541/2	2	24	19/36	.010"	.003"	.016"	.152"
2541/3	3	24	19/36	.010"	.003"	.016"	.161"
2541/4	4	24	19/36	.010"	.003"	.017"	.162"
2542	1	22	19/34	.010"	.003"	.010"	.100"
2542/2	2	22	19/34	.010"	.003"	.016"	.168"
2542/3	3	22	19/34	.010"	.003"	.017"	.178"
2542/4	4	22	19/34	.010"	.003"	.019"	.174"
2543	1	20	19/32	.010"	.003"	.010"	.106"
2543/2	2	20	19/32	.010"	.003"	0.19"	.186"
2543/3	3	20	19/32	.010"	.003"	.019"	.196"
2543/4	4	20	19/32	.010"	.003"	.021"	.193"
2544	1	18	19/30	.010"	.003"	.012"	.120"
2544/2	2	18	19/30	.010"	.003"	.021"	.210"
2544/3	3	18	19/30	.010"	.003"	.022"	.227"
2544/4	4	18	19/30	.010"	.003"	.023"	.218"
2545	1	16	19/29	.010"	.003"	.016"	.137"
2545/2	2	16	19/29	.010"	.003"	.023"	.236"
2545/3	3	16	19/29	.010"	.003"	.023"	.240"
2545/4	4	16	19/29	.010"	.003"	.025"	.275"

STD. PUT-UP: 500 Ft., 1000 Ft. CONDUCTOR COLOR CODE: 1-White, 2-Black, 3-Red, 4-Green. Additional sizes, conductors - variations - available to order.

DABURN**DABURN ELECTRONICS & CABLE CORP.**
WIRE • CABLE • TUBING • MIL/COMM • SWITCHES • ELECTRONIC HARDWARE**PLASTIC HOOK-UP WIRE**
SPECIFICATION MIL-W-16878D**TYPE B — HIGH TEMPERATURE VINYL**
SPECIFICATION MIL-W-16878D

600 VOLT

DESCRIPTION: One conductor stranded tinned copper with rated -55°C to +105°C high temperature thermoplastic light wall insulation.

DABURN Cat. No.	Mil-W-16878D Type Designation	Size AWG	Conductor Strand	Nom. O.D.
2500/32	B-32	32	7/40	.028"
2500/30	B-30	30	7/38	.030"
2500/28	B-28	28	7/36	.033"
2500/26	B-26	26	7/34	.037"
2500/24	B-24	24	7/32	.043"
2501/24	B-24	24	19/36	.043"
2500/22	B-22	22	7/30	.048"
2501/22	B-22	22	19/34	.048"
2500/20	B-20	20	7/28	.057"
2501/20	B-20	20	19/32	.057"
2500/18	B-18	18	7/26	.067"
2501/18	B-18	18	19/30	.067"
2500/16	B-16	16	19/29	.077"
2500/14	B-14	14	19/27	.091"

STD. PUT-UP: 100 Ft.-1000 Ft. STOCK COLORS: Same as for Type B Nylon.

TYPE C — HIGH TEMPERATURE — VINYL JACKET
SPECIFICATION MIL-W-16878D

1000 VOLT

DESCRIPTION: One conductor similar to Type B—heavier wall hi-temp thermoplastic insulation Nom. wall .016".

DABURN Cat. No.	Mil-W-16878D Type Designation	Size AWG	Minimum Strand	Nom. O.D.
2515/24	C-24	24	7/32	.058"
2515/22	C-22	22	7/30	.064"
2515/20	C-20	20	7/28	.079"
2515/18	C-18	18	7/26	.090"
2515/16	C-16	16	19/29	.099"
2515/14	C-14	14	19/27	.114"
2515/12	C-12	12	19/25	.135"

STD. PUT-UP: 100 Ft., 1000 Ft.

TYPE D — HIGH TEMPERATURE — VINYL — 3000 VOLTS
SPECIFICATION MIL-W-16878D

DESCRIPTION: One conductor stranded similar to Type C—heavier wall hi-temp thermoplastic insulation. Nom. wall 24 thru 14 .032, 12 thru 6 .040.

DABURN Cat. No.	Mil-W-16878D Type Designation	Size AWG	Conductor Strand	Nom. O.D.
2525/24	D-24	24	7/32	.084"
2525/22	D-22	22	7/32	.089"
2525/20	D-20	20	10/30	.097"
2525/18	D-18	18	16/30	.107"
2525/16	D-16	16	26/30	.116"
2525/14	D-14	14	41/30	.130"
2525/12	D-12	12	65/30	.163"
2525/10	D-10	10	105/30	.182"
2525/8	D-8	8	133/29	.247"
2525/6	D-6	6	133/27	.291"
2525/4	D-4	4	133/25	.355"
2525/2	D-2	2	665/30	.425"

STD. PUT-UP:
100 Ft.-1000 Ft.**TYPE B — NYLON JACKET**

NYLON JACKET THICKNESS: 32-20 .002, 18-16 .003

DABURN Cat. No.	Mil-W-16878D Type Designation	Size AWG	Conductor Strand	Nom. O.D.
2510/32	B-32	32	7/40	.032"
2510/30	B-30	30	7/38	.036"
2510/28	B-28	28	7/36	.039"
2510/26	B-26	26	7/34	.042"
2510/24	B-24	24	7/32	.047"
2511/24	B-24	24	19/36	.047"
2510/22	B-22	22	7/30	.053"
2511/22	B-22	22	19/34	.053"
2510/20	B-20	20	7/28	.065"
2511/20	B-20	20	19/32	.065"
2510/18	B-18	18	7/26	.075"
2511/18	B-18	18	19/30	.075"
2510/16	B-16	16	19/29	.085"
2510/14	B-14	14	19/27	.099"

STD. PUT-UP: 1000 Ft.

STOCK COLORS: Black, Red, Brown, Blue, Orange, White, Yellow, Green, Gray, Purple.
White/Black White/Red White/Green White/Yellow White/Blue White/Brown White/Orange White/Gray White/Violet**TYPE C — NYLON JACKET**

NYLON JACKET THICKNESS: 24 .002, 22-18 .003, 16-14 .004

DABURN Cat. No.	Mil-W-16878D Type Designation	Size AWG	Conductor Strand	Nom. O.D.
2520/24	C-24	24	7/32	.065"
2520/22	C-22	22	7/30	.064"
2520/20	C-20	20	7/28	.079"
2520/18	C-18	18	7/26	.090"
2520/16	C-16	16	19/29	.099"
2520/14	C-14	14	19/27	.114"
2520/12	C-12	12	19/25	.135"

STOCK COLORS: Black, Red, Brown, Blue, Orange, White, Yellow, Green, Gray, Purple. Also available in tracer colors. Additional types available to order.
STD. PUT-UP: 100 Ft.-1000 Ft.**TYPE D — HIGH TEMPERATURE — VINYL — 3000 VOLTS**
SPECIFICATION MIL-W-16878D — NYLON JACKET

DESCRIPTION: One conductor stranded tinned copper, color coded polyvinylchloride insulation, clear polyimide (nylon) jacket overall.

DABURN Cat. No.	Mil-W-16878D Type Designation	Size AWG	Conductor Strand	Nom. O.D.
2525N/24	D-24	24	7/32	.090"
2525N/22	D-22	22	7/30	.096"
2525N/20	D-20	20	10/30	.104"
2525N/18	D-18	18	16/30	.114"
2525N/16	D-16	16	26/30	.125"
2525N/14	D-14	14	41/30	.139"
2525N/12	D-12	12	65/30	.168"
2525N/10	D-10	10	105/30	.197"
2525N/8	D-8	8	133/29	.265"
2525N/6	D-6	6	133/27	.310"

STD. PUT-UP: 100 Ft., 1000 Ft.

AIRCRAFT PLASTIC HOOK-UP WIRE

SPECIFICATIONS MIL-W-5086A and MIL-C-7078A (105°C Rating)

DESCRIPTION: Type 1 MIL-W-5086A — one conductor stranded tinned copper with plastic insulation nylon jacket overall. Type 2 Mil-W-5086A — one conductor stranded tinned copper, plastic insulation, nylon lacquered glass braid. Color: White. Additional colors available to order.

MIL-W-5086A UNSHIELDED (Supersedes AN-J-C-48A) — 600 V RATING

DABURN Cat. No.	Mil. Type	Type	Conductor Strand.	Nom. O.D.
2601/22	AN-22	No. 1	19/34	.070"
2601/20	AN-20	No. 1	19/32	.080"
2601/18	AN-18	No. 1	19/30	.090"
2601/16	AN-16	No. 1	19/29	.125"
2601/14	AN-14	No. 1	19/27	.125"
2601/12	AN-12	No. 1	19/25	.140"
2602/22	AN-22	No. 2	19/34	.068"
2602/20	AN-20	No. 2	19/32	.078"
2602/18	AN-18	No. 2	19/30	.088"
2602/16	AN-16	No. 2	19/29	.098"

STANDARD PUT-UP: 100 Ft., 1000 Ft.

MIL-C-7078A SHIELDED (Supersedes AN-C-168) 600 V RATING

DESCRIPTION: One conductor stranded tinned copper with plastic insulation, nylon jacket with tinned copper shielded braid overall. Color: White under shield. Additional types to order.

DABURN Cat. No.	Size AWG	Mil. Type	Type	Conductor Strand.	Nom. O.D.
2605/22	22	AN-22	No. 1	19/34	.100"
2605/20	20	AN-20	No. 1	19/32	.110"
2605/18	18	AN-18	No. 1	19/30	.124"

STANDARD PUT-UP: 100 Ft., 1000 Ft.

DABURN Cat. No.	Mil. Type	Type	Conductor Strand.	Nom. O.D.
2602/14	AN-14	No. 2	19/27	.117"
2602/12	AN-12	No. 2	19/25	.137"
2602/10	AN-10	No. 2	49/27	.189"
2602/8	AN-8	No. 2	133/29	.240"
2602/6	AN-6	No. 2	133/27	.297"
2602/4	AN-4	No. 2	133/25	.355"
2602/2	AN-2	No. 2	665/30	.412"
2602/0	AN-0	No. 2	1045/30	.518"
2602/00	AN-00	No. 2	1330/30	.588"

ALL WIRE ON THIS PAGE CAN BE CUT AND STRIPPED TO YOUR SPECIFICATION.

DABURN

DABURN ELECTRONICS & CABLE CORP.
WIRE • CABLE • TUBING • MIL/COMM • SWITCHES • ELECTRONIC HARDWARE

TEFLON* WIRE
TYPE E — 600 VOLTS
SPEC. MIL-W-16878D

High Temperature Rating — -90°C to +250°C

Single conductor, stranded silver plated copper, .010" TFE Teflon® insulation. Acid, alkalis, oil, flame, moisture, fungus, solvent resistant.

DABURN Extruded Cat. No.	DABURN Wrapped Cat. No.	Size MIL Type Designation	Strand	Max. Dia. Over Insul.
2401	—	E-32	7/40	.033"
2402	—	E-30	7/38	.036"
2403	2415/28	E-28	7/36	.039"
2404	2415/26	E-26	7/34	.043"
2405	2415/24	E-24	19/36	.048"
2405-7	—	E-24	7/32	.048"
2406	2415/22	E-22	19/34	.054"
2406-7	—	E-22	7/30	.054"
2407	2415/20	E-20	19/32	.062"
2407-7	—	E-20	7/28	.062"
2408	2415/18	E-18	19/30	.074"
2409	2415/16	E-16	19/29	.079"
2409/14	—	E-14	19/27	.097"
2409/12	—	E-12	19/25	.120"
2409/10	—	E-10	37/26	.139"

STD. PUT-UP: 100 Ft., 500 Ft., 1000 Ft. Solid conductors available. COLORS: Black, Brown, Red, Orange, Yellow, Green, Blue, Purple, Gray, White, White/Black, White/Red, White/Green, White/Yellow, White/Blue, White/Brown, White/Orange, White/Gray, White/Violet.

Additional special custom construction available to order.

TEFLON* WIRE

MIL-W-16878D — TYPE EE

Extruded (1000 Volts) MIL-W-16878D

DESCRIPTION: Single conductor silver plated copper wire concentrically stranded and insulated with .016 TFE extruded TEFLON* insulation.

TEMPERATURE RATING: -90°C to +260°C, 1000 volts.

DABURN Cat. No.	Mil Type Designation	Size AWG	Strand	Nom. O.D.
2428/24	EE-24	24	19/36	.055"
2428/22	EE-22	22	19/34	.062"
2428/20	EE-20	20	19/32	.070"
2428/18	EE-18	18	19/30	.080"
2428/16	EE-16	16	19/29	.089"
2428/14	EE-14	14	19/27	.106"
2428/12	EE-12	12	19/25	.124"
2428/10	EE-10	10	37/26	.145"
2428/8 (wrapped)	EE-8	8	133/29	.210"

STANDARD SPOOL PUT-UPS: 250 Ft., 500 Ft., 1000 Ft. Solid conductors available.

STOCK COLORS: 1—White, 2—Black, 3—Red, 4—Green, 5—Yellow, 6—Blue, 7—Brown, 8—Orange, 9—Gray (Slate), 10—Violet (Purple).

SUBMINIATURE TEFLON* HOOK-UP WIRE

PER MIL-W-16878D — TYPE ET — 250 VOLTS, 200°C

Thin miniature hook-up wire is suitable in miniature slip ring assemblies, as interconnecting wire between wafers in micro-miniature electronic circuitry, instrument wire, medical wire, subminiature thermo-couple lead wire, strain gauge wire, etc. Provides lighter weight, greater flexibility and hi temperature resistance. Size Nos. 32 thru 20 conform to MIL-W-16878D Type ET 250 volts, 200°C. Silver plated copper conductor.

DABURN Cat. No.	Mil Type	AWG Size	Min. Strand	Nom. O.D.
2427/36	—	36	7/44	.018"
2427/34	—	34	7/42	.020"
2427/32	ET-32	32	7/40	.021"
2427/30	ET-30	30	7/38	.024"
2427/28	ET-28	28	7/36	.027"
2427/26	ET-26	26	7/34	.031"
2427/24	ET-24	24	7/32	.036"
2427/22	ET-22	22	7/30	.042"
2427/20	ET-20	20	7/28	.049"

STANDARD SPOOL PUT-UPS: 500 Ft., 1000 Ft.

TEFLON* TFE AIRFRAME LEAD WIRE MIL-W-7139B

CLASS 1: 600V Silver Coated Copper Conductor for -65 to +200°C Operation.
CLASS 2: 600V Nickel Coated Copper Conductor for +260°C Operation.

DABURN Cat. No. Class 1	DABURN Cat. No. Class 2	Size AWG	Strand	Nom. O.D.
2426-22	2425-22	22	19/34	.085"
2426-20	2425-20	20	19/32	.095"
2426-18	2425-18	18	19/30	.110"
2426-16	2425-16	16	19/29	.130"
2426-14	2425-14	14	19/27	.143"
2426-12	2425-12	12	19/25	.163"

STANDARD SPOOL PUT-UPS: 500 Ft., 1000 Ft.

STANDARD COLOR: Class 1 — White/Blue Tracer; Class 2 — White/Orange Tracer.

ADDITIONAL SIZES AVAILABLE.

*TEFLON—Dupont

INSTRUMENTATION CABLES

TEFLON* CABLES — Shielded and Unshielded TO MIL-W-16878D

DESCRIPTION: One or more conductors, each conductor silver plated concentrically stranded copper wire, Type E Extruded TFE .010" insulation. When shielded, braided silver plated copper shield over conductor(s), 90% shield coverage. When covered, either a TEFLON* impregnated fiberglass braid or a .010" TEFLON* fused, double reversed tape jacket overall. Fungus, solvent, moisture, flame, acid, alkali and oil resistant Multiconductors are twisted. TEMPERATURE RATING: -65°C to +260°C. VOLTAGE RATING: 600 Volts

TEFLON* IMPREGNATED BRAID OVER SHIELD

Daburn No.	Conds.	AWG Size	Strand	Nom. O.D.	Daburn No.	Conds.	AWG Size	Strand	Nom. O.D.
2444	1	26	7/34	.075"	2447	1	20	19/32	.093"
2444/2	2	26	7/34	.119"	2447/2	2	20	19/32	.154"
2445	1	24	19/36	.081"	2447/3	3	20	19/32	.163"
2445/2	2	24	19/36	.126"	2447/4	4	20	19/32	.180"
2445/3	3	24	19/36	.133"	2447/5	5	20	19/32	.195"
2445/4	4	24	19/36	.144"	2448	1	18	19/30	.097"
2445/5	5	24	19/36	.156"	2448/2	2	18	19/30	.162"
2446	1	22	19/34	.088"	2448/3	3	18	19/30	.172"
2446/2	2	22	19/34	.137"	2448/4	4	18	19/30	.192"
2446/3	3	22	19/34	.144"	2448/5	5	18	19/30	.207"
2446/4	4	22	19/34	.158"	2449	1	16	19/29	.117"
2446/5	5	22	19/34	.172"	2449/2	2	16	19/29	.197"

STANDARD SPOOL PUT-UPS: 250 Ft., 500 Ft., 1000 Ft.

CONDUCTOR COLOR CODE: 1—White, 2—Black, 3—Red, 4—Green, 5—Yellow.

TEFLON* TAPE WRAP JACKET OVER SHIELD

Daburn No.	Conds.	AWG Size	Strand	Nom. O.D.	Daburn No.	Conds.	AWG Size	Strand	Nom. O.D.
2454	1	26	7/34	.078"	2457	1	20	19/32	.099"
2454/2	2	26	7/34	.125"	2457/2	2	20	19/32	.158"
2455	1	24	19/36	.084"	2457/3	3	20	19/32	.167"
2455/2	2	24	19/36	.128"	2457/4	4	20	19/32	.184"
2455/3	3	24	19/36	.135"	2457/5	5	20	19/32	.204"
2455/4	4	24	19/36	.148"	2458	1	18	19/30	.109"
2455/5	5	24	19/36	.162"	2458/2	2	18	19/30	.178"
2456	1	22	19/34	.090"	2458/3	3	18	19/30	.189"
2456/2	2	22	19/34	.140"	2458/4	4	18	19/30	.208"
2456/3	3	22	19/34	.148"	2458/5	5	18	19/30	.230"
2456/4	4	22	19/34	.162"	2459	1	16	19/29	.130"
2456/5	5	22	19/34	.183"	2459/2	2	16	19/29	.230"

STANDARD SPOOL PUT-UPS: 250 Ft., 500 Ft., 1000 Ft.

CONDUCTOR COLOR CODE: 1—White, 2—Black, 3—Red, 4—Green, 5—Yellow.

SHIELDED BRAID OVERALL

Daburn Cat. No.	Conds.	AWG Size	Strand	Nom. O.D.	Daburn Cat. No.	Conds.	AWG Size	Strand	Nom. O.D.
2434	1	26	7/34	.066"	2437	1	20	19/32	.082"
2434/2	2	26	7/34	.104"	2437/2	2	20	19/32	.142"
2435	1	24	19/36	.068"	2437/3	3	20	19/32	.151"
2435/2	2	24	19/36	.112"	2437/4	4	20	19/32	.168"
2435/3	3	24	19/36	.120"	2437/5	5	20	19/32	.180"
2435/4	4	24	19/36	.132"	2438	1	18	19/30	.093"
2435/5	5	24	19/36	.140"	2438/2	2	18	19/30	.162"
2436	1	22	19/34	.075"	2438/3	3	18	19/30	.172"
2436/2	2	22	19/34	.124"	2438/4	4	18	19/30	.191"
2436/3	3	22	19/34	.132"	2438/5	5	18	19/30	.210"
2436/4	4	22	19/34	.146"	2439	1	16	19/29	.103"
2436/5	5	22	19/34	.154"	2439/2	2	16	19/29	.184"

STANDARD SPOOL PUT-UPS: 250 Ft., 500 Ft., 1000 Ft.

CONDUCTOR COLOR CODE: 1—White, 2—Black, 3—Red, 4—Green, 5—Yellow.

NO SHIELD—TEFLON* IMPREGNATED FIBERGLASS OVERALL

Daburn Cat. No.	Conds.	AWG Size	Strand	Nom. O.D.	Daburn Cat. No.	Conds.	AWG Size	Strand	Nom. O.D.
2464	1	26	7/34	.040"	2467	1	20	19/32	.058"
2464/2	2	26	7/34	.080"	2467/2	2	20	19/32	.118"
2465	1	24	19/36	.044"	2467/3	3	20	19/32	.127"
2465/2	2	24	19/36	.088"	2467/4	4	20	19/32	.144"
2465/3	3	24	19/36	.096"	2467/5	5	20	19/32	.156"
2465/4	4	24	19/36	.108"	2468	1	18	19/30	.069"
2465/5	5	24	19/36	.116"	2468/2	2	18	19/30	.138"
2466	1	22	19/34	.031"	2468/3	3	18	19/30	.148"
2466/2	2	22	19/34	.100"	2468/4	4	18	19/30	.167"
2466/3	3	22	19/34	.108"	2468/5	5	18	19/30	.186"
2466/4	4	22	19/34	.122"	2469	1	16	19/29	.086"
2466/5	5	22	19/34	.131"	2469/2	2	16	19/29	.172"

STANDARD SPOOL PUT-UPS: 250 Ft., 500 Ft., 1000 Ft.

CONDUCTOR COLOR CODE: 1—White, 2—Black, 3—Red, 4—Green, 5—Yellow.

Special cable constructions and colors available.

DABURN**DABURN ELECTRONICS & CABLE CORP.**

96 PRINCE ST., N. Y., N. Y. 10012 • 212 226-4079 — 5833

WIRE • CABLE • TUBING • MIL/COMM • SWITCHES • ELECTRONIC HARDWARE

NEW CRT HI-VOLT CORONA RESISTANT TEFLON* CABLE®

Voltage Rating at Sea Level • Voltage Rating at 80,000 feet,
approximately 1/3 lower

• Minimum life expectancy: 10,000 hours.

SMALL SIZE:

You do not need bulky, thick, insulation jacketing as used with silicone rubber and polyethylene insulations to get your hi-voltage requirements. Wire used is MIL-SPEC QQ-W-343 and MIL-W-16878D. Insulation used conforms and surpasses MIL-SPEC-W-16878D

AVOID CORONA PROBLEMS:

Corona resistant Teflon construction is specifically designed to retard and prevent corona penetration.

Temperature variations from -60° to +300°C have no life effect on the corona resistant Teflon. In addition, there is no stress or crack failure under severe, adverse conditions including mechanical strain, moisture, corona or chemical conditions.

DESCRIPTION:

Single Conductor, Stranded Silver Plated Copper, Corona Resistant Teflon* Insulation.

TEMPERATURE RATING:

-90°C to +250°C.

VOLTAGE RATING:

Based on insulation thickness.

AVAILABLE COLORS:

White, Black, Red, Green, Yellow, Lt. Blue, Brown, Orange, Gray, Violet. (Also available in tracer colors)

PUT-UP: 250', 500', 1000'

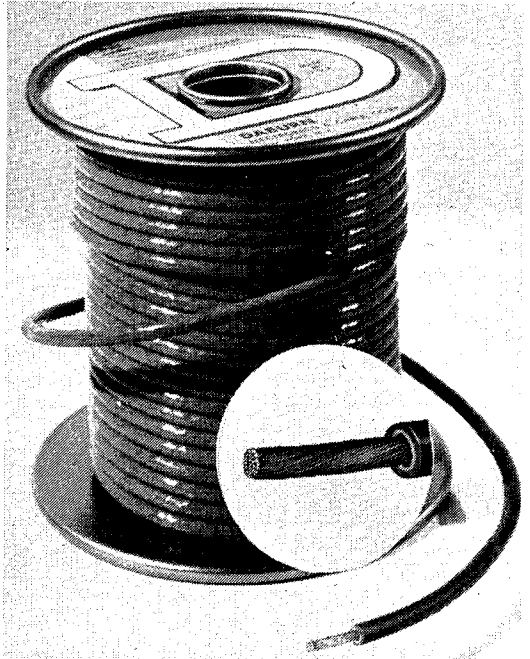

* DUPONT

ADDITIONAL SIZES AND VOLTAGES AVAILABLE

DABURN No.	AWG Size	Strand	Voltage Rating AC	Voltage Rating DC	Nom. O.D.
CRT-12-2	12	19/25	2500	10,000	.142"
CRT-12-2.5	12	19/25	3750	12,500	.152"
CRT-12-3	12	19/25	4500	15,000	.162"
CRT-12-3.5	12	19/25	5300	17,500	.172"
CRT-12-4	12	19/25	6000	20,000	.182"
CRT-12-5	12	19/25	7500	25,000	.202"
CRT-12-6.5	12	19/25	10,000	32,500	.232"
CRT-12-8	12	19/25	12,000	40,000	.262"
CRT-12-10	12	19/25	15,000	50,000	.302"
CRT-14-2	14	19/27	2500	10,000	.124"
CRT-14-2.5	14	19/27	3750	12,500	.134"
CRT-14-3	14	19/27	4500	15,000	.144"
CRT-14-3.5	14	19/27	5300	17,500	.154"
CRT-14-4	14	19/27	6000	20,000	.164"
CRT-14-5	14	19/27	7500	25,000	.184"
CRT-14-6.5	14	19/27	10,000	32,500	.214"
CRT-14-8	14	19/27	12,000	40,000	.244"
CRT-14-10	14	19/27	15,000	50,000	.284"
CRT-16-2	16	19/29	2500	10,000	.109"
CRT-16-2.5	16	19/29	3750	12,500	.119"
CRT-16-3	16	19/29	4500	15,000	.129"
CRT-16-3.5	16	19/29	5300	17,500	.139"
CRT-16-4	16	19/29	6000	20,000	.149"
CRT-16-5	16	19/29	7500	25,000	.169"
CRT-16-6.5	16	19/29	10,000	32,500	.199"
CRT-16-8	16	19/29	12,000	40,000	.229"
CRT-16-10	16	19/29	15,000	50,000	.269"
CRT-18-2	18	19/30	2500	10,000	.102"
CRT-18-2.5	18	19/30	3750	12,500	.112"
CRT-18-3	18	19/30	4500	15,000	.122"
CRT-18-3.5	18	19/30	5300	17,500	.132"
CRT-18-4	18	19/30	6000	20,000	.142"
CRT-18-5	18	19/30	7500	25,000	.162"
CRT-18-6.5	18	19/30	10,000	32,500	.192"
CRT-18-8	18	19/30	12,000	40,000	.222"
CRT-18-10	18	19/30	15,000	50,000	.272"
CRT-20-2	20	19/32	2500	10,000	.092"
CRT-20-2.5	20	19/32	3750	12,500	.102"
CRT-20-3	20	19/32	4500	15,000	.112"
CRT-20-3.5	20	19/32	5300	17,500	.122"

DABURN No.	AWG Size	Strand	Voltage Rating AC	Voltage Rating DC	Nom. O.D.
CRT-20-4	20	19/32	6000	20,000	.132"
CRT-20-5	20	19/32	7500	25,000	.152"
CRT-20-6.5	20	19/32	10,000	32,500	.192"
CRT-20-8	20	19/32	12,000	40,000	.212"
CRT-20-10	20	19/32	15,000	50,000	.252"
CRT-22-2	22	19/34	2500	10,000	.084"
CRT-22-2.5	22	19/34	3750	12,500	.094"
CRT-22-3	22	19/34	4500	15,000	.104"
CRT-22-3.5	22	19/34	5300	17,500	.114"
CRT-22-4	22	19/34	6000	20,000	.124"
CRT-22-5	22	19/34	7500	25,000	.144"
CRT-22-6.5	22	19/34	10,000	32,500	.174"
CRT-22-8	22	19/34	12,000	40,000	.204"
CRT-22-10	22	19/34	15,000	50,000	.244"
CRT-24-2	24	19/36	2500	10,000	.077"
CRT-24-2.5	24	19/36	2750	12,500	.087"
CRT-24-3	24	19/36	4500	15,000	.097"
CRT-24-3.5	24	19/36	5300	17,500	.107"
CRT-24-4	24	19/36	6000	20,000	.117"
CRT-24-5	24	19/36	7500	25,000	.137"
CRT-24-6.5	24	19/36	10,000	32,500	.167"
CRT-24-8	24	19/36	12,000	40,000	.197"
CRT-24-10	24	19/36	15,000	50,000	.237"
CRT-26-2	26	7/34	2500	10,000	.071"
CRT-26-2.5	26	7/34	3750	12,500	.081"
CRT-26-3	26	7/34	4500	15,000	.091"
CRT-26-3.5	26	7/34	5300	17,500	.101"
CRT-26-4	26	7/34	6000	20,000	.111"
CRT-26-5	26	7/34	7500	25,000	.131"
CRT-26-6.5	26	7/34	10,000	32,500	.161"
CRT-26-8	26	7/34	12,000	40,000	.191"
CRT-26-10	26	7/34	15,000	50,000	.231"
CRT-28-2	28	7/36	2500	10,000	.067"
CRT-28-2.5	28	7/36	3750	12,500	.077"
CRT-28-3	28	7/36	4500	15,000	.087"
CRT-28-3.5	28	7/36	5300	17,500	.097"
CRT-28-4	28	7/36	6000	20,000	.117"
CRT-28-5	28	7/36	7500	25,000	.127"
CRT-28-6.5	28	7/36	10,000	32,500	.157"
CRT-28-8	28	7/36	12,000	40,000	.187"
CRT-28-10	28	7/36	15,000	50,000	.227"

DABURN

DABURN ELECTRONICS & CABLE CORP.

WIRE • CABLE • TUBING • MIL/COMM • SWITCHES • ELECTRONIC HARDWARE

FEP TEFLON* CABLE
FEP EXTRUDED JACKET OVER SHIELD



DESCRIPTION: Each conductor silver plated stranded copper wire, Type E extruded TFE .010" insulation. Color coded, cabled, braided silver plated copper shield — 90% coverage, FEP white teflon jacket overall.

TEMPERATURE RATING: -65°C to +200°C. VOLTAGE RATING: 600 V.

DABURN No.	Conds.	AWG Size	Strand	Nom. D.D.
2480	1	24	19/36	.085"
2480/2	2	24	19/36	.130"
2480/3	3	24	19/36	.135"
2480/4	4	24	19/36	.148"
2481	1	22	19/34	.091"
2481/2	2	22	19/34	.150"
2481/3	3	22	19/34	.158"
2481/4	4	22	19/34	.172"
2482	1	20	19/32	.100"
2482/2	2	20	19/32	.168"
2482/3	3	20	19/32	.178"
2482/4	4	20	19/32	.193"
2483	1	18	19/30	.110"
2483/2	2	18	19/30	.183"
2483/3	3	18	19/30	.207"
2483/4	4	18	19/30	.222"
2484	1	16	19/29	.123"
2484/2	2	16	19/29	.220"

STD. PUT-UP: 500 Ft., 1000 Ft.
CONDUCTOR COLOR CODE: 1—White, 2—Black, 3—Red, 4—Green *Dupont

H FILM KAPTON* WIRE

DALITE™

HIGH TEMPERATURE HOOK-UP AND AIRFRAME WIRE
200°C CONTINUOUS TEMPERATURE RATING (a)

INSULATED WITH DUPONT KAPTON* POLYIMIDE FILM WITH TEFLON* — FEP HEAT SEALED COATING CONFORMS TO MIL-W-81381.

CHARACTERISTICS: Dalite™ insulated wire provides high temperature stability, low temperature flexibility, high radiation resistance, resistance to cold flow, impervious to most chemicals, high dielectric strength, low dielectric constant, smaller diameters and lighter weight than any other comparable wire used for continuous operation up to 200°C. This hook-up wire meets the test requirements of MIL-W-16878 for 300 V, 600 V and 1000 V with smaller wall thicknesses, weight and dimensions.

(a) Temperature based on lowest temperature rating of materials in the insulation — FEP 200°C. Will pass 96 hour heat age tests at 290°C per MIL-W-16878.

DESCRIPTION: Single conductor, silver plated annealed copper conductors, Type H* Polyimide film with Teflon* FEP coating tape wrapped overall.



DABURN No.	Type Designation	Size AWG	Strand	Voltage Rating (rms)	Nom. Wall	Nom. O.D.	Weight Per 1000' (lbs.)
2490/30	HF 30	30	7/38	600	.0045"	.021"	0.52
2495/30	HHF 30	30	7/38	1000	.006"	.024"	0.57
2490/28	HF 28	28	7/36	600	.0045"	.024"	0.75
2495/28	HHF 28	28	7/36	1000	.006"	.027"	0.83
2490/26	HF 26	26	7/34	600	.0045"	.028"	1.11
2495/26	HHF 26	26	7/34	1000	.006"	.031"	1.21
2490/24	HF 24	24	19/36	600	.0045"	.034"	1.78
2495/24	HHF 24	24	19/36	1000	.006"	.037"	1.90
2490/22	HF 22	22	19/34	600	.0045"	.041"	2.71
2495/22	HHF 22	22	19/34	1000	.006"	.044"	2.86
2490/20	HF 20	20	19/32	600	.0045"	.049"	4.18
2495/20	HHF 20	20	19/32	1000	.006"	.052"	4.35
2490/18	HF 18	18	19/30	600	.0045"	.059"	6.46
2495/18	HHF 18	18	19/30	1000	.006"	.062"	6.67
2490/16	HF 16	16	19/29	600	.0045"	.066"	8.16
2495/16	HHF 16	16	19/29	1000	.006"	.069"	8.39

STD. PUT-UP: 1000 Ft. Stripping and solid colors available. Variations of conductor material—to special order. *DUPONT
STD. COLOR: Natural Gold.

* KAPTON - DUPONT

UNSHIELDED AUDIO CABLE

SOLID AND STRANDED CONDUCTORS (2 & 3)

Tinned copper, vinyl plastic insulation, FOR INDOOR USE — NO OUTER JACKET, color coded, conductors twisted.

Operating Temp.: -20°C to +60°C. Operating Voltage: #22 AWG 200V, #20 AWG 350V, #18 AWG 400V, #16, #14 AWG 600V.

DABURN No.	Cond.	Size	Strand	Insul. Wall	Nom. O.O.
3004	2	22 Solid	1	.016"	.100"
3004/3	3	22 Solid	1	.016"	.115"
3005	2	20 Solid	1	.016"	.120"
3005/3	3	20 Solid	1	.016"	.140"
3006	2	18 Solid	1	.016"	.145"
3006/3	3	18 Solid	1	.016"	.155"
3007	2	16 Solid	1	.016"	.175"
3007/3	3	16 Solid	1	.016"	.190"
3011	2	22 Stranded	7/30	.016"	.125"
3011/3	3	22 Stranded	7/30	.016"	.140"
3012	2	20 Stranded	10/30	.016"	.145"
3012/3	3	20 Stranded	10/30	.016"	.160"
3013	2	18 Stranded	16/30	.016"	.165"
3013/3	3	18 Stranded	16/30	.016"	.180"
3014	2	16 Stranded	26/30	.016"	.190"
3014/3	3	16 Stranded	26/30	.016"	.210"
3015	2	14 Stranded	41/30	.016"	.220"
3015/3	3	14 Stranded	41/30	.016"	.240"
3016	2	12 Stranded	65/30	.020"	.250"
3016/3	3	12 Stranded	65/30	.020"	.275"

CONDUCTOR COLOR CODE: 1—Brown, 2—Tan, 3—Gray.
STD. PUT-UP: 1000 Ft.

PLASTIC JACKET OVERALL FOR OUTDOOR USE

Tinned copper, vinyl plastic insulation, color coded, twisted, plastic jacket overall.

Operating Temp.: -20°C to +60°C.
Operating Voltage: #22 AWG 200V, #20 AWG 350V, #18 AWG 400V, #16, #14 AWG 600V.



DABURN No.	Cond.	Size	Strand	Nom. Wall	Jacket	Nom. O.D.
3020	2	22	1	.010"	.020"	.125"
3020/3	3	22	1	.010"	.020"	.130"
3020/4	4	22	1	.010"	.020"	.150"
3021	2	20	1	.016"	.020"	.170"
3021/3	3	20	1	.016"	.020"	.180"
3021/4	4	20	1	.016"	.020"	.200"
3022	2	18	1	.016"	.020"	.185"
3022/3	3	18	1	.016"	.020"	.190"
3022/4	4	18	1	.016"	.020"	.220"
3022/5	5	18	1	.016"	.020"	.235"
3022/6	6	18	1	.016"	.020"	.265"
3027	2	22	7/30	.010"	.020"	.130"
3027/3	3	22	7/30	.010"	.020"	.140"
3027/4	4	22	7/30	.010"	.020"	.165"
3028	2	20	10/30	.016"	.020"	.175"
3028/3	3	20	10/30	.016"	.020"	.185"
3028/4	4	20	10/30	.016"	.020"	.195"
3029	2	18	16/30	.016"	.020"	.195"
3029/3	3	18	16/30	.016"	.020"	.205"
3029/4	4	18	16/30	.016"	.020"	.235"
3029/6	6	18	16/30	.016"	.020"	.290"
3030	2	16	26/30	.016"	.020"	.220"
3030/3	3	16	26/30	.016"	.020"	.245"
3030/4	4	16	26/30	.016"	.020"	.270"
3031	2	14	41/30	.016"	.020"	.260"
3031/3	3	14	41/30	.016"	.020"	.280"

STD. PUT-UP: 1000 Ft.
CONDUCTOR COLOR CODE: 1—Black, 2—Red, 3—White, 4—Green, 5—Orange, 6—Blue.

SPECIAL CONSTRUCTIONS AVAILABLE

PLASTIC INTER-COM CABLE

Station to station wiring to eliminate cross-talk. Each conductor tinned copper stranded, color coded PVC, T.C. braid, shield where indicated, paired, grey polyvinylchloride jacket overall.

2935 — Suitable for unbalanced systems.
2935/4 — Suitable for balanced systems.
2935/5 — Suitable for coin operated phonographs.
OPERATING VOLTAGE: 350 Volts.
OPERATING TEMPERATURE: -20°C to +60°C.

DABURN Cat. No.	Cond.	Size	Strand	No. Cond. Shield	Nom. Wall	Nom. Jacket	O.D.
2935	3	22	7/30	1	.016"	.020"	.200"
2935/4	4	22	7/30	2	.016"	.020"	.180"x.285"
2935/5	5	22	7/30	3	.016"	.020"	.200"x.300"

CONDUCTOR COLOR CODE: STD. PUT-UP: 500 Ft., 1000 Ft.
2935 — White — shielded; Black, Red — unshielded.
2935/4 — Black, White — shielded; Black, Red — unshielded.
2935/5 — Black, White, Red — shielded; Black, Red — unshielded.

DABURN**DABURN ELECTRONICS & CABLE CORP.**
WIRE • CABLE • TUBING • MIL/COMM • SWITCHES • ELECTRONIC HARDWARE**NEW DABURN HIGH TEMPERATURE LEAD WIRE**

Small Diameters and High Temperature performance make an outstanding combination for these unique constructions. Basic wire conforms to MIL-W-3861 spec. shielding per MIL-N-46026A. 600V RMS.

800°F TEMPERATURE RATING

High temperature aircraft and missile lead wire for operation between 500°F and 800°F. Nickel clad copper conductors with glass braided fiber insulation impregnated with silicone varnish. Multiconductor and shielded construction will be manufactured to customer's specifications.

DABURN Cat. No.	Size	Strand	CMA	Nom. O.D.
2497/18	18	19/.010"	755	.085"
2497/20	20	19/.008"	1216	.075"
2497/22	22	19/.0063"	1900	.070"

STD. PUT-UP: 500 Ft., 1000 Ft.

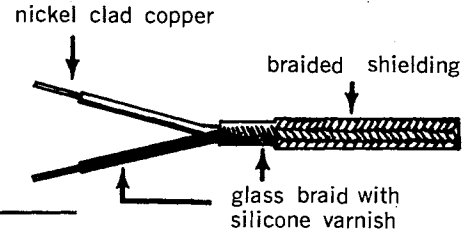
**1500°F TEMPERATURE RATING**

High temperature radiation resistant aircraft and missile lead wire for operation between 800°F and 1500°F. Nickel clad copper conductors with inorganic braided insulation. Useful up to 1500°F providing moisture resistance is not required. Multiconductor and shielded construction can be made to customer's specifications.

DABURN Cat. No.	Size	Strand	CMA	Nom. O.D.
2498/18	18	19/.010"	755	.085"
2498/20	20	19/.008"	1216	.075"
2498/22	22	19/.0063"	1900	.070"

STD. PUT-UP: 500 Ft., 1000 Ft.

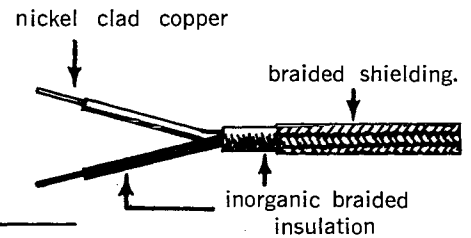
**2000°F TEMPERATURE RATING**

High temperature radiation resistant aircraft and missile lead wire for operation between 1500°F and 2000°F. Nickel clad copper conductors with vitreous silica braided insulation and a braided shielding. Useful up to 2000°F providing no initial moisture resistance or abrasion resistance is required. Multiconductor construction can be made to customer's specifications.

DABURN Cat. No.	Size	Strand	CMA	Nom. Insulation Thickness	Braid Ni. Shield	Nom. O.D.
2499/18	18	19/.010"	755	.025"	16-5-36	.122"
2499/20	20	19/.008"	1216	.025"	24-3-36	.112"
2499/22	22	19/.0063"	1900	.027"	24-3-36	.108"

STD. PUT-UP: 500 Ft., 1000 Ft.

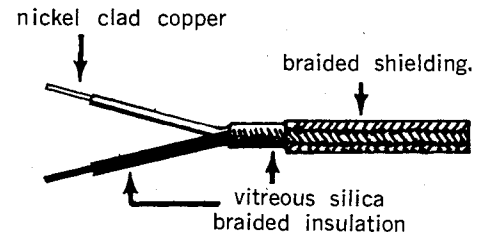

DABURN

DABURN ELECTRONICS & CABLE CORP.
WIRE • CABLE • TUBING • MIL/COMM • SWITCHES • ELECTRONIC HARDWARE

**FLAT RIBBON CABLE, TYPES F & FF PER MIL-W-16878D
PLASTIC, SILICONE RUBBER HOOK-UP WIRE — HIGH VOLTAGE CABLE**

FLAT RIBBON CABLE

**MULTI-CONDUCTOR — POLYVINYLCHLORIDE
INSULATION CONDUCTORS**

Per MIL-W-16878D — TYPE B — 600 V

DESCRIPTION: Each conductor stranded tinned copper .010" polyvinylchloride insulation bonded to form flat ribbon cable.

Rated: -55°C to +105°C. Voltage Rating: 600 volts. Resists acid, alkalis, flame, moisture, oil, solvents, fungus. Conductors are color coded and separate easily for clean terminations. Saves space, time on circuit and interconnecting assemblies, wiring harnesses, sliding drawers and drop assemblies.

DABURN No.	Cond.	Size	Strand	Nom. Wall	Nom. O.D.
1804/4	4	24	7/32	.010"	.043" x .172"
1804/8	8	24	7/32	.010"	.043" x .344"
1804/12	12	24	7/32	.010"	.043" x .516"
1804/16	16	24	7/32	.010"	.043" x .688"
1804/20	20	24	7/32	.010"	.043" x .860"

STD. PUT-UP: 250 Ft., 500 Ft., 1000 Ft.

CONDUCTOR COLOR CODE: Same as noted below for C-22 Series. Additional sizes and types available to order.

**FLAT RIBBON CABLE
MULTI-CONDUCTOR — POLYVINYLCHLORIDE
INSULATION CONDUCTORS**

Per MIL-W-16878D TYPE C

VOLTAGE RATING: 1000 VOLTS

DABURN No.	Cond.	Size	Strand	Nom. Wall	Nom. O.D.
1822/4	4	22	7/30	.016"	.065" x .260"
1822/8	8	22	7/30	.016"	.065" x .520"
1822/12	12	22	7/30	.016"	.065" x .780"
1822/16	16	22	7/30	.016"	.065" x 1.040"
1822/20	20	22	7/30	.016"	.065" x 1.300"

STD. PUT-UP: 250 Ft., 500 Ft., 1000 Ft.

CONDUCTOR COLOR CODE:

1—White	6—Lt. Blue	11—Wh/Black	16—Wh/Brown
2—Black	7—Brown	12—Wh/Red	17—Wh/Orange
3—Red	8—Orange	13—Wh/Green	18—Wh/Gray
4—Green	9—Gray	14—Wh/Yellow	19—Wh/Violet
5—Yellow	10—Violet	15—Wh/Blue	20—Wh/Bk/Red

SEMI-RIGID BUSINESS MACHINE WIRE — U.I.

300 VOLT 80°C — STYLE 1061

Stranded tinned copper, color coded semi-rigid polyvinylchloride insulation. Has Temperature Rating of -10°C to +80°C, 300 volts in electronic computers or business machines only.

DESCRIPTION: One Conductor stranded tinned copper, semi-rigid PVC.

DABURN No.	Size	Strand	Nom. Ins. Wall	Nom. O.D.
2660/26	26	7/34	.009"	.039"
2660/24	24	7/32	.009"	.041"
2660/22	22	7/30	.009"	.048"
2660/20	20	7/28	.009"	.056"
2660/18	18	7/26	.009"	.072"

STD. PUT-UP: 500 Ft., 1000 Ft.

PLASTIC HOOK-UP WIRE

600 VOLT UL APPROVED — 105°C (CSA 600V — 90°C)
STYLE 1015, CSA TR-32

Resistant to acids, alkalis, oil, flame, fungus and moisture. Temperature Rating: -10°C to +105°C.

STRANDED				
DABURN No.	Size	Strand	Nom. Ins. Wall	Nom. O.D.
2630	22	7/30	.032"	.095"
2631	20	10/30	.032"	.102"
2632	18	16/30	.032"	.112"
2633	16	26/30	.032"	.126"
2633/14	14	41/30	.032"	.142"

SOLID				
DABURN No.	Size	Strand	Nom. Ins. Wall	Nom. O.D.
2635/22	22	1	.032"	.095"
2635/20	20	1	.032"	.102"

COLORS: Black, Red, Green, Yellow, Blue, White, Orange, Gray, Purple.

STD. PUT-UP: 100 Ft., 500 Ft., 1000 Ft.

DESCRIPTION: One conductor stranded annealed copper tinned, plastic insulation.

MIL-W-16878D — TYPES F & FF

TYPE F — 600V • TYPE FF — 1000V

Single conductor, stranded tinned copper. Extruded silicone rubber overall. Temp. to 200°C.

DABURN No.	MIL Type Designation	Size AWG	Strand	Nom. O.D.
2620/28	F-28	28	7/36	.046"
2622/28	FF-28	28	7/36	.078"
2620/26	F-26	26	7/34	.050"
2622/26	FF-26	26	7/34	.082"
2620/24	F-24	24	19/36	.055"
2622/24	FF-24	24	19/36	.087"
2620/22	F-22	22	19/34	.062"
2622/22	FF-22	22	19/34	.094"
2620/20	F-20	20	19/32	.070"
2622/20	FF-20	20	19/32	.102"
2620/18	F-18	18	19/30	.080"
2622/18	FF-18	18	19/30	.112"
2620/16	F-16	16	19/29	.088"
2622/16	FF-16	16	19/29	.120"
2620/14	F-14	14	19/27	.118"
2622/14	FF-14	14	19/27	.165"
2620/12	F-12	12	19/25	.137"
2622/12	FF-12	12	19/25	.184"
2622/10	FF-10	10	37/26	.205"
2622/8	FF-8	8	133/29	.290"
2622/6	FF-6	6	133/27	.333"
2622/4	FF-4	4	133/25	.390"

COLOR: White. Additional colors, sizes and types to order, thru size 4/0. STD. PUT-UP: 500 Ft., 1000 Ft.

SILICONE RUBBER LEAD WIRE

600 VOLT — 200°C

FLEXIBILITY FROM -104°C TO +400°F

Suitable for high-heat and hi-frequency applications. Resistant to acids, alkali, oil. Retains physical properties under extremes. Low power factor, low dielectric constant. Tinned copper, stranded, silicone rubber insulation, glass braid, lacquered. Color: White.

DABURN No.	Size	Strand	Nom. Ins. Wall	Nom. O.D.
2625/22	22	7/30	1/32"	.105"
2625/20	20	10/30	1/32"	.121"
2625/18	18	16/30	1/32"	.128"
2625/16	16	26/30	1/32"	.144"
2625/14	14	41/30	1/32"	.165"
2625/12	12	65/30	1/32"	.185"
2625/10	10	65/28	3/64"	.240"
2625/8	8	84/27	1/16"	.320"

DESCRIPTION: One conductor, tinned copper strands, silicone rubber insulation, glass braid, lacquered.

COLOR: White

STD. PUT-UP: 100 Ft., 500 Ft., 1000 Ft.

HI-VOLTAGE CABLE

One conductor, stranded copper tinned, rulan — flame retardant — polyethylene insulation, braided tinned copper overall when shielded. Used as hi-voltage leads in electronic equipment to minimize RF radiation in equipment.

UNSHIELDED					
Daburn Size No.	AWG	Strand	Nom. Ins. Wall	Voltage Breakdown AC	Nom. DC O.D.
2641	22	7/30	.047"	5,000	10,000 .124"
2642	20	10/30	.047"	5,000	10,000 .125"
2643	20	10/30	.068"	10,000	20,000 .168"
2644	18	16/30	.047"	5,000	10,000 .134"
2645	18	16/30	.068"	10,000	20,000 .178"
2648	18	16/30	.095"	16,000	40,000 .235"
2649	18	16/30	.124"	26,000	60,000 .280"

DESCRIPTION: One conductor, stranded copper tinned, rulan (flame retarding type) polyethylene insulation. Available white/red tracer. Temp. Rating: 105°C.

Shielded: Same as above with tinned copper braided shield overall. Special construction available to order.

SHIELDED					
Daburn Size No.	AWG	Strand	Nom. Ins. Wall	Voltage Breakdown AC	Nom. DC O.D.
2652	20	10/30	.095"	16,000	40,000 .252"
2655	18	16/30	.095"	16,000	40,000 .255"
2656	16	26/30	.095"	16,000	40,000 .276"

STD. PUT-UP: 100 Ft., 500 Ft., 1000 Ft.

300 VOLT UL APPROVED — 80°C

STYLE 1007, CSA TR-64

DABURN No.	Size	Strand	Nom. Ins. Wall	Nom. O.D.
2628/24	24	7/32	.016"	.057"
2628/22	22	7/30	.016"	.065"
2628/20	20	10/30	.016"	.070"
2628/18	18	16/30	.016"	.080"
2628/16	16	26/30	.016"	.095"

COLORS: Black, Red, Green, Yellow, Blue, Brown, White, Orange, Gray, Purple.

STD. PUT-UP: 100 Ft., 500 Ft., 1000 Ft.

DABURN

DABURN ELECTRONICS & CABLE CORP.
WIRE • CABLE • TUBING • MIL/COMM • SWITCHES • ELECTRONIC HARDWARE

PORTABLE CORD, CONTROL CABLES — MIL-C-3432B SERVICE CORD

RUBBER, NEOPRENE & PLASTIC PORTABLE CORD
UL APPROVED — 300 AND 600 VOLT

For power line requirement where rough usage is indicated as for amplifiers, sound systems, speakers, vacuum cleaners, washing machines, trouble lights, refrigerators, etc. Color coded. Underwriters approved. Neoprene and plastic construction recommended for equipment exposed to oil, acids, outdoor use, direct burial, etc.

SUGGESTED OPERATING TEMPERATURE: -20°C to +60°C.

Each conductor, copper conductor, paper separator, color coded, rubber insulation, filler, (where necessary) separator, tough rubber or neoprene jacket, black.



UL TYPE	VOLT RATING
SV, SVO, SVTO	300V
SJ, SJO, SJTO	300V
S, SO, STO	600V

RUBBER Daburn No.	UL Type	NEOPRENE Daburn No.	UL Type	PLASTIC Daburn No.	UL Type	Conds. No.	Size	Amp. Rating	Nom. O.D.
2860	SV	2890	SVO	2870	SVTO	2	18	7	.250"
2860/3	SV	2890/3	SVO	2870/3	SVTO	3	18	7	.265"
2861	SJ	2891	SJO	2871	SJTO	2	18	7	.300"
2861/3	SJ	2891/3	SJO	2871/3	SJTO	3	18	7	.330"
2861/4	SJ	2891/4	SJO	2871/4	SJTO	4	18	6	.360"
2862	SJ	2892	SJO	2872	SJTO	2	16	10	.325"
2862/3	SJ	2892/3	SJO	2872/3	SJTO	3	16	10	.365"
2862/4	SJ	2892/4	SJO	2872/4	SJTO	4	16	8	.395"
2863	S	2893	SO	2873	STO	2	18	7	.390"
2863/3	S	2893/3	SO	2873/3	STO	3	18	7	.405"
2863/4	S	2893/4	SO	2873/4	STO	4	18	6	.435"
2864	S	2894	SO	2874	STO	2	16	10	.410"
2864/3	S	2894/3	SO	2874/3	STO	3	16	10	.430"
2864/4	S	2894/4	SO	2874/4	STO	4	16	8	.485"
2865	S	2895	SO	2875	STO	2	14	15	.540"
2865/3	S	2895/3	SO	2875/3	STO	3	14	15	.560"
2865/4	S	2895/4	SO	2875/4	STO	4	14	12	.605"
2866	S	2896	SO	2876	STO	2	12	20	.600"
2866/3	S	2896/3	SO	2876/3	STO	3	12	20	.635"
2866/4	S	2896/4	SO	2876/4	STO	4	12	16	.665"
2867	S	2897	SO	2877	STO	2	10	25	.640"
2867/3	S	2897/3	SO	2877/3	STO	3	10	25	.690"
2867/4	S	2897/4	SO	2877/4	STO	4	10	20	.745"
2868	—	2898	—	—	—	2	8†	35	.700"
2868/3	—	2898/3	—	—	—	3	8†	35	.750"
2868/4	—	2898/4	—	—	—	4	8†	28	.820"
2869	—	2899	—	—	—	2	6†	45	.820"
2869/3	—	2899/3	—	—	—	3	6†	45	.885"
2869/4	—	2899/4	—	—	—	4	6†	36	.975"

Additional conductors and sizes available † Not listed by UL.
CONDUCTOR COLOR CODE: 1-White, 2-Black, 3-Green, 4-Red.
STD. PUT-UP: 250 Ft.

COMPONENT CABLE TYPE SPECIFICATIONS

TYPICAL EXAMPLE:

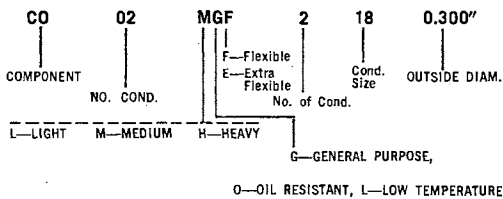

SPEC MIL-C-3432C SERVICE CORD



DABURN Cat. No.	MIL Type	Spec. Design.	Conds.	Size	Spec. No.	Nom. O.D.
2812	CO-02	MGF	2	18	MIL-C-3432C	.300"
2813	CO-02	HGF	2	18	MIL-C-3432C	.380"
2814	CO-02	LGF	2	18	MIL-C-3432C	.250"
2815	CO-02	HGF	2	16	MIL-C-3432C	.405"
2816	CO-02	MGF	2	16	MIL-C-3432C	.338"
2817	CO-02	MGF	2	14	MIL-C-3432C	.400"
2818	CO-02	HGF	2	14	MIL-C-3432C	.535"
2819	CO-02	MGF	3	18	MIL-C-3432C	.340"
2820	CO-03	MGF	3	16	MIL-C-3432C	.375"
2821	CO-03	HOE	3	12	MIL-C-3432C	.635"

Additional Numbers Available From Stock — Your Inquiries Invited

CONTROL CABLE
HEAVY DUTY MULTI-CONDUCTOR
PORTABLE TYPE SO
NEOPRENE JACKETED — 600 VOLT



DESCRIPTION: Stranded bare copper each conductor, rubber insulation color coded, filler where necessary, wrap over conductors, flexible heavy duty black Neoprene jacket overall.

Recommended for outside installation, this heavy duty control cable resists oil, ozone, sunlight, moisture, impact and abrasion. Suitable for remote control automatic equipment, telemetering, signal transmission.

No. 18 AWG-SO CONTROL CABLE

DABURN Cat. No.	Cond.	Size AWG	Strand	Nom. O.D.
3300/5	5	18	16/30	.495"
3300/6	6	18	16/30	.525"
3300/7	7	18	16/30	.525"
3300/8	8	18	16/30	.565"
3300/10	10	18	16/30	.635"
3300/12	12	18	16/30	.665"
3300/14	14	18	16/30	.715"
3300/16	16	18	16/30	.745"
3300/18	18	18	16/30	.775"
3300/20	20	18	16/30	.815"
3300/22	22	18	16/30	.875"
3300/24	24	18	16/30	.895"
3300/26	26	18	16/30	.915"
3300/30	30	18	16/30	.945"
3300/36	36	18	16/30	1.060"
3300/40	40	18	16/30	1.085"

No. 16 AWG-SO CONTROL CABLE

DABURN Cat. No.	Cond.	Size AWG	Strand	Nom. O.D.
3305/5	5	16	26/30	.525"
3305/6	6	16	26/30	.560"
3305/7	7	16	26/30	.560"
3305/8	8	16	26/30	.605"
3305/10	10	16	26/30	.710"
3305/12	12	16	26/30	.745"
3305/14	14	16	26/30	.760"
3305/16	16	16	26/30	.800"
3305/18	18	16	26/30	.840"
3305/20	20	16	26/30	.890"
3305/22	22	16	26/30	.930"
3305/24	24	16	26/30	1.02"
3305/26	26	16	26/30	1.03"
3305/30	30	16	26/30	1.05"
3305/36	36	16	26/30	1.12"
3305/40	40	16	26/30	1.18"

No. 14 AWG-SO CONTROL CABLE

DABURN Cat. No.	Cond.	Size AWG	Strand	Nom. O.D.
3310/5	5	14	41/30	.685"
3310/6	6	14	41/30	.745"
3310/7	7	14	41/30	.800"
3310/8	8	14	41/30	.860"
3310/10	10	14	41/30	.875"
3310/12	12	14	41/30	.945"
3310/14	14	14	41/30	1.000"
3310/16	16	14	41/30	1.075"
3310/18	18	14	41/30	1.115"
3310/20	20	14	41/30	1.155"

No. 12 AWG-SO CONTROL CABLE

DABURN Cat. No.	Cond.	Size AWG	Strand	Nom. O.D.
3315/5	5	12	65/30	.760"
3315/6	6	12	65/30	.810"
3315/7	7	12	65/30	.860"
3315/8	8	12	65/30	.945"
3315/10	10	12	65/30	1.000"
3315/12	12	12	65/30	1.100"
3315/14	14	12	65/30	1.120"
3315/16	16	12	65/30	1.150"
3315/18	18	12	65/30	1.30"
3315/20	20	12	65/30	1.33"

STD. PUT-UP: Cut to Specific Lengths — Min. 100 Ft.

The Color Code for Neoprene Jacket Control Cables Conforms to IPCEA Standards.

MULTI-CONDUCTOR MICROPHONE AND CONTROL CABLE — PLASTIC



Each conductor tinned copper, polyethylene insulation — color coded. Multi-conductors cabled with fillers, textile wrapped, tinned copper braided shield, gray polyvinyl jacket overall.

OPERATING TEMPERATURE: -20°C to +60°C, 600 Volts.

2782	2	22	16/34	31 MMF	1000 V	.231"
2782/20	2	20	26/34	45 MMF	600 V	.240"
2782/24	2	24	10/34	38 MMF	1000 V	.190"

DABURN Cat. No.	Cond.	Size	Strand	Nom. Wall	Nom. Jacket	Nom. O.D.
2783	3	20	26/34	.014"	.030"	.250"
2784	4	20	26/34	.014"	.035"	.260"
2785	5	20	26/34	.014"	.035"	.275"
2786/8	8	20	26/34	.014"	.035"	.330"
2786/10	10	20	26/34	.014"	.035"	.375"
2786/12	12	20	26/34	.014"	.035"	.380"
2786/15	15	20	26/34	.014"	.035"	.410"
2786/20	20	20	26/34	.014"	.035"	.455"

STD. PUT-UP: 100 Ft., 250 Ft., 500 Ft., 1000 Ft.

CONDUCTOR COLOR CODE: 1-White, 2-Black, 3-Red, 4-Green, 5-Yellow, 6-Blue, 7-Brown, 8-Orange, 9-Purple, 10-Slate, 11-White/Black, 12-White/Red, 13-White/Green, 14-White/Yellow, 15-White/Blue, 16-White/Brown, 17-White/Purple, 18-White/Slate, 19-Black/Red, 20-Black/Yellow.

DABURN

DABURN ELECTRONICS & CABLE CORP.

WIRE • CABLE • TUBING • MIL/COMM • SWITCHES • ELECTRONIC HARDWARE

POWER CORDS • COAXIAL CABLE • ROTOR • SPEAKER CABLE

SERVICE CORD — HEAVY DUTY

UL and CSA approved

Suitable for replacement on machinery, tools, refrigerators, electronic devices

DESCRIPTION: Two and three conductors, stranded bare copper, serve, rubber insulation, filler, wrap, tough black rubber jacket overall. Molded plug one end, free end stripped and tinned — Hanked.

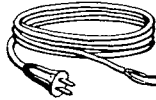

VOLTAGE RATING: 300V

DABURN No.	Cord L'gth.Ft.	Cond.	Size	Strand	Type	Amp Rating	Cord O.D.
1980	8	2	16	65/34	SJ	10	.325"
1980/3	8	3	16	65/34	SJ	10	.355"
1982/3	8	3	18	41/34	SJ	7	.330"
1984	9	2	18	41/34	SV	7	.245"
1984/3	9	3	18	41/34	SV	7	.265"

Std. Pkg. 25

UL APPROVED — SERVICE LINE CORD

Use as an all purpose power supply cord for small appliances, lamps, radios, etc.

DESCRIPTION: Two conductors parallel SP-1 (POSJ) with molded-on male plug, double brass blades, conductor end stripped and tinned — Hanked. Available in black and brown. 300V rating.

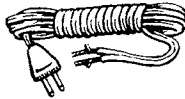

DABURN No.	Length	Cond.	Size	Strand	Nom. O.D.	Std. Pkg.
1987	6	2	18	41/34	130" x .235"	50
1988	7½	2	18	41/34	130" x .235"	50

LAMP CORD

Types SP-1 (POSJ-64) — Type SP-1 (POT) UL Approved

An all purpose approved cord both SP-1 (rubber) and SP-1 (Plastic) for lamps, radios and small instruments and appliances. 300V rating.

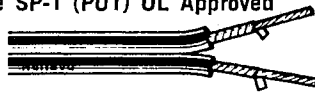

DABURN No.	Cond.	Size	Strand	Insul.	Type	UL Type	Nom. O.D.
1990	2	18	41/34	Rubber	SP-1	POSJ	.130"x.235"
1991	2	18	41/34	Plastic	SPT-1	POT	.130"x.225"
1993	2	18	41/34	Pl. Clear	SPT-1	POT	.115"x.215"
1994	2	16	65/34	Pl. Brown	SPT-2	POT	.160"x.300"

STD. PUT-UP: 100 Ft., 250 Ft., 500 Ft., 1000 Ft.

CDLORS: (Rubber) Brown, Black, White; (Plastic) Brown, Black, Ivory.

DABURN COAXIAL CABLES WITH HIGH TEMPERATURE TEFLON® CORE DIELECTRIC

Meets MIL-C-17C

These Teflon® Core Dielectric Co-Axial Cables combine both miniaturization and hi-temperature qualities. The Teflon Jackets are weatherproof, resistant to fuels and are extremely flexible. Shield: Silver Covered Copper.

DABURN No.	Military Number RG/U Type	Cap. MMFT/Ft. Ohms	Inner Conductor	O.D. Inches	Max. Oper. Volts RMS	Nom. Atten. DB/100' 400 Mc	RG/U Type
D187A/U	187A/U	75 19.5	7/28 Silvered Copperweld	.110	1200	16.0	187A/U
D188/U	188/U	50 29.0	7/.0067 Silvered Copperweld	.110	1200	16.7	188/U
D188A/U	188A/U	50 29.0	7/.0067 Silvered Copperweld	.110	1200	16.7	188A/U
D195/U	195/U	95 15.0	7/38 Silvered Copperweld	.155	1500	11.0	195/U
D195A/U	195A/U	95 15.0	7/38 Silvered Copperweld	.155	1500	11.0	195A/U
D196/U	196/U	50 28.5	7/38 Silvered Copperweld	.080	1000	28.0	196/U
D196A/U	196A/U	50 28.5	7/38 Silvered Copperweld	.080	1000	28.0	196A/U

STD. PUT-UP: 500 Ft., 1000 Ft. *TEFLON—DUPONT

JKT MTL.: D187A/U Teflon. All others TFE Teflon.

POWER CORD SETS

UL and CSA approved

Manufactured for lasting service these 2 and 3 conductor quality black rubber cords are flexible. Rated at 300 volts. One end has molded plastic male plug, other end molded female plug. Will fit conventional plugs and sockets.

Useful for business and data machines, projectors, vacuum cleaners, appliances, etc.

CUSTOM CONSTRUCTION OF POWER CORDS MADE TO ORDER.

Std. Pkg. 25

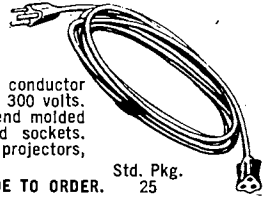

Cat. No.	Size & Conds.	Cord Length Ft.	UL Type	Strand	Amp Rating	Nom. O.D.
9-201	2/18	6	SV	41/34	7	.245"
9-202	2/18	9	SV	41/34	7	.245"
9-203	2/18	10	SJ	16/30	7	.300"
9-204	2/18	25	SJ	16/30	7	.300"
9-206	2/16	10	SJ	26/30	10	.325"
9-207	2/16	25	SJ	26/30	10	.325"
9-208	2/16	50	SJ	26/30	10	.325"
9-211	3/18	10	SJ	16/30	7	.330"
9-212	3/18	25	SJ	16/30	7	.330"
9-213	3/18	50	SJ	16/30	7	.330"
9-215	3/16	15	SJ	26/30	10	.365"
9-216	3/16	25	SJ	26/30	10	.365"
9-217	3/16	50	SJ	26/30	10	.365"

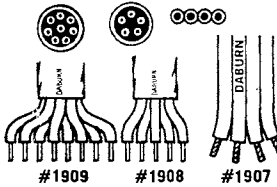

ANTENNA CONTROL ROTOR CABLE

#1907 — 4 cond. flat parallel polyethylene plastic insulation — one outer conductor tinned, balance bare copper.

#1908 — 5 cond. twisted, color coded, vinyl plastic jacket overall.

#1909 — 8 cond. twisted, color coded vinyl plastic jacket overall.

DABURN No.	Cond.	Size	Strand	Nom. O.D.
1907	4	20	7/28	.072" x .390"
1908	5	20	7/28	.180"
1909	8	22	7/30	.205"

CONDUCTOR COLOR CHART FOR #1908, 1909

1-Black, 2-White, 3-Red, 4-Green, 5-Yellow, 6-Blue, 7-Brown, 8-Orange. STD. PUT-UP: 500 Ft., 1000 Ft.

RG/U COAXIAL CABLE

DESCRIPTION: One conductor, polyethylene insulation, copper braid shield, plastic jacket overall.

DABURN No.	Spool	Type	Nom. Imp.	Size	Nom. MMFD/Ft.	Strand	O.D.
1925	500'	RG-8/U	52	13	29.5	7/21 Bare	.405"
1926	500'	RG-9/U	51	13	30.0	7/21 S	.420"
1927	500'	RG-11/U	75	18	20.5	7/26 Tinned	.405"
1928	1000'	RG-58A/U	50	20	29.0	19/.0068 Tinned	.195"
1929	1000'	RG-58/U	53.5	20	28.5	Solid	.195"
1930	1000'	RG-59/U	73	22	21.0	Solid C.W.	.242"
1931	1000'	RG-62/U	93	22	13.5	Solid	.242"

Additional RG numbers available conforming to MIL-C-17B Specs.

PLASTIC SPEAKER CABLE CLEAR AND COLORED INSULATION

DESCRIPTION: Conductors are parallel, stranded bare copper, color coded and clear polyvinylchloride insulation. Conductors separate quickly when split apart. Suitable for hi-fi speaker cable, miniature juke-box speaker connection, rear auto speaker extension cable. Clear insulation blends with any interior.

TEMPERATURE RATING: -20°C to +60°C. OPER. VOLTAGE: 300V

Daburn No.	Cond.	Size	Strand	Nom. Wall	Nom. O.D.	Stock Colors
2754	2*	24	7/32	.016"	.057"x.120"	Brn., Bk., Wh., Gray, Tan
2755	2*	24	7/32	.016"	.057"x.120"	Clear
2756	2	20	10/30	.016"	.085"x.175"	Brn., Bk., Wh., Gray, Tan
2757	2	20	10/30	.016"	.085"x.175"	Clear
2758	2	18	41/34	.032"	.115"x.215"	Brn., Bk., Wh., Gray, Tan
2759	2	18	41/34	.032"	.115"x.215"	Clear

* 1 conductor tinned, 1 bare.

STD. PUT-UP: 100 Ft., 250 Ft., 500 Ft., 1000 Ft.

DABURN**DABURN ELECTRONICS & CABLE CORP.**
WIRE • CABLE • TUBING • MIL/COMM • SWITCHES • ELECTRONIC HARDWARE

Long Lasting Service — useful wherever cords must change length or position. Extend to approximately six times its retracted length. Returns to its original shape or length when released. Eliminates tangling, twisting or knots. Cords are UL and CSA approved.

RETRACTILE COILED CORDS**POWER CORDS — RETRACTED LENGTHS: 1, 2, 3 & 4 FT. • EXTENDED LENGTHS: 6, 12, 18 & 25 FT.****UL APPROVED — NEOPRENE JACKETED CORD**

Operating Temperature: -20°C to +60°C

DABURN CAT. NOS.		RETRACTED LENGTHS				No. Conds.	Size	Strand	UL* and CSA Type	Amps	Volt Rating	Coil Nom. O.D.	Cord Nom. O.D.
4 Ft. Length	3 Ft. Length	2 Ft. Length	1 Ft. Length										
986-4	986-3	986-2	986-1	2	18	41/34	SVO	7	300	7/8"	.250"		
986/3-4	986/3-3	986/3-2	986/3-1	3	18	41/34	SVO	7	300	1"	.275"		
987-4	—	—	—	2	18	41/34	SVT	7	300	7/8"	.250"		
989-4	989-3	989-2	989-1	2	18	41/34	SJO	7	300	1 1/8"	.310"		
989/3-4	989/3-3	989/3-2	989/3-1	3	18	41/34	SJO	7	300	1 3/8"	.330"		
989/4-4	989/4-3	989/4-2	989/4-1	4	18	41/34	SJO	5.6	300	1 7/8"	.360"		
989/5-4	—	989/5-2	—	5	18	41/34	—	5.6	300	1 3/4"	.440"		
989/7-4	—	989/7-2	—	7	18	41/34	—	5.6	300	1 7/8"	.500"		
990-4	—	—	—	2	18	41/34	SJT	7	300	1 3/8"	.310"		
991-4	991-3	991-2	991-1	2	16	65/34	SJO	10	300	1 3/8"	.330"		
991/3-4	991/3-3	991/3-2	991/3-1	3	16	65/34	SJO	10	300	1 7/8"	.365"		
991/4-4	991/4-3	991/4-2	—	4	16	65/34	SJO	8	300	1 5/8"	.395"		
991/5-4	—	991/5-2	—	5	16	65/34	—	8	600	2"	.540"		
991/6-4	—	991/6-2	—	6	16	65/34	—	8	600	2 1/8"	.550"		
991/7-4	—	991/7-2	—	7	6/16 1/14	#16-65/34 #14-41/30	—	#16-8 #14-12	600	2 1/4"	.600"		
993-4	993-3	993-2	—	2	14	41/30	SO	15	600	2"	.535"		
993/3-4	993/3-3	993/3-2	—	3	14	41/30	SO	15	600	2 1/8"	.560"		
993/4-4	993/4-3	993/4-2	—	4	14	41/30	SO	12	600	2 1/4"	.605"		
994-4	994-3	994-2	—	2	12	65/30	SO	20	600	2 1/4"	.605"		
994/3-4	994/3-3	994/3-2	—	3	12	65/30	SO	20	600	2 3/8"	.635"		
994/4-4	994/4-3	994/4-2	—	4	12	65/30	SO	16	600	2 1/2"	.655"		
994/6-4	—	994/6-2	—	6	2/12 4/18	#12-65/30 #18-41/34	—	#12-17 #18-6	600	2 3/4"	.605"		
994/7-4	—	994/7-2	—	7	12	65/30	—	16	600	2 5/8"	.775"		

* Wherever UL type is shown, approved by CSA Testing Laboratories. Preferred Put-up.

Std. Pkg. 5

CONDUCTOR COLOR CODE: 1-Black, 2-White, 3-Green, 4-Red, 5-Blue, 6-Brown, 7-Yellow.

DABURN MINIATURE RETRACTILE COMMUNICATION CORDS**2 Feet Retracted — 10 Ft. Extended**

Miniature size. Suitable for compact equipment. Black plastic jacket overall. Operating Temperature: -20°C to +60°C

DABURN No.	Conds.	Size	Strand	Coil O.D.	Cord O.D.
975/28	2	28	19/40 T.C.	1/2"	.135"
977/28	4	28	19/40 T.C.	1/2"	.150"

RETRACTILE TEST LEAD WIRE

Stretch coiled kinkless test lead wire description. 12" coil — stretches to approx. 6 feet. One conductor #20 stranded copper rubber insulation .165 O.D. Colors: Red, Black. Coil O.D. 3/4". Working Voltage: 1000V, 4 Amps.

DABURN No.	Lgth.	Size	Strand	Coil O.D.	Cord O.D.
984A	12"	20	41/36	3/4"	.165"
984	24"	20	41/36	3/4"	.165"

12" Extends Approx. 6 Ft.
24" Extends Approx. 12 Ft.

Specify Color, Red or Black Std. Pkg. 6

UL APPROVED RETRACTILE POWER CORD SETS**18" Retracted — Approx. 9 Ft. Extended — 300V — UL Approved**

For portable use. Mobile and office equipment. Neoprene jacketed cord sets with molded male plug on one end. OPERATING VOLTAGE 300 VOLTS

DABURN Cat. No.	Conds.	AWG Size	Strand	Type	Coil O.D.	Cord O.D.
980	2	18	41/34	SVO	7/8"	.250"
980/3	3	18	41/34	SVO	1"	.275"
981	2	18	41/34	SJO	1 1/8"	.310"
981/3	3	18	41/34	SJO	1 3/8"	.330"
982	2	16	65/34	SJO	1 3/8"	.330"
982/3	3	16	65/34	SJO	1 7/8"	.365"

CONDUCTOR COLOR CODE: 1-Black, 2-White, 3-Green.

Std. Pkg. 10

RETRACTILE COMMUNICATION COIL CORDS**RETRACTED LENGTHS 2, 3 & 4 FT. — EXTENDED LENGTHS 12, 18 & 25 FT.**

Multi-conductors stranded extra flexible #23 AWG 21/36 tinned soft copper for long flex life. Neoprene or "Danyon" plastic jacketed cable for long life. 120 volt working, current carrying capacity 1 ampere. Nom. cond. resist. .022 ohms per linear foot, .185 ohms per retracted foot.

For communication equip. such as ham operations, telephone car carriers, radio equip., head sets, etc.

SPECIAL CONSTRUCTION AVAILABLE TO ORDER

DABURN CAT. NOS. RETRACTED LENGTHS		No. Conds.	Size	Strand	Nom. Coil O.D.	Nom. Cord O.D.
4 Ft.*	3 Ft.					
975-4	975-3	2	23	21/36	3/4"	.200"
976-4	976-3	3	23	21/36	1 1/4"	.210"
977-4	977-3	4	23	21/36	7/8"	.240"
978-4	978-3	5	23	21/36	1"	.285"
978/6-4	978/6-3	6	23	21/36	1 1/8"	.305"
978/7-4	978/7-3	7	23	21/36	1 1/4"	.320"

Operating Temperature: -20°C to +60°C

DABURN CAT. NOS. RETRACTED LENGTHS		No. Conds.	Size	Strand	Nom. Coil O.D.	Nom. Cord O.D.
4 Ft.*	3 Ft.					
978/8-4	—	8	23	21/36	1 3/8"	.360"
978/10-4	—	10	23	21/36	1 5/8"	.380"
978/12-4	—	12	23	21/36	1 7/8"	.410"
978/15-4	—	15	23	21/36	1 3/2"	.470"
978/37-4	—	37	23	21/36	2 1/2"	.680"

CONDUCTOR COLOR CODING: 1-Black, 2-White, 3-Red, 4-Green, 5-Blue, 6-Yellow, 7-Brown, 8-Orange, 9-White / Black Tracer, 10-White / Red Tracer, 11-White / Green Tracer, 12-White/Blue Tracer, 13-White/Yellow Tracer, 14-White/Brown Tracer, 15-White / Orange Tracer. *Preferred Put-Up.

SHIELDED RETRACTILE COMMUNICATION CORDS**RETRACTED LENGTHS 1, 2 & 4 FT. — EXTENDED LENGTHS 6, 12 & 25 FT.**

Single and multi-cond. Shielded mike cables Neoprene or "Danyon" plastic jacketed shielded conductors are individually shielded. Shield can be pigtailed for soldering. Safe — Reliable.

OPERATING TEMPERATURE: -20°C TO +60°C

DABURN CAT. NOS. RETRACTED LENGTHS		No. Conds.	Size	Strand	Nom. Coil O.D.	Nom. Cord O.D.	Volt Rating	CAPACITANCE	
4 Ft. L'gth.	2 Ft. L'gth.							MMF Lin. Ft.	MMF Retr. Ft.
995-4i	995-2	1	24 Shielded	41/40	5/8"	.160"	75	56	440
996-4	996-2	2	1-23 1-24 Shielded	21/36 41/40	7/8"	.210"	#23-120 #24-75	56	450
997-4	997-2	3	2-23 1-24 Shielded	21/36 41/40	7/8"	.240"	#23-120 #24-75	56	450
999-4	999-2	2	2-24 Shielded	41/40	7/8"	.210"	75	56	450
999-4	999-2	4	2-23 2-24 Shielded	21/36 41/40	1"	.270"	#23-120 #24-75	56	460

† Preferred Put-Up

Conductors are Color Coded.

Std. Pkg. 10

SPECIAL CONSTRUCTIONS AVAILABLE TO ORDER

DABURN

DABURN ELECTRONICS & CABLE CORP.
WIRE • CABLE • TUBING • MIL/COMM • SWITCHES • ELECTRONIC HARDWARE

**RETRACTILE
SUPA HEAVY DUTY
POWER CORDS**

48" RETRACTED, APPROX.
25 FEET EXTENDED NEOPRENE
JACKET

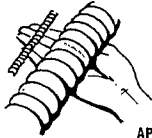

APPROVED UL, CSA,
COAST GUARD, ARMY,
NAVY, BUR. OF MINES

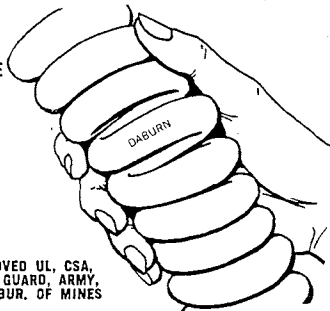

SUGGESTED OPERATING TEMPERATURE: -20°C to +60°C.

Suitable for maintenance of industrial automation equip., refrigerated trucks, mass production, cherry pickers, magnetic cranes, standby power distribution. Wherever a tougher requirement is indicated. Std. Pkg. 6 Retracted length 48" --- extends to 25 ft.

DABURN Cat. No.	No. Cond.	Size	Stranding	Nom. Jacket Thickness	Nom. Cord O.D.
960	3	16	65/34	7/64"	.505"
960/4	4	16	65/34	7/64"	.535"
961	3	14	41/30	7/64"	.620"
961/4	4	14	41/30	7/64"	.660"
962	3	12	65/30	8/64"	.715"
962/4	4	12	65/30	8/64"	.770"



**RETRACTILE COMMUNICATION CORD
PREPARED**

Retracted length 12" — extended length 6 feet.
Same as our regular communication cord but each end is prepared, stripped and tinned

Daburn No.	No. Cond.	Size & Strand	Coil O.D.	Cord O.D.	PREPARED
966	3	#23-21/36	13/16"	.220"	1 END: L'gth 1 1/2". Conductor stripped and tinned. Other end: Total L'gth 1 1/2" jacket removed.
967	4	#23-21/36	15/16"	.250"	1 END: Total length 1". Conductors stripped and tinned. Other end: Total l'gth 1 1/2" jacket removed.
968	5	#23-21/36	1-1/16"	.285"	1 END: Total l'gth 4 3/4". Conductors stripped and tinned. Other end: Total l'gth 4 3/4" conds. stripped and tinned.

Std. Pkg. 10

**AUDIO CABLE — SHIELDED
2 CONDUCTOR SHIELDED
NO OUTER JACKET**

Each conductor copper tinned, plastic insulation, color coded, twisted, tinned copper shield. Suitable for sound systems, industrial paging systems, broadcast-audio cable, rack panel wiring, etc. OPERATING TEMPERATURE: -20°C to +60°C.



DABURN Cat. No.	Conds.	Size AWG.	Strand	Nom. Wall	Nom. O.D.	Nom. Operating Voltage
2902/30	2	30	7/38	.010"	.085"	200V
2902/28	2	28	7/36	.010"	.090"	200V
2902/26	2	26	7/34	.010"	.095"	200V
2902/24	2	24	16/36	.017"	.120"	350V
2902/22	2	22	7/30	.017"	.140"	350V
2902/20	2	20	10/30	.017"	.155"	350V
2902/18	2	18	16/30	.017"	.170"	350V
2902/16	2	16	26/30	.020"	.210"	450V
2902/14	2	14	41/30	.020"	.225"	450V
2902/12	2	12	65/30	.025"	.295"	600V
2902/10	2	10	105/30	.025"	.375"	600V

STD. PUT-UP: 100 Ft., 250 Ft., 500 Ft., 1000 Ft.
CONDUCTOR COLOR CODE: 1—Black, 2—Red.

TELEPHONE CABLE

(Meets REA-PE-22)

**EXCHANGE AREA — COMMUNICATION CABLE
AERIAL, DUCT AND CONDUIT INSTALLATION**



DESCRIPTION: Color coded polyethylene insulation over each bare copper conductor. Conductors are paired. Pairs are cabled with non-hygroscopic tape wrap, corrugated aluminum shield, .008" thick and black polyethylene jacket overall.

Minimal cross talk .083 microfarads/mile — average mutual capacitance 1 KC. This is a tough, long lasting cable — withstands weathering, ultra-violet and weathering.

#22 AWG — SOLID CONDUCTORS

DABURN Cat No.	No. of Pairs	Jkt. T'kness	Nom. O.D.	Ship. Wt. Lbs. M/Ft.
3510/3	3	.060"	.320"	60
3510/6	6	.060"	.390"	100
3510/12	12	.060"	.475"	145
3510/18	18	.060"	.540"	180
3510/25	25	.060"	.605"	226
3510/50	50	.060"	.775"	412
3510/75	75	.060"	.920"	576
3510/100	100	.070"	1.050"	706
3510/150	150	.070"	1.270"	1095
3510/200	200	.070"	1.455"	1382
3510/300	300	.080"	1.750"	1978
3510/400	400	.090"	1.970"	2600
3510/600	600	.100"	2.365"	3900

#19 AWG — SOLID CONDUCTORS

DABURN Cat No.	No. of Pairs	Jkt. T'kness	Nom. O.D.	Ship. Wt. Lbs. M/Ft.
3515/6	6	.060"	.490"	145
3515/12	12	.060"	.660"	231
3515/18	18	.060"	.710"	310
3515/25	25	.060"	.790"	391
3515/50	50	.070"	1.060"	716
3515/75	75	.070"	1.290"	1105
3515/100	100	.080"	1.490"	1380
3515/150	150	.080"	1.750"	2045
3515/200	200	.090"	1.990"	2630
3515/300	300	.100"	2.370"	3900

STD. PUT-UP: 100 Ft. and over. CONDUCTOR COLOR CODE: Per IPCEA. Cut to specification.

TELEPHONE CABLE

DIRECT BURIAL INSTALLATION

(Meets REA-PE-23)



DESCRIPTION: Color coded polyethylene insulation over each bare copper conductor. Conductors are paired. Pairs are cabled with non-hygroscopic tape-wrap, inner jacket of polyethylene, corrugated .005" copper shield, overall black polyethylene jacket.

Minimal cross talk .083 microfarads/mile — average mutual capacitance 1 KC. Suitable for direct burial. Tough, impervious to moisture and abrasion resistant.

#22 AWG — SOLID CONDUCTORS

DABURN Cat No.	No. of Pairs	Jkt. T'kness	Nom. O.D.	Ship. Wt. Lbs. M/Ft.
3525/3	3	.040"	.380"	95
3525/6	6	.040"	.455"	145
3525/12	12	.040"	.535"	195
3525/18	18	.040"	.610"	251
3525/25	25	.040"	.675"	305
3525/50	50	.040"	.860"	507
3525/75	75	.040"	.985"	681
3525/100	100	.040"	1.115"	847
3525/150	150	.050"	1.350"	1240
3525/200	200	.050"	1.505"	1557
3525/300	300	.060"	1.810"	2173
3525/400	400	.060"	2.025"	2853

#19 AWG — SOLID CONDUCTORS

DABURN Cat No.	No. of Pairs	Jkt. T'kness	Nom. O.D.	Ship. Wt. Lbs. M/Ft.
3530/3	3	.040"	.455"	119
3530/6	6	.040"	.500"	206
3530/12	12	.040"	.550"	305
3530/18	18	.040"	.675"	406
3530/25	25	.040"	.770"	519
3530/50	50	.050"	.860"	867
3530/75	75	.050"	1.115"	1250
3530/100	100	.050"	1.350"	1575
3530/150	150	.060"	1.505"	2265
3530/200	200	.060"	1.810"	2900
3530/300	300	.060"	2.025"	4042

STD. PUT-UP: 100 Ft. and over. CONDUCTOR COLOR CODE: Per IPCEA. Cut to specification.

DABURN

DABURN ELECTRONICS & CABLE CORP.
WIRE • CABLE • TUBING • MIL/COMM • SWITCHES • ELECTRONIC HARDWARE

AUDIO, DATA SHIELDED, MICROPHONE & CONTROL CABLES

**AUDIO & DATA SHIELDED CABLE
INDIVIDUALLY ALUMINUM MYLAR FOIL SHIELDED PAIRS**

DESCRIPTION: Each conductor stranded, copper tinned, hi density polyethylene insulation, color coded, conductors — twisted pairs. #22 stranded tinned copper wire. Aluminum foil mylar shield over each pair and copper tinned drain wire. Overall chrome grey PVC jacket. Nom. cap. between conds. of a pair, 25 PF/FT. Capacitance of a single conductor to shield, 45 PF/FT. Sugg. Working Voltage: 300V.

DABURN Cat. No.	No. of Pairs	No. of Conds.	Cond. Strand	Nom. Wall	Nom. Jkt.	Nom. O.D.
2932/3	3	6	7/30	.010"	.025"	.235"
2932/6	6	12	7/30	.010"	.030"	.320"
2932/9	9	18	7/30	.010"	.035"	.370"
2932/11	11	22	7/30	.010"	.040"	.415"
2932/15	15	30	7/30	.010"	.040"	.485"
2932/19	19	38	7/30	.010"	.050"	.530"
2932/27	27	54	7/30	.010"	.055"	.645"

STD. PUT-UP: 500 Ft., 1000 Ft. Construction variations to order.



**AUDIO & DATA SHIELDED CABLE
ALUMINUM MYLAR FOIL SHIELD
INDIVIDUALLY SHIELDED MULTIPLE PAIR**

This construction reduces the bulk in required cables. Multipaired #22 solid tinned copper, vinyl insulated .013", cabled in pairs. Aluminum foil mylar shield over each pair and drain wire over all grey vinyl jacket. Nom. Cap. between Conds. 40 MMF/Ft. Nom. Cap. between 1 Cond. and others connected to shield — 77 MMF/Ft.

DABURN Cat. No.	Pairs	Conds.	Nom. Jacket	Nom. O.D.
2930/3	3	6	.030"	.252"
2930/6	6	12	.037"	.345"
2930/9	9	18	.040"	.410"
2930/11	11	22	.040"	.458"
2930/15	15	30	.045"	.510"
2930/19	19	38	.055"	.570"
2930/27	27	54	.070"	.687"

STD. PUT-UP: 500 Ft., 1000 Ft. Construction Variations Available to Order.



**ALUMINUM MYLAR FOIL SHIELD
PLASTIC JACKETED CABLE**

Extremely light in weight, provides 100% shield coverage — small diameters. Each cond. tinned copper, stranded color coded polyethylene insulation, twisted, drain wire, aluminum mylar foil shield, gray polyvinylchloride jacket overall. Drain wire provides quick and easy grounding.

OPERATING TEMPERATURE: -20°C to +60°C. OPERATING VOLTAGE: 400 Volts.

DABURN Cat. No.	Cond.	Size	Strand	Nom. Wall	Nom. Jacket	Nom. O.D.
2960	2	22	7/30	.015"	.020"	.160"
2960/3	3	22	7/30	.015"	.020"	.185"
2960/4	4	22	7/30	.015"	.020"	.205"
2961	2	20	10/30	.015"	.020"	.185"
2961/3	3	20	10/30	.015"	.020"	.205"
2961/4	4	20	10/30	.015"	.020"	.225"
2962	2	18	16/30	.017"	.020"	.220"
2962/3	3	18	16/30	.017"	.020"	.235"
2962/4	4	18	16/30	.017"	.020"	.255"
2963	2	16	26/30	.017"	.020"	.255"
2963/3	3	16	26/30	.017"	.020"	.275"
2964	2	14	41/30	.017"	.020"	.295"
2964/3	3	14	41/30	.017"	.020"	.305"

STD. PUT-UP: 500 Ft., 1000 Ft.
CONDUCTOR COLOR CODE: 1—Black, 2—Red, 3—White, 4—Green.

SHIELDED CABLE

Suitable for P.A. and sound systems, installation in schools, hospitals and institutions, transmitters, electronic circuits, etc. Construction allows ease of pigtailting. Shield provides additional strength for cable. Each conductor tinned copper, PVC insulation, color coded, twisted, braided T-C shield, gray PVC jacket overall. Suitable for outdoor installations.

OPERATING TEMPERATURE: -20°C to +60°C.

DABURN Cat. No.	Cond.	Size	Strand	Nom. Wall	Nom. Jacket	Operating Voltage	Nom. O.D.
2970	2	22	7/30	.017"	.020"	350V	.175"
2970/3	3	22	7/30	.017"	.020"	350V	.195"
2971	2	20	10/30	.017"	.020"	350V	.195"
2971/3	3	20	10/30	.017"	.020"	350V	.215"
2972	2	18	16/30	.017"	.020"	350V	.235"
2972/3	3	18	16/30	.017"	.020"	350V	.245"
2974	2	16	26/30	.017"	.020"	350V	.255"
2974/3	3	16	26/30	.017"	.020"	350V	.260"
2975	2	14	41/30	.020"	.020"	450V	.290"
2975/3	3	14	41/30	.020"	.020"	450V	.295"
2976	2	12	65/30	.020"	.020"	450V	.235"
2976/3	3	12	65/30	.020"	.020"	450V	.340"

CONDUCTOR COLOR CODE: 1—Black, 2—Red, 3—White.

STD. PUT-UP: 500 Ft., 1000 Ft.

CONSTRUCTION VARIATION TO ORDER

**PLASTIC JACKETED
BRAIDED COPPER SHIELD**



SHIELDED PLASTIC MICROPHONE CABLE



Will withstand abuse and is resistant to oil, moisture, aging. Have low capacitance, hi insulation resistance and low attenuation. Will not strain or mark.

2772 — For hi impedance microphone

2773 — For crystal, ribbon, etc. Mikes all are suitable for hi-fi interconnecting

2774 — For hi impedance lapel mikes.

OPERATING TEMPERATURE: -20°C to +60°C.

SHIELDED MICROPHONE CABLE ONE CONDUCTOR

Uses tinned copper spiral shield — for ease in soldering — extremely flexible-plastic.

DABURN Cat. No.	Cond.	Size	Strand	Shield	Nom. Cap./Ft. MMF	Sugg. Work Voltage	Nom. O.D.
2770	1	25	7/33	Spiral	23	3000	.159"
2771	1	25	7/33	Spiral	33	1000	.120"
2772	1	20	26/34	Braid	36	4000	.175"
2773	1	25	7/33*	Braid	34	3500	.144"
2774	1	25	7/33*	Braid	23	5000	.190"

* 3 strand tinned copper, 4 strand tinned copperweld.

**MULTICONDUCTOR
MICROPHONE CABLE**



Each conductor tinned copper, polyethylene insulation — color coded, twisted with fillers, textile wrap, tinned copper braid shield, gray vinyl jacket overall. OPERATING TEMPERATURE: -20°C to +60°C, 600 Volts.

DABURN Cat. No.	Cond.	Size	Strand	Nom. Cap./Ft. MMF	Nom. Jacket	Nom. O.D.
2782	2	22	16/34	31 MMF	1000	.231"
2782/20	2	20	26/34	45 MMF	600	.240"
2782/24	2	24	10/34	38 MMF	1000	.190"

**SHIELDED ULTRA LOW CAPACITY
MICROPHONE CABLE**

Plastic Jacket — Cellular Foam Polyethylene Insulation
BRAIDED SHIELD

DESCRIPTION: Constructed with white foam polyethylene insulation, braided tinned copper shield, chrome gray vinyl jacket. The low loss foam polyethylene construction has lower capacitance and attenuation than standard polyethylene mike cables as much as 50%. This increases the effective length of cable as much as 50% without signal loss.

OPERATING TEMPERATURE -20°C to +60°C.

DABURN Cat. No.	Cond.	Size	Strand	Nom. Cap./Ft.	Nom. Jacket	Nom. O.D.
2690	1	26	7/34*	30MMF	.020"	.114"
2691	1	24	10/34	20MMF	.030"	.180"
2692	1	24	10/34	15MMF	.030"	.220"
2693	2	22	16/34	11MMF	.030"	.295"

STD. PUT-UP: 100 Ft., 250 Ft., 500 Ft., 1000 Ft.

CONDUCTOR COLOR CODE: 1—White, 2—Black.

* 3 strands tinned copper, 4 strands tinned copperweld.

**PLASTIC JACKETED AUDIO AND
MULTICONDUCTOR CABLE
SPIRAL WRAPPED COPPER SHIELD**



Suitable for P.A. and sound systems, schools, hospitals, institutions, recording studios, paging and call systems.

Each conductor copper tinned, plastic insulation, color coded, twisted, spiral wrapped tinned, copper shield, gray plastic jacket. Temp. -20 to +60°C. Simplifies pigtailting. Provides almost 100% shielding coverage.

DABURN Cat. No.	Cond.	Size	Strand	Nom. Insul.	Nom. Jacket	Sugg. Working Voltage	Nom. O.D.
2950	2	22	7/30	.017"	.020"	350V	.170"
2950/1	1	22	7/30	.017"	.020"	350V	.115"
2950/3	3	22	7/30	.017"	.020"	350V	.190"
2950/4	4	22	7/30	.017"	.020"	350V	.200"
2950/6	6	22	7/30	.017"	.020"	350V	.235"
2949	2	22	1	.017"	.020"	350V	.170"
2952	2	20	10/30	.017"	.020"	350V	.190"
2952/1	1	20	10/30	.017"	.020"	350V	.129"
2952/3	3	20	10/30	.017"	.020"	350V	.205"
2952/4	4	20	10/30	.017"	.020"	350V	.222"
2952/6	6	20	10/30	.017"	.020"	350V	.260"
2953	2	18	16/30	.017"	.020"	350V	.230"
2953/1	1	18	16/30	.017"	.020"	350V	.133"
2953/3	3	18	16/30	.017"	.020"	350V	.230"
2953/4	4	18	16/30	.017"	.020"	350V	.245"
2954	2	16	26/30	.017"	.020"	350V	.235"
2954/4	4	16	26/30	.017"	.020"	350V	.255"
2954/3	3	16	26/30	.017"	.020"	350V	.245"
2955	2	14	41/30	.020"	.025"	450V	.285"
2955/3	3	14	41/30	.020"	.025"	450V	.292"
2955/4	4	14	41/30	.020"	.025"	450V	.310"
2956	2	12	65/30	.020"	.025"	450V	.325"
2956/3	3	12	65/30	.020"	.025"	450V	.335"

STD. PUT-UP: 250 Ft., 500 Ft., 1000 Ft.

CONDUCTOR COLOR CODE: 1—Black, 2—Red, 3—White, 4—Green.

CONSTRUCTION VARIATION TO ORDER

DABURN

DABURN ELECTRONICS & CABLE CORP.
WIRE • CABLE • TUBING • MIL/COMM • SWITCHES • ELECTRONIC HARDWARE

HEAVY DUTY TWISTED PAIRS INTERCOM CABLES — (Stranded)

Where larger conductors are indicated, we suggest these No. 18 gauge cables. Rugged yet flexible — abrasion resistant. Gray vinyl jacket overall. Standard intercom color coding for paired cables applies.

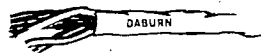

DABURN No.	Pairs	Cond.	Size	Nom. O.D.
3003/3	3	6	18-16/30	.365"
3003/6	6	12	18-16/30	.560"
3003/9	9	18	18-16/30	.650"
3003/15	15	30	18-16/30	.875"

STD. PUT-UP: 500 Ft., 1000 Ft.

PLASTIC INTERCOMMUNICATION CABLES TWISTED PAIRS — SOLID

Each Cond. #22 Solid Tinned Copper, .010" wall (Operating Temp. -20°C to +60°C). Vinyl plastic insulation, conductors color coded, twisted pairs, cabled, gray vinyl jacket overall. Suitable for outdoor installations.

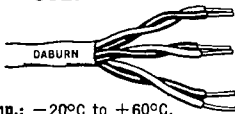

Operating Voltage: 200 Volts. Operating Temp.: -20°C to +60°C.

DABURN No.	Pairs	Cond.	Size	Nom. Jacket	Nom. O.D.
3000	1	2	22 Solid	.020"	.130"
3000/2	2	4	22 Solid	.020"	.205"
3000/3	3	6	22 Solid	.020"	.215"
3000/6	6	12	22 Solid	.020"	.275"
3000/9	9	18	22 Solid	.020"	.310"
3000/11	11	22	22 Solid	.020"	.340"
3000/13	13	26	22 Solid	.025"	.385"
3000/15	15	30	22 Solid	.025"	.390"
3000/16	16	32	22 Solid	.025"	.415"
3000/27	27	54	22 Solid	.035"	.505"
3000/31	31	62	22 Solid	.035"	.555"
3000/41	41	82	22 Solid	.035"	.630"
3000/51	51	102	22 Solid	.045"	.735"
3000/76	76	152	22 Solid	.070"	.970"
3000/101	101	202	22 Solid	.080"	1.140"

STD. PUT-UP: 100 Ft., 500 Ft., 1000 Ft. Other pairs available to order.

PLASTIC INTERCOMMUNICATION CABLES TWISTED PAIRS — STRANDED

Each Cond. #22 7/30 Tinned Copper, .010" wall vinyl plastic insulation, conductors color coded, twisted pairs, cabled, gray vinyl jacket overall. Suitable outdoor installations.

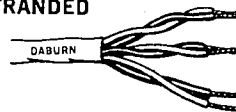

Operating Temperature: -20°C to +60°C. Operating Voltage: 200 Volts.

DABURN No.	Pairs	Cond.	Size	Strand	Nom. O.D.
3002	1	2	22	7/30	.145"
3002/2	2	4	22	7/30	.210"
3002/3	3	6	22	7/30	.225"
3002/4	4	8	22	7/30	.235"
3002/5	5	10	22	7/30	.245"
3002/6	6	12	22	7/30	.290"
3002/9	9	18	22	7/30	.350"
3002/11	11	22	22	7/30	.365"
3002/15	15	30	22	7/30	.455"
3002/19	19	38	22	7/30	.480"
3002/23	23	46	22	7/30	.530"
3002/27	27	54	22	7/30	.570"
3002/31	31	62	22	7/30	.635"
3002/41	41	82	22	7/30	.710"
3002/51	51	102	22	7/30	.800"

STD. PUT-UP: 100 Ft., 500 Ft., 1000 Ft.

CONDUCTOR COLOR CODE CHART FOR PAIRED INTERCOM CABLES

PAIR NO.	COLOR COMBINATION
1	Black paired with Red
2	Black paired with White
3	Black paired with Green
4	Black paired with Blue
5	Black paired with Brown
6	Black paired with Yellow
7	Black paired with Orange
8	Red paired with Green
9	Red paired with White
10	Red paired with Blue
11	Red paired with Yellow
12	Red paired with Brown
13	Red paired with Orange
14	Green paired with Blue
15	Green paired with White
16	Green paired with Brown
17	Green paired with Orange

PAIR NO.	COLOR COMBINATION
18	Green paired with Yellow
19	White paired with Blue
20	White paired with Brown
21	White paired with Orange
22	White paired with Yellow
23	Blue paired with Brown
24	Blue paired with Orange
25	Blue paired with Yellow
26	Brown paired with Orange
27	Brown paired with Yellow
28	Purple paired with Red
29	Purple paired with White
30	Purple paired with Green
31	Purple paired with Blue
32	Purple paired with Brown
33	Purple paired with Yellow
34	Purple paired with Orange

PAIR NO.	COLOR COMBINATION
35	Purple paired with Slate
36	Purple paired with Black
37	Slate paired with Red
38	Slate paired with White
39	Slate paired with Green
40	Slate paired with Blue
41	Slate paired with Brown
42	Slate paired with Yellow
43	Slate paired with Orange
44	Slate paired with Black
45	White/Black paired w. Red
46	White/Black paired w. Green
47	White/Black paired w. Blue
48	White/Black paired w. Brown
49	White/Black paired w. Yellow
50	White/Black paired w. Orange
51	White/Black paired w. Purple

MULTI-CONDUCTOR — PLASTIC JACKET UNSHIELDED AUDIO — FLEXIBLE

Each Cond. #22 7/30 Tinned Copper, stranded, .010" wall plastic insulation color coded, twisted, gray vinyl jacket overall. Suitable for signal, P.A. systems, computer cable—for outdoor use.



STD. PUT-UP: 500 Ft.

DABURN No.	Cond.	Size	Strand	Nom. Wall	Nom. Jacket	Nom. O.D.
3054/2	2	22	7/30	.010"	.020"	.140"
3054/3	3	22	7/30	.010"	.020"	.145"
3054/4	4	22	7/30	.010"	.020"	.170"
3054/5	5	22	7/30	.010"	.020"	.175"
3054/6	6	22	7/30	.010"	.020"	.185"
3054/7	7	22	7/30	.010"	.020"	.190"
3054/8	8	22	7/30	.010"	.020"	.200"
3054/9	9	22	7/30	.010"	.020"	.225"
3054/10	10	22	7/30	.010"	.020"	.235"
3054/12	12	22	7/30	.010"	.020"	.255"
3054/15	15	22	7/30	.010"	.020"	.280"
3054/20	20	22	7/30	.010"	.020"	.310"
3054/25	25	22	7/30	.010"	.020"	.340"
3054/30	30	22	7/30	.010"	.020"	.365"
3054/40	40	22	7/30	.010"	.025"	.425"
3054/50	50	22	7/30	.010"	.035"	.500"
3054/60	60	22	7/30	.010"	.035"	.530"

STD. PUT-UP: From 2 thru 7 cond. 500 ft.; from 8 thru 30 cond. 250 ft.

MULTI-CONDUCTOR COLOR CODE CHART

CONDUCTOR COLOR CODE:

1 — Black	21 — White/Brown	41 — White/Green/Red
2 — Red	22 — White/Orange	42 — White/Green/Green
3 — White	23 — White/Gray	43 — White/Green/Blue
4 — Green	24 — White/Violet	44 — White/Green/Brown
5 — Orange	25 — White/Black/Red	45 — White/Green/Purple
6 — Blue	26 — White/Black/Green	46 — White/Blue/Black
7 — Brown	27 — White/Black/Yellow	47 — White/Blue/Red
8 — Yellow	28 — White/Black/Blue	48 — White/Blue/Green
9 — Violet	29 — White/Black/Brown	49 — White/Blue/Blue
10 — Slate	30 — White/Black/Orange	50 — White/Blue/Brown
11 — Pink	31 — White/Black/Slate	51 — White/Blue/Purple
12 — Tan	32 — White/Black/Purple	52 — White/Brown/Black
13 — Red/Green	33 — White/Black/Black	53 — White/Brown/Red
14 — Red/Yellow	34 — White/Red/Black	54 — White/Brown/Green
15 — Red/Black	35 — White/Red/Red	55 — White/Brown/Blue
16 — White/Black	36 — White/Red/Green	56 — White/Brown/Brown
17 — White/Red	37 — White/Red/Blue	57 — White/Brown/Purple
18 — White/Green	38 — White/Red/Brown	58 — White/Purple/Red
19 — White/Yellow	39 — White/Red/Purple	59 — White/Purple/Green
20 — White/Blue	40 — White/Green/Black	60 — White/Purple/Blue

DABURN

DABURN ELECTRONICS & CABLE CORP.
WIRE • CABLE • TUBING • MIL/COMM • SWITCHES • ELECTRONIC HARDWARE

TEST LEAD WIRE • MINIATURIZATION WIRE & CABLE
PHONO & STEREO WIRE & CABLE—HI TENSION CABLE
RUBBER KINKLESS TEST LEAD WIRE

Suitable as Test Lead Wire in analyzers, instruments, oscillators, meters, etc. Wherever extra flexibility and limpness is necessary. Single conductor, extra flexible stranded soft tinned copper, separator, wall color coded rubber, smooth wax finish.

OPERATING TEMPERATURE: -20°C to +60°C. Colors: Red, black

DABURN No.	Size	Strand	Nom. Insul. Wall	Sugg. Voltage	O.D. Nom.
2715	20	41/36	3/4"	3,000V	.137"
2716	18	65/36	3/4"	5,000V	.145"
*2718	18	65/36	3/4"	5,000V	.145"
2717	18	65/36	3/4"	10,000V	.210"

* Types WS-16/U Black, WS17/U Red Per MIL-W-13169.

STD. PUT-UP: 100 Ft., 500 Ft., 1000 Ft.



PLASTIC KINKLESS TEST LEAD WIRE

Soft formulation vinyl maximum flexibility. Temperature stability from -80°C to +115°C. Exceed requirements for MIL-I-3930A Type JP (PVC). Suitable for test leads, etc. Resistant to gasoline and oil. Excellent abrasion Resistance.

DESCRIPTION: One conductor tinned copper stranded, special formulation vinyl insulation—smooth surface.

OPERATING TEMPERATURE: -80°C to +115°C. 5000V. rating.

COLORS: Black, Red, Yellow, Green, White, Blue.

DABURN No.	Size	Strand	Ins.	Nom. O.D.
2722/22	22	26/36	.032"	.100"
2722/20	20	26/34	.032"	.104"
2722/18	18	65/36	.032"	.112"
2722/16	16	65/34	.032"	.129"

STD. PUT-UP: 100 Ft., 500 Ft., 1000 Ft.



MINIATURIZATION HOOK-UP WIRE AND CABLE **Conforms to MIL-W-16878D Spec.**

UNSHIELDED—ONE CONDUCTOR 105°C—600V RATING

Used as lead computers, transistor circuits, instruments — where fine sizes are required with high temperature conditions. One conductor stranded tinned copper, 105°C vinyl resin overall.

DABURN No.	Conductor	Size	Strand	Nom. Wall	Nom. O.D.
2670/32	1	32	7/40	.010"	.029"
2670/30	1	30	7/38	.010"	.030"
2670/28	1	28	7/36	.010"	.035"
2670/26	1	26	10/36	.010"	.038"
2670/24	1	24	16/36	.015"	.055"

STOCK COLORS: Black, Red, Green, Yellow, Blue, Brown, White, Orange and Purple.
STD. PUT-UP: 500 Ft., 1000 Ft.

DESCRIPTION
One conductor stranded tinned copper with 105°C. high temperature thermoplastic insulation overall.



SHIELDED HOOK-UP WIRE

SUB-MINIATURE • SUPER FLEXIBLE • 600V RATING

One conductor stranded tinned copper, 105°C vinyl resin overall.

DABURN No.	Conductor	Size	Strand	Nom. Wall	Nom. O.D.
2682	1	30	7/38	.010"	.052"
2684	1	28	7/36	.010"	.057"
2686	1	26	10/36	.010"	.060"
2688	1	24	16/36	.010"	.073"

STOCK COLOR: White (Under Shield).

STD. PUT-UP: 500 Ft., 1000 Ft.

DESCRIPTION
One conductor stranded tinned copper with 105°C. high temperature thermoplastic insulation and tinned copper shielded braid overall.



MULTI CONDUCTOR CABLE

SUB-MINIATURE • NOT SHIELDED • FLEXIBLE

Tinned Copper Conductors—Conforms to MIL-W-16878D Spec

Suggested Operating Temperature: -55°C to +105°C

TWISTED—NO OUTER JACKET—600V RATING

DABURN No.	Cond.	Size	Strand	Nom. Wall	Nom. O.D.
2672	2	30	7/38	.010"	.058"
2672/3	3	30	7/38	.010"	.064"
2672/4	4	30	7/38	.010"	.072"

COND. COLOR CODE:
1—Black, 2—White,
3—Red, 4—Green.
STD. PUT-UP:
500 Ft., 1000 Ft.



TWISTED—CLEAR VINYL JACKET OVERALL—600V RATING

DABURN No.	Cond.	Size	Strand	Nom. Wall	Nom. O.D.
2674	2	28	7/36	.010"	.079"
2674/3	3	28	7/36	.010"	.086"
2674/4	4	28	7/36	.010"	.095"

COND. COLOR CODE:
1—Black, 2—White,
3—Red, 4—Green.
STD. PUT-UP:
500 Ft., 1000 Ft.



SHIELDED SUB-MINIATURE MULTI-CONDUCTOR CABLE

Tinned Copper Conductors—Conforms to MIL-W-16878D Spec

Suggested Operating Temperature: -55°C to +105°C

TWISTED—SHIELDED—NO OUTER JACKET

DABURN No.	Cond.	Size	Strand	Nom. Wall	Nom. O.D.
2676	2	24	16/36	.015"	.114"
2676/3	3	24	16/36	.015"	.123"
2676/4	4	24	16/36	.015"	.144"

1,000V Rating
COND. COLOR CODE:
1—Black, 2—White,
3—Red, 4—Green.
STD. PUT-UP:
500 Ft., 1000 Ft.



TWISTED—SHIELDED—CLEAR VINYL JACKET OVERALL

DABURN No.	Cond.	Size	Strand	Nom. Wall	Nom. O.D.
2678	2	28	7/36	.010"	.105"
2678/3	3	28	7/36	.010"	.115"
2678/4	4	28	7/36	.010"	.120"

600V Rating
COND. COLOR CODE:
1—Black, 2—White,
3—Red, 4—Green.
STD. PUT-UP:
500 Ft., 1000 Ft.



TINNED COPPER SHIELDED PHONO WIRE

Suitable where small diameter, limpness and extremely flexibility is necessary as for phono pickups, stereo, etc.

OPERATING TEMPERATURE: -20°C to +60°C.

DABURN No.	Size	Strand	Overall Insul Wall	Nom. O.D.
2737	24	16/36	.010"	.075"
2738	22	7/30	.010"	.080"

COTTON BRAID OVER-SHIELD

DABURN No.	Size	Strand	Overall Insul Wall	Nom. O.D.
2739	24	16/36	.010"	.095"

STD. PUT-UP: 100 Ft., 500 Ft.



7MM HIGH TENSION CABLE

#2730—unshielded one conductor, in sulation, cotton braid highly lacquered.

#2731—same construction as above plus a closely woven tinned copper shielded braid overall.

DABURN No.	Size	Strand	Insul.	O.D.
2730	16	19/29	3/32"	.275"
*2731 (Shielded)	16	19/29	3/32"	.295"

STD. PUT-UP: 100 Ft., 500 Ft.

*10 amps at 25KV Suitable for auto and aircraft ignition systems where grounding is indicated.



SHIELDED HOOK-UP WIRE

One conductor, tinned copper stranded, polyvinyl-chloride insulation, lacquered brass braid, overall tinned copper shielded braid.

OPERATING TEMPERATURE: -20°C to +60°C.

DABURN No.	Size	Strand	Nom. Wall	Nom. O.D.
2727/22	22	7/30	.016"	.095"
2727/20	20	10/30	.016"	.105"
2727/18	18	16/30	.016"	.125"
2727/16	16	26/30	.016"	.135"
2727/14	14	41/30	.016"	.155"
2727/12	12	65/30	.016"	.175"
2727/10	10	105/30	.025"	.200"

STD. PUT-UP: 1000 Ft.



HI-FI STEREO

Interconnecting Cable—Phono Wire

Extremely flexible. Designed for low hum and noise pickup. Special PVC formulation -40°C to +80°C operation.

TWISTED—UNSHIELDED 200V Rating

DABURN No.	Cond.	Size	Strand	Nom. Wall	Nom. O.D.
2741	1	32	7/40	.010"	.028"
2742	2	32	7/40	.010"	.047"
2743	3	32	7/40	.010"	.053"
2744	4	32	7/40	.010"	.061"

TWISTED—SHIELDED

DABURN No.	Cond.	Size	Strand	Nom. Wall	Nom. O.D.
2745	1	32	7/40	.010"	.040"
2746	2	32	7/40	.010"	.067"
2747	3	32	7/40	.010"	.072"
2748	4	32	7/40	.010"	.080"
2751 #	2	32	7/40	.010"	.080"

STD. PUT-UP: 500 Ft., 1000 Ft.

#2751 Individually Shielded. CONDUCTOR COLOR CODE: 1—White, 2—Red, 3—Black, 4—Green.



DABURN

DABURN ELECTRONICS & CABLE CORP.
WIRE • CABLE • TUBING • MIL/COMM • SWITCHES • ELECTRONIC HARDWARE

ELECTRONIC LACING CORDS AND TAPES, CABLE CLAMPS & CLIPS

LACING CORD-TAPE TO MEET MIL-T-713C TYPE P* AND MIL-T-43435 COMP. P-TYPE S NYLON FLAT BRAIDED LACING TAPE



Nylon fiber flat braided impregnated with MW microcrystalline fungicidal wax. Stays flat. Designed to create a wider contact to distribute the stress. Flexible. Won't slip when knotted. Resistant to fungus, flame, abrasion, acids.

DABURN No.	Color	Class	Nom. Width	Nom. Thickness	Tensile Strength	Standard Put-Up Tubes
2035	Natural White	—	.200"	.014"	150 lbs.	500 yd.
2035B	Black	—	.200"	.014"	150 lbs.	500 yd.
2036	Natural White	1	.120"	.014"	80 lbs.	500 yd.
2036B	Black	1	.120"	.014"	80 lbs.	500 yd.
2037	Natural White	2*	.090"	.014"	50 lbs.	500 yd.
2037B	Black	2*	.090"	.014"	50 lbs.	500 yd.
2038	Natural White	3	.065"	.010"	30 lbs.	500 yd.
2038B	Black	3	.065"	.010"	30 lbs.	500 yd.
2039	Natural White	4	.046"	.010"	15 lbs.	500 yd.
2039B	Black	4	.046"	.010"	15 lbs.	500 yd.

DACRON FLAT BRAIDED LACING TAPE



Dacron fiber flat braided impregnated with non-slip fungicidal finish. Will not cut or damage insulation. Stays flat. Has all characteristics of nylon with elongation, better resistance to acids.

DABURN No.	Color	Nom. Width	Thickness Nom.	Strength Tensile	Standard Put-Up Tubes
2041	Natural White	.120"	.014"	80	500 yd.
2041B	Black	.120"	.014"	80	500 yd.
2042	Natural White	.090"	.014"	48	500 yd.
2042B	Black	.090"	.014"	48	500 yd.
2043	Natural White	.060"	.010"	35	500 yd.
2043B	Black	.060"	.010"	35	500 yd.
2044	Natural White	.046"	.010"	25	500 yd.
2044B	Black	.046"	.010"	25	500 yd.

TEFLON* FIBERGLASS FLAT BRAIDED LACING TAPE

Teflon coated fiberglass flat braided lacing tape bonded for high temp. operations (550°F). Stays flat—for strength, stability. Teflon finish increases strength and abrasion resistant surface. Will not cut or damage insulation.

DABURN No.	Color	Nom. Width	Thickness Nom.	lbs. Test	Standard Put-Up Tubes
2045	White	.170"	.025"	150	500 yd.
2046	White	.120"	.020"	90	500 yd.
2047	White	.080"	.020"	70	500 yd.

TEFLON* FLAT BRAIDED LACING TAPE for high temperature operations (550°F)

DABURN No.	Color	Nom. Width	Nom. Thickness	Test lbs.	Standard Put-Up Tubes
2048	Brown	.100"	.016"	35	500 yd.
2049	Brown	.075"	.010"	15	500 yd.



ROUND TWISTED NYLON LACING CORD

Manufactured to meet MIL-T-713A Type P specification, Composition P, Classes 3, 2, 1. Wax finish—compounded with fungicide to resist mildew. Easy to tie.

PUT-UP ON 1 LB. TUBES

DABURN No.	Color	Class	Tensile Strength	Nom. Diam.	Yds. Per Tube
2070	Natural	1	70 lbs.	.039"	600
2070B	Black	1	70 lbs.	.039"	600
2071	Natural	2	48 lbs.	.029"	800
2071B	Black	2	48 lbs.	.029"	800
2072	Natural	3	32 lbs.	.025"	1140
2072B	Black	3	32 lbs.	.025"	1140
2072/1	Natural	4	20 lbs.	.020"	2400
2072/1B	Black	4	20 lbs.	.020"	2400

ROUND TWISTED LINEN LACING CORD

Manufactured from pure flax treated with microcrystalline wax compounded with fungicide to resist mildew. Classes 1, 2, 3 meet MIL-T-713A Type N specifications.

4 OZ. TUBE		8 OZ. TUBE		1 LB. TUBES		Yds. Class Ply	Diam.	Lb. Test	
DABURN No.	Yds.	DABURN No.	Yds.	DABURN No. Nat.	DABURN No. Blk.				
2073	210	2074	425	2075	2075B	850	— 4	.036"	22
2076	150	2077	300	2078	2078B	600	3 6	.044"	33
2082	115	2083	235	2084	2084B	470	2 8	.051"	50
2079	100	2080	200	2081	2081B	400	— 9	.054"	56
2085	75	2086	150	2087	2087B	300	1 12	.063"	72

NYLON CABLE CLAMPS

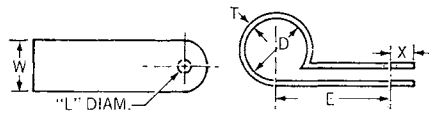

MADE OF DU PONT "ZYTEL" 101 NYLON RESIN

Meets MIL-P-26093A and MIL-P-17091A Amend. 2. Light and tough these nylon cable clamps are used as a clamp, strain relief, clip hanger, fastener or strap. Smooth non-abrasive surfaces, rounded edges will not cause shorts or grounds in cable. Insoluble in solvents, gasoline, oils, hydraulic fluids, alcohol, acids, alkalis. Temperature range -60°F to +300°F. Does not support combustion. Inside matte finish. Prevents slippage and is self aligning. Snaps on cable. Meets MIL-P-20693A specs, fungus resistant.

DABURN No.	To Fit Size	D	E	W	L	H	X
625	1/8"	.125	.316	3/8	.050	.177	.227
626	3/16"	.187	.378	3/8	.050	.177	.277
627	1/4"	.250	.409	3/8	.050	.177	.227
628	5/16"	.312	.441	3/8	.050	.177	.277
629	3/8"	.375	.471	3/8	.050	.177	.277
630	7/16"	.437	.519	3/8	.050	.177	.277
631	1/2"	.500	.550	3/8	.050	.177	.277
631A	5/8"	.563	.625	1/2	.060	.177	.227
632	3/4"	.625	.634	1/2	.060	.177	.227
632A	7/8"	.687	.752	1/2	.060	.177	.227
633	1"	.750	.718	1/2	.060	.177	.227
634	1 1/8"	.875	.760	1/2	.060	.177	.227
635	1 1/4"	1.000	.802	1/2	.060	.177	.227
636	1 3/8"	1.125	.968	1/2	.062	.204	.250
637	1 1/2"	1.250	1.156	1/2	.062	.204	.250
638	1 3/4"	1.500	1.188	5/8	.070	.204	.250

Std. Pkg. 100, 500, 1000

ETHYL CELLULOSE CABLE CLAMPS

Ethocel recommended for general use. Combines light weight and chemical resistance with excellent shock resisting properties in temp. range from -40°F to +185°F. Approved 7-21-44 Army-Navy Aeronautical AN-742. Also made to meet MIL STD. 242A (Ships). Suitable indoor-outdoor. Std. Pkg. 100, 1000.

DABURN No.	To Fit Size	D	E	W	L	H	X
615	1/8"	.125	.325	1/2	.060	.204	3/32
615A	3/16"	.188	.390	1/2	.060	.204	3/32
615B	1/4"	.250	.421	1/2	.060	.204	3/32
615C	5/16"	.313	.457	1/2	.060	.204	3/32
615D	3/8"	.375	.483	1/2	.060	.204	3/32
615E	7/16"	.438	.531	1/2	.060	.204	3/32
616	1/2"	.500	.562	1/2	.060	.204	3/32
616A	5/8"	.563	.625	1/2	.060	.204	3/32
616B	3/4"	.625	.610	1/2	.060	.204	3/32
616C	7/8"	.688	.666	1/2	.060	.204	3/32
616D	1"	.750	.766	1/2	.060	.204	3/32
616E	1 1/8"	.875	.813	1/2	.060	.204	3/32
617	1 1/4"	1.000	.906	1/2	.060	.204	3/32
617A	1 3/8"	1.125	.969	1/2	.060	.204	3/32
617B	1 1/2"	1.250	1.156	1/2	.060	.204	3/32
617C	1 3/4"	1.5	1.0625	5/8	.070	.204	3/32
617D	2"	2.0	1.313	5/8	.070	.204	3/32
617E	2 1/2"	2.5	1.563	5/8	.070	.204	3/32



DABURN ALUMINUM CABLE CLAMPS

Made of hard drawn aluminum, light weight. Useful when mounting resonant lines, elements for beams, etc. Strong, durable, rust-proof.

DABURN No.	To Fit Size	Width	Length	Thickness	Clearance Hole For	Std. Pkg.
651A	1/8"	1/2"	1 3/8"	.050"	10	100
651	1/4"	1/2"	7/8"	.050"	10	100
652	3/8"	1/2"	1 3/8"	.050"	10	100
653	1/2"	1/2"	1"	.050"	10	100
654	3/4"	1/2"	1 1/8"	.050"	10	100
654A	5/8"	1/2"	1 1/4"	.050"	10	50
655	3/4"	3/4"	1 3/4"	.090"	1/4-20	50
657	7/8"	3/4"	1 5/8"	.090"	1/4-20	50
656	1"	3/4"	1 3/4"	.090"	1/4-20	50
656A	1 1/8"	3/4"	1 7/8"	.090"	1/4-20	50
656B	1 1/4"	3/4"	2"	.090"	1/4-20	50

NYLON TENSION CLIPS

Holds cable-wire-tubing-pipe-panels-many and varied uses. Made of nylon, they are insulating, non-corrosive and weather resistant. Easily fastened, easily removed. Strong and elastic.

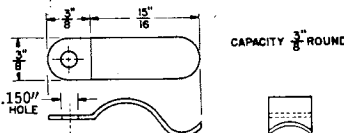

DABURN Cat. No. 641 STD. PKG. 100, 1000 Natural Color

DABURN

DABURN ELECTRONICS & CABLE CORP.
WIRE • CABLE • TUBING • MIL/COMM • SWITCHES • ELECTRONIC HARDWARE

**SPIRAL WRAP FOR HARNESESSES • PUSH BUTTON TIES
WIRE TIES • TEST LEADS • COMPONENT CLIPS**

**SPIRAL WRAP — PLASTIC TUBING
FOR HARNESESSES**

Available in four formulations: Polyethylene, Rulan (flame retardant) Polyethylene, Nylon and Teflon. Easily applied. Twists on easily. Can be flexed repeatedly without cracking or breaking. Reusable, bends around sharp corners. Expandable. Per MIL-P-22692, MIL-I-631C, MIL-P-3803



POLYETHYLENE (Clear) TEMP. RANGE: -105°F to +200°F

DABURN Cat No.	Covers Wire Groups	Outside Diam.	Nom. Wall	Standard Package
605-1/8"	1/8" to 1 1/2"	1/8"	.031"	100', 500', 1000'
605-1/4"	3/8" to 1 1/2"	1/4"	.045"	100', 500', 1000'
605-3/8"	3/8" to 2"	3/8"	.058"	100', 500', 1000'
605-1/2"	3/4" to 4"	1/2"	.058"	100', 500', 1000'

(Carbon Impregnated Polyethylene) **RULAN (White) TEMP. RANGE: -10°F to +200°F**

DABURN Cat No.	Covers Wire Groups	Outside Diam.	Nom. Wall	Standard Package
606-1/4"	3/8" to 1 1/2"	1/4"	.058"	100', 500', 1000'
606-3/8"	3/8" to 2"	3/8"	.058"	100', 500', 1000'

**SPIRAL WRAP — PLASTIC TUBING
FOR HARNESESSES
NYLON**



Per MIL-P-17091B & MIL-P-20693 -150°F to +300°F

DABURN Cat. No.	Covers Wire Range	Outside Diam.	Nom. Wall
607-1/8"	1/8" to 1 1/2"	1/8"	.031"
607-1/4"	3/8" to 1 1/2"	1/4"	.058"
607-1/2"	3/4" to 4"	1/2"	.058"

COLOR: Natural (White). STD. PUT-UP: 100 Ft., 500 Ft.

TEFLON

Per MIL-I-22129 -450°F to +500°F

DABURN Cat. No.	Covers Wire Range	Outside Diam.	Nom. Wall
608-1/8"	1/8" to 1 1/2"	1/8"	.031"
608-1/4"	3/8" to 1 1/2"	1/4"	.058"
608-1/2"	3/4" to 4"	1/2"	.058"

COLOR: Natural (White). STD. PUT-UP: 100 Ft., 500 Ft.

PLASTIC WIRE TIES

Useful for temporary or permanent installation. Can be adapted for immediate bundling or harnessing. Vinyl insulated. Has 70/10 steel gauge, wire reinforcement, 3/32" wide, 30 lb. test.

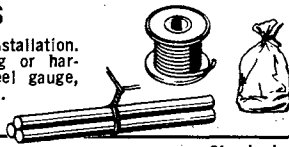

TEMPERATURE: -20°F to +90°C.

DABURN Cat. No.	Description	Standard Package
603	Plastic Wire Ties	100', 500', 1000'

COLORS: White, Blue, Red, Green, Yellow.

DABURN PUSH BUTTON WIRE TIES

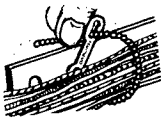

Push button wire ties for harnessing wire. 4 1/2" in length, each tie is adjustable to 30 different diameters. Made of strong polyethylene, it is inert chemically and heat resistant. Breaking strength 45 to 95 lbs. After the tie is placed in hole for anchoring, wires can be replaced or added by loosening tie and pulling tight again. Designed to fit .250" to .265" hole in a .031" to .140" thick panel. Material conforms to Spec. LP590. Temp. to +200°F

DABURN Cat. No.	(Specify Color)	Standard Package
601-4	Red, Blue, Yellow	100, 1000

DABURN NYLON

PUSH BUTTON WIRE TIES

Same description as No. 601-4. Temp. to 300°F.

5 1/2" long. Made of tough Nylon. Higher temperature range than Polyethylene.

DABURN Cat. No.	Color	Standard Package
601-5	Clear	100, 1000

DABURN COMPONENT CLIPS



Hold and insulate, electrical and electronic components, accessories — spare parts. Holds firmly and still permits fast and easy insertion. Convenient for fastening clips and retainers for transistors, batteries, fuses, capacitors, resistors, lamps, etc. These Daburn clips are made of black vinyl (polyvinylchloride). Has high dielectric strength. Can be mounted with screws, rivets or other fastening means.

MATERIAL: Rigid Vinyl.
TEMPERATURE RANGE: -20° to +165°F.
STANDARD PACKAGE: 100, 1000.

DABURN Stock No.	D Diam.	H Height	L Length	E Diam. of Hole	F Dist. Bet. Holes
600-1/4"	1/4"	1 1/2"	1/2"	3/32"	—
600-3/8"	3/8"	1 1/2"	1/2"	3/32"	—
600-1/2"	1/2"	1 1/2"	1/2"	3/32"	—
600-3/4"	3/4"	1 1/2"	1/2"	3/32"	—
600-5/8"	5/8"	5/8"	1/2"	3/32"	—
600-1 1/4"	1 1/4"	3/4"	1/2"	3/32"	—
600-3/4"	3/4"	7/8"	1/2"	3/32"	—
600-7/8"	7/8"	1"	1/2"	3/32"	3/4"
600-1"	1"	1 1/4"	1 1/8"	3/32"	3/4"
600-1 1/8"	1 1/8"	1 1/2"	1 1/8"	3/32"	3/4"

TEST LEADS

**NEEDLEPOINT AND SOLDERLESS
OVERALL LENGTH 50"**

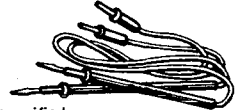

Black and red kinkless test lead wire, handles as specified.

DABURN No.	Description	Standard Package
17-308	Pencil Type Bakelite, 6" Handles	10
17-360	Deluxe Solderless Prod, 5" Handles	25
17-361	Deluxe Needlepoint Prod, 5" Handles	25
17-320	Needlepoint Prods, 4" Handles	25
17-322	Solderless Prods, 4" Handles	25

TEST LEADS

**RETRACTILE KINKLESS WIRE
RETRACTED LENGTH OF WIRE 9".
EXTENDS TO 6 FT. NON-TANGLING.**

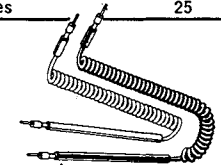

Black and red wire.

DABURN No.	Description	Standard Package
17-364	Solderless Phone Tip, Retractable Wire, Solderless Prod	10

TEST LEADS

ALLIGATOR CLIP TEST LEADS



Black and red kinkless test lead wire with steel cadmium plated clips at each end.

DABURN No.	Wire Length	Standard Package
17-275	12"	12
17-276	24"	12
17-277	36"	12
17-278	48"	12

TEST LEADS

INSULATED ALLIGATOR CLIPS

Black and red kinkless test lead wire with steel, cadmium plated clips; vinyl plastic boot.

DABURN No.	Wire Length	Standard Package
17-280	12"	12
17-281	24"	12
17-282	36"	12
17-283	48"	12

Manufactured by



DEARBORN TELEVISION CAMERA CABLES



Made better by military-level quality controls.

A prime-time show can no more afford a cable fault than an Agena launching—and Brand-Rex builds all its cables so that both can go off without a hitch. The same exacting techniques, quality assurance procedures, and production and test equipment developed for the aerospace and missile markets are used in manufacturing television broadcast industry products.

What Brand-Rex cables offer

Distortion-free signal transmission... for sharper, more detailed color and monochrome pictures.

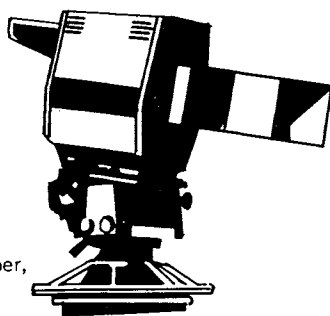

- Stable operation — over wide temperature range.
- Outstanding flexibility — even at extremely low temperatures — for unimpeded camera movement.
- Abrasion resistant, sound absorbing jackets.
 - Long trouble-free service life.
- Individual wires specially positioned and completely color-coded for easy termination.
 - Weather and moisture resistant.
- Stable electrical characteristics, even when bent, compressed, and twisted.

Brand-Rex Type	Application	Coaxials ¹		Grouped Wires					Single Wires			Overall Shield	Jacket				
		No.	Imped.	No. of Groups		Wire per Group			Group Shield	No.	AWG.		Insul. ²	Nom. O.D.	Material	Max. O.D.	Approx. Wt. (lbs./ft.)
				No.	No.	AWG.	Insul. ²	Nom. O.D.									
BR-23/M	Monochrome & Color	2	50Ω	1	3	1-22(7/30)	PE	.095"	No	—	—	—	90%	PVC	.680"	.33	
				2	6	2-18(19/30)	PVC	.082"									
				1	4	22(7/30)	PVC	.065"									
				1	2	18(19/30)	PVC	.082"									
BR-25/M	Monochrome & Color	3	50Ω	1	4	14(19/27)	PVC	.105"	No	4	22(7/30)	PVC	.065"	90%	Neoprene	.865"	.41
				2	7	22(7/30)	PVC	.065"									
BR-33/M	Monochrome & Color	1	75Ω	1	4	16(26/30)	PVC	.124"	Yes	3	22(7/30)	PVC	.051"	90%	Neoprene	.800"	.41
				2	2	22(7/30)	PVC	.051"									
				1	2	22(7/30)	PVC	.051"									
				3	5	22(7/30)	PVC	.051"									
BR-79/C	Color	6	50Ω	1	7	4-14(41/30)	PVC	.141"	Yes	2	14(41/30)	PVC	.141"	90%	Neoprene	1.075"	.83
				3	2	22(7/30)	PVC	.051"									
				2	4	22(7/30)	PVC	.051"									
BR-81/C	Color	6	50Ω	1	7	4-14(41/30)	PVC	.113"	Yes	4	12(65/30)	PVC	.126"	90%	Neoprene	1.100"	.86
				3	2	22(7/30)	PE	.065"									
				11	4	22(7/30)	PVC	.051"									
				1	5	22(7/30)	PVC	.051"									
				1	7	22(7/30)	PVC	.065"									
BR-82/C	Color	8	50Ω	1	7	3-16(19/29)	PVC	.092"	Yes	—	—	—	90%	Neoprene	1.280"	.92	
				4	1	14(41/30)	PVC	.113"									
				12	5	22(7/30)	PVC	.065"									

¹See table of Coaxial Cable Characteristics

²Insulation: PE - polyethylene; PVC - polyvinyl chloride

COAXIAL CABLE CHARACTERISTICS

Construction	50 OHM	75 OHM
Inner Conductor	19/.0071 Tin. Cop.	7/34 Tin. Cop.
Dielectric Material	Polyethylene	Cellular Polyethylene
Shield	=36 AWG. Tin. Cop.	=38 AWG. Tin. Cop.
Drain Wire	—	=26 AWG. Tin. Cop.

Electrical Properties*

Characteristic Impedance	50 ohms	75 ohms
Capacitance	29.5 mmf/ft.	17 pf/ft.
Attenuation @ 400 mc	13.5 db/100 ft.	55 db/100 ft.
Test Voltage	3,000 volts, rms	2,000 volts, rms
Max. Operating Voltage	1,500 volts, rms	600 volts, rms
Velocity of Propagation	69%	78%

*All values nominal.

CROSS REFERENCE CHART

Brand-Rex =	BIW =	RCA =	GE =	Equipment Model =
BR-79/C	—	MI-13356	—	RCA TK-42
BR-79/C	—	MI-13356	—	RCA TK-44
BR-79/C	—	MI-13358	—	Norelco PC-70
BR-81/C	TV-81N	—	7176133	GE 4PE-250
BR-82/C	TV-82N	MI-13394N	—	RCA TK-41

PRICE PER FOOT

PART No.	50 to 249'	250' Up
BR-23M	2.10	1.05
BR-25M	2.98	1.48
BR-33M	3.00	1.50
BR-79/C	5.50	2.75
BR-81/C	5.50	2.75
BR-82/C	5.60	2.80

MINIMUM ORDER 50 FT. CUT TO SPECIFICATION

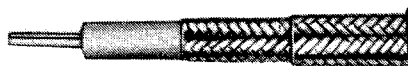

ATTENUATION

1.9db	(@)	10MHz
1.9db	(@)	Channel 2
2.0db	(@)	Channel 3
2.1db	(@)	Channel 4
2.3db	(@)	Channel 5
2.4db	(@)	Channel 6
2.5db	(@)	FM Band
3.5db	(@)	Channel 7
3.6db	(@)	Channel 8
3.7db	(@)	Channel 9
3.7db	(@)	Channel 10
3.8db	(@)	Channel 11
3.9db	(@)	Channel 12
3.9db	(@)	Channel 13

PHYSICAL CHARACTERISTICS

- A. CONDUCTOR: No. 20 AWG. Solid Tinned Copper
- B. INSULATION: Polyethylene to Diameter of .200" to ±.003"
- C. INNER SHIELD: No. 34 AWG. Tinned Copper—96% Coverage
- D. OUTER SHIELD: No. 34 AWG. Tinned Copper—96% Coverage
- E. JACKET: Black PVC to Diameter of .305" ±.005"

PRICE PER

P/N	100'	1000'
T-378	16.78	165.78

75 OHM PRECISION VIDEO CABLE T-378

ELECTRICAL PROPERTIES

Capacitance	20 pf/ft
Velocity Of Propagation	66%
Impedance	75Ω
Dielectric Constant	2.26
Structural Return Loss	29 db minimum from 10 MHz to 220MHz

TYPICAL APPLICATIONS:

Used in TV studios for transmission of video signals in color and monochrome. Cable is manufactured with rigid controls of all dimensional tolerances. Eliminates problems of periodicity while providing high quality carrier of video signal with superior picture definition. 100% SWEEP TESTED.

PRICES

All prices listed in The MASTER are subject to change without notice — they should not be considered final.

Get quick-on-the-spot quotations from your distributor who subscribes to the up-to-the-minute

UNITED *Pricing Reports*

The Perpetual Pricing System for Electronic Parts and Equipment



- Over 750 manufacturers
- Over 400,000 catalog numbers tabulated with current prices
- Revised pages mailed semi-weekly: insert new pages—discard old pages
- Compression type loose-leaf binder for rapid replacement of revised pages
- Weekly summary sheet—Ups, Downs, Additions, Deletions

For complete details and subscription rates write to:



UNITED PRICING REPORTS

A UNITED TECHNICAL PUBLICATION

645 STEWART AVENUE, GARDEN CITY, N. Y. 11530

DELIVERY

Delivery is often dependent on availability of raw materials. Check with your distributor for delivery information at the time you place your order.

ELECTROVERT^{INC} COMPONENTS DIVISION



SEND FOR COMPLETE CATALOG AND PRICES

EL Cable Ties

The Electrovert El Cable Tie is an improved tying system designed to increase the harness tensile strength, provide optional application either by hand or tool, and, when used with a tool, be universally applicable with all such tools currently on the market.

ADVANTAGES

- Self-locking, non-twisting, for permanent, neat tying.
- Hand or tool assembly... will fit all tools.
- Molded of tough, smooth, flexible nylon.
- Infinitely adjustable within their range.
- Four (4) sizes meet all bundle diameters from 1/16" to 4 3/16".
- Lightweight, chemical and abrasion resistant, high tensile strength, excellent dielectric properties, rust and rot resistant.

SPECIFICATIONS:

- Material:** Strap—nylon per MIL-M-20693, Type I.
Strap Lock—metal per QQS-766.
- Color:** Natural. Also available in all colors.
- Design:** To meet requirements of military standard MS-17821, MS-18034 and specification MIL-S-23190.

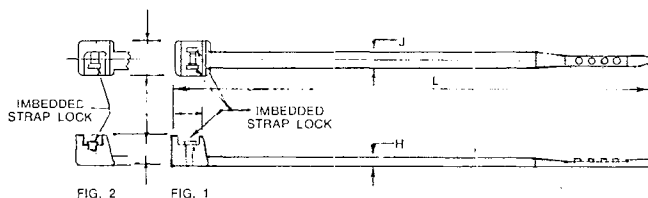

U.S. Patent No. 3397430. World-wide Patent Pending.

Type No.	Military Dash No.	Bundle Dia. (Inch) Min.	Bundle Dia. (Inch) Max.	Tensile Strength (lbs.) Min.	H max (in)	J max (in)	L min (in)	Installation Tool
EL-A	—4	1/16	1	18	.043	.090	4 1/8	MS-17823-2 or equivalent
EL-B	—1	1/8	1 1/16	50	.055	.175	7 1/2	MS-17823-2 or equivalent
EL-C	—2	1/8	4 3/16	50	.055	.175	14 5/8	MS-17823-2 or equivalent
EL-D	—3	3/16	4	120	.083	.290	14 1/4	MS-17824-2 or equivalent

Head design type Fig. 2: EL-A; Fig. 1: EL-B, C and D.

Packaging: Packaged in heavy gauge, heat sealed poly bags and carton, 100 per poly bag and cartons of 100 and 500. Bulk packaging available.

Adjustable P-Clips Nine (9) Sizes Fit Any Loop Diameter From 1/8" Through 2".

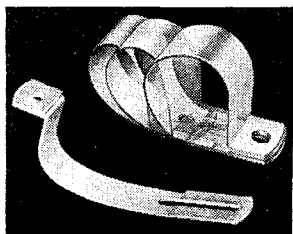

THE SAME SIZE P-CLIP ADJUSTED TO FIT DIFFERENT BUNDLE DIAMETERS.

- Molded of finest natural, virgin nylon.
- Lightweight, chemical and abrasion resistant, high tensile strength, excellent dielectric properties, rust and rot resistant.
- Typical applications include: cables, bundles of wires, components, pipes and tubing wherever a clamp, strain relief or strap is required.

Reduces Inventory — only nine sizes accommodate all bundle and cable diameters from 1/8" through 2" ...simplifies OEM and spare parts inventories.

Controls Tension — you control the tension to fit the loop to the bundle diameter.

Simplifies Changes in Bundle Make-up — add or remove wires, the same clip can be adjusted to the new bundle diameter.

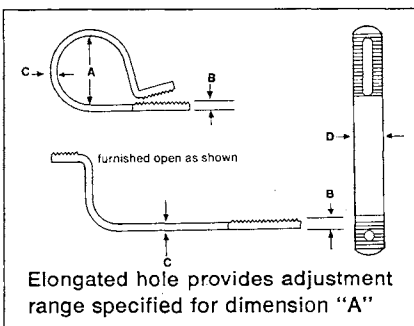

Size No.	Bundle Range "A" Dimension		B	C	D	Screw Clearance	Quantity per package
	Min.	Max.					
0	1/8	3/16	.060	.025	.250	No. 4	500 and 100
1	3/16	1/4	.046	.025	.250	No. 4	500 and 100
2	1/4	3/8	.051	.030	.312	No. 6	500 and 100
3	3/8	1/2	.056	.035	.375	No. 6	500 and 100
4	1/2	7/8	.062	.040	.500	No. 6	200 and 100
5	7/8	1 1/16	.083	.055	.550	No. 10	200 and 100
6	1 1/16	1 1/2	.083	.060	.560	No. 10	100
7	1 1/2	1 3/4	.088	.065	.560	No. 10	100
8	1 3/4	2	.093	.070	.560	No. 10	100

Packaging: Packaged in heavy gauge, heat sealed poly bags and box.
Colors: Standard is natural; colors available on special order.



SEND FOR COMPLETE CATALOG AND PRICES

Cradleclip (Insuloid)

FOR SUPPORTED WIRING
cradles and clips

FOR UNSUPPORTED WIRING
binders and clips

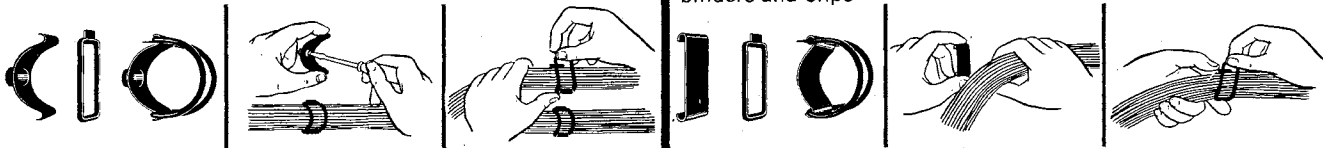

CRADLES

BINDERS

CLIPS

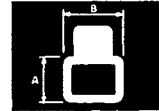
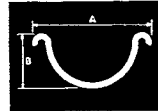
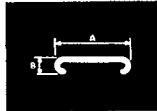
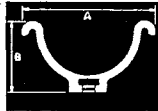

CO-NO
Miniature
with
captive clip

C1, C2, C3

C1-M, C2-M, C3-M
molded in nut
to take 6/32
thread bolts

B1

B2, B12

NO
miniature
(for
replacement)

N1, N3,
N5, N7

DIMENSIONS

Type & Size	Dimensions (inches)		Type & Size	Dimensions (inches)	
	A	B		A	B
Cradles			Binders		
CO*	.500	.330	B0	.500	.250
C1	.937	.562	B1	.875	.187
C1-M	.937	.562	B12	.937	.400
C2	1.375	.750	B2	1.875	.812
C2-M	1.375	.750			
C3	1.875	1.000	Clips		
C3-M	1.875	1.000	NO*	.340	.500
			N1	.500	.937
			N3	1.000	1.000
			N5	1.750	1.000
			N7	2.562	1.000

* Comes assembled as CO-NO

MATERIALS

Cradles and Binders are molded from special nylon. Extensible Clips are molded of Neoprene, Butyl, Viton and Silicone rubber clips also available. Temperature range -76°F to +250°F.

RECOMMENDED COMBINATIONS

DIAMETER OF CABLE FORM	SUPPORTED* WIRING Cradle Clip		UNSUPPORTED* WIRING Binder Clip	
	Code	Code	Code	Code
1/8" - 3/16"	C0	N0	C0	N0
1/4" - 1/8"	C1	N1	B1	N1
1/2" - 1/8"	C1	N3	B1	N5
3/8" - 1/8"	C2	N3	B12	N3
1/2" - 1/8"	C2	N5	B12	N5
3/8" - 1/4"	C3	N3	B2	N3
1" - 1/2"	C3	N5	B2	N5
1 1/4" - 1 1/2"	C3	N7	B2	N7
1 1/2" - 2"	C3	N7	B2	N7

Standard pack: 100 & 500.

Spiroband

Reduces inventory costs • Five standard materials — natural polyethylene, ultraviolet resistant polyethylene, fire resistant polyethylene (Rulan), Nylon, Teflon. Three diameters, each for application to a wide range of bundle sizes.

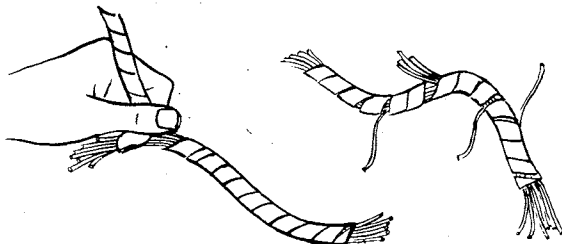

- Clear Polyethylene (Natural):** General applications where there are no special or unusual environmental conditions.
- Ultraviolet and Weather-Resistant Polyethylene (Black):** Contains special additives to resist UV and weathering in general. Additives color the material black.
- Fire-Resistant, Self-Extinguishing Polyethylene (Rulan):** Special fire-resistant additive, colors material bone white.
- Nylon:** For moderate temperature applications up to 250°F constant exposure.
- Teflon:** For very high temperature applications up to 500°F constant exposure.

† Dupont TFE fluorocarbon resin

Size	O.D. (in)	Bundle Range (in)	Polyethylene		Nylon		Teflon	
			Wall Thickness (in)	Length* Std. Coil (ft)	Wall Thickness (in)	Length* Std. Coil (in)	Wall Thickness (in)	Length Std. Coil (ft)
1/8	.125	1/6 - 1/2	.032	100	.030	100	.030	25
1/4	.250	1/6 - 2	.045	100	.030	100	.030	25
1/2	.500	3/8 - 4	.062	25	.030	25	.030	25

* Also available on spools of 250' for 1/2" and 500' for 1/4" and 1/8"

Strapping (Insuloid)

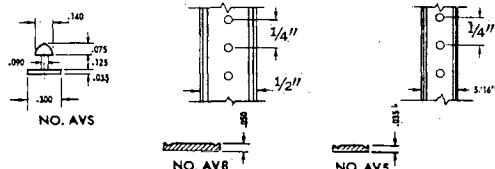

Material: Strapping is plasticized PVC (polyvinylchloride), with unusual strength and elastic properties; requires no tools; temperature range -26°F to +180°F.

Stud molded of nylon.

Colors: Standard black; also available in wide variety of colors.

Packing: Strap, 100 ft. boxed feed-out coil; 500 or 1,000 ft. coils on reels. Studs, 1,000 per box.

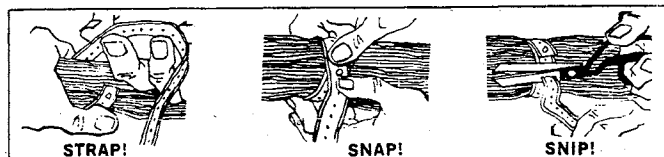

Installation: Stud is inserted in end of strap extending from dispenser carton; strap is then passed under and around wire bringing it back, under tension, over stud again. Strap is then cut at next hole. This operation should be repeated approximately every 6 inches or as required.

ELECTROVERT^{INC} COMPONENTS DIVISION



SEND FOR COMPLETE CATALOG AND PRICES

"C" markers

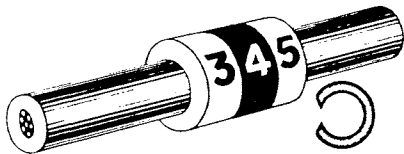

Clip-on type. Quick, easy to fit after connection is made of terminal tag fitted. May be removed for re-coding. Same marker used for right or left hand entry.

Materials: Durable rigid PVC.

Colors: White with black markings (standard). Also available in black, blue, red, green and yellow.

Markings: Single; numerals 0-9, letters A to Z and symbols.

Packing: 50 markers of same size and marking; 500 same size and marking for color.

Size No.	Recommended for Wires/Cable of O.D.	Size No.	Recommended for Wires/Cable of O.D.
2	.080" - .100"	9	.250" - .280"
3	.100" - .118"	10	.280" - .315"
4	.118" - .138"	11	.315" - .350"
5	.138" - .156"	12	.350" - .400"
6	.156" - .187"	13	.400" - .460"
7	.187" - .218"	14	.460" - .510"
8	.218" - .250"	15	.510" - .570"

"Z" markers

Slip-on type marker for applications where marking is attached before terminal attached or connection made.

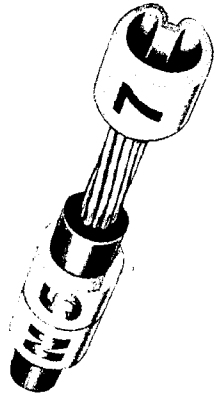

Size No.	Recommended for Wires/Cables of O.D.	Length	Thickness
22	.045"-.065"	.140"	.055"
20	.066"-.085"	.140"	.050"
18	.086"-.115"	.140"	.040"
16	.110"-.135"	.140"	.030"
14	.130"-.160"	.160"	.040"
12	.150"-.175"	.160"	.045"
10	.170"-.195"	.160"	.045"
9	.190"-.215"	.160"	.050"
8	.210"-.250"	.190"	.055"
7	.245"-.295"	.190"	.055"
6	.290"-.360"	.224"	.060"
4-1	.355"-.460"	.224"	.060"

Colors: White with black markings (Standard color). Black with white markings, Blue, Green, Yellow, Red with black markings.

Material: PVC MIL-1-631C, Type F, Form U, Grade a & b, Class I, Category 1, finish: glossy. Specific gravity: 1.21. Hardness (shore A): 73 av. Tensile Strength: 2600 psi. av. Ultimate Elongation: 350% av. Dielectric Strength (20 mil specimen): 750 volts/mil. Cold Brittle Temp. (50% non-failure): -65° F.

Markings: Single: numerals 0-9, letters A to Z, symbols +, -, ~. Multiple any 2, 3, 4 or 5 unit combinations of above.

Packing: Coil of 50 single markers, one size, color and character per package. Coil of 500, as above, on self-servicing reels.

Min. Quantity: per size and character: 50 single white, 500 multiple, 500 colored.

"S" markers

for wire bundles or cables with O.D. of more than .500"

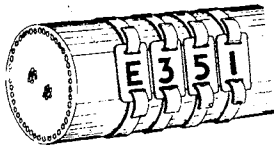

Strap-on-marker: Size: $\frac{3}{8}$ " x $\frac{1}{8}$ " x .040", material P.V.C., colors and material same as ELECTROVERT "Z". Markings: 0-9, A-Z, +, -, ~.

Applications Strip: P.V.C. — covered aluminum, .157" wide x .024" thick.

Min. Quantity: Per size and character: 50 markers; color 500; 165' strip coil.

Min. Order: 500 Markers, 165' coil of strip.

Packing: Markers, 50 per indicator card pouch; strips in 165' coils.

Grommet Strip with the "Snip-n-Fit" feature

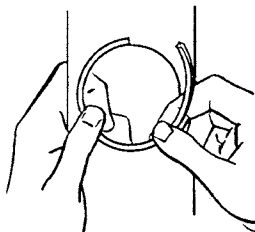

U-shaped, strip-type grommeting material can be cut to size, provides smooth surface around edge of any hole and features quick, simple application. No adhesive or special tools required.

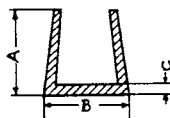

...offers the advantage of one strip only for applications to: round holes; square holes; rectangular holes; oval holes.

SIZES	A INCH	B INCH	C INCH	SHEET THICKNESS MAX/MIN INCH	PACKAGING
GS2	.150	.160	.042	0.0400 to 0.0624	100' coils
GS2A	.150	.160	.042	0.0400 to 0.0624	100' coils
GS3	.170	.170	.042	0.0625 to 0.0999	100' coils
GS4	.175	.240	.045	0.1000 to 0.1449	100' coils
GS5	.215	.290	.045	0.1450 to 0.1870	100' coils
GS6	.275	.370	.055	$\frac{3}{16}$ to $\frac{1}{4}$	50' coils

Specifications

Standard material is natural low density polyethylene. Also available, on request, both in ultraviolet- and weather-resistant, and flame-resistant polyethylene formulations.

The standard, clear Grommet Strip meets the following specifications and standards: ASTM D 1248-63T, Type I, Class A, Grade 4; Federal Spec L-P-390, Type I, Class L, Grades 1, 2 and 3; Federal Spec L-P-390, Type II, Class L, Grade 4; MIL-P-3803; MIL-I-631C; and MIL-E-16400, Classes 1, 2, 3 and 4.

P.V.C. Wiring Duct

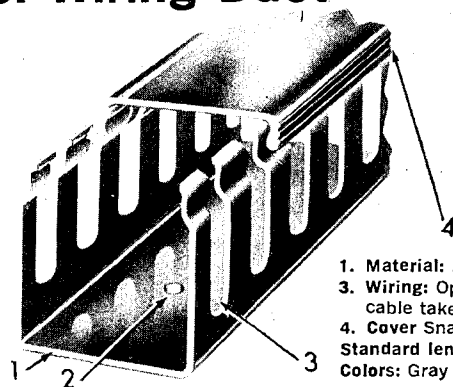

1. Material: Rigid, high impact PVC.
 2. Wiring: Open slot to provide fast cable take off.
 3. Cover Snaps on or off.
 4. Standard length: 6 ft.
- Colors: Gray and white.

APPROVED BY CSA

Sizes, Dimensions, Ordering Data

Size	Nominal W x H (inches)	Approximate Shpg. Wt. Per 100 (Channel & Cover)
1010	1 x 1	25
1020	1 x 2	30
1030	1 x 3	40
2020	2 x 2	35
2030	2 x 3	48
3010	3 x 1	37
3030	3 x 3	60

Channels and cover furnished together. Available on inquiry with adhesive backing.



a subsidiary of ICORE INDUSTRIES

This expandable spiral-cut plastic wrap harnesses, insulates and protects wire assemblies up to 8" diameter.

HARNESSING:

Spiral Wrap applies a strong grip developed both from its torsional cut and the memory of plastic materials used. It retains its strength under repeated flexing and bending, follows wire paths easily, and makes neat, free-running cables. It is extremely useful on long continuous runs where many leads are required; wires can enter or break out at any point. Spiral Wrap can be removed easily for trouble shooting and then re-applied.

PROTECTION:

Spiral Wrap is available in materials which accommodate a heat range from -265°C/-450°F to 260°C/500°F for insulation purposes. It is also available in materials with high abrasion resistance and in materials for use outdoors where resistance to ultra-violet rays is required.

SPIRAL WRAP®**MATERIAL DESCRIPTION**

Polyethylene Versatile, low cost material
Polyethylene, black In addition to above, this material is designed for outdoor use. It resists ultra-violet rays. Oper. Temp. -75°C/-105°F to 100°C/215°F.
Rulan (carbon impregnated polyethylene) Used primarily in applications where a low cost self-extinguishing material is required. Oper. Temp. -25°C/-10°F to 95°C/200°F.
Nylon, natural This material offers best mechanical protection; also has a higher temperature rating than polyethylene. Oper. Temp. -100°C/-150°F to 150°C/300°C.
Nylon, black In addition to the above, this material is designed for outdoor use; it resists ultra-violet rays. Oper. Temp. -100°C/-150°F to 110°C/230°F.
Teflon Primarily used in high temperature applications; also has an extremely low operating temperature, excellent dielectric properties and is not affected by organic solvents or acids. Oper. Temp. -265°C/-450°F to 260°C/500°F.

Cat. # Size	Price 100'
SWN-1/8	\$ 7.50
1/4	14.00
3/8	36.40
1/2	44.00
3/4	128.70
1"	179.30
SWP-1/8	3.60
3/16	5.30
1/4XXT	5.60
1/4XT	5.80
1/4	6.00
3/8	9.50
1/2	14.50
3/4	21.75
1XT	28.55
1"	29.25
SWR-1/8	4.65
1/4	12.05
3/8	16.65
1/2	27.40
SWT-1/8	117.00
3/16	128.00
1/4	139.00
3/8	261.00
1/2	380.00
3/4	570.00
1"	760.00

CATALOG #SWP — POLYETHYLENE

Conforms to: Grade C Fed. Spec. L.P. 390 MIL-I-631D MIL-P-26692

Cat. #	Nominal Outside Dia., (Inches)	Nominal Wall (Inches)	Nominal Pitch (Inches)	Max. Bundle Size (In.)*	Standard Colors**	Standard Package (Ft./Spool)
SWP-1/8	.125	.031	1/4	1/2	Nat., Blk.	100, 500
3/16	.187	.031	1/4	1-1/2	Nat., Blk.	100, 500
1/4XXT	.250	.031	3/8	2	Nat., Blk.	100, 500
1/4XT	.250	.040	3/8	2	Nat., Blk.	100, 500
1/4	.250	.058	5/16	2	Nat., Blk., Bl., Rd.	100, 500
3/8	.375	.058	7/16	3	Nat., Blk., Bl., Rd.	100, 500
1/2	.500	.058	9/16	4	Nat., Blk.	100, 250
3/4	.750	.065	7/8	6	Nat., Blk.	50, 100 (Box)
1XT	1.000	.065	1	8	Nat., Blk.	50, 100 (Box)
1	1.000	.100	7/8	8	Nat., Blk.	50, 100 (Box)

CATALOG #SWN — NYLON

Conforms to: MIL-M-22096

Cat. #	Nominal Outside Dia., (Inches)	Nominal Wall (Inches)	Nominal Pitch (Inches)	Max. Bundle Size (In.)*	Colors**	Standard Package (Ft./Spool)
SWN-1/8	.125	.016	1/4	1/2	Nat., Blk.	100, 500
1/4	.250	.030	5/16	2	Nat., Blk.	100, 500
3/8	.375	.030	7/16	3	Nat., Blk.	100, 500
1/2	.500	.030	9/16	4	Nat., Blk.	100, 250
3/4	.750	.040	7/8	6	Natural	50, 100 (Box)
1	1.000	.040	1	8	Natural	50, 100 (Box)

CATALOG #SWR — RULAN

Cat. #	Nominal Outside Dia., (Inches)	Nominal Wall (Inches)	Nominal Pitch (Inches)	Max. Bundle Size (In.)*	Colors**	Standard Package (Ft./Spool)
SWR-1/8	.125	.030	1/4	1/2	Wh., Gray	100, 500
1/4	.250	.058	5/16	2	Wh., Gray	100, 500
3/8	.375	.058	7/16	3	Wh., Gray	100, 500
1/2	.500	.058	9/16	4	Wh., Gray	100, 250

CATALOG #SWT — TEFLON

Conforms to: MIL-I-22129B AMS 3651B, 3653

Cat. #	Nominal Outside Dia., (Inches)	Nominal Wall (Inches)	Nominal Pitch (Inches)	Max. Bundle Size (In.)*	Colors**	Standard Package (Ft./Spool)
SWT-1/8	.125	.030	1/4	1/2	Natural	25, 50, 100, 500
3/16	.187	.030	1/4	1	Natural	25, 50, 100, 500
1/4	.250	.030	3/8	2	Natural	25, 50, 100, 500
3/8	.375	.030	7/16	2-1/2	Natural	25, 50, 100, 500
1/2	.500	.030	9/16	3	Natural	25, 50, 100, 250
3/4	.750	.040	7/8	4	Natural	25 (Box)
1	1.000	.040	1	6	Natural	25 (Box)

* Size will vary on a specific bundle depending on desired flexibility and protection

** ADDITIONAL COLORS AVAILABLE ON REQUEST

Prices subject to change without notice.

illumitronic engineering is now ICORE ELECTRO-PLASTICS, INC.

PANDUIT® wiring components

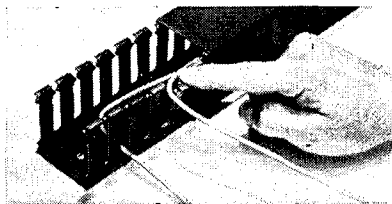

Type E — Open Slot

PART NUMBER SYSTEM

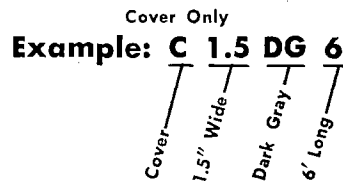
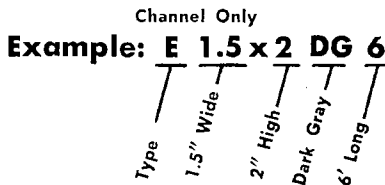

PANDUIT® CHANNEL ONLY

Types Avail.	Nominal Width x Height (Inches)	Approx. Shpg. Wt. Per 100'	Price/Foot		
			Under 200 ft.	200 ft. to 1999 ft.	2000 to 4999 ft.
E	.5x.5	11 lbs.	\$0.39	\$0.31	\$0.28
	.5x.62	12 lbs.	.41	.33	.31
	.5x1	16 lbs.	.45	.36	.34
	.5x1.25	16 lbs.	.51	.40	.37
	.5x1.75	16 lbs.	.53	.43	.40
E	.75x.75	14 lbs.	.44	.35	.33
	.75x1	16 lbs.	.45	.36	.34
	.75x1.5	19 lbs.	.53	.42	.39
	.75x2	23 lbs.	.65	.52	.48
E	1x1	16 lbs.	.45	.37	.34
	1x1.5	18 lbs.	.60	.49	.45
	1x2	21 lbs.	.64	.52	.48
	1x3	31 lbs.	.81	.65	.60
E	1.5x1.5	20 lbs.	.63	.51	.46
	1.5x2	20 lbs.	.69	.55	.50
	1.5x3	30 lbs.	.87	.70	.64
	1.5x4	40 lbs.	1.11	.89	.82
E	2x1	18 lbs.	.62	.50	.45
	2x2	23 lbs.	.75	.60	.55
	2x3	36 lbs.	.90	.72	.66
	2x4	48 lbs.	1.16	.93	.85
E	2.5x3	41 lbs.	.95	.76	.71
E	3x1	20 lbs.	.75	.60	.56
	3x2	33 lbs.	.82	.65	.60
	3x3	43 lbs.	.98	.78	.72
	3x4	53 lbs.	1.21	.97	.89
E	4x1.5	33 lbs.	.86	.69	.64
	4x2	38 lbs.	.88	.71	.65
	4x3	48 lbs.	1.05	.84	.77
	4x4	58 lbs.	1.23	.98	.90

CORRESPONDING COVER ONLY

Nominal Width (Inches)	Approx. Shpg. Wt./100'	Price/Foot		
		Under 200 ft.	200 to 1999 ft.	2000 to 4999 ft.
.5	4 lbs.	\$0.09	\$0.07	\$0.06
.75	6 lbs.	.10	.08	.07
1	9 lbs.	.12	.09	.08
1.5	10 lbs.	.15	.12	.11
2	12 lbs.	.18	.14	.13
2.5	14 lbs.	.22	.18	.16
3	17 lbs.	.25	.20	.18
4	22 lbs.	.33	.26	.24

Order by Total No. of Ft. Req'd. (must be multiple of length per part.)

Standard Mounting Holes: No Charge — Supplied Only if Specified — See Duct Catalog For Dimensions.

NOTE: Standard Length: 6 ft. Other lengths available. Standard Color: Dark Gray. White and Light Gray available.

NOTE: Total length of all sizes of duct and cover, ordered for shipment at one time to one location, determines price columns.

STA-STRAP® CABLE TIES AND CLAMPS

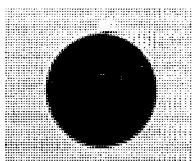

SST—Tie

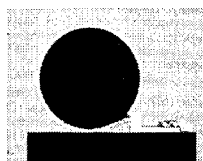

SSC—Clamp

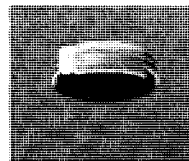

SSM—Marker

STANDARD PKG. OF 100(C)

Part Number	Maximum Bundle Diameter	Approx. Shpg. Wt. lbs./1000	Price Per 100	
			Base Price 100-400	500
SST1C	3/4"	1	\$ 3.60	\$ 2.85
SST1.5C	1 1/4"	1.5	3.75	3.00
SST2C	1 3/4"	2.6	4.30	3.40
SST4C	4"	4.5	9.80	7.80
SST4HC	4"	12	14.50	11.50
SST8HC	8"	24	22.50	18.00
SSC2C	1 3/4"	3.2	4.90	3.90
SSC4C	4"	5.5	10.80	8.60
SSC4HC	4"	14	17.00	13.60
SSM2C	1 3/4"	3.3	8.60	6.80
SSM4C	4"	6	14.10	11.20

BULK PACKAGING*

Part Number	Approx. Shpg. Wt. lbs./1000	Price Per M (1000)		
		1M-24.5M	25M-49.5M	50M
SST1M	1	\$ 23.00	\$ 21.85	\$ 20.70
SST1.5M	1.5	24.00	22.80	21.60
SST2M	2.6	27.00	25.65	24.30
SST4M	4.5	60.00	57.00	54.00
SST4HD	12	93.00	88.35	83.70
SST8HD	24	140.00	136.00	126.00
SSC2M	3.2	30.00	28.50	27.00
SSC4M	5.5	66.00	62.70	59.40
SSC4HD	14	111.80	106.20	100.75
SSM2M	3.3	55.00	52.25	49.50
SSM4M	6	87.50	83.15	78.25

Order by Number of Pieces Required.

Colors: Standard Color — Natural Nylon White.

Other Colors — 10% additional price.

Delivery: F.O.B. Factory. Minimum Billing: \$25.00 net each customer-designated shipment. Terms: Cash Discount 2%, 10th prox. FREIGHT ALLOWED via Panduit routing on domestic shipments of \$300.00 or more net billing. All prices subject to change without notice.

*Bulk packaging quantities indicated by letter suffix in part no. D=500; M=1000.

Order by Number of Pieces Required

STA-STRAP® Installation Tools



GS2B—Manual \$19.00 ea. net. installs all STA-STRAP Ties except Heavy Duty.

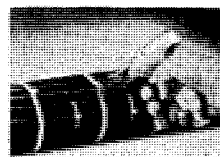

GS4H—Manual \$40.00 ea. net. NEW Heavy Duty—installs all STA-STRAP Ties except SST1 & SST1.5.

PANDUIT CORP.

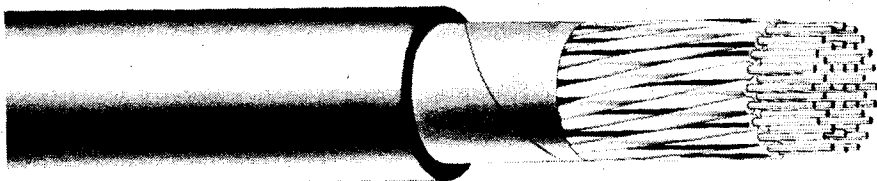

In Stock MIL-SPEC

Multiple Conductor Control Cables

National Wire & Cable Corporation manufactures a complete line of multiple conductor control cables. Conductors are of tinned copper strand with $\frac{1}{64}$ " vinyl primary insulation for use up to 105°C per MIL-W-16878D Type Cf. Insulated for 1000 volts working voltage. Conductors are color coded using 10 standard basic colors, plus spiral tracers on white per MIL-STD. 122.

All conductors are planetary cabled and contra-helically laid with a Mylar tape serve over the cable bundle. The overall jacket is a 105°C black polyvinyl-chloride thermoplastic, meeting specification MIL-I-631 Class F, or may be Neoprene to MIL-R-6855 Class 2 Grade 60 specification. (Neoprene jackets at added cost.)*

National Multiple Conductor SHIELDED CABLES are to the same specifications as above with addition of tinned copper braided shield over cable complex with 85-90% coverage to MIL-C-7078A. STANDARD PUT-UPS: 500 ft. and 1000 ft. No-deposit reels.

* (Standard put-up for Neoprene jacketed cable is 250 ft.)

† Insulated Conductors are also UL approved under UL type 1007 AWM, and are CSA approved as type TR 64.

TECHNICAL DATA (all cables)

Insulation Breakdown Voltage:	Greater than 8000 volts AC RMS, 60 cps.
Capacitance:	Nominal capacitance from a wire to all else in the cable ranges from 40 to 65 mmfd per ft., @ 1000 cps; dependent on gauge and position.
Insulation Leakage Res.:	200. megohms/1000 ft. min. at 500 VDC from any conductor to all else in cable.
Sheath Leakage Res.:	10. megohms/1000 ft. min. at 500 VDC from overall shield through sheath to outside world.
Usable Temp. Range:	Suitable for continuous use from +105°C to -55°C.
Cold Bending Capability:	All cables are suitable for flexing to a circle diam. of approx. 6 cable diameters from +105°C to -20°C; Recommended flex diameter should be greater than 20 cable diam. for flexing at -40°C, or for continuous flexing service to -55°C, specify our neoprene sheath, in lieu of plastic sheath.

MULTI-CONDUCTOR STOCK CABLES

Conductor sizes 22, 20, 18, 16, 14 & 12 gauge. 22 AWG is 7 strand. All others 19 strand.

UNSHIELDED					
PART NO.	NO. COND.	COND. AWG	JKT. THICK	CABLE O.D.	WEIGHT PER M'
NW-722 J	7	22	.040	.295	40 Lbs.
NW-1222J	12	22	.050	.390	70 Lbs.
NW-1922J	19	22	.060	.460	110 Lbs.
NW-2722J	27	22	.060	.530	160 Lbs.
NW-3722J	37	22	.060	.600	200 Lbs.
NW-4822J	48	22	.060	.670	245 Lbs.
NW-6022J	60	22	.060	.730	300 Lbs.
NW-7222J	72	22	.060	.775	360 Lbs.
NW-8822J	88	22	.060	.835	425 Lbs.
NW-10222J	102	22	.060	.880	485 Lbs.
NW-720 J	7	20	.040	.300	50 Lbs.
NW-1220J	12	20	.050	.400	105 Lbs.
NW-1920J	19	20	.060	.470	160 Lbs.
NW-2720J	27	20	.060	.560	210 Lbs.
NW-3720J	37	20	.060	.610	280 Lbs.
NW-4820J	48	20	.060	.700	360 Lbs.
NW-6020J	60	20	.060	.750	435 Lbs.
NW-7220J	72	20	.060	.840	485 Lbs.
NW-8820J	88	20	.060	.900	580 Lbs.
NW-10220J	102	20	.060	.975	670 Lbs.
NW-718 J	7	18	.040	.350	75 Lbs.
NW-1218J	12	18	.050	.460	135 Lbs.
NW-1918J	19	18	.060	.560	225 Lbs.
NW-2718J	27	18	.060	.650	300 Lbs.
NW-3718J	37	18	.060	.730	390 Lbs.
NW-4818J	48	18	.060	.820	510 Lbs.
NW-6018J	60	18	.060	.900	600 Lbs.
NW-7218J	72	18	.060	1.100	720 Lbs.
NW-716 J	7	16	.040	.370	95 Lbs.
NW-1216J	12	16	.050	.500	155 Lbs.
NW-1916J	19	16	.060	.600	230 Lbs.
NW-2716J	27	16	.060	.700	320 Lbs.
NW-3716J	37	16	.060	.785	430 Lbs.
NW-4816J	48	16	.060	.900	625 Lbs.
NW-6016J	60	16	.060	.980	750 Lbs.
NW-714 J	7	14	.050	.450	150 Lbs.
NW-1214J	12	14	.050	.560	240 Lbs.
NW-1914J	19	14	.060	.675	370 Lbs.
NW-2714J	27	14	.060	.800	515 Lbs.
NW-512 J	5	12	.050	.480	175 Lbs.
NW-712 J	7	12	.050	.525	225 Lbs.
NW-1212J	12	12	.060	.700	375 Lbs.
NW-1912J	19	12	.060	.820	560 Lbs.

OVERALL SHIELDED						
PART NO.	NO. CDND	COND AWG	T.C. SHIELD	JKT. THICK	CABLE O.D.	WEIGHT PER M'
NW-722 SJ	7	22	No. 36	.040	.320	55 Lbs.
NW-1222SJ	12	22	No. 34	.050	.420	90 Lbs.
NW-1922SJ	19	22	No. 34	.060	.490	145 Lbs.
NW-2722SJ	27	22	No. 34	.060	.560	200 Lbs.
NW-3722SJ	37	22	No. 34	.060	.630	245 Lbs.
NW-4822SJ	48	22	No. 34	.060	.700	300 Lbs.
NW-6022SJ	60	22	No. 34	.060	.760	355 Lbs.
NW-7222SJ	72	22	No. 34	.060	.810	425 Lbs.
NW-8822SJ	88	22	No. 34	.060	.870	500 Lbs.
NW-10222SJ	102	22	No. 34	.060	.915	560 Lbs.
NW-720 SJ	7	20	No. 34	.040	.335	68 Lbs.
NW-1220SJ	12	20	No. 34	.050	.435	125 Lbs.
NW-1920SJ	19	20	No. 34	.060	.500	195 Lbs.
NW-2720SJ	27	20	No. 34	.060	.595	250 Lbs.
NW-3720SJ	37	20	No. 34	.060	.650	325 Lbs.
NW-4820SJ	48	20	No. 34	.060	.735	415 Lbs.
NW-6020SJ	60	20	No. 34	.060	.785	500 Lbs.
NW-7220SJ	72	20	No. 34	.060	.875	555 Lbs.
NW-8820SJ	88	20	No. 34	.060	.935	660 Lbs.
NW-10220SJ	102	20	No. 34	.060	1.010	750 Lbs.
NW-718 SJ	7	18	No. 34	.040	.380	95 Lbs.
NW-1218SJ	12	18	No. 34	.050	.490	170 Lbs.
NW-1918SJ	19	18	No. 34	.060	.590	265 Lbs.
NW-2718SJ	27	18	No. 34	.060	.680	350 Lbs.
NW-3718SJ	37	18	No. 34	.060	.760	445 Lbs.
NW-4818SJ	48	18	No. 34	.060	.850	575 Lbs.
NW-6018SJ	60	18	No. 34	.060	.935	680 Lbs.
NW-7218SJ	72	18	No. 34	.060	1.135	820 Lbs.
NW-716 SJ	7	16	No. 34	.040	.400	125 Lbs.
NW-1216SJ	12	16	No. 34	.050	.535	195 Lbs.
NW-1916SJ	19	16	No. 34	.060	.635	275 Lbs.
NW-2716SJ	27	16	No. 34	.060	.735	375 Lbs.
NW-3716SJ	37	16	No. 34	.060	.820	500 Lbs.
NW-4816SJ	48	16	No. 34	.060	.935	700 Lbs.
NW-6016SJ	60	16	No. 34	.060	1.015	830 Lbs.
NW-714 SJ	7	14	No. 34	.050	.485	180 Lbs.
NW-1214SJ	12	14	No. 34	.050	.600	280 Lbs.
NW-1914SJ	19	14	No. 34	.060	.710	420 Lbs.
NW-2714SJ	27	14	No. 34	.060	.835	575 Lbs.
NW-512 SJ	5	12	No. 34	.050	.515	210 Lbs.
NW-712 SJ	7	12	No. 34	.050	.560	265 Lbs.
NW-1212SJ	12	12	No. 34	.060	.735	430 Lbs.
NW-1912SJ	19	12	No. 34	.060	.850	625 Lbs.

NATIONAL WIRE & CABLE CORP.

SPECIAL SHIELDED DATA & INSTRUMENTATION CABLES

Designed for Low Level or Low Capacitance Needs • All feature extremely low dielectric leakage both in insulation and outer sheath • Suitable for very long runs in tray or conduit. (1000 ft and up).

SINGLE CONDUCTOR SHIELDED

Part Number	AWG & Stranding	Drain AWG & Str.	Insulation & Thickness	Jacket Thickness	Nom. O.D.	Shld % Coverage	Cap. mmfd/ft	Working Voltage	Surge Impedance Ohms	Temp. °F
S10-516	28(7 x 38)	—	.086" NAFOAM	.015" pvc	.242"	TC Braid 90%*	12.	3000.	120.	+180
S10-328-1 S10-328-2	22(19 x 34)	—	.042" NAFOAM	.020" pvc	.182"	(1) 90% Braid* (2) 100% NAFOIL & Braid	20.7 20.7	1000. 1000.	60.	+180
S10-680	22(19 x 34)	22 7 x 30	.032" poly	.016" pvc	.135"	NAFOIL & Drain	30.	3000.	—	+180
S10-679	22(19 x 34)	24 7 x 32	.010" pvc .002" nylon	.015" pvc	.091"	100% NAFOIL & Drain	100.	600.	25.	+221

TWO CONDUCTOR SHIELDED

S10-010-1 S10-010-2	22(19 x 24)	—	.042" NAFOAM	.020" pvc	.295"	(1) 90% Braid (2) 100% NAFOIL + Braid (3) NAFOIL only	10.6 W-W	1000.	120.	+180
S10-010-3 S10-681	22(19 x 34)	22 7 x 30	.025" NAFOAM	.020" poly	.210"	100% NAFOIL & Drain	15. W-W	600.	84.	+180
S10-686	22(19 x 34)	22 7 x 30	.018" NAFOAM	.020" poly	.178"	100% NAFOIL & Drain	20.	600.	63.	+180
S10-362	22(19 x 34)	22 7 x 30	.010" pvc .002" nylon	.020" poly	.166"	100% NAFOIL & Drain	40. W-W	600.	52.	+180

THREE CONDUCTOR SHIELDED

S10-683	22(19 x 34)	18 19 x 30	.042" NAFOAM	.020" pvc	.297"	100% NAFOIL & Drain	10.	1000.	—	+180
S10-684	22(19 x 34)	20 19 x 32	.018" NAFOAM	.020" pvc	.185"	100% NAFOIL & Drain	20.	600.	—	+180

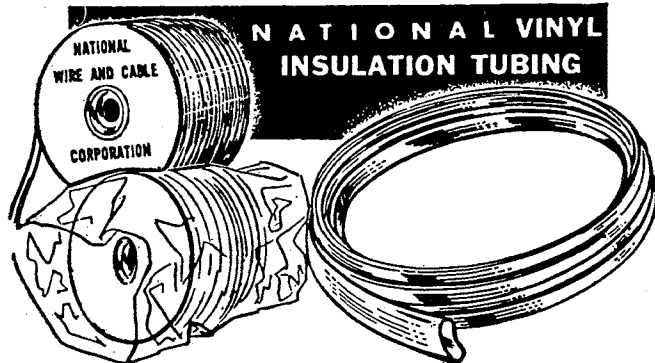

INSULATION

EXTRUDED VINYL AND TEFLON TUBING

SIZES: #24 through 2½" Diam.

PUT-UP: #24 to ¾" on spools, completely sealed in plastic wrapping. Size ¾" to 2½" in tied coils.

SPEC. Vinyl +105°C to -32°C Type: MIL-I-631C, ASTM-D922 Grade C

GRADES: Vinyl + 80°C to -55°C Type: MIL-I-7444B, MIL-I-22076

Teflon +250°C to -55°C Type: MIL-I-22129B (#20 to #2)

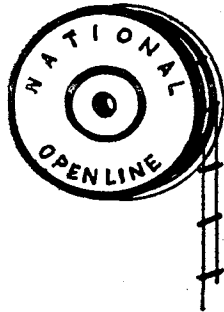

NATIONAL OPENLINE

DESIGNED FOR COMMERCIAL TV DISTRIBUTION SYSTEMS AND RF POWER TRANSMISSION

Specifications: two inch spacing between conductors . . . 12 gauge copperweld . . . 470 ohm impedance . . . attenuation: 150 mc 0.25 DB PER 100 FEET, AT 30 mc 0.1 DB PER 100 FEET. Velocity factor 0.975 . . . copperweld steel for maximum strength and electrical stability, and to insure permanent uniform performance. . . Spreaders are brown polystyrene, spaced at average five foot intervals, staggered slightly to avoid spurious resonances.

Also 1" & ½" copper line for TV leadin Formvar coated.

COMPLETE WIRE AND CABLE INVENTORY ALWAYS AVAILABLE FOR IMMEDIATE SHIPMENT!

National Wire and Cable Corporation maintains one of the largest and most complete stocks of electronic and aircraft wire and cable in the nation. Total footage of floor stocks exceeds 50 million feet!

Your immediate source for "MIL and Jan-Spec" wires, coaxial cables and vinyl sleeving.

Special color coded, shielded and jacketed combinations of hook-up wire and multi-conductor cables can be made to your specifications and delivered promptly without delay.

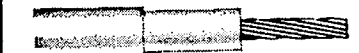

IN STOCK!

MIL-W-76 A
MW, HW, LW

MIL-W-16878/D
B, BN, C, CN, D, DN

E, EE, K, KK

J, JN

NAS -702
CLASS A, B, C

MIL-W-5086 A
Type I, II, III

MIL-C-7078/A
Type I, II, III

JAN-C-76
SRIR, SRHV

FOR COMPLETE INFORMATION AND PRICES, PHONE, WRITE OR WIRE NATIONAL.

NATIONAL WIRE & CABLE CORP.

HOOK-UP WIRE

PLASTIC TYPE

PLASTIC INSULATION STRANDED OR SOLID TINNED CONDUCTOR



SOLID CONDUCTOR

Saxton Number	Style No.	—Conductor—		Insulation Thickness	Nominal O.D.
		Size	Stranding		
1300	1AD22	22	solid	.016"	.061"
1301	1AD20	20	solid	.016"	.064"
1302	1AD18	18	solid	.016"	.072"

STRANDED CONDUCTOR

Saxton Number	Style No.	—Conductor—		Insulation Thickness	Nominal O.D.
		Size	Stranding		
1303	1A24	24	7 x 32	.016"	.056"
1304	1A22	22	7 x 30	.016"	.062"
1305	1A20	20	10 x 30	.016"	.067"
1306	1A18	18	16 x 30	.016"	.077"
1307	1A16	16	26 x 30	.016"	.092"
1308	1A14	14	41 x 30	.016"	.106"

SHIELDED HOOK-UP WIRE

PLASTIC TYPE

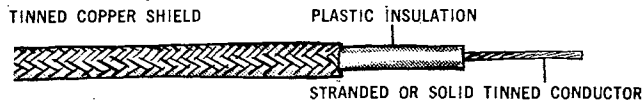

STRANDED CONDUCTOR

Saxton Number	Style No.	—Conductor—		Insulation Thickness	Nominal O.D.
		Size	Stranding		
1309	1AS22	22	7 x 30	.016"	.090"
1310	1AS20	20	10 x 30	.016"	.100"
1311	1AS18	18	16 x 30	.016"	.120"
1312	1AS16	16	26 x 30	.016"	.130"
1313	1AS14	14	41 x 30	.016"	.150"
1314	1AS12	12	65 x 30	.016"	.170"
1315	1AS10	10	105 x 30	.025"	.195"

UNSHIELDED AUDIO CABLE

2 AND 3-CONDUCTOR • NO OUTER JACKET

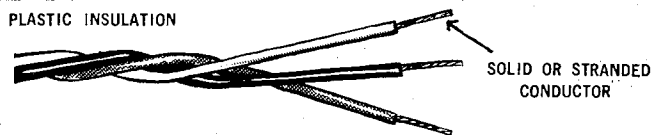

SOLID CONDUCTOR

Saxton Number	Style No.	—Conductor—		Insulation Thickness	Nom. O.D.
		No.	Stranding		
1318	2AD22	2	22 solid	.016"	.100"
1319	3AD22	3	22 solid	.016"	.115"
1320	2AD20	2	20 solid	.016"	.120"
1321	3AD20	3	20 solid	.016"	.135"
1322	2AD18	2	18 solid	.016"	.145"
1323	3AD18	3	18 solid	.016"	.160"
1324	2AD16	2	16 solid	.016"	.175"
1325	3AD16	3	16 solid	.016"	.190"

STRANDED CONDUCTOR

Saxton Number	Style No.	—Conductor—		Insulation Thickness	Nom. O.D.
		No.	Stranding		
1326	2A22	2	22 7 x 30	.016"	.125"
1327	3A22	3	22 7 x 30	.016"	.140"
1328	2A20	2	20 10 x 30	.016"	.145"
1329	3A20	3	20 10 x 30	.016"	.160"
1330	2A18	2	18 16 x 30	.016"	.165"
1331	3A18	3	18 16 x 30	.016"	.180"
1332	2A16	2	16 26 x 30	.016"	.190"
1333	3A16	3	16 26 x 30	.016"	.210"

MULTI-CONDUCTOR JACKETED CABLE

.020"-WALL PLASTIC JACKET

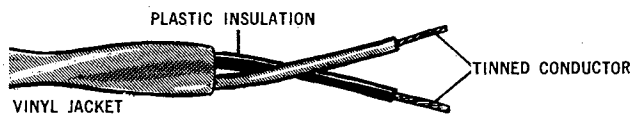

SOLID CONDUCTOR

Saxton Number	Style No.	—Conductor—		Insulation Thickness	Nom. O.D.
		No.	Stranding		
1334	2JD22	2	22 solid	.015"	.140"
1335	3JD22	3	22 solid	.015"	.150"
1336	4JD22	4	22 solid	.015"	.170"
1337	5JD22	5	22 solid	.015"	.185"
1338	6JD22	6	22 solid	.015"	.190"
1339	7JD22	7	22 solid	.015"	.200"
1340	8JD22	8	22 solid	.015"	.210"
1341	9JD22	9	22 solid	.015"	.240"
1342	10JD22	10	22 solid	.015"	.250"
1343	12JD22	12	22 solid	.015"	.270"
1345	2JD20	2	20 solid	.015"	.155"
1346	3JD20	3	20 solid	.015"	.165"
1347	4JD20	4	20 solid	.015"	.195"
1348	5JD20	5	20 solid	.015"	.220"
1349	6JD20	6	20 solid	.015"	.230"
1350	7JD20	7	20 solid	.015"	.240"
1351	8JD20	8	20 solid	.015"	.285"
1352	9JD20	9	20 solid	.015"	.300"
1353	10JD20	10	20 solid	.015"	.315"
1357	2JD18	2	18 solid	.015"	.188"
1358	3JD18	3	18 solid	.015"	.208"
1359	4JD18	4	18 solid	.015"	.223"
1360	5JD18	5	18 solid	.015"	.233"
1361	6JD18	6	18 solid	.015"	.263"

STRANDED CONDUCTOR

Saxton Number	Style No.	—Conductor—		Insulation Thickness	Nom. O.D.
		No.	Stranding		
1370	2J22	2	22 7 x 30	.015"	.145"
1371	3J22	3	22 7 x 30	.015"	.160"
1372	4J22	4	22 7 x 30	.015"	.185"
1373	5J22	5	22 7 x 30	.015"	.190"
1374	6J22	6	22 7 x 30	.015"	.195"
1375	7J22	7	22 7 x 30	.015"	.215"
1376	8J22	8	22 7 x 30	.015"	.225"
1377	9J22	9	22 7 x 30	.015"	.245"
1378	10J22	10	22 7 x 30	.015"	.260"
1379	12J22	12	22 7 x 30	.015"	.285"
1381	2J20	2	20 10 x 30	.015"	.175"
1382	3J20	3	20 10 x 30	.015"	.185"
1383	4J20	4	20 10 x 30	.015"	.205"
1384	5J20	5	20 10 x 30	.015"	.230"
1385	6J20	6	20 10 x 30	.015"	.250"
1386	7J20	7	20 10 x 30	.015"	.260"
1387	8J20	8	20 10 x 30	.015"	.305"
1388	9J20	9	20 10 x 30	.015"	.320"
1389	10J20	10	20 10 x 30	.015"	.325"
1390	12J20	12	20 10 x 30	.015"	.345"
1391	15J20	15	20 10 x 30	.015"	.365"
1392	20J20	20	20 10 x 30	.015"	.420"
1393	2J18	2	18 16 x 30	.015"	.210"
1394	3J18	3	18 16 x 30	.015"	.230"
1395	4J18	4	18 16 x 30	.015"	.245"
1396	5J18	5	18 16 x 30	.015"	.260"
1397	6J18	6	18 16 x 30	.015"	.275"

TELEPHONE STATION WIRE

- 1051 2 Conductor Station Wire with Beige Jacket — 22 gauge solid bare copper — color coded legs. Strips easily and is staple-proof for installation along baseboards. Matches existing telephone installation color. Packed — 1 M' spools
500' spools
- 1050 3 conductor - same as above.

MULTI-CONDUCTOR SHIELDED CABLE*
.020"-WALL PLASTIC JACKET

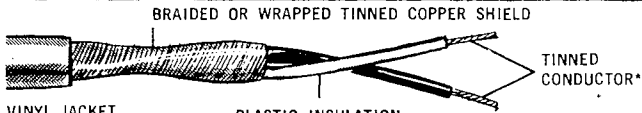

Saxton Number	Style No.	Type Shield	—Conductors—			Insul. Thck.	Jacket Thck.	Nom. O.D.
			No.	Awg	Stranding			
1400	1SSJ22	wrap	1	22	7 x 30	.016"	.020"	.135"
1401	2SSJ22	wrap	2	22	7 x 30	.016"	.020"	.175"
1402	2SSJ022	wrap	2	22	solid	.016"	.020"	.170"
1403	2SSJ20	wrap	2	20	10 x 30	.016"	.020"	.195"
1404	3SSJ20	wrap	3	20	10 x 30	.016"	.020"	.210"
1405	4SSJ20	wrap	4	20	10 x 30	.016"	.020"	.225"
1406	2SSJ18	wrap	2	18	16 x 30	.016"	.020"	.230"
1407	2SSJ16	wrap	2	16	26 x 30	.016"	.020"	.250"
1408	2SJ22	braid	2	22	7 x 30	.016"	.020"	.183"
1409	2SJ20	braid	2	20	10 x 30	.016"	.020"	.195"
1410	2SJ18	braid	2	18	16 x 30	.016"	.020"	.235"

*Bare conductors available. For additional constructions see Audio Cable Section.

INTERCOM CABLE
TWISTED PAIRS WITH PLASTIC JACKET



Saxton Number	Style No.	Number Pairs	—Conductors—			Insul. Thck.	Jacket Thck.	Nom. O.D.
			No.	Awg	Stranding			
1411	2PD22	1	2	22	solid	.015"	.020"	.128"
1412	4PD22	2	4	22	solid	.015"	.020"	.205"
1413	6PD22	3	6	22	solid	.015"	.020"	.230"
1414	12PD22	6	12	22	solid	.015"	.020"	.330"
1415	14PD22	7	14	22	solid	.015"	.020"	.345"
1416	18PD22	9	18	22	solid	.015"	.020"	.370"
1417	22PD22	11	22	22	solid	.015"	.020"	.385"
1418	26PD22	13	26	22	solid	.015"	.025"	.415"
1419	30PD22	15	30	22	solid	.015"	.025"	.450"
1420	32PD22	16	32	22	solid	.015"	.025"	.470"
1421	54PD22	27	54	22	solid	.015"	.035"	.605"
1422	62PD22	31	62	22	solid	.015"	.035"	.630"
1423	82PD22	41	82	22	solid	.015"	.035"	.710"
1424	102PD22	51	102	22	solid	.015"	.045"	.845"

Saxton Number	Style No.	Number Pairs	—Conductors—			Insul. Thck.	Jacket Thck.	Nom. O.D.
			No.	Awg	Stranding			
1425	2P22	1	2	22	7 x 30	.015"	.020"	.155"
1426	4P22	2	4	22	7 x 30	.015"	.020"	.220"
1427	6P22	3	6	22	7 x 30	.015"	.020"	.245"
1428	8P22	4	8	22	7 x 30	.015"	.020"	.275"
1429	10P22	5	10	22	7 x 30	.015"	.020"	.320"
1430	12P22	6	12	22	7 x 30	.015"	.020"	.340"
1431	18P22	9	18	22	7 x 30	.015"	.020"	.375"
1432	22P22	11	22	22	7 x 30	.015"	.020"	.415"
1433	30P22	15	30	22	7 x 30	.015"	.025"	.485"
1434	54P22	27	54	22	7 x 30	.015"	.035"	.645"

AUDIO CABLE
COMBINATION SHIELDED & JACKETED



Saxton No.	Style No.	No.	Conductors		Insuln. Thckns.	Jacket Thckns.	Nom. O.D.
			AWG	Stranding			
1435	2S2J22	4	22	7 x 30	.016"	.020"	.315"
(Two conductors shielded, two unshielded)							
1436	1S2J22	3	22	7 x 30	.016"	.020"	.200"
(One conductor shielded, two unshielded)							

E-Z ZIP-CORD—LAMP-CORD
PLASTIC TYPE • 2 & 3-CONDUCTOR

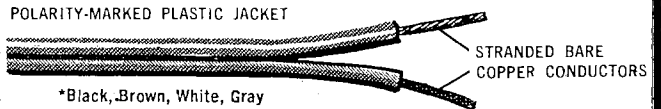

Saxton No.	Style No.	Conductors		UL Type	Wall Thckns.	Nominal O.D.
		No.	AWG Stranding			
1437	2F24*	2	24	7 x 32	.016"	.061" x .137"
1437A	Same as above—clear. (polarized conductors)					
1438	2F20*	2	20	10 x 30	.016"	.105" x .210"
1438A	Same as above—clear. (polarized conductors)					
1439	2F18*	2	18	16 x 30	SPT-1	.016" .130" x .215"
1439A	2F18A Same as above—clear (polarized conductors)					
1440	3F18	3	18	16 x 30	SPT-2	.032" .130" x .300"
1441	2F16	2	16	65 x 34	SPT-2	.032" .160" x .300"
1442	3F24	3	24	7 x 32	—	.032" .061" x .204"

*Black, Brown, White, Gray

STEREO PHONO WIRE
SHIELDED & UNSHIELDED



Saxton No.	Style No.	No.	Conductors		Insuln. Thckns.	Nom. O.D.
			AWG	Stranding		
1163	3A33	3	33	6 x 41	.008"	—
1164	4A33	4	33	6 x 41	.008"	—
1444	2S33	2	33	6 x 41	Shielded	—

AUDIO CABLE
2-CONDUCTOR SHIELDED, UNJACKETED

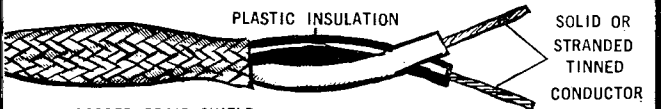

Saxton No.	Style No.	No.	Conductors		Insuln. Thckns.	Nom. O.D.
			AWG	Stranding		
1445	2SD22	2	22	solid	.016"	.132"
1446	2SD20	2	20	solid	.016"	.148"
1447	2SD18	2	18	solid	.016"	.175"

Saxton No.	Style No.	No.	Conductors		Insuln. Thckns.	Nom. O.D.
			AWG	Stranding		
1448	2S24	2	24	16 x 36	.016"	.125"
1449	2S22	2	22	7 x 30	.016"	.140"
1450	2S20	2	20	10 x 30	.016"	.155"
1451	2S18	2	18	16 x 30	.016"	.170"
1452	2S16	2	16	26 x 30	.020"	.210"
1453	2S14	2	14	41 x 30	.020"	.225"
1454	2S12	2	12	65 x 30	.025"	.295"

AUDIO CABLE
2-CONDUCTOR • SHIELDED & JACKETED



Saxton No.	Style No.	No.	Conductors		Insuln. Thckns.	Jacket Thckns.	Nom. O.D.
			AWG	Stranding			
1455	2SDJ22	2	22	solid	.016"	.020"	.172"
1456	2SDJ20	2	20	solid	.016"	.020"	.208"
1457	2SDJ18	2	18	solid	.016"	.020"	.218"

Saxton No.	Style No.	No.	Conductors		Insuln. Thckns.	Jacket Thckns.	Nom. O.D.
			AWG	Stranding			
1458	2SJ22	2	22	7 x 30	.016"	.020"	.183"
1459	2SJ20	2	20	10 x 30	.016"	.020"	.195"
1460	2SJ18	2	18	16 x 30	.016"	.020"	.235"

AUDIO CABLE
LOW LOSS MICROPHONE & INPUT

BRAIDED OR WRAPPED
TINNED COPPER SHIELD

BRAIDED OR WRAPPED
TINNED COPPER SHIELD

POLYETHYLENE INSULATION

Saxton No.	Style No.	Nom. Cap./ft.	Shield Type	Conductors No. AWG	Strdg.	Insl. Th.	Jkt. Th.	Nom. O.D.
1290†	1SSJC20RB	21 mmf.	wrap	1 20	19x34	Special		.200"
1291*	2MFSJC22	34 mmf.	foil	2 22	7x30	.022"	.028"	.225"
1292*	3MFSJC22	36 mmf.	foil	3 22	7x30	.027"	.031"	.286"
1293*	2MFSJC20	32 mmf.	foil	2 20	7x28	.024"	.029"	.228"
1294*	3MFSJC20	30 mmf.	foil	3 20	7x28	.026"	.035"	.288"
1461#	1SSJC26	36 mmf.	wrap	1 26	7x34	**.016	.020"	.125"
1462	1SJC24	35 mmf.	braid	1 24	10x34	.016"	.030"	.145"
1463	1SJC24A	23 mmf.	braid	1 24	10x34	.040"	.030"	.200"
1464	1SJC20	36 mmf.	braid	1 20	26x34	.030"	.030"	.175"
1465	2SJC20	31 mmf.	braid	2 20	16x34	.025"	.030"	.230"
1466	3SJC20	34 mmf.	braid	3 20	26x34	.025"	.035"	.290"
1467	4SJC20	36 mmf.	braid	4 20	26x34	.025"	.035"	.315"
1468	5SJC20	45 mmf.	braid	5 20	26x34	.025"	.035"	.340"
1469	6SJC20	51 mmf.	braid	6 20	26x34	.025"	.035"	.365"

†Heavy duty, foam insulated lo-loss mike cable with woven rayon braid—closely wrap shielded and flexible construction.

*Mylar-foil shield with ground runner. **Copperweld

#Wrap shield—easily pigtailed—for lapel and audio uses—low capacitance—extra flexible.

TEST LEAD WIRE
SUPER-FLEXIBLE VINYL INSULATION*

LOW DUROMETER SUPER-FLEXIBLE
VINYL INSULATION

STRANDED TINNED CONDUCTOR



Saxton No.	Style No.	Type	Conductors AWG	Strndg.	Wall Thkns.	Brkdwn. Voltage	Nom. O.D.
1470	1C20	Standard	20	41 x 36	.040"	5,000	.120"
1471	1C20A	Standard	20	41 x 36	.044"	8,500	.130"
1472	1C20B	Standard	20	41 x 36	.047"	10,000	.135"
1473	1C18	Standard	18	41 x 34	.047"	12,000	.140"
1474	1C18A	Hvy. Duty	18	41 x 34	.109"	22,000	.245"
1475	1C20R*	Standard	20	41 x 36	.040"	5,000	.120"
1476	1C18R*	Standard	18	41 x 34	.045"	5,000	.138"

*Rubber. Also available to MIL-spec from stock. ALL TEST PROD WIRES RED or BLACK. Other colors available.

ROTOR CABLE

POLYETHYLENE INSULATION

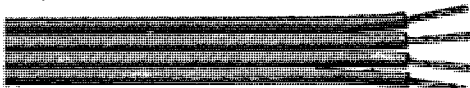

ONE TINNED LEG
FOR POLARITY
IDENTIFICATION

Saxton No.	Style No.	Conductors No. AWG	Strndg.	Insulation Material	Nominal O.D.
1481	4FC2	4 22	7 x 30	polyethylene	.085 x .360"
*1483	4FC3	4 20	10 x 30	polyethylene	.085 x .360"
*1485	5FC3	5 20	7 x 28	polyethylene	.095 x .485"
1039	round	8	6/22- 7 x 30 2/18 7 x 26	polyethylene	0.250
1040	round	8	6/18- 7 x 26 2/22 7 x 30	polyethylene	0.375

* Also available in round constructions and with heavier conductors.

MIL-C-3432 SPECIAL CABLES

Saxton No.	Style No.	Specifctn.	Desgntn.	Construction	Specification Number	Nom. O.D.
1486	2M18	CO-02	MGF	2/18 SJO (shielded)	MIL-C-3432A	0.375
1487	2M18A	CO-02	MGF	2/18	MIL-C-3432B	0.300
1488	2M18B	CO-02	HGF	2/18	MIL-C-3432B	0.380
1489	2M18C	CO-02	LGF	2/18	MIL-C-3432B	0.250
1490	2M16	CO-02	HGF	2/16	MIL-C-3432B	0.405
1491	2M16A	CO-02	MGF	2/16	MIL-C-3432B	0.338

Many other types available; prices on request.

HIGH VOLTAGE WIRE
FLAME-RETARDANT RULAN INSULATION

"RULAN" FLAME-RETARDANT INSULATION

STRANDED TINNED CONDUCTOR



Saxton No.	Style No.	Type	Conductors AWG	Strndg.	Wall Thkns.	Brkdwn. Voltage	Nom. O.D.
1477	1R20	unshielded	20	10 x 30	.047"	10,000	.120"
1478	1R20A	unshielded	20	10 x 30	.063"	20,000	.170"
1479	1R18	unshielded	18	16 x 30	.095"	40,000	.240"
1480	1RS18	shielded	18	16 x 30	.075"	20,000	.243"

MIL-W-76B

WITH CERTIFICATION

TYPE MW—Uncovered Plastic, Medium Wall, 1000V. Rating

PLASTIC INSULATION

STRANDED OR SOLID TINNED CONDUCTOR



SOLID CONDUCTOR

Saxton No.	Style No.	Specification Designation	AWG	Insitn. Thkns.	Nom. O.D.
1503	1MD22	MW-C 22(1)U	22	.016"	.061"
1504	1MD20	MW-C 20(1)U	20	.016"	.064"
1505	1MD18	MW-C 18(1)U	18	.016"	.072"
1506	1MD16	MW-C 16(1)U	16	.016"	.083"

STRANDED CONDUCTOR

SPECIAL QUANTITY PRICES

Saxton No.	Style No.	Specification Designation	Conductor AWG	Strndg.	Insitn. Thkns.	Nom. O.D.
1507	1M24	MW-C 24(7)U	24	7 x 32	.016"	.056"
1508	1M22	MW-C 22(7)U	22	7 x 30	.016"	.062"
1509	1M20	MW-C 20(10)U	20	10 x 30	.016"	.067"
1510	1M18	MW-C 18(16)U	18	16 x 30	.016"	.077"
1511	1M16	MW-C 16(26)U	16	26 x 30	.016"	.092"
1512	1M14	MW-C 14(41)U	14	41 x 30	.016"	.106"
1513	1M12	MW-C 12(65)U	12	65 x 30	.016"	.127"

TYPE HW—Uncovered Plastic, Heavy Wall

Saxton No.	Style No.	Specification Designation	Conductor AWG	Strndg.	Insitn. Thkns.	Nom. O.D.
1514	1M22A	HW-C 22(7)U	22	7 x 30	.032"	.094"
1515	1M20A	HW-C 20(10)U	20	10 x 30	.032"	.099"
1516	1M18A	HW-C 18(16)U	18	16 x 30	.032"	.109"
1517	1M16A	HW-C 16(26)U	16	26 x 30	.032"	.122"
1518	1M14A	HW-C 14(41)U	14	41 x 30	.045"	.165"
1519	1M12A	HW-C 12(65)U	12	65 x 30	.045"	.185"

MIL-W-16878D

WITH CERTIFICATION • SPECIAL QUANTITY PRICES

EXTRUDED TEFLON INSULATION SILVER-PLATED STRANDED CONDUCTOR



TYPE E—Extruded Teflon, 600 V. Rating

1520	1M30E	E-30	30	7 x 38	.010"	.033"
1521	1M28E	E-28	28	7 x 36	.010"	.036"
1522	1M26E	E-26	26	7 x 34	.010"	.041"
1523	1M24E	E-24	24	19 x 36	.010"	.046"
1524	1M22E	E-22	22	19 x 34	.010"	.052"
1525	1M20E	E-20	20	19 x 32	.010"	.060"
1526	1M18E	E-18	18	19 x 30	.010"	.072"
1527	1M16E	E-16	16	19 x 29	.010"	.084"
1528	1M14E	E-14	14	19 x 27	.010"	.098"

TYPE EE—Extruded Teflon, 1000 V. Rating

1529	1M30EE	EE-30	30	7 x 38	.015"	.043"
1530	1M28EE	EE-28	28	7 x 36	.015"	.046"
1531	1M26EE	EE-26	26	7 x 34	.015"	.050"
1532	1M24EE	EE-24	24	19 x 36	.015"	.056"
1533	1M22EE	EE-22	22	19 x 34	.015"	.062"
1534	1M20EE	EE-20	20	19 x 32	.015"	.070"
1535	1M18EE	EE-18	18	19 x 30	.015"	.081"
1536	1M16EE	EE-16	16	19 x 29	.015"	.090"
1537	1M14EE	EE-14	14	19 x 27	.015"	.104"

PLASTIC INSULATION STRANDED OR SOLID TINNED CONDUCTOR

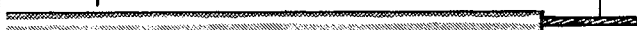

TYPE C—Uncovered Plastic, 1000 V. Rating

Saxton No.	Style No.	Specification Designation	Conductor AWG	Strndg.	Insln. Thkns.	Nom. O.D.
1538	1M22C	C-22	22	7 x 30	.016"	.065"
1539	1M20C	C-20	20	7 x 28	.016"	.073"
1540	1M18C	C-18	18	7 x 26	.016"	.081"
1541	1M16C	C-16	16	19 x 29	.016"	.092"
1542	1M14C	C-14	14	19 x 27	.016"	.103"

TYPE D—Uncovered Plastic, 3000 V. Rating

1543	1M22D	D-22	22	7 x 30	.032"	.097"
1544	1M20D	D-20	20	7 x 28	.032"	.105"
1545	1M18D	D-18	18	7 x 26	.032"	.113"
1546	1M16D	D-16	16	19 x 29	.032"	.124"
1547	1M14D	D-14	14	19 x 27	.032"	.135"

DISPENSER-PACKAGED TRANSMISSION LINE

TANGLE-FREE SELF-DISPENSING WIRE PACKAGES

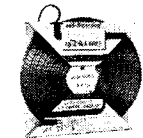

These easy to handle wire dispenser packages let you take the exact length you need. The rest stays neatly in place . . . never tangled, always clean. Ask your Saxton representative about the special dispenser "LIFELINE" series of wire packages.

◆ LIFELINE TWIN LEAD



No. 1665
Full size, heavy duty deluxe twin lead constructed of the finest materials. Chemically protected against deterioration. In Magic Dispenser. Saxton LTL (100-ft.), Brown or Clear.

LIFELINE 100◆ ROTOR CABLE

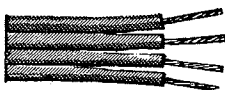

◆ Available 1000' spools.

Extra heavy duty conductor rotor cable. Superior quality. One leg polarized for easy reference. Sold in exclusive Magic dispenser carton.
100' Brown.
1483 - 4 Conductor
1485 - 5 Conductor

300-OHM TWIN LEAD

VHF-UHF TRANSMISSION LINE •

Saxton No. Style No. Name Stranding Nom. Size Web Width

	1550	SH-100	—	7	0.100 x 0.400
--	------	--------	---	---	---------------

	1551	TL-50	—	7	0.050 x 0.385
--	------	-------	---	---	---------------

	1552*	TL-40	standard	7	0.040 x 0.0375
--	-------	-------	----------	---	----------------

	1553*	TL-55	signal sender	7	0.055 x 0.385
--	-------	-------	---------------	---	---------------

	1554*	TL-80	trophy line	10	0.080 x 0.385
--	-------	-------	-------------	----	---------------

	1555*	TL-100	crusader	10	0.093 x 0.355
--	-------	--------	----------	----	---------------

	1556*	TL-100DL	top notch	10	0.095 x 0.383
--	-------	----------	-----------	----	---------------

	1558*	TL-100SDL	double ten	20	0.100 x 0.400
--	-------	-----------	------------	----	---------------

	1559	18/125	brown or gold	41	0.125 x 0.415
--	------	--------	---------------	----	---------------

	1560	TTL-22†	tubular	7	0.160x0.445
--	------	---------	---------	---	-------------

	1036		standard foam 22 gauge	10	.197 x .392
--	------	--	------------------------	----	-------------

	1562**	INS-500	ins. open wire	1	0.075 x 0.975
--	--------	---------	----------------	---	---------------

MATCHING TRANSFORMER AVAILABLE

* Available in special tangle-free self-dispensing packages.
** 18 Gauge Copperweld, Solid, Non Stretch. Stranded Available, on request.

COAXIAL CABLE

COMMERCIAL TYPES

Quotations on cable to MIL-C-178 specifications on request. Quotations on RG-8/U and RG-11/U with 15 AWG solid copperweld conductor on request.

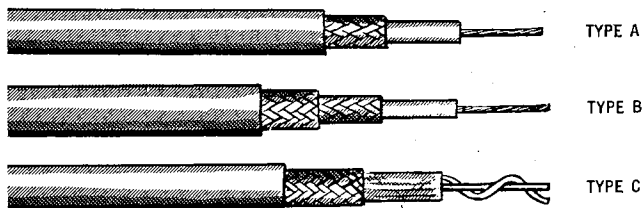

Saxton Cat. No.	Style No.	III. Type	In-sulation (Ohms)	Nom. Imp.	Nom. O.D.	Jacket	Description
1582*	RG-8/U	A	reg.	52	.405	black PE	gen'l purpose
1583‡§	RG-8/U	A	foam	52	.405	black PVC	—
1584*	RG-8A/U	A	reg.	50	.405	non-cont. PE	—
1585*	RG-11/U	A	reg.	75	.405	black PVC	TV & comm.
1586*	RG-11/U	A	foam	75	.405	black PVC	—
1587*	RG-11A/U	A	reg.	75	.405	non-cont. PE	—
1588*	RG-11/UDS	B	reg.	75	.465	black PVC	double-shielded
1589*	RG-58/U	A	reg.	53.5	.195	black PVC	20 AWG solid B.C.
1590‡*	RG-58A/U	A	reg.	52	.195	black PVC	19/.0071 TC
1591*	RG-58C/U	A	reg.	50	.195	non-cont. blk PE	19/.0071 TC
1592*§	RG-59/U	A	reg.	73	.242	black PVC	TV cable
1593*§	RG-59/UDS	B	reg.	73	.285	black PVC	double-shielded
1594*§	RG-59/U	A	foam	73	.242	black PVC	TV cable
1595*	RG-174/U	A	reg.	70	.100	black PVC	miniature "59/U"
1596*	RG-59A/U	A	reg.	75	.242	non-cont. blk PE	.023 copperweld
1597*	RG-62/U	C	reg.	93	.242	black PVC	small size low cap.
1598*	RG-59/U	A	foam	72	.280	black PVC	special 82-channel (UHF) type
1599*	Aluminax	Foam dielectric mylar foil aluminum shield (100%) PVC Jacket.					
1600*	RG58AU	Extra Flexible. Low Loss Foam.					

*Available in 100-ft. lengths.

‡Available extra flexible.

§Available in white

UNINSULATED COPPERWELD *

40% COPPERWELD CONDUCTOR • NON-STRETCH • HARD-DRAWN

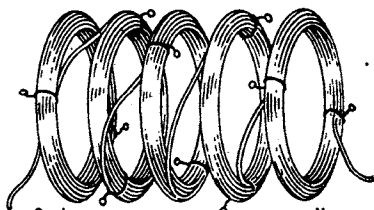

Saxton Number	Awg	Nom. O.D.
5300	18 solid	.0403
5302	14 solid	.0641
5303	12 solid	.0808
5304	10 solid	.1019
5305	8 solid	.1285
5306	6 solid	.1620

* Saxton Copperweld available on 1M' spools. Nos. 5300 to 5303 also in 50' & 100' interconnected coils of 1M' total.

GUY WIRE & MESSENGER CABLE *

HEAVY GALVANIZED STEEL, ALUMINUM & COPPERWELD

Saxton No.	Spec. Desig.	Stranding	Material	Test Strgth. — P.S.I.	Strength Yield Per C Ft.
5100	GW-4/20	4 x 20	hvy. galv. steel	215	4%
5101	GW-6/20	6 x 20	hvy. galv. steel	335	3.6%
5103	GW-6/18	6 x 18	hvy. galv. steel	515	3%
5105	AL-7/18	7 x 18	EC quality aluminum, aircraft temper	370	4.5%
5106	Non Stretch	ALCLAD	7 x 18	Same as 5105 except plastic insulated.	
5112	Tiller Cable	7 x 7 (49 str.)	3/32" cable vinyl jacket 3/16" O.D.	2100	—
5115	Hi Strength	6 x 20	galv. steel, plastic coated.		

*50' and 100' interconnected coils are standard. 500' or 1000' spools available. See Saxton page 10 for non-radiating fibre-glass guy wire.

UNINSULATED TINNED COPPER

SOLID CONDUCTOR

Saxton No.	AWG No.	Saxton No.	AWG No.
1362	ADT-20	1570	ADT-28
1363	ADT-18	1571	ADT-26
1364	ADT-16	1572	ADT-24
1365	ADT-14	1573	ADT-22
1366	ADT-12		

STRANDED

Saxton No.	AWG No.	Stranding	Saxton No.	AWG No.	Stranding
1574	AT-24	7x30	1578	AT-16	26x30
1575	AT-22	7x30	1579	AT-14	41x30
1576	AT-20	10x30	1580	AT-12	65x30
1577	AT-18	16x30			

ANTENNA WIRE ★



Saxton Number	Stranding	Material	Packing
1275	solid	#12 AWG enameled solid copper	1M' interconnected coils of 100' ea.
1280	solid	#14 AWG enameled solid copper	1M' interconnected coils of 100' ea.
1286/50	7 x 22	bare copper	1000' interconnected coils of 50' ea.
1286/100	7 x 22	bare copper	1M' interconnected coils of 100' ea.
1288/50	7 x 24	bare copper	1M' interconnected coils of 50' ea.
1288/100	7 x 24	bare copper	1M' interconnected coils of 100' ea.
1289	7 x 26	bare copper	1M' interconnected coils of 50' ea.

ALUMINUM GROUND WIRE

1240/1M	—	#8 AWG solid dead soft alum.	1000-ft. spool
1240/50	—	#8 AWG solid dead soft alum.	1M' interconnected coils of 50' ea.
1240/100	—	#8 AWG solid dead soft alum.	1M' interconnected coils of 100' ea.
1255/1M	—	#6 AWG solid dead soft alum.	1000-ft. spool
1255/50	—	#6 AWG solid dead soft alum.	1M' interconnected coils of 50' ea.
1255/100	—	#6 AWG solid dead soft alum.	1M' interconnected coils of 100' ea.

* Phosphor bronze and copperweld constructions available.

COLORWIRE TRANSMISSION LINES

*
 Exclusive "Magic Membrane"
 Makes the Difference!



COLOR
 POWER

TV ANTENNA WIRE

FOR MORE BRILLIANT COLOR RECEPTION IN TOWN AND COUNTRY

FOR TOWN

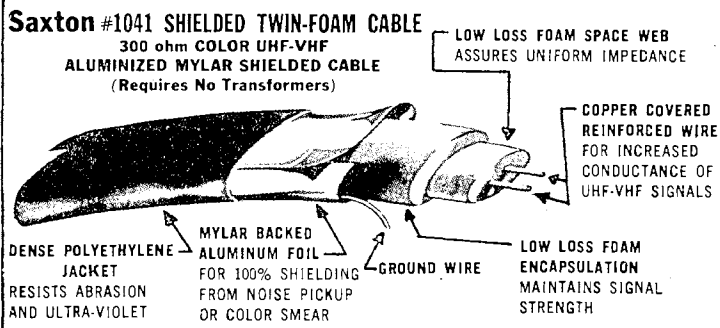

*"Magic Membrane" is Saxton's fully air-foam filled barrier that cuts signal loss to a minimum and sharpens picture clarity.

Sharpest, clearest, smear-free color reception for high noise, crowded, steel-and-concrete areas! Excellent VHF and UHF reception! These are among the many plus benefits available with the Saxton #1041 Foil Shielded Twin-Foam TV Antenna Wire. And they're all the result of our exclusive "Magic Membrane" process that encapsulates the sturdy copper conductor wire with layers of low-loss air foam polyethylene for maximum signal strength. In addition, a mylar-foil shield surrounds the foam to protect against electrical interference and reflected signals. The outer jacket of this highly flexible TV cable wire is made of carbon black filled polyethylene for extra protection against sun, heat, storm, snow . . . and ultra-violet rays! Want more? You can even run the #1041 down a drain-pipe for easy, out-of-sight installation.

UNCONDITIONALLY GUARANTEED FOR 20 YEARS

FOR COUNTRY

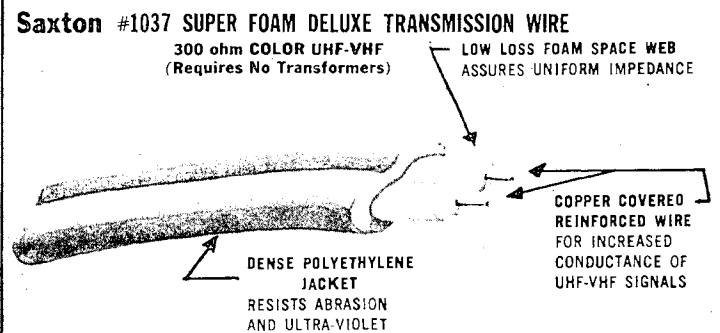

*"Magic Membrane" is Saxton's fully air-foam filled barrier that cuts signal loss to a minimum and sharpens picture clarity.

Open country and suburban fringe areas can now be assured of superb color reception with this remarkable TV antenna wire. Includes all the exclusive Saxton design features required to conduct and maintain signal strength from antenna to set. Electrically superior for all channels, the #1037 also provides unusually fine UHF and VHF results. Physically, this is a flat, twin lead transmission wire that features pre-stretched copper conductors with the exclusive "Magic Membrane" encapsulating the lead wire with polyethylene foam. All are surrounded by a high quality carbon black treated polyethylene jacket. This assures built-in resistance to severe weather conditions as well as ultra-violet rays, and provides finest possible reception.

UNCONDITIONALLY GUARANTEED FOR 20 YEARS

FOR ECONOMY

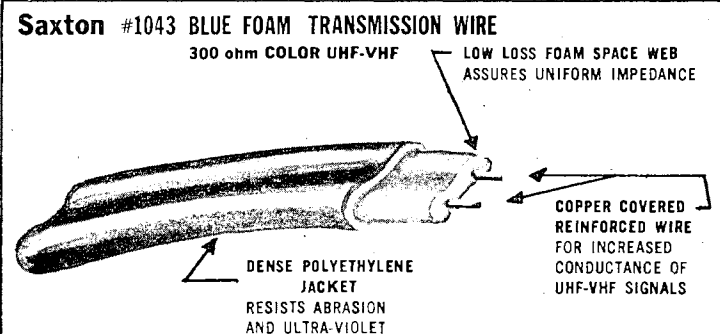

*"Magic Membrane" is Saxton's fully air-foam filled barrier that cuts signal loss to a minimum and sharpens picture clarity.

Made to Saxton standards of quality throughout, this sturdy polyethylene-and-foam encased transmission line answers the demand for clear VHF, UHF, and color reception at lowest cost. Delivers results that are sure to please the most cost-conscious customers, thanks to the engineering skill inherent in its design specifications. Highly resistant to dirt, oil, moisture and salt air, the #1043 outperforms any competitive make in its price class. Foot for foot, and signal for signal, it meets every requirement necessary for improving color reception under today's demanding conditions.

UNCONDITIONALLY GUARANTEED FOR 1 YEAR

See page 1786 for coaxial cable system

SPECIAL PRODUCT SECTION

"MITY-AMP" 2-WATT AUDIO AMPLIFIER

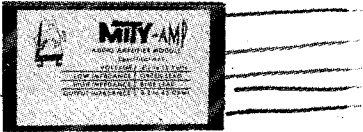

Saxton MA-100

**COMPLETELY EPOXY ENCAPSULATED
MODULE • Shockproof & Moisture-proof
• Dirt & Dustproof**

FEATURES

- **SPACE-SAVING**—2" x 3½" x ¾"
- **HI-FI AMPLIFIER**—20 cy. to 15KC ± db at 1-watt level
- **LIGHTWEIGHT**—Weighs total of 6 ounces
- **RUGGED**—Unconditionally guaranteed. Shock, moisture and dust-proof
- **EASY TO INSTALL & USE**—Hooked up in minutes. Simple instructions make unit functional immediately.
- **ECONOMICAL**—Low in price, big in performance. Long, trouble-free life. Total power requirements 6 or 12 volts.
- **PORTABLE**—Operates on auto or boat battery
- **VERSATILE**—Uses limited only by your ingenuity. Ideal for p. a. system, phono amplifier, stereo, intercom, signal tracer, modulation, tape monitor, etc.

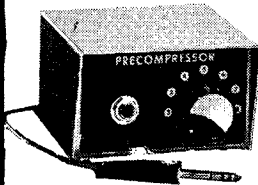

Model A
Saxton No. A-1011
Model B
Saxton No. A-1012

TRANSISTORIZED AUDIO PRECOMPRESSOR-AMPLIFIER

Specifically designed for CB and Amateur transmitters—Latest design incorporates all the advantages of conventional separate compressors, pre-amps, and clippers—Instantaneously compensates for voice fluctuations with low distortion—No wiring necessary, simply plugs into mike input—Requires no modification of transceiver.

ANTENNA ACCESSORIES SPECIAL HARDWARE

GROUND MAST CLAMPS

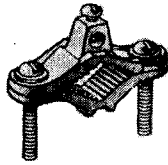

Saxton No. 1100

U-BOLTS AND SADDLES

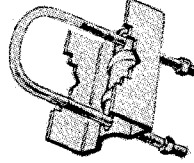

Saxton No. 1103
Also available without saddle

FLOATING GUY RINGS

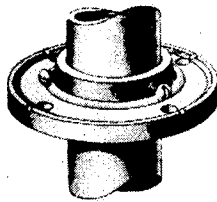

Cast aluminum, two-piece floating guy ring. Fits most masts up to 1½" dia. Individually packed, complete with hardware, in plastic bags. Saxton No. 1099

GROUND RODS

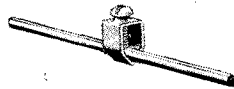

Saxton No. 1064
Four-foot overall length with clamp.

SAXTON BATTERIES

- B 101 Equiv. to: Eveready S-76 - Used in A-1001 & A-1005. 1.5 volts.
- B 102 Equiv. to: Eveready S-41 - Used in A-1002. 1.5 volts
- B 103 1.5 V Battery - Used on A-1003
- B 104 9 V Battery - Used on A-733, Big Ear; A-988, Fun Gun



Airplane type "egg" insulator. Low air resistance, high tensile strength, white porcelain glaze. 1¾" long. Saxton No. 1156

ANTENNA WINDOW STRAPS



Saxton No. 1126

BROWN, PORCELAIN GLAZED INSULATOR



Saxton No. 1154

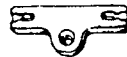

Doublet type antenna insulator, white glazed. Excellent electrical characteristics, high tensile strength. Dim.: 4½" x 2¾" Saxton No. 1155



Transposition block with porcelain glaze finish. Use with many types of doublet antennae. Saxton No. 1157

Film & Recording Tape STORAGE CHEST

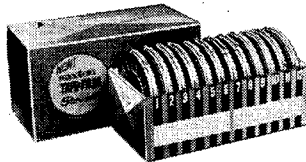

Saxton No. 1230—Complete with 12 Swivel-locked, dust-proof storage cans. Insures moisture and dust-free storage of valuable tape and film. Attractive indexed storage chest. High-impact Styrene containers accommodate 5" and 7" tape or 8mm film

Saxton No. 1231—Individual plastic storage can

ALUMINAX No. 1599

Uses ultra low loss foam dielectric. Uses new super tough Mylar, coated on both sides with highly conductive aluminum foil. Uses four equally spaced telephone sized stranded tinned conductors. Uses virgin polyvinylchloride (PVC) jacket for flexibility, ease of installation and long life.

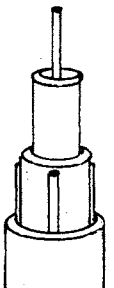

SOLDERLESS COAXIAL CONNECTORS ADAPTERS & FITTERS, "F" AND "C" SERIES

CONNECTORS UHF - BNC

WEATHER BOOT *

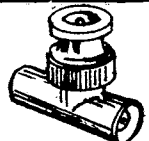
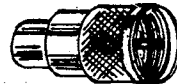

Saxton No.	Type	Saxton Bubble Pk No.	Saxton No.	Type	Saxton Bubble Pk No.	Saxton No.	Type	Saxton No.	Type	Saxton No.	Type	Saxton Bubble Pk No.
700	UG88U		705	S0239	S-605†	713	M-359A	716	C52	719	F59	S-601‡
703	UG175U	S-603‡	706	PL258	S-604†	755	Weather Boot	717	C61	719A	F59A	
704	UG176U		707	PL259	S-602‡			718	C81	720	F61	
										721	F81	

CUSTOM CABLES—Available with any combination of fittings or connectors.

Weatherproof fitting for RG/59U Types.

† 1 in a pack.

‡ 2 in a pack.

‡ For use with 82-channel coax.

SPECIAL PRODUCT SECTION

MAGNET WIRE MERCHANDISER FOR HOBBY, SCHOOL, OFFICE, SCIENCE PROJECTS

Here's a complete assortment of Saxton's finest solderable, softdrawn, insulated copper magnet wire conveniently placed on spools and having many applications...wind coils, transformers, RF chokes, etc. Size #18 to #40; weighs ¼ lb. and ½ lb.
RACK FREE WITH YOUR INITIAL ORDER.

PICK THE DEAL THAT SUITS YOU BEST

DEAL A
Consists of 40 ¼ lb. and 40 ½ lb. spools
Two spools each pin: MWR10

¼ lb. SPOOLS				
2 #18 Ga	2 #20 Ga	2 #22 Ga	2 #24 Ga	2 #24 Ga
2 #26 Ga	2 #26 Ga	2 #28 Ga	2 #28 Ga	2 #28 Ga
2 #30 Ga	2 #30 Ga	2 #32 Ga	2 #32 Ga	2 #32 Ga
2 #34 Ga	2 #34 Ga	2 #36 Ga	2 #38 Ga	2 #40 Ga
½ lb. SPOOLS				
2 #18 Ga	2 #20 Ga	2 #22 Ga	2 #24 Ga	2 #24 Ga
2 #26 Ga	2 #26 Ga	2 #28 Ga	2 #28 Ga	2 #28 Ga
2 #30 Ga	2 #30 Ga	2 #32 Ga	2 #32 Ga	2 #32 Ga
2 #34 Ga	2 #34 Ga	2 #36 Ga	2 #38 Ga	2 #40 Ga

DEAL B
Consists of 60 ¼ lb. and 60 ½ lb. spools
Three spools each pin: MWR12

¼ lb. SPOOLS				
3 #18 Ga	3 #20 Ga	3 #22 Ga	3 #24 Ga	3 #24 Ga
3 #26 Ga	3 #26 Ga	3 #28 Ga	3 #28 Ga	3 #28 Ga
3 #30 Ga	3 #30 Ga	3 #32 Ga	3 #32 Ga	3 #32 Ga
3 #34 Ga	3 #34 Ga	3 #36 Ga	3 #38 Ga	3 #40 Ga
½ lb. SPOOLS				
3 #18 Ga	3 #20 Ga	3 #22 Ga	3 #24 Ga	3 #24 Ga
3 #26 Ga	3 #26 Ga	3 #28 Ga	3 #28 Ga	3 #28 Ga
3 #30 Ga	3 #30 Ga	3 #32 Ga	3 #32 Ga	3 #32 Ga
3 #34 Ga	3 #34 Ga	3 #36 Ga	3 #38 Ga	3 #40 Ga

RACK FREE WITH YOUR INITIAL ORDER.

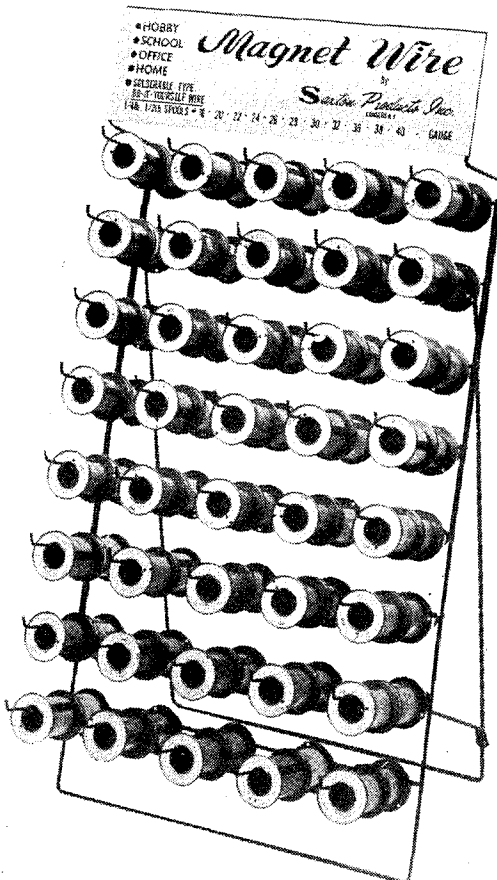

COAXIAL CABLE ASSEMBLIES FOR CB & HAM USE

BAG-PACKED



Staxon Number	Length	Type	Description
800	10'	RG8U	Has PL259 on one end, two terminating spade lugs on the other
801	10'	RG8U	Same as #800 except PL259 to PL259
802	15'	RG8U	Has PL259 on one end, two terminating spade lugs on the other
803	15'	RG8U	Same as #802 except PL259 on both ends
804	20'	RG8U	Has PL259 on one end and two terminating spade lugs on the other
805	20'	RG8U	Same as #804 except PL259 to PL259
806	10'	RG58U	Has PL259 and UG175U reducer on one end, two univ. terminating lugs on other end
807	10'	RG58U	Same as #806 except PL259 and UG175U reducer at both ends
808	15'	RG58U	Has PL259 and UG175U reducer on one end, two univ. type terminating lugs on other end
809	15'	RG58U	Same as #808 except PL259 and UG175U reducers are at both ends
913	50'	RG8U	Foam — PL259 connectors each end.
914	100'	RG8U	Foam — PL259 connectors each end.
915	50'	RG58U	Foam — PL259 connectors with adaptors each end.
916	100'	RG58U	Foam — PL259 connectors with adaptors each end.

BUBBLE-PACKED

810	20'	RG58U	Has PL259 and UG175U reducer on one end, two univ. type terminating lugs on other end
811	20'	RG58U	Same as #810 except PL259 and UG175U reducers at both ends
812	2'	RG58U.CB test lead.	Same construction as #811.

SPECIAL PRODUCT SECTION

THE "BIG EAR"

ELECTRONIC SOUND COLLECTOR

- "Homes in" on faint sounds up to 100 feet away... twice as far over water.
- Exclusive Cordless Broadcast Accessory to increase sensitivity tenfold also available.
- Use indoors or outdoors—from baby sitting to bird watching.
- Practical, instructional and entertaining for young and old.
- The latest in solid state circuitry.

"Big-Ear" opens up the fascinating world of sound around you. It enables you to hear normal, ordinary conversation at 100 feet away; bird calls at up to 200 feet. Basically the "Big-Ear" combines the principle of a parabolic microphone, a high gain amplification system, and stethoscope earphone, for intimate listening. Operates for hours on a standard 9 volt transistor battery. Comes complete with sturdy, adjustable tripod legs for convenient use.

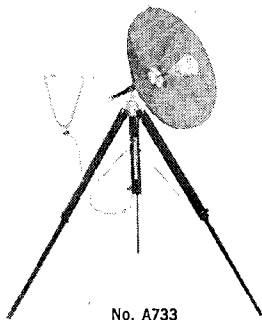

No. A733

Complete with stethoscope earphones less batteries

"Big-Ear" Broadcast Accessory

Broadcasts "Big-Ear" through FM Radio!

Plug in our exclusive cordless Broadcast Accessory and convert "Big-Ear" into a professional listening device, without using the stethoscope. This enables you to broadcast "Big-Ear" sound to any FM receiver up to 30 feet away. With it you hear everything... laughing, breathing, crying — without connecting wires; with 30 times amplification. Includes battery.



No. A-1000

Patented Nos. D212006, D212003, D212005

"ASTRO-COM"™ TM WRIST BROADCASTER

- Broadcast your voice to any FM receiver within 50 feet in any direction.
- No wires! Powerful tiny silver oxide battery good for hours of broadcasting!
- Great for party fun; kids' games; keeps you in touch with playroom, bedroom, or sick room.
- Complete with replaceable silver oxide battery, nylon strap, rugged case, "whip" antenna, and tuning device.
- Electronic components designed by Saxton, first in miniature electronic equipment.

SPECIFICATIONS: Frequency Response: 300 to 6,000 hz. Power: 6 MW input. Range: Up to 50 feet, depending upon conditions. Frequency: FM broadcast band, (tunable ± 3 megacycles through 88 megacycles. Audio Sensitivity: Normal voice at approximately 10 feet. Case: High impact polystyrene—electronics encapsulated in epoxy. Weight: 4 ozs. Includes B-101 battery.

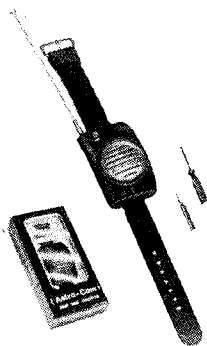

No. A-1005

eyeglass radio

CLIP INSTANTLY TO YOUR GLASSES ONLY 2 3/4 INCHES LONG. PICKS UP ANY STATION IN YOUR AREA!

Earphone plug guarantees complete privacy, while the magnetic swivel antenna permits instant adjustment for fine tuning and reception. On-off switch and tuning knob conveniently located... easy to use.

SPECIFICATIONS: Frequency: 550-1600 KHz. (AM Broadcast band). Earpiece: High fidelity magnetic. Electronics: 5 all Silicon Planar transistors. High gain regenerative circuit. Antenna: Super conductive magnetic ferrite. Case: High impact Polystyrene. Batteries: Includes (2) B-102 batteries.

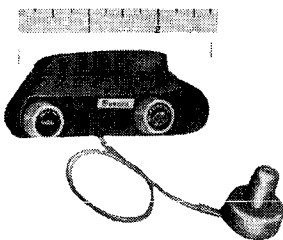

Catalog #A-1002

Patented

HI-FI SENTINEL

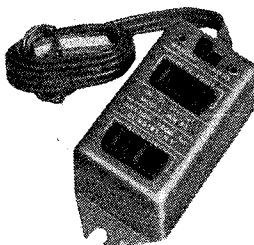

No. MM33

Automatically shuts off Hi-Fi system after last record is played on changer. A must for every hi-fi owner — it's so easy to use, you'll wonder why no one ever developed this before. Hi-Fi Sentinel not only acts as an automatic shut-off control after the last record has been played, but it's also a convenience outlet for auxiliary hi-fi equipment. As a result, it eliminates the usual messy look created by additional power cords plugged into the wall receptacle.

To operate, merely plug into connectors under the record changer and that's it! Conveniently located slide switch permits automatic or manual control.

IMPORTANT: May be used on all Garrard, BSR, and other changers employing AMP "mate-n-lok" panel mount connectors.

the new ASTRO COM telephone amplifier

Transforms any ordinary telephone earpiece into a unique sound-control amplifier! It's a space-age electronic concept that assures the maximum in hearing range and comfort... attaches instantly and securely to any phone with a simple, snug-fitting band.

Carry it in your pocket... or in a purse, it's that portable! Especially suited for high-noise factory and office areas. And, it's a low-cost practical answer to public phone distractions. What's more, the hard-of-hearing, and elderly folks find it a definite aid, while guaranteeing privacy!

Precision-built for reliable performance, the ASTRO-COM amplifies any normal speaking voice up to five times. Complete with easily adjustable fingertip touch volume control.

SPECIFICATIONS:

- Amplification:** More than 30 db.
- Circuitry:** 4 Transistors.
- Case:** High Impact Polystyrene.
- Battery:** For best results, use SAXTON #B-103 battery or equivalent.
- Battery Life:** Approx. 25 hours use. Includes battery.



No. A-1003



ASTRO COM GUITAR BROADCASTER

now—electric guitar sound, the cordless way. Just 3 1/4" long, and no more than 5/8" in diameter at its widest... this unusual device is actually a solid-state electronic creation that transmits guitar sound — your sound, without cord, to any FM radio — as far as 50 feet away!

Easy to use! Simply plug into the output jack of your electric guitar. TUNE IN to your FM radio (88 to 94 mc). TURN ON big, quality sound! Thanks to the unique circuitry and quality components, you can be sure of full range frequency response hour after hour after hour. No distortion! No feedback!

SPECIFICATIONS: Frequency: 88 mc to 94 mc. Range: Up to 50 feet. Power: 6 MV Input. Frequency Response: 20 to 15,000 CPS. Battery: For best results, use SAXTON battery #B-101 or equivalent. Includes B-101 battery or equivalent.

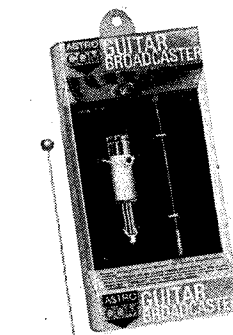

Catalog #A-999

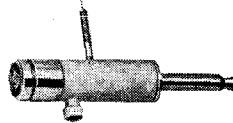

Patented Nos. D212006, D212003, D212005

SPECIAL PRODUCT SECTION

** OPEN WIRE TRANSMISSION LINE LOW LOSS AIR DIELECTRIC • BULK QUANTITIES

Saxton Number	Conductor	Spacing	Imped.	Awg	Insul. No.	Spac.
2500	40% copperweld	1"	450-ohm	18	6"	
2501	40% copperweld	1"	450-ohm	18	12"	
2502	40% copperweld	7/16"	300-ohm	18	6"	
2507	solid copper	1"	450-ohm	18	6"	
2515	solid copper Formvar	1"	450-ohm	18	6"	
2517	solid copper Formvar	7/16"	300-ohm	18	6"	
2520	solid copper Formvar	1"	450-ohm	16	6"	
2525	40% copperweld	2"	475-ohm	14	random spaced	
2526	40% copperweld	2"	450-ohm	12	random spaced	

MAX. SPOOL: 6" spacing, 500 ft.; 12" spacing, 1000 ft.; 300-ohm, 500 ft. 500' spool standard. 100' & 250' available.

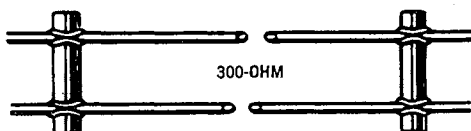

CHARACTERISTIC CHART	TRANSMISSION LINE LOSS DB LOSS PER 100 FT.					
	100 MC		500 MC		1000 MC	
Type	Wet	Dry	Wet	Dry	Wet	Dry
300 Ohm Open Wire	1.20	0.40	2.30	.80	1.9	1.8
450 Ohm Open Wire		0.35		.78		1.1
*Two Inch Spaced Open Wire		.19		.42		.89
300 Ohm Tubular	2.8	1.1	6.8	3.1	10.2	4.8
300 Ohm Flat	7.6	1.5	20.0	3.2	30.0	5.0
RG-59U		3.8		9.4		14.2
RG-11U		1.8		5.0		7.6

* CHARACTERISTIC IMPEDANCE WILL VARY WITH WIRE SIZES USED
** PLASTIC INSULATED OPEN WIRE — SEE SAXTON PAGE 4 ITEM NO. 1562.

OPEN LINE ACCESSORIES STAND-OFFS & STRESS INSULATORS

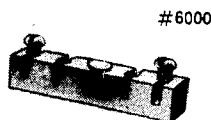
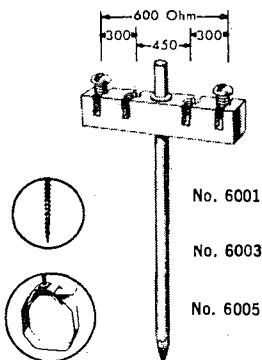

BLOCKS ONLY WITHOUT DRIVE-IN HARDWARE

Complete with 2 plated screws for use as spacer blocks in making your own open line installations.
Saxton No. 6000

Especially designed for use with open line transmission wire installations. Tighten screws after pulling wire taut. For use as spacer, partially tighten set-screws. This permits movement of wire in the slots and avoids potential wire breaks. Use outside slots for 600-ohm wire. The "Tappee" Stand-off Insulator is good for community installations where random spacing of open line is desirable to avoid tuned circuits. Ideal also for use as anchor point or spacer for "fence wire" installations. "Tappee" permits inexpensive, time and labor-saving, trouble-free installations, and is made for use with No. 12 thru No. 18-gauge wire. Hardware constructed of double-dip galvanized steel; block is high impact polystyrene.

6000	Block only
6001	5 1/2" nail type
6003	5" wood screw type
6005	5" pole clamp type
*6007	INS-500 type

SEE PAGE 4 FOR INSULATED OPEN WIRE TYPE INS-500.

OPEN LINE ACCESSORIES STRESS INSULATORS AND BLOCKS

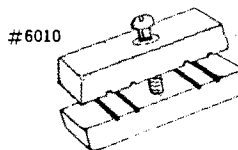

HEAVY DUTY OPEN LINE STRESS INSULATORS

Plastic blocks, slotted on either one or two-inch centers, for taking up slack or as anchor points in open line installations. Complete with plated lag bolt. 12 or 14 gauge.
Saxton No. 6010

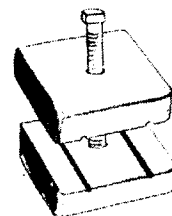

12 AWG INSULATOR

Same as Saxton No. 6010. Has 2-inch spacing for #12 AWG wires. Insulators for other gauges available on special order only.
Saxton No. 6011

FIBRE GLASS GUY LINE



Non-radiating, non-absorbing, high-strength "wireless" guy wire in vinyl jacket. 500-lb test strength. 100-ft. coil.
Saxton No. 7000

SUPER-STRONG FIBRE GLASS GUY WIRE

Same as above but in grey vinyl jacket. 1000-lb. tensile strength. 100-ft. coil.
Saxton No. 7002

PATIO OR STATION WAGON

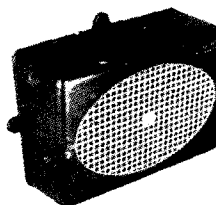

Saxton No. 1205

Made of unbreakable, high impact styrene. Mahogany color. Complete with hardware and mounting instructions. Use for paging, monitoring, patio and stereo extensions, or as extension speaker anywhere. Complete with mounting escutcheon for 5 x 7, 6 x 9, 4, 5 or 6" round speakers.

DELAYED ACTION • COMMERCIAL SAFETY SWITCH HOME AND AUTO

Switch "off" and the lamp goes out SIXTY SECONDS LATER! Allows sufficient time to reach destination SAFELY. Replaces present wall switch in seconds. Ideal for Home, Farm or Auto. Fully guaranteed and UL Approved.
Saxton No. 560 (Ivory) Home
Saxton No. 561 (Brown) Home
Saxton No. 563 (Black) Auto

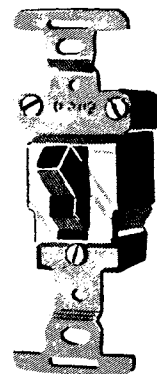

SAXTON WINDOW-PAKS

BUBBLE-PAKS

DISPENSER PAKS

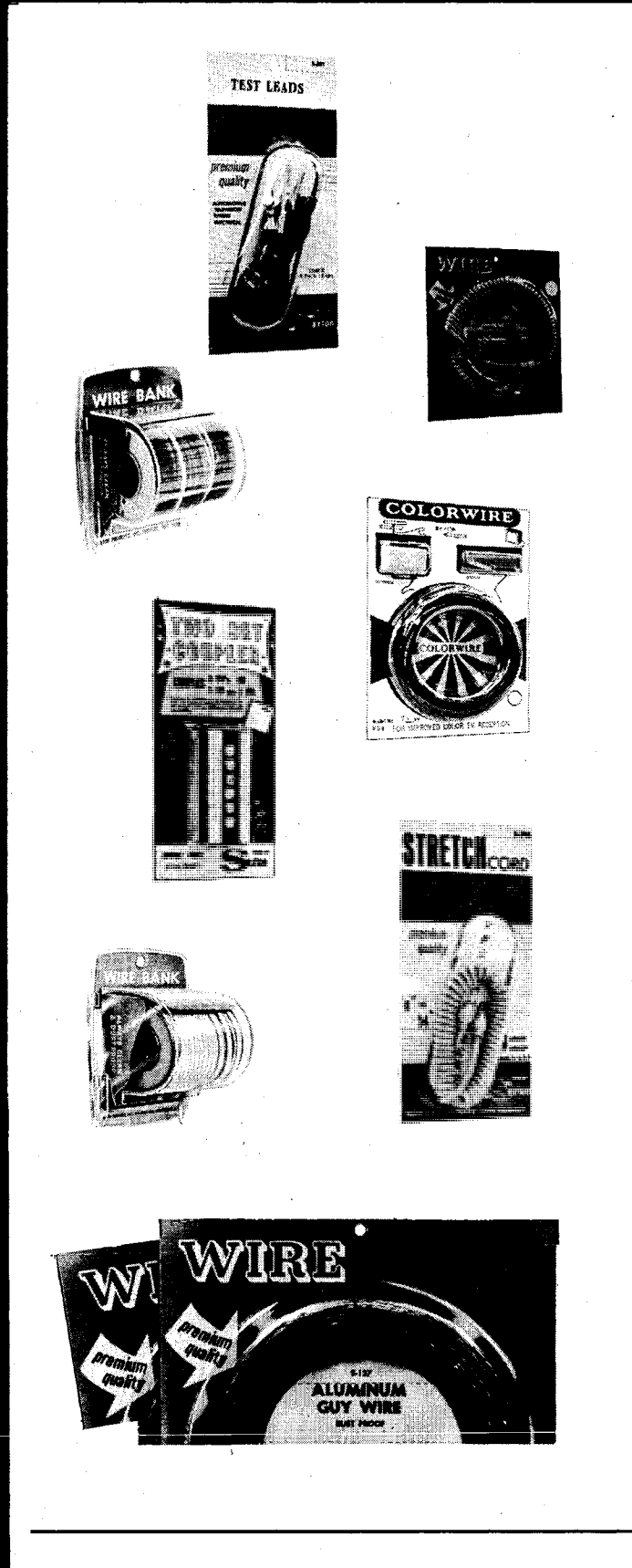

Saxton No.	Description	Footage
S-95	Ignition Wire for auto, boat, oil burner, or model airplane	20
S-96	Audio cable—shielded—2 cond.—22 ga. w/jacket...	16
S-98	Mike cable—2 cond. low impedance—high quality audio cable	18
S-102	Intercom wire—2 cond.—no jacket (excellent thermostat wire)	60
S-103	Intercom wire—2 cond.—w/jacket (excellent thermostat wire)	35
S-104	Intercom wire—3 cond.—no jacket (excellent thermostat wire)	40
S-105	Intercom wire—3 cond.—w/jacket (excellent thermostat wire)	28
S-106	Microphone cable—single cond.—low capacitance high impedance—heavy duty	20
S-107	Zip cord—Vinyl—2 cond.—18 ga. lamp cord—available in gray, brown and white	30
S-109	Zip cord—rubber—extra flexible—lamp cord—oil resistant—available in brown and white	25
S-110	Guy wire—galvanized steel—4 strand—rust resistant	100
S-111	Speaker cable—clear plastic—polarized—heavy duty	25
S-125	Antenna wire—copper—7/24—prestretched	40
S-126	Antenna wire—copper—7/26—prestretched	50
S-127	Guy wire—aluminum—rust proof—will not stain wood or masonry—for guying and general utility use	40
S-128	Guy wire—steel—6 strand—bright galvanized-rust resistant	70
S-130	Ground wire—aluminum—dead soft #8 AWG solid	40
S-135	Copperweld wire—hard drawn—hi-conductivity antenna wire—18 ga. non-stretch	100
S-147*	Telephone extension kit—color coded—4 cond. wire w/plug and jack	25
S-148	Microphone cable—3 cond.—one lead shielded—2 leads unshielded ideal for push to talk microphone application	16
S-149*	Telephone extension cord—4 conductor—std. 4-pin molded plug and jack—adds mobility to phone or intercom	25
S-150	Shielded ignition wire	15
S-160	Television wire—twin lead—300 ohm—crystal clear—highly efficient for indoor use	21
S-161	Four conductor wires; with jacket—intercom, electric trains, kits, etc.	21
S-163	Lo-loss foam Twin Lead for indoor use	25
S-190	40 KV Hi-voltage wire 18 ga.—excellent for use as color picture tube anode wire replacement	10
S-191	3 Cond. Zip Cord—for use as extension for grounded power tools—remote control devices and appliance cords	20
S-192	Superphone—Makes your transistor radio sound like a console—personalized listening for radio, T.V., tape recorder, etc.	—
S-203*	Lazy bones-on-off appliance control for T.V., radio, fan, lamp, etc.	15
S-204*	Aerial kit for improved broadcast and shortwave reception	—
S-205*	Safe-pull—improved type of plug-in device for master T.V. antenna system. Replaces popular Motorola type plug	10
S-206	Same as above (Motorola type plug)	20
S-208*	Retractable coiled cord — microphone cable — 1 shielded — 2 unshielded	6
S-209*	Retractable coiled cord — microphone cable — 1 shielded — 3 unshielded	6
S-211*	Aerial kit — deluxe — for improved broadcast and shortwave reception—heavy duty antenna wire and heavy duty lead-in wire	—

*Special purpose cable.

SAXTON WINDOW-PAKS

BUBBLE-PAKS

DISPENSER PAKS

Saxton No.	Description	Footage
S-212	Same as S-213 (RCA type plug)	10
S-213	Same as S-206 but RCA plugs one end, lugs other end	20
S-214*	Replacement cord—UL approved—w/molded male plug one end, tinned wires other end—suitable for vacuum cleaners, electric brooms, power tools, etc.	15
S-215*	Retractable telephone handset extension cord—available in black, white, beige	25
S-216*	Extension cord—heavy duty deluxe type—w/cube tap one end and molded male plug other end	15
S-222*	Stereo extension cord—to be used as extension cord for stereo headphones	15
S-223*	Stereo extension cord—to be used as extension cord for stereo headphones	25
S-224*	Retractable stereo extension cord for use with stereo headphones—15' long extended	—
S-225*	Same as above—25' long extended	—
S-226	CB and 2-way radio linear amplifier battery lead	25'
S-230	Antenna wire—copper—7/22—prestretched	50
S-231*	Retractable electric guitar extension cord complete with regular and offset plugs	15
S-232*	Telephone handset extension—retractile—available in black, white or beige	15
S-233	Four conductor, flat extra flexible polarized cable for use with stereo tape players—can also be used for train sets, intercom and other purposes where 4 wires are required	30
S-234	Coaxial cable—RG-58/U—52 ohm—for CB—HAM—fixed or mobile use	22
S-235	Coaxial Cable—RG-59/U—72 ohm antenna leads	22
S-236	Single conductor—retractable mike cord	6
S-237	3 Conductor telephone wire—beige	25
S-301*	Test leads—3 color coded—leads w/alligator clips attached at both ends—for all automotive and household use	30"
S-302	Test Leads—(2) leads w/alligator clips	72"
S-306*	FM antenna—folded dipole	—
S-309	Heavy duty lightning arrestor deluxe type—ceramic shell, externally fused, suitable for UHF & VHF applications. Can accommodate coaxial cable, tubular, oval and flat twin lead as well as open wire line	—
S-310	2 set coupler — Deluxe	—
S-311	3 set coupler — Deluxe	—
S-317	Braided bonding strap—used for ground	10
S-318*	Shielded audio cables—retractile—color coded for quick and easy identification. RCA type plugs each end	8"-66"
S-319	Telephone plug and jack—make your own telephone extensions	—
S-320	Telephone plug only—(male)	—
S-321	Telephone jack only—(female)	—
S-325*	Shielded audio cable—retractile—color coded—RCA type plug one end, tinned leads other end	8"-66"
S-326*	Shielded audio cable—retractile—color coded—RCA type plug one end, alligator clips other end	8"-66"
S-327*	UHF folded dipole antenna	—
S-330	Indoor matching transformer—matches 75 ohm coax to 300 ohm terminals on T.V. sets—with F59 connector	—
S-331	Outdoor matching transformer—300 ohm to 75 ohm—with mounting strip, F59 cable connector and weather boot	—
S-332	UHF-VHF-FM antenna splitter—triple tuned—band pass filter	20

*Special purpose cable.



SAXTON WINDOW-PAKS

BUBBLE-PAKS

DISPENSER PAKS

Saxton No.	Description	Footage	Saxton No.	Description	Footage
S-334*	Audio accessory cord—w/plug and alligator clips— for portable and transistor radio speaker extensions and general utility extensions.....	6	WS-115B	Hook up wire—18 ga. stranded.....	52
S-335*	Audio accessory cord—w/built-in matching network —complete w/plug and alligator clips—record di- rectly from output without overloading.....	6	WS-116	Hook up wire—20 ga. solid.....	72
S-336*	Audio accessory cord—inter-connects most audio components—RCA plugs each end.....	6	WS-116B	Hook up wire—20 ga. stranded.....	70
S-337*	Audio accessory cord — interconnects most audio components—RCA plugs each end.....	10	WS-117	Hook up wire—22 ga. solid.....	90
S-341*	Twin stereo audio cord assembly w/RCA plugs both ends—color coded.....	48"	WS-117B	Hook up wire—22 ga. stranded.....	85
S-342	Twin stereo audio cord assembly w/RCA plugs one end—other end tinned.....	48"	WS-118	Bell wire—18 ga.....	58
S-400	Matching transformer kit; 300 ohm to 75 ohm; in- cludes one S-330 transformer, one S-331 outdoor transformer, one mounting strap, one F59 connector and one weather boot.....	—	WS-122	Test prod wire—red—plastic.....	22
S-501	Telephone jack and wall plate—for internal installa- tion of phone extensions.....	—	WS-122A	Test Prod wire—red—rubber—extra flexible.....	16
S-560	Ivory Delay Switch for home—put off garage or basement lights after you leave.....	—	WS-123	Test prod wire—black—plastic.....	22
S-561	Brown Delay Switch for home—put off garage or basement lights after you leave.....	—	WS-123A	Test prod wire—black—rubber—extra flexible.....	16
S-810*	Citizens Band extension; RG-58/U w/PL-259 and UG-175/U reducer one end and two universal termi- nating lugs other end.....	20	WS-156	Three conductor, clear, miniature, parallel cable speaker extensions—stereo and monaural—low volt- age applications.....	36
S-811*	Citizens Band extension; RG-58/U with PL-259 and UG-175/U at both ends.....	20	WS-162	Magnet wire for hobbyists—22 ga.....	93
S-812*	CB cable assembly 24" w/PL-259 plug and reducer at each end. Perfect for interconnecting ham or CB equipment—used in measuring signal strength standing wave ratios; excellent for use with coaxial relays or antenna selection switches.....	—	WS-163	Magnet wire for hobbyists—24 ga.....	150
S-900	Low loss, foam-filled RG-59/U complete with pre- attached F59 fittings each end, weather boot and complete instructions.....	100	WS-164	Magnet wire for hobbyists—26 ga.....	240
S-901	Same as above.....	75	WS-165	Magnet wire for hobbyists—16 ga.....	21
S-902	Same as above.....	50	WS-166	Magnet wire for hobbyists—18 ga.....	36
S-903	Same as above, including two 72/300 ohm match- ing transformers—one for outdoor use, one indoor, complete w/mounting hardware.....	100	WS-167	Magnet wire for hobbyists—20 ga.....	57
S-904	Same as above.....	75	WS-170	Rainbow wire 2 color—2 conductor.....	38
S-905	Same as above.....	50	WS-171	Rainbow wire 3 color—3 conductor.....	29
S-907	All-channel (82 channel) coax complete w/terminal fittings on each end, weather boot, and complete instructions. UHF-VHF.....	100	WS-172	Rainbow wire 4 color—4 conductor.....	25
S-908	Same as above.....	75	WS-173	Magnet wire for hobbyists—27 ga.....	300
S-909	Same as above.....	50	WS-174	Magnet wire for hobbyists—28 ga.....	378
S-910	Same as S-907, except includes two special matching transformers—one for outdoor use, one indoor. Complete w/fittings and mounting hardware.....	100	WS-175	Magnet wire for hobbyists—30 ga.....	600
S-911	Same as S-910.....	75	WS-176	#12 ga. stranded primary Hook-up wire.....	18
S-912	Same as S-910.....	50	WS-177	#14 ga. stranded primary Hook-up wire.....	21
S-913	RG-8/U Poly foam w/PL-259 each end.....	50	WS-178	#16 ga. stranded primary Hook-up wire.....	25
S-914	Same as above.....	100	WS-179*	#32 ga. Magnet wire for hobbyists.....	953
S-915	RG-58/U foam w/PL-259 each end.....	50	WBS-100	Speaker extension cable—miniature parallel—24 ga. 3 colors—low voltage applications.....	54
S-916	Same as above.....	100	WBS-115	Hook-up wire—3 colors—18 ga. solid.....	51
S-917	RG-59/U w/PL-259 each end.....	4	WBS-115B	Hook-up wire—3 colors—18 ga. stranded.....	48
WIRE BANKS			WBS-116	Hook-up wire—3 colors—20 ga. solid.....	66
WS-100	Cable—miniature parallel Speaker Wire—24 ga.— available in black, brown, gray, white and clear.....	53	WBS-116B	Hook-up wire—3 colors—20 ga. stranded.....	60
WS-101	Microphone cable—lapel type.....	20	WBS-117	Hook-up wire—3 colors—22 ga. solid.....	81
WS-108	Audio cable—wrap shield—easily pigtailed—avail- able in other colors.....	20	WBS-117B	Hook-up wire—3 colors—22 ga. stranded.....	72
WS-112	Phono or grid wire—shielded—single conductor.....	30	WBS-119	Hook-up wire—3 colors—24 ga. solid.....	108
WS-113	High voltage wire—20 KV rating—flame retardant rulan.....	21	WBS-120	Hook-up wire—3 colors—24 ga. stranded—high quality.....	96
WS-115	Hook up wire—18 ga. solid.....	55	WBS-121	Bell wire—3 colors—22 ga.—high quality.....	69
			WBS-122	Test prod wire—plastic—3 colors.....	27
			WBS-123	Test prod wire—rubber—extra flexible—3 colors....	18
			WBS-129	Bell wire—3 colors—20 ga.....	54
			WBS-131	Bell wire—3 colors—18 ga.....	48
			WBS-165	Magnet wire—3 sizes—22 ga., 24 ga. 26 ga.— school experiments—coils—home and shop bench....	—
			WBS-166	Magnet wire—3 sizes—18 ga., 20 ga., 22 ga.— school experiments—coils—home and shop bench....	—
			WBS-167	Magnet wire—3 sizes—24 ga., 26 ga., 28 ga.— school experiments—coils—home and shop bench— thousands of uses.....	50-80-126
			WBS-170	Phono pickup wire—stereo arm assortment.....	—
			WBS-172	Bus wire—tinned—20, 22 and 24 ga.—electrical or electronic applications — high conductive — easily soldered—home or factory bench.....	108
			WBS-175	Hook-up wire—Nylon—assortment—high temp.....	60
			WBS-180	High temperature wire — Teflon coated — assorted colors—3 spools.....	69
			TS-25	Twin Lead—300 ohm—Bubble pack—brown, clear— gold and silver.....	25
			TS-50	Twin Lead—300 ohm—Bubble pack—brown, clear— gold and silver.....	50
			TS-75	Twin Lead—300 ohm—same as above.....	75
			TS-100	Twin Lead—300 ohm—same as above.....	100
			DDS-50	Twin Lead—300 ohm—economy-bag—Clear, brown....	50
			DDS-75	Twin Lead—300 ohm—same as above.....	75
			DDS-100	Twin Lead—300 ohm—same as above.....	100

*Special purpose cable.

PRICES

All prices listed in The MASTER are subject to change without notice — they should not be considered final.

Get quick-on-the-spot quotations from your distributor who subscribes to the up-to-the-minute

UNITED *Pricing Reports*

The Perpetual Pricing System for Electronic Parts and Equipment

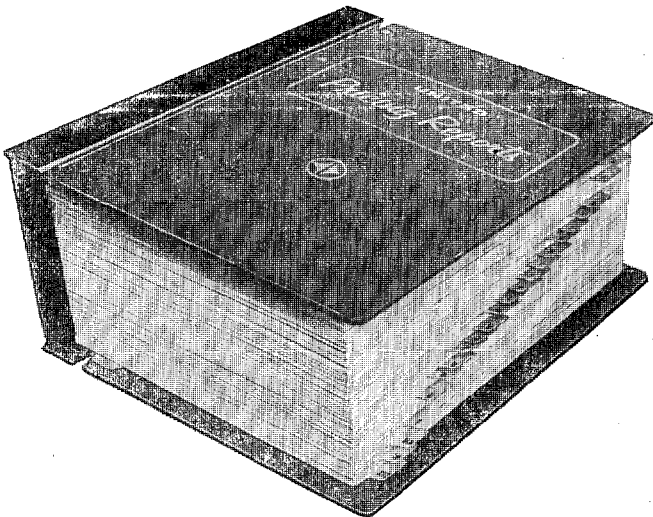

- Over 750 manufacturers
- Over 400,000 catalog numbers tabulated with current prices
- Revised pages mailed semi-weekly: insert new pages—discard old pages
- Compression type loose-leaf binder for rapid replacement of revised pages
- Weekly summary sheet—Ups, Downs, Additions, Deletions

For complete details and subscription rates write to:



UNITED PRICING REPORTS

A UNITED TECHNICAL PUBLICATION

645 STEWART AVENUE, GARDEN CITY, N. Y. 11530

DELIVERY

Delivery is often dependent on availability of raw materials. Check with your distributor for delivery information at the time you place your order.

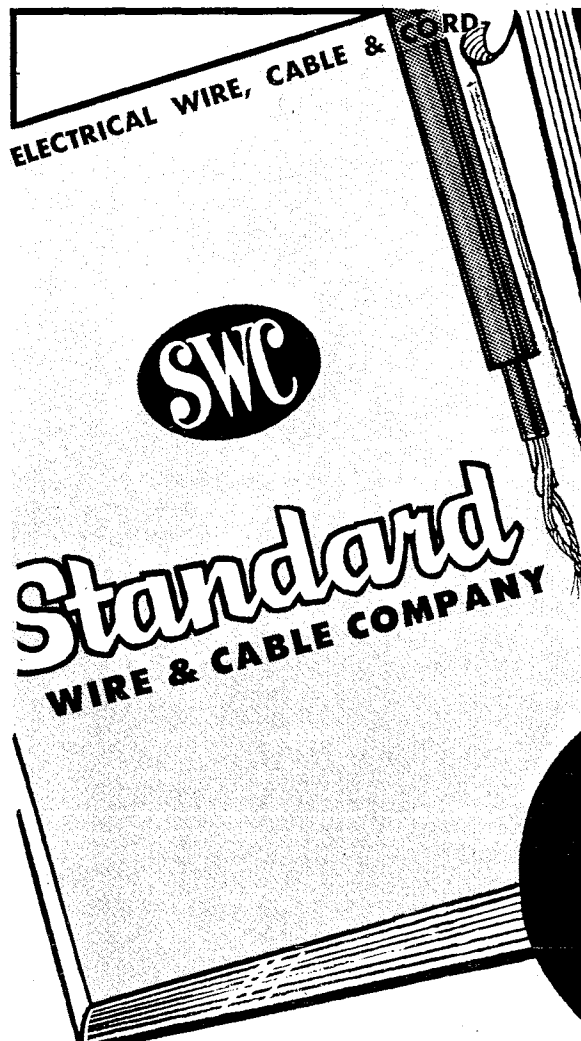

WIRE & CABLE FOR PRODUCTION.. RESEARCH... PROTOTYPE.....

Government Military Specifications . . . Commercial Specifications or Approved Manufacturers Specifications.

IMMEDIATE DELIVERY

- Most Military Specifications
- High Temperature Wire & Cable
- Telemetry Supervisory Control Cable
- Complex Instrument Cable
- Telephone & Inter-Communicating Cable
- Electrical & Electronic Instrument Wire
- Coaxial Cables
- Thermocouple Wire
- Multiple Pair Control Cable
- Microphone Cable
- Computer Cable
- Many more

Complete line of Wire, Cable & Cord in stock . . . or we will custom Cable to your design.

**BRING YOUR
CATALOG FILE
UP TO DATE . . .**

FREE catalog with Charts, Tables, Engineering Characteristics, Constructions, Specifications, Applications, etc.

Abbreviated sample headings of some pages of our catalog. Each page is 8½" x 11" and contains a complete range of sizes, all specifications and other pertinent information for its specific type of wire or cable.

Page 2

AIRCRAFT WIRE (Unshielded) 600 VOLT 22 AWG to 4/0 AWG

STRANDED TINNED COPPER POLYVINYL INSULATION (White)
NYLON JACKET



AWG SIZE	Stranding	Catalog No.	Nominal Diameter (Inches)	Nominal Weight (Lbs./M')	Catalog No.	Nominal Diameter (Inches)	Nominal Weight (Lbs./M')	Catalog No.	Nominal Diameter (Inches)	Nominal Weight (Lbs./M')
22	19 x 34	107-1	.066	3.96	107-1A	.075	4.55	107-1B	.085	5.45

Page 7

HIGH TEMPERATURE WIRE MIL-W-8777 B (ASG) 200°C 600 VOLT MS 25471 (ASG)

POLYESTER FIBER BRAID HEAT RESISTANT FINISHER
SILVER COATED COPPER EXTRUDED SILICONE



Size	Catalog No.	Stranding	Cir. Mil. Area	Max. Bare Diam. (Inches)	Max. Resist. @ 20°C Ohms/1000 ft.	Max. Fin. Diam. (Inches)	Max. Wt. Lbs./1000 ft.
22	1105-3	19 x 34	755	0.033	15.2	.090	5.8

Page 42

ANTENNA WIRE

CATALOG NO.	MILITARY TYPE	AWG SIZE	DIELECTRIC	NOMINAL DIAMETER	MIN. LBS. CONDUCTOR BREAKING STRENGTH
801-175	6370-2	16 Solid CW	Poly	.183	250



STANDARD WIRE & CABLE CO.

**the largest,
most authoritative catalog
of electronic products
sold through distributors**



A UNITED TECHNICAL PUBLICATION